

THE B.B.C. AND THE GREAT WAVELENGTH—FIGHT

Amateur Wireless

Usual Price 3^d

and
Radiovision

Vol. XXI. No. 534

Saturday, September 3, 1932

Your
HOME
RADIO
GRAM

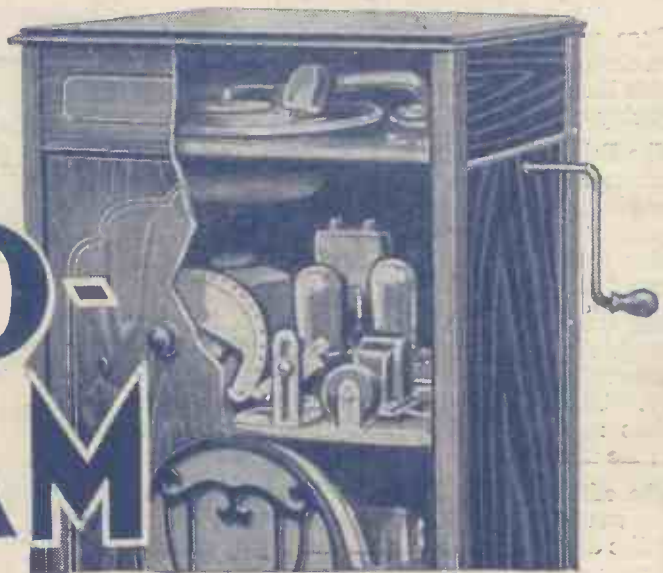

OUR BEST BATTERY-OPERATED RADIO-GRAM:
EASY TO BUILD : SIMPLE TO CONTROL.

Also in this issue:—

THE IDEAL
REGIONAL 2

SPECIFIED FOR "A.W." "Your Home Radiogram"

Price **21/-**

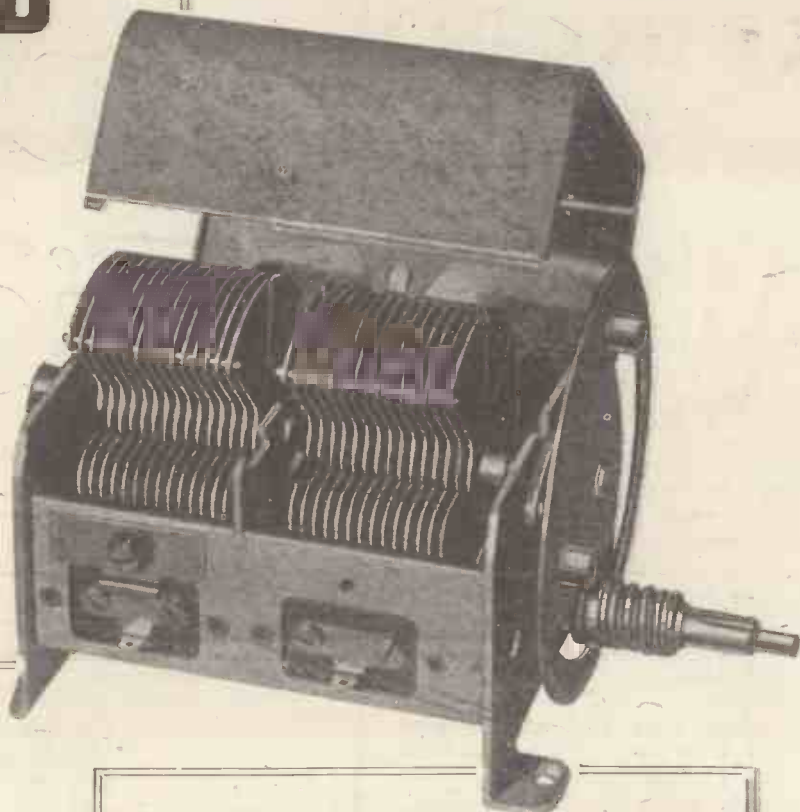

Once again a British Radiophone Condenser has been chosen for a new radiogram. Designers specify British Radiophone products because they can rely implicitly on their quality and efficiency.

The British Radiophone Uni-Control Two-Gang Condenser (Type 458) used in the "A.W." "Your Home Radiogram" is designed so that the variable air dielectric trimming condenser belonging to the section nearer the dial can be adjusted from the front of the receiver.

The rotating spindle of this trimmer is brought through the main spindle and its adjusting knob is mounted concentrically with the main operating knob. This permits very accurate trimming and enables maximum signal strength to be obtained with the minimum of trouble.

The other section has a mica dielectric trimmer which can be pre-set in the usual manner. A cover and disc drive are provided with this highly efficient two-gang condenser.

*Send for full particulars
of The British Radiophone products.*

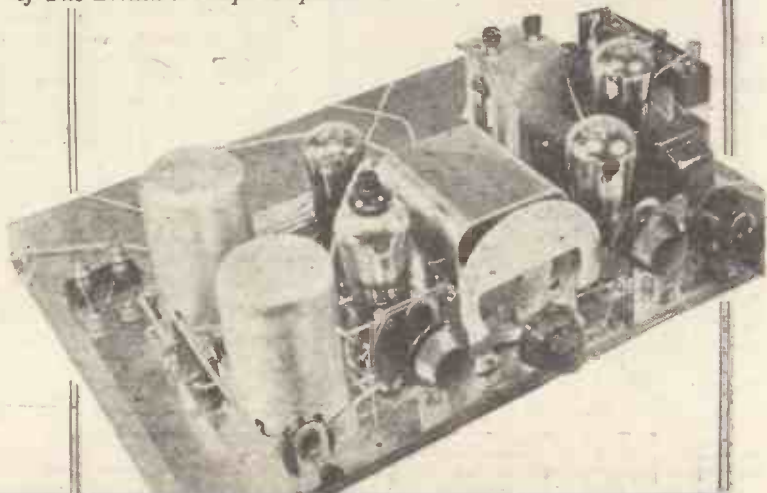

RADIOPHONE GANGED CONDENSERS

THE BRITISH RADIOPHONE LTD., ALDWYCH HOUSE, ALDWYCH, W.C.2

Don't Forget to Say That You Saw it in "A.W."



It's So Simple.

to improve your present set or modernise an old one, with our practical and pictorial descriptions devised to be easily understood by ALL. The alterations or additions can be made with ease. First note the components you will need, but, be sure you obtain nothing but the genuine Bulgin Quality Components—then, note carefully the connections and carry them out to the letter—that's all. You will be agreeably astonished at the results.

SPECIFY BULGIN QUALITY COMPONENTS and your entire satisfaction is assured.

FOR FURTHER HELP IN SET CONSTRUCTION SEND FOR OUR NEW 80-PAGE CATALOGUE AND MANUAL Send 2d. postage.



ADVT. OF A. F. BULGIN & CO., LTD., ABBEY ROAD, BARKING, ESSEX. Tel.: Grangewood 2263-7. London Showrooms: 9-10-11, Cursitor St. E.C.4.

PUT A 'TRANSCOUPER' HERE

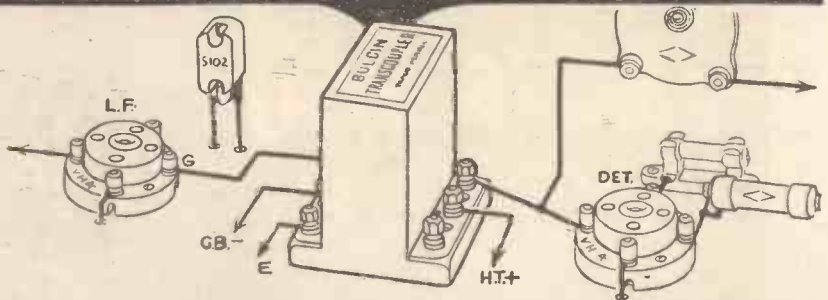

Brilliant reproduction is assured by incorporating this new unit in place of existing L.F. Transformer. This diagram illustrates the simple connections, and, once incorporated you will be astounded at the evenness of amplification and enormous improvement in bass and treble response. Fitted in a few minutes by even inexperienced amateur constructors. One of the greatest successes at Radiolympia.

BULGIN "TRANSCOUPER"
Universal type for use in all receivers. **11/6**

GREATER VOLUME & PURITY

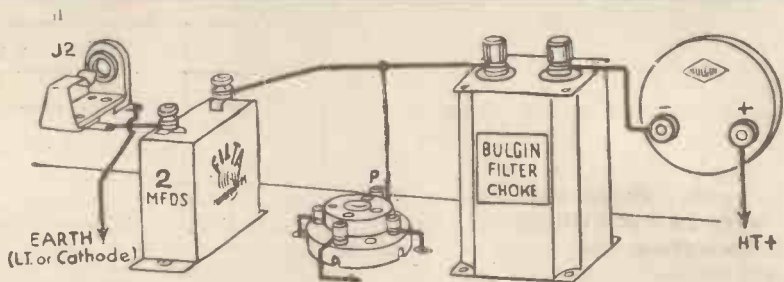

For greater volume and purity fit a Bulgin Filter Choke between H.T. plus and the anode of the valve. Then feed the loudspeaker through a 2 mfd. condenser connected to the anode of the valve. The other side of the loudspeaker should return to L.T.— or the cathode if the valve is indirectly heated. A Bulgin Milliammeter is shown on the right of diagram, and where incorporated serves as a valuable guide not only on current consumption, but also as a visual indicator of overloading or distortion. If meter kicks to the left, valve is under biased; if to the right, over biased.

Keep the pointer steady by correcting bias.

BULGIN FILTER CHOKES
Standard type, 20 H. **7/6**
at 20 m/a
Power type, 20 **10/6**
H. at 50 m/a
MILLIAMMETERS
All ratings **8/6**
Prices from **8/6**

UP-TO-DATE SIMPLIFIED MASTER CONTROL

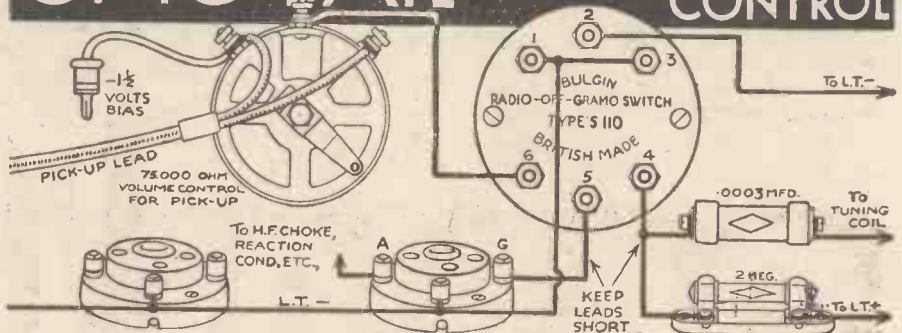

Bulgin S.110 Switch is a D.P.D.T. type with central "OFF" position. It gives complete control over the Radio/gramo and On/Off switching of a battery set. The diagram clearly shows the connections. The normal connections for a Volume Control for use with a pick-up are also shown.

The correct position for the Switch is close to the valve to be controlled. If valveholder is well away from panel, use extension control shaft E.H.4 with supporting bracket E.H.6., this allows the leads to terminals 4 and 5 to be kept short—a most important point.

BULGIN S.110 SWITCH
Rotary D.P.D.T., "OFF" position; with engraved indicating plate. **2/6**

Please Mention "A.W." When Corresponding with Advertisers



FACTS YOU SHOULD KNOW..
ABOUT
THE MAZDA
RANGE OF
RECTIFIERS

If you are using valve rectification on your A.C. mains receiver, there is a definite advantage to be gained by using Mazda indirectly heated rectifying valves. You are safeguarding the condensers, chokes and valves of your receiver.

When an ordinary rectifying valve is switched on, its operating temperature is reached considerably before that of the receiving valves. This causes a voltage surge and damage is frequently done to components. Mazda filaments are designed to heat up with the receiving valves, the voltage thus being gradually applied.

Full details of Mazda indirectly heated rectifiers will be found in the Mazda catalogue, sent FREE on request.

Mazda valves are fitted by all the leading receiver manufacturers. All good radio dealers stock them.

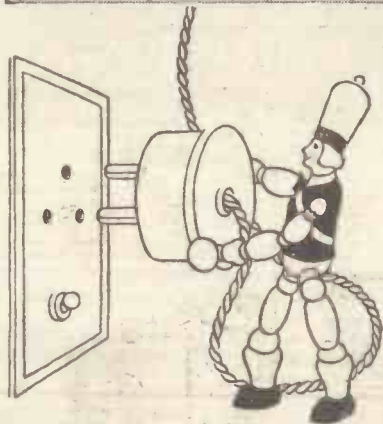

LOOK FOR "EDDY" IN YOUR DEALER'S WINDOW

The amazing
MAZDA
 THE
BRITISH
VALVES

EDISWAN RADIO
100% BRITISH — Designed by British Engineers

The Edison Swan Electric Co. Ltd.



155 Charing Cross Rd. London. W.C.2

Mazda Radio Valves are manufactured for The British

Thomson-Houston Co. Ltd., London and Rugby.

V.170

Don't Forget to Say That You Saw it in "A.W."

TELSEN

TELORNOR

GIVES YOUR HOME-BUILT SET THE DIGNITY AND BEAUTY OF LINE OF A COMMERCIAL RADIO RECEIVER

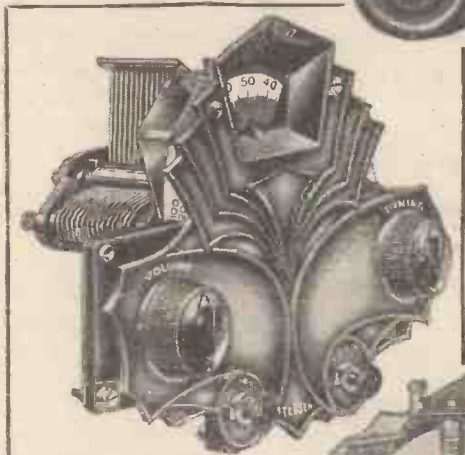
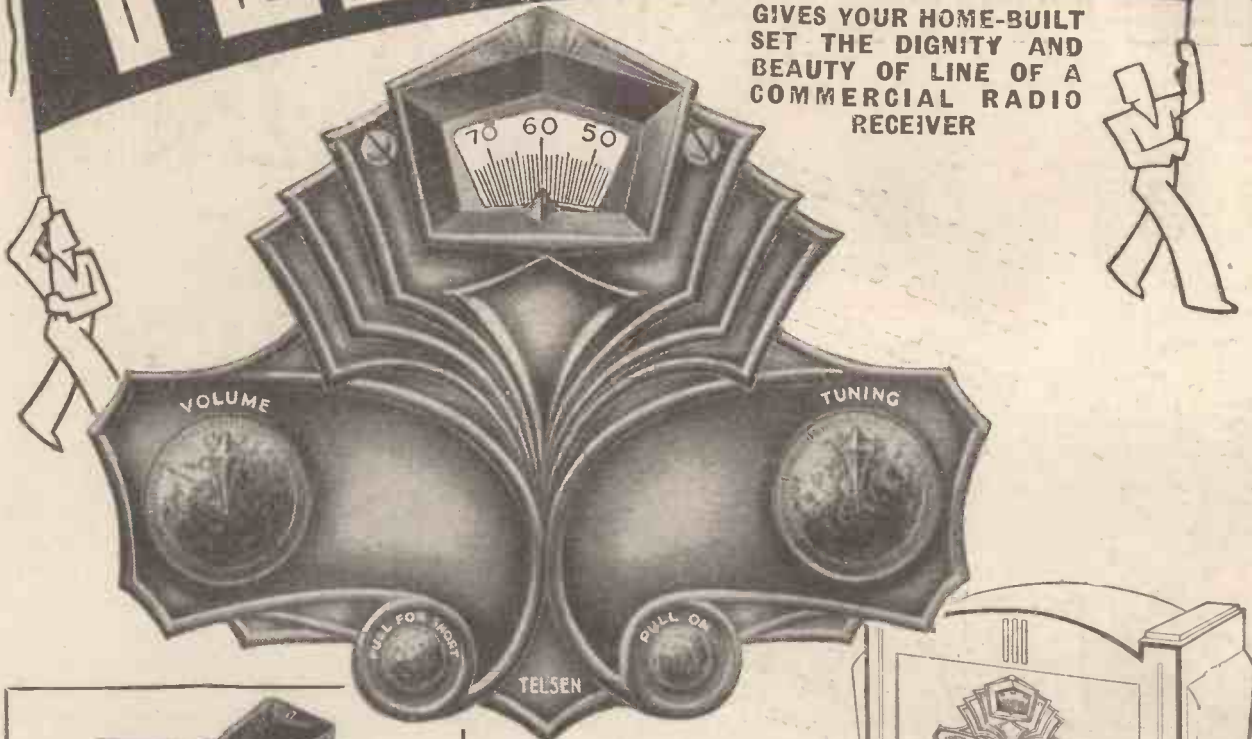

Three-quarter front view of the "Telornor"



Back view of the "Telornor" showing how the components can be mounted.

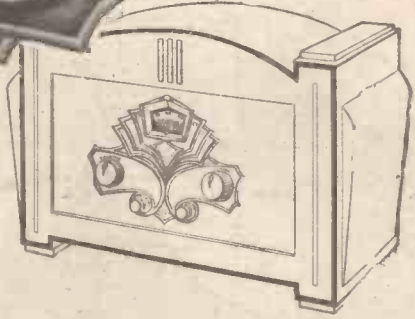

GIVE your home-built set the dignity of an expensive commercial radio receiver with the new Telsen "TELORNOR." It makes better sets easy to build! The handsome silver oxidised escutcheon plate, embodying an illuminated variable ratio slow-motion Disc Drive, adds immensely to the "good looks" of your set and permits, with the minimum of trouble, a very effective grouping of your Volume, Tuning, Push-Pull and On-Off controls. Ask your dealer to show you a "TELORNOR." It will make your set a set to be proud of—in appearance as well as in performance.

No. W. 206

7'6

TELSEN

RADIO COMPONENTS

GOOD RADIO IS A JOY FOREVER

ANNOUNCEMENT OF THE TELSEN ELECTRIC CO., LTD., ASTON, BIRMINGHAM

Advertisers Appreciate Mention of "A.W." with Your Order

TO YOU THE COST OF A BETTER SET— MAY ONLY BE THE PRICE OF A FERRANTI TRANSFORMER

It is easy to spend many pounds on a set giving poorer quality of reproduction than you would get from your own by simply installing a Ferranti Transformer.

Listen IN—critically to your present set. Are the bass notes really there? Do the high notes of the violin really sound like a violin or like a flute? The installation of a Ferranti Transformer is the most economical way of effecting an improvement that will delight you.

Ferranti Ltd., of Hollinwood, Lancashire, have been making transformers since 1882 and every engineer knows that no better transformers are obtainable the world over.

Every Ferranti Transformer is guaranteed to give a performance within 5% of the published curve, AND within 5% of every other Ferranti Transformer of the same type. Ferranti are the only transformers so guaranteed.

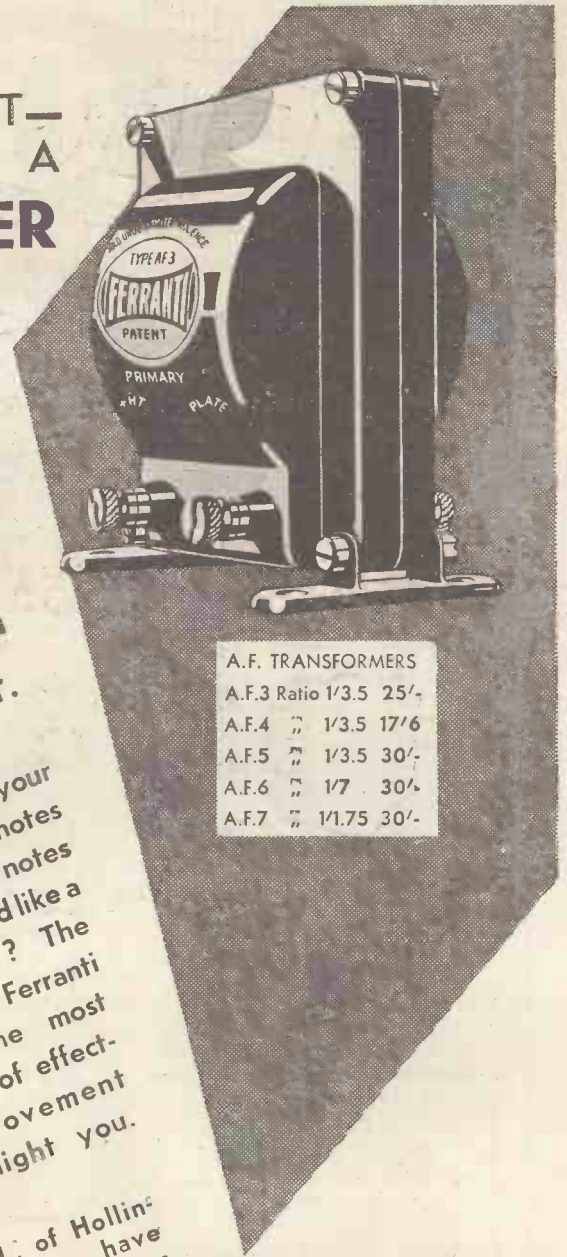

A.F. TRANSFORMERS			
A.F.3	Ratio 1/3.5	25/-	
A.F.4	" 1/3.5	17/6	
A.F.5	" 1/3.5	30/-	
A.F.6	" 1/7	30/-	
A.F.7	" 1/1.75	30/-	

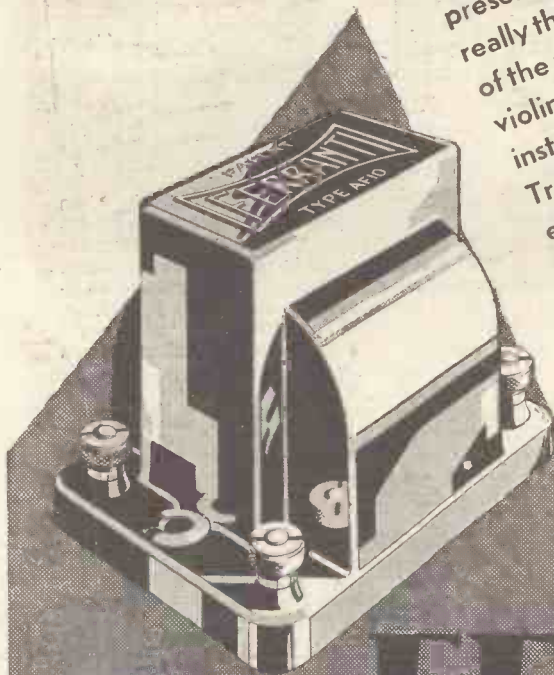

A.F. TRANSFORMERS			
A.F.8	Ratio 1/3.5	11/6	
A.F.10	" 1/3	6/6	

FERRANTI TRANSFORMERS

FERRANTI LTD., Head Office & Works, Hollinwood, LANCASHIRE
LONDON: Bush House, Aldwych, W.C.2.

To Ensure Speedy Delivery, Mention "A.W." to Advertisers

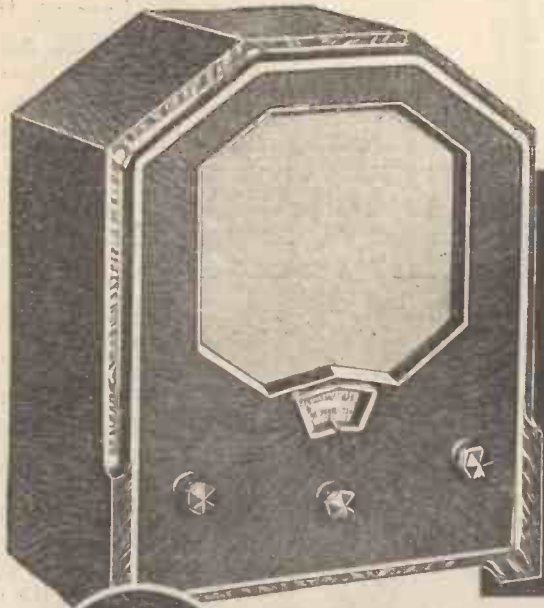

S.E.C. Radio
SUPREMACY
IN RADIO

A REVOLUTION IN HOME CONSTRUCTORS' KITS—
ENTIRELY SELF-CONTAINED—
NEW AND IMPROVED RADIO TECHNIQUE

Osram
THIRTY-THREE
MUSIC MAGNET

The new OSRAM "THIRTY-THREE" MUSIC MAGNET is a great advance on any kit set you have yet seen. It is full of improvements in technique, design, appearance, performance and construction—entirely self-

SPECIAL FEATURES

- 1 A complete table model receiver with built-in loud speaker.
- 2 Batteries housed inside cabinet—no external battery connections.
- 3 Two metallised OSRAM screen-grid valves and latest type OSRAM power output valve.
- 4 Screen-grid detector gives great sensitivity.
- 5 Tuning by one knob only.
- 6 New magnetic loud speaker chassis with floating cone ensures highest quality reproduction.
- 7 Unit assemblies make home construction the essence of simplicity.
- 8 Latest OSRAM valves (battery type) with the Wembley filament.
- 9 Handsome one-piece cabinet in moulded Bakelite—walnut graining.

contained, with built-in loud speaker of latest design and room is provided for batteries and accumulator.

A wide range of stations can be tuned in with the greatest ease at full loud speaker strength. Tuning is effected with one knob only.

POST COUPON TO-DAY

for the full-size Constructor's Instruction Chart. The clear instructions given in this chart will convince you that this is the world's best circuit and assembly kit. **SEND FOR A COPY TO-DAY.**



PRICE

9 GNS.

Including cabinet, built-in loud speaker and OSRAM valves.

HIRE PURCHASE

Deposit £1 and 12 monthly payments of 15/-

Made in England
 Sold by all Wireless Dealers.

Osram THIRTY-THREE MUSIC MAGNET
S.E.C. Radio
PRICE 9 GNS.
A SIMPLE STEP FROM CHART TO SET

COUPON

Please send me the OSRAM "THIRTY-THREE" MUSIC MAGNET INSTRUCTION CHART

Name _____ Address _____

The General Electric Co. Ltd.,
 Magnet House,
 Kingsway,
 London,
 W.C.2.

A SIMPLE STEP FROM CHART TO SET

Cut out and paste on Postcard, or enclose in unsealed envelope, Halfpenny postage in either case.

Advt. of The General Electric Co. Ltd., Magnet House, Kingsway, London, W.C.2.

Advertisers Appreciate Mention of "A.W." with Your Order



Type BB.
From 1/9 to 5/6

Type 9200
From 2/- to 3/9



Type BS.
From 2/- to 5/-

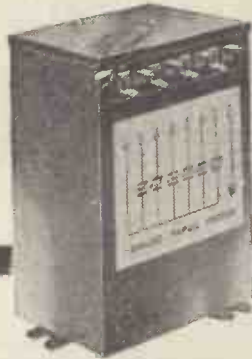

Condenser
Blocks
From 2/6
to 35/-



Type LEC.
From 4/3 to 18/-

FROM A
.09 μ f. at 1/9
TO
CONDENSER
BLOCKS
at 35/-

THERE'S A SIZE AND TYPE
FOR EVERY NEED IN THE
RANGE OF

DUBILIER PAPER CONDENSERS

Whatever kind of Condenser you require, you can safely ask for Dubilier. You know you will receive a Condenser which will give you real service—you know that the money you have spent, whether a small or large amount, is a real investment. Why risk unknown condensers when, for no extra cost, you can get DUBILIER DEPENDABILITY.

DUBILIER CONDENSER CO. (1925) LTD.
Ducon Works, Victoria Road, North Acton, W.3

CONDENSERS WITH A PERSONALITY

Polar condensers do not "follow the crowd." In design and construction Polar condensers are distinctive. They embody those original points which make them different and much more desirable to the man who realises the importance of the variable condenser in his "scheme of things."

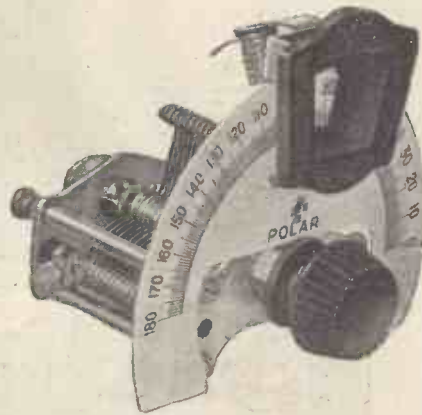

**THE POLAR
'APERTURE'**

A slow motion condenser of unique design providing a most convenient method of control. Operation is by small knob at the base, the scale being actually part of the condenser itself. Simple fitting—one hole only being required for escutcheon. Built of aluminium. Of extremely efficient design and construction. Lamp holder for scale illumination.

.0003
.00035
.0005

7/6

**THE POLAR
'No. 2'**

Owing to its precise workmanship and amazingly low price, it has proved itself the outstanding condenser of its type. Its popular features include fast and slow motion, ball-bearing spindle, positive pig-tail connection, one-hole fixing. It follows midline law, and is made in hard aluminium, with brass pillars for rigidity.

.0003
.00035
.0005

6/6



**POLAIR
CONDENSIEURS**
CATALOGUE OF FULL RANGE—FREE



Correspondence in all languages.
Representative for France: W. A. Swift, 6, Rue Dequerry,
Paris XI.

Wingrove & Rogers, Ltd., 188-9, Strand, London, W.C.2

You will Help Yourself and Help Us by Mentioning "A.W." to Advertisers.

TELSEN SCREENED TUNING COILS



TELSEN COIL SWITCH KNOB ASSEMBLY
 Specially designed for use with the Telsen Screened Tuning Coils. The extension on the knob spindle fits over the switch rod supplied with the Coils, a firm coupling to the rod being ensured by tightening the small screw provided. The assembly is suitable for mounting to any standard thickness of panel, and includes a neat disc escutcheon. The knob is of the push-on type in Black Bakelite. No. W.218 1/-

THE result of much research and experiment, these coils embody the ultimate efficiency attainable in a perfectly shielded inductance of moderate dimensions. Provided with separate coupling coils for medium and long waves, they are suitable for use as aerial coils or as anode coils following a screened grid valve, giving selectivity comparable only with a well-designed band-pass filter. The coils are fitted with cam operated rotary switches with definite contacts and click mechanism, and are supplied complete with aluminium screening cans, bakelite knob and handsome "Wave Change" escutcheon plate finished in oxidised silver. **8'6**
 Telsen Screened Coil. No. W.216

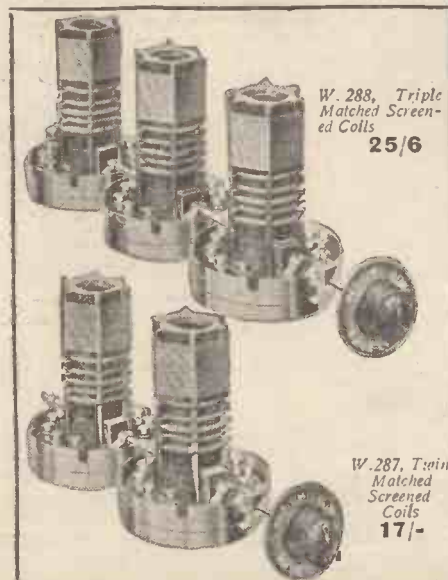

W.288, Triple Matched Screened Coils 25/6

W.287, Twin Matched Screened Coils 17/-

TELSEN COIL SWITCH COUPLING ASSEMBLY
 When it is desired to mount two or more of the Telsen Screened Coils in a line parallel to the panel, and to control the wave-change switching by a single knob on the panel, this switch coupling assembly will be found indispensable. The link arms of the coupler are fitted over the switch rods of the coils, and adjusting slots are provided in the link bar to allow for the spacing of the coils varying from 3 in. to 6½ in. The whole assembly has a neat nickel-plated finish, is perfectly smooth and positive in action, and free from backlash. **6d.**
 No. W.217

TELSEN

RADIO COMPONENTS

GOOD RADIO IS A JOY FOREVER
 ANNOUNCEMENT OF THE TELSEN ELECTRIC CO. LTD., ASTON BIRMINGHAM

Mention of "Amateur Wireless" to Advertisers will Ensure Prompt Attention



RECTATONE

- 1 Has a rising response curve from 1,000 to 4,500 cycles.
- 2 Balances any form of sound reproduction.
- 3 Restores a weakened treble to its correct value.
- 4 Gives a variable compensation and, therefore, complete control of tone correction.
- 5 Gives the required tone correction without an extra L.F. stage.
- 6 Becomes at will and instantly a normal straight-line transformer.
- 7 The ideal L.F. coupling for selective sets.
- 8 Particularly useful where the same L.F. amplifier is used for radio and gramophone reproduction.

Step-up ratio, 1:7. Can be used in all the usual methods, either direct coupled or choke or resistance fed, with or without the tone correction feature in each case. List No. D.P.33 **15/-**

"... does, indeed, mark as great a step forward in set design as did the famous square-peak band-pass tuning coil introduced last year."
 —"Amateur Wireless," August 20, 1932.

Varley

Proprs.: Oliver Pell Control Ltd.

Use this
Coupon

Name _____
Address _____

Please send me, free and post free, the
BOOK OF THE RECTATONE

Date _____

A.W.3

**FREE
COUPON**

To Messrs. Varley,
Kingsway House, 103
Kingsway, London, W.C.2

Please mention "A.W." when corresponding with Advertisers.

TERMINAL- Programme 1932-33

TYPE "B"
 (Patent) Non-removable, bake-life insulated head, non-rotating name. 36 indications. **6d.**

TYPE "M"
 (Patent) As "B" but not insulated, and smaller. Non-rotating name. **4½d.**

TYPE "R"
 (Patent) **REDUCED TO 2½d.**
 Non-removable, insulated head, 36 indications. 4B.A. stem.

TYPE "Q"
 Rotating, removable head. Brown, red or black. **2d.**

TYPE "H"
 A giant model of Type "B," for 100 amperes and 10,000 volts. **NOW 1/6**

SPADE TERMINAL
 Spring prongs, firm grip. Lettered on head. **2d.**

TERMINAL MOUNT
 Mounts two terminals of any make anywhere—vertically or horizontally. Particularly suitable for Belling-Lee "B" type terminals. **8d.**



Advt. of BELLING & LEE, Ltd., Cambridge Arterial Road, Enfield, Middlesex

Please mention "A.W." when corresponding with Advertisers.



EASIWAY TO PERFECT RADIO



Peto-Scott's 13th Year of continuous Service to the Public

MANUFACTURERS' KITS

- COSSOR MELODY MAKER MODEL 335.** Complete with valves, speaker and cabinet. Cash price, £7/17/6. Balance in 11 monthly payments of 14/10. Send **10/-** only
- COSSOR ALL-ELECTRIC MELODY MAKER MODEL 336.** Complete with valves, cabinet, and speaker. Cash Price, £11/15/-. Balance in 11 monthly payments of 21/7. Send **21/7** only
- COSSOR MELODY MAKER MODEL 334** with Metallised Variable-Mu S.G. and Detector Valves, Power Valve and Cabinet. Cash Price, £6/7/6. Balance in 11 monthly payments of 11/10. Send **10/-** only
- RADIO FOR THE MILLION "STATION MASTER 3" (Model A).** With valves and cabinet, for battery use. Cash price, £5/11/-. Balance in 11 monthly payments of 10/2. Send **10/2** only.
- "STATION MASTER 3" (Model B)** with valves, speaker, and cabinet for battery use. Cash price, £7/10/-. Balance in 11 monthly payments of 14/-. Send **10/-** only
- "STATION MASTER 3" (Model C).** All-electric model with valves, cabinet, and moving-coil speaker. Cash price, £14. Balance in 11 monthly payments of 25/8. Send **25/8** only
- OSRAM "THIRTY THREE" MUSIC MAGNET.** Complete kit, comprising all components, including valves, cabinet with self-contained speaker. Cash price, £9/9/-. Balance in 11 monthly payments of 17/6. Send **15/-** only
- READY RADIO 303.** 3 valve Kit (Det. 2 L.F.) with valves, cabinet and permanent magnet moving coil speaker. Cash Price £6/17/6. Balance in 11 monthly payments of 12/7. Send **12/7** only
- READY RADIO METEOR S.G.3.** 3 valve screened-grid receiver with valves, cabinet and permanent magnet moving-coil speaker. Covers short, medium and long waves. Cash Price £8/17/6. Balance in 11 monthly payments of 16/3. Send **16/3** only
- LISSEN SKYSCRAPER 3.** Chassis model with (Lissen) S.G., Detector, and Pentode valves. Cash price, £4/9/6. Balance in 11 monthly payments of 8/3. Send **8/3** only
- FERRANTI BAND-PASS 3 (Battery Model)** with Panel and baseboard, but less valves. Cash price, £7/19/6. Balance in 11 monthly payments of 14/3. Send **14/8** only
- FERRANTI BAND-PASS 3 (All-electric Model)** With Panel and baseboard, but less valves. Cash price, £11/3/6. Balance in 11 monthly payments of 20/8. Send **20/6** only
- TELSEN "AJAX" 3.** Complete kit less valves and cabinet. Cash price, £3/1/6. Balance in 11 monthly payments of 5/3. Send **5/8** only
- TELSEN "JUPITER" S.G.3.** Complete kit less valves and cabinet. Cash price, £3/17/0. Balance in 11 monthly payments of 7/-. Send **7/-** only

SPEAKERS

- EPOCH "20C" PERMANENT MAGNET MOVING-COIL SPEAKER (New Edition).** With 3-ratio input transformer. Cash price, £1/15/-. Balance in 5 monthly payments of 6/6. Send **6/6** only
- EPOCH MM. PERMANENT MAGNET MOVING-COIL SPEAKER** with 5-ratio input Transformer. Cash Price £1/7/6. Balance in 5 monthly payments of 5/-. Send **5/-** only
- ULTRA 1933 IMP PERMANENT MAGNET MOVING-COIL SPEAKER** with input transformer. Cash price, £1/17/6. Balance in 5 monthly payments of 6/10. Send **6/10** only
- W.B. PERMANENT MAGNET MOVING-COIL SPEAKER (Type P.M.4).** Complete with transformer. Cash price, £2/2/-. Balance in 7 monthly payments of 5/3. Send **5/9** only
- BLUE SPOT SPEAKER UNIT AND CHASSIS.** Type 100U. Cash price, £1/19/6. Balance in 7 monthly payments of 5/5. Send **5/5** only
- R. & A. "VICTOR" PERMANENT MAGNET MOVING-COIL SPEAKER DE LUXE** with 6-ratio input transformer and protecting grille. Cash or C.O.D., £3/10/-. Balance in 11 monthly payments of 6/5. Send **6/5** only
- R. & A. "BANTAM" PERMANENT MAGNET MOVING-COIL SPEAKER** with 3-ratio input transformer. Cash price, £1/7/8. Balance in 5 monthly payments of 5/-. Send **5/-** only

ACCESSORIES

- ATLAS ELIMINATOR.** Type A.C. 244. Three tappings. S.G., Detector, and Power. Output 120 Volts at 20 m/A. Cash price, £2/19/6. Balance in 11 monthly payments of 5/6. Send **5/6** only
- ATLAS ELIMINATOR.** Type A.K. 260. Tapped at 60/80 v., 90/100 v., and 120/150 v. at 12 m/A. Trickle charges at 2, 4, or 6 v. accumulators at 3 amps. Cash price, £4/10/-. Balance in 11 monthly payments of 8/3. Send **8/3** only
- B.T.H. PICK-UP (Senior Model)** complete with support arm. Cash price, £2/2/-. Balance in 7 monthly payments of 5/9. Send **5/9** only
- GARRARD INDUCTION GRAMOPHONE MOTOR.** For A.C. Mains model 202. Mounted on 12 in. nickel motor plate with fully automatic electric starting and stopping switch. Cash price, £2/18/6. Balance in 11 monthly payments of 5/4. Send **5/4** only
- BRITISH RADIOPHONE RADIOPAK.** Complete band-pass tuner with band-pass coils, 3-ganged condenser and volume control as advertised. Cash price, £3/4/-. Balance in 11 monthly payments of 5/6. Send **5/6** only
- REGENTONE D.C.I. H.T. ELIMINATOR** for D.C. Mains, tapped S.G. Detector and 120/150 v. at 25 m/A. Cash Price £1/19/6. Balance in 5 monthly payments of 5/8. Send **5/6** only
- REGENTONE W.I.F. H.T. ELIMINATOR** for A.C. Mains, tapped S.G. Detector and 120/150 v. at 12 m/A. Cash Price £2/15/0. Balance in 11 monthly payments of 5/4. Send **5/1** only

ULTRA 1933 TIGER RECEIVER. A.C. or D.C. Mains, S.G., S.G. Detector and Pentode, Moving-coil speaker. Complete with Mazda Valves, ready for use. Cash Price, £15/15/0. Balance in 17 monthly payments of 20/-. Send **20/-** only

SLEKTUN PILOT AUTHOR KIT
SCOUT S.G. 3
 3 valve (S.G. Detector and Power) Pilot Author Chassis Kit with single-dial tuning, screened coils, and ready-drilled panel.
CASH PRICE 88/6 (less Valves and Cabinet)
 or 12 monthly payments of 8/1

C.O.D.
 All orders over 10/- C.O.D. charges and carriage paid
EASIWAY
 NO DEPOSIT. Strict Privacy. No third party collections. We deal with you direct
CASH
 All orders over 10/- sent carriage paid

IMPORTANT

Parts, miscellaneous components or accessories are available under our own Easy Way H.P. system. Send us a list of your wants. We will quote by return without obligation.

If you do not see it advertised here, send details of your requirements to us.

PETO-SCOTT CO. LTD., 77 City Rd., London, E.C.1. Telephone: Clerkenwell 9406/7
 West End Showrooms: 62 High Holborn, London, W.C.2.

Dear Sirs, Please send me CASH/C.O.D./H.P. for which I enclose £.....s.....d. CASH/H.P. Deposit. Also send your FREE 1933 Radio Catalogue.

NAME.....
 ADDRESS.....
 A.W. 3/0/32.

Buy by Post - it's Quicker

Mention of "Amateur Wireless" to Advertisers will Ensure Prompt Attention

You want

SUPER SENSITIVITY AND SELECTIVITY

Use the coils specified for

"YOUR HOME RADIO-GRAM"



"Your Home Radio-Gram" is marked by a super sensitivity and a knife-edge selectivity largely attributable to the Slektun dual range coils used and specified by the designer. These coils are noteworthy for their particularly low-loss construction and extremely low minimum wave-length. You will find Slektun Coils specified frequently "where only the best will do." Screened Aerial Coil, Type A.T.1 Screened H.F. Coil with reaction, type H.F.1

6/6 each complete

SLEKTUN DUAL RANGE COILS

SLEKTUN PRODUCTS LTD., 21 DOUGLAS STREET, WESTMINSTER, S.W. 1

Where only the Best will do!

- Other SLEKTUN Quality Components.
- SUPER TRANSFORMER
- "COLT"
- MAINSTRANSFORMERS
- L.F. CHOKES
- H.F. CHOKES (General Purpose, Short Wave, and Super Het)
- BALANCED ARMATURE LOUDSPEAKER UNIT

Complete Catalogue free from your local dealer, or direct from:

National

You will Help Yourself and Help Us by Mentioning "A.W." to Advertisers



EDITOR:
BERNARD E. JONES

TECHNICAL EDITOR:
J. H. REYNER, B.Sc. AM.I.E.E.

RESEARCH CONSULTANT:
W. JAMES

ASSISTANT EDITOR:
H. CORBISHLEY

NEWS & GOSSIP OF THE WEEK

NOW TO BUSINESS!

THE National Radio Exhibition of 1932 is over, thousands of people have been able to see for themselves the new sets and parts at Olympia, and all "A.W." readers have been able to survey the new season's products through the Olympia reports and full descriptions. Now to business! Fine new components are available for home constructors, and the new complete sets represent an amazing step forward in design. This week the "Home Radio-Gram" and the "Ideal Regional 2" typify set construction with modern parts.

END OF THE CAT!

SO the great cat hunt is over at Broadcasting House. Here is an extract from the log of an engineer, telling of the

fatal *faux pas* that led to the exit of the cat: "Extraneous speech and light laughter for about five seconds on cubicle fading up the concert hall. This was due to sudden appearance and mewing of a cat in the gallery." Followed a grim cat hunt by a B.B.C. posse of twelve trusted and fearless members of staff. At 1.25 a.m. on the night of the hunt, the cat, which appears to have been a particularly brutal specimen, was finally run to earth and removed.

DROITWICH NEWS

AT this early stage it is not possible to say whether the B.B.C. will make its own electricity for the power supply of the new Droitwich station, or whether the local corporation supply will be tapped. The decision is holding up other details,

such as the makers of the transmitter and the layout of the building. It is thought that the contract will go to Marconi's, and that the new building will closely follow the plan of the Regional centres such as Brookmans Park and Moorside Edge.

AERIAL MAST TESTS

AT the present moment the research engineers recently installed in the B.B.C.'s extension at Nightingale Lane are experimenting with types of aerial masts to be erected at Droitwich for the new high-power long-wave station. As this station will also work with the new and more powerful Midland regional station it is thought that possibly three masts will serve to support the long-wave and medium-wave aerial wires. Research on this question is proceeding, and preliminary mast tests are being carried out at the B.B.C.'s listening post at Tatsfield. We hope that the mast construction for Britain's super power station will not be skimped. Not that this is likely, seeing that the station will eventually take over practically the whole of the services now done by medium-wave Nationals.

A POLITICAL THRILL AT THE MICROPHONE



An unexpected thrill at the microphone during the opening of the Berlin Radio Exhibition. A political "fan" is arrested by the police for creating a disturbance in front of the R.R.G. microphones during the opening ceremony. A full account of the Berlin Exhibition is given in this issue

NEW DANCE RHYTHMS

HENRY HALL has joined in the hunt for new dance rhythms. He is said to have discovered a development of the "Bahama-mama" dance, which is, we understand, a species of rumba. Keen dance fans should watch for the new rhythm. There is another one, too, according to Santos Casani, who is inventing special steps to popularise it. This also will be broadcast by Henry Hall in due course. The latest idea of the leader of the B.B.C. Dance Band seems to be to try everything—even if it is only once. Henry has certainly had a fight to live down the fallacy that he is solely a "sweet music" enthusiast. Of course his present repertory covers every type of dance style.

ULTRA-SHORT-WAVE TESTS

AN explanation for the seemingly long time taken by B.B.C. engineers to get down to the real business of testing on seven metres is now forthcoming. Many of the engineers have been away on holiday.

NEXT WEEK: A SIMPLE BAND-PASS UNIT FOR OLD SETS

NEWS & GOSSIP OF THE WEEK —Continued

All those responsible for the seven-metre work are now back. This is emphasised by the recent experience of our correspondent, who, walking along one of the labyrinths of Portland Place, came upon an engineer wearing earphones and holding high above his head, on a sort of builder's hod, a seven-metre receiver—presumably testing out the radiation of the transmitter on the roof. Spasmodic tests are undoubtedly being sent out during most afternoons. It will be many weeks before amateurs have a real chance to join in the experiments, though there is nothing to prevent enthusiasts building sets up. In this connection an article, to be published in the next issue, suggesting suitable circuits, will be of interest.

LAYING THE B.B.C. GHOST

WHAT with cats and ghosts, the B.B.C.'s life at Portland Place has been somewhat hectic of late. A well-known wag at headquarters has been setting the staff's mind at rest over the so-called ghost by his explanation that this ghost is none other than the frustrated "Segg," better known as Sydney Eric Garry Gibson! The moans are ascribed to the worthy Segg on finding it impossible to drag secrets from the locked rooms of the Corporation. We often have the same difficulty ourselves.

WHEN THE DOG BARKED

TALKING of the cat-and-dog life the B.B.C. staff has been leading lately reminds us of the classic occasion, now

probably forgotten by even old-timers, when Miss Ann Spice broadcast from the old 2LO studio. She took with her a little pet dog, which sat down quietly enough until she began to speak into the microphone. The sight of this apparently ridiculous action was too much for the dog, who leapt at "mike" and barked vociferously into it. After that, dogs, even on leads, were forbidden.

MIXED RECEPTION FOR TELEVISION

ACCORDING to the Press writers, the B.B.C.'s new television broadcasts, which started, as we forecast, on August 22, have had a very mixed reception. The trouble at the moment seems to be lack of televisors. Even the B.B.C. has only one on hand, though six more are shortly to be delivered. These will be used by senior officials of the B.B.C. and later it is hoped to install one in the Press Listening Hall, so that scribes may feast their eyes as well as their ears on the broadcasts artists fortunate enough to be televised in the dance-band studio.

SCOTTISH NATIONAL NOW TESTING

ON August 22 the Scottish National station began its tests on the sorely tried wavelength of 288.5 metres. Very little response has so far been evinced by Scottish listeners. On September 5 the test transmissions will be extended to the main programme hours. On the 5th the test will be from 6.30 to 8 p.m., on the 7th

from 8 to 9.30 p.m., and on the 9th from 10 to 11 p.m. The full service of the national programme will, it is now hoped, be started on either September 18 or 25.

NO RELAY INTERFERENCE

ONE of the most gratifying aspects of the Scottish National tests is that, contrary to the gloomy forebodings of certain people, there is no interference between the high-powered signals from Westerglen and the low-powered relay signals also being sent out on 288.5 metres in different parts of the country, such as Bournemouth and Plymouth. Thus the first part of the problem of introducing Scottish National has been solved—the sharing of the wavelength with the relays. Now we must await the opening of West Regional next spring for the second part of the problem, which is the simultaneous working of Scottish and West Nationals on the 288.5 metres. Perhaps this problem will not arise, as in the meantime Madrid is meeting, and with luck we may get another wavelength.

PROMS ENTHUSIASM

IN spite of the great heat the early attendances at Queens Hall for the famous Prom concerts more than satisfied the B.B.C. people in charge of the box office. Abroad the Proms are regarded as good "meat" for relaying, and *via* G5SW America is taking frequent relays. On the continent we hear that Switzerland and Germany are making use of the Proms *via* the new music lines.

FOR NORTH REGIONAL

SEPTEMBER 14 should prove an evening of great interest to North Regional subscribers, for on that occasion there is to be broadcast a regular Blackpool night. Will Hurst will be relayed with his band from the Palace Ballroom, Reginald Dixon at the organ from the Tower Ballroom, turns from the Palace Theatre of Variety, and excerpts from The Arcadian Follies from the Victoria Pier.

COOL IN THE CONTROL TOWER

IT is the proud boast of the B.B.C. that during the recent heat wave the Control Tower at Broadcasting House was probably the coolest place in London. While the rest of us were sweltering in temperatures over the 90 mark a modest 68 degrees was being maintained in the studios of the Control Tower. Artistes and announcers were loud in their praise of the air-cooling system, which engineers state worked perfectly in weather conditions that imposed an unusually severe test.

"TO AN UNNAMED LISTENER"

THIS series is going to arouse great interest among listeners. It will be one of the high-lights of the autumn talks. Well-known names already figure in the list of those who will take part in the series. George Bernard Shaw will talk "To a Politician" while J. B. Priestley's unnamed listener will be "A Highbrow." Other speakers in the series include Evelyn Waugh, Stella Benson and Walter Elliot.

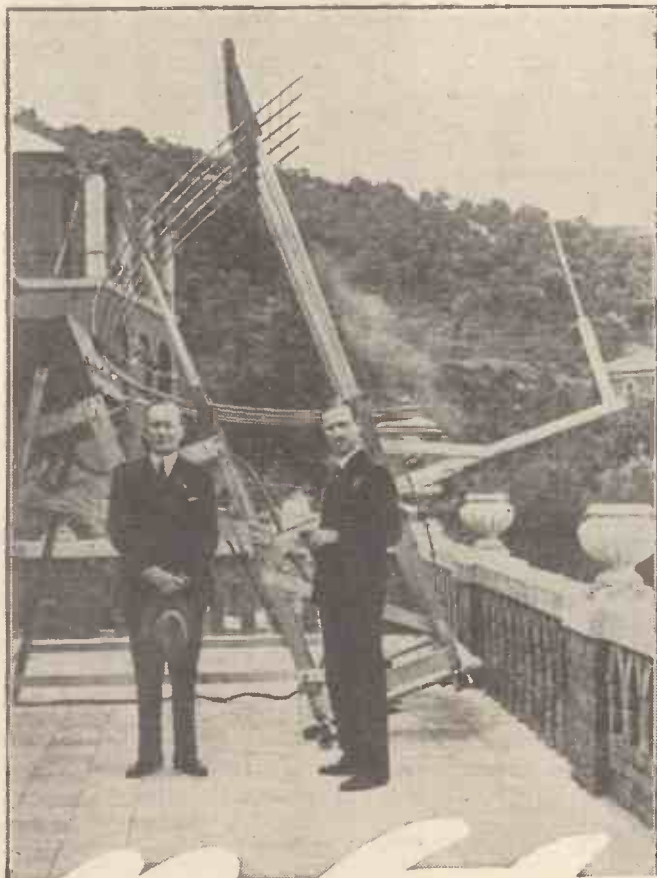

MARCONI'S LATEST

Marconi's new ultra short-wave transmitter working on a wavelength of a twentieth of a metre, is used for 80-mile communication between his famous yacht Elettra and land. The Marchese Marconi (left) is seen standing by the beam aerials

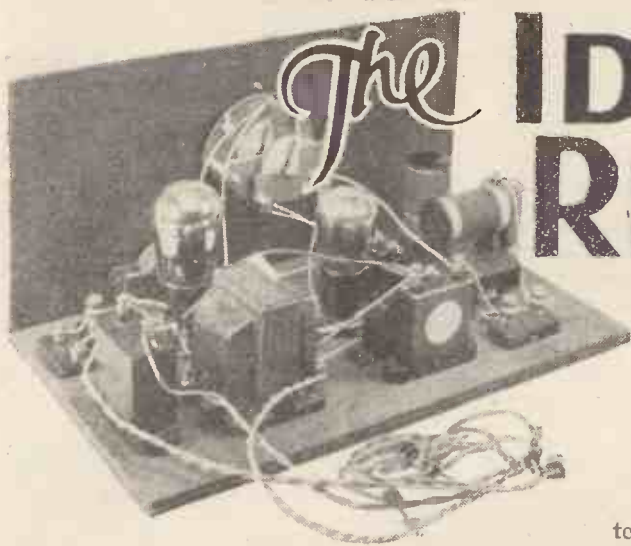

The IDEAL REGIONAL 2



Regional reception demands a special type of set if maximum pleasure is to be derived. Constructional details are given here of a fine two-valver for this purpose.

WHAT would you say is the ideal two-valver for modern regional conditions? The answer depends on how well you are acquainted with the reception conditions that prevail in what is known as a regional area.

Apart from the west of England, which still awaits the completion of its twin Regional stations at Washford Cross, most of the densely populated areas in the British Isles now have to contend with the reception of two strong local signals.

Even the smallest local station set must

Here we have a detector and transformer-coupled pentode power valve, providing really good reception of the local stations with facilities for reaching out for more distant stations when conditions in the ether are favourable.

To make sure of adequate selectivity we have used band-pass tuning for the aerial circuit. The British General dual-range unit is incorporated. This consists of two circuits coupled together in two ways. There is a certain amount of mutual-inductance

as a battery on-off switch, although in other designs it could also be used to change from medium to long waves. This function is not necessary in this set as the British General coil has its own wave-change switch controlled by a panel-mounted knob.

Detector Arrangements

A reaction coil is connected to the band-pass tuning coil, and this is used to give detector reaction in conjunction with a .0003-microfarad bakelite dielectric variable condenser.

The detector arrangement is perfectly standard in that a .0002-microfarad grid condenser and 3-megohm grid leak are used. Any residual high-frequency current in the detector-anode circuit is carefully bypassed to earth through the .0002-microfarad fixed condenser between the detector anode and earth.

There is a high-frequency choke between the detector anode and the primary of the low-frequency transformer as a further means of obtaining good reaction and proper high-frequency by-passing.

The primary of the transformer is decoupled by means of a 10,000-ohm fixed resistance and a .1-microfarad fixed condenser.

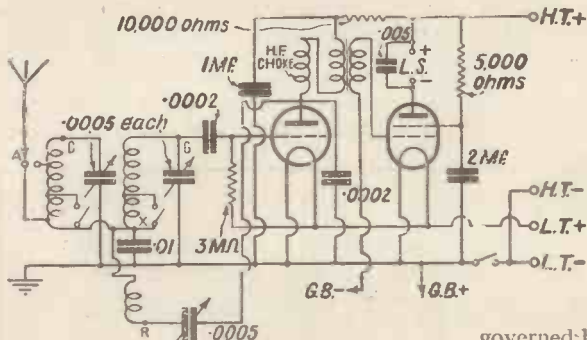

The theoretical circuit of the "Ideal Regional 2"

now be designed with a good degree of selectivity. The problem is not merely the separation of the two strong locals from each other, but the reception of these stations clear of background interference from foreign stations working on adjacent wavelengths.

Another point of view to be considered when designing a two-valve local-station set is that, owing to the strength of the incoming signals, full loud-speaker reproduction can be obtained even with two valves. In fact, the volume of sound from the locals is just as great with a two-valver as with a three- or four-valver, working on a moderate setting of the volume control.

This means that the quality of the reproduction required of the two-valver is just as great as for any other type of set.

The need for good selectivity and good quality has therefore raised the status of the two-valver, and scope is now offered for the designer to incorporate all the latest

governed by the aerial coupling to be maintained equally well on all wavelengths.

The coil is tuned by means of the new Lissen twin-gang condenser, which consists of two independent .0005-microfarad variable condensers of the bakelite dielectric type, controlled by two knobs, one concentric with the other. This virtually provides one-knob control, although maximum efficiency is maintained by the separate adjustment of the superimposed knobs.

Attached to the dial of the Lissen control is a three-way switch-lever. In this set the switch is used simply

A good point about the British General coil is that the aerial coupling to the band-pass is kept constant on medium and long waves by a switching arrangement. This enables the selectivity

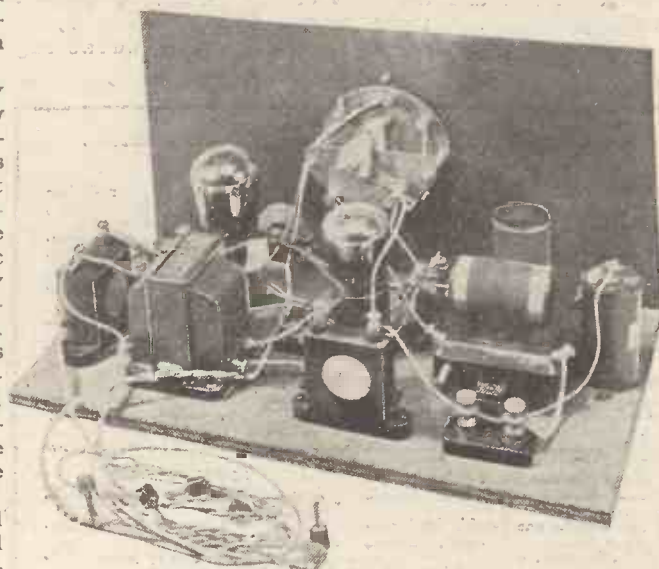

The "Ideal Regional 2" is one of the simplest two-valvers that "A.W." has ever produced

"THE IDEAL REGIONAL 2" (Continued from preceding page)

The pentode-output valve has all the necessary components to ensure distortionless and stable working. Note that the screening grid is decoupled with a 5,000-ohm fixed resistance and a 2-microfarad fixed condenser. Also, that across the loud-speaker terminals is a .005-microfarad fixed

associated non-inductive fixed condenser, the low-frequency transformer and the other small parts specified.

Wiring is carried out with No. 18 gauge tinned-copper wire, covered with insulated sleeving. There is no soldering to be done. Flexible leads for the high-tension, low-tension and grid-bias batteries, are made direct to the appropriate components, as can be seen from the blueprint. Two small terminal blocks are fitted to the base-board, one for the loud-speaker connection and the other for the aerial and earth connections.

In operation, nothing could be simpler than the "Ideal Regional Two." When used even close to a powerful regional station it should be quite easy to get the alternative programmes clear of each other by careful adjustment of the two variable condensers.

Reaction should not be forced too much, otherwise some distortion may be produced.

For more distant reception full use will have to be made of reaction in order to obtain good loud-speaker strength. To some extent the pentode counteracts the high-note loss caused by excessive reaction application.

On the long waves this set should get the Daventry National programme at loud-speaker strength almost anywhere within, say, 200 miles of Daventry. It should also be able to get Radio Paris at fair strength and when conditions are favourable many other foreign stations will come in.

The opening ceremony of the Belfast Wireless Exhibition this year will be broadcast on September 14.

This Exhibition is held in the Ulster Hall and among the speakers who will be heard will be the Rt. Hon. the Marquis of Londonderry. The B.B.C. is exhibiting a new model of Broadcasting House.

CHASING HUM

THE usual causes of hum in A.C. mains receivers are well known and methods of getting rid of the nasty noise of 50- or 100-cycle note in the loud-speaker have been published again and again. Most writers advocate a systematic stage by stage search for the seat of the trouble; but time can be saved often by a good guess.

Quick guessing is based on experience, and experience only comes to those who have had much trouble to overcome—in other words, to the professional set designer or builder, or to a service engineer with a big business.

Setting aside the ordinary causes of hum—insufficient smoothing, inductive pick-up, and suchlike—there are one or two places in some sets which experience immediately fixes upon as likely to be at fault. For instance, in circuits in which the inter-valve transformer is parallel connected, that is, fed through a resistance and a capacity, it will often be found that the condenser connected between the plate of the valve and the transformer is a paper dielectric one of 1 mfd. capacity. This is quite all right in a battery-fed set and will often help in getting desirable characteristics into the speech frequencies; but it is almost always the cause of bad hum in a mains receiver. Take out the 1-mfd. paper condenser and put in a mica one of 0.1 mfd. and, in nineteen cases out of twenty, the hum will disappear. If such a component is too expensive, you can go down to 0.01 mfd. without any serious loss in bass. As this condenser is connected directly between positive and negative H.T., it must have a working voltage well above the normal voltage.



The "Ideal Regional 2" working with a "Motor" speaker. The neat appearance of the finished set is obvious

condenser to counteract the tendency of the pentode to emphasise high notes.

This tone correction presupposes the use of a high-resistance balanced-armature cone-type of loud-speaker, but it is just as satisfactory with a moving-coil provided with an output transformer.

For this circuit we have used a PM1HL valve for the detector, although any of the good modern valves having an impedance around 10,000 ohms should be satisfactory.

The pentode is a PM22A, which combines great sensitivity with very economical anode-current consumption. With a 120-volt high-tension battery the total anode current need not exceed 6 milliamperes.

The best way to build up this circuit is to follow the full-sized blueprint, available from this office price 1s., post free. This gives the dimensions of the panel and base-board layouts, and is also a very clear guide to the wiring. A reduced reproduction of this full-sized blueprint accompanies this article.

Briefly, the layout consists of a panel taking the Lissen twin-gang control, the reaction condenser and the knob of the wave-change switch. On the baseboard are fitted the remaining components, comprising the British General coil with its

COMPONENTS REQUIRED FOR "THE IDEAL REGIONAL 2"

- Ebonite panel, 14 by 7 in. (Lissen, Peto-Scott, Becol).
- Baseboard, 14 by 8 in. (Peto-Scott, Camco, Pickett).
- Dual condenser control unit (Lissen).
- .0005-mfd. reaction condenser (Lissen, Lotus, Telsen, Dubilier, Burton).
- Band-pass aerial coil, with reaction (British General).
- .01-mfd. fixed condenser (Dubilier, type 9200).
- .0002-mfd. fixed condenser (T.C.C., type S.B.; Lissen, Dubilier, Telsen, Ormond).
- One .005-mfd., one .0002-mfd. fixed condensers (T.C.C., type "S"; Lissen, Dubilier, Telsen, Igranic, Ormond, Formo).
- One 4-pin, one 5-pin valve holders (W.B., Lissen, Benjamin, Telsen, Igranic).
- One 1-mfd., one 2-mfd. fixed condensers (Lissen, Dubilier, Telsen, T.C.C., Ferranti, Wego).
- High-frequency choke (Lissen disc, Telsen, Dubilier, Igranic, Lewcos, British General, Ready Radio).

- Low-frequency transformer (Telsen Radiogrand, Lissen, Lewcos, Igranic, Bulgin, British General, Ferranti).
- One 5,000-ohm, one 10,000-ohm spaghetti resistances (Lissen, Lewcos, Telsen, Bulgin, Varley, Graham-Farish).
- One 3-megohm grid leak (Lissen, Dubilier, Telsen, Sovereign).
- Two terminal blocks, marked A, E, (L.S.) 2 (Lissen).
- Four yards thin flex (Lewcoflex).
- Two space terminals, marked L.T.—, L.T.+ (Belling-Lee, Clix, Eelex).
- Four wander plugs, marked H.T.—, H.T.+, G.B.—, G.B.+ (Belling-Lee, Clix, Eelex).
- Connecting wire and sleeving (Lewcos).

ACCESSORIES

- Accumulator (Lissen, Drydex, C.A.V., Pertrix).
- H.T. 120-volt battery (Lissen, Drydex, C.A.V., Pertrix).
- 9-volt grid-bias battery (Lissen, Drydex, C.A.V., Pertrix).
- Loud-speaker (Motor "York," R. and A., Lanchester, W.B., Igranic).

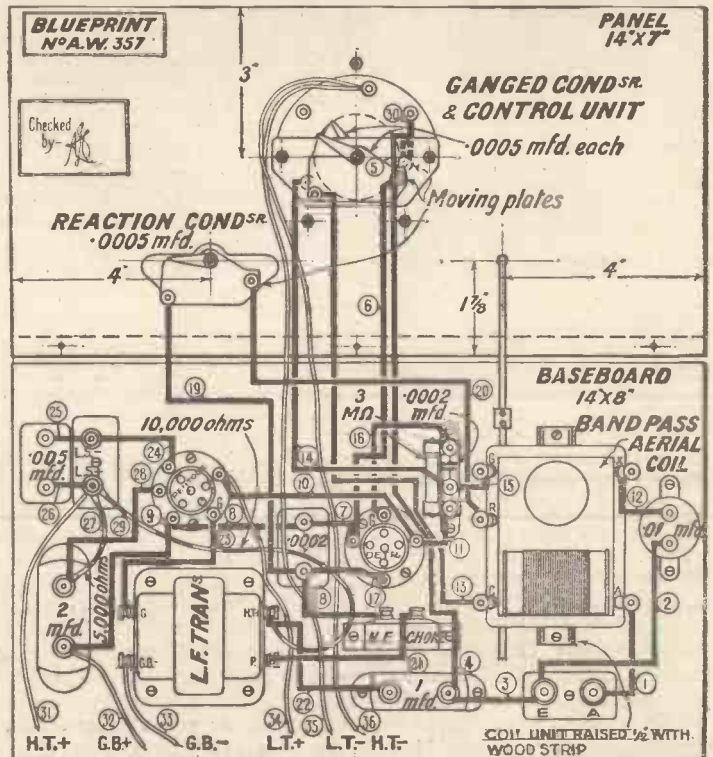

A reproduction of the full-size blueprint of the "Ideal Regional 2." The full-size print can be obtained price 1s., post free

The WAVELENGTH FIGHT IN MADRID

ALAN HUNTER explains the real significance of the forthcoming

MADRID, city of bull fights, tango bands, and revolutions, makes a fitting setting for the biggest wavelength fight in history. The discussions, which will last for several months, may cause a revolution in our present wavelength plan, as formulated at Prague. Out of the deliberations of the Madrid Conference we may get an ether fit, not only for tango bands to play in, but for the multitude of concerts nightly radiated from the studios of Europe.

As our delegates leave England on the day this article is published, namely September 1, the moment is opportune to refresh readers' memories with the general idea behind the forthcoming meeting at Madrid, which is due to start on September 3.

Since 1927

This will be a meeting of the International Radiotelegraph Convention. It last met at Washington in 1927. It meets every five years. This time it will have to face the fact that broadcasting has developed into a part of every nation's life, demanding an attention that even five years ago might not have seemed justified in relation to other users of the ether.

This Convention is the biggest gathering of radio chiefs ever staged. The scope is tremendous. Broadcasting forms only one part of its work, which is concerned with the partitioning of the ether of space among all the contesting services.

Every user of the ether stands to be affected by the findings of the Madrid Convention. And since broadcasting impinges on almost every other radio service it must be very largely tabled in the daily agenda.



Here it might be as well to make the point perfectly clear that Madrid is concerned with the allocation of wavebands to the different radio services. It has nothing to say on the question of how each service's waveband shall be divided up.

As already announced in these pages, the B.B.C. contingent will be particularly strong, comprising Sir Charles Carpendale, Mr. Noel Ashbridge, and Mr. L. Hayes. These three representatives can be relied upon to put the case of broadcasting as authoritatively as possible. As representatives of the International Broadcasting Union their views will command additional respect.

Every other broadcasting organisation in Europe will be sending its experts to plead for more space in the ether. Yet the hopes of better conditions are not particularly rosy, according to the more pessimistic elements at Portland Place.

The really sanguine people connected with broadcasting think that one, two, or perhaps three, more long-wave channels may be the net gain for European broadcasting. At present, it is widely

Madrid Conference and its effect on Radio reception in the future

supposed that the whole of the 1,000-to-2,000-metre band is allocated to broadcasting. Actually, the waveband exclusively used for broadcasting, as decided at the Washington Conference five years ago, is only from 1,550 metres up to about 1,850 metres. Broadcasters share the 1,550-to-1,350-metre band with air services, and any other stations between 1,350 metres and 1,000 metres are interlopers allowed on sufferance by other services.

It seems that a cleared waveband between 1,000 and 2,000 metres will be the main aim of the broadcasters of Europe when they meet at Madrid. The need for reliable long-wave signals to cover mountainous areas in different countries of Europe will be stressed.

The 600-metre Band

Another point that will be made is the possibility of altering the present band allocated to ships' transmissions on the 600-metre waveband. As will be pointed out, though it must already be known to all the delegates, wireless waves are less liable to be attenuated over the sea than over the land, and consequently the shorter wavelengths around 300 metres are really more suitable for ship working than they are for land transmissions.

Tradition may win the day on this point, and the excuse may be made that many existing ship's outfits cannot be readily altered in their tuning circuits from the present 600-metre band. It seems a pity, though, that something cannot be done to make an exchange with some of the ships.

The immediate gain to this country of any wavelength concessions to Europe's

(Continued on page 430)



The British delegation to the Madrid Conference, (left to right) Mr. Hayes, Mr. Noel Ashbridge (the B.B.C. Chief Engineer), and Sir Charles Carpendale



Constructional details of this set, designed for the Special Show Numbers of "Amateur Wireless," and shown on Stand 7 at Olympia, were given in the past two issues. These operating notes are very helpful.

ADJUSTING & OPERATING THE ADVANCE FOUR

By PERCY W. HARRIS, M.Inst.Rad.E.

WITH the constructional work finished there only remains the adjustment of the receiver and a few hints on operation before you are able to get the very best out of this receiver. The adjustments required are as follows:—

- (1) The adjustment of the compression condenser to suit your aerial and the degree of selectivity required.
- (2) Ganging the first two condensers so that they will tune accurately over the whole scale.
- (3) Adjustment of grid-bias to suit the valves chosen.
- (4) Adjustment of volume, reaction, and tone to suit the particular conditions of reception.

First with regard to the adjustment of the compression condenser. This must be set for each particular aerial and only trial on your own receiver will show which is the most satisfactory position. It is very easily found, particularly as it is by no means critical. For starting your adjustment screw the knob down in a clockwise direction so far as it will go without using force and then slacken it back for a turn or two, making the final adjustments later.

The "Advance Four" is designed with a tremendous high-frequency amplification to work on very small aerials. In a great majority of cases a wire round the picture rail will give you all you require, but, of course, a small outside aerial or a roof aerial will give you a greater strength.

Assuming that you have the valves in place, before switching on you should make sure that the grid-bias is correct. Grid-bias No. 1 can generally be $1\frac{1}{2}$ volts, for this applies a small negative bias to the detector valve when the switch is on the gramophone side. Grid-bias No. 2 should be set for the particular output valve you have chosen, having regard to the high-tension voltage of your battery. The leaflet given with the valve should give you all the data required. Grid-bias No. 3 should be placed on the full 18 volts. This is connected, as you will have seen from the diagram, with the potentiometer controlling the bias, and therefore the magnification of the screen-grid valve. Do not switch on until you have all the plugs in the correct position or your valves will be damaged. H.T.+1 should be about 60 and H.T.+2 about 120 or 150.

Easy Ganging

We now come to the second point—the ganging. If you look in the top of the two condensers you will find two screw adjustments which control the small condensers in parallel with each of the first two condensers. Switch the set on to "Radio" and tune in a station, preferably not the local. Until you get used to the set you will find it convenient to turn the first knob slowly from one end of the scale to the other, while you also turn the second knob, keeping the reading of the second dial about the same

as the first. When you pick up a station on the first dial, tune the second alone until you get the best results.

For this tuning the knob of the combined volume and reaction control should be about half-way between maximum and minimum. If it is turned fully over to the right the set will oscillate and if it is fully over to the left (anti-clockwise) you will get no signals at all. The medium position of sensitivity should be chosen for the ganging. Now, with a station tuned in as best you can, give a slight turn to either one of the trimmer adjustments and see whether the signals increase or decrease. The idea of these trimmers is to add or subtract capacity from one of the condensers so that the capacity of one condenser with its trimmer is exactly the same as that of the other with its trimmer. Of course, if one trimmer is put to the maximum or minimum position you may not be able to bring the other condenser completely into tune, so the trimmer of the condenser you are not adjusting should be set at about half capacity. By turning the trimmer backwards and forwards you will soon find the best position and the slight re-tuning on the knob of the condenser itself and a further touch on the trimmer will put things right. The trimmer on the third or detector condenser need not be touched. You can, if you like, use it for altering the reading of this dial slightly, but normally it

(Continued on page 468)

COMPONENTS YOU WILL REQUIRE FOR THE "ADVANCE FOUR"

.0005-mfd. variable double gang condenser unit and dial (J.B. Dreadnought).

.0005-mfd. variable single gang condenser unit and dial (J.B. Dreadnought).

Triple coil unit and special "Advance Four" extension rod, 1 KGO, 1 KGC, 1 KGR (Colvern).

Pre-set condenser, .0001-mfd. maximum (Telsen, Lissen, Formo, Sovereign, Goltone).

Three 1-mfd. fixed condensers (Dubilier type 9200, Lissen, T.C.C., Telsen, Sovereign).

Two 2-mfd. fixed condensers (Telsen, Lissen, Dubilier, T.C.C., Sovereign).

Two .01-mfd. fixed condensers (Dubilier type 670, Lissen, T.C.C., Formo, Ormond).

.0001-mfd. fixed condenser (Lissen, Dubilier, T.C.C., Telsen, Goltone, Formo, Ormond).

.0001-mfd. fixed condenser (Dubilier type 670, Lissen, Formo, Ormond).

Four valve holders (Telsen, Lissen, W.B., Lotus, Benjamin, Wearite, Goltone, Igranic).

Low-frequency choke (Varley Nichoke II).

50,000-ohm variable potentiometer (Tunewell, Lissen, Igranic, Colvern, Wearite, Watmel, Sovereign).

50,000-ohm variable potentiometer (Lissen, Igranic, Colvern, Atlas, Wearite, Watmel, Sovereign).

Four-pole rotary change-over switch (Wearite).

Five terminal blocks (Sovereign, Lissen, Belling-Lee, Goltone).

Ten terminals marked L.S.+L.S.—, two pick-up, L.T.+ , L.T.—, H.T.+1, H.T.+2, Earth and Aerial (Belling-Lee, Clix, Eelex, Bulgin).

Two fuses, one 50 m/a. and one 100 m/a. (Microfuses, Ltd., Bulgin, Igranic, Goltone).

Two 600-ohm decoupling resistances (Wearite).

Three 1,000-ohm decoupling resistances (Wearite, Bulgin, Goltone).

One 30,000-ohm spaghetti resistance (Bulgin, Wearite, Lewcos, Sovereign, Lissen, Telsen, Varley, Igranic).

Two high-frequency chokes (Lissen, Lewcos, Slektun, R.I., Wearite, Goltone, Varley).

Special high-frequency choke (Sovereign Variochrome).

Low-frequency transformer and tone control base (Lissen "Hypernik").

Four plugs marked G.B.—1, G.B.—2, G.B.—3 G.B.—4 (Belling-Lee, Clix, Eelex, Goltone).

$\frac{1}{2}$ -megohm grid leak (Lissen, Dubilier, Sovereign).

Grid leak holder (Readi-Rad, Lissen, Bulgin).

Plywood baseboard 22 x 10 inches (Peto-Scott).

Ebonite panel 22 x 7 x $\frac{1}{4}$ in. (Lissen, Peto-Scott, Becol, Goltone).

Piece aluminium foil 21 $\frac{1}{2}$ x 9 $\frac{1}{2}$ in. (Parex, Peto-Scott, Readi-Rad).

Two screen-grid valve anode connectors (Belling-Lee).

Quantity 2 m/m. single flex or 20 gauge round tinned copper wire and sleeving (Lewcos).

ACCESSORIES.

Cabinet (Camco "Master").

Loud-speaker (Epoch permanent-magnet type A2).

120-volt H.T. battery (Drydex, Lissen, Ever Ready, Pertrix, Fuller, C.A.V.).

2-volt accumulator (Exide, Drydex, Lissen, Ever Ready, Pertrix, Fuller, C.A.V.).

Two 9-volt G.B. batteries (Drydex, Lissen, Ever Ready, Pertrix, Fuller, C.A.V.).

H.T. Unit (Atlas 244, Ekco, Regentone, Lissen, Heyberd).



WATCH THAT DETECTOR STAGE!

It's there that distortion usually creeps in, ruining the work of your H.F. stages, polluting the input to your L.F. side. With the P.M.I.H.L., distortion due to transformer saturation is impossible because of its low anode current; for the same reason, the transformer operates at maximum effective inductance, and gives greatest stage gain. PRICE 7/-.

Microphony, the bugbear of modern reception, is conquered by the "muted filament"; economy in the batteries is assured by low anode consumption.

MADE IN ENGLAND.

Mullard

THE • MASTER • VALVE

Adv. The Mullard Wireless Service Co., Ltd., Mullard House, Charing Cross Road, London, W.C.2

Arks

To Ensure Speedy Delivery, Mention "A.W." to Advertisers

SAY "T.C.C."— for SAFETY



Here are illustrated the 2 mfd. non-inductive type condensers, price 3/10 each. Note the double mounting bracket—a feature of great importance for sub-chassis wiring. Made in capacities from .005 to 2 mfd. Working voltage 200 D.C.

It is simple enough to be **sure** of absolute reliability in the condensers you buy—just say "T.C.C." and you will get a condenser that is backed by a-quarter-of-a-century's specialized research work—a condenser that has won the approval of radjo technicians and set designers the world over. . . . Judge for yourself—see the specifications of press receivers—look at the best of commercial sets—you will always find "condensers by T.C.C."

T.C.C.

ALL-BRITISH
CONDENSERS

The Telegraph Condenser Co. Ltd., Wales Farm Road, N. Acton, London, W.1.

1043

A THIEF— a silent... sneaky thief



Valve deterioration is a slinking silent fellow creeping on you un-awares, robbing your wireless of its tone value, its clarity and even its selectivity. Valve deterioration robs you cunningly—just a little at a time, so little that you scarcely notice it

until one day you realise that you are not hearing the wireless programmes as well, or as clearly, as you used to. The real enjoyment has—somehow—gone.

The fault is not in your set but in your valves. Twelve months work—or even less with some receivers—is as much as you should expect from your valves. After that efficiency is much lowered and running costs are much increased. A new set of ETA valves will restore the original purity and crispness of your reception. ETA valves will make your set as good as ever it was or even better. ETA valves give and maintain the highest possible standard of reproduction.

YOU NEED NEW VALVES
GOOD VALVES — ETA VALVES



PRICES
FL.OM
5/6

ETA

THE INTERNATIONAL VALVE

SERVICE COUPON

To the ELECTRICAL TRADING ASSOCIATION LTD.,
Aldwych House, Aldwych, London, W.C.2.

A. Please let me know the correct type of ETA valves to replace my present valves which are as under

1..... 2..... 3..... 4..... 5.....
(Insert type letters and number)

B. Please advise me which ETA valves to use for the following receiver or circuit.

Specify Type No. and Name

Name.....

Address.....

A.W. 3.9.32

TELSEN LOGARITHMIC CONDENSERS and DRUM-DRIVE



THE Telsen Drum Drive and Condenser Assembly comprises a complete ganged condenser tuning unit incorporating several distinctive features. Two Telsen .0005 logarithmic variable condensers with right- and left-handed movements, and fitted with compensators, are mounted and ganged together through a rigidly constructed drum drive control. Mounted on the same spindle axis as the main tuning drive is a trimmer, giving a swinging movement of about 20 degrees to the stator vanes of the right-hand variable condenser, thereby enabling perfect matching of the condensers to be maintained throughout the tuning range. Two scales are supplied with the unit, one marked in wavelengths and one in graduations from 0-100. The scale is illuminated and has the additional advantage of being easily removable when it is desired to fit one of special calibration. The escutcheon is handsomely finished in oxidised silver, and knobs of the push-on type are fitted. Provision is made for panel and baseboard mounting, and a double-ended spanner is supplied free with the unit for fitting the variable condensers. Full instructions for mounting are included with every unit. No. W.262. Price

17/6

TELSEN DRUM DRIVE

Follows standard practice generally, but embodies several detail refinements, among which may be instanced the cord drive, arranged to reduce wear to a minimum and to prevent over-run, and the rocking stator trimmer, which gives a variation of 20°, and visual indication of setting. For use with Telsen screened coils, an extra scale, marked in wavelengths, is supplied free of charge. Illustration shows escutcheon, handsomely finished in oxidised silver. No. W.255. **8/6**



TELSEN LOGARITHMIC CONDENSERS

The frame is braced by three solid pillars, and the effective clamping of the vanes, each held at three points, makes distortion impossible. The rotor is also built into a rigid unit, the vanes being held at both ends. Generous bearings obviate backlash or end-plate. Models No. 260 and 261 (left-hand and right-hand movements respectively) incorporate a compensator (max. cap. 60 micro-micro henries).

- No. 130 Cap .00025, 4/6
- No. 131 Cap .00035, 4/6
- No. 132 Cap .0005, 4/6
- No. 260 (Left-hand movement with trimmer) Cap .0005, 5/-
- No. 261 (Right-hand movement with trimmer) Cap .0005, 5/-

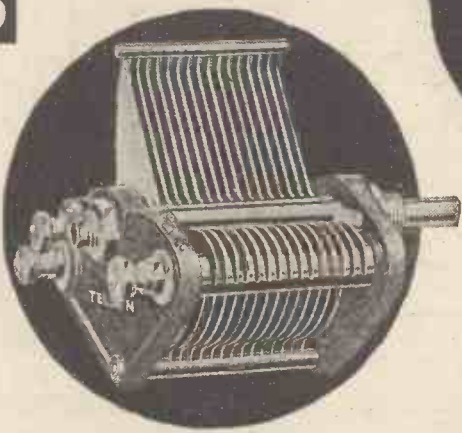

TELSEN
RADIO COMPONENTS

GOOD RADIO IS A JOY FOREVER

ANNOUNCEMENT OF THE TELSEN ELECTRIC CO., LTD., ASTON, BIRMINGHAM

To Ensure Speedy Delivery, Mention "A.W." to Advertisers

A Masterpiece of SCREENED GRID Radio

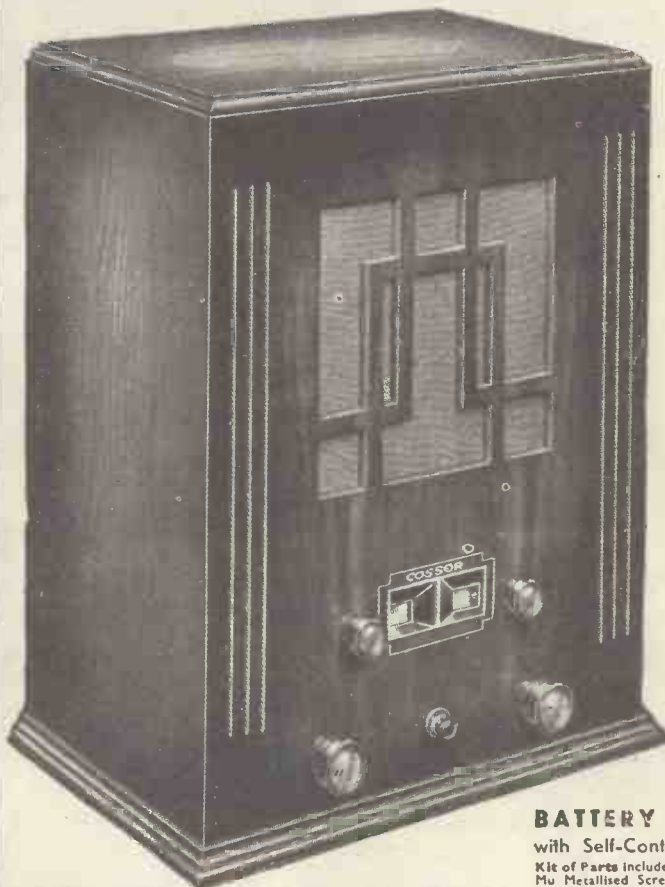

VARIABLE-MU S.G. VALVE
SELF-CONTAINED SPEAKER
ALL-METAL CHASSIS

PRESENT Day Radio conditions demand a *Screened Grid Receiver*. No other-type can cut out powerful nearby stations and bring in the programme you want. And the *Screened Grid Receiver* that offers you the greatest value for money is the new *Cossor Melody Maker*

Incorporating *Cossor Variable-Mu S.G. Valve*—individually shielded coils—all-metal chassis—and many other advanced features of design—the new *Cossor Melody Maker* has an outstanding performance. Under normal conditions it will bring you the best European programmes free from interference. Its tone is rich and true-to-life. It has the professional appearance of costly factory-built models. Never before has any manufacturer—not even *Cossor*—produced such an efficient Receiver at such a moderate price.

The new *Cossor Melody Maker* is so simple that you can build it yourself—and save pounds—even if you know nothing about Wireless. For the bare price of the parts you can own this up-to-date Receiver. Money cannot buy a more efficient 3-valve *Screened Grid Set*.

BATTERY MODEL 334

Complete Kit of Parts, identical with Battery Model 335 except that no loud speaker is supplied. Handsomely finished cabinet 9½ in. high, 13½ in. wide, 10½ in. deep. Price

£6.7.6

Hire Purchase Terms: 14/- deposit and 9 monthly payments of 14/-.

All-Electric Models for A.C. Mains only 200 to 250 volts (adjustable), 40-100 cycles.

ALL-ELECTRIC MODEL 336

Complete Kit of Parts, identical with All-Electric Model 337 except that no loud speaker is supplied. Handsomely finished cabinet 10½ in. high, 17½ in. wide and 10½ in. deep. Price

£9.15.0

Hire Purchase Terms: 19/6 deposit and 10 monthly payments of 19/6.

BATTERY MODEL 335 with Self-Contained Loud Speaker

Kit of Parts includes *Cossor 220 V.S.G. Variable-Mu Metallised Screened Grid, Cossor 210 M.L. Metallised Detector and Cossor 220 P. Output Valves*; Individually Shielded Coils, *Cossor L.F. Transformer*; All-metal Chassis and all the parts necessary for the rapid assembly of the Receiver as illustrated; handsomely finished cabinet 18½ in. high, 13½ in. wide, 10½ in. deep and 10 in. Balanced-Armature Loud Speaker with rear adjustment. Provision is made for fitting Gramophone Pick-up Socket and Plug. Price

£7.17.6

Hire Purchase Terms: 17/6 deposit and 9 monthly payments of 17/6

ALL-ELECTRIC MODEL 337 with Self-Contained Loud Speaker

Kit of Parts includes *Cossor M.V.S.G. Variable-Mu Metallised Screened Grid, Cossor 41 M.H. Metallised Detector, Cossor 41 M.P. Output and Cossor 442 B.U. Rectifier Valves*; Individually-Shielded Coils; *Cossor L.F. Transformer*; All-metal Chassis; *Cossor Heavy-Duty Mains Transformer* and all the parts necessary for rapid assembly. Handsomely finished cabinet 18½ in. x 17½ in. x 10½ in. Balanced-Armature Loud Speaker with rear adjustment. Provision for fitting Gramophone Pick-up Plug and Jack. Price

£11.15.0

Hire Purchase Terms: 25/- deposit and 11 monthly payments of 21/-

To A. C. Cossor Ltd., Melody Dept., Highbury Grove, London, N.5. Please send me free of charge a full size Constructional Chart that tells me how to build the Cossor ^{*Battery}/_{*All-Electric} Melody Maker (*Strike out type not required)

Name

Address

A.W.3/9/32.

COSSOR MELODY MAKER

A. C. COSSOR LTD., Highbury Grove, London, N.5. Depots at Birmingham, Bristol, Glasgow, Leeds, Liverpool, Manchester, Newcastle, Sheffield, Belfast and Dublin

102 ♡ 1031

Advertisers Appreciate Mention of "A.W." with Your Order

On Your Wavelength!

CAUGHT!

THE other Sunday evening I thought that I would try out a new set which had come in for test. The set was a good-looking affair with a single dial calibrated in wavelengths. I chose Sunday evening because one can then generally find a time at which the home stations are silent and there is the best chance of running round the foreigners. The set gave a good account of itself on the medium waveband, though I found that the calibration scale was giving readings that were too low. Then I turned to the long waveband and, starting from the bottom, began to pick up stations. Quite suddenly, when the dial indicated 1,490 metres, in came a station with a perfect roar. With the reaction knob turned back as far as it would go the volume was still too great.

NEAR HOME

WHAT could this transmission be? The only foreigner near that wavelength is Moscow Old Komintern. This is a 100-kilowatt station all right, but somehow it didn't seem to fit in, since the transmission was undoubtedly a relay of a church service, and that sort of thing doesn't come from Moscow in these days. After long practice, I can recognise most European languages now, but this one completely beat me. It certainly wasn't Russian, and it wasn't French, German, Swedish, Norwegian, Danish, or Dutch. Could it be Finnish or Lithuanian? Was Kaunas or Lahti working clean off his wavelength? The mystery remained unsolved that evening, for before I could hear any call-sign I had to switch off and go on to another job. Next morning I tried to puzzle it out with the help of wavelength tables, detailed programmes, and so on. I was just jotting down a note to write a "Wavelength" paragraph on the "mystery station" when it occurred to me to find out what 5XX had been doing at that time. Then the mystery was a mystery no longer: the Midland National had been relaying a church service in Welsh!

THEIR GROUSE

SPEAKING of Welsh reminds me that the inhabitants of Wales complain bitterly that the B.B.C. is not thinking of providing them with a national station of their own. And, what is worse, when the Western Regional comes into operation it will be situated in Somerset, and Cardiff will close down. Is not that a nice how-d'ye-do? Indeed, to goodness, yes! I hear that an anti-licence campaign has already been started in Wales and that die-hards are prepared to go to prison rather than pay the licence fee if there is no Welsh National station. Actually, there are so few listeners in the principality in proportion to its population that a Welsh National station could hardly be justified. Everyone, though, realises the strong national spirit of the Welsh,

and it is earnestly to be hoped that Welsh transmissions will play a considerable part in the programmes of the Western Regional.

OTHER COUNTRIES, TOO

WALES is by no means the only country that is getting restive over the question of transmissions in its own language. I hear that the French are becoming more and more annoyed (and, really, one can hardly blame them) about the growing number of programmes with English announcers that are sent out from their big stations. These are, of course, sponsored advertising programmes and they are meant mainly for English folk. But it must be more than annoying to a Frenchman who does not speak English to hear the interpolations that entreat you to buy the goods of some London firm. And why, I wonder, do some of these advertisers choose such quaint announcers? If we must inflict English upon the French from their own stations, need it be the vilest Cockney?

THE SIDE SHOWS

YOU were, I expect, duly impressed or thrilled or flabbergasted or enthused, as the case might be, by the various side-shows at or in connection with the Olympia Exhibition. Some of them I thought extraordinarily good. One that impressed me very much was that put up by the Varley people. This was thought out by Mr. Higginson, their chief engineer, one of the most original people in the world of wireless. There is nothing, by the way, that Mr. Higginson loves so much as an argument, and he and I have indulged many times in the friendliest of wordy battles. In case you didn't see this side-show, a number of wireless sets and radio-gramophones appeared to be suspended in the air above the little stage. Hoops were passed over them in the correct magician's manner, thus "proving" that there were no wires or strings. Each instrument then proceeded to demonstrate itself and the whole lot indulged in highly entertaining back-chat between themselves. Then there was an excellent film which showed Varley components and receiving sets apparently putting themselves together.

OTHER GOOD ONES

ANOTHER extraordinarily good turn was the Ekco, which had all the elements of surprise. You had a Tommy Handley record played by a radiogram; then suddenly the curtains were raised and you saw, to your surprise, that you were listening to the genuine article, for there was Tommy himself. By cleverly arranged switches you were taken over from Tommy in the flesh to Tommy on a wax record and back again, and asked to say if you could tell which was which. A bold scheme and a very successful one. I liked, too, the Marconi-

phone turn with Claude Hulbert and Enid Trevor at their best. H.M.V. had an excellent film showing what goes on at their huge works at Hayes, and Columbia drew crowds by arranging for Christopher Stone to show in the flesh that he was not simply a voice and nothing more!

MARCONI AGAIN

THE Marchese Marconi has scored another triumph by spanning a range of 168 miles between Rome and Cape Figuri, in Sardinia, with wavelets a fraction of a metre in length. In doing so he has, of course, accomplished the impossible; but that is nothing new for Marconi! Mathematical calculations show that, taking into consideration the height of the transmitting and receiving masts, the utmost range that should have been achieved was about sixty miles. Where did the odd hundred come from? The Radio Research Department at Datchet believes that the condition of the lower layers of the atmosphere must have been particularly favourable for reflecting purposes, thus turning the waves back to earth. I think that this is probably the correct explanation and I feel, myself, that we don't yet know very much about these reflecting layers which sometimes exist far below our old friend the Heavenside. As I pointed out a good many weeks ago, foreign stations, even on the comparatively long waves of the medium band, come in noticeably better in the summer time on dull cloudy afternoons and evenings. The highest clouds are many miles below the Heavenside Layer itself, and I have an idea that there is, at times at any rate, a reflecting layer very much nearer the earth's surface. The presence at odd times of such a layer would account for those astonishing freak receptions that we sometimes have. During the past summer, for instance, I have several times received the little Lille station, and I expect that every long-distance wireless man can speak of similar freaks.

OTHER CURIOSITIES

BUT, frankly, I cannot understand why it is that certain moderately powered stations should occasionally—and sometimes for days on end—show a field strength in this country that is many times their normal. I expect that you know Breslau pretty well. This station has provided fairly good, though somewhat intermittent, loud-speaker reception throughout the summer. He is what you might call a three-nights-a-weeker. You may find him at fine strength on Monday, barely audible on Tuesday, good on Wednesday, and so on. But recently he has gone one better even than this. On certain nights he has been coming through at such tremendous strength that with a couple of screen-grid stages you had to make fair use of the volume control in order to keep him within bounds. It

On Your Wavelength! (continued)

won't last, of course; he will go back to his normal quite good strength. But why on earth should this station, without making any increase in its power, suddenly develop enormous strength over here? Breslau is but one example of many. There must be over a score of stations within the limits of the medium waveband that have shown similar queer behaviour.

AN OUTSTANDING EXHIBIT

ON another page in this issue I give readers my impressions of what was undoubtedly the greatest Radio Show to date. In the Grand Hall, at all events, the Stand holders made a really fine attempt to get away from the "counter-in-the-shop" layout. Many Stands were exhibitions in themselves, telling the story of the firm's products without the aid of the usual glib but non-technical assistant.

While on the subject of Stands, I wonder how many of you took the trouble to examine the background of the AMATEUR WIRELESS exhibits on Stand 7? In addition to the usual array of the new sets for constructors, as fully described in AMATEUR WIRELESS and its brother, *Wireless Magazine*, there were some fascinating photographic enlargements at the back of the Stand.

I was so interested in these that I took a note of the firm responsible for the work. Textophote are the people concerned. On large sheet linen were reproduced—in colours—typical blueprints and covers of this journal and *Wireless Magazine*. These giant reproductions, nearly five times the originals in size, were brilliantly illuminated from behind. They gave visitors to the Stand a vivid impression of our activities, as well as providing us with something different in stand decoration.

HERE'S A TIP

POSSIBLY one of those unfortunate little accidents that do occur in wireless has happened to you in the past, and if it hasn't it is quite likely that it will do so at some time or other. This is to pull off the little cap that fits on to the top of a screen-grid valve. The accident can happen in two ways, one of which is your fault, whilst the other isn't. The first is to take hold of the terminal at the top and to pull the valve out of its holder—a most reprehensible practice. The second is that the thing simply comes to pieces in your hand whilst you are tightening down the plate lead. This is what happened to me the other day. It was a particularly good valve and I didn't want to scrap it, so I thought I would see if a repair could be managed. It proved a surprisingly simple job. In fact, unless the thin plate wire has been broken off short at the tip of the little pip in the bulb, this repair can always be undertaken with every hope of success.

HOW IT IS DONE

THE first thing to do is to file off the little blob of solder at the tip of the male thread of the terminal. Go on filing until the tiny hole appears through which the end of the plate wire must go. If you are lucky, this wire will be long enough to protrude a fraction of an inch through this hole when the cap is put on to the bulb. If it doesn't, solder a piece of fine copper wire on to what is left of the plate lead. Scrape off any big lumps of cement that may remain either on the glass of the bulb or inside the moulded cap. Apply a good coating of seccotine or some similar strong adhesive and press the cap down into place, taking care to thread the plate lead through the hole in the screwed portion. Then leave the valve until the adhesive has set hard. If you have had to solder a little piece of wire on to the plate lead, cut this short with a pair of scissors so that only a tiny fraction of an inch is left protruding. Apply a little non-corrosive flux and put a tiny blob of solder on to the tip of the terminal shank. Your valve will then be as good as ever.

A GOOD IDEA

IHAVEN'T yet mentioned the excellent idea that the Post Office people had of putting on an interference exhibit at the Show at Olympia. I hope you went to see and hear, and if you did you will now be able both to diagnose the cause of man-made interference and to tell the person responsible how it can be prevented. Various kinds of apparatus were shown and visitors were made familiar with the typical sounds which each causes the receiving set to produce. It is surprising how many domestic electrical appliances sold nowadays are shocking radiators of interference. There is not the least reason why they should be, and manufacturers would very soon be compelled to introduce silencing devices if only every purchaser would insist upon hearing the apparatus tried in the neighbourhood of a wireless set before concluding the deal. Anything which causes the loud-speaker to emit unpleasant noises should be turned down immediately.

SOLD AGAIN

ISEEM to be having quite a run of adventures in my efforts to calibrate new sets this season. The other night I began to wonder whether I, or the set under treatment, or the whole of Europe had not gone mad. Starting down near the bottom of the broadcast band, I found a soprano warbling away like anything. An opera or something of the kind was clearly in progress, and as it seemed unlikely that a call-sign would be given for some little time I moved on. A couple of ticks of the dial and in came the same lady. The first station must have been a "parent" and the second a relay or vice versa—at least, so it seemed. But the next adjustment

produced the same lady and the same trills. So did the next and the next and the next. In despair, I dashed right up to the tops of the dials and came down. "Hullo, there's a station! Good heavens, the same soprano still at it. Have I gone soprano mad? Is the set so flat tuned that it will only bring in one station all round the dials?" Feverishly I turned up the detailed programmes for that particular night. The mystery is solved. Of course, I would choose for the calibration of a new set a night upon which the whole of Europe is relaying an opera from Munich!

FOREIGN COMPETITION

THERE will, of course, be a certain amount of foreign competition this year; but it will be healthy competition, and this is all to the good of British wireless. If you could have looked over my shoulder as I opened the contents of my post-bag a year ago you would almost have wept over many of the letters. These came from people who had only just managed to scrape together the amount necessary to buy or to build a wireless set and had invested it, without realising what they were in for, in rubbish from Continental countries. Their sets wouldn't work—or they went on strike after a few weeks of use—and these unfortunate people wrote in to ask if anything could be done. Generally it couldn't, for it is worse than useless to throw good money after bad. Still, it was a pathetic business trying to help people who have been induced to part with their small savings in the purchase of wireless goods that would have been dear at any price at all. We are saved from all this, for, owing to the duties, any foreign goods that now come in must be of reasonably good quality; otherwise it would not pay the vendors to send them over here.

PERFECTING THE SUPER-HET

THERE were just two things required to make the super-het into an ideal wireless receiver. The first was some means of straightening out the tone-balance, which is apt to be upset by the very selective high and intermediate frequency stages. This has been done, as I have described recently, by the tone-correcting L.F. transformer. The other super-heterodyne defect is the hiss which often occurs when very sensitive circuits are employed. I have been a super-heterodyne enthusiast for a long time now, but I must admit that hiss has always been one of the biggest problems to me, and I had not until recently discovered any means of getting rid of it other than reducing the amount of amplification provided by stages ahead of the second detector. I am just experimenting with an entirely new device which has made its appearance this year. This can be described as a hiss filter. It plays in the super-het very much the same part as the scratch filter plays in the radio-gram.

THERMION.

"THERMION" LOOKS BACK AT THE SHOW

Our popular contributor gives his impressions of the National Radio Exhibition and describes



what he considers to be the leading parts and ideas for the new season

PHEW! That, I think, was my chief impression of the opening day. With the thermometer rocketing up towards the hundred mark, I quite expected that almost the only people to visit Olympia on that day would be unfortunates like myself who just had to go. To my amazement, I found a queue of stalwarts, reported to number over a thousand (though I cannot claim to have counted them), waiting for the big doors to open. And when I got inside I must say that I did envy the light and airy costumes of some of the charming ladies at the stands. Luckily, Old Sol relented on the second day, and I was then able to be a good deal more active in fitting from exhibit to exhibit.

A wonderful show it was; one that I would not have missed for anything. Not so many years ago one used to be able to "do" the whole Exhibition in a matter of an hour or two. This year several days were needed even to skim the cream of it properly. And there's another trouble. There was so much cream and so little skimmed milk, so to speak, that really I would need the whole issue of *AMATEUR WIRELESS* to give a full account of my impressions, and this the Editor (how unreasonable editors are!) declines to allow me.

Popular Super-hets

First of all, I was overjoyed to see the super-heterodyne coming into its own. For this *AMATEUR WIRELESS* and *Wireless Magazine* can justly claim the fullest credit. A long while ago, when the super-het was under a cloud owing to the poor performances of early models, I suggested in "On Your Wavelength" that if only first-rate designs could be produced incorporating modern improvements the super-het would become the set of the future. The designers of *AMATEUR WIRELESS* and *Wireless Magazine* got down to the task. They produced the "Century Super," the "Super Sixty," and "Britain's Super," all of which were run-away successes. The public

saw how good a super-het could be, and, having found that it liked them, it is now offered a magnificent choice. Both H.M.V. and Marconiphone have most attractive battery super-hets. These are quite economical to run, since the H.T. current consumption is kept down to about 10 milliamperes. In the mains class I was taken with the super-hets made by the two firms already mentioned as well as those of Varley, Ferranti, Ekco, and Gambrell; but these were only a few of the many good ones that there were to be seen.

A "Threesome"

In past years it has been quite easy to see what was the main feature of the Exhibition: it was a screen-grid year, or a pentode year, or a three-valver year, or a moving-coil year, and so on. This year there is no one feature; instead, there is a threesome. It is a super-het radio-

gram—all-mains year. You can have any of the three by itself or you can obtain them in combination in the all-electric super-hetero-gram, a wonderful piece of apparatus which a good many firms are showing. On its radio side there are anything up to six valves, according to the size and the price of the instrument. There is knife-edge tuning with scales calibrated in wavelengths or containing the actual names of stations. One set allows the automatic selection of any one of nine good stations by merely pressing the appropriate button. With any good set of this kind nowadays there is hardly a station worth hearing that cannot be tuned in at will, except in the most unfavourable circumstances. On the note-magnifying and gramophone side there are first-rate L.F. stages, usually with push-pull output. Combine these with one of the beautiful pick-ups of to-day and a silent, even-running induction motor, and you have the finest of all instruments for reproducing gramophone records. Add automatic changing, if you like, and the apparatus will look after itself during the playing of a whole batch of records. Even with the biggest of radiograms running costs are surprisingly small. They require about the same amount of current as an ordinary large electric-lamp bulb.

Mains Sets Predominate

I have mentioned "all-mains" as one of the features of the year. Mains sets unquestionably predominate and many firms are making nothing else. No one can deny that the mains set now very closely approaches perfection. It is sensitive and selective; even if it contains only three valves, its average undistorted output is in the neighbourhood of 1½ watts—and it really is undistorted output. I wish I could say that the same kind of progress had been made in battery sets. It hasn't, though battery users must for many years outnumber mains users by at least three to one. There are plenty of small and medium-sized battery sets suitable for the man who wants to keep running expenses down by limiting his H.T. to ten or fifteen milliamperes. But there is absolutely nothing, so far as I can see, for the listener, compelled to use batteries, who wants some-



Greeting the Robot! All readers who visited Olympia will remember the mechanical all-action all-talkie Robot on the Mullard Stand!

(Continued at foot of next page).

WHAT IT IS FOR

THE BATTERY VARIABLE-MU VALVE

DURING the coming season there will be a great increase in the use of variable-mu valves, following the almost universal adoption of this improved type of screen-grid valve by the leading set makers.

Mains users will not be alone in enjoying the advantages of distortionless control of volume—perhaps the greatest boon of the variable-mu—and of the reduction in the bug-bear of cross-modulation so prevalent with the older screen-grid construction.

For battery variable-mu valves, which are now available in three makes, it is necessary to arrange a slightly more elaborate circuit for applying the variable negative bias (see diagram). A separate grid-bias battery will be needed, of 9 or 15 volts. Across this must be connected a high-resistance potentiometer of, say, 25,000 ohms. The low potential end of the tuning coil, which would normally go to low-tension negative, is connected to the slider of the potentiometer, thus applying negative bias to valve through coil winding.

As the winding of the potentiometer will take an appreciable current from

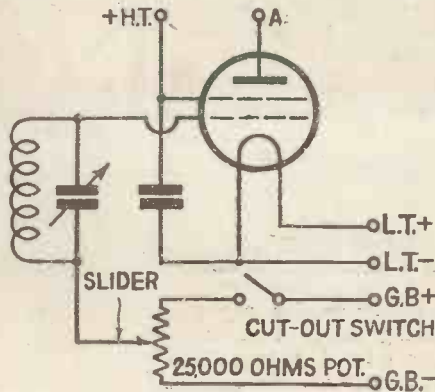

For battery sets the use of a variable-mu type of valve entails the connection of a potentiometer across a separate bias battery, as shown in this diagram. Note the cut-out switch to prevent the grid-bias battery running down through the "pot" winding when the set is not in use

the grid battery it is essential to arrange to switch the potentiometer out of circuit when the set is not in use. This can be done by means of a separate switch, or by means of a combination control acting as a potentiometer and having a cut-out contact at its minimum volume position.

The screen-grid voltage can, of course, be derived from the battery in the normal way, by taking the screen-grid to a suitable point on the high-tension battery, or by arranging a fixed potentiometer as for mains working. If this is done another cut-out switch must be fitted—as can conveniently be done on the battery switch—to stop the high-tension battery running down through the potentiometer winding when the set is not in use.

Although the adoption of the variable-mu involves certain circuit alterations, the advantage of a smooth and distortionless control of volume more than compensates for any trouble taken.

HOTSPOT.

"THERMION LOOKS BACK AT THE SHOW"

(Continued from preceding page)

thing like mains quality and doesn't mind spending a good deal on his apparatus.

You cannot have the finest quality with big volume unless you are prepared to supply a respectable number of milliamperes at a high voltage. This you can do, as I have known from personal experience, if you will forget about standard-capacity dry batteries and will use nice fat H.T. accumulators. Actually, it does not cost a penny more to supply 40 milliamperes at 180 volts from these than to supply 10 milliamperes at 120 volts from small-capacity dry H.T. batteries.

Amongst components, by far the most important this year is the correcting L.F. transformer which enables the low-frequency part of the set to be tuned. Several firms are making these, and if you try one of them you will agree with me that its performances come as a revelation. On the local station you can make speech sound like speech and music like real music.

Next in order of importance (you will hardly realise this until you try it) I place the tapered volume-control potentiometer. This is intended for controlling either the screening-grid potential of ordinary S.G. valves or the grid bias of Multi-mus. If the windings of the potentiometer are arranged so that the resistance varies in direct proportion to the movement of the knob you get a very big reduction in the volume for a small movement to begin with, and afterwards a smaller and smaller reduction for a comparatively big movement. With the tapered volume control the increase or reduction in the volume of sound corresponds to the amount of movement of the knob.

I haven't mentioned the side shows, though they were really a very important feature of the Exhibition. One of the most impressive was the Ekco, which enabled you to compare directly an artiste's own voice with the radiogram reproduction thereof—and I am willing to wager a three-gang condenser to a grid leak that you were surprised. Then there was the H.M.V., which provided yet other opportunities; and, lastly, there was the Varley magic turn.

My general impression of the Exhibition is that wireless has now reached the stage where quality in design, in manufacture, and in reproduction is the main thing that matters. To obtain such quality has been the watchword of manufacturers—and they have succeeded.

"THE WAVELENGTH FIGHT AT MADRID"

(Continued from page 421)

broadcasters is not obvious. We already have a greatly prized long wavelength for Daventry, so it is inconceivable that another will be obtained. What may happen is that one or more of the countries getting a long wave in place of an existing good medium wavelength may be persuaded to hand over their relinquished medium waves to us in exchange for some of our very poor waves, such as London National on 261 metres, and North National on 301 metres.

Any re-allocation of wavelengths would have to wait until after the Madrid Conference has concluded its work. As this may take until Christmas of this year there is not much hope of any change in the wavelength situation until the new year.

In January or February of 1933 we may expect a gathering of the Post Office administrations of Europe. A plan will then be formulated to replace the present much-amended Prague plan. The first stage of the great wavelength fight is Madrid, and then at some place yet to be decided the second stage will be the allocation of wavelengths in accordance with the altered waveband given over to broadcasting by the International Radio Telegraph Convention.

Meanwhile, experiments on ether channels at present so peacefully clear of interruption are proceeding apace. Perhaps in a few years time ultra-short waves around 7 metres will make all the present talk look silly. It is significant that Madrid will deal with 7-metre wavelengths, though no hard and fast rules are likely to be made.

COIL CLIPS AND SHORT CIRCUITS



When tappings are made on a bare wire coil by a crocodile clip, take care to see that there is no possibility of the clip moving so that it can touch a bare metal part, such as the metal backing of the panel of the set illustrated. This may cause a dangerous short-circuit.

TELSEN

**10-1 COUPLING UNIT
& 1-1 COUPLING UNIT**



**TELSEN
10-1 INTERVALVE
COUPLING UNIT**

This is a filter-fed transformer using a high permeability nickel alloy core, which enables a 10-1 voltage step-up to be attained while preserving an exceptionally good frequency characteristic. The response is compensated in the higher frequencies for use with a pentode valve, this combination giving an amplification greater than anything previously achieved, equal to two ordinary L.F. stages, but with better quality of reproduction.



12'6

No. W.215

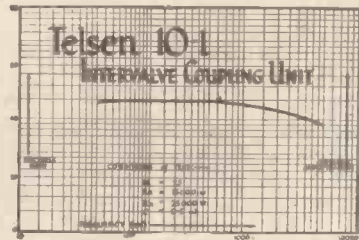

TELSEN 1-1 INTERVALVE COUPLING UNIT

This is a modern development of the one-time deservedly popular R.C. unit. It incorporates a low pass filter feed in its anode circuit, thus effectively preventing "motor-boating," "threshold howl," and other forms of instability arising out of common couplings in eliminator and battery circuits. Used with an H.L. type valve it will give an amplification of about 20 and a perfect frequency response, at the same time consuming negligible H.T. current.

7'6

No. W.214

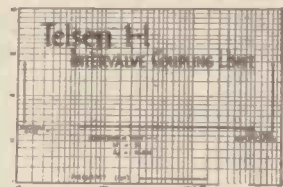

TELSEN

RADIO COMPONENTS

GOOD RADIO IS A JOY FOREVER

ANNOUNCEMENT OF THE TELSEN ELECTRIC CO. LTD., ASTON, BIRMINGHAM.

Advertisers Appreciate Mention of "A.W." with Your Order



TWO MODELS OFFERING SUPERLATIVE QUALITY at a price you want to pay

**ABSOLUTE
RELIABILITY—
SUPERLATIVE
PERFORMANCE**

REAL ENGINEERING CONSTRUCTION

GECOPHONE
All-Electric
Radio Receiver
(For A.C. Mains)

"GALA" Model

Cat. No. BC3335

PRICE 18
including
OSRAM
VALVES
and Royalty
GNS.

HIRE PURCHASE: Deposit
£2 0s. 0d. and 12 monthly
payments of £1 10s. 0d.

MADE IN ENGLAND

GECOPHONE
All-Electric
Radio-Gramophone
(For A.C. Mains)

"CARNIVAL" Model

Cat. No. BC3338

PRICE 30
including
OSRAM
VALVES
and Royalty
GNS.

HIRE PURCHASE: Deposit
£2 12s. 6d. and 12 monthly
payments of £2 12s. 6d.

Sold by all Wireless Dealers

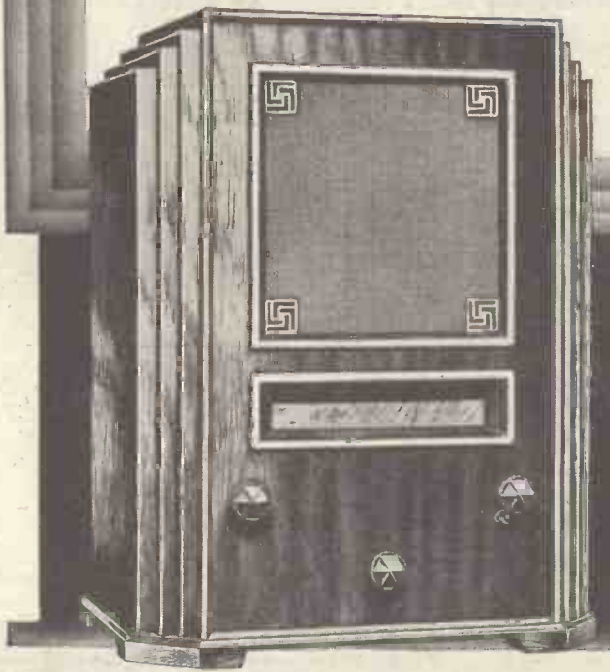
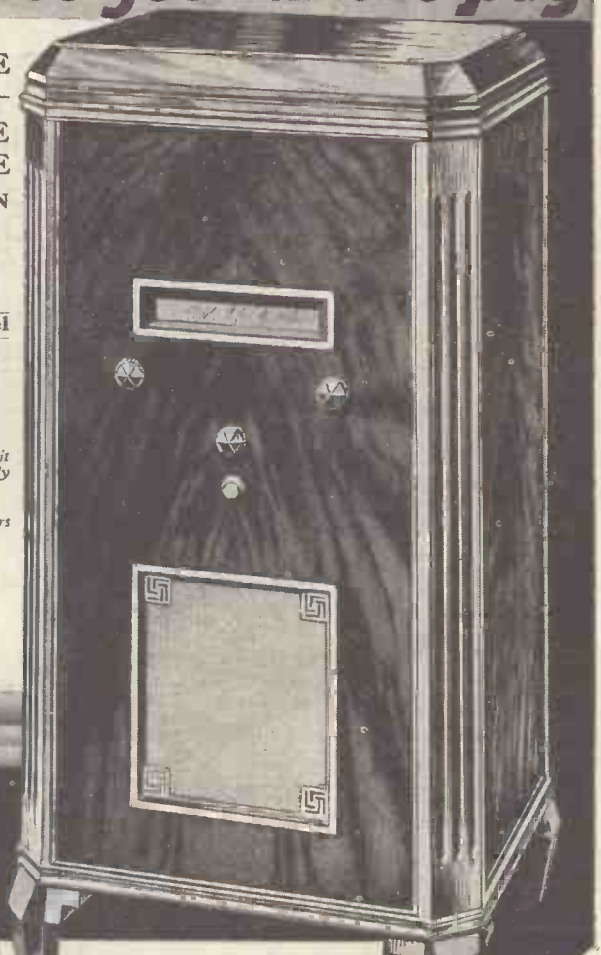

**BETTER RADIO FOR THE
DISCRIMINATING LISTENER**

WRITE for folder BC6312.

This is a most comprehensive production giving the fullest information regarding G.E.C. Radio products. It merits the consideration of everyone who demands the finest reception. The coupon is for your convenience. Make a leisureed choice, but be sure it is GECOPHONE

COUPON

Please send me Folder No. BC 6312 giving particulars of GECOPHONE Radio Receivers and Loud Speakers

Name _____
Address _____

The General Electric Co. Ltd.
Magnet House
Kingsway, W.C.2
A.W.

Cut out and paste on a postcard, or enclose in unsealed envelope, 1d. postage.

Advt. of The General Electric Co. Ltd., Magnet House, Kingsway, London, W.C. 2

Don't Forget to Say That You Saw it in "A.W."

The TELSEN TELELEXOR

THE Telexor represents a new development in radio set construction, and renders unnecessary all existing wave change methods by switching or changing coils. In conjunction with the Telsen Dual Range Tuning Coil, the whole of the medium and long wave broadcast band may be covered by one turn of the dial, without any operation being necessary to change wave lengths. Briefly, it incorporates a special design of tuning condenser, covering the full circle and giving "log law" tuning in both directions, together with an automatic wave change switch and illuminated disc drive.

No. W.180.

MOUNTING INSTRUCTIONS

Full instructions are included with every Telexor for baseboard or panel mounting, together with the necessary screws. The approx. overall dimensions, excluding the escutcheon plate, are 5 1/2" high 4 1/2" wide and 2 1/2" deep.

10/6

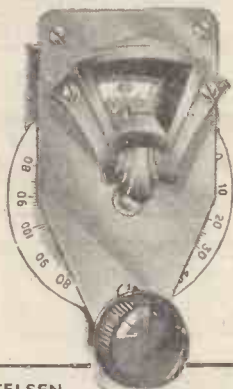
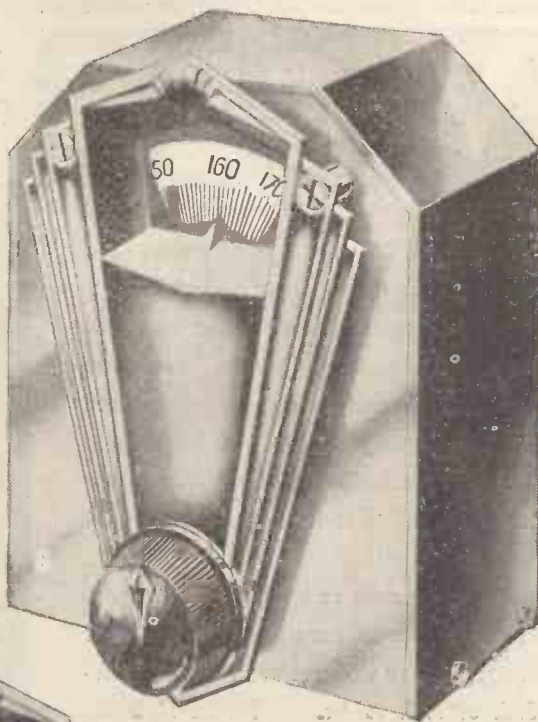

TELSEN SMALL FRICTION DISC DRIVE.

A low-priced disc drive for auxiliary controls. It is extremely robust and may be used for main tuning condensers when such a course is advisable owing to considerations of space.

No. W. 257 **2/6**

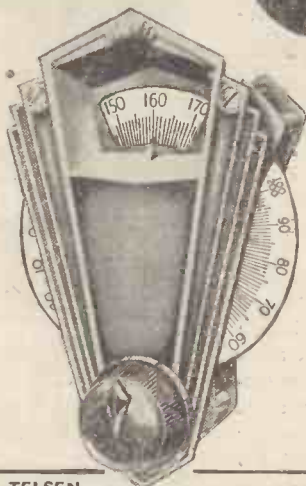

TELSEN ILLUMINATED DISC DRIVE.

Fitted with a handsome oxidised silver escutcheon of modern design, this drive incorporates an improved movement. The gear ratio of approx. 5-1, and the bold and well proportioned figures, make for delightfully easy tuning. The dial may be illuminated by means of an ordinary flash lamp bulb. A double ended spanner, to fit all Telsen one-hole fixing nuts, is supplied free.

No. W. 184 **3/6**

TELSEN SLOW MOTION DIAL.
An exceptionally smooth-acting dial, with an approx. ratio of 8-1. There is no toothed gearing, so that it is impossible to strip the dial. The figures are clear and arranged to provide for right and left hand condensers.
No. W. 141 (black)
No. W. 141a (brown)
2/-
EACH



TELSEN
RADIO COMPONENTS

GOOD RADIO IS A JOY FOREVER

ANNOUNCEMENT OF THE TELSEN ELECTRIC CO., LTD., ASTON, BIRMINGHAM

Mention of "Amateur Wireless" to Advertisers will Ensure Prompt Attention

IGRANIC TUNING DEVICES

IGRANIC tuning devices—like all Igranic components—are built to the highest standards of efficiency and precision as this new Dual-wave Coil exemplifies. These screened coils, with self-contained wave-change switch, have been designed to give maximum efficiency on the medium- and long-wave bands, covering a range of 200-500 metres and 1,000-2,000 metres when tuned with a .0005-mfd. variable condenser. A notable feature is the wave-change switch spindle, which protrudes on either side of the coil base, enabling any number of these coils to be ganged and operated by one movement. These coils are eminently suitable either for aerial tuning, with or without reaction, or intervalve coupling to S.G. or H.F. valves. PRICE 12/6

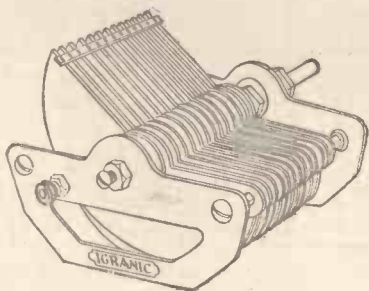
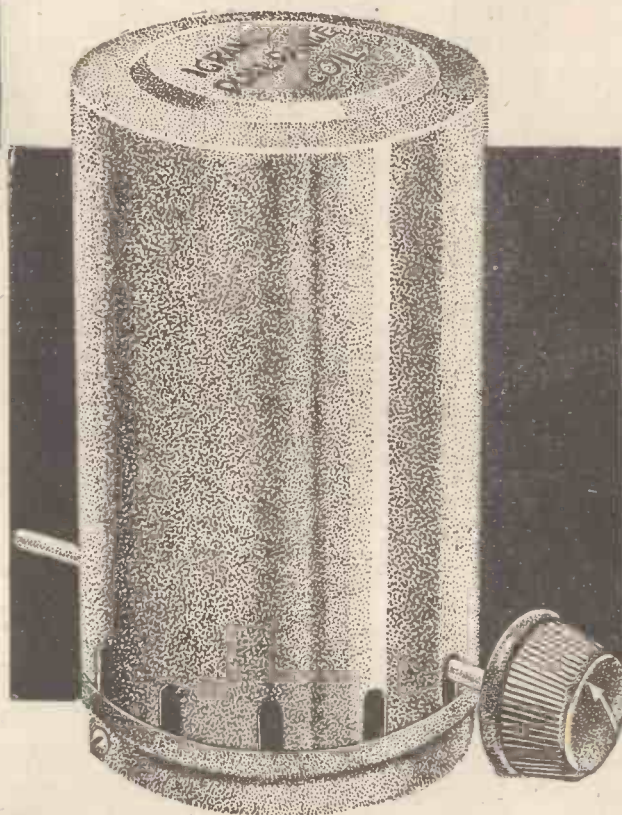

SINGLE VARIABLE CONDENSER

Supplied in capacities .0003 mfd. and .0005 mfd. Designed on the mid-log law principle to ensure a better and more equal separation of frequencies over the tuning scale. One-hole fixing, 1/4 in. diameter spindle. PRICE, .0003 mfd., 5/3 .0005 mfd., 5/6

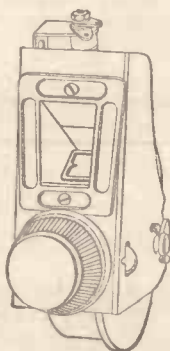

SLOW MOTION DRUM DIAL

A new illuminated drum drive of novel and simple design. Friction-driving mechanism ensures positive action and eliminates backlash.

PRICE 8/6

Write for Catalogue D.166 to

Igranic Electric Co., Ltd.
149 Queen Victoria St., London,
E.C.4

**IGRANIC
COMPONENTS WILL
BE THE MAKING
OF YOUR SET.**



A VISIT TO RADIO PARIS

KENNETH ULLYETT visits the Radio Paris studios, the Clichy transmitter and the new station at Saint-Remy-l'Honore and describes items of interest to listeners to the Radio Paris programmes

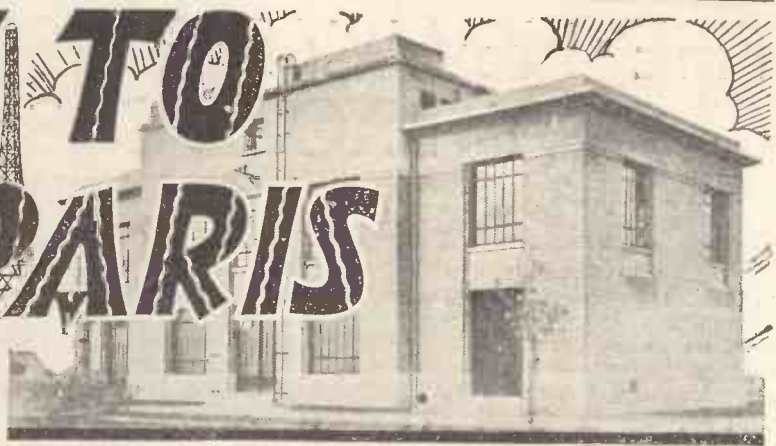

When I visited Radio Paris, the new high-power station at Saint-Remy-l'Honore was not in full swing and about 40 per cent. of the transmissions were being made from the 17-kilowatt transmitter at Clichy.

At the invitation of Mr. Morel of the International Broadcasting Co., Ltd., I went along to the main studios in a quiet part of Paris at 11 rue Francois I. Only a small board announcing the headquarters of the Compagnie Francaise de Radiophonie (French Broadcasting Company) distinguished No. 11 from any of the other houses and office buildings in the quarter.

The Listening Room

The entrance hall led into a very futuristic glass-lined waiting room and through a small door at the end I could see the listening-room where the evening's programme was being checked on a large cone speaker.

After introductions with the Station Manager, I was conducted over the three studios and shown how the gramophone broadcasts are done, which form such a popular part of our Sunday programmes.

There are three studios. The main one is just as cheerful as any of the modernist rooms at Broadcasting House. It is about

60 ft. long by 24 ft. wide and has a kind of domed roof with hidden lighting. Radio Paris has beaten us in one respect. The B.B.C. has not yet an organ of its own. There is quite a large pipe organ on a raised section at the end of the main Paris studio. The pipes are arranged in any order to suit the organ builders. It must be a difficult job for the microphone placers.

There is another raised platform half-way down the studio, where the conductor stands. It has a padded top so that although the microphone is near the conductor he can walk about and turn to any section of the orchestra without the sound of his footsteps being broadcast. One of the two microphones is only a few feet away.

When the French orchestral concerts are broadcast, the orchestra is placed facing the conductor at one side of the studio.

When the British sponsored programmes are given the orchestra generally faces down the length of the studio. That is just a fad of the studio managers.

All the main orchestral items which you hear in the sponsored programmes on Sundays are given from this studio. It is draped, of course, and there is a sliding partition to vary the acoustics.

There is a small talks studio where the announcer sits while the gramophone records are broadcast and a medium-sized studio which is rather old-fashioned in style and like the studios the B.B.C. had at Savoy Hill. I noticed, though, that it was much more brilliant than the B.B.C. studios used to be: none of that "dead" effect caused by too much draping.

The records are put on to dual turntables, electrically driven by synchronous motors from the local A.C. supply. The turntable equipment is in a little room at the side of the main amplifier panels and control gear. There is no actual control room. A corridor of the Radio Paris building is filled with large panels which are the Paris end of the long land-line going out to Saint-Remy-l'Honore (about twenty-five miles away) and to Clichy in the suburbs.

Gramophone Broadcasts

A control man puts on the records in the order marked on a sheet of which the announcer upstairs in the talks studio has a duplicate. The announcer gives the title of each record and touches a buzzer which tells the record operator that he can start the record. While one turntable is playing, the next record is got ready. I noticed that they were using ordinary magnetic pick-ups of a popular French make. The B.B.C. uses needle-armature pick-ups, of course. At Paris they have no special arrangements to ensure accurate tracking.

I saw the amplifier gear used in conjunction with the 38-kilometre long aluminium shielded cable running out to the new high-power transmitter. There was not very much of interest in these low-frequency amplifiers and so arrangements were made for me to see the transmitters at Clichy and Saint-Remy.

The old Radio Paris transmitter at Clichy is housed in two small single-storey buildings. Only the gold lettering "Radio Paris" above the newer building distinguishes the group from one of the out-houses of a huge factory adjacent. The

(Continued at foot of page 468)

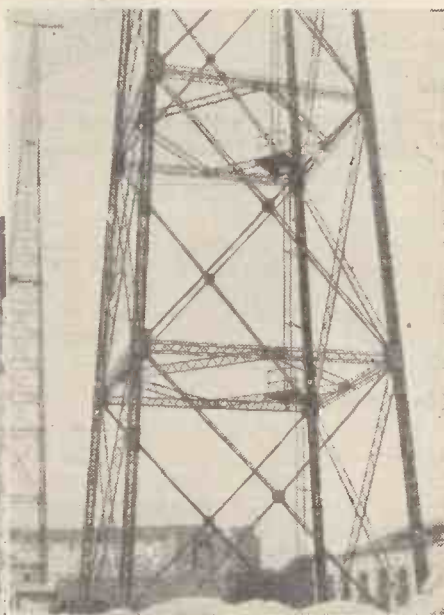
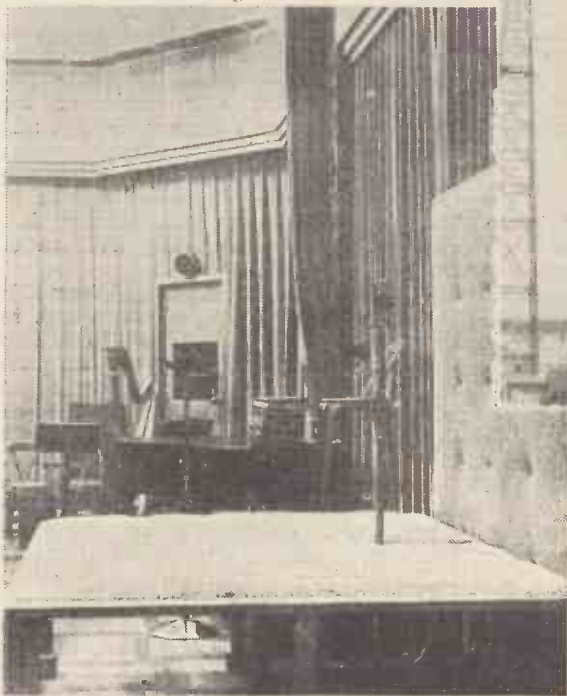

Two impressions of Radio Paris; (Left) The main orchestral studio which has an organ at one end: the conductor's dais is in the foreground. (Above) The base of one of the huge masts of the Clichy transmitter

THE NEW TELEVISION APPARATUS AT BROADCASTING HOUSE

By H. J. BARTON CHAPPLE, Wh.Sch. B.Sc.

THE first experimental transmissions of Baird television started in September, 1929, when the first of the Brookmans Park stations was completed and from March, 1930, on completion of the twin station, dual sound and vision transmissions became a regular daily feature. These continued until a few weeks ago, the programmes emanating from the studio at Long Acre and passing by land line to the B.B.C. transmitters.

Equipment has now been installed in

each cell box is connected to its A amplifier located in the control-room and as near as possible to the cells as can be conveniently arranged. These four A amplifiers are of the two-stage type and the output signals (just audible on 'phones under normal circumstances) pass to the mixer panel. This consists of three main controls and by carefully positioning the groups of cells round the subject or subjects being televised and making judicious adjustments on the panel, very effective lighting schemes

and the experience gained has been embodied in the single mirror-drum television projector which has been designed specially and installed at Broadcasting House.

The New Gear

Two views of the new machine are shown in the accompanying illustrations and although at the moment little information is available concerning its operation, those who have seen it working are intrigued with

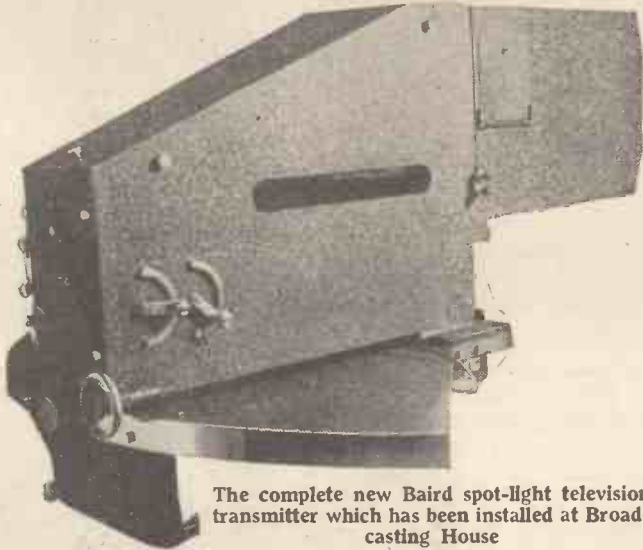

The complete new Baird spot-light television transmitter which has been installed at Broadcasting House

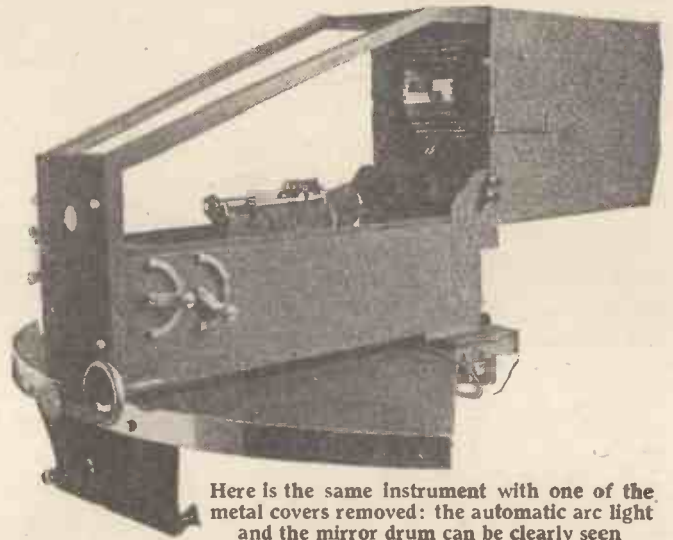

Here is the same instrument with one of the metal covers removed: the automatic arc light and the mirror drum can be clearly seen

Studio BB at Broadcasting House, the B.B.C. having taken over completely the programme and transmitting side as far as these dual broadcasts are concerned. A few test transmissions have already been on the air and judging from results observed at the receiving end this new arrangement augers well for all those enthusiasts who are anxious to devote some of their time to this fascinating science.

Since Monday, August 22, regular broadcasts have been given for four nights per week, the intention at first being to transmit the television signals on the London National station (261 metres) and the accompanying sound on the Midland Regional station (399 metres) at 11 p.m.

Popular Programmes

Undoubtedly the mere fact that television will be on the air at night instead of in the morning will enable a much larger number of people to take advantage of the service and the progress will be watched with interest. At the start, therefore, it is opportune to learn a little regarding the special equipment which has been built by the Baird Co., for the B.B.C. and accommodated in Studio BB's listening room. The actual studio will house the back screen and four groups of photo-electric cells arranged in metal cases on heavy base stands.

By means of a special type of cable,

can be produced in the resultant image.

After the "mixing" the vision signals now undergo amplification in two type B amplifiers, each of which consists of three stages having double outputs. Finally, there are three C type amplifiers and the signal fed to each of these has to pass through a corrector network which can be suitably adjusted on the spot to compensate for all the high-frequency attenuation that may be present in the television signal.

No Transformers!

It will probably come as a surprise to many readers to learn that in the inter-connection of the amplifiers no low-frequency transformers are used except those which feed the lines to the main control-room. A desk-like frame houses the panel controls and all amplifier inputs and outputs are brought to this, which, however, is quite separate from the amplifiers themselves. This precaution was adopted to overcome any effects from valve microphony likely to arise from the handling of the controls.

When the transmissions emanated from Long Acre, two spot-light transmitters were used, one a disc model for close-up and some semi-extended effects, and a mirror-drum model for the remainder of the semi-extended scenes and all the extended ones. Consistently good results have been obtained with this combination

its ingenious character. It will cover all types of scenes from close-up to extended and an automatic arc (seen in the view with the side removed) is the source of light. A thirty mirror drum, perfectly balanced, and built with selected mirrors, projects the fleeting spot from the "mouth" of the mechanism. It is driven from the frequency controlled A.C. mains of the Marylebone Borough Council Supply, and it is therefore important to add that anyone using power from the same electricity supply can use synchronous motors in their vision apparatus and obtain perfect synchronisation without any addition of automatic control.

The transmitter can be turned from side to side and moved up and down and, in addition, runs on rails to allow it to take up any position for following the subjects being transmitted. Focus adjustments that become necessary with change of scene depth are easily effected, the engineer in charge having the controls readily to hand.

A check or monitor Televisor of the new Baird grid-cell type is included in the control-room equipment, so that the engineers can see exactly what the radiated television image looks like and adjustments for signal strength or high-frequency correction are made accordingly. The image watched is about 7 in. by 3 in., slightly less than that shown on the model described recently in AMATEUR WIRELESS.

Direct Radio

We hold large stocks of all Season's Sets and Components on show at Radiolympia

CASH PRICES AND EASY PAYMENTS TERMS OF MANUFACTURERS KITS

OSRAM "THIRTY-THREE" (complete with cabinet and Osram valves) £3 9 0 or 20/- down and 12 monthly payments of 15/-.

S.T.300 BATTERY MODEL Kit No. 1 (less valves and cabinet) £3 13 6 or 8/9 down and 11 monthly payments of 6/9.

Kit No. 2 (with valves less cabinet) £5 5 9 or 9/9 down and 11 monthly payments of 9/9.

Kit No. 3 (with valves and cabinet) £6 4 3 or 11/5 down and 11 monthly payments of 11/5.

Battery equipment (with speaker) £2 4 3

RADIO FOR THE MILLION "STATION MASTER 3" Model A. Complete kit and valves in oak table cabinet. £5 11 0 or 15/6 down and 7 instalments of 15/6.

Model B. Complete kit and valves, special Celestion speaker, and midset type cabinet in walnut finish. £7 10 0 or 17/- down and 9 instalments of 17/-. Particulars of A.C. kits obtainable on request.

COSSOR MELODY MAKER MODEL NO. 337. All electric £11 15 0 or 25/- down and 11 monthly payments of 21/-.

Model No. 334. 3-valve kit without speaker. £6 7 6 or 14/- down and 9 monthly payments of 14/-.

BUILD YOUR "IDEAL REGIONAL TWO" WITH DIRECT RADIO TESTED KIT

1 Ebonite panel 14 by 7, drilled to specification	4 3
1 Baseboard 14 by 8	1 4
1 Lissen dual condenser control unit	14 6
1 .0005 bakelite reaction condenser	2 6
1 British General band-pass aerial coil with reaction	14 6
1 Dubiller .01 mfd. fixed condenser type 9200	2 0
1 T.C.C. .0002 mfd. type SP condenser	2 4
1 T.C.C. .005 mfd. type S condenser	2 0
1 T.C.C. .0002 mfd. type S condenser	1 3
1 W.B. 5-pin valve holder	1 0
1 4-pin valve holder	6
1 T.C.C. 1 mfd. fixed condenser	2 10
1 T.C.C. 2 mfd. fixed condenser	3 10
1 Disc type H.F. choke	2 0
1 Telsen Radiogram L.F. transformer	7 6
1 Lewcos 5,000 ohm spaghetti-resistance	1 0
1 Lewcos 10,000 ohm spaghetti-resistance	1 0
1 3 meg. grid leak	6
2 Terminal blocks marked A, E, and L.S.	2 0
2 Belling-Lee spade terminals and 4 wander plugs	1 0
1 Coil Glazite wire	6
Flex, screws, etc.	6
1 "Direct" polished oak cabinet	15 0
2 Mullard valves, PM1HL, PM22A	1 4 6
	£5 8 4

No. 1 Kit (less valves and cabinet) £3 8 10 or 6/4 down and 11 monthly payments of 6/4

No. 2 Kit (with valves less cabinet) £4 13 4 or 8/7 down and 11 monthly payments of 8/7

No. 3 Kit (complete with valves and cabinet) £5 8 4 or 9/11 down and 11 monthly payments of 9/11.

BUILD YOUR "HOME RADIOGRAM" WITH A DIRECT RADIO TESTED KIT

1 .00015 bakelite diff. reaction condenser	2 6
1 Piece aluminium foil 17 by 10	1 9
4 Brackets to specification	2 0
1 British Radiophone Unit-Control dual condenser	1 1 0
1 Sektun dual range aerial and H.F. coil with reaction	6 6
1 Bakelite .0005 mfd. reaction condenser	2 6
1 R.I. Hypemite L.F. transformer	12 6
1 Bulgin 20 henry output choke	12 6
1 Disc type H.F. choke	2 0
1 Wearite screened H.F. choke	3 0
1 4-pin valve holders	2 0
2 T.C.C. 2 mfd. fixed condensers	7 8
1 T.C.C. .0001 fixed condenser type 8	1 3
2 T.C.C. .0002 fixed condensers type 8	2 6
1 T.C.C. .0006 fixed condenser type 8	2 0
1 Lewcos 30,000 ohm spaghetti resistance	1 6
1 Lewcos 30,000 ohm spaghetti resistance	1 6
1 1-meg. grid leak with wire ends	1 0
1 1-meg. grid leak	1 0
1 3-point push-pull switch	1 6
1 Redifad grid leak holder	6
1 Lissen terminal block	1 0
1 Pair G.B. battery clips No. 1	6
1 Varley 50,000 ohm variable potentiometer CP139	6 0
2 Coils Glazite wire	1 0
2 Spade terminals and 6 wander plugs (Belling-Lee)	1 4
Flex, screws, etc.	6
3 feet single screened tubing	9
1 Canco "Popular" type cabinet	3 15 0
4 Mullard valves, PM12, PM1HL, PM2DX, PM22A	1 19 3
1 Collaro B.30 gramophone motor with autostop	1 13 0
1 A.E.D. Bowyer-Lowe pick-up	1 10 0
1 R. & A. type 40 loudspeaker	16 6
	£14 14 0

No. 1 Kit (less valves, cabinet and gramophone accessories) £5 0 3 or 9/3 down and 11 monthly payments of 9/3.

No. 2 Kit (with valves less cabinet and gramophone accessories) £6 19 6 or 12/10 down and 11 monthly payments of 12/10.

No. 3 Kit (complete with valves, cabinet and gramophone accessories) £14 14 0 or 27/- down and 11 monthly payments of 27/-.

OFFER

Direct Radio Ltd. have established an organisation unequalled for dealing with Mail Order Radio. A postcard will bring you particulars of the New season's goods now on show, together with H.P. terms. Let us know your requirements. We will quote you by return. Deal with Direct Radio Ltd. and experience a new standard of satisfaction.

FOR PROMPT DELIVERY BUY "DIRECT"

CASH, C.O.D. AND EASY PAYMENT EXPRESS ORDER FORM.

To : Direct Radio Ltd., 159, Borough High Street, London, S.E.1.

Please dispatch to me at once the following goods

..... for which (a) I enclose (b) I will pay on delivery (cross out line not applicable) £

NAME

ADDRESS

Amateur Wireless 8/9/32

Mention of "Amateur Wireless" to Advertisers will Ensure Prompt Attention

THE
LAST
WORD
IN
KIT
SETS

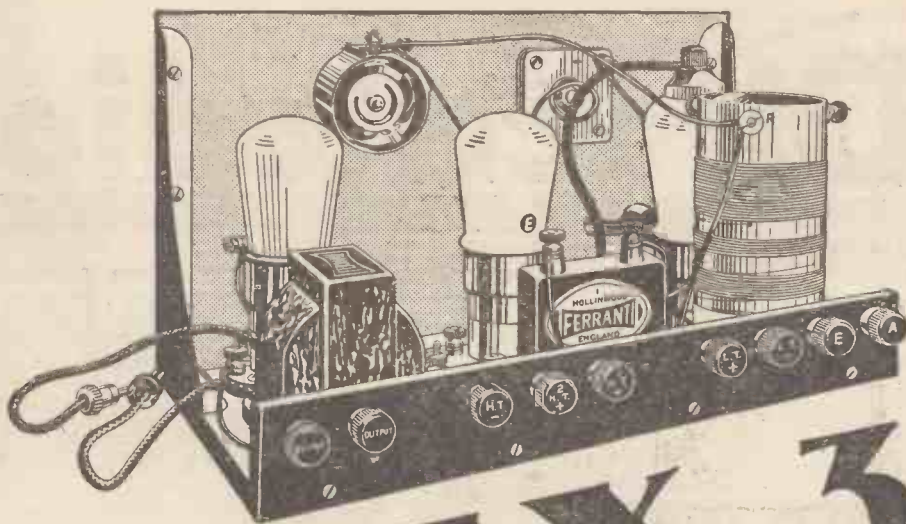

THE MINIMAX 3

Designed
by
Ferranti,
and
only

Minimum Cost — Maximum Quality. An ingenious PATENTED KIT that you can assemble in an hour or so! A battery SG3 Receiver within the reach of every purse.

Not claimed as the "best ever" — super quality cannot be got at so low a price — but the "Minimax" is the product of a House famous for giving the last ounce of value for money.

The motto of the "Minimax" designers has been to obtain the maximum performance at the minimum cost. No low-priced kit set has ever been simpler to construct, and no kit set at anything like the price can give such profound satisfaction.

Don't delay. Ask your dealer for free Constructional Chart, or write direct, enclosing 1½d. postage.

MAKE THE

FERRANTI

MINIMAX 3

40%

FERRANTI LTD.,

M. Charts Dept.,

HOLLINWOOD,

LANCASHIRE

Without Valves, Batteries, Cabinet,
Panel and Baseboard.

You will Help Yourself and Help Us By Mentioning "A.W." to Advertisers

Our Broadcast Critic

TALKS ABOUT

A PASTORAL COMEDY



FLOY PENRHYN,
who broadcast last week

A PASTORAL comedy naturally makes an ideal summer broadcasting. When it is the finest pastoral comedy in existence—Shakespeare's *As You Like It*—little more can be desired.

As I listened to it, not having heard the play for a considerable period, I was struck with the number of familiar phrases that have come down to us from it. "Thereby hangs a tale," "All the world's a stage," "Neither rhyme nor reason," "Love at first sight," "good wine needs no bush," "God rest you merry"—even to "well met" and the expression "so so." All these belong to *As You Like It*. Also the charming lyrics, "Under the Greenwood Tree," "It was a Lover and His Lass," and "Blow, Blow, Thou Winter Wind."

It is, by the way, definitely wrong to pronounce the final word of this last title *wynd*. Shakespeare wrote "Blow, Blow, thou winter *winn*d, thou art not so *un*kynd," thereby making use of an imperfect rhyme—a powerful vehicle for effect. He proves it in the next stanza. He wrote: "Though thou the waters *warp*, thy sting is not so *sharp*. Moreover, a little later, he skits at clattering rhymes by making words like hind, find, kind, bind, rind, etc., rhyme with *Rosalynd* whose name he distorts for the purpose. A small point, but one that would not miss any keen student of Shakespearian productions.

I thought everyone in the cast excellent, but I cannot refrain from making special mention of Gwen Ffrangcon-Davies, whose playing the part of *Rosalind* was delightful. She was not afraid to play it fast—just what it wanted.

One of the remarkable performances of the week was Ravel's piano concerto for left-hand, played by Paul Wittgenstein. This one-armed and remarkably plucky pianist has had concertos written specially for him by Strauss, Korngold, and Prokofiev, who have all realised that Wittgenstein's misfortune has created an artistic possibility. Music written for the left hand naturally alters the outlook of any composer; it is bound to be a thing apart.

Personally I was not an admirer of the Ravel concerto, but I admired the pianist's dexterity in its performance.

Did you hear Marcel Dupré play the Bach organ toccata on Sunday afternoon? Fine! He is one of the very few organists for whom I have respect. I really *did* enjoy that toccata. The next time will M. Dupré kindly give a Bach recital? I say that because I did not care for the rest of his programme. His own Spinning Song made me think of the "Bee's Wedding," only I thought the Queen Bee had turned up to forbid the bans!

Alec Shaw's bird-imitations interested me considerably, mainly because he displayed considerable ornithological knowledge. It is one thing to hear someone imitate a few bird-calls as a sort of freak music-hall turn; it is quite another when he takes the trouble to describe bird-life. The imitation of a parrot screaming was one of the cleverest, I thought; also I was greatly taken by the representation of a nightingale with musical accompaniment. These sort of turns are amusing and instructive at the same time. What about fish-noises? Can anybody imitate a conger eel?

PROGRAMME POINTERS

The advisability of long programmes devoted to the music of a single composer is doubtful. Wagner, of course, excepted. He certainly is better by himself; in fact he upsets any miscellaneous programme. The same number of works of any one composer can be rendered in a season by combining him twice with another composer. This has already been done in a Bach-Handel and a Mozart-Haydn programme. Personally I should always separate Bach from Handel and Mozart from Haydn. On the other hand, a Bach-Brahms, a Schumann-Tchaikovsky, a Beethoven-Mendelssohn, a Schubert-Handel programme would be far more satisfactory to the majority of listeners. The fact that the Queen's Hall is packed for a Bach concert proves very little; the Promsters will congregate for almost any good music. On the other hand there is a great deal to be said against whole concerts (by wireless) representing a single author. In any event there is a sameness about the Proms; the programmes look this year much as they have looked for the last twenty. To divide a number of the programmes into two parts, contrasting the composers with care, would be simple to effect from the B.B.C.'s point of view, and effectively simple for the listener.

Floy Penrhyn always gives a good show, but I make a suggestion. I think better sketches must be written for her. "Yachting" was rather weak in parts. It seems to me that Miss Penrhyn's style, always entertaining, rather tends to show up weak lines. Anyone who entertains by monologue (presumably giving the listener both sides of a conversation) runs the risk of dullness even to a point of failure unless the actual script is strong everywhere. I admire Miss Penrhyn's style; she always amuses me. On the other hand, last Saturday, I thought her better than the material she broadcast.

There was a good ventriloquist that same evening. His name was not in the programme, but I understood it to be A. C. Astor. He is new to me. I thought his ventriloquial talk with his "chauffeur" full of good lines. I liked the remark about pedestrians being divided into two classes—the quick and the dead—not a new one! if a hiker was not one he would soon be the other.

Senator Murphy began well. His slight suggestion of intoxication and consequent difficulty with long words was exceedingly funny—when he *began*. Unfortunately he let himself down later in his broadcast by weak lines. I hope to hear him again, but I also hope he will build up his matter to a climax. An anti-climax is a sad thing in a vaudeville turn.

Payne and Hilliard—very good, but a trifle on the suggestive side. Keep it clean, please! *Quite* clean! Read the Latin inscription in the entrance hall of Broadcasting House as you enter for your next broadcast!

Roy Ping's sound impressions were very clever, the sound of the tube, railways especially. I feel inclined to reiterate my pointer of a week or two ago. Why not have a recital of these impressionists? Let us have a whole programme of them and consequently an opportunity of comparison. Then we might give them a holiday for a little while.

WHITAKER-WILSON.

A concert of Promenade favourites will be given from Belfast on September 17, by Kathleen Daunt and the Belfast Wireless Orchestra.

THE old myth that large power output cannot be obtained with a battery-driven set is now exploded. New power valves which, taking only 2 volts on the filament, and needing not more than 120 volts high-tension, are capable of handling really useful grid swings and giving a good power output, have enabled battery sets to be built which are comparable enough in output with mains-driven articles.

A radio-gramophone which has not a really good output is not a useful instrument, for it will not compare in performance with a good-quality acoustic gramophone. One of the big advantages of electric reproduction, easy variation of volume, is not of so much account if the volume and tone are not up to the standard set by acoustic gramophones. With the old types of 2-volt battery power valve it was not possible to get a really good output.

The Modern Circuit

Now, with the new valves and with new set components that make a surprising difference in performance, it is possible to produce a four-valve radio-gramophone which has exceptional range, which has ganged tuning and so is selective, yet easy to control, and which, on the gramophone side, can rank with many of the mains driven sets on the market and available for home construction.

The "Home Radio-Gram" described here and illustrated by the photographs is aptly described by the title. It is a fine outfit for the home.

It is a good set with the kind of range one expects nowadays from a modern four-valve circuit with a screen-grid stage. It is easy to tune and so, although the expert member of the family can display his skill in ether searching, the other folk can get at least half a dozen stations, without any critical tuning and by turning only the main control knob.

Gramophone Results

A touch of the switch changes the set from radio to gramophone and then the electric reproduction of records is equal

Your HOME RADIO-GRAM

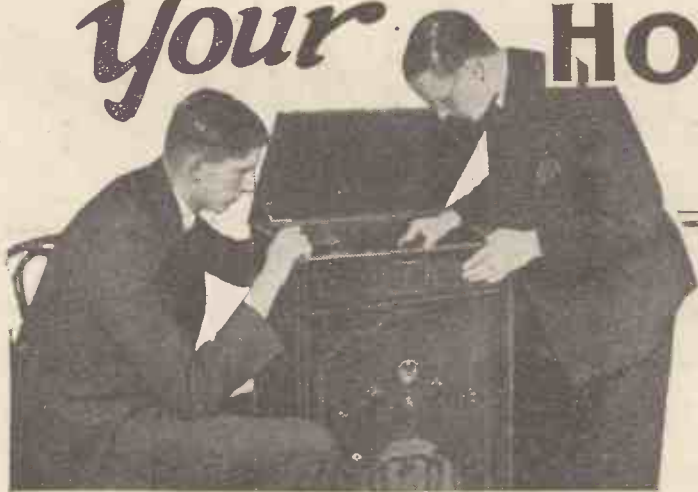

Battery user
and radio-gr
description
who have no
simple set t

to that given by really good commercial sets. There is a handy volume control on the motor-board, so that the output of the low-frequency side, when on gramophone reproduction, can be controlled.

Battery Economy

The proud owner of a big mains-driven radiogram will not believe that such a good output is obtainable with only 120 volts obtained from a dry high-tension battery. Ordinary battery valves are used, the output valve being a triode, and an accumulator must be used for low-tension supply. If you have the mains, and are interested only in a set which uses battery valves, which can have its low-tension accumulator trickle charged and which can take its high-tension from a standard 20-milliampere type of high-tension unit, then the "Home Radio-Gram" is just the thing.

It is a revelation for the man who has no

mains supply and who is far away from reliable charging facilities, so that even a high-tension accumulator is not possible. The high-tension consumption can be kept down to 10 milliamperes, and with modern speakers this is adequate to give a really fine power output.

The "Home Radio-Gram" is as easy to build as it is to work. The photographs give a good general idea of the construction and it will be seen that the receiver itself is mounted up in the most straight-forward way on a flat baseboard.

There is actually no panel, the front of the

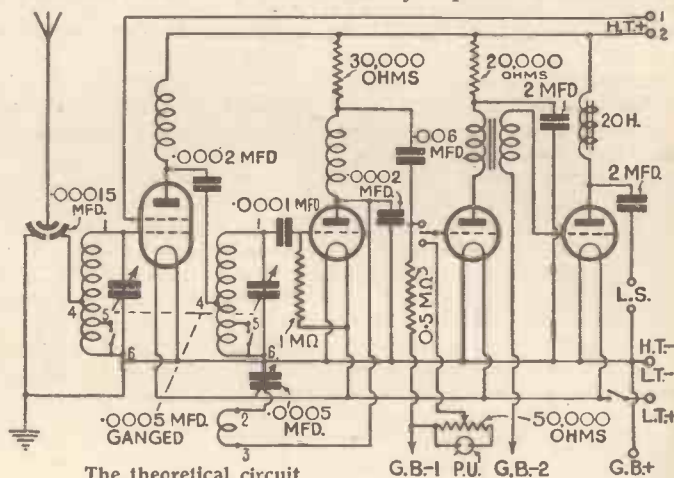

The theoretical circuit

COMPONENTS REQUIRED FOR

- .00015-mfd. bakelite dielectric differential reaction type condenser (Formo, Telsen, Lotus, Igranic, Polar, Utility, J.B.).
- Baseboard, 18 in. by 14 1/2 in. (as supplied with cabinet) (Camco).
- Piece of aluminium foil 17 in. by 10 in. (Peto-Scott).
- Four brackets to specification (Peto-Scott).
- Uni-control dual condenser (British Radiophone, J.B., Utility, Polar).
- Dual-range aerial coil and H.F. coil with reaction (Slektun, Lissen).
- .0005-mfd. reaction condenser (Lissen, Readi-Rad).
- Low-frequency transformer (Lissen Hypernik, Slektun, Telsen, Varley, Atlas, R.L., Igranic).
- 20-henry output choke (Bulgin, Lissen, Heayberd, R.L., Tunewell, Varley, Atlas, Regentone, Ferranti, Slektun).
- High-frequency choke (Lissen Disc, Igranic, Wearite, Readi-Rad, Telsen, Lewcos).
- Screened high-frequency choke (Wearite, Bulg.n.).
- Four 4-pin valve holder (Lotus, Benjamin).
- Combined radio-gramophone (Camco).
- Two 2-mfd. fixed condenser (T.C.C., Dubilier, Ferranti).
- One .0001-mfd. two .0001-mfd. fixed condensers (Lissen, Igranic, Wego, Formo, 20,000-ohm, 30,000-ohm) (Graham Farish, Lewcos, Bulg.n.).
- One 1-megohm grid leak condenser (Dubilier).
- One 1/2-megohm grid leak condenser (Telsen, Sovereign).
- Push-pull 3-point speaker (Readi-Rad, W.B., Telsen).
- One grid-leak holder (Lissen, Wearite, Dubilier).
- One terminal block (Lissen, Wearite, Dubilier).
- Pair G.B. battery clip (Lissen, Colvern, Igranic).

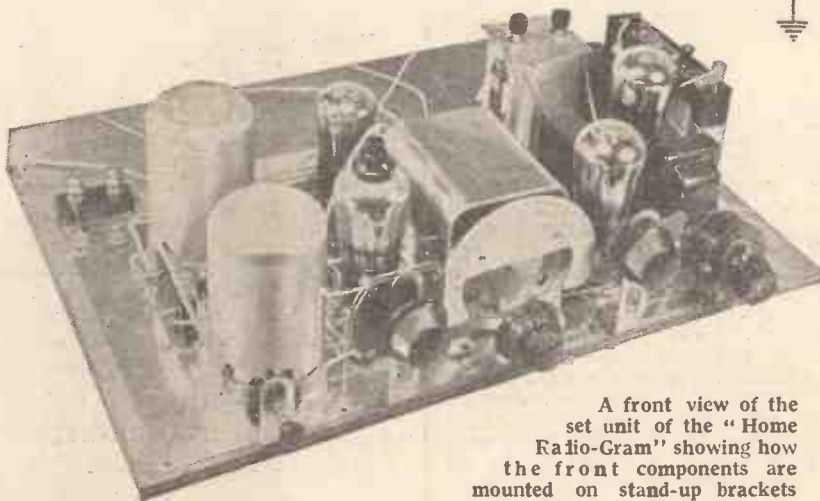

A front view of the set unit of the "Home Radio-Gram" showing how the front components are mounted on stand-up brackets

RADIO-GRAM

are not so well catered for in the way of large sets
gramophones as are mains users, and this constructional
of a fine battery-driven radiogram will interest those
mains supply available or who, alternatively, want a
to work with battery valves and a mains eliminator

cabinet acting as a cover for the set. The
five controls which project through to the
front do not have to be clamped to the
front of the cabinet as four of them are
mounted on L-shaped brackets and the
fifth part is the 2-gang condenser.

Volume Control

The set is mounted up in the conventional
type of radio-gram cabinet. The pick-up,
turntable drive and volume control are
mounted on the motor-board. The speaker
and batteries are carried in the compart-
ment beneath the receiver.

The set can be treated as an entirely
separate unit and, indeed, can be made up
for use with any other type of radio-
gramophone equipment.

Before starting on the constructional
work you should examine the layout and
the theoretical circuit diagram, for both
these diagrams show just why the "Home
Radio-Gram" is a really good outfit.

The circuit is of the straight four-valve
type, having a screen-grid stage, leaky
grid detector, resistance coupling to the
low-frequency valve and transformer
coupling to the power valve. The two
tuned circuits are ganged by the two-gang
condenser, so that there is virtually one-
knob tuning. The coils used are screened,
and true ganging is assured by a small
section of the two-gang condenser, working
independently and being controlled by a

knob concentric with the main knob.
A differential condenser is used to couple
the aerial to the tapping point on the
aerial coil, and this provides a very nice
control of selectivity and volume.

Both coils are tapped and the coupling
to the high-frequency coil (in the grid
circuit of the detector) is by a .0002 micro-
farad condenser. Set users who do not
wish to worry about the technicalities of
the ganging and high-frequency coupling
can rest assured that the most efficient
arrangement has been chosen for use in
the "Home Radio-Gram."

Circuit Details

The first L.F. valve is adequately de-
coupled by a 20,000-ohms resistance and a
2-microfarad fixed condenser. There is
also a detector by-pass of .0002 microfarad,
which is one of those useful little com-
ponents which ensures smooth reaction.
The coupling to the first low-frequency
valve is through a .006 microfarad fixed
condenser, a 1/2-megohm leak being used
when the set is amplifying on the radio
input. The radio-gram change-over switch
is of the simplest possible nature, being
a 2-pole double-throw rotary switch.

In the centre position the whole set is

switched off. When turned to one side
the low-tension circuit is made and the
set is switched to radio, and when in the
other position the set is switched to gram-
ophone, the pick-up volume control being
automatically brought into circuit.

Simple Switching

To simplify the switching the high-
frequency and detector valve filaments
are not switched off when the set is in the
gramophone position, and it is advisable
to remove these valves if the set is used
mainly for gramophone reproduction. In
the ordinary way, however, the extra
complication in the switching is not
justified, as the additional filament drain

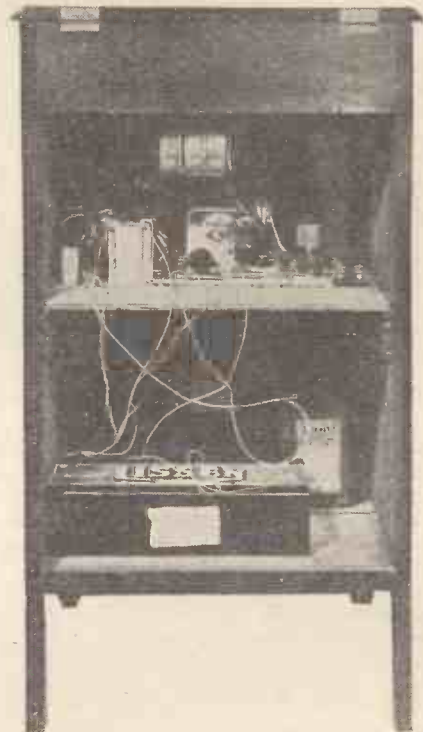

This rear view of the complete radio-
gramophone shows the positions of the
set, batteries and speaker

YOUR "HOME RADIO-GRAM"

W.B., Telsen, Lissen,
off-switch (Bulgin).
condensers (Telsen, Lissen,
ti, Wego).
002-mfd., one .006-mfd.
T.C.C., Dubilier, Telsen,
Graham-Farish).
spaghetti resistances
Telsen, Lissen, Varley,

Connecting wire and sleeving (Lewcos, Jiffilix,
Quickwyre).
Four yards thin flex (Lewcoflex).
Two spade terminals marked H.T.—, H.T.+
(Belling Lee, Clix, Eelex).
Six wander plugs marked H.T.—, H.T.+1,
H.T.+2, G.B.—, G.B.—1, G.B.—2. (Belling Lee,
Clix, Eelex).
Three feet single screened tubing (Goltone).

ACCESSORIES

with wire ends (Lissen,
leak (Lissen, Dubilier,
orting switch (Bulgin,
r (Readi-Rad, Bulgin,
Telsen).
Lissen).
(Bulgin).
potentiometer (Varley
c, Wearite, Bulgin).

Cabinet (Camco type "Popular").
Gramophone motor (Cabaret).
Pick-up (Clarion Radio, Lissen, Bowyer-Lowe,
B.T.H., Marconiphone).
Loud-speaker (Igranic, R. & A., Rola, Motor,
W.B., Lancheater, Epoch).
120-volt H.T. battery (Lissen, Ever Ready,
Pertrix, Siemens).
9-volt G.B. battery (Lissen, Ever Ready, Pertrix,
Siemens).
Accumulator (Lissen, Ever Ready, Exide,
Fallor, C.A.V.).



The neat layout
of the set unit is
obvious. Note the metal
sheet on the wooden baseboard

“YOUR ‘HOME RADIO-GRAM’ ” (Continued from preceding page)

is small and the length of life of the high-frequency and detector valve is not seriously impaired.

There is plain transformer coupling to the power valve, but a good point is the provision of a choke output circuit from

switch, selectivity control, reaction control and the double-purpose on-off and radio-gram switch. The two-gang condenser, which, of course, needs no additional support, is the central component.

Taking into account the fact that the

a great help in construction as it can be used as a mounting template as well as an accurate wiring diagram.

In next week's issue a further article will describe the salient construction points of this fine outfit for radio-gram enthusiasts.



Another rear view of the set unit. Compare this with the layout and wiring guide given below

SHORT-WAVE CIRCUITS

I HAVE often advocated the use of a powerful low-frequency amplifier for short-wave work and it is really surprising to note the advantages which can be gained by boosting up the low-frequency end of the receiver. I am at present using an arrangement consisting of an adaptor in which is incorporated one stage of transformer-coupled L.F. amplification. This is used in conjunction with a receiver using one transformer and a resistance-capacity stage, thus giving a total of three L.F. stages, making a really powerful four-valve short-waver. Of course, an adaptor of this type could not be used successfully with every type of receiver, as, for instance, it would most likely lead to trouble when the receiver itself incorporates two transformer stages.

A combination of transformer and resistance stages can generally be used successfully without introducing any complications and the outfit in question has proved to be completely stable, giving at the same time really enormous volume with very respectable quality. The extra volume available is extremely useful for landing weak stations when conditions are not all they might be! Apart from any question of the super-heterodyne arrangement, it would appear that the ideal short-wave receiver should incorporate one stage of untuned H.F. amplification plus as powerful a low-frequency amplifier as possible.

Tuned H.F. stages in a short-waver can be rather a nuisance and they do not give very much amplification—below 25 metres their amplification appears to be practically nil and unless extremely carefully designed they are liable to develop various unpleasant features.

M. B.

the anode of the power valve to the speaker.

This output circuit insulates the speaker from the steady anode current, and if the “Home Radio-Gram” is used with a mains eliminator, instead of batteries, there is the additional advantage that the speaker and its connecting leads are entirely disconnected from the high-voltage supply. If a D.C. mains unit is used with the “Home Radio-Gram” this is a very great advantage, while even with A.C. units it is an additional protection against the breakdown of transformer insulation.

“Home Radio-Gram” incorporates a modern four-valve circuit, the cost is very low. A list of parts required is given in the accompanying panel. This components list, in conjunction with the scale reproduction of the layout given here, will enable experienced set builders to start the constructional work right away.

A Full-size Blueprint

A full-size blue-print is obtainable, however, price 1s. 6d., post free, from the Blueprint Department, AMATEUR WIRELESS, 58-61 Fetter Lane, E.C.4, and this is

Simple Layout

Now examine the photographs of the set and see how the circuit layout is arranged. The flat baseboard supplied with the radio-gram cabinet is used, part of this being covered with metal foil, so that there is adequate earthing for the whole set, much of the wiring in this way being obviated, common returns being made through the foil. The central component of the set is a two-gang condenser. Looking at the set from the front, the high-frequency and detector components are to the left of this, while the low-frequency and power valves, grid bias battery and choke output circuit components are to the right.

Battery Connections

A terminal block at the back carries the aerial and earth terminals, while flex leads direct from the various components are taken to the batteries, and to the volume control on the motor baseboard.

Mounted on small L-shaped brackets at the front of the set are the wave-change

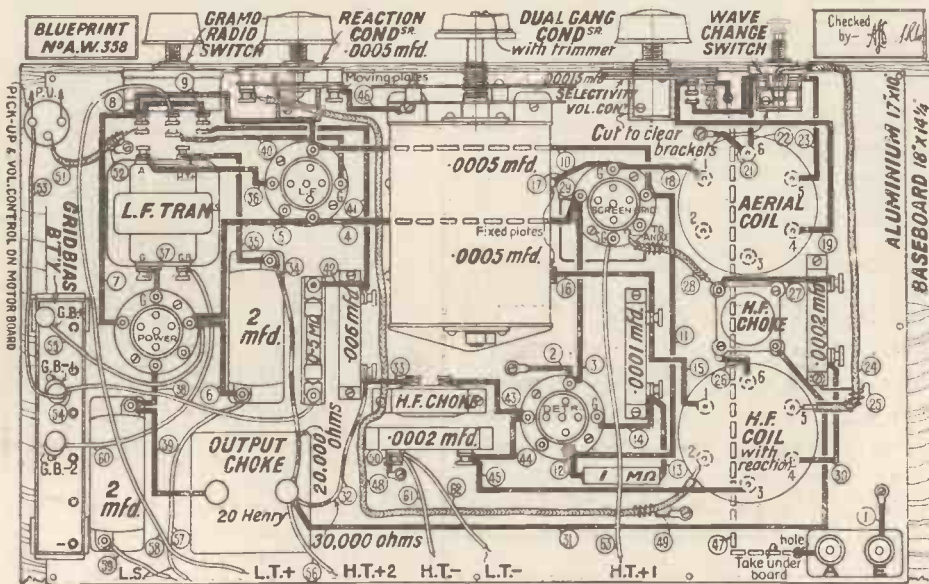

A scale reproduction of the receiver unit : full-size print 1s. 6d. post free

a Thriller



the gang is breaking in

Panels creaking, hinges giving, timber splintering—and the radio “stage effects” that produce these thrilling sounds are but two strong hands twisting the fabric of a new cane basket!

But what does that matter to you when it gives you something akin to stark realism in your radio?

There is another aid to your radio which it is within your own power to choose and use—and that is the pure power of a Lissen H.T. Battery. Notice how it brings out the light and shade of sound. Stage effects come over with realism when you use a Lissen Battery. And it is the longest lasting battery. All dealers sell it. Ask for it firmly by name.

LISSEN H.T. BATTERY

lasts longest and provides a pure high tension current that will give stage realism to your radio drama!

LISSEN LIMITED, WORPLE ROAD, ISLEWORTH, MIDDLESEX

Please Mention “A.W.” When Corresponding with Advertisers



A view down the main hall of the Berlin Show

THIS year marks several important developments at the German Radio Show. It is the ninth of its kind, but it is the first at which the opening ceremony, which was broadcast by all German stations, was interfered with by political demonstrations from among the participants. It is also the first that is not larger than its predecessor.

This year's German radio exhibition is also the first to find the German radio industry not expanding. Exports have gone down badly. Official figures state that exports to England alone are down by 85 per cent.

Cheaper Sets

But this show is not only remarkable for these facts. It is also the first German exhibition with sets even cheaper still, and quality still greater. A five-valve super-het with short-wave adaptor and moving-coil speaker, all-mains driven for under 200 marks (under ten pounds at par)! The valves, of course, cost extra. But even with them the set is still cheap.

The general trend in German set building is towards the super-het. Last year there was hardly one to be seen. This year the number of firms not exhibiting a super-het are few and far between. Personally, I give the Telefunken-Siemens-Aeg super-het the laurels. The Telefunken and the Siemens super-hets have the same chassis but different tuning controls and different cabinets.

Another set, made by the A.E.G., is slightly different, also having a completely different tuning control. Dials are things of the past in Germany. The Telefunken tuner consists of two vertical lists of station names and kilocycles. The stations' names can be added at will. The A.E.G. tuner has a similar arrangement only here four vertical strips take the place of the old dial. A light from the interior of the set is moved up and down the "dial" by turning the tuning control. The moment the light streak evenly illuminates the station name the set is tuned to that station.

Automatic volume control, using variable-mu valves, is another entirely new feature of the show. Super-hets, new dials that are not dials any more, automatic volume control, general use of variable-mu

automobile radio, built into the chassis, livening up of home construction during the last few months; such is the German Radio Show. Moving-coil speakers, with German permanent magnets are another new development! Hitherto nearly all good permanents used British magnets.

The Short-waver

Berlin's new ultra S.W. transmitter is on view. It operates with 15 kw. in aerial telegraphy and 4 kw. 70 per cent. modulation telephony and television. I think I am right in saying that this is the most powerful 7-metre wavelength transmitter in the world. The aerial is on the top of the Berlin Funkturm 140 metres above the town. The transmitter can be either modulated with telephony or with television up to a breadth of 300,000 cycles! This frequency breadth permits of over 120 scanning lines.

The Heinrich Hertz Institute of Berlin has a special auditorium seating 300 persons. Here electric musical instruments are demonstrated at regular intervals. The



Part of the television exhibit—apparatus for televising talkie films

AT THE BERLIN EXHIBITION

An eye-witness account of the great Berlin Radio Exhibition which this year includes a special short-wave and television section

valves, excellent three circuit sets with sharp tuning cut-off at 9 kc., tone-correctors in nearly all better classed sets, super-hets with S.W. attachment for under 200 marks (Schaub), cheaper valves, down by 10 to 20 per cent., cheaper sets, only two makes, or perhaps, three of portables, one make of

Trautonium and the Neo-Bechstein piano are by far the most interesting. The Trautonium now commercially developed by Telefunken and on the market for something like 750 marks can be played in conjunction with any L.F. amplifier and loud-speaker. Large amplifiers and big double loud-speaker give best results in large halls. The Neo-Bechstein piano is a grand piano combined with radio receiver and gramophone pick-up and is played electrically. The Vierling electric piano was also demonstrated as was the Hellenion an instrument similar to the Trautonium. The Trautonium is played by pressing on a wire, this wire changing the resistance in the grid circuit of a Thyatron setting up the required fundamental oscillations.

New Television Ideas

Television takes up the whole two-thirds of a large hall. The German Post Office is responsible for the show. Telefunken have a transmitter on view, together with a combined radio and television receiver using a cathode-ray tube. Tekade of Nürnberg have receivers using the now well-known mirror screw. They are also at work on a new system of cathode-ray tube receiver. The Fernseh A.-G. are well represented. They have a mirror screw receiver, then the older type of Nipkow disk receiver with magnifying lens, and several transmitters on view. The most interesting of the transmitters, they recently supplied the German broadcasters with a complete television transmitter for films, is the new all-light transmitter. All scenes to be televised are filmed in the usual way with a film camera, the film then passes through special developers and fixing baths so that it is ready for projection exactly 15 seconds after it has been taken. The negative is turned into a positive in the usual manner in the amplifier.

Interesting Films

Thus daylight television in bad light (in as bad light as our new cameras and sensitive films will permit) is possible. The sound can be recorded on the same strip of film and thus television in all conditions is now possible with as many as 120 or more scanning lines, this, of course, giving great detail.

The German broadcasters have arranged an interesting show of paintings and sculptures by well-known artists who have chosen broadcasting as a theme. They also have two interesting films on show, giving listeners and the general public an insight into the daily routine of a broadcasting station (Bavarian stations and Emelka film company) and a film made in Berlin showing broadcast transmission and reception in 1923 and in 1932.

**LISSEN
CONDENSERS
REDUCED TO 6^{PD}**



The only **FULL SIZE**
Condenser selling
at **6^p** and
the only **6^p** condenser
selling at **6^p** that
requires **NO SOLDERING**
into circuit!

**LISSEN
GRID LEAKS
REDUCED TO 6^{PD}**



Full size and silent
in circuit. Unvarying
no matter what the
conditions or the
current load!

LISSEN FIXED CONDENSERS AND GRID LEAKS

LISSEN LIMITED, WORPLE RD., ISLEWORTH, MIDDLESEX

Mention of "Amateur Wireless" to Advertisers will Ensure Prompt Attention

PRACTICAL HINTS AND TIPS

A number of useful hints and tips which will interest users of all types of sets, which facilitate operation and which enable you to get better results

SOME sets fitted with .001-microfarad reaction condensers do not give oscillation over the entire waveband, as there is not sufficient capacity to couple the reaction on both medium and long waves. There is no need to fit a new variable condenser, in many cases, or to alter the reaction coil winding. A .001-microfarad fixed condenser connected across the reaction condenser terminals will increase the minimum capacity

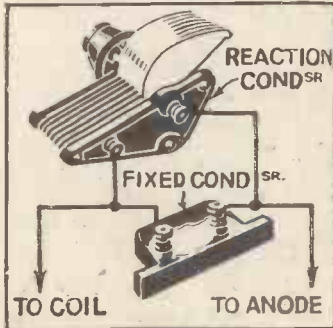

Fig. 1. Increasing the minimum capacity of a reaction condenser by putting a fixed condenser in parallel with it

and may enable oscillation to be obtained over the full wavelength scale without causing the set to burst into oscillation when the tuning condenser is at minimum. (Fig. 1.)

WHILE tone-changer circuits are useful in enabling the tonal reproduction to be varied at will, if the natural tone of reproduction, on local stations, is not satisfactory, then it is better to correct this at source, rather than add a filter circuit to remove the deficiency. Painting the cone of the speaker with a dope such as anylacetate will often make a great difference to tone, especially if the cone is a thin material with a number of resonant points.

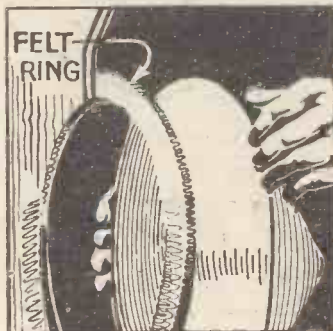

Fig. 2. A felt ring should be glued to a speaker baffleboard or to the front of a transportable set, so that the speaker cone can be mounted against it

TO prevent resonance when a simple type of cone speaker is butted up against the front of a portable-set cabinet, or of an

ordinary baffle board, do not let the edge of the cone touch the wood, but put a ring of felt around the edge of the baffle board hole. This felt can be cut from a plain sheet, but a more economical way is to use thin strips of felt of the draught-exclusion type, bending this to shape round the hole in the board. It should be glued down and the edge of the cone pressed firmly against it. (Fig. 2.)

SOME types of A.C. gramophone motor will run just as well at half-speed as at full speed, if not spun sufficiently fast when starting up. This point should be noted. Motors of this type will generally run equally well backwards or forwards, and this is important because if the motor accidentally starts in the reverse direction a record may be damaged by the needle digging into the groove.

IN a large set there are many occasions when, although a mid-point tapping is required across a voltage supply, it is really a waste to use a variable potentiometer. Two fixed resistances in series with the tapping taken to the join point of the

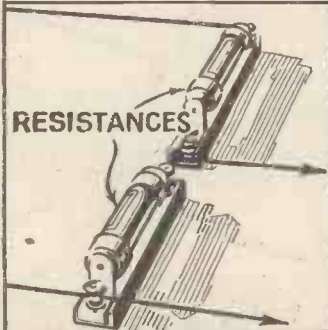

Fig. 3. Using two resistances in series to provide a mid point, in place of a variable potentiometer

resistances, are a good substitute for a variable potentiometer. If the resistances are of the same value then the tapping point will be half that across the outer ends while intermediate voltages can be obtained by having resistances of different values. There is no need to have resistances carrying a heavy current, unless the potentiometer arrangement is for cutting down hum in the L.T. circuit of mains valves. Nevertheless, it is worth while having wire-wound resistances to prevent breakdown, which would upset the voltage obtained on the centre tapping. (Fig. 3.)

A SET which needs a decoupling device does not necessarily have to be altered extensively to fit the wire-wound resistance and the earthing condenser. The anti-motor-

boating circuit can be fitted outside the set, provided that a separate high-tension tapping is available for the valve in which the decoupling is to be fitted. Simply put a wire-wound resistance in series with this tapping and connect a 2-microfarad fixed condenser from the end of the resistance remote from the high-tension supply, to some earthed point, such as high-tension or low-tension negative.

SETS fitted with plain tuning can be converted to band-pass without altering the whole layout to fit a ganged condenser. Separate condenser controls can be used for both circuits, but the two condensers must be screened, for if there is any stray coupling between the sets of vanes the bandpass coupling will be disturbed.

WHEN an aerial down lead comes vertically down to the lead-in tube, a little trouble is often experienced in rain running down the wire and getting into the house through the tube. The remedy is simple. Let the lead-in hang slack so that the wire dips below the level of the tube, so that rain

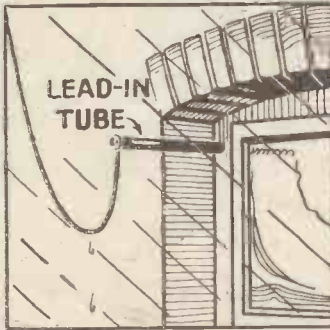

Fig. 4. An arrangement for the aerial lead-in, so that rain is not carried into the house

runs off the wire, and cannot percolate to the small hole of the lead-in tube. (Fig. 4.)

EARTH connections in a set are frequently made to screws which clamp down a metal lining to the baseboard or which support a vertical metal screen. Take care that the wire makes good contact with the screen or metal foil and if there is any lacquer or covering, this should be removed before the wire is clamped down.

A SPARE fixed condenser (.001-microfarad will do) fitted between the aerial terminal and the aerial lead is a worth-while precaution on sets which take their high-tension from D.C. mains. A.C.-driven sets do not need this safeguard as there is a transformer between

the mains supply and the set, and the insulation between the primary and secondary of this mains input is a protection against a mains "short."

IN a gramophone set, it is a great waste for the H.F. valve to be running while the set is working on gramophone reproduction. The gramophone change-over switch should cut out the filament circuit of the H.F. valve when in the gramophone position.

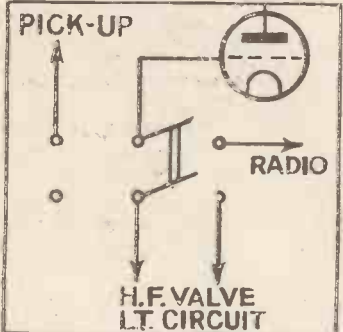

Fig. 5. Connections for a double-pole radio-gram switch which enables the H.F. valve filaments to be cut out of circuit in the gramophone position

This can quite easily be done by a system of connections, as shown in Fig. 5. The two-way switch changes from radio to gramophone and switches off the L.T. supply to the screen-grid valve.

ACCUMULATORS can easily be charged from A.C. mains with an L.T. type metal rectifier, a tapped mains transformer, and a resistance to control the charging rate. The scheme of connections is shown by Fig. 6. The resistance should have a value of about 7 ohms, and the transformer should be tapped to suit the local mains supply and to have secondary-winding output of the right voltage to suit

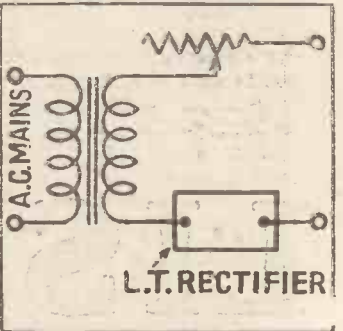

Fig. 6. The theoretical circuit of the L.T. charger described in the accompanying paragraph

the metal rectifier used. A charger of this type for A.C. mains should give an output variable between 2 and 6 volts using a suitable rectifier.

The Greatest Constructional Chart ever published

FREE

HOW TO BUILD THE LISSEN

SKYSCRAPER 3 KIT



KIT COMPLETE WITH

Metallised S.G. Valve - High Mu Detector & Economy Power Pentode

Lissen have published a 1/- Constructional Chart, giving the most detailed instructions ever printed for the building of a wireless set. Every part, every wire, every terminal is identified by photographs. Everybody without technical knowledge or skill of any kind can SAFELY and with COMPLETE CERTAINTY undertake to build this most modern of radio receivers from the instructions given and the parts Lissen have supplied.

This new LISSEN SKYSCRAPER KIT SET is the only one on the market that you can build yourself employing Metallised Screened Grid, High Mu Detector, and Economy Power Pentode Valves. Around these three valves Lissen have designed and produced a home constructor's kit, the equal of which there has never been before. It is the only battery set delivering such power—yet the H.T. current consumption is far less than the average commercially designed three-valve sets.



WHAT YOU CAN BUILD

You buy the Lissen Skyscraper Kit complete with valves—a Lissen Metallised S.G., a High Mu Detector, and a Lissen Economy Power Pentode Valve—and the price is only 89/6. Or you can buy the Lissen Walnut-Consolette Skyscraper Cabinet and Loud-speaker combined, as illustrated. It holds all batteries and accumulator and loud-speaker as well. It makes everything self-contained. A special Lissen Pentode Matched Balanced Armature Loud-speaker of great power is supplied with the cabinet and the price of the Skyscraper Kit, complete with valves, and this cabinet and loud-speaker, is only £6 5s. For this you will possess a receiver which has no equal.

THERE IS A FREE COPY OF THE CHART FOR EVERY READER OF "AMATEUR WIRELESS"—ask your radio dealer for yours, or FILL IN COUPON BELOW.

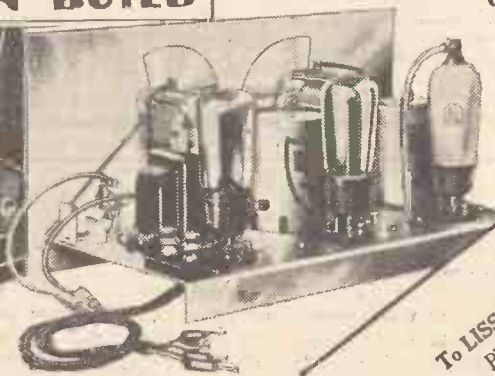

89/6

POST THIS COUPON

COUPON

To LISSEN, Ltd., Worpole Road, Istedworth, Middlesex.
Please send me FREE copy of your 1/- Skyscraper Chart.
Name
Address

Mention of "Amateur Wireless" to Advertisers will Ensure Prompt Attention

IN MY WIRELESS DEN

WEEKLY HINTS—

CONSTRUCTIONAL



& THEORETICAL

By

W. JAMES

VALVES AND GANGING

VALVES have different values of capacity. It is, therefore, usually necessary to re-gang a set fitted with a multiple tuning condenser when a screen-grid or detector valve is changed.

This might be an easy job, as you might be able to reach the trimmer of the section affected without taking the set from the cabinet.

It is advisable to adjust only the one circuit affected and not to try trimming all circuits. If the detector valve is changed, the end section is the one to be adjusted and you should carefully note the section affected.

Screen-grid valves have varying values of leakage capacity. The result is that a set might be not so lively or just the reverse when a new screen-grid valve is fitted. If it is found that the circuit tends to be unstable when the new valve is fitted, the voltage of the screen should be lowered a little. This usually reduces the efficiency of the valve a little and the general results might be improved.

A point that should be noted is that the detector valve loads the circuit attached to the valve before it. The result is that if a new detector valve is fitted the load may be less than formerly. This will tend to make the preceding stage more lively and in certain cases the circuit might oscillate. A change from a plain to a metallised bulb valve might help stabilise a set. The leakage capacity of the metallised valve might be less than that of the plain type, and this would tend to stabilise the circuit.

TREAT WITH CARE

LARGE tuning coils and those of the unshielded type that have been carefully matched must be handled with care and be so placed in the set that the efficiency is not affected.

Certain makes of band-pass tuning coils are not screened. If, therefore, the unit is fitted in a set and one section is near a metal object, such as a screen or tuning condenser, this section will have too low an inductance in comparison with the other section.

This is because the inductance of a coil is reduced by metal situated near it. A unit which is out of balance cannot be tuned over the whole range of a gang-tuning condenser. The result is that when the coil unit is fitted in a position where the matching is upset, the tuning is broad and signal strength poor. There are many instances of circuits which are ganged correctly over a part of the tuning scale.

The trouble here is that one of the

elements is not satisfactory, and careful testing is necessary to discover the fault. A tip worth noting is that the inductance of a coil can be reduced by placing a piece of metal near it. You might suspect that one section of a two-coil unit is out of gang.

Its inductance can be reduced by placing a piece of metal near it and I have seen sets matched by fixing a small piece of copper or aluminium in a suitable position near a coil. The metal is earthed.

BETTER SMOOTHING

A MAINS set, or a set fed from a mains unit, may be noisy even though the smoothing apparatus is ample from the point of view of eliminating hum. And you may try a set in one place and find it satisfactory as regards quiet operation, but noisy when tried on different mains.

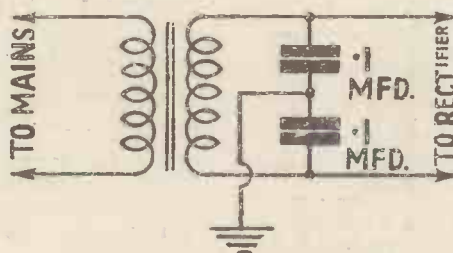
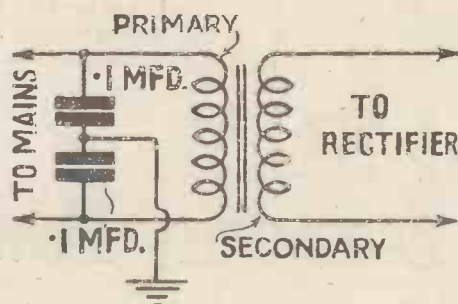

These two systems of improving the smoothing in a mains unit are described in the accompanying diagrams

The fact is that the smoothing apparatus usually takes care only of the rectified output, or in the case of direct current supplies, just smooths the supply and passes a steady current to the set. But some mains are noisy, having fluctuations and high-frequency currents, which pass the main smoothing circuit.

To deal with this a special circuit is usually necessary and it is simple enough. Two condensers are used, as in the accompanying diagrams. The capacities can be from 1-microfarad each. They are joined across the secondary of the transformer, the common terminals being earthed.

If the transformer cannot be got at,

they can be joined across the mains at the set or mains-unit end. Condensers of a high-working voltage must be used and when ordering it is as well to specify the working voltage and whether A.C. or D.C.

A NECESSARY EVIL

SWITCHES are usually looked upon as a necessary evil. There are plenty of good makes about, of course, but there are also types having a poor construction.

In the case of the push-pull pattern, you should see that the action is good. The contacts ought to press firmly against the metal face or against one another as the case may be. If there is the least tendency for the contact to fail to make properly, the results are bound to be poor or noises may be heard. In the case of coil switches, there are many possible faults that occur when contacts are bad.

The usual one is that the set tunes poorly, because a long-wavelength section of a coil is not properly short-circuited. The affected section will weaken signals and affect the tuning.

If you are testing, note that the resistance of a long-wavelength winding is less than that of a medium wavelength. There is also the chance that the switch contacts actually touch, but do not form a low-resistance contact. To discover this it is necessary to examine the springs themselves.

SOME STRANGE NOISES

NOISES are not always due to atmospherics. Quite apart from faults in the set itself, which might easily be of the type that produce noise, there are many other possible causes. One that is frequently met with is really to the advantage of the listener.

The fault referred to is a badly fitting lamp-holder or switch. In many cases the household wiring system has been found to be responsible for the noise, and when, eventually, the wiring and apparatus has been examined, a sad state of affairs has been found to exist.

Some wiring is definitely not safe. Heating of switches and lamp-holders through faulty contacts is really a serious matter and might not be detected until damage had been caused had not noises from the wireless shown that a search was necessary.

You can generally trace a fault by taking all the fuses of sections separately, and it is a good idea to make certain the fuses themselves are making good contact.

Having found a section which has a fault in it, examine switches and lamp-holders. The fault is sometimes found to be due to the plunger of a holder not pressing against the contact of a lamp.

Lissen have built SHIELDED COILS to new standards of accuracy



LISSEN 2-GANG AND 3-GANG SHIELDED COILS

Exactly the same in appearance and design as the Single Lissen Shielded Coils. In each gang the coils are matched to within 1 per cent. Completely shielded. Wave-change switch an integral part of the coils. Further switch position provided for operating filament circuit.

2-GANG Price 17/6
3-GANG Price 26/-



- LOW DAMPING
- HIGH SELECTIVITY
- COMPLETE SHIELDING
- NO BREAK-THROUGH



Accurate in inductance to plus or minus 1%

Inductance variation between coils of the same make presents a very serious difficulty to designers of 1933 circuits. Modern ganged tuning demands exact coil matching. That is why in so many circuits recently you have seen Lissen Shielded Coils specified—and that is why Lissen can claim that the only safe advice for amateurs is to buy a set of Lissen Shielded Coils and use them in every circuit. These coils are matched to within 1 per cent of inductance ; they are definitely interchangeable and their windings are so designed that they are of universal utility.

SINGLE COILS, complete with Shield, each,

6'6

LISSEN SHIELDED COILS DUAL RANGE

LISSEN LIMITED, WORPLE ROAD, ISLEWORTH, MIDDLESEX



THE PICK OF THE MONTH'S RECORDS

A GUIDE TO THE BEST OF THE LATEST RELEASES.

The records reviewed below are a careful selection of the best of the recent issues. It will be noted that criticism is chiefly devoted to the treatment of the music and quality of recording rather than the actual composition.

ORCHESTRAL RECORDS

- A Night at the Hungaria**, 2s. 6d. COL DB872
Colombo and his Orchestra dip into Hungarian, Viennese, and Russian tunes, all as to the manner born. A vocalist gives colour.
- If I Were King (Overture)**, 4s. COL DX361
If you like Suppé, you will enjoy immensely Adam's composition. There's any amount of dash and melody in it.
- Hungarian Rhapsody No. 2**, 4s. DECCA-POLYDOR LY6025
Here is a "different" rendering (by Lilly Gyenes and her Twenty Hungarian Gipsy Girls). The tempo is unusual and there are parts played with delightful abandon.
- Fingal's Cave (Overture)**, 5s. DECCA-POLYDOR CA8090
This is a very stimulating performance by the Berlin Philharmonic under Furt Wängler. The working up to the crashing climax is most skilfully and artistically done.
- Out of the Bottle and Tell Her the Truth**, 4s. H.M.V. C2439
Here is potted melody by the New Mayfair Orchestra. And a very pleasant concoction they make, too!
- Spanish Romance and Nun's Chorus**, 4s. H.M.V. C2435
A very delightful record. These two are extracts from *Casanova*, and the first is finely played by the Grossen Schauspielhauses' Orchestra, of Berlin. The second is a charming vocal effort in German, with Anni Frind as soloist. Definitely a record to buy.
- Love and Life in Vienna and Vienna, City of My Dreams**, 1s. 3d. STERNO 981
Two creditable performances by Mantovani and his Tipica Orchestra.
- At the Tchaikovsky Fountain**, 4s. H.M.V. C2440
These extracts give Marek Weber and his Orchestra plenty of scope. The whole thing is staged in very luxurious fashion and will be immensely liked.

BAND RECORDS

- Dixieland**, 4s. COL DX360
A very good medley by Debroy Scmers' Band. All the best rag-time is there. And how good it all sounds beside most of to-day's dance stuff.
- Songs of Wales**, 2s. 6d. COL DB844
How the Grenadiers romp through them! Fourteen tunes for half a crown!

DANCE RECORDS

- Put That Down in Writing and We've Got the Moon and Sixpence**, 2s. 6d. H.M.V. B6203
These two (by Ambrose and his Orchestra) are skilfully done with more than a touch of American style.
- It's the Biguine and Don't Tell a Soul**, 1s. 3d. STERNO 986
These two fox-trots are played in rattling good fashion by André Astan and his Orchestra.
- Carminito and Carino Gaucho**, 1s. 6d. PANA 25224
Tangoes played in native fashion—and well played too—by Zilo's Tango Orchestra.
- It Ain't No Fault of Mine and Round the Marble Arch**, 1s. 3d. IMP 2720
"Novelty" numbers by Jack Payne's Band. Rather too novel for dancing, I fancy, but his followers may like it.

INSTRUMENTAL RECORDS

- Songs Without Words**, 2s. 6d. COL DB855
These lovely things (No. 1 and No. 20) of Mendelssohn are most appealingly played by Lionel Tertis (viola).

- Dance of the Gnomes (Liszt) and Nocturne in F Sharp Minor (Chopin)**, 1s. 6d. DEC F3053
Another pianoforte record by that young English genius, Wilfred Worden. The first piece is the better.
- Le Cygne and Melodie, Op. 42, No. 3 (Tchaikovsky)**, 4s. H.M.V. DA1143
Here are two superb violin solos by Mischa Elman. The first piece ("Saint Saëns") makes the big appeal; this record is worth while for that alone.

VOCAL RECORDS

- I Know of Two Bright Eyes and Eily Mavourneen**, 2s. 6d. COL DB863
If ever a singer lifted two songs above their sphere, Heddle Nash does so on this record. You'll certainly never hear them sung better.
- The Lute Player and Onaway, Awake, Beloved**, 2s. 6d. COL DB857
Not only a fine piece of singing, but a fine dramatic performance as well. "The Lute Player" is most stirring. Harold Williams is the vocalist.
- My Dear Soul and In an Old-fashioned Town**, 1s. 6d. DEC F3032
These two ancient trifles are most impressively sung by Frank Titterton.
- Lily of Laguna and I Used to Sigh for the Silvery Moon**, 1s. BRDCST 880
G. H. Elliott revives these delightful old favourites in tip-top style.
- Got the South in My Soul and The Voice in the Old Village Choir**, 1s. 6d. BRDCST 3210
Here is an American radio turn by Singing Sam. He certainly has a "great" voice, positively stentorian.
- I Lost My Heart in Heidelberg and Just Humming Along**, 1s. 3d. IMP 2715
Bob and Alf Pearson are better in these two than I have heard them for some time.
- At Dawning and I Hear a Thrush at Eve**, 1s. 3d. STERNO 976
Arthur Leonard (tenor) has a very fine voice indeed and he sings these songs splendidly.
- Man Nennt Mich Den Schwarzen Studenten and O Dürfle Ich Es Glauben**, 4s. DECCA-POLYDOR DE7005
From *The Force of Destiny* and *Il Trovatore* respectively. Schlusshus sings both with his customary skill.

MISCELLANEOUS RECORDS

- The Aldershot Command Searchlight Tattoo, 1932**, 8s. H.M.V. C2437-8
These two records are chiefly interesting as an example of what can be done in outdoor recording on the grand scale. The playing of 1,000 bandmen of the air from *Berenice* is most impressive and magnificently recorded.
- A Trip to Brighton**, 4s. H.M.V. C2436
Another outdoor scene—Mabel Constanduros and Company. Realistic, very, but not quite so successful as the studio efforts.
- Kiss Me and Billy's Love Affairs**, 1s. BRDCST 859
That excellent comedian, Billy Danvers, does some enjoyable fooling in first-class music-hall style.
- When the Fields are White with Daisies and Oh, Flo**, 1s. 3d. IMP 2724
Worth notice as a link with a great past. Florrie Forde's enunciation would put to shame many a concert star of to-day.
- B-B-B-Bertha and Rounderer and Rounderer**, 1s. 3d. IMP 2726
Leslie Holmes is excellent in these two pieces of foolishness.
- The Back Porch**, 1s. 6d. ZONO 6160
One of a number of records made by Carson Robison and his Pioneers during their visit. They are versatile fellows and really do entertain here.
- Laughing, Stuttering Sam and Happy Hikers**, 2s. 6d. COL DB856
By Charles Penrose and "Company." No. 1 is really funny and really well done. The second is not so good.

Bring your set up-to-date with the "MICALOG"

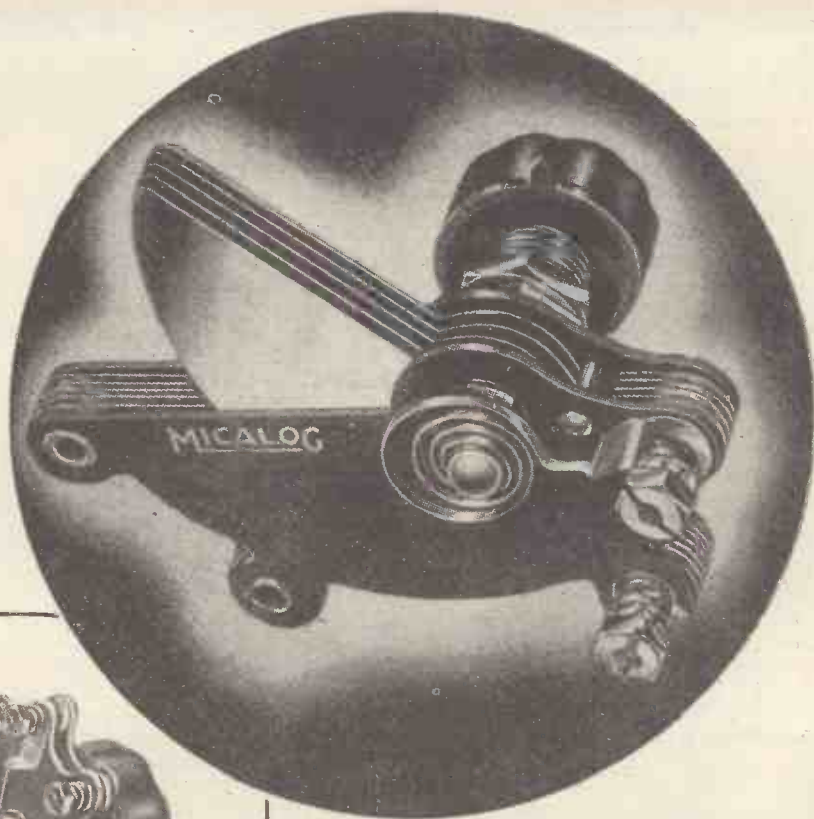

The tuning condenser of the future. Combines all the advantages of a solid di-electric condenser with the efficiency of the best condenser obtainable of any type. Smooth and silent action, self-cleaning plates, positive contact to moving vanes.

Capacities .0003 and .0005 mfd.

Price **3/6** each



Ready Radio Differential Condensers (illustrated above). As specified for all modern reaction circuits. .0001 and .00015 mfd. Price, each **2/6**

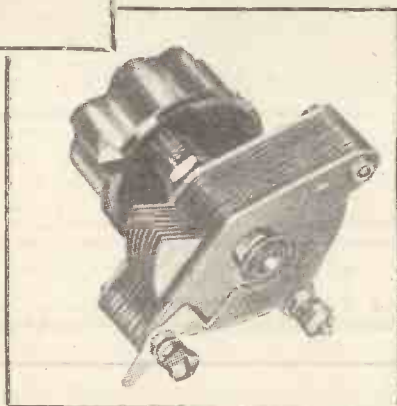

Ready Radio Log Law Condensers (illustrated on right). In all standard capacities from .0001 mfd. Prices from **1/9** (including knob)

Free Send for your free copy of the new 1/- 36-page Book of Kendall-Price Circuits. It contains full constructional details of ten new sets and shows you how to modernise your present set at the cost of only a few shillings.

To : Ready Radio, Ltd., Eastnor House, Blackheath, S.E.3.
Please send me the Kendall-Price Book of ten circuits—free.

Name

Address

If you wish to have, with your free Book, ten full-sized blueprints, enclose 1/- in stamps with this coupon. A.W. 2b

READY RADIO

Advt. of Ready Radio, Ltd., Eastnor House, Blackheath, S.E.3. Phone : Lee Green 5678.

Mention of "Amateur Wireless" to Advertisers will Ensure Prompt Attention

PYE MODEL G

A.C. MAINS SET

SETS OF DISTINCTION

Maker: Pye Radio, Ltd. Price: 18 guineas

HERE is undoubtedly one of the best-designed three-valve cabinet-type sets of the season. In every way the Pye G shows points of superiority over last year's models. The cabinet, in its light walnut finish, will appeal to many set-buyers. Some idea of the attractive figuring can be gained from an examination of the illustration in the heading.

Inside this cabinet is practically everything for wireless reception—everything except the aerial and earth. This model G is for A.C.-mains operation, being designed to work with any voltage from 200 to 250, on the normal periodicities of 50 to 60 cycles.

The connection of the mains plug is made at the back of the cabinet, and near-by is the robust mains on-off switch, marked to show when the set is actually on and off. On removing the back of the cabinet, by undoing four substantial wood screws, we find a modern metal-chassis construction, with accessible tapplings for the mains-voltage adjustment.

Pick-up Connections

Other external connections are for the aerial and earth plugs. Near these are sockets for the connection of a pick-up. I note that no provision has been made for a mains aerial. I thought this connection was more or less standard now.

One of the most thoughtful provisions is a double-contact type of external loud-speaker plug. When this plug is pushed half-way in both internal and external loud-speakers are in circuit, but when pushed right home the plug connected to the external loud-speaker disconnects the internal loud-speaker. This is often wanted, though all too rarely can such a connection be easily made.

If an extra loud-speaker is wanted with this set it must be a moving-coil of low impedance, the speech coil being from 1.5 to 2.5 ohms. No intermediate output transformer need be used then, and accurate matching will be obtained. I am glad to see this point emphasised by the makers, as unsuitable loud-speakers are frequently connected to this type of set.

It is well worth considering the use of a gramophone pick-up with the set, as the volume control is designed to work on both radio and gramophone reproduction. If a lengthy flex connection is made between the pick-up and the appropriate sockets it should consist of screened wire to avoid instability.

Setting up the set is quite simple if the makers' instructions are followed. There

are three valves to be inserted in the metal chassis. A Mazda ACSIVM metalised screen grid valve is used for the first stage, a Mazda AC2HL for the detector, and a Mazda ACPen for the pentode output.

A Metal Chassis

Latest ideas in metal-chassis construction have been adopted, with the distinction that a chain drive is used for the dial control of the gang condenser. Liberal decoupling components can be seen on the chassis, and at every point there is evidence of sound engineering.

The moving-coil loud-speaker is well matched and tone-corrected to work with the pentode, so that the overall tone

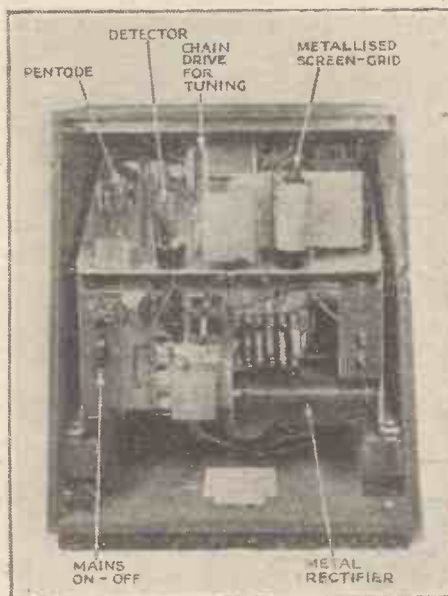

Modern metal chassis construction exemplified by the Pye Model G shown here

sounds very natural and entirely devoid of irritating resonances. Plenty of bass-note response has been achieved, but the top notes appear to have been slightly cut down. This is really essential in these days of ether congestion. Speech is perfectly clear even with some high-note cutting, and there is the great advantage that background noise is exceptionally small.

The tone is unaffected by the setting of the volume control, which, by the way, works exceptionally well. Really the quality is very good indeed considering how selective the tuning has been made.

This selectivity holds good on both wave-bands. On long waves, for example, it was possible to bring in Zeesen clear of Daventry and Radio Paris. There was only an occasional side-band twitter from Daventry and absolutely no interference from Paris.

The two London stations were dismissed within a very small wavelength spread on the tuning scale. Inter-station background noises were noticeably absent. I was able to separate such stations as Sottens and Midland Regional without any deft operating.

Easy to Operate

During the tests I was struck with the simplicity of the operation, in spite of the fact that no attempt has been made to do away with separate control for reaction. As many readers now realise, the use of reaction can often greatly aid the selectivity by cutting down the input on the volume control and making up the strength of the wanted station with reaction.

This procedure is recommended by the makers, who have thoughtfully marked the volume and reaction knobs with numbers, so that not only the tuning setting but the settings for reaction and volume needed to get any given station clear of interference can also be logged—a point that should be appreciated by non-technical listeners wanting stations while the "expert" is not at home!

The tuning scale is very wide and is profusely engraved not only in medium and long waves, but in stations on both wave-bands. Tests show that the tuning calibrations are near enough to help the listener to find the stations with the minimum of searching.

The clear marking of the controls on this set is a very good feature. Even the range switch shows when medium or long waves or gramophone circuits are in use.

This is just the set for the fastidious listener who wants a three-valver of high-grade workmanship, capable of giving pleasing reproduction from a large selection of home and foreign stations with the greatest ease in operation.

SET TESTER.

The Purple Bedroom, a play by Eden Phillpotts, will be given for West Regional listeners on September 12.

KENDALL-PRICE S.G. FOUR

Should give 40 or 50 stations on the speaker after dark with ease and great volume. S.W. stations from all parts of the world whenever conditions permit

The ever-popular 3-valve set is not unlike the medium power motor-car, in that it will do almost everything a reasonable owner can ask of it, yet does not quite please him at times, because it has occasionally to work hard to meet the demands he makes upon it. Consequently, he sometimes feels that if only it had a little more power it would be much more satisfying to use, for it could then do its work easily and without effort.

To anyone who feels so, a four valver is the obvious prescription, and I am including a four-valve version of the wonderful all-wave S.G. circuit in this book, for I feel that this circuit is an ideal basis for the really high-powered set. It has an ample reserve of selectivity to match the increased magnification given by the extra valve, and it is capable of excellent quality of reproduction.

The general arrangement of the H.F. circuit of this 4-valve receiver is closely similar to the corresponding portion of the 3-valve version, and I would ask the reader just to glance through the chapter on the 3-valve

battery set, in order to familiarise himself with it. It is the same extraordinarily efficient circuit, capable of results that I have never known to be equalled by any other equal combination of valves, and it can be depended upon to give a truly superlative performance.

Actually, the performance really merits that over-worked word "wonderful," and even with a decided

poor aerial, it should satisfy any possible demands. Naturally, this set will get a great many more stations upon the loudspeaker than the 3-valve equivalent, amazingly good although the latter may be. The reader will, I hope, realise that this is extremely high praise, because I am prepared to say in all seriousness that this is a design

*This is one of the 36 - pages in the new book of **READY RADIO "Prize Circuits"** - price 1/- Post coupon now and we will send you your copy **FREE!***

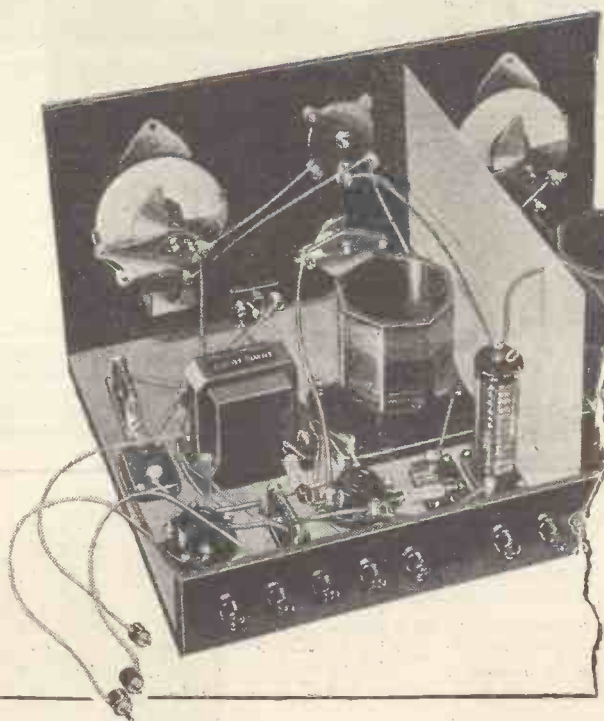

To : Ready Radio, Ltd., Eastnor House, Blackheath, S.E.3.

Please send me a free copy of the Kendall-Price Book which contains full instructions and diagrams, showing how to build 8 modern sets and 2 power units.

Name

Address

If you wish to have, with your free Book, ten full-sized blueprints, enclose 1/- in stamps with this coupon. A.W.2c

Advertisers Appreciate Mention of "A.W." with Your Order

GETTING GOOD RESULTS ON THE SHORT WAVES



All ready for pulling in the stations—the "World-ranger Short-wave 3"

Builders of the "World-ranger Short-wave 3," described last week in "Amateur Wireless," will be interested in these operating details for getting the best results on wavelengths below 100 metres. The operating instructions apply particularly to this latest short-wave "three," but are of value to users of all short-wave outfits

ONE or two of the leads are so short that no insulated covering is needed and if the bare wire is enclosed in insulated sleeving for the main part of the set's wiring, it is unnecessary to have short lengths of covering over these very direct connections.

The grid-bias battery is supported in clips underneath the baseboard, so that you have only to carry two flexes through to the underside of the baseboard and terminate them in wander plugs. The rigid wiring is carried through to the reaction condenser. The aerial, earth, and loud-speaker terminals are connected up beneath the baseboard, as shown on the blueprint. There are four rather important junction points beneath the baseboard and these

emphasise the necessity for soldering, in a set of this description, as the T-joints can so easily be made with a dab of solder, whereas if clamped connections are made throughout, the wiring will have to be rearranged slightly, so that terminal connections can be made for these four junction points.

There are two spaghetti resistances in the set, one being for decoupling and the other for the resistance coupling to the first low-frequency valve. One of these flexibles has to pass through the baseboard and you should take care that it is not frayed or broken. Drill a hole amply large enough.

The wiring finished, the smaller components can be attended to and the grid leaks inserted. The 3-megohm leak is for the detector position and the 1/2-megohm leak for the first L.F. valve. Of the two grid-bias wander plugs, the G.B.—1 (which is connected to the 1/2-megohm leak holder) is taken to 1 1/2 or 3 volts negative on the battery, and the G.B.—2 lead is taken to 4 1/2, 7 1/2, or the full 9 volts on the grid-bias battery, according to the power valve used.

For a first check use the blueprint as a guide, and make sure that the wiring is correct. Then it will be safe to insert the

valves, connect up the batteries and see if the set works satisfactorily.

The operation of a short-waver is similar in general principle to that of a broadcast-band set, but there are many little points you must know in order to get the most out of an efficient arrangement such as the "World-ranger Short-wave Three." Reaction may not be obtained over the entire waveband at the outset, and an amateur who has never previously worked a short-wave set may be surprised at not finding the dial alive with stations on a first test. The tuning has to be carried out much more

(Continued on page 459)

SUITABLE VALVES FOR THE "WORLD-RANGER SHORT-WAVE 3"

Make	20,000	10,000	< 3000
	Det.	L.F.	Power
Mullard ...	PM1HL	PM1LF	PM2A
Mazda ...	HL210	L210	P220
Marconi ...	HL2	L210	P215
Osram ...			
Cossor ...	210HL	210LF	220P
Six Sixty ...	SS210HL	SS210LF	SS220P
Lissen ...	HL2	L210	P220
Fotos ...	BC18	BC9	BD9
Dario ...	Super HF	Universal	Super Power
Tungsrain ...	SD2	TD2	P220
Eta ...	BY2020	BY1210	BW1304

Mullard HL2
Mazda L2
Dario P2

The Specified SPEAKER

The MoToR "YORK"



for the NEW REGIONAL

WITH PATENT COMPENSATING ARMATURE

In attractive Walnut Cabinet Size 16 x 14 x 7 ins.

52/6

The whole secret of the amazing performance of the "York" Loudspeaker lies in the patent compensating armature. This actually consists of three separate armatures coupled together so that the secondary armatures affect the natural resonances of the main armature, producing a sensitivity—a richness—and a startling realism never before deemed possible.

Write for the new pamphlet illustrating the complete range of MoToR Moving Coil and Balanced Armature Loudspeakers



The MoToR S. 40 Unit, which is incorporated in the "York," can be obtained separately for 27/6

TEKADE RADIO & ELECTRIC LTD.
147 Farringdon Road — London — E.C.1

The TELSEN

AJAX 3



Bigger . . . better . . . packed with valuable information from cover to cover—the new Telsen Radiomag is undoubtedly the finest radio sixpennyworth ever offered. For it appeals to all—and all can profit by it. In simple language, illustrated by photographs and diagrams, and complete with three full-size 1s. blueprints, it tells you how to build the latest circuits . . . how to modernise your existing set . . . how to rectify little faults . . . how to get the best out of your set in every way. Get a copy NOW!



TOTAL COST OF
TELSEN MATCHED COMPONENTS

61'6

For building the Ajax 3, including panel, baseboard, terminals, battery cords and all accessories.

A HIGHLY efficient "Straight Three" circuit, as easy to operate as it is to build, giving an exceptionally brilliant all-round performance with a low initial and upkeep cost, the range, power, selectivity and general quality of reproduction setting a new standard for receivers of this type. Free full-size 1s. blueprint, together with full constructional details are contained in the new issue of the Telsen Radiomag, which also gives full particulars of the improved and now all-embracing range of Telsen Radio Components at the still lower prices made possible by Telsen's enormous sale. Now on sale at all radio dealers and newsagents. Price 6d.



"TELORNOR"

CONSTRUCTORS' OUTFIT

Contains all the sundry requirements for the construction of any type of receiver circuits using the Telornor. Of these the Telsen "Triple 3," the "Ajax 3," and the "Nimrod 2" are excellent as examples. All are supplied neatly packed in a carton with instructions.

Cat. No. 220

3'6

Included in the Outfit are the following components:

- Specially cut and drilled crystalline finish panel. 14 in. by 10 in. Baseboard. Eight-way Battery Cord. Complete set of Wander Plugs suitably engraved, and Spade Terminals. Terminals for Aerial.
- Earth and Loud-speaker. Engraved Terminal Strips. An ample supply of 22S.W.G. Tinned Copper Wire and necessary Sleeving for wiring up the set. A double-ended Spanner for mounting the single-hole fixing components.
- A four-way Spanner for tightening up all terminal nuts. All the Wood Screws and sundry other small accessories contributing to the complete assembly of the finished Receiver.

TELSEN

RADIO COMPONENTS.

GOOD RADIO IS A JOY FOREVER

ANNOUNCEMENT OF THE TELSEN ELECTRIC CO., LTD., ASTON, BIRMINGHAM.

Don't Forget to Say That You Saw it in "A.W."



A weekly review of new components and tests of apparatus conducted by J. H. Reyner, B.Sc., A.M.I.E.E.

NEW POLAR CONDENSER

WE have tested this week the new "Polar" Three Gang Condenser. This instrument is built up in a stout shaped metal chassis, heavy gauge metal plates being used as end plates and as partitions between the individual sections. These fixed vanes are supported from the framework by washers of bakelised paper, while the moving vanes are locked on to a hexagonal shaped shaft.

Split end plates are used to enable close matching of the three sections, while trimmers are provided on each section,

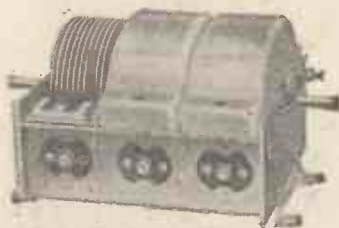

One of the new Polar Condensers

these consisting of the usual compression type with a mica dielectric.

A good point in the design of this condenser is the fact that the trimmers are mounted in such a position that they can be adjusted from the top. In this position the trimmers are, generally speaking, very much more accessible and the whole process of ganging the receiver is simplified.

The moving plate assembly is dropped into the chassis and held in position by specially shaped springs at each end. A slow-motion friction drive can be obtained with the condenser, the reduction ratio being approximately 14-1. Each section of the condenser is provided with an individual cover, with a hole through which the trimmer can be adjusted.

A high-frequency test was conducted on the condenser with the object of measuring the equivalent series resistance which would be introduced into a tuned circuit using the condenser. At 400 metres the resistance proved to be 0.9 ohm, increasing to 2.8 ohms at 250 metres. These figures were taken with the trimmers in minimum position. With these latter in a maximum position the values obtained were 1.0 ohm and 3.0 ohms. These figures are good and indicate that the condenser will give efficient service in actual practice.

The sections appeared to be well matched, the maximum capacity being .0005 microfarads as rated, and the minimum .00034 microfarads. The maximum capacity of the trimmers was approximately 100 microfarads.

The condenser is well made and can be recommended for general use.

SOLON SOLDERING IRON

AN electric soldering iron is an undoubted boon to the wireless experimenter and constructor, but reliability is usually only obtained at some expense, rendering the cost of this commodity very much higher than the ordinary soldering bit as used in a gas flame.

Messrs. Henley's have recently tackled the problem in a most satisfactory fashion by placing on the market their Solon iron, at a price of 7s. 6d. only. The iron is provided with a flat bit at one end, the lower part of which is surrounded by the

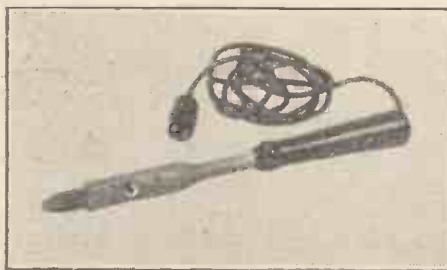

A useful electric soldering iron, the Solon

heating element, while there is a green insulated handle at the other end, the leads being brought out through the centre of this handle. The whole iron is 11 1/2 in. long and nearly 6 feet of flex is provided, finished in an adapter ready for insertion in any electric-light socket.

We have had one of these irons in use for many months and we are, quite frankly, enthusiastic over its performance. The winding is so proportioned that the temperature is just right and the iron remains effective without continual cleaning, almost indefinitely if resin-cored solder is used. This is a really useful gadget!

HOWE BOX BAFFLE KIT

IT is now realised that a large flat baffle surface area is not the only means of preventing low-note leakage with a good speaker. Large baffle boards are not easy to accommodate in the average living-room, especially if the area is adequate to prevent low-note leakage from the front to the back of the speaker diaphragm, and a suitably made box baffle is as effective, and is much more compact.

We have just made a test of an assembled model of the Howe box baffle kit, supplied by F. McNeill & Co., Ltd. This kit, when assembled, forms a box baffle having outside dimensions of approximately 18 in. by 18 in. by 12 in. The interior is lagged

with slag wool and the general method of construction is the same as that tried last week on page 333.

The box is of stout wood, so that the risk of resonance in the box itself is cut down to a minimum, and the packing with the vitreous fibre material effectively prevents resonance and sound leakage. The packing is kept in place with calico and the speaker is mounted against the stout front board of the baffle box.

The opening is approximately 9 in. in diameter and there is ample space inside the box for the mounting of any standard moving-coil speaker. A baffle of this type, however, is just as effective with any type of speaker which is capable of good low-note reproduction and which, therefore, has to be shielded, without entirely closing in the back of the baffle box.

A good feature of the Howe kit is that it appears easy to make up and it is supplied

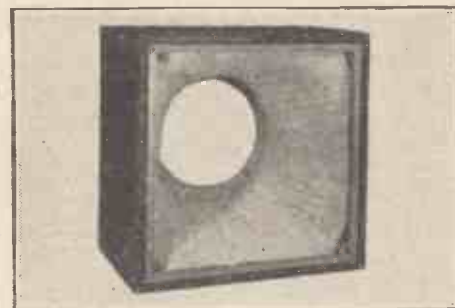

An assembled box baffle made from the Howe kit

complete with all the material. It costs 20s., delivered free and including royalty

IMPROVING THE "SLOPE"

THE unusually high mutual conductance or "slope" of the new micromesh valve—as the name indicates—is due to the extremely close spacing between the electrodes inside the bulb. This naturally reduces the internal resistance, though in the detector valve the amplification factor is kept as high as 80, which gives a very favourable figure of merit for making the most of a small input voltage. In the L.F. or power amplifier both the internal resistance and amplification factor are further reduced, but the "slope" factor or change in output current for each volt applied to the grid attains the remarkably high figure of 12.5. It is well known, of course, that close-spacing improves efficiency, but if this is overdone the grid tends to heat up to the point where secondary emission sets in, which is, of course, fatal.

One shillingsworth of H.T. FREE — every week!

The average 3-valve set costs you over 1/- a week for current when you use batteries. An EKCO unit gives you the same amount of current for a farthing.* You save a shilling a week and get better radio when you use an EKCO Unit. Think what you save as the years go by!

Whatever the size or type of your radio set or portable there is an EKCO Unit for it. All you have to do is to fit it in place of your usual battery, plug into an electric light or power socket — then switch on — that's all! Choose the unit suitable for your set from the table or send coupon for full details.

*Based on 1,000 hours' use of an average 3-v. set.

All EKCO Units are available by Easy Payments.

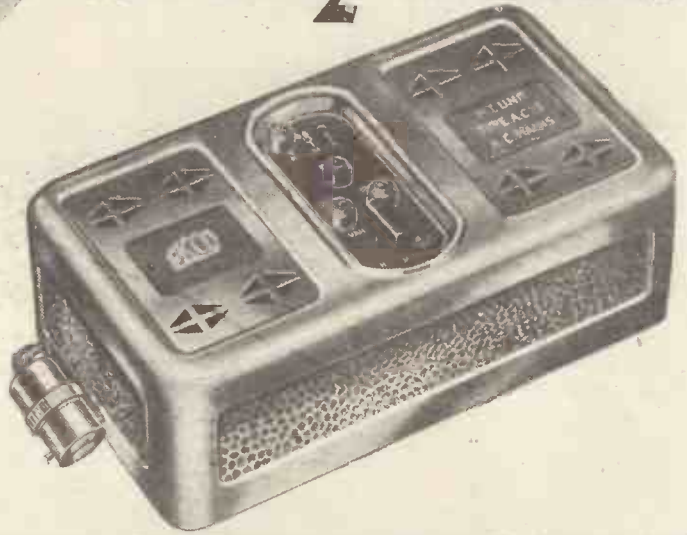

EKCO H.T. UNITS

Model	Current Output	Voltage Tappings	Price	EASY PAYMENTS	
				Initial Payment	11 Monthly Payments of
A.C. 12	12 m/A	S.G.; 80; 120/150	£2.15.0	6/6	5/-
A.C. 18	18 m/A	S.G.*; 50/80*; 120/150	£3. 7.6	7/9	6/2
A.C. 25	25 m/A	S.G.*; 50/80*; 120/150	£3.17.6	8/9	7/1
D.C. 15/25	15 or 25 m/A	S.G.*; 50/80*; 120/150	£1.19.6	6/-	3/8

Combined H.T. & L.T. Charger Units (for A.C. Mains)

Model	Current & Voltage	L.T. Output (for charging accumulators)	Price	EASY PAYMENTS	
				Initial Payment	11 Monthly Payments of
K. 12	Current Output and Voltage Tappings same as Models A.C.12, A.C.18 and A.C.25.	½amp. at 2, 4 or 6 volts	£3.19.6	9/-	7/3
K. 18		½amp. at 2, 4 or 6 volts	£4.12.6	10/3	8/5
K. 25		½amp. at 2, 4 or 6 volts	£5. 7.6	11/9	9/10

Tappings marked * are adjustable.

To E. K. COLE, LTD., (Dept. K.18.),
Ekco Works, Southend-on-Sea.

Please send me full details of EKCO Power Units, Consolettes and Radiograms.

Name

Address



POWER SUPPLY UNITS

Mention of "Amateur Wireless" to Advertisers will Ensure Prompt Attention

The first kit sets to bring LASTING QUALITY to the battery - set user

A new Detector 2 L.F. Kit Set incorporating many important modern developments. Chassis construction — only five wires to connect — built in twenty minutes. Superb moving-coil reproduction at its best.



A new all-wave screened grid three incorporating Micalog tuning. Guaranteed reception of at least thirty stations on medium and long waves in addition to short-wave stations from all parts of the world. Amazingly selective. Superb quality.

'303' KIT MODEL

Complete Kit of Quality Components with set of three Mullard Valves.

£3.10.0

Or by 7 monthly payments of 11/9

'303' CABINET MODEL

Complete Kit and Valves as above with beautiful walnut cabinet fitted with new type moving-coil speaker.

£6.17.6

Or by 10 monthly payments of 16/-

"METEOR" S.G.3 KIT

Complete Kit, together with three Mullard Valves

£5.7.6

or 10 monthly payments of 12/6

"METEOR" S.G.3 CABINET MODEL

Beautiful walnut cabinet, fitted with Moving-Coil Speaker, and complete with Kit and Valves.

£8.17.6

Or 12 monthly payments of 17/-

To : READY RADIO LTD., EASTNOR HOUSE, BLACKHEATH, S.E.3.
Please send me free, the '303' and Meteor S.G.3 Book.

Name

Address

Please put a cross against the '303'
set in which you are interested. Meteor S.G.3

A.W. 2c

Free Post coupon now for your copy of the 20-page Book illustrated above. We will also tell you about our 'REGISTERED USERS SCHEME—your Guarantee and Safeguard.

'GETTING GOOD RESULTS ON THE SHORT WAVES'

(Continued from page 454)

carefully and then you will find that there really are dozens of stations to be heard at nearly every hour of the day below 100 metres.

It is vital to get a short-wave set adjusted to the point of maximum sensitivity before you start searching for stations. This applies just as much to the "World-ranger Short-wave 3" as to any other short-wave receiver and many of the essential points to note in getting the World-ranger adjusted to a degree of good selectivity are of interest in connection with other standard short-wave receivers.

Short-wave Efficiency

Smooth reaction, good tuning, quiet low-frequency amplification and stability ensured by decoupling, all factors of noticeable importance on the broadcast band, are of very real value when you come to reception below 100 metres. Unless a set gives a quiet background, goes smoothly in and out of oscillation and tunes without hand capacity, you cannot hope to make a big bag of distant stations.

The first thing is to get smooth oscillation and in the "World-ranger" this is quite an easy adjustment. You will see that the 3-megohm leak in the detector circuit is not taken back to positive low-tension as is general in broadcast-band sets, but is taken to the slider of a rotary potentiometer. This potentiometer has a winding resistance of 400 ohms, so that there is very little low-tension current consumed.

The position of the potentiometer slider

determines the bias on the grid of the detector valve and this regulates the smoothness of passage into oscillation. The first step, therefore, when you have plugged in the valves and switched on, is to set the potentiometer arm at about the mid-way position and try for oscillation. It is advisable to set the coil switch to the mid-way position so that it is on the 19-43-metre band where many stations are received and where smooth reaction is particularly important.

The best position of the potentiometer arm must be found by trial as the exact

GANGING COILS TOGETHER

Even though a set may have separate condenser controls, for tuned circuits you can cut down the number of knobs on the panel by ganging the wave-change switches. Two coils are shown with their



wave-change switches connected by a ganging rod. Make sure that both switches open and close together, and that the coils are in line, so that the ganging rod does not pull sideways on the switch contacts.

bias needed for each type of detector valve varies. The bias on the low-frequency and power valves to ensure a silent background should be 1 1/2 or 3 volts and 7 1/2 or 9 volts respectively, the latter depending on the type of power valve used.

As loud-speaker operation is possible with this short-wave set, it will generally be found possible to use a mains eliminator if desired for the high-tension supply. This, of course, is a big advantage over a short-waver using 'phones, where mains supply of high-tension is not usually possible, as the ripple is audible. The adequate decoupling by a 20,000-ohms resistance and a 1-microfarad fixed condenser ensure that there will be no threshold howling, either when a battery or eliminator is used. The three positions of the coil switch enable it to cover three wavelength bands of 12-25 metres, 19-43 metres, and 38-85 metres. In order to reach the proper minimum wavelengths, it is necessary to avoid too large an aerial coupling and you will find the neutralising type of condenser a help in cutting down unwanted aerial capacity. Particularly at the first coil position, when it is working on the 12-25-metre band, it is desirable to reduce the aerial loading and the vanes of the series-aerial condenser should be kept wide apart.

Generally, you will find that stations come in best at the mid position of the dial and the 25-metre stations, such as Chelmsford, Radio Colonial, Rome, and Pittsburg, come in better when the set is tuned to the 19-43-metre waveband than when on the lowest band, although probably you may find Chelmsford coming in at the first position of the switch.



THE R.D. RESISTANCE
A series of scientifically designed decoupling resistances. In all values from 50 ohms to 50,000 ohms. Prices from 1/- to 2/9. Plug-in type, complete with baseboard socket, 3d. extra.

"QUALITY" COMPONENTS for "QUALITY" RESULTS

NO matter the efficiency of the circuit—no matter the care in assembly—the components themselves *must* be above question for "quality" results. That is why Wearite insist on stage-by-stage test in the manufacture of their every product. Be it coils, switches, chokes, transformers, resistances, etc., before they can leave the works they must have passed their several tests—they must have proved their worthiness to bear the name "Wearite"—the first name in radio.

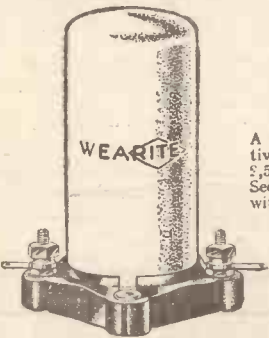

THE H.F.P. H.F. CHOKE

A screened choke, giving effective operation between 15 to 5,500 metres. Price 3/6. See also latest type H.F.P.A. with armoured "pig-tail." Price 4/-

YOU WILL NEED THE FOLLOWING WEARITE PARTS

THE IDEAL REGIONAL TWO	Wearite Paxoline Panel 14 by 7. Price 6/-	YOUR HOME RADIO-GRAM.	Wearite H.F. Choke (H.F.P.) Price 3/6.
	Wearite 4 and 5 pin valve holder (S1). Price 1/3.		Wearite 4 pin valve holders. Price 1/3.
	Wearite H.F. Choke (H.F.P.) Price 3/6.		Wearite "Push-Pull" 3 pt. Switch (G.23). Price 1/-.
	Wearite 5,000 ohm R.D. Resistance. Price 1/6.		Wearite Grid-Leak Holder. Price 6d.
	Wearite 10,000 ohm R.D. Resistance. Price 1/6.		

The Q.V.C. VOLUME CONTROL.

Made in all values from 600 to 100,000 ohms. Up to 50,000 ohms, price 4/6; above 50,000 ohms, price 5/6. Ganging attachment, 1/- extra.

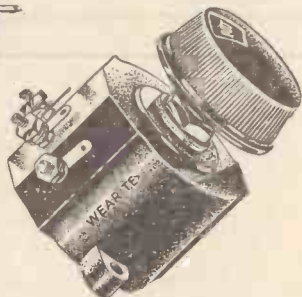

If you should have any difficulty in obtaining Wearite parts write us direct giving name and address of local dealer. Remember too, our "Query Dept." will solve any technical problem—put it to them.



WRIGHT & WEAIRE, Limited
740 HIGH ROAD, TOTTENHAM, N, 17
PHONE: Tottenham 3847/8/9.



The 7-metre Tests

SIR,—I had a very peculiar experience with my set at 12.15 a.m. Wednesday morning, August 10. My receiver is of the detector, low-frequency, and power variety, and uses plug-in coils. While searching for distant stations I heard a rather weak transmission that persisted all round the dial. I was unable to tune it out, this proved that the station was absolutely independent of my tuning system. I therefore waited for an announcement from this mysterious station. When the announcement did come, it turned out to be the B.B.C. testing on 7.5 metres. Evidently, some connecting wires in my set had enough inductance and capacity to resonate at this small wavelength.

A. C. (Islington, N.1).

That Efficient Earth!

SIR,—I visited a friend's house recently and as the earth lead was perished I offered to fit a new one. In removing the old wire I was endeavouring to find the earth tube and after digging down about a foot found the earth lead connected to—a brick!

The set had been fixed a few years ago by "one who knew all about wireless."

E. G. S. (New Malden).

WHEN SUBMITTING QUERIES

Please write concisely, giving essential particulars. A Fee of One Shilling (postal order), a stamped addressed envelope, and the coupon on the last page must accompany all letters. The following points should be noted.

Not more than two questions should be sent with any one letter.

The designing of apparatus or receivers cannot be undertaken.

Modifications of a straightforward nature can be made to blueprints, but we reserve to ourselves the right to determine the extent of an alteration to come within the scope of a query. Modifications to proprietary receivers and designs published by contemporary journals cannot be undertaken.

Readers' sets and components cannot be tested at this office. Readers desiring specific information upon any problem should not ask for it to be published in a forthcoming issue, as only queries of general interest are published and these only at our discretion. Queries cannot be answered by telephone or personally.

Readers ordering blueprints and requiring technical information in addition, should address a separate letter to the Query Department and conform with the rules.

Amplifiers and Battery Connections

SIR,—I have recently built a one-valve amplifying unit to add to an existing receiver, but every time I connect the receiver and the amplifier together I get a flash on joining up the battery wires and cannot get a sound of reception. I must admit that I know very little regarding the technicalities of wireless, but am

able to follow a wiring plan. Does the information I submit enable you to explain to me where I have gone wrong?

F.W. (Lincoln).

It seems to us that you are shorting your L.T. accumulator when connecting together your receiver and amplifier. This is due to your set being wired up with its negative H.T. joined to positive L.T. and the amplifier being wired with its negative H.T. joined to negative L.T. If you will verify this and then alter either your set wiring or the amplifier wiring so that one conforms with the other, you will overcome your difficulty.—Ed.

Short Waves and Harmonics

SIR,—I have a proprietary design of S kit receiver which gives me every satisfaction except in the following. When using the short-wave coils suitable for 20 to 40 metres reception I find that stations only come in when the tuning condensers are adjusted to above 50 degrees using a 100-degree tuning scale. If I change over to the 40 to 60 metre coils the same stations are received at far greater strength, but with the condensers set to between 0 and 20 degrees. The stations being received I know are transmitting on the 20 to 40 metre wave-band, so it strikes me as being very peculiar that I get stronger signals from the stations with the higher wavelength coils. Can you advise me as to what may be the cause of this peculiarity in reception on the short waves?

V.K. (South Africa).

(Continued on page 462)

A WORLD-FAMOUS MAKE OF
TRIPLE SPRING
 GRAMOPHONE MOTORS
 BRAND NEW
 At Less Than
HALF PRICE
 THE FINEST SPRING MOTOR EVER MADE

The Motor Specified for YOUR HOME RADIO-GRAM

Superlative, long-playing motors—offered at an extraordinary price—specified by the designer of "Your Home Radio-gram" because they will give you years of keen enjoyment—always silent—always efficient and trouble-free. These motors were made by the famous Garrard Company for one of the largest English gramophone factories and have come into our hands in exceptional circumstances. You can rely on them implicitly—it is your opportunity to make "Your Home Radio-gram" or your existing gramophone the equal of the finest that money can buy.

Read what the Technical Editor of "Popular Wireless" says:

"This motor is identically similar to those in use by the B.B.C. at Broadcasting House. I cannot conceive a better demonstration of clock-work mechanics... it runs with perfect sweetness and dead silence... it will be an exceptionally good (and probably extremely expensive!) electric motor which will displace this bargain-price triple-spring motor"

Manufactured by the world famous
GARRARD
 Engineering & Mfg. Co. Ltd.

OFFERED AT
 LIST PRICE
£4 : 1 : 3
35/-
 CARRIAGE PAID
 PLAYS 3-12" or 4-10"
RECORDS AT ONE WINDING

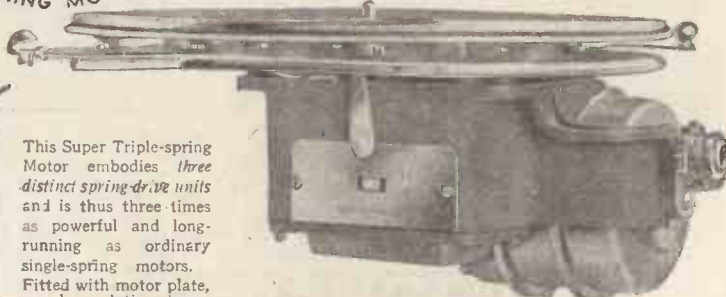

This Super Triple-spring Motor embodies three distinct spring-drive units and is thus three-times as powerful and long-running as ordinary single-spring motors. Fitted with motor plate, speed regulating lever, safety friction clutch, 12-inch turntable, winding handle, and automatic brake. All bright parts heavily nickel plated. All working parts totally enclosed. Silent running, silent wind.

CABARET ELECTRIC Co.

170 Vauxhall Bridge Rd., London, S.W.1 & 238 High St., Lewisham, London, S.E.13

Postal Orders and Money Orders should be crossed and Treasury Notes sent by registered post.

The TELSEN JUPITER S.G.3



TOTAL COST OF TELSEN MATCHED COMPONENTS
77/-

For building the Jupiter S.G.3 including panel, baseboard, terminals, battery cords and all accessories.



Utilising a brilliant circuit arrangement devised by Telsen technicians, ensuring the highest amplification under all conditions, with extreme selectivity, exceptionally wide range and superb quality of reproduction.

Free full-size 1s. blueprints of this and other Telsen circuits, together with full instructions and a wealth of interesting and valuable information, including particulars of the improved and now all-embracing range of Telsen Radio Components at the still lower prices, made possible by Telsen's enormous sale, are contained in the new, bigger and better issue of the Telsen Radiomag. Get a copy NOW—price 6d., from your radio dealer or newsagent.



DRUM DRIVE CONSTRUCTORS OUTFIT

This Outfit contains all the necessary requirements for the construction of the TELSEN "JUPITER S.G.3," but the constructor will find the Outfit of great value in the building up of any receiver circuit employing the drum-drive condenser assembly.

3/6
No. 219

THE OUTFIT CONTAINS THE FOLLOWING:

- 1 Metal panel with attractive crystalline finish, specially cut and drilled for mounting the Telsen Drum Drive and other panel-mounted components normally required in a ganged condenser receiver.
- 1 Baseboard, 14 in. by 10 in.
- 1 Aerial and earth terminal strip.
- 1 Loudspeaker terminal strip.
- 2 Red terminals complete and mounted in holder.
- 2 Black ditto.
- 7 Wander plugs mounted in holder.
- 2 Spade lags.
- 1 8-way Battery cord.
- 1 Cord clip.
- 2 Large insulating washers.
- 1 Small thick insulating bush.
- 1 Small thin ditto.
- 2 Spacing nuts for the reaction and aerial series condensers.
- 2 Spacing nuts for the "on-off" switch.
- 1 Wave-change Escutcheon with two screws and nuts.
- 1 Separator ditto.
- 1 Volume ditto.
- 1 "On-off" escutcheon.
- 2 Height plinths for the matched screened coils.
- 1/4 in. of 3 m.m. sleeving (black).
- 1 1/4 in. ditto (red).
- 20 ft. of 1 1/2 m.m. sleeving (green).
- 21 ft. of 22 S.W.G. tinned copper wire.
- 1 Double-ended spanner for locknuts.
- 1 Four-way spanner. Assortment of 1/4 in., 1/2 in., 3/8 in., and 1 1/2 in. wood screws

TELSSEN

RADIO COMPONENTS

GOOD RADIO IS A JOY FOREVER

ANNOUNCEMENT OF THE TELSEN ELECTRIC CO LTD ASTON BIRMINGHAM

Mention of "Amateur Wireless" to Advertisers will Ensure Prompt Attention

"READERS' IDEAS AND QUESTIONS"

(Continued from page 460)

The peculiarity in reception which you are experiencing is quite common in short-wave reception. You are tuning in the stations on a harmonic of their natural wavelength. Although, theoretically, one would expect rather weaker reception when receiving a harmonic of a particular station, it is quite often a fact that the harmonic may be received at louder volume than the actual wavelength. Various considerations come into effect to make this practicable, chief among which are, the aerial resonating at a definite harmonic of the desired signal and the tuning circuits adjusted to tune critically to the harmonic.—Ed.

Cutting Out Modulation Hum

SIR,—I have a receiver which gives me very good service on the medium waves, but as soon as I tune in a station on the long-waves I get an annoying hum. By tuning slightly off the proper setting of the station I can reduce the hum, but this usually has the effect of reducing the signal strength of the wanted station to such an extent that reception is useless. I have had the service engineer from the manufacturers to overhaul the receiver, and he is unable to assist me as he says the trouble is not in the receiver, nor in the mains unit which works the receiver, each of which work satisfactorily in another locality. I do not wish to go to any further expense in getting another receiver when the present set satisfies me except in so far as the mains-hum trouble is concerned. Can you, from your experience, tell me

what may be wrong and how I can eliminate the trouble? I do not get even the slightest trace of mains hum on the medium wave position of the tuning switch.

J.P. (London).

Your trouble appears to be modulation hum, and this can only be reduced or possibly entirely eliminated by making some alteration to the design of your mains unit. The method about to be suggested is quite suitable for either D.C. or A.C. mains units, but in each case the extra components must be arranged before the existing L.F. smoothing circuit components and after the actual points of D.C. supply. In the case of a D.C. mains unit, the components should be arranged between the leads to the mains unit and the actual unit. In an A.C. unit, they should be placed after the rectifier, but before the L.F. smoothing choke and condenser. The components required are two power-type H.F. smoothing chokes and two 4-microfarad capacity fixed condensers, each of about 400 volts working voltage. Arrange one choke in each of the positive and negative supply leads to the existing L.F. smoothing circuit components and then connect together, in series, the two large capacity fixed condensers. The latter should then be arranged across the ends of the two H.F. chokes nearest to the L.F. smoothing-circuit components.—Ed.

"Testing Radio Sets."—We have been interested to receive a copy of the second edition of "Testing Radio Sets," by our Technical Editor, Mr. J. H. Reyner, B.Sc., A.M.I.E.E. This book deals at length with the various methods of testing for faults in radio receivers, whether of the manufactured or home-constructed type.

After indicating the equipment necessary, the various portions of the receiver are considered in turn, and the methods of analysing the faults are shown. A chapter on special receivers, including the super-heterodyne and short-wave sets, is included, as also is a chapter on the curious faults which have occurred in the author's experience. This latter chapter is particularly interesting in showing how a quite obscure fault can be tracked down by the application of the systematic methods described in the earlier chapters.

The second part of the book deals with the equipment required in works for the production testing of receivers. This section has been considerably expanded since the first edition was produced and much valuable practical information is given regarding the construction of apparatus for sensitivity, selectivity, and fidelity tests on apparatus either in the form of laboratory hook-ups or finished sets. A final chapter deals very comprehensively with the methods of testing components such as are used in the manufacture of receivers.

The book is well illustrated and contains much useful information apart from the actual methods of testing. It is published by Chapman & Hall, and the price is 10s. 6d.

A concert of winners at the recent Royal National Eisteddfod of Wales at Port Talbot will be given from the Swansea studio for West Regional listeners on September 11.

Clarion
 PICK-UP and  TONE-ARM
 THE ALL-BRITISH PICK-UP
 RECOMMENDED BY THE
 DESIGNER OF
 "YOUR HOME RADIOGRAM"

 described on page 440 in this Issue.
**NO CHATTER—NO SCRATCH
 NO CASE RESONANCE
 AMAZING REALISM**
 FITTED TO ANY
 GRAMOPHONE IN 5 MINUTES
PRICE 21/-
BRITISH CLARION CO., LTD.
 CLARION WORKS, MILLER ST., CAMDEN TOWN, N.W.1
 Phone: Museum 3624-5. Grams: "Crossradco, Norwest, London."

**THE LAST WORD IN
 RADIO-GRAM CABINETS**



An entirely new "Camco" Radio-Gram Cabinet that presents an exceptionally handsome appearance. The Gresham is an example of cabinet craftsmanship at its best. It is constructed on sound acoustical lines and finished in selected walnut veneer. Complete with Baffle and Baseboard.
Price £6

Be sure to send for further particulars of this and other "Camco" cabinets described in the NEW "Camco" Catalogue FREE.

Send this Coupon for 24 page Catalogue.

THE  **GRESHAM RADIO-GRAM CABINET**

Showrooms:
CARRINGTON MFG. CO. LTD.,
 24, Hatton Garden, London, E.C.1
 Phone: Holborn 6292 Works: S. Croydon

Name.....
 Address.....
 3AW

TELSEN VALVE HOLDERS SWITCHES AND GRID LEAKS

TELSEN VALVE HOLDERS

A new range of valve holders has been introduced in both solid and anti-microphonic types. These embody special contact sockets of one-piece design with neat soldering tag ends and terminals. They have an extremely low self-capacity and are easily mounted.

SOLID TYPE		ANTI-MICROPHONIC	
NO.	PRICE	NO.	PRICE
4 Pin. W.224	9d.	4 Pin. W.222	1/-
5 Pin. W.225	1/-	5 Pin. W.223	1/3
W.198. Universal Type Valve Holder	-	-	1/-

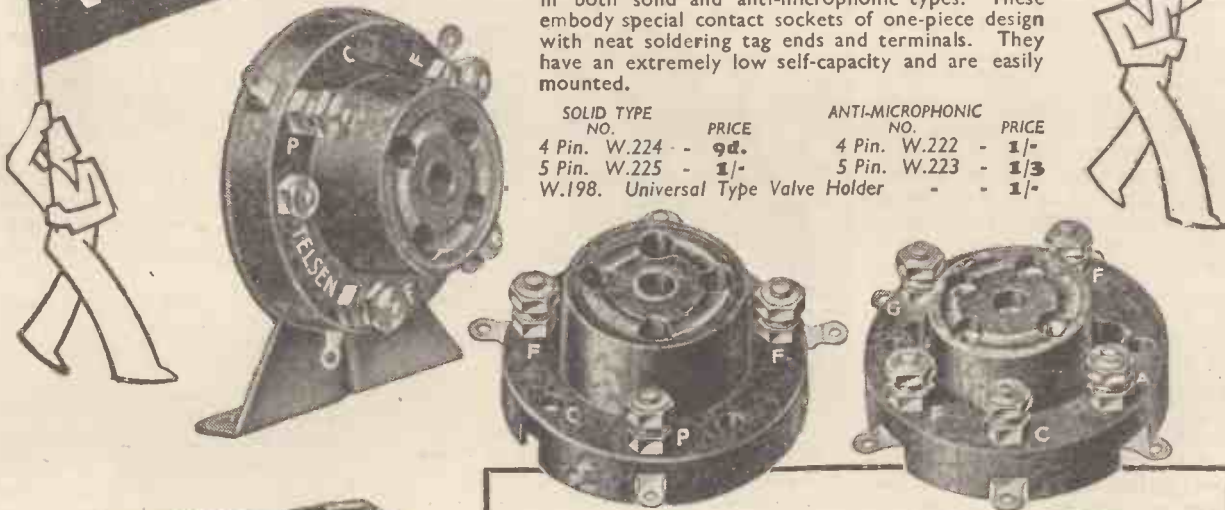

TELSEN GRID LEAKS

These are absolutely silent and practically unbreakable, and do not vary in resistance with application of different voltages. They are non-inductive and produce no capacity effects.

CAP. MEGOHMS. NO.	CAP. MEGOHMS. NO.
5 W.254	1 W.250
4 W.253	1/2 W.249
3 W.252	1/4 W.248
2 W.251	

TELSEN PUSH-PULL SWITCHES

employ the "knife" type of self-cleaning contact, and a positive snap action. The nickel-silver bridge-piece is driven between the springy "fixed" contacts, and the wedge-shaped plunger squeezes the inner contacts outwards, closing the jaws in a firm grip. The series gap reduces self-capacity to a minimum, and the spindle is insulated from all contacts. For use as battery switch, or as wave-change switch with the dual-range short-wave coil unit.

Two-point. No. W.107

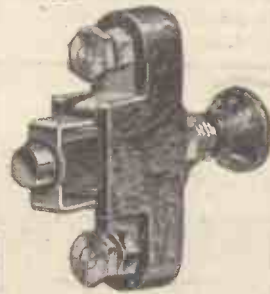

TELSEN

WAVE-CHANGE SWITCH

The wave-change switch for Dual Range Aerial Coil, or for breaking L.T. and H.T. circuits simultaneously.

Three-point No. W.108

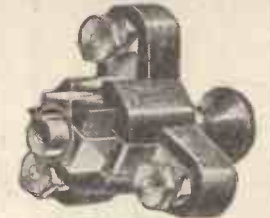

TELSEN FOUR-POINT "TWO-POLE" PUSH-PULL SWITCH

This model is a two-pole switch highly suitable for use in wave-changing on two coils or an H.F. Transformer, or for switching pick-up leads or an additional loudspeaker.

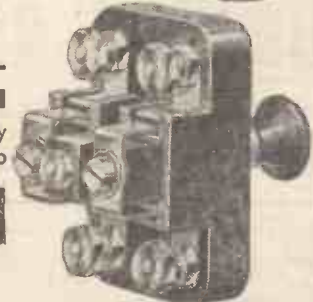

TELSEN

RADIO COMPONENTS

GOOD RADIO IS A JOY FOREVER

ANNOUNCEMENT OF THE TELSEN ELECTRIC CO., LTD., ASTON, BIRMINGHAM

You will Help Yourself and Help Us By Mentioning "A.W." to Advertisers

THE BECOL HANDBOOK

A USEFUL handbook of coils and suitable circuits has just been issued by the British Ebonite Co., Ltd. The book includes handy wire tables and constructional descriptions of H.F. chokes, band-pass coils, matched dual-range H.F. tuners and very modern types of super-het I.F. and oscillator coils. In each case useful photographs, sectional drawings, and wiring diagrams are given, so that the coils can easily be wired at home.

Copies of the book can be obtained, price 6d., from the British Ebonite Co., Ltd., Hanwell, London, W.7.

"4-in-1" GRAMOPHONE RECORDS

GRAMOPHONE records of the standard 10 in. diameter size which carry four tunes instead of two, each side playing for six minutes instead of three, are produced by British Homophone Co., Ltd. The sound track on these records is only half the normal width, but they are used with any standard sound-box or pick-up and with ordinary gramophone needles.

An "A.W." representative recently attended a demonstration of these new records and was quite satisfied with the reproduction and freedom from surface noise. The price of the new records is 1s. 6d. and full details can be obtained from the British Homophone Co., Ltd., Princes House, 190 Piccadilly, London, W.1. The records are already in production on a large scale and are available at all the principal gramophone stores. It is intended to issue one new record, carrying four tunes, on the Friday of every week.

BIG BEN IN TOTTENHAM COURT ROAD!

BY means of the new giant Marconiphone "searchlight" type of public address loud-speaker, the chimes of Big Ben are now clearly heard for a considerable distance from the roof of the Marconiphone offices in Tottenham Court Road, London.

A special microphone has been installed inside the clock tower of Big Ben. This is



Fixing the searchlight speaker on the roof of the Marconiphone building, for the "broadcasting" of Big Ben

connected by private land-line to Tottenham Court Road, where the Marconiphone people have fitted up a large public-address

amplifier, the output of which is taken by means of a leaded cable to the roof.

The searchlight is so placed that the beam of sound is thrown down Goodge Street, opposite the offices. As one of a press party, our representative was able to hear the effect for himself. The volume and quality of the chimes, which are relayed every quarter of the hour, are remarkably true to life.

As Mr. Dyer, of the Marconiphone Company, Ltd., pointed out, the work done in overcoming the snags and problems encountered in the development of the large type of loud-speaker used for this interesting demonstration is often applied to the production of the smaller types.

BROADCASTING HOUSE SPEAKER BAFFLE

IN our last issue we gave instructions for building the particular type of speaker baffle in use in Broadcasting House. Since the article went to Press, we have been informed that a patent on this particular form of construction has been or is about to be issued to the British Broadcasting Corporation, which is granting Messrs. F. McNeill & Co., Ltd., 52 Russell Square, London, W.C.1, an exclusive licence for the manufacture and sale of the baffle. Messrs. McNeill are marketing the Howe box baffle (a Test Report of this kit being given in this issue) and their sub-licensees, Messrs. Weedon Power Link Radio Co., of 185 Earlham Grove, Forest Gate, London, E.7, also announce a special baffle kit. In each case, the price, inclusive of the B.B.C. royalty, is £1.

YOU CANNOT BUILD THE ADVANCE FOUR WITHOUT SOVEREIGN VARIO-CHOKE



SEE LAST WEEK'S "AMATEUR WIRELESS" PAGE 335 ("Components that make a Difference," by Alan Hunter) AND PAGE 364 ("How to build The Advance Four" by Percy W. Harris). THESE ARE BUT TWO INSTANCES OF THE MANY RECOGNITIONS THE VARIO-CHOKE HAS RECEIVED FROM THE RADIO PRESS.

We are pleased to announce publication of the Third (1933) Edition of our famous Components Catalogue which will be forwarded (free) together with our latest Blueprints for building the Sovereign Ambassador and Viceroys Receivers upon receipt of a postcard.

Specification of the Sovereign Vario-Choke (Prov. Pat. No. 111/32) in the "Advance Four" is positive assurance for the vastly improved performance of this wonderful new receiver. The adaptability, constancy, and reliability of this amazing new component makes it the outstanding component invention for 1932. THERE IS NO SUBSTITUTE, ALTERNATIVE, NOR COMPROMISE FOR THE SOVEREIGN VARIO-CHOKE. YOU CANNOT BUILD THE "ADVANCE FOUR" WITHOUT IT.

Complete in Bakelite Case **3/6** with instructions Obtainable from all good dealers.



SOVEREIGN PRODUCTS, LTD., SOVEREIGN HOUSE, ROSEBERY AV. E.C.1

THE MUSIC LOVER'S PICK-UP



30/-

A real music lover can never be satisfied with mediocre reproduction of his favourite records, but this new Pick-up by Bowyer-Lowe has been designed to realise an ideal hitherto unattainable. Every delicate nuance, every inflection, every transient change in volume is as faithfully reproduced as though the actual players were in the room. In your own interest ask your dealer for a demonstration. Send for Catalogue.

BOWYER-LOWE & A.E.D. LTD.
DIAMOND WORKS, BRIGHTON

Amateur Wireless HANDBOOKS

each 2/6 net.

LOUD-SPEAKER CRYSTAL SETS.

WIRELESS-CONTROLLED MECHANISM FOR AMATEURS.

THE WIRELESS MAN'S WORKSHOP.

THE BOOK OF THE NEUTRODYNE, by J. H. Reyner, B.Sc. (Hons.), A.M.I.E.E. Price 1/6 net, or post free for 1/9

Of all Newsagents and Booksellers or by post, 3d. extra, from Cassell & Co., La Belle Sauvage, E.C.3.

TELSEN L.F. TRANSFORMERS

THE "Telsen" Ace is eminently suitable for Receivers where highest efficiency is required at low cost and where space is limited. As its characteristic curve will show, it gives a performance equal to that of the most costly transformers.

RATIO 3-1 No. W.66

RATIO 5-1 No. W.65

5'6

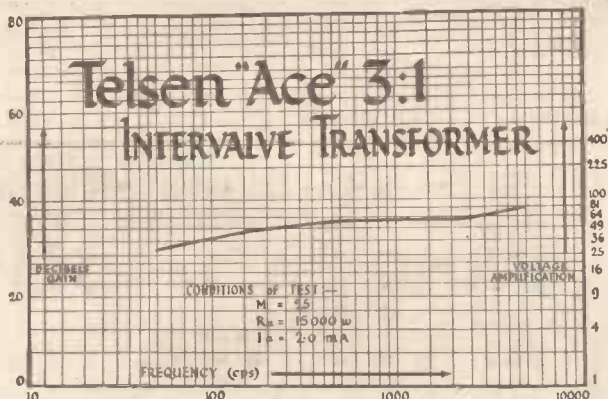
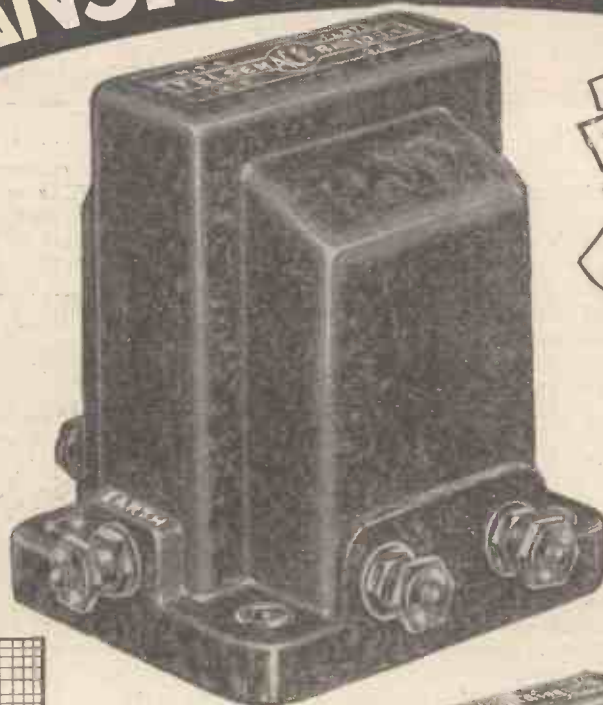

TELSEN "RADIOGRAND" L.F. TRANSFORMERS.

Telsen "Radiogrand" Transformers have signified to expert designers and enthusiastic constructors all that is finest in British Radio craftsmanship. The design is based on the results of recent research coupled with the soundest engineering principles, tested rigorously for immaculate performance and enduring efficiency.

RATIO 3-1. No. W.59.
RATIO 5-1. No. W.58.

7'6



TELSEN "RADIOGRAND" (Ratio 7-1) TRANSFORMER.

This Transformer is designed to give extra high amplification on receivers employing only one stage of L.F. amplification. It is not recommended for use in receivers employing two L.F. stages, as overloading is likely to occur.

No. W.60

10'6



TELSEN "RADIOGRAND" INTERVALVE TRANSFORMER. Ratio 1.75-1.

For use in receivers employing two stages of L.F. amplification, where exceptionally good quality is desired. When used following an L.F. stage employing choke or resistance coupling it will be found to give ample volume with remarkable reproduction.

10'6

TELSEN
RADIO COMPONENTS

GOOD RADIO IS A JOY FOREVER

ANNOUNCEMENT OF THE TELSEN ELECTRIC CO., LTD., ASTON, BIRMINGHAM

To Ensure Speedy Delivery, Mention "A.W." to Advertisers

"THE TELSEN RADIOMAG"

THE third number of *The Telsen Radiomag* has just been issued, this including three full-size shilling blue-prints of the latest Telsen sets. The *Radiomag* has a number of useful articles on getting good reception, on simple ways of testing sets and on simplifying set construction. The blueprints relate to sets which are described in the *Radiomag*, these including the Nimrod 2, The Telsen Ajax 3, and the Telsen Triple Three.

New Telsen parts such as the Telornor and the various kit sets are described, while all set users will be interested in detailed lists of the short and broadcasting band stations.

Copies of *The Telsen Radiomag* can be obtained from most radio dealers, or direct from Telsen Electric Co., Ltd., Aston, Birmingham.

"Broadcasting House."—The B.B.C. has just issued a most interesting 124-page book of coloured plates, photographs, and brief descriptions of all the places of interest in Broadcasting House, London. Photographically, the studios, control rooms engineering sections, sculptures, main offices, listening halls and so on are portrayed in a lucid and artistic manner, and they are bound to interest all listeners. Brief descriptions are given of the main photographs, and there are coloured diagrams, showing schematically the arrangement, offices and control rooms on each floor. There are detailed photographs of some of the engineering sections, especially in connection with the control

room apparatus, and these will appeal to the more technical listeners. Although the book relates primarily only to Broadcasting House, London, it nevertheless illustrates the very latest B.B.C. practice in the way of studios and control gear, and for this reason the book should have a wide general appeal. Copies can be obtained, price 5s. (5s. 9d. post free), from the Publications Department, Broadcasting House, Portland Place, London, W.

THE LISSSEN TONE COMPENSATOR

ONE of the new components which makes a great difference to the performance of a set because of the tonal control possible is the Lissen inter-valve tone compensator. This small component fits beneath the transformer with which it is

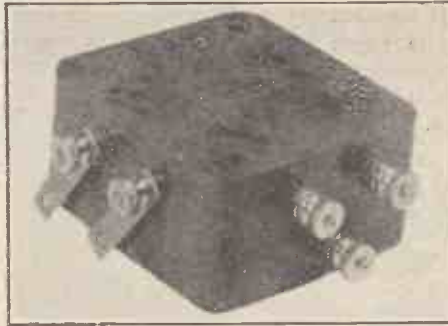

The Lissen tone compensator

used, and three short leads are taken to a special potentiometer supplied with it.

The circuit is interesting, and the method of use is that adopted by Mr. Percy Harris in the "Advance Four" described in this and the previous issue. It is not simply a means of cutting off the high notes to emphasise the bass, but is a proper tone control capable of increasing the bass or intensifying the treble according to the circuit conditions or the programme. Full details of the tone compensator together with suggested circuits can be obtained free on mention of "A.W." from Messrs. Lissen, Ltd., Worples Road, Isleworth, Middlesex. The control, complete with the special potentiometer, costs only 10s.

Nearly all the broadcasting in the Scottish Region during the week beginning September 4 will come from Aberdeen. This is because the North East Trades Exhibition will be taking place in Aberdeen that week, and the B.B.C. is co-operating with the organisers and erecting a model studio in the exhibition from which broadcasting will take place. The model studio will have one of its sides of glass so that the public in the exhibition will be able to watch the broadcasters at their work. They will, of course, not be able to hear the actual tones of the broadcast direct, but will hear them through the loud-speakers in the hall, which will pick up the broadcast. This is the first time this form of public broadcasting has taken place in Aberdeen and it is anticipated that Aberdonians will show great interest in seeing as well as hearing broadcasting that comes from their own city.



has gone **TWO** better!

Formo experts have surpassed themselves—and everyone else. They have brought you something really new in the Multi-coupler. High amplification—super performance—real efficiency—and greater simplicity in set design, these things now have a real meaning, thanks to the exclusive double screen of the Multi-coupler. The electrostatic screen cuts out all H.F. interference, whilst an electro magnetic screen positively eliminates mains distortion and hum, no matter where the Multi-coupler is placed in the set



The MULTICOUPLER is combined with two feed resistances and a coupling condenser. It gives high-quality amplification and its eight terminals can be used to give ratios of 2.5-1, 3.5-1, or 4.5-1.

10/6

ONLY FORMO CAN OFFER THIS DUAL ADVANTAGE

Get the new Formo Catalogue-Handbook of better quality, better value components. If unobtainable locally, send us the name and address of your usual dealer.

The FORMO CO.
Crown Works, Regents Park, Southampton
London: 23 Golden Sq., Piccadilly, W.1

NEW BRITISH GENERAL BAND-PASS COILS AT A LOWER PRICE

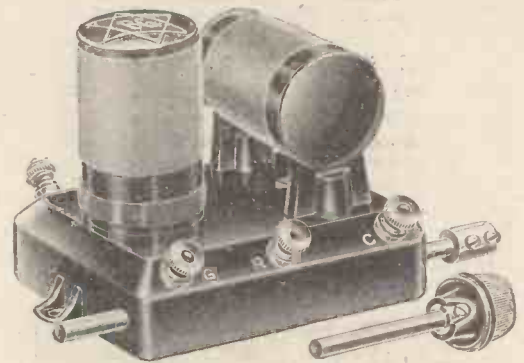

A new series of these famous filter Coils, comprising a band-pass aerial coil, a band-pass H.F. coil, with a screened H.F. coil designed to match with either of the other two. The only really effective method of ensuring perfect separation of stations is by Band-Pass tuning, and these coils enable you to achieve it at small expense.

Wiring diagrams supplied. Note the new Price, each (Aerial and Anode models). From all dealers or direct.

9/6

BRITISH GENERAL MANUFACTURING CO., LTD.
Brockley Works, London, S.E.4

TELSEN CHOKES

COUPLING, OUTPUT, AND SMOOTHING



TELSEN INTERVALVE L.F. COUPLING CHOKES
 These popular L.F. Chokes are primarily intended for use as coupling chokes, but may be used in any circuit not carrying more than the stipulated maximum current. The 100 H. type is for H. or H.L. type valves, the 40 H. type for L. type valves.

RATING	NORMAL CURRENT.	MAX. CURRENT	NO.
40.H. at 5.M.A.		10.M.A.	W.68
100.H. at 3.M.A.		8.M.A.	W.69

5/6

TELSEN TAPPED PENTODE OUTPUT CHOKE

This choke is designed primarily for pentodes taking an anode current of not more than 20.M/A which includes the ordinary battery operated types. The single tapping provided gives (by reversing) ratios of, 1-1, 1.6-1, 2.5-1, which provide for matching under widely varying conditions. The choke is equally suitable for matching a low impedance speaker with an ordinary power valve. A coupling condenser of 1.Mfd. is recommended.

No. W.72 **7/6**

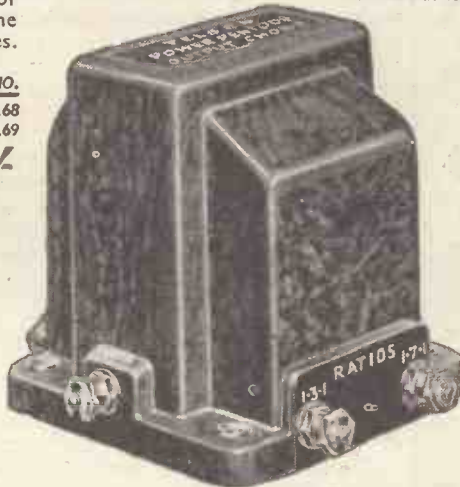

TELSEN POWER PENTODE OUTPUT CHOKE

The purpose of this power pentode output choke is to prevent direct current passing through the Loudspeaker, and also to match the speaker to the pentode valve. By using this choke in conjunction with a condenser of 1.Mfd. the quality obtained from a pentode becomes quite equal to that expected from a normal super power valve, and the volume is much increased. This model is suitable for mains power pentodes carrying currents up to 40 M/A and for correct matching gives the choice of three ratios, viz:—
 1-1, 1.3-1, and 1.7-1.

No. W.172 **10/6**

Designed for use as Output Filter in conjunction with a condenser not less than 1 Mfd., following any power or super power valve taking up to 40 M/A anode current. Gives an ideal response curve under all conditions.

No. W.71 **7/6**

TELSEN

RADIO COMPONENTS

GOOD RADIO IS A JOY FOREVER

ANNOUNCEMENT OF THE TELSEN ELECTRIC CO., LTD., ASTON, BIRMINGHAM

To Ensure Speedy Delivery, Mention "A.W." to Advertisers

PERMANENT MAGNET Moving-Coil Speakers

The New "MANSFIELD" Models



"MANSFIELD SENIOR" P.M.4

A greatly developed form of the famous W.B.—P.M.4. Brilliant reproduction from any 2- or -3 valve set.

42/- COMPLETE with transformer.

"MANSFIELD JUNIOR" P.M.5

Marvellous value that astonished Olympia—"Moving-Coil for the Million."

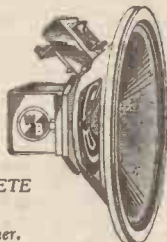

27/6 COMPLETE with transformer.



Write AT ONCE (don't delay) for the new art booklet, "Speaking of Speakers" — full information on all the new W.B. things.

Whiteley Electrical Radio Co., Ltd., Nottingham Road, Mansfield, Notts.

Irish Free State Distributors: Kelly & Shiel, Ltd., 47 Fleet Street, Dublin.

6 OD WILL INSURE YOUR VALVES

You have at least 30/- worth of valves to risk when you use unknown makes. Don't experiment — insist on genuine branded "Competa" fuses in the little orange boxes.

COMPETA THE WORLD'S SELECTED

06A
1 M
15 P
2 S

Advt. of A. F. BULGIN & Co. Ltd., Abbey Rd., Barking

YOUR OLD COMPONENTS

are worth money. Sort out the spare radio parts you no longer require and advertise them in the "Miscellaneous Columns" of AMATEUR WIRELESS. You will be surprised how quickly they will be snapped up.

Your announcement will cost you 3d. a word. Send your list of parts, together with your name, address and remittance to:

"Small Advertisement" Department,

AMATEUR WIRELESS

58-61, Fetter Lane, London, E.C.

"ADJUSTING AND OPERATING THE 'ADVANCE FOUR'"

(Continued from page 422)

can be left alone. Over most of the readings you will find both dials approximately the same, but at the lower end of the scale there may be quite a difference on the detector condenser.

You should now practise tuning in various stations over the whole wave-range, both the medium and long-wave bands. The wave-change switch which, as you know, is a rod which passes through all of the coil cans, is so made that it can pull right out and be re-inserted through a hole in the right-hand end of the cabinet after the chassis is put in position. You then change from one wave-band to the other, by turning the knob on the side of the cabinet, all adjustments being made simultaneously when the switch is turned.

Volume Control

The control of volume and reaction will be found very smooth and pleasant to handle, particularly when the set is tuned to the local station, for by judicious use of this control you can get perfect quality without overloading, which is rare in the case of powerful sets tuned to nearby stations. The tone control, which is varied by the knob on the right of the combined volume and reaction control, is so made that when the knob is turned fully in a clockwise direction you get an over-accentuation of top, while fully in the anti-clockwise direction brings in more bass. Roughly speaking, the anti-clockwise position gives you all bass and very little top; while the clockwise position gives you all top and very little bass. Between the two positions, that is, about half-way round, you should get a quality which suits most conditions, although as you will find in practice some foreign stations require more top and others less top than normal.

A careful adjustment of this knob when listening to some of the long-wave stations will effect a very noticeable improvement in their quality, while for normal reception you will find a position which suits your particular loud-speaker excellently. Note this normal position and return to it for all reception except where you notice the quality to be different from that which you would normally choose.

Battery Connections

The terminals on the back of the set all explain themselves, of course. Only one terminal, however, is used for negative H.T. and negative L.T., as both are joined together in the set and they might as well be joined at the terminal. The pick-up leads from your gramophone (and if you have not yet bought an electrical pick-up for your gramophone you should get one!) are taken to the two pick-up terminals and when the switch is turned from "Radio" to "Gram" (the "off" position of both is half-way between these two) the pick-up is connected and the detector automatically changed from a detector valve to a low-frequency valve with negative bias, while simultaneously the filament of the screen-grid valves are extinguished so as to afford economy in

current consumption and to prevent a break through of radio on the gramophone side.

Make a careful note of the many stations you pick up, show their exact dial readings, otherwise you may mistake some of the more distant stations for locals. I have listed the readings on my own set (first dial readings) for the stations I received over an hour or two in one evening and as there is a station for every degree or two you will soon be able to find others. As a matter of fact, I could have doubled the list if I had put down unidentified stations, but as I only desired to record those I could positively identify, the list is smaller than the actual reception gave.

If the selectivity is not sufficient for your particular district, house, and aerial, you can easily adjust it by unscrewing the compression condenser until you get what you require. It is a mistake to use this set with a very large aerial as the tremendous magnification will be wasted. It is much better to use it with a small aerial and in a sensitive condition than with a very large aerial and the volume control turned well back.

As to the choice of valves, the first two shown are the Cossor battery variable-mu screen-grid valves, type 220V.S.G. The detector can be any good make of the HL type, while the output valve should be one of the economical types of output valve, such as the Cossor 220P, Mullard PM2A, Marconi or Osram P215, Lissen P220, Mazda P220, etc. This will give you economy in H.T. consumption. If, however, you have ample H.T., then you can use an output valve, which will handle a bigger grid-swing without overloading.

"A VISIT TO RADIO PARIS"

(Continued from page 435)

masts, however, are immense, and are almost as impressive as those which I saw later at Saint-Remy. The old-type air-cooled valves are used in the intermediate circuits at Clichy, but still Paris listeners do not complain of any wavelength variations.

The Saint-Remy transmitter, which is the one generally used for the main Sunday programmes, is immense. It is an 80-kilowatt and quite unlike the B.B.C. apparatus. For one thing, it is crystal controlled. All the power comes from the local L'Ouest-Lumiere power company and mercury vapour rectifiers convert this to D.C. Big water-cooled valves are used in the final stages, and whereas the B.B.C. encloses these in metal cases with safety doors, the C.F.R. engineers have all the valves built up on a kind of tower in the centre of the transmitter hall.

All the other valves are behind slate panels, though, so that while Radio Paris is broadcasting there is nothing to be seen but the wavering of meter needles. Before I left, I was able to see the transmitter stop for an interval between programmes. An engineer at the central control desk did everything by touching relay buttons. There are no big generators to control, as at the B.B.C. stations, for the valve and mercury rectifiers supply all the power.

Postcard Radio Literature

GET THESE CATALOGUES FREE

Here "Observer" reviews the latest booklets and folders issued by well-known manufacturers. If you want copies of any or all of them FREE OF CHARGE, just send a postcard giving the index numbers of the catalogues required (shown at the end of each paragraph) to "Postcard Radio Literature," "AMATEUR WIRELESS," 58/61, Fetter Lane, E.C.4. "Observer" will see that you get all the literature you desire. Please write your name and address in block letters.

Wearite Parts

I STRONGLY advise all set builders to get the new book of Wearite components. Wright and Weaire, Ltd., have produced a fine 16-page book, well illustrated, and with full technical details of super-het. coils, dual-range coils, volume controls, potentiometers, H.F. chokes, switches, and the dozens of other parts which have made the name of Wearite popular.

Climax Mains Units

Keep up to date with what Climax are doing in the way of mains units and mains components this season. A new folder has just been issued which gives all the essential information. There are two fine mains units, one for A.C. (giving a 20-milliamperes output at 120-150 volts), and the other for D.C. mains (giving 50 milliamperes from the power supply and being suitable therefore for sets with large power valves and with pentode output). Chokes and potential dividers are in the range of mains components.

New Circuits for You

Ready Radio, Ltd., have just sent me a fine 18. book of circuits and layouts, and I am told that you can obtain free copies of this through my Catalogue Service. Full constructional details, photographs and diagrams are given of ten new circuits, including two-valvers, three-valvers, mains units and short-wavers. Drop a line through my Catalogue Service, mentioning number

A New Atlas Unit

You should get details of the new Atlas A.C.300 mains unit which supplies H.T., L.T., and grid-bias. The grid-bias supply is tapped at 1½, 3, 9, and 16 volts, is independent of the H.T. and smoothed by electrolytic condensers. Full details are available through my Catalogue Service.

A New Mains Set

I have just received details of the Orpheum S.G.P. Three set. A.C., D.C., and battery-driven models are available and there is provision for gramophone working. The A.C. model is adapted for mains-aerial working and all sets except the battery job incorporate a moving-coil speaker. OBSERVER.

New Times Sales Co

NEW 1933

RADIO ON EASIEST OF EASY TERMS

QUICKEST DELIVERY

ULTRA BLUE FOX RECEIVER. With 13/6
For A.C. or D.C. Mains. 2 valves, detector and power. Moving-Coil Speaker. With Mazda Valves. Ready for Use. Cash Price £10/10/0. order
Balance in 17 monthly payments of 13/6.

MANUFACTURERS' KITS

RADIO FOR THE MILLION "STATION MASTER 3" (Model B). With valves, cabinet and speaker as advertised. Cash price, £7/10/-. order
Balance in 11 monthly payments of 14/-. With 10/-

COSSOR MELODY MAKER MODEL 335. Complete with valves, speaker and cabinet. Employs Cossor variable-mu S.G., H.F. stage, detector and power valves. Cash price, £7/17/6. order
Balance in 11 monthly payments of 14/10. With 10/-

OSRAM "THIRTY THREE" MUSIC MAGNET. Complete kit, comprising all components including valves, cabinet with self-contained speaker. Screen-grid H.F., screen-grid detector and power output. Single-dial tuning, wavelength calibrated. Cash price £9/9 0. order
Balance in 11 monthly payments of 17/6. With 15/-

ACCESSORIES

GARRARD INDUCTION GRAMOPHONE MOTOR. For A.C. mains. Model 202. Mounted on 12-inch nickel motor plate with fully automatic electric starting and stopping switch. Cash price £2/18/6. order
Balance in 11 monthly payments of 5/4. With 5/4

B.T.H. SENIOR PICK-UP with arm and base. Cash price £2/2/-. order
Balance in 11 monthly payments of 3/10. With 3/10

FIRST WITH
EASY TERMS
in 1924 and
Still leading
BIGGEST STOCKS

Strictest Privacy Guaranteed

R. & A. "VICTOR" PERMANENT MAGNET MOVING-COIL SPEAKER DE LUXE with 0-ratio input transformer and protecting grille. Cash or C.O.D., £3/10/-. order
Balance in 11 monthly payments of 6/5. With 6/5

R. & A. "BANTAM" PERMANENT - MAGNET MOVING - COIL SPEAKER with 3-ratio input transformer. Cash price £1/7/6. order
Balance in 5 monthly payments of 5/-

W.B. PERMANENT MAGNET MOVING-COIL SPEAKER. Type P.M.4. Complete with transformer. Cash price £2/2/-. order
Balance in 7 monthly payments of 5/9

BLUE SPOT SPEAKER UNIT AND CHASSIS, TYPE 100U. Cash price £1/19 6. order
Balance in 7 monthly payments of 5/5

ATLAS ELIMINATOR, Type A.C.244. Three tappings, S.G., detector and power. Output, 120 volts at 20 m/a. Cash price, £2/19/6. order
Balance in 11 monthly payments of 5/6

ULTRA IMP PERMANENT MAGNET MOVING-COIL SPEAKER, with input transformer. Cash price £1/17/6. order
Balance in 5 monthly payments of 6/10

EPOCH "20 C" PERMANENT MAGNET MOVING-COIL SPEAKER. With 3-ratio input transformer. This speaker will handle up to 5 watts. Cash price, £1/15/-. order
Balance in 5 monthly payments of 6/6

EKCO H.T. UNIT. Type A.C.25. For multi-valve sets requiring up to 25 m/a. 3 tappings, S.G., detector and 120/150 volts. For A.C. mains. Cash price, £3/17/6. order
Balance in 11 monthly payments of 7/1

Any items advertised in this journal sent C.O.D.: If value over 10/- sent all C.O.D. charges paid.

To NEW TIMES SALES CO., 56, Ludgate Hill, London, E.C.4
Please send me (a) 1933 Lists,
(b)..... for which I enclose
first payment of £..... s..... d.....
Name.....
Address.....
..... A.W.3/9/32....

READ

"Wireless
Magazine"

SEPTEMBER

Now on Sale, 1/-



TYPE MSW.1

The New MORLEY SHORT-WAVE COIL UNIT

Price 6/9

7-20 metres with .00025 tuning condenser. Aerial Coupling Coil so positioned to couple correctly for both wave bands, and completely eliminates dead spots. Silver contacts with self cleaning action. Low H.F. resistance. Minimum dielectric losses. Write for illustrated list of Band Pass Screened Coils, special three range, etc., etc.

5 CROWN PARADE, LONDON, N.W.9

LET "AMATEUR WIRELESS"
SOLVE YOUR WIRELESS PROBLEMS

At last! PERMANENT EFFICIENT EVER-DAMP EARTHING

A Sensational
Radio Invention!

Get the ut most out of your set by fitting **FILT**—the newest and most efficient earth ever invented—based on a completely new principle. Its operation is unique. You simply bury the copper receptacle containing the wonderful **FILT** chemical, which at once begins to spread through the earth, attracting moisture and making a **PERMANENT** highly conductive area to the depth of several feet.

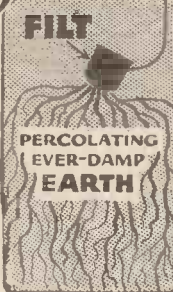

Never dries up in all weathers, in every soil, **FILT** keeps moist and highly conductive. It spreads like a tenticle, earthing your set perfectly and giving you every ounce of power, range, and purity, no matter what set you use.

GET A FILT TO-DAY
It is inexpensive, permanent, and the most efficient obtainable.

GRAHAM-FARISH

FILT PERCOLATIVE EARTH

Ask your dealer to obtain, or write direct to:
GRAHAM FARISH LTD.
203 Mason's Hill,
BROMLEY - KENT

PRICE
2/6
COMPLETE

BROADCASTING STATIONS

Broadcasting Stations classified by country and in order of wavelengths. For the purpose of better comparison, the power indicated is that of the carrier wave.

Kilo-Metres	Station and Call Sign	Power (Kw.)	Kilo-Metres	Station and Call Sign	Power (Kw.)	Kilo-Metres	Station and Call Sign	Power (Kw.)
GREAT BRITAIN								
25.53	11,751 Chelmsford	10.0	208.4	812 Radio LL (Paris)	1.0	NORWAY		
(G5SW)			also on 33 m. (9,090 Kcs.)			235.5	1,274 Kristiansand	0.5
211.3	1,420 Newcastle	1.0	384.4	779 Radio Toulouse	60.0	240	1,249.7 Stavanger	0.5
214.3	1,400 Aberdeen	1.0	447.1	671 Paris (PTT)	6.0	304	824 Bergen	1.0
242	1,238 Belfast	1.0	455	659 Radio Agen	0.5	307.6	816 Fredrikstad	0.7
261.6	1,147 London National	50.0	465.8	644 Lyons (PTT)	1.5	493.4	608 Trondheim	1.2
288.5	1,040 Swansea	0.12	569.1	527.1 Grenoble (PTT)	2.0	1,083	277 Oslo	60.0
288.5	1,040 Plymouth	0.12	1,445.7	207.5 Eiffel Tower	13.5	POLAND		
288.5	1,040 Bournemouth	1.0	1,725	174 Radio Paris	75.0	214.3	1,400 Warsaw (2)	1.9
301.5	995 North National	50.0	GRAND DUCHY OF LUXEMBOURG			235	1,283 Lodz	2.2
309.9	968 Cardiff	1.0	1,250	240 Luxembourg	(tests) 200.0	312.8	959 Cracow	1.5
355.0	843 London Regional	50.0	GERMANY			335	896 Poznan	1.9
376.4	797 Scottish Regional	50.0	19	737 15,200 Zeesen (DJB)	8.0	380.7	788 Lvov	16.0
308.0	752 Midland Regional	25.0	31	38 9,560 Zeesen (DJA)	8.0	408	734 Katowice	12.0
480	625 North Regional	50.0	217	1,382 Königsberg	0.9	503	533 Wilno	16.0
1,554.4	193 Daventry (Nat.)	30.0	227.4	1,319 Flensburg	0.5	1,411.8	212.5 Warsaw	120.0
AUSTRIA			232.2	1,293 Kiel	0.25	PORTUGAL		
218	1,373 Salzburg	0.5	238.9	1,256 Nürnberg	2.0	241.6	1,241.8 Oporto	0.25
245.9	1,220 Linz	0.5	245.9	1,220 Cassel	0.25	282.2	1,063 Lisbon (CT1AA)	2.0
283	1,058 Innsbruck	0.5	253.1	1,185 Gleiwitz	5.0	also on 31.25 m.		
352.1	852 Graz	7.0	259.3	1,157 Frankfurt-a-M	17.0	ROMANIA		
453.2	662 Klagenfurt	0.5	269.8	1,112 Bremen	0.2	394	761 Bucharest	12.0
518	579.1 Vienna	15.0	276.5	1,085 Heilsberg	60.0	RUSSIA		
also testing on 1,252.0 m. from 7 p.m. (Mon., Wed., Sat.)			283.6	1,058 Magdeburg	0.5	351	855.5 Leningrad (RV70)	20.0
BELGIUM			283.6	1,058 Berlin (E)	0.5	358	838 Moscow (Exp.)	15.0
207.3	1,447 Franchimont	0.2	283.6	1,058 Stettin	0.5	389.0	770 Archangel	10.0
208.3	1,440 Liege (Seraing)	0.15	318.8	941 Dresden	0.25	476	630.2 Sebastopol	10.0
211.7	1,416.8 Antwerp	0.3	325	923 Breslau	60.0	502.4	579 Nijni Novgorod	10.0
215.3	1,393 Chatelaineux	0.2	372.2	806 Muhlacker	60.0	644	465.8 Kazan (RV17)	10.0
215.4	1,392.5 Bruxelles	0.2	389.6	770 Leipzig	60.0	720	416.6 Moscow (PTT)	20.0
Conference			419.9	716 Berlin	1.5	825	303.6 Sverdlovsk (RV5)	50.0
215.5	1,392 Liege	0.1	453.2	662 Danzig	0.5	843.7	353.5 Rostov (Don)	20.0
230.3	1,304 Radio Wallonia	0.3	472.4	635 Langenberg	60.0	882	340 Saratov	25.0
239.5	1,258 Binche	0.3	532.9	563 Munich	1.5	937.5	320 Kharkov (RV4)	20.0
240.2	1,420 Liege (Exp.)	0.1	559.7	536 Kaiserslautern	1.5	967.7	310 Alma Ata	100.0
245.9	1,220 Radio Schaeerbeek	0.3	559.7	536 Augsburg	0.3	1,000	300 Leningrad	100.0
272	1,103 Liege (Cointe)	0.4	566	530 Hanover	0.3	1,034	290 Kiev	100.0
337.8	888 Brussels (No. 2)	15.0	569.3	527 Freiburg	0.25	1,071.2	280 Tiflis (RV7)	100.0
509	590 Brussels (No. 1)	15.0	1,620	185 Norddeich KVA	10.0	1,106	271.2 Minsk (RV10)	35.0
BULGARIA			1,634.9	183.5 Zeesen	60.0	1,116	263.5 Moscow Popoff	75.0
318.8	941 Sofia	1.0	2,525	119.3 Königswusterhausen (press)	15.0	1,171.5	256 Taschkent	25.0
(Rodno Radio)			2,900	103.5 ditto	15.0	1,280	238 Bakou	35.0
CZECHO-SLOVAKIA			4,000	75 ditto	15.0	1,304	230 Moscow (Trades Unions)	165.0
58	5,172 Prague	0.5	HOLLAND			also on 50 m. (6,000 Kcs.)		
240	1,205 Prague (Strasnice)	5.0	206.1	1,013 Huizen	8.5	1,380	217.4 Novosibirsk	100.0
263.8	1,137 Moravska-Ostrava	11.0	1,071.4	280 Scheveningen-Haven	10.0	1,481.5	202.5 Moscow RV1	100.0
278.8	1,076 Bratislava	14.0	also on 43.6 m. (6,438 Kcs.)			1,600	187.5 Irkutsk (RV14)	10.0
293	1,022 Kosice	2.5	HUNGARY			SPAIN		
341.7	878 Brunn (Brno)	35.0	208.7	1,437.8 Budapest (2)	3.0	252.4	1,188 Barcelona (EAJ15)	6.0
488.6	614 Prague	120.0	210	1,430 Magyazovar	1.5	266.8	1,124.5 Valencia	8.0
DENMARK			550	545 Budapest (1)	18.5	348.8	860 Barcelona (EAJ1)	8.0
281	1,067 Copenhagen	0.75	also relayed on 75 m.			368.1	815 Seville (EAJ5)	1.5
1,153	260 Kalundborg	7.5	ICELAND			411.4	729.1 Madrid (EAJ7)	2.0
also on 31.51 m. (9,520 Kcs.)			1,200	250 Reykjavik	21.0	424.3	707 Madrid (Espana)	2.0
ESTONIA			IRISH FREE STATE			456.6	557 San Sebastian (EAJ8)	0.6
298.8	1,004 Tallinn	11.0	222.9	1,344.6 Cork (6CK)	1.2	SWEDEN		
465.8	644 Tartu	0.5	416.2	720.7 Dublin	1.2	231	1,301 Malmö	1.2
FINLAND			413	725 Athlone (tests)	00.0	257	1,166 Hórbý	10.0
291	1,031 Tampere	1.0	ITALY			308.5	972.4 Falun	0.5
291	1,031 Viipuri	13.0	25.4	11,510 Rome (2RO)	15.0	321.9	932 Göteborg	10.0
308.1	815 Helsinki	13.2	247.7	1,211 Trieste	10.0	435.4	689 Stockholm	55.0
1,796	167 Lahti	54.0	269.4	1,112 Bari	20.0	5415	554 Sundsvall	10.0
FRANCE			273.7	1,096 Turin (Torino)	7.0	770	389 Ostersund	0.6
220	1,363.2 Béziers	0.5	312.8	950 Genoa (Genova)	10.0	1,229.5	244 Boden	0.6
226.4	1,324.8 Fécamp	10.0	318.8	941 Naples (Napoli)	1.5	1,348	222.5 Motala	30.0
237.2	1,265 Bordeaux	2.0	332.1	903 Milan	7.0	also on 49.46 m. (6,065)		
Sud-Ouest			368.1	815 Bolzano	1.0	SWITZERLAND		
249.8	1,201.2 Juan-les-Pins	0.5	441	680 Rome (Roma)	50.0	244.1	1,229 Basle	0.65
255	1,175 Toulouse (PTT)	1.0	501.8	599 Florence (Firenze)	20.0	245.9	1,220 Berne	0.5
265.4	1,130 Lille (PTT)	1.3	525.9	570.3 Palermo	3.0	403	743 Sttens	25.0
271.4	1,105 Rennes	1.3	LATVIA			459.4	653 Beroinenster	60.0
286	1,049.1 Montpellier	0.8	108.5	1,510 Riga (test)	16.0	760	395 Geneva	1.25
286.7	1,026.3 Radio Lyons	10.0	525	572 Riga	15.0	TURKEY		
293.7	1,021.5 Limoges (PTT)	0.5	LITHUANIA			1,200	290 Istanbul	5.0
304.9	981 Bordeaux (PTT)	13.0	1,935	155 Kaunas	7.0	1,538	195 Ankara	7.0
309.5	969 Radio Vitus	1.0	NORTH AFRICA			307	977 Zagreb (Agram)	9.75
(also on 43.75 m. (6,865 Kcs.)			363.3	825.3 Algiers (PTT)	10.0	430.4	697 Belgrade	2.5
315	950 Marseilles	1.6	419	715.9 Radio Maroc (Kabab)	6.0	574.7	522 Ljubljana	5.2
328.2	914 Poste Parisien	00.0	and 32.26 m. (9,300 Kcs.)					
345.2	869 Strasbourg (PTT)	11.5						

The first broadcast from the Scala Theatre, Long Eaton, for Midland Regional listeners, will be given on September 12, when "The Roosters" are to give selections from their repertoire.

The monthly Religious service in Welsh on the Daventry National and West Regional wavelengths will be taken from the Tabernacle Welsh Independent Church, Fishguard, on September 11.

The Welsh Interlude for West Regional listeners will be given by Mr. D. J. Williams, on September 14.

The Welsh Interlude for Daventry National and West Regional listeners will be given by Mr. E. Morgan Humphreys, on September 17, when he will give his personal impressions of Welsh orators he has met.

The Lord Mayor of Bristol will give a preliminary talk from Bristol on the Bristol Radio Week on September 17.

The third of the recitals of gramophone records, under the title of "Discs," will be given on September 17. This recital will have a Bristol flavour.

JUST OUT



A.C. MAINS USERS need this book. "The All-Metal Way, 1933," is more than a catalogue. Not only does it contain full particulars and prices of Westinghouse Metal Rectifiers, but it tells you how to build battery eliminators and trickle chargers suitable for all sets, from the smallest two-valver to the largest radio-gram; how to convert existing battery-operated sets to all-mains; and gives full details for running moving-coil loud-speakers from the A.C. mains. Most mains radio problems are answered in this book, and "free" field excitation, "automatic" grid bias, hum, motor-boating, etc., are dealt with fully.

If you would like a copy, fill in the coupon and send it to us with 3d. in stamps. You will find the book invaluable.

THE WESTINGHOUSE BRAKE & SAXBY SIGNAL Co. Ltd.
82 York Road, King's Cross, London, N.1

COUPON
WESTINGHOUSE PUBLICITY, 82 York Road, King's Cross, London, N.1
Please send me a copy of your 44-page booklet, "THE ALL-METAL WAY, 1933," for which I enclose 3d. in stamps.

NAME.....
ADDRESS.....

A.W., 3/9/32

GET A COPY NOW

WESTINGHOUSE METAL RECTIFIERS WILL BE ON VIEW AT THE BON MARCHÉ RADIO EXHIBITION, BRIXTON, S.W.9, SEPTEMBER 3 TO 10. IF YOU WERE UNABLE TO VISIT OLYMPIA, HERE IS A CHANCE TO SEE THESE RELIABLE RECTIFIERS—THE ONLY RECTIFIERS TO COMBINE ROBUST CONSTRUCTION, LONG LIFE, AND HIGH EFFICIENCY.

Don't Forget to Say That You Saw it in "A.W."

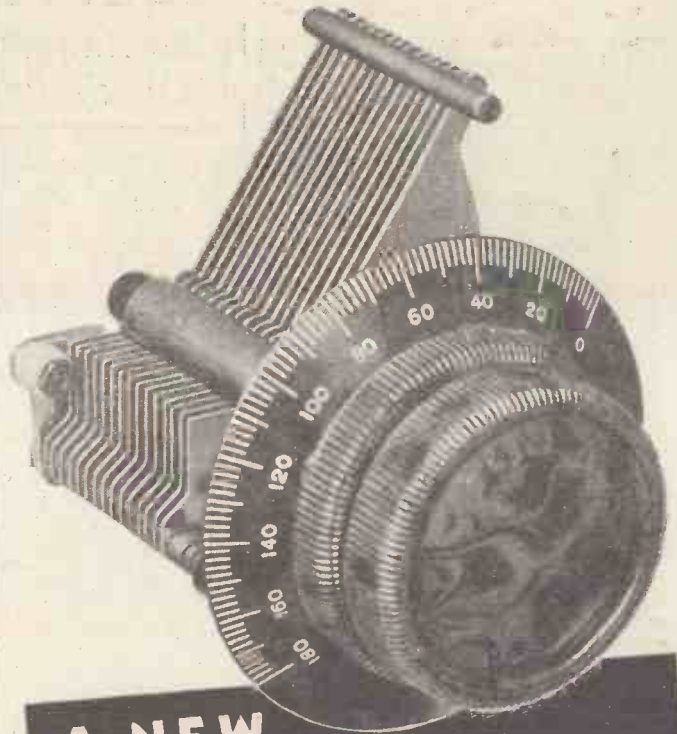

A NEW

Utility MITE

Here is the new Utility Mite, with vernier; a better job than ever and that is saying something, because the old Mite was the finest small condenser made.

Its accuracy is of the highest possible order, its geared slow motion drive is as beautiful an action as you could wish for, and its price is no higher than many a cheaper and inferior job.

If your dealer cannot show you the range, write to us for full particulars.

PRICES

W319 .0005 mfd. as illustrated, 6/6.
Less vernier 4/- W320 .0003 mfd. 6/6.
Less vernier 4/- W321 .0002 mfd. 6/-.
Less vernier 3/6.

From your dealer or post free from the makers.

WILKINS AND WRIGHT LIMITED
UTILITY WORKS, HOLYHEAD ROAD, BIRMINGHAM

AGENTS.—London: E. R. Morton, Ltd., 22 Bartlett's Buildings, Holborn Circus, E.C.4. Scottish: E. B. Hammond, 113 Vincent Street, Glasgow. Lancashire and Cheshire: J. R. Lister, 83 Old Road, Blackley, Manchester. Westmorland, Cumberland, Durham, Northumberland, Yorkshire, and Derbyshire: W. H. C. Rawson, Ltd., 100 London Road, Sheffield. Lawrence Fraser, Chelsea House, Lansdown Road, Bath.



Belmont



**HEAYBERD
MODEL
A.O.2
BATTERY
CHARGER**

2, 4 or 6 volts
at 1/2 amp.

**35/-
COMPLETE**

**CHARGE
YOUR
ACCUMULATORS**

Save the expense, worry and inconvenience incurred in taking your Accumulators to a service station to be recharged—do them yourself at home! Just connect the Heayberd AO.2 Charger to your accumulator, switch on to the mains and do the job quicker, cheaper, and neater in your own kitchen. Charging 2, 4, or 6 volts at 1/2 amp. Incorporating Heayberd Transformer and Westinghouse Rectifier in neat crystalline metal case.

**COMPLETE
35/-**

POST NOW
I enclose 3d. stamps for fully illustrated Catalogue giving Technical Tips and diagrams.

M.....

Address.....

A.W.27

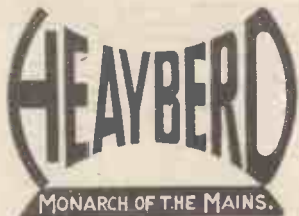

10 FINSBURY STREET, LONDON, E.C.2
One minute from Moorgate Underground Stn.

YOU



Can build your own gram or radio from our parts and save pounds. Lists of kits, cabinets, motors and parts FREE. Cash or Terms. Instructions 3d.

**A. W. BURT, 185, HIGH ST.,
DEPTFORD, LONDON, S.E.8**

DESIGNS FOR APPARATUS FOR ANY RADIO PURPOSE, INCLUDING TRANSMISSION. OVERSEAS ENQUIRIES INVITED; ANY APPARATUS SUPPLIED. CONSTRUCTIONAL WORK UNDERTAKEN.

We undertake to solve your Problems, including obtaining Amateur Transmitting Licence. Whatever your difficulty, write us. Charges: 3/- per query, four or more, 2/6 each, with diagrams.

**Radio Technical Agency, (Dept. A.W.),
2, Westgate Chambers, Newport, Mon.**

REPAIRS to Loudspeakers 4/-, Blue Spots 5/-, Transformers 4/-, Moving Coils, etc. quoted for. Prompt Service. 12 months guarantee. Trade Invited. Streatham 0618.
Loud-speaker Repair Co., 2 SHIPKA ROAD, Balham, London

Buy . . .
**WIRELESS
MAGAZINE**
Price - - - 1/- monthly

OUR LISTENING POST

By JAY COOTE

DURING the past week listening conditions on the longer waves have considerably improved and on many evenings it has again been a pleasure to tune in such stations as Kalundborg, Oslo, Motala, Warsaw, etc., all of which, as luck would have it, were putting out good programmes on the nights devoted to them. Thursday in particular appears to be the day on which first-class concerts may be picked up from Copenhagen, as it is the day of the week on which the augmented symphony orchestra is brought into action. The acoustic properties of the new studio are very good, and consequently the broadcast takes on an exceptional brilliancy.

On Sunday, Tuesday, Thursday, Friday, and Saturday, from 11 p.m. until 12.30 a.m., Kalundborg is on the air with dance music—a period during which reception is invariably good. Variety in bands is assured by the fact that the studio for such entertainments regularly turns to the best restaurants in the Danish capital. Such popular resorts as the Wivel, Ritz, Nimb, and Industrian boast of first-class dance bands in many ways comparable to the combinations heard through our home stations.

Anti-Luxembourg!

By the way, I learn that there is every probability of a strong protest being lodged by the Danish authorities next month at Madrid in respect to the wavelength used by the Luxembourg super-power station, inasmuch as tests have already proved that the newcomer will sadly interfere with the Kalundborg broadcasts. If no concession is vouchsafed by Luxembourg, Denmark is likely to press for the allotment of another channel, a matter which, without doubt, may prove of some difficulty in the longer wave-band.

Under the heading "Warsaw," in my log I find starred entries for Mondays, Tuesdays, Fridays, and Saturdays, as a visit to this studio towards 8 p.m. on any of these days is always a safe one if a well-balanced orchestral and vocal concert is desired. The Pole may always be relied upon for a first-class programme, and I doubt whether in this respect I can recall ever having been disappointed.

A Long-wave Giant

Königsusterhausen although showing somewhat more strength during the past few days, is not yet calculated to attain the status of a star station, and on many evenings is unpleasantly sandwiched between Daventry and Radio Paris to its consequent disadvantage. On the other hand, Leningrad and Kharkov can now be heard very clearly, and the former, with its frequent relays of operatic performances from the new studio-theatre, owing to its increased power, is not so often marred, as hitherto, by the automatic fog beacons.

A station to which I frequently listen is that of Beromuenster (Schweizerische Landessender). On Sundays, in particular, at 6.30 p.m. it is worth while tuning in a broadcast in the English language; it consists usually of a chat on English ways and customs, a talk not only interesting to foreign listeners, but peculiarly attractive to us, as it gives us the other man's point of view. On other days, from roughly 8 p.m., the programmes are agreeably varied, provided as they are by three studios, namely, Berne, Basle, and Zurich. On certain days a relay is carried out of either London Regional or National, and not infrequently the station connects up with Vienna, Munich, and even with one of the Italian transmitters. Beromuenster may be counted upon to supply a worth-while broadcast and possesses the advantage of providing a signal of good strength.

**QUICK
EASY PAYMENT
SERVICE**

We supply all good quality Radio Receivers, Components, and Accessories on deferred terms. Large stocks are carried and orders are executed promptly. Send list of requirements and a quotation will be sent by return of post. Price List free on request.

MANUFACTURERS KITS

NEW COSSOR MELODY MAKER, Model 335 (just released), Complete Kit of Parts, Valves, and Loud-speaker and Cabinet. Cash Price, £7/17/6. **10/-** With order. And 11 monthly payments of 14/10.

NEW OSRAM "33" MUSIC MAGNET A first-class Kit, including Valves, Loud-speaker and Cabinet. Cash Price, £9/9/-. **20/-** With order. And 12 monthly payments of 15/-.

NEW TELSEN JUPITER S.G.3. KIT. Complete set of Components less Valves. Cash Price, £3/17/-. **7/-** With order. And 11 monthly payments of 7/-.

NEW TELSEN AJAX 3. Complete Set of parts for Det.; 2 L.F. Receiver, less Valves. Cash Price, £3/1/6. **5/8** With order. And 11 monthly payments of 5/8.

MURPHY NEW ALL-MAINS 3-VALVE SET, Model A.3.A. Cash Price, £19/19/-. **39/-** With order. And 12 monthly payments of 33/-. We are appointed Murphy Dealers.

NEW MARCONIPHONE 2-VALVE BATTERY RECEIVER, Model 248. Including Valves, Batteries, and Loud-speaker. Ready for use. Cash Price, £4/19/6. **9/-** With order. And 12 monthly payments of 8/3.

NEW ORMOND PERM. MAGNET MOVING-COIL, L.S. UNIT. (just released) Cash Price £1/18/6. **5/4** With order. And 7 monthly payments of 5/4.

ATLAS ELIMINATOR, A.C.244. 3 H.T. Tappings. 20 M/A output. Cash Price, £2/19/6. **5/-** With order. And 11 monthly payments of 5/6.

NEW R. & A. "CHALLENGER" PERM. MAGNET MOVING-COIL UNIT. Cash Price, £1/15/-. **5/-** With order. And 6 monthly payments of 5/8.

NEW EPOCH 20c. PERMANENT MAGNET MOVING-COIL UNIT. Cash Price, £1/15/-. **5/7** With order. And 6 monthly payments of 5/7.

NEW BLUE SPOT 99 P.M. MOVING-COIL UNIT. One of the finest Units available. Cash Price, £2/19/6. **5/-** With order. And 11 monthly payments of 5/6.

12 EXIDE HIGH-TENSION ACCUMULATORS (120 volts W.H.10 super-capacity, 5,000 milliamps). The cheapest form of high-tension supply where electric light mains not available. Cash Price, £3/15/-. **7/-** With order. And 11 monthly payments of 7/-.

BLUE SPOT 100U. INDUCTOR UNIT. Cash Price, £1/19/6. **5/5** With order. And 7 monthly payments of 5/5.

To avoid delay, will customers kindly send first payment with order.
All above carriage paid.

The LONDON RADIO SUPPLY COMPANY ESTD 1925
11, Oat Lane, Noble St., LONDON E.C.2
Phone NATIONAL 1977

OUR RADIO SHOW

THE BIGGEST AND MOST VARIED SHOW OF READY TO BUY ELECTRICAL AND RADIO IN THE CITY.

Many of your Aerials need renewing. Look at these prices.

AERIALS.—Indoor Exten. & 2 Insulators, 5d. 7/22's copper, 50 ft., 1/1d.; 100 ft., 2/-. Braided Proofed 1/16's, 50 ft., 2/-. Fellows Lead-in, 3d. pair. Under Carpet Aerial, 1/-. Indoor Aerial wire, 22 gauge, 1/- 100 ft. Earth Wire, 1/3 doz. yards. Aerial Halyards, 6d. Aerial Winches, with brake, 1/6. Electronic, 100 ft., 1/4. Arresters, 1/-. Earth Tubes, 2/6. Earth Spikes, 1/-. Frame Aerials: tell us the size you want.

ACCUMULATORS AND BATTERIES.—Large stock all sizes. Edison steel cells at low prices.

For Signal Practice or circuit testing with a phone: **BUZZERS.**—High Note Midgets, 3/6. Power Signals, 5/-. Buzzer Signal Sets, 7/6. Electric Bells, G.P.O. Circular, 3/-. Outdoor, 1/6. Large, Ironclad Bells, 5/-.
For smoothing ripples, eliminators and coupling:

CONDENSERS.—Fixed 1 mfd., 1/-. 2 mfd. 1/6; 4 mfd. 4/6; 5 mfd., 5/-. 8 mfd., 8/6; 10 mfd., 9/6; .0005 mfd., for 500 volts, 2/6; .002 5mfd., for 10,000 volts, 3/6 etc. Special bargain, 250 v. G.P.O. 2 mfd., 1/-. Fine Panel Goods for Set Makers at Tempting prices. **CONDENSERS, VARIABLE AND DIALS.** 2,000 Formo De Luxe .0005 mfd., new 4/6 line at 2/- only, or 3/9 per pair. 2 on slow motion dial, 12/-. Tekade bakelite Reaction .0005 mfd., 1/3, half price. Atlas .0005 mfd., 2/-. Lamplugh .0003 mfd., 2/-. Igranitic balanced Diff. Trimmer, 1/3. 140 Preset .001 mfd., 10/1d.

DIALS.—Edibell Twin Drum slow for two Condensers, 4/3. American type Edibell Dials, slow and quick motion flush vertical, 3/3.

The Experimenter's Opportunity in Tuners: **COILS.**—Aerial and Reaction, long, short and multiple tuning coils 2 1/2 in. by 3 in. rib former, 1/6. Former only, 3d. Small Ribbed Former, 3d. H.M.V. tuning long and short wave Band-Pass, 1/-. 8 in. long. 2-pin Short Wave, 6d.

A.C. GRAMO MOTORS.—B.T.H. Universal Gramo Motor, 40/-. Blue Flyer, ditto, £3. Patent ditto, £3. 4 Victor Induction 110 volt H.M.V. type, 25/-.
PICK-UPS.—Phonovox, 12/-. Loewe, 15/-. H.M.V. Heavy recording type, 15/-. Electradix Special, 8/6 Cases for Portables, suitcase size, Rexine, 10/-. Hide 15/-.

MAINS TRANSFORMERS.—Igranitic 100/230 volts, 10/-. 4, Igranitic 220 volts, 300-0-300 volts, 12/-. 37 Igranitic E.H.I. Mains Rectifier Transformers, 120 volts, 20 m.a. output, 8/6. H.M.V. Transformers any A.C. Mains input, 300-0-300 volts, 120 m.a., 4 volts 1 amp., and 4 volts 2 amps., 15/-. Model M.D. 800, 220 volts, 500 volts 120 m.a., 4 volts 1 amp., 4 volts 2 amps., 2/- 0-2 1/2 volts, 20/-. Igranitic Transformer 200/250 volts input, 6-8-11 volts 1 amp. output, 10/-. Transformer Bobbins wound 220 volts, 11 volts 1.5 amps., 7/6. 220 volts to 7 1/2 volts 1 1/2 amps., 6/6 unshrouded. Double output transformers 200/250 volts, 180 volts and 30 volts 30 m.a., 12/6

Parmeko Transformers, 200 volts/100 volts 100 m.a., 20/-. Igranitic Transformers, 100/200 volts, input 400 volts 60 m.a., 7.5 volts 1 1/2 amps., 5.5 volts 2 1/2 amps., 20/-. Igranitic E.B.H. 100 volts or 240 volts input, 250-0-250 volts 50 m.a. output, 20/-. 220 volts, 25 volts 5 amps., 20/-. 220 volts, 2-0-2 volts 5 amps., 15/-. B.T.H. Power Transformers 200/250 volts, three secondaries 600 volts 250 m.a., 7.5 volts; 6 volts, 40/-. Fellows Transformers, 200 volts/30 volts and 100 volts 20 m.a., 10/-. L.F. Transformers output 1/1 W.E., 3/6, output 1/1.5 W.E., 3/6. Sifam L.F. Transformers 3/1 nev 4/6.

CHOKES.—200 H.M.V. 10-henry, 700 ohms, 4/6. Igranitic 20/80-henry 45 m.a., 8/6. 28 Igranitic 5-henry, 4/6. Parmeko heavy duty Choke, 500 m.a., 21/-. B.T.H. double wound heavy duty Chokes, 500 m.a., 25/-. L.F. smoothing Chokes C.T. 160 ohms 200 m.a., 40 henry, 7/6. L.F. double-wound Chokes, 70 ohms 50 m.a., 6/6. Varley double-wound chokes, 50 m.a., 4/6.

TELESCOPES.—Gunsight 24 in., 17/6. Monocular Prism Range Finders, 15/-. Sullivan Marine Reflecting Galvanometers with shunt box and Crompton Wheatstone Bridge Lamp and Scale, 16/6.

THERMOMETERS.—30/140 F. Poeker 5 in. Clinical, 1/3, plated for wall, 1/-. Vertical Telegraph Galvos, 4/6.

BARGAIN PARCELS of Electrical and Radio Sundries, better value than ever for experimenters, 10 lbs., 7/-. 7 lbs. 5/-. Adhesive tape, 1 in., new and sticky, 1d. roll.

STAMPINGS FOR TRANSFORMERS.—All sizes in stock.

MICROPHONES.—Broadcast Studio Western Electric, £18. Marconi ditto, £6. Cairmor, £3. Brown, £12. B.T.H. Moving Coil, £5 10. Siemens Slesimo Microphones for detection of vibration, in solid brass and teak case, 2/6 each. Microphone mouthpieces for G.P.O. phones, 6d. each. Micro Buttons, 1/-. Pendant Mikes, with cord, 4/6. Wrist Mikes, 15/-. Ring Pedestal Mikes, 16/6. Public Address Mikes from 63/-. Write for Special Leaflet.

TRANSFORMERS FOR MICROPHONES.—100/1 Green Bakelite 400 7/6. Ericsson 100/1, 6/6. G.P.O. Type, 3/9.

LIGHT & RAY CELLS.—Selenium Raycraft Cells 24/-. Kingston, 15/-. Raycraft outfit with relay and Amplifier, 45/-. Photo-Cells R.C.A., 25/-. B.T.P. King Cells, 15/-. Beck Prisms mounted, 5/6. Exciter Lamps, 50 watts, 3/6. Focus Lens, 3/6.

SPEAKERS.—50 Kolster Brandes, 6-volt, 10/-. 3 Rola M.C. 6-volt, 12/-. Gramophone sound box reproducers, 2/-. Phonovox Pick-ups, 12/-. Electradix Special, 7/6. Cone Units, new Millgate, 2/3. H.M.V. No. 5, special for portables, 2/6. Browns, 10/-. Lamp Shade Speakers, new. Gold Silk finish, 15/-. Royal Hexon Cabinet Speaker, Cellodlan melody Cone and Tone Filter, dark oak finish. Black and green fret, 15/-. Baker Texas Cone, plated frame, 15/-. The Famous Violina Speaker, reed unit, perfect reception, 12/6. 200 H.K. Cinema Speaker Pots

110 volts D.C. less cone and chassis, 10/-. 20 large cinema sound disc tone arms, 3/6. 15 new Ever Ready Service Inspector's Headlamps with Battery Holder, 7/6. 120 Mazda 50 watt Focus Lamps and lenses, 7/-. pair. 200 Photo Cells for sound on Film, Television and Ray work, 15/- and 25/-. 120 Beck Angle Prisms mounted in carrier, 5/6. 110 Micrometer adjusters for photo-cell inspection, 12/6. 18 Iron Cinema baffles, 12 in., 2/6. 20 Cinema Grilles, 2/6. 32 folding ball bearing turntables for portables, 2/- each. 3 D.C. Utah Moving Coil Speakers, 22/-.
RECTIFIERS.—T.V. Static 6v. D.C. to 200 A.C. Units for H.T., 25/-. M.12 Elkon 6-volt 3 amp., 10/6. 6 volt 1 amp., 5/6. S.8: 4 1/2 volt, 4/6. S.50. 120 volt 20 m.a., 5/6. 18 Westinghouse A.3., 16/6. 8 Westinghouse A.4., 27/6.

Valve Rectifiers.—Tungar type 7/15 volts 2 amps., £4. 30 volts 6 amps., £5 10. 50 volts 2 amps., £5 10. 75 volts 6 amps., £12.

SWITCH GEAR.—Jacks and Plugs, 2/- pair. Hart Rotary 10 amp. switches, 1/6. 75 Large Marconi Morse Keys, 12/6. Sterling 8-pole Panel Radio-Gram Switches, 3/6. 4-pin Plug and Sockets, 3d. pair. 2-pin Wall 50 ditto, 10d. Adaptors, 6d.

SWITCH GEAR.—Mains Set Glass Fuses, 2 amp., 3d. Porcelain, 2-pin Plug, 3d., fuses 4d. Slow-motion Geared-Slide Rheos., 7/6. 147 S.P. Plug Boards, 9-way, 10 amp., 2/-. Lucas 8-way Switch Boxes, mahogany, Brass Cover, 6 S.P., 1 D.P., 1 C.O., 3/6. S.P.C.O. Switches, 1/6; H.T. send receive, 2/6; 100 or 200 v. Lamps, 6d. 2 amp. 110-volt Lamps for charging, 2/6. 1,000-ohm Res. Bulbs, 6d. Auto Cutouts, 7/-. Switches, Controllers and Charging Boards built to order. 8-way Switches, in mahogany case, brass lid, 3/6. 3-amp. Wall Plugs for loud-speaker extension, 9d.

CHARGERS.—Our enlarged Switchboard department can now build anything to specification up to 100 ft. long. Send us your enquiries for METERS, Portable, Laboratory, or Switchboard, A.C. and D.C.

SWITCHES.—Sunk 250 volt 5 amp. by Tucker, etc., 1/- each for mains set or electric light. Surface plates oxidised silver or polished brass, 6d. each.

SUNDRIES.—Neon Tubes, 2/6. Holders, 8d. Power Valves for Eliminators, 4/6. Double Scale Taylor-Hobson Protractors, 5/6. Winsford Static Electric Machines, 45/-. Siemens Torsion Dynamometer, moving coil Lab. heavy current type, 45/-. Laboratory Variable Condensers, Table type from 18/6; by Cambridge Co. & Sullivan, Electroscopes, Metal foil, 10/6. Insulators, H.T., in porcelain and Ebonite, from 2/- each. Empire Insulating Cloth, for coils, chokes, etc., 100 sq. in. for 1/-. Magnets: Permanent Magnets, steel horseshoe, 1 lb. weight, 5 in. high, 2/-; smaller sizes 1/6, 1/3 and 1/-. Electric Pocket Torches, with new "Ever Ready" Battery, 2/6. Airship Safety Lamps, 7/6. 220 volt Candle Lamps 6d. Hand Lanterns, ditto, 4/6. Radiator 250-watt 110-volt Lamps for charging, 2/6.

ELECTRADIX RADIOS, 218, Upper Thames Street, London, E.C.4

Phone: City 0191.

*Grams: Electradix Cent. London

AGAINST INTERFERENCE

ANTI-INTERFERENCE gadgets do not seem to me to be used as much as they should be. With the increasing sensitivity of the modern radio set, irritating crackles, buzzes and similar noises are experienced in much greater profusion than they used to be.

I had an illustration of this the other day when a set which was giving excellent results in my test room developed a most unpleasant crackling when I took it into the house where it was to be used. The noise was a continual fairly rapid ticking, such as one often gets with a broken grid condenser. Yet all my tests failed to show any defective portion in the apparatus.

Short of rebuilding the whole apparatus I did everything I could to find the cause of the trouble without success. The equipment was perfectly satisfactory on gramophone, but as soon as I switched over to radio this appalling din started. In the end I came to the conclusion that the set

itself was all right, and that this interference was coming in on the mains in some way. In order to check this I got hold of two mains H.F. chokes and connected these in the leads to the set with .001 condenser across the mains on either side. This makes a very efficient form of H.F. filter, and in the present instance entirely cured the trouble.

The ticking noise was due to interference from some machinery or defective apparatus connected to the electric light mains, and until I killed it at its point of entry to the set, which was the electric light mains themselves, nothing I could do was of any avail. I made several searches round the house to try to find the offending apparatus, but was unable to locate it, and I came to the conclusion that it was coming from a nearby house connected to the same mains.

Such interference, of course, is entirely beyond one's own control, and the only remedy is to use an anti-interference unit of some sort.

R.

The first relay from the Coventry Hippodrome will be given in the Midland Regional programme on September 14, when Francis Laidler's revue, *The Big Show*, is to be broadcast.

Another interesting broadcast comes from the Birmingham Repertory Theatre studio on September 15, when the company will be heard in a one-act play by Philip Johnson, entitled *The Cage*.

Professor W. Sherard Vines, of Hull University, gives the last of his talks on Topical Reading for Northern Holidays on September 5, when he will deal with books about the Border Country.

The Arcadian Follies, under the direction of Fred E. Rayne, the Yorkshire comedian, will broadcast again from the Arcadian Pavilion at Morecambe on September 8, in the North Regional programme.

An interesting recital takes place in Manchester on September 10. It consists of some entirely new arrangements of Old English folk songs.

PREPAID ADVERTISEMENTS

Advertisements under this head are charged **THREEPENCE PER WORD**, minimum charge **THREE SHILLINGS. DEPOSIT SYSTEM.** As the publishers cannot accept responsibility for the bona fides of advertisers in this publication, they have introduced a system of deposit which it is recommended should be adopted by readers when dealing with persons with whom they are unacquainted. It is here explained.

Intending purchasers should forward to the Publishers the amount of the purchase money of the article advertised. This will be acknowledged to both the Depositor and the Vendor, whose names and addresses must necessarily be given. The deposit is retained until advice is received of the completion of the purchase, or of the article having been returned to and accepted by the Vendor. In addition to the amount of the deposit, a Fee of 6d. for sums of £1 and under, and 1s. for amounts in excess of £1, to cover postage, etc., must be remitted at the same time. In cases of persons not resident within the United Kingdom, double fees are charged.

The amount of the Deposit and Fee must be remitted by Postal Order or Registered Letter (Cheques cannot be accepted), addressed to

"AMATEUR WIRELESS" ADVERTISEMENT DEPARTMENT, 58/61 FETTER LANE, LONDON, E.C.4

PATENTS—Trade Marks, "Advice Handbook" free.—B. T. King, Regd. Patent Agent, 146a Queen Victoria Street, London.

WIRELESS AS A CAREER.—Those already engaged in the radio industry and those who would like to obtain employment in this interesting profession should write for a copy of our booklet, sent post free without obligation.—Northern Counties Wireless School, 55-57 Gullhall Street, Preston.

GUARANTEED MAINS TRANSFORMERS AND CHOKES at Factory Prices, sent c.o.d. or deposit system; send for particulars.—Faulkner's Radio, 40A, Clifton Avenue, Wembley, Middlesex.

PARTS FOR ANY CIRCUIT supplied at attractive prices. Send list for special quotation.—Handley Radio, 49 Witham Road, London, S.E.20.

EBONITE PANELS.—Finest quality, jet black, or beautifully walnut grained. Brilliant mirror polish. Sizes and prices: 12 by 7 in., 2/6; 14 by 7 in., 3/-; 18 by 7 in., 3/9; 16 by 8 in., 3/9, post paid. Drilled to your own specification, 1d. per hole.—Kenneth B. Caplin, 22 Station Road, Totton, Hants.

BARGAINS.—Meteor 3 Kits, £2/12/- (few only). S.T. 300 Author's Kits, £2/15/-. Challenger M.C. P.M. Speakers, £1/0/-. All wireless journals' kits in stock. Old sets taken in part exchange for 1933 models. We quote keenest prices for anything wireless.—Serwell Wireless Supplies, 74 Gough Street, London, E.14.

CONSTRUCTORS!—"coneKraft" special paper makes best loud-speaker cones. 2 sheets 24 in. by 24 in., 1/- post free.—Kippin, Linota, Perceval Rd., Romford.

THE "TONIC" keeps any make 2-volt Accumulator fully charged at home. Electric mains unnecessary. Ideal for remote places. 7/- each, postage 9d. Particulars, copies of testimonials, etc., with pleasure.—Williams, Netherend, Cradley, Birmingham.

"UNIVERSAL" RADIO BARGAINS.—Polar triple-gang condensers, 7/11. Dario valves, 3/11; Super detector, 4/3; Power, 4/11; Screen-grid, 9/3. Chokes, 1/-; Bi-uoc, 1/6; Variable condensers, 1/11; Fixed, 6d. Switches, 6d. Fuse bulbs, 3d. Telsen Ace, 4/7; Grand, 5/11. Voltmeters, 2/11. Copper aerial, 100 ft., 1/11. Valve holders, 4d. Accumulators, 3/3. Six-pin coils, 2/3, bases 10d. Walnut cabinet speakers, 9/6. Ormond units, 8/11. Millgate, 2/11. Vernier dials, 1/3. Triotron units, 8/11. 3-valve Portable, complete, 70/- Screen-grid 3 Kit with valves, yours for 8/6 deposit. Full particulars on request. Thousands of other bargains. Lists Free. Kits, Components, Sets. Get our quotations.—"Universal," 20 Victoria Road, Peckham, S.E.15.

ENGINEERS.—Sit down and think this over. We believe that our 200-page handbook, "ENGINEERING OPPORTUNITIES" will show you the way to well-paid, permanent, and progressive employment. In any case, the handbook costs nothing, and it will at least show you various surprising possibilities about which at present you know nothing. Can you, can any man, who cares a hoot about his future, afford to allow this opportunity for a worth-while job to pass unheeded. Think it over. Can you? We want you to read "ENGINEERING OPPORTUNITIES." Among other things it gives details of all recognised Examinations (A.M.Inst.C.E., A.M.I.-Mech.E., I.E.E., G.P.O., etc.) outlines modern home-study courses in all branches of Civil, Mech., Elec., Motor, Radio, Aero and Talkie Engineering, and explains the unique advantages of our Employment Department. The book is quite free. Send a post-card for your copy NOW. We promise that it will be a moment of your time well spent.—The British Institute of Engineering Technology, 109 Shakespeare House, 29-31 Oxford Street, London, W.1.

FREE.—H.T. Battery supply. Send stamped addressed envelope for particulars.—P. Sharp, 267 Walton Breck Road, Liverpool.

CASH OR EASY TERMS.—Prompt Delivery anything Radio. Mains or Battery Sets, Components, Kits, Valves, Speakers, Etc., Etc. Your inquiry will receive prompt and personal attention.—Newby, Birchwood Avenue, Long Eaton, Nottingham.

BANKRUPT BARGAINS.—New list free. 3-valve kit, 22/6. ST300, 42/-. Century Super, 75/-. Any kit supplied. Dual Coils, 3/6. Transformers from 2/9. S.M. 0005, 3/6. Diffs., 1/9. Harlie Pick-ups, Model 40, 17/-. D.C. M.C. speakers, 18/6. D.C. eliminators, 20/-. Millgate cone units, 2/6. Anything radio. Modern components taken in part exchange. Get my quotation.—Butlin, 143b Preston Road, Brighton.

KEEP THEM APART

It is very good practice to fit the power equipment of a main's set well away from the set itself. Sometimes it is easy to do this.

If you are building a radio-gramophone, for example, the power equipment might well be fitted at the bottom of the cabinet with the set above it.

A good deal of hum is to be traced to induction from parts carrying alternating current, and the simplest way of avoiding this difficulty is to fit the power transformer well away from the set. Usually the total heater current is enough to warrant the use of thick connecting wire.

Music inspired by the sea will be played in a concert from Belfast on September 16.

On the same evening the orchestra will be in reminiscent vein, contrasting the old dance measures with the new. In this programme the microphone will collect strains of a polka, a valse and a minuet, in addition to a more modern fox-trot.

"Amateur Wireless and Radiovision." Price Threepence. Published on Thursdays and bearing the date of Saturday immediately following. Post free to any part of the world: 3 months, 4s. 6d.; 6 months, 8s. 9d.; 12 months, 17s. 6d. Postal Orders, Post Office Orders, or Cheques should be made payable to "Bernard Jones Publications, Ltd."

General Correspondence is to be brief and written on one side of the paper only. All sketches and drawings to be on separate sheets.

Contributions are always welcome, will be promptly considered, and if used will be paid for.

Communications should be addressed, according to their nature, to The Editor, The Advertisement Manager, or The Publisher, "Amateur Wireless," 58-61 Fetter Lane, London, E.C.4.

EASY PAYMENTS

"There's No Place Like HOLMES"

The first firm to supply Wireless parts on easy payments. Eight years advertiser in "Amateur Wireless." Thousands of satisfied customers.

	Deposit	Payments
LISSEN SKYSCRAPER KIT	89/6	8/3 11 of 8/3
TELSEN AJAX 3 KIT	61/6	6/9 9 of 6/9
R.R. 303 KIT, with Valves	70/-	7/9 9 of 7/9
COSSOR KIT 234	£6/7/6	10/- 11 of 11/10
EXIDE H.T. ACCUMULATORS, 120 volt	£3	6/- 9 of 6/8
BLUE SPOT 66R and chassis	£2/2/6	5/6 9 of 4/6
BLUE SPOT 100U	39/6	5/8 7 of 5/4
CELESTION M.C. Sreaker	£2/7/6	5/3 9 of 5/3
EPOCH 20th CENTURY M.C.	35/-	4/10 7 of 4/10

Parts for any Kit Set. Any make of Speaker.

New Goods obtained for Every Order.

Send us a list of the parts you require and the payments that will suit your convenience, and we will send you a definite quotation. Anything Wireless.

H. W. HOLMES,
29 Foley Street, Gt. Portland St., London, W.1.
Phone: Museum 1414.

£5 Radio-Gram CABINET for 65/-
7 DAYS' FREE TRIAL
(OR 10/- MONTHLY.)

Toll-free Oak and Piano built! The acoustic Tone brings a fine thrill. Makers to Radio Press, B.B.C., 3,000 clients. Other Models 35/- to £15. Photographs and List FREE.

PICKETTS Piano-Tone Cabinets,
(A.M.) Albion Road, Bexleyheath.

FULL-SIZE BLUEPRINTS

When ordering, please send Postal Order, NOT STAMPS.

CRYSTAL SET (6d.)

1931 Crystal Set AW308

ONE-VALVE SETS (1s. each)

Easy to Build One AW304
Short-wave One valver AW327
B.B.C. One valver AW344
Portable Short-wave One AW354

TWO-VALVE SETS (1s. each)

Two Star 2 (D, Pen) AW315
The 25/- Two (D, Trans) AW330
Ten-Station Two (D, Trans) AW336
Inexpensive A.C. 2 (D, Trans) AW346
Midget Two (D, RC) AW348
Mascot Two (D, Trans) AW353
Ideal Regional 2 (D, Trans) AW357
Music Lover's Two (D, Trans) WM260
New Economy Two (D, Trans) WM265
Family Two (D, Trans) WM278
Screen-grid Two (SG, Trans) WM289
Economy A.C. Two (D, Trans) WM286
A Two for 7 Metres (D, Trans) WM295

THREE-VALVE SETS (1s. each)

1932 Ether Searcher (SG, D, Pen) AW325
Wide World Short-wave Three (D, RC, Trans) AW332
New Favourite Three (D, RC, Trans) AW334
Home-Lover's All-electric 3 (SG, D, Trans) AW335
The P.W.H. ("Mascot" D, RC, Trans) AW337
Home-Lover's Battery 3 (SG, D, Trans) AW341
£8 Radiogram (SG, D, Trans) AW343
New Regional Three (D, RC, Trans) AW349
World-Ranger Short-wave 3-valver (D, RC, Trans) AW355
Ether Marshal (SG, D, Trans) WM247
Meridian Short-wave (D, RC, Trans) WM255
Five-advantage Three (D, RC, Trans) WM257
Everybody's A.C. Radiogram (SG, D, Trans) WM258
Double Band-pass Three (SG, D, Trans) WM259
Everybody's A.C. Radiogram (with automatic G.B.) WM262
New Economy Three (SG, D, Trans) WM263
New Plug-in Coil Three (D, 2 Trans) WM270
Transportable Three (SG, D, Trans) WM271
Multi-Mag Three (D, 2 Trans) WM288
Percy Harris A.C. Radiogram (D, RC, Trans) WM294
The Prosperity Three for Batteries (SG, D, Trans) WM296
The Prosperity Three for A.C. Mains WM297
The Prosperity Three for D.C. Mains WM298

FOUR-VALVE SETS (1s. 6d. each)

Four Star 4 (SG, D, RC, Trans) AW318
50/- Four (SG, D, RC, Trans) AW331
Advance Four (2 SG, Trans) AW356
Your Home Radiogram, (SG, D, RC, Trans) AW358
Brookman's Three-plus-one (SG, D, RC, Trans) WM233
Ether Rover (SG, D, RC, Trans) WM266
Quadradyne (2 SG, D, Pen) WM273
Double Band-pass Four (SG, D, RC, Trans) WM274
Everybody's Radio Gram. (SG, D, RC, Trans) WM276
A.C. Quadradyne (2 SG, D, Pen) WM279
Ideal A.C. Home Super (Super-het) WM290
Gold Coaster (A.C. Short-waver) WM292
Triple-tune Four (2 SG, D, Trans) WM293

FIVE-VALVE SETS (1s. 6d. each)

James Short-wave Super (Super-het) AW328
Simple Super (Super-het) AW340
Ideal Home Super (Super-het) WM280
Easytune 60 (Super-het) WM284

SIX-VALVE SETS (1s. 6d. each)

Century Super (Super-het) AW287
A.C. "Century Super" (Super-het) AW295
Mains Unit (1/-) AW295A
Super 60 (Super-het) WM229
Super 60 (with Wearite base) WM249
Super 60 (with Lewcos base) WM251
1932 Super 60 (Super-het) WM269
1932 A.C. Super 60 (A.C. Super-het) WM272

SEVEN-VALVE SETS (1s. 6d. each)

Super Senior (Super-het) WM256
Super Senior (Wearite base and Lewcos coils) WM261

PORTABLES (1s. 6d. each)

Hiker's Two (D, Trans) (1/4) AW345
General-purpose Portable (SG, D, RC, Trans) AW351
Town and Country Four (SG, D, RC, Trans) WM282
Everybody's Portable (5-valve super-het) WM291

AMPLIFIERS (1s. each)

Universal Push-pull Amplifier AW300
"A.W." Record Player (L.F. Push-pull) AW319
Quality Amplifier (D.C., 1/6) WM264
A-P-A (Power Amplifier for A.C. Mains) WM275
A-P-A Radio Unit (SG, D) WM281
Economy Gramophone Amplifier WM277

MISCELLANEOUS (1s. each)

Short-wave Plug-in Adaptor (6d.) AW326
Short-wave Super-het Adaptor (6d.) AW329
Ether Searcher Radio-gramophone Motor Board AW333
"A.W." Short-wave Adaptor AW339
"Mascot" Mains Unit AW350
"A.W." Trickle Charger AW352
"W.M." Linen Diaphragm Loud-speaker WM235
Two-Minute Adaptor for Short Waves WM240
Super 60 A.C. Unit WM248
A Simple Mains Unit WM283
Short-wave Director (6d.) (wavemeter) WM285
Voltage Regulator WM287

Copies of the "Wireless Magazine" and of "Amateur Wireless" containing descriptions of most of these sets can be obtained at 1s. 3d. and 1d. respectively, post free Index letters "A.W." refer to "Amateur Wireless" sets and "W.M." to "Wireless Magazine."

Address letters: Amateur Wireless Blueprints Dept., 58-61 Fetter Lane London, E.C.4

Amateur Wireless
INFORMATION BUREAU
COUPON
Available until Saturday
SEPTEMBER 10, 1932
SEE 1/-



FLUXITE
INDISPENSABLE
TO EVERY
RADIO
ENTHUSIAST
IT SIMPLIFIES
ALL SOLDERING

"We're Fluxite and Solder, The reliable pair, Famous for Soldering—Known everywhere! Now here is a statement—Bound to come true, If you'll invite US To come and help You!"

See that Fluxite and Solder are always by you—in the house, garage, workshop—anywhere where simple, speedy, soldering is needed. They cost so little, but will make scores of everyday articles last years longer! For Pot, Pan, Silver, and Brassware; RADIO; odd jobs in the garage—there's always something useful for Fluxite and Solder to do.

All Hardware and Ironmongery Stores sell Fluxite in tins, 8d., 1/4 and 2/6.

NEW "JUNIOR" SIZE, 41. per tin
FLUXITE SOLDERING SET
Simple to use and lasts for years in constant use. Contains special "small-space" soldering iron, with non-heating metal handle; pocket blow-lamp, Fluxite, Solder, etc.; and full instructions, COMPLETE. 7/6, or LAMP only, 2/6.

FLUXITE, LTD.
(Dept. 323)
ROTHERHITHE, S.E.13

ANOTHER USE FOR FLUXITE
Hardening Tools and Casts; Hardening. Ask for Leaflet on improved method.



ALL MECHANICS WILL HAVE
FLUXITE
IT SIMPLIFIES ALL SOLDERING

SELFRIDGE'S

Special offer of a limited number of the
CLIMAX AUTO-BAT
150 VOLTS AT 20 M/A



If you cannot call
POST YOUR ORDER
You are assured of every satisfaction. Order early, quantities are limited.

Originally Priced
52/6

SELFRIDGE'S PRICE
40/-

The makers claim that there is no other British A.C. Mains Unit on the market today, capable of giving an output of 20 m/a. at 150 volts, at a similar price. Once again Selfridge's establish a new record low-price level for a reliable Mains Unit.

Westinghouse metal rectification.

Variable voltage switch for all supply voltages from 200 v. to 250 v. (40-100 cycles), or 100 v. to 125 v.

Three tappings: 00/75 v., 80/100 v., and 120/150 v.

20 m/a. maximum anode current at maximum voltage.

Dimensions: 6 1/2 in. by 5 1/2 in. by 3 1/2 in.

Metal case fitted with earth terminal. No live parts exposed and no possibility of shock.

Complies with all I.E.E. Regulations.

YOU ONLY NEED TO HEAR
KENWELL
POWER-PACK



EVERY BATTERY MAN GUTS COSTS AND CURSING WITH THIS COMPLETE MAINS UNIT AND MOVING COIL SPEAKER



Model AC/L
H.T. and L.T.
£7.19.6

"It's a braw Set—ye Ken."
McQuality

Turn your Battery Set into an ALL-MAINS MOVING COIL SET!

Hundreds of Battery Set users who visited our Stand at Radiolympia discovered that the Kenwell Power Pack was just the unit they required to bring their Set up-to-date.

And then—it is so economical in current consumption that its complete cost can be written off out of savings in the first 18 months!

DON'T SCRAP YOUR BATTERY SET

—it has always been a good friend to you. Ask your Dealer to show you how simple it is with the Kenwell Power Pack to plug into the nearest mains socket and put all dry battery troubles behind you for good!

Listen to the magnificent tone of the Moving-Coil Speaker and you will agree it makes your old Set as good as anything at Radiolympia.

Your Dealer can supply—or write now for illustrated folder describing this money-saving and efficient Power Pack.

SPECIFICATION OF AC/U MODEL
H.T. 80 v. and 150 v. (fixed) 0-100 v. (variable) 25 m/a.
L.T. Trickle Charger at .25 amp.
G.B. 5 Tappings: 1 1/2, 3, 4 1/2, 9, and 15 v.
Mains energised moving-coil speaker.
Price £8 15s. 0d. Other models on request.

KENWELL RADIO, LTD.
200 CITY ROAD, LONDON, E.C.1

See it - Hear it - and KNOW!

Please Mention "A.W." When Corresponding with Advertisers

Take
your
choice
from
the
world's
best



Different listeners have different requirements—and the Blue Spot range of Loudspeaker Units and Cabinet Speakers has been planned to suit every requirement and every purse.

1 66K

the world famous unit improved and brought up-to-date. Clear, pure, undistorted reproduction with every word and note true to life - - - 15/-

66K—the 66K unit mounted to a suitable chassis - - - 19/9

31K—the 66K unit in a specially designed cabinet of oak - - - 31/6

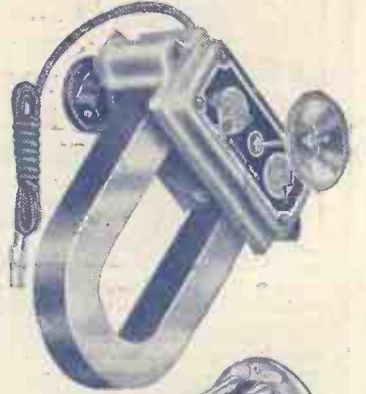

2 100U

the loudspeaker that gives a performance equal to a good moving coil speaker. Both bass and treble notes perfectly reproduced. Normal and Pentode valves — no matching transformer required. Sensitive even to very small inputs. Can be used for battery or electric sets. Complete mounted to chassis - - - 39/6

100D—100U unit in a very special oak cabinet - - - 57/6

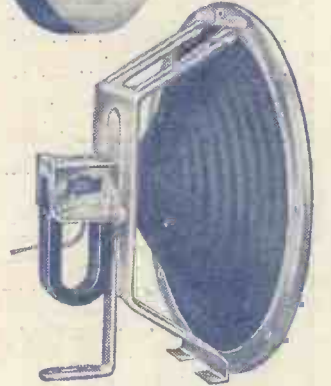

3 66R

the unit that gives tremendous volume without distortion or any signs of distress. Every sound and syllable exactly as the original - - - 35/-

44R—the 66R unit in an oak cabinet of unusual design - - - 52/6

45R—66R unit in a well-made oak cabinet of attractive shape - - - 52/6



4 99PM

the greatest moving coil speaker ever manufactured. Special magnet forged from highest grade magnet steel giving POWERFUL and PERMANENT energy. Exceptionally high magnetic energy in air gap—1,320,000 ergs. Dust proof plates. Cadmium plated pole pieces. Specialy designed cone. The most perfect reproduction wireless has ever known. 59/6

75PM. Last season's Permanent Magnet repeated "by demand" - - - 75/-

32PM—99PM speaker in a cabinet of superfine walnut—a quality cabinet for a quality speaker 87/6

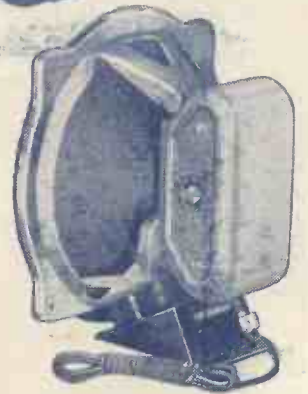

British Made

EACH ONE THE LEADER OF ITS CLASS!

For Units write for Catalogue A.W.47.U
For Cabinet Speakers write for Catalogue A.W.47.S

THE BRITISH BLUE SPOT COMPANY LTD.

BLUE SPOT HOUSE · 94/96 ROSOMAN ST., · ROSEBERY AVENUE, LONDON E.C.1

Telephone: Clerkenwell 3570. Telegrams: "Bluospot, Isling, London."

Distributors for Northern England, Scotland and Wales: H. C. RAWSON (Sheffield and London), Ltd., 100, London Road, Sheffield; 22, St. Mary's Parsonage, Manchester; 41-46, High Bridge, Newcastle; 37-38-39, Clyde Place, Glasgow.

AN EVENING TOUR BELOW 100 METRES

Amateur Wireless

Every
Thursday 3^d

and
Radiovision

Vol. XXI. No. 535

Saturday, September 10, 1932

A GOOD IDEA FOR MAKING OLD SETS SELECTIVE



"GIVING THE FIRST CLASS SERVICE WHICH WAS EXPECTED OF THEM"

"... Radio enthusiasts can purchase them with every confidence. Their outputs are above the average and they give a clean, steady output..."

says the Technical Editor of "Popular Wireless"

You can end all your H.T. battery troubles—you can take all the uncertainty out of battery buying, for Ediswan H.T. Batteries are now GUARANTEED against failure to give absolutely satisfactory service. No battery manufacturer could afford to give such a guarantee unless he had complete confidence in his product. Every single cell in every Ediswan battery must successfully pass four separate tests before it leaves the factory, and special precautions are taken to ensure perfect insulation between cells.

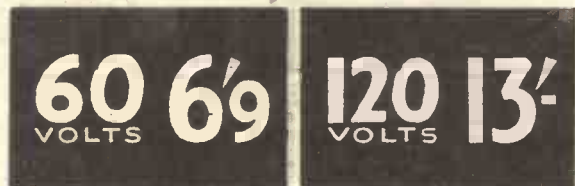

Standard Capacity. Where the anode current required does not exceed 10 M/A these batteries will give highly satisfactory service. If super-power valves are used, the super-capacity type should be used.

Super Capacity. These batteries have twice the capacity of the standard type, and, owing to their large reserve of power, last nearly three times as long when used as a replacement to a battery of standard capacity.

Look for the Ediswan Authorised Dealer sign when you buy!

Send for your FREE copy of "How to get the most out of your H.T. Battery." Full of useful data, hints and tips.

Guarantee

The Edison Swan Electric Co. Ltd. guarantee that Ediswan Batteries are of full voltage and capacity. Should any Ediswan Battery fail to give satisfactory service, we undertake to deal with customer's complaint within 24 hours of receipt of the defective battery.

EDISWAN

the Guaranteed
RADIO H.T. BATTERIES

THE EDISON SWAN ELECTRIC CO. LTD.



PONDERS END, MIDDLESEX

B.173



EASIWAY TO PERFECT RADIO



Peto-Scott's 13th Year of continuous Service to the Public

MANUFACTURERS' KITS		SPEAKERS	
<p>COSSOR MELODY MAKER MODEL 335. Complete with valves, speaker and cabinet. Cash price, £7/7 6. Balance in 11 monthly payments of 14/10.</p> <p>COSSOR ALL-ELECTRIC MELODY MAKER MODEL 336. Complete with valves, cabinet, and speaker. Cash Price, £11/15/-.</p> <p>COSSOR MELODY MAKER MODEL 334 with Metallised Variable-Mu S.G. and Detector Valves, Power Valve and Cabinet. Cash Price, £6/7/6.</p> <p>RADIO FOR THE MILLION "STATION MASTER 3" (Model A). With valves and cabinet, for battery use. Cash price, £5/11/-.</p> <p>"STATION MASTER 3" (Model B) with valves, speaker, and cabinet for battery use. Cash price, £7/10/-.</p> <p>SLEKTUN SCOUT S.G.3. S.G., Detector and Power. Pilot Author Kit "A" (less valves and cabinet). Cash or C.O.D., £4/8/6.</p> <p>OSRAM "THIRTY THREE" MUSIC MAGNET. Complete kit, comprising all components, including valves, cabinet with self-contained speaker. Cash price, £9/9/-.</p> <p>READY RADIO 303. 3 valve Kit (Det. 2 L.F.) with valves, cabinet and permanent magnet moving coil speaker. Cash Price £6/17/6.</p> <p>READY RADIO METEOR S.G.3. 3 valve screened-grid receiver with valves, cabinet and permanent magnet moving-coil speaker. Covers short, medium and long waves. Cash Price £3/17/6.</p> <p>LISSEN SKYSCRAPER 3. Chassis model with (Lissen) S.G., Detector, and Pentode valves. Cash price, £4/9/6.</p> <p>FERRANTI BAND-PASS 3 (Battery Model) with Panel and baseboard, but less valves. Cash price, £7/19/6.</p> <p>FERRANTI BAND-PASS 3 (All-electric Model) With Panel and baseboard, but less valves. Cash price, £11/3/6.</p> <p>TELSEN "AJAX" 3. Complete kit less valves and cabinet. Cash price, £3/1/6.</p> <p>TELSEN "JUPITER" S.G.3. Complete kit less valves and cabinet. Cash price, £3/17/0.</p>	<p>Send 10/- only</p> <p>Send 21/7 only</p> <p>Send 10/- only</p> <p>Send 10/2 only</p> <p>Send 10/- only</p> <p>Send 8/1 only</p> <p>Send 15/- only</p> <p>Send 12/7 only</p> <p>Send 16/3 only</p> <p>Send 8/3 only</p> <p>Send 14/8 only</p> <p>Send 20/6 only</p> <p>Send 5/8 only</p> <p>Send 7/- only</p>	<p>EPOCH "200" PERMANENT MAGNET MOVING-COIL SPEAKER (New Edition). With 3-ratio input transformer. Cash price, £1/15/-.</p> <p>EPOCH MM. PERMANENT MAGNET MOVING-COIL SPEAKER with 5-ratio input Transformer. Cash Price £1/7/8.</p> <p>ULTRA 1933 IMP PERMANENT MAGNET MOVING-COIL SPEAKER with input transformer. Cash price, £1/17/6.</p> <p>W.B. PERMANENT MAGNET MOVING-COIL SPEAKER (Type P.M.4). Complete with transformer. Cash price, £2/2/-.</p> <p>BLUE SPOT SPEAKER UNIT AND CHASSIS. Type 100U. Cash price, £1/19/6.</p> <p>R. & A. "VICTOR" PERMANENT MAGNET MOVING-COIL SPEAKER DE LUXE with 6-ratio input transformer and protecting grille. Cash or C.O.D., £3/10/-.</p> <p>R. & A. "BANTAM" PERMANENT MAGNET MOVING-COIL SPEAKER with 3-ratio input transformer. Cash price, £1/7/6.</p>	<p>Send 6/6 only</p> <p>Send 5/- only</p> <p>Send 6/10 only</p> <p>Send 5/9 only</p> <p>Send 5/5 only</p> <p>Send 6/5 only</p> <p>Send 5/- only</p>
ACCESSORIES			
<p>ATLAS ELIMINATOR. Type A.C. 244. Three tappings. S.G., Detector, and Power. Output 120 Volts at 20 m/A. Cash price, £2/19/6.</p> <p>ATLAS ELIMINATOR. Type A.K.260. Tapped at 60/80 v., 90/100 v., and 120/150 v. at 12 m/A. Trickle charges at 2, 4, or 6 v. accumulators at 3 amps. Cash price, £4/10/-.</p> <p>B.T.H. PICK-UP (Senior Model) complete with support arm. Cash price, £2/2/-.</p> <p>GARRARD INDUCTION GRAMOPHONE MOTOR. For A.C. Mains model 202. Mounted on 12 in. nickel motor plate with fully automatic electric starting and stopping switch. Cash price, £2/10/0.</p> <p>EKGO ELIMINATOR. Type A.C.12. Three tappings: S.G. 80 v., 120/150 v. at 12 m/A. Cash price, £2/15/-.</p> <p>REGENTONE D.C.1. H.T. ELIMINATOR for D.C. Mains, tapped S.G. Detector and 120/150 v. at 25 m/A. Cash Price £1/19/6.</p> <p>REGENTONE W.1.F. H.T. ELIMINATOR for A.C. Mains, tapped S.G. Detector and 120/150 v. at 12 m/A. Cash Price £2/15/0.</p>	<p>Send 5/6 only</p> <p>Send 8/3 only</p> <p>Send 5/9 only</p> <p>Send 4/7 only</p> <p>Send 5/- only</p> <p>Send 6/2 only</p> <p>Send 5/1 only</p>		

ULTRA 1933 BLUE FOX. A.C. or D.C. Send mains. Detector and Pentode valves. Moving-coil speaker. Complete with valves, ready for use. Cash price, £10/10/-.

Balance in 17 monthly payments of 12/9. Send 12/9 only

ADVENTURER

BUILD THIS AMAZING 1933 5-VALVE SUPER-HET

Designed and described by "Maxamp" in PILOT RADIO ENVELOPE No. 3 containing Full-size Blueprint, photographs, assembly and wiring instructions with full operating notes. Obtainable by return of post.

Send 1/- only

ULTRA 1933 TIGER RECEIVER. A.C. or D.C. Mains, S.G., S.G. Detector and Pentode, Moving-coil speaker. Complete with Mazda Valves, ready for use. Cash Price, £15/15/0.

Balance in 17 monthly payments of 20/-.

Send 20/- only

ULTRA 1933 PANTHER. A.C. mains only. Two Variable-mu S.G. H.F., S.G. Detector and Power Pentode output valves. Moving-coil speaker. Complete with valves, ready for use. Cash price, £18/18/-.

Balance in 17 monthly payments of 23/1.

Send 23/1 only

C.O.D.
All orders over 10/- C.O.D. charges and carriage paid

EASIWAY
NO DEPOSIT. Strict Privacy. No third party collections. We deal with you direct

CASH
All orders over 10/- sent carriage paid

IMPORTANT

Parts, miscellaneous components or accessories are available under our own Easy Way H.P. system. Send us a list of your wants. We will quote by return without obligation.

PETO-SCOTT CO. LTD., 77 City Rd., London, E.C.1. Telephone: Clerkenwell 9406/7
West End Showrooms: 62 High Holborn, London, W.C.2.

Dear Sirs, Please send me CASH/C.O.D./H.P. _____
for which I enclose £.....s.....d. CASH/H.P. Deposit Also send your FREE 1933 Radio Catalogue.

NAME _____
ADDRESS _____

A.W. 10/9/32.

If you do not see it advertised here, send details of your requirements to us.

Buy by Post - it's Quicker

Don't Forget to Say That You Saw it in "A.W."

The best Speaker Value in the World

31K 31/6

EVERYBODY remembers the world famous Blue Spot 66K Unit and how much it did to improve radio reproduction.

An improved model of this remarkable unit is used in the Blue Spot 31K cabinet speaker. 31K will be one of the outstanding features of this season, both from the point of view of value for money and superb performance.

31K reproduces every sound with clarity and sweetness. It makes wireless a pleasure to listen to, so delightfully "real" is the standard of its performance. Singers, speakers,

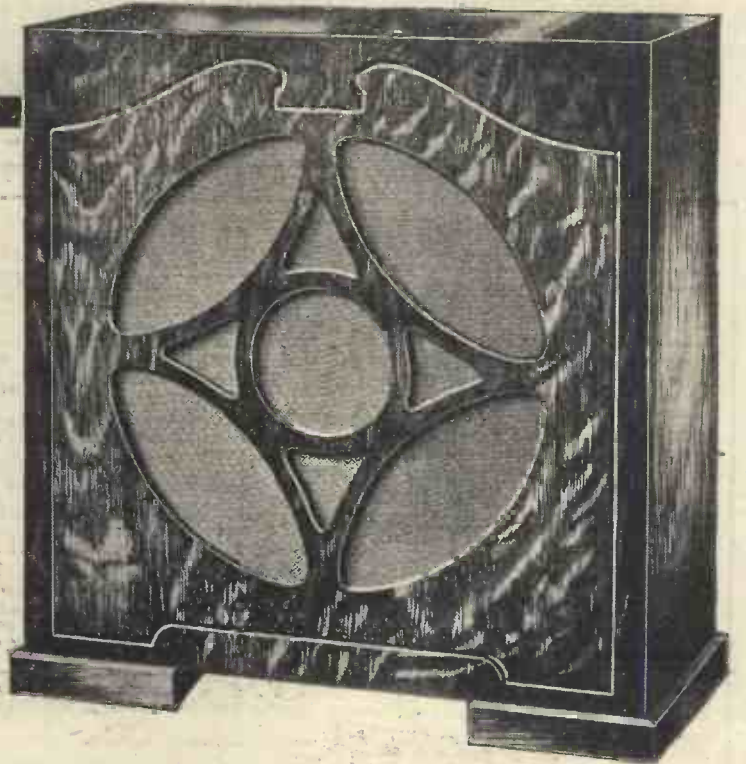

and all kinds of music are reproduced with effortless ease and with never a sign of distortion to mar their beauty.

Aside from its performance 31K is a really well made, handsome piece of furniture. Its rich dark oak cabinet looks well in any surroundings. Ask your dealer to demonstrate 31K for your pleasure and judge it for yourself. Write for Catalogue No. A.W. 48. S.

66K

—UNIT ONLY—the improved model of the world famous 66K
15/-



66KC

—unit mounted to specially designed chassis ready for screwing to baffle board or cabinet, 19/9

THE BRITISH BLUE SPOT COMPANY LTD.
BLUE SPOT HOUSE · 94/96 ROSOMAN STREET · ROSEBERY AVENUE · LONDON · EC1

Telephone: Clerkenwell 3570.

Telegrams: "Bluspot, Isling, London."

Distributors for Northern England, Scotland and Wales: H. C. RAWSON (Sheffield and London), Ltd., 100, London Road, Sheffield; 22, St. Mary's Parsonage, Manchester; 44-46, High Bridge, Newcastle; 37, 38, 39, Clyde Place, Glasgow.

You will Help Yourself and Help Us by Mentioning "A.W." to Advertisers

TELSEN

TELORNOR

GIVES YOUR HOME-BUILT SET THE DIGNITY AND BEAUTY OF LINE OF A COMMERCIAL RADIO RECEIVER

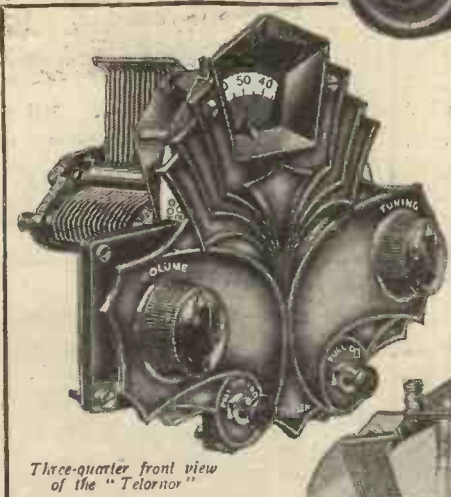
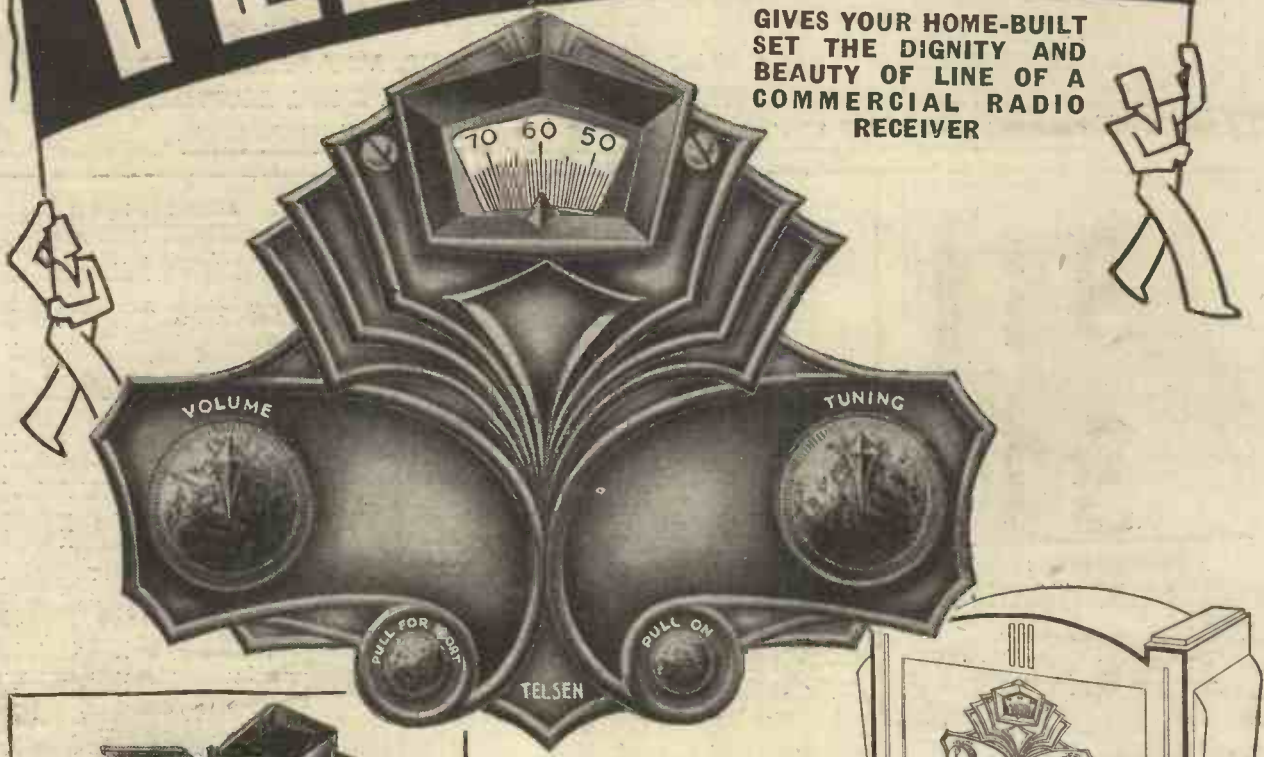

Three-quarter front view of the "Telornor"

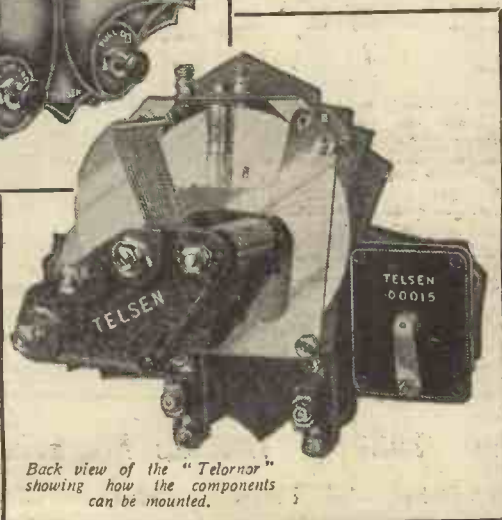

Back view of the "Telornor" showing how the components can be mounted.

GIVE your home-built set the dignity of an expensive commercial radio receiver with the new Telsen "TELORNOR." It makes better sets easy to build! The handsome silver oxidised escutcheon plate, embodying an illuminated variable ratio slow-motion Disc Drive, adds immensely to the "good looks" of your set and permits, with the minimum of trouble, a very effective grouping of your Volume, Tuning, Push-Pull and On-Off controls. Ask your dealer to show you a "TELORNOR." It will make your set a set to be proud of—in appearance as well as in performance.

No. W. 206

7'6

TELSEN

RADIO COMPONENTS

Get your copy of the new **TELSEN RADIOMAG, Issue N° 3**

ANNOUNCEMENT OF THE **TELSEN ELECTRIC CO., LTD.**, ASTON, BIRMINGHAM

You Cannot Go Wrong If You Use An "A.W."

FULL-SIZE BLUEPRINT

EACH BLUEPRINT SHOWS THE POSITION OF EVERY COMPONENT AND EVERY WIRE, AND MAKES CONSTRUCTION A SIMPLE MATTER.

WHEN ORDERING, PLEASE SEND A POSTAL ORDER, NOT STAMPS, TO BLUEPRINT DEPT., "AMATEUR WIRELESS," 58/61 FETTER LANE, LONDON, E.C.4 GIVING NAME OF SET AND NUMBER OF BLUEPRINT REQUIRED.

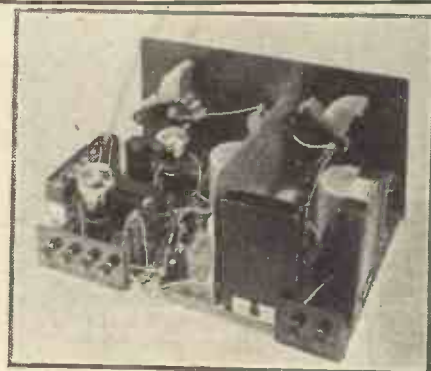

A MODERN THREE
The Home-Lover's Battery Three uses shielded coils and has a screen-grid high-frequency stage. It is an ideal set for constructors who want an outstanding three-valver

CRYSTAL SET

6d., post free.

1931 Crystal Set AW308

ONE-VALVE SETS

1s. post free.

Easy to Build One AW304
Short-wave One-valver AW327
B.B.C. One-valver AW344
Portable Short-wave One AW354

TWO-VALVE SETS

All these 1s. each, post free.

Two Star 2 (D, Pen) AW315
The 25/- Two (D, Trans) AW330
Ten-Station Two (D, Trans) AW336
Inexpensive A.C. 2 (D, Trans) AW346
Midget Two (D, RC.) AW348
Mascot Two (D, Trans) AW353
Ideal Regional 2 (D, Trans) AW357
Music Lover's Two (D, Trans) WM260
New Economy Two (D, Trans) WM265
Family Two (D, Trans) WM278
Screen-grid Two (SG, Trans) WM289
Economy A.C. Two (D, Trans) WM286
A Two for 7 Metres (D, Trans) WM295

THREE-VALVE SETS

All these 1s. each, post free.

1932 Ether Searcher (SG, D, Pen) AW325
Wide World Short-wave Three (D, RC, Trans) AW332
New Favourite Three (D, RC, Trans) AW334
Home-Lover's All-electric 3 (SG, D, Trans) AW335
The P.W.H. "Mascot" (D, RC, Trans) AW337

Home-Lover's Battery 3 (SG, D, Trans) .. AW341
£8 Radiogram (SG, D, Trans) AW343
New Regional Three (D, RC, Trans) AW349
World-Ranger Short-wave 3 (D, RC, Trans) AW355
Ether Marshal (SG, D, Trans) WM247
Meridian Short-waver (D, RC, Trans) WM255
Five-advantage Three (D, RC, Trans) WM257
Everybody's A.C. Radiogram (SG, D, Trans) WM258
Double Band-pass Three (SG, D, Trans) WM259
Everybody's A.C. Radiogram (with automatic G.B.) WM262
New Economy Three (SG, D, Trans) WM263
New Plug-in Coil Three (D, 2 Trans) WM270
Transportable Three (SG, D, Trans) WM271
Multi-Mag Three (D, 2 Trans) WM288
Percy Harris A.C. Radiogram (D, RC, Trans) WM294
The Prosperity Three for Batteries (SG, D, Trans) WM296
The Prosperity Three for A.C. Mains WM297
The Prosperity Three for D.C. Mains WM298

FOUR-VALVE SETS

All these 1s. 6d. each, post free.

Four Star 4 (SG, D, RC, Trans) AW318
50/- Four (SG, D, RC, Trans) AW331
Advance Four (2SG, Trans) AW356
Your Home Radiogram, (SG, D, RC, Trans) AW358
Brookman's Three-plus-one (SG, D, RC, Trans) WM233
Ether Rover (SG, D, RC, Trans) WM266
Quadradyne (2 SG, D, Pen) WM273
Double Band-pass Four (SG, D, RC, Trans) WM274
Everybody's Radio Gram. (SG, D, RC, Trans) WM276
A.C. Quadradyne (2 SG, D, Pen) WM279
Ideal A.C. Home Super (Super-het) WM290
Gold Coaster (A.C. Short-waver) WM292
Triple-tune Four (2 SG, D, Trans) WM293

FIVE-VALVE SETS

1s. 6d. post free.

James Short-wave Super (Super-het) AW328
Simple Super (Super-het) AW340
Ideal Home Super (Super-het) WM280
Easytune 60 (Super-het) WM284

SIX-VALVE SETS

All these 1s. 6d. each, post free.

Century Super (Super-het) AW287
A.C. "Century Super" (Super-het) AW295
" " Mains Unit (1/-) AW295A
Super 60 (Super-het) WM229
Super 60 (with Wearite base) WM249
Super 60 (with Lewcos base) WM251
1932 Super 60 (Super-het) WM269
1932 A.C. Super 60 (A.C. Super-het) WM272

SEVEN-VALVE SETS

1s. 6d. post free.

Super Senior (Super-het) WM256
Super Senior (Wearite base and Lewcos coils) WM261

PORTABLE SETS

1s. 6d. post free.

Hiker's Two (D, Trans) (1/-) AW345
General-purpose Portable (SG, D, RC, Trans) AW351
Town and Country Four (SG, D, RC, Trans) WM282
Everybody's Portable (5-valve super-het) WM291

AMPLIFIERS

All these 1s. each, post free.

Universal Push-pull Amplifier AW300
"A.W." Record Player (L.F. Push-pull) AW319
Quality Amplifier (DC), 1/6 WM264
A-P-A (Power Amplifier for A.C. Mains) WM275
A-P-A Radio Unit (SG, D.) WM281
Economy Gramophone Amplifier WM277

MISCELLANEOUS

1s. each post free.

Choke Output Unit AW240
Simple Tester Unit (6d.) AW246
"A.W." Improved Linen-diaphragm Speaker AW248
Handy L.T. and G.B. Unit for A.C. Mains AW254
Ohmic Coupled DX Unit AW255
Simple Gramophone Amplifier AW257
Novel Linen Diaphragm Speaker AW260
H.T. Unit for A.C. Mains AW262
Gramophone Tone Control AW264
H.T. Unit and Trickle Charger for D.C. Mains AW272
2-watt A.C. Amplifier AW283
"A.W." Selectivity Unit (6d.) AW290
B.B.C. Official Selectivity Unit (6d.) AW294
A.C. Trickle Charger AW305
Amateur's Linen Speaker AW307
D.C. H.T. Unit AW312
Output Unit for Pentode Sets AW316
"A.W." Short-wave Adaptor AW317
Short-wave Plug-in Adaptor (6d.) AW326
Short-wave Super-het Adaptor (6d.) AW329
Ether Searcher Radio-gramophone Motor Board AW333
"A.W." Short-wave Adaptor AW339
"Mascot" Mains Unit AW350
"A.W." Trickle Charger AW352
An Add-on Band-pass Unit AW359
"W.M." Linen Diaphragm Loud-speaker WM235
Two-Minute Adaptor for Short Waves WM240
Super 60 A.C. Unit WM248
A Simple Mains Unit WM283
Short-wave Director (6d.) (wavemeter) WM285
Voltage Regulator WM287

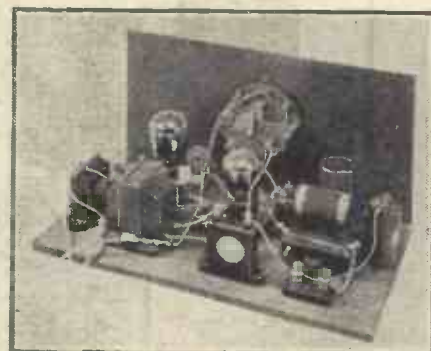

AN UP-TO-DATE TWO
This is the Ideal Regional Two, a set specially designed for those living near the Regional stations. It is very selective

Copies of "Amateur Wireless" and of "Wireless Magazine" containing descriptions of most of these sets can be obtained at 4d. and 1s. 3d. respectively, post free. Index letters "A.W." refer to "Amateur Wireless" sets and "W.M." to "Wireless Magazine" sets.

TELSEN SCREENED TUNING COILS

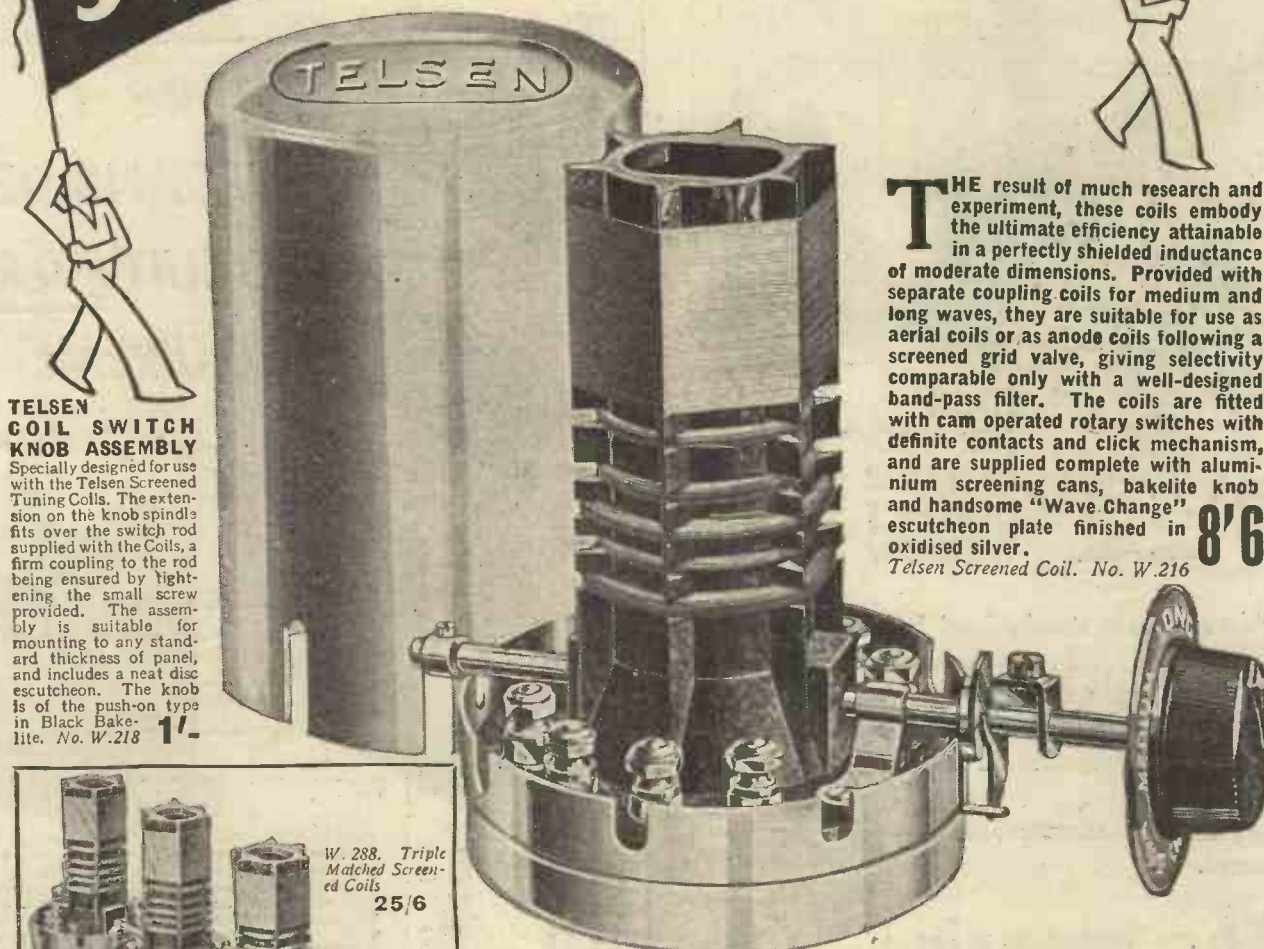

THE result of much research and experiment, these coils embody the ultimate efficiency attainable in a perfectly shielded inductance of moderate dimensions. Provided with separate coupling coils for medium and long waves, they are suitable for use as aerial coils or as anode coils following a screened grid valve, giving selectivity comparable only with a well-designed band-pass filter. The coils are fitted with cam operated rotary switches with definite contacts and click mechanism, and are supplied complete with aluminium screening cans, bakelite knob and handsome "Wave Change" escutcheon plate finished in oxidised silver. **8'6**
Telsen Screened Coil. No. W.216

TELSEN COIL SWITCH KNOB ASSEMBLY
Specially designed for use with the Telsen Screened Tuning Coils. The extension on the knob spindle fits over the switch rod supplied with the Coils, a firm coupling to the rod being ensured by tightening the small screw provided. The assembly is suitable for mounting to any standard thickness of panel, and includes a neat disc escutcheon. The knob is of the push-on type in Black Bakelite. No. W.218 **1/-**

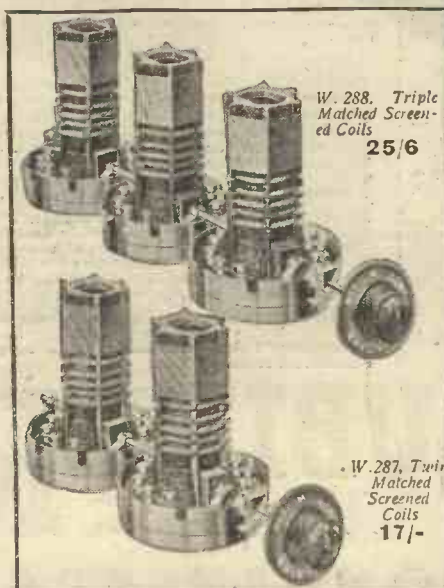

W. 288. Triple Matched Screened Coils **25/6**

W. 287. Twin Matched Screened Coils **17/-**

TELSEN COIL SWITCH COUPLING ASSEMBLY
When it is desired to mount two or more of the Telsen Screened Coils in a line parallel to the panel, and to control the wave-change switching by a single knob on the panel, this switch coupling assembly will be found indispensable. The link arms of the coupler are fitted over the switch rods of the coils, and adjusting slots are provided in the link bar to allow for the spacing of the coils varying from 3 in. to 6 in. The whole assembly has a neat nickel-plated finish, is perfectly smooth and positive in action, and free from backlash. **6d.**
No. W.217

TELSEN

RADIO COMPONENTS

Get your copy of the new **TELSEN RADIOMAG, Issue N°3**
ANNOUNCEMENT OF THE TELSEN ELECTRIC CO. LTD., ASTON, BIRMINGHAM

You will Help Yourself and Help Us by Mentioning "A.W." to Advertisers.

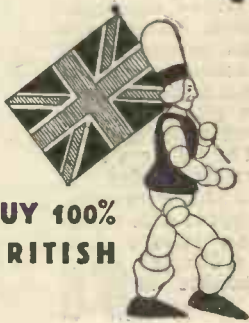

BUY 100% BRITISH

LOOK FOR "EDDY" IN YOUR DEALER'S WINDOW

Mazda valves are standardised by most leading British receiving set manufacturers. They are designed by British engineers and manufactured throughout in our British factory devoted entirely to Mazda valve production. You can buy with confidence!

Always ask for Mazda valves—your dealer has them.

The amazing

MAZDA THE BRITISH VALVES



The Edison Swan Electric Co. Ltd.
155 Charing Cross Rd. London. W.C.2.

Mazda Radio Valves are manufactured for The British Thomson-Houston Co. Ltd., London and Rugby.

From 6^d . . .
to 37/6

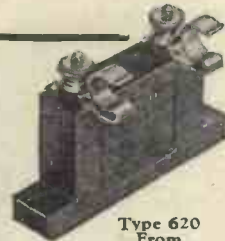

Type 620
From 1/3 to 3/-



Type 610
From 1/3 to 3/-

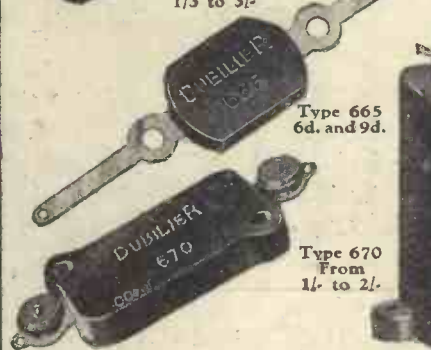

Type B.775
From 3/- to 37/6



Type 665
6d. and 9d.



Type 670
From 1/- to 2/-

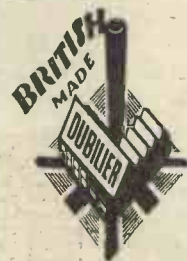

For those who want condensers occupying only a fraction of the space of the ordinary type, yet containing the finest materials and workmanship, there are the Dubilier Types 610, 620, 665 and 670 Mica Condensers for receivers, while for power amplifiers and transmitters there are the Types B770/1/2 and B775/6/7.

No matter whether a Dubilier Condenser is large or small, it is the most up-to-date in design and contains the finest materials it is possible to obtain. On every Dubilier Condenser rests the Dubilier reputation for Dependability. You may be sure that Dubilier will never let you down.

Have you seen the new Dubilier Components Booklet, "Choosing your Condensers and Resistances."? Ask your dealer for a copy or write direct to us.

DUBILIER MICA CONDENSERS

DUBILIER CONDENSER CO. (1925) LTD.
Ducon Works, Victoria Road, North Acton, W.3

TELSEN LOGARITHMIC CONDENSERS and DRUM-DRIVE

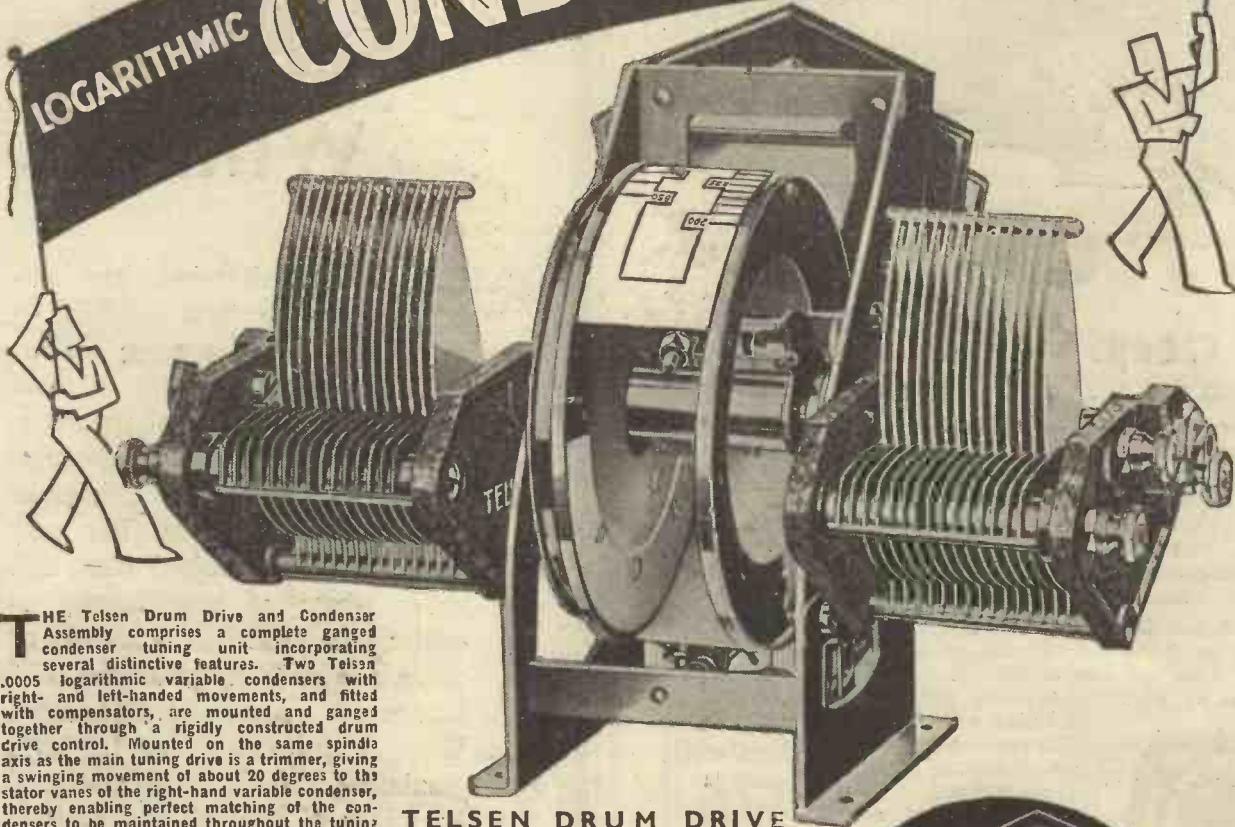

THE Telsen Drum Drive and Condenser Assembly comprises a complete ganged condenser tuning unit incorporating several distinctive features. Two Telsen .0005 logarithmic variable condensers with right- and left-handed movements, and fitted with compensators, are mounted and ganged together through a rigidly constructed drum drive control. Mounted on the same spindle axis as the main tuning drive is a trimmer, giving a swinging movement of about 20 degrees to the stator vanes of the right-hand variable condenser, thereby enabling perfect matching of the condensers to be maintained throughout the tuning range. Two scales are supplied with the unit, one marked in wavelengths and one in graduations from 0-100. The scale is illuminated and has the additional advantage of being easily removable when it is desired to fit one of special calibration. The escutcheon is handsomely finished in oxidized silver, and knobs of the push-on type are fitted. Provision is made for panel and baseboard mounting, and a double-ended spanner is supplied free with the unit for fitting the variable condensers. Full instructions for mounting are included with every unit. No. W.262.

17/6
Price

TELSEN DRUM DRIVE

Follows standard practice generally, but embodies several detail refinements, among which may be instanced the cord drive, arranged to reduce wear to a minimum and to prevent over-run, and the rocking stator trimmer, which gives a variation of 20°, and visual indication of setting. For use with Telsen screened coils, an extra scale, marked in wavelengths, is supplied free of charge. Illustration shows escutcheon, handsomely finished in oxidized silver. No. W.255. **8/6**



TELSEN LOGARITHMIC CONDENSERS

The frame is braced by three solid pillars, and the effective clamping of the vanes, each held at three points, makes distortion impossible. The rotor is also built into a rigid unit, the vanes being held at both ends. Generous bearings obviate backlash or end-plate. Models No. 260 and 261 (left-hand and right-hand movements respectively) incorporate a compensator (max. cap. 60 micro-micro henries).

- No. 130 Cap .00025, 4/6
- No. 131 Cap .00035, 4/6
- No. 132 Cap .0005, 4/6
- No. 260 (Left-hand movement with trimmer) Cap .0005, 5/-
- No. 261 (Right-hand movement with trimmer) Cap .0005, 5/-

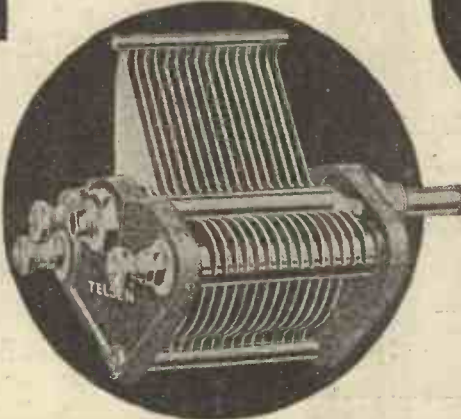

TELSEN

RADIO COMPONENTS

Get your copy of the new TELSEN RADIOMAG, Issue N° 3
ANNOUNCEMENT OF THE TELSEN ELECTRIC CO. LTD., ASTON BIRMINGHAM

Advertisers Appreciate Mention of "A.W." with Your Order



IT CREEPS.
it creeps on you every night!

SLOWLY.....INSIDIOUSLY

Valve deterioration is not sudden like switching out a light. It is so gradual in fact that you scarcely notice any difference until you realise that your wireless receiver is failing to give you really satisfactory reproduction.

If only it were possible to compare your receiver as it is now by placing it beside the same receiver when you bought it a year ago, you would be astonished at the loss in tone value, selectivity and clarity it has suffered.

If you have had your set for twelve months, or even less with some receivers, and only one set of valves, you can be sure that it has lost some of its original purity and crispness. Fit a set of ETA valves to-day and it will be as good as ever it was or even better.

ETA valves give you the highest possible standard of reproduction. They deteriorate much more slowly than many other valves.

PRICES FROM
5/6



YOU NEED NEW VALVES
GOOD VALVES — ETA VALVES

ETA

THE INTERNATIONAL VALVE

SERVICE COUPON

To the **ELECTRICAL TRADING ASSOCIATION LTD.**,
Aldwych House, Aldwych, London, W.C.2.

A. Please let me know the correct type of ETA valves to replace my present valves which are as under

1..... 2..... 3..... 4..... 5.....
(Insert type letters and number)

B. Please advise me which ETA valves to use for the following receiver or circuit.

Specify Type No. and Name

Name.....

Address.....

A. W. 10/0/32

B.I.
ENAMEL
COVERED
WIRES

B.I. Enamelled wires are unequalled for the field windings of small motors, measuring instruments, radio transformers, and other pieces of electrical apparatus where space is all-important. They are produced throughout in our own works, from the raw material to the finished wire, and every phase of manufacture is under the strictest control as regards quality of material and accuracy of gauge. B.I. Enamelled Wire is unexcelled for its high insulation, dielectric strength, flexibility of enamel, and general dependability. We regularly manufacture Enamelled wire as fine as .002 in. diameter.



BRITISH INSULATED CABLES
LIMITED

PRESCOT-LANCS

Makers of B.I. Cables

Telephone No.: PRESCOT 6571

London Office: Surrey House, Embankment, W.C.2

Telephone Nos.: Temple Bar 4793-4-5-6

Mention of "Amateur Wireless" to Advertisers will Ensure Prompt Attention

The simplest and most effective way of operating your existing Battery Type Receiver from the A.C. Mains is to use

FERRANTI UNITS

—an H.T. Eliminator to replace your H.T. Batteries, and a Ferranti Trickle Charger to keep your accumulators perpetually charged and in good condition.

The whole world knows the Ferranti record in the construction and equipment of Power Stations. In the realm of Transformers and associated gear for the transmission of electrical energy Ferranti leadership is admitted.

The first smoothing or filter arrangements ever devised were the subjects of a patent taken out by Dr. Ferranti as long ago as 1888, and the first radio power units to use the metal rectifier were also produced by Ferranti.

A Ferranti Power Supply Unit is a combination of unparalleled experience, manufacturing facilities and skill. No better units are available at any price.

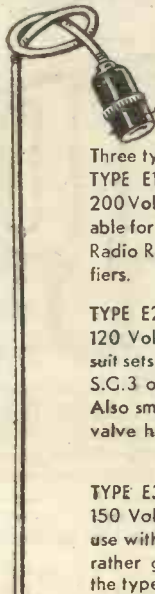

HIGH TENSION

Three types: E1, E2, and E3.

TYPE E1. Maximum output 200 Volts, 115 Milliamps suitable for use with all types of Radio Receivers and Amplifiers. Price £11.11.0.

TYPE E2. Maximum output 120 Volts, 15 Milliamps. To suit sets up to 3 valve, either S.G.3 or Detector and 2LF. Also small portables up to 5 valve having one LF stage. Price £3.10.6.

TYPE E3. Maximum output 150 Volts, 25 Milliamps for use with receivers requiring rather greater outputs than the type E2. Price £4.16.6.

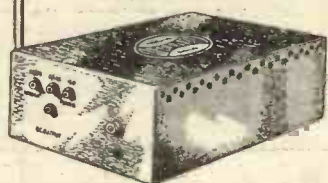
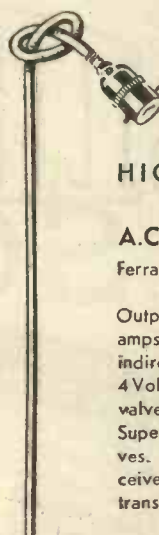
**HIGH TENSION
and
A.C. LOW TENSION**

Ferranti Power Supply Unit TYPE E4.

Output 240 Volts, 70 Milliamps, 4 Volts 5 amp. A.C. for indirectly heated valves, and 4 Volts 1 amp. A.C. for output valves. Specially suitable for Super-Hets having A.C. valves. Will also operate receivers having ordinary HF transformer couplings. Price £8.11.6.



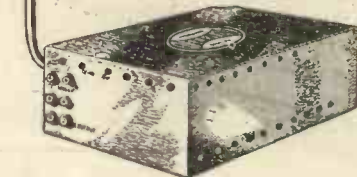
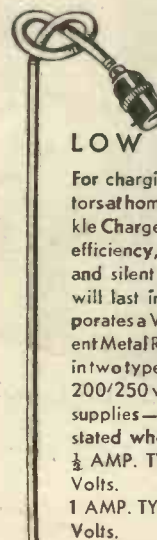

LOW TENSION

For charging L.T. accumulators at home the Ferranti Trickle Charger is ideal. Of high efficiency, it is simple, safe and silent in operation and will last indefinitely. Incorporates a Westinghouse Patent Metal Rectifier. Supplied in two types each suitable for 200/250 volts 40/100 cycle supplies — which should be stated when buying.

$\frac{1}{2}$ AMP. TYPE at 2, 4 or 6 Volts. Price £2.15.0.

1 AMP. TYPE at 2, 4, 6 or 9 Volts. Price £3.15.0.



FERRANTI LTD., Head Office & Works, Hollinwood, LANCASHIRE

LONDON: Bush House, Aldwych, W.C.2.

Please Mention "A.W." When Corresponding with Advertisers



GET YOUR COPY NOW!

It's too good to miss

Don't miss this wonderful opportunity—take this coupon to your dealer TO-DAY and ask him for the FREE book of the Slektun "Scout" S.G.3—the most sensational home constructor's set ever designed.

It is sensational, because it is the outcome of the joint experience and efforts of a group of leading component manufacturers to produce a set which is not only simple to construct, but also easy to operate—easy for the merest novice to bring in station after station at just the loudspeaker strength desired.

You need no previous experience in set construction, for the full-size blueprint, together with the illustrations and the simple instructions contained in this handsome book make success a thing assured.

And the reasonable cost of the "Scout" will astonish you, too—you could not get better Radio for twice the cost. Get your free Slektun "Scout" book from your dealer to-day. It is the greatest Radio gift of the year.

The SLEKTUN SCOUT

250,000 FREE BLUEPRINTS

FREE COUPON

Here is the coupon. Exchange it at your local dealer's or send it to us by post. Do it Now!

Single knob control is an outstanding feature of the "Scout." It will give you 50 stations at full loudspeaker strength, and reveals many unique improvements in design and performance. The "Scout" book explains them all—you will enjoy it—every page is a revelation of the perfection of modern Radio.

You can exchange the coupon at your dealers for the free book of the "Scout," or, if you prefer, pin a 1½d. stamp to the coupon and post it to us. You will receive the Magazine, giving full constructional details, together with a full-size blueprint by return. Send for your copy to-day—NOW!

To Messrs. SLEKTUN PRODUCTS, LTD.,
21 Douglas Street, Westminster, London, S.W.1

Please send me the FREE illustrated Book of the SCOUT S.G.3 together with full-size blueprint. I enclose 1½d. stamp to cover cost of postage.

Name.....
Address.....

A.W.2.

Please write clearly in BLOCK LETTERS.

A GREAT SET

SLEKTUN PRODUCTS, LTD., 21, DOUGLAS STREET, WESTMINSTER, S.W.1

National

To Ensure Speedy Delivery, Mention "A.W." to Advertisers



**BRITAIN'S LEADING RADIO WEEKLY
FOR CONSTRUCTOR, LISTENER & EXPERIMENTER**

EDITOR:
BERNARD E. JONES

TECHNICAL EDITOR:
J. H. REYNER, B.Sc., A.M.I.E.E.

RESEARCH CONSULTANT:
W. JAMES

ASSISTANT EDITOR:
H. CORBISHLEY

NEWS & GOSSIP OF THE WEEK

HIGH POWER FOR BELFAST?

B.B.C. Considering 75 Kilowatts for Northern Ireland

NOW that the regional stations are within sight of completion—only Washford Cross remains to be opened—the B.B.C. is turning its attention to minority demands. First on the list is Belfast, which was to have had a 15-kilowatt station built in place of the existing rather old-fashioned low-power station. Now we learn that engineers are seeking a site some 15 miles to the south-west of Belfast, to be used for the erection of a high-power station of the type used at regional centres. It is suggested that an aerial power of 75 kilowatts may be considered. In this way the whole of Northern Ireland would be covered with a strong signal. Irish listeners would have the additional advantage of the National programme from the super-power Droitwich station to be completed about the same time. From being the worst off it looks as though Northern Ireland listeners will one day be very nearly best served by the B.B.C.

BIG CHANCE FOR BRITISH SET MAKERS!

IF the new proposals for the broadcasting system in Australia are agreed upon there will be a big chance for British manufacturers to beat foreign rivals. Among the proposals is the erection of a chain of eight long-wave stations to serve rural areas in outlying parts of Australia. This would create a demand for double-waveband sets that set makers in this country are peculiarly fitted to meet.

LIVELIER DANCE-BAND TONE

HAVE you noticed the improvement in the "pep" of Henry Hall's band? This is due to the recent change-over from studio BB, which is wanted for television experiments, to studio 3A, where the

Children's Hours have hitherto been broadcast. There is certainly a livelier tone about the acoustics. It is of interest to note that whereas the BB studio has a reverberation time period of .85 second, the 3A studio has only .6 second. This smaller period is said to be better for the broadcasting of rhythmic combinations such as the dance band. At all events, Henry Hall is quite satisfied with the change.



The New York Radio City is rapidly growing. In the centre is the tall seventy-storey R.C.A. building. On the left is the R.K.O. giant theatre, while on the right is the R.K.O. office building and International Music Hall. In the Radio City group is to be a British Empire building

HENRY'S TOUR

DURING the first two weeks in September Henry Hall will be on a busman's holiday, touring the Continental studios looking for new ideas—if any!—in dance-band broadcast presentation. By the way, that new rhythm we were talking about last week has been found. It comprises alternate bars of 4/4 and 3/4, and it will be introduced to listeners with a tune called "The Pep Step."

NO "WAR" WITH FREE STATE

OUR B.B.C. correspondent deprecates the idea that the suggested high-power Belfast station is an answer to the "menace" of the 60-kilowatt Athlone station in the Irish Free State. Despite political tension between the two countries, the B.B.C. maintains the friendliest relations with the broadcasting officials of the Free State. So far as programme interchange is concerned we appear to give more than we take. A military-band concert and two "Proms" have been taken recently from Belfast, whereas we have had nothing since the Eucharistic Congress.

HOW MANY LINES?

ACCORDING to an engineer of the B.B.C., the Germans are inclined to laugh at us for making use of only thirty lines to a television picture, whereas it is common practice in Germany to use between ninety and 120 lines, in order to obtain a well-defined image. Our engineers are not particularly rattled over this matter. They suggest that before the Germans say any more they should take a "look see" at our television images—and then see whether their ideas on lines should not be readjusted.

THE RADIO CURFEW

ST. PANCRAS COUNCIL has made an extraordinary condition on its Brookfield Estate, and one that is likely to cause much annoyance. All

NEXT WEEK: THE "A.W." WIZARD" — A FINE NEW SET

NEWS & GOSSIP OF THE WEEK —Continued

radio sets must be switched off by 11 o'clock! Such a condition punishes nuisances and innocents alike. It is questionable whether this edict could be enforced at law. While we have every sympathy with bye-laws encouraging the suppression of loud-speaker nuisances, we are against the idea of attempting a wholesale dictatorship of listeners' rights.

TEST MATCH ACCOUNTS FOR BREAKFAST

THERE is a strong possibility that the B.B.C. will break its usual rule of being silent at breakfast time when the test matches come along in Australia during the coming winter. By means of the England-to-Australia beam service it would be possible for the B.B.C. to relay eye-witness accounts of the matches immediately at the close of play. This evening period in Australia would, of course, correspond to early morning in this country. An idea we hope will not be merely pigeon-holed!

EXCITING SCOTTISH NEWS BULLETINS

NOW that we can so easily keep in touch with Scotland by the night-time reception of Scottish Regional we are learning some of the differences of policy that are allowed by the B.B.C. in its various outlets. The regional news from Scottish Regional, which we happened to hear the other night, was notable for its absence of censorship. There were two thrilling accounts of hold-ups in Glasgow and quite a lot of "meaty" stuff that would never be allowed from London Regional—a station that seems to devote most of its local news time to reports on the doings of the L.C.C. and accounts of service re-unions!

OUR IMPARTIAL RADIO CRITICS!

NOT content with having the B.B.C.'s programme lads out to lunch, the Critics' Circle has now asked out Charles Siepmann and the Talks Department. While such informal gatherings may do something to inspire better understanding between the critics and those criticised, we cannot help wondering whether such gatherings will prove inimical to really unbiased criticism. You cannot be entirely callous to a man who has just had lunch with you. Let our radio critics retain their position of "splendid isolation."

EMPIRE RECORDING

THIS business of recording programmes for Empire consumption proceeds apace. We hear that *Dr. Abernethy*, the very successful play produced by Howard Rose, has been added to the ever-growing list. John Watt is busy writing a *Cavalcade* type of entertainment for the same purpose. On the other side of Empire broadcasting, we hear that the two 20-kilowatt short-wave transmitters will be installed during this month, which means that Empire test transmissions may be expected before Christmas.

A REAL ORIENTAL TOUCH

GET ready for the return from his long Indian tour of Ernest Longstaffe, the popular producer especially known to listeners for his Christmas pantomimes. Ernest Longstaffe has been preparing what he calls "A Revusical Journey from India to England," for which he has been collecting camel bells from the Sind Desert as well as tonga and rickshaw bells. All these will add to the Oriental touch. This show will be broadcast sometime during the week beginning October 16.

WIRELESS MADE EASY!

Don't miss the important announcement on page 489 which deals with two special features in next week's issue. A special course for beginners will be started and the issue will also contain constructional details of a fine new set. Both the beginners' course, "Wireless Made Easy" (a special supplement in the issue), and the new "A.W.' Wizard" receiver will interest all listeners. Make sure of your copy of next week's issue.

THE "WIZARD" IS COMING!

EMPIRE NEWS PROBLEMS

AT his presidential address to the Institute of Journalists, Sir Emsley Carr made an interesting allusion to the effects of the Empire news bulletins broadcast from Chelmsford. He said that many of the smaller papers in India, mostly of a seditious nature, and published in the vernacular, were making a habit of "lifting" news from the B.B.C.'s broadcast bulletins. They were thus getting a free news service for which the larger papers had to pay considerable sums. This copyright infringement is certainly one of the problems of Empire news broadcasting. It is up to the agencies to solve it.

DECLINED WITH THANKS!

WOULD-BE visitors to the studios at Broadcasting House should take note of the following extract taken from a letter received by an applicant from the B.B.C. Chief Engineer: "Whilst we much appreciate the interest in our work your application denotes, we have found that it is impossible to conduct an unlimited number of tours round the building without serious interference with the work of either transmission or rehearsal taking place in our various studios. We have, therefore, no option but to express our inability to accede to your request."

THE RADIO PARIS PROGRAMMES

Broadcasting the Programmes!

SO many last-minute alterations have been made in the published programmes of Radio Paris that the station now broadcasts a summary of the day's programme three times every day, so that listeners can know what to expect in the following programme session. At 11 p.m. a summary is broadcast of the programme for the following day. If you are listening late on Saturday evening you should make a point of noting the items of the Sunday Radio Paris programmes.

THE "EARS" OF THE HAMPSHIRE "FRONT"



During the autumn manoeuvres of the Army at the Hampshire "front" portable wireless sets in cars are used to communicate between the sections. Here the operators are having a busy time with a portable receiver

Make your Set Selective with

AN ADD-ON BAND-PASS UNIT

It is quite easy to convert old and unselective sets to band-pass tuning, and constructional details are given here of a simple add-on unit, which, with the average plain-tuned circuit, forms an efficient band-pass arrangement



THANKS to modern band-pass circuits, selectivity is not necessarily expensive. Most of the "straight" sets nowadays (that is those which are not super-hets) have some form of band-pass tuning, while even super-hets sometimes have band-pass tuned intermediate frequency stages.

The reason for band-pass popularity is not hard to find. A well set up band-pass circuit is as selective as modern arrangements will allow, and is ever so much easier to operate and more effective than a wavetrap.

Acceptor and rejector wavetraps are, after all, only a remedy, whereas a good band-pass arrangement is not just a correction for poor tuning, but is a cure at the source for non-selectivity.

No Ganging

Some set users are deterred from building up a band-pass outfit because they are afraid that ganging and tuning will be too difficult. It is quite true that early band-pass circuits needed careful setting up and that, owing to ill-matching between coils and ganged condensers, results were often not so good as those obtained with a plain tuned circuit, and in addition the bugbear of double humping was introduced.

Most of these troubles, however, apply only to band-pass circuits which are ganged, that is in which the two coils are

tuned by the two sections of a ganged condenser. If the coupling between the ganged circuits of the band-pass arrangement is not fairly constant, results will be poor on the long waves, while good on the medium or vice versa. Also if the tuning points of the two circuits do not correspond over practically the whole range, signal strength will be lost and station strength will be weaker owing to one of the circuits being out of tune with the other. Not only does this cut down strength, but it destroys the inherent value of the band-pass arrangement, for the double humping destroys any selectivity that might otherwise be apparent.

How it Works

In its bare essentials a band-pass circuit consists only of an additional tuned circuit capacity coupled to the normal tuning of the grid circuit. Apart from the convenience of operation in a big set, there is no reason why the two circuits should be ganged. They can just as well be tuned independently and this immediately cuts out all the difficulties associated with ganging and trimming. Trimming is only necessary to correct for errors of condenser adjustment, and if ganging between the condenser sections is not necessary, then all the difficulties associated with ganging and trimming are removed. If the two condensers are separately operated, the correct tuning point of each circuit can be found at any place on the wavelength scale and there need never be any fear of double humping provided that the circuits are properly tuned.

Matching Unnecessary

Where the circuits are independently adjusted, it is not even essential for

the coils of the two halves of the band-pass circuit to be identical, although in the ordinary ganged band-pass arrangement this is a vital point.

The possibility of having separately adjusted band-pass sections opens up all kinds of possibilities in the way of adapting old-fashioned band-pass sets to band-pass tuning. The average plain-tuned arrangement of a "straight" set is virtually one-half of a band-pass circuit. If another tuned circuit is put in parallel with this tuning of the set, and a suitable form of coupling provided between the two tuned arrangements, a band-pass circuit is formed. The independent condenser adjustment removed all difficulties and the resulting band-pass circuit is much more effective in operation than a wave-trap and is just as easy to tune.

A simple unit which can be added to

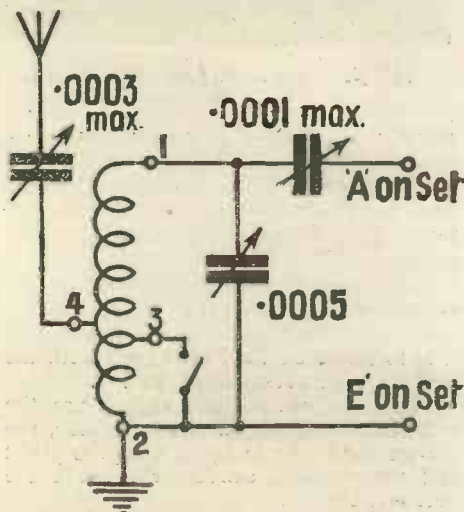

This theoretical circuit of the band-pass unit shows how simple is the arrangement



A rear view of the unit showing all the components. The screen on the left is earthed, and the coil is effectively screened

Components Required for THE ADD-ON BAND-PASS UNIT

- One .0005 mfd. tuning condenser (Lotus, Polar, Utility, Lissen, Telsen, J.B.)
- One .0001 mfd. reaction type condenser (Readi-Rad, Lissen, Utility, Peto-Scott, Formo, Lotus)
- One dual range aerial coil (Lissen, Slektun)
- One on-off switch (Readi-Rad, Lissen, W.B., Telsen, Bulgin, Junit, Wearite)
- One .0003 mfd. max. preset condenser (Sovereign type J., Formo, Lissen, Telsen)
- Ebonite panel, 9 in. by 6 in. (Lissen, Becol, Redfern)
- 5-ply baseboard, 9 in. by 6 in. (Peto-Scott, Carrington, Pickett)
- Screen to specification, 5½ in. by 5½ in. (Peto-Scott)
- Two terminal blocks (Lissen, Sovereign, Belling-Lee)
- Connecting wire and sleeving (Lewcos, Jiffilinx)

"AN ADD-ON BAND-PASS UNIT"

(Continued from preceding page)

practically any old-fashioned set with plain tuning to form a band-pass arrangement is illustrated by the accompanying photographs. Constructionally, nothing could be simpler. It consists, essentially, only of a coil and condenser, a coupling condenser and a series aerial condenser.

The unit is extremely simple to make up and as it is shielded it can be worked right at the side of the set without causing any ill-effects in the way of mutual coupling between the coils. It is, in fact, essential to keep the unit and the receiver

being secured to the baseboard to cut down stray coupling.

A reproduction is given here of the full-size wiring guide and blueprint. The small reproduction is handy in showing how the wiring goes, but it is much better to have the full-size blueprint in order to get the positions of the parts right. The full-size print can be obtained, price one shilling, post free, from the Blueprint Department, AMATEUR WIRELESS, 58-61 Fetter Lane, London, E.C.4.

The construction of the unit exactly as illustrated will be described and those who want to modify it in any way can do so, and the construction will be apparent from this description.

The special dual-range coil used in the bandpass unit is switched on to medium or long by a panel-mounting short-circuiting switch, connected across one section of the coil. The panel therefore carries the main tuning condenser, the wave-change switch and the small coupling condenser.

The blueprint shows you just where to mount the baseboard parts and is also a guide in drilling the panel.

The main variable condenser recommended in the components list is a one-hole

facing the rear edge of the baseboard. This is because terminals 1, 2, and 4 are wired to components nearer the panel.

The wiring itself can be either soldered or clamped direct under the terminal heads. The unit photographed is wired on the point-to-point system, and, as you will see, it looks quite neat.

Easy Wiring

If you follow the blueprint you cannot possibly go wrong. You will see that the aerial is connected through the pre-set condenser to terminal 4 of the coil, and that the wave-change switch is connected across terminals 2 and 3. The earth terminal on the terminal block at the left of the set looking from the back is connected by a short piece of wire to the screen. This wire should be tucked under the flanged edge of the screen and the screen then firmly screwed down to the baseboard.

When all the wiring is done, the coil screen should be put over the coil and clamped down by the small terminal on the top.

Now for connecting up. Disconnect the aerial and earth wires from your set and connect them to the aerial and earth terminals on the right-hand terminal block of the unit, on looking at the unit from the back. The right-hand terminal is for the aerial and the left-hand for the earth.

The unit is wired to the set via the left-hand terminal block. Of the two terminals on this block, the right-hand is the earth and the left-hand the aerial connection.

(Continued on page 528)

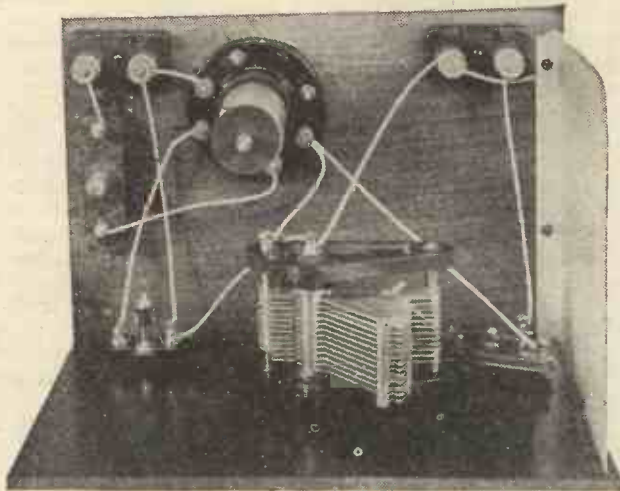

This plan view of the unit emphasizes the simplicity of the construction

fairly close together, so that there is not a long coupling wire on the above-earth potential side. A simple vertical screen prevents coupling between the coils, for this would destroy the true bandpass tuning.

Cheapness, as well as simplicity, is the salient feature and, in fact, a glance at the list of components will show you how easy it is to convert an old set to one with the modern type of bandpass tuning.

The main components needed are the coil, and condenser on the aerial side, the pre-set condenser in series with the aerial and the coupling condenser between the unit and the set.

Terminal Connections

To facilitate connections there are two terminal blocks.

One set of these terminals is connected to the aerial and earth terminals on the receiver, the aerial and earth wires being taken to the other terminal bracket.

The layout of the little unit is straightforward, but it is advisable to follow the arrangement of parts suggested, as this makes for short and direct connections.

Of course, if you want to build the unit into the set, this can be done, but you should follow the suggested layout to minimise the possibility of stray coupling. Some old sets have plenty of panel space to spare and quite probably you will find that the tuning coil and condenser, the pre-set condenser and the coupling condenser can be mounted at one end of the baseboard, the vertical screen on the unit

mounting component, and the coupling condenser and wave-change switch also require only one-hole for fixing, and are secured by a clamping nut.

Drill the panel from the back, using the blueprint to show the exact centres and do not forget to drill three small holes along the lower edge for the woodscrews, as well as the three main holes for the component fixing.

Mount the switch and the two condensers and screw the baseboard firmly to the panel.

Now you will be able to see where to mount the coil and the three other small baseboard parts. The vertical screen is mounted at the left-hand side of the unit, looking from the back. Do not screw the screen down firmly at this stage, however, as one of the terminals has an earth return wire clamped under the screw. If this were not done the vertical screen would not be so effective as it would not itself be connected to earth. Make sure that you mount the coils the right way round with the terminals 2, 6, and 5

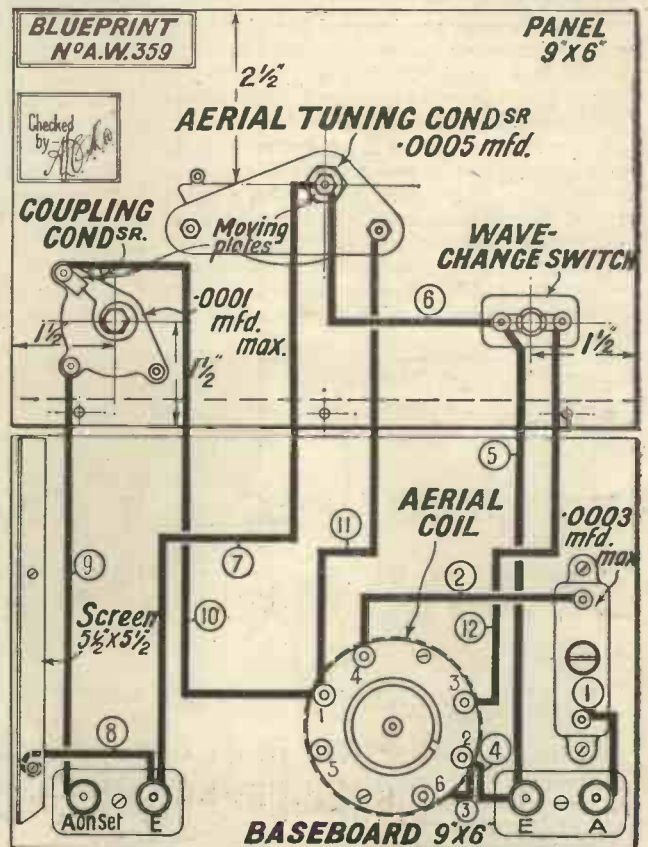

The wiring diagram of the unit: a full-size print is available, price 1s. post free

Next Week's Issue of "Amateur Wireless"—
September 17—will include a special

WIRELESS MADE EASY SUPPLEMENT

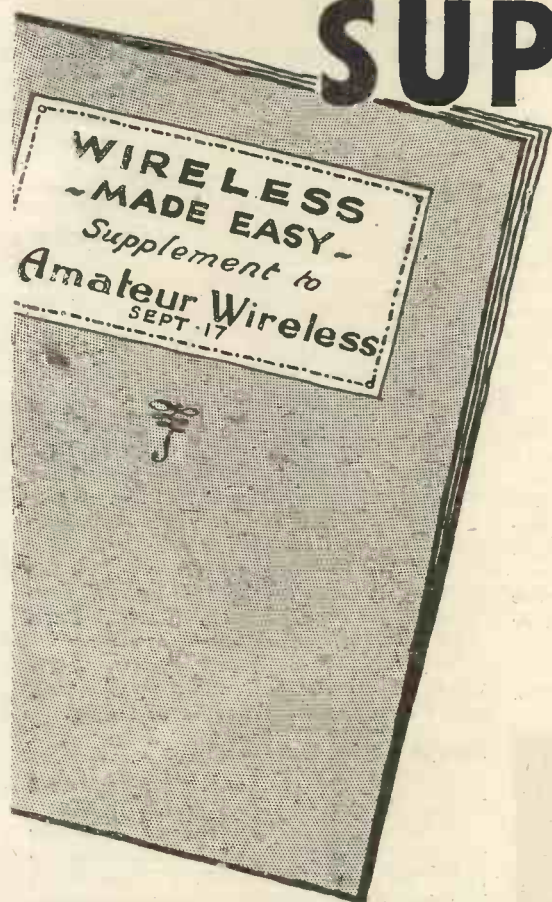

CONTAINING a variety of practical features, a very special Percy Harris contribution of great novelty and interest, and, in particular, a main idea which we have been cogitating for months. In meeting many thousands of the public at Olympia, Manchester, and elsewhere, we have become aware that there is a tremendous number of people to whom wireless would come as a most delightful and welcome hobby but who are deterred from taking it up by their avowed ignorance of even the simplest wireless facts. Now, we naturally want to bring into wireless as many people as possible, and our supplement next week is an earnest of a very serious attempt we have made to interest those who at the moment do not know the first thing about it. We have compiled an **Elementary Wireless Course for Beginners**. It is on entirely new lines. It has been discussed and criticised by many members of staff, and a number of brains have been brought to bear upon the problem of conveying essentially difficult ideas in essentially simple language. The brunt of the work has fallen upon our technical editor, Mr. J. H. Reyner, who with those assisting him has prepared a course of instruction to meet the needs of the veriest beginner. The instruction is sound scientifically, but brightly and even delightfully presented. Readers with some radio knowledge, and those without any at all, will be able to make progress from the very first sentence; will more readily enjoy the use of their set; will obtain a sound understanding of the laws of set operation; and will be enabled to reach out to bigger and more interesting things. The illustrations have been originally conceived and bring home wireless truths in a new way.

ON SALE THURSDAY, SEPT. 15,
USUAL PRICE—3d.

and details of a **VERY SIMPLE-TO-BUILD**
'STAR' RECEIVER—The "WIZARD"

A wizard is a sorcerer, an enchanter. Both ideas apply well to this set. It enchants by its simple basic idea and by its performance. As a sorcerer, the set brings you the

stations from the "vasty deep" of ether space—brings them in plenty, and does not mix them! On another page of this issue we talk at length about it. Anybody with our instruc-

tions can build the "Wizard" and make a great success of it. And almost without instructions, anybody can operate it! Next week's "A.W." will be a great issue.

AN EVENING WITH A SHORT-WAVER

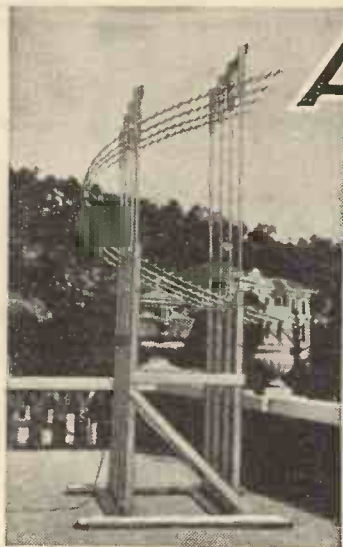

Conditions are fine for short-wave reception now, and this interesting article describes a short tour with a popular short-wave set, the "World-ranger Short-wave 3"



THE other evening I sat down in the sole company of a short-wave set, with the fixed intention of seeing just what stations are to be heard nowadays below 100 metres.

One of the joys of short-wave working is that while there are always dozens of stations to be received (the interest never flags), the conditions vary; and on any night you cannot be quite sure what new giants have sprung up in the short-wave ether and what old favourites have relegated themselves to the background.

Loud-speaker Results

The set used for this brief ether tour was the "World Ranger," described in AMATEUR WIRELESS Nos. 532 and 533, and this was chosen not only because it was the latest short-wave set produced by the AMATEUR WIRELESS Technical Staff, but because it is typical of very many short-wave sets; it is a straightforward detector and low-frequency "hook-up" (capable of working a speaker) with no H.F. stage.

To start with, I had a 120-volt dry battery and an inductor speaker, the latter connected up through a tapped transformer to the loud-speaker terminals.

Later on, an attempt was made to use 'phones, but these were found quite unnecessary and the set was also worked from a 120-150-volt eliminator, giving 20 milliamperes. This was an A.C. mains unit, but, owing to the decoupling in the detector circuit of the "World Ranger," there was no instability; nor was there any appreciable hum heard in the speaker.

A quick turn of the dials settled any doubts as to whether nowadays the short waves are worth while. I started listening at 9.30 in the evening, and about the first station I picked up was W2XAF. This station was heard at good strength throughout the evening up to about 11.30, and it was "America" with a vengeance! American reception is impossible on the medium and long wave-bands with all but the biggest sets, but it is my experience that nowadays you will get America on the short waves on practically any good evening—using only 2 or 3 valves!

There is an undeniable thrill in hearing stations thousands of miles away. On the inductor, W2XAD romped in at about the

strength (at maximum) of the German stations on the medium waveband, and even when there was bad fading at certain times during the evening, the station was still audible.

Short-wave Static

It did not take long to make it obvious that on the short waves one part of the condenser dial may cover a band almost obliterated with static, but the other part of the dial gives interference-free reception. I tuned round and found another American transmitter, W8XK, and, as a matter of fact, this was searched for and found on and off until the early hours of the morning.

The three-position switch was shifted and almost immediately Moscow was heard broadcasting on 50 metres.

Up on the broadcast bands, the Russian stations are mostly all in between 1,000 and 1,200 metres and Morse interference makes them extremely difficult to receive at times. The 50-metre Moscow transmissions were absolutely free from jamming.

The Spanish stations are often heterodyned on the broadcast band, but down the short waves I found Madrid (EAQ) free from jamming. The quality was not good, but it was, I think, as good as that which one generally gets from the Spanish stations.



B.B.C. engineers working one of the special short-wave receivers which are used in some outside broadcasts

When the tuning of the "World Ranger" was mastered and when the best position for the potentiometer had been found, the stations simply romped in and the surprising thing was the selectivity.

Radio Colonial (Paris) was heard on 19.68 metres and higher up the dial (on the next coil tapping) on 25.16 metres. Right at the side of it on this latter wavelength, was our own Chelmsford G5SW. As I was working the "World Ranger" not far from Chelmsford, the station was not heard well owing to "skip" effects. This, of course, was quite the reverse from what one gets on the broadcast band.

Mind you, it is not only the American and Australian stations which have right of way on the short waves. Early in the evening I heard some well-known Continental stations, Zeesen, Rabat, Paris (FLJ), and Bucharest.

The famous 9-kilowatt Italian short-waver in Rome, 2RO, was a good signal, and was remarkably devoid of fading.

Searching for S.A.!

The American station log was increased by the addition of W9XF and W3XAL.

A short-wave list was consulted and for nearly an hour I sat at the dials trying to bring in the Johannesburg short-wave broadcaster on 49.2 metres—a station about which a friend of mine in South Africa sends such glowing reports. The fates were unkind, and JB remains on the log as one of the stations yet to be conquered.

My evening at the dial of the "World Ranger" extended itself to the early hours of the morning and a total of 23 stations was brought in between the tuning coil limits of about 14-80 metres. Prague was heard working at good loud-speaker strength, proving that the triple-range short-wave coil is efficient at the top end of the scale.

Twenty-three stations, each providing real programme value, open up an entirely new field of listening and is a welcome diversion when the broadcast band is full of heterodynes and giant station jamming. I am certain that another evening at the dials will double the length of the reception log and it shows above all, that a listener who cannot receive below 100 metres is missing something of vital interest in wireless nowadays.

K. U.

HERE IT IS

• THE P.M.1HL



The construction that conquered microphony; that registered the biggest advance ever made in the history of valve development; that made possible the P.M.1HL non-microphonic detector.

In addition to absolute freedom from microphony, the P.M.1HL operates at very low anode consumption thus abolishing all risk of distortion, due to transformer saturation.

Price 7/-

MADE IN ENGLAND

The following Mullard Valves are specified for "Your Home Radiogram" described in this issue:

P.M.12, P.M.1HL, P.M. 2DX, P.M. 2A or P.M. 202

Mullard

THE MASTER VALVE

Adv. The Mullard Wireless Service Co., Ltd., Mullard House, Charing Cross Road, London, W.C.2.

ARKS

Mention of "Amateur Wireless" to Advertisers will Ensure Prompt Attention

**WHEN
YOU
CAN
BUY A**

**DUBILIER
GRID
LEAK**

1/-

**FOR
Why trust to
unproved GRID
LEAKS ?**



In the past you may have been tempted into buying Grid Leaks and Resistances of unproved efficiency by the prospect of saving a copper or two. But with the arrival of Dubilier Grid Leaks and Resistances you need never again imperil the performance of your set with components of unproved merit. For the Dubilier Grid Leak costs only 1/-. The famous Dubilier one watt Metallized Resistances sell at the same price. Both are unmatched in performance and their dependability has been proved alike by technicians and public.

Have you seen the new Dubilier Components Booklet, "Choosing your Condensers and Resistances." Ask your dealer for a copy or write direct to us.

Use only Dubilier Grid Leaks and Resistances in your Set. You will never find better.



**1/-
EACH**

DUBILIER CONDENSER CO. (1925) LTD.
Ducon Works, Victoria Road, North Acton, W. 3

SPECIFIED

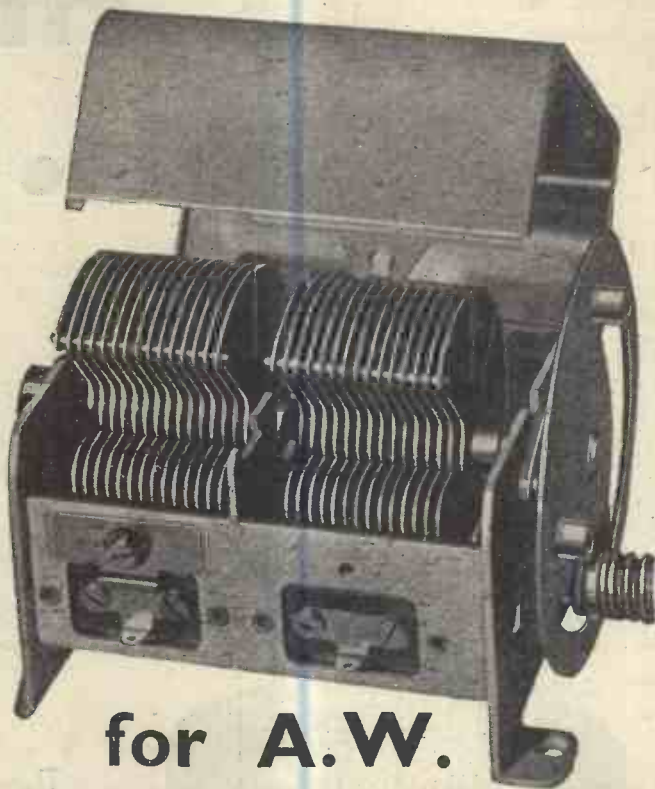

**for A.W.
"YOUR HOME
RADIOGRAM"**

Once again a British Radiophone Condenser has been chosen for a new radiogram. Designers specify British Radiophone products because they can rely implicitly on their quality and efficiency.

The British Radiophone Uni-Control Two-Gang Condenser (Type 458) used in the "A.W." "Your Home Radiogram" is designed so that the variable air dielectric trimming condenser belonging to the section nearer the dial can be adjusted from the front of the receiver.

The rotating spindle of this trimmer is brought through the main spindle and its adjusting knob is mounted concentrically with the main operating knob. This permits very accurate trimming and enables maximum signal strength to be obtained with the minimum of trouble.

The other section has a mica dielectric trimmer which can be pre-set in the usual manner. A cover and disc drive are provided with this highly efficient two-gang condenser.

Price 2 1/2

**RADIOPHONE
GANGED CONDENSERS**

THE BRITISH RADIOPHONE LTD., Aldwych House, Aldwych, W.C.2.

To Ensure Speedy Delivery, Mention "A.W." to Advertisers

Oh You Waverer!

A PROBLEM

TO me one of the greatest of all wireless mysteries is not the temporary waxing and waning of certain foreign stations, but the way in which some of them provide terrific signal strength during the first months of their existence and then become feebler and feebler. Motala, Radio Iberica, Barcelona, Warsaw, Hamburg, Frankfurt, Bero-muenster, Sottens, Lwow, Zeesen, and Bratislava are just a few examples that leap instantly to one's mind. I was discussing this matter the other day with an eminent wireless engineer and he confessed that it had worried him a good deal. The only thing he could think of was that possibly the actual soil in which the earth connections of big transmitting stations are buried undergoes in course of time a chemical or physical change, or possibly both. There seems to be something in this idea, and it would be interesting if investigations could be carried out. But even if it is found that these changes occur, I doubt if it will entirely solve the mystery, for I think I am right in saying that in more than one case where the range of a station has become enormously reduced with the passage of time its field strength has been found at a checking point fifty or sixty miles away from the transmitter to remain absolutely constant.

GRID-GLOW RELAYS

PERHAPS the most interesting example of close-set electrodes is seen in the so-called grid-glow discharge tube or thyratron relay, where the spacing is of the same order as the "free" movement of the gas molecules inside the bulb. This gives an amazingly sensitive combination, a very small variation in grid voltage setting up a sustained output current sufficient to operate a heavy relay. The thyratron valve is, in fact, the most sensitive general-purpose relay at present known, but unfortunately it is of the "trigger" type. That is to say, the slightest impulse is sufficient to set it going at full strength, but there is no sustained proportion between input and output, such as is necessary, for instance, in amplifying broadcast signals. Some day we may perhaps discover the secret of combining this property with the sensitivity of the thyratron and so pass another milestone on the path of progress.

A PUSH-PULL POINT

PLAYING around with a push-pull amplifier the other day I was very puzzled by a curious distortion which was occurring. The notes did not appear to be clearly defined, and I was quite unable to see the reason why. Moreover, the amplifier seemed to me to be overloading rather more quickly than it should do, although it was sufficiently sensitive to give me all that I required. In fact, I was just vaguely dissatisfied with the performance because the result was not

what I should be getting either in quality or punch, but I could not see where the trouble was occurring. I finally came to the conclusion that, perhaps, I was using two valves which were far from matched. I therefore decided to check up the anode current of the two valves to see whether they were reasonably similar.

I found that one was about 18 milli-amperes and the other nearly 30, so that I appeared to have spotted the cause of the trouble. On replacing the 30 milliamper valve with another, however, I found very much the same state of affairs. What is more, I found that if I changed over the two valves, the one which formerly took 18 milliamperes now took 30 and vice versa. This naturally caused me considerably perplexity, and it was not for quite a long time that I found the cause of the trouble, which was a break in one-half of the secondary winding of the push-pull input transformer. Consequently, one valve was not receiving any grid-bias at all while the other valve was receiving its normal value. The valve without any grid-bias was taking 30 milliamperes instead of the normal 18, and it so happened that that particular make of valve was uniform in that particular, so that any valve of that type inserted in the circuit without any grid bias would give a reading of approximately 30 milliamperes.

NEEDLES FOR PICK-UPS

IN a good many pick-ups, the socket is so deep that the ordinary needle, when inserted, protrudes but a very little way. This sometimes makes it rather difficult to start it properly on its journey along the grooves of a record. There is one way out of the difficulty which is well worth trying, though I cannot guarantee that it will be successful in every case. This is to use talkie needles, which are obtainable at most gramophone shops, instead of those of the ordinary variety. Talkie needles are much longer and they last well, since they are designed for playing giant records.

AN UNUSUAL FAULT

TALKING of counting revolutions of the turntable, there is a fault often unsuspected which is apt to spoil reproduction in radio-grams which contain clockwork motors of rather cheap type. Most of these will play one side of a 12-in. record well enough, but often when they are used for the second side without rewinding there is something noticeably unpleasant in the reproduction. What happens is that the record speed falls off

a little towards the end of the second side and this causes the pitch to drop gradually. It is just as well, therefore, to make sure by counting the revolutions how many records your motor can play at one winding without beginning to lose speed. Adjust it to seventy-eight in the way already suggested, then wind up fully and play the first side of a record. Without re-winding, turn over and re-start on the other side. About half-way through the second side, make a re-count. If the speed is still seventy-eight, make another one near the end. If yours is a double- or treble-spring motor, continue the process with the first and second sides of another record. Once you have found the point at which the speed begins to fall, you will know just how many record sides can be played at one winding without loss of quality.

ONE WORD OF WARNING

I FEEL I ought to raise a gentle word of caution and warn the reader against rushing into the purchase of sets of American manufacture pushed by glowing advertisements. This warning does not refer to sets of American design and manufactured in this country, though even here it is as well to consider carefully whether the completely British article is not better value. What I have chiefly in mind is the catch-penny set made in America last year and unsold over there on account of the appalling trade depression (we have known nothing like it in this country) which prevailed over there. The first-rate American set is first-rate. The cheap-jack American set is horrible. It appears to offer you more than you can obtain for the same amount of money in British sets. Do, please, remember that you cannot get more than you pay for. Bear in mind that the cheaper lines are out-of-date models and that they are offered over here simply and solely because they couldn't be sold in the country where they were made. Lastly, do not be taken in by the nasty habit of including the mains-rectifying valve in the number of valves that a set is announced to contain. It would be just about as honest to advertise a motor-car as a six-wheeler and to add in the smallest of type (if you added it at all) that one of these was the spare and the other the steering wheel.

VALVES AND "TOOBS"

I HAVE had a certain amount of experience of American sets, and I can say that the best of them are very good indeed and that the rest are—well, the rest. One of the worst features of American sets is that they use American valves. There are some good American valves and there are also some extraordinarily bad ones. Last year, to give an example, an American firm, which was endeavouring to capture the British market, sent me down a set to test. I adjusted it as directed for the local voltage, plugged in, and switched on. There was

DON'T MISS THE SPECIAL
ANNOUNCEMENT ON
PAGE 489

On Your Wavelength! (continued)

complete silence. Tests showed that one of the screen-grid valves was a "dud." I telephoned to the company concerned, which immediately sent down a demonstrator in a swift car. With him he bore all kinds of test instruments and a selection of "toobs." He also brought a spare set, which, after a brief examination of the first, he decided to install. He rigged the thing up and switched on. This time there was not silence, but there was horrible distortion. The testing instruments pointed to a defective valve and from a capacious bag he produced a number of spares. He had three screen-grids with him (the culprit was an S.G.), but every one of these turned out to be defective. But all of them, mark you, were supposed to have passed the most stringent tests and were therefore fit for sale to the ordinary purchaser. Can you beat it?

EVERYBODY'S DOING IT

It is pretty well certain that, before this note appears in print, the great army of listeners will have gone beyond the five-million mark. When you think that there are only just over eleven million homes in Great Britain—and this number includes the tiniest of cottages in the wildest parts of the country—you will realise what extraordinary progress this represents. Almost every other house in the country now has its wireless set. Not until November does broadcasting here celebrate its ninth birthday. Nine years ago there were probably not more than 50,000 listeners at the very outside. Our numbers have increased a hundred-fold in this short period, and that, I think, is something like history.

WRONG AGAIN

IN company, I think, with a very large proportion of writers on wireless subjects, I believed that, owing to its being held in August—the holiday month—the Wireless Exhibition

this year had slender chances of being a great success. I was utterly wrong. Despite the handicap imposed by the heat wave which came along during its early days, the 1932 Radio Olympia was definitely the most successful exhibition that has yet been held. It was visited by 170,000 people, and the Radio Manufacturers' Association estimates that at least £50,000,000 worth of trade will be done during the season in wireless sets and wireless components as against £29,000,000 for last season. Orders have already been placed for 2,000,000 sets (as against 1,250,000 last year), and very nearly double last year's number of valves and batteries.

A BUSY TIME AT MADRID

BY the time that this note appears in AMATEUR WIRELESS the International Telegraphy and Radio Telephony Conference will be sitting at Madrid. No less than seventy countries are sending delegates and there will be an enormous amount of work to do. The interests of broadcasting on this side of the Atlantic are being looked after by representatives of the U.I.R., who intend to take as their slogan "Broadcast wavebands for broadcasting." As matters are at present, there is still far too much commercial morse on both the medium band from 200 to 550 metres and the long waveband between 1,000 and 2,000 metres. It is believed that a way may be found of effecting a clearance.

LONG-WAVE PROBLEMS

ONE of the greatest of all problems confronting the Madrid Conference is that of the number of countries which demand a place on the long waves. It is not always realised that the long waves were, so to speak, the birth-place of broadcasting. The earliest regular transmissions were those of the Eiffel

Tower, made, if I remember aright, on 2,600 metres. Hilversum followed on about 1,100 metres; later came the services using wavelengths between 200 and 550 metres. Everyone realises the enormous advantage of the long waves for broadcasting. A 50-kilowatt station with a wavelength of over 1,000 metres has a very much larger service area than a station of the same power using a wavelength between one-fifth and one-half this amount. Perhaps the greatest of all advantages of the higher wavelengths is that transmissions upon them are comparatively little affected by conditions of daylight and darkness. Again, fading on the long waves is virtually non-existent. Unfortunately, though, the band between 1,000 and 2,000 metres is already overcrowded, and one does not see how newcomers are to be fitted in.

THE BIG PROBLEM

THE great difficulty is that if broadcasting stations are not to interfere with one another the separation between them must be based not upon wavelengths, but upon kilocycles. It has been found that at least a 10-kilocycle separation is required between powerful long-wave transmitters. Now, the higher the wavelength, the greater is the wavelength difference required to produce a 10-kilocycle interval. For instance, two of the little Swedish relays, Boras and Ornskoeldsvik, are separated by only one metre, but the frequency difference between them is 10 kilocycles. On the other hand, though the difference in wavelengths between Königswusterhausen and Radio-Paris is 90 metres, the frequency difference is only 10½ kilocycles, and the 60-metre wavelength difference between Huizen and Kaunas is equivalent to a kilocycle difference of only five. This means that to fit in a considerable number of stations an enormous band of long waves will be required.

THERMION

PERSONALITIES IN THE WEEK'S PROGRAMMES

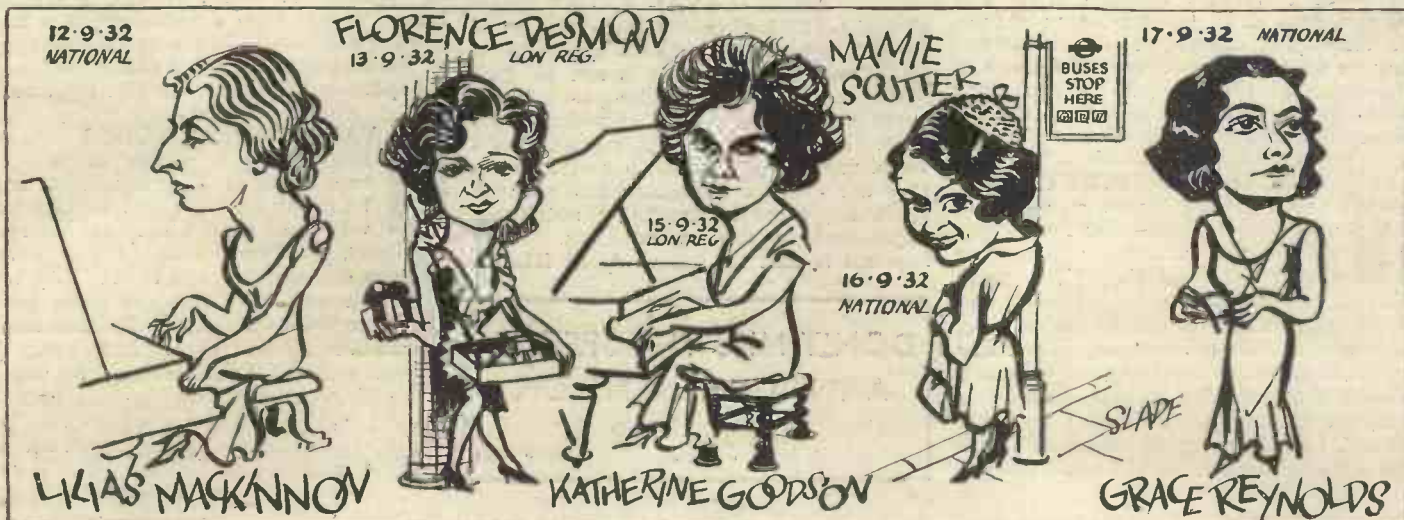

AT THE B · B · C ·

The New TELEVISION BROADCASTS



KENNETH ULLYETT gives an impression of the television broadcasts now being made by the B.B.C. on the Baird system, from Broadcasting House, London

THE usual stately solemnity of the B.B.C. studios is being invaded by Mr. Robb and his associates, who are doing the new television broadcasts from Broadcasting House.

Like a Film Studio

The studio (that which Henry Hall uses when the television experts are not busy) looks more like a film studio than a B.B.C. room, while the Baird broadcasts are on!

A visitor on the little gallery of the dance-band studio looks down on an interesting scene during a television broadcast.

Through the glass windows of the silence cabinet he can see the nose of the spot-light television transmitter. One of the glass windows is removed so that the

done, at the end of the studio right under the gallery.

The pianist is tucked away in a far corner of the studio and all over the floor there is a maze of microphone and photocell cables.

A trouble they are up against is in changing quickly from a close-up to a long shot. It means that the artiste being televised has to step back quickly away from the scanning apparatus, the lenses have to be changed, the photocell positions checked and, of course, the microphones moved, so that although the artiste's position in the studio is different, the volume is still the same.

Quick Changes

All this has to be done as quickly as possible, so that there is the minimum delay between the close-up and extended screen transmissions. Later on, they may have dual sets of photocells, microphones, and scanning apparatus, so that one ganged change-over switch will suffice.

first few days of the television transmissions!) and the only effective illumination is the reflected light of the scanning spot.

The transmissions start at 11 p.m., but Robb, Birkinsbaw and the other television enthusiasts are busy nearly all day in trying out new studio arrangements and rehearsing the artistes. This rehearsing is done down to the minutest detail and the artistes have to rehearse with their heavy make-up on, so that the final television transmissions will be just the same as the rehearsals. After each section of the rehearsal, the stands supporting the photocell groups and the microphones are shifted and a new test made.

The Check Set

The control-room engineers can tell at once, of course, whether the speech and music are O.K., and a mirror-drum monitor receiver in the control-room is a check on the quality of the television. As a matter of fact, there is no need to watch the monitor closely for the meter readings on the various amplifiers tell the whole story. The B.B.C. engineers have a receiver which gives a picture measuring 7 in. by 3 in., the proportions of this picture being the same as those of the background screen.

There has been a great deal of secrecy observed about the new television broadcasts, but I am sure that the photographs on this page will go a long way towards satisfying the curiosity of television enthusiasts.

Heavy Make-up

The photograph in the heading shows a coon singer undergoing a close-up in front of the scanning machine. There are photo-cell stands on both sides of him. His heavy make-up is obvious. The artistes are told that great contrasts, such as black and white, televise best. The nose of the scanning machine can just be seen behind the control-room window.

Enthusiasts can hear these broadcasts on four nights a week from 11 p.m. onwards. The television signals are given on London National and the accompanying sound on Midland Regional.



IN BROADCASTING HOUSE

(Above) Controlling the mirror-drum scanning machine in the anteroom of the television studio. (Right) At the controls of the television mixing panel in the control room, where the photocell inputs are blended into the main amplifier input

spot-light apparatus can come close up to the glass. He sees the 7-ft. by 3-ft. white screen which forms the background for the close-up and full-length broadcasts and

The change-over is rendered more difficult by the fact that the studio is in semi-darkness. The pianist has a small reading light (even a candle was used during the

PERCY W. HARRIS on

THE PROBLEM OF TUNING RANGE

Stray capacity and poor component design affect the tuning range of a set, and the problems to be faced in this connection are fully dealt with

ALTHOUGH one does not hear much about it, the problem of tuning range is a considerable worry both to the commercial set designer and to the experimenter at home. I am led to this conclusion on examining a number of the new commercial sets at the Exhibition, and in reading over letters from readers who have been building their sets not from published designs, but according to their own ideas and experiments. Let us see what really are the problems we have to face.

Medium and Long

At the present time, and excluding the ultra-short wave-bands, we have to deal with two ranges of wavelengths. On the lower band we go from about 200 metres to 550 metres and on the upper band from—well, from where? We used to say from 1,000 to 2,000 metres, knowing that within this band we could include all stations wanted, but look at the list to-day! You will find a string of stations below 1,000 metres. Between 600 metres and 1,000 there are two 10-kilowatt stations, three 20-kilowatt, and one 50-kilowatt, all Russian; while on 1,000 metres we have the 100-kilowatt Leningrad station. Actually, however, unless you are a Bolshevik (and I sincerely hope you are not) you will not find much interest in the interminable lectures and propaganda sent out by these stations. From the entertainment point

of view the range from 1,000 to 2,000 metres will generally give you all you want.

Going Down Low

Unless we make our sets quite elaborate with condenser switching we desire that the one variable condenser should serve for both wave bands, only the coils being changed. The .0005 variable condenser is fairly well standardised, and there is no difficulty whatever in making this condenser cover the upper band satisfactorily. Most trouble arises in the lower band, where if we choose a coil of sufficient inductance to tune to 550 metres with the .0005 condenser at a maximum, we may in certain circumstances have difficulty in getting as low as 200 metres at the other end of the scale. Experimenters did not notice this when there was nothing of any importance below about 300 metres, and the station which has drawn attention to the problem is undoubtedly Fécamp, which comes in very well indeed in many parts of England. Its wavelength is 223 metres, and Scotch readers naturally wish to get Aberdeen, which is on 214 metres, or 55 kilocycles higher.

Stray Capacity

What are the reasons why a set will not go down low enough? The answer is quite

simple—either the inductance of the coil is too high or the capacity of the condenser together with associated capacities (this last is important) is too high on the minimum setting. So far as the inductance is concerned this is fairly well defined, for with .0005 across it, it must tune up to as far as we want to go, which is generally 550 metres. If you are used to making wireless calculations you will not find it difficult to work out how much capacity is required across this inductance to tune to 200 metres, and if you do so you will find the figure is quite appreciable, which might lead you to think there is no need to worry on this score. If, however, you are not provided with the apparatus and facilities for measuring the minimum capacities of condensers as well as the self capacities of coils and different windings, and the associated aerial coupling, you may be gravely misled. You would be surprised to know how greatly different makes of condensers vary in their minimum capacity. It is not unusual to find a cheap condenser in which the minimum capacity is not much less than a tenth of the maximum. With such a condenser, and a fairly tight aerial coupling, you will not be able to go down to 200 metres however hard you try.

Cutting Down Capacity

But let us assume that you have a condenser with a very low minimum, what other troubles have you to face? Capacity due to distributed capacity between the leads, capacity between valve pins and sockets, and inter-electrode capacity in the valve. You have also another very important place to look—distributed capacity between the windings of the coils. You may have two coils, each with the same inductance, and each tuning up to 550 metres approximately with a given low-minimum condenser. At the other end of the scale with the variable condenser set at minimum one may tune to 200 metres and the other as high as 250 metres because in the latter case the windings are so arranged to give quite a high capacity between themselves, and the overall distributed capacity may add sufficiently to the minimum of the condenser and that of the wiring generally that you cannot get down to the figure you want. Bunch-wound coils made with thin wire may have a lower distributed capacity than coils wound with the same wire in neat layers with the turns touching. The "scramble windings" often used for temporary coils have a surprising way of working out more efficiently than neat turn by turn winding which looks as if it is done on a machine!

This is a very interesting and important subject for all set users, and I propose to devote more space to it in a future article.

THE LEAGUE'S OWN STATION

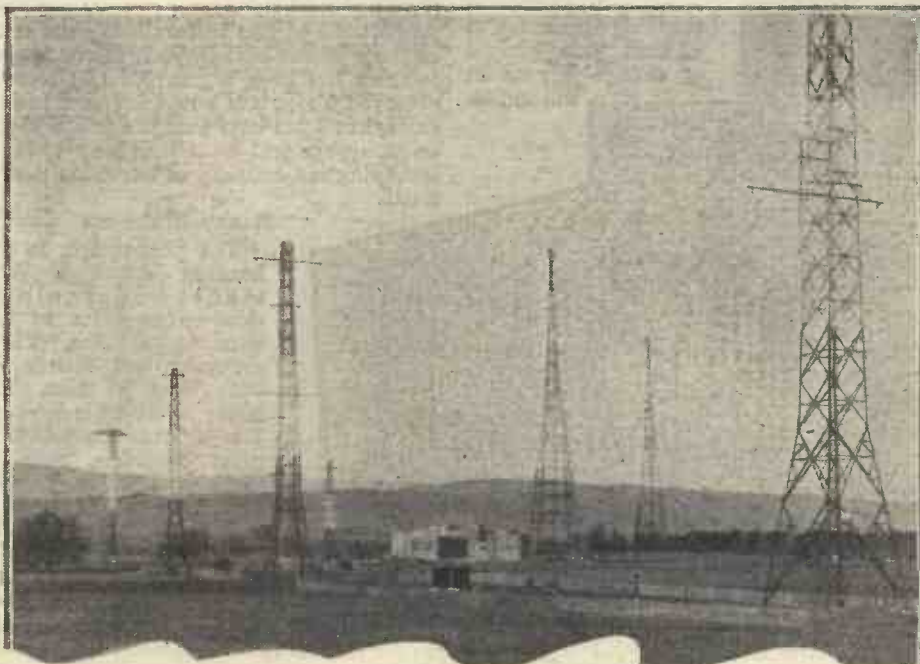

The League of Nation's station at Prangins, Lake Geneva. The medium-wave and beam aerials of this famous station can be seen in this view.

TELSEN

**10-1 COUPLING UNIT
& 1-1 COUPLING UNIT**



TELSEN 10-1 INTERVAL COUPLING UNIT

This is a filter-fed transformer using a high permeability nickel alloy core, which enables a 10—1 voltage step-up to be attained while preserving an exceptionally good frequency characteristic. The response is compensated in the higher frequencies for use with a pentode valve, this combination giving an amplification greater than anything previously achieved, equal to two ordinary L.F. stages, but with better quality of reproduction.

12⁶

No. W.215



TELSEN 1-1 INTERVAL COUPLING UNIT

This is a modern development of the one-time deservedly popular R.C. unit. It incorporates a low pass filter feed in its anode circuit, thus effectively preventing "motor-boating," "threshold howl" and other forms of instability arising out of common couplings in eliminator and battery circuits. Used with an H.L. type valve it will give an amplification of about 20 and a perfect frequency response, at the same time consuming negligible H.T. current.

7⁶

No. W.214

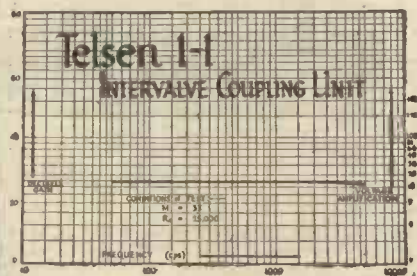
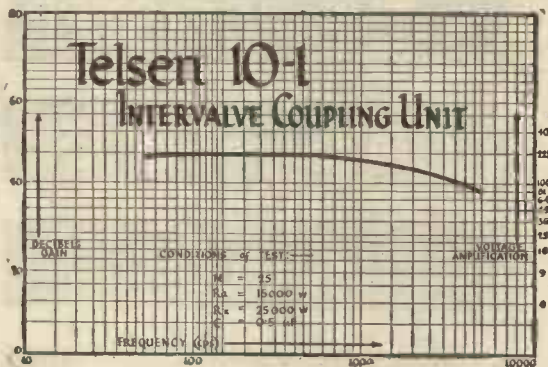

TELSEN
RADIO COMPONENTS

Get your copy of the new TELSEN RADIOMAG, Issue N°3

ANNOUNCEMENT OF THE TELSEN ELECTRIC CO., LTD., ASTON BIRMINGHAM.

Don't Forget to Say That You Saw it in "A.W."

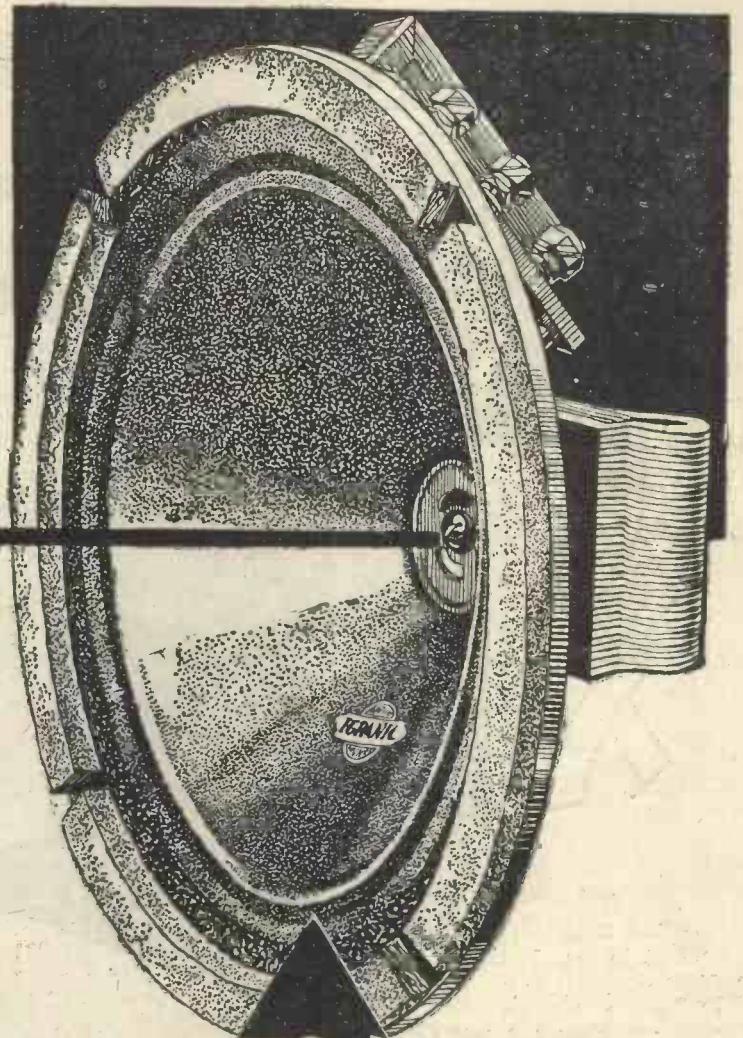

●

EVERY NOTE
 IN THE REGISTER
 COMES THROUGH
 FAITHFULLY
 VIVIDLY
 AND TRUE

32/6

SPECIFIED
 FOR THE 'A.W.'
 HOME RADIO - GRAM

IGRANIK

D.9.

**NEW TYPE PERMANENT MAGNET
 MOVING COIL
 LOUD SPEAKER**

From the top register down to the deep bass of the drum the Igranik D.9 delivers every note with its true tonal value. Stations which were once mere murmurings come in at full volume — Igranik D.9 widens the scope of your set. Let your dealer demonstrate that the Igranik D.9 permanent magnet moving-coil loud-speaker at 32/6 is the best value that money can buy.

Write for Catalogue D.167 to
 Igranik Electric Co. Ltd., 149, Queen Victoria
 Street, E.C.4.

CVS-11

Please Mention "A.W." When Corresponding with Advertisers

TRUE TONE CONTROL

THE MULTITONE WILL CORRECT THE TONE OF ANY SET

The Multitone Tone Control Transformer has no equal, but it has many imitations. No other method of tone control can claim to do what it has been proved the Multitone most definitely does.

By means of a Multitone Transformer you can amplify low tones, middle tones, and high tones at will; that is, you have "two-way tone control," which has never before been available.

The Multitone will correct the tone of any radio set or radio-gramophone.

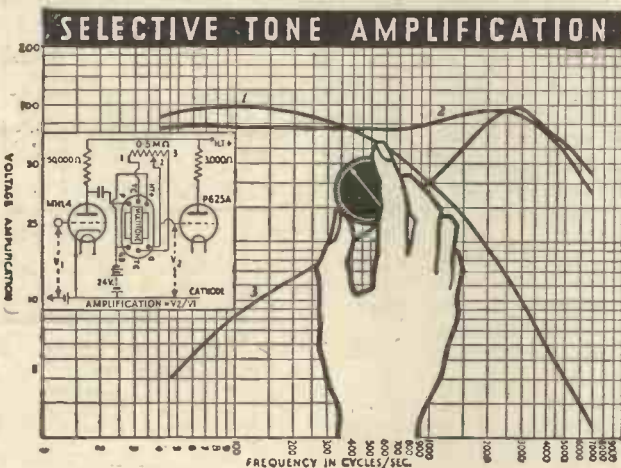

By changing the setting of a Potentiometer, the response-curve of the Multitone Transformer is progressively altered from a falling (1) through a level (2), to a rising characteristic (3). The limiting responses and an intermediate level-response are shown by these curves. When the response is level the transformer ratio is 4-1. True Two-way Tone Control is immediately at your disposal on any set. In use all that is necessary is to turn the Potentiometer until the desired overall response is obtained.



Any good Potentiometer exceeding 0.5 megohms can be used with the Tone Control Transformer, but the best results are obtained with the Multitone Graded Potentiometer (price 3s. 6d.) which has been specially designed for this purpose.

17/6

Our Booklet on Tone Control will be sent post free on receipt of a postcard.

MULTITONE

TONE CONTROL LF TRANSFORMER

Multitone Electric Co., Ltd.
95/98, White Lion St., London, N.1. 'Phone: North 5063

M.C.17

PUT THE TROUBLE TRACKER ON THE TRAIL!



Whatever fault develops in any radio set, it cannot long elude the vigilance of an "All-in-One" Radiometer. Simply connect each component in turn to the "All-in-One" Radiometer and instantly the sensitive finger of the wonderful instrument points where the trouble lies.

With the aid of this ever reliable trouble-tracker you can keep your set in 100% condition at all times.

Get an "All-in-One" Radiometer to-day and become the master of your radio. Ask to see it at any radio dealer's or electrician's. If in any difficulty, write direct to:—

PIFCO Ltd.,
High Street,
MANCHESTER.

Standard Model "All-in-One" Radio meter for Battery Sets only, as shown here. Price **12/6**

De Luxe Model for Battery Sets, Electric Receivers, and Mains Units. Price

£2 . 2 . 0



PIFCO ALL IN ONE RADIOMETER

Don't Forget to Say That You Saw it in "A.W."

INTRODUCING THE "A.W." WIZARD"

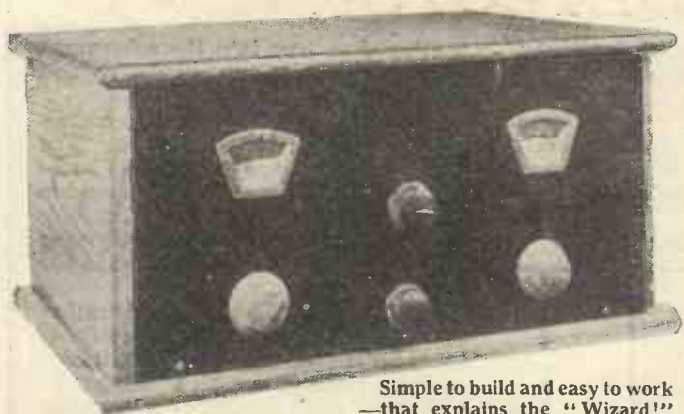

Simple to build and easy to work —that explains the "Wizard!"

IN the "A.W. Wizard"—a fine new set to be described constructionally in next week's issue—the "A.W." Technical Staff is combining all the good features of the new season to make a really outstanding, easy-to-build three-valver.

Modern reception conditions call for something special in the way of circuits and a difficulty that the Technical Staff has had to contend with so far has been the increase in set complication when the theoretical circuit is made good enough to cope with present ether conditions.

A set nowadays must be, above all, selective; it must give good tone at full volume without necessitating too much high tension, and it must be easy to build and work. It is extremely difficult to combine these features, for many ultra-selective circuits are difficult to make up. They need a large number of components in the H.F. and detector stages. The wiring is complicated. The operation is above the capabilities of non-technical listeners. Ganging and trimming have to be done.

Accurate Tuning

The "A.W. Wizard" strikes a new note in all these features. Its circuits are not ganged. There is individual control for both the highly selective tuning circuits. Two separately controlled condensers ensure that you get accurate tuning over the whole wave-range. That overcomes a snag of many ganged sets in which the tuning is good at one part of the scale and poor at the other end.

The "Wizard's" claim to selectivity is founded on fact, and it has undergone rigorous tests within a few miles of the London National and Regional transmitters. The sharp tuning is obtained by having a very small coupling to the tuning coils, both of the detector circuit and of an efficient screen-grid stage.

Most listeners now are aware that a good screen-grid high-frequency stage in front of a leaky grid detector sharpens up the tuning and cuts down inter-station jamming, due to the fact that a smaller aerial input will give the same volume output.

Wizard" both circuits have the condenser control brought out to the panel.

Simple Control

This does not complicate tuning because there is a condenser in series with the aerial to reduce aerial loading on the first tuning circuit and therefore the dials move practically in step. There is no ganging or trimming to be done and no matter what station is being received you can be sure that the "Wizard" is accurately tuned to it. That is the surest way to produce knife-edge selectivity.

The coupling between the screen-grid valve and the detector is of a low-loss nature. Both the tuning condensers have one set of vanes at earth potential and therefore both tuning controls are stable. There is no risk of the "Wizard" squealing as the hands are moved near the dial!

Good Tone

Good tone, it should be noted, in the "A.W. Wizard" is assured by a parallel-fed type of coupling between the detector and the power valve. The set gives an output sufficient to work a good inductor or moving-coil speaker and yet the H.T.

A fine new set, simple enough for everybody to build, extremely easy to operate and, above all, outstanding in performance, is on the way. A constructional description of it will be given in next week's issue and these preliminary notes are of vital importance to all listeners on the look-out for a better set

This applies only when the tuning circuits of each valve stage are accurately in tune and in the "A.W."

consumption can be kept down to within 10 milliamperes.

As a result, the "Wizard" can be worked from a 15- or 20-milliamper type of mains unit or from a medium-capacity high-tension battery.

A feature of outstanding importance to novices in the construction has not been overlooked. The "Wizard" can be built by any handy man in a couple of hours, and there are no soldered joints in it.

No Soldering

This will remove all constructional difficulties and as there is no soldering to be done in the "Wizard" all the work of construction can be done with a brace and a bit, a screwdriver and a pair of pliers! What could be simpler?

Circuit refinements which make the "Wizard" absolutely up-to-date, include a simple change-over switch arrangement for radio or gramophone and a combined wavechange and on-off switch. There are only four knobs on the panel, and only two knobs to be operated in the actual tuning.

Constructional details of this fine new outfit will be given in next week's issue, and a special method of presentation of the constructional features will ensure that the "A.W. Wizard" can be made up within a couple of hours and that it will work right first time.



A snap taken last week in the "A.W." laboratory of the new "Wizard" being put through its paces. The complete set is of striking appearance, and is housed in a special type of cabinet to be shown next week. The set is a real winner!

WHAT IT IS FOR

THE VALVE DETECTOR

TO the average beginner studying these articles, it must seem rather obvious that the function of a detector is more than merely "detecting" wireless waves. In fact, to say that the valve used in what is commonly referred to as the detector position detects signals is misleading. If any detecting can be said to be done, it is surely a process that takes place in the tuned aerial circuit. At that early point the aerial may perhaps be said to detect waves in the ether that would pass unheard but for the phenomenon of resonance—which is another story.

At the detector stage, wireless signals undergo a decisive change, whereas any valves preceding the detector merely amplify whatever signals are being picked up. At the detector a separating or de-modulating process occurs, which can be grasped only by those who have a knowledge of what a wireless telephone signal really is.

For the present we must consider the telephony received as being composed of a very high-frequency alternating current, upon which is super-imposed, by the process of modulation, the much lower frequencies of speech and music. As the medium of transmission is ether and not air, the original audible frequencies have to be carried on the very much higher frequencies of wireless waves.

The job of the detector is to regain the original audible frequencies, by separat-

ing them from the carrier high-frequency. The circuit shown by the diagram is the usual arrangement for a detector. The grid leak and the grid condenser together play an important part in making the audible frequencies wrapped up in the incoming signal affect the anode current of the valve.

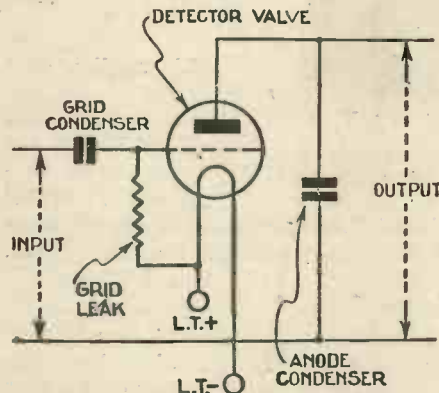

This diagram shows the main outline of a modern detector-valve circuit. The grid condenser isolates the grid from the low-tension negative side of the filament supply, while the grid leak applies a small positive potential to the grid. The anode condenser serves to by-pass the unwanted high frequency, appearing in the anode circuit after separation by the detection process, from the audible frequencies

The anode condenser serves to drain away the high-frequency current, which, once the effect of the low frequencies has been obtained, is of course no longer required. Indeed, if the high-frequency

is allowed to pass into the subsequent amplifier, there will be distortion and instability.

Values for the grid leak and condenser must be carefully chosen. The modern tendency is to use a .0001-microfarad condenser and a 1-megohm grid leak. Such values will effectively prevent what is known as frequency distortion—cutting of high notes in the audible scale.

Another form of frequency distortion can be caused by the incorrect choice of value for the capacity of the anode condenser. Usually, with a moderate-impedance valve, a capacity of not more than .0003-microfarad is recommended. If a lower capacity is used the high frequency by-passing will not be sufficient, while if a much larger capacity is chosen the higher notes of the audible scale will be by-passed with the high frequency it is primarily desired to eliminate.

Although the detector's function is mainly to obtain the effect of the audible frequencies impressed on the carrier wave, it also acts as a low-frequency amplifier. This sometimes unsuspected function of the detector can again upset the quality unless suitable precautions are taken. The detector in its function of amplifier must be arranged so that it does not overload. This is best achieved by using a medium impedance valve with as much high tension on the anode as possible.

HOTSPOT;

"A SEARCH FOR THE BEST CIRCUIT"

(Continued from page 499)

condenser c in the anode lead from this valve to the detector valve. The coil P H in Fig. 2 has become coil P F, the end F being connected to the common negative and earth.

What next? Clearly there is no need for the tightly-coupled coils P F and R F. We shall get the same result by using the one coil R F. Hence we may take the lead

Our next step is to consider the aerial circuit. There are two ways of making this circuit selective. We can introduce a coil of the same kind as the coil R F G in the aerial circuit as shown in Fig. 4, or we can introduce an aerial-series condenser of the variable type. Experimental tests proved the latter to be the better alternative. We now have a complete circuit as drawn in Fig. 5.

What is there novel in the circuit diagram given in Fig. 5? Merely the one change, that is all. A simple change

one simple change, there is a great deal of systematic experimental work with its inevitable disappointments.

A four-valve receiver built according to the circuit diagram of Fig. 5 has been used by the writer for several weeks. The selectivity of the receiver is unusually good. On the long-wave coil it is possible to obtain clear reception of Königswusterhausen when both Daventry National and Radio Paris are working. This is the most severe test of a long-wave coil in this district, and there are few receivers which can be made to pass this test successfully.

On the medium wavelengths, using coils covering a wavelength band of 230 to 580 metres, over fifty stations have been received at good loud-speaker strength. A further list of ten stations has been compiled for coils covering wavelengths from 120 to 230 metres. On lower wavelengths the usual stations have been received, Amsterdam Experimental on 80 metres, French amateurs, the Vatican station, Moscow on 50 metres, Schenectady, Zeesen, Madrid, Rome, and several other stations not yet identified. No attempt has been made to build a special short-wave receiver using this circuit. Only ordinary apparatus and assembly have been used. The lowest wavelength so far recorded has been Paris Poste Colonial on 25.20 metres.

Further work on the circuit is in progress, and there is promise of interesting results.

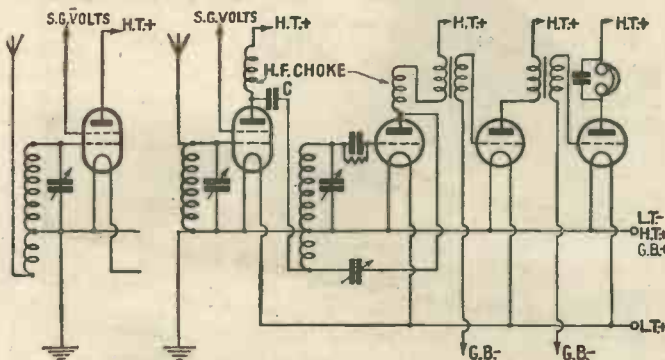

Fig. 4 (left). The next circuit modification, and Fig. 5 (right) the final circuit arrangement

from condenser c to point R of the coil R F G. We then have a detector valve coil which corresponds exactly to the coil R F G in Fig. 1. We know that we can make this coil almost as selective as we please by shortening the length of the section R F.

which takes the lead from the condenser c to the reaction end of the detector-valve coil instead of to the grid end of that same coil. It has not taken long to describe how this change was evolved, but those who are used to experimental work of this kind in wireless will know that, behind this

DIRECT RADIO

159
BORO'
HIGH
STREET

TELSEN Kits to Manufacturers' Specification.

Ajax Three Kit, £3/1/6. Deposit 10/- and 8 monthly payments of 7/6.
 Ajax Three Valve Kit, £4/4/3. Deposit 10/- and 11 monthly payments of 7/6.
 Ajax Three Valve Cabinet Kit, £4/15/- . Deposit 15/- and 11 monthly payments of 8/6.
 Jupiter Three Kit, £3/17/- . Deposit 10/- and 10 monthly payments of 7/6.
 Jupiter Three Valve Kit, £5/18/- . Deposit 15/- and 11 monthly payments of 10/6.
 Jupiter Three Valve Cabinet Kit, £6/-/- . Deposit 20/- and 11 monthly payments of 10/8.
 The cabinets are the new type "Directus" model, in hard polished veneered walnut.
 Your "Radiomag" and Blueprints come to you free with every Kit.

"RADIO FOR THE MILLION" Stationmaster Three Sealed Kits.
 Battery Model "A" with Table type Cabinet and Valves, £5/11/- . Deposit 15/- and 11 monthly payments of 10/- .
 Battery Model "B" with Console type Cabinet, Valves and Celestion Speaker, £7/10/- . Deposit 20/- and 11 monthly payments of 13/- .
 A.C. Model "C" with Walnut Console Cabinet, Mains Valves and Magnavox Moving-coil Speaker, £14/-/- . Deposit 35/- and 11 monthly payments of 25/- .
 A.C. Model "D" Chassis only with Mains Valves, £10/10/- . Deposit 30/- and 11 monthly payments of 18/6 .
 Instruction book free with each Kit.

NEW COSSOR MELODY MAKERS

All Mains Kit No. 337 with Mains Valves, Speaker and Handsome Console Cabinet, £11/15/- . Deposit 25/- and 11 monthly payments of 21/- .
 Battery Kit No. 335 with new High-efficiency Valves, Speaker and Console Cabinet, £7/17/6 . Deposit 17/6 and 11 monthly payments of 18/6 .

CSRAM THIRTY THREE

Battery Kit with Cabinet and Valves, £9/9/- . Deposit 20/- and 12 monthly payments of 15/- .

We specially recommend these selected accessories.

	£	s.	d.
Batteries { Pertrix Ultra-capacity 12-volt H.T.	1	5	6
{ Pertrix G.B.	1	0	0
{ Pertrix P.Z. 2 2-volt Accumulator	2	19	6
{ Atlas A.C. 241. H.T. only	4	10	0
{ Atlas A.K. 260. H.T. and L.T.	1	19	6
{ Atlas D.C. 15/25 H.T. only	1	19	6
{ Atlas D.E.D. Mark III	1	19	6
Mains Unit { Atlas D.E.D. Mark III	8	6	
Pick-up Bowyer-Lowe A.E.D.	1	7	6
Pick-up Volume Control, Bowyer-Lowe A.E.D.	1	15	0
log law	3	10	0
Moving-coil Speakers -			
R. & A. "Bantam"	1	7	6
R. & A. "Challenger"	1	15	0
R. & A. "Victor"	3	10	0
All including input transformers.			
Our special "Soundex" Speaker Cabinet in polished veneered Walnut can be supplied at £15/- extra.	1	13	0
Gramo Motor, Collaro Induction type	3	8	10
Gramo Motor, Collaro spring type B.33	3	8	10
"IDEAL REGIONAL TWO"			
No. 1 Kit (less valves and cabinet)	4	13	4
Or 6/4 down and 11 monthly payments of 6/4.			
No. 2 Kit (with valves less cabinet)	5	8	4
Or 8/7 down and 11 monthly payments of 8/7.			
No. 3 Kit (complete with valves and cabinet)	5	8	4
Or 9/11 down and 11 monthly payments of 9/11.			
"HOME RADIOGRAM"			
No. 1 Kit (less valves, cabinet and gramophone accessories)	5	0	3
Or 9/3 down and 11 monthly payments of 9/3.			
No. 2 Kit (with valves less cabinet and gramophone accessories)	6	13	6
Or 12/10 down and 11 monthly payments of 12/10.			
No. 3 Kit (complete with valves, cabinet and gramophone accessories)	14	14	0
Or 27/- down and 11 monthly payments of 27/- .			

WITH COMPLETE CONFIDENCE

You can of course buy your favourite accessories direct from Direct Radio. Write us for lowest quotations and suggestions.

CASH, C.O.D. AND EASY PAYMENT ORDER FORM
 To: Direct Radio, Ltd., 159, Borough High Street, London, S.E.1.

Please dispatch to me at once the following goods for which (a) I enclose (b) I will pay on delivery (c) I enclose first deposit of (cross out line not applicable) £.....
 Amateur Wireless, 10/9/32

NAME.....
 ADDRESS.....

COME EARLY Here is an announcement that will interest you! Clearance sale of last season's components and cabinets at "give away" prices to callers only at 159 Borough High Street.

To Ensure Speedy Delivery, Mention "A.W." to Advertisers



TELSEN CONDENSERS

BAKELITE DIELECTRIC

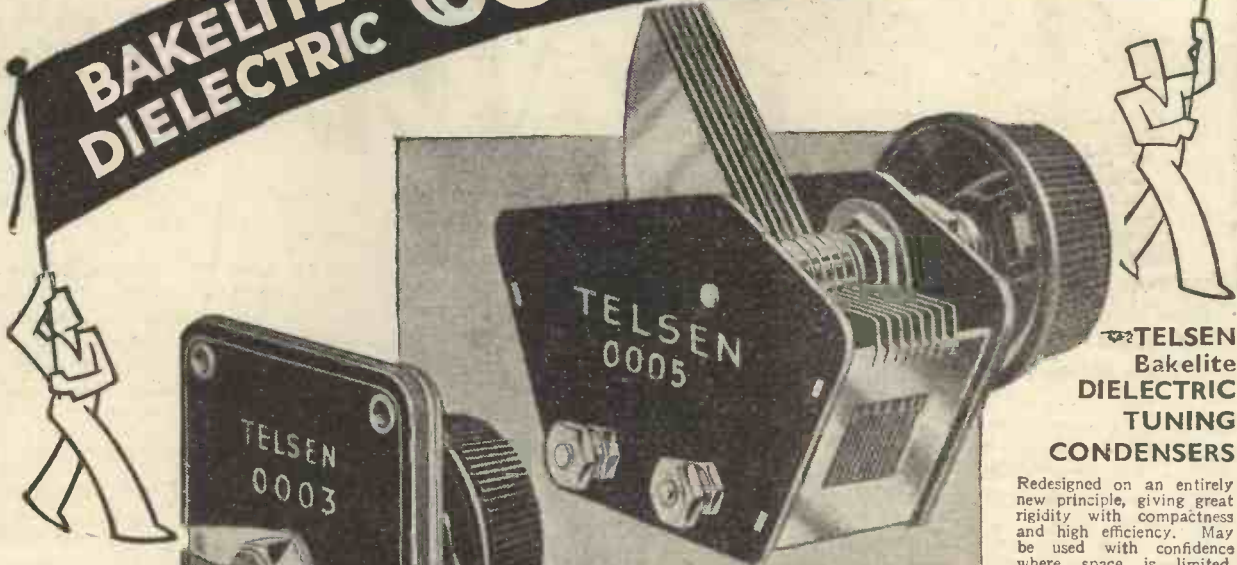

TELSEN Bakelite DIELECTRIC TUNING CONDENSERS

Redesigned on an entirely new principle, giving great rigidity with compactness and high efficiency. May be used with confidence where space is limited. The well-braced vanes are interleaved with a minimum of highest quality solid dielectric, ensuring complete accuracy of tuning. Supplied complete with knob.

Capacity No
.0005 - W.193
.0003 - W.194

2⁶/₆

TELSEN AERIAL SERIES CONDENSER

The ideal volume and selectivity control. The internal construction permits of an extremely low minimum capacity. Keyed externally on the spindle is a switch arm which connects with a contact on the fixed vanes when rotated to maximum position. This short circuits the condenser for maximum volume. The rotor movement is limited by definite stops. The vanes are interleaved with the finest quality solid dielectric. Supplied complete with knob.

Capacity .0003 - W.205

2³/₃

TELSEN DIFFERENTIAL CONDENSERS

Improved type, of great rigidity and precise construction. The Rotor Vanes are keyed to the spindle, and fitted with definite stops. The vanes are interleaved with finest quality solid dielectric. A strong nickel silver contact makes connection to the rotor, and a positive connection is made to the stator vanes. Supplied complete with knob.

Capacity. No.
.0003 W.185
.00015 W.186
.0001 W.187

2⁶/₆

TELSEN

RADIO COMPONENTS

TELSEN REACTION CONDENSERS

Capacity .0003 No. W.188
" .00015 " W.189
" .0001 " W.190
" .00075 " W.191
" .0005 " W.192

2⁴/₆

2⁶/₆

Get your copy of the new TELSEN RADIOMAG, Issue N°3

ANNOUNCEMENT OF THE TELSEN ELECTRIC CO., LTD., ASTON BIRMINGHAM

Advertisers Appreciate Mention of "A.W." with Your Order

Our Broadcast Critic

TALKS ABOUT

FINE PIANO-PLAYING



ARTHUR DE GREEF
The Famous Pianist

THERE has been some bad alternating again. The other night I came into the house a few minutes after eight and switched into the National without looking at the programme. The orchestra did not sound quite like the full B.B.C. orchestra, so I switched round to the Regional. That sounded very much the same. I found, however, that I was wrong over the National. It was Queen's Hall, and the other was Section C. It occurred to me then that it is really rather feeble to find Sir Henry Wood conducting the Prom orchestra on one side and Adrian Boult conducting Section C on the other, both playing classical music. Musicians would hesitate, not knowing which to choose; non-musical people would dislike both. There were sopranos in both programmes. For forty minutes things were like that, regardless of public taste. Surely something can be done to see that the Regional Scheme is properly carried out?

I am not alone in admiring Harold Samuel's playing of Bach in the Queen's Hall this week. Press opinions have been unanimous. Apart from the performance as an interpretation of Bach, Mr. Samuel's pianism might well be cited as a model for other pianists—something for them to imitate in the wireless sense.

Naturally, when any player steps on to the platform in the Queen's, or any other hall, his first consideration is the audience before him. Anything else is unthinkable. The fact that a few microphones are slung across the building probably means nothing to him. In a studio at Broadcasting House it is a different matter; he feels he is there for one reason only—broadcasting. If he has any taste he guards his tone, remembering that misjudgments in the dynamic sense may have bad results. All this misses a player at one of the Proms, and he may commit indiscretions. Most of them do.

Harold Samuel's playing completely satisfied both his visible and invisible audience because his tone was so round and soft. He gave the Promsters all the intensity a *fortissimo* suggests, but with such restraint that *not once* did the piano

sound hard. I wish every pianist would do the same. No wonder, at the conclusion, the hall rang with the cheers of an excited audience!

That was a good concert. Dorothy Silk sang with taste and feeling—and with a certain depth of interpretation. She, also, was well received. Arthur Cranmer was another success.

The Bach Proms are generally homely affairs, the instrumental soloists being culled from the orchestra itself. Charles Woodhouse (violin), Robert Murchie, and Frank Almgill (flutes), played beautifully in a Brandenburg Concerto. They have done it all before, of course—many times—but it sounded very fresh and crisp.

One of the outstanding features of the Proms thus far was the amazing performance by Lionel Tertis of an arrangement of his own for viola of Elgar's 'Cello Concerto. I remember the concerto coming out in 1919 when Felix Salmond played it with the London Symphony, and I was interested in the adaptation, which I thought skilful.

Most people would have enjoyed Keith Faulkener's singing of three of the "Songs of Travel" by Vaughan Williams. They are light enough for anybody. I always think Vaughan Williams has slightly overscored them. I found the orchestra rather heavy in places. In any case it

would be a good idea to reduce the number of players to an absolute minimum in these orchestrated songs. It is irritating to miss the singers' words.

Only three out of Holst's seven "Planets" were given. I must own to wanting the other four. They are very beautiful. And now, Mr. Holst; what about writing your eighth "Planet" to celebrate the discovery of Pluto? A tone poem centred round the god of Hades ought to excite your imagination!

The Saturday-night Prom was light in weight all through. I suggest to those of you who do not profess to follow the Proms (but who are open to conversion to good music) that the Saturday-night Proms make a very good beginning. Surely nobody could fail to have enjoyed the *Peer Gynt Suite*? Or the Saint-Saens piano concerto? My only grumble about the latter is that Mr. de Greef played too loudly—in one place so loudly that the piano sounded out of tune to me. He is so masterful a player that he would be wise to guard his tone a little more—just for the sake of the audience he cannot see.

I have heard no vaudeville this week. I missed the only one. I am not sure that I minded; they have become a bit tedious recently. I listened to Ashley Sterne's little affair called "Grand Slam." Until recently I did not know he was a musician. Composers are not often humorous writers and humorous writers are very rarely composers. However, he seems to be both. In this instance I liked his music immensely, but his humour did not appeal to me. I suppose it is always the way when one expects too much. "Book by Ashley Sterne," I read in the programme. "That should be amusing," I thought. But it wasn't a bit. All the same it made a pleasant show, very suitable for summer broadcasting.

The Sunday afternoon recital by May Mukle ('cello) was one of those personal, intimate broadcasts for which I have asked so frequently. I hope we shall have them throughout the winter. Miss Mukle is quite one of our best 'cellists.

Later in the evening I listened to the Canadian Trio. They had changed their pianist, but I am sure they could not have minded, because the deputy possessed a distinct and pleasant sense of rhythm. What a difference rhythm makes to music!

WHITAKER-WILSON.

PROGRAMME POINTERS

Drama by wireless is unquestionably a power. That much, at least, has been abundantly proved. There have been successful "thrillers" of various kinds. One or two have been morbid; many listeners thought "Rope" rather on that side. My pointer this week is not exactly to morbidity in "Obsession," but to its being too human. That play, on the stage when one is in a theatre for the purpose, might pass without comment, but there is a limit—there must be a limit—to what is broadcast in the form of these human dramas. In the home it is a different matter altogether. Also the fact that the whole thing is unseen tends to make these human plays almost unbearable. This one—all honour to Dulcima Glasby—was impelling; one had to endure everything in it in order to hear how it ended. As a matter of fact, it ended happily, but there were some very harrowing moments in it. The whole question of these intensely human plays requires thought. Plays with big moments in them are naturally welcome, but agony piled on—especially piled on via the ether—needs careful censoring. This particular play was a little bit—well—too human.

FIRST constructional details of this battery-operated radio-gramophone were given last week on pages 440-442.

The radio-gramophone consists of an up-to-date four-valve receiver unit, a permanent-magnet moving-coil speaker, a clockwork-driven turntable, pick-up, volume control, and batteries.

The set itself is made up on a flat baseboard in the conventional way, and as there is actually no panel it is, in fact, a great deal simpler to build than many complete receivers.

The Layout

On this page is a complete list of the parts you need for building "The Home Radio-Gram," together with a list of accessories, gramophone motor, pick-up, batteries, and so on. In last week's issue a small scale reproduction was given of the full-size blueprint of the set unit. This is a guide to the wiring, but it will pay you to get the full-size print, which can be obtained, price 1s. 6d., post free, from the Blueprint Department, AMATEUR WIRELESS, 58-61 Fetter Lane, London, E.C.4. There is a particular reason why the print is handy when you start building the "Home Radio-Gramophone" and it is that not only does it give a full-size plan view of the set, but it gives a half-scale reproduction of the drilling needed on the cabinet front. A little diagram illustrating this is given on this page, but if you have the half-scale sketch of this drilling layout before you, it is quite easy to make the holes in just the right places in the cabinet front.

Starting Construction

The set itself is quite straightforward to make up from a kit of parts, but it is as well to detail the various constructional steps.

First, you will see that all the parts are mounted on the wooden baseboard supplied with the Camco "Popular" cabinet. Not all of this baseboard is needed for mounting the parts and only the front part of the board is used. This should first be covered with a piece of aluminium foil measuring

HOME

This fine set for battery operation was introduced in last week's "A.W." No. 534, on page 440. These further constructional notes and operating details will assist home constructors

17 in. by 10 in. Make sure that the metal used is fairly stout and free from bumps, for if there are any raised places on the metal, they may short-circuit the under-wiring of some of the components, although if all the parts are firmly screwed down, this is very improbable.

The Metal Base

You will see from the blueprint, that the foil sheet is cut away at two places along the front edge, so that, at a later stage in construction, two L-brackets can be screwed to the baseboard to support condensers without making electrical contact with the foil.

When these two cuts have been made in the sheet it can be tacked down to the baseboard. Some metal foil is covered with an insulating lacquer to preserve the polish, and it is essential to remove this coating before the various electrical connections are made to the foil which covers the baseboard.

When you have finished this job, you should put the full-size blueprint over the top of the foil and baseboard to see where the components are to be mounted. The screwholes can be lightly pricked through and scratched on to the foil. Get the exact positions for the variable condenser,

coils, valve-holders, smoothing choke, terminal block, and the rest of the parts.

The two coils are screwed down on to the bases of the screens. The battery clips for the grid-bias battery are screwed down to the foil. The on-off switch and the wavechange switch are mounted on L-brackets which are screwed through the foil to the baseboard and which make contact with it.

Panel Layout

The four brackets needed for supporting the differential and reaction condensers and the wavechange and on-off switches, are supplied with some complete kits of parts or can be made out of brass or aluminium strip. The exact height of the parts on these brackets is not critical, but you should

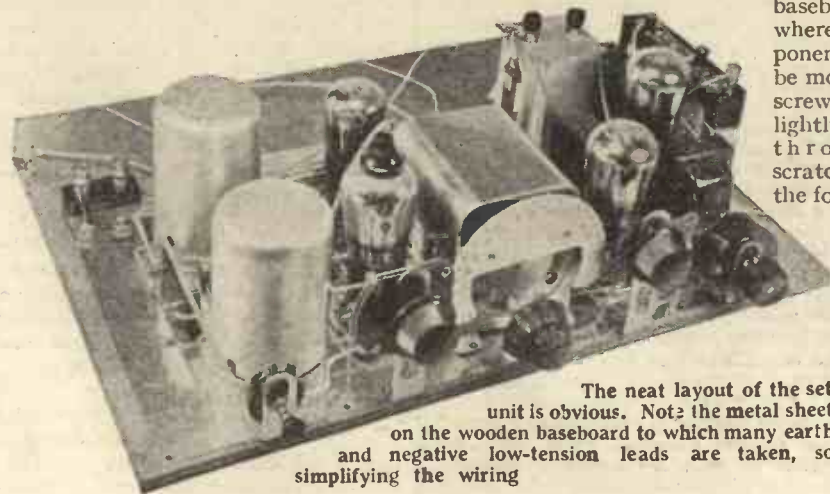

The neat layout of the set unit is obvious. Note the metal sheet on the wooden baseboard to which many earth and negative low-tension leads are taken, so simplifying the wiring

WORKING



HOME

RAD

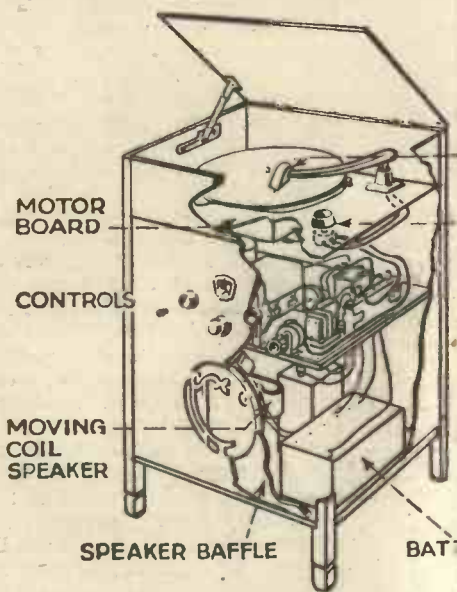

This sketch shows how the turntable equipment, speaker and batteries are placed in the "Popular" cabinet

SUITABLE CIRCUITS FOR SEVEN METRES



ALAN HUNTER offers suggestions to amateurs wanting to experiment on the ultra-short waveband around seven metres

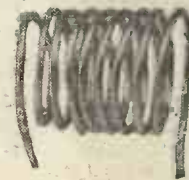

BEFORE any real progress can be made on the ultra-short waveband around seven metres experiments will have to be made at both transmitting and receiving ends. This fact is appreciated by the B.B.C. engineers, who in addition to the erection of the seven-metre transmitter on top of Broadcasting House are now building a series of special short-wave receivers in order to pick up the experimental transmissions.

Most amateurs can, at very small

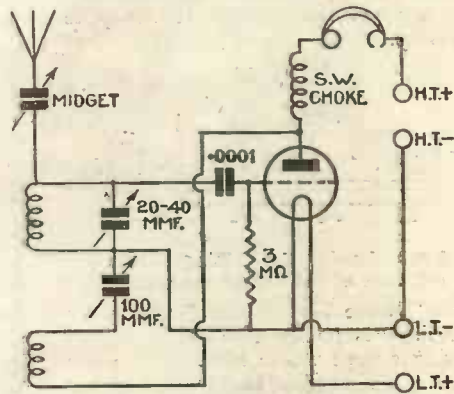

Fig. 1. Simple detector circuit for seven-metre reception. Instead of connecting the grid leak to low-tension negative it could be connected to the slider of a potentiometer across the low-tension supply

expense, participate in the reception side of the tests. No field of amateur work is likely to offer more scope for individual experiment than seven-metre reception. It might be thought that as the range of the signals from the B.B.C.'s headquarters is limited to 15 miles or so the only amateurs able to take part in the tests are those living in the London district. As a matter of fact many amateur transmitters in various parts of the country are now turning attention to ultra-short waves, and we hear reports of signals being sent out on the authorised amateur waveband of 5 metres.

At this early stage in the development of ultra-short waves it is not possible to lay down any hard and fast rules about circuits for reception. Only extensive practical experience can fully determine which of the several alternatives is the best for all-round reception.

At present there appear to be four types

of circuit for ultra-short wave reception. For a start the simple detector valve circuit shown by Fig. 1 is to be recommended. The arrangement is very similar to that used for ordinary short-wave reception, but values for the coils and condensers are, of course, much smaller. The coils can be home-made at practically no expense.

A member of our technical staff has obtained satisfactory tuning and oscillation with an 8-turn tuning winding and a 16-turn reaction winding. About 25 in. of No. 16 gauge D.C.C. wire should be wound on a 1-in. former and about 50 in. of similar wire will do for the reaction. When removed from the former the windings will spring out to about 1 1/4 in. diameter.

Ultra-short Range

Such coils, with a neutralising type of tuning condenser, having a minimum capacity of 1 1/2 micro-microfarads and a maximum of 20 micro-microfarads, will tune from just below 6 metres to just over 8 metres. The valve capacity has an important effect on the tuning at such high frequencies, and the amateur must therefore experiment with the exact number of turns needed.

An HL type of valve with an impedance around 10,000 ohms will be satisfactory

one with a very small minimum being essential.

The capacity of the grid condenser should be .0001 microfarad, and the grid leak can be either 2 or 3 megohms.

More Powerful Circuit

For more powerful results on the seven-metre band there is much to be said for the super-het converter type of unit. This is illustrated by Fig. 2. Here we have the circuit diagram of the Eddystone

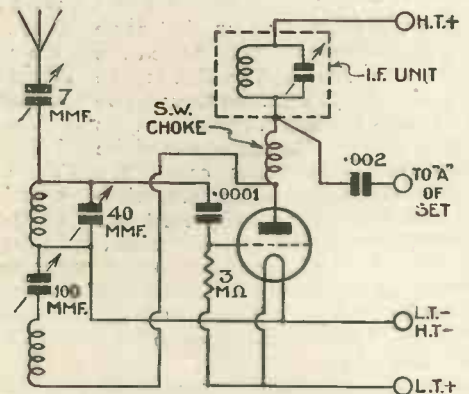
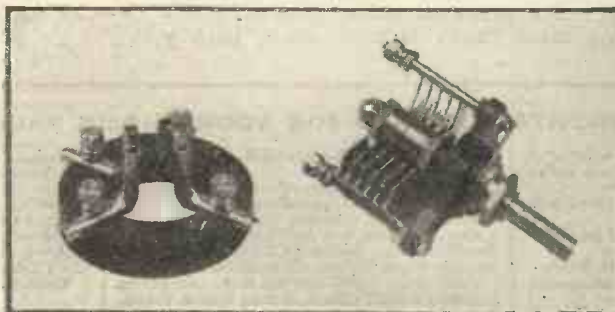

Fig. 2. The Eddystone super-het converter circuit for seven-metre reception. This converts a broadcast set tuned to medium waves into an ultra-short-wave super-het of great sensitivity. Note the special I.F. coupling unit



Typical short-wave components for seven-metre working—an Eddystone variable condenser and a low-loss valve holder

with this Fig. 1 circuit—preferably a metallised type of valve. As with all ultra-short wave circuits, use an aerial of not more than 20 ft. total length, otherwise reaction will be difficult or impossible to obtain.

For the coupling of the aerial to the tuning coil a midget or neutralising type of condenser should prove satisfactory—

converter recently introduced by Messrs. Stratton & Co., Ltd., who specialise in every branch of short-wave reception.

It will be seen that this converter circuit follows the usual plan of arranging two high-frequency chokes in series in the anode circuit of the autodyne detector, and taking a fixed condenser from the junction of the two chokes to the aerial terminal of the set.

The aerial tuning circuit consists of an Eddystone seven-metre coil in parallel with a 40 micro-microfarad Eddystone Microdenser. A 100 micro-microfarad Microdenser is used for the reaction.

The special component of this circuit is the Eddystone intermediate-frequency coupling unit, which consists of a tuned circuit in series with the ultra-short wave choke. This is instead of the more usual long-wave choke used in the position shown by the dotted line of the Fig. 2 circuit.

(Continued on page 528.)

Honour at Stake!

HOW STUDIO SOUNDS
ARE PRODUCED



The clash of swords—steel hissing on steel—this effect is produced by sharply drawing one spoon against another. That is how realism is introduced into radio. You can retain this realism if you use a Lissen High Tension Battery.

No power better for *volume*—no power better for *tone*—no power at all so pure and long lasting as the current of a Lissen H.T. Battery. All radio dealers sell it. Ask firmly by name of Lissen.

LISSEN HT. BATTERY

lasts longest and provides a pure high tension current that will give stage realism to your radio drama!

Please Mention "A.W." When Corresponding with Advertisers



This is the mains transformer described. It can easily be made at home

HOW TO MAKE YOUR OWN MAINS TRANSFORMER

It is quite a simple matter to wind transformers for mains units, and a practical description of a good home-made transformer is given here by G. H. WRAY, F.C.S.

THE transformer described was designed to work on 50-cycle mains, and to give an output of 210 volts, for the input to a Westinghouse H.T.8-type metal rectifier, and 14 volts for the input to an A.3-type rectifier, the output from the latter being used to energise the field windings of a low-resistance moving-coil speaker. A 4-volt filament winding, designed to carry 3 amperes, was also included. This article will be confined to the practical constructional details, the somewhat complex theoretical side of transformer design having been dealt with in several excellent articles published recently in the wireless press.

A Low-loss Design

The efficiency of a transformer depends upon certain losses, known as copper loss, and iron loss, and in the transformer described in this article the writer considers that these losses have been kept as low as

and has a cross sectional area of 1.5 sq. in. The end clamps shown on the transformer illustrated were made in cast iron, at a local foundry, from a pattern made in ply-wood, but clamps which are equally suitable and in some ways better, can be obtained, together with the necessary clamping bolts, from Messrs. Savage, or from Sound Sales, Ltd. The terminal plate is mounted on top of the transformer and held in position by four 1/8-in. screws through four corner fixing holes in the plate and screwed into the tops of the end clamps. The terminals are the small pattern Belling Lee. The windings are layer-wound on the Type 4F. bobbin, which is made of Paxolin, and is also obtainable from Messrs. Savage. These bobbins are the correct size for use with No. 4 pattern stampings, and have a winding space of 2 1/4 in. long by 3/4 in. deep.

Choosing the Wire

Enamelled wire is used for the primary and secondary windings, and d.c.c. wire for the 14-volt and 4-volt windings. The design of the transformer gives a winding ratio of six turns per volt, and the primary is wound with a total of 1,500 turns for 250 volts input, and is tapped at the 1,320th, the 1,380th, and the 1,440th turn, to enable the transformer to be used on supplies of 220, 230, or 240 volts. 28 S.W.G. wire is used for the primary, and the leads and windings may either be brought through holes drilled in the cheeks of the bobbin, or as some difficulty may be experienced in deciding upon the position of these holes, saw cuts about 3/8-in. deep may be made in the bobbin cheeks with a hacksaw, and the windings brought through these slots. The turns should be wound on firmly and evenly, finishing each layer closely up to the cheek of the bobbin, and in order to support the cheeks and prevent them from being pushed outwards during the process of winding, a piece of wood should be cut to fit inside the bobbin, also two wooden end cheeks. A piece of screwed rod is passed through the centre and the whole is tightened up with nuts at either side. When the primary winding is completed, two layers of "Empire" cloth are wound over it as insulation.

A thin earthed screen, sheet copper is the most suitable, may now be placed between the primary and the other windings; its object being to reduce background noises when the transformer is on circuit.

The same effect can be obtained by wind-

ing the 4-volt filament coil immediately over the primary winding, the centre point being earthed, the coil, therefore, provides a screen and this procedure was followed in winding the transformer illustrated in this article.

If, however, a thin copper screen is used instead, it must not completely encircle the primary winding or it would have the effect of a short-circuited turn of very heavy

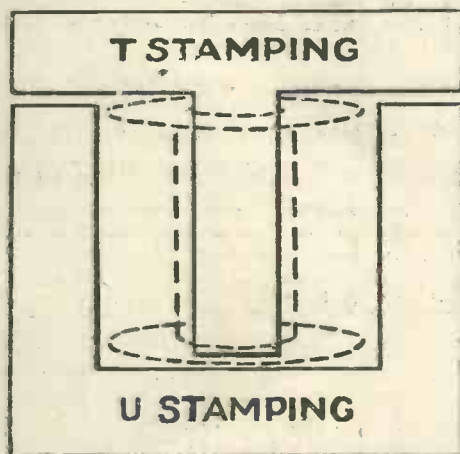

The arrangement of the transformer core stampings

gauge wire, and current would flow with the possibility of damage.

The 4-volt winding is next wound on, this consists of 26 turns of No. 19 d.c.c. wire and a centre tapping is brought out at the thirteenth turn. Two layers of "Empire" cloth are wound over the filament coil, and the H.T. secondary winding can now be commenced. This consists of 1,330 turns of No. 30 S.W.G. enamelled wire. This is slightly more than the calculated number of turns, in order to allow for drop in voltage due to D.C. resistance of the wire. Two layers of insulating cloth are wound over the H.T. winding, and the 14-volt which is the final winding, is then commenced. Eighty-four turns of No. 22 d.c.c. are required, and when completed, the winding is protected and an improved finish given to the transformer by covering the coil with one layer of thin Leatheroid. During the winding of the bobbin and final assembly of the transformer, careful attention should be given to insulation, as unless this is reasonably good throughout, the reliability of the transformer will be impaired.

The transformer is now ready to be assembled. The bobbin is placed on its side on the table, and the core is built up by inserting a T-piece stamping in the core opening at one side, and a U-piece from the opposite side, reversing the order of

(Continued on page 538)

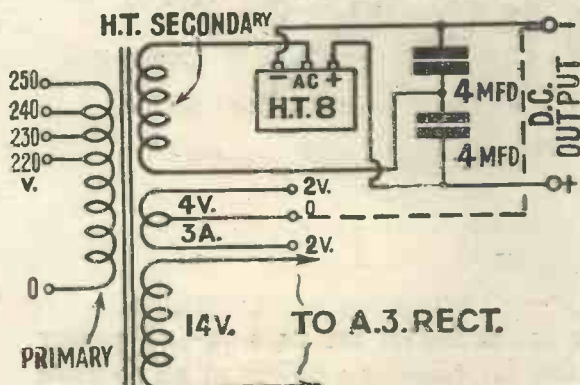

The recommended rectifier circuit for use with the mains transformer described here

possible, consistent with a transformer of this type. Other losses may be introduced by insufficient care in workmanship either in coil winding or assembly, and too much attention cannot be attached to this point.

Building the Core

In constructing the transformer, the first part to be considered is the iron core, and this is built up of Stalloy iron which is a special alloy, giving high efficiency. The stampings are a standard size, listed as No. 4 pattern, and are stocked by Messrs. Brian Savage, and by Messrs. J. Sankey and Sons. Nine dozen pairs are required, the core is built up to a thickness of 1 1/2 in.

LISSEN SHIELDED COILS

A FINE BASIS for the MOST SELECTIVE SETS OF 1933

Lissen Shielded Coils have been produced to meet the demand for a range of coils of universal utility, high efficiency, and matched to unusually close limits. Selectivity is of a very high order, and "break-through" on the long waveband is almost entirely eliminated. Damping losses are exceptionally low, shielding is particularly complete. All the Lissen Shielded Coils are laboratory matched in inductance to within 1 per cent.

TWO-GANG AND THREE-GANG INCORPORATE WAVE-CHANGE AND FILAMENT SWITCHES

No need to keep on buying new coils for every circuit you build—just get a set of these Lissen Coils and you can adapt them to any circuit.

Single Lissen Dual-range Shielded Coil 6/6 Two-gang Lissen Shielded Coil 17/6 Three-gang Lissen Shielded Coil 26/-

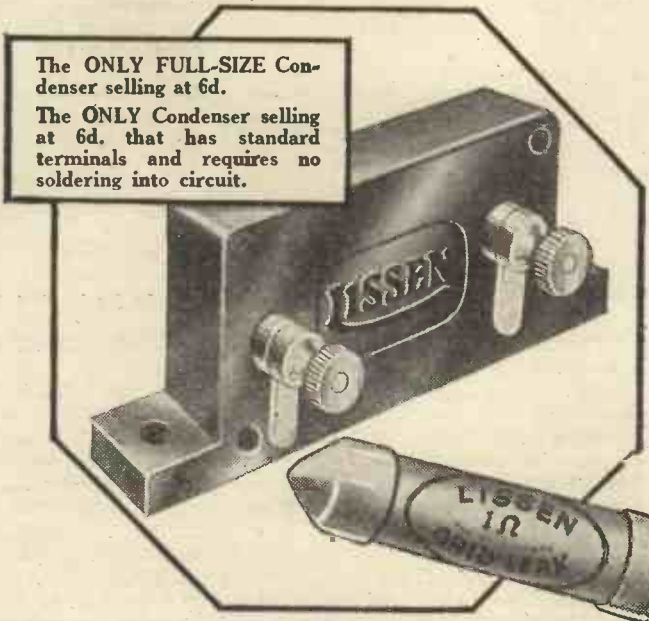

The ONLY FULL-SIZE Condenser selling at 6d.
The ONLY Condenser selling at 6d. that has standard terminals and requires no soldering into circuit.

LISSEN

FIXED CONDENSERS AND GRID LEAKS

EXACTLY THE SAME LISSEN CONDENSERS AND GRID LEAKS FOR WHICH YOU WERE PREVIOUSLY PAYING 1/-

REDUCED TO **6^D**

LISSEN LIMITED, WORPLE ROAD, ISLEWORTH, MIDDLESEX

Mention of "Amateur Wireless" to Advertisers will Ensure Prompt Attention

REGIONAL RECEPTION

Regional reception demands a special type of set if maximum pleasure is to be derived. Constructional details were

FOR modern local-station reception in this country a well-designed set, such as the "Ideal Regional Two-valve," is absolutely essential. Yet, in spite of the need for such attributes as a high degree of selectivity and an ability to give good-quality reproduction, the local-station set must be easy to build and simple enough to be operated by non-technical members of the family.

These guiding rules of set design were before the Technical Staff when the "Ideal Regional Two" was designed. The result, as can be seen from an examination of the circuit diagram and the illustrations, is an outstanding product possessing many points of interest.

Selectivity Needed

Probably the main need in a local-station set of to-day is a high degree of selectivity. Not only is this essential for the separation of two approximately equal-strength signals, but for the reception of the locals clear of interference from powerful adjacent foreigners.

Band-passing, as incorporated in this two-valve set, is undoubtedly one of the best ways of making a simple set really selective. This method, which consists essentially of two tuned circuits coupled together in a scientific manner so that equal performance is obtained over all wavelengths, and without loss of quality, has been adopted in the "Ideal Regional Two" by making use of the new British General coil unit.

This covers both wave-bands with panel

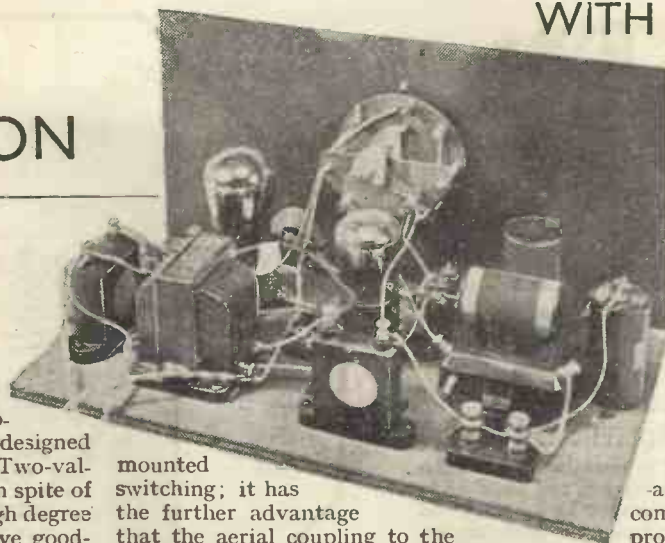

WITH THE "IDEAL REGIONAL 2"

given last week of a fine two-valver for this purpose, and these operating notes are of great assistance.

to 10 miles of 50-kilowatt stations, such as Brookmans Park, Moorside Edge and Westerglen, the shorter aerial may be necessary to obtain complete separation of the alternative programmes.

The operation of the "Ideal Regional Two" could hardly be made simpler. In spite of the fact that a very selective band-pass aerial tuning system is incorporated the tuning is virtually a one-knob procedure.

Easy Control

The Lissen two-gang condenser, with its two concentric control knobs, will be found ideal in action, providing as it does the advantage of simultaneous variation in the two tuning circuits with the invaluable advantage that either of the circuits can

mounted switching; it has the further advantage that the aerial coupling to the coil is maintained by an ingenious method of aperiodic coil switching. In effect this means that the selectivity, as governed by aerial coupling, is just as good on medium and long waves, so that the ultimate performance of which a two-valve combination is capable is obtained.

Pentode Output

As might be expected, the two valves in this set are arranged in the order of detector with reaction and power output. The two valves are of course transformer coupled, and the output valve, as a further aid to maximum amplification, is a low-consumption pentode.

The Mullard PM22A pentode has enough undistorted output to meet average domestic needs when a sensitive loud-speaker is used. It has the very great advantage that the anode-current consumption is only 4 or 5 milliamperes. With the HL type of detector valve recommended the total anode current is well within the capabilities of a standard type of high-tension battery.

Before discussing the operating aspects of this set a word or two on the aerial and earth may be of assistance. We suggest

that with this set, having a large degree of inherent selectivity, an aerial of not less than 70 feet should be used in order to get the maximum sensitivity. If a shorter aerial is used the results will still be satisfactory, but the range, particularly on the long waves, will not be as great as possible.

The only condition under which a really short aerial may be advisable with this set is when it is worked within the "blanketing" area of the regionals. Within say 6

be separately adjusted to get the last ounce out of a weak station.

Reaction should be used sparingly on nearby stations, though for the more distant ones it will of course have to be pushed to the limit in order to get sufficient signal build-up to work the loud-speaker.

Apart from the tuning and reaction, the controls on the "Ideal Regional Two" consist of the battery on-off switch, which is integral with the tuning dial, and the wave-change switch connected to the band pass tuning coil. The set is switched off when the lever under the tuning dial is moved to the left—the position being clearly marked "off"—and the set is switched on in either of the other two positions of this lever, which could also be used for medium and long wave-changing.

For good loud-speaker reception within fifty miles of a regional centre of broadcasting this set, as its name is intended to indicate, is absolutely ideal. Its well-designed circuit also lends itself to more distant reception when conditions are favourable.

COMPONENTS REQUIRED FOR "THE IDEAL REGIONAL 2"

Ebonite panel, 14 by 7 in. (Lissen, Peto-Scott, Becol).

Baseboard, 14 by 8 in. (Peto-Scott, Camco, Pickett).

Dual condenser control unit (Lissen).

.0005-mfd. reaction condenser (Lissen, Lotus, Telsen, Dubilier, Burton).

Band-pass aerial coil, with reaction (British General).

.01-mfd. fixed condenser (Dubilier, type 3200).

.0002-mfd. fixed condenser (T.C.C., type S.B.; Lissen, Goltons, Dubilier, Telsen, Ormond).

One .005-mfd., one .0002-mfd. fixed condensers (T.C.C., type "S"; Lissen, Dubilier, Telsen, Goltons, Igranic, Ormond, Formo).

One 4-pin, one 5-pin valve holders (W.B., Lissen, Benjamin, Telsen, Igranic, Goltons).

One 1-mfd., one 2-mfd. fixed condensers (Lissen, Dubilier, Telsen, T.C.C., Ferranti, Wego).

High-frequency choke (Lissen disc, Telsen, Dubilier, Igranic, Lewcos, Goltons, British General, Ready Radio).

Low-frequency transformer (Telsen Radiogrand, Lissen, Lewcos, Igranic, Bulgin, British General, Ferranti).

One 5,000-ohm, one 10,000-ohm spag-ketti resistances (Lissen, Lewcos, Telsen, Bulgin, Varley, Goltons, Graham-Farish).

One 3-megohm grid leak (Lissen, Dubilier, Telsen, Goltons, Sovereign).

Four yards thin flex (Lewcoflex).

Two space terminals, marked L.T.—, L.T.+ (Belling-Lee, Clix, Ealex).

Four wander plugs, marked H.T.—, H.T.+ , G.B.—, G.B.+ (Belling-Lee, Clix, Ealex).

Connecting wire and sleeving (Lewcos).

ACCESSORIES

Accumulator (Lissen, Drydex, C.A.V., Pertrix).

H.T. 120-volt battery (Lissen, Drydex, C.A.V., Pertrix).

9-volt grid-bias battery (Lissen, Drydex, C.A.V., Pertrix).

Loud-speaker (Motor "York," R. and A., Lanchester, W.B., Igranic).

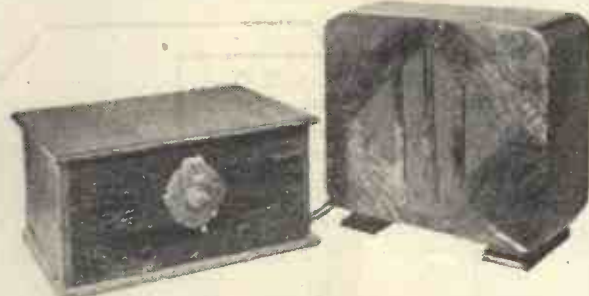

The "Ideal Regional 2" all ready for its first tests.

The **ONLY** Metallised S.G. High-Mu Detector and Economy Power Pentode SET you **CAN** build for yourself!



INCLUDING WALNUT CABINET & SPEAKER

£6.5

POST COUPON BELOW FOR YOUR COPY - OR ASK YOUR DEALER

KIT ONLY INCLUDING METALLISED S.G. VALVE · HIGH · MU DETECTOR & ECONOMY POWER PENTODE

89¹/₆

FROM GREAT LISSEN

FREE CHART



Lissen have published a 1/- Constructional Chart, giving the most detailed instructions ever printed for the building of a wireless set. Every part, every wire, every terminal is identified by photographs. This new LISSEN SKYSCRAPER KIT SET is the only one on the market that you can build yourself employing a Metallised Screen-grid High-mu Detector and Economy Power Pentode Valve. Around these three valves Lissen have designed and produced a home constructor's kit the equal of which there has never been before. It is the only battery set delivering such power—yet the H.T. current consumption is far less than that of the average commercially designed 3-valve set.

You buy the Lissen Skyscraper Kit complete with valves—a Lissen Metallised S.G., a High-mu Detector, and a Lissen Economy Power Pentode Valve—and the price is only 89/6. Or you can buy the Lissen Walnut Console Skyscraper Cabinet and Loud-speaker combined as illustrated. It holds all batteries, and accumulator and loud-speaker as well. It makes everything self-contained. A special Lissen Pentode Matched Balanced-armature Loud-speaker of great power is supplied with the cabinet and the price of the Skyscraper Kit complete with valves and this cabinet and loud-speaker is only £3 5s.



LISSEN SKYSCRAPER 3 KIT

POST THIS COUPON

Please send me FREE copy of your 1/- Skyscraper Chart.

Name

Address

.....

.....

A.W.1

LISSEN LTD., Dept. A.W.1., WORPLE ROAD ISLEWORTH, Middlesex.

To Ensure Speedy Delivery, Mention "A.W." to Advertisers

SETS OF DISTINCTION

LOTUS BAND-PASS THREE

for A.C. MAINS

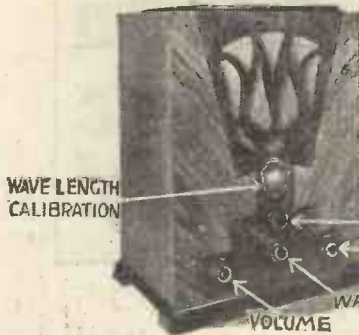

Makers: Lotus Radio, Ltd. Price: 16 gns.

IN the Lotus three-valver illustrated on this page we have an excellent example of a powerful and selective combination of three valves working from the A.C. mains. It is this type of set that provides us with the real reason for the man in the street's preference for the straight three as against all other types.

Flexible Control

There is, in this Lotus model, a flexibility of control that will delight the expert knob twiddler, yet withall a simplicity of operation that enables many home and foreign stations to be tuned in without any control *finesse*. The simplicity and the flexibility are at one and the same time achieved by the inclusion of just the right number of controls. There is nothing superfluous or muddling in the control, yet there is everything needed to get the ultimate ounce of performance from the three valves.

As might be expected, the inevitable sequence of the three valves is screen-grid, detector, and pentode. With this simple sequence of valves the designer has fashioned a circuit that, in practice, provides as much in the way of "hot" performance as I have yet encountered.

Let us look into the circuit. The screen-grid is a variable-mu type, which means that its sensitivity is well under control, which, in turn, means that no matter what the volume level may be the quality is

maintained at par—there is no high-note skimping when the volume is cut down. Further, this variable-mu valve avoids cross modulation and other interference troubles. Preceding the variable-mu, which is a Mazda A.C.SC/VM, is a capacity-coupled bandpass input-tuning circuit. There is no need to emphasise the value of this circuit, which provides good-quality selectivity in a way that cannot be obtained any other simple way. The aerial is loosely coupled to the bandpass through a condenser in series with an aperiodic winding. While on the screen-grid stage I must

mention that the variable cathode bias for the valve, needed to provide the control of volume, is obtained from a portion of a potentiometer across the high-tension supply. The "pot" resistance is in series with two fixed resistances providing the fixed screen-grid volts, and in series with the "pot" slider and the cathode is a limiting resistance of 300 ohms. I mention this just to show the care and ingenuity taken over the whole circuit.

Circuit Details

Another very good point is the method of connecting the variable condenser in the tuned-anode circuit for the screen-grid stage coupling to the detector. The moving plates of the inter-valve condenser, which is part of the three-gang condenser, are at earth potential. This is made possible by the series connection of a 1-microfarad fixed condenser, which has no effect on the tuning, but effectively prevents the high potential on the anode from being shorted to earth. Reaction is applied to the anode coil by the differential system.

The detector is coupled to the pentode by the usual transformer method. Bias for all three valves is by means of cathode resistances, which provide grid-bias at the expense of anode volts. The anode supply comes through a Westinghouse metal rectifier, ample smoothing being provided by using the loud-speaker field as the smoothing choke and by using an electrolytic condenser at the output.

This circuit, which I have space only briefly to describe, has been interpreted in the modern way. There is a metal chassis with canned coils, a three-gang condenser, metalised screen-grid and detector valves, a mains-energised Magnavox moving-coil loud-speaker —

volume control, and on the right reaction. When bringing the set into action for test, I was careful to adjust the little trimmer knob at the back of the set, as per instructions, so that the aerial loading was made just right.

This initial adjustment is highly important, and is made at about the 300-metre mark. Once made, this trimmer adjustment can be entirely forgotten, though its benefits will be realised whenever the set is operated. I found the set distinctly lively after I had set the trimmer and on

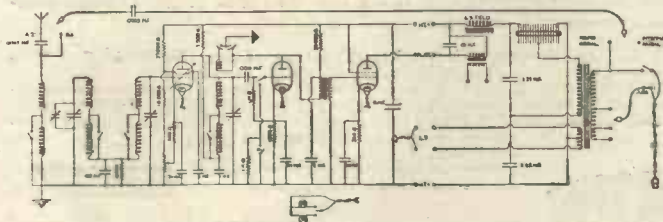

The circuit of the Lotus Band-pass Three

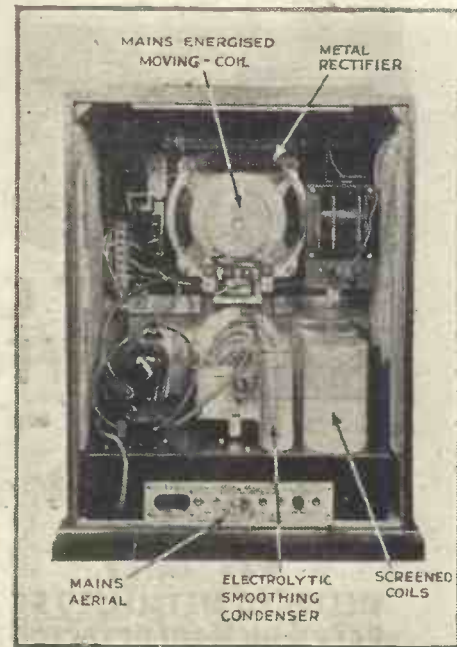

The salient features of the Lotus Band-pass Three are clearly shown by this lettered photograph

the single tuning control I immediately brought in Brussels No. 1 at full loud-speaker strength, with hardly any reaction.

A very good point about the tuning scale, which is calibrated in medium and long wavelengths, is that only the appropriate calibrations are illuminated. When tuning in medium waves the scale is illuminated by a bulb mounted behind the medium-wave calibrations, and when the long waves are being tuned the medium-wave bulb is dead, while another bulb behind the long-wave calibrations comes into action.

In addition to Brussels No. 1 in daylight I was able to bring in Huizen, Poste Parisien, Fécamp, Langenberg, and North Regional. These came in at such strength during daylight that I was tempted to

(Continued on page 516)

all housed within a pleasing-looking cabinet. The external connections are made to a strip at the back of the chassis. In addition to the usual aerial and earth sockets there are alternative connections for internal and mains aeriels. Each has its uses. There are sockets for a pick-up and at the back of the loud-speaker you can connect an external loud-speaker, provided it is of the high-resistance moving-iron type.

Controls are brought out to suitable positions on the front of the cabinet. There are four knobs, one at the centre for tuning, below it a wave-change and mains-switch knob combined, on the left the

maintained at par—there is no high-note skimping when the volume is cut down. Further, this variable-mu valve avoids cross modulation and other interference troubles.

While on the screen-grid stage I must mention that the variable cathode bias for the valve, needed to provide the control of volume, is obtained from a portion of a potentiometer across the high-tension supply. The "pot" resistance is in series with two fixed resistances providing the fixed screen-grid volts, and in series with the "pot" slider and the cathode is a limiting resistance of 300 ohms. I mention this just to show the care and ingenuity taken over the whole circuit.

An Inter-Valve Tone Control

Here is a component which opens up new possibilities of quality reproduction—the Lissen Inter-valve Tone Control. Hitherto the best you could do in the control of tone was to attempt to correct in the output stage those faults of quality inherent in the receiver itself. Now the Lissen Inter-valve Tone Control gives you **SCIENTIFIC CONTROL OF TONE IN THE HEART OF THE RECEIVER.** By rotation of the special potentiometer (which is fitted to the front panel of the receiver) you get real variable control, so that for any particular item you can bring out deep bass or obtain brilliant high-note-response just as your ear demands.

A wonderful tone control for radio gramophone work, entirely eliminates needle scratch without sacrifice of quality. Specially designed to fit under the base of the Lissen Hypernik Transformer—can also be fitted in a few moments into any transformer-coupled receiver

LISSEN

INTER-VALVE TONE CONTROL

PRICE COMPLETE WITH
SPECIAL POTENTIOMETER **10/6**

LISSEN

HYPERNIK L.F. TRANSFORMER

If you want absolute truth of tone, use the Lissen Hypernik Transformer, as all the foremost set designers are doing. You cannot get such a good response curve—such fine quality reproduction—from any other transformer at anything like this price.

With a primary inductance of fully 100 henries, the Lissen Hypernik Transformer yet operates perfectly when passing currents up to 5 m/A or more. Its step ratio is 4 to 1 and a stage amplification of more than 100 is obtained. PRICE **12/6**

LISSEN LTD., WORPLE ROAD, ISLEWORTH, MIDDLESEX

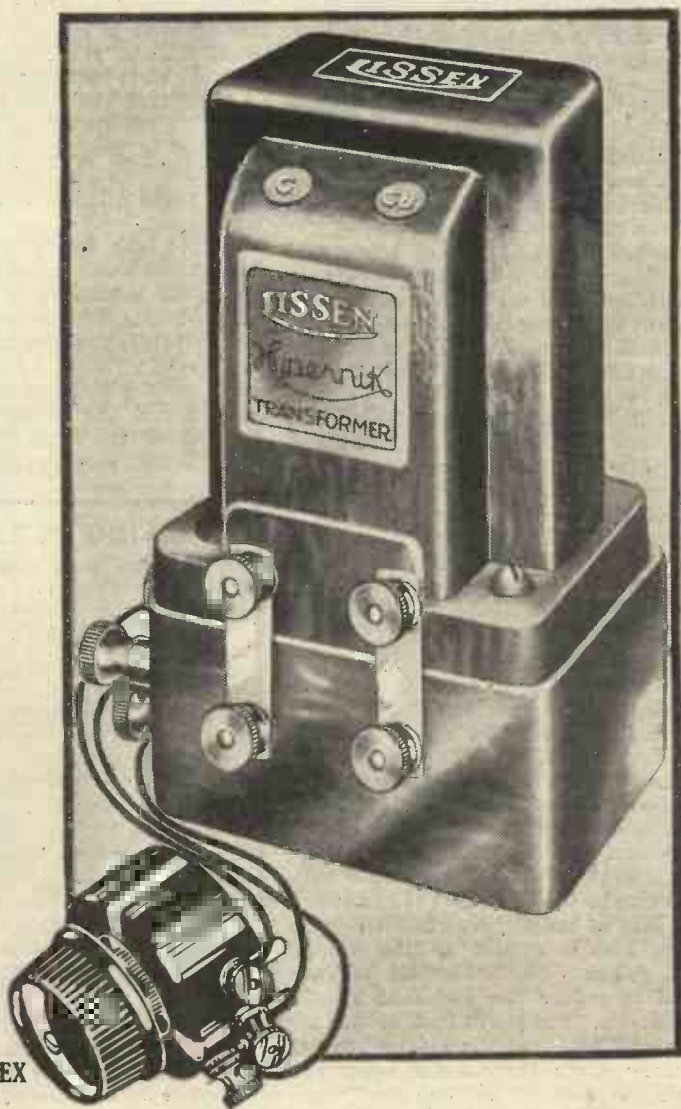

IN MY WIRELESS DEN

WEEKLY HINTS —

CONSTRUCTIONAL



& THEORETICAL

BY W. JAMES

NEW VALVES AND OLD

THERE is nothing quite so disappointing as to fit a valve just purchased and to find that the results are no better than when the old valve is used.

This happens usually because of a fault in the set or else the new valve is of the wrong type. You might think that a new detector valve will improve the volume of the weaker stations, for example, and find that no noticeable improvement is obtained.

If the new valve has exactly the same characteristics as the old one the results are bound to be equivalent. Usually, however, the amplification factor of the new valve is different from that of the old, and the impedances are not the same.

Thus there is a chance that the sensitivity, quality, and anode current will be different. The new valve may well not handle the signals from the local station so comfortably as the old, and so on. It is, therefore, rather dangerous to purchase a new valve having characteristics very different from the old. This applies as well to all stages.

There are several types of screen-grid valves, and while the set may work very well with one type the results when using a different type may be poor.

With power valves there is the question of anode current, and the type of loud-speaker. If is, of course, possible to overload the high-tension supply, whether this is a battery or mains unit, and the result is always loss in output.

The various factors concerned must, therefore, be considered before a change is made, or the results may be worse than before the new valves were obtained.

A GRID CONDENSER DETAIL

THE fixed condenser in the grid circuit of a detector valve may have a value of from .0003 to .0001 microfarad.

The value of .0003 microfarad was nearly always used a few years ago and is still used in some sets. A value of .0002 is found in a proportion of sets, and some use a .0001. Now if you tried your set with these different values the chief point noted would be the change in quality. The high notes would increase in strength as the value of the condenser is decreased.

This fact is usually remembered when there is high-note loss in the tuning circuits. The detector circuit is then designed to reduce the high-note loss so far as possible. You might find, in the case of your own set, that the results are not satisfactory when the smaller condenser is fitted, but this will be true only when the set now gives plenty of top.

There may be an effect upon the reaction when the grid condensers are changed, but usually the effect is negligible. Hum may be altered when the set is of the mains type. Usually the hum is reduced by fitting the larger condenser.

The changes produced are not large unless the set is of the good-quality type. With some loudspeakers the quality will be poor in any case, but when the quality is good, changes in the value of the grid condenser will produce considerable differences in the results.

"SHORT" AERIAL TO EARTH

IF you short-circuit the aerial and earth terminals of a set and listen, the noises should be the minimum. A quiet background is essential for good results from distant stations or the noise will prevent clear reception.

Low noise can arise from many causes. Some valves are noisier than others. The detector is frequently the most difficult to make quiet. Then, again, there are some parts which if not sound will introduce noise.

A grid leak, for example, may be noisy because its value is not constant. A leaky condenser is also likely to produce noise. Bad contacts, such as poor joints and badly fitting valves are also troublesome. Much can be discovered by testing by stages. First try the power stage alone.

Then add the detector, and so on. If tests show that a stage is noisy it should be examined very carefully. There may be

no well defined fault, but rather a series of little faults.

Dust may be the cause of the trouble. Therefore keep the parts clean. Dampness is also responsible for many difficulties. Leakage paths may alter the characteristic of a set completely, quite apart from the noise introduced.

Some sets will bring in a much greater background of noise than others. Those fitted with a pentode, and not having a filter to reduce the strength of the higher notes are troublesome in this way. The remedy is to add the filter and to weaken the top notes. This will cut down the rush and noise and make reception more pleasant if less accurate.

"THE LOTUS BAND-PASS THREE"

(Continued from page 514)

try out the mains aerial. Even with this admittedly poor pick-up I got Brussels at good strength by advancing the reaction.

The sensitivity is just as good on the long-wave band. This was proved by the truly exceptional strength of Hilversum, while Radio Paris needed a toning down on the volume control. The sensitivity is, I think, above the average.

Fortunately, this good feature of the performance is not, as might be expected, obtained at the expense of the selectivity. I found the tuning had true bandpass characteristics, the locals and other powerful stations spreading for an appreciable amount and then falling away sharply on each side of the spread limits. Midland Regional was clear of London Regional, with a silent space in between. On long waves Zeesen was almost clear of Daventry.

An example of the usefulness of the internal aerial—a short length of insulated wire on the inside of the cabinet—was afforded later, when crackles were rather unbearable on the outdoor aerial owing to approaching thunder. The internal connection gave full loud-speaker reproduction of the locals without the slightest trace of background. This connection would also be useful in the wipe-out area of a regional.

The quality of the reproduction is well up to the generally high standard set by this year's models. Remember, it is a Magnavox moving-coil, and it is driven by an Osram MPT4 pentode power valve. This quality is unaffected by the setting of the volume control, which has a wide range of audibility, specially valuable in cutting down the local stations.

Very little mains hum could be detected during my tests of this set, and when actually listening to a programme, even a distant one, the hum is quite negligible.

SET TESTER.

SAVING IN TERMINALS

There are many little instances where you can save the use of a terminal strip by making connections direct to parts on the baseboard. The photograph shows a terminal which can quite well be used for the aerial connection. The condenser is in



series with the aerial and the variable condenser, part of which can just be seen, so the free terminal of the fixed condenser dispenses with the usual aerial-earth terminal block. The earth connection is made to the low-tension wiring.

Convert your set to the KENDALL-PRICE 3

The new high efficiency multi-purpose coil employed in this receiver, combined with its amazing performance and ease of operation, make it far superior to the ordinary type of Detector-2 L.F. Set.

Free Post coupon now and we will send you **FREE** a 36-page 1/- Book (the size of a normal issue of "Amateur Wireless"). It shows you how, at the cost of only a few shillings, you can bring your present set right up-to-date. It contains complete instructions, photographs and diagrams of ten modern circuits both battery and mains-operated. Post coupon now.

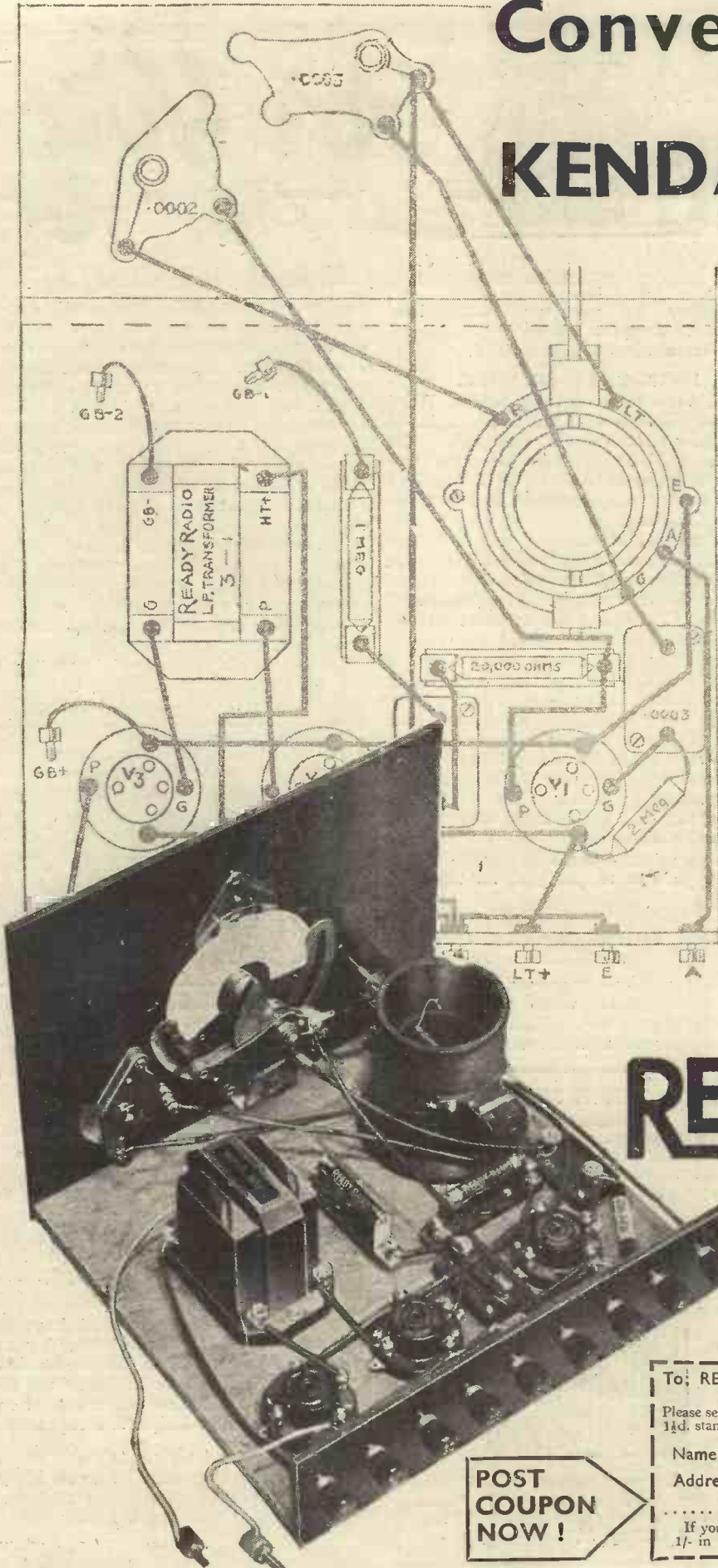

READY RADIO

ANOTHER GREAT OFFER

The sets described can be built from the diagrams in the Book but if you require full-sized dimensioned blue-prints of the ten circuits, enclose 1/- with your coupon.

To: READY RADIO, LTD. (Book Department), Eastnor House, Blackheath, S.E.3.

Please send me the 1/- Kendall-Price Book of Ten Circuits—FREE. I enclose a 1d. stamp for postage.

Name

Address

If you wish to have, with your free Book, ten full-sized blueprints, enclose 1/- in stamps with this coupon. A.W.3a

**POST
COUPON
NOW!**

Announcement of READY RADIO, LTD., Eastnor House, Blackheath, S.E.3

You will Help Yourself and Help Us by Mentioning "A.W." to Advertisers



A weekly review of new components and tests of apparatus conducted by J. H. Reyner, B.Sc., A.M.I.E.E.

THE OSRAM V.D.S.

THE well-known Osram range of D.C. valves taking 0.25 amps. at 16 volts on the heaters has recently been supplemented by a variable-mu screen-grid type known as the V.D.S. The heater characteristics are those just stated, while the anode and screen volts for optimum working are 200 and 80 respectively with .5 volt negative on the grid. The mutual conductance is 2.4 mA/v., this value tailing off to the standard value of .005 mA/v. at 40



Slektun low-frequency transformer

volts grid bias. Whether the full use is made of the maximum mutual conductance depends on the permanent grid bias resistance in series with the variable portion, but it will be clear that the valve is capable of giving all the amplification required in a normal H.F. stage, together with the ease of control which is usually associated with the variable-mu working.

SLEKTUN L.F. TRANSFORMER

THE Slektun L.F. transformer which we have tested this week is a neatly made component which can be obtained in four types having ratios varying from 2—1 to 5—1, the actual model tested being rated at 4—1. These transformers are housed in black moulded bakelite cases which are shaped to the winding and core. The necessary terminals are accommodated on the base which is formed as part of the casing.

The transformer was tested under actual working conditions, that is besides being preceded by the normal type of detector valve a complete output valve circuit was wired across the secondary.

The preceding valve was an HL210 type, the steady anode current being approximately 2 milliamps.

The primary inductance of the transformer with no direct current in the winding was 32 H., this figure falling to 20 H. with 6 mA. D.C. These figures are quite good and the transformer should be

satisfactory for use even with low-impedance detector valves.

The transformer retails at 8s. 6d.

IRON-BRAIDED WIRE

WE have received from Messrs. Ward and Goldstone, Ltd., two samples of their new iron-braided sleeveings. As readers will know, hum troubles are likely to occur in A.C. or D.C. receivers if the heater supply circuit is not made entirely fieldless.

One method of ensuring this is to use ordinary electric light twisted flex, but an alternative method is to use an earthed shield round the wiring. The "Goltone" iron-braided sleeving has been introduced to enable this to be carried out simply and easily. The tubing consists of a centre of insulated sleeving, this being covered with a tinned iron braiding, the tinning being employed to ensure that rust troubles do not occur.

This sleeving is worth considering when a mains-driven receiver is being built, being definitely better than the usual twisted flex and much more easy to use than lead-covered cable.

The retail price is 9d. per yard for the single type, and 1s. per yard for the twin type.

LISSEN TRIPLE-WAVE-CHANGE SWITCH

AN interesting component recently put on the market is the Lissen Triple-Wave-change Switch. This is designed primarily for use with the two coils which

this firm has recently introduced, but it has a variety of possible uses in other directions. There are three terminals, one in contact with the moving sector and the other two connected to contact springs. There are two contact springs to each terminal, and a flat metal sector slides in between the two. Since the springs are tipped with gold-silver, and as a continual rubbing action is obtained whenever the switch is operated, a good contact is certain.

The moving sector is located with a spring-loaded ball to occupy one of three definite positions depending on whether the sector is in contact with one or two of the contact springs or out of contact altogether.

As the switch is designed for fitting to the coils already mentioned, its size is rather larger than is necessitated by the



Lissen triple-wave-change switch

mechanism itself. It is actually $2\frac{1}{2}$ by $3\frac{1}{8}$ inches deep, and is designed for panel mounting so that in most circumstances it will fit snugly behind the panel and can be wired to the appropriate points in the circuit. It sells at 3s. 6d.

MAKING SPEAKER CONES

One of the secrets of getting good results with a home-made speaker cone is to make a good join which does not weaken the cone formation, for if there is a flabby



part on the cone surface, it will cause resonance. The cut should be made exactly to the centre of the cone and a firm join made with adhesive.

A London Regional vaudeville programme on September 13 will be given by Florence Desmond, Mario Lorenzi, Morton and Ridley, Carson Robison and His Pioneers, Gaby Vallé, Mr. and Mrs. Sargent ("developers of comedy"), and the B.B.C. Theatre Orchestra.

Organ music will be relayed from St. Nicholas Church, Bristol, on September 22, when the organist will be Rowland Shiles. An organ recital will be relayed from the Bristol Radio Exhibition on September 23. The organist will be Ralph T. Morgan.

Harold Gray, who gives talks on music in the Midland Regional Children's Hour, will be the pianist at a concert by the Midland Studio Orchestra on September 11. On this occasion the orchestra will be directed by Albert Moore.

The **TELSEN**

AJAX 3

BUILD THIS BRILLIANT CIRCUIT WITH THE AID OF THE FULL-SIZE 1/- BLUE-PRINT GIVEN FREE WITH THE NEW AND ENLARGED EDITION OF THE

TELSEN RADIOMAG



The Telsen "Ajax 3" represents one of the greatest circuit triumphs ever achieved by Telsen technicians. For here, at last, is a circuit which is as inexpensive to build and operate as only a "straight three" can be, yet which, owing to its brilliance of design, gives an all-round performance of hitherto unattainable excellence, with

a degree of range, power, and selectivity which definitely sets a new standard for receivers of its type. Full constructional details of this and several other brilliant circuits together with free full-size 1/- blueprints, are contained in the new, bigger, and better issue of the Telsen Radiomag—price 6d. You'll agree that it's the finest radio sixpenny-worth ever offered, for not only does it tell you how to build the latest types of receiver—not only is it crammed with valuable information from cover to cover—but it also contains full details of the improved and now all-embracing range of Telsen radio components at the revised prices now made possible by Telsen's enormous sale—the largest in the world! Get your copy of the Telsen Radiomag NOW—from your radio dealer or newsagent.

TOTAL COST OF
TELSEN MATCHED COMPONENTS

61'6

For building the Ajax 3, including panel, base-board, terminals, battery cords and all accessories.



"TELORNOR"

CONSTRUCTORS' OUTFIT

Contains all the sundry requirements for the construction of any type of receiver circuits using the Telornor. Of these the Telsen "Triple 3," the "Ajax 3," and the "Nimrod 2" are excellent as examples. All are supplied neatly packed in a carton with instructions.

Cat. No. 220

3/6

Included in the Outfit are the following components:

Specially cut and drilled crystalline finish panel. 14 in. by 10 in. Baseboard. Eight-way Battery Cord. Complete set of Wander Plugs suitably engraved, and Spade Terminals. Terminals for Aerial,

Earth and Loud-speaker. Engraved Terminal Strips. An ample supply of 22S.W.G. Tinned Copper Wire and necessary Sleeving for wiring up the set. A double-ended Spanner for mounting the single-

hole fixing components. A four-way Spanner for tightening up all terminal nuts. All the Wood Screws and sundry other small accessories contributing to the complete assembly of the finished Receiver.

TELSEN

RADIO COMPONENTS

Get your copy of the new **TELSEN RADIOMAG, Issue No. 3**

ANNOUNCEMENT OF THE TELSEN ELECTRIC CO., LTD. ASTON, BIRMINGHAM.

To Ensure Speedy Delivery, Mention "A.W." to Advertisers

A COMPARISON OF PROGRAMMES— OURS AND THEIRS

By WHITAKER-WILSON

CASUALLY glancing through the foreign programmes the other day I came to the conclusion that we in England are better off than most other countries. After a careful examination of a week's radio activity all over the world I came to the conclusion that we are better off than the rest of Europe.

Of course it all depends upon your point of view. If you judge a broadcasting concern by its vaudeville your opinions are likely to clash with those of your next-door neighbour who judges entirely by serious music, or with the fellow on the other side of you who pays his licence mainly to hear talks and news bulletins.

Linguistic Difficulties

So far as vaudeville and humour is concerned, most of us have to discount foreigners altogether. I myself, for instance, have long given up listening to vaudeville in Polish. The same may be said of talks. I have had to miss two from Vienna this week—one of "Aboriginals at Home" and the other on "Poisonous Fungi"—on account of linguistic difficulties.

Except when the B.B.C. makes an occasional blunder by bad alternating, such as opposing Sir Henry Wood and the Prom. orchestra with Adrian Boult and Section C—which, fortunately, it does

not often do—as far as I can see the English programmes are much more distinctive in type, and certainly calculated to please a greater number of listeners.

The B.B.C. programmes have always been censured. Thousands of grumbles are received each year, but there is no getting away from the fact that a regional scheme such as ours does *in the main* provide entertainment for most shades of opinion.

Foreign Dance Music

The preponderance of light music and of dance programmes abroad is most noticeable. No doubt such broadcasting represents the outlook on life of foreign nations, who do not take their pleasures sadly as the Englishman is supposed to do. Even the bigger orchestral concerts, if you look into what they actually play and sing at such concerts, are less serious in intent than ours.

That is just the difference between giving a public what it is *supposed* to want and giving it what it *ought* to want. By saying that I do not mean to suggest that the B.B.C. has been perfect in all it has done.

Nevertheless, I must say one thing for the British Broadcasting Corporation on the question of giving people what they ought to want rather than what they are credited

with wanting: there is a definite attempt here to educate the public.

There are a good many people, we know, who do not want to be educated up to anything. Unfortunately they exist in quite large numbers. They object to anything they can describe as highbrow. The B.B.C. has never taken the view that such people are hopeless. On the contrary it has been the policy of Broadcasting House to turn away the wrath of these people with a soft answer. Yet the B.B.C. has always gone on, determined that serious music shall be broadcast if only as a distinction from light music.

Cafe-type Music

My impression of the general run of foreign programmes is that a great deal of it is really café-music. I mean music which, by its nature, mingles with your conversation at meal-times. I never go to a restaurant which possesses a band, personally, but I can quite understand the attitude of those who do. On the other hand, I am bound to state with considerable conviction that it is definitely bad for anyone (in the psychological sense) to make a habit of listening to music by wireless in the same manner as one listens to it in a café. There are people who

(Continued on page 522)

THEY COMPLETELY CAPTURED
"Rad'olympia"

The new



"MANSFIELD"

PERMANENT MAGNET
Moving-Coil Speakers

Write NOW for the art booklet, "Speaking of Speakers," giving full information on all the new W.B. moving-coil speakers. They caused intense interest at Olympia. W.B. are and always have been Pioneers and Leaders in this field. Makers also of the famous valve holders, switches, and the new Mansfield Kit—the only kit with a moving-coil speaker—ask for all the latest lists.



"Mansfield Senior"
(The Improved P.M.4.)

42/- COMPLETE with 3-ratio transformer



Fits any of the W.B. Cabinets.

"Mansfield Junior"
(P.M.5.)

27/6 COMPLETE with 3-ratio transformer



*distortionless
amplification
for 11/6*

The Benjamin Transfeeda in one neat and attractive component gives you all the advantages of purity and volume of reproduction which previously could only be had at a prohibitive cost. Chief designers and Radio engineers have recognised the advantages of this new principle and are specifying the Benjamin Transfeeda in all their kits and sets. Follow their wise choice and specify the **BENJAMIN TRANSFEEDA** for your set.

TRANSFEEDA

THE BENJAMIN ELECTRIC LTD., Tariff Road, Tottenham, N.17

The famous

BRITISH GENERAL TUNING UNIT

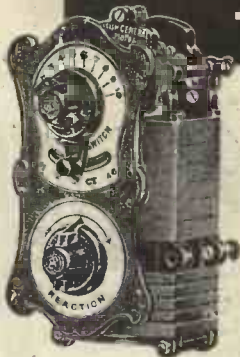

*now reduced
to 10/6*

Write for Full List of B.G. GUARANTEED COMPONENTS POST FREE.

By reason of increased demand and enlarged production we are able this season to offer our well-known Tuning Unit at 10/6 instead of 14/6 as before. This Unit effectively replaces plug-in coils and covers the entire wave-band, from 200-2,000 metres. Easy fixing; simple tuning. Full instructions supplied with every model.

From all dealers or direct from the manufacturers—

BRITISH GENERAL MANUFACTURING CO., LTD.
Brockley Works, London, S.E.4

MODERN RECEIVER DESIGN DEMANDS WEGO SMOOTHING CONDENSERS

Wego condensers are essential to the efficient functioning of modern radio receivers because of their low power factor, their high dielectric strength, their ability to withstand their rated voltages for an unlimited period of continuous running and their small dimensions.

These are the reasons why more and more important manufacturers are turning to Wego . . . why constructors insist upon them. And they only have to buy 'Wego' ONCE!

WRITE FOR FULLY DESCRIPTIVE LEAFLET

WEGO CONDENSER Co., Ltd.
Spencer House, South Place,
E.C.2. Phone: National 4500



Mention of "Amateur Wireless" to Advertisers will Ensure Prompt Attention

**'A COMPARISON of PROGRAMMES
—OURS AND THEIRS'**

(Continued from page 520)

play bridge with a loud-speaker turned full on. I know of one family which regularly plays on Sunday evenings through a broadcast service, a symphony concert, and the Epilogue. These are the sort of people who are no good to the B.B.C. and whose opinions on music are not worth consideration.

The point of this is that the foreign stations mostly cater for these sort of people by broadcasting music that really does not require listening to at all. I have no remarks to make about the *quality of performance* abroad compared with that in England; I am going entirely by the programmes.

Foreign Opera

The best part of foreign transmissions undoubtedly comes under the heading of opera. We in this country do not regard opera in the same way as, for example, they do in Vienna. There it is part of municipal life. Here it is not. Neither is wireless likely to make it so, here or abroad. On the other hand, they are so used to performing opera in foreign countries, and have such a distinctive manner of rendering it, that those who are really attracted to what is a great form of art cannot do better than listen to foreign opera. The relays we have had here from abroad have all been good.

Our own programmes certainly suit the English temperament far more than anything to be found on the continent. Our

programmes are far from perfect; probably they will be so for some time yet, but no intelligent listener can deny that there is obviously a serious and determined attempt to entertain and to educate at the same time.

We are still filling odd spaces with too much routine-work, such as quintets and sextets and gramophone records; there is still too much that "sounds like the wireless," if I may thus beg the question; but there is much that is really worth listening to. There is one thing, however, that the B.B.C. has denied us. *Accordion solos at midnight*. If you want accordion solos at midnight you must switch in Radio Normandie (Fécamp). They have them there.

WIRELESS MADE EASY!
See the Special Announcement on page 489 of an outstanding new feature next week.

Popular songs will be given by Clifford Atkinson and the Revue Chorus in a vaudeville programme for London Regional listeners on September 23. The programme, which will be relayed from the Northern Region, will be supported by the Wagstaff-Greenwood Dance Band.

The short religious services, conducted by the Rev. W. H. Elliott, and relayed from St. Michael's, Chester Square, which were broadcast on Thursday evenings until recently, will be resumed in the National programmes starting on October 6.

A CHANGE OVER

READERS will be interested to note that Ready Radio, Ltd., have sold their mail-order business to Direct Radio Ltd. The Ready Radio policy is now to distribute their goods direct through the usual trade channels. "A.W." readers can therefore still obtain any Readi-Rad parts from local dealers. It is the aim of Direct Radio, Ltd., to carry on all the traditions of Ready Radio, Ltd., and the mail order business is being dealt with at 159 Borough High Street, London, S.E.

Direct Radio, Ltd., will offer after-sales service in connection with all parts and a feature will be made of prompt delivery so that set-builders will not be delayed. Hire-purchase facilities are available, and the after-sales service will apply to parts purchased on the deferred-payment system as well as to those for cash. Kits of parts will be sold for all sets described in this journal, as well as the components of all leading manufacturers. Details of the Direct Radio, Ltd., service can be obtained free on mention of "A.W."

Lance Sieveking has written a new musical comedy called *Money for Nothing*, which will be heard by London Regional listeners on September 19.

The talks on "New Problems in Northern Industry," which have been given each month recently by prominent northern speakers, have proved of great interest to listeners. On September 13 Mr. Leslie Runciman, son of the President of the Board of Trade, will broadcast from Newcastle a talk on "New Ships for Old."

GOLTONE COMPONENTS

AGAIN RECOMMENDED

**"IDEAL REGIONAL 2" &
YOUR "HOME RADIOGRAM"**

FOR THE



**"GOLTONE"
PUSH-PULL
SWITCH**
R26/744 7d. each



**"GOLTONE"
BINOCULAR H.F.
CHOKE**

R3/36 2/6 each



**"GOLTONE"—BRAIDED SINGLE
TINNED COPPER TUBING**
Exclusively Specified for YOUR
"HOME RADIOGRAM"
Air Spaced and low loss. No. R43/91.
Per yard lengths, 2m/m Bore .. 9d.
See Radio Catalogue FREE on request
for Full range of Screened Conductors.

**OTHER "GOLTONE" COMPONENTS
USED IN THE SETS DESCRIBED IN
THIS ISSUE—**

- 4 and 5 Socket Valve Holders.
- 1 and 2 mfd. fixed Condensers.
- High-frequency Choke.
- Low-frequency Transformers.
- Spaghetti Resistances.
- Terminal Blocks.
- Connecting Wire and Sleeving.
- .001, .0002, .008 fixed Condensers.
- 3 Point Push-pull Switches.
- Indicating Wander Plugs.

"GOLTONE" Components are obtainable from all first-class Radio Stores. Refuse Substitutes. If any difficulty write direct.

New edition of large Radio catalogue sent FREE on request



The TELSEN JUPITER S.G.3

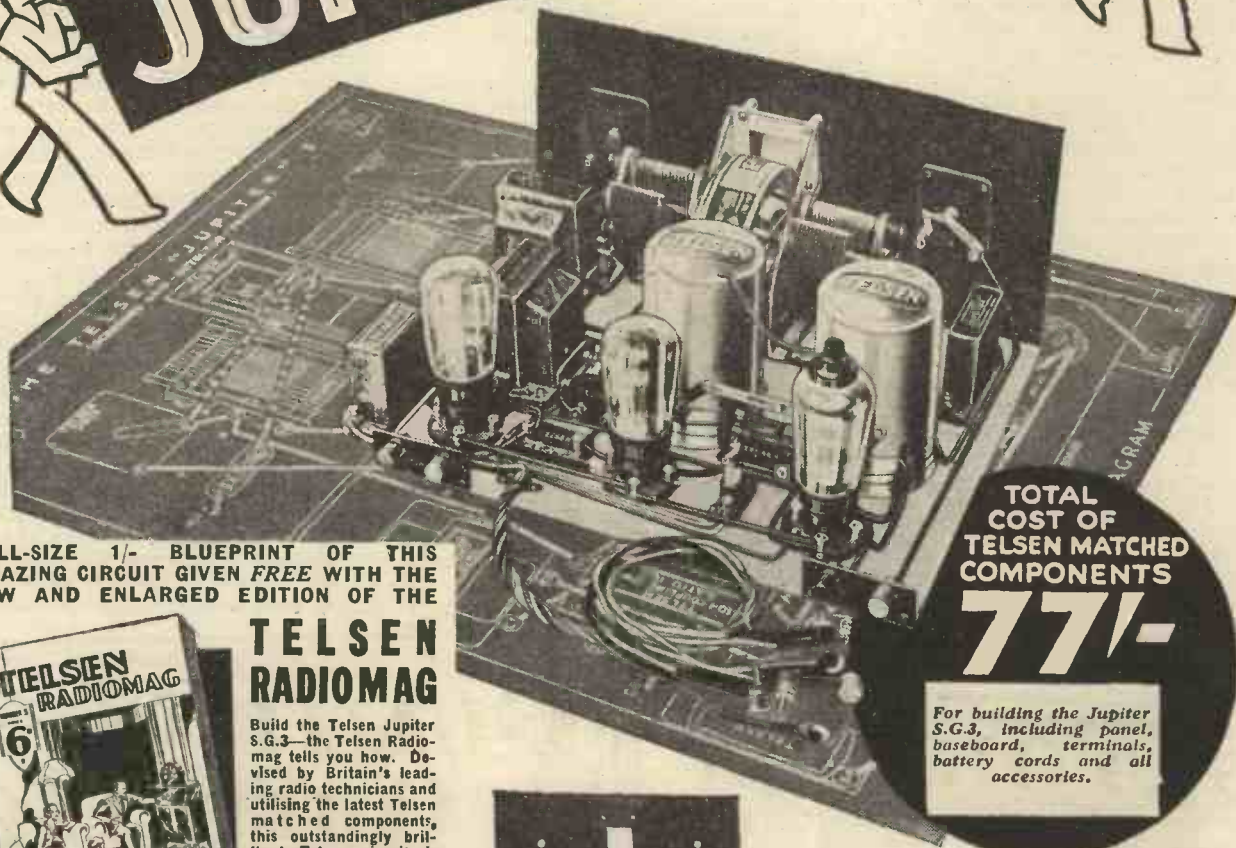

FULL-SIZE 1/- BLUEPRINT OF THIS AMAZING CIRCUIT GIVEN FREE WITH THE NEW AND ENLARGED EDITION OF THE

TELSEN RADIOMAG

Build the Telsen Jupiter S.G.3—the Telsen Radiomag tells you how. Devised by Britain's leading radio technicians and utilising the latest Telsen matched components, this outstandingly brilliant Telsen circuit is one which every keen home constructor will want to build. For it gives a performance immeasurably ahead of anything previously

achieved—not only in its extreme selectivity, its exceptionally wide range, and its tremendous amplification, but also in its really superb quality of reproduction. Complete constructional details, together with a full-size 1/- blueprint, are contained in the new Telsen Radiomag, issue No. 3. Packed with valuable information, this biggest and best issue also tells you all about the improved and now all-embracing range of Telsen radio components, at the revised prices only made possible by Telsen's enormous sale—the largest in the world. Get your copy now, price 6d., from your radio dealer or news-agent.

TELSEN

RADIO COMPONENTS

Get your copy of the new **TELSEN RADIOMAG, Issue No 3**

ANNOUNCEMENT OF THE TELSEN ELECTRIC CO. LTD ASTON BIRMINGHAM

TOTAL COST OF TELSEN MATCHED COMPONENTS

77/-

For building the Jupiter S.G.3, including panel, baseboard, terminals, battery cords and all accessories.



DRUM DRIVE CONSTRUCTORS' OUTFIT
This Outfit contains all the necessary requirements for the construction of the TELSEN "JUPITER S.G.3," but the constructor will find the Outfit of great value in the building up of any receiver circuit employing the drum-drive condenser assembly.

No. 219
3/6

THE OUTFIT CONTAINS THE FOLLOWING:

- | | | |
|--|---|--|
| 1 Metal panel with attractive crystal-line finish, specially cut and drilled for mounting the Telsen Drum Drive and other panel-mounted components normally required in a ganged condenser receiver. | 7 Wander plugs mounted in holder. | 1 Volume ditto. |
| 1 Baseboard, 14 in. by 10 in. | 2 Spade tags. | 1 "On-off" escutcheon. |
| 1 Aerial and earth terminal strip. | 1 8-way Battery cord. | 2 Height plinths for the matched screened coils. |
| 1 Loudspeaker terminal strip. | 1 Cord clip. | ½ in. of 3 m.m. sleeving (black). |
| 2 Red terminals complete and mounted in holder. | 2 Large insulating washers. | 1½ in. ditto (red). |
| 2 Black ditto. | 1 Small thick insulating bush. | 20 ft. of 1½ m.m. sleeving (green). |
| | 1 Small thin ditto. | 21 ft. of 22 S.W.G. tinned copper wire. |
| | 2 Spacing nuts for the reaction and aerial series condensers. | 1 Double-ended spanner for locknuts. |
| | 2 Spacing nuts for the "on-off" switch. | 1 Four-way spanner. |
| | 1 Wave-change Escutcheon with two screws and nuts. | Assortment of ½ in., ¾ in., 1 in., and 1½ in. wood screws. |
| | 1 Separator ditto. | |

You will Help Yourself and Help Us By Mentioning "A.W." to Advertisers

Some Notes on Present-

day Short-wave Conditions

Around the Short-wave Dial



By M. BARNETT

THE transatlantic stations in the 49-metre group are now beginning to make themselves heard again before midnight. They will no doubt increase in strength as the winter approaches and the light evenings shorten. When they are to be heard at all, these stations are generally more reliable than the lower-wave stations, fading not being so erratic as a rule, although admittedly there is generally considerably more trouble from atmospheric in this band than there is at, say, 25 metres. Nevertheless, these stations are quite useful and will very often give good signals when the lower-wave stations are not to be heard at all.

I have noticed that quite a number of amateurs appear to consider that there is nothing useful to be heard over the 32-metre mark, and indeed make no provision for tuning their short-wave receiver or adaptor up to these longer-wave stations. If you have never tried for these stations before, and have not got a wave-meter handy, and assuming that your receiver uses plug-in coils, select a

coil which will tune in the 30-metre group of stations (W2XAF, Zeesen, etc.), at the bottom of the dial.

If your tuning condenser is of the usual .00025 mfd. short-wave type, 50 metres

should now come in at about 120 degrees on the dial. Search around here any evening after nine o'clock and you are certain to hit on what is generally the most powerful of all the short-wave stations—RW59, at Moscow, U.S.S.R. This station operates on exactly 50 metres, so that this will provide you with a very good point for calibration. Immediately above him you will find HVJ, the Vatican City station on 50.26 metres. This station does not broadcast very frequently, however, and is only on the air for a short period every day. Now, providing you choose a night when conditions are reasonably good, you should find a number of American stations, and possibly one or two Canadians, just below the Moscow station. The later the hour, the better, as far as most of these stations are concerned and at the present time of the year, there is precious little to be heard of them before eleven o'clock (except, of course, the Moscow and Vatican City stations already mentioned).

The short-wave stations have, on the whole, been coming through very well

CUTTING DOWN HUM

Hum and interaction can be avoided by the strict observance of an old but useful tip; do not mount transformers with the

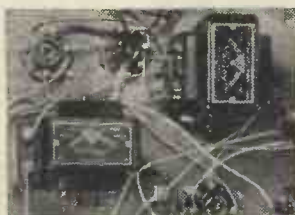

magnetic fields in line. Here are two transformers mounted with the cores (and therefore the magnetic fields) at right-angles.



Build your eliminator with a metal rectifier and ensure years of service without the annoyance of breakdown or falling-off in output. Prices from 12/6.

Full particulars, circuits and prices are given in the new and enlarged 1933 edition of "THE ALL-METAL WAY." Post the coupon now, with 3d. in stamps, and get a copy.

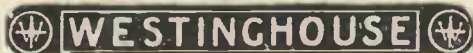

WESTINGHOUSE

METAL RECTIFIERS

THE WESTINGHOUSE BRAKE AND SAXBY SIGNAL CO., LTD.
82 York Road, King's Cross, London, N.1.

COUPON

Westinghouse Publicity, 82 York Road, King's Cross, London, N.1
Please send me a copy of your 44-page booklet "THE ALL-METAL WAY 1933" for which I enclose 3d. in stamps.

NAME.....

ADDRESS.....

A.W., 10/9/32.

QUALITY and QUANTITY

—the wonderful blend that makes

Player's Please



Save your Player packets for the Imperial Tobacco Company's POSTER COMPETITION. IN CASH PRIZES

£20,000

Ask your tobacconist for particulars

5 FOR 3^D
10 FOR 6^D
20 FOR 11½^D

during the last week or so. W2XAF, despite the fact that it is reported to use a beam aerial system directed towards South America, is quite a good signal now, although not so good as W1XAZ. CT/AA is also excellent on Friday nights. This station is very easily identified as the call is frequently announced, sometimes also in English. However, the call is quite easily distinguishable when given in the local tongue, the phonetic rendering of which is "say tay un ah ah." Good quality and very frequent announcing of the call sign mark this as a go-ahead station.

I see from the published lists of transmitters that there are now quite a number of ultra-short-wave transmitters in operation, or at least, licensed for operation, in the United States. The lowest of these is apparently W2XAB on 5.83 metres at New Brunswick. I wonder what is the lowest wave which has ever spanned the Atlantic, apart from amateur operators? The lowest commercial telephone is possibly WLO on 14.01 metres.

"WORKING YOUR HOME RADIO-GRAM"

(Continued from page 507)

no fear of the anode current tending to demagnetise the speaker movement.

Mains-users may care to use an electric turntable drive in place of the clockwork motor shown. In this event, it will be necessary to keep the two wires going to the motor well away from the rest of the set wiring.

Of the two high-tension leads of the set, the H.T. plus 2 is taken to the point of

Valves Required for your "Home Radio-gram"

Make	Screen-grid	Detector	L.F.	Power
Mullard	PM12	PM1HL	PM2DX	PM2A or 202
Marconi	S21	HL2	L210	LP2
Osram	S21	HL2	L210	LP2
Mazda	SG215	HL210	L210	P220
Cossor	215SG	210HL	210LF	720P
Six-Sixty	SS215SG	SS210HL	SS210LF	S 3220P
Lissen	SG215	HL2.0	L210	P220
Fotos	BC150	BC18	BC9	BD9
Dar'o	S9	Super HF	Universal	Super Power BW303
Eta	BY6	BY2020	BY1814	

maximum voltage on the battery and the H.T. plus 1 is taken to 70-90 volts. If a mains unit is used, the H.T. plus 1 wander plug should be put on the variable tapping, or that marked S.G.

The "Home Radio-Gram" when mounted in the "Popular" cabinet is not only an efficient receiver, but is a good-looking piece of furniture. London readers can see the "Home Radio-Gram" in the Radio Department windows of Messrs. Selfridge and Co., Ltd., W.1.

With the coming of autumn a new series of broadcast talks will begin. Two innovations are promised, which should attract wide interest. One is to be a series of relays from various European capitals by that popular broadcaster, Vernon Bartlett. Mr. Bartlett is shortly starting on a tour of Europe and his reports of current events are likely to enhance his reputation at the microphone. A second innovation will take the form of eye-witness accounts of special events of the day, to be broadcast during the news bulletins.



Why pay 5/- for 3/6 worth of H.T.?

you can save money with a Lively 'O' H.T. Accumulator BECAUSE:

IT ELIMINATES WASTE

When you discard a run down H.T. Dry Battery you are throwing away power. Due to self-discharge the voltage of a Dry Battery continuously falls. Nothing can stop it. Finally it is too weak to work your Set but there is still power left in it—power you cannot use—waste! The Lively 'O' H.T. Accumulator is waste-proof. Its famous "air-spaced" construction prevents self-discharge. It is full of life right up to the time when it needs recharging.

IT COSTS LITTLE TO RECHARGE

For only a few shillings—much less than the cost of a new H.T. Dry Battery—the Lively 'O' Accumulator can be recharged—made like new again—full of life and energy, ready to run your Set for another three or four months.

IT LASTS FOR YEARS

Provided it is charged every three or four months the Lively 'O' Accumulator will last for years. It is definitely the most economical H.T. supply you can use. Every Wireless Dealer sells it in convenient 10 volt units.

TWO TYPES:

Standard 10 volt unit capacity 2,750 milliamps. **5/6**

Extra large capacity 5,500 milliamps (10 volt unit). **6/9**

BRITISH MADE by Oldham & Son Ltd., Denton, Manchester. Est. 1865, and at London, Glasgow, Belfast and Dublin.

The

Lively 'O'

H.T. ACCUMULATOR

PUT THE LIVELY 'O' INTO YOUR RADIO

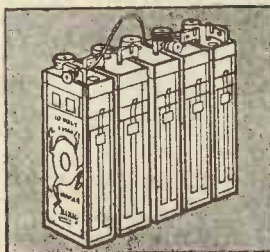

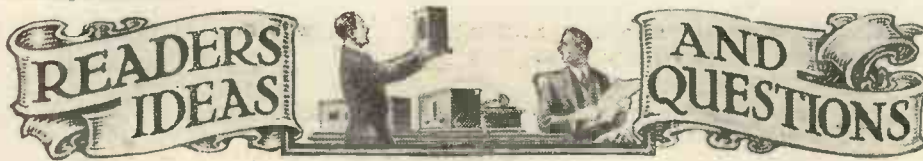

The "A.C. Century Super"

SIR,—I feel I must write you an appreciation of my set as built to Mr. James' specification, in the "A.C. Century Super." I am within three miles of North National and Regional, and can receive Prague and Langenberg free of any interference. I was astounded at the results of this set. I have had it since January and had never seen the inside of a wireless set until I bought the blueprints and necessary parts for this set, and found the assembling of it quite easy. I have just converted it into a radiogram. From Radio Normandy at 40 on dial round to Vienna at 170, I can get every station of 1 kilowatt and over clear and distinct, and the same on the long band. It is a pleasure to work and with a Blue Spot 100D the set is delightful, both in tone, volume and purity. This set is quite reasonable in price to build and, honestly speaking, I would not change it for any other set. I know the tendency of every amateur wireless fan is to brag a little about his set, but this set of mine is absolutely it! I am more than delighted at it, as it was to be my first and last venture in set making. Please thank Mr. James from me for a real good set—the only one that is any good for this district.

W.D. (Huddersfield).

Adding Variable H.T. Tapping

SIR,—I have a mains unit which does not allow my getting a sufficiently low voltage for applying to the anode of a bi-grid valve in my receiver. I have no knowledge of how to go about reducing the voltage to give me a current consumption of .1 milliampere for the valve in question, and would therefore welcome your assistance in the matter.

K. R. (Surrey).

The easiest way to overcome your difficulty is to add an arrangement to your mains unit whereby you can get a variable voltage supply for the point in question. This is best accomplished by connecting one end of a 20,000 ohms fixed resistance to the maximum positive output terminal of your mains unit and joining the other end of this resistance to one end terminal of a 50,000 ohms wire-wound potentiometer. The other end of this latter should then be taken to the negative output terminal of the mains unit. The centre terminal of the potentiometer is then connection for the variable output voltage tapping, and a 2-microfarad capacity fixed condenser should be wired between this point and the negative output terminal of the supply unit.—ED.

Gramophone Pick-up Wiring

SIR,—I am having trouble with my receiver, which I have recently adapted for gramophone work. The set is a pro-

prietary one with a console-type cabinet. To avoid having to take out the back of the cabinet each time I wish to use the set for gramophone work I have fitted a change-over switch to switch in the pick-up. My trouble is that when I use the pick-up there is a terrific noise set up which drowns the music from the record. Perhaps I have gone wrong in wiring up the switch so will explain my connections in an endeavour to assist you. The centre terminal of the switch is wired to the grid terminal of the detector-valve holder and one of the side terminals of the switch is connected to one of the pick-up terminals. The other pick-up terminal is joined to a point giving 1½ volts negative bias in the grid-bias battery. The other terminal of the switch is left dead. The switch itself is arranged on the back-board of the cabinet. Can you, from these details, advise me where I may have gone wrong?

F. M. (Eastbourne).

The wiring between your detector-valve holder and the gramophone switch is far too long for satisfactory working. Grid-circuit wires should never exceed about two inches or three inches at the most. If you will arrange the gramophone switch by the side of the detector valve-holder to keep the wiring short and then break the grid-condenser and leak circuit when wiring up the switch, you will overcome your trouble.—ED.

Curing Modulation Hum

SIR,—I experience a rather curious form of mains hum now that I have adapted my receiver to work from the lighting mains. The hum is very noticeable when I
(Continued on page 528).



EXPRESSLY WRITTEN FOR THE BEGINNER

"The How and Why of Radio," written by ALAN HUNTER, has been expressly compiled for beginners.

It provides a clear conception of the general theory and practices of wireless reception in simple, non-technical terms, and contains over ninety clearly-defined illustrations. It has been mainly compiled from that popular series of articles in AMATEUR WIRELESS:—"The How and Why of Radio."

Get this indispensable book NOW. Of all Newsagents and Booksellers, or 2/9 post free

from

"AMATEUR WIRELESS,"
58/61 Fetter Lane, London, E.C. 4



"ECLIPSE" ACTIVITIES

QUITE a host of American listeners have been busy taking records of the effect on wireless reception of the recent total eclipse of the sun. As the eclipse was not visible in this country, Professor Appleton, of King's College, hopes to utilise the American observations to verify his theory of the "double" Heaviside layer. He is of opinion that the upper layer is produced by the action of ultra-violet light, whilst the lower is caused by electronic emission from the sun. If this is so, the effect of the eclipse on the upper layer will be practically simultaneous with the cutting-off of the light, whereas, owing to the much lower speed of the electron stream (about 1,000 miles a second), there should be a "lag" in the effect on the lower layer. The higher layer reflects short waves of 80 metres or less, whilst the lower reflects the medium waves used for ordinary broadcasting. By a comparison of the relative behaviour of the two types of wave during the eclipse period, it is hoped to remove some of the mystery which still surrounds the constitution of the Heaviside layer. R.

The attempts to relay from Detroit running commentaries on the competition for the British International Trophy will be made on September 3, 5 and 6, and not on September 2, as previously announced. Kaye Don, in Miss England III, and Gar Wood, in Miss America X, are the competitors.

Episode 4 of "An Omnibus Romance" will be given by Mamie Soutter and Blake Adams in a National vaudeville programme on September 16. Others in the "bill" are the Three Ginx, Our Bill, Mario de Pietro, Rose Perfect, Haver and Lee, and the B.B.C. Theatre Orchestra.

The opening speeches on the occasion of the Worcester General Infirmary Gala Week are to be relayed in the Midland Regional programme from the Guildhall, Worcester, on September 22. Among the speakers will be the Mayor of Worcester—Councillor Diana Ogilvy—and Viscount Cobham, who is Lord Lieutenant of the County of Worcester.

An appeal on behalf of the Harborne Home and Dispensary for Animals is to be given by Miss Janet Joye, the well-known revue artiste, on September 18 in the Midland Regional programme.

In his gramophone recital for Midland Regional listeners on September 19, Robert Tredinnick has arranged a programme of miscellaneous pieces. Many of the new mid-month issues will be heard on this occasion, including one record of special interest to Midland listeners.

In a programme of "requests" to be given by the Midland Studio Orchestra on September 24, Geoffrey Dams is to be the soloist and David Branson will be heard in numbers at the piano.

The Sheffield soprano, Ida Bloor, will sing from Manchester on September 11.

Joseph Farrington and the King Cross Subscription Prize Band from Halifax will broadcast for North Regional listeners on September 11.

New Times Sales Co NEW 1933 RADIO

MANUFACTURERS' KITS

- RADIO FOR THE MILLION "STATION MASTER 3"** (Model B). With valves, cabinet and speaker as advertised. Cash price, £7/10/-. Balance in 11 monthly payments of 14/-. **10/-** order
- COSSOR MELODY MAKER MODEL 335.** Complete with valves, speaker and cabinet. Employs Cossor variable-mu S.G., H.F. stage, detector and power valves. Cash price, £7/17/6. Balance in 11 monthly payments of 14/10. **10/-** order
- OSRAM "THIRTY THREE" MUSIC MAGNET.** Complete kit, comprising all components including valves, cabinet with self-contained speaker. Screen-grid H.F., screen-grid detector and power output. Single-dial tuning, wavelength calibrated. Cash price £9/9/0. Balance in 11 monthly payments of 17/6. **15/-** order

ACCESSORIES

- GARRARD INDUCTION GRAMOPHONE MOTOR.** For A.C. mains. Model 202. Mounted on 12-inch nickel motor plate with fully automatic electric starting and stopping switch. Cash price £2/10/0. **4/7** order
- Balance in 11 monthly payments of 4/7. **3/10** order
- B.T.H. SENIOR PICK-UP** with arm and base. Cash price £2/2/-.
- Balance in 11 monthly payments of 3/10. **3/10** order

ULTRA 1933 TIGER RECEIVER. A.C. or D.C. Mains, S.G., S.G. Detector and Pentode, Moving-coil speaker. Complete with Mazda Valves, ready for use. Cash price, £15/15/0. Balance in 17 monthly pymts. of 20/-.

20/- only

FIRST WITH EASY TERMS in 1924 and Still leading BIGGEST STOCKS

Strictest Privacy Guaranteed

ON EASIEST OF EASY TERMS QUICKEST DELIVERY

- R. & A. "VICTOR" PERMANENT MAGNET MOVING-COIL SPEAKER DE LUXE** with 6-ratio input transformer and protecting grille. Cash or C.O.D., £3/10/-. **6/5** order
- Balance in 11 monthly payments of 6/5 **5/-** order
- R. & A. "BANTAM" PERMANENT-MAGNET MOVING-COIL SPEAKER** with 3-ratio input transformer. Cash price £1/7/6. **5/9** order
- Balance in 5 monthly payments of 5/- **5/9** order
- W.B. PERMANENT MAGNET MOVING-COIL SPEAKER.** Type P.M.4. With transformer. Cash price £2/2/-.
- Balance in 7 monthly payments of 5/9 **5/5** order
- BLUE SPOT SPEAKER UNIT AND CHASSIS, TYPE 100U.** Cash price £1/19/6. **5/6** order
- Balance in 7 monthly payments of 5/5 **5/6** order
- ATLAS ELIMINATOR, Type A.C.244.** Three tappings, S.G., detector and power. Output, 120 volts at 20 m/A. Cash price, £2/19/6. **5/6** order
- Balance in 11 monthly payments of 5/6 **5/-** order
- EPOCH "SUPER JUNIOR" Type MM.** Permanent Magnet Moving-Coil Speaker with 5-ratio transformer. Cash or C.O.D., £1/7/6. **5/-** only
- Balance in 5 monthly payments of 5/- **6/6** order
- EPOCH "20 C" PERMANENT MAGNET MOVING-COIL SPEAKER.** With 3-ratio input transformer. This speaker will handle up to 5 watts. Cash price, £1/15/-. **6/6** order
- Balance in 5 monthly payments of 6/6 **7/1** order
- EKCO H.T. UNIT.** Type A.C.25. For multi-valve sets requiring up to 25 m/a. 3 tappings, S.G., detector and 120/150 volts. For A.C. mains. Cash price, £3/17/6. **7/1** order
- Balance in 11 monthly payments of 7/1.

Any items advertised in this Journal sent C.O.D. if value over 10/- sent all C.O.D. charges paid.

To NEW TIMES SALES CO., 56, Ludgate Hill, London, E.C.4
 Please send me (a) 1933 Lists,
 (b)..... for which I enclose
 first payment of £.....s.....d.....
 Name.....
 Address.....
 A.W.10/9/32....

PROTECT YOUR VALVES

FROM ACCIDENTAL SHORT-CIRCUITING



BY FITTING THE "BUSCO" FUSE SWITCH

All "BUSCO" Switches have Self-cleaning Contacts and "Set Cracking" is safeguarded through the Vice-like Grip at Contact Points.

3/- EACH
 Post Free
 Complete with Fuse Bulb

BUSBY & Co. Ltd, Price St., BIRMINGHAM

REPAIRS to Loudspeakers 4/-. Blue Spots 5/-. Transformers 4/-. Moving Coils, etc. quoted for. Prompt Service. 12 months guarantee. Trade Invited. Streatham 6618.
 Loud-speaker Repair Co., 2 SHIPKA ROAD, Baiham, London

A 6d Insurance Policy

Ask for Genuine "Competa" Green Top Fuses. The only reliable make which fuse instantly on 50% overload.

TRADE MARK COMPETA

THE WORLD'S SELECTED

06
1
15
2
AMPS

Advt. of A. F. BULGIN & Co. Ltd., Abbey Rd., Barking

TAYLEX WET H.T. BATTERIES
 Give long service, improved volume and tone. Very economical. Replacements for Taylex or Standard batteries at low prices; details post free. Also Bargain List; Radio Kits and parts at lowest prices.
 A. TAYLOR, 57 STUDLEY ROAD, STOCKWELL, LONDON

"READERS' IDEAS & QUESTIONS"

(Continued from page 526)

switch over for long-wave reception, but not quite so apparent when working on the medium waves. If I use my set for gramophone amplifying there is no hum at all. I have experimented with extra smoothing chokes and large capacity condensers, but this has not effected a cure. I am therefore seeking your advice with a view to eliminating the hum from my apparatus.

C. D. (Kent.)

It seems from what you tell us that you are experiencing modulation hum. This form of hum is usually only noticeable when radio is being used, and does not occur when a pick-up is being employed. We assume you have alternating current supply mains from which you are working your receiver. If you have a valve rectifier in the mains unit, you should connect a .01 microfarad capacity condenser between each anode of the rectifying valve and the centre point of its filament heater winding. Should you have a mains unit with a metal rectifier in its construction, you should arrange to fit a couple of power-type H.F. chokes between the rectifier and the ordinary L.F. smoothing circuits, one in each lead. You should then connect two 2- or 4-microfarad capacity condensers in series and across the L.F. smoothing circuit end of the two H.F. chokes and connect the centre point between the two condensers to earth.—Ed.

Simple Anode-current Tests

SIR,—During the course of my endeavours to experiment, I often have occasion to test the anode-current consumption of valves. I find it somewhat tedious to disconnect wires in order to arrange the milliammeter in series with the anode

circuits of different valves and would welcome any advice you may be able to offer in connection with simplifying this form of testing.

W. R. (Leigh-on-sea).

One of the most useful things we have discovered in connection with the simplification of valve anode-current tests is a special valve-plug adaptor with a split circuit arrangement whereby a valve may be withdrawn from its holder, the adaptor inserted in its place, and the valve reinserted in the adaptor. By connecting the meter to the two terminals provided on the adaptor the anode current consumption of the valve may be determined.—Ed.

Filtering Out Heterodyne Whistles

SIR,—The greatest difficulty I have experienced during the last twelve months in connection with my wireless reception has been the cutting out of heterodyne whistles. I use a moving-coil speaker, which seems to accentuate the troubles. If I use a cheap balanced-armature speaker the whistles are greatly reduced. Quality, however, from this cheap speaker is not to my liking. Is there any way in which I can overcome the nuisance without spoiling the quality of reproduction when using my moving-coil speaker?

E. H. (Wiltshire).

It is now possible to obtain special heterodyne filters for filtering out the whistles usually heard in high-quality loud-speakers. These filters take the form of low-pass high-frequency rejectors and are designed to be connected in the anode circuit of the detector valve in the receiver. Their frequency cut off is in the

region of 3,500 cycles, which frequency is sufficiently high for those of normal taste in quality of reproduction.—Ed.

Gramophone Volume Controls

SIR,—I wish to fit a volume control on the turntable of my gramophone motor, and it is to be used solely for controlling the volume of gramophone reproduction. I have a circuit diagram of the wiring required but am uncertain what value potentiometer to use.

A.P. (Bath).

A high resistance potentiometer, one having a resistance of at least 150,000 ohms, should be used unless a lower value is specifically stated to be desirable by the manufacturers of the pick-up. Even then the lowest value of potentiometer should not be less than 25,000 ohms.—Ed.

Reducing Needle Scratch and Surface Noises

SIR,—I am using loud-tone gramophone needles and find these cause more needle scratch and surface noises than the soft tone. Unfortunately I do not get enough brilliance from my speaker when using soft-tone needles, and am therefore forced to use needles which give rise to unwanted noises. Is there any way in which I can overcome the trouble without going to great expense in the matter?

T. D. (Bucks).

It is quite likely that the extraneous noises you are experiencing are mainly due to your working your gramophone with its lid open. You should arrange to close down the lid over the gramophone turntable and pick-up so as to avoid direct sound interaction between the pick-up and record and the loud-speaker.—Ed.

"AN ADD-ON BANDPASS UNIT"

(Continued from page 488)

The wires from this block to the aerial and earth terminals on the set should be quite short and should be well spaced, for otherwise they will upset the bandpass action.

If there is a pre-set condenser in the main set, it should be short-circuited, or it can be removed entirely (the wires being joined across) and used in the bandpass unit. In any case, it should be cut entirely out of circuit, for it will upset the value of the capacity coupling between the circuits.

Operation is easy. The coupling condenser (right-hand control on the panel-front) should be set at maximum with the vanes in, and the wave-change switch, for a first test, should be pulled out so that the unit is operating on the medium waves. The set must also be switched on to the medium waves, of course.

How to Tune

Leave the tuning condenser of the main set at the normal setting for a local station and tune in the unit until the station is heard. The addition of the unit may alter the original readings somewhat, but you will soon find out the best position.

The dials on the unit and mains set should move approximately in step and when you have found two or three main stations in this way, you can start to improve the selectivity and get a true bandpass effect. Screw down the pre-set condenser on the unit, so that there is the maximum aerial coupling, but gradually turn the knob of the coupling condenser

in an anti-clockwise direction, so that the coupling between the unit and the set is reduced and the bandpass effect sharpened. You will find a certain value of this coupling condenser which gives the best selectivity. On local stations it will probably be found possible to slacken off the coupling condenser more than on distant stations. Variation of coupling will also make a slight difference to the dial readings.

When you are accustomed to the operation of the unit in conjunction with the set you can then slacken off the pre-set condenser to sharpen up the tuning on the aerial side—that is, on the tuning of the added unit. You will probably find that as you rotate the pre-set condenser knob, the selectivity is increased up to a point, but the dial readings on the unit are altered slightly.

You will soon accustom yourself to operating the two dials and you will find that, correctly adjusted, this bandpass unit is just as effective in increasing selectivity, as the addition of an ordinary H.F. valve. At the point of correct adjustment, there should not be any drop in signal strength, owing to the greater selectivity.

NEXT WEEK:

TWO SPECIAL FEATURES

See the Important Announcement on page 489

"SUITABLE CIRCUITS FOR SEVEN METRES"

(Continued from page 508)

The pre-set type of condenser at the top of the unit enables a suitable intermediate-frequency to be determined during actual reception. When connected to a set it is necessary to tune the set to the same wavelength as that of the intermediate-frequency unit. The unit covers a range from about 240 to 500 metres, and a suitable wavelength in this range is selected on which to amplify the initial ultra-short wave signals brought in on the autodyne detector.

The two circuits already discussed are, at the moment, favourites among amateurs who have already done extensive experiments on the ultra-short waveband. There are two others that may come into use later. One is the Armstrong super-regenerative circuit, whereby a separate quenching valve is used to enable much greater reaction effects to be obtained from the detector.

The remaining circuit consists of a screen-grid valve in front of the normal detector. No amplification can be expected from the screen-grid at such high frequencies, but it may prove useful as a means of stabilising the set's reaction.

For a start there is nothing to beat the two circuits shown at Figs. 1 and 2.

They provide ample scope for the keen amateur, who in the near future will find plenty of telephony and possibly television signals to justify the ultra-short-wave set's existence.

TELSEN

H.F. CHOKES

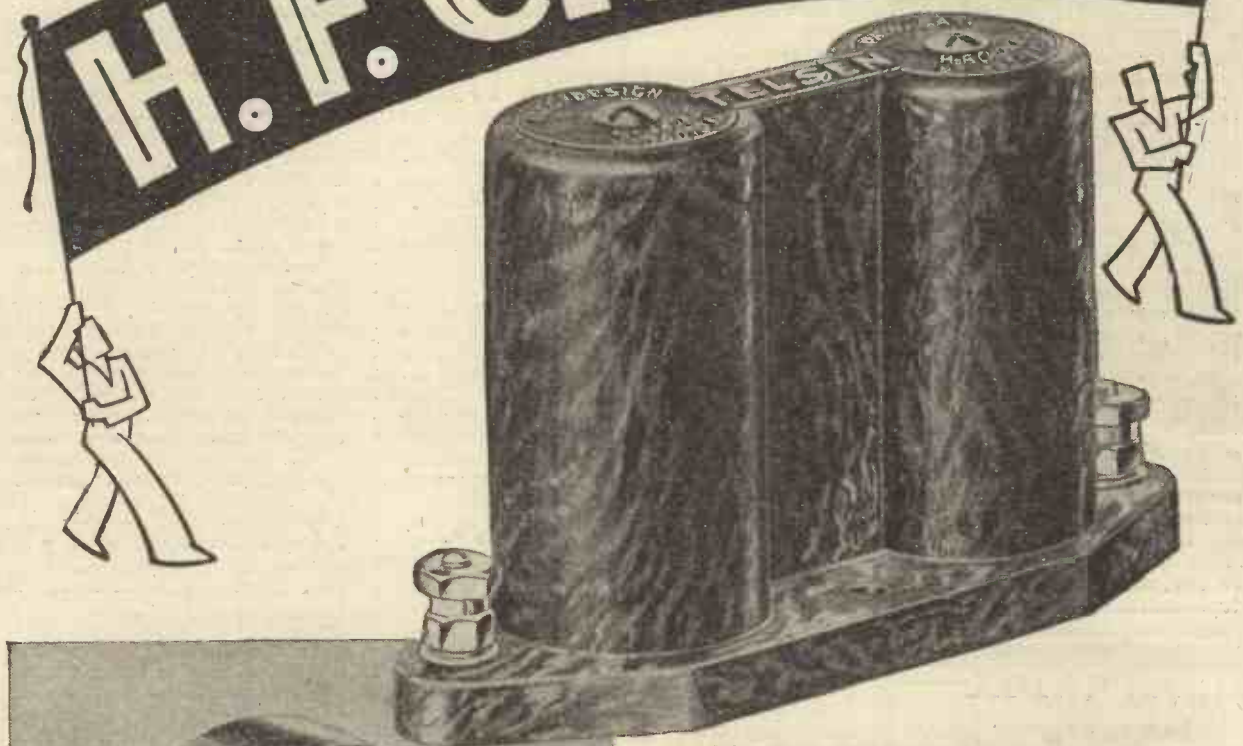

TELSEN BINOCULAR H.F. CHOKE

In H.F. amplification the performance of a choke is of supreme importance. The Telsen binocular H.F. Choke is called for wherever the highest efficiency is required. It has a high inductance of 180,000 microhenries, low self-capacity, and a negligible external field, due to the binocular formation, making it the ideal choke for a high class circuit. No. W.74

5/-

TELSEN STANDARD H.F. CHOKE

The Telsen Standard H.F. Choke utilises the minimum baseboard space. It is designed to cover the whole broadcast band, has very low self-capacity, and is highly suitable for reaction circuits. The inductance is 150,000 micro-henries and the resistance 400 ohms. It has proved very popular and has been incorporated by set designers in many of the leading circuits. No. W.75

2/-

TELSEN
RADIO COMPONENTS

Get your copy of the new TELSEN RADIOMAG, Issue N°3

ANNOUNCEMENT OF THE TELSEN ELECTRIC CO., LTD., ASTON, BIRMINGHAM

Advertisers Appreciate Mention of "A.W." with Your Order

CLIX

CHEAPEST PERFECT CONTACT

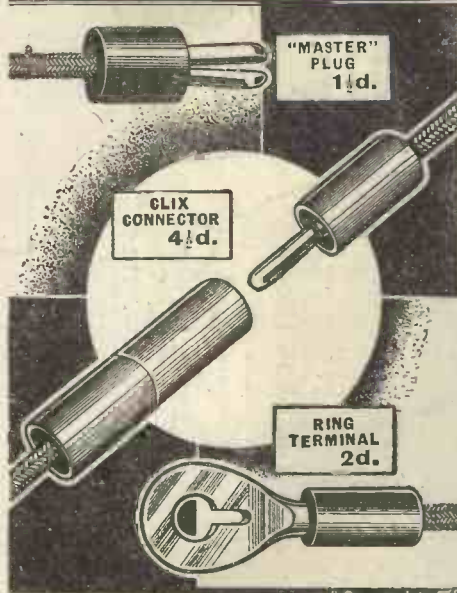

For every form of contact you require in radio there is a 'Clix' component designed to make a better job of it. Write us for folder 'A,' fully describing the wide 'Clix' range. Also ask your dealer for 'Clix.'

LECTRO LINX LTD., 254, Vauxhall Bridge Rd., S.W.1.

ELECTRADIX

for nearly
**Everything Electrical
and
Radio**

There is no store in London that has so comprehensive a stock of scientific apparatus at such

BARGAIN PRICES

The new edition of our famous Sale List issued on Sept. 1st., will more than interest you, it will

SAVE YOU POUNDS!

ELECTRADIX RADIOS,
218, UPPER THAMES STREET, E.C.4.

10,000 Gramo-motors from Stock.
Big Cash Discount Allowed!
Make a Gramophone or Radiogram. Order loose kits and assemble them at home. Get for 3d. our new 64-page catalogue with scale drawings and instructions how to make cabinets, gramophones or radiograms, and what parts to choose. We sell motors from 7/6, tone-arms, soundboxes, 1/6, pick-ups, big volume horns, loud-speakers, radio-kits, complete receiving sets, gramophones, radiograms and parts. Established 1903.—The Regent Fittings Co., A.W., 120 Old Street, London E.C.1.

RADIO SUPPLIES

Send your list of Radio needs for our quotation. Kits, Parts, Sets, etc. Everything in Radio stocked. Prompt delivery; seven days' approval. Catalogue free. Taylex and Standard Wet H.T. replacements stocked.

G. TAYLOR, 57 STUDLEY ROAD, STOCKWELL, LONDON

OUR LISTENING POST

By JAY COOTE

HAVE you already picked up tests by Radio Luxembourg? They have not yet been made at high power, but the transmitter is being experimentally tried out on about 1,275 metres between 12.30 and 1.30 p.m., and again between 5.30 and 6 p.m. B.S.T. daily. All announcements are given out by a woman in German and French and sometimes in the Luxembourg dialect, which almost coincides with *platt-Deutsch* (low German), and thus rather akin to Dutch or Flemish. In French you may hear: "Allo! Allo! Ici Radio Luxembourg expérimental," the name of the city being pronounced as if it were written: *Looks-am-boor*. At present, during the preliminary canter, the wavelength of the station is far from stable; according to reports from listeners, it varies between 1,190 and 1,275 metres.

A Newcomer

Another newcomer on the ether is Radio Nimes (France), which, having closed down about a year ago, similar to the mythological Phoenix, seems to have resurrected from its ashes. It has been entirely reconstructed and is now heard testing on 238 metres. Regular daily transmissions having been advertised to take place from September 3, under favourable conditions, by the time these notes are in print they may have been faintly audible to you on this wavelength. At present the power is hardly likely to be more than 500 watts (aerial), if as much, but a slight increase is promised in the near future. Violent deviations from the channel it has adopted for its broadcasts should not take place, as the owner of the station, impelled by an earnest endeavour to stick to his wavelength, has adopted quartz-crystal control.

With the reorganisation of the German broadcasting system and the completion of two more high-power transmitters, the Reichsfunk has effected some drastic cuts and alterations in the programmes and time schedules of the studios. No longer when London has closed down shall we be able to switch over to Berlin for a further half-hour of dance music, as the stations, with the exception of two nights per week, will close down daily at midnight. This will spell 11 p.m. when we revert to winter time.

However, as a slight compensation on the two nights in question, special late concerts will be broadcast, which will also be taken by the Zeesen short-wave station for the benefit of Germans living abroad. In order to effect economies, it is possible that these transmissions may be simultaneously broadcast by all German stations.

New German Stations

You may have already heard the new Breslau, Leipzig, and Frankfurt-am-Main stations, as every step was taken to try and get them ready in time for the Berlin Radio Exhibition, which coincided in dates with our own. Unfortunately, however, this was found impossible, but the filip given to the builders and engineers has advanced the opening date by some weeks. News reaches me that the new Munich high-power transmitter will also soon be on the air.

It is good to learn that a practical working agreement has been concluded between the E.I.A.R. (Italian broadcasting authorities) and the Scala Opera House at Milan by which it has been decided that the studios are to assist the theatre financially. From time to time we have been given relays of performances from the Scala, and with the new arrangement we may expect more visits to that famous opera-house. I am told that there is every likelihood of these broadcasts being taken by Rome as well as by the North Italian group of stations, thus bringing the transmissions within the reach of a greater number of European listeners.

Finding a Wavelength

There would appear to be some doubt regarding the wavelength to be used eventually by the 175-kilowatt station which is to be built at Lakihegy (Hungary) to take the Budapest programmes. So far, it would seem that the 550-metre channel may be abandoned in favour of 210 metres, but I cannot yet secure a definite confirmation of this drastic move. Anyhow, it is hoped to get this new transmitter working before the end of the year. Budapest programmes will be an agreeable addition to our daily log; as it is with the present station, it is seldom they can be heard at a useful strength except during the winter months.

Listening on the short waves a night or so ago, I picked up Lisbon (CT1AA) and noticed that this very up-to-date amateur station had adopted a cuckoo call as interval signal. Announcements on that night were made in at least five different European languages, and in each instance the studio referred to itself as Radio Colonial, Lisbon. By the way, the wavelength is now regularly 31.25 metres, and if you can find Zeesen or Schenectady it is quite easy to tune in the Portuguese transmission, as it is a very powerful signal.

A new series of talks to begin in October is called "The Doctor and the Public." Sir Thomas Horder will be the first speaker and the series will be given by two physicians and a surgeon, who will discuss the difficulties which doctors encounter, fallacies concerning medical matters, and various other aspects of the profession. As in the case of the talks on law, the speakers will remain anonymous.

Harold Spicer, who has been Director of Music at Manchester College, Oxford, since 1919, is to give an organ recital from the Church of the Messiah on September 21. Midland Regional listeners will hear this recital.

MOUNT BATTERIES FIRMLY

Do not let the batteries in the battery compartment of a transportable move about, for they may pull the wiring loose and wander plugs may come out of their



sockets. A wooden batten is shown jamming a high-tension battery in position.

TELSEN DUAL-RANGE AERIAL COILS



THE TELSEN H.F. COIL

May be used for H.F. amplification with Screened Grid Valve, either as an H.F. Transformer or, alternatively, as a tuned grid or tuned anode coil. It also makes a highly efficient Aerial Coil where the adjustable selectivity feature is not required.

No. W.154

5/6

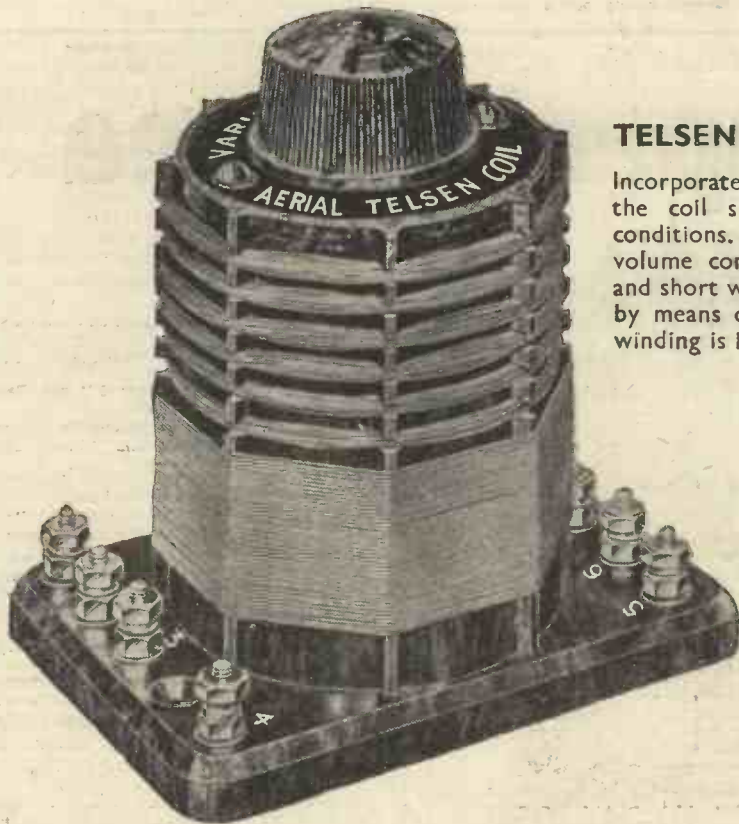

TELSEN DUAL-RANGE AERIAL COIL

Incorporates a variable selectivity device, making the coil suitable for widely varying reception conditions. This adjustment also acts as an excellent volume control, and is equally effective on long and short waves. The wave-band change is effected by means of a three-point switch and a reaction winding is included.

No. W.76

7/6

TELSEN

RADIO COMPONENTS

Get your copy of the new **TELSEN RADIOMAG, Issue N° 3**

ANNOUNCEMENT OF THE TELSEN ELECTRIC CO., LTD., ASTON, BIRMINGHAM

Advertisers Appreciate Mention of "A.W." with Your Order

THE NEW READI-RAD PARTS

SET builders will be interested in the new range of home-constructor parts produced by Ready Radio, Ltd. A selection of these is shown in a group in the accompanying photograph. All the components are built up on moulded bakelite having a very attractive brown mottled

moulded case, the terminal indications being stamped on the top. There are some handy slow-motion condenser controls in the new range, and also some handy base-board mounting potentiometers in 200, 400, 500, and 1,000-ohm cycles. These are of the straight slider type as can be

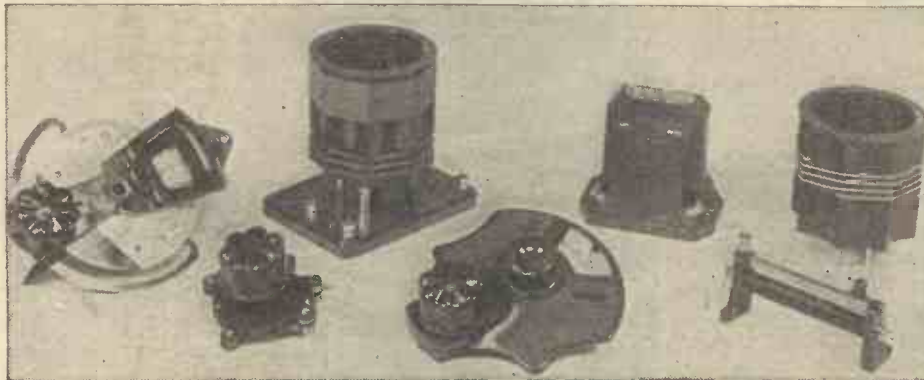

A selection of the new Readi-Rad components described, including slow-motion dials, Micalog condenser, dual-wave coil, low-frequency transformer, baseboard-mounting potentiometer and short-wave coil

finish and the insulation of this material is perfect. The knobs of the variable components are also made of this moulded bakelite and in the case of the condenser controls there are panel escutcheons to match, also of the same material.

Among the newcomers is a useful and compact low-frequency transformer, having a ratio of 3 to 1. This is covered in a

clearly seen from the above photograph.

Short-wave and dual-wave plug-in coils, wound on ribbed bakelite formers of a low-loss type, are handy for all circuits, while the new Micalog variable condensers facilitate construction. These are available in .0003 and .0005-microfarad sizes and combine all the advantages of solid di-electric condensers with the efficiency

usually considered to be the prerogative of air-spaced types. There are some .0001 and .0005-microfarad reaction condensers and also a range of log-law condensers in all standard capacities from .0001 microfarad.

Full details of all these parts can be obtained free on mention of AMATEUR WIRELESS from Messrs. Ready Radio, Ltd., Eastnor House, Blackheath, London, S.E.3.

A SOUTH LONDON EXHIBITION

MR. CHRISTOPHER STONE opened a wireless exhibition at the Bon Marche, Brixton Road, London, S.W.9, last Saturday, September 3, and readers who can possibly find time to visit the exhibition will find it very worth while. The entrance is in Ferndale Road. More than a score of well-known radio firms are represented, including Climax, Columbia, Cossor, Ekco, Ealex, Ferranti, Gecophone, Kolster Brandes, Lissen, Lotus, Marconi, McMichael, Philips, Portadyne, Pye, Tannoy, Triotron, Ultra, Varley, Westinghouse and others. AMATEUR WIRELESS has a stall. Following the very keen interest re-awakened by the Olympia Exhibition, many thousands of readers in South London who may have missed the great show will be glad to have an opportunity of seeing and hearing some of the most notable sets of the day. Admission is free and the exhibition is open until Saturday, September 10. (Saturdays, 10.30 a.m. to 10 p.m.; other days, 10.30 a.m. to 9 p.m.)

The Prosperity Three



DESIGNED FOR
BATTERIES,
A.C. and D.C. MAINS

All three versions of the "Prosperity Three" have certain features in common. In each case the valve sequence is a variable- μ high-frequency amplifier followed by a detector and a pentode output valve. Each set, moreover, covers the short waves from 15 to 80 metres as well as the medium and long broadcast wavelengths.

The turn of a switch enables you to reproduce gramophone records with a purity and volume unobtainable from an acoustic instrument. Constructors who build up any one of these three versions can rest assured that they will possess a first-class radio outfit that will give them many months of enjoyable musical reproduction!

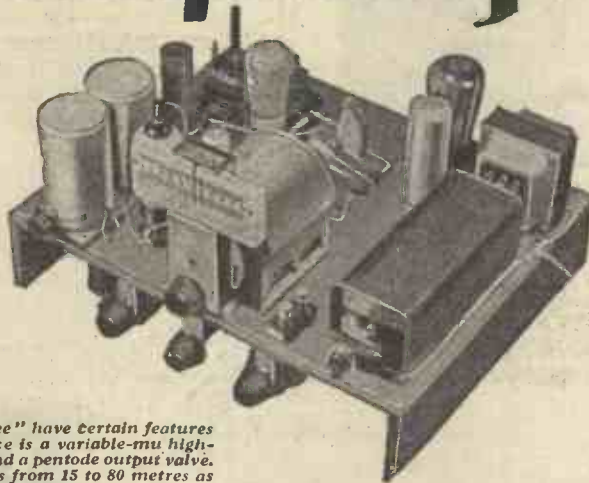

— CHIEF CONTENTS OF THE — SEPTEMBER "WIRELESS MAGAZINE"

- THE "PROSPERITY 3" FOR BATTERIES, A.C. and D.C. MAINS.
- A TWO FOR 7 METRES. By K. Jowers.
- MORE ABOUT THE "PERCY HARRIS RADIOGRAM."
- THE ABC OF STATION IDENTIFICATION. By J. Godchaux Abrahams.
- HOW TO CHOOSE A NEW SET. By Alan Hunter.
- THE B.B.C. WEATHER FORECASTS.
- BROADCAST RELIGION. By Whitaker-Wilson.
- "A" QUALITY FROM D.C. MAINS. By P. K. Turner, M.I.E.E.
- ARE WE GETTING THE BEST FROM THE LONG WAVES? By J. H. Reyner, B.Sc., A.M.I.E.E.
- SOMETHING ABOUT NOISE! By W. H. O. Sweeney.
- THE LOW-FREQUENCY TRANSFORMER. By Percy W. Harris, M.Inst.Rad.E.
- GRAMO-RADIO SECTION
- THE NEEDLE AND THE RECORD. By P. Wilson, M.A.

164
PAGES
PRICE 1/-

GET YOUR COPY TO-DAY, OF ALL NEWSAGENTS AND BOOKSTALLS

WIRELESS MAGAZINE

TELSEN

MANSBRIDGE AND MICA CONDENSERS



TELSEN MANSBRIDGE TYPE CONDENSERS

These are made by the most advanced processes from the finest materials it is possible to obtain, and subjected during manufacture to a series of stringent tests under laboratory conditions. They are of the true Mansbridge type, self-sealing, non-inductive, and hermetically sealed. They are offered in two types, the capacities from .01 to 2 microfarad in Bakelite cases, and in blocks of 4, 6 and 8 microfarad in metal cases with soldering tags.



Cap. Mfd.	500 Volt Test No.	Price.	1,000 Volt Test No.	Price.
.01	W.232	1/6	W.239	2/6
.04	W.230	1/9	W.237	2/9
.1	W.231	1/9	W.238	2/9
.25	W.229	2/-	W.236	3/-
.5	W.228	2/3	W.235	3/3
1	W.227	2/3	W.234	3/6
2	W.226	3/-	W.233	5/-



TELSEN TAG CONDENSERS

This type is of extremely compact and sturdy construction. It may be mounted on either insulated or metal panels by utilising the two baseboard screw holes in the neatly designed moulded casing. The tags enable the condenser to be connected to any other component either directly or by soldering. H.F. losses are negligible. The capacity is stamped on the soldering tag.

Capacity.	No.
.0001	W.207
.0002	W.208
.0003	W.209
.0004	W.210
.0005	W.211
.001	W.212
.002	W.213

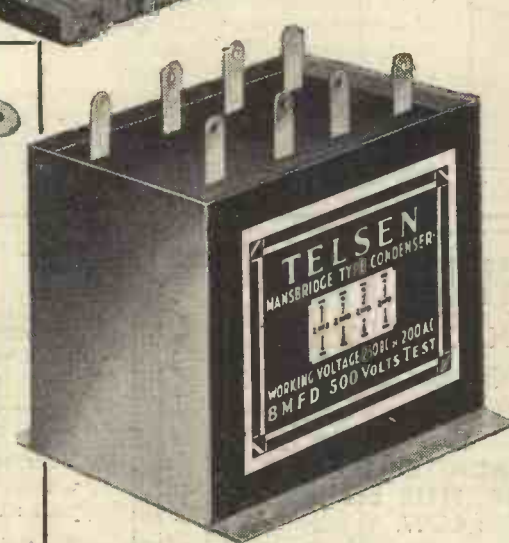

TELSEN MANSBRIDGE BLOCK CONDENSERS

These are contained in metal cases finished in brown and with fixing holes. As with the other types of Telsen Mansbridge Condensers they are self-sealing, non-inductive and hermetically sealed. Three types, each made having total capacities of 4, 6 and 8 microfarads, each type being divided into 2 microfarad sections, so that several arrangements of capacity may be obtained. Neat and substantial soldering tags are provided for each section.

Cap. Mfd.	500 Volt Test Cat. No.	Price.
4	W.175	5/6
6	W.176	8/-
8	W.177	10/6

1,000 Volt Test Cat. No.	Price.
W.178	9/6
W.179	14/6

TELSEN "MICA" CONDENSERS

The new Telsen "Mica" Condensers represent an important advance in technique. H.F. losses have been practically eliminated even in the larger capacities. In order to distinguish them from the earlier types, now to be discontinued, the new condensers are enclosed in a re-designed case which, while possessing all the adaptability of the previous one as to flat and vertical mounting, is of more attractive appearance. Grid leak clips may, as heretofore, be mounted in series or in shunt, and are supplied at no extra charge with capacities .0001, .0002, and .0003 microfarad.



Cap. Mfd.	No.
.0001	W.240
.0002	W.241
.0003	W.242
.0004	W.243
.0005	W.244
.001	W.245
.002	W.246



.006 W.247 ... 1/3



TELSEN PRE-SET CONDENSERS

Very low minimum capacity, giving a wide range of selectivity adjustment when used in aerial circuit. Substantially made, easily adjusted and provided with locking ring. High insulation and low loss.

Max. Cap. Mfd.	Min. Cap. Mfd.	No.
.002	.00025	W.149
.001	.00052	W.150
.0003	.00016	W.151
.0001	.00005	W.152



TELSEN RADIO COMPONENTS

Get your copy of the new **TELSEN RADIOMAG, Issue N°3**

ANNOUNCEMENT OF THE TELSEN ELECTRIC CO., LTD., ASTON, BIRMINGHAM.

Mention of "Amateur Wireless" to Advertisers will Ensure Prompt Attention

SIMPLE TONE CONTROL

TONE control and the ability to regulate the natural tone of reproduction to suit individual station reception, is one of the most popular features of modern circuits. There are many ways of varying the tone, and as some of these are merely drastic corrections (such as the deliberate cutting off of bass or top) not all of them are satisfactory.

A practical form of tone control and one which commends itself on the score of simplicity is that used in the Multitone tone transformer. This system, which is fully covered by a patent, gives true tone control and is a great improvement on the normal two-way tone control at present effected by units consisting of an L.F.

choke, condenser and potentiometer placed between the set and speaker.

The Multitone tone transformer, in addition to the usual four terminals for primary and secondary, has two additional

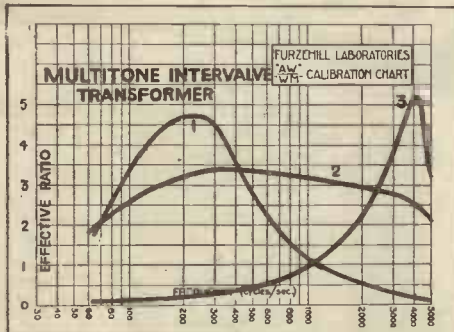

Performance curves of a Multitone transformer tested by "A.W."

terminals to which the ends of the winding of a special potentiometer are connected, while the centre terminal of the potentiometer is connected to the grid terminal of the transformer. There are several ways of connecting the transformer, either for direct or resistance feed. The potentiometer used should have a winding resistance of at least .5 megohms, and a special Multitone graded potentiometer has been produced for this special job.



The Multitone tone-control transformer

The mean ratio of the Multitone transformer is 4 to 1 as the primary inductance is rated at 54 henries with no D.C. flowing, and 31 henries with 4 milliamperes steady D.C. flowing.

The metal baseplate of the transformer is in contact with the core, which is thus automatically earthed if used on a metal chassis. In other types of set the core can be earthed if necessary by clamping a wire under one of the fixing screws. A good idea of the tone variation possible with the Multitone transformer can be gauged from the accompanying curve, which was taken recently during an "A.W." test on a standard Multitone.

It is interesting to note that each transformer is tested by the Multitone Electric Co., Ltd., by putting it in the plate circuit of a valve oscillator covering a wide range and feeding the secondary output into a valve stage measuring at the same time the voltage across the secondary. The tone control is then brought into operation and the transformer checked up with the voltage amplification curve for a standard job.

Full details of these transformers can be obtained from the Multitone Electrical Co., Ltd., 95-8 White Lion Street, London, N.1.

A running commentary on the fifth official speedway test match between England and Australia is to be relayed from the Empire Stadium, Wembley, in the National programme on September 15.



British Made

THE RELIABLE BECOL EBONITE FORMER which has stood the **TEST OF TIME** and tested before despatch. Prices **LOW**.

EFFICIENCY COUNTS!!!

LOOK FOR TRADE-MARK. SOLE MAKERS

THE BRITISH EBONITE CO., LTD.
HANWELL, W.7

HERE IT IS
EXACTLY WHAT
YOU REQUIRE FOR
SHORT WAVES

YOUR OLD COMPONENTS

are worth money. Sort out the spare radio parts you no longer require and advertise them in the "Miscellaneous Columns" of **AMATEUR WIRELESS**. You will be surprised how quickly they will be snapped up.

Your announcement will cost you 3d. a word. Send your list of parts, together with your name, address and remittance, to:

"Small Advertisement" Dept.,

AMATEUR WIRELESS

58-61 Fetter Lane, London, E.C.

"NEW SETS FOR OLD"

YOU MUST

have that new set **this year** and get it at practically half price by purchasing through us, disposing of your old set (if any) at a most generous allowance.

HUNDREDS OF SATISFIED CLIENTS WILL ENDORSE THIS

Just write for particulars, enclosing 1½d. stamp, naming your old set, which we will buy and the new set you fancy and a free quotation will follow. Balance payable in cash or hire-purchase.

FREE Wireless Set, to introduce the Radialaddin Club.

Please forward this **INQUIRY FORM** (without obligation):

I am interested in purchasing the undermentioned Radio Receiver:

Make..... Model and list price.....

Present set: Make..... Batteries or mains.....

Date of purchase..... Original cost of set.....

Balance of purchase price would be payable by me as follows:

Plan A. Whole of balance in cash.

Plan B. Whole of balance over (six, nine, twelve* months).

* Delete unwanted words.

NAME (in full)

Block Letters.

ADDRESS

RADIALADDIN, Limited

THE LARGEST RADIO EXCHANGE DEALERS IN THE UNITED KINGDOM

(Dept. A.W.), 47-48 Berners Street, London, W.1. Museum 1821.

Postcard Radio Literature

GET THESE CATALOGUES FREE

Here "Observer" reviews the latest booklets and folders issued by well-known manufacturers. If you want copies of any or all of them **FREE OF CHARGE**, just send a postcard giving the index numbers of the catalogues required (shown at the end of each paragraph) to "Postcard Radio Literature," "AMATEUR WIRELESS," 58/61, Fetter Lane, E.C.4. "Observer" will see that you get all the literature you desire. Please write your name and address in block letters.

Radiopak Units

TO my mind one of the most interesting components for the new season is the Radiopak. I have just received a folder dealing with the band-pass model of this. The Radiopak includes the H.F. and detector components needed for an efficient band-pass tuning arrangement, and the wire-wound volume control, completely screened coils and ganged condenser with escutcheon plate and pilot lamp attachment comprise a most useful unit which greatly simplifies set construction. The folder gives full practical and technical details.

831

A Fine Bulgin Book

I was very pleased to receive a copy of the new Bulgin comprehensive catalogue. It describes a wide range of parts, of outstanding interest to set builders, and if you cannot find something to interest you in the 80 pages of this catalogue, well...! I understand that free copies of this useful book will be sent through my Catalogue Service to readers who enclose 2d. in stamps to cover postage. Take my tip, it's worth it.

832

Another Price Reduction

Price reduction seems popular just now! The British Blue Spot Co., Ltd. tell me that they have made a ten-shilling reduction in the price of the popular 66K unit, which now costs only 15s. They have also sent me the latest literature describing this speaker and the other well-known models.

833

The New R.I. Catalogue

I advise every listener to write for a free copy (through my Catalogue Service) of the new R.I. Catalogue, which deals with everything from superhet complete receivers to small parts such as volume controls and H.F. chokes. This 40-page book will interest all set owners.

834

OBSERVER

In the Morley announcement in last week's issue, dealing with the Morley short-wave coil unit, the wavelength range was incorrectly given. This coil unit when tuned with a .00025-microfarad condenser tunes from 12 to 70 metres. Aperiodic aerial coupling ensures that there is an adequate coupling over the whole wave range.

GRIP

The "BOWSPRING" gives strong pressure over a far wider range of diameters than any plug we have so far tested.

Here are some tests with various well-known types of wander plugs. Starting from a small socket, each plug was pushed into progressively larger sockets until no contact was made, the force needed to remove the plug from each size of socket being measured in ounces.

In each case the "Bowspring" showed itself the better plug. Here is an example.

Socket diameter.	Grip of Bowspring.	Grip of typical split-pin Plug.
.127"	65 oz.	20 oz.
.133"	36 oz.	2 oz.
.134"	28 oz.	No contact.

The "Bowspring" continued to make contact until a socket just over .144" was reached.



Strong spring and wide self-adjustment. Side entry with Belling-Lee patent grip for flex. 12 indications and 6 plain colours.

BELLING-LEE
FOR EVERY RADIO CONNECTION

Advr. of Belling & Lee, Ltd., Cambridge Arterial Road, Enfield, Mdx.



pop a COP on your aerial



This little fellow is a well-made super lead-in which dispenses with all fiddling selectivity gadgets, lightning protectors, safety switches, wave traps, extra condensers—all these cost money, while a single COP at half a crown will do the work of all and do it properly. Controls volume, cuts out static nuisance, enables you to pick and choose your stations with vastly improved selectivity. Fixed in a few moments! Controlled by a touch of the finger! Adds so much to your pleasure, that you will find the COP the best friend you ever made in the radio world! Get one from your local radio dealer to-day, or send P.O. (postage free) direct to the makers: Clifford Pressland (Sales) Ltd., 84 Eden Street, Kingston-on-Thames

PRICE
2/6

6-in. size, 2/6
9-in. size, 3/-
12-in. size, 3/6

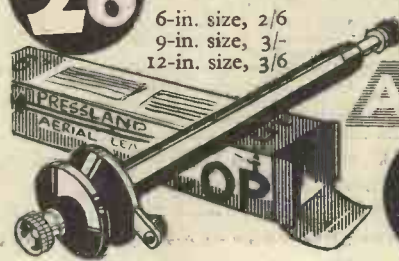

PRESSLAND
AERIAL CONTROL
COP

Scientific

BROADCASTING STATIONS

Broadcasting Stations classified by country and in order of wavelengths. For the purpose of better comparison, the power indicated is that of the carrier wave.

Kilo-Metres	Station and Call Sign	Power (Kw.)	Kilo-Metres	Station and Call Sign	Power (Kw.)	Kilo-Metres	Station and Call Sign	Power (Kw.)
GREAT BRITAIN			Radio LL (Paris) 1.0			NORWAY		
25.53	11,751 Chelmsford (G5SW)	10.0	also on 33 m. (9090 Kcs.)			235.5	1,274 Kristiansand	0.5
211.3	1,420 Newcastle	1.0	384.4	779 Radio Toulouse	60.0	240	1,249.7 Stavanger	0.5
214.3	1,400 Aberdeen	1.0	447.1	671 Paris (PTT)	0.0	304	824 Bergen	1.0
242	1,238 Belfast	1.0	465	659 Radio Agen	0.5	367.6	816 Fredrikstad	0.7
261.6	1,147 London National	50.0	466.8	644 Lyons (PTT)	1.5	493.4	608 Trondheim	1.2
288.5	1,040 Swansea	0.12	509.1	527.1 Grenoble (PTT)	2.0	1,083	277 Oslo	60.0
288.5	1,040 Plymouth	0.12	1,445.7	207.5 Eiffel Tower	13.5	POLAND		
288.5	1,040 Bournemouth	1.0	1,725	174 Radio Paris	75.0	214.3	1,400 Warsaw (2)	1.9
288.5	1,040 Scottish National	50.0	GRAND DUCHY OF LUXEMBURG			235	1,283 Lodz	2.2
301.5	995 North National	50.0	1,275	235.3 Luxembourg	(tests) 200.0	312.8	959 Cracow	1.5
309.9	968 Cardiff	1.0	GERMANY			335	866 Poznan	1.0
355.9	843 London Regional	50.0	10,737	15,200 Zeesen (DJB)	8.0	380.7	788 Lvov	10.0
376.4	797 Scottish Regional	50.0	31.38	9,560 Zeesen (DJA)	8.0	408	734 Katowice	12.0
398.9	752 Midland Regional	25.0	217.1	1,382 Königsberg	0.9	563	533 Wilno	16.0
480	625 North Regional	50.0	227.4	1,319 Flensburg	0.5	1,411.8	212.5 Warsaw	120.0
1,554.4	193 Davenport (Nat.)	30.0	232.2	1,292 Kiel	0.25	PORTUGAL		
AUSTRIA			238.9	1,256 Nürnberg	2.0	282.2	1,063 Lisbon (CT1AA)	2.0
218	1,373 Salzburg	0.5	246.9	1,220 Cassel	0.25	also on 31.25 m.		
245.9	1,220 Linz	0.5	253.1	1,185 Gleiwitz	5.0	ROMANIA		
283	1,058 Innsbruck	0.5	259.3	1,157 Frankfurt-a-M	17.0	394	761 Bucharest	12.0
352.1	852 Graz	7.0	267.1	1,123 Bremen	0.2	RUSSIA		
453.2	662 Klagenfurt	0.5	276.5	1,085 Heilsberg	60.0	351	855.5 Leningrad (RV70)	20.0
518	579.1 Vienna	15.0	283.0	1,058 Magdeburg	0.5	358	838 Moscow (Exp.)	15.0
also testing on 1,254 m. from 7.0p.m. (Mon., Wed., Sat.)			283.0	1,058 Berlin (L)	0.5	385	779 Stalino (RV20)	15.0
BELGIUM			283.0	1,058 Stettin	0.5	389.6	770 Archangel	10.0
207.3	1,447 Brachmont	0.2	318.8	941 Dresden	0.25	476	630.2 Sebastopol	10.0
208.3	1,440 Liege (Seraing)	0.13	325	923 Breslau	60.0	502.4	579 Nijni Novgorod	10.0
211.7	1,416.8 Antwerp	0.5	300.6	832 Mühlacker	60.0	644	465.8 Kazan (RV17)	10.0
215.3	1,393 Chatelneau	0.2	372.2	806 Hamburg	1.5	720	416.6 Moscow (PTT)	20.0
215.4	1,392.5 Bruxelles	0.2	389.6	770 Leipzig	150.0	825	363.6 Sverdlovsk (RV5)	50.0
Conference			419.9	716 Berlin	1.5	848.7	353.5 Rostov (Don)	20.0
230.3	1,304 Radio Wallonia	0.3	453.2	662 Danzig	0.5	882	340 Saratov	20.0
239.5	1,258 Binche	0.3	472.4	635 Langenberg	60.0	937.5	320 Khar'kov (RV4)	25.0
240.2	1,249 Liege (Exp.)	0.1	532.9	563 Munich	1.5	967.7	310 Alma Ata	10.0
245.9	1,220 Radio Schaarbeek	0.3	559.7	536 Kaiserslautern	1.5	1,000	300 Leningrad	100.0
272	1,103 Liege (Coinite)	0.4	559.7	536 Augsburg	0.3	1,034	290 Kiev	100.0
337.8	888 Brussels (No. 2)	15.0	569.3	527 Hanover	0.3	1,071.2	280 Tiflis (RV7)	100.0
509	590 Brussels (No. 1)	15.0	569.3	527 Freiburg	0.25	1,106	272.2 Minsk (RV10)	35.0
BULGARIA			1,020	185 Norddeich KVA	10.0	1,116	268.5 Moscow Popoff	75.0
318.8	941 Sofia (Rodno Radio)	1.0	1,034.9	183.5 Zeesen	60.0	1,171.5	256 Taschkent	25.0
CZECHO-SLOVAKIA			2,525	119.3 Königswuster-		1,200	293 Novosibirsk	4.0
58	5,172 Prague	0.5	2,900	103.5 Hausen (press)	15.0	1,304	230 Moscow (Trades Unions)	105.0
249	1,205 Prague (Strasnice)	5.0	4,000	75 ditto		also on 50 m. (6,000 Kcs.)		
263.8	1,137 Moravska-Ostrava	11.0	HOLLAND			1,380	217.4 Bakou	100.0
278.8	1,076 Bratislava	14.0	296.1	1,013 Huizen	8.5	1,481.5	202.5 Moscow RV1	100.0
293	1,022 Kosice	2.5	1,071.4	280 Scheveningen-Haven	10.0	also on 46.6 m. (6,438 Kcs.)		
341.7	878 Brunn (Brno)	35.0	1,875	160 Hilversum	8.5	1,600	187.5 Irkutsk (RV14)	10.0
488.6	614 Prague	120.0	HUNGARY			SPAIN		
DENMARK			208.7	1,437.8 Budapest (2)	3.0	252.6	1,187.3 Barcelona (EAJ15)	3.0
281	1,067 Copenhagen	0.75	210	1,430 Magyarovar	1.8	266.8	1,124.5 Valencia	8.0
1,153	260 Kalundborg	7.5	550	545 Budapest (1)	18.5	348.8	860 Barcelona (EAJ1)	8.0
also on 31.51 m. (9,520 Kcs.)			also relayed on 75 m.			368.1	815 Seville (EAJ5)	1.5
ESTONIA			ICELAND			411.4	729.1 Madrid (EAJ7)	2.0
298.8	1,004 Tallinn	11.0	1,200	250 Reykjavik	21.0	424.3	707 Madrid (Espana)	2.0
465.8	644 Tartu	0.5	IRISH FREE STATE			456.6	557 San Sebastian (EAJ8)	0.6
FINLAND			222.9	1,344.6 Cork (6CK)	1.2	SWEDEN		
291	1,031 Tampere	1.0	413	725 Dublin	1.2	231	1,301 Malmö	1.2
291	1,031 Viipuri	13.0	413	725 Athlone (tests)	60.0	257	1,166 Hôrby	10.0
368.1	815 Helsinki	13.2	ITALY			308.5	972.4 Falun	0.5
1,790	167 Lahti	54.0	25.4	11,810 Rome (2RO)	15.0	321.9	932 Göteborg	10.0
FRANCE			247.7	1,211 Trieste	10.0	435.4	689 Stockholm	55.0
220	1,363 Beziers	0.5	269.4	1,112 Bari	20.0	5415	554 Suedsvall	10.0
226.1	1,327.5 Fécamp	10.0	273.7	1,096 Turin (Torino)	7.0	748	401 Ostersund	0.8
237.2	1,265 Bordeaux-Sud-Ouest	2.0	312.8	959 Genoa (Genova)	10.0	1,229.5	244 Boden	0.6
238	1,260 Nimes	0.5	318.8	941 Naples (Napoli)	1.5	1,348	222.5 Motala	30.0
249.8	1,201.2 Juan-les-Pins	0.5	441	680 Rome (Roma)	50.0	SWITZERLAND		
255	1,175 Toulouse (PTT)	1.0	500.8	599 Florence (Firenze)	20.0	244.1	1,229 Basle	0.65
265.4	1,130 Lille (PTT)	1.3	525.9	570.3 Palermo	3.0	245.9	1,220 Bern	0.5
271.4	1,105 Rennes	1.3	LATVIA			403	743 Söthen	25.0
286	1,049.1 Montpellier	0.8	198.5	1,570 Riga (test)	10.0	459.4	653 Beromünster	00.0
286.7	1,046.3 Radio Lyons	10.0	525	572 Riga	15.0	760	395 Geneva	1.25
293.7	1,021.5 Limoges (PTT)	0.5	LITHUANIA			TURKEY		
304.9	984 Bordeaux (PTT)	13.0	1,935	155 Kaunas	7.0	1,200	250 Istanbul	5.0
309.5	969 Radio Vitus	1.0	NORTH AFRICA			1,538	195 Ankara	7.0
(also on 43.75 m. (6,865 Kcs.)			303.3	825.3 Algiers (PTT)	16.0	YUGOSLAVIA		
315	950 Marseilles	1.6	419	715.9 Radio Maroc (Rabat)	0.0	307	977 Zagreb (Agram)	0.75
328.2	914 Poste Parisien	00.0	and 32.26 m. (9,300 Kcs.)			430.4	697 Belgrade	2.5
345.2	869 Strasbourg (PTT)	11.5				574.7	522 Ljubljana	5.2

FREE! RESISTANCE CALCULATION CHART

You may not have had a chance to visit the Exhibition, in which case if you would like a copy of this chart just drop us a line, and we will forward one along to you.

If you are thinking of constructing a set at the present time, consider using WATMEL Components—"They get the best out of any set," and we have three specialities at the present moment—Potentiometers—Resistances and Coils.

NEW WATMEL SQUARE-LAW TAPERED RESISTANCE

This resistance is specially wound on a tapered former which gives a perfect square-law reading. This is the first resistance of its kind.



NOTE THE POINTS:

- Polished pointer knobs.
- Engaged bakelite front plate.
- Wire wound former.
- Insulating brush to insulate spindle from panel.
- Contact finger. Phosphor Bronze.
- One-hole fixing—Brass bearing bush resulting in perfect bearing.
- Bakelite case—protects winding.
- Back self-cleaning contacts.
- Large contact plate.
- Stops at end of wiring.

Any resistance up to 50,000 ohms.

Standard wiring Square Law type
5/6 6/6

Ask your dealer for full particulars or write direct to us. Trade inquiries invited.



WATMEL WIRELESS CO., LTD.,
Imperial Works, HIGH STREET, EDGWARE.
Telephone: Edgware 0323

M.C.71a

WHEN SUBMITTING QUERIES

Please write concisely, giving essential particulars. A Fee of One Shilling (postal order), a stamped addressed envelope, and the coupon on the last page must accompany all letters. The following points should be noted.

Not more than two questions should be sent with any one letter.

The designing of apparatus or receivers cannot be undertaken.

Modifications of a straightforward nature can be made to blueprints, but we reserve to ourselves the right to determine the extent of an alteration to come within the scope of a query. Modifications

to proprietary receivers and designs published by contemporary journals cannot be undertaken.

Readers' sets and components cannot be tested at this office. Readers desiring specific information upon any problem should not ask for it to be published in a forthcoming issue, as only queries of general interest are published and these only at our discretion. Queries cannot be answered by telephone or personally.

Readers ordering blueprints and requiring technical information in addition, should address a separate letter to the Query Department and conform with the rules.

A treat is in store for gramophone listeners on September 18, when a recital of gramophone records made by Melba and Caruso will be given in the National programme.

The Regional Revellers, a combination of artists well known to wireless listeners, are to appear again in a new show of "Song and Story" in the Midland Regional programme on September 22.

PPM
SOUNDEX

27/6
INCLUDING TRANSFORMER

The Celestion P. P. M. Soundex is truly amazing! For such a compact speaker the volume is extraordinary—the tonal quality is perfect, being free from mush or distortion, giving a rich, deep note without boom or vibration. Truly a speaker of which Celestion can be justly proud, a speaker that will amaze you because of its realism.

Whatever your set, the Soundex will improve its quality.

Insist on your local dealer demonstrating the P.P.M. Soundex or write to Celestion for illustrated list.

Only 27/6 including universal transformer.

CELESTION
The Very Soul of Music

Celestion Ltd., London Road, KINGSTON-ON-THAMES. London Showrooms: 108 Victoria Street, S.W.1

THE CONVERT!

By E. Noel Roberts

I REMOVED Angela's cat from my easy chair, seated myself and gazed expectantly at the loud-speaker. Lured by the mystic potency of my eye, the first few bars of music burbled merrily from out of the depths. Simultaneously, Angela entered the room.

"Do shut that thing off, Jack!" she said briskly. "You know mother doesn't like the wireless."

"But the variety programme's just starting," I pointed out stiffly. "I suppose you wouldn't like to take your mother to the pictures to-night—?"

Angela favoured me with one of her extra-special reinforced glances and I rapidly took cover behind a screen of pipe smoke.

"And I wish," pursued my spouse, "that you wouldn't put your feet on the fender. Your slippers are scorching! Or is it the smell of that awful tobacco of yours—?"

Sighing, I switched off the wireless. Angela and the loud-speaker in competition sounded like a brewing riot.

"I can't understand why your mother won't listen to a good wireless programme," I remarked bitterly. "It isn't as if she wanted to read—"

"Mother likes to talk in the evenings," sniffed Angela.

"That had not escaped my notice," I retorted crushingly, and before Angela could reply, her mother appeared.

Stifling a moan of resignation, I tried to read the evening paper, but the light chatter of Angela and her mother battered down the walls of concentration.

Then came inspiration. I crept away upstairs and returned with an old pair of earphones. Very soon I was placidly listening in, while the flood-tide of talk swept unheeded over my head.

The variety was good and I laughed long and heartily. Angela and her cat eyed me without any show of pleasure, but once or twice my mother-in-law gazed at me with thinly veiled curiosity.

The following day I returned home early to find the loud-speaker in full cry. Angela and her mother looked round guiltily as I entered.

"We were just—" began Angela defensively.

"You seemed to be enjoying yourself last night," broke in the parent, as if she was accusing me of something.

"And so you decided to sample it for yourself?" I finished blandly.

We had quite a restful evening listening-in. Our guest admitted that the entertainment provided was not without merit. When she left us a week later she had run our battery flat and was a confirmed wireless "fan." I hoped it would be a lesson.

"Oh, Jack," said my partner not long afterwards, "It's mother's birthday tomorrow and, as she's so keen on wireless now, I've ordered a portable to be sent to her. It will be so nice for her and it was such a ducky little set and not a bit dear—at least, not really dear. I thought you'd better know, because they'll be sending the bill, and—"

I surveyed the girl bleakly.

QUICK EASY PAYMENT SERVICE

We supply all good quality Radio Receivers, and Accessories on deferred terms. Large stocks are carried and orders are executed promptly. Send list of requirements and a quotation will be sent by return of post. Price List free on request.

MANUFACTURERS KITS

NEW COSSOR MELODY MAKER, Model 335 (just released). Complete Kit of Parts, Valves, and Loud-speaker and Cabinet. Cash Price, £7/17/6. And 11 monthly payments of 14/10. With **10/-** order

NEW OSRAM "33" MUSIC MAGNET A first-class Kit, including Valves, Loud-speaker and Cabinet. Cash Price, £9/9/-. And 12 monthly payments of 15/-. With **20/-** order

NEW TELSEN JUPITER S.G.3. KIT. Complete set of Components less Valves. Cash Price, £3/17/-. And 11 monthly payments of 7/-. With **7/-** order

NEW LISSEN "SKY SCRAPER" 3 KIT. Cash price £4/9/6. And 11 monthly payments of 8/3. With **8/3** order

NEW TELSEN AJAX 3. Complete Set of parts for Det.; 2 L.F. Receiver, less Valves. Cash Price, £3/1/6. And 11 monthly payments of 5/8. With **5/8** order

MURPHY NEW ALL-MAINS 3-VALVE SET, Model A.3.A. Cash Price, £19/19/-. And 12 monthly payments of 33/-. We are appointed Murphy Dealers. With **39/-** order

NEW MARCONIPHONE 2-VALVE BATTERY RECEIVER, Model 248. Including Valves, Batteries, and Loud-speaker. Ready for use. Cash Price, £4/19/6. And 12 monthly payments of 8/3. With **9/-** order

NEW ORMOND PERM. MAGNET MOVING-COIL L.S. UNIT. (just released) Cash Price £1/18/6. And 7 monthly payments of 5/4. With **5/4** order

ATLAS ELIMINATOR, A.C.244. 3 H.T. Tappings. 20 M/A output. Cash Price, £2/19/3. And 11 monthly payments of 5/6. With **5/-** order

NEW R. & A. "CHALLENGER" PERM. MAGNET MOVING-COIL UNIT. Cash Price, £1/15/-. And 6 monthly payments of 5/8. With **5/-** order

NEW EPOCH 20c PERMANENT MAGNET MOVING-COIL UNIT. Cash Price, £1/15/-. And 6 monthly payments of 5/7. With **5/7** order

NEW BLUE SPOT 99 P.M. MOVING-COIL UNIT. One of the finest Units available. Cash Price, £2/19/6. And 11 monthly payments of 5/6. With **5/-** order

NEW R. & A. "VICTOR" PERM. MAG. MOVING-COIL REPRODUCER DE-LUXE. With 6 Ratio Transformer and Cadmium plated Grill. Cash Price, £3/10/-. And 11 monthly payments of 6/5. With **6/5** order

BLUE SPOT 100U. INDUCTOR UNIT. Cash Price, £1/19/6. And 7 monthly payments of 5/5. With **5/5** order

To avoid delay, will customers kindly send first payment with order.

All above carriage paid.

The LONDON RADIO SUPPLY COMPANY ESTD 1925
11, Oat Lane, Noble St., LONDON E.C.2
Phone NATIONAL 1977

PREPAID ADVERTISEMENTS

Advertisements under this head are charged **THREEPENCE PER WORD**, minimum charge **THREE SHILLINGS. DEPOSIT SYSTEM.**

As the publishers cannot accept responsibility for the bona fides of advertisers in this publication, they have introduced a system of deposit which it is recommended should be adopted by readers when dealing with persons with whom they are unacquainted. It is here explained.

Intending purchasers should forward to the Publishers the amount of the purchase money of the article advertised. This will be acknowledged to both the Depositor and the Vendor, whose names and addresses must necessarily be given. The deposit is retained until advice is received of the completion of the purchase, or of the article having been returned to and accepted by the Vendor. In addition to the amount of the deposit, a Fee of 6d. for sums of £1 and under, and 1s. for amounts in excess of £1, to cover postage, etc., must be remitted at the same time. In cases of persons not resident within the United Kingdom, double fees are charged.

The amount of the Deposit and Fee must be remitted by Postal Order or Registered Letter (Cheques cannot be accepted), addressed to

"AMATEUR WIRELESS" ADVERTISEMENT DEPARTMENT, 58/61 FETTER LANE, LONDON, E.C.4

WIRELESS AS A CAREER.—Those already engaged in the radio industry and those who would like to obtain employment in this interesting profession should write for a copy of our booklet, sent post free without obligation.—Northern Counties Wireless School, 55-57 Guldhall Street, Preston.

PARTS FOR ANY CIRCUIT supplied at attractive prices. Send list for special quotation.—Handley Radio, 49 Witham Road, London, S.E.20.

ENGINEERS.—Sit down and think this over. We believe that our 200-page handbook, "ENGINEERING OPPORTUNITIES" will show you the way to well-paid, permanent, and progressive employment. In any case, the handbook costs nothing, and it will at least show you various surprising possibilities about which at present you know nothing. Can you, can any man, who cares a hoot about his future, afford to allow this opportunity for a worth-while job to pass unheeded? Think it over. Can you? We want you to read "ENGINEERING OPPORTUNITIES." Among other things it gives details of all recognised Examinations (A.M.Inst.C.E., A.M.I.-Mech.E., I.E.E., G.P.O., etc.), outlines modern home-study courses in all branches of Civil, Mech., Elec., Motor, Radio, Aero and Talkie Engineering, and explains the unique advantages of our Employment Department. The book is quite free. Send a post-card for your copy NOW. We promise that it will be a moment of your time well spent.—The British Institute of Engineering Technology, 109 Shakespeare House, 29-31 Oxford Street, London, W.1.

"UNIVERSAL" RADIO BARGAINS.—Polar triple-gang condensers, 7/11. Dario valves, 3/11; Super detector, 4/3; Power, 4/11; Screen-grid, 9/3. Chokes, 1/-; Bi-noc, 1/6. Variable condensers, 1/11; Fixed, 6d. Switches, 6d. Fuse bulbs, 3d. Telsen Ace, 4/7; Grand, 5/11. Voltmeters, 2/11. Copper aerial, 100 ft., 1/11. Valve holders, 4d. Accumulators, 3/3. Six-pin coils, 2/3, bases 10d. Walnut cabinet speakers, 9/6. Ormond units, 8/11. Millgate, 2/11. Vernier dials, 1/3. Triotron units, 8/11. 3-valve Transportable, complete, 70/- . Screen-grid 3 Kit with valves, yours for 8/6 deposit. Full particulars on request. Thousands of other bargains. Lists Free. Kits, Components, Sets. Get our quotations.—"Universal," 20 Victoria Road, Peckham, S.E.15.

THE "TONIC" keeps any make 2-volt Accumulator fully charged at home. Electric mains unnecessary. Ideal for remote places. 7/- each, postage 6d. Particulars, copies of testimonials, etc., with pleasure.—Williams, Netherend, Cradley, Birmingham.

RYALL'S RADIO, 33 Chancery Lane, London, W.C.2. New, surplus, and tested used radio components at very reasonable prices. Write for free list or inspect our display personally. We purchase approved goods for cash, or accept same in part payment for new only.

RADIO.—Special discount home constructors.—Write, Page, 42 Moray Road, London, N.4.

WIRE—FREE SAMPLE.—All gauges. 2 m/m. Coloured Rubber Flexible Connecting Wire, 18-ft. coils, 6d. All colours. Postage paid on three coils. Also D.C.C., D.S.C., Enamelled, etc.—British Radio Utilities, 7 Abbey Lane, London, N.W.6.

BRUCE PRODUCTS.—Grade "A" quality Mains Transformers and L.F. "Constant Inductance" Smoothing and Output Chokes. Recommended and tested by "Amateur Wireless." Bryce Products.—A.B.23A, for "A.W." Home Lover's A.C.3, terminal type, 26/-; stripped type, 19/11. Model A.B.250, for "W.M." High-tension Unit, 26/9 and 19/11. Post free. Bryce & Co. carry stocks of "Peak" Condensers, guaranteed 12 months, 1,500-volt D.C. test, 750-volt working, 4 mfd., 6/9; 2 mfd., 3/9; 1 mfd., 2/8. Bryce Products.—Delivery of all models or to specification within 48 hours. Guaranteed 5 years. Write for our lists.—W. Andrew Bryce & Co., Woodfield Works, Bury, Lancs. Phone 1251.

SLAG WOOL, for B.B.C. type Box Baffles, 14 lb., 7/6. Carriage paid.—Power Engine Co., 169 Pentonville Road, London, N.1.

MAINS TRANSFORMER REPAIRS.—If you have a faulty or burnt-out mains transformer, we can rewind to your requirements at very moderate charges. Write for quotation.—The Sturdy Electric Co., Derwent View, Dipton, Newcastle-on-Tyne.

CASH OR EASY TERMS.—Prompt Delivery anything Radio. Mains or Battery Sets, Components, Kits, Valves, Speakers, Etc., Etc. Your inquiry will receive prompt and personal attention.—Newby, Birchwood Avenue, Long Eaton, Nottingham.

BARGAINS.—Meteor 3 Kits, £2/12/- (few only). S.T. 300 Author's Kits, £2/15/-. Challenger M.C. P.M. Speakers, £1/6/-. All wireless journals' kits in stock. Old sets taken in part exchange for 1933 models. We quote keenest prices for anything wireless.—Servwell Wireless Supplies, 74 Gough Street, London, E.14.

EBONITE PANELS.—Finest quality, jet black, or beautifully walnut grained. Brilliant mirror polish. Sizes and prices: 12 by 7 in., 2/6; 14 by 7 in., 3/-; 18 by 7 in., 3/9; 16 by 8 in., 3/0, post paid. Drilled to your own specification, 1d. per hole.—Kenneth B. Caplin, 22 Station Road, Totton, Hants.

WE CAN MAKE A SPECIALLY GOOD ALLOWANCE for your old Set, Speaker, or Components, as part payment for any modern apparatus. State what you have to sell. State what you wish to buy. Offer by return post.—Mutual Radio Services, 97 Rodney Street, Birkenhead.

AGENTS WANTED to sell Private Christmas Cards. Sample Book Free. Good Commission.—Apply, Denton, Ltd., Dept. D118, Accrington.

BANKRUPT BARGAINS.—List free with 3-valve diagram. 3-valve Kit, 22/6. Century Super, 75/- . S.T.300, 42/- . Dual coils, 3/6. Transformers from 2/9. H.F.C., 1/- . Panels 2/3. S.M.0005, 3/6. Valve holders, 4d. 1-mfd, 1/8. 2-mfd., 2/- . Switches, 4d. D.C. M.C., 18/6. Brown Vee, 10/- . Millgate, 2/6. D.R. voltmeters, 4/- . Cabinets from 4/- . Speakers complete, 7/6. Quotes by return.—Butlin, 143b, Preston Road, Brighton.

FIVE-VALVE SUPER-HET KIT, complete with valves (Mazda Pentode), O.P. transformer, assembled or otherwise, £6.—W. Bushell, Briston, Melton Constable, Norfolk.

John Watt's *Songs from the Shows* enter upon a new series in the coming autumn, when he intends to take popular successes of the London theatres as the central idea, giving listeners samples of Victorian musical comedy interspersed with extracts from more recent shows.

**THE MOST POPULAR
RADIO-GRAM CABINET
ON THE MARKET**

Reduced to **39/6** Carriage to **39/6** Paid!!!

Quality Guaranteed Improved
Soundly constructed in selected oak etc. and hand polished.

SPECIFICATION.—3' 3" high, 1'10" wide, 1'6" deep. To take panels up to 18" x 7". Panel opening to suit set. These cabinets allow ample room for the following:—
Pick-up, Motor, Speaker, Batteries, etc., all for the reduced price of 39/6.

Catalogue Post Free. From one of the Largest Mail Order Works in England: **W. S. WILKIN, Cabinet Manufacturer, 12-28 Nelson Mews, Southend-on-Sea, Essex.**



DESIGNS FOR APPARATUS FOR ANY RADIO PURPOSE, INCLUDING TRANSMISSION. OVERSEAS ENQUIRIES INVITED; ANY APPARATUS SUPPLIED. CONSTRUCTIONAL WORK UNDERTAKEN.

We undertake to solve your Problems, including obtaining Amateur Transmitting Licence. Whatever your difficulty, write us. Charges: 3/- per query, four or more, 2/6 each, with diagrams.

Radio Technical Agency, (Dept. A.W.), 2, Westgate Chambers, Newport, Mon.

OUR CATALOGUE

contains much useful information on the winding of small transformers and chokes.

3d. POST FREE.

LUMEN ELECTRIC COY, 9 Scarisbrick Ave., Litherland, Seaforth, Lancs.

"PAULETTE" All-Wave TUNERS
(Reg.)

No coils to change. Greatly improved selectivity and range. Price, with switch, 7/-, post paid. Also Ultra Short-wave Tuner, with switch, 5/6; Short-wave Adaptor Coil, 4/- . Send stamp for six free wiring diagrams of "Paulette" Sets, including "Paulette" Triple Three and Short-wave Adaptor, easy to construct or change over to Triple Three. Parts for "Paulette" Three cost £2 9s. 3d.

PAUL'S WIRELESS STORES, 43 Caroline Street CARDIFF

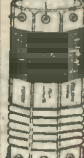

"HOW TO MAKE YOUR OWN MAINS TRANSFORMER"

(Continued from page 510)

assembly of T and U pieces in each layer, from left to right. The insulated side of the stampings must be kept the same way, upright through the core, in order to maintain a layer of insulation between each. The core opening is packed tightly with as many stampings as possible, so that when the stampings are clamped the bobbin may not be loose on the core. Before fixing the end clamps, two pieces of Leatheroid should be cut to fit over the sides of the bobbin, and lie on the faces of the stampings. These are placed on either side of the transformer, between the stampings and the end clamps, to prevent the clamps from being in metallic contact with the faces of the iron core.

Clamping the Assembly

The clamps are now fixed in position, and the whole assembly tightened up. Any looseness in the core will be apparent when the transformer is in use, in the form of a buzzing or humming sound. The terminal board is next mounted in position, and the leads and tappings from the windings are connected to the terminals in the manner shown in the illustration. Systoflex tubing being used to insulate the wires. The positioning of the terminals on the terminal board has no influence on the performance of the transformer, and may be left to individual constructors. On the transformer illustrated in the heading, spacing pieces were placed between the clamps and the terminal board to give added room under the terminals, but the clamps, which can be obtained from suppliers previously mentioned, are sufficiently high to make the addition of spacers unnecessary.

A Test

The transformer was silent on test, and the test results were as follows:—
Insulation resistance, Infinity.
Efficiency with all windings at full load, 86.6 per cent.

Ratios, 220 volts 230 volts	} 211 volts, 13.87 volts, 4.0 volts.
240 volts 250 volts	

This transformer being designed to work on 50-cycle mains, will operate satisfactorily on any frequencies higher than 50 cycles, at the voltages which the primary tappings provide for, but if it is connected to mains on which the frequency is appreciably lower, unsatisfactory working, together with overheating and excessive primary current will result.

"Amateur Wireless and Radiovision." Price Threepence. Published on Thursdays and being the date of Saturday immediately following. Post free to any part of the world: 3 months, 4s. 6d.; 6 months, 8s. 9d.; 12 months, 17s. 6d. Postal Orders, Post Office Orders, or Cheques should be made payable to "Bernard Jones Publications, Ltd."

General Correspondence is to be brief and written on one side of the paper only. All sketches and drawings to be on separate sheets. Contributions are always welcome, will be promptly considered, and if used will be paid for. Communications should be addressed, according to their nature, to The Editor, The Advertisement Manager, or The Publisher, "Amateur Wireless," 58-61 Fetter Lane, London, E.C.4.

Amateur Wireless
FEE 1/-

**INFORMATION BUREAU
COUPON**
Available until Saturday
SEPTEMBER 17, 1932

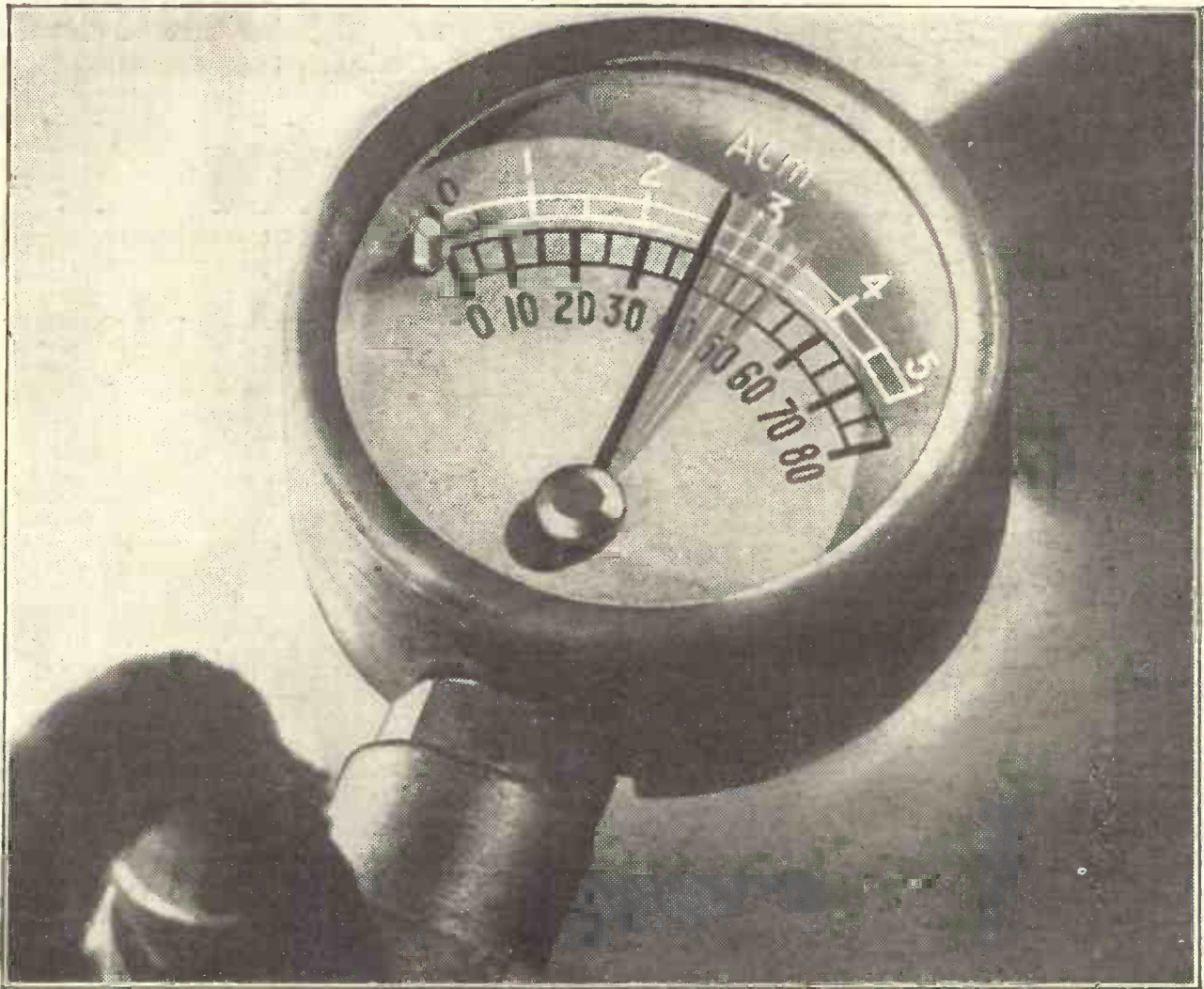

MORE SALES PRESSURE!

When buying resistance is greatest, then is the time to increase sales pressure. If you have yet to experience the countless ways in which advertising will help your business to progress more rapidly and profitably than it has ever done before, now is the opportune moment to start. The advertising which appears day by day is issued because its sponsors have proved its value.

IT PAYS TO ADVERTISE

Issued by the Institute of Incorporated Practitioners in Advertising in conjunction with the Federations of Master Process Engravers and Master Printers, etc.

A14-1

Don't Forget to Say That You Saw it in "A.W."

Your H.T. for 1/- a year



How long does one shilling's worth of H.T. run your set? A week—or a year? If you run from batteries you spend at least 50/- annually on upkeep; replace your battery with an Ekco Unit and your yearly cost is one shilling only.* All you have to do is plug into the electric light or power socket and switch on—that's all!

Whatever the type or size of your radio set, there is an Ekco Unit for it

See your dealer about it, or post coupon below.

Based on 1000 hours' use of average 3 v. Set.

All Ekco Units are obtainable by Easy Payments.

D.C. Units 39/6 ; A.C. Units from £2. 15. 0



Housed in solid drawn steel case, oxidised copper finish. Connecting plug recessed below surface of case. Size:— 9" x 5" x 3 1/2" (R.25 and 25 cycle models 9 3/4" x 5 3/8" x 3 3/4")



To E. K. COLE, LTD., (Dept. K19), Ekco Works, Southend-on-Sea. Please send me details of EKO Electric Power Units, Consolettes, Consoles and Radiograms.

Name.....
Address.....

Handwritten signature or scribble at the bottom left corner.

FREE SUPPLEMENT "WIRELESS MADE EASY"

Amateur Wireless

and
Radiovision

BIG
SPECIAL
ISSUE

Every
Thursday

3^d

Vol. XXI. No. 536

Saturday, September 17, 1932

FREE →
Supplement

**Wireless
MADE EASY**

CONTENTS OF THIS SUPPLEMENT FOR
ELEMENTARY WIRELESS COURSE FOR
BEGINNERS—STEP 1 By J. H. Keyser, B.S.
(MONTREAL, QUEBEC)
PERCY W. HARRISS BUILDING OF A
A unique construction for an amateur
simple construction—wired.
BY DE WITTS 2240 T.M. FOR BEGINNERS
ADDITIONAL INFO SEND For 10 C.P.S. 13

**A SIMPLE-TO-BUILD
"STAR" RECEIVER** **THE WIZARD**

IN THE HANDS OF RADIO EXPERTS



The leading electric wire manufacturers for over fifty years, Lewcos have been in the van of radio progress from the commencement. Lewcos Components are indispensable for perfect reception. Write for leaflets with these reference numbers.

COMPONENTS OF EVERY		DESCRIPTION
L.F. and H.F. Transformers	Leaflets Ref. Nos. A76
L.F. and H.F. Chokes	" " A76 & 78
Potentiometers	" " A79 & 81
Band-pass Filters	" " A73a
Spaghetti Resistances	" " A78
Silk and Covered Wires.		Glazite Connecting Wire.

Lewcos

REGD

LEWCOS RADIO PRODUCTS FOR BETTER RECEPTION
 THE LONDON ELECTRIC WIRE COMPANY AND SMITHS LIMITED, CHURCH ROAD, LEYTON, LONDON, E.10

To Ensure Speedy Delivery, Mention "A.W." to Advertisers

Whatever set you possess, an Ever Ready Battery will power it most economically, most satisfactorily and for a longer time; Ever Ready Batteries are made to fit and power exactly every wireless set made. And every Ever Ready Battery is guaranteed satisfactory by the makers of batteries for the past 30 years.

**CHEAPER TO USE
BETTER QUALITY
GREATER VOLUME
LONGER LIFE**



EVER

**WIRELESS
DRY
BATTERIES**

READY

THE BATTERY YOU WILL ULTIMATELY USE

THE EVER READY CO. (Great Britain) Ltd. HERCULES PLACE
HOLLOWAY, LONDON, N.7.

Mention of "Amateur Wireless" to Advertisers will Ensure Prompt Attention

EVERYTHING **The S.E.C.** ELECTRICAL
Your Guarantee



LATEST DEVELOPMENTS

OSRAM 2-VOLT SCREEN-GRID BATTERY VALVES with the WEMBLEY FILAMENT

VS.2 (Metallized or Clear) PRICE 16/6

A new variable mu. valve with outstanding characteristics—long range, improved selectivity, adequate volume control, with only a 9-volt grid bias battery.
 MUTUAL CONDUCTANCE 1.25 ma/volt at Ea 150, Esg 70, Eg. 0.
 at Eg-9 0.05 ma/volt.

S.22 (Metallized or Clear) PRICE 16/6

The high slope screen grid valve to improve the reception of any three valve Kit set. Replace your old screen-grid valve with an OSRAM S.22.—A tonic to any set with single stage screen-grid.
 MUTUAL CONDUCTANCE 1.75 ma/volt at Ea 150, Esg 75, Eg. 0.

S.21 (Metallized or Clear) PRICE 16/6

The screen-grid valve with new automatic OSRAM cushion springing and special non-microphonic construction. Designed for range with stability. A sensitive detector valve with entire absence of microphonics.
 MUTUAL CONDUCTANCE 1.1 ma/volt at Ea 150, Esg 70, Eg. 0.

OSRAM
 2-volt Valves with the WEMBLEY FILAMENT

PRICES

		PRICE
VS.2	Variable Mu. Screen Grid	16/6
S.22	High slope Screen Grid	16/6
S.21	Medium slope Screen Grid	16/6
H.2	High amplification Det. and RC.	7/6
HL.2	The non-microphonic Detector	7/6
LP.2	L.F. and Small Power	8/9
P.2	Super Power	12/6
PT.2	Economy Power Pentode	17/6

The OSRAM VS.2, S.22, S.21, H.2, HL.2 can be supplied either metallized or clear.

Osram Valves

Write for the OSRAM Wireless Guide (1932 Edition) Sent Post Free on request.

MADE IN ENGLAND

Sold by all Wireless Dealers

EXTRA QUALITY WITHOUT EXTRA COST

Adv. of The General Electric Co. Ltd., Magnet House, Kingsway, London, W.C.2

To Ensure Speedy Delivery, Mention "A.W." to Advertisers

BY FERRANTI- THE PERFECTION OF THE SUPER - HETERODYNE PRINCIPLE

Technical men are enthusiastic in their praise of the foresight shown in the design of the Ferranti 7-Valve Super-Heterodyne. This new receiver provides the sharp selectivity and freedom from interference demanded by modern conditions—and something more. For the Ferranti designers realised the vital importance of ensuring that no microphonic vibrations should occur in this super-sensitive super-heterodyne receiver, and made special provision for this purpose. Accordingly, the whole chassis is non-microphonically mounted on resilient rubber. This is just one instance of the care taken in perfecting the Ferranti Super-Heterodyne to the highest standard of efficiency yet attained.

† Suitable only for 200/250 volts A.C. supplies having frequencies between 40 and 60 cycles.

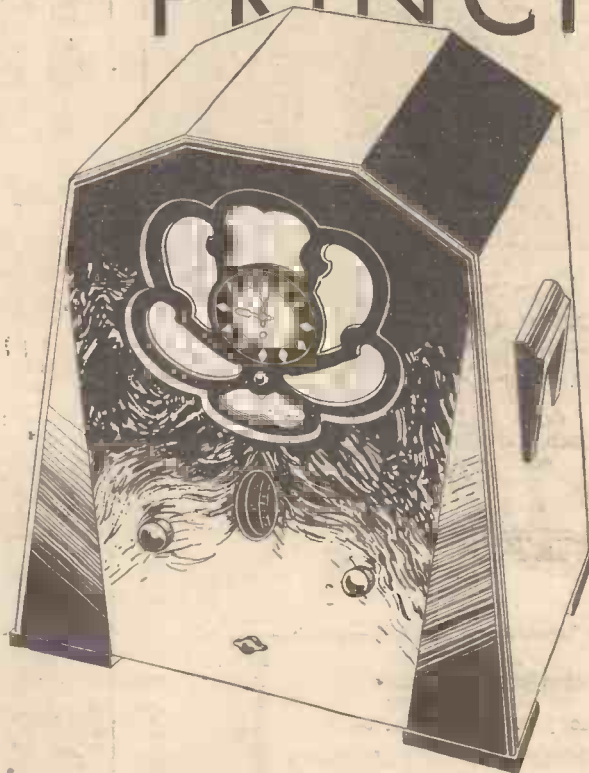

The design incorporates the most modern features, including INITIAL H.F. AMPLIFICATION, preventing interference with other sets; VARIABLE MU VALVES, providing the best form of volume control, GANGED CONDENSERS, giving one knob tuning; BAND PASS COUPLING, ensuring high selectivity without loss of high notes; MOVING COIL SPEAKER, for high quality reproduction; TONE CONTROL, to provide sharp or mellow tone at will; ILLUMINATED WAVELENGTH SCALE, giving instant station identification; AUTOMATIC MAINS AERIAL DEVICE, enabling the Receiver to be moved easily from room to room and used wherever an A.C. light or power socket is available; and provision is made for GRAMOPHONE PICK-UP.

CLOCK MODEL,

Incorporating Ferranti Electric Clock and Station Dial—for time controlled frequencies only—25 GUINEAS, or Deposit 45/- and 12 Monthly Payments of 44/-.

STATION DIAL MODEL, 23 GUINEAS

or Deposit 43/- and 12 Monthly Payments of 40/4d.

STANDARD MODEL,

as described in specification, with wavelength indicator, 22 GUINEAS or Deposit 42/- and 12 Monthly Payments of 38/6.

FERRANTI

7-VALVE SUPER-HET

For illustrated literature write to

FERRANTI LTD., HOLLINWOOD, LANCS. AND BUSH HOUSE, LONDON, W.C.2.

Please Mention "A.W." When Corresponding with Advertisers

unseen, unheard,
unsuspected

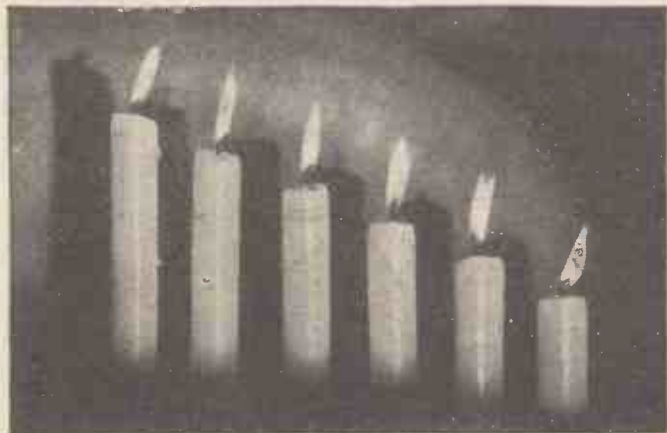

**It robs you under
your very eyes!**

You cannot watch the gradual onslaught of valve deterioration as you can watch a candle gradually being consumed. Probably you notice nothing until, one day, you suddenly realise that your set is, somehow, failing to give you the same pleasure as before.

Fortunately the remedy is simple. Fit a set of ETA valves and your set will be as good as, or even better than, it was when new. ETA valves will restore its original purity and richness of tone, its selectivity, its clarity, and every item of every programme will be a joy to listen to. There is an ETA valve for every purpose and every set. ETA valves are famous for their high quality. They give and maintain perfect reproduction. And yet they cost less than valves that are no better in any way. If you are uncertain which ETA valves your set requires send the coupon below.

**YOU NEED NEW VALVES
GOOD VALVES — ETA VALVES**

ETA
THE INTERNATIONAL VALVE



Prices
from
5/6

SERVICE COUPON

To the **ELECTRICAL TRADING ASSOCIATION LTD.**,
Aldwych House, Aldwych, London, W.C.2.

A. Please let me know the correct type of ETA valves to
replace my present valves which are as under

1..... 2..... 3..... 4..... 5.....
(Insert type letters and number)

B. Please advise me which ETA valves to use for the following
receiver or circuit.

Specify Type No. and Name.....

Name.....

Address.....

A.W. 17/9/32

**Whatever type of
MICA CONDENSER
you want...ask for
DUBILIER**

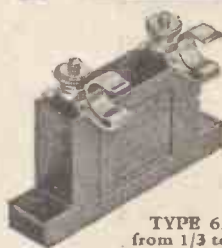

TYPE 620
from 1/3 to 3/-

TYPE 665
6d. and 9d.

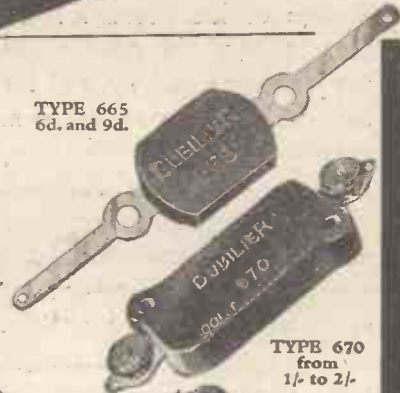

TYPE 670
from
1/- to 2/-



TYPE B.775 from 3/- to 37/6



TYPE 610
from
1/3 to 3/-



DUBILIER
MICA CONDENSERS

From the Type 665 at 6d. to the Type B.772 at 37/6, there is a Dubilier Mica Condenser for your every need.

When you know that Dubilier Condensers contain the finest materials, that they are rigorously tested before leaving the factory and that behind them they have over 20 years reputation for Dependability, you can be sure that for every penny you invest in Dubilier Condensers you receive REAL VALUE.

DUBILIER CONDENSER CO. (1925) LTD.
Ducon Works, Victoria Road, North Acton, W.3

Have you seen the new Dubilier booklet, "How to choose your Condensers and Resistances"? Ask your dealer for a copy or write direct to us.

They Never Disappoint!



COMPONENTS are built to a purpose not to a price. They are in a class that is acknowledged to be superior yet they cost no more, and in the very critical circuits of 1932-33 their selection is absolutely essential to satisfactory results.

DUX

The Transformer for the Million

There is no doubt that "DUX" has set the standard of super-efficiency in Low Priced Transformers.

The New Season's Productions definitely prove that no advance has been made to equal the performance of "DUX," which again leads in its pre-eminent suitability for all new phases of Modern Radio.

Full Technical details are given with "DUX" as with the highest priced Transformers. You are assured of its unflinching reliability before you buy—"DUX" never disappoints.



PRICE
6/9

INDUCTANCE
30 HENRIES.
List No. DY 29. Ratio: 3-1
standard or 1-4 (auto-connection).



8/9

DUX' AUDIRAD

The Choke that has again Proved Absolute Supremacy as a combination component dealing with H.F. as well as L.F.

It is specially suitable for all modern circuits and particularly so for mains receivers.

FOR MAINS SETS it is super-efficient for smoothing or output filtering in A.C. or D.C.

FOR BATTERY SETS it gives an amazing output filter service and ensures freedom from unwanted current fluctuations.

List No. DY 31. L.F. Inductance 25 henries. H.F. Inductance of H.F. Stopper 10,000 micro-henries. Maximum D.C. Current 50 m.a.

ASK YOUR DEALER OR US FOR COPIES of THE "DUX" AUDIRAD LEAFLET and "DUX" TRANSFORMER FOLDER. Full Technical information and diagrams are given therein.



FOR CIRCUITS of SATISFACTION specify

Advt. of R.I. Ltd., Purley Way, Croydon.

Telephone: Thornton Heath 3211.

To Ensure Speedy Delivery, Mention "A.W." to Advertisers



CONDENSERS OF REPUTE

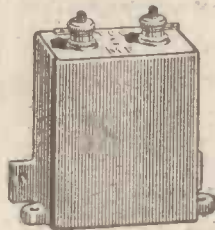

A 2 mfd. Non-Inductive T.C.C. Condenser. Price 3/10d. Made in capacities from .01 to 2 mfd. prices 1/10 to 3/10. Working voltage 200 D.C.

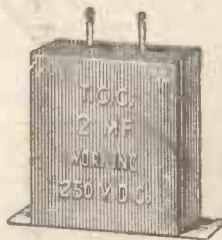

Here is a 2 mfd. T.C.C. Paper Condenser type 64 tested 500v. D.C. for working up to 250v. D.C. peak—in capacities from 0.1 to 10 mfd. Prices 1/10 to 14/-.



The latest T.C.C. production—a chassis mounting aqueous Electrolytic condenser. In capacities 8 mfd. 440 volts working, 9/-; 4 mfd. 440 volts working, 8/-; and 7 mfd. 460 volts working, 9/-.

WHAT THE INITIALS T.C.C. MEAN TO YOU

WHEN you see a condenser with the initials T.C.C. on it you see a condenser that is the result of 25 years specialized research—one that is built up of the finest materials procurable, by highly skilled workers. It is a condenser of unquestioned reliability—one in which radio technicians, set designers, experimenters and amateurs alike pin their faith. Be guided—use only T.C.C.



Here is shown the T.C.C. type "M" Mica Condenser. Made in capacities from .00005 to .01. Prices 1/- to 2/3. Working voltage 250 D.C.

The Upright Mica Condenser with grid leak clips. In capacities from .00005 to .25 mfd. Prices 1/6 to 18/- Working voltage 250 D.C.

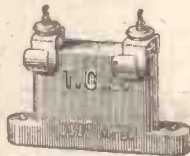

T.C.C. ALL-BRITISH CONDENSERS

The Telegraph Condenser Co., Ltd., Wales Farm Road, N. Acton, W.3.

♥ 1160

PUT POWER IN YOUR SET!

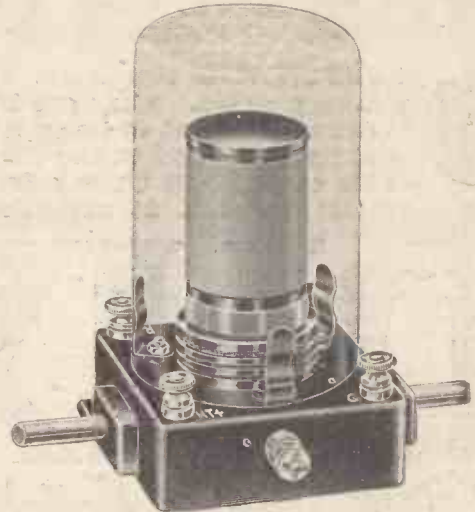

These new British General Dual-Wave Coils enable you to achieve remarkable results in regard to both power and selectivity.

The ordinary cheap receiver, with these coils incorporated, can be converted into a strikingly effective modern set.

Full details and wiring diagrams supplied.

Price 9/6, Aerial and anode models (suitable for ganging).

From all dealers or direct from the manufacturers.

BRITISH GENERAL

British General Manufacturing Co., Ltd., Brockley Works, London, S. E. 4.



"We're Fluxite and Solder, The reliable pair, Famous for Soldering—Known everywhere! Now here is a statement—Bound to come true, If you'll invite US To come and help You!"

See that Fluxite and Solder are always by you—in the house, garage, workshop—anywhere where simple, speedy, soldering is needed. They cost so little, but will make scores of everyday articles last years longer! For Pots, Pans, Silver, and Brassware; RADIO; odd jobs in the garage—there's always something useful for Fluxite and Solder to do.

All Hardware and Ironmongery Stores sell Fluxite in tins, 8d., 1/4 and 2/8.

ANOTHER USE FOR FLUXITE Hardening Tools and Case Hardening. Ask for Leaflet on improved method.

NEW "JUNIOR" SIZE, 41. per tin FLUXITE SOLDERING SET

Simple to use and lasts for years in constant use. Contains special "small-space" soldering iron, with non-heating metal handle; pocket blow-lamp, Fluxite, Solder, etc.; and full instructions.

COMPLETE, 7/6, or LAMP only, 2/6.

FLUXITE, LTD. (Dept. 323)

ROTHERHITHE, S.E.13

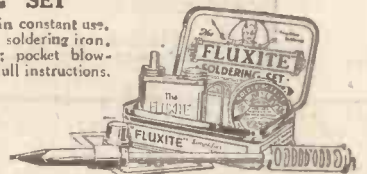

ALL MECHANICS WILL HAVE

FLUXITE IT SIMPLIFIES ALL SOLDERING

You will Help Yourself and Help Us by Mentioning "A.W." to Advertisers

G.E.C. Radio

Supremacy in Radio

POINTS THAT HAVE SOLD THOUSANDS—

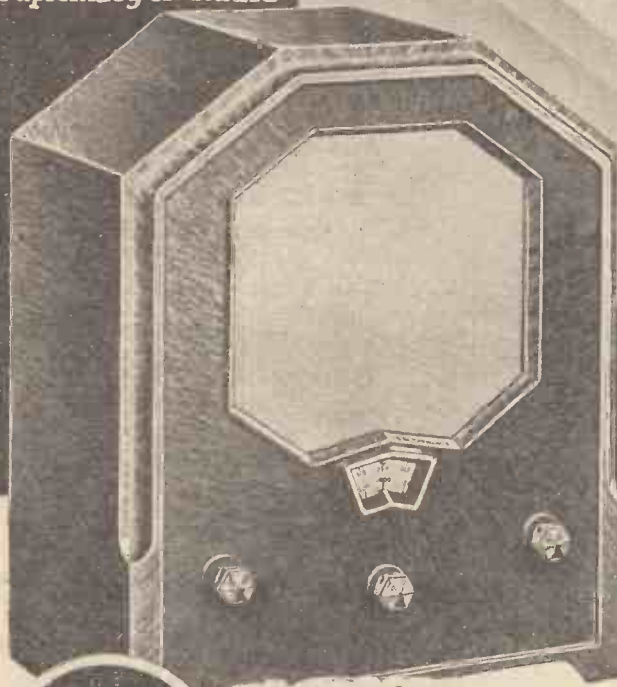

- 2 OSRAM SCREEN-GRID VALVES**
- ENTIRELY SELF-CONTAINED WITH ACCOMMODATION FOR BATTERIES**
- HANDSOME ONE-PIECE BAKELITE CABINET**
- SINGLE KNOB TUNING**

ALL FOR 9 GNS.

Complete with cabinet, built-in loud speaker and OSRAM VALVES

HIRER PURCHASE—Deposit £1 and 12 monthly payments of 15/-

SPECIAL FEATURES

- 1 A complete table model receiver with built-in loud speaker.
- 2 Batteries housed inside cabinet—no external battery connections.
- 3 Two metallised OSRAM screen-grid valves and latest type OSRAM power output valve.
- 4 Screen-grid detector gives great sensitivity.
- 5 Tuning by one knob only.
- 6 New magnetic loud speaker chassis with floating cone ensures highest quality reproduction.
- 7 Unit assemblies make home construction the essence of simplicity.
- 8 Latest OSRAM valves (battery type) with the Wembley filament.
- 9 Handsome one-piece cabinet in moulded Bakelite—walnut graining.

MADE IN ENGLAND

Sold by all Wireless Dealers

Osram

THIRTY-THREE

MUSIC MAGNET

3 OSRAM VALVES
Two Screen Grids

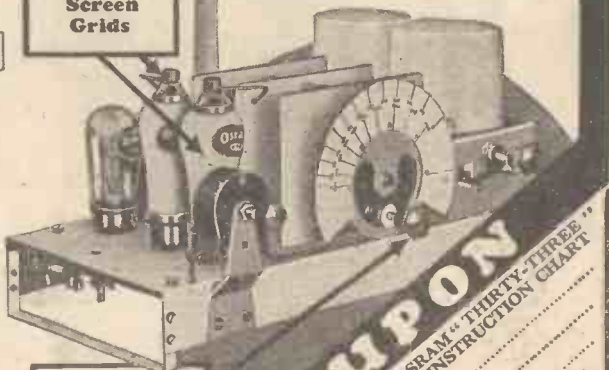

ONE KNOB ONLY FOR TUNING

WRITE for the OSRAM "THIRTY-THREE" Constructor's Instruction Chart. It is crammed full of useful hints and tips. The clear instructions will convince you that this is the world's best circuit and assembly kit.



This extremely efficient and reliable Kit set instantly fires the imagination of everyone who is looking for a first-class receiver that will satisfy modern ideals of performance and appearance. It has no competitor in its class. Cheaper sets—yes! But the OSRAM "THIRTY-THREE" is built up to a standard and not down to a price. The policy of sound engineering construction has always been placed first in designing all models of OSRAM Music Magnets. Already it has resulted in the selling of thousands of OSRAM "THIRTY-THREE" Kits.

COUPON

Please send me the OSRAM "THIRTY-THREE" MUSIC MAGNET INSTRUCTION CHART

Name: _____
Address: _____

The General Electric Co. Ltd.
Magnet House,
Kingsway,
London,
W.C.2.

A.W. Cut out and paste on postcard, or enclose in unsealed envelope. Half-enny postage in either case.

A SIMPLE STEP FROM CHART TO SET

Advt. of The General Electric Co. Ltd., Magnet House, Kingsway, London, W.C.2.

A WORD about FIXED CONDENSERS

The chief consideration in buying fixed condensers is service, and from this point of view Ferranti Condensers are a by-word. Add to this the fact that Ferranti are the lowest priced quality condensers on the market, and you'll decide on Ferranti—the Condensers you can 'fit and forget.'

Just consider these features in addition to those above:

FERRANTI CONDENSERS

1 Their test pressures are higher than those of many other condensers of similar type and price, yet the dielectric material is not unduly stressed.

2 Their insulation resistances are much higher per 2 Mfd than can usually be claimed, and are maintained in service.

3 They are not of the "Mansbridge" pattern but are of the rolled foil type giving extremely low internal resistance. This facilitates the smoothing action and greatly reduces the possibility of back coupling.

4 They are easily capable of withstanding all service conditions for a long period, being designed and made by Engineers whose experience includes the building of condensers for working pressures of more than 1,000,000 Volts.

It is only natural that Ferranti Fixed Condensers should be so often recommended when experts are designing a Receiver or Unit in which Quality is the dominating factor. There are types to suit your need exactly—detailed in Leaflet W.522.

Ferranti Ltd. Head Office & Works, Hollinwood, Lancashire.
London: Bush House, Aldwych, W.C.2.



PRICES from 3/- to 9/6
PACKS from 24/- to 30/-

POLAR STAR CONDENSERS

STRONG SPRING MAINTAINS TRIMMER AT CONSTANT VALUE



MINIMUM TRIMMER

Throughout the whole of their traverse, the adjusting screws maintain an even tension. Whatever the position of the trimmers, they cannot go out of adjustment and the capacity remains unaltered under all conditions.

Trimmers operated from top.

Other outstanding features: ACCURATE SPACING OF VANES obtained by Precision Machine Assembly; MATCHING ACCURATE to within one half of 1 per cent., plus or minus 1 mmfd. ALL-STEEL FRAME; STRONG SPRING JOURNAL BEARINGS give absolute freedom from shake or end-play.

From the "Wireless Trader" test report:

"... remarkable accuracy in matching has been obtained.

"This is undoubtedly one of the best gang condensers on the market..."

PRICES	
3 x .0005	25/6
Super-hot Type. two sections .0005 with one tracking section	27/6
4 x .0005	34/-
All prices include covers	
DISC DRIVE	5/-
DRUM DRIVE	7/6

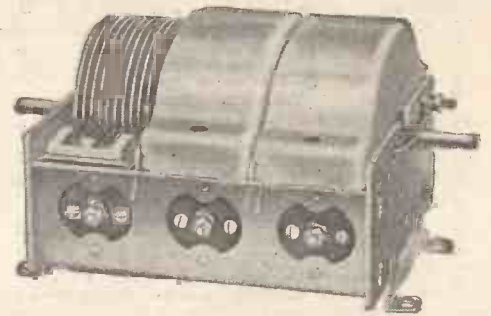

POLAR

FREE — CATALOGUE OF COMPLETE RANGE
WINGROVE & ROGERS LTD.
188-9 STRAND, LONDON, W.C.2
POLAR WORKS LIVERPOOL

Correspondence in all languages. Representative for France: W. A. Swift, 6, Rue Dequerry, Paris, XI.



You will Help Yourself and Help Us by Mentioning "A.W." to Advertisers

FOR EVERY SET — there's a PILOT AUTHOR KIT

CASH — C.O.D. — or H.P.

EVERYTHING RADIO Manufacturers' Kits

COSSOR MELODY MAKER. Model 335. Complete with valves, speaker, and cabinet. Cash Price, £7/17/6. Balance in 11 monthly payments of 14/10. **Send 10/- only**

COSSOR ALL-ELECTRIC MELODY MAKER. Model 336. Complete with valves, cabinet and speaker. Cash Price, £11/15/0. Balance in 11 monthly payments of 21/7. **Send 21/7 only**

RADIO FOR THE MILLION "STATION MASTER 3" (Model A.). With valves and cabinet. For battery use. Cash Price, £5/11/0. Balance in 11 monthly payments of 10/2. **Send 10/2 only**

"STATION MASTER 3" (Model B.). With valves, speaker and cabinet. For battery use. Cash Price, £7/10/0. Balance in 11 monthly payments of 14/-. **Send 10/- only**

SLEKTUN SCOUT S.G.3.—S.G., Detector and Power. Pilot Author Kit "A" (less valves and cabinet). Cash or C.O.D., £4/8/6. **Send 8/1 only**

Balance in 11 monthly payments of 8/1

OSRAM "THIRTY THREE" MUSIC MAGNET. Complete Kit comprising all components, including valves, cabinet, with self-contained speaker. Cash Price, £3/9/0. **Send 15/- only**

Balance in 11 monthly payments of 17/6.

THIS YEAR'S WINNER

LISSEN "SKYSCRAPER 3." Chassis model with (Lissen) S.G., Detector and Pentode valves. Cash Price £4/9/6. **Send 8/3 only**

Balance in 11 monthly payments of 8/3.

READY RADIO KENDALL-PRICE S.G.4. S.G. Detector, L.F. and Power. Complete Kit less valves and cabinet. Cash Price £4/6/6. **Send 8/- only**

Balance in 11 monthly payments of 8/-

READY RADIO 303. 3-valve kit (Det., 2 L.F.) with valves, cabinet and permanent-magnet moving-coil speaker. Built in 20 minutes! Cash Price £5/17/6. **Send 12/7 only**

Balance in 11 monthly payments of 12/7

READY RADIO "METEOR" S.G.3. 3-valve screen-grid receiver with valves, cabinet, and permanent-magnet moving-coil speaker. Covers short, medium, and long waves without coil changing. Cash Price £8/17/6. **Send 16/3 only**

Balance in 11 monthly payments of 16/3

TELSEN "AJAX 3." Complete Kit less valves and cabinet. Cash Price, £3/1/6. **Send 5/8 only**

Balance in 11 monthly payments of 5/8

TELSEN "JUPITER" S.G.3. Complete Kit less valves and cabinet. Cash Price, £3/17/0. **Send 7/- only**

Balance in 11 monthly payments of 7/-

ULTRA 1933 TIGER RECEIVER. A.C. or D.C. Mains. S.G., S.G. detector and Pentode. Moving-coil Speaker. Complete with Mazda Valves ready for use. Cash Price £15/15/0. **Send 20/- only**

Balance in 17 monthly payments of 20/-

PILOT BAND-PASS UNIT

Whether your set is Mains or Battery operated, the **PILOT BAND-PASS UNIT** cuts out programme interference effectively and sharpens tuning to needle-point selectivity. It is simple to attach and can be operated by anyone without technical knowledge. No valves or extras required.



CASH or C.O.D. Or 6 monthly payments of 4/6.

WIZARD

KIT "A"

As described in this week's issue. Author's Kit of specified parts, including ready-drilled panel, less valves and cabinet.

CASH OR C.O.D. DELIVERY FROM STOCK

80/-

or 12 monthly payments of 7/4.

1 PETO-SCOTT SPECIAL CABINET £1 0 0
SPECIFIED VALVES £1 12 3

THESE ARE THE PARTS THE AUTHOR USED.

Any items supplied separately. If order value over 10/- sent C.O.D. Post charges paid.

	s.	d.
1 Red Triangle ebonite panel, 14 in. by 7 in., ready drilled	4	6
1 Peto Scott baseboard, 14 in. by 9 in.	1	6
2 Ready Rad "Micalog" .0005-mfd. condensers	7	0
2 Ready-Rad slow-motion disc drives	8	0
1 Lissen two-gang coil unit and switch	17	6
1 Lissen .0005-mfd. variable reaction condenser	6	6
2 Telsen 1-mfd. fixed condensers	4	6
1 Telsen 2-mfd. fixed condenser	3	0
1 Dubilier .00005-mfd. fixed condenser, type 670	1	0
2 Lissen .0002-mfd. fixed condensers	1	0
1 Dubilier 2-megohm grid leak with wire ends	1	0
1 Tunewell 30,000-ohm spaghetti resistance	1	4
1 Wearite screened high-frequency choke	3	6
1 Slektan standard high-frequency choke	4	0
3 W.B. 4-pin valve holders	1	6
1 Bulgin "Senator" resistance-fed transformer	6	9
2 Terminal strips	8	8
1 Sovereign .0003-mfd. pre-set series aerial condenser	1	3
2 Belling-Lee terminals marked "Pick-up"	5	5
1 Ready-Rad radio gram change-over switch	2	9
6 Belling-Lee wander plugs, marked	1	0
2 Belling-Lee spade terminals, marked: L.T., L.T., L.T.	4	
6 Yards thin flex, connecting wire, sleeving, length flexible tubing, screws and 1 terminal strip 3 in. by 2 in.	1	8
KIT "A" Cash or C.O.D.	4	0 0

KIT-BITS

Selected C.O.D. lines for the "Wizard." You pay the postman. We pay post charges on orders value over 10/-.

	s.	d.
1 Red Triangle ebonite panel ready drilled, 14 in. by 7 in., and Peto-Scott baseboard, 14 in. by 9 in.	6	0
2 Ready-Rad "Micalog" .0005-mfd. condensers	7	0
2 Ready-Rad slow-motion disc drive	8	0
1 Lissen 2-gang coil unit and switch	17	6
1 Bulgin "Senator" resistance-fed transformer	6	9

IMMEDIATE DELIVERY FROM STOCK

PETO-SCOTT CO. LTD. 77 City Rd. London, E.C.1. Telephone: Clerkenwell 9406/7
West End Showrooms: 62 High Holborn, London, W.C.2.

Dear Sirs, Please send me CASH/C.O.D./H.P. for which I enclose £.....s.....d. CASH/H.P. Deposit Also send your FREE 1933 Radio Catalogue.

NAME

ADDRESS

A.W. 17/9/32.

EVERYTHING RADIO Speakers • Accessories

EPOCH "SUPER JUNIOR" Type MM Permanent-magnet moving-coil speaker with 5-ratio transformer. Cash or C.O.D. £17/6. **Send 5/- only**

Balance in 5 monthly payments of 5/-

R & A "VICTOR" PERMANENT-MAGNET MOVING-COIL SPEAKER DE LUXE. With 6-ratio input transformer and protecting grill. Cash Price £3/10/0. **With 6/5 order**

Balance in 11 monthly payments of 6/5

R & A "BANTAM" PERMANENT-MAGNET MOVING-COIL SPEAKER. With 3-ratio input transformer. Cash Price £1/7/6. **With 5/- order**

Balance in 5 monthly payments of 5/-

EPOCH "20 C" PERMANENT-MAGNET MOVING-COIL SPEAKER. (New Edition.) With 3-ratio input transformer. Cash Price £1/15/0. **Send 6/6 only**

Balance in 5 monthly payments of 6/6

ULTRA 1933 IMP PERMANENT-MAGNET MOVING-COIL SPEAKER, with input transformer. Cash Price £1/17/6. **Send 6/10 only**

Balance in 5 monthly payments of 6/10

W.B. PERMANENT MAGNET MOVING-COIL SPEAKER. Type PM4. Complete with transformer. Cash Price £2/2/0. **Send 5/9 only**

Balance in 7 monthly payments of 5/9

EASIWAY

NO DEPOSIT. Strict Privacy. No third party collections. We deal with you direct

BLUE SPOT SPEAKER UNIT AND CHASSIS. Type 100U. Cash Price, £1/19/6. **Send 5/5 only**

Balance in 7 monthly payments of 5/5

ATLAS ELIMINATOR. Type A.C.244. Three tapplings. S.G., detector and power. Output: 120 volts at 20 m/a. Cash Price £2/19/6. **Send 5/6 only**

Balance in 11 monthly payments of 5/6

REGENTONE D.C.1 H.T. ELIMINATOR for D.C. mains, tapped S.G. detector and 120/150 volts, at 25 m/a. Cash Price £1/19/6. **Send 5/6 only**

Balance in 5 monthly payments of 5/6

GARRARD INDUCTION GRAMOPHONE MOTOR. For A.C. mains. Model 202. Mounted on 12-inch nickel motor plate with fully automatic electric starting and stopping switch. Cash Price £2/10/0. **Send 4/7 only**

Balance in 11 monthly payments of 4/7.

IMPORTANT

Part Kits, miscellaneous components or accessories are available under our own Easy Way H.P. system. Send us a list of your wants. We will quote by return without obligation.

Buy by Post — it's Quicker

Mention of "Amateur Wireless" to Advertisers will Ensure Prompt Attention

THREE FAMOUS "RADIOGRAMS" BY "HIS MASTER'S VOICE"

Now—on the threshold of the 'home season' just when thoughts are turned naturally to lengthening evenings and the revived joys of radio and gramophone—the prices of the three most popular "His Master's Voice" instruments are down! Two things have alone made possible such price reductions at such a time: the unprecedented flow of orders at Olympia, and extensive rationalisation at the great Hayes factories of "His Master's Voice"—already renowned for their scientific organisation.



Only 25 guineas now for a table radio-gramophone with the performance of a full-sized cabinet model—with all that amazing 'true to life' quality and satisfying reliability for which "His Master's Voice" instruments are famous everywhere—with simplicity of operation involving the use of but one switch for gramophone, long and medium wave wireless.



NOW COST YOU LESS!

And again—Model 521—the most popular 'radiogram' ever produced—popular because it is so easy to operate, so reliable, and so wonderfully life-like in reproduction. Now 39 guineas.

The Automatic Record-changing Model 522, identical with 521, except that it plays eight records without attention, is more compact than any other record-changing radiogram in existence. Now 46 guineas.

HEAR THESE INSTRUMENTS AT ANY "HIS MASTER'S VOICE" DEALER

"HIS MASTER'S VOICE"



"True to Life"

The Gramophone Co., Ltd., London, W.1.

Mention of "Amateur Wireless" to Advertisers will Ensure Prompt Attention



**BRITAIN'S LEADING RADIO WEEKLY
FOR CONSTRUCTOR, LISTENER & EXPERIMENTER**

EDITOR:
BERNARD E. JONES.

TECHNICAL EDITOR:
J. H. REYNER. B.Sc. AM.I.E.E.

RESEARCH CONSULTANT:
W. JAMES.

ASSISTANT EDITOR:
H. CORBISHLEY.

NEWS & GOSSIP OF THE WEEK

OUR SUPPLEMENTS!

The First of a Series Starts This Week
THIS-week we present readers with a Unique Guide to Simple Wireless—an Eight-page Supplement containing a Special Beginners Course, prepared by J. H. Reyner in collaboration with the AMATEUR WIRELESS Staff, and Mr. Percy Harris's "Build As You Learn," a step-by-step constructional feature that will appeal alike to old hands and novices. In addition, there will be found a number of helpful articles specially written for those who know little or nothing about wireless. And, remember, *this eight-page supplement will be given next week*, when the beginner's course and the constructional feature will be continued, again backed up with much information for every listener.

THE "WIZARD" IS HERE

THE "A.W." Wizard—the fine new set for all home constructors introduced in last week's issue is described in the centre pages this week. *It is the set for you.* The leading features of it are given in the drawing on page 551 and on that page also is a station log obtained on a first test. Don't miss it.

ELECTRICAL INTERFERENCE TROUBLES

Aberdeen Corporation Opposes Post Office Remedies

WHAT looks like developing into a first-class "row" has started as the result of the Aberdeen Corporation's refusal to have anything to do with remedies suggested by the Post Office to cure local electrical interference. Many complaints have lately been received about the machinery under the control of the Aberdeen Corporation, the contention being that broadcast reception is being spoiled by needless interference. We cannot understand the matter, especially as the Post Office has offered to pay the cost of the cure. This is just one more example of the

chaos that is going on through lack of legislation in electrical interference to broadcast reception. The whole question is down for discussion at Madrid, and next year we may expect the Post Office to introduce a Bill to empower them to enforce remedies where necessary.

GOOD OLD 2XAD!

B.B.C. Forsakes Beam Service for Latest American Relay

FOR the relay of Kaye Don's vain attempt to win the Harmsworth trophy the B.B.C. made use of the receivers at



The Marchese and Marchesa Marconi, snapped while on shore temporarily at Brion, after experimenting with 57 centimetre transmissions on board his yacht the Elettra.

In this Issue:

FEATURES YOU SHOULD NOT MISS

- Gramo Radio in a Nutshell.
- J. H. Reyner's Elementary Wireless Course for Beginners.
- Percy W. Harris's "Build As You Learn"—a unique constructional feature that very simply combines theory with practice.
- From Microphone to Loud-speaker.
- The "A.W." WIZARD—An All-star simple-to-build three-valver.
- Stations You Can Hear on the Short Waves

Tatsfield, where the three American relays, 2XAD, 8XK, and 3XAL, were brought in at varying degrees of intelligibility. The best was 2XAD, which was the relay used for most of the broadcast part of the transmission. There was some fading, but in view of the conditions and the time of the day we think Mr. Partridge and his assistants at Tatsfield are to be congratulated.

NEW MUSIC LINE

TALKING of music relays from the Continent, it must be remembered that for good-quality broadcasting, specially corrected lines are needed. The network of such lines is gradually spreading all over Europe, and the latest extension is now announced, from Graz to Milan. Operatic relays from La Scala Theatre, Milan, are now a possibility, though nothing has yet been fixed up by the B.B.C.

BETTER MICROPHONES

MANY listeners have commented on the improvement in the quality of the transmissions of this year's "Proms" concerts. The reason is the use of new type Western Electric condenser microphones.

NEXT WEEK: ANOTHER EIGHT-PAGE SUPPLEMENT FOR THE BEGINNER

NEWS & GOSSIP OF THE WEEK —Continued

In the vaudeville and dance-band studios, Edison Bell condenser microphones are being used with great success, due to their non-directional effect. Another type is being tried out in No. 10 studio. This is an R.C.A. moving coil, already achieving success in America.

ISLE OF MAN CALLING!

MORE recognition of its entertainment resources is being claimed by the inhabitants of the Isle of Man, who want to know why the B.B.C. does not relay any of its attractions. As a matter of fact, the line connecting Manchester with Belfast, in the B.B.C. network, passes through the Isle and it would be quite easy to tap the line. What does the North Regional Director think about it?

ULTRA-SHORT-WAVE TESTS

"WE do not want amateurs to help us in these ultra-short-wave tests—yet!" stated a B.B.C. engineer. At the moment, the great idea is for engineers to go around the town in mobile listening vans, tracking down the ultra-short-wave signals and so determining the so-called polar diagram. When this has been done, perhaps the much-postponed amateur participation will be invited. We think the B.B.C. underestimates the help amateurs could offer in this series of tests. It will be the amateurs who popularise the new waveband, anyway.

PLANS TO IMPROVE LIGHT ENTERTAINMENT

FOR the coming season the B.B.C. is greatly augmenting the light entertainment side of its Productions Department. Mark Lubbock, the young composer

A NEW TALKING TAPE



Stille-tape portable recorder used at a German school for training broadcast artistes

who wrote the music for *The King Can Do No Wrong*, will help Denis Freeman—a young man responsible for the importation of many of the fresh ideas in vaudeville. Added to these bright young men will be Lance Sieveking, so that Val Gielgud should soon have a very strong and capable team for the preparation of light entertainment for the microphone.

SWANSEA RELAY TO BE CLOSED

Sequel to the Opening of West Regional in New Year

EARLY in the New Year, West Regional, the last remaining regional station in

FOR BIRTHDAY WEEK

IN addition to the attractions already mentioned in these columns in connection with the B.B.C.'s Tenth Birthday Celebration week in November, we now hear that relays are to be given from several European capitals. Land-line relays of opera and musical concerts will be strongly featured. From America we shall get dance music over the beam service. By all accounts, this special birthday week is going to be something to shout about.

600 AT MADRID

THE International Radiotelegraphic Convention, which opened in Madrid

Fine Features for Next Week's Issue

Next week's issue will be another special bumper number, full of fine features of interest to all readers.

You will be interested in PERCY W. HARRIS on "BUILD AS YOU LEARN," and J. H. REYNER on TUNING in his ELEMENTARY WIRELESS COURSE FOR BEGINNERS SERIES.

Readers on the lookout for a fine new set for the new season should not miss the further detailed description of the "A.W. WIZARD," with which a full-size wiring plan will be given.

A SPECIAL BUMPER NUMBER

ORDER YOUR COPY NOW

the B.B.C.'s scheme, will start its tests. When in full service, this will mean the closing down of the Swansea-relay station, though its studios are to be retained to augment the talent of the Cardiff centre. Only Bournemouth and Plymouth will be left to share the 288.5-metre common wavelength, but it is feared that these two relays may cause serious interference with West National when that station gets going on the common wavelength. It looks as though the B.B.C. will have to borrow another wave or two for these south-western relays. The experiment of putting Newcastle and Aberdeen on unappropriated shortish waves has certainly proved a success. Will it be repeated for Plymouth and Bournemouth?

WHEN THE CAT'S AWAY . . .

NOW that Broadcasting House is without its ferocious cats, following their removal, as recounted not long ago, we hear that the B.B.C.'s headquarters is plagued with mice. To combat this new nuisance, the Rodent and Insect Pest Destruction Company is hard at work. Well, the name alone ought to scare off most intelligent mice!

LONG ARM OF THE N.B.C.

IN America the initials N.B.C. stand for the biggest broadcasting organisation in the Union, although over here probably many do not know that these initials stand for the National Broadcasting Company. On his way over right now is Mr. Frederic Bates, who in future is to represent the N.B.C.'s interests in this country. We shall therefore hear more of N.B.C.—much more!

on September 3, is being attended by about six hundred representatives from some seventy countries and the results of their deliberations will be awaited with interest in many parts of the world. That part of the conference which is to deal with wireless will discuss the wavebands allotted to the various services, such as broadcasting, aeronautical, shipping, direction-finding, and the like.

FROM ALL STUDIOS

WHEN the "Farewell to Savoy Hill" programme was broadcast last May, listeners were taken in turn to every studio in the building. A similar idea is to be carried into effect during the B.B.C. birthday celebrations in November, when a microphone tour of Broadcasting House will form part of the special programmes. Savoy Hill possessed nine studios—Broadcasting House has twenty-two. Ought to be some scope!

FACTS AND FIGURES

THE International Broadcasting Union recently published statistics showing the increase in licensed listeners between the end of 1926 and the end of 1931. These statistics showed that the total number of receiving sets in the world to-day is approximately 26,000,000, representing a potential audience of over 100,000,000 listeners.

On September 29 and 30 the musical play, *The Gypsy Princess* is to be revived. The broadcast adaptation is by Gordon McConnell.

FEATURES OF THE "WIZARD"

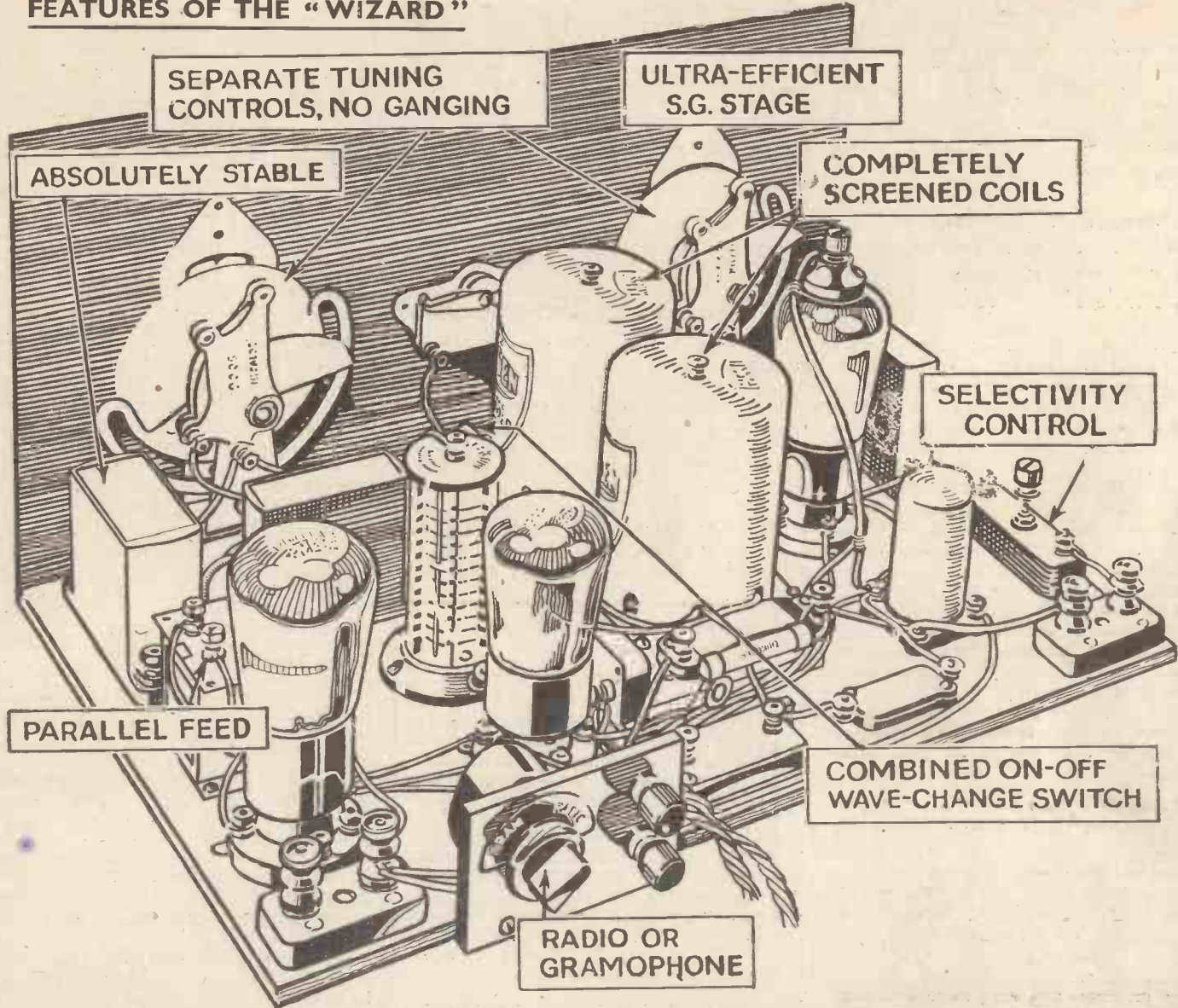

The leading-features of the "A.W. Wizard" are shown in this lettered drawing, and a Station Log is given below. Constructional details of this fine set are given on pages 568-572

STATIONS HEARD WITH THE "A.W." WIZARD

(The asterisks denote stations heard in daylight)

LONG WAVES			
*Hilversum	93	89	
Lahti	91	85	
*Radio Paris	97.5	84	
*Berlin	83	81	
*5XX	79	74	
*Eiffel Tower	72	70	
Warsaw	71	69	
Motala	69	67	
Kalundborg	65	55	
Oslo	52	47	
*Croydon	49	45	
MEDIUM WAVES			
Budapest	98	97	
Munich	95	94	
Vienna	92.5	91.5	
*Brussels (1)	91	91	
Prague	89.5	89.5	
*North Regional	88	88	
*Langenberg	87	87	
Beromunster	85	85	
Paris P.T.T.	83	83	
Rome	82.5	82.5	
Stockholm	81.5	81.5	
Berlin	79.5	79.5	
Dublin	78	77.5	
Katowice	77.5	76	
Sottens	77	75.5	
*Midland Regional	76.5	75	
Toulouse	75.5	73	
Scottish Regional	73	71	
Muhlacker	70	68	
*London Regional	68	66	
Barcelona	67	65	
*Brussels	66.5	64.5	
Milan	64	62	
Breslau	63	61	
Marseilles	61.5	59.5	
Bordeaux	59.5	57.5	
*North National	59	57	
*Huizen	57	56	
Bratislava	54	52	
Heilsberg	53	50	
Turin	52.5	49	
*Lille	50.5	46	
*London National	50	45	
Horby	49.5	44.5	
Trieste	45.5	40	
Belfast	44.5	39.5	
*Fecamp	38	34	
Cork	37.5	32	
Swedish Relay (205 m.)	30	24	

Stations You Can Hear On the Short Waves



Mander Barnett tells what short-wave reception is like now below 100

metres, and gives the result of short-wave listening during the past week.

I WONDER if you have ever given any consideration to the vast amount of entertainment which is yours for the asking on the waves below one hundred metres? At a rough guess, how many stations do you think are working on the short waves to-day? Well, some of the published lists say there are just over a hundred licensed broadcasting stations operating between 18 and 100 metres in different parts of the world. Of course, these stations are not all heard in the British Isles and quite a number of them are not regular broadcasters, but are heard on the air only occasionally. In the opinion of some of our greatest experts, the short waves are going to be absolutely the most important thing in radio in years to come. From your point of view, they will provide you with experiences and thrills which you will never be able to get on your ordinary broadcast receiver.

Daylight Range

Straightaway we must bear in mind the fact that the short waves have entirely different properties to those which we are accustomed to tuning in on our medium- and long-wave receivers. Tremendous distances can be covered in broad daylight. Signals can be sent around the world with a fraction of the power that is necessary for medium- and long-wave transmission. With a simple short-wave receiver containing no more valves than you use in your ordinary receiver, you can hear stations from all the continents.

Don't get the idea that the short waves are a hundred per cent. reliable—they certainly are not as most of the "old hands" will tell you. Their degree of reliability is unfortunately low, as short-wave transmissions are affected to a considerable extent by atmospheric conditions which may not have any effect whatsoever on a medium-wave transmission. The fact remains, though, that the short waves offer a vast scope for entertainment in the way of DX (amateur slang for "long distance") listening and for the more advanced experimenter in the way of research.

What You will Hear

The most important question that will strike the newcomer to short-wave work is perhaps—just *what* shall I hear on the short waves and how will these stations come over? Well, the following paragraphs are devoted to a few convincing answers to these questions.

First of all for the Americans. The

American stations are, I suppose, the biggest attraction for the European listener on the short waves and even in 1932 it is a pleasant boast to be able to tell the uninitiated that you received so many American stations last night! Luckily, the Americans are fairly easy to receive, and come over with good strength, as a rule. Starting at the bottom of the scale, we commence with the most popular and generally the most easily received of all the American stations—W2XAD, which oper-

WHY WORRY?

The Editor,
Amateur Wireless.

Sir,

Another wave-length conference, at Madrid, where it will be decided how we listeners are to fare for the next five years:

The B.B.C. will, I understand, be very well represented, as also Germany, Poland, Holland, Hungaria, and the Swedes. At this rate it may develop into a scramble.

The Conference may drag on for months.

When such circuits as the "Ether Searcher," "Mascot," and the "Simple Super" are supplying the needful it makes one wonder why all the fuss and worry.

J.H.T. (March, Cams.).

ates on a wavelength of 19.56 metres. You will hear him practically any evening between nine and eleven o'clock and he is often on the air at other times relaying special programmes. This is the station which the B.B.C. sometimes use for relaying programmes from the States. Sometimes, also, they make use of the commercial stations belonging to the trans-Atlantic telephone circuits, which include such stations as WMI, WNC, WND, WQV, etc. However, to return to our subject—this W2XAD station relays the programmes from the medium-wave station of WGY in Schenectady, in New York state.

A Good Stand-By

What the experienced short-wave listener cannot tell you about W2XAD will not be worth hearing, but you, as a beginner, will find him an attractive short-wave "bait," as he is very easy to identify and often comes over with a good "punch." Note here, in fact, that *all* the American stations are easy to identify. Every fifteen minutes the programme is interrupted, when the call sign is given. (This is compulsory by law.)

American programmes are run like clock-work and you can set your watch by this fifteen-minute call. Apart from this, most American stations make a point of announcing the time very frequently. These American stations broadcast a certain amount of their own programme material and the remainder is generally taken from one of the networks of either the C.B.S. (Columbia Broadcasting System) or the N.B.C. (National Broadcasting Company). Even then, the fifteen-minute call is given, except in cases where a long programme of national importance is being given, where the rule is occasionally waived.

From Pittsburgh

Going up the dial, we next find another friend of the old-timers—W8XK, better known by its medium-wave call of KDKA. This station is located at Saxonburg, near Pittsburg and can generally be relied upon to give a good signal and can be heard most evenings relaying the longer-wave programme. The wavelength of this station is 25.24 metres and he can also sometimes be heard operating on 19.72 and 48.83 metres, although these other wavelengths are not, as a rule, so well heard in the British Isles.

On 31.30 metres we have W3XAU at Byberry, Pa., which relays the programme from WCAU. This station, however, only has a very low power and is only occasionally heard in the British Isles. Directly above him we find W1XAZ. This station is at Boston and works on 31.33 metres, to the great satisfaction of a number of listeners over here! He is quite a good signal in the late evenings.

An Old Favourite

The next station to be heard from over the pond is W2XAF, once a very old favourite, but now not so good as far as we are concerned, as he works with a directional aerial system designed for reception in South America. Sometimes, however, he comes over quite well despite this, and is to be found relaying the same programme as the W2XAD station. His wavelength is 31.48 metres.

We now leave this group of stations and tune up the dial closer to 50 metres, where we find a number of stations such as W2XE, New York, on 48.99 metres; W3XAL, Bound Brook, on 49.15 metres; and W8XAL, Cincinnati, on 49.50 metres. These are all more or less "winter" stations and are best heard after eleven p.m. as a rule, on a winter's night.

Gramo-Radio In a Nutshell

By W. OLIVER

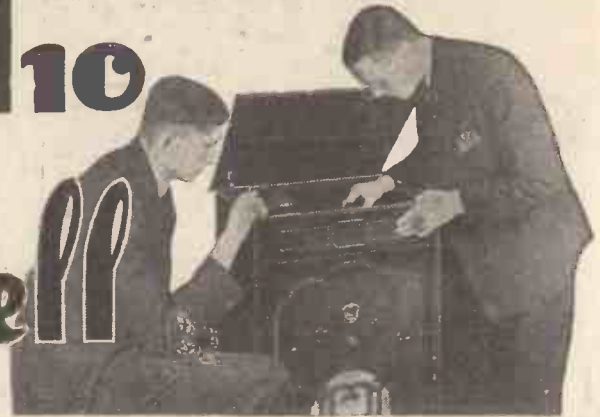

CHOOSING A PICK-UP

THE choice of a gramophone pick-up resolves itself very largely into a question of *f-s-d.*, seeing that the performance of the instrument is generally more or less directly proportional to its price. Efficient pick-ups range in price

provided, of course, that the amplifier and loud-speaker are efficient enough to do justice to it.

CORRECT NEEDLE-TRACKING

The carrier-arms supplied with pick-ups are specially shaped, as a rule, to ensure correct needle-tracking. But in order to take proper advantage of the scientific design of the carrier-arm, it is absolutely

essential that the amplifier and loud-speaker are efficient enough to do justice to it. These connections are shown in Fig. 1.

Moving the slider towards the G.B. end of the winding cuts down volume, while moving it in the opposite direction, of course, increases the volume. The resistance of the potentiometer winding should not be less than 50,000 ohms, as a rule; with many pick-ups a value as high as

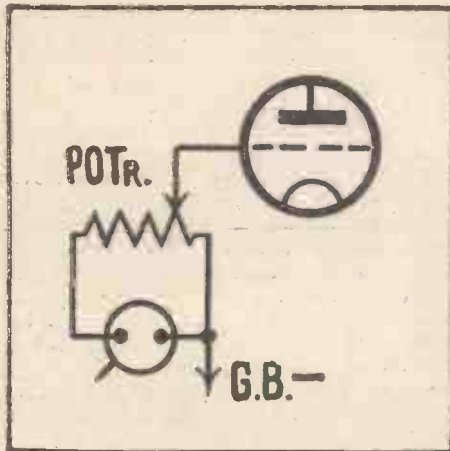

Fig. 1. How to connect a pick-up volume control

All the points one should know when buying, building, or adapting a set for gramophone work are summarised here in a clear and concise form.

essential to set it up correctly. In other words, the distance from the centre of the carrier-arm pivot to the centre of the turntable spindle must be exactly right. When mounting the carrier-arm base on the motor-board, therefore, it is important to adhere strictly to the manufacturer's directions—unless, of course, you care to work out for yourself, by means of the necessary mathematical calculations, the exact position that the base should occupy in order to attain the highest possible degree of accuracy in needle-tracking.

ADAPTING A GRAMOPHONE

If you are adapting an existing gramophone for electrical reproduction, and are replacing the tone-arm with a carrier-arm do not jump to the conclusion that the carrier-arm base should necessarily occupy the same position as the original tone-arm support. The length and shape of the carrier-arm may be so widely different from the length and shape of the tone-arm that a position which is correct for the one may easily be radically wrong for the other.

VOLUME-CONTROL CONNECTIONS

If a volume control is not included as an integral part of the pick-up assembly, it is necessary to fit a suitable one externally, to regulate the pick-up output before applying it to the amplifier. A high-resistance potentiometer forms an excellent volume control. The resistance winding should be shunted across the pick-up; one end of the winding is also connected to G.B. negative, while the moving contact-

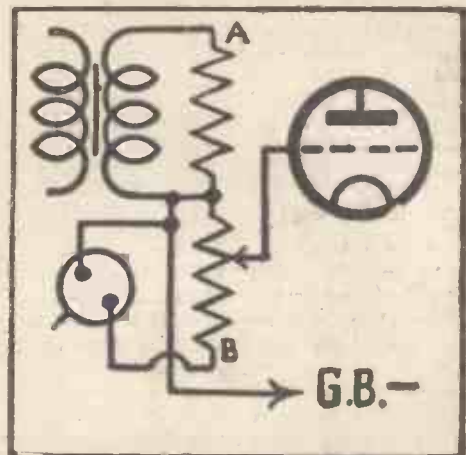

Fig. 2. Fader connections with transformer coupling

250,000 ohms is necessary to avoid cutting off the high notes in the reproduction.

(Continued at foot of next page)

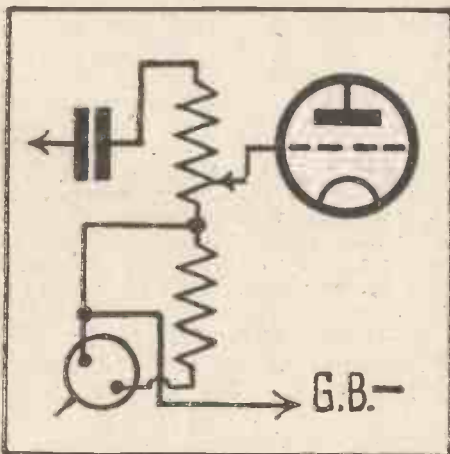

Fig. 3. Fader connections with resistance-capacity coupling

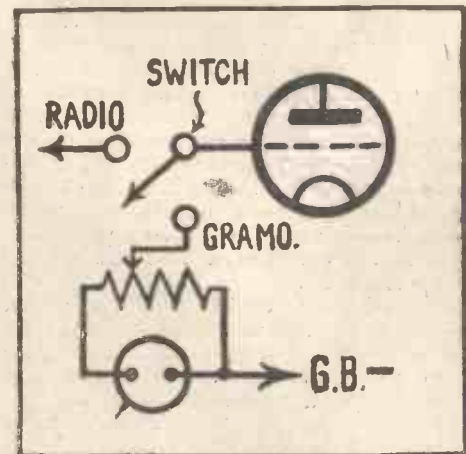

Fig. 4. Connections of a simple gramophone-radio switch



The new Baird aerials used for ultra-short-wave television on six metres

EXPERIMENTS with the ultra-short-wave Baird television transmissions are still going ahead and the results obtained show definite improvement over those secured when this method of trans-

"GRAMO-RADIO IN A NUTSHELL" (Continued from preceding page)

USING A FADER

As an alternative to the ordinary type of volume control, one can use a "fader." This (when following an L.F. transformer) is connected in circuit as shown in Fig. 2. Such an arrangement is useful for changing over gradually from radio to gramophone record reproduction and *vice versa*. The resistance winding of the fader is centre-tapped; with transformer coupling, one half of the winding is connected across the secondary of the L.F. transformer, and the other half across the pick-up. The centre tapping is joined to G.B. negative, and the slider or moving contact-arm to the grid of the following valve. When the slider is over the centre tapping, volume is at zero; if the slider is moved towards the end of the winding marked A in Fig. 2, the volume of radio reproduction gradually increases to a maximum, while if it is moved towards the end marked B, the volume of gramophone reproduction gradually increases in a similar manner. Therefore one can fade out the radio programme and fade in a record, or *vice versa*, without the abrupt change-over that occurs when a switch is employed.

If resistance-capacity coupling is used instead of a transformer, one half of the fader resistance-winding can take the place of the usual grid-leak (provided, of course, that it is of a suitable value for the purpose). Fig. 3 shows how a fader can be connected in an R.C.C. circuit.

METHODS OF SWITCHING

In the absence of a fader, some sort of

more, rigidity of construction was a difficult matter to arrange.

The new method of feeding overcomes this. A half-wave aerial (3.05 metres) is still used with a meter registering the aerial current interposed at the centre junction of the aerial rods; but the transmission lines are a pair of $\frac{1}{2}$ -in. diameter copper tubes

mitting the signals was first shown to the press in April, 1932. One of the most important alterations is that which has been effected at the transmitting aerial and the accompanying illustration will help to make this clear.

In the original scheme a pair of transmission lines from the aerial made two separate connections to the copper rods in such a way that it was split into three sections. The parallel wires then passed through insulators and were joined to the extremities of a coil inductively coupled to the main oscillator drive. This arrangement was found to be liable to cause a certain amount of unsteadiness in the transmission and furthermore, rigidity of construction was a difficult matter to arrange.

The new method of feeding overcomes this. A half-wave aerial (3.05 metres) is still used with a meter registering the aerial current interposed at the centre junction of the aerial rods; but the transmission lines are a pair of $\frac{1}{2}$ -in. diameter copper tubes

gramo-radio switch is desirable to change over quickly and easily from radio to records and *vice versa*. Several different methods of arranging such a switch are available, but that shown in Fig. 4 is perhaps the most satisfactory on the whole. The switch used should preferably be of a specially-designed "gramo-radio" type, and the leads to it should be kept as short as possible, since any inefficiency in the grid circuit of the valve is liable to cause poor results, especially in radio reception.

As an alternative to a switch, a twin-plug and socket device, or a plug and jack of a suitable type, can be used for connecting the pick-up in circuit. Yet another arrangement that is sometimes used is a plug-in adapter which is interposed between the valve and its holder.

INPUT TRANSFORMERS

Some pick-ups are so insensitive that it is necessary, or at any rate desirable, to use an input transformer to step up the output from the pick-up before applying it to the amplifier. The pick-up is connected across the primary of the transformer, while the volume control is shunted across the secondary. One end of the secondary winding is connected also to

**ALL THAT A GOOD SET
SHOULD BE—THE "A.W."
WIZARD"
SEE THE CONSTRUCTIONAL
DESCRIPTION ON
PAGES 568-572**

6-METRE TELEVISION

A description of the new aerial arrangements for ultra-short-wave television transmissions, by H. J. Barton Chapple, Wh.Sch. (Hons.), A.M.I.E.E.

mitting the signals was first shown to the press in April, 1932. One of the most important alterations is that which has been effected at the transmitting aerial and the accompanying illustration will help to make this clear.

In the original scheme a pair of transmission lines from the aerial made two separate connections to the copper rods in such a way that it was split into three sections.

The parallel wires then passed through insulators and were joined to the extremities of a coil inductively coupled to the main oscillator drive. This arrangement was found to be liable to cause a certain amount of unsteadiness in the transmission and further-

more, rigidity of construction was a difficult matter to arrange.

The new method of feeding overcomes this. A half-wave aerial (3.05 metres) is still used with a meter registering the aerial current interposed at the centre junction of the aerial rods; but the transmission lines are a pair of $\frac{1}{2}$ -in. diameter copper tubes

about 4 in. apart. One of these tubes makes metallic contact with one end of the aerial proper and the other is free. The purpose of the "free" tube is to neutralise any radiation that would otherwise occur in the transmission line.

The scheme is commonly designated the "Zepp aerial," and, as will be gathered from the illustration, rigidity of construction is secured. Furthermore, the type of feed is simpler and is particularly adaptable to those situations where the transmitting hut roof accommodates the stayed aerial.

A much steadier transmission is found to result and the importance of this should be self-obvious, for any deviation from the true wavelength of 6.1 metres is likely to upset calculations and possibly spoil reception. If desired, the transmission lines can take the form of concentric copper tubes, the inner one of $\frac{1}{2}$ -in. diameter being the main feed and the outer tube of about 2 in. diameter the "free" line acting as neutraliser.

National vaudeville on September 21 will be given by Leslie Weston, Dorothy McBlain, the Geddes Brothers, Mabel Constanduros and Michael Hogan in another "Mrs. Buggins" episode; Nancie Lovat, and Leonard Henry.

G.B. negative, and the volume-control slider is connected to the grid of the following valve. The ratio of the transformer may be between 1 to 3 and 1 to 7 inclusive; if a cheap transformer is used it is better not to choose one having a high ratio, as it may introduce distortion. A tapped L.F. choke might be used as an alternative to the input transformer.

AMOUNT OF AMPLIFICATION

With an average pick-up, at least two stages of L.F. amplification are necessary to give adequate loud-speaker volume. It is usually an easy matter, however, to adapt a detector valve so that it will serve as the first L.F. stage in the amplifier. This simple expedient enables even a two-valver (containing a detector and power valve) to be used for gramophone work. The switching arrangement shown in Fig. 4 provides an efficient means of introducing the pick-up into the grid circuit of the detector valve. A point to watch is the grid bias: unless a suitable negative bias is applied to the grid of the detector valve, by way of the pick-up and volume control, distortion may occur. Also, it is usually desirable to apply a rather higher anode potential to the detector valve when working as an L.F. amplifier than when it is used for its ordinary purpose.

HOW TO AVOID OVERLOADING

If the pick-up output is considerable, the first valve in the amplifier may be seriously overloaded, unless steps are taken to prevent this happening. The volume control should be used to reduce

(Continued on page 591)

IT'S PERFECTLY SIMPLE

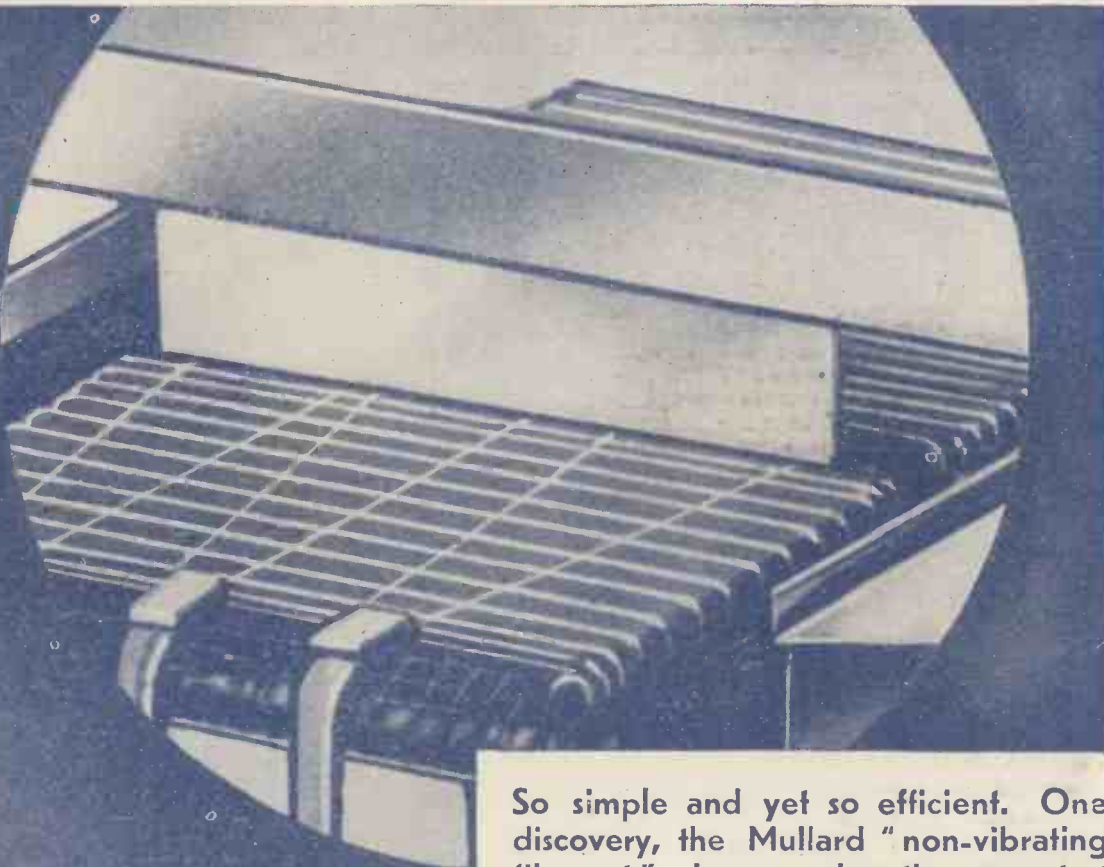

So simple and yet so efficient. One discovery, the Mullard "non-vibrating filament," has made the greatest advance in modern valve construction — microphony has been overcome.

This new construction is incorporated in the P.M.1HL — further, the low anode consumption of this remarkable detector eliminates distortion due to transformer saturation and allows maximum stage gain to be obtained.

P.M.1HL — the valve for trouble-free reception.

PRICE 7/-. MADE IN ENGLAND.

The Mullard Valves specified for the Wizard described in this issue are 1P.M.12, 1P.M.1HL and 1P.M.2A.

Mullard

THE · MASTER · VALVE

Adv. The Mullard Wireless Service Co., Ltd., Mullard House, Charing Cross Road, London, W.C.2.

To Ensure Speedy Delivery, Mention "A.W." to Advertisers

ARKS

**ENTIRELY NEW
AND POWERFUL RECEIVER**

**G.E.C.
Radio
Supremacy in
Radio**



**AMAZING POWER
SELECTIVITY
AND PURITY**

**YOU NEED THIS
SET FOR MODERN
STANDARDS OF QUALITY**
GECOPHONE RADIO RECEIVER
for A.C. Mains
"VIKING" Model

Here is Radio that satisfies in the highest degree. All that you have ever known of superb quality, rich broad tone and selectivity is definitely superseded by a new sense of thrilling realism given by this set with five valves (including rectifier).

WRITE for Folder BC 6312. This is a most comprehensive production giving the fullest information regarding G.E.C. Radio products. It merits the consideration of everyone who demands the finest reception. The coupon is for your convenience.

SPECIFICATION.

- 1 Four tuned circuits with band-pass input filter.
- 2 Two H.F. screen-grid stages with variable-mu valve.
- 3 Screen-grid detector.
- 4 Power pentode giving undistorted output of 2½ watts A.C.
- 5 Energised Moving Coil loud speaker; provision for external loud speaker.
- 6 Single tuning control, 200-550 and 900-2,000 m.
- 7 Automatic station index.
- 8 Variable-mu volume control without reaction.
- 9 Mains aerial device and facilities for gramophone pick-up.
- 10 Universal mains transformer with 100-150 and 200-250 voltage range, 40-80 cycles.
- 11 Ample smoothing and heterodyne filter.
- 12 Distinguished Gothic cabinet of matt walnut.

PRICE 23 GNS.

including OSRAM Valves and Royalty.

HIRE PURCHASE

TERMS:
Deposit £2,
12 monthly
payments
of £2.

COUPON

Please send me Folder No. B.C. 6312 giving particulars of GECOPHONE Radio Receivers and Loud Speakers

Name _____ Address _____

The General Electric Co. Ltd.
Magnet House,
Kingsway, London
W.C.2

**BETTER RADIO FOR THE
DISCRIMINATING LISTENER**

Advt. of The General Electric Co. Ltd., Magnet House, Kingsway, London, W.C.2

Cut out and paste on a postcard, or enclose in unsealed envelope, 4d. postage

Advertisers Appreciate Mention of "A.W." with Your Order

Something **NEW** for Amateur and Expert



**PART
ONE
NOW ON
SALE**

NEWNES COMPLETE WIRELESS

IN ABOUT 24 WEEKLY PARTS

FREE INSIDE

A fine Design Chart containing full instructions and wiring diagram for making a Double-cone Portable Set.

WHY YOU SHOULD BUY THIS WORK

Because it explains the theory of wireless in a way you can understand.

Because it contains many new designs by the best designers.

Because it is authoritative yet easy to understand.

Because it gives you the expert advice of wireless specialists.

Because when completed it will be *worth much more than it has cost you.*

Contributors include:

- SIR OLIVER LODGE
- SIR AMBROSE FLEMING
- L. McMICHAEL
- RALPH STRANGER
- J. ROBINSON
- F. HAYNES
- N. ASHBRIDGE
- A. E. WATKINS

And many other experts, but every article is written in simple language.

GET YOUR COPY TO-DAY

Obtainable at all Newsagents and Book-stalls or post free 1/2 from George Newnes, Ltd., 8-11, Southampton Street, Strand, London, W. C. 2

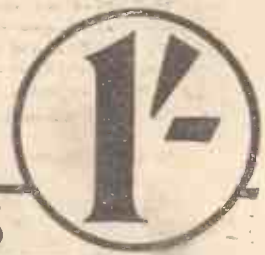

Geo. Newnes Ltd.

Please Mention "A.W." When Corresponding with Advertisers



Did you
note
Columbia's
Ten Points?

And
the largest
range to
choose
from!

Now
let's hear
it in our
homes

The curtain has fallen on the Olympia stage. The show is over; but the *real* performance is only just commencing now—Columbia offers you the choice of the most impressive range of *quality* radio ever presented to the public. Fifteen different models from £4. 7. 6. to 90 guineas!

One for every home —for every local condition! Be guided to complete satisfaction by these ten, clear-cut points.

(1) Tone of remarkable purity and clearness. (2) Easy station selection with (3) all Europe at your finger tips. (4) Startling volume that can be hushed to the merest whisper. (5) A child can operate the few and simple controls. (6) Cabinet design to blend with modern homes, every model planned and built to give (7) long, worry-free service at (8) the lowest possible running cost. On sheer quality, beauty, and performance, (9) prices are decidedly low, and every model is (10) British made.

Columbia

TEN POINT RADIO & RADIO-GRAPHOPHONES

★ Please send me a catalogue of the new 1933 Columbia models or if you are already familiar with the new models. ★ Please arrange a demonstration free and without obligation, of Model in my own home. ★ Cross out if not required.	NAME _____	
	ADDRESS _____	
A.W. 17 Sep. Cut this out and post it in an unsealed envelope bearing 1d. stamp to Columbia, 98/108, Clerkenwell Road, Londrn, E.C.1.		

Don't Forget to Say That You Saw it in "A.W."

On Your Wavelength!

KEEP THEM DOWN OR KEEP THEM UP?

NOT long ago I referred to the standard-capacity battery complex from which both the public and the set designer suffer. The public will use standard-capacity batteries; therefore the designer must keep down the H.T. current for any battery set to somewhere about the 10-milliampere mark.

If he doesn't, his set soon achieves a fatal reputation for being expensive to run. Some day, people will realise that the standard-capacity dry battery, except when used for working single-valve or little two-valve sets, is far and away the most expensive means of supplying high-tension current. Once this glorious truth dawns, designers will be able to keep up their milliamperes and fine quality will be obtained from battery sets. Till then, there must always be a pretty big difference between the performances of the mains set and the battery set.

QUALITY AND MILLIAMPS

GOOD quality with reasonable volume is mainly a matter of milliamperes. (Not a bad alliterative effort, that!) And it isn't only the output valve that requires a fairly juicy current; you obtain infinitely better results from the detector valve if, instead of cutting its current down to one milliampere or less, you work it up to 4 or 5. As regards the output stage, my firm conviction is that for the finest quality from a battery set, push-pull is the thing. With 180 volts H.T. the output team will probably need 30 milliamperes all to themselves—but doesn't the loud-speaker just deliver the goods? This means at least 40 milliamperes for the whole set—my big super-het needs 45 when the variable-mus are working all out—but, as I have mentioned before, it is a great deal cheaper to take this amount of current from a 5.5-ampere-hour accumulator battery than to draw anything much over 10 milliamperes from a standard-capacity dry H.T.B.

And a point that very few people realise is that if you are putting a heavy load on a small dry battery, the voltage is continually falling, not only from evening to evening, but even from minute to minute, whilst the set is in use. With the accumulator H.T.B. under heavy load the voltage remains practically constant until just before the time when a recharge is required. The quality, therefore, does not slowly deteriorate, but remains first-rate.

HERE'S HOPING

IT isn't often that I have a dig at component makers, but I want to indulge in one now. Why is it, I wonder, that binding screws are so often put straight into bakelite mouldings without any metal bush? I feel rather strongly on the point, because only the other day I

found the drum drive of a variable condenser slipping. This particular condenser is in just about the most inaccessible spot that it can occupy and, to my horror, I found that the binding screw of the drum—or, rather, the threads made for it in the bakelite moulding—had stripped.

The same thing not infrequently happens with bakelite knobs, and a real nuisance it is. It isn't a difficult business to incorporate a threaded brass bush or even a 4 B.A. nut in the moulding, and this should always be done. Bakelite is such soft stuff that binding screws are almost bound to strip in time if you put the necessary pressure on to them to tighten them properly down. And tighten them down you must, for otherwise your drum or your knob will slip; and if you can tell me of anything more exasperating than a slipping drum in a set over whose calibration you have spent many hours—well, I shall be glad to hear of it.

Will component makers please take note of this cry for help and do something about it? Good wine may need no bush, but good components do.

HE SOUNDS LIKE IT

RECENTLY I expressed surprise at the strength of Breslau, which was shown in the tables as a 1.5-kilowatt station. When I wrote that note, that was the latest information I had on the subject; but, curiously enough, in the issue of "A.W." in which it appeared, Breslau was shown as putting out 60 whole kilowatts.

A new transmitter is now at work, with the result that Breslau is quite one of the strongest Continental stations. You needn't wait until dark to try for him, and if you haven't heard him for some little time you will be quite astonished when you reach the settings required to bring him in. He sounds like every one of his 60 kilowatts.

WHERE'S YOUR LOW-LOSS NOW?

NOT so long ago, we were all low-loss enthusiasts, particularly in the matter of coils. We used skeleton formers of the largest diameter from which every possible fragment of ebonite had been removed.

We wound them with wire specially chosen to give the best results, and everybody was quite convinced that no other sort of coil would do for the efficient wireless set. Compare the coils of yesteryear with their canned counterparts of to-day. Though no one can deny that they do their job and do it well, you won't find much of the low-loss principle about them. They are wound with very thin wire upon a small former—in fact, they are just the kind of things that would have moved us to tears two or three years ago. The reason, of course, is that if you "pot" a coil you must keep its field reasonably small, and it is also desirable to make the coil itself compact in order that it may fit into the small receiving sets of to-day. Funny, isn't it, how rapidly and how completely ideas about wireless change?

DOES IT PAY?

THOUGH it is very convenient to be able to tune a receiving set with one knob and to have nothing else in the way of controls but a filament switch, a wave-change switch, and a volume control, I often wonder whether the "few-knob" set of to-day really pays. For the complete novice or for the utterly lazy fellow, the fewer knobs the better. But if you want to get the very most out of a set in the way of sensitiveness, selectivity, and high quality in reproduction, then it is certainly an advantage to have a few more knobs. Take, for instance, the question of ganged condenser tuning. Though the coils and the multiple condensers of to-day are components of wonderful precision, it is a physical

A NEW MARCONI TELEVISION IDEA



The operators at part of the new Marconi television apparatus which is being used for television tests between this country and Australia through the Chelmsford G2BS beam station. G5SW, the well-known short-waver, is also used for these television tests

On Your Wavelength! (continued)

impossibility so to trim, say, a three-gang that all the circuits are completely in step over the whole of the waveband covered.

You can arrive at a compromise which will give you something very near the desired result—near enough, that is, for all ordinary purposes. Myself, I like to have at least one trimmer knob on the control panel, for its presence often makes all the difference to the performance of a set at one end or the other of a waveband. Then I want adjustable tone control, at any rate, in the set used for long-distance work. In the super-het I have a weakness for two independent volume controls, one adjusting the grid bias of a variable-mu high-frequency valve and the other doing the same duty for the intermediate frequency stages. One thing I do know is that no very great amount of time elapses after the installation of a new set until it begins to sprout additional knobs here and there.

A SOUND SCHEME

A GOOD many D.C. users are rather worried just now over the question of installing new sets. The trouble is that they know that their mains supply will be changed over some time not very far ahead to A.C. The alteration may not take place for two or three years; on the other hand, it may be made quite soon. Thus a D.C. set may become useless, and in a good many localities the authorities have disclaimed any liability to compensate owners of wireless sets so affected. Two firms have schemes that will appeal to the prospective purchaser who is now on D.C. One of them names at the time of purchase a price for the conversion of the set from D.C. to A.C.; another has only one D.C. model and the price of conversion is fixed at £5. In both cases you thus know exactly where you are.

AN AMAZING SPOT

PROBABLY the world's queerest wireless centre is Cortlandt Street in New York. This is the home of what Americans call the "gyp" shop, which, being translated, means the cheap-jack or price-cutter. A recent issue of an American magazine contains some astonishing photographs of the wares offered in Cortlandt Street. There are piles and piles of second-hand sets at almost any price you like. None of them are guaranteed; you

must take them as you find them. But, considering that the price of a four-year-old three-valve set is 25 cents, or a little over a shilling, you cannot be very badly done in the eye. More modern sets, of course, fetch higher prices; some of them go even as high as a whole dollar.

One of the photographs shows a crop of large receivers from which the purchaser can pick what he likes for a dollar. One of the sets in the picture cost nearly three hundred dollars not very long ago. The same street contains the shops of service men who guarantee to re-wire any set and make it work for almost nothing at all. So you can buy your dollar's worth at one shop and take it along two doors to the wireless doctor. I need hardly say that the purchase price does not include valves.

GOOD WORK

BOTH the Marconiphone Company and the H.M.V. Company have taken a bold step in making big reductions in the prices of several of their sets as a result of the large amount of business obtained at the Olympia Exhibition. The reductions will come as a very pleasant surprise to many people who ordered these sets at their original prices. The orders will be fulfilled, but the new prices only will be charged, and this in many cases means a very substantial rebate to the purchaser. An outstanding instance is the eight-valve super-het with automatic record-changer, whose price has dropped by nine whole guineas, from 55 to 46. That, I think, is the stuff to give 'em.

A QUEER POSITION

QUITE a number of readers have set me a rather pretty problem. They want to buy new three- or four-valve sets and they want them without loud-speakers. Will I please tell them something really good? If you think for a moment, you will see what the difficulty is. Practically every maker this year is turning out the transportable type of set which has its own built-in loud-speaker. There are very few sets indeed which don't include a moving-coil or balanced-armature reproducer. But the reader doesn't want a built-in speaker, for the excellent reason that last year he purchased a first-rate moving-coil instrument with whose performance he is delighted. What is he to do? Others again,

having tried out the box baffle and found how good it is, want external instruments and suitable sets to work them. It really is rather queer, when you come to think of it, that makers with one accord should have gone in for what I believe is called the console type of set and should have forgotten that so many possible purchasers already possessed really good loud-speakers.

BUILT-IN OR NOT?

MYSELF, I certainly prefer to have the loud-speaker quite separate from the receiving set, for a good many reasons. I admit that it is very handy to have the speaker inside the set, because you can then carry the whole apparatus about from room to room and, anyhow, your wireless receiving equipment is just about as compact as it could be. But I have a preference for the kind of loud-speaker that is too big and too heavy to be built into any but the largest kind of pedestal set, and I do like either a big flat baffleboard or a box baffle. Another advantage about having the loud-speaker right away from the set itself is that you are never troubled with "singing round the ring," if one of the valves in the set happens to have microphonic tendencies.

THE POPULAR PENTODE

IMAGINE most visitors to the recent Show were struck by the almost complete changeover to pentodes for the output stage. While there was still a number of sets using triodes, the vast majority employed pentodes. The old idea that good quality cannot be obtained with this type of valve has now been exploded for there was surely plenty of bass in evidence in the various demonstration rooms. I suppose everybody has plumped for pentodes because one can get something like 2-2½ watts output with only 10-12 grid swing. I am speaking, of course, of the A.C. variety.

THE BATTERY USER

IN the battery world there is an enormous gap. Everybody seems to have concentrated on low H.T. consumption and here again the pentode offers the greatest output for a given H.T. supply. Unfortunately, the output here is of the order of milliwatts only, about 300 milliwatts being the maximum from a single valve with reasonable H.T. As there are still large numbers of battery users, I suggest that manufacturers have left this market out in the cold. Surely with a little bit of ingenuity it should be possible to approach 1-watt output, at any rate on peak signals without much additional expense. One method is the quiescent push-pull system, which takes practically no anode current when the valves are not working, but which enables each valve to give considerably more than its normal output. Some details of this system were given by our Technical Editor recently, and I think we shall see more of it.

THERMION.

PERSONALITIES IN THE WEEK'S PROGRAMMES

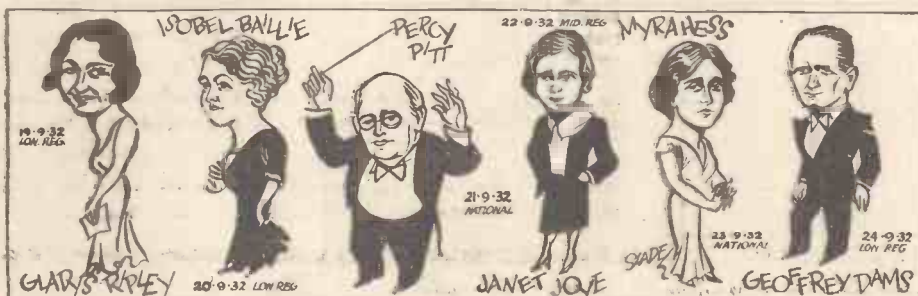

'50 guinea TONE' for

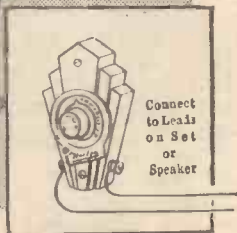
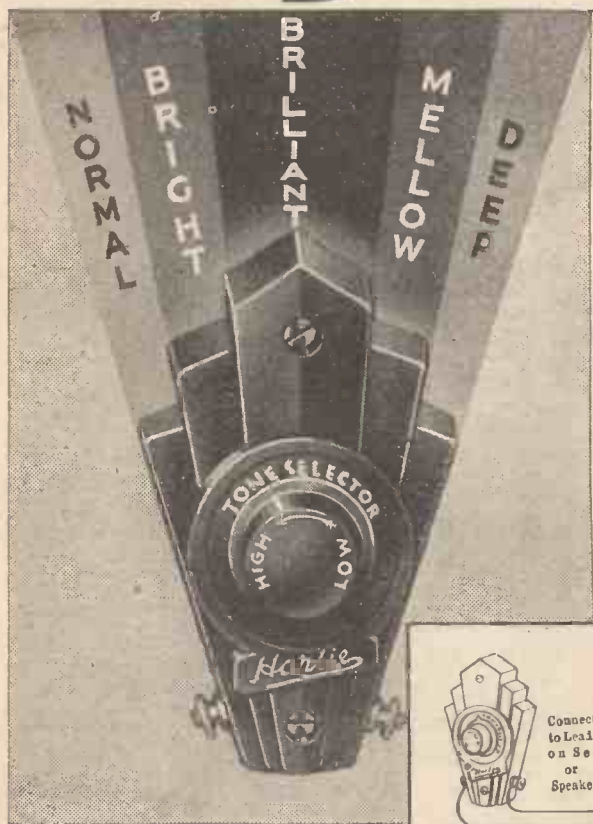

NOW—by simply turning the Harlie Tone Selector Knob any owner can instantaneously adjust his Set to speech, symphony music, jazz, or if he should happen to be in a noisy location, he may cut down the noise and enjoy the programme in a way never before possible. "BRIGHT" — "BRILLIANT" — "MELLOW" — or "DEEP" shades of tone are now at his finger-tips.

Harlie
 LR
 Cambridge Arterial Rd.,
 Enfield, Middlesex.

Please forward :— FREE BOOKLET
 TONE SELECTOR } Cross out items not
 DE LUXE PICK-UP } wanted.

For which I enclose P.O. value..... (no stamps).

Name.....

Address.....

.....

A.W.2

Advertisers Appreciate Mention of "A.W." with Your Order

4/6 CASH or
1/6 DOWN

And further 1/- in 7 days and
 2 monthly payments of 1/6

On this page you will see one of the most revolutionary inventions ever associated with Radio reception and Radio reproduction of gramophone records. It is the new and improved HARLIE Tone Selector and Scratch Filter, which actually gives you a choice of different tones and astonishingly improves the quality of reproduction by "balancing" your set with your speaker. It gives that rich Tonal clarity hitherto associated only with sets costing upwards of fifty guineas, yet it costs only 4/6, or 1/- down and a further 1/- in 7 days and 2 monthly payments of 1/6—"50-Guinea Tone" for 4/6 ! It reduces undesirable noises, too, and eliminates needle-scratch when playing records through a gramophone pick-up. Everybody says "Marvellous." You will give it three loud cheers. Fill in and post the coupon below !



2/6 DOWN

Further 2/6 in 7 days and 5 monthly payments of 5/-.

DE LUXE PICK-UP
 Model 36
 Cash Price 27/6.

Complete with Tone Arm and Built-in Volume Control. Finished throughout in Brown Bakelite. Pick-up head swivels in order to facilitate needle-changing. Ball-bearing movement of tone arm enables the needle to follow the record grooves with extreme accuracy, ensuring perfect parallel tracking and eliminating record wear. Special twin-spring balance suspension controlled by tensioning knob, permits of feather-weight adjustment, so that weight of Pick-Up on record is under complete control.

HARLIE PRODUCTS CAN BE SUPPLIED ON
 OUR H.P. TERMS by all Registered Dealers.

A TRIUMPH OF PRECISION

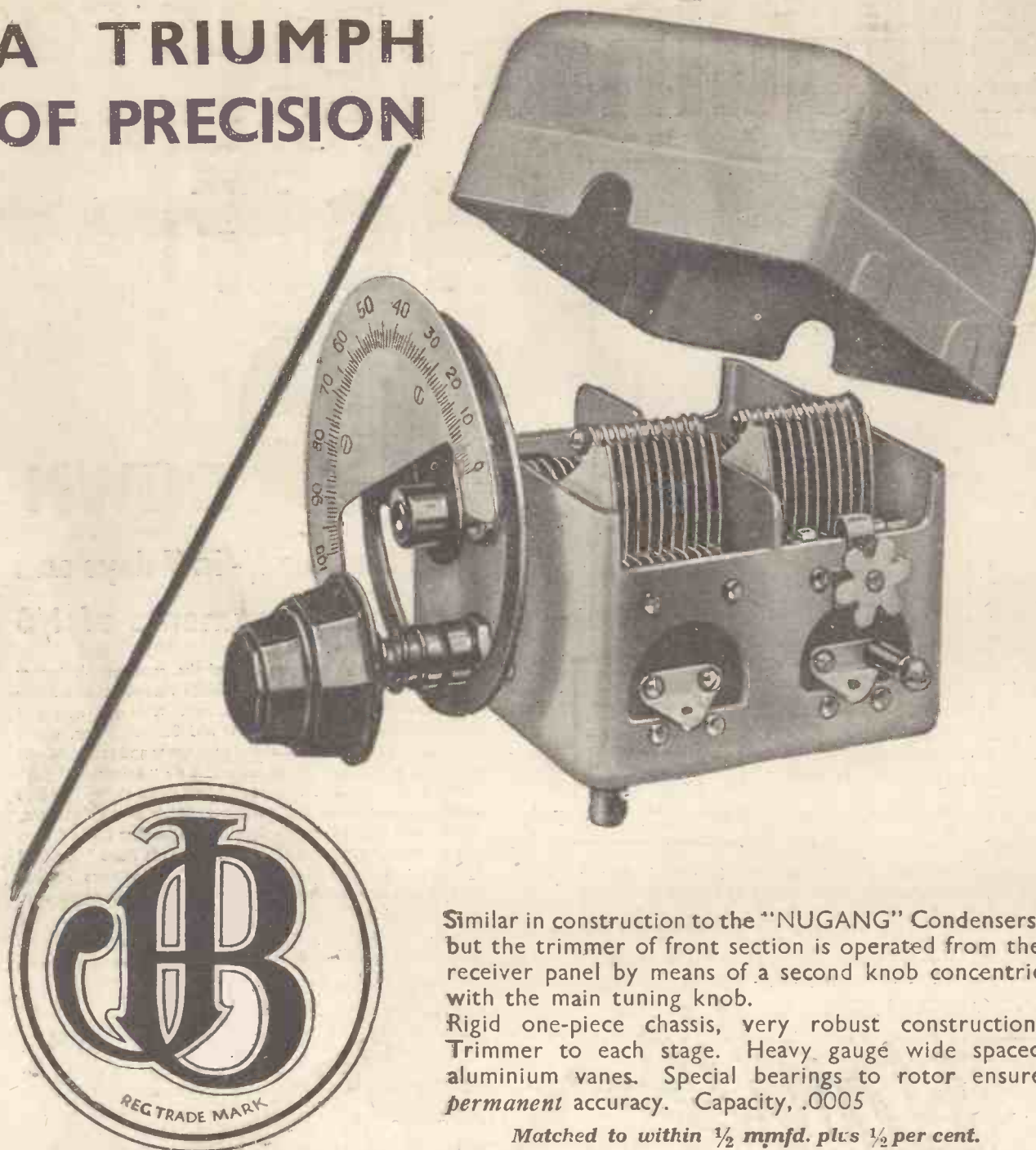

**PRECISION
INSTRUMENTS**

Similar in construction to the "NUGANG" Condensers, but the trimmer of front section is operated from the receiver panel by means of a second knob concentric with the main tuning knob.

Rigid one-piece chassis, very robust construction. Trimmer to each stage. Heavy gauged wide spaced aluminium vanes. Special bearings to rotor ensure permanent accuracy. Capacity, .0005

Matched to within 1/2 mmfd. plus 1/2 per cent.

Complete with disc drive and bakelite escutcheon plate.

2 gang - 18.6 3 gang - 27/-

NEW J.B. 'UNITUNE'

Advertisement of Jackson Bros., 72, St. Thomas' Street, London, S.E. 1.

Telephone: HOp 1837.

Mention of "Amateur Wireless" to Advertisers will Ensure Prompt Attention



NEW IDEAS FOR RADIO PLAYS

Some brilliant new ideas are in force in connection with forthcoming radio plays. Details of these new plays and the methods of producing them are given here.

OUR B.B.C. play producers have studied the German methods of radio play production. We look like having some "plums" in the new season's broadcast plays and sketches.

Brigade Exchange and *Flags on the Matterhorn* are two well-known German plays which we have sampled over here and which tax the noise producers' abilities to the full. The first was by a well-known young Hamburg author, and the second partly by an Alpine climber and radio expert, Dr. Pfeil. Germany has been specialising in plays which are really a sequence of short scenes typifying the life of the characters and linked up with music.

The Breslau studios have spent a great deal of time in producing plays of this kind, which are known as *Horfolge*.

Some Forthcoming Productions

The B.B.C. is not going on quite such ultra-modern lines, but one of the plays for the new season, to be heard in the second week of October, is *Conversations at the Dance, 1790-1931*, which is the work of a German authoress and is a series of scenes at dances during the period named in the title of the play. It is not a German play, though; it deals

with everything from a Darlington ball-room scene at the opening of the first British Railway, to an American dancing marathon!

Towards the end of October, a new play of the *Mary Celeste* type, called *Nor' West*, will be heard, and as this deals with a haunted iceberg it will introduce some new problems for the sound producers. Whittaker-Wilson's anniversary play on Sir Christopher Wren is also being given at the end of next month, on October 20, and the sound effects in this include a relay from St. Paul's Cathedral and the noises of the Fire of London!

To cope with the new demands on the radio-play noise-producing section, two dramatic control panels are used.

"D.C. 1," the larger of the two dramatic control panels at Broadcasting House is shown by an accompanying photograph. The volume controls, studio indicator lights, "flick" keys for warning the artistes, and so on, can all be seen, while the check loud-speaker equipment in the corner, on which the play as a whole can be heard, is a conspicuous piece of furniture of the dramatic control room.

Most of the gadgets in the effects studio 6E, are well-known, such as the travelling

microphones on long "booms," the special table made up of composite materials to give various sound effects, the pneumatically operated wind machines and beaters, and the special little doors for slamming!

Both the dramatic control rooms are on the eighth floor and the producer can



Val Gielgud, the B.B.C. Productions Director, who is responsible for the new radio plays

WHERE THE PLAYS ARE "TUNED IN"

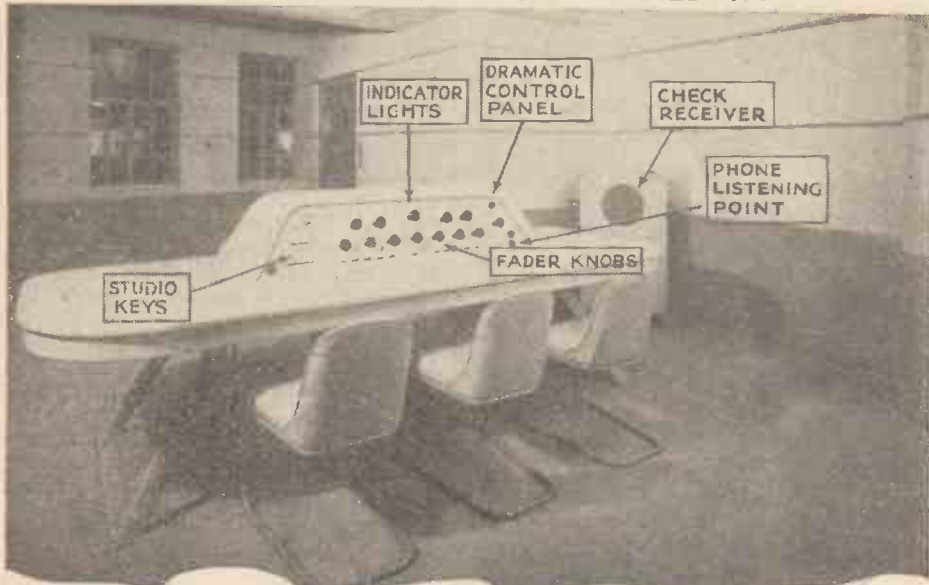

A peep into one of the two Dramatic Control rooms at Broadcasting House. The special features of the "D.C.P." are shown by this lettered photograph

mix the inputs from as many as ten studios at once.

These dramatic control panels are used only on plays produced within Broadcasting House. Not all the good plays of the new season are home-made! There are to be some outside broadcasts of outstanding plays.

Relays

The landline to St. Hilary is being chartered again for a relay of a special play from the famous church of that Cornish village where Bernard Walke, the author of this play and many others, and vicar of the parish, is producing a new play to celebrate All Souls' Eve. The new portable outside broadcast amplifiers are used for dramatic control on an occasion like this and the play comes straight into the control room of Broadcasting House.

Another outside broadcast is from the B.B.C. studios at Cardiff early in November. A Drinkwater play which has already been heard from Birmingham is to be produced at Cardiff and as it should be of outstanding interest it has been selected for broad-

(Continued at foot of next page)

WHAT IT IS FOR

THE ELECTROLYTIC CONDENSER

CONDENSERS of all kinds consist, as most readers know, of two sets of plates separated by a di-electric material. The plates may be made of copper and the di-electric of mica, as in a fixed condenser of small capacity; or the plates



Chief constructional features of the Electrolytic condenser

may be made of aluminium and the di-electric air.

Lately, another kind of condenser has come in prominence, called the electrolytic condenser, because its action

depends on an initial electrolytic action for the formation of the di-electric, which takes the form of a very thin film.

The construction of the electrolytic condenser varies according to the make, but in general it consists of an outer plate or container of brass or aluminium with an inner rod or foil immersed in the liquid forming the electrolyte.

There are two types of electrolytic condenser, one wet and the other "dry."

The great advantage of the electrolytic condenser is that a large capacity can be made up in a very small space. Even in home-made sets there is often a restriction of space, especially in the smoothing circuit of a power pack.

Perhaps the only disadvantage of this type of condenser is its inability to work with alternating voltages. Its use is ruled out in high-frequency wireless work, and its chief function, at the moment anyway, is in the output smoothing of mains rectifiers.

Unlike ordinary condensers made up with metal plates and some dielectric material, the electrolytic has positive and negative terminals. It has to be connected the right way round in the circuit. This question of polarity is wrapped up in the action of the electrolytic. When first made, the electrolyte—usually a solution of borax and boric acid—is, of course, a conductor. Very soon after the "forming" voltage has been applied, a thin film forms on the anode, or centre plate. This remains almost indefinitely, and even if the film does deteriorate with time, the applica-

tion of the voltage of the circuit in which it is being used will restore it to normal.

Another point is that, should the voltage applied exceed the working voltage, there is no harm done. For the current that flows momentarily during the breakdown will re-form the film.

This film is very thin, and as this is the di-electric, it means that the capacity formed between the plates is very high. As this capacity varies with frequency in electrolytic condensers, the makers have had to standardise matters, so that the

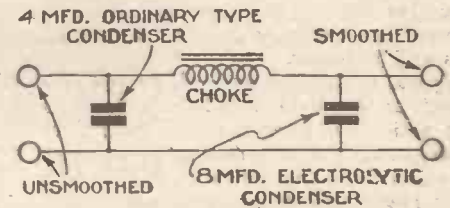

Typical circuit for Electrolytic Condenser as the output in a smoothing circuit

present-day 8-microfarad electrolytic, for example, has a capacity equivalent to 8 microfarads in an ordinary type.

The very nature of the electrolytic condenser, as already indicated, involves positive and negative connections. We can only use this type of condenser in a D.C. circuit, and there is a specially useful application in the output of smoothing circuits in mains units.

The position for an electrolytic in such a circuit is indicated. It is not advisable to use this condenser on the rectifier side of the choke, as there is an appreciable amount of alternating current there.

"NEW IDEAS FOR RADIO PLAYS"

(Continued from page 563)

casting in the National programme. On that evening the sound producers will have a well-earned rest, but the radio play experts at London will be listening on the check receivers.

They are making good use of the special acoustic Broadcasting House studios. Studios 6c and 7c are for speech in radio plays, and these are treated to have absolutely no echo at all. There is also a talks studio on the third floor which has a "dead" reverberation time.

You would think that these no-echo studios would be too dull for radio plays, but the reverse is true. Many of the new plays, such as *Wren*, make good use of commentators to describe scenes which could not be produced before the microphone.

The commentators, unlucky wights, have to read their parts in these "dead" studios, and the lack of echo provides a clean background on which the man at the dramatic control panel can superimpose echo if he wants it or some other



"Using Spaghettis"

effect, such as the clanging of a bell or the noise of traffic to heighten the dramatic effect of the commentator's reading.

Many listeners have criticised radio plays in the past on the score of too much artificial sound effect and because the plays are too dull when they are not comedies, and too intensely dramatic (*Rope*, for instance) when they are meant to be serious. None of the plays in the new list seems to answer these criticisms. *The Three Musketeers*, *The Other Room*, and *Ghosts at Solberga* are among plays in a rather serious key.

No doubt Val Gielgud, the Productions Director, is hard put to it to find good radio comedies. Gordon McConnel, who was previously kept busy producing the lighter type of radio comedy, has now changed over to broadcast opera. The B.B.C. needs more musical comedy and a little less Shakespeare.

The idea of broadcasting plays on a Sunday has caught on, but the Productions Department seems afraid to toy with anything of a lighter nature than Shakespeare for microphone presentation on the Sabbath.

Direct Radio

159
BORO
HIGH
STREET

THE "WIZARD"

1 Ebonite panel, 14 in. by 7 in.	£ 4 0
1 Baseboard, 14 in. by 9 in.	1 0
2 Read-Rad .0005-mfd. solid dielectric variable condensers, "Micalog"	7 0
2 Read-Rad S.M. disc drives	8 0
1 Lissen 2-gang shielded coil unit and combined filament switch...	17 6
1 Read-Rad .0005-mfd. variable reaction condenser	2 6
3 T.C.C. fixed condensers—(2) 1 mfd. and (1) 2 mfd.	8 6
1 T.C.C. .0005-mfd. fixed condenser, type 4	1 3
2 T.C.C. .0002-mfd. fixed condensers, type 8	2 6
1 Dubilier 2-megohm grid leak with wire ends	1 0
1 Lewcos 30,000-ohm spaghetti	1 6
1 Wearite screened H.F. choke, HFP	3 6
1 Read-Rad standard H.F. choke	1 6
3 4-pin valve holders	1 6
1 R.I. resistance-fed transformer, Parafeed	8 6
2 Terminal blocks, Aerial, Earth, L.S. +, L.S.—	1 0
1 Sovereign pre-set series aerial condenser, .00003-.00025 mfd.	1 3
1 Drilled ebonite strip, 3 in. by 2 in.	6
2 Belling Lee terminals, Pick-up	2 9
1 Read-Rad radiogram c/o switch	2 9
6 Belling Lee wander plugs: H.T.—, H.T.+1, H.T.+2, G.B.—, G.B.—, G.B.—2	1 0
2 Belling Lee spade terminals: L.T.—, L.T.—	6
6 Yards Lewcoflex, Glazite, shielded flexible tubing, screws, etc.	1 7
3 Mullard valves: PM12A, PM1H1, PM2A	1 12 3
1 Special cabinet	1 0 0
	£6 10 0

Build the WIZARD with a Direct Radio Kit and get MAGICAL results! It is a truly magnificent set, worthy of the finest construction. True WIZARD results can only be expected when you build with a first-class kit of components as supplied by Direct Radio. Post your order to-day—cash, C.O.D., or by easy payments—make acquaintance with the finest value-for-money in radio!

Kit No. 1 (Less Valves and Cabinet) **£3:17:9**
or 7/- down and 11 monthly payments of 7/-

Kit No. 2 (With Valves less Cabinet) **£5:10:0**
or 10/- down and 11 monthly payments of 10/-

Kit No. 3 (With Valves and Cabinet) **£6:10:0**
or 12/- down and 11 monthly payments of 12/-

ACCESSORIES

1 Siemens 120-volt H.T. battery	£ 13 6
1 Siemens 9-volt G.B. battery	1 0
1 Oldham 050 2-volt accumulator	9 0
1 R. & A. "Bantam" loud-speaker	1 7 6
1 Atlas H.T. mains unit, A.C.244	2 19 6

Mains Units	£ s. d.
Atlas A.C.244 H.T. only	2 19 6
Atlas A.K.260 H.T. and L.T. 4	10 0
Atlas D.C.15/25 H.T. only	1 19 6
Pick-up	
Bowyer-Lowe A.E.D. Mark III	1 10 0
Pick-up Volume Control	
Bowyer-Lowe A.E.D. log law	8 5
Moving-coil Speakers	
R. & A. "Bantam"	1 7 6
R. & A. "Challenger"	1 15 0
R. & A. "Victor"	3 10 0
All including input transformers. Our special "Soundex" Speaker Cabinet in polished veneered Walnut can be supplied at £15/0 extra.	
Gramo motor, Collaro spring type B.30	1 12 0
Gramo motor, Collaro induction type	2 10 0
Oldham H.T. accumulator, 120 volts 5,500 m/A. hour capacity, £4/1/0, or 7/6 down and 11 monthly payments of 7/6.	



CASH, C.O.D. AND EASY PAYMENT ORDER FORM
To: Direct Radio, Ltd., 159 Borough High Street, London, S.E.1.

Please dispatch to me at once the following goods.....

for which (a) I enclose
(b) I will pay on delivery { cross out line }
(c) I enclose first deposit of { not applicable }

NAME

ADDRESS

A.W. 17/9/32.

You can of course buy your favourite accessories direct from Direct Radio. Write us for lowest quotations and suggestions.

Don't Forget to Say That You Saw it in "A.W."

CONSISTENCY

The employment of Mica Bridge Mounting in Cossor Valves ensures microscopic accuracy in the assembly of the electrode system. As a result the characteristics of every valve are identical with those of the original design developed in the laboratory. Variation is impossible. The performance of each valve is therefore safeguarded—the Mica Bridge is a virtual guarantee of performance and reliability.

Below is an enlarged section of a Cossor A.C. Mains triode—the 4X1 M.H.L. The use of two Mica Bridges ensures life-long alignment of the elements. Note the "cut-away" view of the cathode, showing the heater wire in position.

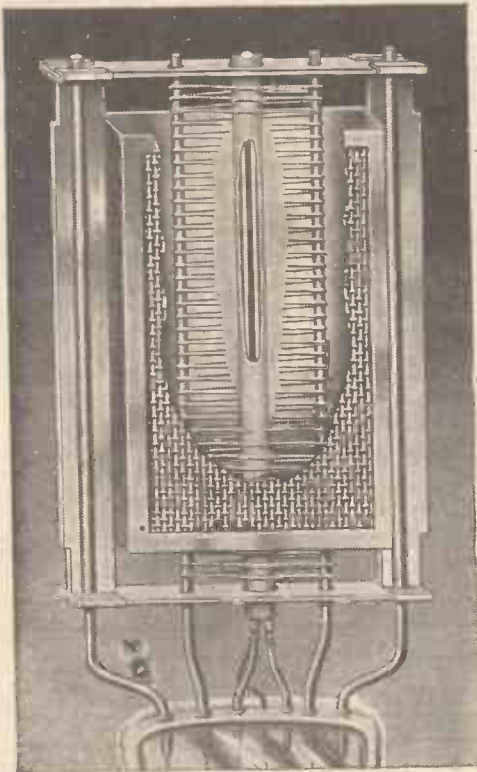

SPECIAL OFFER

Send for a free copy of one of the most comprehensive valve catalogues ever published. This, the Cossor 72-page Valve Catalogue, contains full technical data, characteristics, curves, operating conditions, etc. of all types of Cossor Valves. Please use the coupon

COSSOR VALVES

To Messrs A. C. Cossor Ltd., Melody Dept., Highbury Grove, London, N.5

Please send me, free of charge, a copy of the 72 page Cossor Valve Catalogue, B.14.

Name _____

Address _____

A. C. Cossor Ltd., Highbury Grove, London, N.5.
Depots at Birmingham, Bristol, Glasgow, Leeds, Liverpool,
Manchester, Newcastle, Sheffield, Belfast and Dublin.

1145

Please Mention "A.W." When Corresponding with Advertisers

OUR BROADCAST CRITIC ON SPIRITUALISTIC PLAYS



EVELYN OVER
who sang in a recent vaudeville

I AM not at all sure that I am really qualified to talk about spiritualistic plays, or spiritualistic anything for that matter, not being a spiritualist. On the other hand, spiritualism need not be condemned out of hand merely because one is not in the habit of practising it.

That spiritualistic plays, or plays to do with telepathy, can be excellent in effect by wireless, so long as care is taken in their treatment, hardly needs pointing out. The unseen is all the more effective because the actors themselves are unseen. No one has to dress up as a ghost or anything of that kind. The medium for an occasional thrill is obvious in wireless transmission.

I liked *The Pinchbeck Ring* immensely. The method of telling its story was good. I think the use of a narrator disguised as a character in the play—for that is what it amounted to—is a thoroughly good wireless device. The subject of this particular play—thought transference—was very well handled; had it not been, the play would have failed because so much depended upon the actual lines themselves rather than upon their presentation.

So long as the plays are not morbid I think the touch of thought-transference, telepathy, or any form of occultism, can be safely exploited. Once they become morbid or harrowing, wireless plays of any kind fall in value. The trouble with most writers who essay to produce occult or spiritualistic plays is that they *must* make the spirits *evil*. Personally, I think it not at all a bad idea to have nice, respectable spirits. They need not be fatuous, of course.

The Proms.

The Mendelssohn Prom. was a great show. I thoroughly enjoyed it. The Germans turn up their noses at Mendelssohn nowadays, despite the fact that he founded the Leipzig Conservatoire.

Isolde Menges gave a fine account of his violin concerto. I thought her tone very beautiful—in the slow movement especially. So did the Promsters, judging from the noise they made at the conclusion.

Robert Easton sang "I'm a Roamer" splendidly. What a jolly song it is! The words, of course, are the merest patter, but I thought the singer gave an excellent impression of inconsequence which, of course, suited the roving spirit of the song.

"The Fire Cross" (*Ave Maria*) of the veteran Max Bruch takes some beating for—shall I say—religious drama. Of course, it is a song that *must* have an orchestra to accompany it. It *can* be played on a

piano, but it loses nearly all its colour. May Blyth gave an excellent rendering of it in the Thursday Prom. I rather think she must have sounded better broadcast than in the hall itself. Standing nearer the microphone than her accompanists must surely have been an advantage in such a song.

Some Alternatives

I indulged in a little knob-twisting on Saturday evening. Confronted with a vaudeville and also an attractive Prom., I switched from one to the other. I do not know that the experience quite agreed with me, but I extracted pleasure out of both. Missing guitar solos, light songs, and negro spirituals, I managed to hear Dorothy Standon who, seemingly, sang in place of Odette de Foas in the Prom. I admired her tone very much, but I should have liked

a more open top B flat. Still, it was a beautiful voice.

Switching back to the vaudeville, I caught Claude Hulbert and Enid Trevor, whom I recognised by their voices. They were very funny. Some of his replies to the letters she read out were clever. Naturally, the letters were "arranged" for the replies, but the latter were good enough to make it all seem quite natural.

After that I wandered back to Langham Place in time to hear Stuart Robertson begin Stanford's "Sea Songs," which he sang without the usual male chorus. I do not remember *ever* hearing a singer pronounce his words so clearly. I was really taken aback at the way each syllable came through. All I can say is, if he can do it, why cannot all the others?

Abie and Sandy—my next—were good, but I did not laugh at them as much as I have done. Were they stale or was I? Perhaps it was the result of too much knob-twisting, but what is a poor critic to do when he wants to hear two things at the same time?

I thought the musical service in the Regional programme on Sunday evening a great improvement upon the general run of these broadcast services. Some very attractive music was sung. There is no doubt that the system of pointing in use at the B.B.C. does make sense of the psalms, which is more than most systems do.

I was not a little attracted to Frank Merrick's recital at 5.30 on Sunday afternoon. I am not sure I liked *all* his programme, but his playing of the "Allegro de Concert" of Chopin, as his last item, won me completely because he did not attempt to pull it about or fool with it, as so many pianists do. He gave an honest, straightforward interpretation which Chopin himself would have enjoyed. Good! Let us have him again.

On Monday evening there was quite a good sketch in the vaudeville. It was called *The Invalid* and was written by Frank Layton, who evidently has grasped the principles of writing for the microphone. Apart from its technical power, it was a very good comedy. One loved "old George," the octogenarian invalid who declared he had never been washed since his mother washed him and did not see why the district nurse should interfere with his arrangements.

WHITAKER-WILSON.

PROGRAMME POINTERS

When does an adaptation cease to be an adaptation? The answer is "when it obliterates the original." That is what I think happened when "Love in Greenwich Village" was adapted. So little of the original book or libretto was allowed to remain that the production was practically a travesty. Also there is surely a limit to the "arrangement" of music by a man like Dr. Arne. It is one thing to re-score him so that he can be the better represented on modern instruments; it is quite another to crab his rhythm by turning him into jazz. The result was modern musical comedy; no one would deny that. It was also a dishonour to Arne. Why, if one wants to produce a modern musical comedy, not write it and be done with it? Why dig up a composer who wrote in 1760 and distort him till he looks like 1932? Personally, I see no sense in it. If you begin doing that sort of thing there is no end to it. Bach's sacred aria, "My Heart ever Faithful," is in perfect foxtrot rhythm, but I hope nobody will make use of the fact and broadcast it in the dance music programme. I submit to Broadcasting House that a production of this sort, which is little better than a parody on the original, is undignified and an insult to a composer who is not here to prevent it. Are we so destitute of librettists and composers that we must exhume the remains of those long since gone?

THIS set does not need any glowing adjectives, for it speaks for itself. For months the AMATEUR WIRELESS Technical Staff has been getting down to real facts about the construction of a set which overcomes all the troubles that beset the average listener. So many people get poor reception and little satisfaction from their radio reception, because they are using out-of-date sets.

The "Wizard" is the real answer.

You cannot afford to be without a good set nowadays. You soon tire of the stations coming in jammed one on top of another as the dials are turned. You begin to weary of bad quality, and you naturally wonder whether the tone can be improved without making the set expensive to run.

The "Wizard" is the set for you when other set designs have failed to give satisfaction. It really does work amazingly well.

It is a fine set for local B.B.C. recep-

What is wrong with your set ? Is it unselective ? Does it give poor tone ? Is it hard to tune, or is it just "out of date" ?

Answer these searching questions honestly and if the answers are unsatisfactory then you will know why you should build the new 'A.W.' "Wizard."

tion, as the tone is excellent. It is easily tuned, and can be worked by the non-technical members of the family. It is a fine station-getter and has none of the disadvantages which sometimes are associated with complicated ganged and bandpass circuits.

What is of outstanding importance to the handyman is the fact that the "Wizard" can be built in a couple of hours and there are no soldered joints in it. There are just the panel and baseboard and less than a couple of dozen components. Even the two coils are supplied ready mounted and ganged together.

HOW IT WORKS

You will be curious to know why the "Wizard" is such an outstanding success.

Well, look at the photographs. These show the simple construction. It is quite obvious that here in the "Wizard" you have nothing complicated. Complications in a

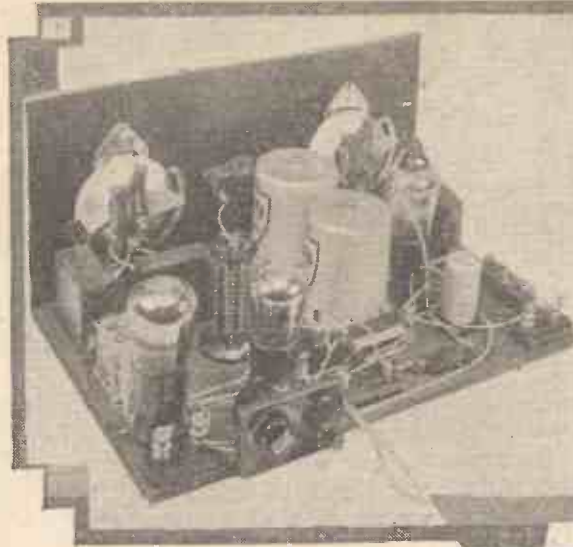

THE WIZARD

THE SIMPLE-TO-BUILD

wireless set generally mean poor results. The "Wizard" is straightforward. As there are no snags every set-builder stands a chance of building it up to work properly, and not in just a mediocre fashion.

OUTSTANDING FEATURES

The "Wizard," in the language of the technicians, is a "S.G., det. power hook-up."

Don't let that frighten you! It means that the "Wizard" has a screen-grid stage, a detector, and a power stage. It doesn't sound specially thrilling, but if you look at the set itself you will see that this very popular circuit arrangement is translated into the form of an ultra-modern layout, using all the best parts of the new season.

The technical features are described later, and the general outstanding features of the set can be seen from the lettered drawing on page 551. Even the least technical listener will know that a set cannot get many foreign stations unless it has a high-frequency amplifying valve to increase the reaching-out properties.

The "Wizard" has a very up-to-date screen-grid valve circuit. This circuit has to be tuned. The detector circuit has to be tuned too. In some sets these two

tuning condensers are ganged together on the same spindle, so that there is only one knob to turn. It is a fine idea in theory, but in practice it may raise all kinds of difficulties as the condenser settings for both circuits cannot always be adjusted to be the same at any point on the wavelength scale.

It means that many complicated one-control sets lose efficiency because they are never properly tuned.

The "Wizard" has separate controls for both these tuning circuits.

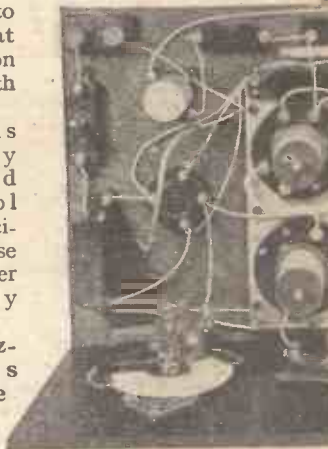

Simple construction is a feature of view with the

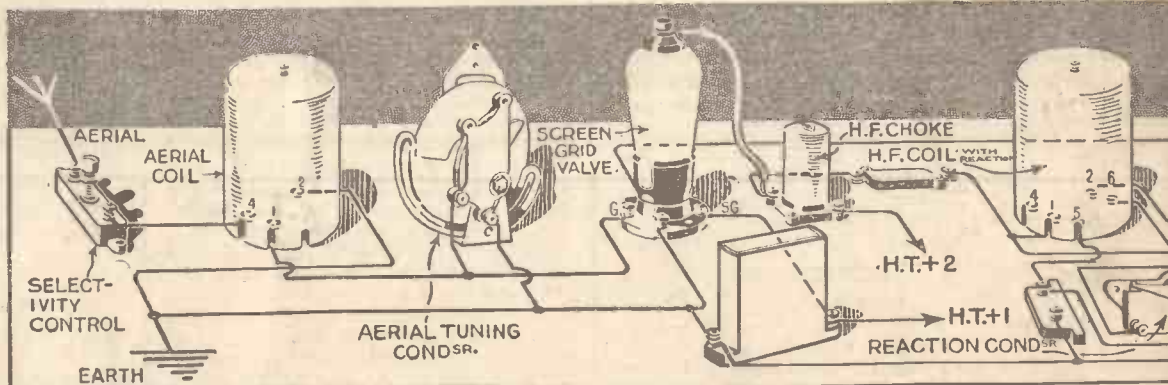

In this circuit arrangement of the 'A.W.' "Wizard" we have departed from the normal practice of giving the components a pictorial layout of the circuit shows you just how the "Wizard" is wired up. The components are shown in their circuit arrangements. The theoretical



pictorially below, and the following detailed technical description explains the "Wizard's" salient points.

THE CIRCUIT

The circuit of the "A.W. Wizard" is shown pictorially below, and this method of presentation makes it understandable even to non-technical listeners. You should compare this with the layout of the actual set. The photographs are a help, too.

The pictorial circuit shows you how the screen-grid valve is arranged. It also explains, in some measure, why the selectivity is so good.

You will see that the aerial is connected through a small condenser of .0003 mfd. maximum capacity to a tapping part way down the aerial coil. This .0003-mfd. condenser is a pre-set, and is on the baseboard of the set.

The screen-grid valve of the "Wizard" is coupled through a .00005-mfd. condenser to the grid coil. In the pictorial circuit the aerial coil is on the left, and the

WIZARD

"STAR" THREE-VALVER

These tuning controls are worked separately and so the "Wizard" is always properly tuned in to a station. There is no hit-and-miss business, owing to wrong ganging. That is one of the secrets of its success. It is always properly tuned in.

If your old set is unselective and brings in one station with a background of the others, you will have a pleasant surprise in the "Wizard" for it uses special screened coils with the tapping on the aerial coil arranged to give knife-

edge tuning. Other arrangements which will be described in the technical section make for real selectivity of an order hitherto not considered possible without complicated and expensive circuits.

REAL PROOF OF SELECTIVITY

If you have doubt about this knife-edge tuning of the "Wizard," look at the authentic station log given on page 551. Without real selectivity, these stations could not have been received, for there would have been inter-station jamming.

The "Wizard" gives good tone. Why? Simply because the power-output valve is coupled to the detector through a special type of circuit which the technical folk know as "parallel feed." This, again, you will find dealt with in the technical section. It means that using normal components and a good detector valve, you can get the best possible tonal reproduction.

To build the "Wizard" and get good results from it, you do not need to be an expert. You need not even have built a set previously. But to know just why the "Wizard" gives you such good results, and how each part of the circuit functions, you should take an interest in the technical features. The circuit of the set is shown

Why the "Wizard?" The "Wizard" is a sorcerer to conjure in the stations for you. It is an ultra-modern three-valver which does not need any ganging or trimming. It can be worked from batteries or a mains eliminator. It is easy to build, a fine station getter and the ideal family set.

grid coil just to the right of the screen-grid valve. The aerial coil has no reaction winding, but the coil in the grid circuit of the detector valve has a reaction section connected through a .0005-mfd. condenser to the earth end of the grid coil.

You can see in the pictorial circuit the switching arrangement for gramophone and radio. The fact that a pick-up can be used with the "Wizard" is a big advantage. The switching is simple and brings the pick-up into circuit in an efficient manner.

In the "Wizard" the detector valve is in a circuit of rather unusual interest. You will be wise to follow the technical points about this special arrangement.

First of all, you will see that there is a small .0002 mfd. condenser connected between earth (that is the low-tension negative wiring) and the anode of the detector, to the lead going to terminal 5 of

of the Wizard. Compare this plan layout on page 572

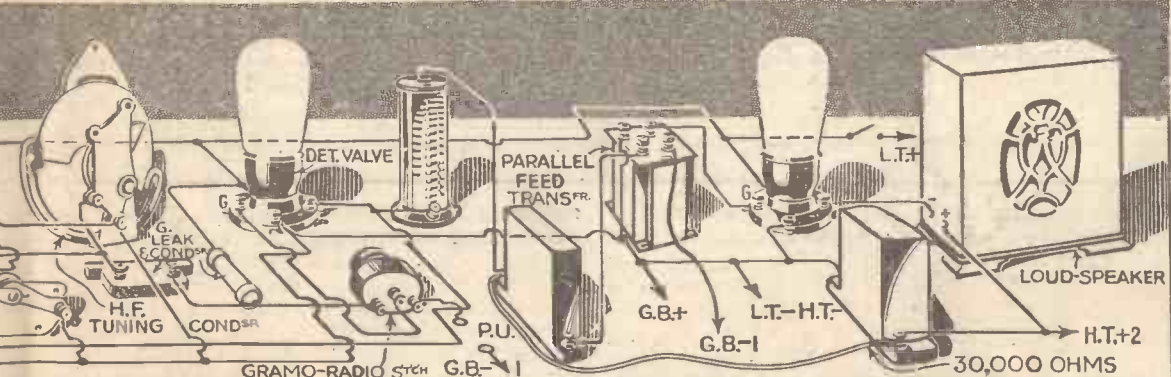

components and wiring in the usual theoretical type of symbols. Theoretical circuits are not easy for everyone to follow, shown as they really are, and not as represented by circuit symbols. The wiring is complete so that you can follow the pictorial circuit is given on the next page

THE ULTRA - MODERN SIMPLE THREE - VALVER (Continued from preceding page)

the reaction winding. This is a by-pass condenser and ensures smooth oscillation.

There is the usual high-frequency choke, in the anode circuit of the detector, and connected to this is the 30,000-ohms resistance of the parallel-feed circuit to the low-frequency transformer. One end of the transformer primary winding is taken through a 1-mfd. condenser to the join

see that no costly components have been included. The main components are the coil unit, variable condensers, low-frequency transformer, and so on. The smaller components you may already have by you from a previous set. Even if you have to buy all new parts, the total cost is surprisingly low.

That is a good feature about the

set and baseboard layout.

Beginners, however, will want to have a full-size layout of the set, in order to gauge the drilling centres and to know just where to mount all the parts.

The "A.W." Technical Staff prepares full-size blueprints in connection with all the sets published in this journal and a full-size blueprint of the "A.W." "Wizard"

COMPONENTS THAT YOU WILL REQUIRE TO BUILD THE "WIZARD"

EBONITE

- 1—Ebonite panel, 14 by 7 in. (Lissen, Becol, Goltone, Peto-Scott).
- 2—Terminal blocks, marked Aerial, Earth, L.S., L.S.— (Lissen)
- 1—Ebonite strip, 3 by 2 in. (Becol, Goltone, Peto-Scott, Lissen).

CONDENSERS, VARIABLE

- 2—.0005-mfd. solid dielectric (Ready Radio "Micalog," Lissen, Telsen, Peto-Scott, Polar, Utility).
- 1—.0005-mfd. variable reaction (Lissen, Ready Radio, Telsen, Peto-Scott, Polar, Utility).
- 1—Pre-set series aerial condenser, .00003 mfd. to .00025 mfd. (Sovereign, Lissen, Telsen, Formo, Igranic, Goltone).

COIL

- 1—Two-gang shielded coil unit and combined filament switch (Lissen).

CONDENSERS, FIXED

- 2—1-mfd. (Telsen, Lissen, Dubilier, Igranic, T.C.C., Formo).
- 1—2-mfd. (Telsen, Lissen, Dubilier, Igranic, T.C.C., Formo).
- 1—.00005-mfd. (Dubilier, type 670; T.C.C., Ormond, Formo).
- 2—.0002-mfd. (Lissen, Telsen, T.C.C., Dubilier, Goltone, Formo, Sovereign).

CHOKES, HIGH-FREQUENCY

- 1—Screened high-frequency choke (Wearite, Bulgin).
- 1—Standard high-frequency choke (Slektun, Lissen, Tunewell, Telsen, Wearite, Goltone, Igranic, Varley, Climax, Sovereign, Watmel, Ready Radio).

RESISTANCES, FIXED

- 1—2-megohm grid leak with wire ends (Dubilier, Lissen, Igranic).
- 1—30,000-ohm spaghetti resistance (Tunewell, Lewcos, Ready Radio, Lissen, Varley, Goltone, Bulgin, Sovereign, Telsen, Igranic).

HOLDERS, VALVE

- 3—Four-pin valve holders (W.B., Lissen, Lotus, Telsen, Junit, Benjamin, Clix, Wearite).

TRANSFORMER, LOW-FREQUENCY

- 1—Resistance-fed transformer (Bulgin "Senator," R.L., Igranic "Parvo," Varley).

SWITCH

- 1—Radiogram change-over switch (Ready Radio, Bulgin, Tunewell).

SUNDRIES

- 1—Baseboard, 14 by 9 in. (Peto-Scott, Cameo).
- 2—Slow-motion disc drives (Ready Radio, Lissen, Utility, Lotus, Telsen, J.B.).

- 6—Wander plugs, marked H.T.—, H.T.+1, H.T.+2, G.B.—, G.B.—1, G.B.—2 (Belling-Lee, Clix, Eelex).
- 2—Spade terminals, marked L.T.—, L.T.— (Belling-Lee, Clix, Eelex).
- 2—Terminals, marked Pick-up (2) (Belling-Lee, Clix, Eelex).
- Six yards thin flex (Lewcoflex).
- Connecting wire and sleeving (Lewcos).
- Length of shielded flexible tubing (Goltone, Lewcos).

ACCESSORIES

BATTERIES

- 1—120-volt high-tension (Lissen, Pertrix, Drydex, Oldham, Ever Ready).
- 1—0-volt grid-bias (Lissen, Pertrix).
- 1—2-volt accumulator (Lissen, Exide, C.A.V., Oldham).

CABINET

- 1—Special cabinet (Peto-Scott).

LOUD-SPEAKER

- 1—Motor "York," Blue Spot, R. & A., Lanchester, Epoch.

MAINS H.T. UNIT

- 1—Atlas, A.C. 244; Ekco; Tunewell H.R. 120/15; Regentone, Lissen, Climax.

point of the high-frequency choke and the 30,000-ohm resistance.

In the average set the low-frequency transformer is wired up with its primary winding in the anode circuit of the detector, "I.P." to high-tension, "O.P." to the plate of the valve, and so on. In the "Wizard" the primary of the transformer is not subjected to the steady direct current in the anode circuit. It is parallel fed through the 1-mfd. condenser. This is a much better idea. It ensures good tone.

Just to make sure that the whole set is stable, there is a 2-mfd. condenser connected between high-tension positive and earth or high-tension negative.

The "Wizard" is a cheap set. There can be no argument about this for you have only to look at the list of parts specified in the accompanying panel to

"A.W." "Wizard." On account of its low cost it brings good reception within the reach of all.

In the components list, the first-mentioned makes of parts are those used in the original "Wizard"—the set illustrated by the accompanying photographs. In most cases alternatives are given, and these components can safely be used if the first-mentioned parts are not available.

If you do not buy all the parts in a complete kit from one of the many suppliers of kit outfits for the "A.W." "Wizard," choose your components with care and check them over with the accompanying list, so that when you start the constructional work you do not find you have any parts missing or have bought components of the wrong electrical values.

is obtainable, price is, post free, from the Blueprint Department, AMATEUR WIRELESS, 58-61 Fetter Lane, London, E.C.4. This is a proper full-size professional blueprint of the whole set, giving the layout, mounting centres, and wiring.

To ensure that all constructors can



The final touch—connecting up the batteries. There is no reason why you should not build the "Wizard" in about a couple of hours

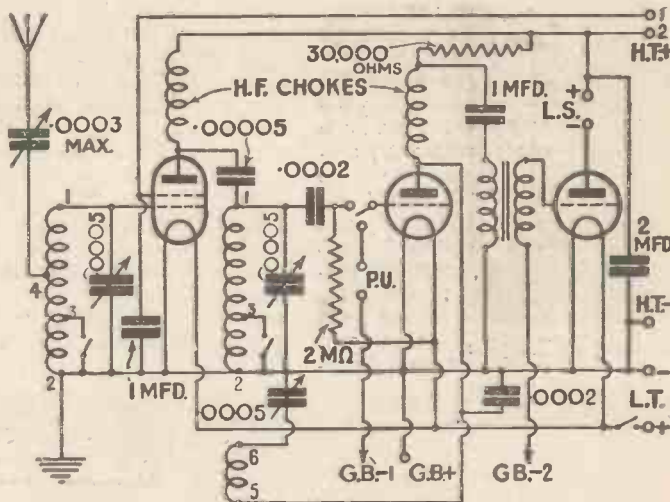

Here is the theoretical circuit of the "Wizard." A useful comparison can be made with the pictorial circuit on the preceding page

Starting the Construction

The experienced set builder, when he has purchased the full kit of parts, will be able to start construction using only the accompanying photographs and the small drawing of the

make up the "Wizard" without difficulty, a full-size wiring plan of this set will be given in next week's issue.

As you will see from the photograph, the main components are mounted on a wooden baseboard, including the terminal blocks for the aerial, earth, and loud-speaker connections, the small strip of ebonite which carries the pick-up terminals and the radio-gram switch.

(Continued on page 572.)

A FULL-SIZE WIRING PLAN OF THE "WIZARD" FREE NEXT WEEK

HOW
STUDIO
SOUNDS ARE
PRODUCED

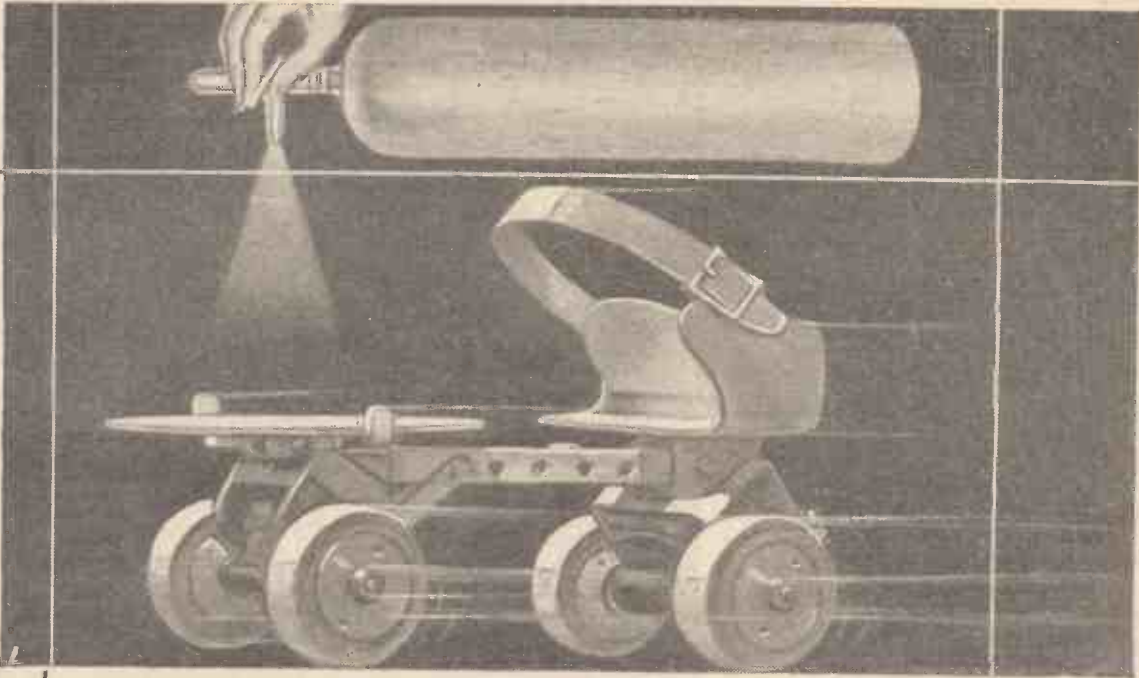

Here's your radio railway train



Shrill whistles, hissing steam, the clank of wheels, the gathering speed . . . all these noises are produced in the Effects Studio by means of simple mechanical devices like the roller skate and the compressed air cylinder you see above. The result is amazingly realistic; and that realism you can retain in your reproduction by using the pure power of a Lissen Battery in your set. There is a process used exclusively in this Lissen Battery which produces power of remarkable purity; power so sustained that over prolonged periods of time it remains steady, noiseless and abundant always. Every radio dealer sells the Lissen High Tension Battery : ask for it firmly by name.

LISSEN H.T. BATTERY

lasts longest and provides a pure high tension current
that will give stage realism to your radio drama!

Mention of "Amateur Wireless" to Advertisers will Ensure Prompt Attention

THE ULTRA-MODERN SIMPLE THREE-VALVER (Continued from preceding page)

The "control" components—the variable condensers for tuning, the reaction condenser and the combined wavechange and on-off switch, are on the panel. If you do not purchase the components in the complete kit (when the panel drilling may be done for you) it will be necessary to drill the holes for these components and to cut out the orifices for the tuning scale escutcheons. This is not a difficult job, and the rest of the construction, screwing down the components, and wiring up, takes well under a couple of hours.

In next week's issue, apart from the presentation of the full-size wiring plan for the "Wizard," a detailed description will

CAN YOU BEAT IT ?

A reception log obtained on a first test of the new "A.W. Wizard" is given on page 551. If your set won't give these results then build the "Wizard."

be given of the rest of the construction, so that if you cannot follow the photographs alone, you will have no difficulty in making up your "Wizard" to work right first time.

Don't forget—next week: a detailed constructional description and a free full-size wiring plan!

London readers can see the "A.W. Wizard" in a special display in the radio department windows of Messrs. Selfridge & Co., Ltd., of Oxford Street, London, W. The "Wizard" display is in Somerset Street, which is at the back of the main Selfridge building and parallel with Oxford Street. See the "Wizard" in the flesh!

Two interesting religious services will be relayed in the North Regional programmes on Sunday, September 18. The first is at 3 o'clock in the afternoon and comes from Ripon Cathedral. It is specially designed for cyclists and wayfarers. The second comes from Stoke Parish Church in the evening.

NOTWITHSTANDING the fact that there is to be a cut in the time schedule of the German programmes, it will be still possible twice weekly to hear a late transmission when the B.B.C. stations have closed down. Make a note that the Berlin studio will be on the air every Monday and Thursday from midnight until 1.30 a.m. The transmissions may be captured through a number of stations, including Königswusterhausen (1,634 metres) and DJA, Zeesen (31.38 metres).

As regards the early morning concert which can be picked up through the high-power long-wave station, you will now find there is a break between 8.5 and 8.30 a.m. when Königswusterhausen closes down, in order not to interfere with the weather forecast broadcast by Norddeich for the benefit of shipping in the Baltic and North Seas.

Germany this week provides me with several items of interesting news. Freiburg-in-Breisgau, a relay of the Stuttgart programme, is to be dismantled and a new 5-kilowatt is to be erected at Betzenhausen. When completed

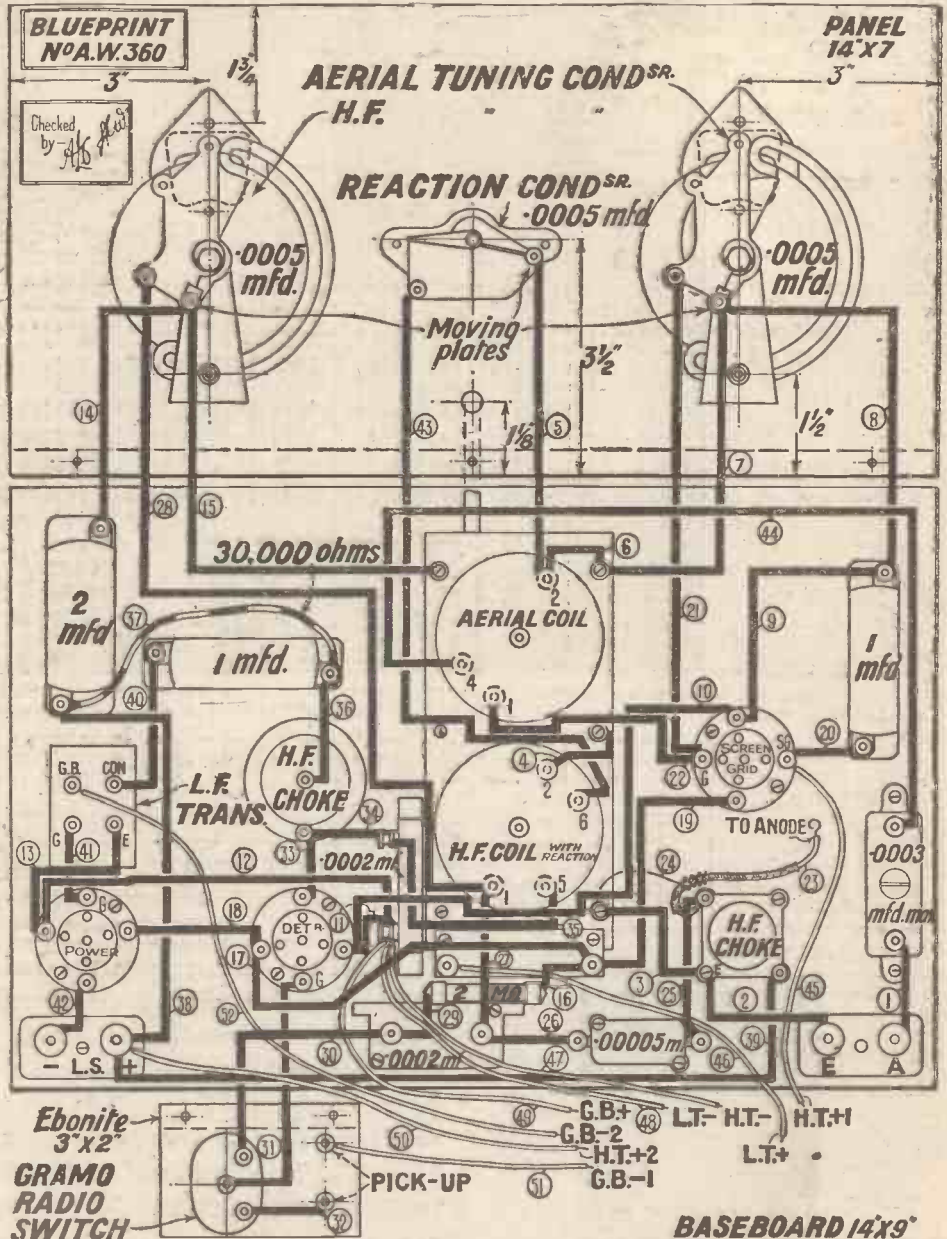

This is a reproduction of the layout of the "Wizard." A full-size blueprint can be obtained from these offices, price 1s., post free. A full-size wiring plan will be given next week.

OUR LISTENING POST

By JAY COOTE

it will link up with Frankfurt-am-Main, Cassel and, later, Treves, to work on the common wavelength of 259.3 metres (1,157 kilocycles).

Leipzig-Wiederau, the latest super-transmitter, is now on the air, and probably when tuning in to the setting which previously gave you Frankfurt-am-Main (398.9 metres) you will have picked up its powerful signals. Leipzig on this more favourable channel is now clear of London National and Moravska-Ostrava, and should become a prominent feature in your daily log. If you wish to make a comparison with some other European broadcaster you may put the new German station down as on a par with Prague. You will know what to expect from it in the im-

mediate future, for Leipzig is roughly 100 miles nearer than its Czech competitor.

You may also expect to hear Frankfurt-am-Main on its new wavelength (259.3 metres) in the course of a day or so; in this case, however, the strength of signal, although better than hitherto, will not be as noteworthy, for the new transmitter is only a 17-kilowatt. Perhaps it is all for the best, in view of its proximity to London National.

Some mystery appears to surround the wavelength to be used by the proposed 200-kilowatt station destined to replace the present Radio Bucarest. Rumour had it that the 550-metre wavelength would be abandoned in favour of 210 metres, but it now seems that Rumania is anxious to work on the higher waveband. For the purposes of measurement tests, etc., a 1-kilowatt transmitter has been installed in a railway train at some little distance from the capital. Experiments with gramophone records, and also with the relay of the Bucarest programmes, are carried out on 1,980 metres.



INTER-VALVE

TONE-CONTROL

Introduced for the first time
TONE VARIATION IN THE HEART OF THE RECEIVER

Here is a component which opens up new possibilities of quality reproduction—the Lissen Inter-valve Tone Control. Hitherto the best you could do in the control of tone was to attempt to correct in the output stage those faults of quality inherent in the receiver itself. Now the Lissen Inter-valve Tone Control gives you **SCIENTIFIC CONTROL OF TONE IN THE HEART OF THE RECEIVER.** By rotation of the special potentiometer (which is fitted to the front panel of the receiver) you get real variable control, so that for any particular item you can bring out deep bass or obtain brilliant high-note response just as your ear demands. Specially designed to fit under the base of the Lissen Hypernik Transformer—can also be fitted in a few moments into any transformer-coupled receiver. **10/-** Price complete with special potentiometer

USE IT WITH A LISSEN HYPERNIK TRANSFORMER

If you want absolute truth of tone, use the Lissen Hypernik Transformer, as all the foremost set designers are doing. You cannot get such a good response curve—such fine quality reproduction—from any other transformer at anything like this price.

With a primary inductance of fully 100 henries, the Lissen Hypernik Transformer yet operates perfectly when passing currents up to 5 mA or more. Its step ratio is 4 to 1 and a stage amplification of more than 100 is obtained.

12/6

PRICE

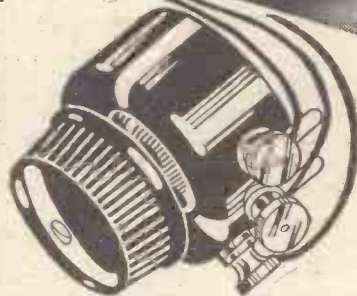
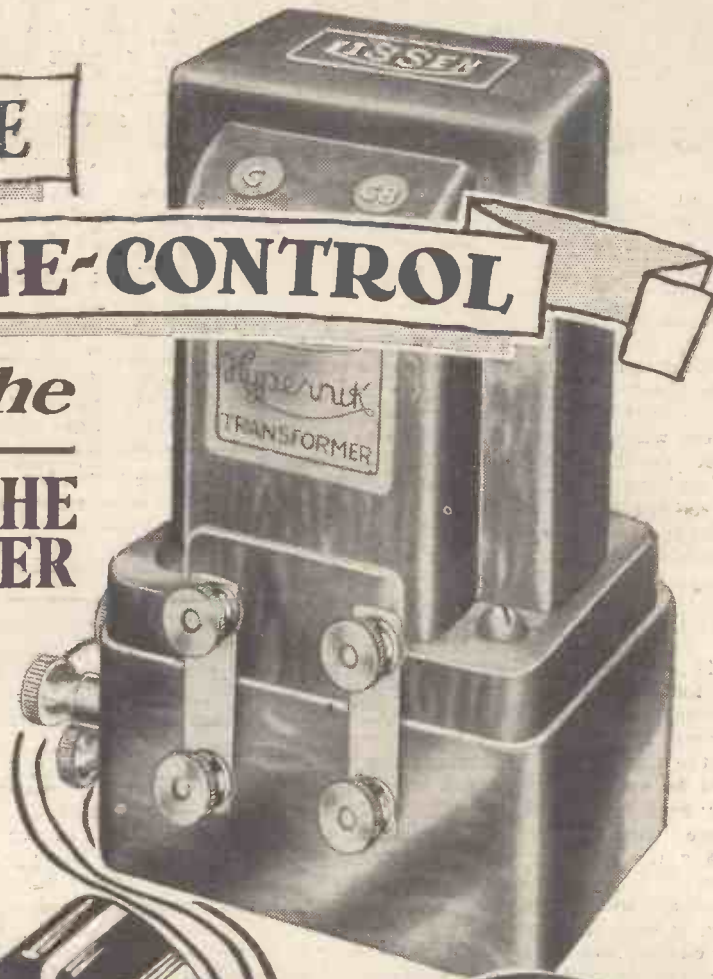

TONE CONTROL COMPLETE WITH

10/-

SPECIAL POTENTIOMETER

"ONE of the LISSEN

MATCHED PARTS"

LISSEN

The only full-size Condenser selling at

FIXED CONDENSERS WERE **1/6**

6^D

LISSEN

Exactly the same Grid Leaks for which you were previously paying 1/-

FIXED GRID LEAKS WERE **1/6**

6^D

Please Mention "A.W." When Corresponding with Advertisers



What Our Readers Think

The Editor does not necessarily agree with the views expressed by readers and does not accept responsibility for the letters published. Letters cannot be published which do not bear the sender's full name and address.

Radio "Thrillers"

SIR,—In this week's issue of **AMATEUR WIRELESS**, your broadcast critic refers in his pointer to a play being "too human." I agree that "thrillers" are very acceptable on the wireless, but I should like to know what your readers think of Mr. Whitaker-Wilson's contribution that playwrights can go too far in the matter of plays which strike too human a note. Is Mr. Whitaker-Wilson pointing to a truth or is he merely being squeamish?

W. G. (Croydon).

On the Long Waves

SIR,—Why do all the radio experts press for a new long-wave station as an alternative to 5XX? The B.B.C. seems anxious to have another long-waver, and all the Continental authorities are trying hard to get new long-wave stations. Do they really know what conditions are like above 1,000 metres? I have found that during the last few weeks, reception has been simply intolerable on the long waves. Static and even fading have been more than usually bad. If there were another long-wave B.B.C. station it would certainly be of no use to me, and I am sure that thousands of other listeners would not like to have to

have long-wave difficulties, either. The American scheme of sticking to the 200-600 metre band seems best.

A. K. (Leeds).

These Wander Plugs

SIR,—I do not use many dry batteries, but I often notice that the sockets vary greatly in size. Can't the manufacturer do something about this? For, in spite of the new spring type wander plugs, it is difficult at times to find one which will make good

The Editor invites letters from readers on all interesting radio subjects. For the most interesting letter published each week a general-purpose valve or other component to the same value will be given

contact with every H.T. or grid-bias battery. It rather makes me wonder if the difference in size is not a matter of a lack of standard, but rather a carelessness in manufacture of the small brass parts.

J. P. (Bolton).

Scrap This Regional Scheme!

SIR,—Anyone who has studied the development of the B.B.C.'s Regional Scheme during the past few years must have come to the conclusion that it is a sheer waste of good and precious wavelengths. Just now, when we read of wavelength squabbles at Madrid, the B.B.C. must be feeling rather uncomfortable at the thought of its waste of wavelengths.

Obviously, the super-power long-wave station should have been started a year or more ago, then the present medium-wave stations, National at London, Manchester and Falkirk, would be unnecessary, as would the coming West National station. Surely the nation-wide range of a 100-kilowatt long-wave station occurred to the B.B.C. before this?

Sometimes it is really ludicrous the way our stations broadcast exactly the same programme. There are times when all the Regionals are doing one programme and all the Nationals another, with the result that about nine wavelengths are being used up to broadcast two programmes.

What any thinking listener demands at the present time is to know why the medium-wave nationals are proceeded with, while the new Droitwich station apparently hangs fire.

T. R. (Nottingham).

Box Resonance in the New Sets

SIR,—Now that the Radio Exhibition at Olympia is over and listeners have had time to reflect on what was on view, it occurs to me that there is too much standardisation, especially in the cabinet design. Most of the popular sets seem to be housed in small table cabinets, which, although they may be marvels of compactness, are not conducive to really good reproduction.

So far as I can see very few set makers have paid much attention to the question of box resonance, which is bound to be troublesome in very confined loud-speaker cabinets. The B.B.C. box-baffle idea, as described in your recent issue, strikes me as a simple way out of this difficulty, but none of the sets on view incorporated this slag wool padding.

As most of these sets now use a small moving-coil loud-speaker, which itself tends to accentuate the bass around 150 cycles, is it not even more important that the question of resonance in the cabinet should be carefully studied? Otherwise boominess seems inevitable, and we shall be relegated to the position so unenviably held by the Americans two years ago, when "woofy" quality was supreme across the herring pond.

A. S. (Sidcup).

COME TO THE COOK-HOUSE DOOR!



Jack Payne and his boys have been on a camping holiday at the seaside and here Jack is seen calling them to breakfast with the cheery note of a "sax".

CAN YOU BEAT IT?

A reception log obtained on a first test of the new "A.W. Wizard" is given on page 551. If your set won't give these results then turn to the constructional description of the "Wizard" in the centre pages.

How to build yourself a better set—and SAVE POUNDS!



Here's the only Kit you can build yourself employing such **HIGH POWER Valves!** **YOU CAN'T GO WRONG!**

THIS new LISSEN SKYSCRAPER KIT SET is the ONLY ONE on the market that you can build yourself employing a Metallised Screen-grid Valve, High Mu Detector, and Economy Power Pentode Valve. Around these three Valves LISSEN have designed and produced a home constructor's kit the equal of which there has never been before. It is the only battery set delivering such power—yet the H.T. current consumption is far less than the average commercially designed 3-valve set. And the LISSEN SKYSCRAPER is made simple for you to build—such detailed instructions are given to you, and so clearly, in the FREE Lissen Constructional Chart, that everybody, with no technical knowledge or skill, can build it quickly and with complete certainty of success.

Why be satisfied with whispering foreign stations when you can BUILD WITH YOUR OWN HANDS this LISSEN SKYSCRAPER that will bring in loudly and clearly distant stations in a profusion that will add hugely to your enjoyment of radio?

1/2 CONSTRUCTIONAL CHART—FREE

Lissen have published a 1/2-Constructional Chart, giving the most detailed instructions ever printed for the building of a wireless set. Every part, every wire, every terminal is identified by photographs. Everybody, without technical knowledge or skill of any kind, can SAFELY and with COMPLETE CERTAINTY undertake to build this most modern of all radio receivers from the instructions given and the parts Lissen have supplied. THERE IS A FREE COPY OF THE CHART FOR EVERYBODY—GO AND ASK YOUR DEALER FOR YOURS—or fill in the coupon below.

You buy the Lissen Skyscraper Kit complete with valves—a Lissen Metallised S.G., a High Mu Detector, and a Lissen Economy Power Pentode Valve—and the price complete is only 89/6. You can start straight away and build it, using, if you like, any existing batteries and any suitable cabinet.

Or you can buy the Lissen Walnut Console Skyscraper Cabinet and Loud-speaker combined, as illustrated. It holds all the Batteries, and Accumulator and Loud-speaker as well as the Skyscraper Kit—it makes everything self-contained. A special Lissen Pentode Matched Balanced Armature Loud-speaker of great power is supplied with the cabinet, and the price of the Skyscraper Kit complete with valves and this cabinet and loud-speaker is only £6.5.0. For this you will possess a receiver which has no equal.

LISSEN

SKYSCRAPER KIT

COMPLETE CONSTRUCTIONAL CHART FREE!

TELLS YOU EXACTLY WHAT TO DO WITH EVERY SINGLE NUT & SCREW

to "Amateur Wireless" Readers

There is a FREE COPY of the CHART for everybody—ask your dealer or

POST THIS COUPON

3

The LISSEN

To LISSEN Ltd., Dept. A.W.3, Worples Rd., Isleworth, Middlesex

Please send me FREE copy of your 1/2- Skyscraper Chart.

Name.....

Address.....

You will Help Yourself and Help Us By Mentioning "A.W." to Advertisers

SETS OF DISTINCTION

H.M.V. SUPER-HET —PORTABLE SIX—

Makers: The Gramophone Co., Ltd. Price: 17 guineas

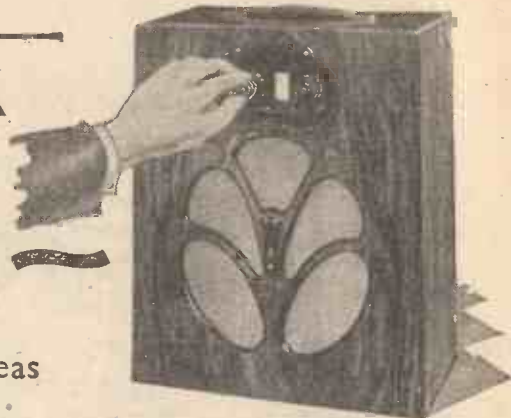

I WONDER whether the H.M.V. Press Department is right in saying that "the engineers in H.M.V. research laboratories have designed an instrument that will set a new fashion in portable receivers." It is a bold statement when we remember how, in point of fact, portables are distinctly out of fashion compared with other types of sets.

As to setting a new fashion, well, this new H.M.V. product really emphasises a fashion that has been all too evident for a year or more—the fashion of cutting down the total anode-current consumption to a bare minimum. With a nominal total anode current of 10 milliamperes for six valves, the makers can certainly be congratulated in pursuing this particular fashion to its logical conclusion.

Cutting Anode Current

Speaking in general terms, it is questionable whether *vox populi* will proclaim this ruthless pruning down of anode current in the way the research engineers anticipate. All credit for attaining such a meritorious performance with such a meagre power expenditure—but does the end justify the means? That is the point to be decided this year, not by engineers, be they ever so scientific, but by the "man in the street." This solid entity will decide whether the logical limit of anode current economy imposes too great a sacrifice in the quality of the reproduction. With a public educated up to the idea that quality of reproduction is the ultimate criterion—an idea H.M.V. has in no small way helped to inculcate during the past year!—it will be very interesting to see how the modern portable, and this H.M.V. model in particular, is finally judged by the public.

The Quality

Always, when writing of the quality of a portable set, I try to be fair, in that I make no attempt to compare the tone with that obtainable from powerful A.C.-mains sets. Rather, I attempt to judge portable quality in terms of the power available. This is really the only course.

"The quality of reproduction from the balanced-armature cone loud-speaker sets a very high standard for portable receivers." The words are H.M.V.'s. The italics are, needless to say, mine. I would say that the quality, in view of the power limitations, and the frequency limitations of the moving-iron loud-speaker, is quite as good as can be expected. The real danger is that users may "open the throttle" too generously, with the result that the combined amplification of the five valves preceding

the PT₂ pentode output valve will cause distortion through gross overloading. That is a danger common to some extent to all portables, but particularly so with this multi-valver.

No one can fail to be impressed with the general specification of the H.M.V. instrument. It is by far the most ambitious battery-operated set I have yet tested. It is, in brief, a six-valve super-het. The sequence of the valves will interest all super-het enthusiasts; there is a first stage of high-frequency, with a Marconi S₂₁ metallised valve, a separate oscillator valve, HL₂ metallised, a first detector, S₂₁ metallised, an I.F. amplifying valve, S₂₁ metallised, a second detector, HL₂ metallised, and a pentode output valve, PT₂.

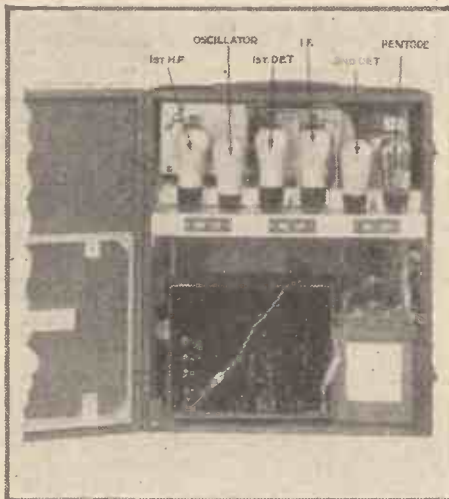

The sequence of the super-het valves can be seen from this lettered photograph

To technical-minded readers the most ambitious part of this circuit is the ganging together of the frame tuning, first high-frequency tuning, and oscillator. This is done with a three-gang condenser, having specially shaped vanes that provide a frequency difference of 125 kilocycles for the intermediate frequency over both wavebands. This really outstanding feat is accomplished by the padding-condenser idea, and there is an additional trimmer control for the aerial tuning.

A Sheer Delight

I congratulate the designers on the clever simplicity of the controls of this set. It is a sheer delight to operate. There are two combination control knobs mounted one

each side of the tuning escutcheon. That is all! A really praiseworthy simplification of control has been effected, the more so because performance is in no way sacrificed by this remarkable elimination of complication.

The control on the left has an outer ring working the volume control, which is applied to the grid-bias on the first high-frequency valve. Inside this ring is a control knob that provides medium and long waves and also switches off the set.

The control on the right epitomises the ingenuity of the whole design. For in this control is wrapped up all the one-time complication of super-het circuits. Reduced to the last degree of simplicity—yet retaining all the inestimable advantages of the super het—here you have local-station-set simplicity of control in a set that, so far as range is concerned, knows no limit except that imposed on us by the ether itself.

The outer ring of this right-hand control works the gang condenser and the wave-length-calibrated tuning scale. The inner knob trims the aerial tuning.

Marvellous Achievement

I can say without hesitation that this set provides an absolutely constant super-het performance on both wavebands. To anyone knowing even a little of the design difficulties of double-waveband super-hetting with one-knob control, this constancy of performance is a marvellous achievement.

As this is a portable, it has, of course, a frame aerial and that adds to the inherently good selective properties provided by the super-het valve sequence. On the long waves, for example, I got Zeesen absolutely clear of Radio Paris and Daventry, while on the medium waves stations normally jammed beyond hope were separated with almost uncanny ease.

The anode-current consumption is supposed to be 10 milliamperes, but when I found the model on test took 15 milliamperes, I was not really surprised. This is about what one would expect, though possibly by a reduction of the high-tension voltage a lower reading might be obtained, with, of course, a further restriction in the undistorted output.

The walnut cabinet is designed on simple and attractive lines, as can be seen from the illustration. There is a Packawa handle for carrying the set about from one room to another, and the total weight is 34 pounds.

SET TESTER.

LISSEN
SHIELDED

DUAL RANGE **COILS**

You are going to use a Lissen 2-gang Shielded Coil Unit in your "A.W." "Wizard"! It is a simple set to build—because of these Lissen Coils. It is an easy set to handle—because of the perfect matching of these Lissen Coils. Its advanced yet simplified circuit design is made possible only by the Lissen Coils. Its high selectivity depends upon them, its attractive appearance even is enhanced by the combined wave-change and filament switch incorporated in this Lissen 2-gang Coil Unit.

LISSEN 2 GANG SHIELDED COILS USED in the "A.W." WIZARD

Break-through on the long wave-band is almost entirely eliminated. Damping losses are exceptionally low. Shielding is particularly complete. All Lissen Shielded Coils are matched in inductance to within 1 per cent. Price of 2-gang Coil Unit complete with inbuilt wave-change and filament switches. **17/6**



You understand now why "Amateur Wireless" have chosen these Coils for their star set of the season—and remember, when once you have bought Lissen Shielded Coils you can adapt them to any circuit.

Single Lissen Dual-range Shielded Coil	6/6	Two-gang Lissen Shielded Coil	17/6	Three-gang Lissen Shielded Coil	26/-
--	------------	-------------------------------	-------------	---------------------------------	-------------

SINGLE 6/6 EACH COILS

ONE of the LISSEN MATCHED PARTS

You will Help Yourself and Help Us by Mentioning "A.W." to Advertisers

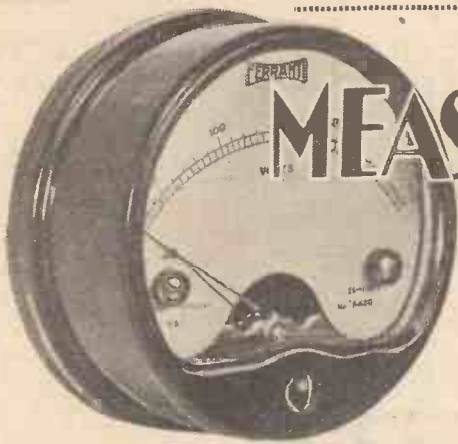

MEASURING INSTRUMENTS IN RADIO WORK

You need meters in order to test the working of your set, and this practical article explains how the meter tests are made

IN any wireless set the best results as regards efficiency, quality, and volume can only be obtained by having the correct voltages on the filaments, anodes, and grids of the valves, and with battery-operated sets the necessary instruments will soon pay for themselves in the increased life of H.T. batteries and valves. Delicate tuning adjustments are useless if the valves are not getting their correct voltages; grid bias, if incorrect, causes distortion and, if insufficient, causes, as well, a heavy drain on the H.T. battery. With a voltmeter and milliammeter many defects can easily be traced that would be very difficult to locate otherwise.

All tests should be made under actual working conditions to allow for the potential drop in the circuit due to connections, switches, joints, and so on. Low-resistance

moving-iron voltmeters usually take an excessive current and are only suitable for testing the voltage of L.T. batteries on open circuit. They should not be connected in parallel with a valve as the circuit conditions will be altered; if the battery or supply voltage is raised to allow for the additional load the valves may be damaged when the voltmeter is disconnected.

To test H.T. and L.T. batteries and filament voltages under true circuit conditions an instrument with a resistance of at least 100 ohms per volt is essential. Double-range moving-coil instruments are available, embodying a switch knob which, when rotated, gives alternative ranges of 0-160 and 0-16 volts, the lower range being suitable for testing filament voltages and L.T. battery voltages when on circuit. The voltmeter should be connected to the fila-

ment terminals of the valves, and the battery voltage adjusted to give the correct reading when current is flowing in all the valves.

With H.T. eliminators the output varies with the load. So as not to increase the load and give false readings, an extremely sensitive voltmeter should be used, such as a moving-coil instrument with a resistance of 1,000 ohms per volt; this will take a current of only 1 milliamperes.

Where screen-grid volts are obtained by the resistance drop method it is necessary to measure the anode current and calculate the voltage drop. For this purpose a milliammeter is necessary to ascertain the current taken from the H.T. battery, which can be varied by altering the grid bias. The correct grid bias to obtain the most

(Continued on page 580)

BE UP-TO-DATE

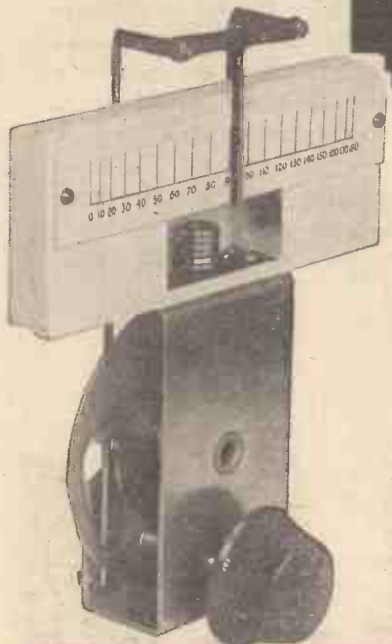

Modernise your set by fitting the new Utility Straight Line Dial, a dial that makes any other form of tuning control obsolete.

The whole of the scale is exposed to view and illuminated. No bending up to a dim and distant future or turning back to a murky past. The

whole of your tuning range always before you—to be read at a glance.

Obviously the common-sense method of tuning is to have a moving pointer traversing a stationary scale. That is the essential feature of this new Utility dial. But ask your dealer to show it to you and judge for yourself.

From your dealer or post free from the makers

PRICE 7/6
complete with Escutcheon.

6d. extra if fitted with panel lamp indicator.

WILKINS & WRIGHT LIMITED

UTILITY WORKS, HOLYHEAD ROAD, BIRMINGHAM

AGENTS.—London: E. R. Morton, Ltd., 22 Bartlett's Buildings, Holborn Circus, E.C.4. Scottish: E. B. Hammond, 113 Vincent Street, Glasgow. Lancashire and Cheshire: J. R. Lister, 83 Old Road, Blackley, Manchester. Westmorland, Cumberland, Durham, Northumberland, Yorkshire and Derbyshire: H. C. Rawson, Ltd., 100 London Road, Sheffield. Lawrence Fraser, Chelsea House, Lansdown Road, Bath



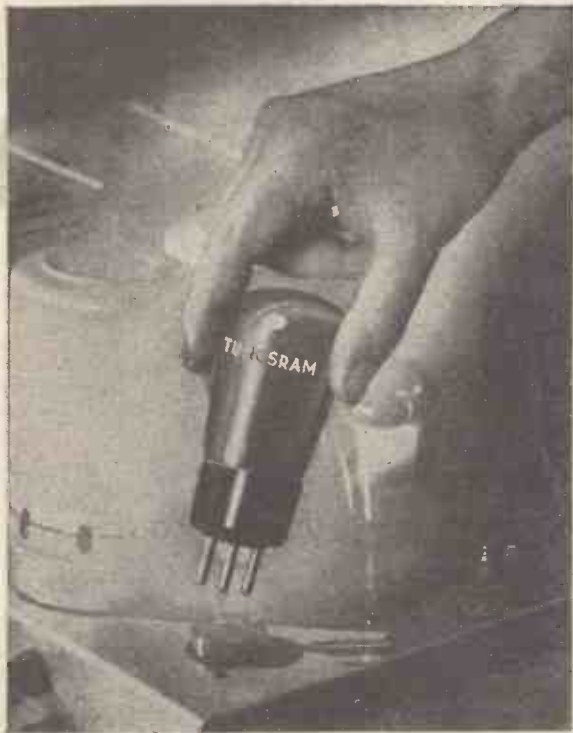

A NEW SET OR A RENEWED SET at a fraction of the cost

Perhaps your radio reception is on the downward path. Fewer stations; less volume; worse tone. Your set is not to blame. Your set is as up-to-date to-day as it was a year ago. It's your valves; they are not pulling their weight. Renew your set throughout with Tungram Valves. Make it as good, or even better than when you bought it, or built it. More stations; increased volume; perfect tone. But it must be Tungram! For this reason; Tungram Valves are the most efficient that modern science has so far produced. Tungram Valves are used by 61 British set manufacturers. But they cost very much less than the price you're used to paying. You cannot get Tungram quality in any other valve, even by paying twice the Tungram price! Insist on Tungram. Don't be put off. Go to a Tungram dealer; take nothing but Tungram!

RENEW YOUR SET WITH

TUNGSRAM

Tungram Electric Lamp Works (Gt. Britain)
Ltd., Radio Dept., S.T.4, Commerce House,
72, Oxford Street, London, W.1.

BARIUM VALVES

To Ensure Speedy Delivery, Mention "A.W." to Advertisers.

"MEASURING INSTRUMENTS IN RADIO WORK"

(Continued from page 578)

economical working of the valve can then be determined by comparison with the makers' curve supplied with the valve. A slight variation on both sides of the steady anode current indicates that the valve is correctly biased. An unsteady reading indicates either that the grid bias or plate voltage is incorrect, or that the power valve is overloaded. Upward kicks of the anode current indicate that the grid bias is too great, and downward kicks that it is too small.

Checking Distortion

If the power valve is overloaded a more suitable valve must be used in the last stage, or the input to the receiver reduced. If the valve used has a suitable characteristic, the grid bias or the plate voltage must be adjusted. In measuring the anode current of the detector valve an unsteady reading does not necessarily mean that the valve is overloaded; on the grid-leak system the anode current will decrease (up to a point) with the signal strength, and on the anode-bend method the reverse is the case.

Any slight leakage occurring when the set is not switched on and the H.T. battery is left connected is a continuous load that reduces the life of the battery considerably. It can be detected by testing the H.T. circuit with a milliammeter.

Grid voltages must be measured with a high-resistance voltmeter as no current should normally flow from the grid-bias battery. Connection should be made from

the grid side of the grid-bias battery to the negative filament terminal, giving the open circuit voltage of the battery.

On A.C. mains sets the various voltages are best measured with rectifier instruments, a combination of moving-coil instruments and metal-oxide rectifiers; these should have a resistance of at least

100 ohms per volt to ensure accurate readings at low voltages. In such cases moving-iron instruments are unsuitable. A 3-in. instrument, having two ranges, 0-10 and 0-300 volts, is recommended for mains, filament, and transformer tapping voltages. Current measurements may be made with ordinary moving-iron ammeters.

FROM A NEW FILM



An amusing scene from the new Jack Hulbert film "Love on Wheels," in which the H.M.V. radiogram on the left plays a star role with Jack

**"SOUND" QUALITY
is specified for
the "WIZARD"**



BRITISH
MADE

In attractive figured walnut cabinet.
Size 15 x 14 x 7 ins., 52/6.

The
**MoToR
"YORK"**

LOUDSPEAKER

Your "Wizard" demands the amazing "sound" quality reproduction of the MoToR "York" Loudspeaker.

The richness of tone—the sensitivity—the startling realism of the "York" are entirely due to the patent compensating armature.

This is the most sensational improvement yet made in balanced armature units. It consists of three separate armatures, coupled together so that the secondary armatures affect the natural resonances of the main armature, producing results never before thought possible.



**WITH
PATENT
COMPENSATING
ARMATURE**

The MoToR S.40 Unit incorporated in the "York" Loudspeaker can be obtained separately.
Price 27/6

Write for illustrated pamphlets of the complete range of MoToR Balanced Armature and Moving Coil Speakers to:—

52/6

TEKADE RADIO & ELECTRIC, LTD.
147, FARRINGTON ROAD, LONDON, E.C.I.
Telephone : Clerkenwell 2486

COLVERN -T.D.COIL

AN UP-TO-DATE COIL WITH
UP-TO-DATE FEATURES

TYPE T.D., an entirely new COLVERN COIL, designed to give super selectivity on both long and broadcast wave-bands. The coil is completely screened, giving a very neat appearance, and incorporates tapped aerial coupling and reaction, while the four alternative aerial tapplings are arranged as sockets with a wander plug. The first two tapplings give aerial couplings similar to those normally employed, but with greatly increased selectivity. Nos. 4 and 5 give a high degree of selectivity with weak aerial coupling—suitable for use in a "swamp" area. A most important feature of this coil is that there is no break through on the long wave-band from B.B.C. stations.

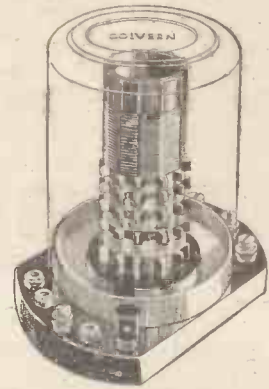

TYPE T.D.

PRICE
8/6

VARIABLE COLVERSTATS

Wire-Wound.
For Voltage Regulation
and Volume Control

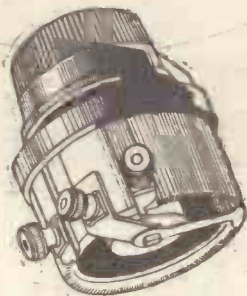

Type S.T.10. Rating,
10 watts. Standard
values, 500 to 50,000
ohms - - - 5/6

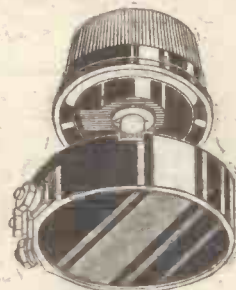

Type S.T.5C. Protected
Windings. Rating,
5 watts. Standard
values, 250
to 25,000 ohms. 5/3

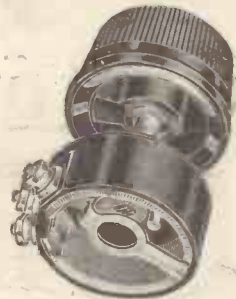

Type M.T. Rating,
3 watts. Standard
values 25 to 10,000
ohms - - - 4/6

STRIP RESISTANCES

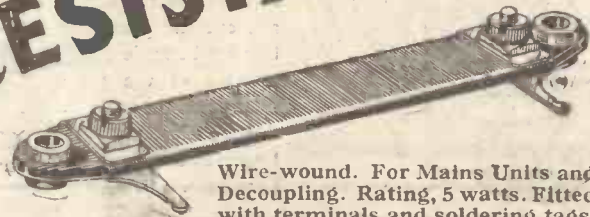

Wire-wound. For Mains Units and
Decoupling. Rating, 5 watts. Fitted
with terminals and soldering tags.
Price, values up to 25,000 ohms, 1/9
Price, values from 25,000 to 50,000
ohms - - - 2/3

Our 1933 Booklet Radio List No. 10 is now available and free on request.

COLVERN LIMITED
MAWNEYS ROAD, ROMFORD, ESSEX

"Mention of "Amateur Wireless" to Advertisers will Ensure Prompt Attention

"MICALOG" Tuning Chosen for the "WIZARD"

"Micalog" tuning opens a new era in radio! "Micalog" condensers employ an entirely new type of di-electric and combine all the advantages of a solid di-electric condenser with the efficiency of the air-spaced type.

Invented by Mr. G. P. Kendall, the famous radio scientist, who incorporates "Micalog" tuning in all his well-known set designs. Its adoption by "Amateur Wireless" for the "Wizard" is sure proof that "Micalog" tuning is the tuning system of the future.

.0003 and .0005 mfd. Price **3/6** each



SLOW MOTION DISC DRIVE

SPECIFIED for the "WIZARD"

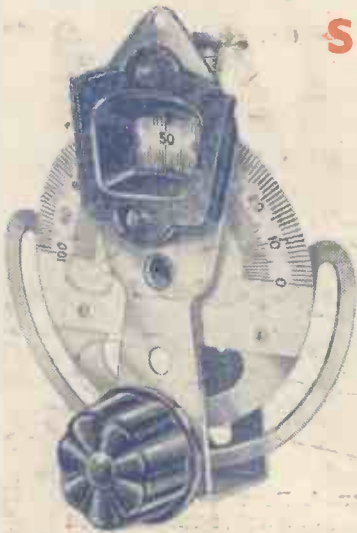

a particularly attractive slow-motion disc drive having a ratio of 25 to 1. Very smooth in action. Fitted with new type easy grip walnut coloured knob. Scale moves in same direction as rotation of knob and extremely accurate readings can be made owing to the position of the pointers in relation to the scale. The dial may be illuminated by means of a flash-lamp bulb. Price **4/-**

Free

Mr. G. P. Kendall, B.Sc., the designer of many famous sets, and his assistant Mr. H. D. Price, the famous short-wave experimenter, have written a book containing complete instructions, photographs and diagrams of ten modern circuits, both battery and mains operated. It shows you how, at a cost of a few shillings, you can bring your present set right up to date. At its published price of 1s. it represents remarkable value for money.

Full-sized dimensioned Blueprints of these ten wonder circuits are also available at the exceptionally low price of 1s. for the set of ten. Send 1s. or stamps with coupon below and we will also send you a FREE copy of the "Kendall-Price" Book. Post coupon now!

READY RADIO

To: **READY RADIO, LTD.** (Book Department), Eastnor House, Blackheath, S.E.3. I enclose 1/- for the ten full-sized blueprints. Will you also send me—FREE—a copy of the Kendall-Price Book of Ten Circuits.

Name
Address

A.W.4

Mention of "Amateur Wireless" to Advertisers will Ensure Prompt Attention



A weekly review of new components and tests of apparatus conducted by J. H. Reyner, B.Sc., A.M.I.E.E.

"FILT" EARTH

THE method of obtaining a good earth connection is often a matter requiring some thought. If one can make a contact



The new Graham-Farish "Filt" percolative earth

to a rising water main this is usually good enough, but it may not be convenient to

take a lead to the nearest water pipe.

The alternative is to sink an earth of one's own immediately outside a convenient window in the room where the set is to be used. The difficulty is to choose a moist spot or to keep the earth moist, because the effectiveness of the reception depends essentially upon the ground in the immediate neighbourhood being damp.

Messrs. Graham Farish have recently introduced an ingenious device known as the Filt Percolative Earth. The earth itself is in the form of a small bowl having a terminal on the side and this is buried in a convenient place about a foot below the surface of the ground with a wire running from the terminal on the side.

Before it is covered in, however, the bowl is filled with Filt powder which is a composition having a strong affinity for moisture. Consequently, the moisture in the surrounding earth is attracted towards this earth bowl and a good con-

tact with the ground is thereby ensured.

The price of the device is 2s. 6d., and it should commend itself to those who have difficulty with their earth connection.

HARBROS AERIAL WIRE

WE have recently received for test a coil of the new Harbros Insulated Aerial. This aerial is made up of seven strands of twisted 24-gauge bare copper wire, twisted together and insulated with a weatherproof braiding. It is suited for both indoor and outdoor use, as it is definitely weatherproof. No insulation other than the braiding is required.

This type of aerial certainly merits consideration when a new installation is being contemplated. It retails in hanks of 50, 75, and 100 feet, the prices being respectively 1s. 9d., 2s. 6d., and 3s. 3d. It is made by Messrs. Hart Bros. Electrical Manufacturing Co., Ltd., of Ponders End.

(Continued on page 584)



The **R & A**

"BANTAM"
PERMANENT MAGNET MOVING COIL
REPRODUCER

The thousands of visitors who listened to the amazing performance of the "Bantam" at Olympia acclaimed it in no uncertain terms. And justly so. They marvelled at the clarity of speech and music, the even response over the whole audible range. The volume and sensitivity exceeded expectations for so low priced an instrument. The "Bantam" is truly the small reproducer with the big performance, designed, manufactured, and finished with characteristic R. & A. thoroughness. Ask your dealer to demonstrate.

27/6

The R. & A. "Standard" Cabinet is produced to worthily accommodate the "Bantam." It is a cabinet you will be proud to own: a piece of furniture at once distinctive, dignified, and low-priced. Matt walnut is the vogue; the "Standard" Cabinet is a tasteful example. Dimensions, 16 in. by 16 in. by 8 in. deep.

25/-

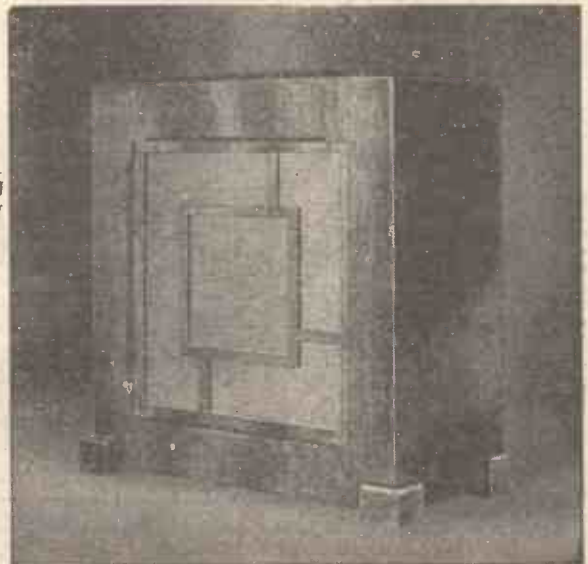

Insist on R. & A. and refuse a substitute. Write us for Illustrated Descriptive Leaflet.

REPRODUCERS & AMPLIFIERS, LTD.

WOLVERHAMPTON

DAVENSET MAINS TRANSFORMER

THE Davenset range of mains transformers is one which must appeal to the constructor who likes a high finish on his work.

We have tested, this week, one of their No. 12 transformers which is presumably intended for use with the new H.T.9 metal rectifier, requiring an input of 240 volts with the voltage doubler circuit. The transformer is provided with the usual tapped primary covering a range of



A Davenset Class "A" transformer

200-250 volts, an H.T. secondary giving 240 volts at 180 milliamperes A.C., and a low-tension secondary, centre tapped, delivering 4 volts at 4 amperes.

All the connections are brought out to a bakelite terminal board in which great care has been taken to protect the user from shock. The wires are inserted into sockets at the side of the terminal board and are held in place by grub screws operated from the top, the whole being well counter-

sunk so that no live metal projects anywhere. The skirt on the terminal board covers the connections from the bobbins themselves, thereby completing a very neat assembly.

The iron circuit is held in place by two massive aluminium castings provided with three sets of feet so that the transformer may be mounted either upright or on either side as required. All the markings are particularly clear and the whole appearance is one of neatness and rigidity.

On test, the transformer was found to deliver its rated voltages, the figures being 245 volts at 180 milliamperes on the H.T. winding, and exactly 4 volts at 4 amperes on the L.T. On no load these figures rose to 252 and 4.1, which is a truly remarkable regulation. We used to consider a rise in voltage of 30 or 40 per cent. quite good on these small power transformers, and here we have less than 3 per cent. on both windings.

We found the no-load loss a little high, being actually 9.3 watts, but perhaps we were expecting too much in view of the excellent performance from other points of view. In any case, this figure is not bad, resulting as it does in a full load efficiency of 87 per cent.

WEARITE R.D. RESISTANCES

WE have received from Messrs. Wright and Weaire, Ltd., two samples of their R.D. resistances which have been designed for use in decoupling and voltage-dropping circuits. The resistances are in two types, type A rated at 2 watts, and type B at 4 watts.

Type A can be obtained in all normal resistance values from 25,000 ohms down to 50 ohms, and type B from 50,000 ohms down to 50 ohms, with current ratings varying from 8 to 200 milliamperes in the one case and 9 to 280 milliamperes in the other. Both types can be arranged for baseboard mounting or for use with a plug-in mounting in which case a small two-pin adaptor is used. The resistances are in sections, these being wound alternately in opposite

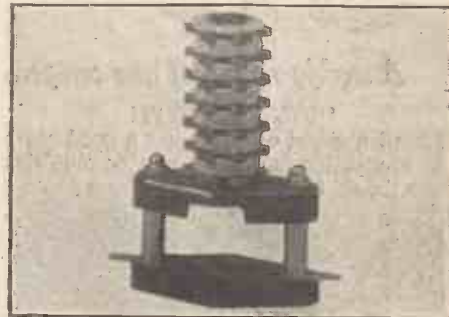

A Wearite R.D. decoupling resistance

directions to minimise inductance effects as far as possible.

The two samples tested were 600-ohm 2-watt type and a 750-ohm 4-watt type. Both these resistances proved to be satisfactory in every way, the actual measured values being 600 ohms and 760 ohms respectively.

These resistances retail at varying prices from 2s. to 1s. for the 2-watt type, and 2s. 9d. to 1s. 3d. for the 4-watt type, according to the resistance value.

YES! — A LONGER USEFUL LIFE

Exaggerated claims are often made about the life of dry batteries, but it can be claimed quite definitely for a Pertrix Dry Battery that it has an undoubtedly longer useful life.

PERTRIX

TRADE MARK

DRY BATTERIES & ACCUMULATORS

Advt. of Britannia Batteries Ltd., 233 Shaftesbury Avenue,
London, W.C.2. Telephone: Temple Bar 7971 (5 lines)
Works: Redditch (Worcs.)

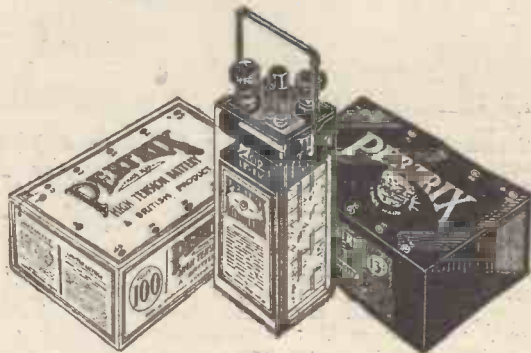

H.T. BATTERIES - - - From 5/6
L.T. ACCUMULATORS - - - From 4/6

The "WIZARD" is the right set for YOU - use



SLEKTUN

STANDARD H.F. CHOKE

the right Choke for the "WIZARD"

For super sensitivity, for knife-edge selectivity—use Slektun Dual Range Coils.

Their exceedingly low-loss construction gives a range of 185 to 2,300 metres. You will get station after station—clear and uninterrupted.

Slektun Coils have already been specified for many famous sets. Follow the lead of the experts for results really worth having.

SLEKTUN PRODUCTS LTD., 21, DOUGLAS STREET, WESTMINSTER, S.W.1

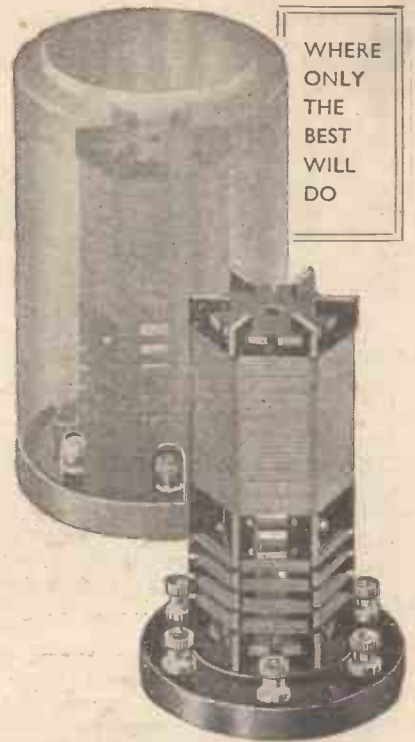

SCREENED AERIAL COIL Type A.T.1
 SCREENED H.F. COIL with reaction Type H.F.1
6/6 EACH.
 Other Slektun Quality Components. L.F. Chokes, Short-Wave and Super-het Chokes, L.F. Transformers, Mains Transformers, Balanced Armature Loud-speaker Units.

REAL VALUE FOR MONEY!

The **CAMCO** "Popular" Cabinet only 75/-



Unequaled for design and finish—supplied at a price that revolutionises cabinet values—that is why AMATEUR WIRELESS chose the Camco "Popular" Cabinet for their latest Radio-Gram circuit. The acoustical properties of this cabinet are well in evidence. Includes motor-board, shelf, baffleboard and automatic stay, with ample room for Batteries or Eliminators. Shaded walnut finish, 75/- complete.

THE CAMCO "TABLEGRAM" CABINET

No longer need you hesitate about converting your set into a Radiogram owing to lack of space. The Camco "Tablegram" Cabinet immediately overcomes this difficulty, it is compact, sturdy and attractive, finished in shaded walnut. Price only 55/- complete.

Call in and inspect the complete "Camco" range of handsome cabinets at our showrooms. Open 9.15 to 5.45. Saturdays, 12.30. In any case send Coupon for your copy of the New Camco Cabinet Catalogue FREE.



Showrooms:
CARRINGTON MFG. Co., Ltd.,
 24 Hatton Garden, London, E.C.1.
 'Phone: HOLBORN 8202.
 Works: S. Croydon.

Name.....
 Address.....
 Post in 1/4d. envelope.....4A.W.

Advertisers Appreciate Mention of "A.W." with Your Order

IN MY WIRELESS DEN

WEEKLY HINTS—

CONSTRUCTIONAL



& THEORETICAL

By

W. JAMES

WET ELECTROLYTICS

THE wet electrolytic condenser is popular just now for various reasons. In the first place the shape is convenient and the capacity is considerable. Secondly, they have good electrical characteristics and have proved reliable in service.

A wet type electrolytic will seal itself if it is broken down momentarily. This style of condenser was at first looked upon with suspicion, but it is now regarded as a satisfactory job.

Manufacturers use them in the smoothing circuits of mains sets because they are relatively cheap and probably prove more satisfactory than the paper type.

IS THE BIAS DOWN?

MANY a battery set having an old grid bias battery seems to be working well.

If you measure the voltage of the bias battery, using a cheap voltmeter, the

chances are that the reading will be below normal. After a few seconds the reading will fall, and you might find that the voltage shown was, say, 5 for a 9-volt battery.

This might lead you to think that the grids of the valves were not having enough bias. The truth might well be, however, that the bias was enough. You see, the grid battery does not supply current when working. The voltage might therefore be the rated voltage, but as the battery is old and the voltmeter takes current, the reading is less. Now the reading will fall because of the load placed upon the battery by the meter.

If you used a meter of higher resistance the voltage shown would probably be higher, and with a very good instrument the reading would be very close to the actual open circuit pressure. It is not worth while purchasing a good voltmeter for measuring a grid battery, but the above note may account for the apparent

difference between the results expected and those obtained.

For measuring a high-tension dry battery an ordinary voltmeter is good enough. It does not matter if the meter does load the battery, because it can be tested with the set turned off.

"NO-KNOB" SETS

THERE is a tendency to reduce the number of tuning controls still further. The number of knobs should, however, not matter much to those who know how to tune.

Many a gang-tuning set would give much better results if a trimming condenser were fitted to the panel. This control would provide just that fine adjustment to the tuning that brings up the strength or improves the selectivity so much. There are many instances of a good set that is definitely working below normal

(Continued on page 588)

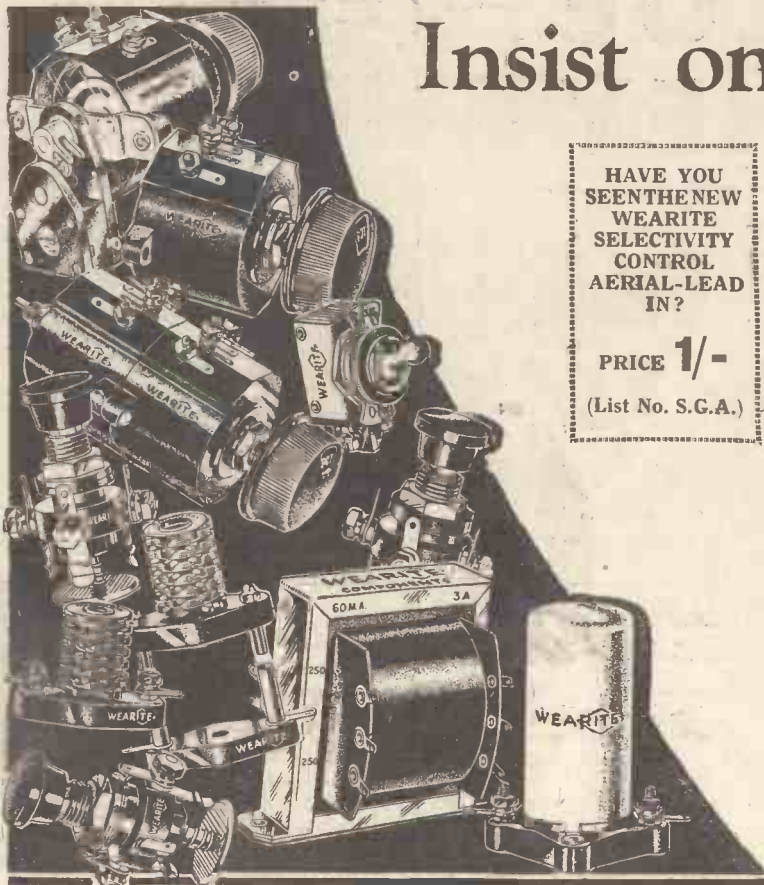

Insist on

WEARITE

—and be SAFE

HAVE YOU SEEN THE NEW WEARITE SELECTIVITY CONTROL AERIAL-LEAD IN?
PRICE 1/-
(List No. S.G.A.)

When you say "Wearite" you are certain of getting a component that is going to do its job *and do it properly*. That has always been Wearite's creed. To produce a component that in every way fulfils the demand made of it, and Wearite is the first name in radio components and their unique experience is crystallised in their every product—fit Wearite and be safe.

USE THE FOLLOWING WEARITE PARTS IN THE "WIZARD"

- 1 Paxolin Panel, 14 in. by 7 in. 6/-
- 1 Screened High-frequency Choke (H.F.P.) 3/6
- 1 Standard High-frequency Choke (H.F.O.) 6/6
- 3 4-pin Valve Holders (S.I) each 1/3

And a good earth—always. Wear-3/6 the Earth Tube

Should you experience any difficulty in obtaining Wearite parts—write us direct giving name of your local dealer. Have you a technical query—of any kind? Then ask our "Service Dept."

WRIGHT & WEAIRE, LTD.
740 HIGH ROAD, TOTTENHAM, N.17
Phone: Tottenham 3847/8 and 3015.

Micromesh

THE
MODERN VALVE
FOR MODERN
RADIO.

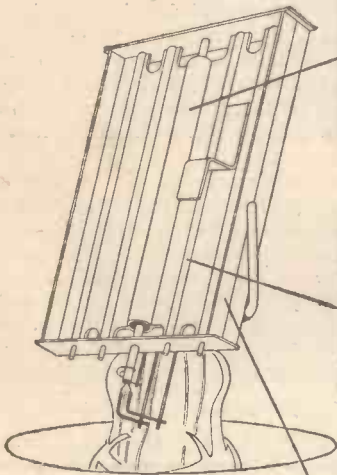

Extremely close spacing of the electrodes, assuring high slope.

Large surface radiation fins eliminate distortion through grid emission and furnish extra cooling for anode.

Assembly, constructed as separate unit, gives unusual accuracy and rigidity.

The new methods employed in Micromesh construction assure a valve having really remarkable characteristics. The Detector (type H.L.A.1), for example, has a mutual conductance of 8.0 ma/v. Leaflet giving details of the under-mentioned types will be sent on request.

- Detector, Type H.L.A.1, list price 13/6.
- Power Output, Type P.A.1, list price 17/6.
- Indirectly Heated Full-wave Rectifiers:
- Type R.1, list price 12/6.
- Type R.2, list price 15/-.

Standard

Micromesh

TRADE MARK

VALVES

Standard Telephones and Cables Limited

Standard Telephones & Cables Ltd.,
(Radio Merchandise Dept.)

St. Chad's Place, 364 Gray's Inn Rd.,
London, W.C.1. Telephone: Terrinaus 0235

Put in 1/4d.
worth of
Power...

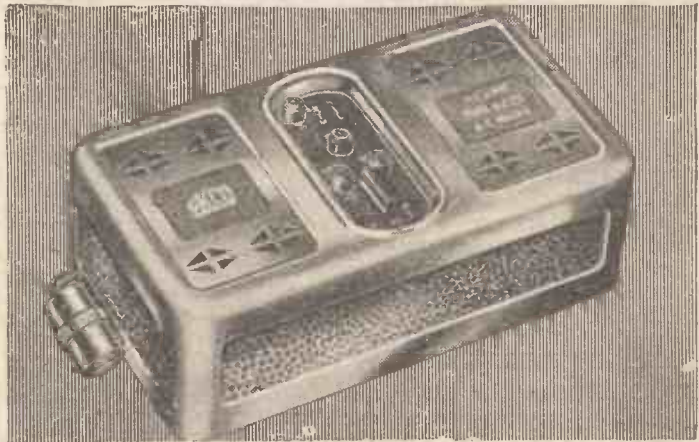

Take out
1/- worth
of H.T.

An H.T. battery can only give your battery set a farthingworth of High Tension for a farthing. An EKCO Unit will give you fifty times as much—over a shillingsworth. A 3-valve set needs on an average four batteries a year costing approximately fifty shillings. An EKCO Unit runs your set for one shilling a year—one fiftieth of the cost. All you have to do is to plug into the electric light or power socket—and switch on—that's all! There is an EKCO Unit for every type of radio set and portable; Units which supply H.T. only as well as Units which supply H.T. and keep your L.T. Accumulator constantly charged. Prices from 39/6 or by easy payments from as little as 3/3 per month. No alterations to set, valves or wiring.

Based on 1,000 hours' use at 3d. per unit.



ELECTRIC RADIO
POWER UNITS

To E. K. Cole, Ltd., Dept. K, Ekco Works, Southend-on-Sea
Please send me full details of Ekco Power Units, Consoles and Radiograms.

Name.....
Address.....

Mention of "Amateur Wireless" to Advertisers will Ensure Prompt Attention

"IN MY WIRELESS DEN"

(Continued from page 586)

because one of the circuits is not correctly in tune. Then again the ganging of controls, such as volume controls, may tend to lower the results obtainable:

Sometimes a reaction condenser and a potentiometer or other resistance are ganged together and the result may be that the best results are not obtained from either component.

It would be foolish to suggest that we should go back to the design of five years ago when many controls were used. But there is the definite danger that we might go too far in the other direction and use too few controls.

How often does one hear it said that a tone control would be an advantage, but is not used because it means an extra knob? This is a typical illustration of sacrificing performance for appearance. Then again, volume controls may be ganged when separated ones would be better, and so on.

PENTODE ADVANTAGES

PENTODE valves are pretty reliable. Their advantages are now well known. Used properly pretty good results can be obtained.

There are three things to be seen to. The first is the supply of the auxiliary grid. This grid is usually joined direct to the high-tension. But sometimes the best results are only obtained when the supply to this grid is filtered.

Use, say, 5,000 ohms and a 2-microfarad

condenser to filter the supply to the auxiliary grid and to avoid a coupling with other circuits.

The next circuit to watch is the grid bias. Make this circuit safe in the sense that there is very little chance of the bias being removed from the valve. In the case of a mains set the bias circuit ought to be de-coupled. This will help stability and may cut down hum.

Next is the anode circuit. A resistance condenser filter should usually be con-

nected here in order to restrict the high notes and to protect the valve from high voltages in the event of the loud-speaker circuit being disconnected. The condenser must be a high-voltage one and usual values are .015 microfarad and 15,000 ohms.

THESE VARIABLE-MU'S

SCREEN-GRID valves of the variable-mu type are definitely better suited to many circuits than the ordinary pattern.

The fact that the grid circuit can be adjusted to accept strong signals without overloading is a very real advantage. So many sets have a screen-grid stage that is easily overloaded, and the quality suffers as well as the selectivity. Then again the amount of the high-frequency amplification can be adjusted so easily by altering the bias.

Many sets would definitely be improved by fitting a variable-mu valve in place of the existing screen-grid type. A volume control grid-bias potentiometer would also have to be fitted and it would form a good control quite apart from those now fitted to the set.

The valve should have the screen voltage recommended by the makers or the results will fall short of the best, and further a graded form of potentiometer is worth having. With a valve of this sort the local station can be handled quite nicely, which is usually more than can be said when an ordinary screen-grid valve is used.

Mr. F. E. Doran will give another of his talks called "In Search of Northern Dishes," on September 19, from North Regional.

TRIMMING UP GANGED CONDENSERS

Some condensers are provided with a convenient insulated milled control for trimming, as shown by the accompanying photograph. Where the trimmers have



metal heads, however, use an insulated-handled screwdriver. This will prevent hand capacity upsetting the trimming adjustment.

THE ESSENCE OF SUCCESS TEAM WORK

YOU need the perfection of

FORMO DUAL RANGE COILS

Aerial, H.F., 1st. & 2nd. Band Pass **7/6**

EACH

Pair of matched Aerial and H.F. Coils mounted on aluminium base, with ganged switching **16/-**

Pair of Band Pass Coils and H.F. Coil similarly mounted and switched **23/6**

FORMO

DUAL RANGE COILS

Each component must function correctly with its neighbour—that is why you need Formo Dual Range Coils. They are matched with a scientific care that ensures maximum efficiency, and they give you exceptional selectivity. Each Formo Coil too, has its distinguishing colour to help you when rebuilding or wiring your set. Don't hesitate—use Formo components—you can't use better.

The FORMO CO.
Crown Works, Regents Park, Southampton.
London: 23, Golden Square, Piccadilly, W.1

If you cannot obtain them locally, send the name and address of your local dealer to:

The BROADCASTING HOUSE
SPEAKER BAFFLE

(Licensed to manufacture under patent application No. 378,286)

The Sensation of the Radio Show (as described in "A.W.", August 27 issue). The bugbear of most speaker cabinets is their tendency to resonate and boom at certain frequencies. This can be entirely eliminated by converting your speaker into a box baffle, as actually used in the B.B.C. studios. Conversion Kit, 20/- (for converting existing cabinet). Complete Kit, with all wood machined to size and leatherette covering for constructing complete box, Slag-bestos, with instructions, price 30/-. Complete Box, ready for fitting unit, 50/-. All prices are inclusive of royalty and are Carriage Paid.



Write for Illustrated List :
WEEDON POWER LINK RADIO CO., 185 Earham Grove, London, E.7. Maryland 4344.

Bowyer-Lowe

The Bowyer-Lowe A.E.D. volume control introduced two years ago has definitely established itself as the most reliable control possible where small currents are dealt with such as that generated by a pick-up.

Made in all resistances from 50,000 ohms to two megohms. Logarithmically graded for regular increase in volume.

8/6

Send for catalogue.

BOWYER-LOWE & A.E.D. LTD.
Diamond Works - Brighton

TOO MANY STATIONS

SOLVING THE PROBLEM
OF SELECTIVITY

A GREAT ADVANCE

With the growing power of home and European stations, foreign listening has become a form of entertainment within the reach of all. The design of receiving apparatus has improved with the years, and now a three-valve receiver will accomplish what only a multi-valve set would accomplish three years ago. ONE SCREEN-GRID VALVE IS SUFFICIENT TO BRING IN ALL THE BEST FOREIGNERS.

That is half the story: now what of keeping the "other station" out? Transmission powers are high. Many valves are not necessary; but plenty of tuned circuits are all the more necessary. THREE TUNED CIRCUITS ARE REQUIRED TO FEED THE RIGHT SIGNALS TO ONE SCREEN-GRID VALVE.

Now a screen-grid valve is an amplifying device. It takes signals from an "input circuit" and delivers them magnified to an "output circuit." Both these circuits can be tuned. We have still to find a place for our third tuned circuit. This is coupled up to the input or the output circuit and the arrangement is called a "band-pass" pair of circuits; this term is applied because the whole arrangement passes a "band" of frequencies, corresponding to the whole range from low to high notes of the transmission from one station. Up to the present, band-pass pairs have always been on the input side of the valve to avoid "cross-modulation," really a form of overloading of the screen-grid valve, spoiling the selectivity of the whole receiver. Now valves called "variable-mus" have been developed which cannot be overloaded so easily. So it is no longer necessary to put the band-pass pair on the input side. We didn't. We experimented and found that MORE magnification, MORE selectivity, came from using the band-pass pair on the output side.

Now you cannot tune three circuits with three different knobs, unless you are a professional wireless operator, or find life too long. You must use a ganged condenser. And if a ganged condenser, matched coils. In the band-pass Radiopak both condenser and coils are matched with the highest possible degree of accuracy of 1 per cent. They have to be. The circuits are so sharp that if they were moved 1 or 2 per cent. out of tune, one tune one way and one another, with loss of all performance.

One other point. We refer in our technical description to "peaked aerial couplings," "mixed band-pass couplings," and the like. The ordinary band-pass receiver suffers from "deadness" at full condenser settings—it is often six times less sensitive here than at the other end of the scale—and poor selectivity at low wavelengths—again very often in a six-to-one ratio. THE RADIOPAK keeps even selectivity and even sensitivity all over its range; it gives no "flat spots." Also the band-pass is kept at just the right coupling, to pass on all the wanted frequencies without unwanted ones.

THE RADIOPAK PRICE COMPLETE £3

RADIOPAK
TRADE MARK
THE ONLY COMPLETE BAND-PASS TUNER

BRITISH RADIOPHONE LIMITED,
ALDWYCH HOUSE, ALDWYCH, W.C. 2.

NEW RECTATONE L.F. TRANSFORMER



Radio reproduction with full and natural treble response. Gramophone reproduction with the bass in proper balance, without over-emphasis of treble. You can get both, from the same receiver with the Varley RECTATONE.

This new transformer compensates for high-note losses in the tuning circuits by frequency compensation in the L.F. amplifier. The RECTATONE frequency response curve is straight up to 1,000 cycles per second and then rises reaching a maximum at approximately 4,500 cycles—the ideal arrangement.

The degree of compensation is controlled by a variable resistance connected externally between two of the transformer terminals. If this resistance is omitted the RECTATONE functions as a normal transformer, giving high and even amplification.

RECTATONE is thus the ideal L.F. coupling for sets using a pick-up or for radio gramophones, since the tone control so valuable on radio, can be switched out on gramophone where it is unnecessary.

Price - - 15/-

Varley
Props. Oliver Pell Control, Ltd.

Advert. of Oliver Pell Control, Ltd., 103 Kingsway, London W.C. 2
Telephone: Holtorn 8303

NEW FORMO PARTS

THERE are three outstanding features of the new Formo range. Each Formo coil has its own distinguishing colour. Red is used for the aerial, blue for the high-frequency, and green and yellow for the first and second band-pass stages. A coloured connection chart is available in connection with these parts.

can thus be put in any part of the receiver with total disregard of H.F. and L.F. "strays."

The third important feature is that, owing to the accurate construction, ganged sets of coils and condensers are available and assemblies of this type can be put straight into the constructor's set and will

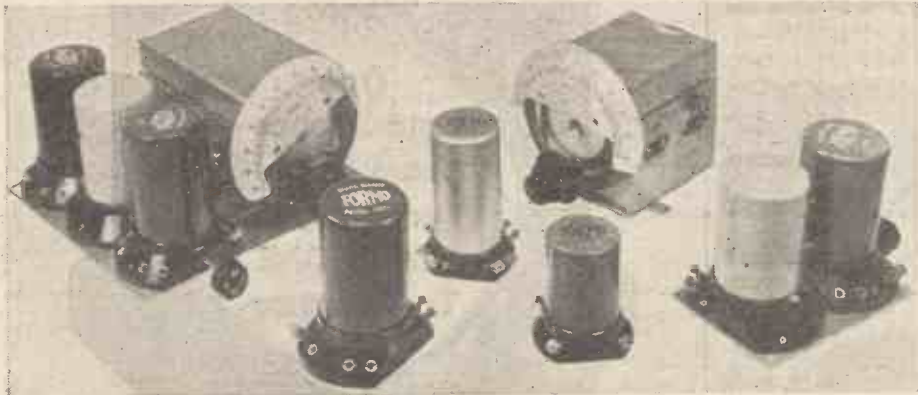

Some of the new Formo components including the combined condenser and coil assembly, dual-range aerial coil, Nigen transformer, Mononob ganged condenser and matched coil assembly

A second important feature is that in the Nigen and Multicoupler transformers, there is a double screening device, these components being fitted with an electrostatic and an electromagnetic screen. They

match without further adjustment.

The new components include dual-range aerial and high-frequency coils, band-pass coils, the Nigen and multicoupled L.F. transformers, the Mononob dual and triple-

gang condensers, and the combined assemblies of coils and condensers. These assemblies are available in the dual-gang and triple-gang types and are complete with the matched coils mounted on an aluminium base. The Formo Hymeg fixed condensers are available in a wide range and these are all tested at 1,000 volts A.C.

Full details of the new parts can be obtained free on mention of AMATEUR WIRELESS from Formo (Arthur Preen and Co., Ltd.), 23 Golden Square, Piccadilly Circus, W.1.

AT THE "PROMS"

AT the Beethoven concert on September 2 the "Eroica" Symphony was given a noble rendering, and the Second Piano Concerto rolled, or fell, delightfully from the fingers of Harold Samuel and the orchestra, but I think that the best performance of the week was of Mozart's G Minor Symphony on Tuesday, which was superb. The orchestra was fully conscious of both the aching sadness and the smooth beauty of the symphony, and could scarcely have bettered their performance if they had proper time in which to prepare for the concerts. Curiously the hall was not packed, but I believe more people came to hear Haydn and Mozart than at the "Proms" two years ago.

L. R. J.

Another relay from the Manchester Hippodrome will be broadcast in the North Regional programme on September 17.

Use 'GOLTONE' COMPONENTS and Secure MAXIMUM RESULTS from the new "WIZARD" CIRCUIT

Obtainable from all First-class Radio Stores—Refuse Substitutes. If any difficulty, write direct. Large New Radio Catalogue FREE on request



"GOLTONE" SUPER H.F. CHOKE

Inductance 350,000 mics.
D.C. Resistance 225 ohms.
Maximum amplification from "Variable-Mu" Valve.
Price 4/6



"GOLTONE" COMPRESSION TYPE CONDENSER

Panel or Baseboard Mounting as recommended for the "Wizard" circuit. A unique feature is that this Condenser can be mounted on the panel and adjusted from outside the set as with the ordinary controls.

Type "J" ... 1/- each

"GOLTONE" COMPONENTS RECOMMENDED FOR THE "WIZARD"

Ebonite Panel, size 14 in. by 7 in. by 3/8 in. 3/2

.0002 fixed Condenser, .5d.

30,000-ohm Spaghetti Resistance 1/-

Screened Flexible Tubing 9d. per yard length

Ward & Goldstone
PENDLETON MANCHESTER LTD.

Now Ready!



The "EDDYSTONE" Short Wave MANUAL

OF GREAT INTEREST TO EVERY SHORT WAVE ENTHUSIAST.

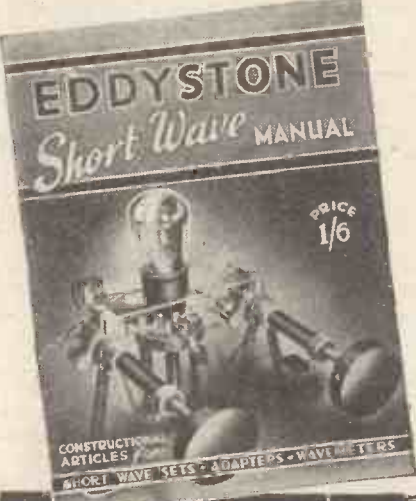

CONSTRUCTIVE ARTICLES
SHORT WAVE SETS - ADAPTERS - WAVE METERS

Contents include fully illustrated constructional articles for building 2-, 3-, and 4-valve short-wave receivers, a 1-valve superhet. S.W. converter, a 1-valve S.W. adaptor, a dynatron and heterodyne wavemeter, and a 7-metre ultra S.W. converter. List and cost of parts given in detail for each set. Articles on short waves, short-wave tuning, S.W. condensers, trouble locating, etc.

PRICE 1/6 (Post free)

STRATTON & CO. LTD.
BROMSGROVE STREET,
BIRMINGHAM

EDDYSTONE Service Depot—
WEBB'S RADIO STORES,
164, Charing Cross Road, W.C.2.

EDDYSTONE

"GRAMO-RADIO IN A NUTSHELL"

(Continued from page 554)

the pick-up output to a value that the first valve can handle efficiently, and it is a good plan to ascertain, by means of a suitable milliammeter connected in the anode circuit, whether distortion is occurring. Provided that the first valve is not overloaded, the subsequent valves in the circuit, if they have been correctly chosen, should not give any trouble in that respect.

CUTTING OUT UNWANTED VALVES

In a set that is to be used for gramophone reproduction, it is advisable to provide some means of cutting out of circuit any of the valves that are not required when playing records (so as to economise as much as possible in H.T. and L.T. current). This applies to any valves that precede the pick-up—certainly to the H.F. stages, if any, and also to the detector valve, unless, of course, it is adapted to form the first L.F. stage for gramophone record reproduction.

All that is necessary is to arrange some suitable device for breaking one of the L.T. leads to the filaments of any valves preceding the pick-up. Almost any efficient type of on-off switch will serve the purpose; but in order to simplify operation as much as possible, it is, of course, advisable to employ one that can be ganged to the gramophone switch, so that both switches are operated simultaneously by moving a single control-knob or lever. An alternative arrangement is to employ a double-pole switch for the two circuits.

If the only valve that is not in use when playing records is an H.F. valve with a rheostat in its filament circuit, it is hardly necessary to use a switch to cut it out, as the current supply can be cut off by simply turning the rheostat to the "off" position.

NEEDLE-SCRATCH

A radio-gram that gives really good reproduction of the high notes in music generally tends to reproduce a good deal of needle-scratch; and it is not easy to eliminate the one without losing the other. A well-designed scratch filter, however, solves the problem to a great extent; the filter may conveniently be connected between the pick-up and the input of the amplifier.

WHEN CHANGING NEEDLES

The volume control should be turned to the minimum position when changing needles, so as to avoid any microphonic noises being heard from the loud-speaker as a result of handling the pick-up. When the needle-point has been placed on the smooth edge of the moving record, and gently slipped into the first groove, the volume control can be advanced towards its maximum setting as the opening bars of music are heard.

MOUNTING THE NEEDLE-CUPS

It is a good plan to mount the cup for used needles in such a position that the pick-up is directly over it when the carrier arm is swung round; the used needles can then be allowed to drop straight into the needle-cup.

The "SENATOR"

"THE CHOICE OF CRITICS"

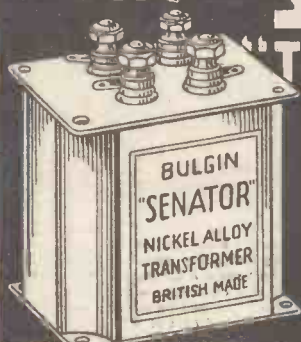

UNIVERSAL MOUNTING
UNIFORM AMPLIFICATION
SIZE ONLY 1 1/8" x 1 1/8" x 2"
INDUCTANCE 80 HENRIES
NICKEL ALLOY CORE
PRICE 6/9

The Senator L.F. Transformer is the latest, most modern, and highly efficient nickel-alloy core transformer. It has, in spite of its small size, a primary inductance of over 80 Henries, and is specially intended for parallel feed.

The coupling condenser should be 0.5 M.F., and we recommend that the anode coupling resistance have a value three times that of the valve. This outstanding component is assembled in the new "Bulgin" Universal-Mounting Screening Case with attractive Frosted Aluminium finish so that it is, without alteration, suitable for either chassis (inverted) or baseboard mounting.

It can with advantage be used as a pick-up transformer, especially with sets having only one L.F. stage.
(Registered Design No. 773746.)

Write now, enclosing 2d. postage, for 80 pp. Catalogue and literature.



NOTE THE CURVE



A F BULGIN & CO LTD ABBEY RD BARKING ESSEX CRANGEWOOD 3266

USED UNIVERSALLY

The World's Standard for Eight Years—Still the Best



"B" TYPE TERMINAL—Insulated non-rotating name. 36 permanent white letterings. Price 8d. each.

"R" TYPE TERMINAL—Non-removable rotating head. Now 21d. (Patent)

BELLING-LEE TERMINALS

Advert. of Belling & Lee, Ltd., Cambridge Arterial Road, Enfield, Middlesex.

EELEX

ALL-BRITISH TESTED RADIO COMPONENTS and ACCESSORIES

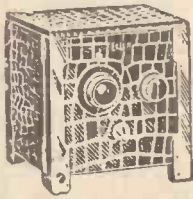

EELEX SHORT WAVE CONVERTOR

This wonderful instrument is just what you have been looking for. It enables you to receive stations on the ultra-short wave bands with your present set. Price complete 60/-. All-mains model, 65/-.

EELEX FRAME AERIAL

Originally designed for use with super-het receivers, it will be found to be very efficient when used with any circuit with or without centre tap. Definite minimum silent point. Price 20/- but worth 40/-.



EELEX TREBLE DUTY TERMINALS

Improved Type T2LC. The new T2LC terminal is similar to the old type but on the new model the indicating tabs are interchangeable. The screw-tops cannot be lost as they are not removable. Price 4½d.

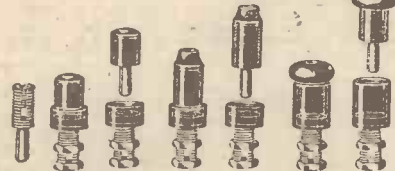
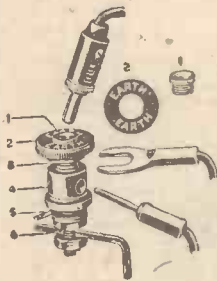

ALL MAINS PLUGS AND SOCKETS
2DM. Type S. 2DW. Type S. MPS Type.
Plugs 2d. Sockets 2d.
Series MPS in red and black only.
Plugs 4d. Sockets 2d.

EELEX TESTING PRODS

EELEX testing prods have now been improved. Ball points have been fitted to the existing pointed prods for greater ease in use. Recommended by all wireless papers. Price 3/6 per pair.



For further particulars of these, and other components write for free illustrated list B24.

J. J. EASTICK & SONS

EELEX HOUSE,
118 Bunhill Row, London, E.C.1
Phone: Metropolitan 0314/5/6



GET THESE CATALOGUES FREE
Here "Observer" reviews the latest booklets and folders issued by well-known manufacturers. If you want copies of any or all of them FREE OF CHARGE, just send a postcard giving the index numbers of the catalogues required (shown at the end of each paragraph) to "Postcard Radio Literature," "AMATEUR WIRELESS," 58/61, Fetter Lane, E.C.4. "Observer" will see that you get all the literature you desire. Please write your name and address in block letters.

Skyscraping

If you have not yet received your copy of the literature on the Lissen Skyscraper 3, then write for one. It is one of the most popular kits of the new season and is a three-valver which no one can afford to miss. **835**

New Mullard Valves

The PM24M directly-heated mains pentode, the PM12A super-sensitive S.G. valve and the PM22A economy pentode are only a few among the Mullard newcomers. I have just received details of all the new types and advise you to be put on the Mullard mailing list. **836**

Igranic Parts

Igranic have just sent me an interesting little catalogue dealing with the new components, Midget and Acme transformers, and so on, and if you are out to build a new set, or improve an old one, I think you should get a copy of this. Write through my Free Catalogue Service, mentioning this number. **837**

Slektun Transformers

There are some good low-frequency transformers in the new Slektun range and they are described in literature just available. It is well worth getting. The Slektun "Scout" S.G.3 is described, too. **838**

The Radiopak Idea

No doubt you have seen the bandpass model Radiopak produced by the British Radiophone people. They have just published a full description of the Radiopak idea, and some new Radiopak units are on the way. **839**

Goltone Parts

The Goltone Super H.F. choke, short-wave choke, fuse holder, and pre-set condensers are among the new Goltone parts described in an interesting catalogue, a copy of which has just been sent me by Ward & Goldstone, Ltd. They will interest set builders. **840**

A Super-het, Portable

H.M.V. have the distinction of being the first concern to introduce a portable super-het, and this is one of the star sets described in the new Gramophone Co. literature. It is battery-operated and will therefore make a big appeal to those without an electric-light supply, but who, nevertheless, want to get a good foreign station "bag."—OBSERVER. **841**

At last!
PERMANENT EFFICIENT EVER-DAMP EARTHING

A Sensational Radio Invention!

Get the utmost out of your set by fitting FILT—the newest and most efficient earth ever invented—based on a completely new principle. Its operation is unique. You simply bury the copper receptacle containing the wonderful FILT chemical, which at once begins to spread through the earth, attracting moisture and making a PERMANENT highly conductive area to the depth of several feet.



Never dries up in all weathers, in every soil, FILT keeps moist and highly conductive. It spreads like a tentacle, earthing your set perfectly and giving you every ounce of power, range, and purity, no matter what set you use.

GET A FILT TO-DAY. It is inexpensive, permanent, and the most efficient obtainable.

GRAHAM-FARISH

FILT PERCOLATIVE EARTH

Ask your dealer to obtain, or write direct to:
GRAHAM FARISH LTD.,
203 Mason's Hill,
BROMLEY - KENT



EPOCH

are not ordinary
**Moving Coil
Speakers**

Epoch Loud-speakers have years of experience and research ahead of other makes. Every model is definitely superior to others in their price classes. Take, for example, the

New Edition

20th Century Model

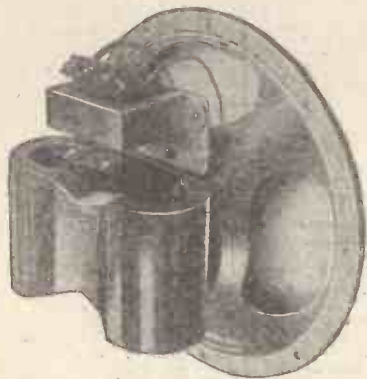

It looks almost identical with many others selling at a higher or even a lower price, but examine it more closely. Note that it has a generous cobalt steel (not chrome steel or tungsten steel) magnet, an aluminium (heavy gauge) frame (not an iron frame), an 8 1/2-in. diaphragm (not 7 1/2 or 6 or 5 in.), a specially impregnated coil system (not just shellacked or varnished), a specially moulded cone (not ordinary paper or buckram), a 5-ratio scientifically matching transformer, etc.

Then compare it with other makes costing more and you will note that its quality of reproduction is far better; in fact, its quality will surprise you for marvellous accuracy and perfection. For sensitivity you will find it superior to speakers costing pounds more. The price is within the reach of all.

35/-

Including 5-ratio transformer, or in handsome cabinet at 47/6.

Ask your dealer for it.

Send for full particulars, or call for a demonstration.

EPOCH RADIO MANUFACTURING CO., LTD.,
Exmouth House, Exmouth Street, London, E.C.1
(at the junction of Rosebery Avenue and Farringdon Road)
Phone: Clerkenwell 6666.

New Times Sales Co

**NEW 1933
RADIO
ON EASIEST OF
EASY TERMS**

QUICKEST DELIVERY

MANUFACTURERS' KITS

- LISSEN "SKYSCRAPER 3" Chassis model with (Lissen) S.G., Detector and Pentode valves. Cash price £4/9/6. With order 8/3
- Balance in 11 monthly payments of 8/3. With order 10/-
- COSSOR MELODY MAKER MODEL 335. Complete with valves, speaker and cabinet. Employs Cossor variable-mu S.G., H.F. stage, detector and power valves. Cash price, £7/17/8. With order 15/-
- OSRAM "THIRTY THREE" MUSIC MAGNET. Complete kit, comprising all components including valves, cabinet with self-contained speaker. Screen-grid H.F., screen-grid detector and power output. Single-dial tuning, wavelength calibrated. Cash price £9/9/0. With order 17/6
- Balance in 11 monthly payments of 17/6.

ACCESSORIES

- GARRARD INDUCTION GRAMOPHONE MOTOR. For A.C. mains. Model 202. Mounted on 12-inch nickel motor plate with fully automatic electric starting and stopping switch. Cash price £2/10/0. With order 4/7
- Balance in 11 monthly payments of 4/7.
- B.T.H. SENIOR PICK-UP with arm and base. Cash price £2/2/-.
- Balance in 11 monthly payments of 3/10. With order 3/10

ULTRA 1933 TIGER RECEIVER. A.C. or D.C. Mains, S.G., S.G. Detector and Pentode, Moving-coil speaker. Complete with Mazda Valves, ready for use. Cash price, £15/15/0. Send only 20/-

Balance in 17 monthly pymts. of 20/-.

**FIRST WITH
EASY TERMS
in 1924 and
Still leading**

BIGGEST STOCKS

Strictest Privacy Guaranteed

- R. & A. "VICTOR" PERMANENT MAGNET MOVING-COIL SPEAKER DE LUXE with 6-ratio input transformer and protecting grille. Cash or C.O.D., £3/10/-.
- Balance in 11 monthly payments of 6/5. With order 6/5
- R. & A. "BANTAM" PERMANENT-MAGNET MOVING-COIL SPEAKER with 3-ratio input transformer. Cash price £1/7/6.
- Balance in 5 monthly payments of 5/-.
- W.B. PERMANENT MAGNET MOVING-COIL SPEAKER. Type P.M.4. With transformer. Cash price £2/2/-.
- Balance in 7 monthly payments of 5/9.
- BLUE SPOT SPEAKER UNIT AND CHASSIS, TYPE 100U. With order 5/5
- Cash price £1/19/8.
- Balance in 7 monthly payments of 5/5.
- ATLAS ELIMINATOR, Type A.C.244. Three tappings, S.G., detector and power. Output, 120 volts at 20 m/a. Cash price, £2/19/6.
- Balance in 11 monthly payments of 5/6.
- EPOCH "SUPER JUNIOR" Type M.M. Permanent Magnet Moving-Coil Speaker with 5-ratio transformer. Cash or C.O.D., £1/7/6.
- Balance in 5 monthly payments of 5/-.
- EPOCH "20 C" PERMANENT MAGNET MOVING-COIL SPEAKER. With 3-ratio-input transformer. This speaker will handle up to 5 watts. Cash price, £1/15/-.
- Balance in 5 monthly payments of 6/6.
- EKCO H.T. UNIT. Type A.C.25. For multi-valve sets requiring up to 25 m/a. 3 tappings, S.G., detector and 120/150 volts. For A.C. mains. Cash price, £3/17/6.
- Balance in 11 monthly payments of 7/1. With order 7/1

To NEW-TIMES SALES CO., 56, Ludgate Hill, London, E.C.4
Please send me (a) 1933 Lists,
(b) for which I enclose
first payment of £.....s.....d.....
Name.....
Address.....
..... A.W.17/9/32.....

OUR BLUEPRINT SERVICE

Constructors of receivers described in this Journal should make full use of our Blueprint Service and avoid all risk of failure.



WONDERFUL VALUE IN CABINETS for WIRELESS or RADIO-GRAM

This handsome cabinet is fit to grace any room. It is constructed from first quality oak for front and top, with best quality birch for the sides. Standing on shaped legs and fitted with hinged lid supported by strong stay-joint, it has ample accommodation for batteries and accumulators.

- No. 506 for WIRELESS only, 30 in. high by 21 in. wide by 12 in. deep. Takes a panel 20 in. by 8 in. Loud-speaker compartment, 20 in. by 18 in. ... 29/6
- R.T.A., 19/6. Completely finished and polished ... 29/6
- No. 506 for RADIO-GRAM, 30 in. high by 21 in. wide by 15 in. deep. Takes a panel 20 in. by 8 in. Loud-speaker compartment, 20 in. by 18 in. ... 29/6
- R.T.A., 25/- Completely finished and polished ... 35/-
- Fitted mask—cut to your special sizes, 1/6 extra.
- Either of the above may be fitted fret front as illustrated or two doors. State which you require when ordering.
- Cash with order. Carriage paid anywhere in England and Wales, add 1/- extra for Scotland and Ireland.

(Dept. A14), A. H. FOSTER & CO.,
11, HIGH STREET, ERDINGTON, BIRMINGHAM.

Don't Forget to Say That You Saw it in "A.W."

EASY PAYMENTS

"There's No Place Like HOLMES"

The first firm to supply Wireless parts on easy payments. Eight years advertiser in "Amateur Wireless." Thousands of satisfied customers.

	Deposit	Monthly Payments
LISSEN SKYSCRAPER KIT 89/6	8/3	11 of 8/3
TELSEN AJAX 3 KIT 61/6	6/9	9 of 6/9
R.R. 303 KIT, with Valves 70/-	7/9	9 of 7/9
COSSOR KIT 234 56/7/6	10/-	11 of 11/10
EXIDE H.T. ACCUMULATORS, 120 volt	£3	6/- 9 of 6/8
BLUE SPOT 66R and chassis	£2/2/6	5/6 9 of 4/6
BLUE SPOT 100U	39/6	5/8 7 of 5/4
CELESTION M.C. Snesker	£2/7/6	5/3 9 of 5/3
EPOCH 20th CENTURY M.C.	35/-	4/10 7 of 4/10

Parts for any Kit Set. Any make of Speaker.
New Goods obtained for Every Order.
Send us a list of the parts you require and the payments that will suit your convenience, and we will send you a definite quotation. Anything Wireless.

H. W. HOLMES,
29 Foley Street, Gt. Portland St., London, W.1.
Phone: Museum 1414.

OSTAR-GANZ

UNIVERSAL HIGH-VOLTAGE MAINS VALVES

work direct from either A.C. or D.C. Mains without the need of transformer or breakdown resistances.

Most economical in current consumption. Made for any mains voltage up to 250 volts. State voltage when ordering.

G.P., Det. and Power, 17/6. Super Power 18/-, Rectifying—50 M.A. 14/6. 125 M.A. 15/6. All Mains KITS supplied for Receivers and Amplifiers. Write for full particulars.

EUGEN FORBAT,
Sole Representative for Great Britain,
c/o Nivalight, Ltd., 1 Rosebery Avenue, E.C.1. Telephone: Clerkenwell 1825.

"RED DIAMOND" H.F. Choke

Finest Quality Ebonite Former. Best Quality Wire. Designed to give maximum results when used as High-frequency coupling, or for reaction purposes in the detector circuit. Exceptionally high amplification. Beautifully smooth reaction control. Maximum inductance. Minimum D.C. Resistance.

RD74
3/6
EACH

By Indesured post 3/9
Of all high-class Radio Dealers or Sole Makers.

JEWEL PEN CO., LTD.,
(Radio Dept. 45), 21-22, Great Sutton Street, LONDON, E.C.1

LET US BUILD THAT SET FOR YOU !!

WE SPECIALISE IN BUILDING ALL "A.W." SETS

"The Wizard 3"

Ready wired chassis, aerial tested complete with valves **£6**

WRITE US FOR PARTICULARS.

RADIOVOX CO.,
34 BASINGHALL ST., LEEDS,

RADIO SUPPLIES
Send your list of Radio needs for our quotation. Kits, Parts, Sets, etc. Everything in Radio stocked. Prompt delivery; seven days' approval. Catalogue free. Taylor and Standard Wet H.T. replacements stocked.
G. TAYLOR, 57 STUDLEY ROAD, STOCKWELL, LONDON

LET "A.W." SOLVE YOUR WIRELESS PROBLEMS.

BROADCASTING STATIONS

Broadcasting Stations classified in order of wavelengths. For the purpose of better comparison, the power indicated is that of the carrier wave.

Kilo-Metres cycles	Station and Call Sign	Power (Kw.)	Kilo-Metres cycles	Station and Call Sign	Power (Kw.)	Kilo-Metres cycles	Station and Call Sign	Power (Kw.)
10.737 15,200	Zeesen (DJB)	8.0	288.5 1,040	Swansea	0.12	476 630.2	Sebastopol	10.0
25.4 11,870	Rome (2RO)	15.0	291 1,031	Tampere	1.0	480 625	North Regional	50.0
25.53 11,751	Chelmsford (G5SW)	16.0	293 1,022	Vitupuri	13.0	488.6 614	Prague	120.0
81.38 9,560	Zeesen (DJA)	8.0	293 1,021.5	Kosice	2.5	493.4 608	Trondheim	1.2
58 5,172	Prague	0.5	296.1 1,013	Limoges (PTT)	0.5	500.8 599	Florence (Firenze)	20.0
198.5 1,510	Riga (test)	16.0	298.8 1,004	Huizen	8.5	502.4 579	Nijni Novgorod	10.0
206 1,460	Antwerp	0.3	301.5 995	Tallinn	11.0	509 590	Brussels (No. 1)	15.0
207.3 1,447	Franchimont	0.2	304.9 984	North National	50.0	518 579.1	Vienna	15.0
208.3 1,440	Liege (Seraing)	0.15	307 977	Bordeaux (PTT)	13.0	also testing on 1,254 m. from 7.0p.m. (Mon., Wed., Sat.)		
208.5 1,438.5	Budapest (2)	3.0	307.1 976.6	Zagreb (Agram)	0.75	525 572	Riga	15.0
210 1,430	Magyarovar	1.5	307.3 974.3	Falun	0.5	525.9 570.3	Palermo	3.0
211.3 1,420	Newcastle	1.0	(also on 43.75 m. (6,865 Kcs.))			532.9 563	Munich	1.5
214.3 1,400	Aberdeen	1.0	309.9 968	Cardiff	1.0	550 545	Budapest (1)	18.5
214.3 1,400	Warsaw (2)	1.9	312.8 959	Cracow	1.5	also relayed on 75 m.		
215.4 1,392.5	Bruxelles	0.2	312.8 959	Genoa (Genova)	10.0	559.7 536	Kaiserslautern	1.5
	Conference	0.2	315 950	Marseilles	1.6	559.7 536	Augsburg	0.3
215.6 1,391	Chatelineau	0.3	318.8 941	Dresden	0.25	563 533	Wilno	16.0
217.1 1,382	Königsberg	0.9	318.8 941	Naples (Napoli)	1.5	566 530	Hanover	0.3
218.5 1,373	Salzburg	0.5	318.8 941	Sofia	1.0	569.1 527.1	Grenoble (PTT)	2.0
220 1,363.2	Béziers	0.5		(Rodno Radio)	1.0	569.3 527	Freiburg	0.2
222.9 1,344.6	Cork (CKK)	1.2	321.9 932	Göteborg	10.0	574.7 522	Ljubljana	5.2
226.1 1,327.5	Fécamp	10.0	325 923	Breslau	60.0	644 465.8	Kazán (RV17)	10.0
227.4 1,319	Flensburg	0.5	328.2 914	Poste Parisien	60.0	720 416.6	Moscow (PTT)	20.0
230.3 1,304	Radio Wallonia	0.3	332.2 902.8	Milan	7.0	748 401	Ostersund	0.6
231 1,301	Malmö	1.2	335 896	Poznan	1.9	790 395	Geneva	1.2
232.2 1,292	Kiel	0.25	337.8 888	Brussels (No. 2)	15.0	825 363.6	Sverdlovsk (RV5)	50.0
235 1,283	Łódź	2.2	341.7 878	Brno (Brno)	35.0	848.7 353.5	Rostov (Don)	20.0
235.5 1,274	Kristiansand	0.5	345.2 869	Strasbourg (PTT)	11.5	882 340	Saratov	20.0
237.2 1,265	Bordeaux	2.0	348.8 860	Barcelona (EAJ1)	8.0	937.5 300	Kharkov (RV4)	25.0
	Sud-Ouest	2.0	351 855.5	Leningrad (RV70)	20.0	907.7 310	Alma Ata	10.0
£38 1,260	Nîmes	0.5	352.1 852	Graz	7.0	1,000 300	Leningrad	100.0
238.9 1,256	Nürnberg	2.0	355.9 843	London Regional	50.0	1,034 290	Kiev	100.0
239.5 1,258	Binche	0.3	358 838	Moscow (Exp.)	15.0	1,071.2 280	Tiflis (RV7)	100.0
240 1,249.7	Stavanger	0.5	360.6 832	Mühlacker	60.0	1,071.4 280	Schlevingen-Haven	10.0
240.2 1,249	Liege (Exp.)	0.1	363.3 825.3	Algiers (PTT)	16.0	1,083 277	Oslo	60.0
242 1,238	Belfast	1.0	364 824	Bergen	1.0	1,106 272	Minsk (RV10)	35.0
244.1 1,239	Basle	0.65	367.6 816	Fredriksstad	0.7	1,116 268.5	Moscow Popoff	75.0
245.9 1,220	Berne	0.5	368.1 815	Bolzano	1.0	1,153 260	Kalundborg (PTT)	7.5
245.9 1,220	Cassel	0.25	368.1 815	Heisinki	13.2	also on 31.51 m. (9,520 Kcs.)		
245.9 1,220	Linz	0.5	368.1 815	Seville (EAJ5)	1.5	1,171.5 256	Taschkent	25.0
247.1 1,211	Trieste	10.0	369.3 812.1	Radio LL (Paris)	1.0	1,200 250	Istanbul	6.0
249 1,205	Prague (Stranice)	5.0	also on 33 m. (9,090 Kcs.)			1,200 250	Reykjavik	21.0
249.8 1,201.2	Juan-les-Pins	0.5	372.2 806	Hamburg	1.5	1,229.5 244	Boden	0.6
250 1,200	Radio Schaerbeek	0.3	376.4 797	Scottish Regional	50.0	1,260 238	Novosibirsk	4.0
252.6 1,187.3	Barcelona (EAJ15)	3.0	380.7 788	Lvov	16.0	1,275 235.3	Luxemburg	200.0
253.1 1,185	Gleiwitz	5.0	384.4 779	Radio Toulouse	60.0	(tests) 200.0		
255 1,175	Toulouse (PTT)	1.0	385 779	Stalino (RV20)	15.0	1,304 230	Moscow (Trades Unions)	165.0
257 1,166	Hörby	10.0	389.0 770	Archangel	10.0	also on 50 m. (6,000 Kcs.)		
259 1,160	Liege (Cointe)	0.4	389.0 770	Leipzig	150.0	1,348 222.5	Motala	30.0
259.3 1,157	Frankfurt-a-M	17.0	394 761	Bucharest	12.0	1,380 217.4	Bakou	160.0
261.6 1,147	London National	50.0	398.9 752	Midland Regional	25.0	1,411.8 212.5	Warsaw	120.0
263.8 1,137	Moravska-Ostrava	11.0	403 743	Söttens	25.0	1,445.7 207.5	Eiffel Tower	13.5
265.4 1,130	Lille (PTT)	1.3	408 734	Katowice	12.0	1,481.5 202.5	Moscow RV1	100.0
266.8 1,124.5	Valencia	8.0	411.4 729.1	Madrid (EAJ7)	2.0	also on 46.6 m. (6,438 Kcs.)		
267.7 1,121.6	Bremen	0.2	413 725	Athlone (tests)	60.0	1,538 195	Ankara	7.0
269.4 1,112	Bari	20.0	413 725	Dublin	1.2	1,554.4 193	Daventry (Nat.)	30.0
271.4 1,105	Rennes	1.3	416.4 720.5	Radio Maroc (Rabat)	6.0	1,600 187.5	Irkutsk (RV14)	10.0
273.7 1,096	Turin (Torino)	7.0	419 716	Berlin	1.5	1,620 185	Norddeich KVA	10.0
276.5 1,085	Heilsberg	60.0	424.3 707	Madrid (Espana)	2.0	1,634.9 183.5	Zeesen	60.0
278.8 1,076	Bratislava	14.0	430.4 697	Belgrade	2.5	1,725 174	Radio Paris	75.0
281 1,067	Copenhagen	0.75	435.4 689	Stockholm	55.0	1,796 167	Lahti	54.0
282.2 1,063	Lisbon (CTIAA)	2.0	441 680	Rome (Roma)	50.0	1,875 160	Hilversum	8.5
	also on 31.25 m.		447.1 671	Paris (PTT)	6.0	1,935 155	Kaunas	7.0
283 1,058	Innsbruck	0.5	453.2 662	Danzig	0.5	2,525 119.3	Königs-wusterhausen (press)	15.0
283.6 1,053	Berlin (E)	0.5	455 659	Klagenfurt	0.5	Häusen (press) 15.0		
283.9 1,053	Magdeburg	0.5	456.6 557	San Sebastian (EAJ8)	0.6	3,006.6 832	Mühlacker	60.0
286 1,049.1	Stettin	0.8	459.4 653	Beromuenster	60.0	4,000 75	Königs-wusterhausen (press)	15.0
287.1 1,045	Montpellier	10.0	465.8 644	Lyons (PTT)	1.5	5,415 554	Sundsvall	10.0
288.5 1,040	Bournemouth	1.0	465.8 644	Tartu	0.5			
288.5 1,040	Plymouth	0.12	472.4 635	Langenberg	60.0			
288.5 1,040	Scottish National	50.0						

THE "A.W." WIZARD—

A

SORCERER

TO

ENCHANT

IN THE

STATIONS

FOR YOU

OUR LATEST & MOST WONDERFUL

RADIO OFFER!

THE FAMOUS BROWN 1933

P.M. MOVING COIL UNIT & CHASSIS

A new permanent magnet Moving Coil Unit and Chassis, including tapped transformer. Extremely sensitive, suitable to work with any good 2- or 3-valve set; gives volume without distortion; protected to prevent entry of dust or metal particles. Fitted complete on Baffle Board. Height 12 in., Width 12 in., Depth 4 1/2 in. Only a limited number available at this special price.

IN MAGNIFICENT WALNUT CABINET

The Same Speaker in cabinet of special design. List Price, £3 19s. 6d. **OUR PRICE, only £2 19s. 6d.**

Send 2/6 deposit for 7 days trial. If satisfied, send further 6/- and 8 monthly payments of 7/6.

2/6

DOWN

List Price 50/-. OUR PRICE only 32/6.
On 7 days approval—only 2/6 deposit; if satisfied, pay further 5/- and 6 monthly payments of 5/- (Cash in 7 days 32/6). Leaflet post free.

E. J. HERAUD, LTD., DEPT. A.W.10
NUMBER ONE, EDMONTON, LONDON, N.18

THE GLASGOW RADIO SHOW

IT is hoped that in the week beginning September 25, with the opening of the Scottish National transmitter at Falkirk, the Scottish Regional transmitter will be able to run a Scottish programme with much greater freedom than hitherto. Through the National transmitter Scottish listeners will hear the Daventry National programme relayed from England. Those who wish to hear the programmes emanating from Scotland can do so by tuning in their sets to the Regional wavelength operating alongside its twin, the Scottish National

Coincident with the opening of this full Regional programme there is to be held in Glasgow the *Glasgow Weekly Herald* Radio Exhibition in St. Andrew's Hall, and the B.B.C. is arranging for a model studio to be erected in the Exhibition, one of the sides of which will be made of glass. Through this visitors to the Exhibition may see at most times of the day broadcasting going on from the studio, and though they will not hear the broadcasters directly (as the studio is sound-proof), they will be able to listen to them through the many speakers in the hall.

Among the programmes which are to be broadcast from the Model Studio in the Glasgow Exhibition are two vaudeville programmes—on September 28 and September 30—when there will be heard many of the better known of the West of Scotland variety and vaudeville artists, including Ike Freedman, Sylvia Watt, Dave Bruce, James McPhee, Anne Ballantine, James Gibson, and Ernie Gower and his Band.

The children also will not be neglected in these broadcasts from the Model Studio. On Wednesday, Thursday, and Saturday of the week beginning September 25 the Children's Hour will be relayed from the Exhibition. In the Saturday Children's Hour there will be Reels and Strathspeys played by the 5th Renfrewshire Scouts' World Championship Pipe Band. B.

In connection with the Broadcasting House Speaker baffle described recently in "A.W." it should be noted that the kits of parts supplied by the Weedon Power Link Radio Co. and F. McNeill & Co. Ltd. cost 30s. complete with cabinet. The kit alone, without the cabinet, cost 20s. In both cases the prices include Royalty.

TUNEWELL'S 2 BIG OLYMPIA HITS!

Amazing interest was shown at Olympia in the new range of Tunewell Super-Radio Components, which have removed the price-bar to quality radio. Whatever set you intend to build, there are Tunewell Components to improve reception—and save you money! Get the "Guide to Super-Radio," which gives details, and includes 8 Free Blueprints (Kit Eliminator, All-Mains Band Pass 3, etc.).

The new Tunewell A.C. All-Electric Radio-Gramophone also made a great hit. This instrument has given Tunewell the lead in Radio-Gramophones. Its greatest features are wonderful fidelity and purity of tone. Send now for the illustrated Brochure.

TUNEWELL

To Tunewell Radio, Ltd., 54 Station Road, New Southgate, London, N.11.

Please send me

- * (a) "Guide to Super Radio."
- * (b) Radio-Gramophone Brochure.

NAME

ADDRESS

* Cross out if not required. A.W.6



WILL INSURE
YOUR VALVES

COMPETA
THE WORLD'S
SELECTED

You have at least 30/- worth of valves to risk when you use unknown makes. Don't experiment—insist on genuine branded "Competa" fuses in the little orange boxes.

06A
1 M
15 P
2 S

Advt. of A. F. BULGIN & Co. Ltd., Abbey Rd., Barking

PERMANENT MAGNET Moving-Coil Speakers

The New "MANSFIELD" Models



"MANSFIELD SENIOR" P.M.4

A greatly developed form of the famous W.B.—P.M.4. Brilliant reproduction from any 2- or 3-valve set.

42/-

COMPLETE with transformer.

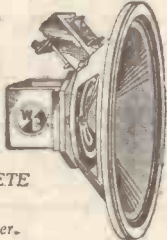

"MANSFIELD JUNIOR" P.M.5

Marvellous value that astonished Olympia—"Moving-Coil for the Million."

27/6

COMPLETE with transformer.



Write AT ONCE (don't delay) for the new art booklet, "Speaking of Speakers"—full information on all the new W.B. things.

Whiteley Electrical Radio Co., Ltd., Radio Works, Mansfield, Notts.
Irish Free State Distributors: Kelly & Shiel, Ltd., 47 Fleet Street, Dublin.

IN THE WIZARD

A
SOVEREIGN COMPRESSION TYPE
CONDENSER TYPE J IS SPECIFIED

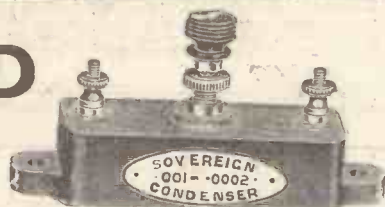

1/3

We are pleased to announce publication of the Third (1932) Edition of our famous Components Catalogue which will be forwarded (free) together with our latest Blueprint for building the Sovereign Ambassador and Viceroy Receivers upon receipt of a postcard to Dept. A.W.

Sovereign Components may be obtained from all good Dealers. Use them as much as you can in building the Wizard.

SOVEREIGN PRODUCTS, LTD. SOVEREIGN HOUSE, ROSEBERY AV. E.C.1

Get your
Copy
of the
WIRELESS
MAGAZINE

Now
on Sale

Price - 1/-

Don't Forget to Say That You Saw it in "A.W."



**HEYBERD
MODEL
A.O.2
BATTERY
CHARGER**
2, 4 or 6 volts
at 1 amp.

35/-

COMPLETE

**HOME
BATTERY CHARGER**

Why not charge your accumulators in your own home? Simply connect one side of the Heyberd AO.2 Battery Charger to your electric supply and the other side to your accumulator, in a very short time your L.T. battery is restored to full efficiency. Cheaper, quicker, and neater than a service station. This model is supplied complete in a neat metal case, with Heyberd Transformer and Westinghouse Rectifier. Model AO.3 charges 2, 4, or 12 volts at 1 amp., for 42/6.



MONARCH OF THE MAINS.



Post Coupon

for Heyberd
handbook on
Mains Working

I enclose 3d stamps for
New Handbook of Mains
Equipment. Packed with
Technical Tips, Service
Hints and diagrams

Mr. _____
Address _____

F.C. HEYBERD & Co.,
10 FINSBURY STREET, LONDON, E.C.2
One minute from Moorgate Stn

**IGRANIC
COMPONENTS**

**WILL TELL YOU HOW GOOD
THEY ARE**

We undertake to solve all Radio Problems,
including S/W Transmission and Reception.
Whatever your difficulty, write us.

Charges: 3/- per query, four or
more 2/6 each, including diagrams.

RADIO TECHNICAL AGENCY,
(Dept. A.W.) 2 Westgate Chambers, Newport, Mon.

TAYLEX WET H.T. BATTERIES

Give long service, improved volume and tone. Very economical.
Replacements for Taylex or Standard batteries at low prices
details post free. Also Bargain List; Radio Kits and parts at
lowest prices.

A. TAYLOR, 57 STUDLEY ROAD, STOCKWELL, LONDON

OUR QUERY DEPARTMENT?

The attention of readers is directed to the rules printed below. Replies are sent by post, only a selection of queries of general interest are printed here.

Mains Hum in Gramophone Amplifier

SIR,—I have just adapted my receiver for gramophone amplification and experience a terrific mains hum as soon as the pick-up is brought into circuit. I work my receiver from a mains unit, but there is no trace of hum when receiving radio broadcasts. I have a switch which cuts out the radio circuits when working on the gramophone and have placed this switch close up to the first valve holder of the amplifier. Have done everything I can think of to eliminate the hum, and now own myself mystified and seek your assistance. Can you suggest anything which I may have overlooked to enable me to eliminate the trouble?

P. Q. (Salford).

When switching off the radio circuits to incorporate an electric pick-up, it must not be forgotten that a load is taken off the mains unit and there is a possibility of a rise in voltage being applied to the remaining valves in the amplifier. This will have some effect and may cause the valves to become swamped. There is also a likelihood that in switching off

tions' wavelengths. We suggest your best plan is to return the coils to the makers with the request that they reduce the effective inductance of the coils and, if necessary, rematch them. They may, perhaps, charge a nominal fee for the alteration, but this will be cheaper than your purchasing new coils or a new receiver.

Electrolytic Condensers

SIR,—I have a liquid electrolytic condenser of 8 microfarads rated capacity and a dry one of similar capacity. The wet condenser is of American origin and, apart from its working voltage and capacity, I have no working instructions. The dry condenser is of British manufacture and a leaflet issued with it states that it may be placed in either a vertical or horizontal position in a receiver without detriment. This seems to suggest that there may be a rule relating to the arrangement of liquid-type condensers, so before putting mine into use I would welcome any information you may be able to give me on the subject.

W. P. (Manchester).

Electrolytic condensers of all types must always be used in direct-current circuits. This does not necessarily mean that they may not be used in the rectified side of an A.C.-mains unit, but it is preferable that they be kept to the receiver side of the smoothing circuits, and not placed on rectifier side of the smoothing choke. Furthermore, liquid-type electrolytic condensers must be fitted in a horizontal position when put in a receiver, amplifier, or mains unit, and the vent holes should always be at the top. The outer metal covering or can of all electrolytic condensers must be connected in the negative side of the D.C. circuit whilst the central terminal should be joined to the positive circuit. Dry electrolytic condensers, as the makers suggest, may be placed horizontally or vertically, as occasion demands, without detriment to their normal functioning.

ALL THAT A GOOD SET
SHOULD BE—THE "A.W."
WIZARD"
SEE THE CONSTRUCTIONAL
DESCRIPTION IN THE
CENTRE PAGES

the radio circuits you have cut off the earth from the receiver, and the amplifier is therefore permanently above earth potential. It is always advisable to keep the amplifier earthed when working with a gramophone pick-up. Finally, you may be experiencing inductive effects between the long pick-up leads and the connections between the mains and the mains unit. A way to overcome this latter difficulty is to use metal-braided cable in place of the usual pick-up leads, and to earth the braiding to the nearest negative L.T. connection in the receiver.

Newcastle and Fécamp

SIR,—My receiver, which has given me every satisfaction for the past two years, does not satisfactorily receive the local Newcastle station now that the latter has reduced its wavelength. Furthermore, I am not able to receive the French station Fécamp on Sundays like other residents in my locality. It seems that if I could reduce the capacity of my tuning condensers I should get just what I require. Can you suggest how I may go about getting the desired results?

J. G. (Durham).

Your trouble is your tuning coils have too much capacity in their design and do not enable you to tune down to the required sta-

WHEN SUBMITTING QUERIES

Please write concisely, giving essential particulars. A Fee of One Shilling (postal order), a stamped addressed envelope, and the coupon on the last page must accompany all letters. The following points should be noted.

Not more than two questions should be sent with any one letter.

The designing of apparatus or receivers cannot be undertaken.

Modifications of a straightforward nature can be made to blueprints, but we reserve to ourselves the right to determine the extent of an alteration to come within the scope of a query. Modifications to proprietary receivers and designs published by contemporary journals cannot be undertaken.

Readers' sets and components cannot be tested at this office. Readers desiring specific information upon any problem should not ask for it to be published in a forthcoming issue, as only queries of general interest are published and these only at our discretion. Queries cannot be answered by telephone or personally.

Readers ordering blueprints and requiring technical information in addition, should address a separate letter to the Query Department and conform with the rules.

RADIOGRAMS

AFTER an absence of nearly ten months, Ernest Longstaffe comes again to the microphone in the middle of October with a new revue on which he has been working during his return journey from India. Listeners will, no doubt, recall Mr. Longstaffe's many broadcast productions of the past few years, in particular, his pantomime, *Aladdin*, which was broadcast last Christmas on the eve of his departure for India. In the meantime he has covered some thirty thousand miles and has collected a considerable amount of material for his new show. He promises listeners some novel effects in the shape of camel bells from the Sind Desert, tonga and rickshaw bells.

Stanford Robinson will conduct the Wireless Male Voice Choir, with Arthur Cranmer in a recital of students' songs on October 1. Their programme includes "Over the Hills and Far Away," "Spanish Ladies," "Robinson Crusoe," and "Old King Cole."

THE "A.W." WIZARD—A SORCERER TO CONJURE IN THE STATIONS FOR YOU!

"That divorce is too easy" and "That our present system of punishment is too severe" are the subjects of a series of "unfinished debates" which are to form part of the "Law" series to be broadcast during the autumn.

In the past several English versions of Schiller's "Ode to Joy" have been used for the choral movement of Beethoven's Ninth Symphony, none of which have been entirely satisfactory. Mr. Owen Mase, a member of the B.B.C. Music Department, is responsible for a new translation which is to be sung for the first time when the Ninth Symphony is performed at the Promenade Concert on September 30.

Appleby Matthews, the well-known Birmingham musician, will give another recital of pianoforte music on September 25 in the Midland Regional programme. This time his subject will be the music of Grieg.

Leonard Dennis, the 'cellist in the Midland Studio Orchestra, is to be heard with the orchestra in part of Haydn's "Sonata" and works by Goltermann and Gillet, at a concert on September 26. The other artists will be Constance Astington.

The Promenade season is now more than half over and the final concert, as in previous years, is to be broadcast in its entirety. This will take place on October 1, when a programme of popular music is to be given, ending with Sir Henry Wood's *Fantasia on British Sea Songs*.

It should be noted, in connection with the new four-in-one records, that the address of the British Homophone Co., Ltd., is Barry Road, Stonebridge Park, London, N.W.10.



We supply all good quality Receivers, Loudspeakers and Accessories on convenient Easy Terms. All orders are executed promptly. Our aim is your satisfaction.

Receivers

- NEW MURPHY A3A ALL-MAINS 3-VALVE A.C. RECEIVER. One of the finest sets on the market. With 39/- order
Cash Price £19/19/0.
And 12 monthly payments of 33/-.
- WE ARE APPOINTED MURPHY DEALERS.
- PHILIPS 4-VALVE A.C. RECEIVER. Model 830A. This is very fine value. With 30/- order
Cash Price £16/16/0.
And 11 monthly payments of 30/-.
- NEW PYE "K" 2-VALVE A.C. RECEIVER. With 22/6 order
Cash Price £12/12/0.
And 11 monthly payments of 22/6.

Manufacturers' Kits

- NEW COSSOR MELODY MAKER. Model 335 (just released). Complete Kit of Parts, Valves, and Loud-speaker and Cabinet. With 10/- order
Cash Price £7/17/6.
And 11 monthly payments of 14/10.
- COSSOR MELODY MAKER, MODEL 334. Complete with cabinet and valves, less loud-speaker. With 10/- order
Cash Price £6/7/6.
And 11 monthly payments of 11/10.
- NEW OSRAM "33" MUSIC MAGNET. A first-class Kit, including Valves, Loud-speaker and Cabinet. With 20/- order
Cash Price £9/9/0.
And 12 monthly payments of 15/-.
- NEW TELSEN JUPITER S.G.3 KIT. Complete set of Components less Valves. With 7/- order
Cash Price £3/17/0.
And 11 monthly payments of 7/-.
- NEW LISSEN "SKYSCRAPER" 3 KIT. With 8/3 order
Cash Price £4/9/6.
And 11 monthly payments of 8/3.
- NEW TELSEN AJAX 3. Complete Set of parts for Det.; 2 L.F. Receiver, less valves. With 5/8 order
Cash Price £3/1/6.
And 11 monthly payments of 5/8.
- READY RADIO "METEOR" S.G.3 KIT, including cabinet, valves, and moving-coil unit. With 11/- order
Cash Price £8/17/6.
And 11 monthly payments of 16/8.
This Receiver tunes to Ultra-short Waves.
- READY RADIO 303 KIT. Cabinet Model, including moving-coil unit and valves. With 10/- order
Cash Price £6/17/6.
And 11 monthly payments of 12/9.

Loudspeakers

- NEW ORMOND PERMANENT MAGNET MOVING-COIL L.S. UNIT (just released). With 5/4 order
Cash Price £1/18/6.
And 7 monthly payments of 5/4.
- NEW R & A "CHALLENGER" PERM. MAGNET MOVING-COIL UNIT. With 5/- order
Cash Price £1/15/0.
And 6 monthly payments of 5/8.
- NEW EPOCH 20C PERMANENT MAGNET MOVING-COIL UNIT With 5/7 order
Cash Price £1/15/0.
And 6 monthly payments of 5/7.
- NEW BLUE SPOT 99 P.M. MOVING-COIL UNIT. One of the finest Units available. With 5/- order
Cash Price £2/19/6.
And 11 monthly payments of 5/6.
- NEW R & A "VICTOR" PERM. MAG. MOVING-COIL REPRODUCER DE LUXE with 6-ratio Transformer and Cadmium plated Grill. With 6/5 order
Cash Price £3/10/9.
And 11 monthly payments of 6/5.
- BLUE SPOT 100U INDUCTOR UNIT. With 5/5 order
Cash Price £1/19/6.
And 7 monthly payments of 5/5.
- MOTOR MINOR MOVING-COIL UNIT. With 5/5 order
Cash Price £1/19/6.
And 7 monthly payments of 5/5.

Eliminators

- ATLAS ELIMINATOR, A.C.244. 3 H.T. Tappings. 20 M/A output. With 5/- order
Cash Price £2/19/6.
And 11 monthly payments of 5/6.
- HEAYBERD ELIMINATOR KIT, C.200, complete kit of parts in steel case for making a first-class eliminator. Three H.T. tappings, 50 M/A output and 4 V 5-amp. L.T. tapping for A.C. valves. With 8/- order
Cash Price £5/7/6.
And 11 monthly payments of 10/-.
- HEAYBERD ELIMINATOR KIT, C.150, 3 H.T. tappings; 25 M/A output. With 6/6 order
Cash Price £3/16/0.
And 11 monthly payments of 7/-.
- ATLAS A.K.260, 3 H.T. tappings and trickle charger 2-4-6 volts. With 8/3 order
Cash Price £4/10/0.
And 11 monthly payments of 8/3.
- EKCO A.C. 25, 3 H.T. tappings 25 M/A output. With 7/1 order
Cash Price £3/17/6.
And 11 monthly payments of 7/1.
- EKCO A.D.18, 3 H.T. tappings, 18 M/A output. With 6/3 order
Cash Price £3/7/6.
And 11 monthly payments of 6/3.

To avoid delay, will customers kindly send first payment with order.

All above carriage paid.

The **LONDON RADIO SUPPLY COMPANY**

11, OAT LANE · LONDON · E.C.2

Established 1925 Phone National 1977

PREPAID ADVERTISEMENTS

Advertisements under this head are charged **THREEPENCE PER WORD**, minimum charge **THREE SHILLINGS. DEPOSIT SYSTEM.** As the publishers cannot accept responsibility for the bona fides of advertisers in this publication, they have introduced a system of deposit which it is recommended should be adopted by readers when dealing with persons with whom they are unacquainted. It is here explained.

Intending purchasers should forward to the Publishers the amount of the purchase money of the article advertised. This will be acknowledged to both the depositor and the vendor, whose names and addresses must necessarily be given. The deposit is retained until advice is received of the completion of the purchase, or of the article having been returned to and accepted by the Vendor. In addition to the amount of the deposit, a Fee of 6d. for sums of £1 and under, and 1s. for amounts in excess of £1, to cover postage, etc., must be remitted at the same time. In cases of persons not resident within the United Kingdom, double fees are charged.

The amount of the Deposit and Fee must be remitted by Postal Order or Registered Letter (Cheques cannot be accepted), addressed to

"AMATEUR WIRELESS" ADVERTISEMENT DEPARTMENT, 58/61 FETTER LANE, LONDON, E.C.4

PATENTS—Trade Marks, "Advice Handbook" free.—B. T. King, Regd. Patent Agent, 146a Queen Victoria Street, London.

THE "TONIC" keeps any make 2-volt Accumulator fully charged at home. Electric mains unnecessary. Ideal for remote places. 7/- each, postage 9d.—Particulars, copies of testimonials, etc., with pleasure.—Williams, Netherend, Cradley, Birmingham.

"UNIVERSAL" RADIO BARGAINS.—Polar triple-gang condensers, 7/11. Dario valves, 3/11; Super detector, 4/3; Power, 4/11; Screen-grid, 9/3. Chokes, 1/-; Bi-noc, 1/6. Variable condensers, 1/11; Fixed, 5d. Switches, 6d. Fuse bulbs, 3d. Tolsen Ace, 4/7; Grand, 5/11. Voltmeters, 2/11. Copper-aerial, 100 ft., 1/11. Valve holders, 4d. Accumulators, 3/3. Six-pin coils, 2/3, bases 10d. Walnut cabinet speakers, 9/6. Ormond units, 8/11. Milkate, 2/11. Vernier dials, 1/3. Triotron units, 8/11. 3-valve Transportable, complete, 70/-. Screen-grid 3 Kit with valves, yours for 8/6 deposit. Full particulars on request. Thousands of other bargains. Lists Free. Kits, Components, Sets. Get our quotations.—"Universal," 20 Victoria Road, Pockham, S.E.15.

ENGINEERS.—Sit down and think this over. We believe that our 200-page handbook, "ENGINEERING OPPORTUNITIES" will show you the way to well-paid, permanent, and progressive employment. In any case, the handbook costs nothing, and it will at least show you various surprising possibilities about which at present you know nothing. Can you, can any man, who cares a hoot about his future, afford to allow this opportunity for a worth-while job to pass unheeded? Think it over. Can you? We want you to read "ENGINEERING OPPORTUNITIES." Among other things it gives details of all recognised Examinations (A.M.Inst.C.E., A.M.I. Mech.E., I.E.E., G.P.O., etc.) outlines modern home-study courses in all branches of Civil, Mech., Elec., Motor, Radio, Aero and Talkie Engineering, and explains the unique advantages of our Employment Department. The book is quite free. Send a post-card for your copy NOW. We promise that it will be a moment of your time well spent.—The British Institute of Engineering Technology, 109 Shakespeare House, 29-31 Oxford Street, London, W.1.

RYALL'S RADIO, 33 Chancery Lane, London, W.C.2. New, surplus, and tested used radio components at very reasonable prices. Write for free list or inspect our display personally. We purchase approved goods for cash, or accept same in part payment for new only.

BRYCE PRODUCTS.—Grade "A" quality Mains Transformers and L.F. "Constant Inductance." Smoothing and Output Chokes. Recommended and tested by "Amateur Wireless." Bryce Products.—A.B.23A, for "A.W." Home Lover's A.C.3, terminal type, 28/-; stripped type, 19/11. Model A.B.250, for "W.M." High-tension Unit, 26/9 and 19/11. Post free. Bryce & Co. carry stocks of "Peak" Condensers, guaranteed 12 months, 1,500-volt D.C. test, 750-volt working, 4 mfd., 6/9; 2 mfd., 3/9; 1 mfd., 2/3. Bryce Products.—Delivery of all models or to specification within 48 hours. Guaranteed 5 years. Write for our lists.—W. Andrew Bryce & Co., Woodfield Works, Bury, Lancs. 'Phone 1251.

MAINS TRANSFORMER REPAIRS.—If you have a faulty or burnt-out mains transformer, we can rewind to your requirements at very moderate charges. Write for quotation.—The Sturdy Electric Co., Derwent View, Dipton, Newcastle-on-Tyne.

AGENTS WANTED to sell Private Christmas Cards. Sample Book Free. Good Commission.—Apply, Denton, Ltd., Dept. D118, Accrington.

MAINS OR BATTERY SETS, also Kits as advertised in "Amateur Wireless" and other journals. Very easy terms or cash. Miscellaneous parcels against cash a speciality. Speedy and painstaking service. Write for literature, stating requirements.—Newby, Birchwood Avenue, Long Eaton, near Nottingham.

RADIO.—Special discount home constructors.—Write, Page, 42 Moray Road, London, N.4.

WE CAN MAKE A SPECIALLY GOOD OFFER for your old set, speaker, or components, as part payment for any modern apparatus. State what you have to sell. State what you wish to buy. Offer by return post.—Mutual Radio Services, 97 Rodney Street, Birkenhead.

COMPONENTS.—The following components, dismantled from unused talkie amplifiers, and are as new; all prices post paid:

- 30, Weston 0-5, ditto 0-25, ditto 0-300, Moving-coil Milliammeters, model 508, 15/6 each.
 - 15, Weston 0-600 Voltmeters, 500 ohms per volt, model 506, 30/- each.
 - 12, Weston 0-20 Ampmeters, model 506, 12/6 each.
 - 15, Ferranti A.F.5 Transformers, 16/- each; 12 A.F.6 ditto, 7/1 ratio, 16/- each.
 - 16, Ferranti 10/1 Transformers, 10/- each. 12, Ferranti Double-wound Chokes, 12/6 each.
 - 14, Ferranti special heavy duty tapped output Transformers, 40/1 and 1.5/1, suitable for three LS6A valves, 21/- each.
 - 15, G.E.C. Heavy-duty Smoothing Chokes, 10 h, 180 ma., 12/6 each. 12, ditto, 50h. 35 ma., 6/6 each.
 - 10, Weston 0-4 Moving-coil Ampmeters, model 290, 16/- each. 8, Lion 60-watt type valves, 20/- each.
- To callers: A large quantity of Resistors, Changing Panels, cut-outs, A.C. Transformers, various Motor Generators, Converters, and gear dismantled from large amplifiers. Can be seen at the below address. Please 'phone before calling.
- H. Franks, 42a St. George's Street, Shadwell, London, E.1. Nearest Underground, Shadwell Station. 'Phone: Royal 8546.

HURRY UP BARGAINS.—One only, A.C. chassis, 2 S.G., 1 pentode, bandpass, £5/10-. One only, A.C. American chassis for 6 valves and rectifier, less valves 50/-. Two only, Forme "Economy 3" kits, 27/6. Four only, D.C. 220-Rola M.C. speakers, 20/-. One only, 5-valve Lisson portable, new and complete, list £15, £5/10-. One Cossor 2-valve batt., £2/10/-, less valves. One Sovereign "Mascoot" kit, 43/6. Half post paid.—Modern Radio, 77 Newington Butts, Elephant and Castle, London.

BANKRUPT BARGAINS.—List free with 3-v. diagram. Three-valve kit, 22/6. ST300 kit, 42/-. Any kit supplied. Special this week, A.C. eliminators. Regentones. W.I.D. 35/-. W.I.A. 42/6. W.5A. 45/-. S60 50/-. Ekeo A.C. v. £3. Bulbphone slightly faulty, all mains, cost £6, clear 35/-. Spencer 5-v. super het, cost 22 gns., clear £7. All parts cheap. Transformers, 2/9. Dual coils, 3/6. Panels, 2/3. S.M. 0006, 3/6. Differentials, 1/9. Switches, 4d. Valve holders, 4d. Every part a bargain. Part exchange.—Butlin, 143b Preston Road, Brighton.

"Amateur Wireless and Radiovision." Price Threepence. Published on Thursdays and bearing the date of Saturday immediately following. Post free to any part of the world: 3 months, 4s. 6d.; 6 months, 8s. 9d.; 12 months, 17s. 6d. Postal Orders, Post Office Orders, or Cheques should be made payable to "Bernard Jones Publications, Ltd." **General Correspondence** is to be brief and written on one side of the paper only. All sketches and drawings to be on separate sheets. **Contributions** are always welcome, will be promptly considered, and if used will be paid for. **Communications** should be addressed, according to their nature, to The Editor, The Advertisement Manager, or The Publisher, "Amateur Wireless," 58-61 Fetter Lane, London, E.C.4.

ELECTRADIX BARGAINS

See
**Sept. - Oct.
Sale List**

ELECTRADIX RADIOS
218 Upper Thames St., E.C.4
Telephone: City 0191

1 famous Maker's Offer!

£5 Radio-Gram CABINET for 65/-

7 DAYS' FREE TRIAL
(OR 10/- MONTHLY.)

Tollish Oak 1 and Piano built! The acoustic Tone brings a fine thrill. Makers to Radio-Press, B.E.C., 3,000 clients. Other Models 35/- to £15. Photographs and List FREE.

PICKETTS
Piano-Tone Cabinets,
(A.M.) Albion Road, Bexleyheath.

REPAIRS to Loudspeakers 4/-. Blue Spots 5/-. Transformers 4/-. Moving Coils, etc. quoted for. Prompt Service. 12 months guarantee. Trade invited. Streatham 6618. Loud-speaker Repair Co., 2 SHIPKA ROAD, Balham, London

FULL-SIZE BLUEPRINTS

When ordering, please send Postal Order, NOT STAMPS.

- CRYSTAL SET (6d.)**
- 1931 Crystal Set AW308
- ONE-VALVE SETS (1s. each)**
- Easy to Build One AW304
Short-wave One valver AW327
B.B.C. One valver AW344
Portable Short-wave One AW354
- TWO-VALVE SETS (1s. each)**
- Two Star 2 (D, Pen) AW315
The 25/- Two (D, Trans) AW330
Ten-Station Two (D, Trans) AW336
Inexpensive A.C. 2 (D, Trans) AW346
Midget Two (D, RC) AW348
Mascoot Two (D, Trans) AW353
Ideal Regional 2 (D, Trans) AW357
Music Lover's Two (D, Trans) WM260
New Economy Two (D, Trans) WM265
Family Two (D, Trans) WM278
Screen-grid Two (SG, Trans) WM289
Economy A.C. Two (D, Trans) WM286
A Two for 7 Metres (D, Trans) WM295
- THREE-VALVE SETS (1s. each)**
- 1932 Ether Searcher (SG, D, Pen) AW325
Wide World Short-wave Three (D, RC, Trans) AW332
New Favourite Three (D, RC, Trans) AW334
Home-Lover's All-electric 3 (SG, D, Trans) AW335
The P.W.H. ("Mascoot" D, RC, Trans) AW337
Home-Lover's Battery 3 (SG, D, Trans) AW341
£8 Radiogram (SG, D, Trans) AW343
New Regional Three (D, RC, Trans) AW349
World-Ranger Short-wave Three (D, RC, Trans) AW355
The Wizard (SG, D, Trans) AW350
Ether Marshal (SG, D, Trans) WM247
Five-advantage Three (D, RC, Trans) WM257
Everybody's A.C. Radiogram (SG, D, Trans) WM258
Double Band-pass Three (SG, D, Trans) WM259
Everybody's A.C. Radiogram (with automatic G.B.) WM262
New Economy Three (SG, D, Trans) WM263
New Plug-in Coil Three (D, 2 Trans) WM279
Transportable Three (SG, D, Trans) WM271
Multi-Mag Three (D, 2 Trans) WM288
Percy Harris A.C. Radiogram (D, RC, Trans) WM294
The Prosperity Three for Batteries (SG, D, Trans) WM296
The Prosperity Three for A.C. Mains WM297
The Prosperity Three for D.C. Mains WM298
- FOUR-VALVE SETS (1s. 6d. each)**
- Four Star 4 (SG, D, RC, Trans) AW318
50/- Four (SG, D, RC, Trans) AW331
Advance Four (2 SG, Trans) AW356
Your Home Radiogram, (SG, D, RC, Trans) AW358
Brookman's Three-plus-one (SG, D, RC, Trans) WM233
Ether Rover (SG, D, RC, Trans) WM266
Quadradyne (2 SG, D, Pen) WM273
Double Band-pass Four (SG, D, RC, Trans) WM274
Everybody's Radiogram, (SG, D, RC, Trans) WM276
A.C. Quadradyne (2 SG, D, Pen) WM279
Ideal A.C. Home Super (Super-het) WM290
Gold Coaster (A.C. Short-wave) WM292
Triple-tune Four (2 SG, D, Trans) WM293
- FIVE-VALVE SETS (1s. 6d. each)**
- James Short-wave Super (Super-het) AW328
Simple Super (Super-het) AW340
Ideal Home Super (Super-het) WM280
Easytune 60 (Super-het) WM284
- SIX-VALVE SETS (1s. 6d. each)**
- Century Super (Super-het) AW287
A.C. "Century Super" (Super-het) AW295
"Mains Unit (1/-) AW295A
Super 60 (Super-het) WM229
Super 60 (with Wearite base) WM249
Super 60 (with Lewcos base) WM251
1932 Super 60 (Super-het) WM269
1932 A.C. Super 60 (A.C. Super-het) WM272
- SEVEN-VALVE SETS (1s. 6d. each)**
- Super Senior (Super-het) WM256
Super Senior (Wearite base and Lewcos coils) WM261
- PORTABLES (1s. 6d. each)**
- Hiker's Two (D, Trans) (1/-) AW345
General-purpose Portable (SG, D, RC, Trans) AW351
Town and Country Four (SG, D, RC, Trans) WM282
Everybody's Portable (5-valve super-het) WM291
- AMPLIFIERS (1s. each)**
- Universal Push-pull Amplifier AW300
"A.W." Record Player (L.F. Push-pull) AW319
Quality Amplifier (DC), 1/6 WM264
A-P-A (Power, Amplifier for A.C. Mains) WM275
A-P-A Radio Unit (SG, D.) WM281
Economy Gramophone Amplifier WM277
- MISCELLANEOUS (1s. each)**
- Short-wave Plug-in Adaptor (6d.) AW326
Short-wave Super-het Adaptor (6d.) AW329
Ether Searcher Radio-gramophone Motor Board AW333
"A.W." Short-wave Adaptor AW339
"Mascoot" Mains Unit AW350
"A.W." Trickle Charger AW352
An Add-on Band-pass Unit AW359
"W.M." Linen Diaphragm Loud-speaker WM235
Super 60 A.C. Unit WM248
A Simple Mains Unit WM283
Short-wave Director (6d.) (wavenometer) WM285
Voltage Regulator WM287
- Copies of the "Wireless Magazine" and of "Amateur Wireless" containing descriptions of most of these sets can be obtained at 1s. 3d. and 6d. respectively, post free. Index letters "A.W." refer to "Amateur Wireless" sets and "W.M." to "Wireless Magazine." Address letters:

Amateur Wireless Blueprints Dept., 58-61 Fetter Lane London, E.C.4

Amateur Wireless

FEE 1/-

**INFORMATION BUREAU
COUPON**
Available until Saturday
SEPTEMBER 24, 1932

99 P.M.

SPECIAL FEATURES

- 1 Heavy Magnet forged from highest grade magnet steel.
- 2 Powerful and permanent energy.
- 3 Magnetic energy in air gap is exceptionally high — 1,320,000 ergs.
- 4 Pole pieces cadmium plated to prevent rusting.
- 5 Milam side plates are fitted to the Magnet to exclude dust and magnetic particles from being attracted into the air gap.
- 6 Specially designed cone and speech coil. Astonishing faithful reproduction.
- 7 Valve matching transformer incorporated. Undistorted output 3½ watts.

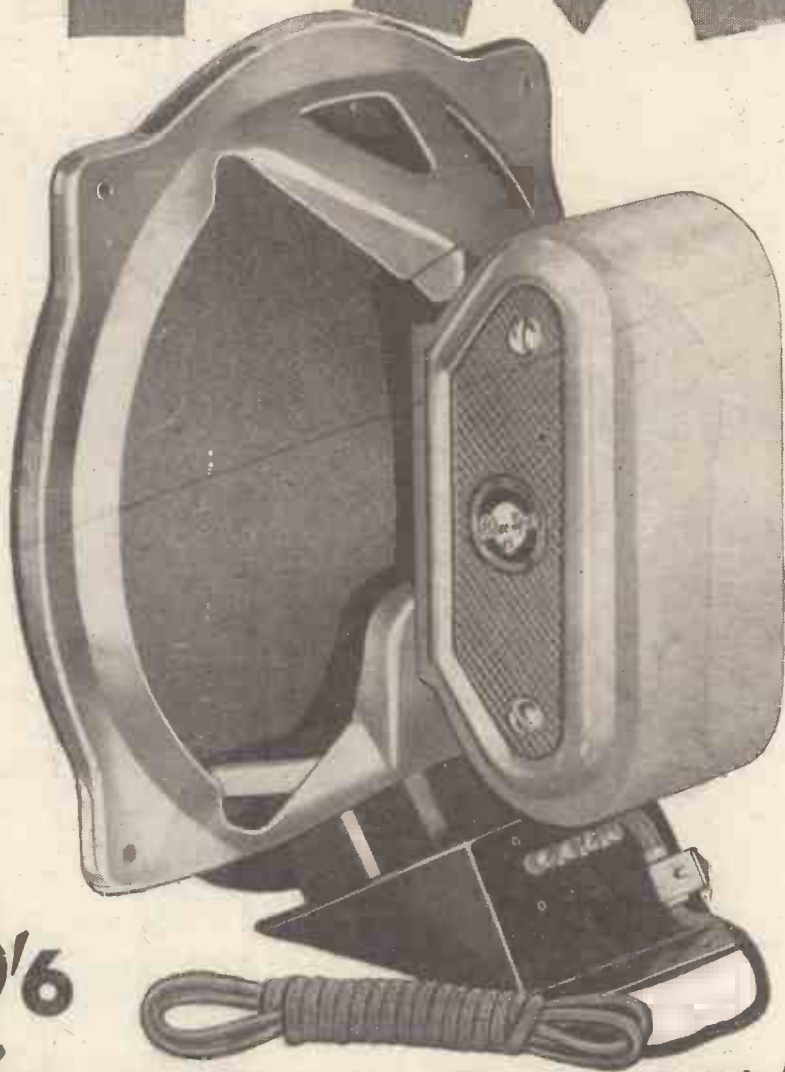

★ Write for Catalogue No. A.W. 49.U.

PRICE

59/6

makes Moving Coil History

BRITISH MADE



There are many moving coil speakers but only one Blue Spot 99 P.M.—and it is absolutely and completely unique.

No misleading figures as to flux density are given since these do not give a true indication of the quality of the magnet. An inferior magnet will give a very high flux density in a small air gap. The magnetic energy in the air gap of Blue Spot 99 P.M. is of the exceptionally high order of 1,320,000 ergs. 99 P.M. is a speaker of the highest quality from every point of view.

THE BRITISH BLUE SPOT COMPANY LTD
 BLUE SPOT HOUSE · 94/96 ROSOMAN STREET · ROSEBERY AVENUE · LONDON · E C 9
 Telephone: Clerkenwell 3570. Telegrams: "Bluspot, Isling, London."
 Distributors for Northern England, Scotland and Wales: H. C. RAWSON (Sheffield and London), Ltd., 100, London Road, Sheffield; 22, St. Mary's Parsonage, Manchester; 44-46, High Bridge, Newcastle; 37-8-9, Clyde Place, Glasgow.

FACTS YOU SHOULD KNOW

... ABOUT THE MAZDA RANGE OF POWER OUTPUT VALVES

LOOK FOR "EDDY" IN YOUR DEALER'S WINDOW

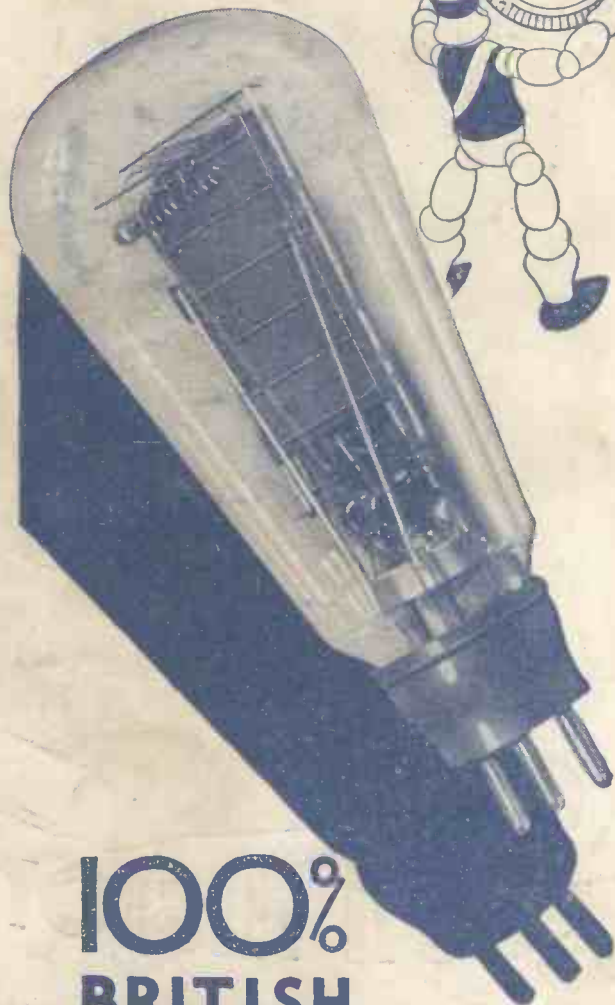
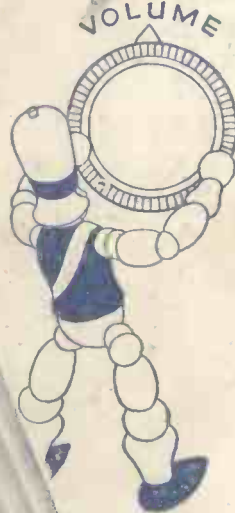

A good receiver, whether battery or mains operated, can be made or marred by the power valve. Each type of Mazda Power valve has been designed to give its most efficient performance under specific conditions. Here is a guide to the selection of the correct Mazda Mains Power Valve for your particular purpose.

THE AC/P—a low consumption power valve for operating balanced armature speakers. It is sensitive to comparatively small inputs, and will give good results on anode voltages as low as 150.

THE AC/P1 will handle a bigger signal input and will satisfactorily operate a moving coil speaker. It requires 200 volts H.T.

THE PP5/400 is a heavy power output valve capable of fully loading a large moving coil speaker. The anode current at 400 volts is 60mA with 30 volts bias.

For Battery operated receivers there are the following:

P220 and P220A, both capable of giving ample volume with a reasonable input. The former valve is particularly recommended where economy of anode current is a consideration.

Full details of these and other useful Mazda types will be found in the Mazda catalogue, sent FREE on request

Mazda valves are fitted by all the leading receiver manufacturers. All good radio dealers stock them.

The amazing

MAZDA

THE
BRITISH
VALVES

100%
BRITISH

Designed by British Engineers

The Edison Swan Electric Co. Ltd.



155 Charing Cross Rd. London. W.C.2

Mazda Radio Valves are manufactured for The British

Edison-Swan Co. Ltd., London and Rugby.

V.169

FULL-SIZE PLAN of the AMAZING "WIZARD"

Read our
**BEGINNERS'
COURSE**

Amateur Wireless

and
Radiovision

Every
Thursday

3^d

Vol. XXI. No. 537

Saturday, September 24, 1932

The
WIZARD
SIMPLE TO BUILD

Another
FREE
Supplement

wireless
MADE EASY

**PERCY HARRIS'S
BUILD AS YOU LEARN**

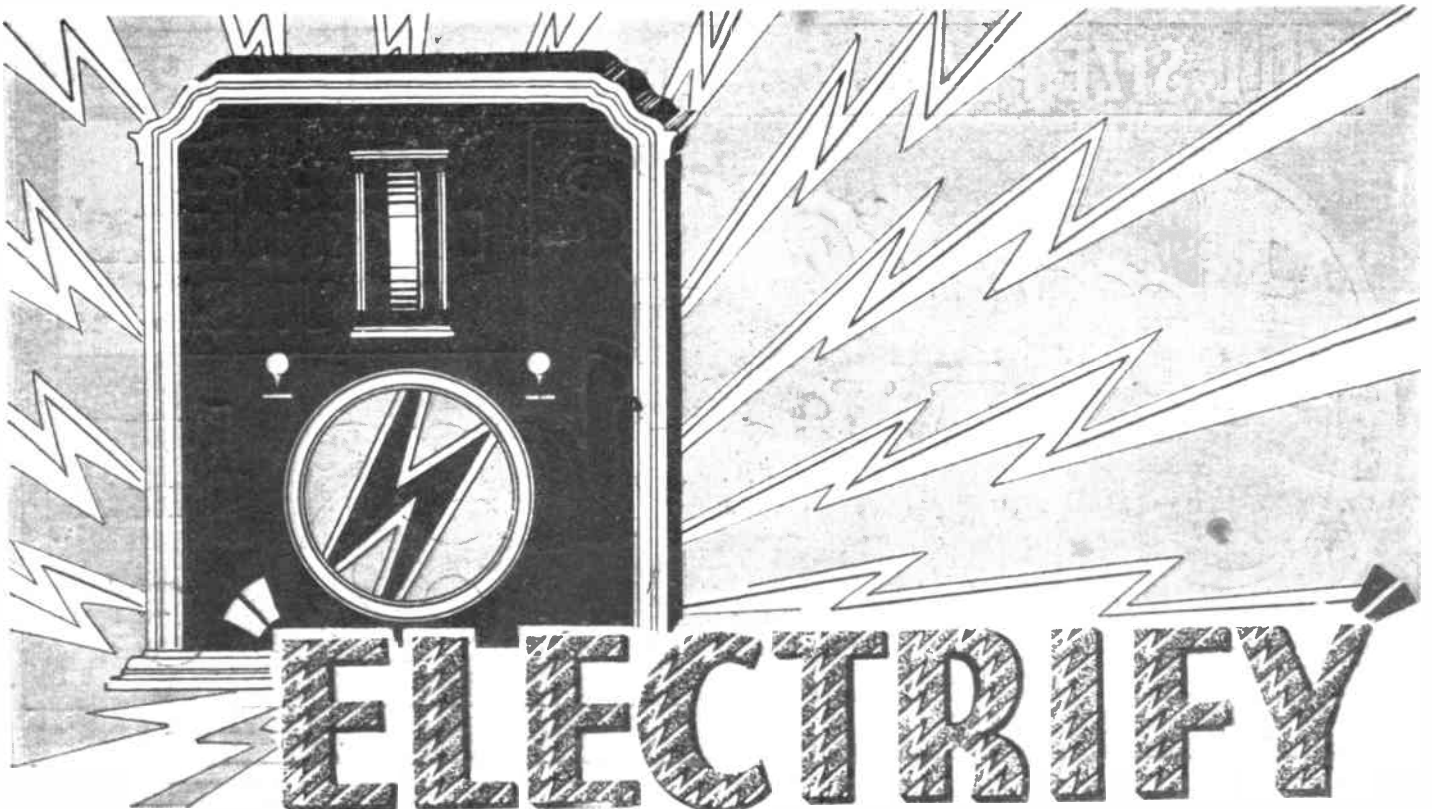

ELECTRIFY

YOUR SET WITH

PERTRIX

TRADE MARK

DRY BATTERIES AND ACCUMULATORS

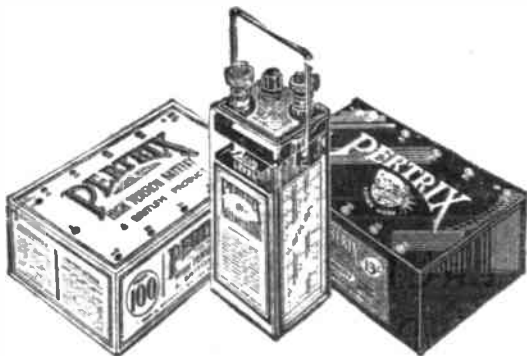

They will put new life into your set—new power to get stations that you have never heard clearly before—and they'll last longer; definitely longer, for they are made by a patent process which provides a recuperative quality unknown to other batteries. "Electrify" your set by Pertrix Power.

H.T. Batteries from 5/6

L.T. Accumulators from 4/6

Advt. of Britannia Batteries Ltd., 233, Shaftesbury Avenue, London, W.C.2. Telephone: Temple Bar 7971 (5 lines)
BRANCHES: Manchester, Bristol, Glasgow, Dublin, etc. Works: REDDITCH (Worcs.)

Advertisers Appreciate Mention of "A.W." with Your Order

**NOW CONVERT
YOUR SET TO A
RADIOGRAM**

Transform your Set to a thing of beauty with this Modern Walnut Cabinet that is the craftsman's last word in style and appearance. Decorated with carefully matched inlaid walnut veneers of contrasting colour. Hand french polished to reveal the hidden beauty of grain only to be found in the finest Walnut, while bringing to perfection the acoustic properties of the correctly proportioned speaker compartment. **Gives a new and better tone to your Set; adds beauty to your home at minimum cost.**

1933 ADAPTAGRAM

This 3 Guinea Cabinet makes your Set look worth 30 Guineas

MODEL A Never before such a clever and conveniently designed Cabinet for the instant conversion of your existing Set to a Radiogram. Comes to you with Vignotted front as illustrated and motor board, ready to take your own Set, Gramophone Motor and Pickup. No skill or expensive tools are required to transform your Radio into a combination instrument, presenting the professionally finished appearance of the most luxurious Radio Gramophone money can buy. Suitable for all popular Sets such as the Olympus Four, S.T.300, etc., etc., etc., described in "Popular Wireless," "Wireless Constructor," "Modern Wireless," and all other leading technical journals.

- Designed by Peto-Scott—foremost for Cabinets since 1919—originators of the "Adaptagram Principle" in 1928.
- With Standard Vignette and shelf taking any Set of panel size not exceeding 18 in. wide, 8 in. high and baseboard 14 in. deep.
- Generous accommodation for Super H.T. and L.T. Batteries or full mains equipment.
- Constructed with room for mounting any type of Speaker behind the modern silk-covered fret.

Dimensions: Height, 30½ in.; width, 21½ in.; depth, 15½ in.; panel size: 18 x 8 in.; baseboard depth, 14 in. Speaker Compartment, 17 x 19½ in.; Clearance between motor board and underside of lid, 4 in. Ready fitted with back. Baffle Board 3/6 extra if required.

If you do not already possess motor, pick-up etc., then we refer you to Model B or Model C as detailed below.

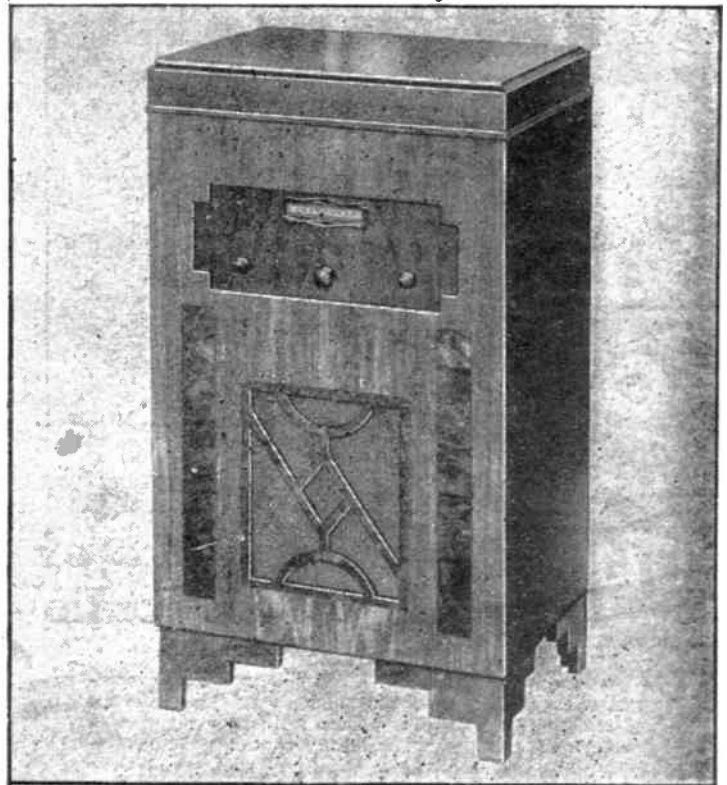

BUILT LIKE A FINE PIANO

**IT COMES TO YOU
DIRECT from our FACTORY**

Carriage and Packing 2/6 extra England and Wales.

MODEL "A"
63/-
CASH or C.O.D.
or 12 monthly payments of **5/9**
IMMEDIATE DELIVERY

MODEL B SPRING MOTOR

Standard 1933 ADAPTAGRAM Garrard Double Spring Motor ● 12" Plush covered Turntable ● Automatic Stop ● B.T.H. Tone-Arm with Pick-up, and Volume Control complete ● Automatic Needle Cup that delivers new needles one at a time to your finger tips ●

Model B

Fitted as described above—ready to convert your existing Set to a Radiogram.

Cash or C.O.D. **6 Guineas** or 12 monthly payments of

12/-

MODEL C ELECTRIC MOTOR

Standard 1933 ADAPTAGRAM CABINET ● Collaro Induction Electric Motor with Tone-Arm, Pick-up and Volume Control in one Unit ● 12" Plush covered Turntable ● Automatic Stop ● Automatic Needle Cup that delivers NEW needles one at a time to your finger tips ●

Model C (For A.C. Mains 100-130 and 200-260 volts 25-100 cycles.) Fitted as described above—ready to convert your existing Set to a Radiogram. Details of D.C. Model on application.

Cash or C.O.D. **7 Guineas** or 12 monthly payments of

13/9

PETO-SCOTT CO. LTD. 77, CITY RD. LONDON, E.C.1

Dear Sirs, Please send me CASH, C.O.D. or H.P.

1933 ADAPTAGRAM { Model A 63/-, Model B 6 Guineas, Model C 7 Guineas.

for which I enclose £ s. d. Cash/Deposit

Name _____

Address _____

A.W. 24/0/32.

GRAMO FITTINGS FITTED FREE

1933's GREATEST RADIO ADVANCE

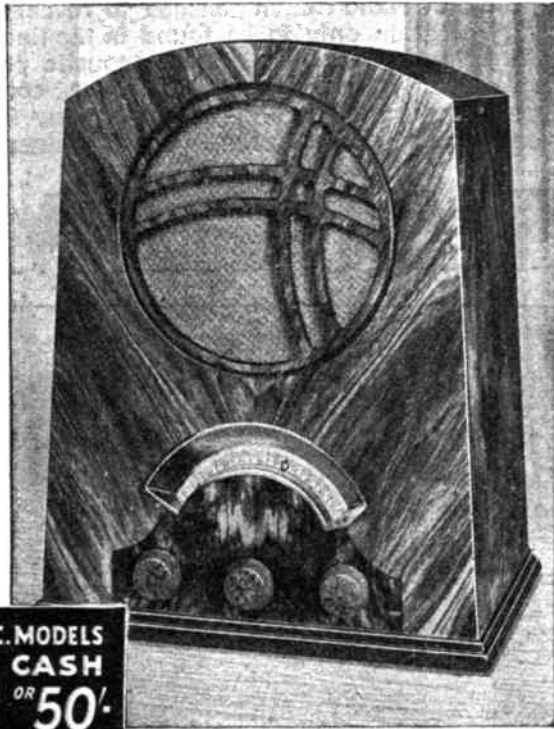

A.C. & D.C. MODELS
10 CASH OR **50** DOWN
 GNS. GNS.
 BATTERY MODEL
6/10 CASH OR **40** DOWN
 (Less Batteries)

The "ATLAS TWO" starts new era of Tone-True Radio

♦ ♦ ♦ The "ATLAS TWO" now brings a completely new thrill to every music-lover: catching the very personality of the artist: with a brilliance and sparkle that seems to put you in the front row at every entertainment. You're actually there with the "ATLAS TWO."

The specification includes "ATLAS" Moving-coil Speaker, One-knob Tuning, provision for Pick-up and Extra Speaker, Westinghouse Rectifier in A.C. Model, Mains Aerial in both A.C. and D.C. Models.

See, hear, and test it for yourself. Ask your dealer for a demonstration and insist on the "ATLAS TWO." Post the coupon to-day for full details.

CLARKE'S "ATLAS

H. CLARKE & CO., (M/CR) LTD.
PATRICROFT, MANCHESTER
London Offices: BUSH HOUSE, W.C.2

TWO" ®

POST THIS COUPON NOW

Messrs. H. CLARKE & CO. (M/CR), LTD.,
GEORGE STREET, PATRICROFT, MANCHESTER.

Please send me full details of the new "ATLAS TWO" Receivers.

Name (in capital)

Address

29/24/32

APART FROM LOW PRICE

THERE ARE

6

QUALITY REASONS

Why you should choose DUBILIER DRY ELECTROLYTIC CONDENSERS

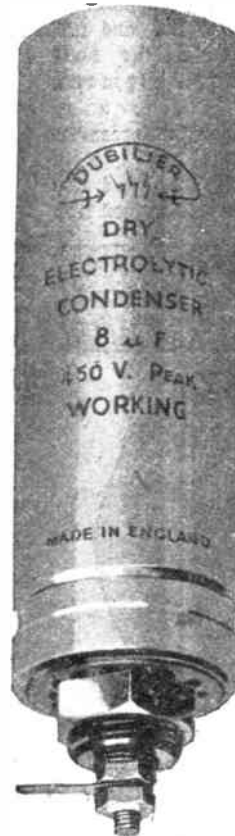

QUALITY POINT No. 1

LOW POWER FACTOR

The power factor of these condensers is about 8%, which is less than half that of the "aqueous" types.

NOTE THESE PRICES

4 μ f. . . .	4/6
6 μ f. . . .	5/-
8 μ f. . . .	5/6

These Condensers are designed for a Maximum Peak Voltage of 450 (D.C. + A.C.)

Have you seen the new Dubilier Component booklet, "Choosing your Condensers and Resistances"? Ask your dealer for a copy or write to us.

DUBILIER CONDENSER CO. (1925) LTD.
Ducon Works, Victoria Road, North Acton, W.3

Advertisers Appreciate Mention of "A.W." with Your Order



IMPERIAL AIRWAYS



trust to

MARCONI VALVES



This is "HELENA," the largest and probably the safest air liner in the world (note the height of its wheels compared with that of a car). From the moment of taking off the pilots are in constant communication with their air ports. Flags track their movement on control room maps at Croydon, Le Bouget and Brussels; they are told what weather to expect en route, and when visibility is bad this 2,200 h.p. monster is even directed by wireless. Its wireless gear *must* be reliable—so much depends on it—that is why "HELENA," like other Imperial Air-

ways machines, and like the air traffic of almost every nation, trusts to Marconi valves. *When lives depend on a valve they choose Marconi.*

THERE IS A MARCONI VALVE FOR EVERY PURPOSE

Ask your local dealer, or write direct to The Marconiphone Co., 210/212, Tottenham Court Road, London, W.1, for the Marconi valve folder which gives curves, facts and figures for all types.

THIS IS THE TWO VOLT RANGE

VS.2.	Variable-Mu Screen Grid	16/6
S.22.	Screen Grid (Single stages)	16/6
S.21.	Screen Grid (Multi stages)	16/6
H.2.	High Magnification	7/-
HL.2.	Medium Magnification	7/-
HL.210.	Medium Magnification	7/-
LP.2.	Power	8/9
P.2.	Super Power	12/-
PT.2.	Pentode	17/6
DG.2.	Double Grid	20/-

VS.2. A NEW 2-volt VARIABLE-Mu

VS.2 is the latest Marconi development, providing the user of a battery-operated receiver with the enhanced selectivity, purer tone and perfect control of volume which only a Variable-Mu Valve can give. It is comparable in range and sensitivity to its famous A.C. counterpart, the VMS.4, and offers definitely improved performance to almost every user of a 2-volt S.G. Receiver.

Price 16/6

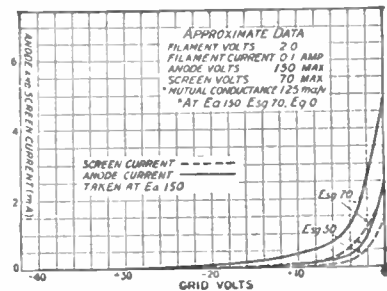

To Ensure Speedy Delivery, Mention "A.W." to Advertisers

What Amazing Value!!! What Unequalled Results!!!

FARRAND 12 POLE INDUCTOR

42% OF ALL RADIO STORES



To all Discriminating Radio Enthusiasts we now offer without fear of comparison the Undy 12-pole Farrand Inductor which has gained the most recent and unstinted approbation of experts on scientific acoustical research. Never before have you heard music and speech so truthfully and perfectly reproduced as by this new Undy product —undoubtedly the world's best speaker—and which at the low price of 42 - is within the reach of everyone.

Both the 12-pole and the Undy Ultra Minor are so constructed that they are adjustable to all types of valve.

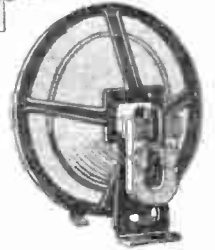

Undy 4 pole Farrand Inductor, Model : Ultra-Minor

UNDY unique Trader Service

Every Undy Farrand Inductor is GUARANTEED for 12 MONTHS whilst every stockist has at call the UNDY Information and Service Dept., where technical information and a fully qualified staff are available.

29%

Go to your dealer, hear the best, then listen to the Undy Farrand Inductor

J. HEMELIK

8 Cullingworth Rd., London, N.W.10. Telephone : Gladstone 3033

The famous BRITISH GENERAL TUNING UNIT

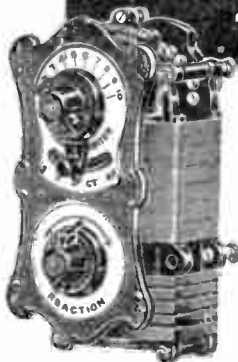

now reduced to 10'6

By reason of increased demand and enlarged production we are able this season to offer our well-known Tuning Unit at 10/6 instead of 14/6 as before. This Unit effectively replaces plug-in coils and covers the entire wave-band, from 200-2,000 metres. Easy fixing; simple tuning. Full instructions supplied with every model.

Write for Full List of B.G. GUARANTEED COMPONENTS POST FREE.

From all dealers or direct from the manufacturers—

BRITISH GENERAL MANUFACTURING CO., LTD. Brockley Works, London, S.E.4

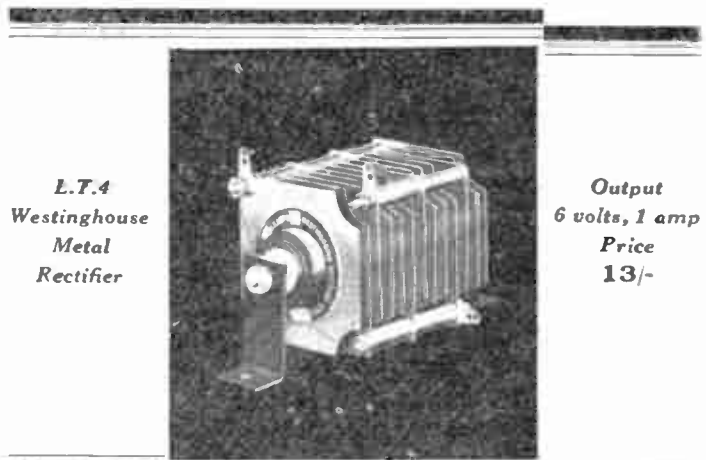

L.T.4 Westinghouse Metal Rectifier

Output 6 volts, 1 amp Price 13/-

BUILD your trickle-charger with a Westinghouse Metal Rectifier and keep your batteries up to scratch always. A rectifier, transformer and resistance are all that is necessary to charge from A.C. mains, and the total cost should not exceed 30-. Full details, circuits and prices are given in the new and enlarged 1933 edition of "The All-Metal Way." The attached coupon and 3d. in stamps will bring you a copy.

WE ARE EXHIBITING AT STAND 73, MANCHESTER RADIO SHOW. THE WESTINGHOUSE BRAKE & SAXBY SIGNAL CO., LTD. 82 York Road, King's Cross, London, N.1.

COUPON Westinghouse Publicity, 82 York Road, King's Cross, London, N.1. Please send me a copy of the 1933 edition of "THE ALL-METAL WAY," for which I enclose 3d. in stamps.

NAME ADDRESS

When the higher notes are missing RECTATONE restores them

YOU NEED IT NOW

Rectatone—the Varley component that restores to their true value the all-important higher notes. It is by deliberately cutting off these higher notes that to-day's Superhets and ultra-sharp tuned circuits achieve their selectivity. Now comes Rectatone to put them back again . . . and millions know they need it.

VARIABLE COMPENSATION

The degree of compensation may be suited to the particular tuned circuits in use or employed to correct deficiencies due to the loud-speaker or to the acoustics of the room.

RECTATONE

- 1 Has a rising response curve from 1,000 to 4,500 cycles.
- 2 Balances any form of sound reproduction.
- 3 Restores a weakened treble to its correct value.
- 4 Gives a variable compensation and, therefore, complete control of tone correction.
- 5 Gives the required tone correction without an extra L.F. stage.
- 6 Becomes at will and instantly a normal straight-line transformer.
- 7 The ideal L.F. coupling for selective sets.
- 8 Particularly useful where the same L.F. amplifier is used for radio and gramophone reproduction.

THE NEW
RECTATONE
L. F. TRANSFORMER



Ratio 7-1 List No. D.P. 33

Compensation is controlled by a variable resistance of about 5,000 ohms connected externally between the terminals H.T. + and RES. With a pentode output valve a 2,000 ohm fixed resistance may be connected in series with the variable resistance in order to prevent excessive amplification of high frequencies with consequent liability to self-oscillation.

Suitable Resistances for use with Rectatone are :

- Varley C.P.157 5,000 ohm Wire-Wound 5/6
- Varley C.P.123 2,000 ohm Spaghetti 9d.



To Messrs. Varley, Kingsway House, 103 Kingsway, London, W.C.2.

Please send me, free and post free, the

“BOOK OF THE RECTATONE”

Date.....

Name.....

Address.....

A.W.4.

"RADIO ENTHUSIASTS CAN PURCHASE THEM WITH EVERY CONFIDENCE"

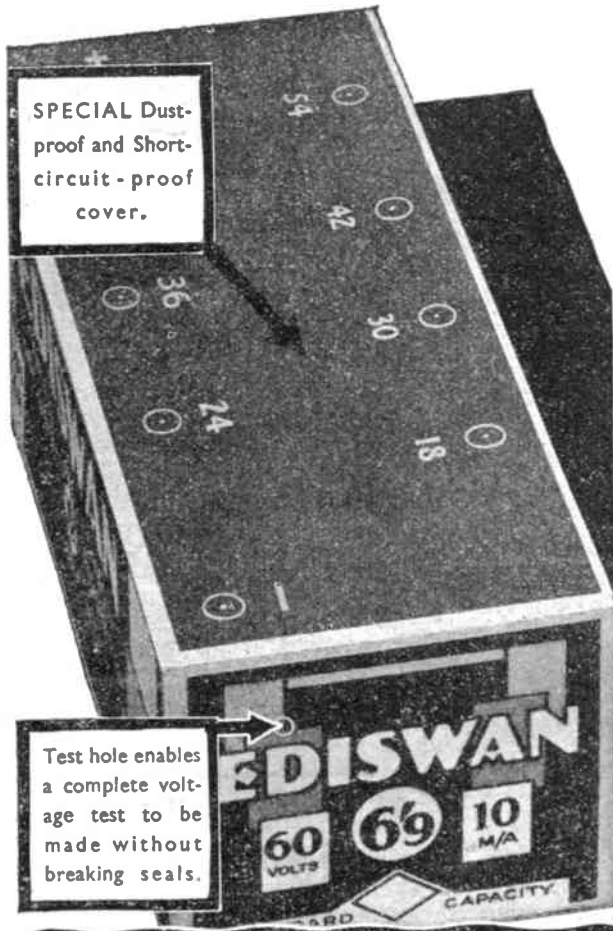

The Ediswan Batteries are giving the first-class service expected of them. Radio enthusiasts can purchase them with every confidence. Their outputs are above the average and they give a clean, steady output . . .

says the Technical Editor of "Popular Wireless"

Settle the H.T. Battery problem once and for all—take no more risks buying batteries "on spec."—It is unnecessary, for Ediswan H.T. Batteries are now GUARANTEED against failure to give completely satisfactory service. Every single cell in every Ediswan Battery must successfully pass four tests before it leaves the factory, and special precautions are taken to ensure perfect internal insulation between cells.



Standard Capacity. Where the anode current required does not exceed 10 M/a these batteries will give highly satisfactory service. If super-power valves are used, the super-capacity type should be used.

Super Capacity. These batteries have twice the capacity of the standard type, and, owing to their large reserve of power, last nearly three times as long when used as replacements to standard capacity batteries.

Look for the Ediswan Authorised Dealer sign when you buy!

Send for your FREE copy of "How to get the most out of your H.T. Battery." Full of useful data, hints and tips.

Guarantee

The Edison Swan Electric Co. Ltd. guarantee that Ediswan Batteries are of full voltage and capacity. Should any Ediswan Battery fail to give satisfactory service, we undertake to deal with the customer's complaint within 24 hours of receipt of the defective battery.

EDISWAN Guaranteed RADIO H.T. BATTERIES

THE EDISON SWAN ELECTRIC CO. LTD.



PONDERS END, MIDDLESEX

B.174

A THIEF— a silent... sneaky thief



Valve deterioration is a slinking silent fellow creeping on you un-awares, robbing your wireless of its tone value, its clarity and even its selectivity. Valve deterioration robs you cunningly—just a little at a time, so little that you scarcely notice it

until one day you realise that you are not hearing the wireless programmes as well, or as clearly, as you used to. The real enjoyment has—somehow—gone.

The fault is not in your set but in your valves. Twelve months work—or even less with some receivers—is as much as you should expect from your valves. After that efficiency is much lowered and running costs are much increased. A new set of ETA valves will restore the original purity and crispness of your reception. ETA valves will make your set as good as ever it was or even better. ETA valves give and maintain the highest possible standard of reproduction.

**YOU NEED NEW VALVES
GOOD VALVES — ETA VALVES**



ETA

THE INTERNATIONAL VALVE

PRICES FROM
5/6

SERVICE COUPON

To the ELECTRICAL TRADING ASSOCIATION LTD.,
Aldwych House, Aldwych, London, W.C.2.

A. Please let me know the correct type of ETA valves to replace my present valves which are as under

1..... 2..... 3..... 4..... 5.....
(Insert type letters and number)

B. Please advise me which ETA valves to use for the following receiver or circuit.

Specify Type No. and Name

Name.....

Address.....

A.W. 24.9.32

Something **NEW** for
Amateur and Expert



**PART
ONE
NOW ON
SALE**

FREE INSIDE

Design Chart for making a
Double-Cone Portable Set.

Why You Should Buy this Work

- Because it explains the theory of wireless in a way you can understand.
- Because it contains many new designs by the best designers.
- Because it is authoritative yet easy to understand.
- Because it gives you the expert advice of wireless specialists.
- Because when completed it will be worth much more than it has cost you.

PART 2 READY FRIDAY, SEPT. 23

NEWNES COMPLETE WIRELESS

Obtainable at all Newsagents and Bookstalls or by post 1/2i from
George Newnes, Ltd., 8-11, Southampton Street, Strand,
London, W.C.2.

IN ABOUT 24 WEEKLY PARTS



Geo. Newnes, Ltd.

FOR EVERY SET — there's a PILOT AUTHOR KIT CASH — C.O.D. — or H.P.

EVERYTHING RADIO
IMMEDIATE DELIVERY—
CASH, C.O.D., or H.P.

CARRIAGE PAID TO YOUR DOOR

- COSSOR MELODY MAKER. Model 335.** Send 10/- only. Complete with valves, speaker and cabinet. Cash Price, £7/17/6. Carriage Paid. Balance in 11 monthly payments of 14/10.
- COSSOR ALL-ELECTRIC MELODY MAKER. Model 336.** Send 21/7 only. Complete with valves, cabinet and speaker. Cash Price, £11/15/0. Carriage Paid. Balance in 11 monthly payments of 21/7.
- SLEKTUN SCOUT S.G.3.—S.G.,** Detector and Power. Pilot Author Kit "A" (less valves and cabinet). Cash or C.O.D., £4/8/6. Carriage paid. Balance in 11 monthly payments of 8/1.
- R & A "VICTOR" PERMANENT-MAGNET MOVING-COIL SPEAKER DE LUXE.** With 6-ratio input transformer and protecting grill. Cash Price £3/10/0. Carriage Paid. Balance in 11 monthly payments of 6/5.
- EPOCH "20 C" PERMANENT MAGNET MOVING-COIL SPEAKER.** (New Edition). With 3-ratio input transformer. Cash Price £1/15/0. Carriage Paid. Balance in 5 monthly payments of 8/6.
- W.B. PERMANENT-MAGNET MOVING-COIL SPEAKER. Type PM4.** Complete with transformer. Cash Price £2/2/0. Carriage Paid. Balance in 7 monthly payments of 5/8.

THIS YEAR'S WINNER

LISSEN "SKYSCRAPER 3." Send 8/3 only. Chassis model with (Lissen) S.G., Detector and Pentode valves. Cash Price £4/9/6. Carriage paid. Balance in 11 monthly payments of 8/3.

BLUE SPOT SPEAKER UNIT AND CHASSIS. TYPE 1000. Send 5/5 only. Cash Price £1/10/6. Carriage Paid. Balance in 7 monthly payments of 5/5.

ATLAS ELIMINATOR. Type A.C.244. Send 5/6 only. Three tappings, S.G., detector and power. Output: 120 volts at 20 m/a. Cash Price £2/19/6. Carriage Paid. Balance in 11 monthly payments of 5/8.

GARRARD INDUCTION GRAMOPHONE MOTOR. Send 4/7 only. For A.C. mains. Model 202. Mounted on 12-inch nickel motor plate with fully automatic electric starting and stopping switch. Cash Price £2/10/0. Carriage Paid. Balance in 11 monthly payments of 4/7.

REGENTONE W.I.F. H.T. ELIMINATOR for A.C. mains, tapped S.G., detector and 120/150 v. at 12 m/a. Cash Price £2/15/0. Carriage Paid. Balance in 11 monthly payments of 5/1.

COLLARO INDUCTION MOTOR WITH PICK-UP. Send 7/4 only. For A.C. mains. 12-in. turntable, moulded pick-up, volume control and automatic stop. Cash Price £4/0/0. Carriage Paid. Balance in 11 monthly payments of 7/4.

PILOT BAND-PASS UNIT

Whether your set is Main or Battery operated, the **PILOT BAND-PASS UNIT** cuts out programme interference effectively and sharpens tuning to needle-point selectivity. It is simple to attach and can be operated by anyone without technical knowledge. No valves or extras required.

Instantly converts any Set to Band-pass Tuning with Needle-sharp Selectivity.



25/- CASH or C.O.D. or 6 monthly payments of 4/6.

WIZARD

KIT "A"

As described in last week's issue. Author's Kit of specified parts, including ready-drilled panel, less valves and cabinet.

80/-

CASH OR C.O.D. DELIVERY FROM STOCK CARRIAGE PAID

Or 12 monthly payments of 7/4. Carriage paid.

KIT 'B' Kit "A" as above, WITH VALVES but less cabinet. CASH or C.O.D. Carriage Paid **£5-12-3**

Or 12 monthly payments of 10/4. Carriage paid.

KIT 'C' Author's Complete Kit, with valves, cabinet and ready drilled panel. CASH or C.O.D. Carriage Paid **£6-12-3**

Or 12 monthly payments of 12/2. Carriage paid.

FINISHED INSTRUMENT CASH or C.O.D. **£8-0-0**

Fully Assembled WIZARD. Aerial Tested. Complete with Valves and Cabinet, excluding batteries. Carriage paid. Or 12 monthly payments of 14/9.

IMPORTANT.—Parts, Kits, Miscellaneous Components, Finished Receivers or Accessories for Cash, C.O.D. or H.P. on our own system of Easy Payments. Send us a list of your wants. We will quote you by return. C.O.D. orders value over 10/- sent carriage and post charges paid.

THESE ARE THE PARTS THE AUTHOR USED.

- 1 Red Triangle ebonite panel, 14 in. by 7 in., ready drilled ... 4 6
 - 1 Peto Scott base-board, 14 in. by 9 in. ... 1 6
 - 2 Ready Rad "Mecatog" .0005-mfd. condensers ... 7 0
 - 2 Readi-Rad slow-motion disc drives ... 8 0
 - 1 Lissen 2-mfd. fixed coil unit and switch ... 17 6
 - 1 Lissen .0005-mfd. variable reaction condenser ... 6 6
 - 2 Telsen 1-mfd. fixed condensers ... 4 6
 - 1 Telsen 2-mfd. fixed condenser ... 3 9
 - 1 Dubilier .00005-mfd. fixed condenser, type 070 ... 1 0
 - 2 Lissen .0002-mfd. fixed condensers ... 1 0
 - 1 Dubilier 2-megohm grid leak with wire ends ... 1 0
 - 1 Trowell 30,000-ohm spaghetti resistance ... 1 4
 - 1 Weatco screened high-frequency choke ... 3 6
 - 1 Sektun standard high-frequency choke ... 4 0
 - 3 W.B. 4-pin valve holders ... 1 6
 - 1 Belgis "Senator" resistance-fed transformer ... 6 9
 - 2 Terminal strips ... 6 6
 - 1 Severign .0003-mfd. pre-set series aerial condenser ... 1 3
 - 2 Belling-Lee terminals, marked "Pick-up" ... 1 5
 - 1 Readi-Rad radiogram change-over switch ... 2 0
 - 6 Belling-Lee wander plugs, marked ... 1 0
 - 2 Belling-Lee spade terminals, marked: L, T, I, L, T. ... 6
 - 6 Yards thin flex, connecting wire, sleeving, length flexible tubing, screws and 1 terminal strip 5 in. by 2 in. ... 1 8
- KIT "A" Cash or C.O.D. ... 4 0 0**

1 Peto-Scott Special Cabinet £1 0 0
Specified Valves £1 12 3

BUILD IT YOURSELF — it's easier with a PILOT RADIO ENVELOPE



AN AMAZING GO STATION SET

The Selective Family 3

YOU CAN BUILD THIS SET IN AN EVENING with this PILOT RADIO ENVELOPE

THIS SET WILL PRINT 3 PROGRAMS AND 3 COMPLETE SETS OF PARTS AND COMPLETE INSTRUCTIONS IN EVERY ENVELOPE

Complete

GET YOUR COPY TO-DAY POST FREE

PILOT RADIO ENVELOPE No. 1. Buy this and build a city-station 3-valve battery set. Blueprint, photographs and complete assembly and operating instructions in every envelope.

PILOT RADIO ENVELOPE No. 2. Tells you how to build an amazing 5-valve super-het. Contains point-to-point wiring, assembling and operating instructions.

1/- WITH FULL SIZE BLUEPRINTS



PILOT RADIO ENVELOPE No. 3

ADVENTURER 5-VALVE SUPER HETERODYNE

Build it Yourself!

COMPLETE PILOT AUTHOR KIT PRICES FOR THESE TWO AMAZING BATTERY RECEIVERS

SELECTIVE FAMILY THREE

Kit of parts in sealed carton as specified by Maxamp, the Designer, for building a wonderfully selective GO-station 3-valve receiver. Includes necessary Pilot Radio Envelope, but excludes valves and cabinet.

Cash or C.O.D. **65/-** Carriage Paid.

Or 12 monthly payments of 5/11. Carriage paid.

ADVENTURER 5-VALVE SUPER-HET

Kit of parts in sealed carton as specified by Maxamp, the Designer. This is a wonderfully selective and powerful set with built-in moving-coil speaker. Includes necessary Pilot Radio Envelope but excludes valves, cabinet and speaker.

Cash or C.O.D. **£6 10** Carriage Paid.

Or 12 monthly payments of 11/11. Carriage paid.

BACKED BY PETO-SCOTT—ORIGINATORS OF CONSTRUCTOR KITS IN 1919

PETO-SCOTT CO. LTD. 77 City Rd. London, E.C.1. Telephone: Clerkenwell 94007

Dear Sirs, Please send me CASH/C.O.D./H.P. for which I enclose £.....s.d. CASH, H.P. Deposit. Also send your FREE 1933 Radio Catalogue.

NAME

ADDRESS

A.W. 24/1/32

Buy by Post — it's Quicker

You will Help Yourself and Help Us by Mentioning "A.W." to Advertisers

Get YOUR FREE COPY of this Book to-day!



Thousands have literally snapped it up—and are making this outstanding set

Every day more thousands send for this free book of the "Scout S.G.3." Thousands who own average receivers are now making this sensational set. Those who have made it are enthusiastic in their reports of its performance, simplicity and moderate cost.

Most definitely there has never before been such a cleverly designed home constructor's set—for the "Scout S.G.3" is the result of a united effort by leading component manufacturers to design a specialist's set that even a novice can construct—at a cost that brings it within reach of the most modest purse.

The set is a sensation. It has created a sensation. The tremendous demand for the Free Book and Blueprint proves how outstanding it is. Get your copy to-day.

The SLEKTUN SCOUT S.G.3

Take the coupon below to your dealer for the Free Book and Blueprint of the "Scout S.G.3," or, if more convenient, post it to us with a 1½d. stamp affixed.

- One-knob tuning—fifty stations at full loud-speaker strength.
- Extreme selectivity. "The Broadcaster" says: "Even with a large aerial at ten miles from Brookmans Park, the local stations were easily separated."
- "Simplicity is one of the outstanding features—"
- "The constructional details are very explicit, and we can imagine no difficulties."

Messrs. SLEKTUN PRODUCTS LTD.,
21, Douglas Street, WESTMINSTER, S.W.1

Please send me the FREE illustrated Book of the SCOUT S.G.3, together with the full-size Blueprint. I enclose 1½d. stamp to cover cost of postage.

Name.....
Address.....
A.W.3.....

SLEKTUN PRODUCTS LTD., 21 DOUGLAS STREET, WESTMINSTER, S.W.1

National

Advertisers Appreciate Mention of "A.W." with Your Order



BRITAIN'S LEADING RADIO WEEKLY FOR CONSTRUCTOR, LISTENER & EXPERIMENTER

EDITOR:
BERNARD E. JONES

TECHNICAL EDITOR:
J. H. REYNER, B.Sc. AM.I.E.E.

RESEARCH CONSULTANT:
W. JAMES

ASSISTANT EDITOR:
H. CORBISHLEY

NEWS & GOSSIP OF THE WEEK

OUR FREE SUPPLEMENT

INCLUDED in this issue is the second of the "A.W." Special Supplements for beginners. It is an eight-page feature brimful of interesting topics for all readers, and it gives everybody a chance to brush up his technical knowledge. You will find this supplement in the centre pages of the issue. The "Wizard" is a big feature this week, too. The construction of this fine set is described in simple, illustrated stages. It is really something new in sets.

GIVING THE EMPIRE WHAT IT WANTS

BACK from their holidays, Sir John Reith, Director-General, and Mr. Cecil Graves, the new Empire Broadcasting Director, have been planning the make-up of the Empire programmes to be broadcast from the new stations nearing completion at Daventry. The Empire is to have just what it wants. *Not what the B.B.C. thinks it ought to want!* If the cry goes up for vaudeville, it shall be given. If overseas listeners like their humour "broad," they shall have it—but there will be nothing vulgar! A big demand for light entertainment is expected—hence the bustle to augment the programme staff with revue

producers who will be ready for home or Empire work.

SPARING NO EXPENSE

ALTHOUGH no contributions to the Empire Service are as yet forthcoming from overseas, the B.B.C. is determined to make use of its best material. It is recognised that the programmes must be "robust" to catch the ear of the colonial. The very best artistes of every department of the B.B.C. will be engaged in this Empire work.

FEEDING THE FIVE ZONES

ONE of the difficulties of this Empire broadcasting is the time differences between the various countries, and even between one part of a country and another. At first, Mr. Graves will be satisfied if he can feed each of the five zones with programmes between 8 and 10 p.m. local time, extending the period later from 6 p.m. to 12 midnight local time.

BOTTLING PROGRAMMES FOR LATER USE

GREATLY improved quality is being obtained from three Blattnerphone machines of a new type now being tested at the B.B.C.'s Research Laboratory at

In this issue:

Free wiring plan of the "Wizard."

The A.B.C. of Mains Working. Practical Hints and Tips.

Some Developments in Low-frequency Amplification.

Our Second Special 8-Page Supplement, "Wireless Made Easy."

Nightingale Lane, Clapham. These new recording machines will enable the B.B.C. to "bottle" programmes sent out from the studios in the normal way, so that later wax-disc impressions can be taken for distribution to the Empire.

FIRST EMPIRE RECORDING

CURIOSLY enough, the first recording for Empire distribution made by the B.B.C. is a Maux programme, lasting half an hour and comprising folk music and a comic song. There may be difficulty in finding material for this scheme, as we hear that several authors are unwilling to sell their "Empire rights."

DANCE MUSIC FOR OCTOBER

HENRY HALL will be back in the Thursday evening dance-music period during the month of October, and bands from the Dorchester, Monseigneur, Savoy, and Mayfair will be relayed on other evenings. It is interesting to note that Maurice Winnick will also be playing from the Carlton on three nights of the month. Bertini will take a well-earned holiday, being on the air only once.



Practising for the outside broadcast of the speedway racing at the Wembley Stadium. The engineers are trying microphone positions during motorcycle testing.

NEXT WEEK: A NEW USE FOR YOUR OLD SPEAKER

NEWS & GOSSIP OF THE WEEK —Continued

STUART HIBBERD BACK

LISTENERS have probably noticed that the B.B.C.'s Chief Announcer, Mr. Hibberd, is now back at the microphone. He is in fine voice after spending several weeks down in Devonshire, where Mr. King-Bull is now recuperating and seeking inspiration in a coast-guard cottage on a cliff!

PLYMOUTH PROGRAMMES TROUBLES

ALTHOUGH the Plymouth relay station has been successfully synchronised with Scottish National on a wavelength of 288.5 metres, it is feared that after night-fall it will be impossible for the relay to send out a programme different from the National. This will mean the scrapping of the local children's hour. Although great disappointment is anticipated, the B.B.C. points out that such a move would be inevitable next spring, when West National is also synchronised on 288.5 metres.

VARIETY IN THE LUNCH-TIME MUSIC

BY the policy of pooling the lunch-time music resources of Midland, Scottish, and North Regional stations the B.B.C. believes that listeners are gaining a greater variety of broadcasting. Anyway, the policy is to be continued.

A TELEVISION SCOOP

ALL credit for "televising" Jim Mollison and Amy Johnson is due to Eustace Robb, the enthusiastic television producer recently taken on by the B.B.C. His waking hours are one long round of auditions, rehearsals, and transmissions, and he is certainly "delivering the goods." Ventriloquists, conjurers, cartoonists, Yo-Yo players, a sea-lion and a cat have already figured in the programmes! Sir Joseph

Duveen came to the studio to discuss the best methods of televising works of art. He was followed by a Jap who was wanted to discover whether ju-jitsu would be a television success!

B.B.C.'s CONTRIBUTION TO CRISIS

THIS year the B.B.C. is handing over £150,000 of listeners' money to the Treasury as a contribution to the nation's

begins. For seven days the Midland Regional programme will be flavoured with the history, music, literature and customs of Worcestershire. During the week the Prince of Wales will be heard opening a new bridge in the county town.

ANOTHER 'MUSIC HALL' FROM NO. 10

JOHN SHARMAN and John Watt, in double harness once again, will produce

ANOTHER SPECIAL SUPPLEMENT NEXT WEEK!

Next week's issue will contain another special eight-page supplement of outstanding interest to beginners in wireless, and those who want to brush up their technical knowledge.

PERCY W. HARRIS describes another interesting addition to the special receiver of the **BUILD AS YOU LEARN** series.

J. H. REYNER continues his fascinating **ELEMENTARY WIRELESS COURSE FOR BEGINNERS**.

The Supplement will also be full of helpful hints and tips for set-users, and for those who are curious to know just "how it works."

ANOTHER BUMPER NUMBER.

ORDER YOUR COPY NOW.

needs in these difficult times. Next year, as the result of discussions now ended, a larger sum will be handed over. Listeners need not fear that the programmes will suffer, although development work is likely to be somewhat checked.

WIRELESS ON TRAINS

Differences Between First and Third!

WHILE third-class travellers availing themselves of the wireless earphone service on L.N.E.R. trains prefer jazz it seems that the first-class occupants plump for symphonic music! Radio-grams, as fitted on the Scottish expresses, are now installed in the London-Leeds train—which was the pioneer of travelling radio in this country. Alternative programmes can be supplied with these instruments. The charge has now been reduced to 10d. The pages who hand round the phones appreciate the change!

NOT SO HIGH-BROW!

CHARLES SIEPMANN, the new Talks Director of the B.B.C., has produced a programme of talks that promises good listening. In doing so he has managed to confound the critics who expected a highbrow "bias." Some talks are quite human!

MIDLANDS COUNTY WEEK

ON October 18 the first of the Midland Regional County Weeks

a Music Hall bill on October 1, in studio No. 10. The programme is not complete, but if the artistes are available the bill will include Lily Morris, Clarice Mayne, Walter Williams, and Billy Bennett—a galaxy of stars! The concert studio in Broadcasting House is in constant use for musical programmes, and it is doubtful whether it will be used again for vaudeville. The Productions Department has not entirely abandoned hope about using this studio, and feeling at the moment is running rather high between the contestants.

BETTER RELATIONS!

LADY SNOWDEN and Dr. Adrian Boulton are to be congratulated upon the better relations existing between the B.B.C. and the musical world. At least six Philharmonic concerts will be relayed during the season, starting on September 29. Sir Thomas Beecham himself will conduct several performances. A series of operatic relays from the Carl Rosa tour begins with an excerpt from Bristol in the week of September 26.

A. J. ALAN AGAIN

THAT ever-popular broadcaster, A. J. Alan, will make his first appearance in the Children's Hour with a story called "Percy the Prawn." He has also promised to tell his evening audience another story. Both of these broadcasts will take place in October.

POETRY READINGS!

A new experiment in the reading of poetry and prose is to be tried during the autumn and winter months. Every evening of the week for a period of five minutes (except on Wednesdays, when the period will be extended to fifteen minutes) a reading of poetry or prose will be broadcast immediately before dance music begins at the end of each day's programme.



"You know, Alf, this 'ere wireless is like the rows me and the missus 'ave!"
 "'Ow's that, Bill?"
 "Words over nothin', Alf!"

SEVENTEEN STATIONS IN DAYLIGHT DURING A SHORT TEST OF THIS AMAZING SET

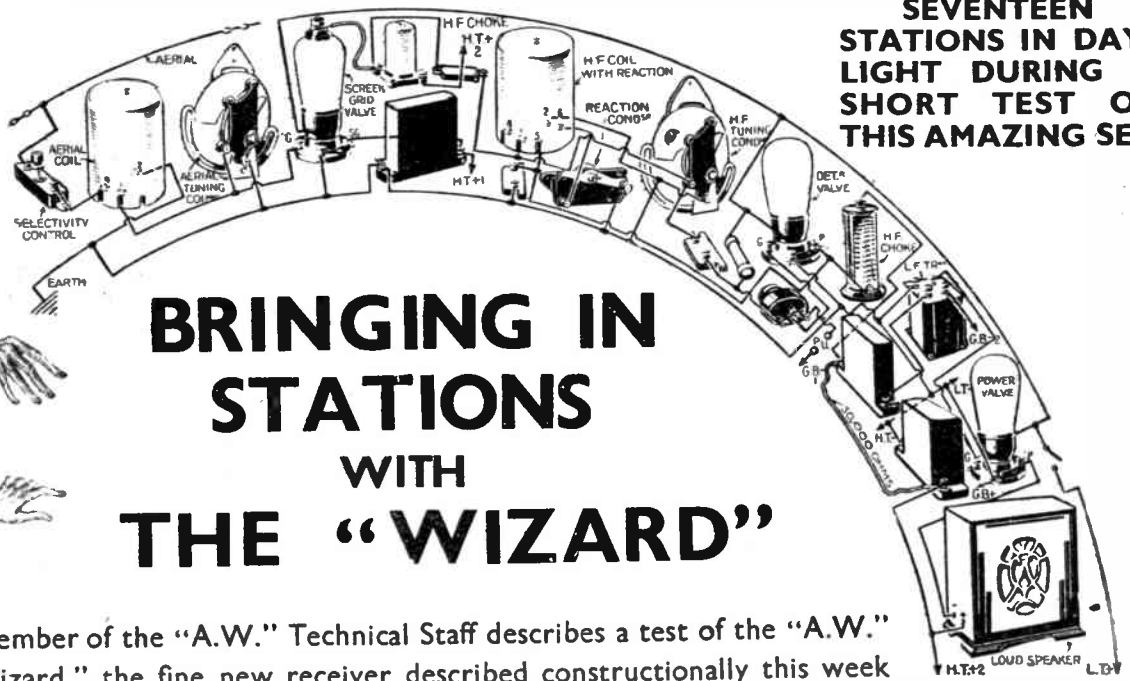

BRINGING IN STATIONS WITH THE "WIZARD"

A member of the "A.W." Technical Staff describes a test of the "A.W." "Wizard," the fine new receiver described constructionally this week

I WONDER why many of us go to the expense of buying large, costly receivers when one can listen to over fifty stations on an efficient three-valve receiver, costing only a moderate sum.

I tested the "Wizard" on a Saturday afternoon and evening at Letchworth, about 30 miles, "as the crow flies," from Brookman's Park. Using an aerial of about 38 ft. in length, and the specified valves, batteries, etc., the results obtained were really remarkable considering the simplicity of the apparatus.

In the Daytime

The receiver was connected up round about 3 o'clock to see that it was in good working order. As I idly tuned the receiver, I was struck by the liveliness and the smooth reaction, so I decided to see just how many stations could be received during daylight.

Tuning to the top end of the long-wave scale, Hilversum was received at good strength, giving a Trio Concert; only

6 degrees lower Radio Paris came in, with reaction practically at zero, giving an introductory gramophone record prior to starting the afternoon programme. At approximately 83 degrees Berlin was heard at fair strength, but not for long, as Daventry started up a few minutes later, interfering badly.

Although Eiffel Tower could be separated from 5XX, care had to be taken in adjusting the aerial condenser to do this completely. The carrier wave of Kalundborg was received together with a faint signal, but it was not of sufficient strength to be of entertainment value.

Croydon was very interesting for a few minutes. I listened to a conversation between a 'plane going to Cologne and the operator at the Control Tower giving a weather forecast and bearings.

On Medium Waves

The medium waveband is not usually very much used in daylight except for the local stations, but the long-wave stations

being so very good, I decided to try and see just what could be obtained.

The North Regional was quite a strong signal but it was inclined to fade a little, but Langenberg, only 1 degree lower, came in quite clearly and free from interference. This, in my opinion, was a double achievement: firstly, to receive this station at all in daylight, and, secondly, to be perfectly clear from the North Regional.

On 200 Metres!

The London Regional was far too strong for comfort, and, even with the reaction condenser at zero was still rather too loud. Huizen was giving a splendid concert and could be received quite easily without having to force reaction in the least.

After 5 o'clock Brussels No. 1 at 91 degrees came in very strongly, as did its sister station, Brussels No. 2, on 65.5 and 61.5.

The Midland Regional can be received nearly everywhere in the country, so the reception of this station is not of much interest, but the North National, relaying dance music, came in at practically the same strength, and, at the same time, did not jam Huizen. Lille, only a minor station of 1½ kilowatts, nevertheless came in on the speaker at good strength, when the London National allowed. As the two stations were less than 1 degree apart, this is not to be wondered at.

Finally, Fécamp, which nearly everyone seems to want to obtain, came in at 38 and 32, showing that the receiver is not only very sensitive, but is capable of tuning down to well under 200 metres. This, incidentally, should be of interest to Newcastle and Aberdeen readers who have trouble in this respect.

Seventeen stations in daylight is certainly a "bag" to be proud of and I was very keen on trying again later in the day. I decided to give the receiver a thorough test that evening as the conditions seemed quite good, and there was a com-

(Continued at foot of next page).

A FINE FAMILY SET!



The "Wizard" at home! As the test report on this page shows, it is an ideal station-getter; nevertheless it is a good set for family use, being easy to operate and economical to work



HOW TO TEST YOUR BATTERIES

THE average wireless enthusiast, if asked to check the condition of his low-tension accumulator, would simply put his voltmeter across the terminals and answer quite glibly, "Oh, it's fully charged; reading 2 volts now—look." And he would be quite satisfied. Unfortunately, however, a reading of 2 volts per cell is not always an indication that the accumulator is in good condition and the knowing battery user never relies upon voltmeter readings alone.

In the first place, many radio fans fail to realise that the popular "2-volt accumu-

lator" has a voltage when fully charged of something like 2.3 volts and that a cell that is to all intents and purposes worn out may yet read nearly 2 volts on open circuit.

Secondly, it must be remembered that a voltage test should never be taken on open circuit, but only when the battery is under load, i.e., actually discharging. Readings taken in this manner (while the radio is working) are, for the most part, reliable, but open-circuit voltages may be very misleading.

A Hydrometer Provides the Best Test

A good hydrometer gives a far better idea of the condition of a battery than does any voltmeter. Notice that a *good* hydrometer is specified. That is, one which has an accurately graduated float to indicate the actual strengths of the acid, as shown by the photograph. Hydrometers of the "floating-ball" type, or those with floats marked "charged," "half charged," and so on may not give sufficient warning when the electrolyte is too strong or too weak.

Watch the Acid Strength

For example, a cell with this type of hydrometer would read "fully charged" if the specific gravity of the electrolyte was 1.250 or more. Now supposing that the acid strength were fifty points in excess of that recommended by the battery makers (a regrettably frequent occurrence when an inefficient charging station has been patronised) the "floating ball" hydrometer would give no indication of this and the battery plates would soon be ruined.

Don't, therefore, begrudge an extra shilling or so when buying your hydro-

meter. A "cheap" instrument is seldom an economical proposition, whereas a good hydrometer will last a lifetime—always provided that it is not knocked off the table too frequently. Incidentally, a cardboard "collar," cut as shown by the diagram and slipped round the hydrometer will curb the instrument's tendency to roll and, perhaps, prevent a regrettable accident.

Leaking Floats

Of course, there are times when even the best hydrometer appears to be "playing tricks." The writer has vivid recollections of a time when the specific gravity of the electrolyte in his batteries obstinately refused to rise above the 1.230 mark. But the trouble in that case was ultimately

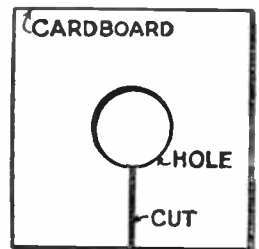

A piece of cardboard cut as this and slipped over the hydrometer may prevent accidents

traced to a microscopic crack in the hydrometer float. A little acid had found its way inside the float, thereby increasing the weight of the latter and causing inaccurate readings.

There are additional causes for variation in hydrometer readings. For instance, if distilled water has been added to an accumulator and not thoroughly mixed with the original electrolyte, false readings may be obtained. Similarly, if the acid level in one cell of a battery is allowed to fall much below normal, a higher specific gravity will be registered in that particular cell than in those at the correct level. This is because a considerable volume of water has evaporated and left concentrated acid behind in the cell.

"BRINGING IN STATIONS WITH THE WIZARD."

(Continued from preceding page)

plete absence of atmospherics.

The first thing I did was to adjust the pre-set condenser in the aerial until I obtained a sufficient degree of selectivity, because, as it was now quite dark, stations were coming in at greatly increased strength and additional selectivity was required.

On the long waves all the main stations came in without any trouble, including Lahti on 1,796 metres; this is quite an achievement, as this station is received very rarely. Berlin was interfered with to a certain extent by 5XX, but probably in a more favourable area (I am less than thirty miles from 5XX) this would not be the case. Several other stations were obtained at varying strength, but as they were not identified, were not included in the log.

It was on the medium waves that I had a pleasant surprise. Over forty stations were received during the evening; more than thirty of them sufficiently loud and free from interference to be worth listening to for a

whole evening's entertainment. Thirty alternative programmes on three valves!

Perhaps an idea as to how these stations were received will make quite sure that new constructors will be able to duplicate these results.

The Ideal Set FOR BEGINNERS AND EXPERTS THE "A.W." "WIZARD."

As the receiver is fitted with 25-1-ratio dials, little difficulty will be experienced in obtaining a very slow movement of the condensers, and the reaction being quite smooth the receiver does not go into oscillation with a "plop." The set could be left in its most sensitive condition (that is, nearly oscillating) when searching for your stations, the volume being adjusted when a station has been received satisfactorily.

The long-wave tuning hardly requires any description, as all the main stations could be received without any trouble by referring to the dial readings or by checking

the call signs. It will be noticed, however, that the pre-set condenser in the aerial will have to be screwed further down than when used on the medium waves.

On this band reception is not quite so simple. The stations are not only very close together, but in many cases the languages are very similar, so that one's log of stations has to be compiled carefully.

One or two stations of little consequence were to be found between zero and 37 degrees, but the first station to come in at all well was Cork on 37.5 and 32 degrees. Just above this was Picamp, broadcasting a programme for English listeners. Belfast and Trieste came next, followed by Hörby, which in most cases will be interfered with by the London National, for listeners who are within 30 miles or so of this station. Lille will also be interfered with to a certain extent by this same station, but as it is an excellent daylight station the Sunday morning programmes provided will be of considerable interest.

Heilsberg is a tremendous signal at 53 and 50 degrees and it is quite free from interference from the National. Between this reading and the London Regional over

(Continued on page 642)



How the A.C. mains can be used to replace the batteries of the wireless set is simply explained in this practical contribution by a designer of mains wireless apparatus

IN one article it is not possible to give anything more than a general idea of how the mains are used to supply the wireless set with its power. Let us see what we have in a mains supply and what we want in the receiver. The mains give

The low-tension is much more simply obtained, by stepping down the voltage of the mains to the 4 volts at which the filaments have to be heated. This needs only a transformer, or more usually an extra winding on the high-tension transformer.

doubler metal-rectifier circuits the secondary has to be centre-tapped. So has the filament secondary, unless two resistances are connected in series across the winding to provide an artificial centre tap.

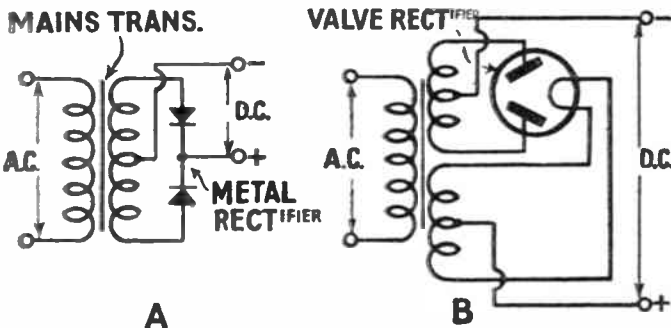

Circuits for mains rectification. At A is a centre-tap circuit for use with a metal rectifier and at B the standard circuit for a double-wave valve rectifier is shown

us an almost unlimited amount of power at a fixed voltage, usually 200 or 230 volts. The set needs three distinct voltages—high-tension for the anodes of the valves, low-tension for their filaments and grid-bias for their grids. The job in mains working is to obtain these various potentials from the fixed voltage of the mains.

The high-tension is obtained from a sequence of components consisting firstly of a transformer, then a rectifier, then a smoother and finally a potential divider.

many designs for transformers. The final choice depends on the rectifier to be used and on the amount of high tension wanted. There is a primary winding connected across the mains, with tapplings for the different voltages of supply. Then there is a number of secondaries, usually two, one for the high-tension rectifier and the other for the filaments.

The function of the transformer is *not* to transform but to alter the voltage of the mains to whatever voltage is needed for the rectifier and the filaments. As a rule, the rectifier voltage is higher than the mains voltage, so more turns are put on the secondary than on the primary. For the filaments only 4 volts is wanted, so a very much smaller secondary winding is provided.

With some types of metal rectifier a simple high-tension secondary is sufficient, but generally with valve and voltage

Of which more later.

The grid-bias is obtained in quite a subtle way. It does not need any special components. Grid-bias is, to use a common term, "pinched" from the high-tension. Some of the voltage that would have gone on the anodes is diverted to the grids.

TRANSFORMERS

FOR mains working there are many designs for transformers. The final choice depends on the rectifier to be used and on the amount of high tension wanted.

RECTIFIERS

WHAT you have inevitably to decide is whether you will use a valve or a metal rectifier. Some form of rectifier is essential, for the current passed on by the transformer is of its original nature, flowing backwards and forwards, usually 50 times a second. This is of no use for the anode supply, which must be smooth direct current, otherwise there will be a humming noise in the loud-speaker.

The modern valve rectifier has the advantage that the smoothing after it does not have to be very extensive. On the other hand, most of the new metal rectifiers provide a direct-current output that can quite easily be smoothed, with the additional advantage that the metal rectifier is practically everlasting. The valve should give at least a thousand hours service and may last considerably longer.

The valve rectifier consists of two half-wave rectifiers inside one bulb, with

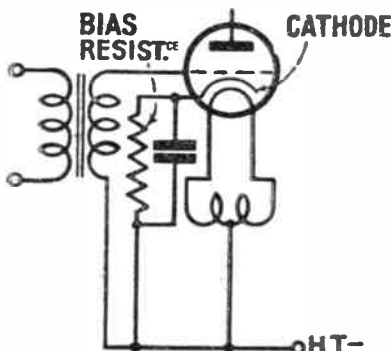

Grid-bias circuit for an output power valve using an indirectly heated mains valve. Note that a bias resistance is connected between the cathode and high-tension negative. This has the effect of making the cathode positive with respect to the grid, which is the same as making the grid negative

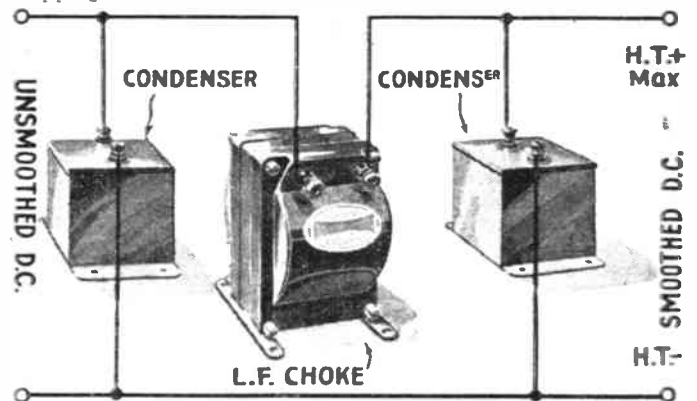

The essentials of a smoothing circuit are shown here. There is firstly a reservoir condenser, then a choke and finally an output condenser. The condensers store up the voltage while the choke tends to oppose any change in the current producing this voltage, so the effect is to smooth the output

separate anodes but a common filament. The transformer for such a rectifier has to provide a secondary for heating the filament and a centre-tapped high-voltage secondary for the anodes.

With metal rectifiers one secondary (Continued at foot of next page)

WHY NOT FADE OUT THE APPLAUSE?

Asks WHITAKER WILSON

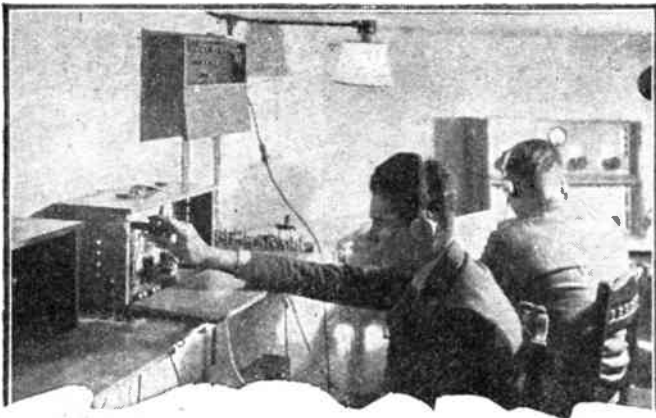

If you look amongst the published correspondence of the B.B.C. you will find an occasional outburst from some enraged listener protesting against the applause at Queen's Hall during the Proms and symphony concerts. Often these letters have been protests against applause as such, generally casting aspersions at the mentality of those who applaud. That sort of criticism is hardly worth while writing; it is certainly not worth reading.

On the other hand, I am inclined to think there is something in the point of view if modified into reason. Unfortunately, the broadcast effect of people clapping is not good. If allowed to transmit for three or four minutes, as is often the case, it certainly becomes a nuisance.

On the other hand, if you are in the hall it is entirely another matter. The reason is simple. You can see the artiste you have thus approved; you can see him (or her) acknowledge your approbation; you can see Sir Henry Wood bowing, the

orchestra rising and the various other movements and actions. That makes all the difference.

At home you see nothing of this. You have heard the music, but that is the only experience common to you and the people in the hall. Everything else is their gain and your loss.

The stimulus to applaud comes from being in a place crowded with people. You will applaud vigorously when two thousand people applaud with you, but if you happen to be in a theatre or concert hall where, for some reason, there is but a handful of people you are almost afraid to applaud. Surely it is not unreasonable to suggest that in the privacy of your drawing-room you have no desire to applaud at all?

On the other hand, it is not reasonable to argue that because you are not a member of what may be called the primary audience you are justified in objecting to their clapping and cheering, but it may be argued that the effect of applause immediately a work has finished is inartistic and even unpleasant under ordinary listening conditions.

Even if a work ends brilliantly, with crashing chords, or a long note held by the

full orchestra, a sudden outburst of clapping is by no means good in effect, but if a work ends like a breath—as, for instance, does the *Pathetic Symphony* of Tchaikovsky, which ends so softly that it is difficult to be sure when it really has ceased—then the effect of tumultuous clapping jars the nerves of any keen listener.

I have just been making an experiment with my watch. At the conclusion of a symphony in a Prom I switched round into silence for ten seconds. I then faded in the applause with considerable effect. Looking at it as though it had been done for me, I am bound to state I felt the benefit of the ten seconds complete silence.

I should like the controller to try the experiment one evening of cutting off for ten seconds, then allowing the applause to fade up to a good strength for half a minute, fading out a second time for the announcement of the next item, and finally fading in the end of the applause. The arrangement could be variable; there is no need to make any hard and fast rules.

Until television is established everything broadcast must be thought of and viewed as something heard but not seen. We are all better listeners than we were ten years ago—even a year ago. We are getting used to appreciating music and plays by means of the ear alone.

'THE A.B.C. OF MAINS WORKING'

(Continued from preceding page)

voltage for the high tension is sufficient, and with either the bridge circuit or the voltage-doubler circuit the secondary voltage does not have to be very much greater—and is sometimes less—than the required output voltage.

SMOOTHING

AFTER the mains current has passed through the rectifier, whether metal or valve, it is "one-way" current, but by no means smooth enough to be applied to sensitive anode circuits. Between the final output of the mains equipment and the rectifier we therefore insert smoothing devices.

There are smoothing condensers and smoothing chokes. The condensers store up the voltage applied to them and thus tend to maintain the output at a constant level. The chokes oppose changes in the value of the current flowing through them and thus also help to keep the output smooth. There is more in smoothing than this, of course, but you have the general idea.

Usually, enough smoothing is obtained with two condensers and a choke between them. The important point about the condensers is not so much their capacity, though this is, of course, taken into consideration, but their working voltage.

Condensers consist of metal plates sepa-

rated by an insulating material called the dielectric. The better the dielectric the greater the voltage you can safely apply to the condenser. It costs money to put in

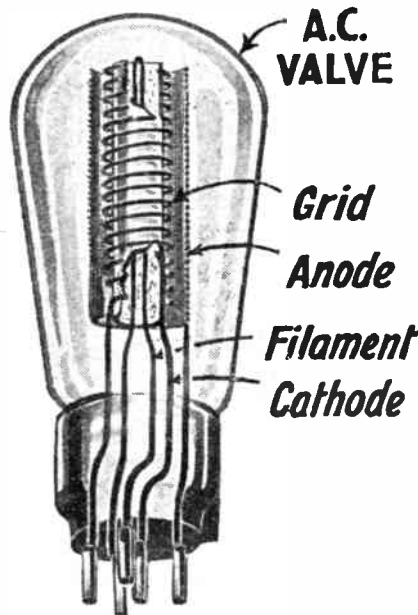

A typical mains-valve construction. The heater or filament is fed with the raw A.C. at 4 volts and this heat is communicated to the cathode, which is insulated from the heater. The cathode is the electron emitter, and corresponds to the negative side of the filament of a battery valve

dielectrics to stand up to high voltages, and your job is to choose a condenser with just the right dielectric for your applied voltage.

Smoothing condensers are now generally sold on their working voltage, which is less than half the test voltage.

The choice of the choke depends on how much current the mains supply is delivering. A choke of not less than 30 henries inductance is needed. The inductance varies with the current flowing through it, so do not be guided by the inductance figure alone. Take it with a current figure—such as 30 henries at 40 milliamperes, to give a typical example.

The condenser immediately connected to the rectifier—called the reservoir—should have a capacity of 4 microfarads. This value must not be exceeded with a valve or serious damage may be done. After the choke is another condenser, which may be anything from 4 to 8 microfarads. In this output position it is now possible to use an electrolytic condenser.

VOLTAGE DIVIDERS

AFTER the smoothing has been done we have a fixed voltage providing direct current. For the output power valve this voltage may be suitable as it stands, but for the preceding valve stages, such as the screen-grid and detector valves, a reduction in the voltage must be made.

This reducing is done with potential

(Continued on page 645)

A SIMPLE DISCOVERY—

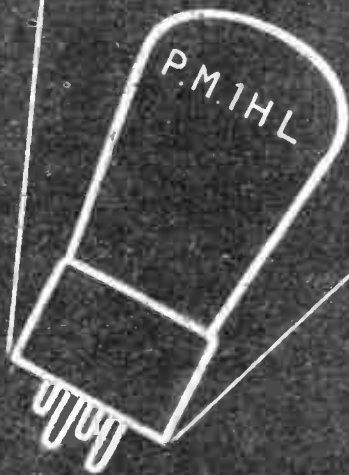
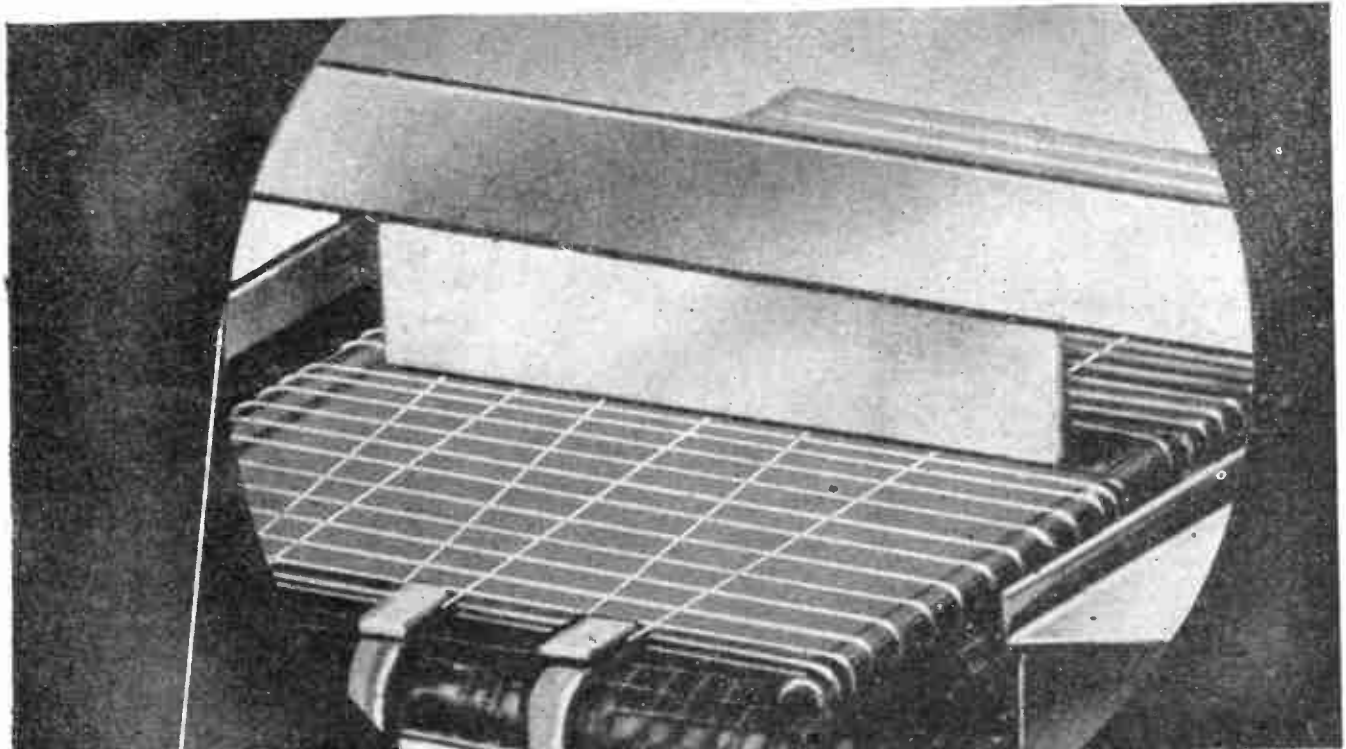

—yet it means so much; a damping device on the filament—and microphony is conquered. That's the story of the greatest advance in modern valve construction.

This wonderful detector also works at a very low anode current which abolishes distortion due to transformer saturation and consequently gives greatly improved quality. For the same reason of course, the life of your H.T. Batteries is prolonged.

PRICE 7/-. MADE IN ENGLAND.

The Mullard Valves specified for the Wizard described in this issue are 1P.M.12, 1P.M.1HL and 1P.M.2A.

Mullard

THE · MASTER · VALVE

Advt. The Mullard Wireless Service Co., Ltd., Mullard House, Charing Cross Road, London, W.C.2. ARKS

Please Mention "A.W." When Corresponding with Advertisers



“ . . . not that I’m necessarily thinking of a set that’ll bring in Timbuctoo and Pernambuco. Let me get the really worth-while programmes sounding good. That’s the main thing — *sounding good*. Can’t do without records, though—must be able to choose my own stuff when I want to. There’s an H.M.V. radio-gramophone at thirty-nine guineas. It’d look fine, over there under the little window”



“TRUE TO LIFE”

THE MOST FAMOUS RADIO-GRAMOPHONE IN THE WORLD — MODEL 521 — IS 39 GUINEAS ; WITH AUTOMATIC RECORD-CHANGING DEVICE, FOR 8 RECORDS, 46 GUINEAS.

Photographic catalogue fully describing 22 models gladly sent on request. “His Master’s Voice,” 367a Oxford Street, London, W.1.

His Master’s Voice

INSTRUMENTS FOR RADIO AND RECORDS

On Your Wavelength!

MY MISTAKE!

IF ever one's pen slips in AMATEUR WIRELESS, plenty of readers are always sure to spot the lapse and to write in about it with chuckles. I was guilty of a funny mistake a week or two back when I wrote that broadcasting would not celebrate its ninth birthday until November next. Here is how it happened. I turned up the reference, just to make sure, in the 1923 Whitaker's Almanack, in which I read that broadcasting had begun in November. Stupidly enough, it didn't occur to me that this meant November, 1922; though, of course, I knew it perfectly well if only I had thought for a moment.



"... not a sound could be coaxed from the set!"

Yes, broadcasting is just on ten years old, right enough; and ten jolly eventful years they have been.

PACKED YEARS

IHAVE before me as I write a copy of the first popular book on wireless ever published in this country—published, too, under the auspices of the Editor of "A.W.", though this paper was not then born. The first edition of the book appeared some time before broadcasting began. It deals with coherers and all kinds of funny old apparatus. The carborundum and crystal detectors it knows, but it does not get as far as the valve! Then there's another book which appeared in the very early days of broadcasting. This was quite a revelation in its time, for it not only dealt with the theory of the valve, but also showed how to make a five-valve set. You couldn't buy many components in those days; so full instructions were given for making the variable condensers, low-frequency transformers, and fixed condensers, as well as the tuning coils. The five valves were all of the general-purpose type; so you can just imagine what the distortion was like when this set got going. There was, of course, no negative grid-bias anywhere.

SOME EVENING!

ISHALL never forget the evening when I gave my first more or less formal wireless demonstration. This must have been in the late summer of 1922, and the show took place after a dinner party to which guests had been specially invited to see and hear the new wonder. The set was a unit affair with two H.F., a detector, and two L.F. stages (all

G.P. valves) connected to the original Brown type "H" loud-speaker. Old hands will remember this speaker well enough.

THE THRILL OF IT

IT grieves me to have to say it, but not a sound could be coaxed from the set until after Writtle had closed down. Whilst I was engaged in trying to discover the fault, my accomplice endeavoured to keep the audience interested by telling them of the wonderful things that were shortly to happen. When, at long last, I discovered that the grid leak had died on me and replaced it with the line of Indian ink drawn on paper that we so often used for the purpose in those days, I was overjoyed to find that several amateurs were hard at work transmitting. One of these was sending out a Harry Lauder record and, by stupendous feats of tuning, I got the transmission up to loud-speaker strength. Positive thunders of applause greeted what we should now regard as an appalling performance. A few more amateurs were picked up, and the evening closed with a world tour, which consisted in tuning in long-wave morse signals. My audience listened to those pings and pipings from far-away places with more interest than a present-day audience would display in the perfect and powerful reproduction of some outstanding musical programme from Budapest or Madrid. Those were the days!

SAD BUT TRUE

WITH the autumn increase in signal strength that we are experiencing just now, heterodynes are becoming far more marked. Actually, the growing number of heterodyne whistles is due not only to seasonal effects, but also to the fact that so many Continental stations have increased their power and are therefore more capable of producing "action at a distance." This is a very serious problem for all wireless folk. It is quite clear that where powerful transmitting stations are concerned as wavelength neighbours, a 9-kilocycle separation is about as much use as the proverbial sick headache.

With a selective receiver you can separate the two stations easily enough, but you cannot get rid of the heterodyne whistle which accompanies either. We shall, I think, have to make more use of filter cir-

cuits to obviate this nuisance. Since the general separation of stations is 9 kilocycles, the frequency of the heterodyne is well defined, and it is not difficult to design a filter for it. The use of such a filter means, of course, that this particular frequency is strained out, whether it occurs as a whistle or as a musical note. In theory, this might seem a fatal objection, but in practice it does not make a great deal of difference.

OLD AGE IN LOUD-SPEAKERS

IHAVE had so many letters recently from correspondents who have found old or oldish loud-speakers developing various annoying habits, that I think I had better mention again the hints that I gave in these columns a year or two back. All loud-speakers of the balanced-armature type and the majority of moving-coil loud-speakers made to-day incorporate permanent magnets. The trouble is that, like permanent waves, permanent magnets are not everlasting. There is no greater enemy of the permanent magnet than vibration, and this must come the way of those which form part of loud-speakers. As time goes on, the magnet slowly loses strength. The instrument then overloads more and more easily and the quality suffers badly. There are several firms which carry on re-magnetizing, and the process is not at all an expensive one. I have had several loud-speakers treated in this way and it has invariably produced beneficial results.

ERRATIC FADING

WHEN a set plays the old soldier's game of gradually "fading away," it is generally because one of the batteries has run down, specially



J. A. Mollison making one of his numerous appearances before the "mike." On his return he was asked to broadcast, with Mrs. Mollison, during a late-night television transmission

On Your Wavelength! (continued)

the L.T. But there are fading symptoms of a more erratic kind. For instance, not long ago I was called in to "vet" a set which worked quite normally for a couple of minutes, and then fell off nearly to nothing. After a while, the signals came back only to go off again, and so on. Now this kind of thing is usually due to grid trouble—either the leak resistance is too high or else it is open-circuited—so that the grid voltage gradually builds up until it paralyses the valve by shutting-off the plate current. After a while the excess voltage manages to find some path of escape, possibly across the base of the holder, and the valve starts to function properly. But not for long, because the same defect soon causes it to choke up again. If the set works all right so long as you keep your fingers on the faulty grid terminal, you can be pretty certain you have found the cause of the trouble.

"DATING" VALVES

A PROPOS of a recent paragraph in which I commented on the long and faithful service given by the average valve before "passing out," I find that, as usual, there is another side to the story. In fact, judging by recent correspondence it rather looks as if the mains-driven valve is more prone to give up the ghost at an early stage than the battery-driven type. This, of course, is not as it should be, but I notice that the evidence as to length of service is not always very convincing. Personally I think it is a very sound plan, whenever one has to put in a new valve, to stick on it a small label plainly marked with the date of purchase. One can then at least be certain exactly how long it has been in operation, without having to strain one's memory and possibly do the valve manufacturer something less than full justice.

WHAT'S IN A NAME

THE first time I saw the term humbucking coil in print I thought it was a rather amusing misprint. But in point of fact it is used, quite aptly, to describe a special coil used for cutting-out "hum" from a moving-coil speaker energised from the mains. I think the term "bucking circuit" was first used in America to describe a coupling which introduced reverse reaction, i.e. one tending to cut down any tendency to self-oscillation. Hence a humbucking device is one which helps to eliminate hum. Another interesting bit of radio slang is the word "wow," used by the B.B.C. engineers as a snappy way of referring to the otherwise indescribable effect produced, when transmitting from a gramophone record, by a momentary alteration in the speed of the turntable carrying the disc. One can, of course, get the same effect by altering the speed on an ordinary gramophone, but I don't think you could find a terser way of describing it.

KEEPING A CHECK

THERE is a very useful way of keeping a check on the condition of loud-speaker and other magnets. To a piece of iron, attach by threads one of those little paper cups in which ices are sold. Place the iron against the magnet, as near the pole pieces as you can, and go on placing pennies in the cup until you find the greatest number that it will support. Three pennies go to an ounce. Scratch the number of pennies on the magnet, and there you are. If you make this test first of all when the magnet is new you can always try it out at any time to see whether it is remaining in good form. A more exact measurement can be made by using small shot instead of pennies and subsequently weighing the contents of the cup.

A PENTODE YEAR

IT is really amazing to find what numbers of ready-made sets nowadays incorporate pentode valves, whether designed for mains or for battery operation. As I prophesied some time that it would, the pentode has come into its own. It has shown that, given a chance, it can be a wonderful performer. The trouble in the past was that we did not give the poor thing a chance, for too often the loud-speaker was not properly matched to its impedance by means of the right kind of output filter or transformer. Or, again, no corrector circuit was used with the pentode, with the result that reproduction was apt to be thin and shrill. You won't find these faults in the well-designed pentode sets of to-day.

REFORMED!

FROM another point of view, the pentode is a reformed valve. It used to be horribly greedy in the matter of high-tension current, and this made its use in battery sets almost impossible unless super-capacity H.T.B.'s were

"HOOK-UP" CONDENSERS

Experimental circuits may be tried out on a baseboard without using any proper panel. The condensers should be mounted right at the edge, so that the knobs are

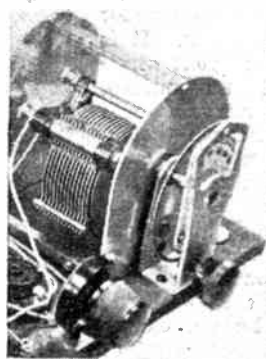

accessible and scales should be provided, so that you do not have to guess at the dial readings.

employed. Most of the early pentodes required the best part of 20 milliamperes all to themselves. I remember testing the H.T. current drain of a four-valve pentode portable worked from a standard-capacity battery which appeared on the market a few years ago. This turned out to be 28 milliamperes, and the set was therefore just a little expensive to run. The modern battery pentode really is economical, for there are several types which require not more than 5 milliamperes and yet provide an undistorted output of a very respectable fraction of a watt.

SINGLE-WAVE TELEVISION

HITHERTO, the "sight" portion of a television transmission has always been sent on one wavelength and the "sound" portion on another. The drawbacks of such a system are obvious: two transmitters and two receivers are required, and the combined transmissions monopolise two of the limited number of wavelengths available. A very ingenious new system has just been tried out successfully from the well-known American short-wave station W2XAB. The wavelength used was 107 metres, and both sight and sound were transmitted upon it. So successful were the first tests that transmissions are now being made daily, except on Saturdays and Sundays. In case any short-wave enthusiast wants to try for the transmissions, the programme begins at 1 a.m. British Summer Time and continues for two hours.

HOW IT IS DONE

THE method employed is exceedingly clever. To begin with, the sound waves occurring in the studio are used to modulate a feeble carrier with a frequency of 45 kilocycles. No actual transmission at 45 kilocycles is, however, made. The modulation due to television consists of frequencies up to 40 kilocycles. This and the afore-mentioned 45 kilocycles are impressed upon the main carrier and radiated as a single transmission. At the receiving end only one set is required. Frequencies up to 40 kilocycles are passed to the neon tube, but a filter keeps out the higher frequencies, which thus cause no interference with the reception of the picture. The second detector, tuned to 45 kilocycles, takes charge of the speech part of the transmission.

The system appears to be very promising and it is working well on the short waves. It could not, however, be used on the long waves, for the simple reason that the channel required by a broadcasting station for such a transmission is 45 plus 45, or 90 kilocycles in width. This is equivalent to ten of the 9-kilocycle channels at present employed under the Prague Plan. This means that ten single-wave television transmitters operating in different parts of the Old World would completely cover the whole of the "broadcast" band. There is heaps of room on the short waves. But the broadcast band is already very much overcrowded.

THERMION.

Whatever set you possess, an Ever Ready Battery will power it most economically, most satisfactorily and for a longer time; Ever Ready Batteries are made to fit and power exactly every wireless set made. And every Ever Ready Battery is guaranteed satisfactory by the makers of batteries for the past 30 years.

**CHEAPER TO USE
BETTER QUALITY
GREATER VOLUME
LONGER LIFE**



EVER

**WIRELESS
DRY
BATTERIES**

READY

THE BATTERY YOU WILL ULTIMATELY USE

THE EVER READY CO. (Great Britain) Ltd. HERCULES PLACE HOLLOWAY, LONDON, N.7.

Mention of "Amateur Wireless" to Advertisers will Ensure Prompt Attention

LOOK FOR "EDDY" IN YOUR DEALER'S WINDOW

Full-sized constructional models (Battery or A.C. Mains) of the "Sunday Express" S.G.2 Radiogram, specifying Mazda Radio Valves, are obtainable at W. H. Smith's bookstalls and radio dealers, price 1/-



FACTS YOU SHOULD KNOW.. ABOUT THE MAZDA PENTODES



The output stage in portable battery-driven receivers has always presented a problem to the designer on account of the limited H.T. supply available.

THE MAZDA PEN 220 has solved this problem as, owing to its extreme sensitivity, ample volume can be obtained with only 4 M/a anode consumption. The Pen 220 has, in addition, rapidly gained favour in the case of standard battery-operated receivers where economical H.T. consumption is an important consideration.

THE PEN 220A is a high-power output pentode suitable for driving a large moving-coil speaker. It should be used in conjunction with an eliminator.

THE PEN 425 for receivers operating on anode voltages above 150.

THE AC/PEN, the finest all-mains power pentode, sensitive enough to operate a loud speaker direct from aerial input.

Full details of these and other useful Mazda types will be found in the Mazda catalogue, sent FREE on request.

Mazda valves are fitted by all the leading receiver manufacturers. All good radio dealers stock them.

The amazing

MAZDA THE BRITISH VALVES

EDISWAN RADIO
100% BRITISH—Designed by British Engineers

The Edison Swan Electric Co. Ltd

Mazda Radio Valves are manufactured for The British



155 Charing Cross Rd. London. W.C.2

Thomson-Houston Co. Ltd., London and Rugby.

V.167

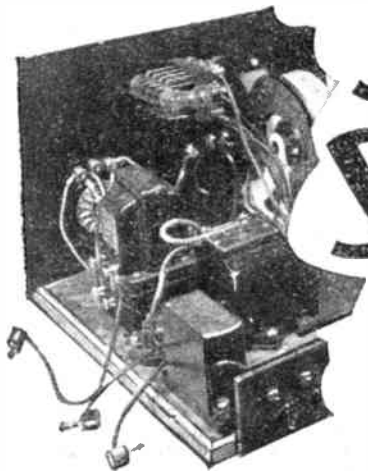

J.H. REYNER EXPLAINS SOME DEVELOPMENTS IN L.F. AMPLIFICATION

A Forecast of Some Interesting Possibilities
in Low-Frequency Amplification

IT is a long time since there was any marked change in the methods adopted for amplifying the low-frequency signals after the detector stage. In fact, one can say that the introduction of grid bias was the last really important development in this field. There have been numer-

ous changes in the form of the device used to couple one valve to the next, but all the systems hitherto employed operated on the common principle that the grid swing permissible ranged between the

point where the characteristic starts to curve at one side and the point where grid current begins to flow on the other. This latter point usually occurs round about zero grid bias (see Fig. 1); so that it has been the practice to apply negative grid bias to the valve of a value approximately half that at which the characteristic first begins to curve, and we operate over the straight-line portion of the characteristic and so obtain distortionless amplification.

A Matter of Grid Swing

This leaves all the characteristic to the right of the zero grid-bias line unused and imposes a serious limitation on the power output obtainable from a given valve. In general, the principles just outlined remain unaltered even in the case of the power valve which supplies the loud-speaker, and the output obtainable is very largely dependent on the grid swing which is possible without overshooting the two limits already stated. If we could, in some way, extend the characteristic so that without altering anything else we could put, say, 50 per cent. more grid swing into the valve we should obtain over twice the power output.

Attempts are now being made to do this. It is not practicable to run over the

curved portion of the characteristic, so that the direction in which attention has been turned is that of extending the swing on the positive side of the characteristic. This means that grid current flows during all or part of the time. So far we have regarded such a state of

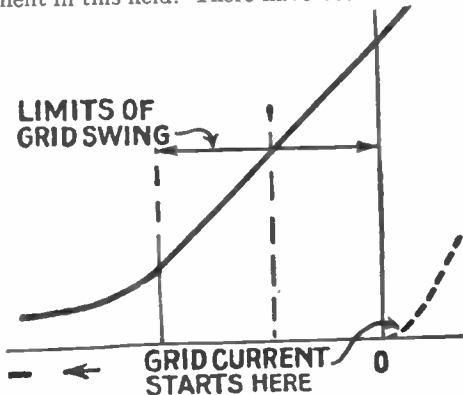

Fig. 1. Under normal operating conditions the grid voltage swings over the straight portion of the curve

ous changes in the form of the device used to couple one valve to the next, but all the systems hitherto employed operated on the common principle that the grid swing permissible ranged between the

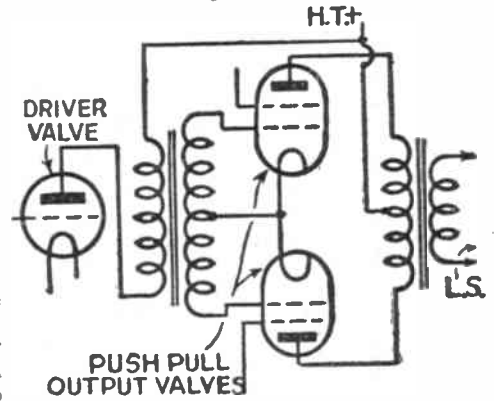

Fig. 2. Circuit of grid-current push-pull amplifier. The driver valve is designed to work as a power amplifier

affairs as one to be avoided at any cost, but it now appears likely that under proper control it may not prove such a bugbear as was anticipated.

Various methods are being tried out, most of which, unfortunately, require special valves, but I hope in future articles to give details of some experiments which can be carried out with existing valves under suitable operating conditions so that those who are interested can try the various effects for themselves. For the present, reference will be made to two systems either of which may be widely used in the future.

New Systems

The first of these is the triple-twin tube. This is a two-valve arrangement which is put on the market in the one bulb and behaves, as far as external connections are concerned, as if it were a single valve. The main part of this valve is an ordinary power valve normally operating with zero grid bias. A negative voltage applied to the grid causes the anode current to decrease in the normal manner and operates over what we term

(Continued on page 644)

GETTING BUSY AT MADRID



Some of the delegates in the Senate Palace at Madrid, where the big International Congress is taking up the time of 600 members from the leading European countries. The B.B.C. is represented by Sir Charles Carpendale Mr. Noel Ashbridge, and Mr. Hayes

PRACTICAL HINTS AND TIPS

Useful advice for set-builders and users. These hints and tips will enable you to get better results, and make for simpler and safer set-operation

FITTING A FUSE

IN a portable set there is sometimes a chance that the low-tension wiring may be pulled loose and a short circuit will result, which may burn the wiring insulation. The best prevention is a fuse fitted close up to the accumulator terminals. Many types of fuse for inter-lead connection are now on the market, but in emergencies a short length of thin fuse wire of the electric-light type can be

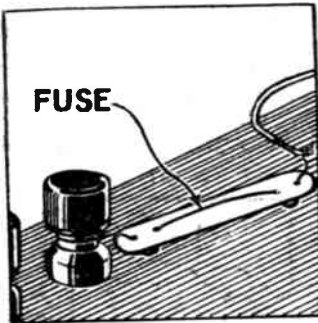

How to fit a fuse in a portable set

used and this should be connected quite close to one of the terminals.

EARTHING A TRANSFORMER

SOME transformers are shielded in a metal case but are not provided with an earthing terminal. To prevent spread of the magnetic field it is sometimes necessary to earth the base and core, and it is a good plan to scrape away a little of the insulation underneath the base of the transformer and to clamp it down on a wire (making good electrical contact), which can be connected to negative low-tension, thus earthing and stabilising the transformer. This can safely be done with low-frequency transformers, but is not a wise precaution with mains transformers as the casing may not be well insulated from the core.

A SHORT-WAVE COIL

IF you wind a short-wave aerial coil with a reaction winding on the same former you can in most cases easily convert your set to short-wave working. A piece of ribbed ebonite tubing should be used as the former and bare wire should be wound on it so that you can make the connections to the coil at suitable points. On a former of about 3 in. diameter wind on 15 or 20 turns of No. 24 bare copper wire and space the turns about 1/4 in. apart. Small nicks may be cut in

the ebonite ribs of the former to keep the turns in position. Brass clips known as "crocodile" clips should be used to take the tappings to the coils, but a rough test may be made by twisting the coil connections around the bare wire turns. The reaction winding should consist of 5-8 turns of wire and if the right number of turns is found for the local set conditions there is no need to have this winding tapped.

PARALLEL-FEED

IF you have a small transformer which is easily upset by the steady direct current of the anode circuit flowing through its windings, it can generally be made to give better results by putting it in a parallel-feed circuit. This is quite easily arranged. Leaving the secondary winding in its original position in the circuit, remove the primary winding connections and substitute a fixed resistance of 30,000 ohms. Connect one end of the primary winding to a 1-microfarad condenser connected on its other side to the join point of this fixed resistance and the high-frequency choke in the anode circuit. The other end of the primary winding is connected to earth through the negative low-tension wiring. When you scheme this out you will see that it is on similar lines to the arrangement of a choke output circuit, the secondary winding of the transformer being connected as usual to grid and grid bias.

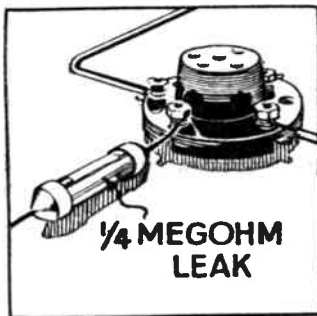

A good idea to prevent motor-boating—a leak in the low-frequency grid circuit

FITTING A LEAK

IF your set motor-boats, and gives rise to threshold howl, even though the detector stage is decoupled, try fitting a grid-leak of about 1/4-megohm in the wiring to the grid of the valve following the detector. The leak

should be put in series with the existing wire going to the grid terminal and not placed from grid to negative low-tension. This will stop high-frequency instability.

LABEL YOUR VALVES

VALVES have a long length of life nowadays but it is worth while keeping a record when each new valve is put into the set. The B.B.C. always does this. All the amplifiers in the control rooms have the valves ticketed with an indication of the tested emission when new and of the date of insertion. Stick a piece of stamp paper on your valves and make a note when each valve is bought.

ADDING COIL TURNS

SOMETIMES it is necessary to add a winding to a coil, as for example when an aperiodic winding is required to improve the selectivity. This is a tip worth noting. There is no need to scrap the coil or to move the main winding in order to get winding space for the additional turns. The winding can be put over the main turns, using covered wire kept away from the body of the coil with small strips of ebonite, or even pieces of matchwood if the wire is well insulated. In this way the selectivity of a coil can often be improved. Put an additional winding outside it of 15 or 20 turns of wire of not too thin a gauge. Connect one end of this additional winding to earth, remove the aerial lead from the

condenser chassis at a number of positions and which are variable in height. The sets of feet must match for otherwise there will be a constant strain on the chassis which will upset the ganging.

A WIRING HINT

A SIMPLE tip, but one which makes a great difference to the neatness and trouble-free nature of the wiring in a set; when baring flex or battery

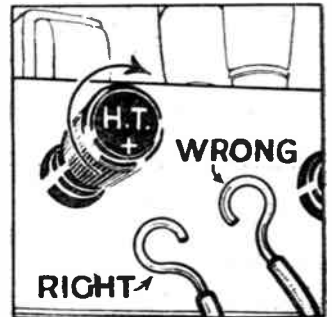

How do you wire up? The correct and incorrect methods of making a terminal connection are shown

connections, take care that only the rubber is cut and that the wire is not nicked; also when the wire ends have been bared, twist the strands tightly together and make a loop in a clockwise direction. If the loop is made in the other direction the strands will tend to unravel as the terminal head is tightened.

NOISY PIGTAILS!

NOISY tuning in a short-wave set can often be traced to the pigtail connection rubbing against some part of the condenser frame. When working down on 15 metres and thereabouts, the rubbing of the pigtail turns against themselves will sometimes even cause a scraping noise. Keep the pigtail connection as short as possible and spaced away from the condenser frame.

VARY THE H.T.

IT is important to vary the high-tension in a short-wave set to get smooth reaction. Smooth descension into oscillation is much more important in a short-wave set than it is on the long waves. Try altering the H.T. to the detector valve for you will probably find that this makes a great difference to reaction control. A lower H.T. value than normal for broadcast-band working is frequently an advantage as it enables smoother oscillation to be obtained at the risk of reducing the handling power of the detector.

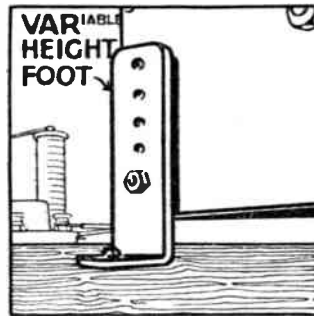

You should watch this point when fixing ganged condensers. The foot shown is adjustable for height

coil and take it to the other end of the added winding.

GANG CONDENSER MOUNTING

SOME ganging condensers are provided with L-section feet, which can be clamped on to the

YOU SHOULD BUILD THE "WIZARD"

Direct Radio

THE "WIZARD"

159 BORO HIGH STREET

	£	s.	d.
1 Ebonite panel, 14 in. by 7 in.	4	0	0
1 Baseboard, 14 in. by 9 in.	1	0	0
2 Readl-Rad .0005-mfd. solid dielectric variable condensers, "Minclog"	7	0	0
2 Readl-Rad S.M. disc drives	8	0	0
1 Lissen 2-gang shielded coil unit and combined filament switch...	17	6	0
1 Readl-Rad .0005-mfd. variable reaction condenser	2	6	0
3 T.C.C. fixed condensers—(2) 1 mfd. and (1) 2 mfd.	6	0	0
1 T.C.C. .0005-mfd. fixed condenser, type 8	1	3	0
2 T.C.C. .0002-mfd. fixed condensers, type 8	2	6	0
1 Dubiller 2-megohm grid leak with wire ends	1	0	0
1 Lewcos 30,900-ohm spaghetti	1	6	0
1 Wearite screened H.F. choke, H.F.P.	3	6	0
1 Readl-Rad standard H.F. choke	1	6	0
3 4-pin valve holders	1	6	0
1 R.I. resistance-fed transformer, Parafed	8	6	0
2 Terminal blocks, Aerial, Earth, L.S.+, L.S.—	1	0	0
1 Sovereign pre-set series aerial condenser, .00003-.00025 mfd.	1	3	0
1 Drilled ebonite strip, 3 in. by 2 in.	6	0	0
2 Belling Lee terminals, Pick-up... ..	5	0	0
1 Readl-Rad radiogram e/o switch	2	9	0
6 Belling Lee wander plugs: H.T.—	1	0	0
H.T.+1, H.T.+2, G.B.+1, G.B.—2	1	0	0
2 Belling Lee spade terminals: L.T.+1, L.T.—	6	0	0
6 Yards Lewcoflex, Glazite, shielded flexible tubing, screws, etc.	1	7	0
3 Mullard valves: PM12A, PM11H, PM2A	1	12	3
1 Special "159" cabinet	1	0	0
Total	£6	10	0



The special "159" Cabinet, in hand polished walnut

- Kit No. 1** (Less Valves and Cabinet) **£3 : 17 : 9**
 or 7/- down and 11 monthly payments of 7/-
- Kit No. 2** (With Valves less Cabinet) **£5 : 10 : 0**
 or 10/- down and 11 monthly payments of 10/-
- Kit No. 3** (With Valves and Cabinet) **£6 : 10 : 0**
 or 12/- down and 11 monthly payments of 12/-

ACCESSORIES

	£	s.	d.
1 Siemens 120-volt H.T. battery	15	6	0
1 Siemens 9-volt G.B. battery	1	0	0
1 Oldham 050 2-volt accumulator	9	0	0
1 Epoch Twentieth Century speaker	1	15	0
1 Atlas H.T. mains unit, A.C.244	2	19	6

	£	s.	d.
Mains Units			
Atlas A.C.244	2	19	6
H.T. only	2	19	6
Atlas A.K.260	4	10	0
H.T. and L.T.	4	10	0
Atlas D.C.15/25	1	19	6
H.T. only	1	19	6
Pick-up			
Bowyer-Lowe A.E.D. Mark III	1	10	0
Pick-up Volume Control			
Bowyer-Lowe A.E.D. log law	8	6	0
Moving-coil Speakers			
R. & A. "Ban-tam"	1	7	6
R. & A. "Chal-lenger"	1	15	0
R. & A. "Vic-tor"	3	10	0
All including input transformers. Our special "Soundex" Speaker Cabinet in polished veneered Walnut can be supplied at £1/5/0 extra.			
Gramo motor, Collaro spring type B.30			
£ 1 12 0			
Gramo motor, Collaro induction type			
£ 2 10 0			
Oldham H.T. accumulator, 120 volts 5,500 m.A. hour capacity, £4 10 0 , or 7/6 down and 11 monthly payments of 7/6.			

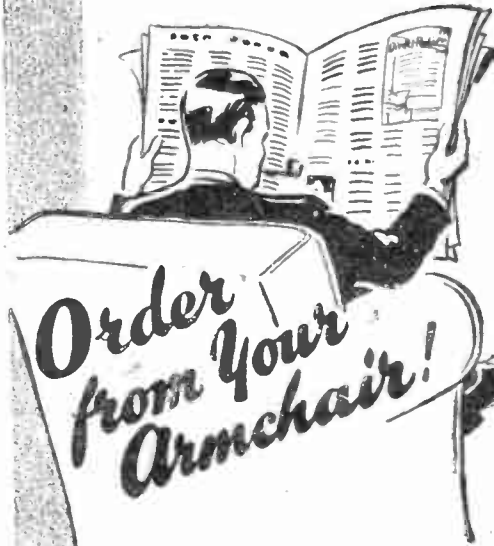

CASH, C.O.D. AND EASY PAYMENT ORDER FORM

To: Direct Radio, Ltd., 159 Borough High Street, London, S.E.1.

Please dispatch to me at once the following goods.....

for which (a) I enclose
 (b) I will pay on delivery { cross out line }
 (c) I enclose first deposit of { not applicable }

NAME

ADDRESS

A.W. 24/9 32

TO OVERSEAS CUSTOMERS. We specialise in Radio for Export. Goods to your exact specification are very carefully packed and insured, all charges forward. Terms: Cash with order, or deposit one-third with order, balance C.O.D.

FULL-SIZE PLAN

and

WIRING GUIDE

A Simple-to-build

Ultra-modern "Three"

Amateur Wireless

THE WIZARD

GRAMO-RADIO SWITCH

BLUEPRINT
NO A.W. 360

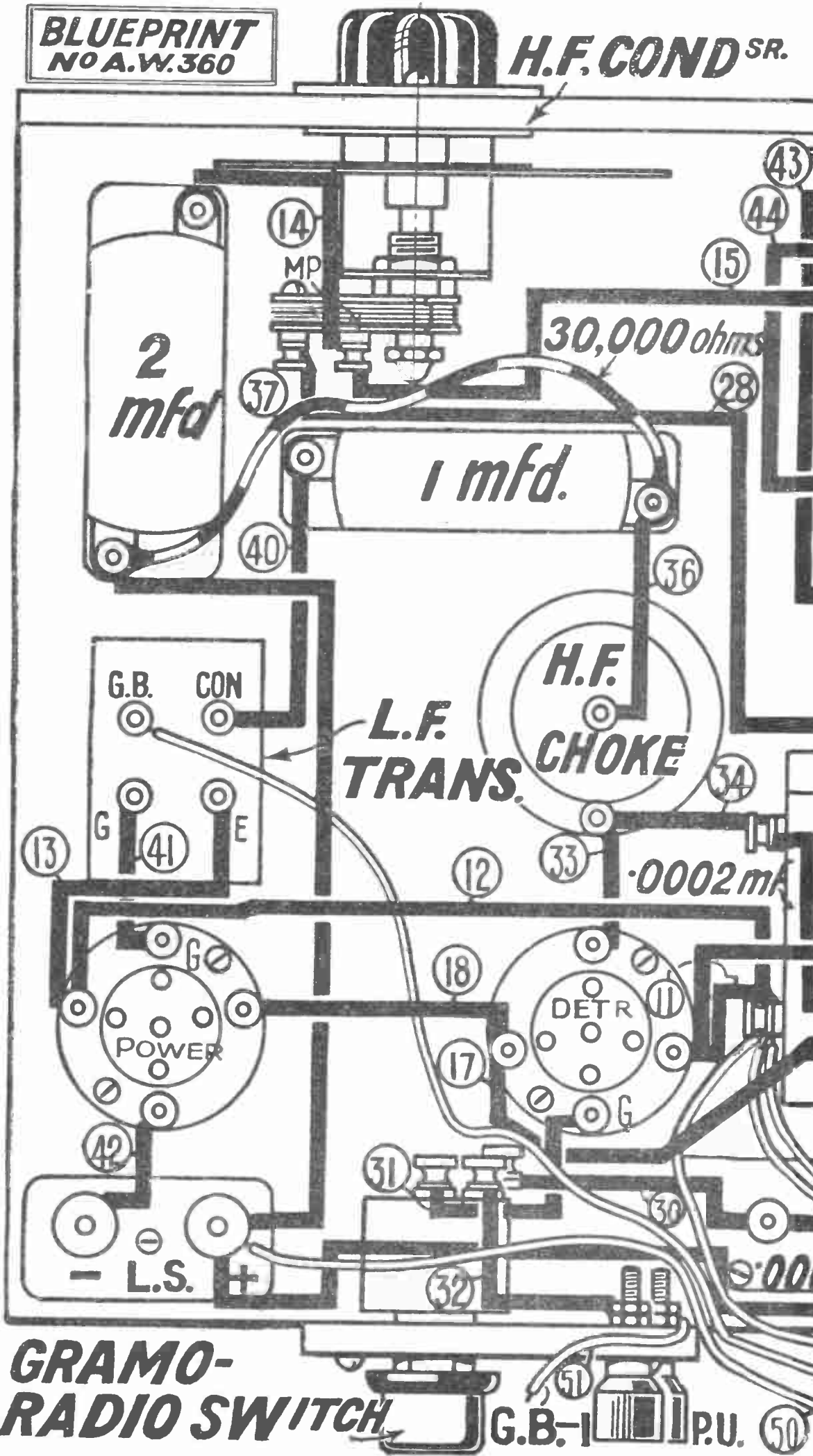

REACTION COND. AERIAL COND.

PANEL 14x7

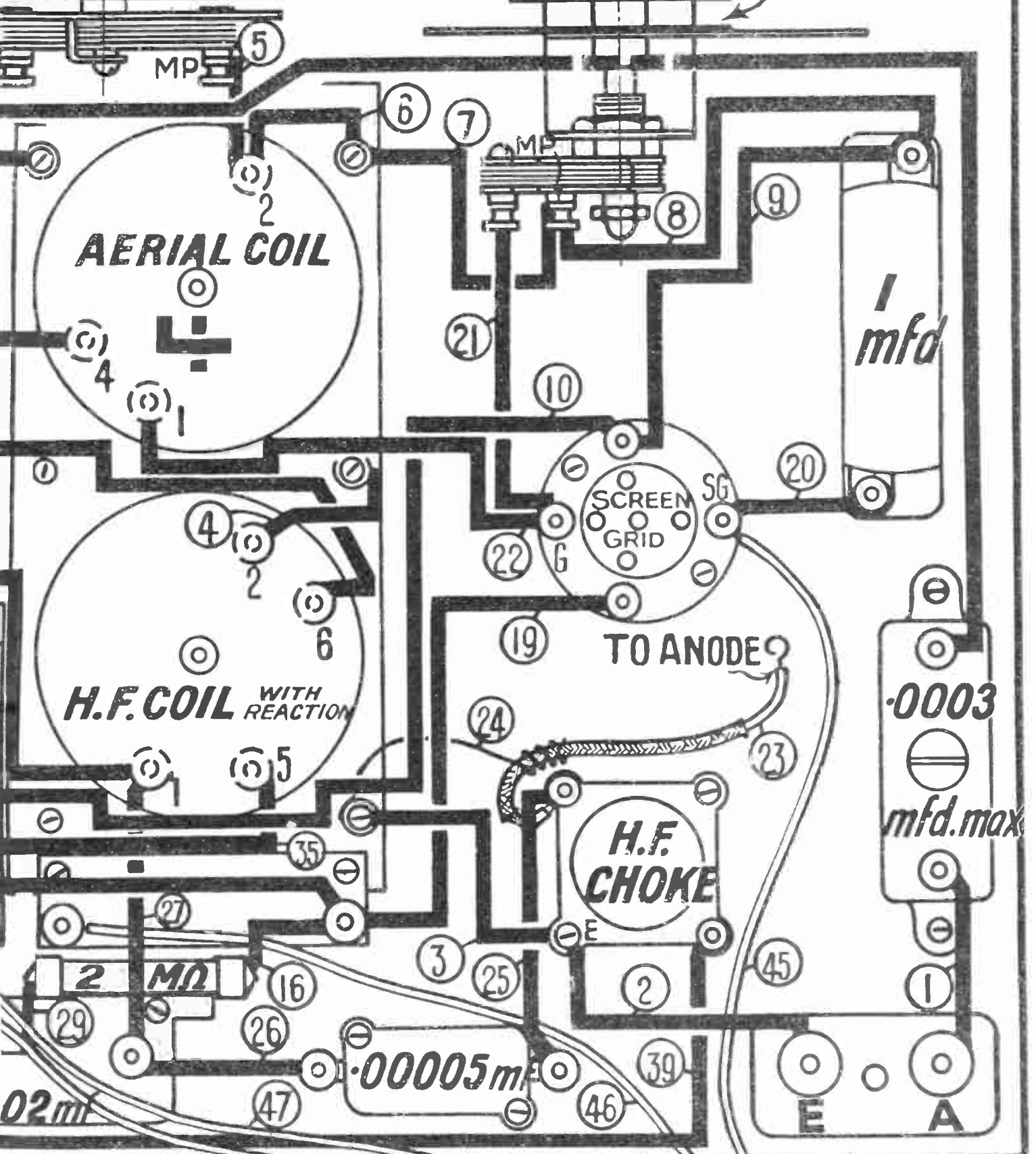

BASEBOARD 14"x9"

G.B.+ 52
 G.B.- 2 49
 L.T.- 48
 H.T.-
 H.T.+1
 H.T.+2
 L.T.+

WIZARD

Here is a full constructional description of the fine new "A.W." set which is the subject of the free full-size wiring plan in this issue. The "Wizard" is a three-valver with an amazing performance and can be built in a couple of hours.



undertake in the actual construction, the plotting out of the mounting centres on the baseboard and the marking for the holes in the panel.

If you prefer to work from one of the professional-type full-size actual blueprints, as produced in connection with every "A.W." receiver, then write for a blueprint of the "Wizard" set, enclosing a postal order for one shilling, to the Blueprint Department, AMATEUR WIRELESS, 58-61 Fetter Lane, London, E.C.4.

HOW TO USE THE FREE WIRING PLAN

The wiring plan should be put flat down on the plywood baseboard. Take some sharp tool, such as a bradawl, and prick through on to the wood the screw holes of each of the components shown. If one of the parts used is not of a make first specified in the components list, then the mounting centres may be different from those shown on the print.

Do not move the print while the holes are being marked through or you will find that some of the screw holes are out of true.

Now for a slightly more difficult job, the marking of the panel. The wiring plan or blueprint is again used to show the centres and the panel is marked on its reverse side, so that the marking lines do not show.

Put the print flat down on the back of the panel and for safety's sake temporarily attach it at each of the four corners with spots of adhesive. This will prevent it moving while you mark the centres. A small punch is best used for marking centres on the ebonite or the sharp point of a bradawl can be pushed through the paper against the ebonite. In either case take care not to crack the panel. Only light taps should be given on the punch to make a small indentation in the ebonite. On the baseboard it is sufficient to mark the centres with the point of the bradawl, but on the panel a more definite mark is needed not only to show the drilling centre, but to give the

point of the drill a start, so that it does not slip on the panel surface.

DRILLING THE PANEL

Holes need to be marked for the two condenser shafts, for the reaction condenser, for the wave-change switch, and for the three wood screws along the bottom edge of the panel. In addition there are the two windows to be cut for the tuning condenser scales.

Drill the condenser wave-change switch and screw holes with an ordinary brace and bit, drilling through from the reverse side of the panel to the front. *Put the panel on some sheets of newspaper so that it does not get scratched.*

There are two good ways of cutting the condenser-scale windows. The most professional way, of course, is with a fretsaw. An easier way for the man who is not adept with tools is to drill a number of small holes around the outline of each window and then lightly to tap out the centre piece of ebonite. The edges of the holes thus formed can be smoothed down with a file. Don't forget the two small holes on each window for the small bolts which hold the escutcheon plates in position.

When the holes are drilled, screw the panel firmly to the baseboard, making sure that they are at right angles.

HOW TO MOUNT THE PARTS

Everything is now in order for mounting all the components. The panel parts should be mounted first, and then, of the

**SEE THE TEST REPORT
ON PAGE 611
and be convinced of the real
worth of the "Wizard"**

baseboard components, the ganged coil assembly. Do not screw all the parts down firmly at this stage, for you must check up to see that you have components such as the valve holders and the low-frequency transformer the right way round. When you are satisfied that this is O.K., the parts should be screwed down, leaving only the one special wood screw of the screened high-frequency choke, for this screw clamps an earthing wire to the screen and cannot, therefore, be tightened down until the wiring is started.

The small ebonite strip carrying the gramophone switch and pick-up terminals is easily drilled and the switch and two terminals should be mounted on it. Do not screw the strip to the back of the



THE SIMPLE - TO - BUILD MODERN THREE (Continued from preceding page)

baseboard, though, until some of the wiring to the switch has been done, otherwise you will find it awkward to manipulate the pliers.

The coil unit it will be noted, is mounted on a strip of plywood, so that it is raised higher from the baseboard and leaves more room for the operation of the wave-change knob.

WIRING UP

Many listeners may have previously fought shy of making a wireless set because they have believed that the wiring is difficult. This is true of some complicated sets, but the "Wizard" is as simple as A B C.

As there is no soldering, the whole job of wiring can be done with a pair of pliers. The leads are best made with bare copper wire enclosed in insulated sleeving. This is a trifle easier to carry out than wiring with insulated wire, the ends of the insulation having to be removed in order to make terminal connections.

Use the blueprint as your guide and cut each length of the bare copper wire to run conveniently from point to point. About half an inch should be allowed at each end to make the looped connection underneath the terminal head. Cut each length of the insulated sleeving to the exact length required to run from terminal to terminal.

When putting each lead in place, loop one end under the terminal and clamp it down. Slip on the insulated covering and then make the second looped connection. One or two wires in the "Wizard" are so short that no insulated covering is needed. Terminal 2 of the coil nearer the panel is taken to one of the fixing screws, thus earthing it. The grid leak (one end of which

COMPONENTS FOR THE "WIZARD"

EBONITE
 1—Ebonite panel, 14 by 7 in. (Lissen, Becol, Goltone, Peto-Scott).
 2—Terminal blocks, marked Aerial, Earth, L.S.+, L.S.— (Lissen).
 1—Ebonite strip, 3 by 2 in. (Becol, Goltone, Peto-Scott, Lissen).

CONDENSERS, VARIABLE
 2—.0005-mfd. solid dielectric (Ready Radio "Micalog," Lissen, Telsen, Peto-Scott, Polar, Utility).
 1—.0005-mfd. variable reaction (Lissen, Ready Radio, Telsen, Peto-Scott, Polar, Utility).
 1—Pre-set series aerial condenser, .00003 mfd. to .00025 mfd. (Sovereign, Lissen, Telsen, Formo, Igranic, Goltone).

COIL
 1—Two-gang shielded coil unit and combined filament switch (Lissen).

CONDENSERS, FIXED
 2—1-mfd. (Telsen, Lissen, Dubilier, Igranic, T.C.C., Formo).
 1—2-mfd. (Telsen, Lissen, Dubilier, Igranic, T.C.C., Formo).
 1—.00005-mfd. (Dubilier, type 670; T.C.C., Ormond, Formo).
 2—.0002-mfd. (Lissen, Telsen, T.C.C., Dubilier, Goltone, Formo, Sovereign).

CHOKES, HIGH-FREQUENCY
 1—Screened high-frequency choke (Wearite, Bulgin).
 1—Standard high-frequency choke (Slektun, Lissen, Tunewell, Telsen, Wearite, Goltone, Igranic, Varley, Climax, Sovereign, Watmel, Ready Radio).

RESISTANCES, FIXED
 1—2-megohm grid leak with wire ends (Dubilier, Lissen, Igranic).
 1—30,000-ohm spaghetti resistance (Tunewell, Lewcos, Ready Radio, Lissen, Varley, Goltone, Bulgin, Sovereign, Telsen, Igranic).

HOLDERS, VALVE
 3—Four-pin valve holders (W.B., Lissen, Lotus, Telsen, Junit, Benjamin, Clix, Wearite).

TRANSFORMER, LOW-FREQUENCY
 1—Resistance-fed transformer (Bulgin "Scuator" R.1., Igranic "Parvo," Varley).

SWITCH
 1—Radiogram change-over switch (Ready Radio, Bulgin, Tunewell).

SUNDRIES
 1—Baseboard, 14 by 9 in. (Peto-Scott, Camco).
 2—Slow-motion disc drives (Ready Radio, Lissen, Utility, Lotus, Telsen, J.B.).
 6—Wander plugs, marked H.T.—, H.T.+1, H.T.+2 G.B.+1, G.B.—1, G.B.—2 (Belling-Lee, Clix, Ealex).
 2—Spade terminals, marked L.T.+1, L.T.— (Belling-Lee, Clix, Ealex).
 2—Terminals, marked Pick-up (2) (Belling-Lee, Clix, Ealex).
 Six yards thin flex (Lewcoflex).
 Connecting wire and sleeving (Lewcos).
 Length of shielded flexible tubing (Goltone, Lewcos).

ACCESSORIES

BATTERIES
 1—120-volt high-tension (Lissen, Pertrix, D Oldham, Ever Ready).
 1—9-volt grid-bias (Lissen, Pertrix).
 1—2-volt accumulator (Lissen, Exids, C.A.V. hau).

CABINET
 1—Special cabinet (Peto-Scott).

LOUD-SPEAKER
 1—Motor "York," Blue Spot, R. & A., Lanc Epoch.

MAINS H.T. UNIT
 1—Atlas, A.C. 244; Ekco; Tunewell H.R. 1 Regentone, Lissen, Clinax.

you will see is connected to the switch on the end of the coil chassis) is also supported in the set by the two short wires, which are ready soldered to the caps of the leak.

The major part of the set wiring is done with the bare wire in the insulated sleeving, but the battery flexes for high tension, low tension, and grid bias also form part of the

set wiring and are taken direct from the various terminals. These battery flexes are clearly seen from the wiring plan. They can be of any convenient length to join up the set with the batteries or mains eliminator and should not be twisted together until the connections have been properly made and until wander plugs and spade tags have been attached.

There is one spaghetti resistance in the "Wizard," and this is connected directly between the terminals shown on the wiring plan. The spaghetti resistance is fitted with spade tags, so that it clamps easily underneath the terminals.

Take particular note of the lead going to the top terminal of the screen-grid valve. It is of metal-sheathed wire, and a thin wire is twisted round this sheathing and connected to the coil base.

When the wires have been connected to the gram-radio switch and the two pick-up terminals, the small ebonite strip carrying these parts can be screwed at right angles to the baseboard.

Under some of the terminals more than one wire is clamped. Be sure to see that all of them make good contact and that the wire does not loop out from underneath the terminal as the head is tightened down.

The last stage in getting your "Wizard" ready to work is checking. It is impossible to over-emphasize the importance of making sure that each lead is in its right place. A wrongly connected wire may mean burnt-out wires and quickly run-down batteries. A few minutes spent in comparing your set with the wiring plan may save you a great deal of expense and worry.

In next week's issue a special illustrated article will describe the operation of the "Wizard" and will give you many practical hints and tips on bringing in the stations.

ALL THE GOOD POINTS A SIMPLE SET SHOULD HAVE

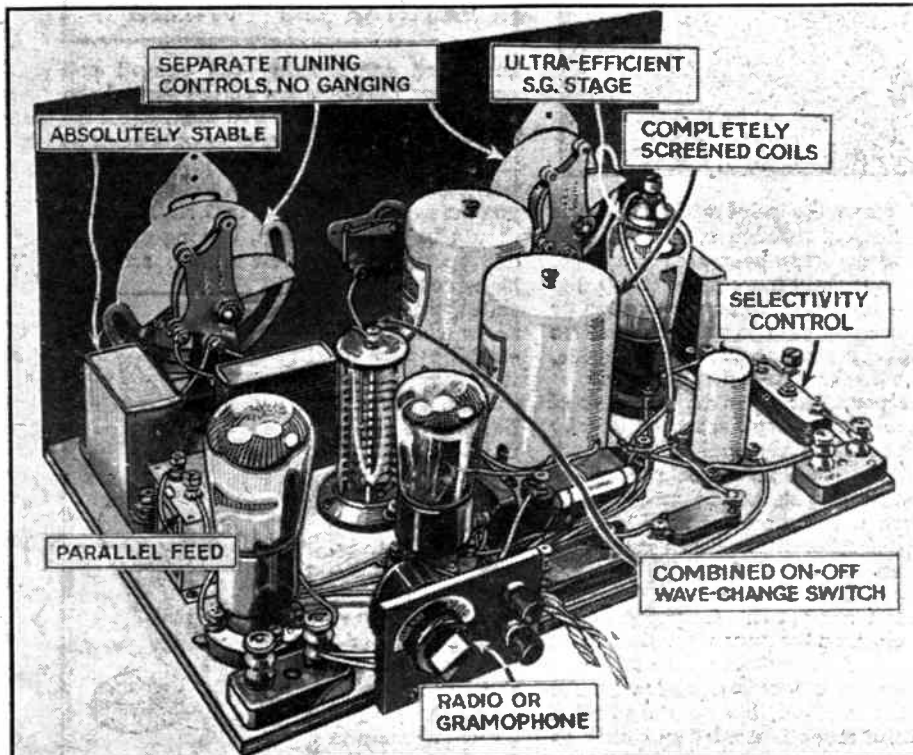

A test report of the "Wizard" appears on page 611. If your set will not put up a performance equally as good, then you should build this

OUR BROADCAST CRITIC

ON A POOR SHOW



EVELYN SCOTNEY,
who made such a success of Delibes Bell Song

HIL-AIR-ITY. That is what they called it in the programme, but nothing was said about *our* being hilarious as a result of it. Personally, I was almost reduced to tears. I was intensely sorry for those who took part in that show because they must have been under the impression that it was a good show. It was a very bad show, but not altogether the fault of those who played in it. *The material was not there.* One line—I noticed many of the kind—was a statement that “an extra large depression had arrived from Iceland by parcel post.”

It seems to me that unless the book and lyrics of this type of show are really brilliant it is just as well to engage a number of artistes and let them do what they like. The result would be much more satisfactory, even if it only amounted to a kind of vaudeville. I think the idea of varying vaudeville is so good that I am doubly disappointed when I hear a transmission of this nature with no sense in it from beginning to end.

I noted that the music was by Billy Mayerl. I only hope his admirers enjoyed his part of the business. I thought his imitation of a cinema organ on the piano very poor. It was nothing like a cinema organ. But then—what is, except another cinema organ? Why try to imitate one?

The Bach Prom.

The Bach concert seems to have been a record in attendance, hundreds being turned away. There were two thousand people standing in the Prom. that night. Popular fellow, Bach!

In some respects it was an outstanding concert, even unique. I do not remember seeing five pianists sit down to play at one concert before. I wonder what Bach himself would have thought had he been suddenly transported into Queen's Hall last Wednesday. I think he might well have been proud of his audience and the reception his music received. If he had thought of the tiny clavichords for which he wrote his concertos, and then looked at the three enormous grands on the platform he might have been forgiven had he remarked that he wrote for three *pianos*, not *pantechonics*.

Those concertos made fine broadcasting. Bach's lucid way of dealing with two or three pianos just marks the difference between music properly written for the instruments and the rubbish for two pianos often played in the vaudeville programmes.

The one blemish in the programme that night was the slow speed at which Maria Basilides sang the *Agnus Dei* from the Mass. It is admittedly a slow aria, but the rhythm is on the crotchets; she made it on the

quavers and converted the song into a very funereal affair.

I hope you heard Val Gielgud's *Exiles*. Unfortunately I could not hear it, but I am told it was a great play.

Evelyn Scotney scored a great success in the “Bell Song” of Delibes in the Saturday night Prom. Her high C sharp was a wonderful note. I was surprised that the audience was not more enthusiastic about her.

It would be interesting to know how many sets were switched off during “Nights in the Gardens of Spain,” played by Harriet Cohen (piano) with the orchestra. A work not worth playing, in my opinion. I have rarely heard any of de Falla's works and liked them, but that was one I found very distasteful. I thought the piano sounded rather silly, to be quite candid. If those

are the sort of nights they have in gardens in Spain I think I shall stay in my own.

I listened to Strauss' *Don Juan* with increasing pleasure—every bar. I remember that work when it was first played in England many years ago. I also remember I thought myself very modern—and therefore superior—because I liked it on first hearing, but the criticisms at the time were very hot. Yet, as I listened to it last Saturday, I wondered why I ever thought it modern at all. That just shows how we have become accustomed to dissonances. At all events, Sir Henry brought the house down with it.

Dr. Alcock gave an organ recital from Queen's Hall on Sunday morning. I do not think the Queen's Hall organ particularly good for solo purposes, but I enjoyed his clear phrasing and refined way of playing.

The sonata recital (violin and piano) by Licco Amar and Philip Jarnach was a bit dull. They chose the wrong works. They finished with the dullest chamber work Schubert ever wrote. No amount of pleasing tone will ever make up for a dull programme. It is exactly the same thing as writing dull libretti and lyrics for a light show. No comedian will ever pull a show together if the lines he has to deliver are weak. These chamber music recitals *should* be acceptable to many listeners if only on the grounds that they transmit so well. Chamber music is going to be served a bad turn every time artistes choose dull works. Cut off from seeing the players—which is really a large percentage of the enjoyment—we are left very high and dry when what we hear seems bereft of inspiration.

The 5.30 recital on Sunday afternoon by Arthur Cranmer proved the point I have just tried to make. He chose the right material, but I still quarrel with singers who persist in singing Schubert in German. Why not make good translations for broadcasting purposes? At a recital in Wigmore Hall (where one has only to study a few enthusiasts), to sing in German is all very well; but broadcasting is too general. I am sure that English is best for romantic songs of the classical period.

Incidentally, I never heard any section of the B.B.C. Orchestra play more out of tune than they did through the whole of this particular concert. The intonation during the Rameau suite was a disgrace to the B.B.C. The sooner it is realised that some of us have ears, the better.

WHITAKER-WILSON.

PROGRAMME POINTERS

There have been too many “shows” recently of which the actual matter has been distinctly poor. I have already pointed to one this week. Surely something ought to be done about the quality of libretti, of what is evidently intended to amuse and to entertain in a light manner? The same thing applies to the lyrics of light songs often broadcast in vaudeville. Light songs have a proper place in broadcast programmes. It would be hard on a good many listeners were they excluded, but there must be some sort of standard set with regard to the words. I have listened to far too many songs recently whose words are sheer rubbish, an insult to any intelligent person. Can there not be a committee at Broadcasting House specially for this sort of thing? Somebody is allowing anything to pass, no matter how insensate. Unless something definite is done before long the lighter side of broadcasting will come into disrepute. That would be serious because it seems to be a fact that the greater part of the total revenue from licences accrues from subscriptions from those who look to the programmes as a light entertainment only. The whole aspect of light broadcasting needs tightening up. Whoever is responsible for these songs and libretti going through as they are is evidently not awake to facts

TUNING A SHORT-WAVE RECEIVER

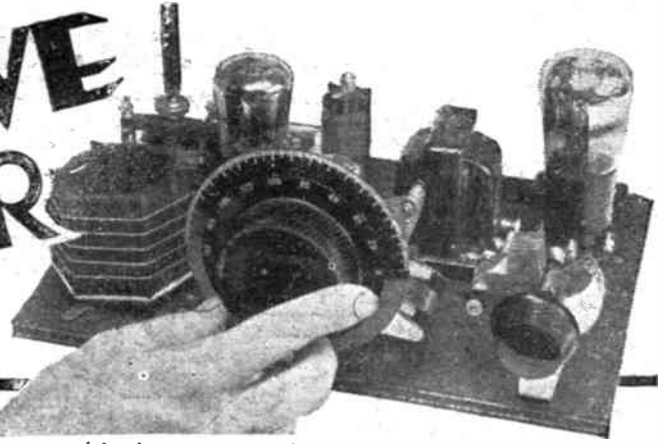

Although with a really good receiver, tuning on short waves need be by no means difficult, to some extent short-wave tuning is an art to be acquired only by sufficient practice, helped along by plenty of patience. Helpful hints are given here by MANDER BARNETT

AFTER having acquired a short-wave receiving outfit, whether this may consist of a complete receiver or merely a short-wave adaptor or convertor, the first thing that the newcomer to the short waves will learn is that the actual tuning of a short-wave receiver differs in many respects from that of a normal broadcast receiver.

The greatest mistake which many beginners appear to make is that they believe that all they have to do is to turn the receiver or adaptor dial in a similar manner to that of the broadcast receiver, then manipulate the volume control and in comes Pittsburgh, or something like that.

Many beginners have probably found that after even several hours' trial of a short-wave receiver they have heard nothing probably more than a few ear-

splitting code telegraph stations, which naturally enough convey no meaning at all to them, and thus they gain their first—and perhaps last—impression of short-wave work in general. Not a very helpful one, certainly, but one which is probably fifty per cent. their own fault. Let us state then, that tuning a short-wave receiver is a vastly different procedure to that of tuning a medium- or long-wave receiver.

First Impressions

The first impression which the beginner will probably gain is the fact that tuning on the short waves appears to be abnormally sharp and this sharpness of tuning is often mistaken for that factor which is known as "selectivity" in a normal broadcast receiver. This is quite wrong, for the average short-wave receiver of to-day is a notoriously unselective affair, although at first glance this might certainly seem otherwise.

Where there are a number of stations working comparatively closely together on the short waveband, we may find a number of these stations coming in within a few degrees on the dial. For instance, take the cluster of stations operating between 30 and 32 metres, or taken more practically, between Madrid EAQ on 30.4 metres and Rabat on 32.26 metres. These two stations will come in on the dial within only a few degrees and the tuning of each single carrier will appear to be exceedingly sharp. Between these two stations, however, we have a frequency separation of 569 kilo-cycles! Supposing we were to operate a number of new stations here and separate them by our minimum frequency

separation of 6 kilocycles, which we use to-day in our normal tuning bands, there would be room for no less than sixty-three stations between 30.4 and 32.26 metres! And if you have had any experience at all of a short-wave receiver you may be well sure that you could not, with our present-day standard of selectivity, tune in all these stations without mutual interference! When referring to selectivity, then, we have to think more in terms of frequency, or kilocycles, than in metres, or wavelength, as the respective characteristics vary in each separate set of wavebands which we have in use to-day.

A Large Frequency Separation

In view of these considerations, therefore, the short-wave listeners of to-day should be thankful that the short-wave stations now in existence are still able to keep to such a large frequency separation. What will happen when further short-wave stations arrive, remains to be seen, but we shall certainly have to devote more thought to short-wave selectivity.

Now for some practical considerations of what the above remarks hold for us in our short-wave receiver. Tuning undoubtedly is sharp and we keep our condenser capacity as low as is practicable—generally using a capacity of .00025 microfarad—exactly half of that used for the average broadcast receiver. This isn't really anything like low enough for sensible tuning, but we have to use this figure in order to avoid further coil complications.

Tune Slowly

See, therefore, that your receiver is equipped with a really good vernier dial, the higher the ratio the better, and acquire the habit right at once of tuning this dial, extremely slowly. It is quite possible entirely to miss a whole station by turning the dial too quickly.

Another bugbear with which we have to contend to-day is that in many short-wave receivers the reaction control itself has a very large effect on tuning. You tune a carrier in on the main dial, then adjust the reaction condenser to bring it nearer the edge of oscillation and phwit! the carrier has gone. Therefore, it is now necessary to again adjust the main dial until the carrier is once more in tune and to keep up this process until the edge of oscillation is

(Continued on page 652)

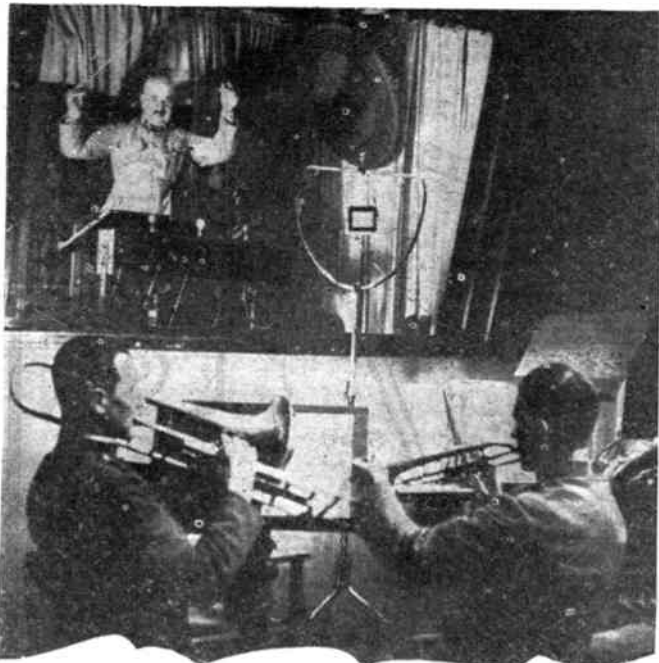

Radio Budapest is trying a new way of broadcasting orchestral concerts, in which the conductor is in a soundproof asbestos-lined cabinet. He hears the orchestra's playing through a pilot loud-speaker. Signal lights are used so that the conductor can give orders. It is claimed that in this way the conductor can judge the playing in the same way as wireless listeners



HOW STUDIO
SOUNDS ARE
PRODUCED

The wind is rustling the tree-tops!

What wonderfully expressive things are trees—their swaying branches, their rustling leaves make Nature's music in accompaniment of Nature's moods . . . and yet the Effects Studio produces all the characteristic sounds of gale force wind or gentle zephyr breeze by merely rustling torn pieces of paper in a bowler hat. The result is realism itself. . . . Realism too that you can retain in your reproduction by using the pure power of the Lissen High Tension Battery in your set. There is a process used *exclusively* in this Lissen Battery which produces power of remarkable purity; power so sustained that over prolonged periods of time it remains steady, noiseless and abundant always. Every radio dealer sells the Lissen High Tension Battery; ask for it firmly by name.

LISSEN H.T. BATTERY

lasts longest and provides a pure high tension current
that will give stage realism to your radio drama!

You will Help Yourself and Help Us by Mentioning "A.W." to Advertisers



The ATLAS A.C.2.

SETS OF THE SEASON

WHAT more do you want for local-station reception than a two-valver? Even if you want an occasional tour round the chief Continental stations the well-designed "two" of to-day will still serve quite well, especially if you are prepared to make critical adjustments with the reaction knob.

Here, then, is just the set for local reception—the "Atlas Two-valver," with a built-in moving-coil giving pleasing quality. I have just tried out the A.C. model and can recommend it as being a bright little set at a reasonable price.

THE ATLAS A.C.2 IN BRIEF

Makers.—H. Clarke & Co. (Manchester), Ltd.

Circuit.—Power-grid detector (Cossor 41MH), coupled by the parallel-feed transformer system to a power output valve (Cossor 41MP), which is connected to the energised moving-coil through an output transformer. Metal rectification for the mains.

Controls.—Four: Tuning, operating condenser and pointer over large fixed scale; wave-change switch for medium and long; reaction control; and, at the back, a mains on-off switch.

Type.—Table set in attractive walnut cabinet, containing set, power pack, and moving-coil speaker.

External Connections.—Extra loud-speaker sockets, pick-up sockets, mains-aerial connection, and mains plug for wall or lamp fitting.

Remarks.—A bright little two-valver for pleasing reproduction of the local stations.

There are many little points about this set that will please the amateur who "knows his stuff." The tuning coil, for example, comprises a large solenoid for the medium waves, and it is wound with stranded wire. A real low-loss looking coil—which on test shows just how much we are losing with the modern screened coil as used in the big sets.

I ought to add, in fairness to other designers, that only in the two-valver, with its single tuning circuit, can we make use of really low-loss coils, because the large field produced by a massive winding, while of no great consequence in a small set, would cause untold trouble in a set having several tuning circuits.

Next I was struck with the metal rectifier used for converting the A.C. mains

supply into D.C. for the anodes of the detector and power valves. I can assure you that there is no mains hum with this set, as the smoothing after the metal rectifier is more than adequate.

A Straightforward Circuit

The two-valve circuit is quite straightforward. The low-loss tuning circuit precedes a power-grid detector, with a .0001-microfarad grid condenser and a .25-megohm grid leak. The detector is paralleled to the power valve. Which means that the anode current passes through a resistance and not through the primary of the transformer.

The filaments of both valves are heated by 4-volt A.C. obtained from the mains transformer, an artificial centre tap on a small secondary winding being obtained with a resistance. Bias is obtained for the power valve as part of the high-tension output from the metal rectifier and not with a cathode resistance as is normally employed.

The moving coil is also fed from the metal rectifier, and is both sensitive and excellent in frequency response. It has an incorporated output transformer, which tests prove matches up extremely well with the power valve.

On test my impressions were immediately favourable, especially in regard to the amount of undistorted output that could be obtained. I was frankly amazed to find that in so small a cabinet there was absolutely no "boom." The tone is a pleasant change

from the "woofy" quality that we hear so often, even in quite expensive sets these days.

There appears to be more high-note reproduction than usual, giving an exceptional clarity to speech and a brilliant incisiveness to the music that more than compensates for the inevitable heterodynes heard on some of the foreign stations. You cannot have it all ways!

Simple Operation

Operation is just as simple as you would expect. I will say that reaction is as smooth as I should make it myself! And don't forget this: smooth reaction means sensitivity on foreign stations; which I certainly got.

London National at 25 degrees on the wide and easy-to-read tuning scale and London Regional at 45 degrees were absolutely clear of interference. On long waves Radio Paris came in at quite good strength, as did Hilversum. Naturally, Daventry was very strong. The two aerial terminals provide a choice of coupling to suit most aerial lengths.

On the mains-aerial connection, at twenty miles from Brookmans Park, I got both London stations at good strength. There was no appreciable increase in mains hum, but I found the earth essential.

There is enough power in reserve, thanks to the good tuning coil and the efficient reaction, to justify the use of an indoor aerial with this set. High praise indeed!

SET TESTER.

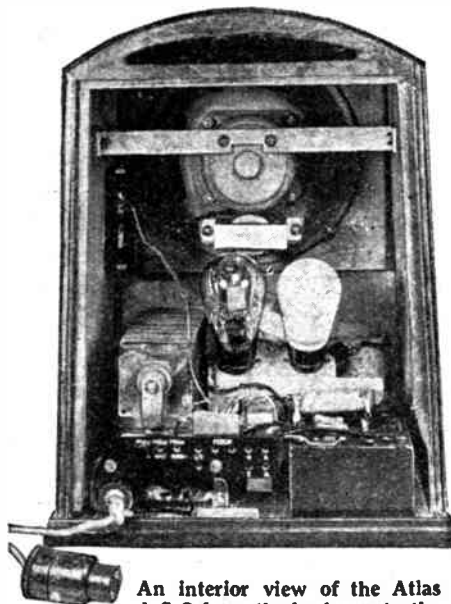

An interior view of the Atlas A.C.2 from the back: note the rectifier unit on the left and the ample spacing of the components and speaker

Those Four Chaps—Bobbie Comber, Paul England, Claude Hulbert, and Arthur Clay—will be heard in a National vaudeville programme on September 27.

A repetition of "Great Grandfather's Song Book," a collection of popular songs of 1770, will be heard by Midland Regional listeners on October 3.

A play, "Full Tide," will be broadcast from Birmingham studios on October 5 with Gladys Joiner and Herbert Lees among the artistes.

The first performance in Birmingham of Vaughan Williams' Ballet Music "Job," will be a feature of the first Symphony Concert of the season to be given by the City of Birmingham Orchestra on October 6.

Muriel Richardson will give a pianoforte recital in the Leeds studio on September 26.

The two young musicians, who spent the summer wandering about the South with a piano, a barrow and a donkey, will be the artistes at the second Manchester Tuesday Mid-day Society's concert on September 27.

The 2 Gang Coil for the A.W. WIZARD

INCORPORATING
WAVECHANGE
AND FILAMENT
SWITCHES



LISSEN SHIELDED

DUAL RANGE COILS

LISSEN SHIELDED COILS

3 GANG 26¹/₂ COILS

SINGLE 66¹/₂ EACH COILS

You are going to use a Lissen 2-gang Shielded Coil Unit in your "A.W." "Wizard"! It is a simple set to build—because of these Lissen Coils. It is an easy set to handle—because of the perfect matching of these Lissen Coils. Its advanced yet simplified circuit design is made possible only by the Lissen Coils. Its high selectivity depends upon them, its attractive appearance even is enhanced by the combined wave-change and filament switch incorporated in this Lissen 2-gang Coil Unit.

Break-through on the long wave-band is almost entirely eliminated. Damping losses are exceptionally low. Shielding is particularly complete. All Lissen Shielded Coils are matched in inductance to within 1 per cent. Price of 2-gang Coil Unit complete with inbuilt wave-change and filament switches

17¹/₆



What Our Readers Think

The Editor does not necessarily agree with the views expressed by readers and does not accept responsibility for the letters published. Letters cannot be published which do not bear the sender's full name and address.

An "Amateur Wireless" Lead

SIR,—To my mind, the most outstanding feature of the Radio Show was the number of super-hets shown, proving that AMATEUR WIRELESS was on the right track when it startled British listeners with the achievement of Mr. James' "Century" and other super-hets. The next most important feature is the wholesale adoption of the multi-mu valve and here, I presume, we must give the Americans their due, because it is their invention.

"Thermion" is tilting a broken lance at them when he keeps on about the inclusion of the rectifying valve in the number of a set's valves, because most of the British manufacturers have copied that reprehensible habit too. But for "Thermion's" agitation in your columns, I am afraid the British valve makers would have been still slower in adopting the multi-mu. Now, he might use his powerful pen in inducing them to make a multi-mu pentode, so as to save Mr. James one valve in the I.F. stage of the next super-het—which I for one am ready for—otherwise, in spite of "Thermion's" warning, I shall have to buy a British-built four- (or shall we say five-) valve super-het with American multi-mu pentode in the first stage.

My experience with British components is very much like "Thermion's" with that American set. Out of one kit I recently had to return faulty:

1. Tuning condenser and S.M. dial,
2. L.F. transformer,
3. Valve socket,
4. Fixed condenser,

which did not leave much of the kit on my bench to get on with, and that in spite of the multiple tests the firm in question claim to pass their components to in the various stages of manufacture. True, the parts were all in rotation replaced, with profound apologies, but it only goes to show that radio manufacturers in this country are in as great a hurry to make money as their colleagues across the pond.

T. M. B. (London, W.1).

The Editor invites letters from readers on all interesting radio subjects. For the most interesting letter published each week a general-purpose valve or other component to the same value will be given

The Loud-speaker Nuisance

SIR,—In a recent issue of AMATEUR WIRELESS reference was made to the action of the St. Pancras Borough Council in making it an offence against the housing estate regulations to operate a loud-speaker after 11 p.m., and the writer of the paragraph holds the opinion that the Council is making an attempt to interfere with the rights of listeners.

May I be allowed to raise a point which appears to have been overlooked? The housing estate is presumably for the benefit of working-class tenants, and there are numbers who are compelled by force of circumstance to rise in the early hours, no doubt, and the Council, by its action, is merely safeguarding the resting hours of such tenants. Consequently, instead of the Council's action being depreciated, it should be applauded.

Anyone who has had experience of a loud-speaker disseminating distorted dance music until the early hours of the morning can appreciate the point. Sleep under such

circumstances is well nigh impossible for adults and out of the question for children; I have had sufficient experience of neighbours' receivers to speak with authority.

Furthermore, I venture to offer a suggestion which may well be adopted with advantage by the loud-speaker fiends. It is this: If you must listen after 11 or 12 at night, cut out the speaker and put 'phones into circuit, they cost very little and by so doing the neighbours are considered and no one can, therefore, raise any objection. I might add that this practice is invariably adopted by myself.

E. C. (Hounslow).

Super-het Design

SIR,—Of late I have been experimenting with a super-het circuit which has not such refinements as the factory-matched oscillator and I.F.T.'s which figure in the excellent designs based on this circuit. A few points, practical and theoretical, which arose, may be of interest to you.

I am using a detector-oscillator arrangement based on the Autodyne system. (This is, apparently, against your principles, by the way, as the only "super" you have ever published without a separate oscillator valve was the "W.M." "Home Super.") The oscillator unit is one-wave, consisting of two plug-in coils, one being connected in the anode circuit of the "mixer." This reaction coil was wound generously, and the coupling between it and the grid coil varied by rotating the former on one screw until most satisfactory reaction was obtained. The I.F.T. coils are actually 300 turns of 36 d.s.c. on a 1½-in. former—this, with a .001 semi-variable, tuning to about 2,000 metres. I considered that 150 kilocycles was a satisfactory intermediate frequency, although 126 kilocycles was more usual; and this for the following reason, one which I have never seen exploited in favour of a longer I.F.

With a very low I.F. of, say, 50 kilocycles, consider the settings of the aerial and oscillator condensers for any stations—take Midland Regional on 398.9. This is a frequency of 752 kilocycles. The oscillator reading will, therefore, be 752+50 kilocycles. Taking it as 752+50, this is equal to 802 kilocycles. Interpreted in metres, this is approximately 375 metres. Now, unless the aerial circuit is exceptionally selective, the local oscillations will "bridge" that small frequency gap and cause the aerial to radiate, causing interference. But with an I.F. of nearly three times that, the oscillations are proportionately prevented from radiating, so that, although less amplification is obtainable on the lower frequency, the higher permits of the use of an open aerial with a much larger input.

C. G. B. (Bedford).

A WIRELESS PIANO



NEW USE FOR OSCILLATING VALVES!

One of the interesting features of the recent German Wireless Exhibition was a wireless piano with which a wide range of tones was obtained by means of oscillating valves controlled from the keyboard seen here

New Tone for Old Sets — Better Tone for New Sets —

BY ADDING A

LISSEN INTER-VALVE TONE CONTROL

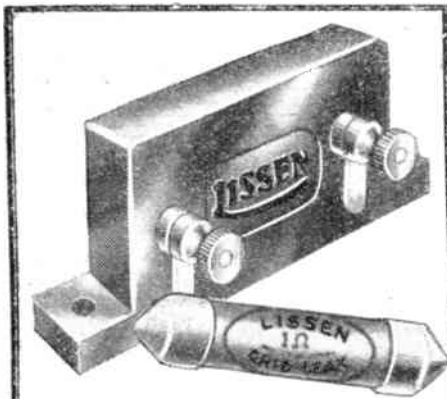

Here is a component which opens up new possibilities of quality reproduction—the Lissen Inter-valve Tone Control. Hitherto the best you could do in the control of tone was to attempt to correct in the output stage those faults of quality inherent in the receiver itself. Now the Lissen Inter-valve Tone Control gives you **SCIENTIFIC CONTROL OF TONE IN THE HEART OF THE RECEIVER.** By rotation of the special potentiometer (which is fitted to the front panel of the receiver) you get real variable control, so that for any particular item you can bring out deep bass or obtain brilliant high-note response just as your ear demands.

The illustration shows the Lissen Inter-valve Tone Control used in conjunction with a Lissen Hypernik Transformer. It can be used successfully with any transformer, and gives real control of tone. But, if possible, use a Lissen Hypernik Transformer, which will give you magnificent amplification over the whole band of audible frequencies and in conjunction with this new Lissen Intervalve Tone Control will make every item natural and true.

PRICE COMPLETE WITH SPECIAL POTENTIOMETER - - **10/-**

LISSEN
HYPERNIK
TRANSFORMER

If you want absolute truth of tone, use the Lissen Hypernik Transformer, as all the foremost set designers are doing. You cannot get such a good response curve—such fine quality reproduction—from any other transformer at anything like this price.

With a primary inductance of fully 100 henries, the Lissen Hypernik Transformer yet operates perfectly when passing currents up to 5 mA or more. Its step ratio is 4 to 1 and a stage amplification of more than 100 is obtained. PRICE **12/6**

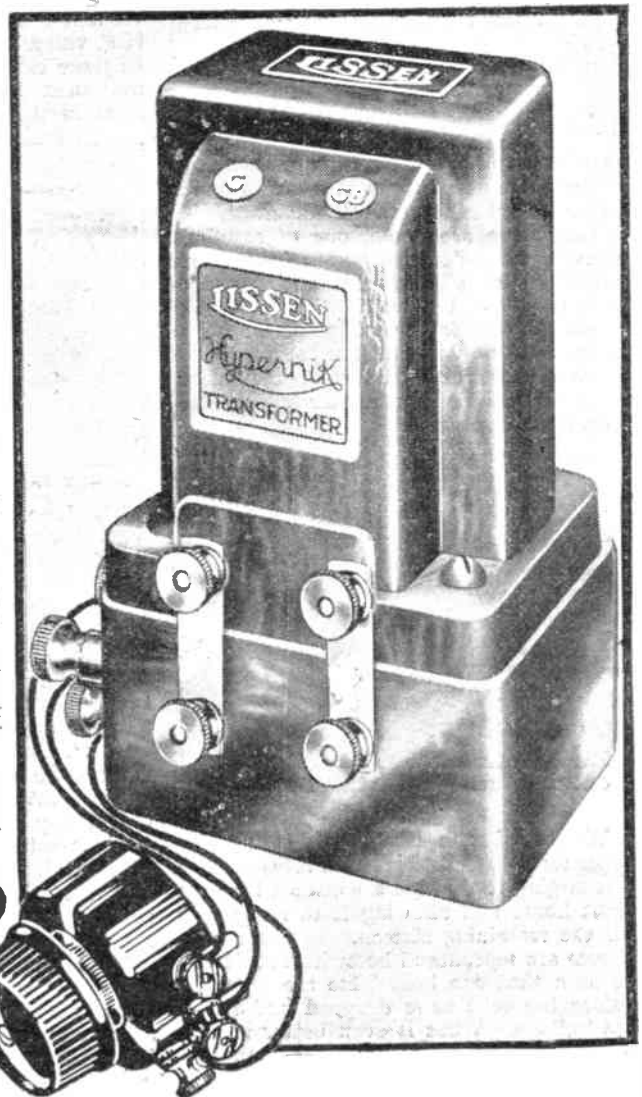

LISSEN
FIXED
CONDENSER

The only full-size Condenser selling at

6^D

LISSEN

FIXED
GRID LEAK

Exactly the same Grid Leaks for which you were previously paying 1/-.

6^D

LISSEN LTD., WORPLE ROAD, ISLEWORTH, MIDDLESEX

Please Mention "A.W." When Corresponding with Advertisers



A weekly review of new components and tests of apparatus conducted by J. H. Reyner, B.Sc., A.M.I.E.E.

EDISWAN H.T. BATTERY

A NEW battery of considerable merit has recently been placed on the market by the Edison Swan Electric Co. These new batteries utilise the modified process of manufacture which not only

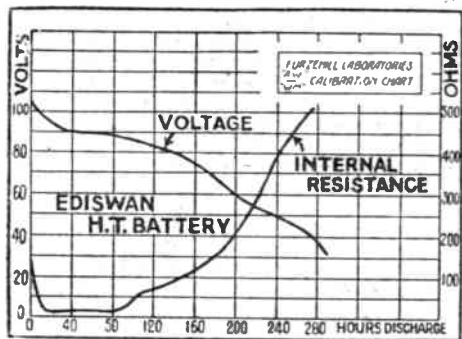

These voltage and internal resistance curves for the Ediswan battery tested show its useful life

enables them to be made considerably more cheaply but also results in a performance which is decidedly above the average.

Two types are made, one of standard capacity intended to give a maximum output of 10 milliamperes and a super-capacity type for which the maximum current rating is 20 milliamperes. The prices for a 60-volt unit are 6s. 9d. in the standard size and 12s. 6d. in the super size, and correspondingly more for higher voltages up to 120 volts.



One of the range of Ediswan batteries—a 120-volt job

We tested one of the single-capacity types for voltage and internal resistance by discharging it through a constant load for eight hours and allowing it to recuperate for the remaining sixteen. The discharge curves are reproduced herewith and it will be seen that 250 hours' life are obtained before the cells have dropped under half the voltage. What is even better is that the internal resistance remains very low during the greater part of this discharge

period. Indeed, at the end of the useful life the resistance is only in the neighbourhood of 500 ohms. The actual capacity is 1,760 milliampere-hours, which is over 40 per cent. better than the value which we usually consider standard for the single-capacity cell.

These new batteries are really good and can be confidently recommended.

A NEW LEWCOS "POT"

HIGH-RESISTANCE potentiometers are used to a very large extent in modern radio construction. For example, volume control these days is usually arranged by a high-resistance potentiometer connected in the grid circuit of a variable- μ valve, the screen circuit of an H.F. valve, or even across the aerial itself. In these circumstances it is not surprising that there has been considerable development in these components quite recently.

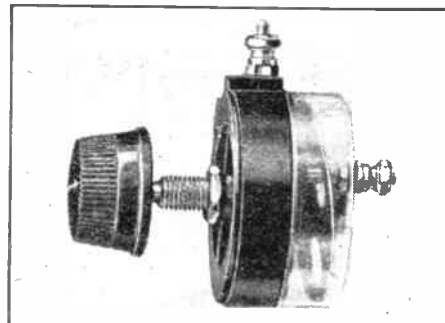

A new Lewcos wire-wound potentiometer

The Lewcos people have just put on the market a very ingenious and inexpensive arrangement. A wire-wound resistance is used, the winding being carried on flat strips of fibre in the usual way and housed inside a bakelite moulding. Instead of making contact with this resistance wire by means of a rotating or sliding contact, however, a flat disc is used which is mounted at a slight angle to the spindle. This disc rests on the element at one point, and if the spindle is rotated the disc rolls round the element so that its point of contact is continually changing.

This produces smooth and even variation of the resistance without any rubbing contact at all, as the disc only exerts a light pressure on the resistance wire and there is no friction between the two at any point.

With ordinary uniform variation of resistance the component sells at the remarkably low price of 3s. Graded types are available at 4s. 6d. and 5s. respectively, depending upon the type of grading required. All the usual values are obtainable

and, indeed, it is possible to obtain the component in values up to 250,000 ohms. Altogether the device is a most effective one and should appeal to the constructor.

TUNEWELL MATCHED COILS

An interesting set of tuning coils which we have tested recently are those marketed by Messrs. Tunewell Radio, Ltd.

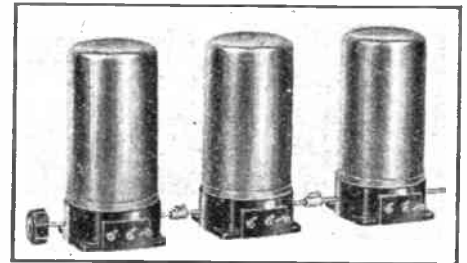

The Tunewell triple coil set described in the accompanying paragraph

There are three coils in this set, two being designated respectively A.1 and A.2 and forming a dual-capacity-coupled band-pass filter, and the third, G.1, the intervalve coil. The coils are wound on ribbed ebonite former, the overall diameter being 1 1/2 in. They are mounted on moulded bakelite bases, which house the switching mechanism and carry the necessary connecting terminals. Each coil is provided with a copper screening can and a copper base plate.

The coupling condenser recommended for use at the low-potential end of the coils is .05 microfarad, but there is also a small capacity coupling between the high potential ends of the coils, this being included in the base of the coil A.2. As the capacity required here is exceedingly small, this condenser consists merely of two small copper plates spaced about 1/4 in. apart.

Tested with a three-valve receiver, the coils gave excellent results, the signal strength being very good, while the selectivity was adequate for all normal purposes.

The high-frequency resistance of the coils was measured and at 400 metres was found to be 6.5 ohms, while at 1,600 metres the figure obtained was 41 ohms. Both these figures are good, as one would expect from the signal strength obtained.

The coils are turned out accurately matched to within one half per cent., and no difficulty should be experienced with ganging, assuming that a good three-gang condenser is employed. The overall dimensions of the coils are 3 in. diameter and 6 1/2 in. in height.

They can be recommended.

Use your own hands, save pounds & get a better set!

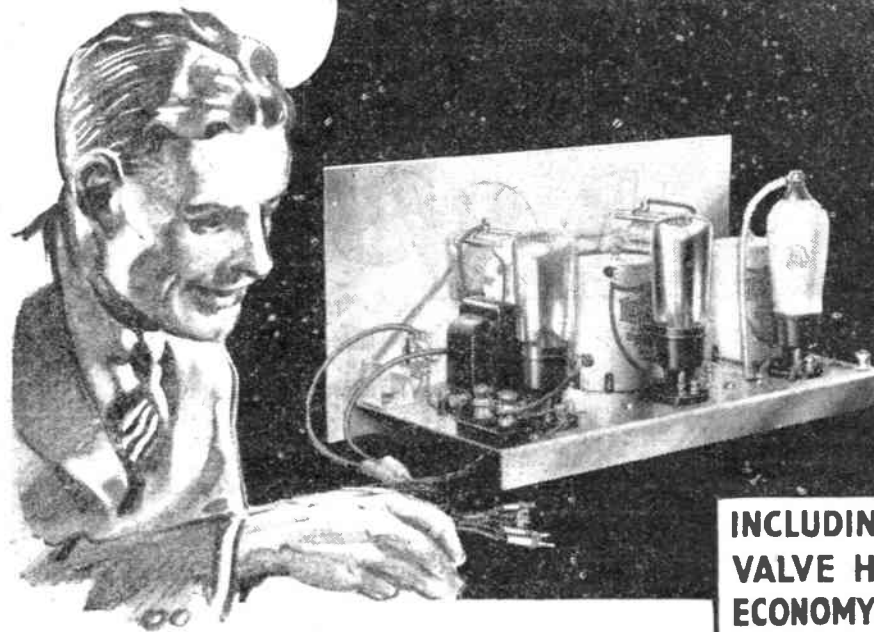

YOU CANT GO WRONG — YOU ARE TOLD WHAT TO DO WITH EVERY SINGLE NUT & SCREW!

INCLUDING METALLISED S.G VALVE HIGH MU DETECTOR & ECONOMY POWER PENTODE

89%

This is the only kit you can build yourself employing such HIGH POWER VALVES

There never has been the equal of this set within the range of the home constructor—this new Lissen Skyscraper is the only one on the market that you can build yourself, employing Metallised Screened Grid, High Mu Detector and Economy Power Pentode Valves. No factory—however well-equipped—can build a better receiver. No manufacturer, however large, can produce a receiver whose results will surpass those you will get from the Lissen Skyscraper you build yourself. It is the only battery set that can deliver such power—yet the H.T. current consumption is far less than that of the average commercially designed 3-valve set.

INCLUDING VALVES CABINET AND LOUDSPEAKER

£6.5



Yet the Lissen Skyscraper is made simple for you to build. Elaborate care has been taken to ensure your success by giving—in the Skyscraper Constructional Chart—such detailed instructions and such profuse illustrations that everybody, with no technical knowledge or skill at all can build it quickly and with complete certainty of success.

You buy the Lissen Skyscraper Kit complete with valves—a Lissen Metallised S.G., a High-mu Detector, and a Lissen Economy Power Pentode Valve—and the price is only 89 6. Or you can buy the Lissen Walnut Console Skyscraper Cabinet and Loud-speaker combined as illustrated. It holds all batteries, and accumulator and loud-speaker as well. It makes everything self-contained. A special Pentode Matched Balanced-armature Loud-speaker of great power is supplied with the cabinet and the price of the Skyscraper Kit complete with valves and this cabinet and loud-speaker is only £6 5s.

LISSEN COMPLETE CONSTRUCTIONAL CHART — FREE TO AMATEUR WIRELESS READERS

Photographs and instructions make every detail easy and clear—NO SKILL REQUIRED! Send Coupon below for your copy of FREE CHART!

To LISSEN, LTD.,
Dept. A.W.3, Wexple Road, Isleworth, Md.lx.
Please send me FREE copy of your L. Skyscraper Chart.

Name

Address

LISSEN

SKYSCRAPER KIT 3

A description of the new Marconi system by means of which television tests are made between a beam station at Chelmsford and the Sydney wireless station in Australia

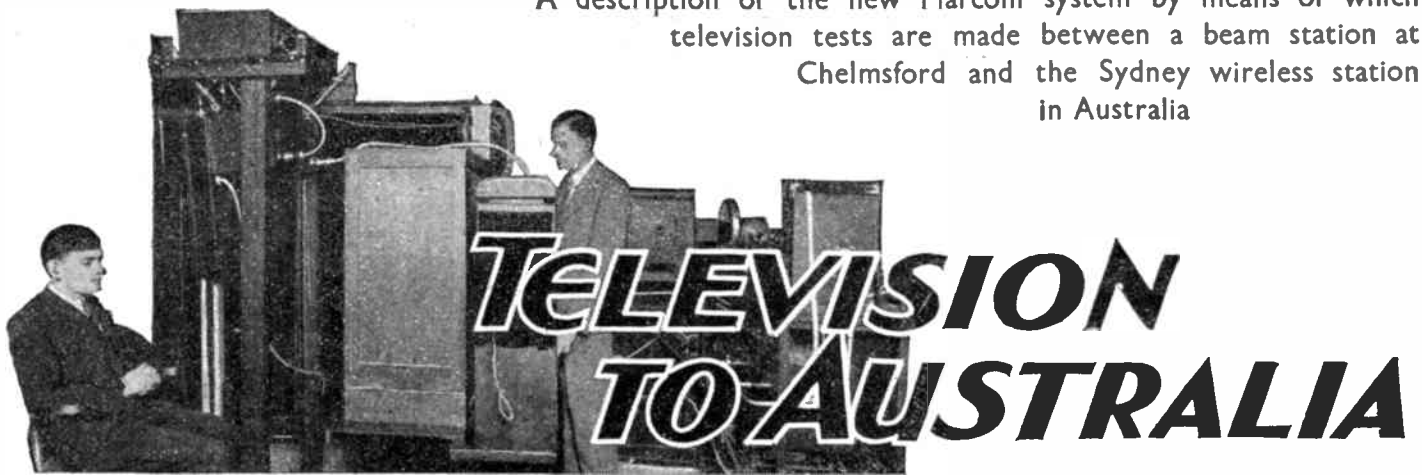

TELEVISION to Australia! The Marconi people, by using the beam system, have set a long-distance record for television transmissions.

They have, however, done much more than set up a mileage record. They have perfected a new television system which transmits news and verbal messages from characters printed on a moving tape. The receiver used in these tests is of the broadcast type and uses a mirror drum.

The beam station G2BS at Chelmsford was used, the receiving point on the Australian side being at Sydney. Our ordinary 25-metre short-waver 5SW also played a part in the tests.

A "Tape Scan" Set

The television signals were received by means of a simple type of receiver designed to have a very broad frequency response curve. This set consists of one stage of high-frequency magnification, anode-bend detection, and one stage of low-frequency amplification. The output from this receiver was taken to a power amplifier for use in the 15-line tape scan receiver.

The 15-line receiver gives a picture on a ground glass screen 25 in. by 3 in. A sodium tube of the dumbbell type is mounted close to an aperture, the modulated light being projected on to the screen by means of a mirror wheel, driven by a synchronous motor and giving a horizontal scan. The speed of the mirror wheel is 1,200 r.p.m., and gives 20 pictures per second. Synchronism is effected by a synchronising amplifier, A.C. mains operated, and consisting of two valves with large power output. This amplifier is connected to follow the second stage in the television signal amplifier.

The 50-line receiver gives a picture on a ground glass screen 8 in. by 8 in. A

similar sodium tube is used as on the 15-line receiver, the light is projected on to the screen by means of a mirror wheel driven by a synchronous motor and giving a horizontal scan. The speed of the mirror wheel is 900 r.p.m., and gives 15 pictures per second. Synchronism is effected by the same amplifier used for the 15-line receiver.

The 50-line "Projection" receiver gives a picture on a white screen 4 ft. by 4 ft. The light source is an arc modulated from a Kerr Cell, and is projected on to the screen by a mirror wheel driven by a synchronous motor giving a horizontal scan. The speed of the mirror wheel is 900 r.p.m., and gives 15 pictures per second. Synchronism for this motor is effected by another synchronising amplifier similar to that used for the sodium receiver, and is connected to follow the second stage in the amplifier modulating the Kerr Cell.

The 15-line transmitter, which was in operation at Chelmsford, is designed to modulate any high-class transmitter in such a way that images of characters printed on a semi-transparent tape can be received. The tape on which the characters are printed may be set in motion at the transmitter and the resultant image at the receiver will then consist of a series of letters moving from right to left at the receiver screen.

A Narrow Frequency Band

The frequency band occupied by transmissions of this nature can be made narrower than that needed for transmission of "head-and-shoulders" pictures, and in the present case is, in fact, very little wider than is necessary for good telephone transmission.

The characters on the tape are printed in a single line and the tape is fed forward

through the transmitter in a continuous manner at speeds which may correspond to from 60 to 120 five-letter words per minute.

The minimum number of scan lines needed for good detail is fixed by the
(Continued on page 640)

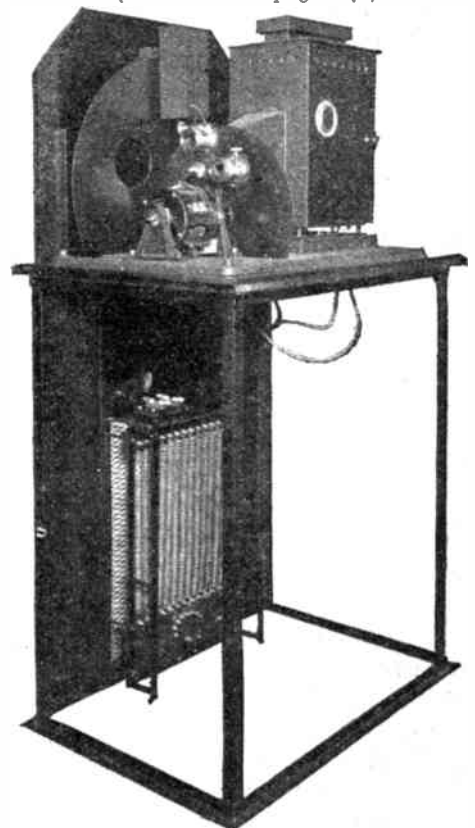

The scanner of the broadcast type transmitter. The photo shows the disc, arc, lens arrangement and synchro motor

DO YOU KNOW—

THAT if crackling noises are caused when a dual or triple condenser is rotated, all sections should be disconnected and the two or three wires put back one at a time? This will make it obvious which section is short-circuiting, very possibly owing to dust between the vanes or a bent vane.

THAT when adding a pick-up, the return lead on the negative side should not be taken to L.T.—, but to 1½ or 3 volts on the G.B. battery? In a mains set a dropping resistance shunted by a condenser should be put in circuit to provide about the same value of negative bias.

THAT difficult tuning will result if there is any end play or loose movement in the bearings of a solid dielectric reaction condenser? The slightest movement of the knob up or down will affect the capacity before one has a chance to turn the knob.

“MICALOG” Tuning Chosen for the “WIZARD”

“Micalog” tuning opens a new era in radio! “Micalog” condensers employ an entirely new type of di-electric and combine all the advantages of a solid di-electric condenser with the efficiency of the air-spaced type.

Invented by Mr. G. P. Kendall, the famous radio scientist, who incorporates “Micalog” tuning in all his well-known set designs. Its adoption by “Amateur Wireless” for the “Wizard” is sure proof that “Micalog” tuning is the tuning system of the future.

Capacities .0003 and .0005 mfd.

3/6



READY RADIO SLOW MOTION DISC DRIVE

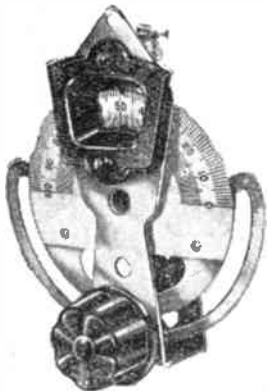

Specified for the
“Wizard”

A Robust Slow Motion Disc Drive having a Ratio of 25-1. Ideally suited for use with Micalog Condensers.

4/

READY RADIO

Advt. of READY RADIO, LTD., Eastnor House, Blackheath, S.E.3

Free

Mr. G. P. Kendall, B.Sc., the designer of many famous sets, and his assistant Mr. H. D. Price, the famous short-wave experimenter, have written a book containing complete instructions, photographs and diagrams of ten modern circuits, both battery and mains operated. It shows you how, at a cost of a few shillings, you can bring your present set right up to date. At its published price of 1s. it represents remarkable value for money.

Full-sized dimensioned Blueprints of these ten wonder circuits are also available at the exceptionally low price of 1s. for the set of ten. Send 1s. in stamps with coupon below and we will also send you a FREE copy of the “Kendall-Price” Book. Post coupon now!

To: READY RADIO, LTD. (Book Department), Eastnor House, Blackheath, S.E.3.
I enclose 1/- for the ten full-sized blueprints. Will you also send me—FREE—a copy of the Kendall-Price Book of Ten Circuits.

Name

Address

A.W.5

Mention of “Amateur Wireless” to Advertisers will Ensure Prompt Attention

"TELEVISION TO AUSTRALIA"*(Continued from page 638)*

character of the type. If capitals are employed, consisting mainly of arrangements of horizontal and vertical lines, each letter requires to be cut up into at least seven horizontal strips to ensure reasonable reproduction at the receiver.

In the present case, the number of scan lines covering the complete picture width has been chosen as 15, and while this enables sufficient detail to be transmitted, only a comparatively narrow band of frequencies is utilised. Scanning is accomplished by means of a rotating lens drum, and the 15 lenses are arranged round a spiral on the periphery of the drum.

The lamp house is of the standard type and is mounted at right angles to the main chassis of the transmitter. The light source is a standard 1,000-watt gas-filled metal filament projection lamp mounted vertically

with reflector behind it. A spherical condensing lens system is mounted in the lamp-

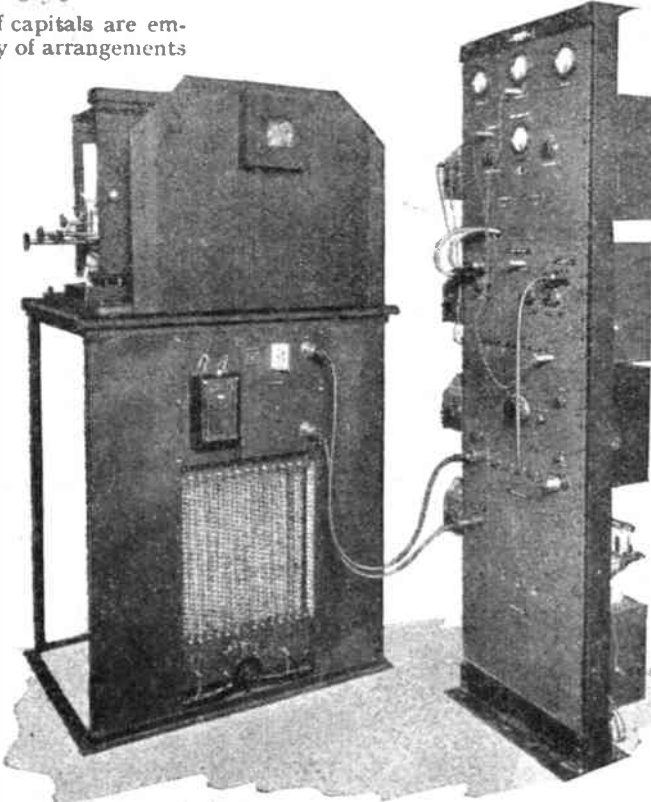

The new Marconi broadcast-type television transmitter connected to the first stage amplifier. The arc controls can just be seen, while a regulating resistance is below

house and a carrier in front of the lamp-house contains an aperture, a cylindrical lens and reflecting prism so arranged that the emergent light just covers the area of the lens system on the lens drum. The lenses in the drum focus sharp images of the apertures on to the tape. The tape is carried vertically between two rollers, the bottom one of which is driven by the same motor that drives the lens drum through suitable gearing.

Calcium Cells

Behind the tape is mounted the photo cell and photo-cell amplifier, both of which are contained in a single shielded unit slung by springs on an angle iron framework. The photo-cell receives its light from the transmission of the aperture image through the tape. One large-sized photo-cell is employed, with an aperture size of 8 in. by 1½ in. The light-sensitive material used is Caesium and the cell is gas-filled. The photo-cell amplifier consists of two stages of screen-grid valves which are resistance-capacity coupled. A screened lead is taken from this amplifier to the line amplifier.

The motor driving the disc is kept running at constant speed by means of an electrically driven fork, the output of which is fed into the A.C. windings of the motor.

An important talk will be heard at 7.35 p.m. on September 27, when the North Regional Director will tell listeners all about "Northern Programmes for the Autumn."

COLVERN

-T.D. COIL

AN UP-TO-DATE COIL WITH
UP-TO-DATE FEATURES

TYPE T.D., an entirely new COLVERN COIL, designed to give super selectivity on both long and broadcast wave-bands.

The coil is completely screened, giving a very neat appearance, and incorporates tapped aerial coupling and reaction, while the four alternative aerial tappings are arranged as sockets with a wander plug.

The first two tappings give aerial couplings similar to those normally employed, but with greatly increased selectivity.

Nos. 4 and 5 give a high degree of selectivity with weak aerial coupling—suitable for use in a "swamp" area.

A most important feature of this coil is that there is no break through on the long wave-band from B.B.C. stations.

This coil is specified for the "MULTI-MAG 3" described in "Wireless Magazine," and many other modern receivers.

Our 1933 Booklet Radio List No. 10 is now available and free on request.

COLVERN LIMITED

MAWNEYS ROAD, ROMFORD, ESSEX

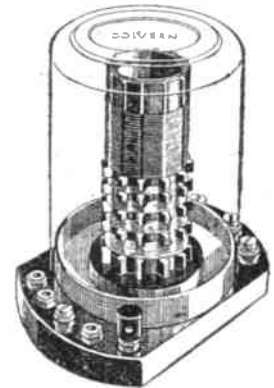
**TYPE T.D.**

PRICE
8/6



Pick-ups.



DISTINCTIVE IMPROVEMENTS KEEP HARLIE PICK-UPS ALWAYS IN THE LEAD

Other manufacturers have taken the Harlie as the model of perfection and have tried to make their quality and output the same as the Harlie, but Harlie Pick-ups are always "a Season ahead" because the improvements are our own and not released until the Olympia Exhibition. Therefore, by our specialising we offer the finest Pick-up obtainable.

EXCLUSIVE HARLIE FEATURES

1. The original Harlie knife-edge bearing has been improved.
2. Free and highly sensitive stylus movements.
3. 35 per cent. of cobalt magnet.
4. Pole pieces of special high permeability alloy.
5. Spring counter-balance — ensures correct weight on record.
6. Ball-bearing base allows free swing over record.
7. Remarkable frequency response range giving uniform tone quality.
8. Unusual tone volume for reproduction from screen-grid Receivers.
9. Is triple tested for frequency output by the finest precision instruments.
10. Individually tested for tone accuracy.

The new Harlie Electric Pick-ups will successfully deliver all the quality that the Engineer and Manufacturer built in the Radio Receiver, Amplifier and Speaker Unit.

2/6 DOWN Further 2/6 in 7 days and 5 monthly payments of 5/-.
(Cash Price, 27/6.) Complete with Fixing and Connecting Instructions.

Harlie

HARLIE LTD.,
Cambridge Arterial Rd.,
Enfield, Middlesex.

The New Harlie Pick-up Booklet TELLS HOW TO BRING YOUR RECORDS TO LIFE

Tells you how to play records with superb realism and brilliant distinction through your Radio Set, with only a few minutes' alteration; how to eliminate needle-scratch; how to double the playing life of your records; how to obtain volume control . . . It tells you all about how a Pick-up works, and much more besides. It is written in the simplest way so that you don't get a headache over technicalities and is bang up-to-date.

Post coupon below for your
FREE copy now.



TONE SELECTOR and SCRATCH FILTER

Definitely improves reproduction of radio or gramophone records—gives different tones—normal, brilliant, bright, mellow, deep. When used in conjunction with a gramophone pick-up it eliminates all needle scratch. Obtainable for 1/- and further 1/- in 7 days, and 2 monthly payments of 1/6. (Cash Price, 4/6).

All Harlie Products are obtainable on our Hire Purchase scheme through our registered Dealers.

Please forward :—
Free Booklet
De Luxe Pick-up } Cross out items not wanted.
Tone Selector
for which I enclose P.O. value. (No stamps.)

Name

Address

A.W.6.

THE NORTHERN NATIONAL RADIO EXHIBITION

City Hall, Deansgate, Manchester: September 28 to October 8

NEXT Wednesday, September 28, the Ninth Northern National Radio Exhibition opens at the City Hall, Deansgate, Manchester.

Everything points to it being a better Show than ever before, and Midland and Northern readers who were not able to see the new developments at Olympia last month will welcome this fine opportunity to see, at Manchester, the latest in radio.

The Northern National Exhibition runs from Wednesday, September 28, to Saturday, October 8—ten days packed with interest for all radio enthusiasts.

While, of course, not so vast as the National Radio Exhibition at Olympia, the Northern Show is nevertheless similarly planned, and the Exhibition is organised by the Radio Manufacturers' Association in conjunction with Provincial Exhibitions, Ltd. The stall arrangements are similar to those at Olympia, and during the ten days of the Radio Show the main hall of the City Hall (with a bridge over the central aisle), the Tonman Hall, New Hall and galleries will be a brilliantly illuminated display of new sets and components. The Stands are varied, but a uniform scheme of stand-fitting is adopted for the bridge over the main hall. There are eight Stands on the bridge, and, of course, many others in the rest of the gallery.

In next week's issue a full account of the Exhibition will be given, together with floor plans, a full list of the exhibitors and a detailed description of the new developments on show.

"A.W." is, of course, represented, and all visitors to the Northern Radio Exhibition should take this opportunity of seeing the new AMATEUR WIRELESS and *Wireless Magazine* sets, including the "Wizard" described this week. The "A.W." Stand is No. 34 in the Tonman Hall, in a very convenient position in the Exhibition.

COIL MOUNTING



Tuning coils having the axis parallel with the baseboard should not be mounted flat down against the wood, but should be supported at least $\frac{1}{4}$ -in. away. The best way of doing this is to slip $\frac{1}{4}$ -in. lengths of ebonite tubing over the mounting screws to form small supports.

"BRINGING IN STATIONS WITH THE 'WIZARD'"

(Continued from page 612)

eight stations were received at full loud-speaker strength without any trouble, and no doubt if I had been more used to the receiver, I could have increased this number considerably. Barcelona was badly swamped by London Regional together with Muhlacker, but the Scottish Regional came in well. Above this an unknown station was received at enormous strength, but I could not identify it; it was probably Lvov relaying Warsaw. The Midland Regional, at 76.5 and 75, is a little too close to Sötten to be pleasant, but between this reading and the North Regional at least eight stations were received at full loud-speaker strength. Here again many more would have been received if sufficient time had been taken to log them.

Prague is always a reliable station and in this instance it was no exception, giving a recital of Maurice Chevalier's records, to which I listened for over half an hour. Brussels came in louder than the North Regional and, if anything, at better quality.

Between 91 and 100 degrees six or seven stations were received, but only Vienna, Munich and Budapest were definitely identified.

Readers will probably wonder why this receiver should be so sensitive. I think the most important reason is that independent tuning obviates the necessity for careful ganging, and the use of closely matched coils, so the utmost efficiency is obtained from the receiver.

PIONEERS & LEADERS ALWAYS

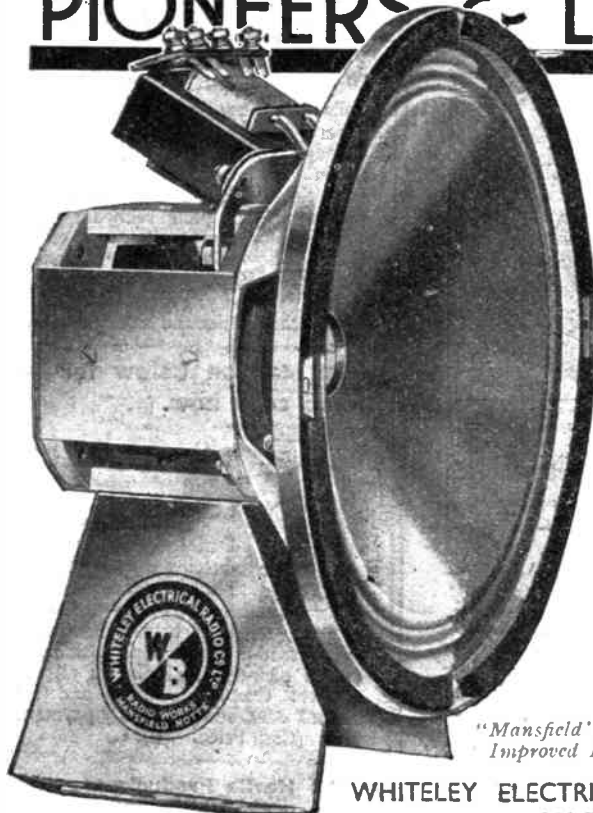

Get our new art booklet "Speaking of Speakers"—write for it NOW. It gives full information on all the new "W.B." productions—"Undoubtedly the leaders in their price class"—and

The "MANSFIELD" new PERMANENT MAGNET Moving-Coil Speakers

"Mansfield" Senior Improved P.M.4.

"Mansfield" Senior P.M.4. 42/- complete

"Mansfield" Junior P.M.5. 27/6 complete

WHITELEY ELECTRICAL RADIO CO. LTD., Radio Works, Mansfield, Notts.

Irish Free State distributors: Kelly & Shiel Ltd. 47 Fleet Street, Dublin.

RADIOPAK

TRADE MARK
THE ONLY COMPLETE BAND-PASS TUNER

MATCHED PERFECTION

REVOLUTIONISING SET CONSTRUCTION

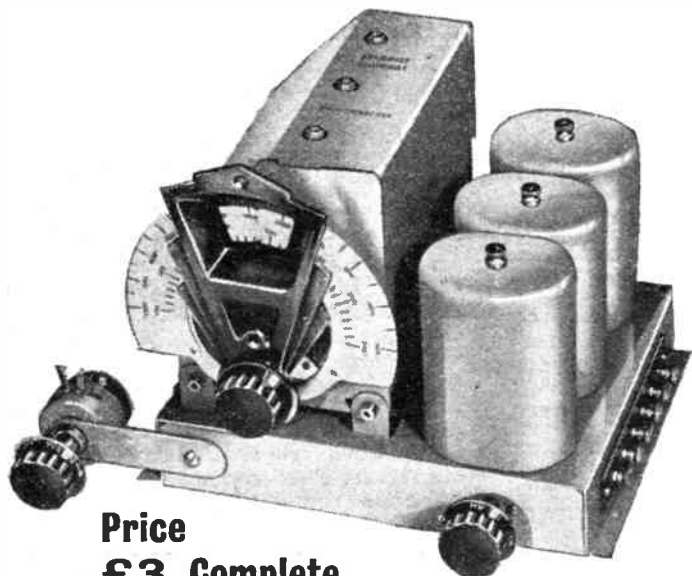

Price
£3 Complete

The British Radiophone Radiopak unit has been specially produced to bring perfect Band-pass tuning within reach of all constructors.

The unit consists of the necessary coils; the gang condenser with illuminated slow-motion escutcheon and disc drive calibrated in wavelengths; a wave-change switch; and a wire-wound volume control complete with on-off Q.M.B. power switch. The switching arrangement is the best yet devised for any radio component, and the combined volume control and switch is one of the famous Radiophone standard types needing no further recommendation. Owing to the high degree of accuracy in the matching of the coils and condensers, this unit will REVOLUTIONISE modern set construction. Write for full descriptive particulars to Dept. A.W.

THE BRITISH RADIOPHONE LTD.
ALDWYCH HOUSE, ALDWYCH, W.C. 2

Telephone: HOLBORN 6744



The "ATLAS" A.C.244
SPECIFIED AGAIN

MODEL A.C.244.
59/6 Cash.
1 Tapping 60/80v.
(Max. & Min.)
1 Tapping 50/90v.
(Max., Med., & Min.)
1 Tapping 120/150v.
Output 20 mA at 120v.
MODEL A.K.260.
With L.T. Trickle Charger
for 2-, 4-, and 6-volt
Accumulators.
90/- Cash.
Westinghouse Rectifiers
Guaranteed 12 months.

... Yet again "ATLAS" is the designer's choice and definitely specified to ensure the finest possible reception from the "Wizard" Receiver described in this number.

Make sure of getting the best in value and performance by insisting on "ATLAS," winners of the Olympia Ballots in 1930 and 1931.

Ask your dealer for a demonstration and post the coupon to-day for your FREE Folder.

"CLARKE'S" "ATLAS" MAINS UNITS

H. CLARKE & CO. (M/CR.), LTD.
Patricroft, Manchester

LONDON OFFICES: Bush House, W.C.2
SCOTTISH DISTRIBUTORS:
G.E.S. Co. Ltd., 38 Oswald St., Glasgow

POST THIS COUPON TO-DAY:

H. CLARKE & CO. (M/CR.) LTD., George St., Patricroft, M/cr.
Please send FREE copy of Folder No. 68.

NAME _____

ADDRESS _____
29/24/9

"DEVELOPMENTS IN L.F. AMPLIFICATION"

(Continued from page 621.)

the straight part of the characteristic. A positive voltage causes the anode current to increase and operates over the positive portion of the characteristic.

In doing so, grid current flows so long as the grid is positive, which means that the grid-filament path of the valve has quite a low resistance. Under normal conditions this would short-circuit the preceding transformer or resistance and cause the amplification to drop off considerably, so that there would be an unequal amplification of the two halves of the wave with very serious distortion in consequence. To overcome this, the valve is fed from a driver which is another valve designed to operate normally when the grid of the power valve is negative, but to give an increased amplification when the power-valve grid is positive. This effect is obtained by a special design of the characteristics of the driver valve, and the net result is an undistorted amplification, the short-circuiting effect of the grid current in the output valve being compensated for by the increased amplification from the driver valve.

It will be clear that this arrangement allows twice the normal grid swing on the output valve and therefore *four times the power output*, while the anode current has only been increased to about twice the normal value so that the arrangement is considerable more efficient. As against this there is the necessity for the driver

valve which must be allowed for even when it is included within the same bulb.

The second system is a form of push-pull arrangement shown in Fig. 2. The two push-pull valves are of the screen-grid or pentode type so designed that the anode current is practically zero with no grid bias. Each half wave, therefore, one of the valves swings over its characteristic, which is all on the positive side, while the other valve is idle. During the whole time each valve is operative, grid current is flowing so that there is a permanent load across the transformer feeding the valves. This is an easier condition to contend with than the last, for provided the load is reasonably constant, we can design the preceding stage to give undistorted amplification.

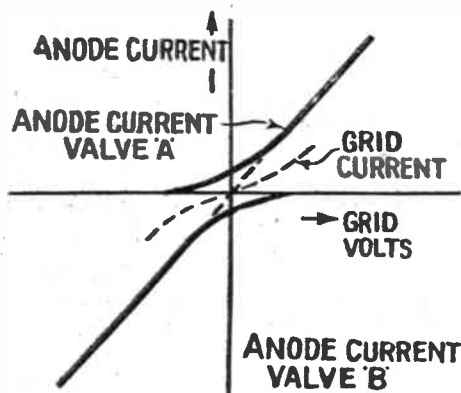

Fig. 3.—The valves are designed so that the anode current is practically zero with no grid bias

The case, indeed, is very similar to the design of the output circuit at present, where the power valve has to feed into the load imposed by the loud-speaker. The first valve therefore is arranged to operate as a power amplifier and delivers undistorted voltage to the grids of the push-pull valves.

Due to the fact that there is no grid current limitation the grid swing of these valves can again be extended and considerably increased power output is obtainable, at the expense of the driver valve, as before (Fig. 3). On the other hand, the two push-pull valves take practically no anode current when they are not working, which means considerable economy in H.T. consumption.

A typical valve just marketed in America delivers 3½ watts output with 180 volts H.T. This is for two such valves in push-pull as just described, the total anode current for both valves with no signal being only 4 milliamperes. One valve by itself used as a normal amplifier only gives an output of 200 milliwatts.

I should add that these figures are taken on trust. I have not yet had an opportunity of verifying them, but they do indicate the considerably greater power output which can be obtained. Some valve designers claim that they can get just as good results with straight methods of amplification if they are given sufficient rein. Time will show, but there is no doubt that these new methods are going to cause considerable thought in the immediate future.

"NEW RADIOS FOR OLD"

RADIALADDIN EXCHANGE SERVICE THE SUCCESS OF OLYMPIA

(All orders placed at the Radio Exhibition are being dealt with in strict rotation.)

In purchasing by mail order, it is essential that the supplier's dealings, methods and bona fides should be subject to the strictest scrutiny, and it is therefore with pleasure that we have compiled a pamphlet illustrating numerous satisfactory experiences of those who have dealt with us—and also the Press. It will pay you to write for particulars of our amazing exchange offer, enclosing 1½d. stamp, naming your old set which we buy, and the new set you fancy. A free quotation will follow. Balance payable in cash or hire-purchase.

FREE Wireless Set to introduce the Radialaddin Club.

Please forward this INQUIRY FORM (without obligation)

Please quote me free your allowance for this new set:

Make..... Model and list price.....

My Present Set is: Make..... Batteries or Mains.....

Date of Purchase..... Original Cost of Set.....

Balance of purchase price would be payable by me as follows:

Plan A. Whole of balance in cash.

Plan B. Whole of balance over six, nine, twelve * months.

*Delete unwanted words.

NAME (in full).....

ADDRESS.....

RADIALADDIN, Limited

THE LARGEST RADIO EXCHANGE IN THE UNITED KINGDOM. (Dept. A.W.), 47-48 Berners Street, London, W.1. Museum 1821.



British Made

THE RELIABLE BECOL EBONITE FORMER which has stood the TEST OF TIME and tested before despatch. Prices LOW.

EFFICIENCY COUNTS!!!

LOOK FOR TRADE-MARK. SOLE MAKERS

THE BRITISH EBONITE CO., LTD. HANWELL, W.7

HERE IT IS EXACTLY WHAT YOU REQUIRE FOR SHORT WAVES



FOR THIS SPLENDID NEW 1933 "BLUE SPOT" SPEAKER

NEW 1933 PERMANENT MAGNET SPEAKER No. 50PM.



The chassis is an outstanding example of first-class workmanship and the unit, with its heavy permanent magnet containing a high percentage of cobalt, is wonderfully sensitive. From any set this new "Blue Spot" Speaker will reproduce every detail of speech or music to perfection. Send only 2/6 deposit for 7 days' trial. If satisfied, pay further 3/6 at once, then 8 monthly payments of 7/6. (Cash in 7 days, 50/6). Leaflet discussing this and other "Blue Spot" Speakers post free on request.

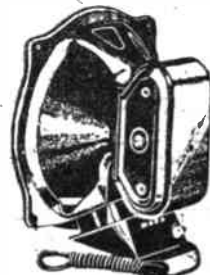

E. J. HERAUD LTD., DEPT. A.W.11, NUMBER ONE, EDMONTON LONDON. N.13

and at Tottenham Walthamstow, and Enfield Wash. Estab 33 years.

"THE A.B.C. OF MAINS WORKING"

(Continued from page 614)

networks, either potentiometers, as for screen-grid stages, or as series resistances, as for the detector anode.

To work out the required resistance in series between the maximum output and the anode of the valve is quite easy when you know the anode current of the valve. It involves a simple application of Ohm's Law. You subtract the voltage required from the voltage you have: This gives the voltage to be dropped. Then you divide this voltage by the valve's anode current in milliamperes and the answer, when multiplied by 1,000, will be the resistance in ohms required.

LOW-TENSION SUPPLY

As already indicated, the problem of the low-tension supply for heating the filaments from the A.C. mains is simply solved by means of a 4-volt secondary on the high-tension transformer. The 4 volts delivered by this small secondary is, of course, A.C., which even in its "raw" state can be applied directly to the cathodes of the valves.

The variations in the heating effect of the alternating current passing through the heater elements never reaches the actual filament—never affects the real electron emitter, called the cathode, and corresponding in circuit connection to low-tension negative of a battery set.

GRID BIAS

When the high tension is obtained from the mains the grid bias is automatically derived by means of resistances in the cathode leads. The anode currents flow through these resistances, and thus cause voltage drops across them determined by the value of the currents and the value of the resistances.

What we do is to find out how many volts grid bias is needed for each stage, measure the anode current of each stage and then apply Ohm's Law to find what the resistance value should be to cause the wanted voltage drop.

Example: We might want to bias the detector valve, say, 2 volts negative for using it as a gramophone amplifier, and the anode current of the valve might be 4 milliamperes. The value of the resistance needed to give 4 volts drop across it when the current flowing through it was 4 milliamperes would be found by dividing the voltage drop, that is 2 volts, by the current in milliamperes, that is 4, and multiplying the answer by 1,000; which, in this example, works out to 500. A 500-ohm cathode resistance would therefore give the required grid bias of 2 volts.

It is important to note that this voltage gained for the grid bias is voltage lost for the anode of the valve. Potentials are measured with respect to the cathode.

The point is that when we get negative bias by making the cathode more positive we obviously make this cathode less negative with respect to the anode, or in other words we make the anode less positive with respect to the cathode.

In modern mains sets cathode-bias resistances are used for each valve, so that different bias voltages can be obtained quite easily, especially as a wide variety of resistance sizes is now available.

**Why
throw away
2½ worth of H.T.
— when your H.T.
Battery runs down?**



When you throw away an old H.T. Battery there is still power left in it—power you cannot use—its voltage is too low to work your set. You are compelled to waste this energy—energy for which you have already paid.

The Lively 'O' H.T. Accumulator eliminates waste. It is full of life and vitality right up to the time when it is ready for recharging (3 or 4 times a year). Its "air-spaced" cells are proof against electrical leakage. Its voltage is constant. Get the best out of your set with the smooth, unvarying H.T. supply ensured by the Lively 'O'. Your Dealer stocks it.

TWO TYPES:

Standard 10 volt unit capacity 2,750 milliamps **5/6**

Extra large capacity 5,500 milliamps (10 volt unit) **6/9**

The

Lively 'O'

H.T. ACCUMULATOR

PUT THE LIVELY 'O' INTO YOUR RADIO

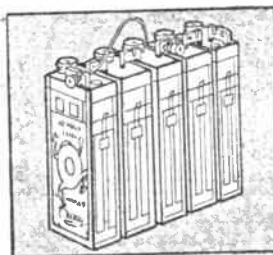

Oldham & Son Ltd.,
Denton, Manchester.
Est. 1865, and at
London, Glasgow,
Belfast and Dublin.

IN MY WIRELESS DEN

WEEKLY HINTS —

CONSTRUCTIONAL



& THEORETICAL

By

W. JAMES

HOW M.C.'S DIFFER

If you tested a number of moving-coil speakers of the same make you might be surprised at the slight differences in the results.

This may be traced to various small faults. Sometimes the cones are not quite right. The centre holding pieces do not always have the same flexibility and the distance between the front of the magnet and the beginning of the winding of the speech coil is not always equal.

You might find slight scratching sounds. Some overload and give bad quality or rattle before others. Naturally, if you have one speaker, as most of us have, it is difficult to detect slight faults in the reproduction, but scratchy noises and overloading will be noted. It is possible that the fixing might be loose and this should be seen to.

To clear filings or other material, lay the speaker unit upon its face and pass a strong signal through it; at the same time gently bump the face of the unit against the table. This treatment will usually clear away the particles of foreign matter lodged in the gap.

If the coil is rubbing against the poles,

slightly loose the fixing screw holding the centre piece and adjust very carefully.

I have noted that a fault may be produced by fastening the unit carelessly. The screws used to hold the unit to the cabinet or board may not be tightened evenly, and this might twist the frame slightly.

See to this, therefore, when fitting the unit. A moving-coil speaker should be dealt with carefully and reasonably and if it is exposed it is a good idea to fit a bag of cotton or silk over the back of the unit, the silk covering the fret protecting the front.

LOSING VOLUME BY CHANGING

TO NE

A FORM of tone correction is usually employed by all of us. We usually do our best in the low-frequency side to make the sounds from our loud-speaker as natural as possible.

If top is lacking we try a transformer having a rising characteristic, and when there is too much top we cut it down by using a resistance-condenser filter. It is difficult to make a set having very sharp tuning circuits which cut the top notes and low-frequency circuits which correct faithfully for this.

The detector plays a part and must be carefully arranged. A satisfactory detector would have a straight-line characteristic, and this generally means that the input must be adjusted within limits to work only on the straight part. A detector of this class, such as a properly set up "power grid" type, distorts very little itself.

It is interesting to note that a correcting circuit usually works by taking away rather than by adding to the signal. This is why two low-frequency stages are sometimes needed instead of one stage.

WHAT'S THE RATIO ?

THE ratio of a transformer is reckoned as the number of turns of wire in the secondary divided by the number in the primary.

Thus, if, for example, the turns are 16,000 and 4,000, the ratio is said to be 4 : 1. Now it is possible that if you connect a 7 : 1 transformer to your set the magnification may be no greater than when a 3 : 1 is used.

The frequency characteristics will probably be quite different and the most uniform results may be obtained with the 3 : 1. Much depends upon the valve to which the primary is connected. The valve may have an impedance of 20,000 ohms, when the normal 3 : 1 transformer would be satisfactory. A transformer of higher ratio would only spoil the results. There would probably be a reduction in the bass notes and perhaps the higher notes would be weakened in comparison with the valve and 3 : 1 ratio combination.

A VOLTMETER OF FIRST GRADE ACCURACY

is essential to all radio builders

FERRANTI METERS

are of accuracy guaranteed within the limits of the British Standard Specification No. 89, for first-grade Moving Coil Instruments.

A wide open scale (110°—2½ inches) ensures accurate readings in all ranges. Particularly useful instruments for normal purposes are the **Types 16P and 17P**. For measurements in very high resistance circuits, the following are recommended.

TYPE 25P - - - £3 : 8 : 6
Ranges 7½—30—150 volts.

TYPE 26P - - - £3 : 14 : 6
Ranges 10—50—250 volts.

Resistance, 1,000 ohms per volt.

TYPE 16P - - - £2 : 12 : 6
Range 7½—30—150 volts.

TYPE 17P - - - £3 : 0 : 0
Range 10—50—250 volts.

Resistance, 200 ohms per volt.

Clearly divided scale
Absolutely dead
beat Accuracy
within 1%

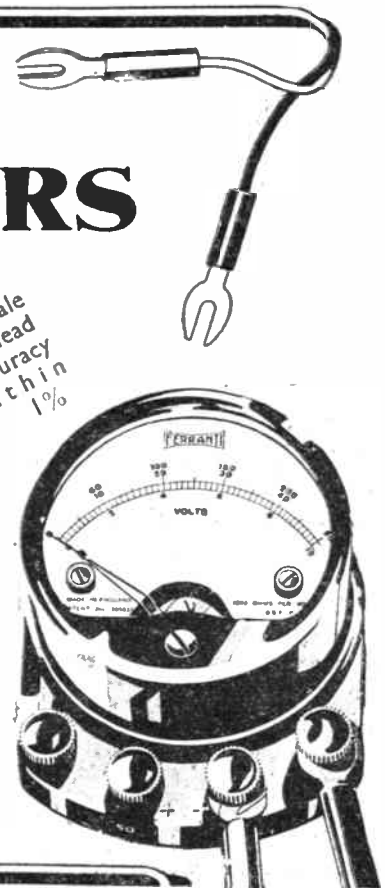

NO BETTER INSTRUMENTS ARE AVAILABLE AT ANY PRICE

Ferranti have been famous for instruments since 1882

FERRANTI LTD., Head Office and Works, HOLLINWOOD, LANCASHIRE.

LONDON: Bush House, Aldwych, W.C.2

The point here is that the valve and transformer work together and cannot be considered separately. If the valve were replaced with another of 10,000 ohms the results would probably be quite different. With a good 7:1 transformer the results might be much better than with the 3:1.

Then again, the output valve plays a part. This valve has capacity which is across the transformer, and being across the secondary, has much more effect than an equal capacity joined across the primary.

A 7:1 transformer may, therefore, not be as good as a component having a lower ratio, but if the impedance of the valve joined to the primary is low the high-ratio transformer may be worth while.

IS IT EARTHED ?

A POWER transformer or choke mounted upon a metal chassis is automatically earthed in many cases. The fixing feet or perhaps the metal core make contact with the chassis. To avoid this when the practice results in hum it is necessary to insulate the parts.

A piece of cardboard may be used beneath the component affected. The effect is to introduce a short gap between the cone and the chassis, which is often of steel, plated to preserve it.

The earthing may not be important by itself, but hum is sometimes introduced by the core resting against the surface of the chassis.

Earthing is sometimes more important than is usually thought, and it may be much more satisfactory to earth the parts by taking wires to the earthing terminal instead of relying upon contacts with the chassis itself.

'WARE HIGH TENSION!

A PROTECTING terminal ought to be used for the top of a metallised screen-grid valve. If an ordinary wire connection is used there is always the chance that it might touch the metal covering of the bulb and cause damage.

The metal coating is earthed through the low tension or cathode, and if the high-tension wire going to the anode should by chance touch it there will be practically a short circuit.

The metal covering will be damaged, but the valve is usually not harmed apart from this. With a proper terminal fitted to the stem at the top of the bulb this cannot happen.

New Times Sales Co

MANUFACTURERS' KITS

LISSEN "SKYSCRAPER 3" Chassis With
model with Lissen S.G., Detector and Pentode valves. Cash price 8/3
£4/9 6 Carriage Paid. Balance in 11 monthly payments of 8/3.

COSSOR MELODY MAKER MODEL 335. Complete with valves, speaker and cabinet. Employs Cossor variable-mu S.G., H.F. stage, detector and power valves. Cash price, £7/17 6. Balance in 11 monthly payments of 14/10. Carriage Paid.

SLEKTUN SCOUT S.G.3.—S.G., Detector and Power. Pilot Author Kit "A" (less valves and cabinet). Cash or C.O.D., £4/8 6. Carriage Paid. Balance in 11 monthly payments of 8/1.

ACCESSORIES

GARRARD INDUCTION GRAMOPHONE MOTOR. For A.C. mains. Model 202. Mounted on 12-inch nickel motor plate with fully automatic electric starting and stopping switch. Cash price £2/10 0. Carriage Paid. Balance in 11 monthly payments of 4/7.

B.T.H. SENIOR PICK-UP with arm and base. Cash price £2/2 6. Balance in 11 monthly payments of 3/10. Carriage Paid.

COLLARO INDUCTION MOTOR WITH PICK-UP. For A.C. mains. 12 inch turntable, moulded pick-up, volume control and automatic stop. Cash price £4 0 0. Carriage Paid. Balance in 11 monthly payments of 7/4.

NEW 1933 RADIO
ON EASIEST OF EASY TERMS
QUICKEST DELIVERY

Strictest Privacy Guaranteed

R. & A. "VICTOR" PERMANENT MAGNET MOVING-COIL SPEAKER DE LUXE with 6-ratio input transformer and protecting grille. Cash or C.O.D., £3 10 6. Carriage Paid. Balance in 11 monthly payments of 6/5.

R. & A. "BANTAM" PERMANENT - MAGNET MOVING - COIL SPEAKER with 3-ratio input transformer. Cash price £1/7 6. Carr. Paid. Balance in 5 monthly payments of 5/-.

W.B. PERMANENT MAGNET MOVING-COIL SPEAKER. Type P.M.4. With transformer. Cash price £2/2 6. Balance in 7 monthly payments of 5/9.

BLUE SPOT SPEAKER UNIT AND CHASSIS, TYPE 100U. Cash price £1/19 6. Carriage Paid. Balance in 7 monthly payments of 5/5.

ATLAS ELIMINATOR, Type A.C.244. Three tappings, S.G., detector and power. Output, 120 volts at 20 m/A. Cash price, £2/19 6. Carriage Paid. Balance in 11 monthly payments of 5/3.

EPOCH "SUPER JUNIOR" Type M.V. Permanent Magnet Moving-Coil Speaker with 5-ratio transformer. Cash or C.O.D. £1/7 6. Carriage Paid. Balance in 5 monthly payments of 5/-.

EPOCH "20 C" PERMANENT MAGNET MOVING-COIL SPEAKER. With 3-ratio input transformer. This speaker will handle up to 5 watts. Cash price, £1/15 6. Carriage Paid. Balance in 5 monthly payments of 6 6.

EKOK H.T. UNIT, Type A.C.25. For multi-valve sets requiring up to 25 m/a. 3 tappings, S.G., detector and 120/150 volts. For A.C. mains. Cash price, £3/17 6. Carriage Paid. Balance in 11 monthly payments of 7/1.

Any items advertised in this Journal sent C.O.D. if value over 10/- sent all C.O.D. charges paid.

FIRST WITH EASY TERMS in 1924 and Still leading BIGGEST STOCKS

To NEW TIMES SALES CO., 37, Ludgate Hill, London, E.C.4
Please send me (a) 1933 Lists,
(b)..... for which I enclose first payment of £.....s.....d.....
Name.....
Address..... A.W. 24/9/32.....

Miscellaneous Components. Accessories, etc., etc., supplied CASH, C.O.D. or H.P. on our own Private System of Easy Payments.

IN THE WIZARD

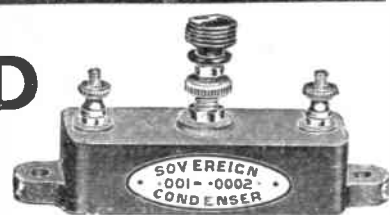

A SOVEREIGN COMPRESSION TYPE CONDENSER TYPE J IS SPECIFIED

1/3

We are pleased to announce publication of the Third (1932) Edition of our famous Components Catalogue which will be forwarded (free) together with our latest Blueprint for building the Sovereign Ambassador and Plessey Receivers upon receipt of a postcard to Dept. A.W.

Sovereign Components may be obtained from all good Dealers. Use them as much as you can in building the Wizard.

SOVEREIGN PRODUCTS, LTD. SOVEREIGN HOUSE, ROSEBERY AV. E.C.1

OUR BLUEPRINT SERVICE
Constructors of receivers described in this Journal should make full use of our Blueprint Service and avoid all risk of failure.

A 6d Insurance Policy
Ask for Genuine "Competa" Green Top Fuses. The only reliable make which fuse instantly on 50% overload.
TRADE MARK COMPETA
THE WORLD'S SELECTED
Adv. of A. F. BULGIN & Co. Ltd., Abbey Rd., Barking

RADIO SUPPLIES
Send your list of Radio needs for our quotation. Kits, Parts, Sets, etc. Everything in Radio stocked. Prompt delivery; seven days' approval. Catalogue free. Taylor and Standard Wet H.T. replacements stocked.
G. TAYLOR, 87 STUDLEY ROAD, STOCKWELL, LONDON

OUR QUERY DEPARTMENT?

The attention of readers is directed to the rules printed below. Replies are sent by post, only a selection of queries of general interest are printed here.

Using an Absorption Wavemeter

SIR,—I have been presented with what I have been told is an absorption wavemeter. It contains a variable tuning condenser connected to a coil-holder and mounted on a simple panel and baseboard arrangement. There are several plug-in coils for use with the gadget. Can you explain to me how I may use this instrument?
F. W. (London).

The wavemeter is not of much use unless it is calibrated. You do not say whether you have any calibration curves with the instrument, but we will assume you have these. The meter should be arranged near to the receiver so that its tuning coil is close to, and parallel with, the plane of the aerial tuning coil in your set. If you tune in a station and want to find out its wavelength, you adjust the tuning condenser of the wavemeter until you find a position on its condenser scale where signals from your actual receiver fade away. This is the absorption spot and a reference to the condenser setting on your meter calibration curve will indicate the wavelength of the station. It is best not to place the meter near to the tuning coil of the receiver until after a station has been tuned in, as absorption effects in the meter may affect the tuning of the receiver.

Advantages of H.F. Stage in Short-wave Sets

SIR,—I have often heard it remarked that a high-frequency stage in a short-wave set is virtually a passenger, but this does not explain much to me. Is it a fact that there are no advantages gained when incorporating a high-frequency amplifying valve before the detector in a short-wave set, and, if so, why do so many designers put in such a stage of amplification?
R. D. (Belfast).

It is not quite true to say that an H.F. stage in a short-wave set is a passenger. It is not possible to gain much pre-detector amplification from such a stage when working on wavelengths below about 30 metres, but there is a great advantage in using an H.F. stage on these low wavelengths and this is, it stabilises the whole receiver, makes detector-circuit reaction extremely smooth, and permits elimination of much of the mush usually experienced when a plain detector with reaction on to the aerial is used. Above about 30 metres it is common to expect a good H.F. amplification stage gain, and it often makes all the difference between just hearing a station and receiving it at full speaker strength.

Obtaining a Transmitting Permit

SIR,—I am very interested in short-wave work and wish to take up transmission experiments. Other short-wave enthusiasts with whom I have spoken on the subject have stated their willingness to report upon my work. I should therefore be pleased to learn how I should go about applying for a licence for a transmitter and

what other steps I should take to qualify for it.
W. R. (Middlesbrough).

It is necessary, first, that you be able to transmit and receive morse code signals at twelve words a minute. Next, you must be able to satisfy the authorities regarding your ability to operate a transmitting station in a proper manner. You must also be prepared to sit for an examination with regard to these two subjects, if called upon. A letter to the Secretary of the P.M.G. will bring to you the necessary application forms and these should be filled in to the best of your ability. A circuit of the transmitter you will be using, together with brief details of the type of experiments you intend to conduct, should be included with the licence application forms when returned to the authorities. You would gain much practical assistance in the matter by joining a well-informed radio society.

THE BRIGHTON RADIO EXHIBITION

AN event in which South Coast listeners will be interested is now in course of preparation and will be officially opened by the Mayor of Brighton at 3 p.m. on Monday, October 3, at the Georgian Room of the Regent Cinema, North Street, Brighton.

The Brighton Radio Exhibition is a united effort by most of the radio manufacturers and the leading radio traders of Brighton, Hove, and Portslade, and upon thirty-one stands practically all of the new designs shown at Olympia will be displayed and demonstrated. The Exhibition will be open daily from 3 to 10 p.m., October 3 to 8 inclusive, admission 6d.

Captain C. B. Graves, who described his journey from England to New Zealand in a Liverpool Barque in a talk last June, will on September 27 give an account of the return journey.

WHEN SUBMITTING QUERIES

Please write concisely, giving essential particulars. A Fee of One Shilling (postal order), a stamped addressed envelope, and the coupon on the last page must accompany all letters. The following points should be noted.

Not more than two questions should be sent with any one letter.

The designing of apparatus or receivers cannot be undertaken.

Modifications of a straightforward nature can be made to blueprints, but we reserve to ourselves the right to determine the extent of an alteration to come within the scope of a query. Modifications to proprietary receivers and designs published by contemporary journals cannot be undertaken.

Readers' sets and components cannot be tested at this office. Readers desiring specific information upon any problem should not ask for it to be published in a forthcoming issue, as only queries of general interest are published and these only at our discretion. Queries cannot be answered by telephone or personally.

Readers ordering blueprints and requiring technical information in addition, should address a separate letter to the Query Department and conform with the rules.

P.P.M. SOUNDEX 27/6 INCLUDING TRANSFORMER

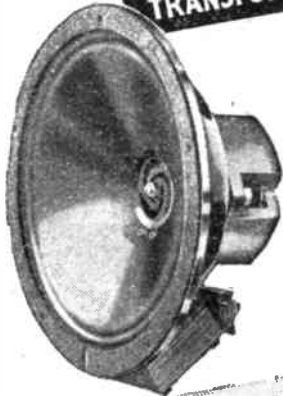

PPM 69



P.P.M. SOUNDEX CHASSIS
Have you heard Celestion's latest chassis speaker? You will be amazed that such a small speaker can produce such wonderful tone and volume. Incorporating the famous Hyflex diaphragm. Price, including universal tapped transformer, 27/8.

P.P.M. 69 (CABINET)
The most outstanding achievement of the year. A wonderful magnet giving extraordinary sensitivity and a large Hyflex diaphragm combine to make this speaker really amazing. Housed in a dignified cabinet that will fit in with any style of furniture. Prices: 85/- Oak; 90/- Mahogany and Walnut.

CELESTION
The Very Soul of Music

Celestion Ltd., London Rd., Kingston-on-Thames
London Showroom: 108, Victoria Street, & W.



Go over your set with an "All-in-One" Radiometer and quickly trace the true source of any trouble. You can't go wrong in radio

with this wonderful little instrument to guide you.

Its never-failing aid enables you to track down a fault instantly. Wherever it may be—valves, batteries, transformer, circuit, or other component—an "All-in-One" Radiometer gets to the root of the matter and registers it at once.

There is no other instrument like it. Ask to see it demonstrated at your radio dealer's or electrician's. If in any difficulty, write direct to

PIFCO, Ltd., High Street, Manchester.

Standard Model "All-in-One" Radiometer for Battery Sets only, as shown here.

Price 12/6



De Luxe Model, for Battery Sets, Electric Receivers and Mains Units.

Price £2/2/0

Φ F

PIFCO ALL IN ONE RADIOMETER



Here is your Opportunity—Make Wireless Batteries—It is a Paying Proposition!

WHETHER you are a Wireless Enthusiast or not, you know what an enormous demand there is for Wireless Batteries—a demand which is ever increasing by leaps and bounds. If you are a Wireless Enthusiast you know also that you and millions of others are constantly on the look out for BETTER Batteries.

Here is a way in which you can meet the demand for BETTER Batteries and Profit Financially—make them yourself in your Spare time by means of our Patented Method and Formula. By making your own Batteries you can SAVE money—by supplying your friends and others you can MAKE MONEY—and you may make up to £300 a year per licence!

ANYBODY CAN DO IT!

YOU Can

Do this :

It has probably never crossed your mind before. You have thought of batteries as "Technical" things—always regarded them as something "mysterious."

The exact opposite is the case. Study the pictures on the left and you will see how really simple it is.

You will need no expensive "plant" or machinery—only a few simple tools and hand presses. You need have no special accommodation—a start can be made upon your present Kitchen Table. The Children can help you.



WE WILL TELL YOU HOW

You may know nothing about Wireless or Electricity—it does not matter in the slightest. We will tell you how to do it—FREE. After receiving our instructions you can start right away to Manufacture! And the work is intensely interesting as well as easy—more fascinating than making your own Wireless Set! The saving is huge—an average worker can complete a 60 roll H.T. Battery in 2 hours at a cost of 2/3 approximately. Compare this with Shop Prices!

Make your Friends' Wireless Batteries and MAKE MONEY.

Consider what this means to you. Not only can you SAVE Money on your own Batteries—and get BETTER Results—but directly your friends know of them they will want some, too! Thus you can begin to build up a profitable Spare-time Business and reap a Golden Harvest from the Wireless and Electrical Market. Many men are already making comfortable EXTRA incomes in this Pleasant, Easy Way.

There's MONEY in it—big money if you are energetic and anxious to get out of the rut! What could you do with £300 a year?

PROFITS GUARANTEED.

Your market is unrestricted—it can never be overcrowded—you sell where you like and when you like. If necessary, we will purchase sufficient of your output to guarantee you a weekly Profit, providing it reaches the required standard of efficiency, which is easily attainable. We will continue your training FREE until you reach that standard—that's fair, isn't it?

Don't hesitate—if you have never seen a Battery before you can MAKE money this way. Let us explain this GILT-EDGED, HONEST PROPOSITION fully. Write at ONCE! Make your SPARE Hours—GOLDEN Hours.

SEND THIS FORM FOR FREE INSTRUCTIONS HOW TO START

COUPON

To Mr. V. ENGLAND-RICHARDS, The ENGLAND-RICHARDS Co., Ltd., 1, 222 King's Lynn, Norfolk.

Sir,—Please send me at once, and FREE, full details as to how I can Make Wireless Batteries and Make Money at Home in my spare time. I enclose 2d. stamps for postage.

Print your name and address boldly in capital letters on a plain sheet of paper and pin this coupon to it.

"Amateur Wireless," Sept. 24, 1932

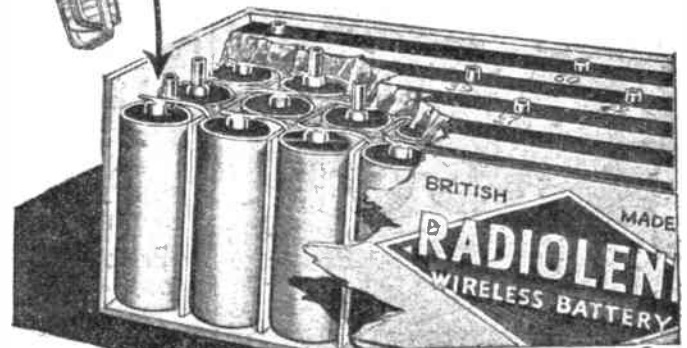

CLIX "MASTER" PLUG

Test this against all others—we are confident you will choose 'CLIX'

The technical press congratulates 'Clix' on the design and efficiency of the 'Clix' "Master" Plug.

POPULAR WIRELESS

Radio enthusiasts who have experienced trouble from soft pronged or too rigid plugs and tapered H.T. Battery sockets will welcome the 'Clix' "Master" Plug.

METAL TO METAL CONTACT. FIRM GRIP. FULL SURFACE CONTACT WITH ANY H.T. OR G.B. BATTERY SOCKETS.

Full range of markings.

Send for Illustrated Folder 'A' of all 'Clix' products.

1 D. 1/2

Supplied with long or short shanks and insulators.



Cheapest PERFECT CONTACT

Lectro Linx Ltd., 254, Vauxhall Bridge Road, S.W.1

7 vital radio accessories in 1

I get stations you've never heard before!
I cut out atmospheric!

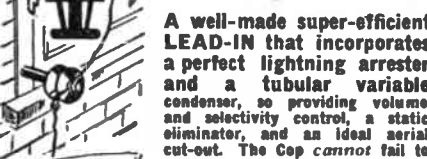

A well-made super-efficient LEAD-IN that incorporates a perfect lightning arrester and a tubular variable condenser, so providing volume and selectivity control, a static eliminator, and an ideal aerial cut-out. The Cop cannot fail to improve vastly the performance of any set with an outdoor aerial. And—it carries a \$100 FREE Insurance Policy. From your local radio dealer, or send P.O. for 2/6 direct to the manufacturers:

CLIFFORD A. PRESSLAND (SALES), LTD., 84 Eden Street, Kingston-on-Thames.

PRESSLAND AERIAL CONTROL

COP

£100 FREE INSURANCE POLICY

PRICE 2/6

POST FREE 6' 5/6 2/6 9' 3/6 12' 3/6

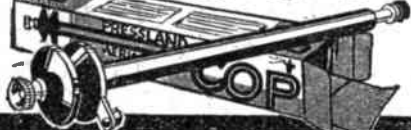

Scientific

BROADCASTING STATIONS

Broadcasting Stations classified in order of wavelengths. For the purpose of better comparison, the power indicated is that of the carrier wave.

Kilo-Metres cycles	Station and Call Sign	Power (Kw.)	Kilo-Metres cycles	Station and Call Sign	Power (Kw.)	Kilo-Metres cycles	Station and Call Sign	Power (Kw.)	
19.737	15,200 Zeesen (DJB) ...	8.0	288.5	1,040 Scottish National	50.0	472.4	635 Langenberg	60.0	
25.4	11,810 Rome (2KO).....	15.0	288.5	1,040 Swansea	0.12	476	630.2 Sebastopol	10.0	
25.53	11,755 Chelmsford (G5SW)	16.0	291	1,031 Tampere	1.0	480	625 North Regional	50.0	
31.25	9,598 Lisbon (CTIAA) ...	2.0	293	1,022 Vapuri	13.0	488.6	614 Prague	120.0	
31.51	9,520 Skamleback.....	0.5	293.7	1,022.5 Limoges (PTT)...	2.5	493.4	608 Trondheim	1.2	
31.38	9,560 Zeesen (DJA) ...	8.0	298.1	1,013 Huizen	8.5	500.8	599 Florence (Firenze)	20.0	
32.28	9,300 Rabat	0.5	298.5	1,004 Tallinn	1.0	502.4	579 Nijni Novgorod	10.0	
33.0	9,090 L.L. Paris.....	0.5	301.5	995 North National	50.0	509	590 Brussels (No. 1)	15.0	
43.75	6,865 Vitus/Paris	0.5	304.9	984 Bordeaux (PTT)	13.0	518.8	578.9 Vienna	15.0	
50.0	6,000 Moscow	20.0	306.5	977 Radio Vitus	1.0	also testing on 1,254 m. from 7.0 p.m. (Mon., Wed., Sat.)			
58	5,172 Prague	0.5	307	977 Zagreb (Agrain)	0.75	525	572 Riga	15.0	
198.5	1,510 Riga (test).....	18.0	307.1	976 Falun	0.5	527	519.8 Palermo	3.0	
206	1,460 Antwerp	0.3	309.9	968 Cardiff	1.0	532.9	563 Munich	1.5	
207.3	1,447 Franchinont	0.2	312.8	959 Cracow	1.5	542	554 Sundsvall	10.0	
208.5	1,438.5 Budapest (2).....	3.0	312.8	959 Genoa (Genova)	10.0	550	545 Budapest (1)	18.5	
210	1,430 Magyarovar	1.5	315	950 Marseilles	1.6	559.7	536 Kaiserslautern	1.5	
211.3	1,420 Newcastle	1.0	318.8	941 Naples (Napoli)	1.5	559.7	536 Augsburg	0.3	
214.3	1,400 Aberdeen	1.0	(Rodno Radio)			1.0	503	531 Wilno	16.0
214.3	1,400 Warsaw (2).....	1.9	319.7	946 Dresden	0.25	506	530 Hanover	0.3	
215.4	1,392.5 Bruxelles Conference	0.2	321.9	932 Göteborg	10.0	509.1	527.1 Grenoble (PTT)	2.0	
217.1	1,382 Königsberg	0.9	325	923 Breslau	60.0	509.3	527 Freiburg	0.25	
218	1,373 Salzburg	0.5	328.2	914 Poste Parisien	60.0	574.7	522 Ljubljana	5.2	
220	1,363.2 Béziers	0.5	332.2	902.8 Milan	7.0	644	465.8 Kazan (RV17)	10.0	
222.0	1,344.6 Cork (6CK)	1.2	335	896 Poznan	1.9	720	416.6 Moscow (PTT)	20.0	
226.1	1,327.5 Fécamp	10.0	334.2	888 Brussels (No. 2)	15.0	740	401 Ostersund	0.6	
227.4	1,319 Flensburg	0.5	341.7	879 Brunn (Brno)	35.0	825	395 Geneva	1.25	
230.6	1,301 Malmö	1.2	345.2	868 Strasbourg (PTT)	11.5	848.7	373.5 Sverdlovsk (RV5)	50.0	
233.4	1,292 Kiel	0.25	348.8	860 Barcelona (EAJ1)	8.0	882	370 Saratov	20.0	
235	1,283 Lodz	2.2	351	855.5 Leningrad (RV70)	20.0	937.5	370 Khar'kov (RV4)	25.0	
235.5	1,274 Kristiansand	0.5	352.1	852 Graz	7.0	967.7	310 Alma Ata	10.0	
237.2	1,265 Bordeaux-Sud-Ouest	2.0	355.8	843 London Regional	50.0	1,000	300 Leningrad	100.0	
238	1,260 Nimes	0.5	358	838 Moscow (Exp.)	15.0	1,035	290 Kiev	100.0	
238.9	1,256 Nürnberg	2.0	360.5	832 Muhlacker	60.0	1,071.2	280 Tbilis (RV7)	100.0	
239.5	1,258 Binche	0.3	363.3	825.3 Algiers (PTT)	16.0	1,071.4	280 Scheveuingen	10.0	
240.0	1,247 Stavanger	0.5	364	824 Bergen	1.0	Haven			
242	1,238 Belfast	1.0	367.0	816 Fredriksstad	0.7	1,083	277 Oslo	60.0	
244.1	1,229 Basle	0.65	368.1	815 Bolzano	10.0	1,106	271.2 Minsk (RV10)	35.0	
245.9	1,220 Berne	0.5	368.1	815 Helsinki	13.2	1,116	268.5 Moscow Popoff	75.0	
245.9	1,220 Cassel	0.25	369.3	815 Seville (EAJ5)	1.5	1,153.8	260 Kalundborg	7.5	
245.9	1,220 Linz	0.5	also on 33 m. (900 Kcs.)			1,171.6	256 Tashkent	25.0	
247.7	1,211 Trieste	10.0	372.2	806 Hamburg	1.5	1,200	250 Istanbul	5.0	
249	1,205 Prague (Strasice)	5.0	376.4	797 Scottish Regional	50.0	1,200	250 Reykjavik	21.0	
250	1,200 Radio Schaerbeek	0.3	380.7	788 Lvov	16.0	1,229.5	244 Boden	0.6	
251.1	1,195 Juan-les-Pins	0.5	385	779 Radio Toulouse	60.0	1,280	237 Novosibirsk	4.0	
253.8	1,180 Barcelona (EAJ15)	3.0	385	779 Stalino (RV26)	15.0	1,275	235.3 Luxemburg	200.0	
253.4	1,183 Gleiwitz	5.0	389.6	770 Archangel	10.0	1,304	230 Moscow (Trades Unions)	165.0	
255	1,175 Toulouse (PTT)	1.0	389.6	770 Leipzig	120.0	1,348	222.5 Motala	30.0	
257	1,166 Hörby	10.0	394	761 Bucharest	12.0	1,380	217.4 Bakou	100.0	
259.3	1,157 Frankfurt-a-M	17.0	398.9	752 Midland Regional	25.0	1,411.8	212.5 Warsaw	120.0	
261.0	1,147 London National	50.0	403	743 Sottens	25.0	1,445.7	207.5 Eiffel Tower	13.5	
263.8	1,137 Moravska-Ostrava	11.0	408	734 Katowice	12.0	1,481.5	202.5 Moscow RV1	100.0	
265.4	1,130 Lille (PTT)	1.3	411.4	729.1 Madrid (EAJ7)	2.0	1,538	195 Ankara	7.0	
268.8	1,124.5 Valencia	6.0	413	725 Athlone (tests)	0.0	1,554.4	193 Daventry (Nat.)	30.0	
267.0	1,120.9 Breinen	0.2	416.4	725 Dublin	1.2	1,600	287.5 Irkutsk	10.0	
269.4	1,112 Bari	20.0	419	716 Radio Marce (Rabat)	6.0	1,620	185 Norddeich KVA	10.0	
271.4	1,105 Rennes	1.3	424.3	707 Berlin	1.5	1,634.9	183.5 Zeesen	60.0	
273.7	1,096 Turin (Torino)	7.0	430.4	697 Madrid (Espana)	2.0	1,725	174 Radio Paris	75.0	
276.5	1,085 Heilsberg	60.0	435.4	697 Stockholm	55.0	1,796	167 Lahti	54.0	
279.5	1,073.5 Bratislava	14.0	441	680 Rome (Roma)	60.0	1,875	160 Hiversum	8.5	
281	1,067 Copenhagen	0.75	447.1	671 Paris (PTT)	0.5	1,935	155 Kaunas	7.0	
282.2	1,063 Lisbon (CTIAA)	2.0	453.2	662 Danzig	0.5	2,525	119.3 Königs-wuster-Hausen (press)	15.0	
283	1,058 Innsbruck	0.5	453.2	662 Klagenfurt	0.5	2,900	103.5 Königs-wuster-Hausen (press)	15.0	
283.6	1,058 Berlin (E)	0.5	455	650 Radio Agen	0.5	4,000	75 Königs-wuster-Hausen (press)	15.0	
283.6	1,058 Magdeburg	0.5	456.0	557 San Sebastian	0.5				
288	1,049 Montpellier	0.8	450.4	653 Beromuenster	60.0				
287.1	1,045 Radio Lyons	10.0	405.8	644 Lyons (PTT)	1.5				
288.5	1,040 Bournemouth	1.0	405.8	644 Tartu	0.5				
288.5	1,040 Plymouth	0.12							

The New "LANGMORE" No. GI

RADIO-GRAMOPHONE CABINETS IN FIGURED OAK
Size overall, 3 ft. 6 in. high by 21 in. wide by 15 in. deep.
THE TOP SECTION. Size, 4 1/4 in. high by 18 in. wide by 14 in. deep.
THE CENTRE SECTION. Size 10 in. high by 18 in. wide by 14 in. deep, to take a panel either 18 in. by 7 in. or 18 in. by 8 in.
THE BOTTOM SECTION. Size, 16 in. high by 18 in. wide by 13 1/2 in. deep. With "GALLEON," as illustrated, or "CATHEDRAL" Fret Fronts.
Wooden panels to fit, with oval aperture, 12 in. by 5 1/2 in., 2/- extra.

The whole of the back is enclosed by double doors, so that all parts are easily accessible. ALL are fitted with hinged top, heavy platform to take a 12-in. turntable for the Gramophone, and a substantial baseboard for the Wireless Set.

Beautifully Finished Jacobean Oak
NEW ILLUSTRATED CATALOGUE FREE
THE MISCELLANEOUS TRADING CO. LTD.
13 & 17, NEW OXFORD ST., London, W.C.1.
Phone: Holborn 4894. Trade Inquiries Invited

PRICE
49/6 each
Packed FREE and sent Carriage Paid to any address in Great Britain.

The Ideal Set FOR BEGINNERS AND EXPERTS—THE "A.W." "WIZARD."

FREE!

CALCULATION RESISTANCE CHART!

This is without doubt one of the most valuable charts yet published, as it can quickly give you the four following factors: 1, Current; 2, Watts; 3, Volts; 4, Ohms. Drop us a line and we will send you a copy. If you are thinking of constructing a set at the present time, consider using WATMEL Components—"They get the best out of any set," and we have three specialties at the present moment—Potentiometers, Resistances and Coils.

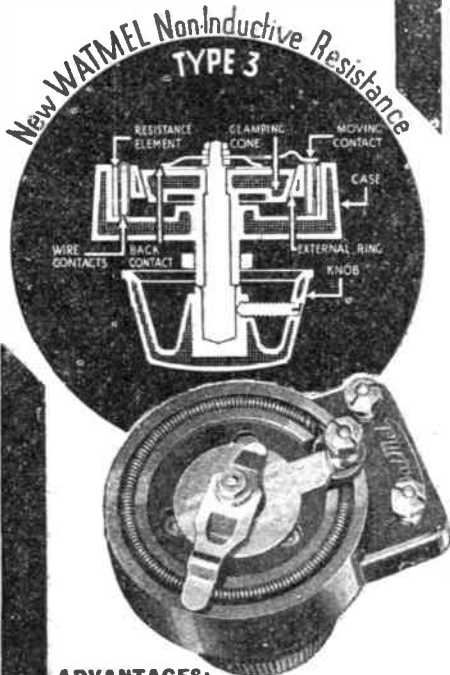

ADVANTAGES:

1. NON-INDUCTIVE. This is because the resistance element is not wire.
2. Furthermore, the wire contacts shown make contact with the resistance element so that the moving contact does not wear out the element. This guarantees true and true contact always.
3. The extremely firm and even contact with element. This is obtained by a new patented clamping cone which directly it is screwed down forces the sprung external ring against the wire band. The pressure is so great that perfect all-round contact is made with the element which will not vary under any circumstances.
4. Self-cleaning wiping contacts—this ensures perfectly clean contact always.
5. Silent in operation.
6. Price **4/6**

We recommend this resistance (Type 3) only for values above 50,000 ohms where wire-wound potentiometers are not required. Patents for this new resistance have been applied for.

If you have any difficulty in obtaining Watmel Components, WRITE DIRECT TO US.

TRADE ENQUIRIES INVITED



Watmel Wireless Co., Ltd., Imperial Works, High Street, Edgware.
Telephone: Edgware 0323. W.C.72



GET THESE CATALOGUES FREE
Here "Observer" reviews the latest booklets in folders issued by well-known manufacturers. If you want copies of any or all of them FREE OF CHARGE, just send a postcard giving the index numbers of the catalogues required (shown at the end of each paragraph) to "Postcard Radio Literature," "AMATEUR WIRELESS," 58/61, Fetter Lane, E.C.4. "Observer" will see that you get all the literature you desire. Please write your name and address in block letters.

K.B.'s Latest

TAKE my tip and get the new pocket folder of Kolster Brandes' sets and radio-grams. There are some "stars" such as a six-valve mains-driven super-het. and the new inexpensive Cobra three-valver. Copies of this pocket folder can be obtained free on request. **842**

Automatic Tuning

Automatic tuning has been introduced on the Zetavox eight-valve super-het. Automatic volume control in combination with automatic tuning means that once the control is set, any one of the stations on the automatic dial can be brought in at the same strength, and with practical elimination of fading. The Zetavox chassis is described in a new booklet, a copy of which I have just received. **843**

The Telnor

When building your new set, why not try the new Telsen Telnor, which will enable you to get a very neat panel layout with all the controls grouped together on one escutcheon plate? The Telnor is one of the new components described in the latest Telsen catalogue. **844**

Becker Switches

Some very well made moulded switches are in the new Becker range. These are suitable for mains switching and for many wireless jobs, such as radiogram change-over. Some of them are of the one-hole fixing type suitable for panel mounting. Get the new Becker folder and see the range for yourself. OBSERVER. **845**

ELECTRADIX BARGAINS

SEE
SEPT.-OCT.
SALE LIST

ELECTRADIX RADIOS,
218, Upper Thames St., E.C.4
Phone: City 0191.



We supply all good quality Radio Receivers, and Accessories on deferred terms. Large stocks are carried and orders are executed promptly. Send list of requirements and a quotation will be sent by return of post. Price List free on request.

MANUFACTURERS' KITS

NEW COSSOR MELODY MAKER, Model 335 (just released). Complete Kit of Parts, Valves, and Loud-speaker and Cabinet. Cash Price, £7 17/6. And 11 monthly payments of 14 10. With order **10/-**

NEW TELSEN JUPITER S.G.3 KIT. Complete set of Components less Valves. Cash Price, £3 17/-. And 11 monthly payments of 7/-. With order **7/-**

NEW LISSEN "SKY SCRAPER" KIT, including Valves. Cash price £4/9/6. And 11 monthly payments of 8/3. With order **8/3**

NEW TELSEN AJAX 3. Complete Set of parts for Det.; 2 L.F. Receiver, less Valves. Cash Price, £3 1/6. And 11 monthly payments of 5/8. With order **5/8**

READY RADIO "METEOR" S.G.3 KIT, including cabinet, valves, and moving coil unit. Cash Price, £8/17/6. And 11 monthly payments of 16/8. This Receiver tunes to Ultra-short Waves. With order **11/-**

READY RADIO 303 KIT, Cabinet Model, including moving-coil unit and valves. Cash Price, £6/17/6. And 11 monthly payments of 12/9. With order **10/-**

ACCESSORIES

NEW ORMOND PERM. MAGNET MOVING-COIL L.S. UNIT. (just released) Cash Price £1 18/6. And 7 monthly payments of 5/4. With order **5/4**

ATLAS ELIMINATOR, A.C.244. 3 H.T. Tappings. 20 A.A. output. Cash Price, £2 19/6. And 11 monthly payments of 5/6. With order **5/-**

NEW R. & A. "CHALLENGER" PERM. MAGNET MOVING-COIL UNIT. Cash Price, £1 15/- And 6 monthly payments of 5/8. With order **5/-**

NEW EPOCH 20c PERMANENT MAGNET MOVING-COIL UNIT. Cash Price, £1 15/- And 6 monthly payments of 5/7. With order **5/7**

NEW BLUE SPOT 99 P.M. MOVING-COIL UNIT. The finest of the new Permanent Magnet Units. Cash Price, £2/19/6. And 11 monthly payments of 5/6. With order **5/-**

NEW R. & A. "VICTOR" PERM. MAG. MOVING-COIL REPRODUCER DE-LUXE. With 6 Ratio Transformer and Cadmium plated Grill. Cash Price, £3/10/-. And 11 monthly payments of 6/5. With order **6/5**

BLUE SPOT 100U. INDUCTOR UNIT. Cash Price, £1/12/6. And 6 monthly payments of 5/2. With order **5/-**

To avoid delay, will customers kindly send first payment with order.
All above carriage paid.



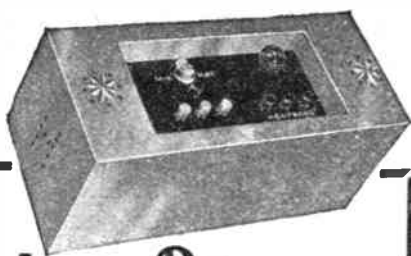

Mains Power for your Radio

Here is a Mains Unit that will run a 3- or 4-valve Receiver from A.C. Mains. High Tension and raw A.C. supply for A.C. Valves solves your H.T. and L.T. problems. Scrap your batteries and accumulators now and increase the range and selectivity of your Radio set.

HEYBERD MAINS UNIT, MODEL M.W.1.
Alternative Outputs: 50 m/A. at 200 volts, or 30 m/A. at 150 volts. L.T., 4 volts 5 amps for A.C. valves.

Tappings: 60/120 volts var. S.G., 180 volts and 200 volts fixed.

Incorporating Heayberd sterling components and Westinghouse Rectifier. Complete in neat metal case—ready to switch on. Fully Guaranteed. Price, £6 7s. 6d.

Models at all prices to suit all types of receivers, for A.C. or D.C., are dealt with fully in the New Handbook.



Post Coupon for Heayberd handbook on Mains Working

I enclose 3d stamps for New Handbook of Mains Equipment. Packed with Technical Tips, Service Hints and diagrams

Mr. _____
Address _____

F.C. HEYBERD & Co.,
10 FINSBURY STREET, LONDON, E.C.2
One minute from Moorgate Stn

The ACME of CRAFTSMANSHIP High Grade RADIO GRAMOPHONE CABINET

of exclusive modern design, with record wells, handmade and polished, on Queen Anne legs.
Figured Oak .. 27 13 6
Figured Walnut or Mahogany .. 29 9 0
(Carriage Paid.)
Illustrated Catalogue Free. Cabinets made to order a speciality.

GILBERT
Cabinet Maker, SWINDON
Estimates Free. Estd. 1866.



MATERIALS SUPPLIED FREE

in Profitable Spare Time Employment making Leather Matting at Home

Finished Work Bought at Fixed Rates.
Write for particulars, Dept. D420.

ARNOLDS (Wellingborough) Ltd., Wellingborough.

LET "A.W." SOLVE YOUR WIRELESS PROBLEMS

"TUNING A SHORT-WAVE RECEIVER"

(Continued from page 630)

reached with the carrier satisfactorily in tune.

If your short-wave receiver or adaptor is equipped with a variable aerial coupling device, make this coupling about 50 per cent. "in," whether it be by means of a variable condenser or a movable coil. Making the coupling too tight will, no doubt, increase signal strength to some extent, but it will also introduce many further troubles and the receiver will probably become "live"; that is to say, the tuning will alter when your hand comes near to any metal part of the set. If your receiver uses a high-frequency valve in front of the detector, however, this effect will probably not be noticed at all. The above remarks apply in general to all receivers or adaptors of the straight type which do not work on the super-heterodyne principle.

Therefore, we now step to the super-heterodyne type of outfit, which may, of course, consist of either a complete super-heterodyne receiver or an ordinary receiver used in conjunction with a convertor. This type of outfit is undoubtedly the easiest to tune, and this, perhaps, adds largely to its general effectiveness, as the results obtained do not rely to such a great extent on the skill of the operator.

Assume we are using a convertor in conjunction with an average type of screen-grid three-valve receiver. The most important thing to remember is that volume is not controlled by the reaction condenser on the convertor. Volume is,

instead, controlled entirely by the normal reaction condenser on the receiver itself and the convertor must be in a state of continuous oscillation all the time. Only when both the convertor and the receiver or second detector are oscillating will you be able to hear any carrier waves. Once a carrier wave is found, slacken off the receiver reaction control and generally, without further adjustment, you will now hear the required station.

Thus with an outfit of this type, it is possible to set the receiver just under the oscillation point and the whole outfit will now remain just under this point, while you can tune in all the stations on the adaptor itself without hearing a single whistle. So it is not necessary to be continually "following up" the short-wave dial every time the reaction condenser is adjusted—at least this might happen to some exceedingly slight degree, but the effect will be hardly noticeable.

The general procedure for tuning a complete super-heterodyne receiver is generally the same as that outlined above, but controls may vary slightly in type on individual receivers. Remember that you probably won't have absolute success the first time "out" with your short-wave receiver and a few nights' practice will certainly be well spent. You will probably gather the impression that the short-wave world is full of code and telegraph stations, but a few hours spent in careful searching will (provided atmospheric conditions are reasonably good) prove that this is not correct and that there are quite a number of really interesting stations to be tuned in below 100 metres.

FUSE HOLDERS AND FUSES

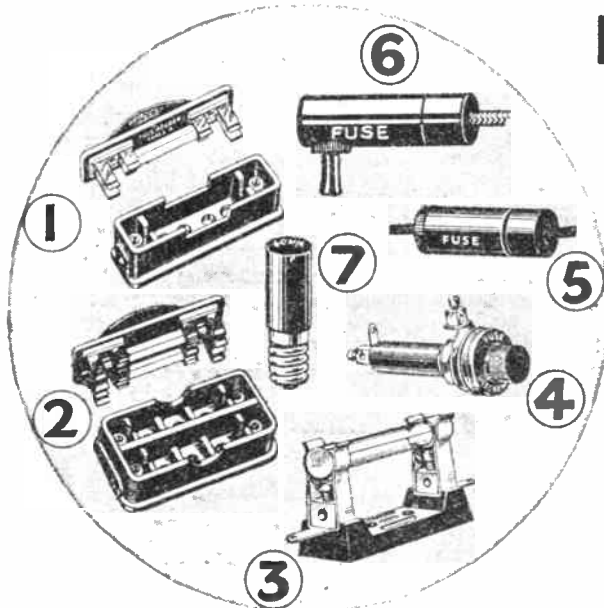

- 1 SINGLE SAFETY BASE BOARD FUSE-HOLDER. Fuse carried on lid, making shocks impossible. Complete with 1 amp. fuse 1/6
- 2 TWIN SAFETY BASE BOARD FUSE-HOLDER. Fuses carried on lid, rendering shocks impossible. Complete with two 1 amp. fuses. 2/6
- 3 SINGLE OPEN FUSE-HOLDER. With 1 amp. fuse 9d.
- 4 PANEL FUSE-HOLDER. For panel mounting. With 1 amp. fuse .. 1/6
- 5 FLEX FUSE-HOLDER. With 1 amp. fuse .. 1/-
- 6 WANDERFUSE. With 150 m.a. fuse 1/-
- 7 "SCRUFUSE," Not bulb, not cartridge, yet both! .. 6d.

SPARE FUSES, LONG FUSE. 60, 150, 250, 500, 750 m/a., 1, 2, or 3 amp. SHORT FUSE for wanderfuse only, 60 and 150 m.a.

Each rating a different colour, avoiding possibility of error.

5 different colour-coded ratings 60 to 750 m.a.

BELLING-LEE

Advert. of Belling & Lee, Ltd., Cambridge Arterial Road, Enfield, Middlesex

Dealers will fit other ratings in any of these holders at the time of purchase.

DARIO PRICE REDUCTIONS & NEW RANGE



Fit Dario Valves in your receiver and its sensitivity, range, and volume will increase enormously. Do not tolerate valve deterioration. Why let those worn-out valves spoil your reception when, at such a little cost, you can restore the original sensitivity and purity of your set with Dario Valves. You will be amazed at the improvement.

FREE—Write to us now and we will send you free the Dario Booklet, which illustrates the full Dario range of valves, together with slopes and all technical information. If you are in doubt as to the valves you should be using in your receiver, write to us for a Free Valve Inquiry Coupon and we shall be pleased to tell you the correct valves for your set.

DARIO 2-VOLT VALVES	
DARIO Screenodion Bivolt	12/6
DARIO Screenodion Variable Mu	13/6
DARIO Universal Bivolt, reduced to ..	5/-
DARIO Super H/f Bivolt, reduced to ..	5/-
DARIO Detector Bivolt (non microphonic) to	5/-
DARIO Super Detector Bivolt reduced	
from 6/6 to ..	5/-
DARIO Super Power Bivolt reduced to ..	6/6
DARIO Hyper Power Bivolt reduced to ..	7/-
DARIO Polyodion (Multi-grid)	12/6

DARIO A.C. MAINS VALVES (I.H.)	
DARIO A.C. Screenodion	13/6
DARIO A.C. Super Screenodion (Steep slope)	13/6
DARIO A.C. Variable Mu Screenodion ..	13/6
DARIO A.C. Super Detector reduced to ..	9/6
DARIO A.C. Super H.F. reduced to ..	9/6
DARIO A.C. Super Power	10/-
DARIO A.C. Polyodion (Multi-grid) ..	13/6

DARIO D.C. MAINS VALVE 20-VOLT (I.H.)	
DARIO D.C. Screenodion	15/-
DARIO D.C. Super Detector	11/6
DARIO D.C. Super Power	12/6
DARIO D.C. Polyodion (Multi-grid) ..	15/6

FULL WAVE RECTIFYING TUBES (4 VOLT A.C.)	
DARIO F.W.1 (2x250 v-60 m.a.)	9/-
DARIO F.W.2 (2x350 v-120 m.a.)	11/-
DARIO F.W.3 (2v500 v-120 m.a.)	14/-

Also the usual 4-volt Battery range.

IMPEX ELECTRICAL LTD., 538 High Road, Leytonstone, London, E.11

DARIO VALVES FOR-PROGRESS, EFFICIENCY, ECONOMY

STENIBAC



RADIO CABINETS

"First in Their Class"
MODEL V26. Beautiful Radiogram Cabinet. 3 ft. 2 in. high, 1 ft. 10 in. wide, 1 ft. 4 in. deep. Accommodates any type of Gramophone Motor and set with Baseboard, 18 in. by 14 in. or smaller. Hand polished.
PRICES: (All Models)
 OAK - - - £3 15 0
 MAHOGANY - - £4 0 0
 WALNUT - - - £4 5 0

STAND 80 (Gallery)
 Northern National Radio Exhibition City Hall, Manchester Sept. 28—Oct. 8

Write for Free Catalogue of Latest Models Post Free.

STENIBAC Ltd. DEPT. A.W. 303, ESSEX ROAD, ISLINGTON, LONDON, N.1.

PROTECT YOUR VALVES FROM ACCIDENTAL SHORT-CIRCUITING



BY FITTING THE "BUSCO" FUSE SWITCH

All "BUSCO" Switches have Self-cleaning Contacts and "Set Cracking" is safeguarded through the Vice-like Grip at Contact Points.

3/- EACH Post Free Complete with Fuse Bulb

BUSBY & Co. Ltd, Price St., BIRMINGHAM

Tunewell All-Purpose H.F. Choke.
 Wound on hollow-cored moulding. Capacity reduced to absolute minimum. Resistance unequalled by any other. Range 20/2,000 metres, 3/6.

Tunewell Volume Control.
 Increases power of reception. Expenses much less than with ordinary types. Logarithmically wound with double silk-covered wire. Paper-aid between windings. Type V. All sizes up to 50,000 ohms, 5/6. From 50,000 to 100,000 ohms, 7/6. Type F. Variable Resistance or Potentiometer. Equal resistance between studs. Max. Dissipation 3 watts, 5/6.



"Guide to SUPER RADIO" with 8 BLUE PRINTS FREE!

This interesting Guide has already shown many thousands the way to Super Radio—at lower cost. It incorporates 8 Blueprints (Bandpass All Mains 3, S.G.3, S.W.3, Kit Eliminator, etc.) and details of the New Tunewell

Super-Radio Components. Whatever the set, Tunewell Components will give you better results. Get this Guide now—FREE.

FILL IN AND POST THIS—NOW!

To Tunewell Radio Ltd., 54, Station Rd., London, N.11.
 Send me "Guide to Super-Radio" to:

Name

Address

My nearest dealer is

Post in unsealed envelope, half-penny stamped.

to—TUNEWELL RADIO, LTD. 54 Station Road, London, N.11.

A.W.7

TUNEWELL

SET EXPERTS ARE SET ON IGRANIC

PREPAID ADVERTISEMENTS

Advertisements under this head are charged THREEPENCE PER WORD, minimum charge THREE SHILLINGS. DEPOSIT SYSTEM.

As the publishers cannot accept responsibility for the bona fides of advertisers in this publication, they have introduced a system of deposit which it is recommended should be adopted by readers when dealing with persons with whom they are unacquainted.

The amount of the Deposit and Fee must be remitted by Postal Order or Registered Letter (Cheques cannot be accepted), addressed to "AMATEUR WIRELESS", ADVERTISEMENT DEPARTMENT, 58/61 FETTER LANE, LONDON, E.C.4

ENGINEERS.—Sit down and think this over. We believe that our 200-page handbook, "ENGINEERING OPPORTUNITIES" will show you the way to well-paid, permanent, and progressive employment. In any case, the handbook costs nothing, and it will at least show you various surprising possibilities about which at present you know nothing.

RYALL'S RADIO, 83 Chancery Lane, London, W.C.2. New, surplus, and tested used radio components at very reasonable prices. Write for free list or inspect our display personally.

BRUCE PRODUCTS.—Grade "A" quality Mains Transformers and L.F. Constant Inductance Smoothing and Output Chokes. Recommended and tested by "Amateur Wireless".

MAINS TRANSFORMER REPAIRS.—If you have a faulty or burnt-out mains transformer, we can rewind to your requirements at very moderate charges.

REVELATION! By fitting a "Vita" Wizard Tuning Coil in any two- or three-valve (straight) receiver. Marvellous results. Fitted in ten minutes. Satisfaction guaranteed.

EXPERIMENTERS' SURPLUS. Transformers, Coils, Headphones, etc., 6/- parcels. Postage paid.—Hodgson Radio, Mareham-le-Fen, Boston, Lincs.

RADIO CABINET SPECIALISTS.—Redrup & Son (A.W. Dept.), 178 Albert Road, Southsea. Send 2d. stamp for Illustrated Catalogue.

VALVES.—PM1LF, Tungram LG210, 6d. each; PM2, PM6, 9d. each; PM2DX, Six Sixty 217D, 1/- each. Emission passable, filament continuity guaranteed.—Below.

LOUD-SPEAKERS.—Amplion Wall Cones, 10/-; Senior Horn type, 4/-; Junior ditto, 3/6.—Below.

L.F. TRANSFORMERS.—5-1 ratio, shrouded, 1/9. Four-pin Anti-micro. Valve Holders, 3d. each. Above subject unsold, per C.O.D.—Tonge, 10 West Crescent, St. Annes.

POUNDS SAVED on kits, components, batteries. Quotations given. Write Childs, 29 Moray Road, London, N.4.

MODERN RADIO GRAMOPHONE CABINETS.—The most wonderful bargains ever offered. Made by skilled craftsmen and hand polished. Finished figured walnut, mahogany, and oak, 70/-. Satisfaction guaranteed.

OAK CABINETS.—Beautifully finished, hinged lid. 14 in. by 7 in. by 10 in., 7/6; 16 in. by 7 in. or 8 in., and 18 in. by 7 in. by 10 in., 8/-; 21 in. by 7 in. by 10 in., 9/6; Baseboards, 6d. Refused unsatisfied. 18 in. by 7 in. by 10 in. cabinet, Permeol panel and baseboard, 14/6 C.P. Other sizes stocked. Quick dispatch. Fret fronts. Baffles. Speaker cabinets from 8/6. Trade supplied. All kinds of Radio apparatus. Send for "Guide to Wireless," 1/-.—F. S. Gibson, 99 Burnley Road, Ainsdale, Lincs.

BANKRUPT BARGAINS.—Lst free with 3-valve diagram. Three-valve Kit, 22/6; S.T. 300, 42/-; Century Super Kit, 75/-. Meter 3, 40/-. Any kit supplied. Part exchange. Let me know what you have for disposal and what you require. Transformers from 2/9. Dual Coils, 3/6. Panels, polished, 2/3. Fixed Condensers, 5d. Valve Holders and Switches, 4d. Telsen Ace, 4/9; Radiogram, 6/-. Speaker Units from 2/6. D.C. M.C., 18/6. P.M. M.C., 22/6. Eliminators, D.C. and A.C., cheap. S.M. type air-spaced, 0005, with dials, 3/6. Mica, 0005, 10d. Differentials, good quality, 1/9. H.F. Chokes from 1/-. Tungrams from 4/6. Polar 3-gang, 7/-. Complete Speakers from 7/6. Accumulators from 2/9. Headphones, 3/9. Cabinets, oak, from 6/-. All goods of decent quality. Advice free.—Dutlin, 143b Preston Road, Brighton.

RADIO AT LESS THAN COST! Kits and Components. Send list of requirements. Twenty to 80 per cent. saving on any circuit guaranteed now. "This week's special," comprising limited stock, quality components below cost (Dubilier, Burndet, etc.): L.F. Transformers, 1/3; Binocular H.F. Chokes, 8d.; Speaker Units, 1/11; v-condensers (0005, 0003), 11d.; f-condensers, v-holders, 3d.; g-leaks, 4d.; Valves, guaranteed, 2/11. Kits (with diagrams), 3-v. S.G., 18/6; 3-v., 10/6; 2-v., 8/6. Over 10,000 sent C.O.D.—(City Radio Surplus Suppl. s, 14 Currier Street, E.C.4.

"Amateur Wireless and Radiovision." Price Threepence. Published on Thursdays and bearing the date of Saturday immediately following. Post free to any part of the world; 3 months, 4s. 6d.; 6 months, 8s. 9d.; 12 months, 17s. 6d. Postal Orders, Post Office Orders, or Cheques should be made payable to "Bernard Jones Publications, Ltd."

General Correspondence is to be brief and written on one side of the paper only. All sketches and drawings to be on separate sheets. Contributions are always welcome, will be promptly considered, and if used will be paid for. Communications should be addressed, according to their nature, to The Editor, The Advertisement Manager, or The Publisher, "Amateur Wireless," 58-61 Fetter Lane, London, E.C.4.

THE MOST POPULAR RADIO-GRAM CABINET ON THE MARKET. Reduced 39/6 Carriage to Paid!!! Quality Guaranteed Improved. Soundly constructed in select oak etc., and hand polished. SPECIFICATION.—3' 3" high, 1'10" wide, 1'6" deep. To take panels up to 18" x 7". Panel opening to suit set. These cabinets allow ample room for the following:—Pick-up, Motor, Speaker, Batteries, etc., all for the reduced price of 39/6.



SHORT-WAVE BARGAIN!

SHORT-WAVE PLUG-IN COILS, Nos. 2-3 TURNS. 8D EACH Usual Price 1/6. AIR DIELECTRIC STANDARD SIZE. 4 for 2/4, 8 for 4/6, all Post Paid. The set of eight covers whole S.W. range. Base-board Coil Holders 4d.



SCIENTIFIC SUPPLY STORES, DEPT. A.W., 126, NEWINGTON CAUSEWAY, SOUTHWARK, LONDON, S.E. Phone: Hop 4177.

DESIGNS FOR APPARATUS FOR ANY RADIO PURPOSE, INCLUDING TRANSMISSION. OVERSEAS ENQUIRIES INVITED; ANY APPARATUS SUPPLIED. CONSTRUCTIONAL WORK UNDERTAKEN. We undertake to solve your problems, including obtaining Amateur Transmitting Licence. Whatever your difficulty, write us. Charge: 3/- per query, four or more, 2/6 each, with diagrams. Radio Technical Agency, (Dept. A.W.), 2, Westgate Chambers, Newport, Mon.

10,000 Gramo-motors from Stock. Big Cash Discount Allowed! Make a Gramophone or Radiogram. Order loose kits and assemble them at home. Get for 3d. our new 64-page catalogue with scale drawings and instructions how to make cabinets, gramophones or radiograms, and what parts to choose. We sell motors from 7/8, tone-arms, soundboxes, 1/6, pick-ups, big volume horns, loud-speakers, radi kits, complete receiving sets, gramophones, radiograms and parts. Established 1903.—The Regent Fittings Co., A.W., 120 Old Street, London E.C.

REPAIRS to Loudspeakers 4/-. Blue Spots 5/-. Transformers 4/-. Moving Coils, etc. quoted for. Prompt service. 12 months guarantee. Trade Invited. Streatham 6618. Loud-speaker Repair Co., 2 SHIPKAY ROAD, Balham, London

TAYLEX WET H.T. BATTERIES Give long service, improved volume and tone. Very economical. Replacements for Taylex or Standard batteries at low prices details post free. Also Bargain List; Radio Kits and parts at lowest prices. A. TAYLOR, 57 STUDLEY ROAD, STOCKWELL, LONDON

FULL-SIZE BLUEPRINTS

When ordering, please send Postal Order, NOT STAMPS. CRYSTAL SET (6d.) 1931 Crystal Set ... AW308 ONE-VALVE SETS (1s. each) Easy to Build One ... AW304 Short-wave One valver ... AW327 B.B.C. One valver ... AW344 Portable Short-wave One ... AW354 TWO-VALVE SETS (1s. each) Two Star 2 (D, Pen) ... AW315 The 25/- Two (D, Trans) ... AW330 Ten-Station Two (D, Trans) ... AW336 Inexpensive A.C.2 (D, Trans) ... AW346 Midget Two (D, RC) ... AW348 Mascot Two (D, Trans) ... AW353 Ideal Regional 2 (D, Trans) ... AW357 Music Lover's Two (D, Trans) ... WM260 New Economy Two (D, Trans) ... WM265 Family Two (D, Trans) ... WM278 Screen-grid Two (SG, Trans) ... WM289 Economy A.C. Two (D, Trans) ... WM286 A Two for 7 Metres (D, Trans) ... WM295 THREE-VALVE SETS (1s. each) 1932 Ether Searcher (SG, D, Pen) ... AW325 Wide World Short-wave Three (D, RC, Trans) ... AW332 New Favourite Three (D, RC, Trans) ... AW334 Home-Lover's All-electric 3 (SG, D, Trans) ... AW335 The P.W.H. ("Mascot" D, RC, Trans) ... AW337 Home-Lover's Battery 3 (SG, D, Trans) ... AW341 18 Radiogram (SG, D, Trans) ... AW343 New Regional Three (D, RC, Trans) ... AW349 World-Ranger Short-wave Three (D, RC, Trans) ... AW355 The Wizard (SG, D, Trans) ... AW360 Ether Marshal (SG, D, Trans) ... WM247 Five-advantage Three (D, RC, Trans) ... WM257 Everybody's A.C. Radiogram (SG, D, Trans) ... WM258 Double Band-pass Three (SG, D, Trans) ... WM259 Everybody's A.C. Radiogram (with automatic G.B.) ... WM262 New Economy Three (SG, D, Trans) ... WM263 New Plug-in Coil Three (D, 2 Trans) ... WM270 Transportable Three (SG, D, Trans) ... WM271 Multi-Mag Three (D, 2 Trans) ... WM288 Percy Harris A.C. Radiogram (D, RC, Trans) ... WM294 The Prosperity Three for Batteries (SG, D, Trans) ... WM296 The Prosperity Three for A.C. Mains ... WM297 The Prosperity Three for D.C. Mains ... WM298 FOUR-VALVE SETS (1s. 6d. each) Four Star 4 (SG, D, RC, Trans) ... AW318 50/- Four (SG, D, RC, Trans) ... AW331 Advance Four (2 SG, Trans) ... AW356 Your Home Radiogram (SG, D, RC, Trans) ... AW358 Brookman's Three-plus-one (SG, D, RC, Trans) ... WM233 Ether Rover (SG, D, RC, Trans) ... WM266 Quadryne (2 SG, D, Pen) ... WM273 Double Band-pass Four (SG, D, RC, Trans) ... WM274 Everybody's Radiogram (SG, D, RC, Trans) ... WM276 A.C. Quadryne (2 SG, D, Pen) ... WM279 Ideal A.C. Home Super (Super-het) ... WM290 Gold Coaster (A.C. Short-waver) ... WM292 Triple-tune Four (2 SG, D, Trans) ... WM293 FIVE-VALVE SETS (1s. 6d. each) James Short-wave Super (Super-het) ... AW328 Simple Super (Super-het) ... AW340 Ideal Home Super (Super-het) ... WM280 Easytune 60 (Super-het) ... WM284 SIX-VALVE SETS (1s. 6d. each) Century Super (Super-het) ... AW287 A.C. "Century Super" (Super-het) ... AW295 Mains Unit (1/-) ... AW295A Super 60 (Super-het) ... WM229 Super 60 (with Wearite base) ... WM249 Super 60 (with Lewcos base) ... WM251 1932 Super 60 (Super-het) ... WM269 1932 A.C. Super 60 (A.C. Super-het) ... WM272 SEVEN-VALVE SETS (1s. 6d. each) Super Senior (Super-het) ... WM256 Super Senior (Wearite base and Lewcos coils) ... WM261 PORTABLES (1s. 6d. each) Hiker's Two (D, Trans) (1/-) ... AW345 General-purpose Portable (SG, D, RC, Trans) ... AW351 Town and Country Four (SG, D, RC, Trans) ... WM282 Everybody's Portable (5-valve super-het) ... WM291 AMPLIFIERS (1s. each) Universal Push-pull Amplifier ... AW300 "A.W." Record Player (L.F. Push-pull) ... AW319 "Quality" Amplifier (D.C.), 1/6 ... WM264 A-P-A (Power, Amplifier for A.C. Mains) ... WM275 A-P-A Radio Unit (SG, D) ... WM281 Economy Gramophone Amplifier ... WM277 MISCELLANEOUS (1s. each) Short-wave Plug-in Adaptor (6d.) ... AW326 Short-wave Super-het Adaptor (6d.) ... AW329 Ether Searcher Radio-gramophone Motor Board ... AW333 "A.W." Short-wave Adaptor ... AW339 "Mascot" Mains Unit ... AW350 "A.W." Trickle Charger ... AW352 An Add-on Band-pass Unit ... AW359 "W.M." Linen Diaphragm Loud-speaker ... WM235 Super 60 A.C. Unit ... WM248 A Simple Mains Unit ... WM283 Short-wave Director (6d.) (wavemeter) ... WM285 Voltage Regulator ... WM287 Copies of the "Wireless Magazine" and of "Amateur Wireless" containing descriptions of most of these sets can be obtained at 1s. 3d. and 4d. respectively, post free. Index letters "A.W." refer to "Amateur Wireless" sets and "W.M." to "Wireless Magazine." Address letters: Amateur Wireless Blueprints Dept., 58-61 Fetter Lane, London, E.C.4

Amateur Wireless INFORMATION BUREAU COUPON Available until Saturday OCTOBER 1, 1932 FEE 1/-

What a difference!



100D NOW **52/6**

All Blue Spot Products may be purchased by instalments.
Send for Catalogue A.W. 52.S.

EVERYBODY who hears Blue Spot 100D makes this remark. Old speakers, other speakers, seem muffled and indistinct. You wonder how you could possibly have enjoyed, yes actually enjoyed, listening to their wheezy mumbling or raucous roaring.

Afterwards, when you've got over your first surprise, you can appreciate the quality of the reproduction 100D gives you. You can sit and listen for those half-hidden notes (those that were really hidden on other speakers), and you will actually hear them, just as they should be. You will listen to lecturers and find them friends. Singers become human beings instead of disembodied voices. Dance bands seem to regain the "pep" you thought they'd lost.

100D has, of course, 100U unit inside its handsome oak cabinet, and 100U gives as good a performance as a really good moving-coil speaker. It is sensitive

to very small inputs and needs no matching transformer for Pentode valves. You will find it hard indeed to discover a better speaker, especially for the smaller sets—whether mains or battery driven.

Make your Gramophone into a Radio-Gram

Fit a Blue Spot Pick-Up on your gramophone and link it up with your set. You will hear your records in a new way, with all the hidden beauty of the original developed and reproduced to perfection. Price with self-contained volume control, 63/-



SEE ALSO
ADVERTISEMENT
ON PAGE 644

THE BRITISH BLUE SPOT COMPANY LTD.
BLUE SPOT HOUSE · 94, 96 ROSOMAN STREET · ROSEBERY AVENUE · LONDON · EC1

Telephone: Clerkenwell 3570. Telegrams: "Bluspot, Isling, London."
Distributors for Northern England, Scotland and Wales: H. C. RAWSON (Sheffield and London), Ltd., 100, London Road, Sheffield; 22, St. Mary's Parsonage, Manchester; 44-46, High Bridge, Newcastle; 37, 38, 39, Clyde Place, Glasgow.

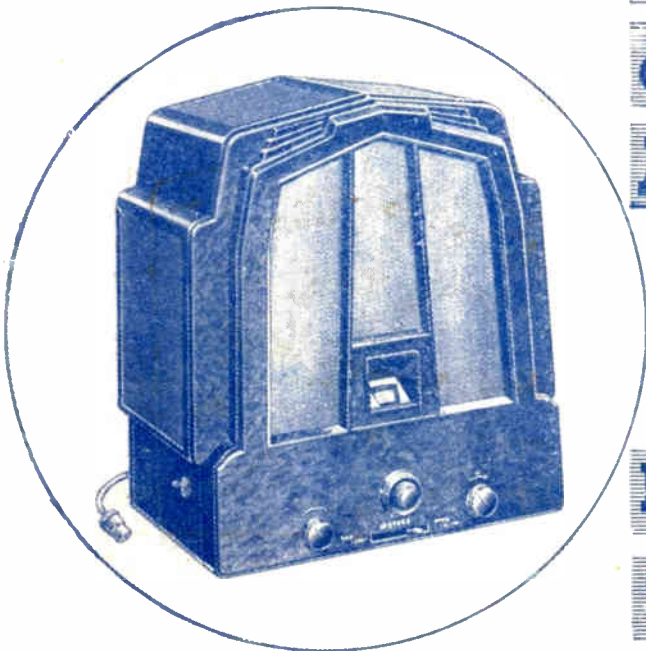

**The GREATEST
of all 1933 3-valve
All-Electric Sets**

**FLAWLESS Quality
Selectivity Sensitivity**

PRICE **17** GUINEAS
or 12 monthly payments of
32/9

THE NUMBER OF VALVES stated in descriptions of EKCO receivers signifies the actual number of RADIO RECEIVING STAGES. Rectifying stages in A.C. models are not included. With one exception, all EKCO receivers, etc., employ the Westinghouse patent Metal Rectifier, which is of a definitely permanent character.

**10 DOMINATING FEATURES OF
THE EKCO CONSOLETTA M.23**

1. Very latest type of three-valve circuit (Screen Grid, Detector and Pentode).
2. Wide choice of stations from home and abroad at full loud-speaker strength.
3. Can be used without an aerial or earth if desired.
4. Simplicity itself—single knob tuning with illuminated dial calibrated in wavelengths.
5. Latest type of moving-coil speaker.
6. Selectivity and volume control.
7. Connections for gramophone pick-up and additional speaker.
8. Figured walnut bakelite cabinet.
9. Westinghouse Metal Rectifier in A.C. Model.
10. All-electric—just plug in to your electric supply and switch on—that's all.

Consult your dealer or post coupon now

To : E. K. Cole, Ltd., Dept. K.20,
EKCO Works, Southend-on-Sea.
Please send me full details of EKCO Consolettes, Radiograms,
Consoles and Power Units.

Name

Address



ALL - ELECTRIC RADIO



Wireless MADE EASY



THE WAVE-CHANGE SWITCH

ON practically every set there is a little knob called the wave-change switch. Do you know why this is needed? Because in Europe broadcasting is done on two distinct wavelength bands, known as the medium waveband and the long waveband. The medium waveband extends from about 200 metres to 550 metres. The long waveband from 1,000 to 2,000 metres.

It is impossible, with one coil and one tuning condenser to vary the wavelength continuously from 200 to 2,000 metres. What we do is to provide two distinct rotations of the condenser.

At one setting of the wave-change switch the variation of the tuning condenser takes us from 200 to 550 metres, and at the other setting of the switch this same condenser takes us from 1,000 to 2,000 metres.

Between the two rotations, though, we have to move the wave-change switch. This switch brings the tuning condenser into contact with either the medium-wave coil windings or the long-wave coil windings.

WHAT'S INSIDE THE VALVE?

ASK a friend for one of his old valves and take it to bits—you will be amazed at the construction. Wrap the bulb inside a handkerchief and gently tap with a hammer. The glass will break away.

Hold the bakelite base of the valve. What is that little circle of metal tacked on to the main structure? It was only used when the valve was being made. On it was placed a small piece of magnesium. After the bulb had been sealed as much air as possible was pumped out. The magnesium was "fired."

CONTENTS FOR THIS SUPPLEMENT

PERCY HARRIS'S "BUILD AS YOU LEARN."

A unique constructional feature that will appeal alike to the seasoned amateur and the newcomer to wireless. Simple practical experiments that will teach you theory without tears.

Pages 2, 3 and 6

ELEMENTARY WIRELESS COURSE FOR BEGINNERS.

Prepared by J. H. Reyner and the staff of "Amateur Wireless," this brilliant series of articles explains the theory of wireless in a vivid and interesting way.

Pages 4, 5 and 7

AND NINE OTHER SIMPLE ARTICLES

The magnesium, in burning, used up all the remaining gases and air in the bulb, thus making the vacuum almost perfect. The silver coating you noted on the inside of the bulb was magnesium oxide.

Now look at the metal structure. It is supported in a glass "pinch" by several stout wires. These supports, or some of

the filament, and a grid formation coming between the shell and the filament, which is called the grid.

Note that the grid is nearer to the filament than to the plate or anode. There is a very good reason for this.

The filament, when heated by a current sent through its two ends, shoots off tiny particles

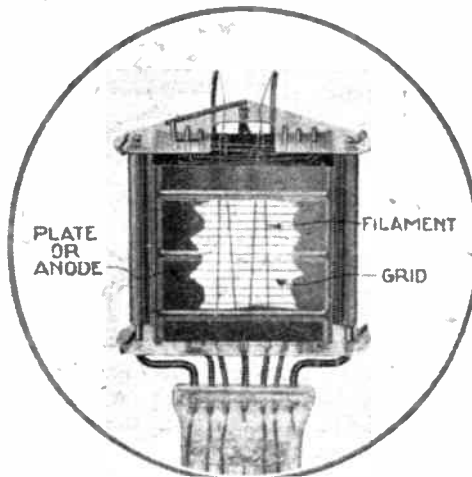

This valve has been taken to bits in a way that shows you the main construction. There is a central filament, surrounded by a wire grid that comes between the filament and the outer metal shell or anode

them, are joined to the pins of the valve base by wires embedded in the pinch.

In a battery valve there are four such wires. One is for the metal shell of the valve structure. Another is for the grid wire. The two other wires are both for the thin thread of wire at the centre.

Continue your destruction of the valve and you will find that inside the metal shell, which we call the anode or plate, is a very thin wire, which we call

of electricity, called electrons. These pass right through the meshes of the surrounding grid wire on their way to the anode.

Why should they go to the anode? Because we apply a very powerful inducement. The anode or plate is charged up with a high voltage, and this is the attraction for the electrons.

Why the grid in between? Well, to this grid we apply the wireless signal, and it interrupts the flow of the electrons going from the filament to the anode.

DO YOU SPEAK OF WAVELENGTHS OR FREQUENCIES?

IN most of the published lists of stations the wavelength is given beside a somewhat mysterious figure called the frequency.

Note that there is a simple connection between the wavelength of a station and its frequency. The connecting link is the velocity or speed with which the waves travel through space.

All wireless waves, no matter what their wavelength may be, travel through the ether of space with a speed of 186,000 miles per second, or roughly 300,000,000 metres per second.

If the wavelength of the signal were 300,000,000 metres the frequency with which it would pass a given point in a second would obviously be one. If the wavelength were 300 metres the frequency would be 1,000,000.

How did you arrive at these figures? Simply by dividing the velocity or speed of the waves per second by the wavelength, which gave the frequency or number of waves per second.

That is all there is in frequency—the number of waves passing a given point in a second. With the speed constant for all waves you can find the frequency by dividing the speed by the wavelength.

On looking up any list you will always find that the long-wave stations have much lower frequency figures than the short-wave stations. The wavelength of 300 metres corresponds to a frequency of 1,000,000 cycles per second, whereas a wavelength of 3,000 metres corresponds to a frequency of only 100,000 cycles.

You can easily find the wavelength if you know the frequency of the waves, since you also know the speed of the waves. Simply divide the speed by the frequency and the answer will be the wavelength.

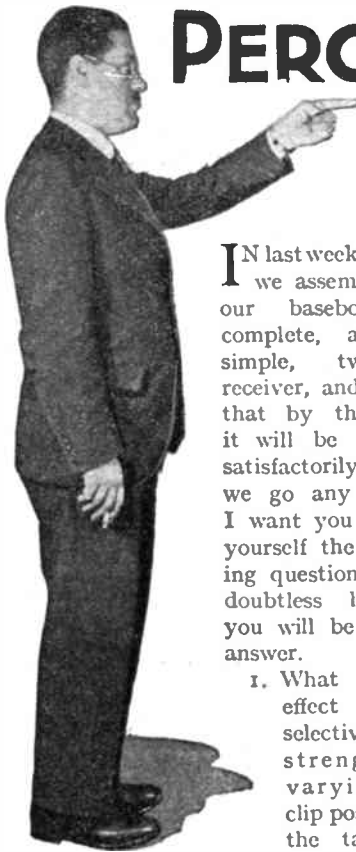

PERCY W. HARRIS'S BUILD AS YOU LEARN

IN last week's lesson we assembled our complete, although simple, two-valve receiver, and I hope that it will be working satisfactorily. Before we go any further I want you to ask yourself the following questions which doubtless by now you will be able to answer.

1. What is the effect on (a) selectivity, (b) strength, of varying the clip position on the tapings?
2. What is the effect of varying the compression condenser with the clip connected to the top of the coil?
3. Does the position of a station on the tuning dial vary with (a) different positions of the clip on the coil, (b) different positions of the compression condenser knob?
4. Which clip position on the coil gives you the best results on your local station when the compression condenser is out of circuit—that is to say, when the lead from the aerial terminal goes straight to the clip?
5. With the clip on the top of the coil (the lead which goes to the fixed plates on the variable condenser) what kind of setting on the compression condenser gives you best results (screwed right down, screwed right up, or an intermediate position)?

Do as much experimenting as you can in this direction until you "get the hang" of the set. I do not want to give you the answers to these questions in the present issue, as we can discuss the results later.

When you have tried these various experiments and have become clear in your mind as to what happens with the different settings, I want to take you one step further and teach you the

fundamental points regarding reaction circuits. For this and the next lesson we want one or two more parts. We want, for example, a piece of cardboard, another bracket, and a small condenser known as a .0003 microfarad differential reaction condenser. We do not need any more wire as we have plenty over on our 1/4-pound reel.

This week Mr. Harris adds a reaction coil and condenser to the simple two-valver he introduced to beginners in last week's supplement. For the benefit of those who built the original version we give the wiring alterations needed to bring the set up to the present stage:—

Remove wire No. 11 from terminal "P" of low-frequency transformer and connect to one end of the reaction coil.

Remove wire No. 12 from the set entirely.

Connect a new wire, marked No. 27 in this week's layout, between terminal "P" on low-frequency transformer and right-hand terminal of .0003-microfarad differential reaction condenser (looking from the back).

Connect remaining wire from reaction coil to the same terminal of the above reaction condenser—wire No. 26.

Connect a new wire (No. 12) between the centre terminal of the reaction condenser and the terminal of the .0003-microfarad condenser to which wires No. 5 and No. 6 are already connected.

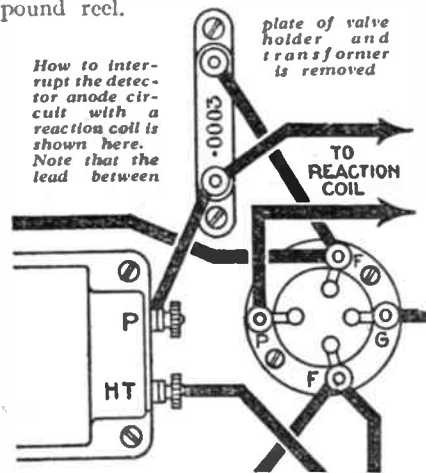

The first thing to do is to take the piece of cardboard and draw on it a circle of the same diameter as the coil

former, leaving a piece of projecting cardboard to act as a handle, so that it looks like a frying pan or a ping-pong bat. Now cut out seven slots about a quarter of an inch wide as shown in the drawing and pierce two holes near the handle.

Leaving about a foot of wire to start, wind a coil of wire in and out as indicated by the diagram, the wire going down through the first slot, up through the next, down through the next and so on till we have made a complete circle. Owing to the odd number of slots the coil will appear wound in basket fashion, and I want you to wind on twenty-five turns until you come to

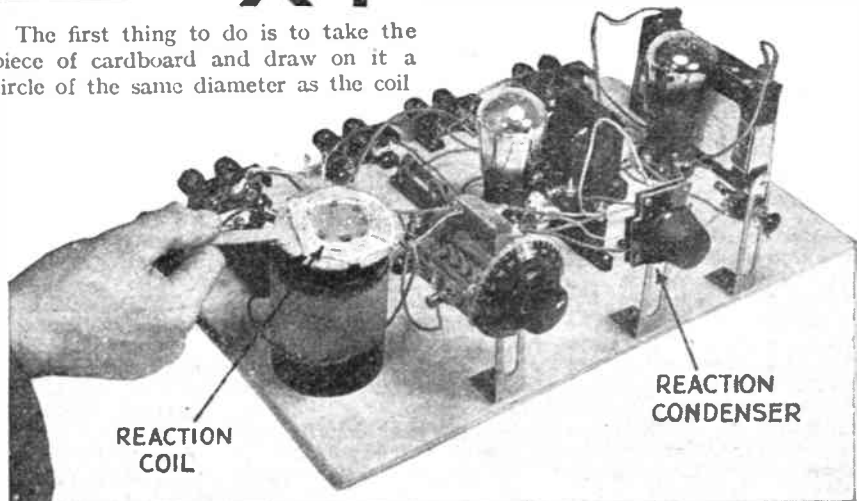

Applying reaction to the set by bringing the reaction coil close to the tuning coil, as shown by this picture and explained in the text

SIMPLE REACTION EXPERIMENTS

the end, when, leaving another foot of wire for connection, you thread it through the second hole.

As the set stood last week the signal currents set up in the coil are applied directly to the valve through the detector condenser and on being rectified are magnified in the low-frequency end. I want to show you how we can bring back some of the signal current from the plate side of the valve and re-magnify it, thus adding considerably to our signal strength.

Altering the Leads

All we have to do to make the change is to disconnect the lead which goes from the plate terminal of the valve to the plate terminal of the low-frequency transformer and that which goes from the plate of the valve to the .0003 by-pass condenser.

Before you make these changes pull out the positive plug from the high-tension battery in case you have an accident, and do not replace it until the new leads are made. Now connect one of the free wires from your new reaction coil to the plate terminal of the valve and the other to the plate terminal of the low frequency transformer, taking a further lead from this last terminal to the .0003 fixed condenser. (See small sketch).

You will see now that the currents from the valve, instead of going straight to the low-frequency transformer have to come through the reaction coil, and if you take this coil in your hand by means of the cardboard handle and gradually bring it down on top of the tuning coil, one of two things will happen—either when you get near the coil you will suddenly hear a rushing sound, indicating the set has gone into oscillation or else nothing whatever will happen! If

the latter is the case, turn the coil over and repeat the experiment, when you will get the rushing noise.

As the set is oscillating when the rushing sound occurs, and is liable to cause interference with your neighbours, try this part of the experiment some time out of broadcasting hours, such as on a Sunday morning. You will find after a little practice that as the reaction coil approaches the tuning coil so will the set oscillate. You can stop it oscillating either by holding it a little distance away from the coil or else by laying it on top of the coil and sliding it sideways so that, so to speak, it overhangs.

Practise a good deal and find a position where the set will just not oscillate at any position of the tuning condenser when the reaction coil is laid on top of the coil. This will probably be when it is about half overhanging the side.

When, out of broadcasting hours, you have found this position, switch on the

set during broadcasting hours and (Cont. n.d. on pag. six)

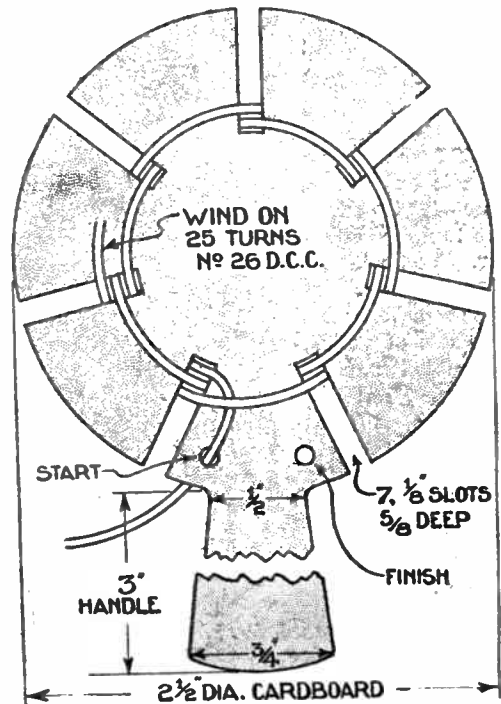

This is a sketch of the cardboard former on which you must wind the reaction coil. Trace this sketch—it can be used as a template for marking out the former

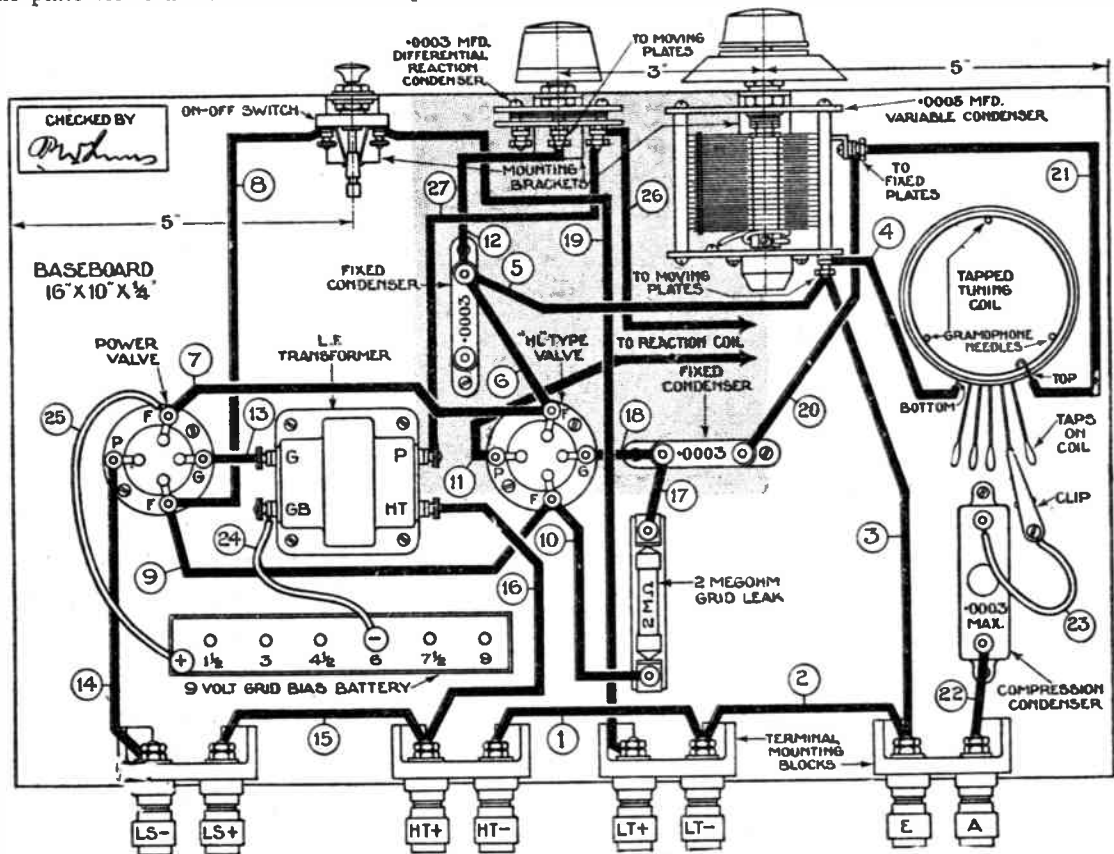

From this layout you can see how the components are wired together. The shaded portion indicates the area in which alterations have been made on the original layout given in last week's supplement. Compare this with the list of alterations on the preceding page. Note that the home-made reaction coil has to be connected to the two leads marked "to reaction coil." Note also the fixing of the reaction condenser on a bracket, and that one terminal of this component is not used this week—it will be next week!

STEP 2. THE CONDENSER: WHAT IT IS AND WHAT IT DOES

JUST consider this component here—it is called the tuning condenser. You will see there is one for each coil. There are two sets of plates, assembled parallel to one another. One set is fixed and the other set can be rotated with this knob so as to interleave with the fixed plates. (See Fig. 1.)

What are they used for?

To adjust the currents in the coils. Each coil has to be connected to a condenser.

One end of the coil goes to the fixed plates and the other to the moving plates (see Fig. 2). Let us assume for simplicity that there is only one pair of plates, one being fixed and the other moving.

We can do this because the action is exactly the same for two plates as for two sets of plates. Now assume that there is an electro-motive force in the coil. As we saw last week, this will try to produce a stream of electrons which will flow through the wire. I also pointed out that the electrons must have somewhere to go. In other words, there must be a *circuit*.

With a condenser by itself, as at Fig. 1, we have no complete circuit. In between the two plates connected to the ends of the coil is a layer of insulating material—in this condenser it is the air. Therefore, no direct current can flow but there can be a momentary current.

As I said last week, the electrons in the insulating material—the *dielectric*—between the plates will “side-slip,” and there will be a corresponding motion of electrons through the whole circuit. This will result in a piling up of spare electrons on one plate. (See Fig. 3.)

What is more important, this general shifting of the electrons through the wire will leave the other plate with less electricity than it should have.

Do you mean that electricity has been transferred from one plate to another?



ELEMENTARY WIRELESS COURSE FOR BEGINNERS

Precisely! We say that the condenser is charged, and it will remain like this as long as the electro-motive force continues to be applied.

You will now want to know how much electricity there is in this charge on the condenser. That depends. The movement of electrons from one plate to another corresponds exactly to the displacement in the dielectric. This in turn depends on the dielectric itself.

If we can produce a greater side-slip of the electrons in the dielectric, we obtain a larger current. This effect can be obtained with a stronger electro-motive force. In fact, the charge on the condenser is directly proportional to the electro-motive force, but it is also dependent upon the amount of dielectric between the plates.

If the plates are large and close together, the e.m.f. can produce a large movement of electrons in the dielectric between them, but if we reduce the area or move the plates farther apart, the capacity is reduced.

What do you mean by capacity?

Exactly what I say!—the capacity the condenser has for storing electrons under good conditions. With a tuning condenser the capacity is variable, because the overlap of the fixed and moving plates can be altered. (See Fig. 4)

If the plates do not overlap, the condenser has very little capacity for storing electrons, because there is practically no dielectric between the plates. With one set of plates completely overlapping the other we have the maximum capacity and we can get any intermediate capacity by rotating the moving plates.

The idea of having a number of plates is to increase the capacity. If we connect another fixed plate on the other side of the moving plate, we are able to produce displacement currents on both sides of the moving plate and thus obtain twice the capacity.

For wireless purpose we cannot obtain enough capacity with one pair of plates

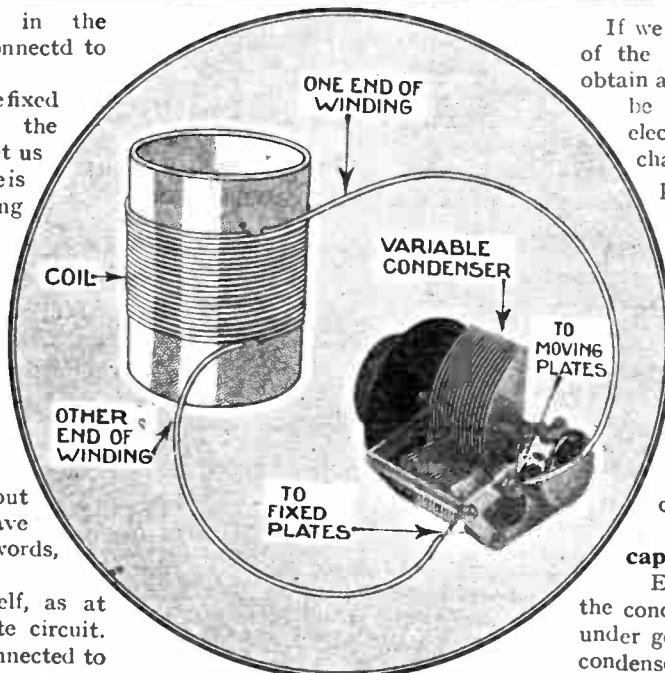

Fig. 2. How the ends of the tuning condenser are connected to the ends of the tuning coil to complete the electrical circuit. In every tuning circuit there is a coil and a condenser

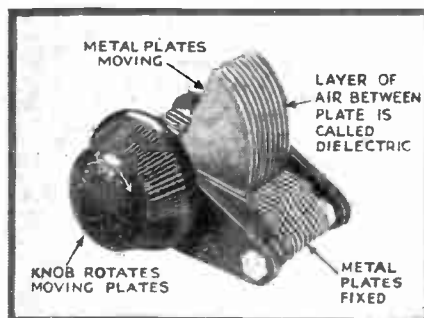

Fig. 1. The essential construction of a variable condenser. The plates connected to the control knob are the moving and the other plates are the fixed. The dielectric in this condenser is the layer of air between each plate and its neighbours

By J. H. REYNER

AND STAFF OF "AMATEUR WIRELESS"

alone, and we have to use something like ten or a dozen plates, as you can see.

Then is the purpose of this condenser to store up the current picked up on the aerial?

Momentarily, yes. You will remember that I said the condenser would only remain charged as long as the applied electro-motive force continues. In wireless reception, we receive from the aerial a very rapid succession of small impulses. Each one of these forces a charge into the condenser and then retires from the scene. The condenser accepts the charge, but then discharges again.

Discharging means that the electrons return to their original state. Once we remove the external force, there is nothing to hold the electrons in the plates, and they resume their normal positions. (See Fig. 5.)

A condenser will not remain charged?

It will if you remove any circuit which may be connected across it. Suppose, for example, we charge the condenser by connecting a battery across it and then remove the battery. There will still be an excess of electrons on one plate and the condenser will remain charged until we connect a piece of wire across the two plates, when the electrons will return to their normal positions.

But is there not a coil connected across the condenser in this wireless set all the time?

Yes—and that is why the condenser discharges as soon as the electro-motive force has disappeared. As a matter of fact, it is the rather peculiar method which the condenser adopts in discharging itself which is the basis of

wireless tuning. I will try to explain this to you now.

Assume that the condenser has been charged so that one plate is holding a store of electrons. As soon as we release them they will rush back to the other plate through the coil and give us a momentary discharge current.

This current flows through the coil. When a current flows through a coil it produces a magnetic field. Now, here is the point. Last week I likened the coil to a cup of tea in which the liquid had been stirred round rapidly with a spoon. If I stop stirring the tea will settle down again, but not immediately. *It will go on spinning round for some time before it finally settles down.*

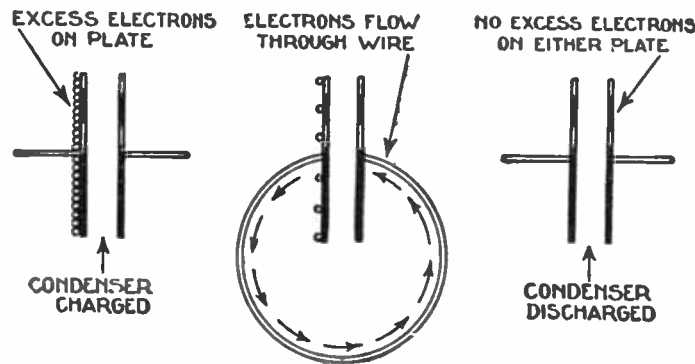

Fig. 5. Illustrating how a condenser with one plate charged will discharge itself as a flow of currents between the two plates

You get just the same effect with a magnetic field. Once you have "twisted up" the atoms in the neighbourhood of the coil, they take a little time to disentangle themselves, and while they are doing that they try to keep the current flowing.

If you are stirring a cup of tea, and

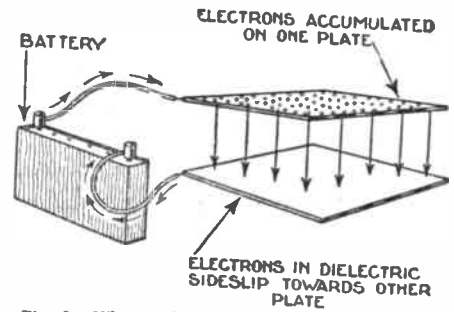

Fig. 3. When a force is applied to a condenser's plates, as here, the electrons in the dielectric—the air between the plates—will side-slip and cause a piling up of electrons on one of the plates

you suddenly stop stirring, without removing the spoon, you will find that the liquid tries to carry the spoon round with it; in fact, if you want to hold the spoon still, you have to exert quite an appreciable force. (Fig. 6 on page 7.)

So a magnetic field tries to carry the current along with it?

That is the idea! If you withdraw the force which initially started the current, the magnetic field itself will supply a force of its own, tending to keep the current flowing.

You mean the current flows on indefinitely?

No! The force is not sufficient for that, but it is strong enough to prolong the current appreciably.

This is a very important effect, which is often found in electricity. Let us see (Continued on page seven)

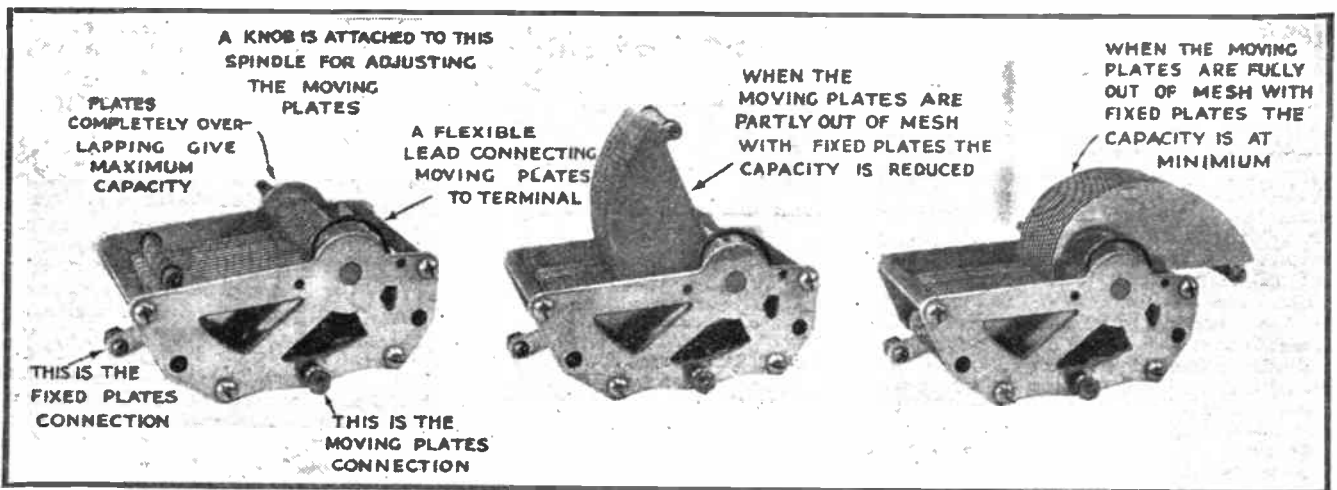

Fig. 4. All you need to know about the construction of a variable tuning condenser is told by these three diagrams. On the left the plates are totally in mesh and the capacity is at its maximum. At the centre, with the plates partially out of mesh, the capacity is reduced, and on the right, with the plates entirely out of mesh, the capacity is at its minimum.

PERCY W. HARRIS'S BUILD AS YOU LEARN

(Continued from page three)

re-tune and you will find there is a tremendous increase in signal strength, and you may be able to get in several distant stations. Be careful in your adjustment of the coil so that the set does not oscillate during broadcasting hours.

You will now find that the reaction coil position to some extent governs the strength of reception. The nearer the set is to oscillation, the stronger the signal. Be careful, however, in the setting, and if you hear squeals and whistles when you tune the set, alter the reaction setting at once, as the set will be oscillating and causing interference.

The next experiment is still more interesting. Set up the third bracket and make the connections shown by the shaded

Do scrape water pipes clean and bright before clamping down the earthing connection. Dirty pipes will mean high resistance, and that will mean a bad earth. Do try to install the best possible earth, and go in for a buried earth plate or tube if at all possible.

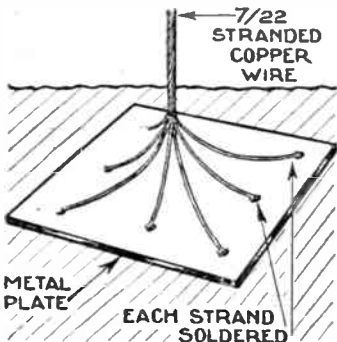

Two efficient arrangements for the earth connection are shown above. On the left is a buried plate, with stranded wire connection lead. On the right is a water-pipe connection, with a clamping piece to make good contact

Don't under any circumstances "earth" to a gas pipe.

Gas pipes are not really dangerous, but they are very inefficient, because of their white-lead joints—and white lead has a high resistance.

Don't forget that the connection of a stranded wire to a buried plate provides a very low-resistance earth. But you must solder each strand to a different part of the plate.

Don't just wind the wire

round an earth tube in the garden, but make sure the wire is well soldered. Otherwise corrosion and oxidation due to the atmosphere will quickly make the connection high resistance.

Don't worry unduly if you have to use a fairly long earth

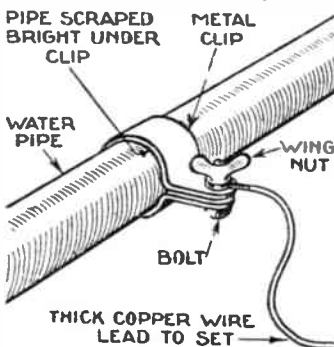

lead to join to set to a really good contact, but make quite sure the wire is thick, or the total resistance will be high.

Don't forget to earth the aerial when you finish listening at night. The earth, when connected to the aerial outside the house, will effectively drain away any static charges that may accumulate on the aerial and will act as a protection against the remote possibility of lightning.

STARTING UP A NEW SET

BEFORE attempting to make a new set do its job of picking up wireless programmes you should carefully read the makers' instruction book.

Read how to connect up the batteries, or to adjust the set to the voltage of your mains supply; read how to insert the valves in their correct order; how to plug in the aerial lead in the correct socket; or how to prepare the set for mains-aerial reception.

If the dials and knobs are not marked, read which is which, so that you know which is for tuning, which for volume, and which for changing the wavelength.

While you are at it, read the wording of your guarantee, which may be for six months or for a year. Note that although the maker will readily undertake to make good faults in the material and possibly in the assembly, he cannot be held responsible for faulty valves.

Also, in this guarantee, note that the undertaking is usually to replace the faulty material. You may have to pay quite an appreciable sum for the replacement of a faulty component—not for the material, but for the repairer's time.

If the set is not a portable, some form of external aerial system will be needed, even with the most ornate instrument, such as a super-hetero radio gramophone. The question you will have to decide is how long the aerial shall be and whether it shall be indoors or outdoors.

The answer will depend on your locality and on the power of the set. If it is a small set use a good outside aerial of not less than 70 feet total length. If this set is very close to a regional centre the length may have to be reduced to give complete separation of the programmes.

With a large set, whether near or far from a regional centre, a big outdoor aerial is neither necessary nor desirable. A total of 50 feet should be ample, and often it will not be necessary to erect it outdoors.

With all new sets, big or small, near or far from regionals, the earth is of first importance, and should be made as efficient as possible. With mains sets, bad earths often cause an unpleasant background humming noise.

Remember that when a mains set is first switched on you will not immediately hear anything, as the indirectly-heated filaments of the valves take about half a minute to warm up and operate. This applies whenever the set is switched on.

COMPONENTS NEEDED

Baseboard, 18 in. by 10 in. Four terminals blocks, each to take two terminals. Eight terminals, one each marked A., E., L.T., L.T., H.T., H.T., L.S., L.S. + Compression condenser, .0003 microfarad max. Coil former, 3 in. by 2 1/2 in. 1 lb. No. 26 D.C.C. wire. Crocodile clip. Flexible wire for connections. Three brackets (made specially by Peto-Scott for this set). .0003 microfarad variable condenser with one-hot spring. On-off switch. Two valve holders. Two fixed condensers .0003 microfarad, 1/2 in. lead, 2 megohms, and holder. Low-frequency transformer. .0003 differential condenser. Piece of cardboard for reaction coil. 120-volt high-tension battery. 2-volt accumulator and 9-volt grid-bias battery, with appropriate wadding plugs and tags. Note.—With the exception of the brackets, which are special for this set, the components may be of any reputable make. As a safeguard, use only branded products. You can rely on 'A.W.' advertisers.

portion of this week's layout reproduction. Try again out of broadcasting hours and you will now find that if you lay the reaction coil flat on top of the tuning coil and turn the knob of the reaction condenser one way or the other, you will have a perfect control of reaction and oscillation. After a little practice try it in broadcasting hours, and increase your range!

YOUR WIRELESS EARTH
Do's and Don'ts for the Beginner

A good earth is a low-resistance earth. Low resistance means the minimum opposition to the flow of the wireless waves coming in on the aerial and going to earth via the earth contact. The lower the resistance the more efficiently will the earth connection act.

Do, if you possibly can, see that the earth lead is short. If it is unavoidably long do see that it is made of thick wire. That known as 7/22 stranded-copper will serve fine.

Do make sure that, if you use a water-pipe earth, the pipe is on the main supply, and not just a cistern pipe.

BATTERY OR MAINS?

BEGINNERS often want to know whether a mains set is entirely different from the battery-operated type of set. The answer is that all sets are much the same in their general action. The difference between the battery and the mains types of set lies in the power supply alone.

The mains set has no batteries at all. It derives all its current and voltage from the electric-light supply. Before this supply can be used to feed the wireless set it has to be converted, altered, or modified in some way. The electric-light supply is too "raw" for the delicate valves of the set.

With A.C. mains sets there are three distinct processes before the domestic supply can be used in the set. First, the voltage has to be "stepped up." This is done with a transformer, which has a winding connected across the mains and another

larger winding connected to the rest of the apparatus.

The next step is the conversion of the alternating current of the mains into direct current. This is done with a rectifier, which can be either a valve or a metal device. This rectifier makes the electricity go all the same way, instead of shooting backwards and forwards.

Although it is a one-way current when it gets past the rectifier the electricity from the mains is still far from suitable for the set. It has to be "smoothed" by several devices after the rectifier.

The "raw" stuff can be used for heating the valve filaments, just as it can be used for the lighting of the bulbs in the house.

There is no magic in the mains set—just a greater convenience of maintenance and an ability to give more volume because of the more robust power available.

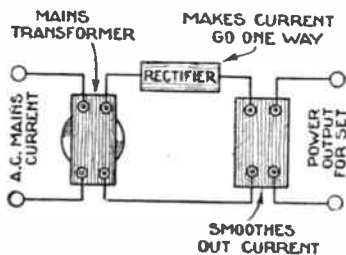

The three essential parts of a mains unit—the transformer, the rectifier and the smoother

ELEMENTARY WIRELESS COURSE FOR BEGINNERS

(Continued from page five)

what it means. The electrons in the condenser have rushed out of one plate into the other so that the condenser is now discharged and the dielectric is in a normal condition.

We have produced a current in the coil, however, which has set up a magnetic field, and because of the time required for this field to collapse, the current goes on flowing after the condenser has been discharged. Consequently we pile up electrons on the other plate, and this goes on until the magnetic field has died away. (See Fig. 7.)

You mean that the condenser will charge again?

Yes. This time in the opposite direction, with the electrons on the other set of plates.

Then how long does this oscillating go on?

Probably 50 to 100 times in normal circuits. It does not go on for ever because of the *resistance* in the circuit.

Resistance is a form of electrical *friction*. When we have electrons moving between the atoms of the material in a haphazard fashion there are bound to be crashes! If two electrons collide they cease to be useful in providing current, so that gradually the various electrons "knock out" each other and the current becomes smaller and smaller.

We call this tendency of electrons to collide the *resistance* of the material. In some materials, like copper, the number of collisions is relatively small, so that with a given electro-motive



Fig. 6. When you suddenly stop stirring a cup of tea the force tends to carry the spoon along. So with a magnetic field, for when you stop the current the magnetic field of force tends to keep the current flowing

we deal in wireless. The oscillations take place at a tremendous rate, hundreds of thousands of times a second, and it is really due to their extraordinary rapidity that wireless waves are produced.

I don't quite see the connection between these currents and wireless.

We shall come to that next week. Perhaps I can give you some idea by telling you that every one of these oscillations produces a wireless wave. Just what that means you will discover in due course.

Here is another thing. The speed or frequency of these vibrations depends on the capacity of the condenser. That is why we make the capacity variable on our wireless set, so that we can adjust the frequency of the oscillations to correspond with the various wireless waves.

Is that what you call tuning?

Yes. When you rotate the knob you are making the oscillations in your set correspond with the wireless waves from the particular transmitter you are receiving. Next week I will explain this process of tuning more carefully and will show you a mechanical analogy which I think will make it perfectly clear.

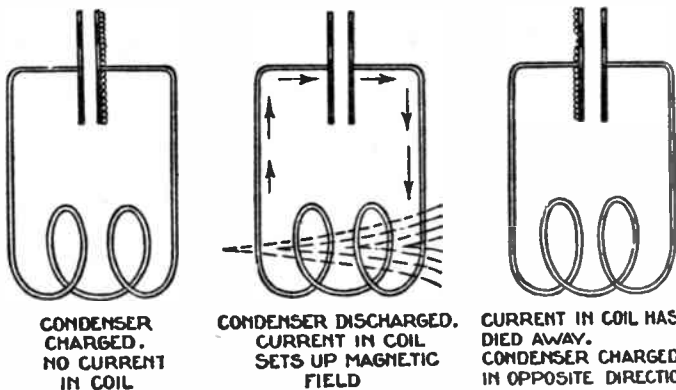

Fig. 7. These three diagrams show how a charge on a condenser will discharge itself as a current through a coil connected to it, and then this current will charge up the other side of the condenser, leaving no current in the coil

More or less as we were before?

Wait! When the coil has finished forcing electrons into the condenser, it starts to discharge again, and a current rushes through the coil once more. Exactly the same thing happens and we have a continual rush of electrons out of one plate into the other and then back again.

We say that the current is *oscillating* and it is the effects produced by these oscillating currents that are responsible for wireless.

force we obtain a large current. With a high resistance, on the other hand, the "casualties" are enormous and only a relatively small proportion of the electrons is able to travel on its way unhindered. Different metals have different resistances as you will see later.

All you need worry about at the moment is that this oscillating current rushing in and out of the condenser sooner or later dies away because of these casualties.

That is the form of current with which

SOME SIMPLE WIRELESS SYMBOLS EVERYBODY SHOULD MEMORISE

<p>EARTH</p> <p>The earth lead, shown in symbol on the left, and as a water-pipe connection on the right</p>	<p>JOINED WIRES</p> <p>WIRES CROSSING</p> <p>POSITIVE (RED)</p> <p>NEGATIVE (BLACK)</p>	<p>FIXED CONDENSER</p> <p>The condenser symbol is on the left. This is for a fixed condenser, such as that on the right</p>	<p>AERIAL</p> <p>The symbol for the aerial is shown on the left and a typical horizontal aerial erection on the right</p>
---	---	---	---

SOME POINTS ON PORTABLES

THE portable set is the only type of set that does not need either an externally-connected aerial or earth. The aerial in a portable is wound in the form of a frame—it is nothing more than a large

rather restricted in both tone and volume.

Lately the moving-coil type of loud-speaker has found its way into the portable, which can therefore give more realistic performance.

Probably the biggest drawback of the portable—even today, with so many excellent models available—is the limitations in volume imposed by the small batteries carried in the portable cabinet

To overcome this trouble as much as possible, many portables now use what is known as a pentode output valve, which for a given amount of battery energy provides more power to the loud

speaker than can be supplied by the ordinary type of power valve.

Weight in a portable, while irksome during transport, should never be utterly condemned, because this weight is probably due to the inclusion of large batteries capable of providing ample volume.

One last point in favour of the portable. Its frame aerial, though so limited in its ability to pick up signals, has the great advantage that it will pick up signals only in one direction at a time.

If two signals are causing interference and are coming from different directions the portable will usually separate them more easily than will a set with an ordinary aerial, because the frame aerial in the portable will respond much more energetically to the station in whose direction it is pointing than to stations in all other directions.

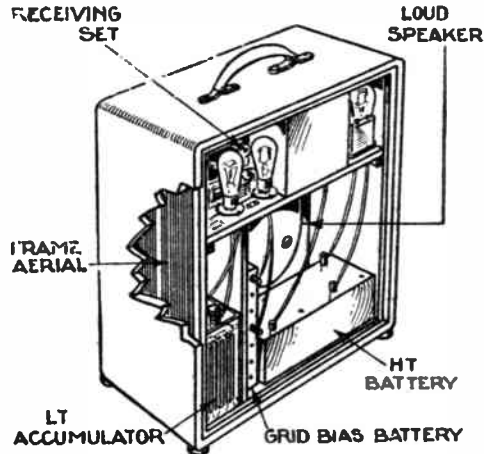

How a modern portable set is constructed

tuning coil some 1½ feet or more in diameter.

Due to the limited pick-up of energy obtained with this frame aerial, the portable set has to employ several amplifying valves to give good loud-speaker strength. Owing to the very great amplification obtained from the latest valves, it is now possible to overcome the drawback of the frame aerial with as few as four valves.

The great advantage of the portable set is that it will work entirely on its own, and it is therefore of great value to travellers and to those living in restricted dwellings, such as flats and tenements.

Besides the frame aerial, the cabinet of the portable contains the set, the batteries, and the loud-speaker. Until recently the limitation in the space has meant that only a cheap type of loud-speaker could be used, and the quality has been, therefore,

HOW LONG OUGHT YOUR BATTERIES TO LAST ?

MOST newcomers to wireless want to know how long the batteries will last. It is quite simple to work out how long the low-tension battery—sometimes called the accumulator—will last before it wants re-charging, but it is not so easy to say how long the high-tension battery will last before requiring renewal.

Let us take a simple example to illustrate the accumulator problem. We might have what is called a 20-ampere hour

accumulator working a three-valve set, which might take a total filament current of .4 ampere. If we divide the capacity of the accumulator, as represented by the ampere-hours, by the current we are taking from the accumulator in an hour, which is the total filament current in amperes, we shall find the number of hours the accumulator can be used.

In this simple example 20 is divided by .4, and the result, 50, is the number of hours we can

expect the accumulator to work.

It is unwise to allow an accumulator to stand for any length of time in a totally discharged state so we should deduct say 5 hours from this service, thus ensuring that when the accumulator goes to the charging station it will not come to harm through standing uncharged for a day or so.

The high-tension battery also has capacity, but is not so readily worked out. The current drain upon the high-tension is small, being a matter of thousandths of an ampere—milliamperes—but then the cells inside the battery are also small, and will quickly become exhausted if over-run.

The capacity of high-tension

batteries is arbitrarily divided into standard, double, and treble, according to the size of the cells. In general, when worked to the maximum limit, these batteries will last from two months upwards, according to the amount of use.

For maximum anode current not exceeding 7 milliamperes a standard battery can be used. For anything up to 10 or 12 milliamperes a double-capacity high-tension is needed. For currents over this a treble capacity is essential.

If attempts are made to run a set needing, say, 15 milliamperes from a standard battery the life of the battery is very short—perhaps not more than six weeks.

HOW THE MOVING-COIL WORKS

DO you know how the modern loud-speaker works? It is quite a simple idea. In the latest popular type of loud-speaker, called the moving-coil, the action depends on the movement of a small coil of wire.

What makes this coil move ?

The currents flowing through the coil.

What currents ?

The currents in the output circuit of the power valve—currents bearing the low-frequency signals corresponding to audible sounds of speech and music.

Tuning coils have currents flowing through them—how is it they do not move ?

Because they are not arranged like the moving-coil of a loud-speaker.

Then how is this moving-coil arranged ?

In a very powerful magnetic field, set up by lines of force travelling across the poles of a large field magnet, which may be permanently magnetised or magnetised by applying current from the mains.

It is the current flowing through the little coil that causes the coil to move, because in passing through the coil the current disturbs the lines of force. Something has to go—it is the little coil—backwards and forwards.

Attached to this little coil is a conical-shaped diaphragm, which vibrates in sympathy with the movements of the coil attached to its centre.

The air is set in motion around the cone, and sound waves are set up corresponding to the currents flowing through the coil. These currents are electrical transcriptions, so to speak, of the sounds originated in the studio.

The moving-coil has the great advantage of responding very faithfully to all the audible frequencies. It works on a theoretically perfect idea, and only the imperfections of assembly prevent it giving perfect reproduction. As it is, it gives better reproduction than any other known type of loud-speaker mechanism.

The coil and cone mechanism are delicately balanced, and it

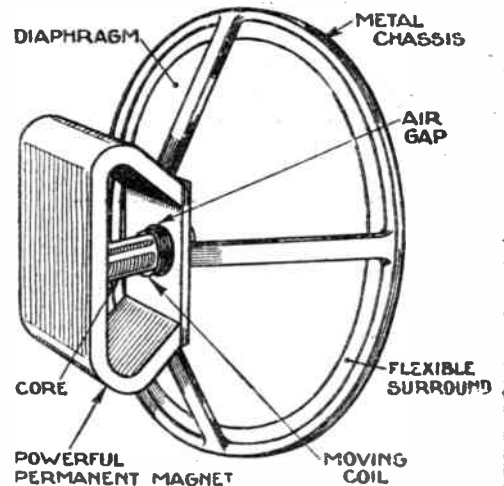

Working details of the moving-coil loud-speaker. Note the coil is in a strong magnetic field of force

is a great mistake to tamper with them in the hope of getting better results.

The moving-coil has a certain resistance or impedance, which must be accurately matched to the impedance of the power valve in the set if the maximum power and the most faithful reproduction are to be obtained.