

SECRETS OF THE NEW SEASON'S SETS

Every
Thursday 3^d

Amateur Wireless

and
Radiovision

Vol. XXI. No. 531

Saturday, August 13,

The NEW SEASON'S DEVELOPMENTS



The

GREATEST RADIO SEASON
YET!

EVERYTHING **S.E.C.** ELECTRICAL
our guarantee

OSRAM

new automatic cushion
filament springing
ensures
ABSOLUTE CONSISTENCY



CONTROLLED CONSISTENCY

means reliable performance—unvarying under all conditions. If the determined position of the electrodes of a radio valve varies when the filament is heated—how can you have consistency? In all the new OSRAM 2-volt battery valves there is a very far-reaching advance in valve design (the OSRAM automatic cushion filament-springing). It ensures absolute consistency by maintaining absolute parallelism of the electrodes *always*. Microphonics and all effects of internal and external vibration are finally *eliminated*, securing dead silent background during longer and more useful valve life.

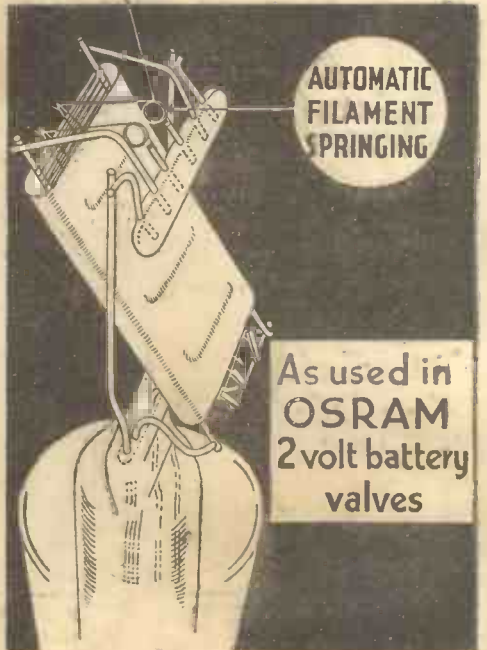

Osram

2 VOLT BATTERY

Valves

MADE IN ENGLAND
SOLD BY ALL WIRELESS DEALERS

WITH THE WEMBLEY FILAMENT

Agents: The General Electric Co., Ltd., Magnet House, Kingway, London, W.C.2

To Ensure Speedy Delivery, Mention "A.W." to Advertisers

A.C. MAINS USERS

SHOULD

RADIO EXHIBITION
OLYMPIA,
AUGUST 19th—27th.



VISIT STAND 89

AND SEE THE LATEST DEVELOPMENTS IN



METAL RECTIFIERS

—the only rectifiers to combine
long life with high efficiency

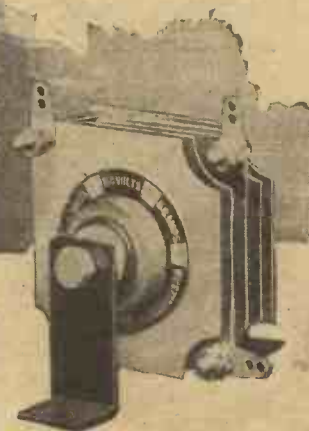

THE WESTINGHOUSE BRAKE & SAXBY SIGNAL CO., LTD., 82, YORK ROAD, KING'S CROSS, LONDON, N.1

You must go to the Radio Show

You'll be going to the Radio Show, of course! This is an event that claims the attention of all modern-minded people. See all these sensational new sets for yourselves and hear, examine and discuss them with the experts on the spot. Last year's Radiolympia broke all records. The 1932 Radio Show must be seen to be believed. It's bigger — more spectacular — an absolute wonderland.

COME
TO

RADIOLYMPIA

WHERE BRITISH IS BEST!

AUGUST 19-27

ADMISSION 1/6.

DANCING FREE

11 a.m. to 10 p.m. Daily

ORGANISED BY THE RADIO
MANUFACTURERS' ASSOCIATION

Mention of "Amateur Wireless" to Advertisers will Ensure Prompt Attention

NEW J.B. 'UNITUNE' CONDENSER - a triumph of precision

NEW J.B. PRODUCTS include the J.B. "NUGANG" Condensers in semi- or fully-screened types. New Gang Condensers for Super Hets. New Illuminated Disc Drive for use with above gangs.

New Short-wave Condensers with many novel features. New capacities in Air-spaced Differential Condensers. J.B. "Illuminator" for use with J.B. Chassimount and "R" Type gangs. Practically all existing J.B. models are being retained.

**STAND NO. 204,
NATIONAL RADIO
EXHIBITION**



J.B. "UNITUNE" Gang Condenser

Rigid one-piece chassis. Very robust construction. A pre-set trimmer is fitted to one half, while the other half has a trimmer which is operated from the front of the panel. The panel-trimmer control is concentric with the main tuning knob. Capacity, .0005. Complete with disc drive and bakelite escutcheon plate.

2 gang 18/6 3 gang 27/-

PRECISION INSTRUMENTS

Advertisement of Jackson Bros., 72, St. Thomas' Street, London S.E.1.

Telephone: Hsp 1837

Advertisers Appreciate Mention of "A.W." with Your Order



BRITAIN'S LEADING RADIO WEEKLY
FOR CONSTRUCTOR, LISTENER & EXPERIMENTER

EDITOR:
BERNARD E. JONES

TECHNICAL EDITOR:
J. H. REYNER, B.Sc., A.M.I.E.E.

RESEARCH CONSULTANT:
W. JAMES.

ASSISTANT EDITOR:
H. CORBISHLEY

NEWS & GOSSIP OF THE WEEK

THE SHOW!

Big Ideas for Olympia

EVERYBODY is getting ready for the "Show"—the National Radio Exhibition at Olympia. It opens on August 19 and runs till August 27—eight days packed with things of outstanding interest to keen listeners and set builders. Next week's issue of "A.W." will contain a complete guide and description of the exhibits among a wealth of topical Show features. Don't miss your copy.

ON SEVEN METRES

The B.B.C. Gets Busy

THERE is still a hush-hush air being maintained with regard to the 7-metre transmissions from the top of Broadcasting House, but our Special Correspondent has been able to glean some information about the gear and the results so far. It is found that the optical range extends to about Hampstead, the Crystal Palace, the Tower

YOUR GUIDE TO THE SHOW!

Make sure of next week's copy of "A.W." for it will be of outstanding interest to every reader. It will contain a complete stand-to-stand guide to the National Radio Exhibition, together with full-size plans. No matter whether you are able to go to Olympia or merely want to be informed about the new season's novelties, you must have "A.W." to guide you. The stand-to-stand guide is in itself a complete review of the exhibition and a handy means of reference when you want to know what new sets and components have been introduced.

SPECIAL BUMPER NUMBER

USUAL PRICE—3d.

ORDER YOUR COPY NOW

of London and Kensington in the four main directions. Ten ultra-short-wave sets now being built will be installed at the

fringe of the beam and polar diagrams will be made. The Marconi gear used can tune from 6 to 8.5 metres, so each wavelength is being tried. The transmitter takes about 1.2 kilowatts and, as accurately as can be measured at the moment, the output is about 300 watts. The Franklin aerial is still used on the roof. It is adjusted for each waveband. It is understood that Mr. Ashbridge is personally interested in the 7-metre experiments and spends a good deal of his time in the seventh floor room of Broadcasting House where the gear is installed.

FOR THE EMPIRE

IN preparation for the introduction of the Empire Broadcasting Service, Mr. C. G. Graves has been appointed Director of the Empire Department. Mr. G. C. Beadle, Station Director, Belfast, becomes Assistant Director of Programmes in place of Mr. Graves, and Mr. G. L. Marshall, Station Director, Newcastle, succeeds Mr. Beadle as Station Director, Belfast.

—AND MORE CHANGES

WELL-KNOWN members of the B.B.C. staff are making a change at the end of September. Gordon McConnell, the popular vaudeville producer, will take over the studio production of opera. Lance Sieveking, of Programme Research fame and the compiler of the "End of Savoy Hill" stunt, will try his hand at vaudeville. Martyn Webster, from Glasgow, will also help with the vaudevilles, his first effort being booked for August 22 on Regional. This newcomer to London will also do a revue on September 7.

HOME-MADE INSTRUMENTS!

SHAKESPEARE'S *As You Like It*, in an adaptation by Dulcima Glasby, is to be broadcast next week. The interesting point about it is that the incidental music, arranged by Julian Herbage, will be played by members of the Dolmetsch family, who will play upon treble and alto viols, viola da gamba, recorder and lute—instruments made by them in their own workshops at Haslemere. The Wireless Singers will take part in the play.



Starting young at radio! Public school cadets experiment with field transmitters and receivers while at the annual training camp at Cirencester

NEXT WEEK: "A.W." WILL GIVE A COMPLETE GUIDE TO THE SHOW. Special Bumper Number

NEWS & GOSSIP OF THE WEEK —Continued

TENTH ANNIVERSARY OF BROADCASTING

B.B.C.'s Gala Week Plans

IN recent years the B.B.C. has not specially marked the anniversaries of its birth, but this year, during the third week in November, a very special significance will be attached to the tenth anniversary. The B.B.C. intends to spend a lot of money on making this a real gala week. The co-operation of the radio trade, the press, the stage and the concert world will be enlisted to make the tenth anniversary memorable for all listeners. Programme departments are already preparing special stunts.

A NEW O.B. STUNT

AN ambitious idea for a novel outside-broadcasting stunt is maturing at B.B.C. headquarters. It is intended to give a "sound picture" of communications—by land, sea and air. Microphones will be taken on high-speed cars, trains, ships and aeroplanes. We shall hear the noises!

HENRY HALL'S VOCALISTS

"MACK MIDDLETON" is the name given to one of the latest additions to Henry Hall's galaxy of occasional vocalists during dance-band broadcasts. The B.B.C. is, we find, reluctant to disclose the real names of the assistant vocalists of its dance bands. We were much amused recently at the attempt of another singer, already quite well known to listeners, to disguise his voice during his efforts with Henry Hall. Why this shame-faced attitude? The vocalist of a modern dance band is a tremendous asset.

BIG BEN FROM "B.H."

FOLLOWING somewhat extensive tests, B.B.C. engineers have now decided to build a big amplifier for relaying the chimes of Big Ben from the roof of Broadcasting House. Large loud-speakers are to be fitted up. It is proposed to turn them on at 1 p.m. and 6 p.m. every day so that passers-by will be able to synchronise their watches just as if they were at Westminster. The volume of sound from the loud-speakers relaying the chimes will be rather less than the volume heard from Big Ben itself. The relayed sound will be about as great as the chimes from the nearby All Souls, Langham Place, church. Let us hope the two sets of chimes synchronise—not heterodyne!

THE "SHOW" IN YOUR ARMCHAIR.

No matter whether you go to Olympia or have to follow radio progress only by reading about the novelties, you will find next week's "A.W." invaluable.

THUNDER AND LIGHTING!

NEARLY every vaudeville broadcast at Broadcasting House is now accompanied by the elaborate lighting effects which Ridgeway used in his recent Parade broadcasts. Theatre-style limelights at the ends of the U-shaped gallery shine down on to the miniature stage. The boys from the effects room who make the horse taps, door slams and thunder which accompany radio plays, go down to the vaudeville studio and operate the limes. In other words, they provide the thunder and lighting!

THE CONCERT HALL ORGAN

Not Cinema Style

AT long last definite plans have been made for an organ in the London concert-hall studio. The organ is to be built by a well-known British firm, Messrs. John Compton. The name is not unknown in connection with cinema organs, but the B.B.C. organ is to be suitable for everything from Bach to Mayer!

It will be fitted in the space behind the grille which backs the orchestra stage in the concert hall, but it has not yet been decided where the console will go. Probably, as in cinema practice, it will be on a long flexible cable, so that it can be shifted about.

TELEVISION DELAYS

AS we have already indicated, the B.B.C.'s new series of television broadcasts may be delayed a little owing to difficulties in studio accommodation. The television apparatus is installed in the listening room adjoining the dance-band studio, so that the televised objects must be in this studio. Unfortunately, the month of August will be particularly difficult as Henry Hall will want the studio for twenty-one nights in the month. It looks as though Henry will have to make shift with some other studio for the time being. But why, we ask, was no provision made at the very start of Broadcasting House for television broadcasting? The present arrangement is at best only a makeshift. Was it lack of foresight—or lack of faith in television?

FOR ONE HAND ONLY

PAUL WITTGENSTEIN, the distinguished pianist who lost his right arm in the war, has had pianoforte works written expressly for him—that is, for the left hand only. One is by Richard Strauss and is called "Parergon." Korngold and Prokofiev have also written music for him. Still another specially written work is Ravel's "Pianoforte Concerto for the Left Hand." Wittgenstein will play the latter at a next week's "Prom." and the performance will be relayed to Regional listeners. Wittgenstein makes his left hand do almost all that other virtuosi achieve with ten fingers.

HENRY HALL IN NEW ROLE

AT the present time Henry Hall, the leader of the B.B.C. Dance Band, is working on the music to accompany Marjory Lawrence's dramatised version of her well-known book *Red Heels*, and it is expected that as a result of this collaboration a popular musical show will be put on in the West End of London after Christmas of this year.

MIDLAND ENTERPRISE

AN example of the use being made of a special broadcasting studio fitted up at the Birmingham Repertory Theatre will be the relay on August 26 of a play called *Shame the Devil*, to be performed in the theatre studio and relayed by the Midland Regional station.

TALKING TO THE STATES



The heart of the Post Office radio system by which the B.B.C. now takes most of its transatlantic broadcasts and Canadian relays. These operators in London control the output through Rugby and handle the input from the Baldock super-het receivers

EARTHS AND ALL ABOUT THEM



Many listeners do not realise that the earth is of greater importance than the aerial. In this article Alan Hunter gives some very practical advice on this part of the equipment

WHILE fashions come and go in aerials, the earth connection remains what it has always been—a highly important link in the wireless chain. Every year sees less and less importance attached to the question of the aerial wire, because the sets have

"AERIAL"

so much inherent amplifying properties that almost any sort of aerial wire will serve to bring in dozens of foreign stations when conditions in the ether are suitable.

SET

With the earth there can be no such skimping, for amplification in the set cannot make up for the unique function of the earth connection. While it might be maintained that rigid rules about aerials no longer apply, there has not been, and will not be for a long time to come, any relaxation in the wise experimenter's efforts to fit up the best possible earth connection.

EARTH

The arrangement used in the original Hertz aerial system comprises two vertical wires, the lower corresponding to the earth now used

It is, perhaps, a little curious that, in the beginning, wireless communication was carried out without using the earth, either at the transmitter or receiver. Hertz carried out his pioneer experiments with two conductors separated from each other by an appreciable vertical distance. One of these conductors corresponded to the earth of to-day, and the other was of course, the aerial. Then along came Marconi, who earthed one side of the Hertzian oscillator and elevated the other, thereby obtaining a much greater range.

The generally accepted theory of the earth connection is seldom discussed by amateurs, but it is just as well to know that if the earth were a perfect conductor (which it certainly is not), an electric image of the upper conductor—the aerial—would be produced and take the place of the lower conductor of the Hertzian arrangement.

From our point of view the importance of this theory is that, in the normal outside aerial system, the greater part of the resistance of the system is in the earth connection. No matter how good the earth connection may be, there will be some resistance in the earth part of the aerial system,

due to the fact that the earth itself is not a perfect conductor of electricity.

Such losses as are produced by the nature of the earth cannot normally be combated, but much can be done to lessen the resistance evil by keeping down preventable losses in the contact between the earth lead and the earth itself.

Reducing Earth Losses

Incidentally, recent research has indicated that earth losses can be eliminated by using an insulated metal plate instead of the usual earth lead and pipe or tube. It would not be within the amateur's scope to fit up such a plate, but almost equally good results can be obtained by erecting a number of wires parallel to the horizontal portion of the aerial wire. These earth wires, forming a sort of earth screen, should be fitted up two or three feet from the ground and insulated from it just as carefully as the aerial is insulated.

Such an earth system may appeal to the true enthusiast searching for the lowest possible resistance earth. It has been found that this type of earth has a total resistance of a very few ohms, whereas a normal earth with a poor connection may

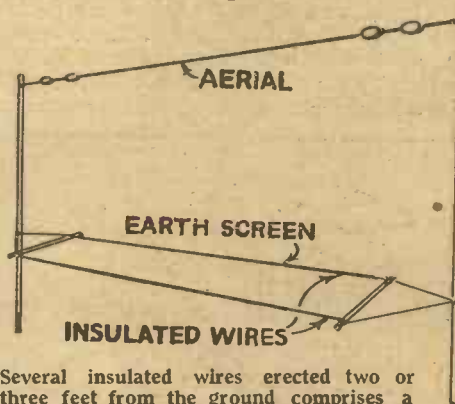

Several insulated wires erected two or three feet from the ground comprises a screen that has a much lower resistance than the normal earth

have as much as 50 ohms resistance, leading to greatly reduced efficiency.

Most listeners will be content with a moderately efficient earth system such as can be most conveniently obtained from the domestic water pipe. Such an earth may often prove to be just as efficient as a buried earth. Certainly the chances of the water pipe remaining efficient are greater than for the buried earth.

One of the most potent causes of high

resistance in the earth connection is corrosion due to the effect on the connection of the atmosphere. In course of time, oxidation of the copper contacts is inevitable and in towns this process will take place much sooner than in the country.

When considering which to fix—an indoor water pipe or a buried plate, tube, or spike—remember this point: many an initially

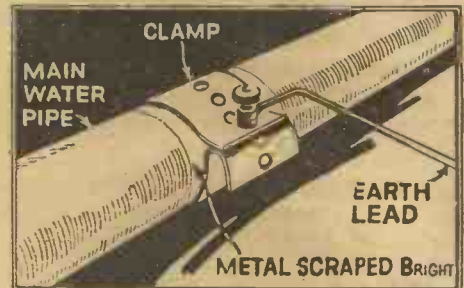

When making use of the water pipe for the earth connection it is most important that the metal be scraped bright so that a low resistance contact is ensured

effective earth has unaccountably deteriorated the set's performance through no other cause than oxidation of the contact between the earth lead and the earthing device.

Before deciding on a water-pipe earth, it is well worth while investigating the run of the pipe system, in order to make sure that the pipe to which the set is connected really does go to earth and not just to a cistern. Some sort of result will be obtained wherever the earth terminal of the set is connected—even a short length of wire will

(Continued at foot of next page)

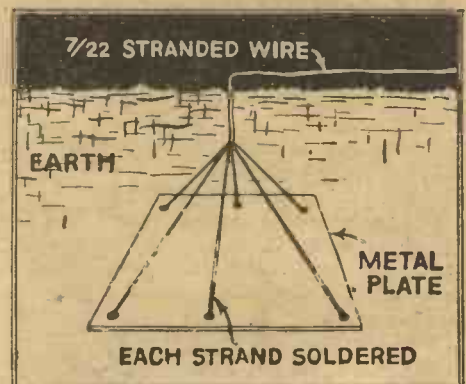

The connection of a stranded wire to a buried earth plate must be made by soldering each strand of the cable to a different part of the plate

HOW IT IS DONE

JUDGING THE QUALITY



The check receivers at a B.B.C. Regional station which are used with the key switches and speaker-testing apparatus described here

At the London Regional station there is a sound-damped listening room in which the control engineers can judge the quality of the transmissions. The room is sound-insulated to keep out machine noise, but its acoustics inside

are approximately the same as those of an ordinary living-room. In one corner is a big moving-coil speaker with a baffle.

The control desk is fitted with three key switches, the main one changing over from National to Regional so that rapid comparison may be made between the two programmes.

When the other two switches are in one position, the moving-coil speaker is connected to the amplifiers at the station end of the microphone lines from London. The moving-coil speaker thus reproduces either the National or Regional programme before it goes through the main speech amplifiers and the transmitter downstairs. When the switches are changed over, the moving-coil speaker is connected to two side-tone receivers, permanently tuned in, one to National and one to Regional.

Thus the control engineer at the touch of a switch can hear either what is

coming into Brookmans Park by line or what is actually being broadcast, on either programme.

The circuits are balanced so that the volume between the preliminary line signals and the radio reproduction is about the same. The test is a rough and ready one, but is often made by the listening engineer at the station, who sits at this control desk with a programme sheet before him.

The receivers used for picking up the local signals are right under the shadow of the aerials, but are fitted with filters, so that there is practically no mutual interference.

This quality test is occasionally made during programme hours, especially when National and Regional are both giving the same item, so that the comparison is more direct. The key switches are also brought into use when the periodic tests are made, usually during the very early hours of the morning.

"EARTHS—AND ALL ABOUT THEM"

(Continued from preceding page)

form a capacity earth. Such earths are not really efficient and the difference in signal strength between a really sound earth and one of the makeshift variety is so marked as to leave no doubt about the importance of ensuring a really good contact.

Another point to watch in making an earth contact to the water pipe is to see that the metal is scraped clean and bright before screwing down the earth clamp. And every few months this brightening up of the metal will repay the trouble by maintaining the efficiency.

A Difficult Question

Often the amateur is puzzled to know how long the earth lead may be without losing efficiency. The choice sometimes rests between an efficient contact with a long lead and an indifferent contact with only a short lead. The advice to keep the earth lead short often misleads the amateur into abandoning his pet earth just because to get to it a long lead would be essential.

The long lead need not have an excessively high resistance if a stout gauge of wire is used. Nothing less than 7/22 aerial wire should be used for an earth connection and, if possible, still thicker wire would be an advantage.

I have fitted up very efficient earths with leads exceeding 20 feet from the set to the point of contact, simply by employing really thick wire. The long earth lead is only really bad when too small a gauge of wire is used.

Outside earth connections appeal to many amateurs as being "professional," but, as already indicated, such earths can be decidedly inefficient unless proper precautions are taken against the effects of corrosion. The only really sound scheme is to solder the earth lead to the tube or plate.

Even when all precautions have been taken against corrosion, there is every possibility of high resistance owing to the nature of the soil. Sandy soil is apt to become very dry and even clay soil will need moisture in the summer months to keep the earth contact of low resistance.

Earth Trouble Symptoms

So much for the guiding rules of earth connections; the symptoms that the earth is not as good as it should be are not always obvious and that is why so many bad earths are tolerated. If the amateur could be shown the improvement in signal strength, the freedom from mains hum when using a mains set or unit, and the absence of hand-capacity effects when using a short-waver, there would be no need to harp on the necessity for looking with a critical eye at

this part of the installation. Always remember that in the normal aerial system the earth is one of the two plates of a condenser. It is useless to erect an efficient upper plate—the aerial—or make up for inefficiency in the aerial by adding to the high-frequency amplification, unless the best possible earth, which means the lowest possible resistance contact, has already been ensured by attention to the points outlined.

"BEAM" TELEVISION

THE latest forecast of the future of television, given by Dr. Alexanderson, consists of an arc-lamp "transmitter," sending out a modulated beam of light from a high tower situated in the centre of a city. The modulated rays will be picked up by each receiver through an exposed photoelectric cell—instead of on an aerial as in radio transmission. The received light energy thus converted into electric currents is amplified in this form, and then handled as if it had been transmitted by wireless waves. One merit of the scheme is that it does not interfere in any way with ordinary broadcasting through an already overcrowded ether.

M. A. L.

LOUD-SPEAKERS FOR THE THEATRE

AN extensive voice-amplifying system has been fitted in one of the largest "legitimate" theatres in New York, where it not only augments the actors' voices, but also the orchestra. Amongst other things, it allows the platform on which the orchestra is seated to be lowered out of sight, and the space to be bridged over to extend the available stage space, the microphone and loud-speaker installation meanwhile maintaining the full orchestral quality. A loud-speaker is also fitted in each dressing-room to enable "off-stage" principals to keep constantly in touch with the progress of the play.

H.



Radio term: Amplification'

NEW VALVES and ----- BETTER RESULTS



Facts you should know about the new season's Valves
By J. H. REYNER, B.Sc., A.M.I.E.E.

ONE of the first things which the radio enthusiast looks for at the Show is the improvement in valve technique. For the past few years there has been some outstanding improvement. First we had the screen grid, then the pentode, and last year a marked increase in the efficiency of the valves.

As far as valves are concerned, this year there will be little that is spectacular. There have been improvements since last year, but these have been in directions of which the advantage is not immediately apparent. The exception to this is the variable-mu valve, which is now supplied by all manufacturers as a mains valve and by two (Cossor and Mullard) as a battery valve. As I suggested in a recent article, this form of valve represents a distinct step forward in H.F. amplification.

These Variable-mu's

It is actually a valve of which the amplification can be varied according to the grid bias. The first effect of this is to provide a convenient method of volume control which does not introduce distortion even on quite small volumes. It also gives a better performance from a selectivity point of view, and very largely removes the largest defect of the older form of S.G. valve—cross modulation.

A variable-mu valve, in fact, will handle an appreciable input, so that there appears to be no reason any longer for adherence to a neutralised triode for H.F. amplification. Those readers who still use this form of coupling would be well advised to consider a change over.

Coming to the detector stage, we find more enlightened methods in evidence. It is now realised that a valve with a high amplification does not give better results as a detector. Even assuming that the anode circuit is correctly designed to utilise such a valve with its correspondingly high impedance, the damping introduced into the tuned circuit which feeds the valve nullifies the gain which would otherwise be obtained.

H.F. Feed-back

This is due to feed-back through the valve capacity, similar to that which causes instability in an un-neutralised H.F. valve, but in this instance the feed-back definitely reduces signal strength and causes flat tuning. The tendency in detector valves has been towards a reduction in the internal capacity and a reduction in the valve impedance, maintaining the amplification factor at a reasonable value around the twenties.

At first sight, therefore, there would seem to be little difference, but the improvement is there, due to a rearrangement of the internal construction.

The question of microphonic noise has also received consideration, particularly with mains valves, and several manufacturers have introduced special methods of construction which largely eliminate this trouble even when rigid type valve holders are used. In the output stage, attention has been directed principally to pentodes. This class of valve has the advantage of giving a better conversion of the power drawn from the H.T. supply into audio-frequency power. There has been a general improvement in this efficiency, which is now about double what it used to be with ordinary power valves.

Mains Valve Economy

There have been further improvements for this class of valve. With mains types the trend has been towards an improved sensitivity and greater output, so that with the same grid swing, usually 10-12 volts, 2-2½ watts output can be obtained. With battery valves it is recognised that an output of 300-500 milliwatts is all that can be obtained from a single valve, and attention has been concentrated on obtaining this output with less H.T. current consumption. The Mazda people were the pioneers of this movement with the Pen220, while Mullards and Cossors have recently introduced similar types.

Generally speaking, there has been a steadying influence. The very high con-

ductances of last season have tended to be discouraged, and there is a general levelling at a round figure between 2 and 4, depending on the type. The life of mains valves has been improved considerably, again by research into the actual construction, and in particular the insulation between cathode and heater has been much improved.

Reference should be made to the new Mazda D.C. valves. These are indirectly heated and similar to their A.C. types, but they only consume 0.1 ampere at from 20-40 volts, according to type. The Marconi and Osram ¼-amp. D.C. valves are still being retained, and time will show which value, if any, proves more satisfactory. Possibly a compromise will be resorted to by adopting the Continental standard of 0.18 amp.

No American Types

So much for the new season's valves. One cannot help being a little disappointed that no manufacturer has introduced any of the super-control "tubes" so popular with the Americans at the present time. These valves are designed to permit the flow of grid current without distortion and so obtain a considerably higher power output. A push-pull system with these valves can be arranged to take no anode current at all when there is no signal, and this results in a conversion efficiency of output power to H.T. consumption of 60-80 per cent.—far more than anything yet obtained by ordinary methods. There is also the triple-twin tube, which contains two valves in the same bulb. The second valve supplies a large power output by deliberately using the positive side of the characteristic, while the first element supplies it with voltage in such a manner that no distortion results. Possibly English equivalents to these types will make their appearance during the season.

MEASURING THE H.T.

There is no need to find a definite H.T. negative connection each time the high-tension voltage is measured. When



measuring the voltage on the screen-grid anode, for instance, as shown here, some earthed part, such as the frame of the ganged condenser, can generally be taken as low-tension negative.

A NEW FULL-WAVE RECTIFIER

THE new "micro-mesh" valve rectifier is designed to have a specially low internal resistance, so as to give a larger output current at high efficiency. The secret lies in the use of special cooling-fins attached to each of the rectifying anodes. Because of the extra cooling effect, the anodes can be arranged much closer to the cathode than usual without over-heating. Actually, the spacing is less than 20 millimetres, giving a very short and comparatively low-resistance path for the discharge current. Any danger of short-circuiting is prevented by using a multiple support for the anodes, with mica bridge pieces above and below

M. A. L.



MOSPHERICS THAT AREN'T

There is a strong tendency at this time of year to overlook any faults which develop in the receiving circuit if they happen to give rise to noises resembling atmospheric. This article, by W. OLIVER, explains how the source of the trouble can be located

DURING the summer and autumn months, when atmospheric are prevalent, one grows more or less accustomed to the unwelcome background of extraneous noises caused by Nature's wireless signals, and one is apt to jump to the conclusion that they are responsible for every crackling, grating or sizzling noise heard in the course of reception.

Most of us are caught napping in this way sooner or later. But it is a pitfall that is really quite easy to avoid if one makes a point, when in doubt, of carrying out the few simple tests that are necessary to determine the source of noises which mar reception.

Noise Sources

The sources of all the extraneous noises that occur from time to time in the course of wireless reception may be broadly classified thus:—

(1) Atmospheric, or "static." (These, being due to natural causes, cannot be entirely eliminated, but their effect can be minimized by using an indoor aerial or frame instead of an outdoor aerial.)

(2) "Man-made static," or interference caused by various kinds of electrical apparatus in use in the vicinity of the receiving installation.

(3) Faults in the transmission, such as a faulty landline between the studios and the transmitting station, which may produce crackling or grating noises.

(4) Faults in the receiving circuit.

The first three sources of disturbance are, of course, purely external and are beyond the control of the listener to a great extent; the fourth source, however, can be dealt with and remedied (often quite quickly and easily) if the trouble is definitely narrowed down to this cause.

How to Test

If grating or crackling noises are heard when a transmission is being received, it is an easy matter to ascertain whether they are due to a fault at the transmitting end, by simply tuning in signals from other stations radiating different programmes, and noting whether they are affected by the same interference or not.

Should the noises prove to be independent of whatever transmission is being received, they are clearly due either to external causes such as atmospheric and "man-made static," or to internal causes taking the form of some fault or other in the receiving circuit itself.

The most important point to establish, then, is whether the source of disturbance is located inside the receiving circuit, or

outside it. That is, fortunately, quite an easy matter.

As the aerial and earth are the principal collectors of external interference of any kind, disconnecting these leads from their respective terminals affords a valuable clue to the location of the trouble.

If, on removing the outside aerial and earth leads, you find that the crackling, grating or other noises disappear completely, or are reduced to negligible proportions, you may rest assured that their cause is an external one, which may be traceable either to natural atmospheric or to some form of electrical interference; or else that they are due to a fault in your aerial and earth system.

Remedying Faults

This latter point is one that can be checked up quite easily by a brief inspection, or by substituting an alternative aerial—say an indoor one—and temporary earth or counterpoise if one is available.

Should the disturbance continue quite unabated in spite of the absence of the aerial and earth, this fact may be taken as fairly conclusive proof that the whole cause of the trouble is traceable to a fault in the set itself, its associated batteries or the loud-speaker.

Some of the faults most likely to give rise to noises resembling atmospheric are as follows:—

(1) Loose connections or bad contacts in components or wiring; (2) faulty resistances; (3) intermittent contact due to

breaks in coil, transformer or other windings; (4) run-down H.T. dry batteries; (5) run-down L.T. accumulators. (If the spade tags under the terminals of an accumulator are making bad contact owing to corrosion, a peculiar sizzling noise, not at all unlike that produced by a certain form of atmospheric, is very prone to occur.)

Detailed practical instructions on the methods of tracing and remedying the foregoing faults have already appeared from time to time in *AMATEUR WIRELESS*, so there is no need to reiterate them in the present article.

To sum up, the simple tests that have to be made in order to determine whether atmospheric-like noises are due to real "X's," to the man-made kind, to a fault in transmission, or to a fault in the receiving circuit, may be briefly enumerated as follows:—

(1) Alter the tuning of the set to ascertain whether all transmissions are affected, or only the signals from one station.

(2) Disconnect aerial and earth to ascertain whether the source of disturbance is an external or internal one.

(3) If possible, substitute an alternative aerial and temporary earth connection, to see whether the fault lies in the original aerial and earth.

These elementary tests can be carried out quite easily by anyone, and are but the work of a few moments.

"TUNING MADE EASY"

THE new indicators, marked with the names of the stations to be received, make a welcome change to the old tuning-dials marked with degrees only. At all events, they save one the fag of having to remember the exact condenser settings of foreign stations, or of referring to a calibration chart. Of course, their extra-large size is rather a handicap, especially on compact sets, where it becomes a problem where to mount them conveniently. This particular difficulty has now been overcome in one case by arranging the station dial around the periphery of the cone or diaphragm of the contained loud-speaker, and gearing the indicator needle up to the spindle of the tuning-control. M. B.

On August 21 Mr. Ian Macpherson, the Scottish baritone, will take part in one of the Sunday afternoon concerts which have been lately begun in the Scottish Region.

'WARE CONDENSERS

You can get a nasty shock from the condensers in a mains unit even for several minutes after the power has been switched off. The large capacity con-



densers store enough current to give a small spark. It is a wise plan momentarily to short-circuit each condenser with a piece of wire before making any adjustments behind the mains unit panel.

IT'S SIMPLY MARVELLOUS

We use a modern expression for the P.M.IHL because it is a modern valve; it's in step with the times to give you the performance of to-day and to-morrow instead of the performance of yesterday. An entirely new construction, the greatest development in modern valve design, makes the P.M.IHL NON-MICROPHONIC, so that it can be used in modern battery-operated receivers.

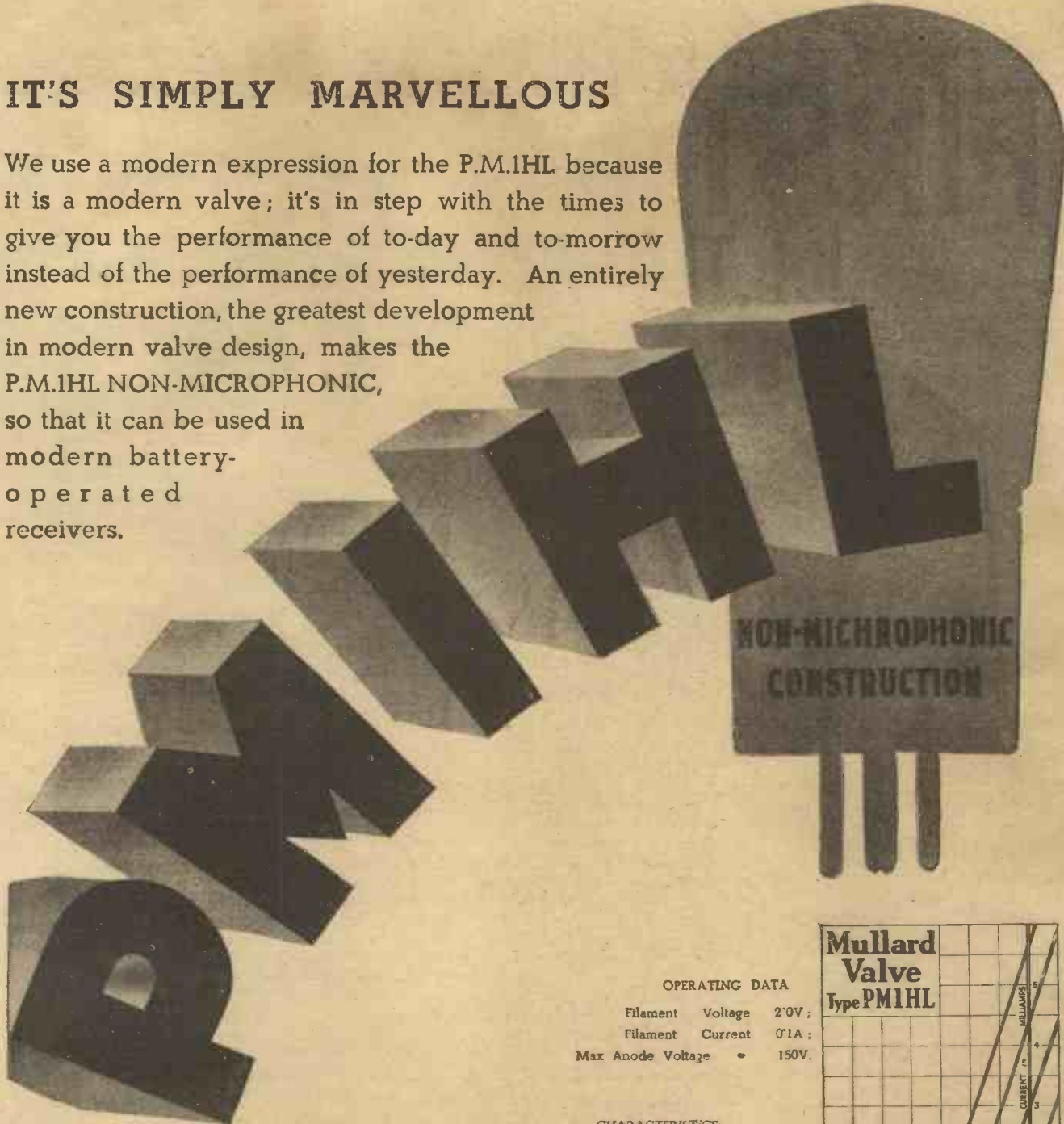

OPERATING DATA
 Filament Voltage 2'0V;
 Filament Current 0'1A;
 Max Anode Voltage • 150V.

CHARACTERISTICS.
 (At Anode Volts 100; Grid Volts zero.)
 Anode Impedance - - - 20,000 ohms
 Amplification Factor - - - 28
 Mutual Conductance - - - 1.4mA/V



PRICE 7/- MADE IN ENGLAND.

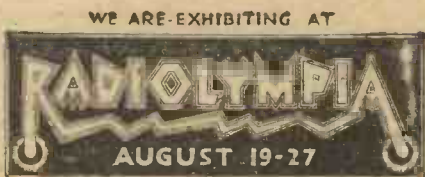

Mullard

THE · MASTER · VALVE

Advt. The Mullard Wireless Service Co., Ltd., Mullard House, Charing Cross Road, London, W.C. 2.

ARKS

Don't Forget to Say That You Saw it in "A.W."

FIRST IN THE PREFERENCE OF PRACTICAL MEN

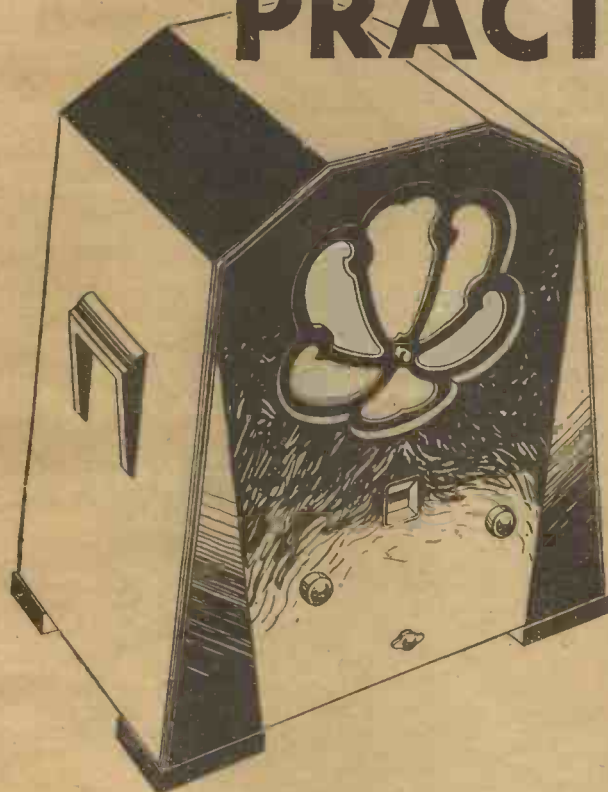

The new FERRANTI 7-Valve Super-Heterodyne was designed to satisfy the most critical of all audiences—the practical men who are able to test technical efficiency by their own exacting standards. Selectivity, reproduction, simplicity of operation—each feature has been tried and compared with an impartial mind—each has revealed definite points of superiority. Everywhere, the FERRANTI Super-Heterodyne is becoming recognised as the finest wireless receiver yet created. Among its notable developments is the new Tone Control, which enable the listener to obtain sharp, clear speech, and rich, mellow music — exactly adjusted to personal taste.

Suitable only for 200/250 volts, A.C. Supplies having frequencies between 40 and 60 cycles.

The design incorporates the most modern features, including INITIAL H.F. AMPLIFICATION, preventing interference with other sets; variable MU VALVES, providing the best form of volume control; GANGED CONDENSERS, giving one knob tuning; BAND-PASS COUPLING, ensuring high selectivity without loss of high notes; MOVING COIL SPEAKER, for high quality reproduction; TONE CONTROL, to provide sharp or mellow tone at will; ILLUMINATED WAVELENGTH SCALE, giving instant station identification; AUTOMATIC MAINS AERIAL DEVICE, enabling the Receiver to be easily moved from room to room wherever an A.C. light or power socket is available; and GRAMOPHONE PICK-UP.

SEE AND HEAR IT AT STAND **78**

RADIO EXHIBITION, OLYMPIA. AUG. 19th-27th

FERRANTI

7-VALVE SUPER-HETERODYNE CONSOLE

RETAIL PRICE **22 GNS** Or by Deferred Payments -42/- down and 12 monthly payments of 38/6.

FOR ILLUSTRATED LITERATURE, WRITE TO
FERRANTI LTD., HOLLINWOOD, LANCS., or BUSH HOUSE, LONDON. W.C.2

You will Help Yourself and Help Us By Mentioning "A.W." to Advertisers

On Your Wavelength!

QUEER GOINGS ON

IT has been, on the whole, a wonderful summer for foreign reception, though atmospheric have been something of a nuisance from time to time. Anyhow, it has been a very interesting one, owing to the queer goings on of a good many stations. It is no exaggeration to say that when you switch on in the evening you don't know what you are going to hear. You do know, of course, that you will be able to receive the big fellows like Brussels and Langenberg, and Rome and Toulouse, and Heilsberg and a good many others; but you can never tell when some stations that you haven't heard for weeks won't pop up at full loud-speaker strength. One of the most surprising foreign stations is Lille. He is only a 1.3 kilowatt, and I have had him several times this summer on the loud-speaker in broad daylight, and on occasional evenings he has required a good deal of volume control to keep him within bounds. Other stations liable to produce these wireless surprise packets are Lyons Doua, Falun, Belgrade, Poznan, Moravska-Ostrava, Budapest, Florence, Katowice, and Marseilles.

FUN WITH PORTABLES

HAVE you ever tried the amusing game of tracking down interference with portable sets? You want two of them for the job, and it is a highly interesting pastime, besides proving very useful on occasion. The sets chosen should have strongly marked directional properties; the better these are, the greater your chance of locating the source of the trouble. Suppose that you and your friends have been complaining for some time of a crackling kind of interference that comes on at certain times of the day. Two people arm themselves with portables and go to points some distance apart in cars. Then each switches on his set and tunes it to the wavelength which brings out the interference at its loudest. The next process is to discover the direction from which the interference comes. This is done by rotating the set until the sounds are at a minimum. The frame of the portable is now approximately at right angles to a straight line between the set and the source of interference. By following the general direction of this straight line, first one way and then the other, you soon find, by the alterations in strength, whether you are driving towards or away from whatever is causing the trouble. Meantime, the other car is proceeding in the same manner, and before very long the two sleuth hounds come into sight of one another.

TRACKING IT DOWN

THE possible area is now reduced to something pretty small, and before very long the actual building in which the offending machinery is at

work is located. Sometimes the final stages are quite easy: a flashing sign, for instance, comes into view. Eye and ear working together discover that the crackles synchronise exactly with the flashes, and that is that. Or, again, the direction-finding work tracks down the source of the interference to a certain street or block of buildings. There is only one which contains electrical machinery; so that must be the culprit.

Sometimes the business is not quite such plain sailing as has been described, for it may be that, owing to "reflections" of various kinds, you don't get quite a true bearing of the source of the trouble. Or, again, if the interference is very powerful it may be difficult to decide whether it is growing more powerful or less powerful until you have moved some considerable distance in one direction or the other. Still, it happens more often than not that a little work of this interesting kind serves to track down the trouble, and once it has been located the necessary steps can be taken.

TWO-VOLTERS SUPREME

WHEN I make a "bloomer" I don't in the least mind owning up to it. As one who was formerly amongst the staunchest six-volt die-hards, I now take off my hat to the two-volter and confess that I was completely in error some years ago when I said that the two-volt battery valve could never be quite so good as the six-volter. If I remember aright, I then criticised the attitude of valve manufacturers and suggested that if they wanted to eliminate the six-volt valve they would be much better advised to concentrate their efforts on super-efficient four-volt filaments. Nobody nowadays uses four-volt battery valves and there are very few who still cling to the six-volter. Our manufacturers have given us a superlative range of two-volt valves which fulfil all our requirements. With variable-mu screen-grid valves, a good detector, and push-pull output you can turn out a battery-operated set which, in point of sensitivity and fine quality of reproduction, leaves nothing to be desired.

M.C.'S FOR ALL

THIS year permanent-magnet moving-coil loud-speakers will be available at prices very little higher than those ruling not long ago for reed or moving-iron instruments. The moving-coil loud-speaker, in fact, is now brought within the reach of all. But don't jump to the conclusion that your reproduction is necessarily going to become perfect if you scrap the moving-iron instrument and fit the moving-coil to the old set. Unless you exercise a little care in making the change, you may find that you have jumped out of the frying pan into the fire.

The moving-coil does not gloss over faults in the set; on the contrary, it brings them out. In many cases very pleasing quality is obtainable with an indifferent set and moving-iron loud-speaker just because the faults of the one happen precisely to counter-balance those of the other. Here the use of a moving-coil will not improve matters at all, for every scrap of distortion due to the set will be faithfully shown up by the speaker. Don't forget that to operate a moving-coil loud-speaker satisfactorily you must match its impedance to that of the last valve. This means that a suitable output transformer is essential. Lastly, don't buy a very cheap moving-coil unless it is of reliable make. If the price has been cut by the use of cheap and unreliable magnets the quality will not be maintained for very long.

WHY NOT A MAD WEEK?

SEVERAL London music-halls scored enormous successes during the summer months, when entertainment business is usually very slack, by putting on crazy programmes. Every one of the artistes was allowed to do pretty well what he liked, and the net result was a riot of fun. I don't suppose that it has ever happened before that on the hottest of days people were being turned away from the doors of variety shows because the places were filled to capacity. Why shouldn't the B.B.C. try the effect of going mad for a week or so? I can see enormous possibilities in the idea, and if it were tried out I believe that it would give a wonderful boost to wireless at the present time.

AMERICAN TRENDS

AMERICAN magazines seem to be full of Class A and Class B amplifiers. These are the designations which Americans use for the different types of push-pull output stage. The Class A amplifier is one biased in the normal manner, with each valve working at the same grid bias as would be used for the valve by itself. Under these conditions, of course, one obtains twice the output from the stage and avoids second harmonic distortion if the valves are reasonably matched, this being the feature of push-pull amplification.

The Class B amplifier is the push-pull stage, with each valve biased back to the bottom bend of the characteristic in the manner described by Mr. Reyner in a recent article. This scheme, of course, has the advantage of a very low-standing anode current, and is a method which is rapidly gaining favour. The actual anode current, of course, rises momentarily every time there is a signal; so that the true anode current is appreciably more than the standing value, but the efficiency of the operation is considerably increased, the ratio of A.C. power to D.C. consumption

On Your Wavelength! (continued)

from the battery being 50 or 60 per cent. The latest developments are even more startling, being in the direction of deliberately allowing the grid current to flow and thereby extending the characteristic to an enormous extent. This would be considered sheer heresy a year or two back, but I should not be surprised if the greater part of our amplifiers in the future were built on this principle.

A RAY OF HOPE

RECENTLY I mentioned that I was rather apprehensive about the deluge of mains receiving sets promised for the coming season, and the apparent neglect of the battery user. I am still afraid that our manufacturers are suffering from a rather bad attack of mains mania, though I am glad to say that I do hear that one firm, at any rate, is going to put on a big set for the battery man. We have suffered for far too long from the idea that the battery set must always be a small affair, relying largely on reaction for its sensitiveness and incapable of producing anything like the volume and quality of its mains counterpart. There will always be a large market for the smaller type of battery set, but I am quite sure that there will also be a big demand for the more ambitious kind of non-mains receiving set.

"LOCKED" TUNING

TIME was when the owner of a long-range set rather delighted in the number and complexity of the tuning controls, and in his skill in handling them. For instance, the change-over from a medium-wave to a long-wave station could be made an impressive job, calculated to inspire respect if all the family circle saw it done. Nowadays single-knob control and automatic waveband switching are the general rule, and the glory of the home "expert" has departed.

But there are still further developments ahead. I see, for instance, that the makers

of an American super-het are featuring what they call "locked" tuning, which prevents any signal from getting through to the loud-speaker until the input circuits have been tuned to the dead centre of the carrier-wave to be received. The idea is to cut out all the static and other "noise" usually picked up when passing from one station to another. The effect is secured by means of a special control valve which imposes a paralysing bias on one of the intermediate valves, until the incoming carrier reaches a certain strength, when the current path to the loud-speaker is automatically "unlocked."

REGULATING SELECTIVITY

ANOTHER tuning control already on the horizon is one giving a variable degree of selectivity according to the particular station being received. It applies more particularly to band-pass sets where the input circuits are normally designed to admit side-bands over a width of, say, 10 kilocycles, i.e., 5 kilocycles on each side of the carrier. This is sufficient to give excellent quality on the local or any other station not subject to severe interference. But in many cases a 10-kilocycle band will overlap the next nearest station on the frequency scale, and so bring in a certain amount of interference. To avoid this the selectivity control is used to narrow down the band width of the input circuits, say, to 5 kilocycles, or whatever is necessary to cut out the interfering station. Of course, this can only be done at the expense of some falling-off in quality, but on the other hand one does get the best possible compromise in the circumstances.

NOW FOR OLYMPIA

SINCE the Exhibition opens on August 19, we are starting the wireless season off a whole month earlier than in past years. In some ways, this is no bad thing. I have always contended, as old readers may remember, that an opening date towards the end of September was just

too late, since both schoolboys and school-girls were back at work, and therefore could not attend. They will be there this year in their thousands, and I shouldn't be surprised if a good many fathers and mothers are urged to cut short the holidays by the seaside so that the family may take part in the great pilgrimage to Olympia. It is certainly going to be a very fine show, though there won't be any startling innovations.

SETTLING DOWN

THE fact is that the wireless set has developed very much as the motor-car did, though at a far more rapid rate. Not so many years ago, when the Motor Exhibition came along, the new models put those of the previous year completely in the shade, for they contained such enormous and obvious improvements. Now car makers are having to tax their ingenuity to find possible improvements. So with wireless. Up to about two years ago, each Show at Olympia made us feel as if our existing receiving sets had come out of the Ark. From now onwards, the improvements that take place will be mainly in matters of detail—unless, of course, some utterly revolutionary invention comes along, which is, to say the least of it, unlikely. You can buy this year with a comfortable feeling that the apparatus will certainly not be out of date in a short time. Think for a moment and you will see that it cannot be. There is little or no room for improvement—so far, at any rate, as the mains set is concerned—in sensitiveness, selectivity, quality, simplicity, or economy in running. In the battery set as much has been done already with three or four valves as can be done. The only improvement likely in the future is the marketing of larger sets requiring bigger H.T. voltage and more current.

THERMION.

THE EXHIBITS DESCRIBED —Next week in "A.W."—A complete Stand-to-Stand Guide.

PERSONALITIES IN THE WEEK'S PROGRAMMES

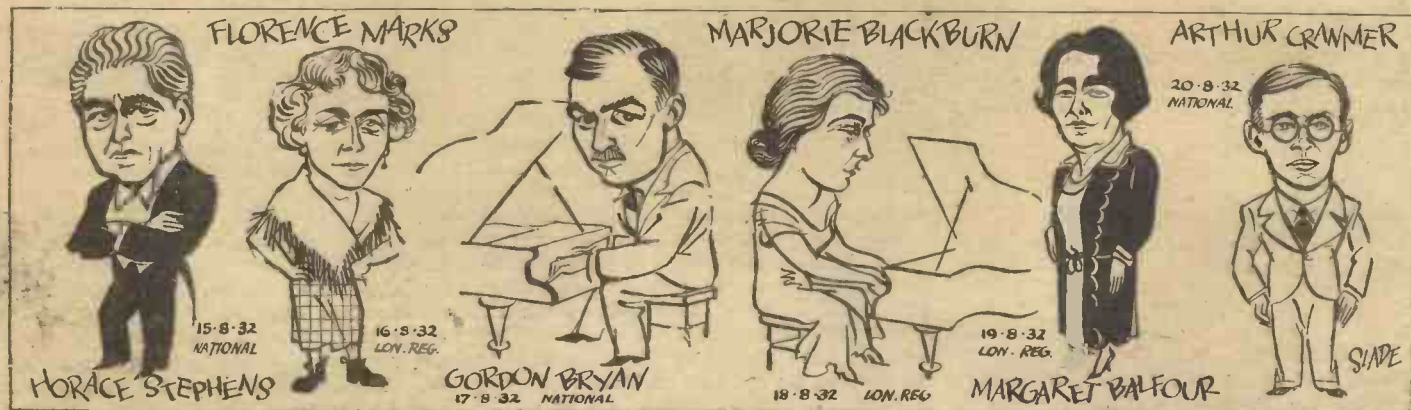

FLORENCE MARKS
15-8-32 NATIONAL
HORACE STEPHENS

16-8-32 LON. REG.
GORDON BRYAN

MARJORIE BLACKBURN
17-8-32 NATIONAL

19-8-32 LON. REG.
MARGARET BALFOUR

20-8-32 NATIONAL
ARTHUR CRAMMER

SHADE

AT THE B.B.C.

A RECITAL of ----- GRAMOPHONE RECORDS



Our Special Commissioner discusses with the B.B.C. Effects Producer the new gramophone arrangements for the broadcasting of record music and specially-prepared radio play effects

WHEN Broadcasting House first opened visiting Press representatives were shown the special gramophone room where there are six electric gramophones all capable of being worked at once.

A little amusement was caused at the suggestion that Mr. Christopher Stone or any other record broadcaster would get so enthusiastic as to want six turntables running simultaneously, but the other day I happened to go into the 6E gramophone room while the operator there was actually using all six at once.

There was a reason for it. He was not giving what Ashley Sterne calls a "recital of granolithic records by Mr. Portland Stone"! He was using the six turntables

tables, because at Savoy Hill they could not prevent the turntable motors causing interference with the pick-up and "mike" lines.

When the 6E operator had finished his synchronising practice, he showed me how the gear works.

"I use the six turntables in here," he said, "for radio play effects. Only when the new studios are full are the gramophone turntables here used for ordinary record recital broadcasts. The news studios are much more comfortable when a long recital of records is being given. There are two electric turntables in each.

"Mr. Stone has a special lamp on a balanced arm which can be brought right close down to the turntables so that there is plenty of light when changing needles. All the wiring, even the electric light wiring, is shielded.

done by the six potentiometer knobs you see in the centre here, but the main control is done from the dramatic control room two floors above."

I saw that the old type of needle armature pick-up is still used for the B.B.C. record broadcasts. All the turntable chassis are fitted with them. These pick-ups are very light and are fitted on long extension arms.

Together we peered beneath the turntables and traced out the wiring. Each balanced armature pick-up coil is connected to the slider and one end of a volume control fader. The fader bank is wired up to the amplifier through the usual coupling circuit.

There are no amplifiers in the 6E studio. The wires simply go straight out and up the steel-shielded panels in the studio tower wall to the amplifier racks in the control room at the side of the Military Band studio.

Mr. Stone says that he is very pleased with his new gramophone fittings. The



The six turntables in the gramophone studio overlooking the effects room

simultaneously for a wireless play rehearsal.

Over a year ago critics of the B.B.C. said that if the B.B.C. was to give as much programme space to records as Radio Paris and the other Continentals do, the gramophone equipment would have to be modernised. Now this has been done.

For five years the B.B.C. had to put up with spring-driven gramophone turn-

tables, putting on two or three records at once and fading one into the other, so that no one crowd noise broadcast ever sounds like another!"

"I suppose," I said, "these six knobs are for volume control on each of the turntables."

"Not exactly," he explained. "The fading from one turntable to another is

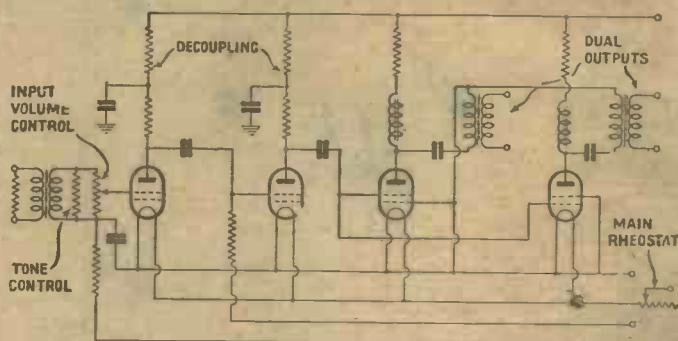

A amplifier used for gramophone broadcasts

"The turntables in the effects room here are quite easy to work. There is really no difficulty in running all six at once. It is very seldom that an effects noise is made with only one record. Even crowd noises are made by

wireless play producers are finding the new turntable equipment a big advantage.

The room with six turntables overlooks the main effects studio 6D. A microphone on a talkie film type of pivoted arm can be swung round so that the operator can broadcast, or speak through the Broadcasting House loud-speakers to the radio-play actors in another studio.

It is all very efficient, and a hundred per cent. better than the former spring-driven wooden-cased pick-up mounts at Savoy Hill.

I asked what had become of the 600 records of strange noises which were kept in a steel file in the basement of Savoy Hill, and the Effects Producer showed me their new home in the production centre of Broadcasting House.

HOW TO TUNE A BAND-PASS SET

Owners of modern band-pass tuned receivers will find this practical tuning advice by Kenneth Ulyett, of great assistance in getting the best results



Does it seem to you that a trimmer on the aerial side of a band-pass set is a waste of time? It is not, and it is not a waste of space either. It is a very important part of the set, and it is one that you will find it difficult to do without. The modern band-pass receiver has become a very complicated affair, and it is one that is difficult to tune. It is one that is difficult to tune, and it is one that is difficult to tune.



Case 1. Keep the driver when adjusting the aerial so that your capacity does not affect the band-pass adjustment. Each trimmer should be independently adjusted in consultation with the main control, as explained in the text.

There are a few simple points to remember when you are tuning a band-pass set. The first is to keep the driver when adjusting the aerial so that your capacity does not affect the band-pass adjustment. Each trimmer should be independently adjusted in consultation with the main control, as explained in the text.

A band-pass set should be properly set up when you first start to tune it. Until

and delicate control of the aerial, and the detector and converter sections, are adjusted in the best way. Control of the aerial section is, however, still of the greatest importance, and it is one that you will find it difficult to do without. The modern band-pass receiver has become a very complicated affair, and it is one that is difficult to tune. It is one that is difficult to tune, and it is one that is difficult to tune.

In connection with the series aerial condenser, it is important to remember that it must be adjusted in the best way. The tuning of the aerial section is, however, still of the greatest importance, and it is one that you will find it difficult to do without. The modern band-pass receiver has become a very complicated affair, and it is one that is difficult to tune. It is one that is difficult to tune, and it is one that is difficult to tune.

There are a number of points to remember when you are tuning a band-pass set. The first is to keep the driver when adjusting the aerial so that your capacity does not affect the band-pass adjustment. Each trimmer should be independently adjusted in consultation with the main control, as explained in the text.

The series aerial condenser in a band-pass set must be adjusted to correct the ganging. Variation of this condenser's capacity will enable the sections to be matched, as it alters the aerial loading on one of the two band-pass coils. It is often a good idea to have the knob of this condenser on the panel.

The tuning of the aerial section is, however, still of the greatest importance, and it is one that you will find it difficult to do without. The modern band-pass receiver has become a very complicated affair, and it is one that is difficult to tune. It is one that is difficult to tune, and it is one that is difficult to tune.

Do not forget that the knob of a series aerial condenser should be on the panel. This is a very important point, and it is one that you will find it difficult to do without. The modern band-pass receiver has become a very complicated affair, and it is one that is difficult to tune. It is one that is difficult to tune, and it is one that is difficult to tune.

Turn a trimmer a turn or so one way until the loudest results are obtained and then make a similar adjustment with the other trimmer. One trimmer in a set of this description may be more effective in sharply tuning the coil than the others. When you have found this, it is merely a matter of tuning in a station simultaneously on this trimmer and the main tuning knob.

Probably the easiest will be very weak. Each section of the gang of tuning coils should have a small trimmer adjustment. These should be completely slack

and the main control is adjusted. Make sure that the sections really do return to minimum capacity. Some trimmers are of the compression type, and the spring leaves may be returned to the minimum position when the trimmer knobs are rotated.

The trimmer on the section of the condenser which tunes the aerial side of the band-pass coil is not likely to be so critical in adjustment as the other two. In any case, a range of correction is possible afterwards by a series aerial condenser. Try to trace out each section of the ganged condenser down the aerial section of the band-pass coil; for this will simplify the final fine adjustment.



The series aerial condenser in a band-pass set must be adjusted to correct the ganging. Variation of this condenser's capacity will enable the sections to be matched, as it alters the aerial loading on one of the two band-pass coils. It is often a good idea to have the knob of this condenser on the panel.

Turn one of them trimmers a turn or so one way until the loudest results are obtained and then make a similar adjustment with the other trimmer.

One trimmer in a set of this description may be more effective in sharply tuning the coil than the others. When you have found this, it is merely a matter of tuning in a station simultaneously on this trimmer and the main tuning knob.

(Continued at foot of next page)

Some Notes on "Present-

day Short-wave Conditions

Around the Short-wave Dial

By M.
BARNETT

THE problem of operating short-wave receivers off either A.C. or D.C. mains is one which a large number of short-wave enthusiasts do not seem to be prepared to tackle. Even to-day, one comes across plenty of people who do not seem to think that such a system is workable on the short waves. That this idea is definitely incorrect will be at once apparent in the majority of cases when an actual test of a soundly constructed receiver has been made. Of course, we come across many cases which are more obstinate than others, owing to the peculiar nature of the mains supply in question. Generally, we shall find that the only symptoms present in the worst of cases will consist of excessive humming, a tendency to motor-boating effects and an unsteady reaction effect owing to fluctuations of the mains voltage. These, of course, sound bad enough but in the majority of cases the first two complaints can be got over by careful circuit and construction design.

Smoothing Troubles

The third item admittedly presents a rather more serious problem but is luckily not very often come across in a sufficiently high degree to be really serious. If a really good smoothing system is used—whether the mains supply be A.C. or D.C.—and the

hum is still present, it will in all probability be originating in the detector stage, where it is amplified by the following stages. Here the best method of curing the trouble is to extend the amount of shielding used and, in particular, to shield the grid wiring, which should also be kept short. This may sound rather like old advice, but I can assure the newcomer that it is a trick which pays every time. Personally, I prefer to solder one end of my grid condenser directly to the valve socket, wherever possible.

Where a short-wave adaptor is being used with an A.C. receiver and whether the adaptor uses its own separate power supply or takes it from the receiver itself, it will generally be preferable to use an adaptor of the super-heterodyne type, not only because of the general superiority of this arrangement where a number of screen-grid stages are used, but because of the fact that the adaptor does not have to pass on audio-frequency currents to the receiver in normal cases and thus a hum originating in the detector portion of the adaptor will not normally be passed on to the receiver and the output stages. There is, of course, always a possibility that the hum may be passed along by other means, such as parallel power leads and output leads for instance, but this can always be

avoided if sufficient care is taken. More about A.C. short-wavers will undoubtedly be heard anon.

I wonder how many readers have tuned in the television signals which have lately been heard in the 30-metre group? On the one occasion when I heard them myself, I was testing out a new receiver and not having a wavemeter handy at the time, I cannot profess to know the exact wavelength or where the signals were originating from. Perhaps somebody can supply this information.

The New Short-wave Adaptors

Not many of the new season's receivers announced so far appear to have provision for short-wave reception although there is slight activity in the short-wave adaptor or convertor field. It will no doubt not be very long before ultra-short-wave receiving equipment is made available and this will no doubt take the form of a super-heterodyne convertor or a complete receiver working on this principle. We can presume that in the not-very-distant future a number of ultra-short-wave transmitters, operating between 5 and 8 metres, will be erected in various parts of the country and existing receivers, of course, will not be of any use for the reception of these stations.

"HOW TO TUNE A BAND-PASS SET"

(Continued from preceding page.)

After a little time spent at the dials in finding the correct trimmer positions, you should have this one local station come in as loud as possible, and sharply tuned.

If the station reaches full volume at two points close together on the dial then the trimmer adjustment is not right. When you are satisfied that there is no double-humping, turn to a station at one end of the tuning scale and see if any readjustment of the trimmers is necessary.

In every case this initial trimming adjustment should be done on the medium waves. In some sets the ganging may not still be accurate on the long waves, but it is on the medium waveband that you need the most selectivity.

With good coils you should find that Radio Paris and Daventry 5XX can be prevented from giving a double-hump effect simply by altering the series aerial condenser.

In localities where the main station on the medium waveband comes in at the extreme end of the scale, readjustment of the series aerial condenser may always be needed. That is one main difference between the operation of a band-pass set and of a straight set.

The series aerial condenser in a band-pass outfit must not be regarded as a selectivity control, but rather as a trimmer for the ganging. If your set has been properly ganged then on a station which comes in at about a medium reading on the dials, the first movement of the series aerial condenser will sharpen up the tuning.

Beyond that point the ganging of the set will be disturbed and signal strength will go down.

If you are working from the extreme end of the condenser scale then this varia-

tion in ganging may make just the correction that is needed and signal strength may go up!

In a set which is adjusted to be in a very sensitive condition, alteration of the screening grid voltage to the screen-grid valve may upset the tuning, and in an outfit where the screen-grid voltage control is used for volume regulation this point must be watched. As the screening-grid voltages are cut down to reduce signal strength the point of tuning may be disturbed.

The real test of true ganging is when the set remains properly in gang and the volume progressively increases as the reaction knob is rotated. If the set is not properly ganged then, as the tuning is sharpened by increasing reaction, the discrepancy will be more noticeable, stations will "hump" at two points on the dial and increasing reaction may decrease the volume.

STRETCH IT FIRST

You cannot make a job of wiring up a set on the square-corner system unless



the tinned copper wire is first stretched straight. Stretch the wire through round-nosed pliers.

A unique talk entitled "Tramps—Their Ways, Habits and Haunts," will be given for Midland Regional listeners by the Rev. Frank Jennings on August 23. Mr. Jennings is able to speak from first-hand knowledge as he has spent several periods singing or peddling.

An Irish programme entitled "Dreams of Ireland" will be given by the Midland Studio Orchestra on August 23.



"Thermion" looks forward to the Show

Once again we are on the eve of the Wireless Exhibition, and this year's will be by far the biggest that has yet been held. The Editor has asked me to jot down, as I have in previous years, what I expect to see when the great doors of Olympia open.

FIRST of all, as regards complete receiving sets. This is undoubtedly to be a radiogram year; so far, that is, as mains sets are concerned. I can award myself a pat on the back at having been the first person to suggest (a long while ago now) that the wireless set and the gramophone would one day become partners, and not rivals. This happy alliance has taken place, and in the radiogram we have the finest home entertainer imaginable.

There will be radiograms to suit all tastes and all pockets, for prices will range from a surprisingly small number of pounds up to £100 or so, whilst the instruments themselves will contain any number of valves, from three to nine.

I expect great things of the modest three-valve radiograms and three-valve mains sets this year, for you can do wonders nowadays with such a simple circuit as H.F., detector, and L.F. But the greater the number of valves, the easier a set is to manipulate; since no knobs are needed but those for tuning, volume control, and wave-change purposes, once you have enough H.F. to enable you to dispense with reaction.

Speaking of volume control reminds me that one or two firms will be showing super-heterodyne receiving sets and radiograms

fitted with this most convenient and attractive device. In "On Your Wavelength," I have been hammering away at automatic control, and I am glad to see that some makers, at any rate, have realised its possibilities.

New Tuning Devices

There will be some very neat tuning devices. A good many of the dials will be marked off in wavelengths or frequencies and some will have the actual names of stations. One tuning method that appeals to me very much is applied to a super-het. If a super-het is very selective it is by no means an easy business to tune it properly, unless you have some device in the plate circuit of the second detector valve to show you when exact resonance has been reached—and if you don't get the exact tuning there is liable to be a certain amount of distortion. One method, of course, is to connect up a milliammeter in the plate circuit; but measuring instruments, somehow, don't appeal to the man (or woman) in the street.

In one set, a rectangular shadow appears on the dial as you are approaching the settings needed for a station. You simply tune until you make this shadow as narrow as possible, and there you are. Not the least of

the advantages of this scheme is that you can tune in a station by-eye with the volume control in the "off" position and not hear a sound until you have found the correct settings. You then "fade it in" gradually by means of the volume control.

The battery user will be catered for pretty well, up to a point, but I am afraid that there is a strong tendency among makers to regard the battery-operated set as something which *must* be inferior to the mains receiver. I know that this is not true, because I have both a radiogram, and a big super-het operated from batteries; but I had to make them myself. If battery users and wireless-set manufacturers would only realise that it costs no more to supply 40 milliamperes at 180 volts from an accumulator H.T.B. than it does to supply 10 or 12 milliamperes at 100 volts from a standard-capacity dry cell battery, the way to bigger and better battery sets would be plain.

I hear of two battery-operated super-hets, but so far I cannot discover a single battery radiogram, nor have I any tidings of a battery set with push-pull output. As *AMATEUR WIRELESS* and *Wireless Magazine* have shown, a last stage on these lines is easy to operate from batteries by the use of economy push-pull.

There will be exhibited some very attractive pick-ups at reasonable prices. The pick-up has made big strides since it first appeared. We used, if you remember, to buy little gadgets which we fitted on to the tone arm of our gramophone in place of the soundbox. These were not found too good, owing to faults in tracking; they were followed by the pick-up with its own arm; its only disadvantage was its rather high price. Large scale production and clever design have made it possible to produce first-rate pick-ups that are not too expensive.

In valves there is not likely to be anything startling; nothing, I mean, so revolutionary as the introduction of the screen-grid, the pentode, or the variable-mu. Steady but marked improvement is, in fact, the keynote of valve-making at present. The same remarks apply to tuning coils intended for use on the medium and short wavebands: there won't be anything hair-raising, but you will be very favourably impressed by the sound, compact designs and by the general excellence of the components themselves.

Amongst variable condensers I expect to find those of the solid dielectric type coming into prominence for medium- and long-wave

(Continued at foot of next page)

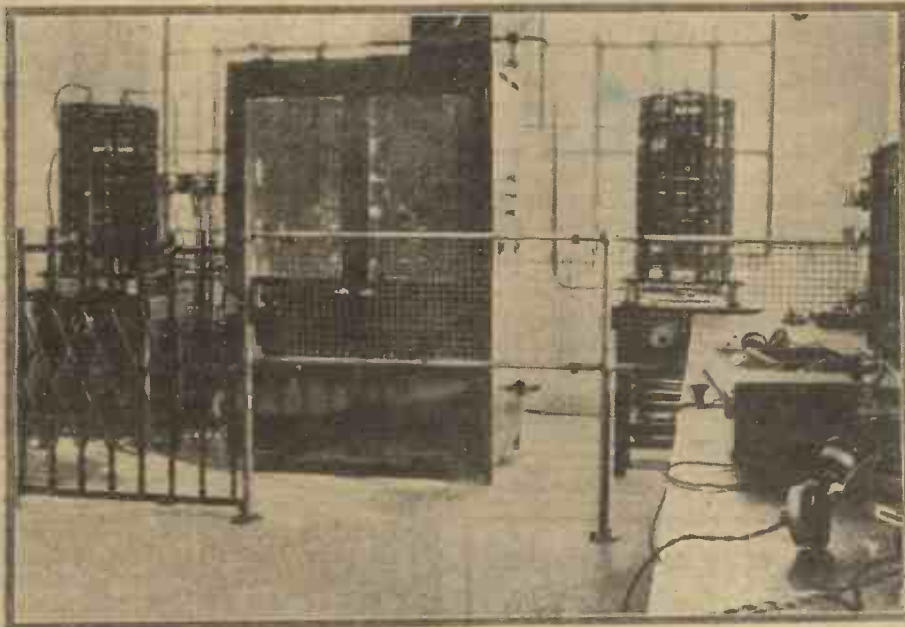

The interior of a modern coastal wireless station for telegraphic communication with ships: the 3 kw. Marconi installation at the new Creek station near Athens, which came into service recently

WHAT IT IS FOR

THE LIGHTNING SAFETY SWITCH

THIS is the time of year when an earthing switch is a useful precaution against the possibility of damage to the set from a sudden lightning discharge.

Which more or less tells you what an earthing switch is for—nothing more or less than a common-sense precaution. Of course the risk of damage is very slight, but the damage, if you are one of the unlucky ones, can be very considerable in the event of a direct hit.

Yet by means of a simple, but albeit robust, earthing switch, properly erected you can almost entirely eliminate the risk of damage, even if by some hundred-to-one chance the aerial is actually struck.

In view of this, a knowledge of earthing the aerial is worth seeking. It is quite simple to arrange with any set. What you need is a double-pole change-over switch, with a porcelain base, as stocked by almost every electrician's stores, and by many radio dealers.

This switch should be mounted outside the house, and leads to the set should consist of stout gauge wires, the

aerial and earth being kept well apart.

Now for the action. When the switch handle is moved down the aerial is automatically connected to earth, and the set is entirely disconnected from both aerial and earth. When the switch is moved up, the aerial is connected to the aerial terminal of the set, and the

earth connection is made to the earth terminal.

Both these switch positions are useful, and you should make a practice of closing the earth switch at the end of an evening's reception.

It will be seen that the aerial and earth leads are not taken direct to the set, but to the two central points on the two-pole switch. Then the two "outers" at one end of the switch are taken to the aerial and earth terminals, while the remaining two "outers" are connected together.

The only point to watch is the connection of the correct outer points to the set's terminals. A little carelessness and you may find the aerial lead switch to the earth terminal, and the earth connected to the aerial terminal!

This type of earthing switch is much to be preferred to a single-pole change-over switch, in which the aerial is merely connected to the earth without disconnecting the leads from the set. This system is not nearly so safe a precaution against lightning, as the set is not entirely isolated.—HOTSPOT.

TESTING THE INSULATION

A good fixed condenser of fairly high capacity will store an appreciable amount



of current, and if short-circuited should give a bright spark. This is a good test of the insulation.

"THERMION LOOKS FORWARD TO THE SHOW"

(Continued from preceding page.)

work. I hear that one firm is turning out a ganged and screened condenser on these lines, which should be a very attractive component on account of its cheapness and its small size. In the days when we all went low-loss mad, there was a prejudice against the solid dielectric variable condenser, which lasted until it was shown that at high frequencies resistance losses are vastly more important than dielectric losses.

Tone Correction

There will be two particularly interesting low-frequency intervalve transformers shown by different firms of manufacturers. The purpose of both of these is to apply tone correction to any existing set, and after trying these instruments I have no hesitation in saying that the results obtained will come as a revelation to many people.

Just as we all went low-loss mad a few years ago, we went bass-mad a little later. In fact, the slogan of the wireless man almost became "Take care of the bass and the top will take care of itself." But it didn't and it doesn't. The big fault in many receivers to-day is that music and speech don't sound as they should, owing to the absence of a proper amount of high frequencies. This is particularly the case in sets that are naturally very selective and in those in which both selectivity and sensitivity are helped by the use of reaction. In such cases a suppression of the treble is almost bound to occur.

These tone-correcting transformers allow

you to tune the output very much as you tune the high-frequency stages. You can adjust your loud-speaker reproduction to suit the circumstances and to meet the requirements of your own ear.

Better than Ever

Ability to do this is especially valuable when you are listening to far-away foreign stations. I dare say you have noticed, when listening (to take an extreme case) to WJZ or KDKA from across the Herring Pond, that you not infrequently hear nearly all bass and very little treble. Give one small twiddle to the control knob of the compensating transformer and this drawback disappears. One of the last arguments against long-distance reception goes by the board, for with one of these components you can obtain just as good a balance of musical frequencies as you can when listening to your local station.

A Worth-while Show

These are just some of the things that I look forward to seeing at Olympia. There will be heaps of others, and no doubt many highly interesting sets and components will be sprung upon us as last-minute surprises. Of one thing I am quite sure, and that is that a visit to Olympia this year will be better worth while than it has ever been before.

**NEXT WEEK—A Complete
Stand-to-stand Guide to
Olympia.**

"TWO-SPEAKER" SETS

THE American market has, for some time, been "featuring" sets incorporating two and sometimes three separate loud-speakers, with the object of improving quality and, at the same time, producing an agreeable binaural or stereophonic effect. The cost is very little more than that of a single high-grade instrument, since each of the separate instruments is designed to cover only a relatively restricted frequency band; viz., either the upper, lower, or intermediate ranges. The innovation is particularly advantageous in the case of small self-contained sets where it is impossible to fit a large-sized baffle. It is quite likely to "catch on" over here, for many listeners have already discovered what a surprising improvement in quality can sometimes be effected by resuscitating a discarded horn speaker and running it in harness with a cone model. B.

Compton Long will give a description of Sam Gurney's "Mystery Trip" on August 18.

A recital by George Mantle-Childe of some of Liszt's transcriptions of operatic music will be given for Midland Regional listeners on August 14.

During the autumn and winter months the B.B.C. in Scotland intends to relay all the symphony concerts of the Reid Orchestra, five concerts of the Scottish Orchestra, and five of the Scottish Philharmonic Orchestra, most of the latter from country centres which are seldom, if ever, able to make visits of a large orchestra financially feasible.

Our Broadcast-Britic

TALKS ABOUT

A BEAUTIFUL PLAY



CARR LYNN,
the well-known impersonator

BREAD. A simple title for a play of beautiful thoughts. I should like to think every farmer in England heard it. Not that it was aimed at one of them. It was aimed at the American Big Business men who cornered the wheat market, but no farmer, hearing that play, could fail to be proud of his profession. The growing of corn and wheat was convincingly shown to be a noble act because it helped to feed mankind.

"A farmer's got to fight nature and he's got to fight man; yet he's servant to both," seemed very true at the moment in the play when the words were uttered. "So long as there is a hungry man in the country, no farmer should stay in his bed," was another great thought. Mr. du Garde Peach has always earned my admiration for his amazingly pointed and pithy dialogue; he surpassed himself in *Bread*.

The production, by Howard Rose, had no flaw in it as far as I could see; it seemed all so natural as to defy any effort on my part to distinguish production technique from actual writing technique. When things happen like that, there is no more to be said; the result is above criticism.

Have you ever come in after a heavy day feeling you want to rest your body, but stimulate your mind? I have. I came in that way on Sunday evening. The singing of Joan Cross, the oboe-playing of Leon Goossens, the tone of the London String Players, heard in the dusk of a peaceful summer evening, revived my drooping spirits. Leon Goossens is the sort of player of whom one naturally expects a great deal. I found myself wondering whether old Handel ever heard anyone play an oboe—or that particular concerto—like him.

Handel was an acid critic. When angry, he was not above knocking his singers about; he once shook Madame Cuzzoni and dragged her to the Haymarket balcony. I think he would have been very charming to Miss Cross had he been in the tower of Broadcasting House on Sunday evening. He could be very charming—when he pleased.

Will someone tell me how to make a loud-speaker capable of taking Jetsam's lowest notes? I was very concerned when he descended to thunder-level in *Listener's Inn* the other night. He admitted he had partaken of refreshment there; even so, it was no excuse for nose-diving to the low B flat in that fashion. A very good show, by the way. I enjoyed all of it.

A Ridgeway Parade may be announced almost any day now. There is no foundation, however, for the rumour that the performance will be a Dance and Yo Yo Show.

The reproduction of the first Promenade Concert of all must have brought back many memories to Sir Henry Wood. Thirty-seven years is a good slice out of any man's life. Two people of my acquaintance were present at the original of this concert, on August 10, 1895; it would be interesting to know how many others were amongst listeners on August Bank Holiday evening. The pictures of the founder and conductor of the famous Proms given in the programmes made a fascinating comparison to me; I have known Sir Henry Wood for twenty out of the thirty-seven years and have seen him gradually change from one appearance to the other. Yet I doubt if Sir Henry, aged sixty-three, is any less virile

than Mr. Henry Wood, aged twenty-six. He has amazing energy. I trust we shall have him with us for many a season to come.

The last of the Hazards was a good yarn. I am personally sorry it is to be the last, for they have been well worth hearing. I hope the B.B.C. is contemplating some similar series for the winter months. Those sorts of broadcasts are pleasant to hear by one's fireside.

The Bank Holiday Night Star Vaudeville was a great success. Now that Star Vaudevilles have begun—the vaudeville last Boxing Night was the beginning of them—they should be given every Bank Holiday.

Jenny Howard, who came on first (and therefore stood the least chance of success) was vivacious, as usual. Vivacity of the right kind will always come through a microphone, but that hoarse voice, vivid sibilants, and north country accent—as well as her natural vivacity—make Jenny Howard an exceptional vaudeville artiste.

Master Graham Payn, the so-called boy soprano, is difficult to judge fairly. To begin with, his voice is nothing like a choir-boy's voice. In some respects it may be better trained than the voices of most choristers, but for all the world it sounds like a woman's by wireless. Then the judgment must be given that way; his voice gives a wrong impression. You need to see him to appreciate that he is a boy.

Dora Gregory was better than I have ever heard her. "Mrs. Adams" (who periodically meets her friend "Sarah") is quite a microphone character. There were very good lines in that dialogue.

Flotsam and Jetsam are never better than when in their own particular idiom. Comparing their performance on Bank Holiday night with that in *Listener's Inn*, I think they must be very hard to write for, or to cast in a production. They are so distinctive in their style that it seems a pity to disturb them.

So Gillie Potter has returned to the microphone? I must say he was welcome. As for Alexander and Mose, they excelled themselves. Whether Tom Burke and his Human Voice Orchestra made a suitable climax for the vaudeville is a matter of opinion. I think they would have been better placed earlier. Where was Leonard Henry, by the way? I missed him.

WHITAKER-WILSON.

PROGRAMME POINTERS

I have frequently commented upon the various (and very varied) performances of imitators, mimics, and impersonators. I think by now most of us know what to expect from them as soon as we read their names in the programmes. These impersonations seem to cover a very wide field; they range from imitations of comedians and other actors and actresses to those of animal life. Impersonation is obviously one of the arts of the microphone and there is little doubt that it is keenly appreciated. My pointer this week is a suggestion that there shall be a novelty in the form of a vaudeville-recital devoted to imitations and impersonations. It would be something out of the ordinary and might prove very entertaining. I have catalogued the names of those I have recently heard, and here give them in no order other than as they occur to me. The names are: Carr Lynn, Rita Brunstrom, Elsie and Doris Walters, Florence Desmond, Imito, Percy Edwards, Ann Penn, Reginald Gardiner, Barbara Couper, Ronald Gourley, Jimmy Elliott. The list is, I am sure, incomplete; it will, however, serve for my purpose of suggesting the outline for what might be termed a vaudeville-recital devoted to this kind of thing.

ALTHOUGH several of the more prominent firms have already lifted the veil of secrecy surrounding their new season's sets, there is a general feeling among set buyers that many "hush-hush" sets will be revealed only when the doors of Olympia open on August 19.

We are very near that time now and I shall not be guilty of any breach of confidence if I take this early opportunity of summing up the various "secrets" of the new sets as I have seen and heard them on various occasions during the past few weeks.



One of the new Lissen kit sets, the Sky-scraper, incorporating a high-quality speaker

For a start, I would emphasise the almost unanimous discovery made by the set manufacturers that the great British listening public wants—and will insist on getting—better quality than it has been possible to obtain during the past year.

The Question of Quality

Whether the set people have discovered the secret of good quality remains to be decided by popular vote, but at any rate they have made a good effort to do much better than in any previous year. Almost all the sets will be of the self-contained type, with built-in loud-speakers, known variously as consolettes, table consoles, and table cabinets. These self-contained



Another Lissen table-type set for the new season. Simple control is a feature of the new chassis



**SECRETS
NEW S**

All intending set
summary of the ne
well-known c

speakers will, with very few exceptions, be of the moving-coil type, some permanent magnet, and many mains energised. There will be a grand swop over from mediocre balanced-armature cones to moving coils. And about time, too!

Quality of reproduction should be better all round the Show, if only for the completeness of the moving-coil succession. Other factors will contribute to better quality, not least of which will be the use of larger power valves, giving more undistorted power output. The variable-mu type of screen-grid valve will also help to keep the quality good at all volume levels.

In past years, there has been a marked tendency to ignore the battery market almost entirely and to concentrate the star items of the range on mains-driven models. Of course, it is easy to get good quality with mains sets, but this year more than one

firm has made a determined effort to meet the very insistent demand for high-quality battery sets.

One battery set will be a super-het and another will have a moving-coil loud-



The Telsen Model S91, a battery-driven set with an all-metal chassis

speaker. Although there is no really concerted effort to do as much for the battery users as for the more fortunate mains-fed listeners, more than one firm has evidently seen the light—and so I would class the new battery-operated sets among the secrets of the Show.

More Super-hets

Talking of super-hets brings me to the by no means closely guarded secret that many of our leading firms have turned to the super-het principle as their solution of the grave problem of separating the station. That the super-het can give split-hair tuning needs no emphasis. What more particularly interests the ordinary listener is whether this much-desired selectivity can be obtained without sacrificing quality of reproduction.

Candidly, I am among those die-hards who deny that the last word in quality can be obtained on the super-het system, but I am more than willing to admit that several of the super-hets to be shown at Olympia



A companion to the popular "Q" portables—one of the new Pye console sets

OF THE SEASON'S SETS

Buyers should read this critical review of the new season's developments by our contributor "SET TESTER"



set, but it is only fair to say that great improvements have undoubtedly been made and without materially adding to the retail prices.

With variable-mu screen-grid valves, sometimes screen-grid detectors, and almost invariably power pentode output valves, the three-valvers of the coming season will be remarkable for their exceedingly great "punch." Driving moving-coil loudspeakers, these three-valvers will satisfy a great part of the mains market. Such sets would be impossible in any other country, for only here can such highly sensitive valves be made.

give quality far in advance of the ordinary sets at present in use.

Let me put it this way: you will be able, with these super-hets, to get real 9-kilo-cycle separation between stations, even between a local and a much more distant foreigner, with a quality of reproduction that is above the average standard of to-day. This represents a great achievement. It has been made possible only by the most painstaking research into the problems of eliminating background noises.

Waveband Comparison

Not least of the problems tackled and solved by our super-het manufacturers is the equalising of the performance on the medium and long wavebands. Some of the

new sets will give just as good selectivity on the Daventry band as on the 200-to-550-metre band.

There has not been the great swing over



The Marconiphone model 253, a three-valver available in A.C. and D.C. models

to the ultra-short waves that was anticipated. The wavelengths below 100 metres still seem to be, in the main, the happy hunting ground of the amateur enthusiast, as distinct from the ordinary broadcast listener.

Very few of the super-hets seem to make provision for the ultra-short waves and most of the straight sets concentrate on the usual medium and long wavebands. To make up for this there will be a host of short-wave units and adaptors of every type, from the simple detector to the more complicated mains-operated two-stager.

Most of the big firms have played for safety in including a modern three-valve mains console in their ranges. Quite rightly, the three-valver is looked upon in this country as the set for the ubiquitous man in the street. For a moderate outlay, such a set now provides first-class reproduction from as many stations as the ordinary listener cares to tune to—twenty, at least, after dark.

No secrets surround this popular type of

Valve Matters

Whether our policy of raising the mu of the valves is wise remains to be seen. If such valves can be made reliable, there is nothing against going on increasing the mu, especially in the interests of the cheap set market. But we must not sacrifice reliability of performance for excessive magnification. This season will be the testing time for our high-mu policy. If sets come through the next year with flying colours, which means without constant servicing for valve renewals, we can indeed be proud of our "hotted-up" three-valvers.

Coming between the three-valvers and



The Varley model AP44, one of the new sets in a striking figured walnut cabinet



A new H.M.V. super-het all-mains set, the Lowboy Seven

"SECRETS OF THE NEW SEASON'S SETS" (Continued from preceding page)

the elaborate six- and seven-valve super hets is a type of set that offers most of the desirable features of de-luxe radio reception without making sacrifices in any respect whatsoever. I refer to the four- and five-valve straight sets with two variable-mu high-frequency stages before the power-grid detector.

To many discriminating listeners this type of set will appeal as being very close to ideal. It has a large reserve of power and does not require expert manipulation of the

of critical adjustment of the knobs. It would save a lot of heartburning if enthusiastic salesmen would take this lesson to heart.

So far as I can see, control of the new sets will certainly be easier than in previous years. Tuning will in many of the better-class sets be done on a wavelength-calibrated scale. De-luxe sets will be marked in stations. Whether this is an advantage I am not prepared to say. It would be if stations could keep on their allotted wavelengths.

One-knob control of tuning has become practicable since gang-tuning condensers were made so much more accurately. Very few set makers dare to put in more than one

should call it a year of detailed improvement, a year in which the weaknesses of past models have been eliminated and the good points more firmly established.

Although prices are not startlingly lower than for the past season, we must remember that improvements such as those so



The rear view of the Lissen Skyscraper battery-operated set showing the all-metal chassis beneath the battery compartment

reaction control—if, indeed, such a control is included—to get plenty of foreigners. It gives first-class quality of reproduction without any skimping of high notes. If preceded by an aerial band-pass, such a four-valver will have as much selectivity as can reasonably be expected in the present stage of the technique.

A great deal will be talked about ease of control this year. Possibly a great deal of nonsense has already been talked on this subject. To the ordinary listener, and it is to such a class I am appealing in this article, control of a wireless set does not mean absence of knobs so much as absence

YOUR SHOW GUIDE.
Next week, in "A.W.," a complete Stand-to-stand Guide to the exhibits at the National Radio Exhibition.

main tuning knob, although on the cheaper sets the use of a tuning trimmer is not merely tolerated—it is obviously needed to ensure the last ounce of sensitivity.

Apart from tuning, the only other knob of importance on the bigger sets is the volume control. This definitely is a better control, due to the almost complete swing-over to the variable-mu type of valve for the screen-grid stages. A wider range of audibility on the volume control and less attenuation of the frequency range at low volumes—this is the "secret" of the improved volume control.



An H.M.V. battery-driven set—the super-het Portable Six. It weighs only 34 lbs.

freely abounding in the new season's products cost money to incorporate. So really, the value for money is greater than ever. Predominant is the improvement in the quality of the reproduction. This, I think, is the most marked improvement, but ease of control and a higher standard of performance, in which are wrapped up selectivity and sensitivity, are all appreciably better.



A distinctive consolette—the Ekco 5-valve super-het with moving-coil speaker, available for both A.C. or D.C. mains operation



The Columbia 356, one of the new seven-valve super-hets. It has a moving-coil speaker

A very interesting development in control is the inclusion of a heterodyne-whistle eliminator. Several sets have this type of control fitted to combat the nuisance of background noises in general and of whistles in particular. Mostly the elimination of such interference can only be gained at the expense of quality. Many listeners anxious to get into touch with a given foreigner suffering from some form of background noise will, I think, agree that some loss of brilliance in the reproduction is amply compensated by the reduction or elimination of the interference.

Quite frankly, this is not a year of secrets in the radio-set market. More truthfully, I



One of the new Atlas sets (H. Clarke & Co. (Manchester), Ltd.) The mains models incorporate an energised moving-coil speaker



IN MY WIRELESS DEN

Weekly Hints — THEORETICAL
CONSTRUCTIONAL & BY
W. JAMES

MAKE GOOD CONNECTIONS

A GOOD deal of hum from mains sets can be traced to poor connections. I have just had a case where a loud hum was heard and which vanished when the detector valve was fitted properly.

The grid pin of the valve was making a poor contact with the grid socket of the holder. Actually the pin was of the solid type, but I bent it a little and then it made a satisfactory contact.

The difficulty with faults of this sort is that the contact, by inspection, may look good enough. But sometimes the contact is faulty because the parts concerned do not press tightly together. In other instances one of the contacts may be dirty, and if the parts do not rub a clean surface, contact is not formed.

A case which comes to mind is a good illustration of the point. A chassis of steel had been cleaned and finished. Various screens were fitted and connections made to tags held down by the screens. The contacts were poor because the surface had not been scraped clean. In this case the coils were earthed to the metal and the result was poor tuning.

You cannot be too careful of how connections with a metal chassis or screens are made. It is usually necessary to scrape the surface at the place where contact is to be made. A bolt tightly fixed will then be likely to make a good connection.

DON'T USE CARDBOARD

A GOOD tuning coil must have a good former or support. If you wrap the wire round a piece of cardboard tube the results might be good or bad.

Dry cardboard is not so bad, but as it is likely to get damp, is not satisfactory as it stands. Treated cardboard is better, as it is not likely to become damp. It pays, however, to use a piece of good material, such as ebonite or paxolin.

An ebonite former will keep its shape and not reduce the efficiency of the winding, excepting when the winding is of the best litzendraht, perhaps. Paxolin is also satisfactory as a rule. Trouble has been experienced in the past by moisture. The tube has not been thoroughly dried and coated. Holes pierced for the ends of wires to pass through have either collected moisture or the tube has been damp, with the result that the wire has been eaten away at these holes. Ebonite has proved safe and, if of good quality, is as good a material as can be found.

VARYING THE S.G.

DO you know what happens when you vary the voltage of the screen of a screen-grid valve?

First, the anode current is changed. An increase in the voltage of the screen from, say, 60 to 80 will increase the anode current. This increase in the voltage will also, no doubt, lower the impedance of the valve. Now the result of this is usually to increase the amplification, which accounts for the fact that the volume control of many sets is only a control of the screen voltage.

The accompanying diagram shows a typical arrangement. Here the fixed resistance R_1 is in series with the potentiometer

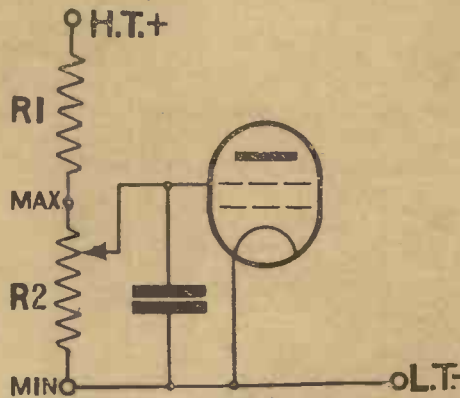

The typical screen-grid stage referred to by W. James

R_2 and the sliding contact is taken to the grid. As the position of the contact is changed, so the voltage of the screen is altered. There is a danger in that if the voltage of the screen is reduced to a certain value or to below a certain value, the valve will rectify or distort.

To get over this the circuit can be altered slightly so that the range in the voltage variations shall not exceed the safe range. A resistance for this purpose may be added between the bottom of the potentiometer R_2 and negative. The extra resistance is, however, not often used in practice. A condenser is connected as usual, between the screen and earth. This condenser is the usual high-frequency bypass, but it also acts to hold the voltage steady against low-frequency variations. The result is that a movement of the contact is not likely to produce a noise.

WANDERING WANDER PLUGS

MOST standard wander plugs are so arranged that the wire is easily attached. Care must, however, be taken to see that a good job is done.

Loose ends may give trouble. A few strands of wire from one plug may easily make contact with another part and the result may be a short-circuited battery. A badly made connection with a wander plug is likely to prove troublesome in several ways.

In the first place the set may be "noisy." This fault may be easily traced by going over the connections. With a really bad joint to a plug used in the high-tension circuit there is always the chance that the circuit will be broken and no results will be obtained. If, however, the poor connection were in the grid circuit the results might not be affected to such an extent that you would shut down and examine the circuit for the fault.

You can easily see that if the wander plug for the grid bias to the power valve was not making contact with the connecting wire, the power valve would have no bias. It would then pass a heavy current and the valve might be ruined.

It is a fault of this nature that gives most trouble. Some faults either stop the set from working or produce noises which call for immediate investigation. A break in the grid-bias circuit would not cause noises or stop reaction. Considerable damage might be done before the fault was suspected. It, therefore, pays to make sure that the grid bias wander plugs fit properly and are connected to the leads.

HOW TO CHARGE AT HOME

IT is very easy to charge a low-tension accumulator from a direct-current supply.

The essential things are, first, a lamp or resistance to limit the value of the current to that desired. An ordinary electric lamp is usually suitable. The second thing is to make the circuit safe—you do not want to get a nasty shock by accident. Therefore, place the battery in a tray and if you know the earthed side of the circuit put the battery there.

The positive or the negative side of the direct current mains may be earthed. Take care, therefore, that the lamp is connected in the right side of the circuit.

COMPLETE SHOW GUIDE
NEXT WEEK

LISSEN THE GREATEST KIT

SKYSCRAPER 3

KIT

SENSITIVE-SELECTIVE-POWERFUL
Metallised S.G. - Detector - Pentode Output

You've got something sensationally good in this new Lissen Skyscraper Three Kit Set. Far-flung range is provided by the new Metallised Screen-grid Valve whose super-efficient screening has made it so absolutely stable that you can push it to the limit of its capabilities. Mighty volume is put out by the Lissen Economy Pentode Valve, and the power you get from it imparts a brilliance of tone to Skyscraper reproduction, never before heard from

any home-constructor's set. The whole circuit is designed for the conservation of every atom of energy that comes to your aerial. Use is made of new shielded coils, which are specially matched and balanced—there is a metal chassis with modern under-baseplate wiring—hair-breadth tuning with geared ball-bearing condensers—all these points and more are combined for the first time in the Lissen Skyscraper.

**WHEN YOU HAVE
 BUILT IT!**

89¹/₆

**HOW YOU INCLUDING
 BUY IT VALVES**



LISSEN LTD.

You will Help Yourself and Help Us By Mentioning "A.W." to Advertisers

FOR HOME CONSTRUCTORS EVER PRODUCED

Have you ever seen a finer looking, more compact, more complete home-built receiver?

You buy the Lissen Skyscraper Kit complete with valves—a Lissen Metallised S.G. Valve, a lively Lissen Detector Valve and a Lissen Economy Power Pentode Valve—and the whole price is only 89/6. You can start straight away and build it, using if you like your existing batteries and any suitable cabinet.

But Lissen have provided for you a beautiful walnut Consolette style cabinet, made in sections for you to put together yourself. That saves you a lot of money and is perfectly simple. This Lissen Skyscraper Cabinet houses batteries, accumulator, chassis and loud-speaker—a special Lissen Pentode-matched Loud-speaker is provided with it, which makes the Skyscraper the most compact and best-looking home-built receiver ever produced. The price complete with this cabinet and the loud-speaker is only £6 5s. Easy terms are available to purchasers of the Lissen Skyscraper.

WHAT IT WILL DO!

What do you expect to-day from the finest set you can possibly build? All Europe? Yes, and all Europe at real entertainment strength. Radio Paris as loud as your local station . . . Moscow at full strength . . . Muhlacher as free from background and as strong as London . . . all the best of the European programmes like next-door neighbours, and with glorious tone and extreme ease of tuning.

SAVE MONEY — BUILD WITH YOUR OWN HANDS — YOUR SUCCESS IS CERTAIN



FREE!

1/- CONSTRUCTIONAL CHART

A two-colour, lavishly produced Constructional Chart has been published, giving detailed instructions and photographs for every step in the building of the Lissen Skyscraper Three. Never before has such a complete Chart been published—every terminal, every wire, every screw is fully dealt with. **THERE IS A FREE COPY FOR EVERYBODY—GO AND ASK YOUR DEALER FOR YOURS!**

Ask your dealer for it!

WORPLE RD, ISLEWORTH.

Mention of "Amateur Wireless" to Advertisers will Ensure Prompt Attention

We Test For You

A weekly review of new components and tests of apparatus conducted by J. H. Reyner, B.Sc., A.M.I.E.E.

HANDY FIXERS

WE have received for review this week four samples of the Kniffy Radio Pins. These pins have a comparatively large head made of erinoid, in which is embedded a stout steel pin just under 1/2 in. in length. The pins have a variety of uses, the first of which is immediately apparent, and consists in the fixing of all types of flex in position on a baseboard. The head of the pin is specially shaped in order to grip twisted, flat, or single type flex.

These pins are suitable for fixing to wood or plaster or other material, and the head is made in six colours to suit the wallpaper or paint where they are mounted.

The pins retail at 1d. each or 7 for 6d., and may be obtained from S. Kniveton, 7b London Road, Enfield.

BULGIN TRANSCOUPLER

THE Bulgin Transcoupler which we have examined this week is an interesting application of the parallel-feed principle. It consists essentially of a small transformer on a high-permeability core, together

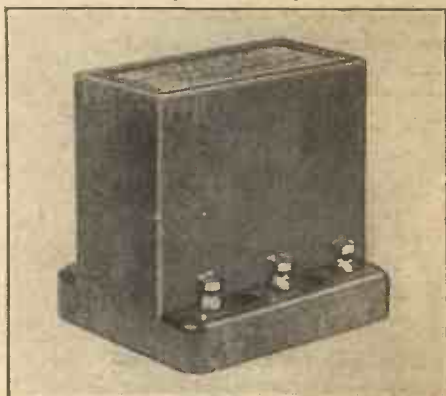

The Bulgin Transcoupler which consists of a high-permeability core transformer in conjunction with an anode resistance and coupling condenser

with the necessary anode resistance and coupling condenser for parallel feed. The whole is mounted in one moulded case measuring 2 3/4 in. by 2 3/8 in. by 2 1/2 in. high. The necessary terminals are contained in a flange along the bottom, which also carries the holes for fixing. The component is finished in the familiar Bulgin mottled green and is of handsome appearance.

The anode resistance is of 50,000 ohms tapped at 30,000, so that by suitable connections, various values of feed resistance may be obtained to suit different valves. We tested the component first of all with a 10,000-ohm valve using the 30,000-ohm tap.

With 150 volts H.T., this will be seen to give a remarkably level step-up of just under 2-1, from 60 to 5,000 cycles. With higher impedance valves, even with the full anode resistance, the response is not quite so good, tending to fall off at both ends.

The use of a lower value of H.T. also has a similar effect, more especially in the bass, but even with both these conditions, the performance is still good. The dotted curve on the accompanying chart was taken

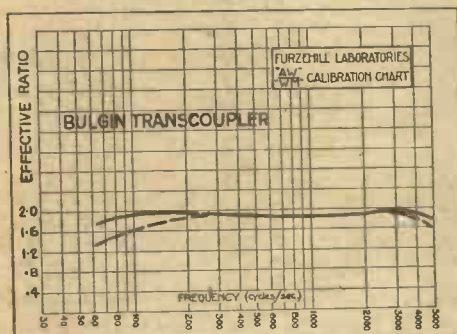

This curve illustrates the performance of the Bulgin Transcoupler

with a 23,000-ohm valve and 110 volts H.T.

The actual amplification per stage is obtained by multiplying the effective step-up ratio by the μ value of the valve, so that a step-up of between 20 and 50-1 can be obtained according to the requirements of the user.

The component is well made and at a price of 11s. 6d. merits consideration.

THE SOVEREIGN VARI-CHOKE

AN interesting component which we have tested this week is the Sovereign Vari-choke. This component consists essentially of an H.F. choke with a small compression type by-pass condenser housed in a moulded bakelite case. The condenser is

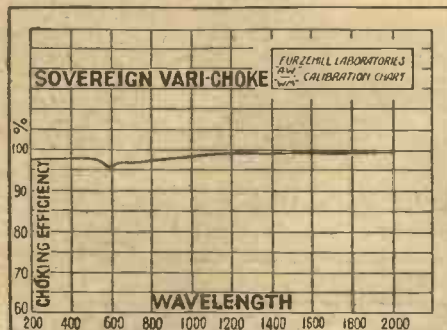

The results of the H.F. test conducted on the Sovereign Vari-choke are shown by this curve

of the normal type, constructed of brass plates with mica dielectric, and is controlled by a small knob on top of the casing.

This component has a variety of uses, for example, the H.F. coupling device in a tuned-grid high-frequency stage. Again, it



The Sovereign Vari-choke, a combination of an H.F. choke and a compression type by-pass condenser

may be used with advantage as a high-frequency stopper in the grid circuit of the L.F. valve, or as an H.F. filter in the anode circuit of the detector valve. These are, of course, but a few of the uses to which the component can be put.

A high-frequency test was conducted on the choke in accordance with our usual practice. The results which are shown plotted on the curve accompanying this report indicate that the efficiency of the choke is excellent over the whole broadcast range, from 200 to 2,000 metres. The inductance of the choke is approximately 173,000 micro-henries.

This component can be recommended for use in all cases where a good high-frequency choke is required.

LEKTRITE AERIAL WIRE

INSULATED stranded aerials have recently become much more popular for both indoor and outdoor use. Readers will recall that some time ago we reviewed the Ward & Goldstone "Negrolac" aerial in these columns. The same firm has now introduced the "Lektrite" insulated aerial at a very popular price. This aerial contains seven strands of bare copper wire, 24 S.W.G. in size. The seven wires are stranded together and covered with a black waterproof braiding. This braiding forms ample insulation when fixing the aerial and no other suspending insulators are required even for outdoor work. The overall diameter is approximately 1/16 in. The aerial can be obtained in coils of 50, 75 and 100 feet, the retail prices being 1s. 6d., 2s. 3d., and 3s. respectively.

This aerial fulfils its purpose admirably.

BACK AGAIN

IMPROVED!

BETTER THAN EVER!

The World Famous

66K

B— makes a welcome re-appearance — improved, brought up-to-date **AND BETTER VALUE THAN EVER.**

The new 66K has lost none of its former cunning in reproducing both speech and music to perfection. It passes on everything the broadcast station gives it without alteration or amendment. It does its job faithfully and competently—which is to let you hear the programmes *in your own home* exactly as they are sent out from the studio.

66K will have a bigger success than ever before. It represents the finest value on the market for a Loudspeaker Unit.

Send for the newly published catalogues of Blue Spot Speakers (A.W.44S), Units (A.W.44U) and Receivers—Battery-operated and all-mains (A.W.44R).

BRITISH MADE
RADIO EXHIBITION
Stand 35
Demonstration Room D13

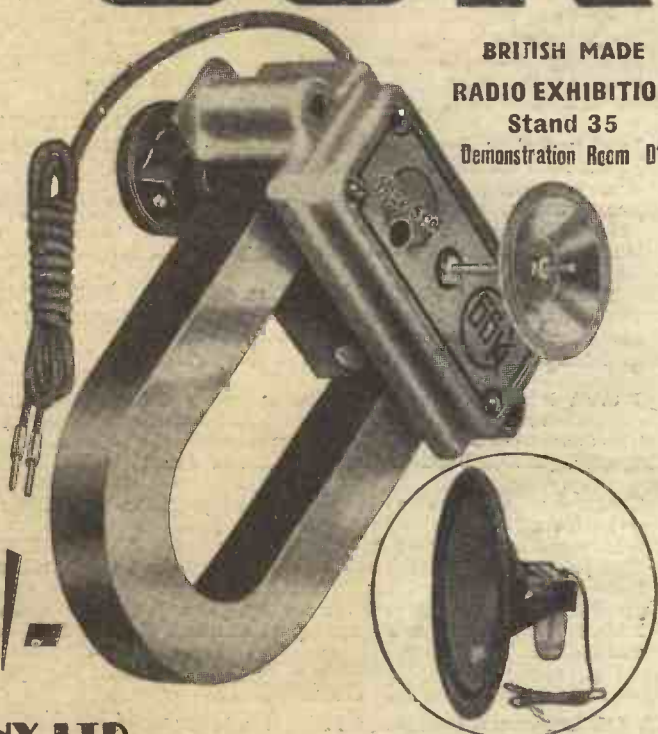

PRICE

15/-

THE BRITISH BLUE SPOT COMPANY LTD

BLUE SPOT HOUSE · 94/96 ROSOMAN STREET · ROSEBERY AVENUE · LONDON · E C 1

Telephone: Clerkenwell 3570.

Telegrams: "Bluospot, Isling, London."

Distributors for Northern England, Scotland and Wales: H. C. RAWSON (Sheffield and London), Ltd., 100, London Road, Sheffield; 22, St. Mary's Parsonage, Manchester; 44-46, High Bridge, Newcastle; 37-8-9, Clyde Place, Glasgow.

FOR YOUR CONVENIENCE 66KC

This is 66K mounted on a suitable chassis. In this form it is ready for screwing direct on to your baffle or into your set or cabinet.

19/9
Price

To Ensure Speedy Delivery, Mention "A.W." to Advertisers



THE PICK OF THE MONTH'S RECORDS

A GUIDE TO THE BEST OF THE LATEST RELEASES.

The records reviewed below are a careful selection of the best of the recent issues. It will be noted that criticism is chiefly devoted to the treatment of the music and quality of recording rather than the actual composition.

ORCHESTRAL RECORDS

- Two Elegiac Melodies (Grieg), 6s. COL LX168**
Splendid! I wondered when somebody would do these delightful two. They are entitled, "The Last Spring" and "Heart Aches." The first is an unforgettable thing—indeed, they both are. I commend most sincerely the magnificent performance of the Concertgebouw Orchestra under Mengelberg.
- Mignon—Overture, 4s. COL DX355**
One of those pieces which is ever with us: Never mind, we like it every time we hear it. Even if you have this, go into a shop and hear side two first. You will have to buy this performance of the Orchestre Symphonique (Paris). Really, a robust, colourful rendering.
- Casino Dances and Love, Here is My Heart, 2s. 6d. COL DB840**
Gung'l and Silésu, plus Albert Sandler's Orchestra. You get a sparkling presentation of each, in fact, the first Continental favourite is quite in the best German tradition.
- You and Lawd, You Made the Night Too Long, 2s. 6d. DEC K664**
Two Jack Hylton performances. They are quite representative but this type of music palls very rapidly.
- On With the Show, 1s. 6d. ZONO 6142**
Another medley, quite orthodox, vigorously played by the London Orchestra.
- Reginello (Waltz) and Rosita (Tango), 2s. 6d. COL CB470**
Really, this should be included in the "dance" section, but this performance by Geraldo's Gaucho Tango Orchestra is so delightful as to elevate it to the classification of real music. Would that all modern dance music were of this standard and charm.
- Beatrice and Benedict—Overture (Berlioz), 4s. DECCA POLYDOR LY6006**
Very typical of Berlioz. And a first-rate performance by the Berlin Philharmonic Orchestra. The piece has a straightforward, clean-cut structure and is so presented.
- Andante Cantabile, Op. 11 (Tchaikovsky), 1s. 6d. DEC F2745**
This old favourite is most adequately presented by the Hastings Municipal Orchestra. A most soothing potion for ragged nerves. Try it!
- Il Est Charmant and A Nous La Liberté, 1s. 6d. DEC F2950**
Two splendid morsels by Campoli and his Salon Orchestra. The first selection will be enormously popular.
- Second Suite of Ancient Dances and Airs (Respighi), 4s. H.M.V. C2346**
I think it will be agreed that our ancestors claimed some sad dances. This record is a collector's piece, but charming withal. The Covent Garden Royal Opera Orchestra are the performers.
- Spring's Delight and Deutschmeister Regimental March, 2s. 6d. H.M.V. B4196**
Two fine tunes played with the snap and precision that always go with Marek Weber's Orchestra.
- Little Italy and By the Swiss Mill, 1s. 6d. BRDCST 3193**
Two pieces of the "descriptive" school. I prefer the dangers of Soho to the horrors of the mountains if they yodel like this. Really, I suppose the performance by John Johnson and his International Orchestra is quite up to standard for this kind of composition.

BAND RECORDS

- With Oak Leaves and Swords and Kaiser Frederick March, 2s. IMP Z127**
Two rousing German marches well played by the Imperial Military Band. (And there are lots more good ones where these came from!)
- Chantecler March and Régiment de Sambre et Meuse, 1s. 6d. BRDCST 3200**
Very competent playing by the Grand Military Orchestra. (Heresy, I know, but I can't stand "Sambre et Meuse!") The other is better, but not in the same category as the two above.

DANCE RECORDS

- Five Minutes to Twelve and Whistle and Blow Your Blues Away, 1s. 6d. ZONO 6138**
An extraordinarily bright performance by the Blue Lyres.
- Bird Songs at Eventide and A Brown Bird Singing, 2s. 6d. H.M.V. B6184**
These waltzes need no introduction, and no praise can be too high for this performance of Ray Noble's New Mayfair Orchestra—and his vocalist.
- Drums In My Heart and Tell Me with a Love Song, 2s. 6d. H.M.V. B6186**
Excellent. The first may be called original; the second belongs to the Saccharine School. But the vocalist in the latter is poor.
- Dream, Sweetheart and Turning of the Tide, 2s. 6d. H.M.V. B6180**
Two really sparkling performances by Ambrose and his Orchestra. The second is distinctly "hot."
- Pals of the Little Red School and When It's Spring Time in the Blue Ridge Mountains, 1s. 3d. IMP 2709**
Members of a large family—old village choir and so forth. But they are really attractively played by Dan Roberts and his Home Towners.
- The Mouse, the Piano, and the Cat and Nursery Masquerade, 1s. 6d. STERNO 967**
Two novelty fox-trots by André Astair's Orchestra. Rather off the beaten track, but the recording could be better.
- Maree and In Old Seville, 1s. 6d. STERNO 951**
Two good numbers by Bertini and his Band.

INSTRUMENTAL RECORDS

- The Dubarry and How Long Will it Last? 2s. 6d. DEC M414**
These "rhythmic" arrangements played by Edythe Baker show off the supple fingers of the pianist.
- Liebestraum and Nocturne in E Flat (Chopin), 4s. COL DX362**
Two very soothing, orthodox, popular pieces by the J. H. Squire Celeste Octet.
- Funeral March from Sonata, Op. 35 (Chopin) and (a) Anitra's Dance (Grieg), (b) Bees' Wedding, 2s. 6d. DEC K661**
Here is variety! William Murdoch glides through these with his usual skill. But the funeral march will prove strangely different from the memories one has of its usual performance—a military band.

MISCELLANEOUS RECORDS

- Darkietown and Good Evening, 1s. 6d. ZONO 6139**
Nobody can do this type of song better than Sam Browne. As each will disappear in a few weeks, it might be advisable to hear the record now. (I mean the songs will disappear: heaven forbid that Sam Browne should!)
- Rhine Legend and The Drummer Boy, 5s. DECCA POLYDOR CA8082**
These two songs admirably show off the splendid voice of Schlusius, to say nothing of his versatility, for they differ widely in character. The second has an insistent drum-roll, which is most realistic. The tuneful lilt of the first gives it considerable charm. An unusual record for the German scholar and the musician.
- The Ratcatcher's Daughter and Villikins and His Dinah, 1s. 3d. IMP 2714**
How well worth while are these two old gems. And John Thorne manipulates the Cockney accent splendidly. A first-class effort all round.
- When Yuba Plays the Rumba on the Tuba and Darling, Do You Come from Spain? 2s. 6d. H.M.V. B4164**
Delightful and extraordinarily clever. The Revellers sing the first and the Comedy Harmonists the second. There isn't a pin to choose between the Americans and the Germans.
- Tan Tan Tibby Tally Ho and Czecho-Slovakia, 1s. 3d. IMP 2718**
Cheery fooling by Leslie Holmes. The first is quite a good number.

NEW RECTATONE L.F. TRANSFORMER



Radio reproduction with full and natural treble response. Gramophone reproduction with the bass in proper balance, without over-emphasis of treble. You can get both, from the same receiver with the Varley RECTATONE.

This new transformer compensates for high-note losses in the tuning circuits by frequency compensation in the L.F. amplifier. The RECTATONE frequency response curve is straight up to 1,000 cycles per second and then rises reaching a maximum at approximately 4,500 cycles—the ideal arrangement.

The degree of compensation is controlled by a variable resistance connected externally between two of the transformer terminals. If this resistance is omitted the RECTATONE functions as a normal transformer, giving high and even amplification.

RECTATONE is thus the ideal L.F. coupling for sets using a pick-up or for radio gramophones, since the tone control so valuable on radio, can be switched out on gramophone where it is unnecessary.

Price - - 15/-

Varley

Props. Oliver Pell Control, Ltd.

Agents of Oliver Pell Control, Ltd., 103 Kingsway, London W.C. 2
Telephone: Holborn 3303

STAR
3-GANG
25'6



POLAR 'STAR' CONDENSERS

SIMPLE ASTRONOMY
THE LITTLE BEAR
OR CASSIOPEIA.

ACCURATE SPACING OF VANES OBTAINED BY PRECISION MACHINE ASSEMBLY

entirely eliminates the possibility of error in spacing—hence this guarantee: Polar "Star" Gang Condensers are guaranteed accurately matched to within 1/2 of 1%, plus or minus 1 mmfd. And their construction ensures that this accuracy will never vary.

Other outstanding features:

1. Trimmers always at constant value.
2. Strong spring journal bearings.
3. All-steel frame.

Prices:

3 x .5000	-	-	-	25/6
Special Super-het	-	-	-	27/6
4 x .0005	-	-	-	34/-
Polar Drum Drive	7/6			Polar Disc Drive 5/-

SEND FOR NEW POLAR 35-PAGE FULLY ILLUSTRATED CATALOGUE "A"

STAND 129 OLYMPIA

POLAR CONDENSERS

Wingrove & Rogers, Ltd., 188-9 Strand, London, W.C.2

Mention of "Amateur Wireless" to Advertisers will Ensure Prompt Attention

THE GREATEST RADIO SEASON YET!

PERCY W. HARRIS, M.Inst.Rad.E discusses radio progress since the 2LO days and shows just why we may look forward to a thrilling 1933 radio season

APPROXIMATELY ten years ago a programme of wireless entertainment emanated from an improvised studio in the Strand. It was not the first—we had had some before—but, at any rate, it was official, for wireless broadcasting had passed out of the apologetic experimental stage, the B.B.C. was born, and we had our first real broadcasting season.

To-day we have such a fine wireless service that everybody grumbles at it. The danger would be if nobody grumbled, for that would mean that nobody was listening! We have better sets, better service, better valve, and ever so much better components for the home-constructor. We also have better and bigger difficulties to overcome.

Better Than Before

I have been professionally connected with radio for just twenty-two years, and when I say that we are now opening the greatest wireless season yet, I have some basis for the opinion. No matter whether you buy your set ready-made, or build it from one of the published designs, you are getting much better value and far better performance than ever before. I remember the time, even if you don't, when the only valve holder that was any good cost five and sixpence, and the valve to fit it twenty-seven and sixpence. Nowadays, you can build a complete three-valve set for what we used to pay for the valves alone.

Home-built Sets

And it still pays you, value for value, to build your own set, if you choose a good design. Every year we hear somebody say that sets are now so cheap that it no longer pays to build your own, yet as set prices fall, so do those of components, and as the ingenuity of the set manufacturer goes up, so does that of the designer who

works with the home-constructors requirements in mind. New and improved circuits are often complicated, yet simplifications usually follow, and the component manufacturer often wipes out a host of constructional difficulties in a single new device. Witness the sets of shielded coils for simple, and super-heterodyne, circuits which more than halve the bother of matching and tuning.

The New Ideas

New improvements by no means always originate in the laboratories of the set manufacturers. Some set manufacturers have not any laboratories anyway! The present almost universally used form of condenser-controlled reaction was worked out in a practical form by an American amateur, and the variable-mu valve, one of the greatest steps forward in valve design, was invented by my friend Stuart Ballantyne, at his own research laboratories at Boonton, New Jersey, although he subsequently sold the patents to the Radio Corporation. For some reason I have not yet fathomed, he gets little, if any credit in this country, although his work is fully recognised in the States.

I should not be surprised if some British amateur does not originate something just as important during the coming season. He has every inducement and opportunity to do so. There is no branch of wireless experimental work barred to him, and it is quite a mistake to imagine that elaborate and expensive equipment is a *sine qua non*. It helps, of course, and some work cannot be done without quite elaborate measuring instruments, yet often the best-equipped laboratories miss something which the less well-equipped amateur seizes on.

The home-constructors this year will show great activity, as thousands will realise that their existing sets are now out-

of-date. Selectivity requirements are now so much greater than they used to be, foreign programmes, as well as our own, are steadily improving, and more and more sensitive sets are being called for. AMATEUR WIRELESS has some wonderful set designs under way—sets which the most discriminating listeners will be proud to own—and I know enough about them to realise that they will really fill the bill.

Set-maker's Products

It would be unfair in such an article as this not to refer to the wonderful value the set-maker is now giving. No longer is he dishing up old designs in new cabinets. The receivers are in the great majority of cases really engineered in first-class style, so as to give an overall performance in keeping with the most exacting requirements. I feel certain that there will be splendid business, for just as people want to change their cars when they get out of date, so they will appreciate the new performance of the latest sets.

Servicing, too, is being well catered for, not only by the manufacturer, but by the local and duly accredited dealer. In the ideal state, no servicing would be required, and some people seem to think that there should not be now. But a moment's thought will convince you that we have no right to expect complete freedom from servicing so long as wireless receivers have any consumable parts. Valves wear out and have to be replaced, batteries come to the end of their life and occasional adjustments will be needed from time to time.

On the comparatively rare occasions, when something goes wrong, the manufacturer or his dealer now looks after the customer much more satisfactorily than used to be the case. Here's to a bumper season, then, for all of us!

COUPLING-FACTOR

THE "coupling-factor" between two circuits measures the rate at which energy is transferred from one to the other. In the ordinary tuned circuits used in wireless reception, this factor varies with the frequency being received, so that the efficiency of a set is usually better on the shorter waves than on the long. In many up-to-date receivers the circuits are now being specially designed to transfer a part of the energy by magnetic coupling and the rest by capacity coupling. This gives a constant coupling factor—or, in other words, uniform amplification—at all points on the tuning scale. B. A.

WORKING "OVER THE BEND"

THE effect of passing beyond the straight-line part of the characteristic curve varies according to whether the valve is operating on the high- or low-frequency side of the receiver. In the former case, working "over the bend" will produce harmonic frequencies which are usually filtered out by the tuned couplings; or it may produce cross-modulation which cannot be got rid of by subsequent tuning. On the low-frequency side, however, any departure from the straight-line part of the curve at once introduces distortion. M. A. L.

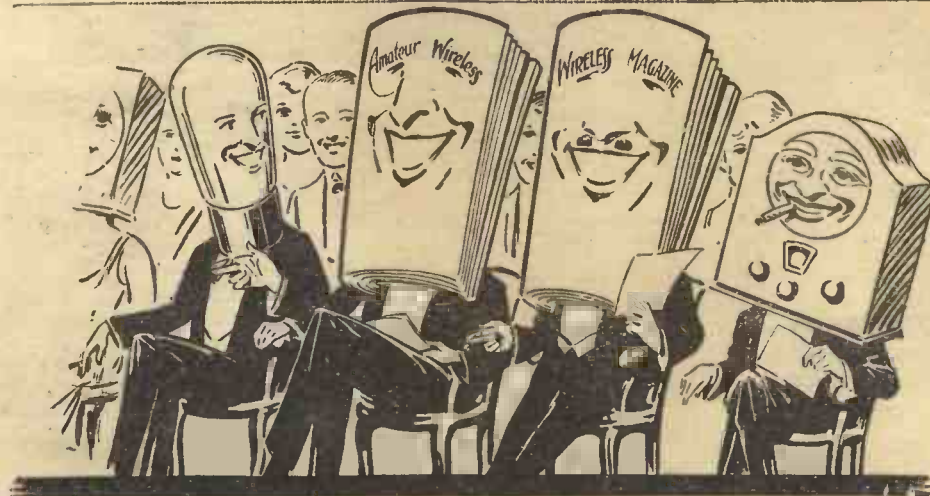

In the front stalls at Olympia!

Which is the better plug ?

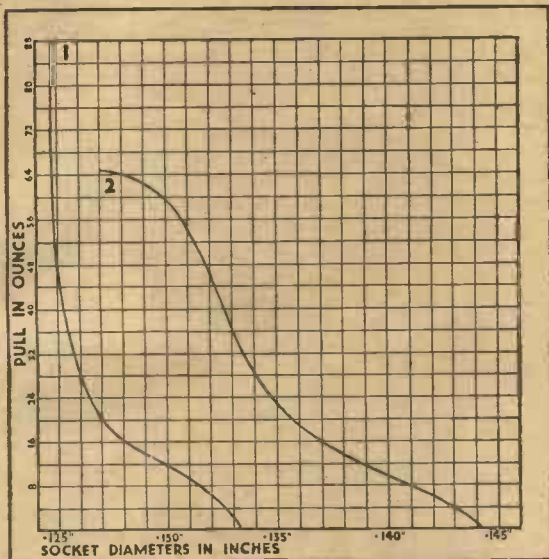

New "BOWSPRING" Wander plug

Some wander plugs grip a limited range of sockets strongly. Others adapt themselves to a wide range of sockets, but make such light contact that they easily come adrift.

The curves above record the performance of two wander plugs —(1) a typical "split pin" type and (2) the new Belling-Lee "Bowspring." Starting from a small socket, each plug has been pulled out and pushed into progressively larger sockets until no contact is made. The curves show the force in ounces needed to pull each plug from the various sockets.

A glance will show which is the better plug. The "Bowspring" gives strong pressure over a far wider range of diameters than any plug we have so far tested.

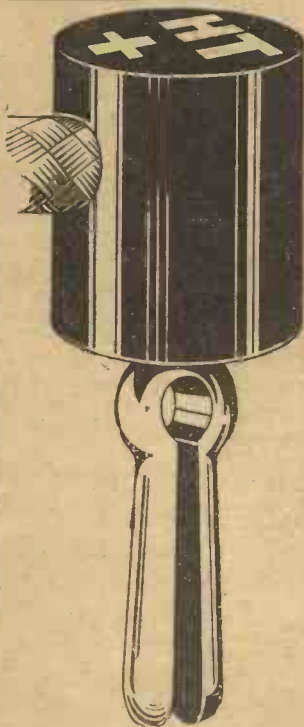

BELLING-LEE
FOR EVERY RADIO CONNECTION

Advt. of Belling & Lee, Ltd., Cambridge Arterial Road, Enfield, Mdx.



should be the first call for AMATEUR CONSTRUCTORS

The British Radiophone exhibit this year is full of interest for Amateur Constructors. Many new and fascinating lines are on view, comprising:

BRITISHRADIOPHONE GANGED CONDENSERS

Midget Condenser...	Price	6/-
2-Gang Condenser	15/-	Cover 2/6
3-Gang Condenser	25/-	" 3/-
4-Gang Condenser	30/-	" 3/6

SUPER-HET TYPES

2-Gang Condenser <th>Price</th> <th>17/-</th> <th>Cover</th> <th>2/6</th>	Price	17/-	Cover	2/6
3-Gang Condenser	27/-	"	3/-	
4-Gang Condenser	32/-	"	3/6	

Oxidised Silver escutcheon and drive assembly, complete with pilot lamp attachment ... 5/-
Drum Drive ... 8/6

A Full Range of Volume Controls, Potentiometers, Pre-Set Condensers, Q.M.B. Switches, Combined Pick-ups and Tone Arms

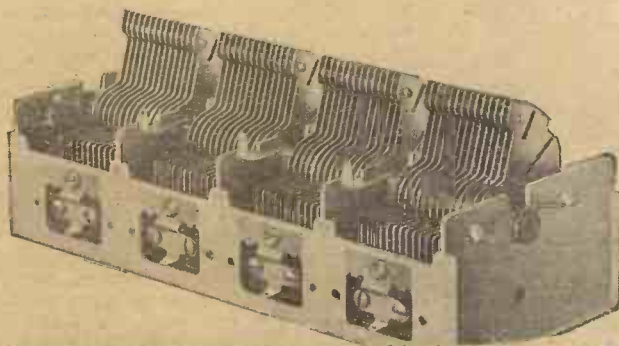

RADIOPHONE
GANGED CONDENSERS

THE BRITISH RADIOPHONE LTD., Aldwych House, Aldwych, W.C.2

Don't Forget to Say That You Saw it in "A.W."

H.M.V. PLANS FOR THE NEW SEASON

At a recent press reception attended by members of our staff, the Gramophone Company, Ltd., disclosed its plans for the coming season. Mr. Richard Haigh, the English manager, reminded us that the H.M.V. system of distributing radio sets to a limited number of dealers was the outcome of the success of this system as applied for many years to gramophones and records.

Technical instruction had been provided for dealers not acquainted with radio science, with the result that the trade as a whole had undoubtedly benefited by the influx of hundreds of music dealers properly equipped with the knowledge to carry on the sale of radio and radio-gramophone apparatus.

Vast factory space, covering nearly 60 acres of ground at Hayes, Middlesex, was required for the production of the H.M.V. gramophones and radio apparatus. In addition to the research laboratories at Hayes, the company had the advantage of a large mansion near Hayes for the testing of experimental models.

Production of the various models in the new range had been simplified by the installation of conveyor systems, over three miles in length, arranged to move at speeds varying from 3 inches per minute to 10 feet per minute.

Each year the factories used over 4,000 trees, 50 ft. by 6 ft., for the making of the cabinets for the H.M.V. instruments. Three thousand gallons of stain were needed to give the cabinets their well-known rich ground colour.

It required 120 hours to manufacture a medium-priced radio-gramophone, which was composed of no less than 2,461 separate parts. All these parts were made at Hayes, 40 electric trucks being needed to augment the conveyors for carrying them from place to place.

With regard to the sets of the season, as Mr. Radford, of the H.M.V. Research Laboratories pointed out, the technically advanced design of some of the existing models had led to their retention during the coming season.

Reductions in price were announced as the result of improvements and modifications in production. The very popular table radio-

gramophone, for example, in future to be known as the Transportable Radiogram, would be reduced from 29 to 25 guineas. The straight three-valver for A.C. mains, originally reduced from 22 guineas to 20 guineas, would now be known as the De-luxe Radio Four, and would be marketed at the extraordinary low price of 17 guineas.

Many of the existing radio-gramophone models would be continued and would be augmented by several new models. All the new

On the right the new H.M.V. Super-het Ten Autoradiogram. It will regularly receive over 80 stations, besides playing up to eight records continuously. Below—H.M.V. Super Power speaker. The cabinet of picked walnut houses a high-power permanent-magnet moving-coil loud-speaker incorporating a multi-ratio transformer



H.M.V. instruments would employ super-heterodyne circuits. There would be the Super-het Radiogram Seven and the Super-het Ten Autoradiogram, the latter being available at extra cost in an ultra-modern cabinet of striking design.

phones, we ought to mention the new Super Power moving-coil loud-speaker, price £7 10s. It will handle up to 10 watts

HAVE you picked up tests by the new 20-kilowatt at Bari (Italy)? I always understood that the wavelength allocated to this station was 280 metres; but, as usual, Italy appears to have chosen her own channel, and experimental transmissions may be heard almost nightly between 7 and 8 p.m. B.S.T. on 269.2 metres (1,115 kilocycles). There is no mistaking the broadcast, as the announcer gives out the name of the station (phon.: Bar-ee) every few minutes.

During the past week or so, Lisbon, on 282.5 metres, has also been a good signal. As the days are already growing shorter, you should have no difficulty in hearing Radio Lisboa between 10.30 p.m. and 1 a.m. B.S.T. on any Monday, Wednesday, or Saturday. Owners of short-wave receivers may capture special transmissions on 31.25 metres between 11 p.m. and 1 a.m. B.S.T. on Thursdays and Fridays. As all announcements are made in several languages, including English, no mistake can be made in logging the station.

On 210 metres you might make a search for Magyarovar, the new 1½-kilowatt relay on the Hungarian-Austrian frontier; this station takes the Budapest programmes, which are also simultaneously broadcast on 208.7 and 550 metres.

When Cologne, Munster, and Aachen closed down their local relay stations, the 227.4-metre wavelength, an exclusive German channel, became free. As already stated in these notes, it is to be used by the Hamburg relays

OUR LISTENING POST

By JAY COOTE

within the next few weeks. Flensburg, however, will be placed on it immediately, and you may find it a suitable medium for the reception of the Hamburg concerts.

Conditions generally have improved lately, and daily I have made fresh additions to my "summer" log. Prague, which had been compelled to revert to its older and weaker plant at Strasnice, owing to the destruction of the aerial of the high-power station by lightning, has now reappeared on the horizon and, although not up to its usual strength, comes in fairly well. Rome, also after 9 p.m., provides fair volume, and there is a distinct improvement in the transmissions—and quality—of Paris, PIT. Of the longer wave stations, such as Kalundborg, Motala, Oslo, and Hilversum, there is not much to be said; at present they are fitful and on many evenings decidedly anaemic. Curiously enough, some of the low-power broadcasts, such as Nice-Juan-les-Pins, and the weaker Swedish and German stations, can be heard at good strength in the latter part of the evening.

Although during the past few weeks I have not succeeded in capturing any broadcasts from the U.S.A. transmitters, notwithstanding the fact that, according to reports, tests were being made by KDKA (East Pittsburg) and WGY (Schenectady) at much greater power, to my surprise on two different occasions, towards the early morning-hours I was able to pick up concerts direct from Buenos Aires, via LR4 (Radio Splendid) on 303 metres and LR3 (Radio Nacional) on 316 metres. There could be no doubt about the matter, in view of the distinct calls, but also in each case full announcements were made in both Spanish and English.

LR4 frequently broadcasts for the benefit of listeners in the United States; these special concerts are transmitted to WABC (New York) by short wave and re-radiated through the Columbia Broadcasting system.

During the summer season, it will be worth your while to tune in nightly, if only for a short time, to Brussels (No. 1), as regular relays are taken of concerts from the Ostend Kursaal. It was just my luck on a recent Sunday to turn my condensers to the 508-metre wave in time to hear Jack Hylton and his boys playing at that well-known Belgian seaside resort. British dance bands enjoy considerable popularity on the Continent, and this particular combination, judging from the deafening applause which followed each item, had every reason to be mightily pleased with its reception.



Here is your time signal!

No need now to wait for Big Ben . . . the "Blue Bird" heralding a new era in time pieces—is here . . . a masterpiece of accuracy.

- ① The "Blue Bird" has no glass, dial or hands, and is dust and damp-proof.
- ② Three little windows, mica-protected on the underside, show the correct hour, minute and second.
- ③ 5-jewel lever movement, with extra large gear train and escapement, maintains a wonderful standard of time-keeping.
- ④ Fitted in Nickel Chromium case, curved to wrist and with Chromium wristband. (Leather strap or wire band if preferred).

ADDITIONAL MODELS :
 9 carat gold (narrow case) £3 15 0 cash
 or 12 monthly instalments of 11/3.
 9 carat gold (square face) £7 15 0 cash
 or 12 monthly instalments of 13/.

LADIES' MODELS :
 Nickel Chromium £3 5 0 cash
 or 12 monthly instalments of 5/6.
 9 carat gold £3 15 0 cash
 or 12 monthly instalments of 9/3.

NOTHING TO BREAK WHILE EXPERIMENTING OR BUILDING YOUR NEW SET!

5/- DOWN
 Send 5/- with order and the balance in monthly instalments of 5/-, or 59/6 cash.
 Every watch carries 12 months' written guarantee

On reaching 60 minutes the hour instantaneously changes.

Peter Roland, Ltd.
 Premier House,
 12 Hatton Garden,
 London, E.C.1.
 Phone: Holborn 6751.

BLUE BIRD

The Sportsman's Watch

THE BENJAMIN TRANSFEEDA

(REGD.)

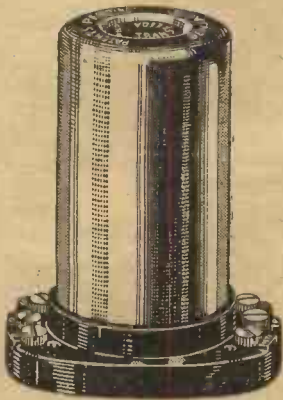

Wherever an L.F. Transformer can be fitted a Benjamin Transfeeda will give you what you have been looking for—wonderfully pure and powerful reproduction with a uniform response throughout the audible scale right down to the deepest bass. The Transfeeda will be the making of your receiver, giving you luxury transformer results for the modest price of 11/6.

May we send you the fully descriptive two-colour leaflet giving curves and circuits? Ask for list 1299.

PRICE **11/6**

The original resistance-fed transformer

The Benjamin Electric Ltd., Tariff Road, Tottenham, N.17

You Will Help Yourself and Help Us by Mentioning "A.W." to Advertisers

THE NEW DUBILIER TYPE 610 & 620 CONDENSERS MAKE THEIR BOW



So popular has their repeated recommendations by leading radio journals made the Type 610 and 620 Dubilier Condensers that this famous range is now enlarged so that it is capable of supplying EVERY need for this particular type of condenser.

The new series, at low prices, are worthy bearers of the name Dubilier. From start to finish they are made with all the Dubilier tradition of dependability and long life. Use them in your next set. You will never find condensers which so well merit your implicit confidence.



Capacities .0001-.0005 mfd. are now available with Grid-leak Clips only at 1s. 3d. each, the price of the series parallel types remaining as before.

DUBILIER CONDENSER CO. (1925) LTD.
 Ducon Works, Victoria Rd., N. Acton, London, W.3

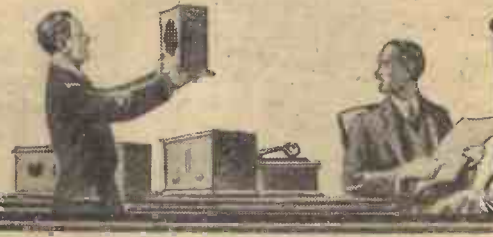

A Decorative Aerial

SIR,—I would like to inform your readers that the "Decorative Aerial" recently described by Mr. F. W. J. Winter would constitute an infringement of my patent No. 337,866, which fully covers the use of bunches of antenna wires at the upper end of a lead-in wire. I feel sure Mr. Winter is not aware of these facts, nor perhaps yourselves either, and as my patent is shortly to be placed on the market it may save much trouble if you will kindly publish this letter. I have no objection to any reader of "A.W." making such an aerial for his own use exclusively, but not for any other purpose or for sale.

K. T. Hardman, A.M.Inst. Patentee's (London).

Valve Microphony

SIR,—I am terribly disappointed with my radio-gramophone receiver, which I have just completed. As soon as I switch on, whether for wireless or gramophone, a howl or hum develops in the speaker, which cannot be stopped except by taking the speaker out of the receiver and moving it to the other end of the room. This rather upsets my idea of what a complete radio-gramophone and piece of furniture should be, and I therefore appeal to you to help me out of the trouble. It certainly seems that there is some kind of interaction between the speaker and the receiver, but my limited knowledge of wireless matters does not enable me to trace and remedy the defect.

F. M. (Tankerton).

It is certain that one or more of your valves suffers from microphony—microphonics—and it is most likely to be traced to the detector or first L.F. amplifying valve. The trouble may sometimes be overcome by loosely padding the valve bulb with cotton wool. A change of valve holder is also sometimes effective, but if neither of these suggestions enables you to overcome the trouble we are afraid that the only definite cure is a complete change of valve. It is now possible to purchase valves specially proof against microphonics; so we advise you to make a point of selecting one of these special types should you find that a change of valve is necessary.—Ed.

Systematic Distortion Tracking

SIR,—For some time I have been troubled with a peculiar form of distortion in my receiver, and although I have replaced H.T., G.B., and L.T. batteries this distortion still occurs. I understand that it is possible to trace distortion in a receiver by means of a milliammeter, and am considering getting such an instrument, but, unfortunately, I do not know how to go about the work.

R. J. C. (Banbury).

You do not state what form of receiver you are using, but we are assuming it is a simple detector and two L.F. receiver. In such a receiver distortion may be occurring in any one of the valve stages, and it is therefore suggested that the meter first be connected in the plate circuit of the detector valve. If the meter needle remains more or less steady during reception of a programme it is unlikely that the distortion is occurring in this stage. If the needle kicks during reception and an H.F. type valve is used in the detector position, try using an L.F. type valve, as this has a greater grid swing and will therefore accept a more powerful signal input without overloading. Drastic changes, such as altering the form of rectification, are not to be recommended, as this would entail redesigning the whole of the receiver circuit. When satisfied with the detector circuit, attention may be directed to the first L.F. valve. Kicking of the meter needle when in this anode circuit will indicate distortion, and a valve with a larger grid input or increasing anode volts should effect a cure. Variation of grid-bias voltage will sometimes effect the desired result, but too much bias should not be applied in an endeavour to avoid grid overloading. It is far better to introduce a volume control to reduce the input signal volts. After the first L.F. valve has been checked and adjusted for best results, attention should be turned to the power valve. The same procedure should be adopted as in the case of the other two valves, and the simplest way of connecting the meter in circuit is to disconnect the wire normally going to the anode terminal of the valve holder and to connect it to the positive terminal of the meter. The negative terminal of the meter should then be connected direct to the anode terminal of the valve holder under test.—Ed.

When the Set Stops Working

SIR,—Quite recently my receiver has developed a curious fault. It will work satisfactorily when first switched on, but

if I happen to switch off for any particular reason and switch on again a little later the set remains almost dead. If I take out the fuse in the negative H.T. lead, after first switching on the receiver, I get satisfactory results upon replacing it; but surely it should not be necessary to juggle like this in order to get reception. Can you tell me what may be the cause of this recent trouble and also suggest a remedy?

E. W. (London).

It seems fairly obvious to us that one of your valves has developed what is commonly known as a reverse grid emission, and this stops the valve from working until the reverse emission is stopped. It is due to the valve having become soft and is most likely to be traced to the detector valve. A somewhat similar form of trouble may also occur in connection with a mains-type valve, but in this case the grid becomes hot, due to the close proximity of the heater element, and the grid begins to emit electrons in addition to the heater and normal cathode. This trouble may usually be stopped by switching off the receiver to let the grid and other electrodes cool down. The valve will then work in a normal manner until its other electrodes again get so hot as to begin emitting electrons.—Ed.

The Lightning Danger

SIR,—My wife is very nervous of the house being struck by lightning, and her concern in this matter has been emphasised just recently by my erecting an outdoor aerial for the wireless. I feel sure that an outdoor aerial will not in any way increase the possibilities of danger from lightning. G. W. (Kent).

The outdoor aerial in itself is a protector against lightning, provided that it is properly earthed during a storm. This is because it is a good conductor of electricity and will conduct to earth any lightning discharges which occur in the vicinity of your house. If you will inspect any tall building or chimney in your locality you will observe that at the top is fitted a metal spike at least two or three feet in length. Attached to the lower end of this spike is a flat strip of copper which extends from the spike to the ground. This is merely a lightning conductor which conveys any lightning discharge to earth in preference to allowing it to strike the brickwork of the building or chimney and reducing the latter to wreckage. Your outdoor aerial, if properly earthed, will act in exactly the same way as a safety device.—Ed.

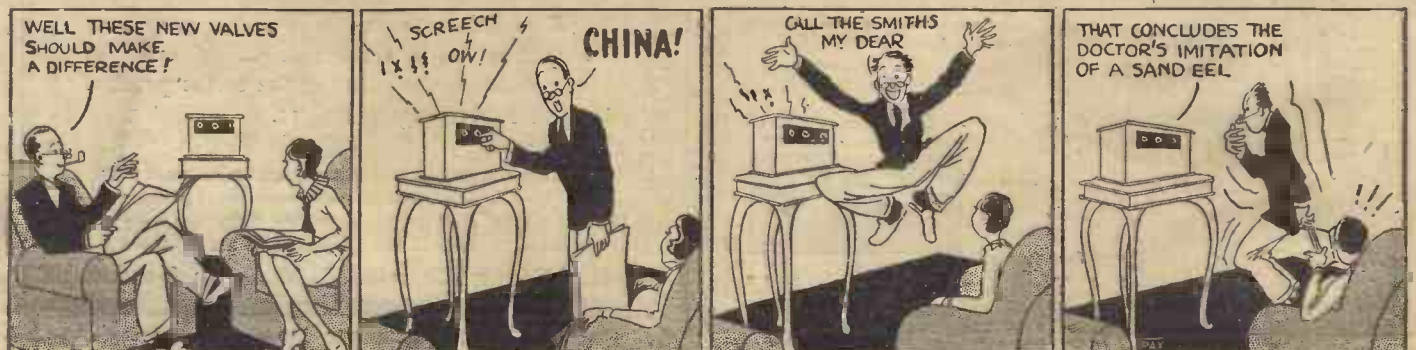

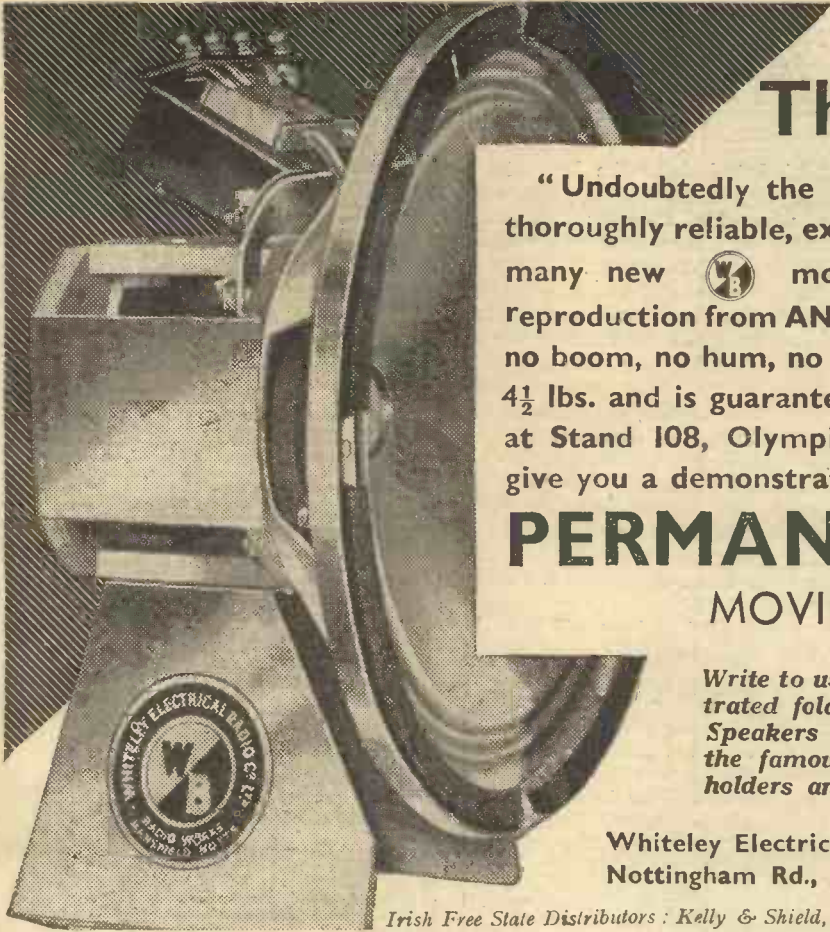

The great P.M.4

"Undoubtedly the leader in its price class." This sturdy, thoroughly reliable, exceedingly sensitive speaker is one of the many new  moving-coil speakers. True moving-coil reproduction from ANY 2-, 3- or multi-valve set. Fine volume, no boom, no hum, no resonance. Cobalt-steel magnet weighs 4½ lbs. and is guaranteed for five years. See it at Stand 108, Olympia. Or your dealer will give you a demonstration.

42/-

Complete with output Trans- former mounted on top

PERMANENT MAGNET MOVING-COIL SPEAKER

Write to us for the new illustrated folder of the "W.B." Speakers and Cabinets, and the famous "W.B." Valve-holders and Switches.

Whiteley Electrical Radio Co., Ltd.
Nottingham Rd., Mansfield, Notts.

Irish Free State Distributors: Kelly & Shield, Ltd., 47 Fleet St., Dublin.



HERE IT IS
EXACTLY WHAT YOU REQUIRE FOR SHORT WAVES

British Made

THE RELIABLE BECOL EBONITE FORMER which has stood the TEST OF TIME and tested before despatch. Prices LOW.

EFFICIENCY COUNTS!!!

LOOK FOR TRADE-MARK. SOLE MAKERS

THE BRITISH EBONITE CO., LTD.
HANWELL, W.7

Amateur Wireless HANDBOOKS

WIRELESS-CONTROLLED MECHANISM FOR AMATEURS

Price 2/6 net.

THE BOOK OF THE NEUTRODYNE

by J. H. Reyner, B.Sc. (Hons.), A.M.I.E.E.

Price 1/6 net, or post free for 1/9



Of all Newsagents and Booksellers, or by post 3d. extra, from Cassell & Co., La Belle Sauvage, E.C.4.



SEE THE NEW COMPONENTS BY

Bowyer-Lowe

AT OLYMPIA

STAND No. 156
MARK III PICK-UP
30/-



The Bowyer-Lowe Mark III pick-up marks a new departure in design, the frequency response of from 25 to 6,000 cycles being designed to be complementary to that of the usual moving-coil speaker. The resulting reproduction is a faithful replica of the original recording.

In the small space of 3 in. by 1½ in. by 2½ in. this unit includes all that is necessary for a complete stage of L.F. Amplification, excluding only the valve.

The nickel-iron cored transformer has a primary inductance of over 80 Henries, while the resistances are wire wound and non-inductive.



P.F.T. UNIT 11/6

SEND FOR CATALOGUE

BOWYER-LOWE & A.E.D. LTD., Diamond Works, Brighton.

CLIX

CHEAPEST PERFECT CONTACT

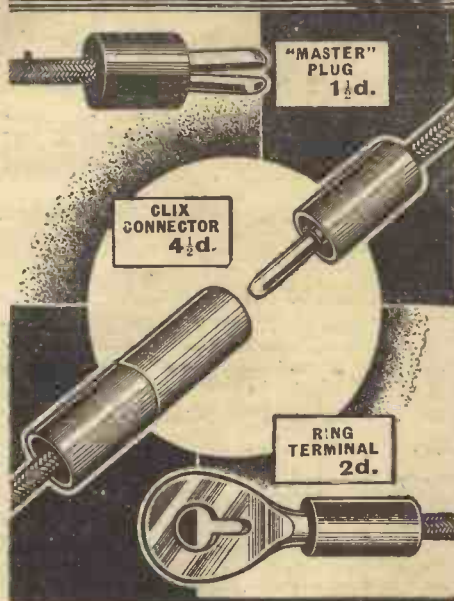

VISIT STAND 225
RADIOLYMPIA

Write for Folder 'A'
Ask your dealer for 'Clix.'

Lectro Linx Ltd., 254, Vauxhall Bridge Road, S.W.1.

and examine the full 'Clix' range of components for every form of contact. Expertly designed to give Perfect Contact—and better radio.



Your Safeguard

MAINS TRANSFORMERS and CHOKES which carry a **5 Years Guarantee**

P.A. AMPLIFIERS FOR CINEMA, DANCE HALL or THE HOME
Write now for lists

Approved by "Amateur Wireless" &c.

W. Andrew BRYCE & Co.
WOODFIELD WORKS,
BURY, Lancs.

London Area:

WILBURN & Co.,
23, Bride Lane, E.C.4

BURY, Lancs.

Phone-1251

We undertake to solve all Radio Problems, including S/W Transmission and Reception. Whatever your difficulty, write us.

Charges: 3/- per query, four or more 2/6 each, including diagrams.

RADIO TECHNICAL AGENCY,
(Dept. A.W.) 2 Westgate Chambers, Newport, Mon.

REPAIRS to Blue Spots 5/-. Loudspeakers, Head-phones and Transformers 4/- each. Mains and Eliminators quoted for. Prompt Service. 12 months' guarantee. Trade invited.
Loud-speaker Repair Co., 2 SHIPKA ROAD, Balham, London

TAYLEX WET H.T. BATTERIES
New Prices: Jars 1/3, Sacs 1/2, Zincs 10d. Sample doz. 18 Volts complete with bands and electrolyte 4/1 post 9L. Sample unit 6d. illus. booklet free. Bargain list free.
AMPLIFIERS 30/-. 3 VALVE ALL-STATION SET 6s.
A. TAYLOR, 57, Studley Road, Stockwell, LONDON.

RADIOGRAMS

THE Welsh Interlude in the Daventry National programme will be given on August 20, when Mr. Caradoc Prichard gives a talk on the Poetry of the National Eisteddfod at Port Talbot, 1932.

Wortley Allen, who is so well known to Midland listeners for his character sketches, will be heard in some characters from Charles Dickens on August 15.

The address at the broadcast service from St. Martins in the Fields, on August 14, will be given by the Rev. H. R. L. Sheppard.

For his Midland Regional organ recital on August 18 Dr. Harold Rhodes will play Handel's "Overture in D Minor," the "First Symphony in D Minor" of Guilment and a Bach number complete the programme.

On August 19 Muriel Sotham will broadcast to Midland Regional listeners songs of Michael Head.

An orchestral ballad concert, with Dorothy Richards as contralto soloist, will be given by the Midland Studio Orchestra on August 20.

Mr. Walter Glynnne will be the vocalist in a West Regional programme from the Cardiff studio on August 16. The title of this programme is *From the Heights*, and the Western Studio Orchestra will play.

The first performance in England of Francesco Malipiero's *Cantari alla Madri-galesca* will be included in a concert by the Alex Cohen String Quartet on August 21 for Midland Regional listeners.

Winifred Browne is to give a pianoforte recital for Midland Regional listeners of the music of Chopin on August 21.

Listeners have been astonished at the great number of novels to which Professor W. Sherard Vines has referred in his talks on Yorkshire in the series entitled "Topical Readings for Northern Holidays." On August 15 Professor Vines will deal with Lancashire books.

The "Super Optimists" have made many friends in the course of their relays from the Floral Pavilion, New Brighton. Their next broadcast to the Northern Region is on August 15.

Recitals on two pianos have become very popular recently, and on August 15 Doris Wilson and Clifford Marshall will play music from the great masters Bach, Schumann and Brahms. They will also play two works by Norman Demuth. Their programme will be broadcast to the Northern Region.

Mr. J. W. Eves, who will give the North Regional talk on "The Northern Garden" on August 18, is new to the microphone. He is a lecturer in horticulture at the University of Leeds.

In the test report on Grantona speaker cones, which was given recently, it was not explained that the cones are made from a special paper pulp, and are not of cloth fabric. These cones are made by R. O. Bridger & Co., 334 Goswell Road, London, E.C.1.

QUICK EASY PAYMENT SERVICE

We supply all good quality Radio Receivers, Components, and Accessories on deferred terms. Large stocks are carried and orders are executed promptly. Send list of requirements and a quotation will be sent by return of post. Price List free on request.

NEW COSSOR MELODY MAKER, Model 335 (just released). Complete Kit of Parts, Valves, and Loud-speaker. With order **10/-**
Cash Price £7/17/6.
And 11 monthly payments of 15/-.

MURPHY NEW ALL-MAINS 3-VALVE SET, Model A.3.A. Cash Price £19/19/0. With order **39/-**
And 12 monthly payments of 33/-.
We are appointed Murphy Dealers.

ATLAS ELIMINATOR, A.C.244. 3 H.T. Tappings. 20 M/A output. With order **5/-**
Cash Price £2/19/6.

And 11 monthly payments of 5/6.
NEW ORMOND PERM. MAGNET MOVING-COIL L.S. UNIT. (just released) With order **5/4**
Cash Price £1/18/6.

And 7 monthly payments of 5/4.
EKO H.T. ELIMINATOR, A.C.18. Suitable for 3-Valve S.G. Sets. With order **6/3**
Cash Price £3 7/6.

And 11 monthly payments of 6/3.
NEW R. & A. "CHALLENGER" PERM. MAGNET MOVING-COIL UNIT. With order **5/-**
Cash Price £1/15/0.

And 6 monthly payments of 5/8.

NEW EPOCH 20c PERMANENT MAGNET MOVING-COIL UNIT. With order **5/7**
Cash Price £1/15/0.

And 6 monthly payments of 5/7.
12 EXIDE HIGH-TENSION ACCUMULATORS (120 volts WH-10 super-capacity, 5,000 milliamps). The cheapest form of high-tension supply where electric light mains not available. With order **7/-**
Cash Price £3/15/0.

And 11 monthly payments of 7/-.
BLUE SPOT 100U. INDUCTOR UNIT. With order **5/5**
Cash Price £1/19/6.

And 7 monthly payments of 5/5.
To avoid delay, will customers kindly send deposit with order.

All above carriage paid.

The **LONDON RADIO SUPPLY COMPANY** ESTD 1925
11, Oat Lane, Noble St., LONDON E.C.2
Phone NATIONAL 1977

PROTECT YOUR VALVES FROM ACCIDENTAL SHORT-CIRCUITING



BY FITTING THE "BUSCO" FUSE SWITCH

All "BUSCO" Switches have Self-cleaning Contacts and "Set Cracking" is Safeguarded through the Vice-like Grip at Contact Points.

BUSBY & Co. Ltd, Price St., BIRMINGHAM

LET "A.W." SOLVE YOUR WIRELESS PROBLEMS.

A LONDON RADIO HEADQUARTERS

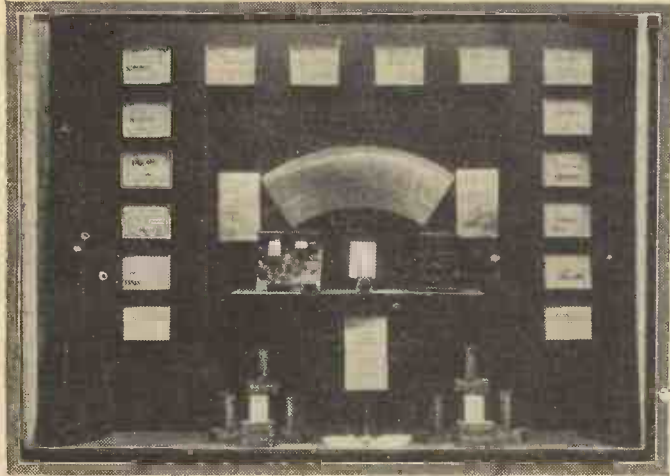

London readers should take the opportunity of seeing this window display, featuring "A.W." and "W.M." sets, in the Radio Department windows of Selfridge & Co., Ltd.

SET builders and buyers who have not previously come in contact with the Radio Department of Selfridge & Co., Ltd., of Oxford Street, London, W.1, should note the interesting fact that a very large stock of receivers and components is kept and several service facilities are available which make Selfridges an important London radio "headquarters." "A.W." sets are demonstrated each week and this week there is a special window display of the "A.W." General-purpose Portable and the Ideal A.C. Home Super of our associate journal, the *Wireless Magazine*.

The "A.W." circuits are shown already wired in the Radio Department on the first floor and it should be noted that sets and components to the value of £3 and over can be had on the Selfridge no-deposit deferred-payment scheme. The Selfridge window display this week also includes a range of the popular Key high-tension batteries, which are obtainable in the 99 and 108-volt sizes.

The window display at Selfridges always includes the current "A.W." and *Wireless Magazine* sets, so London readers should not miss the opportunity of seeing them.

S.G. SPACE-CHARGE

AS a means of preventing back-coupling between the plate and grid circuits, the introduction of a second or screening grid inside the valve was a distinct success. But because it is placed in the path of the normal electron stream, it intercepts some of the electrons, and so forms a "space-charge" which tends to block their passage to the plate. In other words, it increases the internal resistance of the valve. By way of compensation it also increases the amplification factor, though it is difficult to reap the full advantage of this without using a very high-impedance coupling. In the pentode a third grid, connected to the filament, is inserted to remove the undesirable space-charge, thus reducing the internal resistance and allowing the valve to pass a comparatively heavy current to the loud-speaker. M. B.

MAGNETISED CORES

THE advantage of the so-called parallel-feed is that it prevents the D.C. plate component from passing through the core of the low-frequency coupling-transformer and so magnetising it. Magnetisation reduces the effective inductance of the coupling to any audible-frequency currents, particularly the lower notes, which pass through the windings without producing their proper voltage effect on the grid of the next valve, and are therefore practically lost so far as reproduction in the loud-speaker is concerned. In the same way a choke-feed to the plate of a valve tends to shunt the lower frequencies away and to give a high-pitched response on the speaker. M. L.

Stanford's Irish Rhapsody No. 1 in D Minor and a number of unaccompanied Irish reels and jigs played on the violin will be features of the Irish programme from Belfast on August 26. The reels and jigs are all traditional and will be played from manuscripts.

A WATCH FOR STATION-SEARCHERS

THINGS you need to know when searching for foreign stations are the wavelengths and transmission times of the stations. Unfortunately, even the most complete programme information is of no value unless, at the outset, you know the exact home time. A good watch which can be checked against the Greenwich "pips" is an advantage, and a very suitable watch for the wireless man is produced by Peter Roland, Ltd., of Premier House, 12-13 Hatton Garden, E.C.1. This is of the armoured wristlet type with no glass nor hands, but three little windows which show the hour, minute, and second. The movement is of the 15-jewelled type, and the watch is obtainable in various chromium-plated and gold cases. Full details are obtainable from Messrs. Roland free on mention of "A.W.", and set owners are bound to find this style of watch of particular value. The windows through which the figures denoting the time are seen are protected on their inner side by mica. The minutes and seconds revolve, but the hours instantly change at the correct second. A wrist watch often comes in for a deal of rough use, and the armouring is of great value, both for wireless work and in everyday use.



CASH—C.O.D.—H.P. IMMEDIATE DELIVERY

JUST RELEASED
COSSOR MELODY MAKER
 MODEL 335
 Complete with Valves, Speaker and Cabinet. Employs Cossor Variable-Mu S.G., H.F. stage, Detector and Power Valves. Cash Price £7/17/6. Balance in 11 monthly payments of 14/6.
 Send 14/6 only

OSRAM "THIRTY THREE" MUSIC MAGNET

Complete Kit, comprising all components including Valves, Cabinet with self-contained Speaker. Screen-grid H.F., Screen-grid Detector and Power output. Single-dial tuning, wavelength calibrated. Cash Price £9/9/0. Balance in 11 monthly payments of 17/6.
 Send 15/- only

W.B. PERMANENT MAGNET MOVING-COIL SPEAKER P.M.3. Complete with 3-ratio input transformer. Cash Price £2/12/6. Balance in 11 monthly payments of 4/10.
 Send 4/10 only

R. & A. "100" PERMANENT-MAGNET MOVING-COIL SPEAKER with multi-ratio input transformer. Cash Price £2/17/6. Balance in 11 monthly payments of 5/4.
 Send 5/4 only

EPOCH "20 C" PERMANENT MAGNET MOVING-COIL SPEAKER. With 3-ratio input transformer. This speaker will handle up to 5 watts. Cash Price £1/15/0. Balance in 5 monthly payments of 6/6.
 Send 6/6 only

EPOCH MOVING-COIL SPEAKER TYPE A2. Complete with 5-ratio input transformer. Cash Price £3/3/0. Balance in 11 monthly payments of 5/9.
 Send 5/9 only

ULTRA IMP PERMANENT MAGNET MOVING-COIL SPEAKER, with input transformer. Cash Price £2/15/0. Balance in 11 monthly payments of 5/-.
 Send 5/- only

W.B. PERMANENT MAGNET MOVING COIL SPEAKER. Type P.M.4. Complete with Transformer. Cash Price £2/2/0. Balance in 7 monthly payments of 5/9.
 Send 5/9 only

BLUE SPOT SPEAKER UNIT AND CHASSIS, TYPE 100U. Cash Price £1/19/6. Balance in 7 monthly payments of 5/5.
 Send 5/5 only

ATLAS ELIMINATOR, TYPE A.C.244. Three tappings, S.G., detector and power. Output, 120 volts at 20 m/A. Cash price, £2/19/6. Balance in 11 monthly payments of 5/6.
 Send 5/6 only

ATLAS ELIMINATOR TYPE AC 188. Combined H.T. and Trickle Charger for 2, 4 or 6 volts. Cash Price £6/0/0. Balance in 11 monthly payments of 11/-.
 Send 11/- only

GARRARD INDUCTION GRAMOPHONE MOTOR. For A.C. Mains. Model-202. Mounted on 12-inch Nickel Motor Plate with fully automatic electric starting and stopping switch. Cash Price, £2/18/6. Balance in 11 monthly payments of 5/4.
 Send 5/4 only

Send 1/- only For **PILOT ENVELOPE No. 1, SELECTIVE FAMILY THREE.** Contains full-size Blueprint, 5 Photographs and List of Parts with details of newly invented system of Home Construction for this amazing 60 Station Receiver.

PETO-SCOTT CO. LTD. 77, City Road, LONDON, E.C.1

Please send me C.O.D./CASH/H.P.

KIT "A"

Parts as indicated.....

for which I enclose £.....

CASH/H.P. Deposit.....

NAME.....

ADDRESS.....

A.W. 13 8/32

West End Showrooms: 62 High Holborn, W.C.1



60 ma. at 250 volts

Suitable for any receiver—from a single-valve to a six-valve super-het—HEAYBERD Model D250 Mains Unit gives alternative outputs of 200v. or 250v. at 60 ma., Tappings: 60/80v. Var.S.G., 0-150v. Var., 100-200v. Var., and 250v. fixed. Housed in attractive black metal case. Bakelite Panel carries the tappings and controls. Costs little to run. Complete and ready to switch on! Price 170/-

Write NOW, enclosing 3d. stamps, for full details.

Don't forget to visit our Stand Number **13 OLYMPIA**

HEAYBERD

MONARCH OF THE MAINS.

10, FINSBURY STREET, LONDON, E.C.2. ONE MINUTE from MOORGATE UND. STATION.

New Times Sales Co

EVERYTHING RADIO EASIEST TERMS

W.B. PERMANENT MAGNET MOVING-COIL SPEAKER: Type P.M.4. Complete with Transformer. Cash Price £2/2.0. **5/9** order
Balance in 7 monthly payments of 5/9.

ATLAS A.C. ELIMINATOR, TYPE A.C.244. Three tappings S.G., detector, and power. Output, 120 volts at 20 ma. Cash Price £2/19/6. **5/6** order
Balance in 11 monthly payments of 5/6.

EPOCH J.1 PERMANENT MAGNET MOVING-COIL SPEAKER with 3 ratio input transformer. Cash Price £2/5/0. **4/2** order
Balance in 11 monthly payments of 4/2.

IMMEDIATE DELIVERY!

COSSOR MELODY MAKER.

Model 335. Complete with valves, Speaker and Cabinet. Employs Cossor Variable-Mu S.G. H.F. stage, Detector and Power. Cash Price £7/17/6. **14/6** order
Balance in 11 monthly payments of 14/6.

BLUE SPOT SPEAKER UNIT AND CHASSIS, TYPE 100U. Cash Price £1/19/6. **5/5** order
Balance in 7 monthly payments of 5/5.

GARRARD INDUCTION GRAMOPHONE MOTOR, Model 202. For A.C. Mains. Mounted on 12-in. Nickel Motor Plate with fully automatic electric starting and stopping switch. Cash price £2 18s. 6d. Balance in 11 monthly payments of 5/4. **5/4** order

Any items advertised in this journal sent C.O.D. If value over 10/- sent all C.O.D. charges paid.

To NEW TIMES SALES CO. 54 Ludgate Hill, London, E.C.4

Please send me (a) Free 1932 Catalogue

(b).....for which I enclose first payment of £.....d.....

Name.....

Address.....

A.W.1318/32

BROADCASTING STATIONS

Broadcasting Stations classified by country and in order of wavelengths. For the purpose of better comparison, the power indicated is that of the carrier wave.

Kilo- metres	Station and Call Sign	Power (Kw.)	Kilo- metres	Station and Call Sign	Power (Kw.)	Kilo- metres	Station and Call Sign	Power (Kw.)
GREAT BRITAIN								
25.53	11,751 Chelmsford (G5SW)	16.0	528.2	914 Poste Parisien	60.0	235.5	1,274 NORWAY	
211.3	1,120 Newcastle	1.0	345.2	869 Strasbourg (PTT)	11.5	240.6	1,247 Kristiansand	0.5
214.3	1,400 Aberdeen	1.0	369.4	812 Radio LL (Paris)	1.0	304	824 Stavanger	0.5
242	1,238 Belfast	1.0	384.4	779 also on 33m. (9090 Kcs.)	8.0	304	824 Bergen	1.0
261.6	1,147 London Nat.	50.0	447.1	671 Radio Toulouse	8.0	387.6	816 Fredrikstad	0.7
268.5	1,049 Swansea	0.12	465.8	644 Paris (PTT)	8.0	493.4	603 Trondheim	1.2
288.5	1,040 Plymouth	0.12	568.5	527.7 Lyons (PTT)	1.5	1,083	277 Oslo	60.0
288.5	1,040 Bournemouth	1.0	1,445.7	207.5 Eiffel Tower	13.5	214.3	1,400 POLAND	
288.5	1,040 Scottish National	50.0	1,725	174 Radio Paris	75.0	235	1,283 Warsaw (2)	1.9
301.5	995 Newcastle (temp.)	1.0	227.4	1,319 GRAND DUCHY OF LUXEMBURG		312.8	959 Lodz	2.2
309.9	968 Cardiff	1.0	1,250	240 Luxembourg (tests)	200.0	335	866 Cracow	1.5
355.9	843 London Regional	50.0	19,737	15,200 GERMANY		380.7	738 Lvov	16.0
376.4	797 Scottish Regional	50.0	31.38	9,560 Zeesen (DJB)	8.0	403	774 Katowice	12.0
398.9	752 Midland Regional	25.0	217.1	1,382 Zeesen (DJA)	8.0	563	533 Wilno	16.0
480	625 North Regional	50.0	227.4	1,319 Königsberg	0.9	1,411.8	212.5 Warsaw	120.0
1,564.4	293 Daventry (Nat.)	30.0	232.2	1,292 Flensburg	0.5	PORTUGAL		
AUSTRIA								
218	1,373 Salzburg	0.5	232.2	1,292 Kiel	0.25	241.6	1,241.8 Oporto	0.25
245.9	1,220 Linz	0.5	238.9	1,256 Nürnberg	2.0	282.2	1,067 Lisbon (CTIAA)	2.0
283	1,058 Innsbruck	0.5	245.9	1,220 Cassel	0.25	ROMANIA		
352.1	852 Graz	7.0	253.1	1,185 Gleiwitz	5.0	394	761 Bucharest	12.0
453.2	663 Klagenfurt	0.5	259.3	1,157 Leipzig	2.0	RUSSIA		
518	579.1 Vienna	15.0	269.8	1,112 Bremen	0.2	351	855.5 Leningrad RV70	20.0
also testing on 1,252.6 m. from 7.0p.m. (Mon., Wed., Sat.)								
BELGIUM								
207.3	1,447 Franchimont	0.2	283.6	1,058 Heilsberg	0.0	358	838 Moscow (Exp.)	15.0
208.3	1,440 Antwerp	0.4	283.6	1,058 Magdeburg	0.5	385	779 Stalino (RV26)	15.0
210.1	1,428 Liege (Scraining)	0.15	283.6	1,058 Berlin (E)	0.5	389.3	770 Archangel	10.0
215.3	1,393 Chatelineau	0.2	318.8	941 Stettin	0.5	476	630.2 Sebastopol	10.0
215.4	1,392.5 Bruxelles	0.2	325	923 Dresden	0.25	602.4	597 Nijni Novgorod	10.0
Conference								
215.5	1,392 Liege	0.2	360.0	832 Breslau	60.0	644	465.8 Kazan (RV17)	10.0
230.3	1,304 Radio Wallonia	0.3	372.2	806 Muhlacker	0.0	720	416.6 Moscow (PIT)	20.0
239.5	1,258 Binche	0.3	389.6	770 Hamburg	1.5	825	363.6 Sverdlovsk KV5	50.0
240.2	1,249 Liege (Exp.)	0.1	389.6	770 Frankfurt	1.5	848.7	353.5 Rostov (Don)	4.0
245.9	1,220 Radio Schaerboek	0.3	419.9	770 Leipzig (testing)	120.0	937.5	320 Kharkov (KV20)	25.0
268.5	1,217 Liege (Comite)	0.4	453.2	662 Danzig	0.5	1,000	300 Leningrad	100.0
337.8	888 Brussels (No. 2)	15.0	472.4	635 Langenberg	0.0	1,034	290 Kiev	100.0
509	590 Brussels (No. 1)	15.0	532.9	563 Munich	1.5	1,071.2	280 Tiflis	35.0
BULGARIA								
318.8	941 Sofia (Rodno Radio)	1.0	559.7	536 Kaiserslautern	1.5	1,107	271 Minsk (RV10)	35.0
CZECHO-SLOVAKIA								
58	5,172 Prague	0.5	566	530 Augsburg	0.3	1,111	270 Moscow Popoff	75.0
249.6	1,201.8 Prague (2)	5.0	669.3	527 Hanover	0.3	1,171.5	256 Taschkent	25.0
263.8	1,137 Moravska-Ostrava	11.0	1,620	185 Freiburg	0.25	1,260	238 Bakou	35.0
270.3	1,073.6 Bratislava	14.0	1,634.9	183.5 Zeesen	0.0	1,304	230 Moscow (Trades Unions)	165.0
293	1,022 Kosice	2.5	2,625	219.3 Königswusterhausen (press)	15.0	also on 50 m. (6,000 Kcs.)		
341.7	878 Brunn (Brno)	35.0	2,900	75 ditto		1,380	227.4 Novosibirsk	100.0
488.6	614 Prague	120.0	296.1	1,013 Huizen	8.5	1,481.5	202.5 Moscow RV1	100.0
DENMARK								
281	1,067 Copenhagen	0.75	1,071.4	283 Scheveningen-Haven	10.0	also on 46.8 m. (6,438 Kcs.)		
1,153	260 Kalundborg	7.5	1,875	160 Hilversum	8.5	1,910.8	157 Sverdlovsk (RV38)	20.0
also on 31.51 m. (9,520 Kcs.)								
ESTONIA								
298.8	1,004 Tallinn	11.0	HUNGARY					
465.8	644 Tartu	0.5	208.7	1,437.2 Budapest (2)	3.0	252.3	1,193 Barcelona (EAJ15)	3.0
FINLAND								
291	1,031 Tampere	1.0	210	1,430 Magyazovar	1.5	267.6	1,121 Valencia	8.0
291	1,031 Viipuri	13.0	550	545 Budapest (1)	18.5	348.8	860 Barcelona (EAJ1)	8.0
368.1	815 Helsinki	13.2	also relayed on 75 m.					
1,796	167 Lahti	54.0	ICELAND					
FRANCE								
220	1,363.2 Béziers	0.5	1,200	250 Reykjavik	21.0	231	1,301 SWEDEN	
225.7	1,329.1 Fécamp	10.0	224.4	1,337 IRISH FREE STATE		257	1,166 Malmö	1.2
237.2	1,265 Bordeaux-Sud-Ouest	2.0	413	725 Cork (OCC)	1.2	308.5	972.4 Hörby	10.0
249.6	1,207.7 Juan-les-Pins	0.5	413	725 Dublin	1.2	321.9	932 Falun	0.5
255	1,175 Toulouse (PTT)	1.0	25.4	11,810 Rome (2RO)	15.0	435.4	680 Göteborg	10.0
265.4	1,130 Lille (PTT)	1.3	247.7	1,211 Trieste	10.0	446.5	680 Stockholm	55.0
271.4	1,105 Rennes	1.3	269.2	1,115 Bari (testing)	20.0	541.5	554 Stoksvall	10.0
286	1,049.1 Montpellier	0.8	273.7	1,090 Turin (Torino)	7.0	770	389 Ostersond	0.6
287	1,045.1 Radio Lyons	10.0	312.8	959 Genoa (Genova)	10.0	1,229.5	244 Boden	0.6
293.7	1,021.5 Limoges (PTT)	0.5	318.8	941 Naples (Napoli)	1.5	1,348	222.5 Motala	30.0
304.9	984 Bordeaux (PTT)	13.0	332.1	903 Milan	7.0	also on 49.46 m. (6,065)		
309	970.8 Radio Vitus	1.0	368.1	815 Bolzano	1.0	SWITZERLAND		
also on 43.75 m. (6,865 Kcs.)								
315	950 Marseilles	1.6	441	680 Rome (Roma)	50.0	244.1	1,229 Basle	0.65
and 32.26 m. (9,300 Kcs.)								
LATVIA								
LITHUANIA								
NORTH AFRICA								
TURKEY								
YUGOSLAVIA								

WHEN SUBMITTING QUERIES

Please write concisely, giving essential particulars. A Fee of One Shilling (postal order), a stamped addressed envelope, and the coupon on the last page must accompany all letters. The following points should be noted.

Not more than two questions should be sent with any one letter.

The designing of apparatus or receivers cannot be undertaken.

Modifications of a straightforward nature can be made to blueprints, but we reserve to ourselves the right to determine the extent of an alteration to come within the scope of a query. Modifications to proprietary receivers and designs published by contemporary journals cannot be undertaken.

Readers' sets and components cannot be tested at this office. Readers desiring specific information upon any problem should not ask for it to be published in a forthcoming issue, as only queries of general interest are published and these only at our discretion. Queries cannot be answered by telephone or personally.

Readers ordering blueprints and requiring technical information in addition, should address a separate letter to this Query Department and conform with the rules.

A selection of songs from Stage and Screen will be presented to West Regional listeners by Francis Worsley on August 23, under the title of "Hurdy Gurdy."

Miss Mary Maddock, the popular Welsh soprano, and Joseph Cooper will be the artistes at a concert for West Regional listeners on August 24.

Postcard Radio Literature

GET THESE CATALOGUES FREE.

Here "Observer" reviews the latest booklets and folders issued by well-known manufacturers. If you want copies of any or all of them **FREE OF CHARGE**, just send a postcard giving the index numbers of the catalogues required (shown at the end of each paragraph) to "Postcard Radio Literature," "AMATEUR WIRELESS," 58-61, Fetter Lane, E.C.4. "Observer" will see that you get all the literature you desire.

Wego Condensers

NEAR my work bench I like to have data sheets about condensers, resistances, and other parts which are in constant use, and about which accurate rating is important. The Wego Condenser Co., Ltd., have just issued a useful folder describing condensers of all kinds from the little tubular fellows of .00005 mfd. up to 15,000-volt test transmitting condensers. Drop a line through my Free Catalogue Service for a copy of this folder, which is bound to be of practical interest. **808**

These Wire Wounds

I see that some new wire-wound fixed resistances capable of dissipating upwards of $2\frac{1}{2}$ watts have been introduced by Rotor Electric Ltd., the people who make those smooth-working wire-wound variable resistances and potentiometers. These new fixed jobs are described in the latest Rotor Electric folder, copies of which you can get free. **809**

A Topical Reduction

Lightning arresters and outdoor knife switches are topical subjects these hot days and you will be interested to know that a reduction has just been made in the prices of the combined knife switch, lead-in tube, and lightning arrester made by J. J. Eastick & Sons. When overhauling your aerial equipment, you should take advantage of this price reduction. **810**

A New Marconiphone H.T. Battery

An additional type has been added, I hear, to the new range of Marconiphone H.T. and grid bias batteries introduced a month or so ago. The new type is a 60-volter selling at 5s. 6d. and full details of it can be had through my Catalogue Service. **OBSERVER 811**

Clio Pala is a 'cellist new to Northern listeners. She is of English birth but has made her reputation in Italy. In her broadcast on August 20 she will play modern compositions by Neruda, Goossens and Caix d'Hervelois.

Tom Clough enjoys great popularity for his playing of the Northumbrian Pipes. The music to be played in a programme for North Regional listeners on August 20 is traditional.

Definitely BETTER Radio At LESS COST!

The new Tunewell Components have removed the price-bar to Super-Radio. They have brought reception of an exceptionally high order within everybody's reach. Yet, they cost as little as "cheap" components—and in many cases even less! Only by careful design and lowering our profits are the low prices made possible.

**STAND
96**

The range includes Coils, Chokes, Transformers, Resistances, Volume Controls, Mains Components, and Eliminators, etc.

**STAND
96**

Select the components you require from the Tunewell "Guide to Super Radio," free from Stand 96, or address below. This Guide contains—

8 FREE BLUEPRINTS

including Kit Eliminator and All-Mains Bandpass 3.

*See the new Tunewell Super-Radio Components and wonderful new Radio-Gram. at STAND 96.

**TUNEWELL RADIO LTD.,
54, Station Road, LONDON, N.11.**

TUNEWELL

A New "Amateur Wireless" Handbook

The HOW and WHY of RADIO

By ALAN HUNTER

2/6 NETT.

This book has been expressly written for beginners. It provides a clear conception of the general theory and practice of wireless reception in simple non-technical terms. It has been mainly compiled from the series of articles in "Amateur Wireless"—"The How and Why of Radio"—which proved so popular during the past twelve months.

Of all Newsagents and Booksellers, or 2/9, post free, from "Amateur Wireless," 58/61 Fetter Lane, London, E.C.4.

THE NEW ELECTRADIX SALE LIST WILL SAVE YOU POUNDS

It is full of bargains of Aerials, Batteries, Buzzers, Condensers, Cabinets, Chokes, Coils, Chargers, Dynamos and Motors, Galvos, Engines, Lamps, Photo Cells, Neons, Microphones, Mains Sets, Magnets, Meters, Receivers, Spark Coils, Telephones, Valves, Wavemeters, Wire, Meggers, and Capacity Bridges, etc., etc.



NAVAL TELESCOPE.—Gun sighting pattern, internal focus ring, 24 in. long, 2 in. dia; weight 6 lb., magnification 6; suitable day or night; short or long range. Cost £25. Sale 17/6.

MONOCULAR for range spotting, Cooke prism and lens with distance gauge. Fine job, small and handy, 15/-.

BARGAIN PARCELS of electrical and radio sundries, dismantled W.D. parts, etc. for experimenters; 10 lb., 7/-; 7 lb., 5/-.

Wonderful value. 1,000 other bargains in our Sale List, post free.

Send stamped addressed envelope to

ELECTRADIX RADIOS

218 Upper Thames Street, London, E.C.4

Let "AMATEUR WIRELESS"
solve your wireless problems

PREPAID ADVERTISEMENTS

Advertisements under this head are charged **THREEPENCE PER WORD**, minimum charge **THREE SHILLINGS. DEPOSIT SYSTEM.**

As the publishers cannot accept responsibility for the bona fides of advertisers in this publication, they have introduced a system of deposit which it is recommended should be adopted by readers when dealing with persons with whom they are unacquainted. It is here explained.

Intending purchasers should forward to the Publishers the amount of the purchase money of the article advertised. This will be acknowledged to both the Depositor and the Vendor, whose names and addresses must necessarily be given. The deposit is retained until advice is received of the completion of the purchase, or of the article having been returned to and accepted by the Vendor. In addition to the amount of the deposit, a fee of 6d. for sums of £1 and under, and 1s. for amounts in excess of £1, to cover postage, etc., must be remitted at the same time. In cases of persons not resident within the United Kingdom, double fees are charged.

The amount of the Deposit and Fee must be remitted by Postal Order or Registered Letter (Cheques cannot be accepted), addressed to

"AMATEUR WIRELESS" ADVERTISEMENT DEPARTMENT,
58/61 FETTER LANE, LONDON, E.C.4.

WIRELESS AS A CAREER.—Those already engaged in the radio industry and those who would like to obtain employment in this interesting profession should write for a copy of our booklet, sent post free without obligation.—Northern Counties Wireless School, 55-57 Guildhall Street, Preston.

INVENTIONS PATENTED, advice free.—E. C. Ax, 27 Chancery Lane, London. Holborn 6829.

NEW BALL-BEARING SAWBENCHES, 24 in. by 18 in. table, complete 14-in. saw, etc., £4/10/-.—Send for List. Frank Hartop & Sons, Miller Road, Bedford.

WIRELESS COMPONENTS.—All makes supplied. Special discount home constructors. Also Cabinets. New leaflet ready.—Send to Imperial Radio, 18 Summerhill Street, Birmingham.

REQUIRED.—A young man for Service Dept. of well-known manufacturing concern. Write, giving fullest particulars to Box 33, "Amateur Wireless," 58-61 Fetter Lane, E.C.

WIRELESS CONSTRUCTOR, TAKE NOTICE.—Cheaper wireless. Join our Association, write for particulars, enclosing 1d. stamp.—Radio and Electrical Supply Association, 118 Freer Road, Birchfield, Birmingham.

MAINS TRANSFORMER REPAIRS.—If you have a faulty or burnt-out mains transformer, we can rewind to your requirements at very moderate charges.* Write for quotation.—The Sturdy Electric Co., Derwent View, Dipton, Newcastle-on-Tyne.

ENGINEERS.—Sit down and think this over. Time is going by and you are still on the look out for a worth-while job. Will you be doing the same thing next year—and the year after that? You have got to do something about it before it is too late. We believe we can show you the way to well-paid permanent and progressive employment. In any case it costs nothing to inquire and you will at least learn of various surprising possibilities about which at present you probably know nothing. The first thing to do is to send for our 200-page prospectus, "Engineering Opportunities." Free and without obligation. Do not delay. This is a matter which affects your very livelihood. Send for your copy now—not to-morrow, but now.—British Institute of Engineering Technology, 109 Shakespeare House, 29-31 Oxford Street, London.

RADIO REPAIRS OF ANY KIND.—Loud-speakers, Pick-ups rewound, remagnetised. L.F. Transformers. Chokes, any make, from 3/-. Mains Transformers repaired, rewound to any voltage. D.C. Eliminators converted to A.C. Eliminators repaired. Quotations on application. All repairs guaranteed and tested in laboratory before return. Twenty-four-hour service. C.O.D. system.—Weedon Power Link Radio Co., 185 Earham Grove (1 min. Forest Gate Station), London, E.7. Phone: Maryland 4344.

BANKRUPT BARGAINS.—List free with 3-valve diagram. S.T.300 kit, 45/-. Century Super, 70/-. Straight 3, 22/6, or with cabinet, 27/6. Any kit supplied. Part exchange. No junk supplied. Mullard S.G. Pentode 3-v. type 1932, with valves, 70/-. as new. Super-het., with frame, £4. S.M. .0005, 3/6; transformers from 2/9; dual coils, 4/- with switch; Brown Vee units, 10/-; Millgate, 2/6; D.C.M.C. 20/-. Quotes return.—Butlin, 143b Preston Road, Brighton.

You **MUST** have the
"WIRELESS MAGAZINE"

Every Month

Price 1/-

(Continued from page 178)

"TELEVISION IN ROME"

chronising apparatus is built into the receiver underneath the motor support, and this is worked from the mains. There is a 60-toothed wheel and an A.C. driven motor, while the four knobs on the front of the receiver serve to alter the number of revolutions of the motor, frame the image (by rotating the motor case) and change in stages or continuously the frequency of the valve generator.

The spiral holed discs for both the vertical and horizontal picture formations mentioned earlier, are readily interchangeable, so that it is necessary only to move the mask line to convert the receiver from one to the other. For enlarging the images to a size of 9 cm. by 12 cm. there is a plano-convex lens and a chromatic lens, and the resultant angle of observation is quite large.

Two large rooms in the Palazzo E.I.A.R. house the apparatus, one accommodating the transmitter and associated amplifiers while the other, complete with photo-electric cells and stands, is the studio. The persons being transmitted have provided for them a movable stage, there being the usual glass aperture in the dividing partition between the rooms for the scanning beam to pass through

Both the wireless transmitters lie in a southerly direction from Rome. The station Pratosmeraldo, distant 18 kilometres, and working on a wavelength of 80 metres transmits the television signals, while Santa Palomba distant 24 kilometres, undertakes the simultaneous sound transmissions on a wavelength of 441 metres.

In linking the television studio with the radio transmitter, special precautions have been taken to ensure the frequency range of 50,000 cycles being handled without distortion, and the initial tests have proved most satisfactory.

YOUR SHOW GUIDE

—Next week in "A.W."—A complete Stand-to-Stand Guide to Olympia.

The consecration ceremony of the Abbey Church, Buckfast Abbey, will be relayed to National listeners on August 25, when the sermon will be delivered by Cardinal Bourne.

The Creswell Colliery Band are broadcasting to the Northern Region on August 17 in a concert with John Armitage.

"Amateur Wireless and Radiovision." Price Threepence. Published on Thursdays and bearing the date of Saturday immediately following. Post free to any part of the world: 3 months, 4s. 6d.; 6 months, 8s. 9d.; 12 months, 17s. 6d. Postal Orders, Post Office Orders, or Cheques should be made payable to "Bernard Jones Publications, Ltd."

General Correspondence is to be brief and written on one side of the paper only. All sketches and drawings to be on separate sheets. Contributions are always welcome, will be promptly considered, and if used will be paid for. Communications should be addressed, according to their nature, to The Editor, The Advertisement Manager, or The Publisher, "Amateur Wireless," 58-61 Fetter Lane, London, E.C.4.

FULL-SIZE BLUEPRINTS

When ordering, please send Postal Order, NOT STAMPS.

CRYSTAL SET (6d.)

- 1931 Crystal Set AW308
- ONE-VALVE SETS (1s. each)**
- Easy to Build One AW304
- Short-wave One valver AW327
- B.B.C. One valver AW344
- Portable Short-wave One AW354

TWO-VALVE SETS (1s. each)

- Two Star 2 (D, Pen) AW315
- The 25/- Two (D, Trans) AW330
- Ten-Station Two (D, Trans) AW336
- Inexpensive A.C.2 (D, Trans) AW346
- Midget Two (D, RC.) AW348
- Mascot Two (D, Trans) AW353
- Station-finder Two (D, Trans) WM253
- Music Lover's Two (D, Trans) WM260
- New Economy Two (D, Trans) WM265
- Family Two (D, Trans) WM278
- Screen-grid Two (SG, Trans) WM289
- Economy A.C. Two (D, Trans) WM286

THREE-VALVE SETS (1s. each)

- 1932 Ether Searcher (SG, D, Pen) AW325
- Wide World Short-wave Three (D, RC, Trans) AW332
- New Favourite Three (D, RC, Trans) AW334
- Home-Lover's All-electric 3 (SG, D, Trans) AW335
- The P.W.H. ("Mascot") D, RC, Trans) AW337
- Home-Lover's Battery 3 (SG, D, Trans) AW341
- £8 Radiogram (SG, D, Trans) AW343
- New Regional Three (D, RC, Trans) AW349
- Five-point Three (SG, Trans) WM212
- New Brookman's Three (SG, D, Trans) WM218
- Five-point Short-waver (D, RC, Trans) WM223
- Band-pass Inceptor-dyne (SG, D, Trans) WM244
- Ether Marshal (SG, D, Trans) WM247
- Meridian Short-waver (D, RC, Trans) WM256
- Five-advantage Three (D, RC, Trans) WM257
- Everybody's A.C. Radiogram (SG, D, Trans) WM258
- Double Band-pass Three (SG, D, Trans) WM259
- Everybody's A.C. Radiogram (with automatic G.B.) WM262
- New Economy Three (SG, D, Trans) WM263
- New Plug-in Coil Three (D, 2 Trans) WM270
- Transportable Three (SG, D, Trans) WM271
- Multi-Mag Three (D, 2 Trans) WM288
- Percy Harris A.C. Radiogram (D, RC, Trans) WM294

FOUR-VALVE SETS (1s. 6d. each)

- Four Star 4 (SG, D, RC, Trans) AW318
- 50/- Four (SG, D, RC, Trans) AW331
- Five-point Four (SG, D, RC, Trans) WM216
- Brookman's Three-plus-one (SG, D, RC, Trans) WM233
- Ether Rover (SG, D, RC, Trans) WM266
- Quadradyne 2 (SG, D, Pen) WM273
- Double Band-pass Four (SG, D, RC, Trans) WM274
- Everybody's Radio Gram. (SG, D, RC, Trans) WM276
- A.C. Quadradyne 2 (SG, D, Pen) WM279
- Ideal A.C. Home Super (Super-het) WM290
- Gold Coaster (A.C. Short-waver) WM292
- Triple-tune Four (2 SG, D, Trans) WM293

FIVE-VALVE SETS (1s. 6d. each)

- James Short-wave Super (Super-het) AW328
- Simple Super (Super-het) AW340
- Ideal Home Super (Super-het) WM280
- Easytune 60 (Super-het) WM284

SIX-VALVE SETS (1s. 6d. each)

- Century Super (Super-het) AW287
- A.C. "Century Super" (Super-het) AW295
- Mains Unit (1/-) AW295A
- Super 60 (Super-het) WM229
- Super 60 (with Wearite base) WM249
- Super 60 (with Lewcos base) WM251
- 1932 Super 60 (Super-het) WM266
- 1932 A.C. Super 60 (A.C. Super-het) WM272

SEVEN-VALVE SETS (1s. 6d. each)

- Super Senior (Super-het) WM256
- Super Senior (Wearite base and Lewcos coils) WM261

PORTABLES (1s. 6d. each)

- Hiker's Two (D, Trans) (1/-) AW345
- Town and Country Four (SG, D, RC, Trans) WM282
- Everybody's Portable (5-valve super-het) WM291
- General-purpose Portable (SG, D, RC, Trans) AW351

AMPLIFIERS (1s. each)

- Add-on H.F. Screened-grid Unit AW296
- Universal Push-pull Amplifier AW300
- "A.W." Record Player (L.F. Push-pull) AW319
- Quality Amplifier (DC), 1/6 WM264
- A-P-A (Power, Amplifier for A.C. Mains) WM275
- A-P-A Radio Unit (SG, D) WM281
- Economy Gramophone Amplifier WM277

MISCELLANEOUS (1s. each)

- A.C. Trickle Charger AW305
- Amateur's Linen Speaker AW307
- D.C. H.T. Unit AW312
- Output Unit for Pentode Sets AW316
- Short-wave Plug-in Adaptor (6d.) AW326
- Short-wave Super-het Adaptor (6d.) AW329
- Ether Searcher Radio-gramophone Motor Board AW333
- "A.W." Short-wave Adaptor AW339
- "Mascot" Mains Unit AW350
- "A.W." Trickle Charger AW352
- Big H.T. Unit for A.C. Mains WM230
- Loud-speaker Tone Control (6d.) WM234
- "W.M." Linen Diaphragm Loud-speaker WM235
- Two-Minute Adaptor for Short Waves WM240
- Super 60 A.C. Unit WM248
- A Simple Mains Unit WM283
- Short-wave Director (6d.) (wavemeter) WM285
- Voltage Regulator WM287
- Copies of the "Wireless Magazine" and of "Amateur Wireless" containing descriptions of most of these sets can be obtained at 1s. 3d. and 4d. respectively, post free Index letters "A.W." refer to "Amateur Wireless" sets and "W.M." to "Wireless Magazine."

Amateur Wireless Blueprints Dept., 58-61 Fetter Lane, London, E.C.4

Amateur Wireless
FEE 1/-

INFORMATION BUREAU
COUPON
Available until Saturday
AUGUST 20, 1932



IN fair weather the barque may make good progress, but it never rivals in speed the "ocean greyhound." In the doldrums it stands becalmed, and in the storm it goes where the wind takes it—whilst the liner pursues its steady course.

The advertised product, like the liner, has its own power and directive force. The turbines of scientifically evolved selling-appeal drive it forward and compel consumer acceptance, so that it passes undeterred through the calms of depression and rides the economic storm.

IT PAYS TO ADVERTISE

Issued by the Institute of Incorporated Practitioners in Advertising in conjunction with the Federations of Master Process Engravers and Master Printers, etc.

A 27-3 6

You will Help Yourself and Help Us By Mentioning "A.W." to Advertisers

ENJOY THE MAGIC OF MAZDA...



LEARN ALL ABOUT THE LATEST MAZDA MASTERPIECES AT THE EDISWAN STAND NOS 75 & 230 RADIOLYMPIA

There is nothing more enjoyable in radio than a good set equipped with Mazda valves. Leading set manufacturers have standardised them; the experts use them. They will improve results for you too. All good radio dealers stock Mazda types to suit every receiver.

The amazing

MAZDA THE BRITISH VALVES

100 PER CENT BRITISH

The Edison Swan Electric Co. Ltd. 155 Charing Cross Rd. London. W.C.2

Mazda Radio Valves are manufactured for The British



Thomson-Houston Co. Ltd., London and Rugby.

V.171