

A NEW NOTE IN HOME-CONSTRUCTOR SETS

"STAR" SET DETAILS

Amateur Wireless

Every Thursday 3^d

and Radiovision

Vol. XIX, No. 491

Saturday, November 7, 1931

The THREE STAR



A
NEW TYPE
OF
HOME-CON-
STRUCTOR
SET

NEW

1932

IDEA

THIS

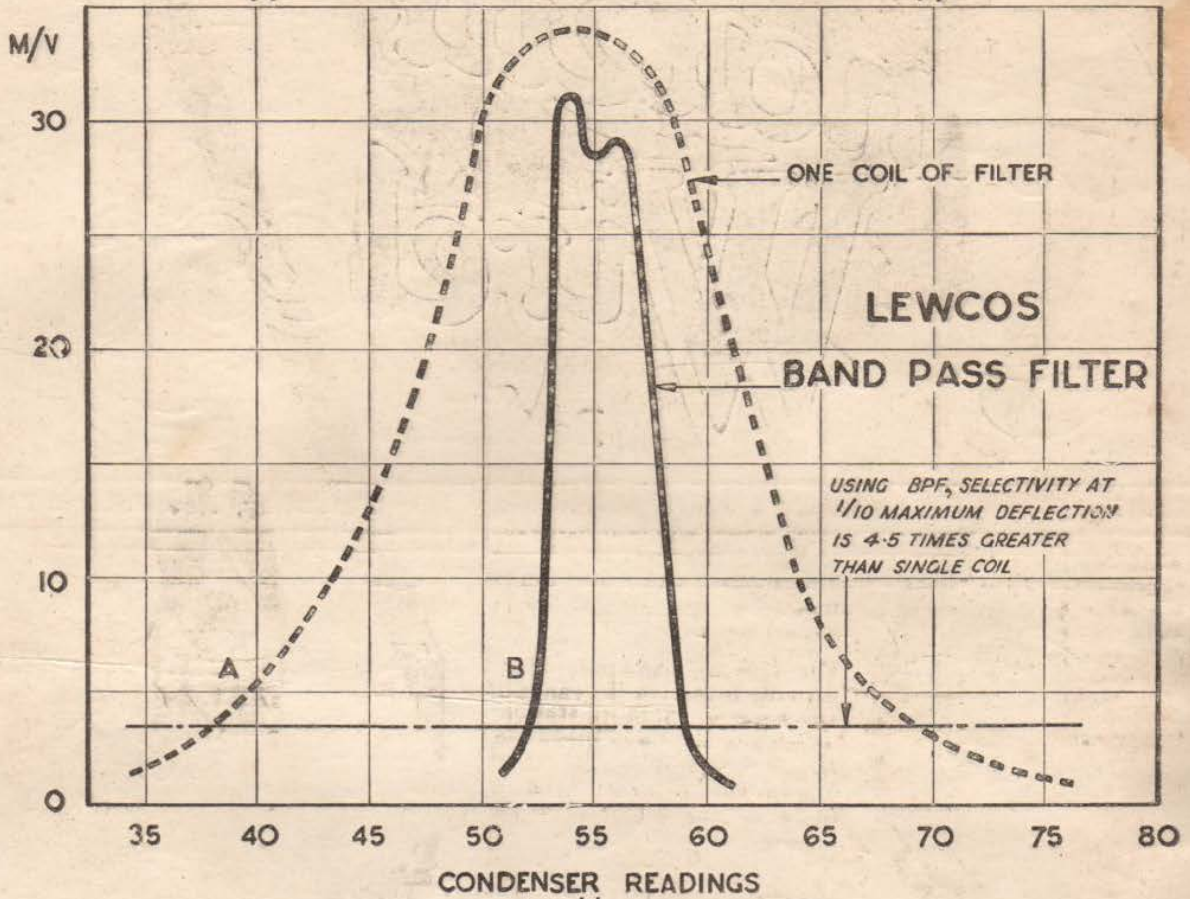

IS WHY THE LEWCOS
 BAND PASS FILTER IS
 A STAR  PERFORMER!

SEE PAGE



OPPOSITE

LEWCOS RADIO PRODUCTS FOR BETTER RECEPTION
 THE LONDON ELECTRIC WIRE COMPANY AND SMITHS LIMITED, CHURCH ROAD, LEYTON, LONDON, E.10

Don't Forget to Say That You Saw it in "A.W."

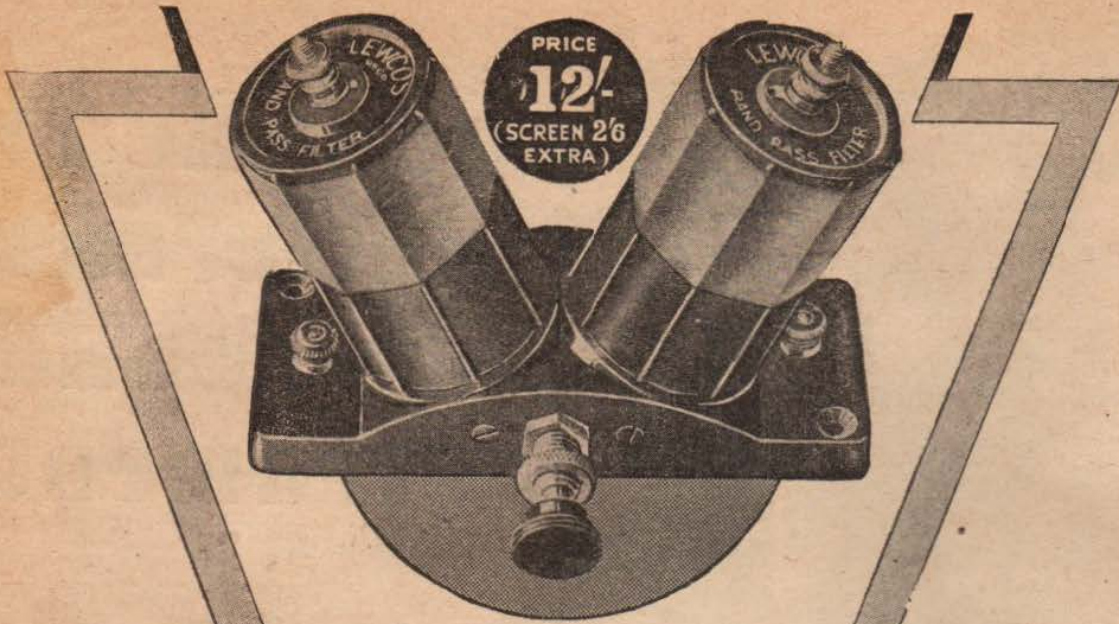

Write for
SIX
Recommended
CIRCUITS
incorporating
LEWCOS
Components
Reference
R. 74

Here, at last, is a component over which you will naturally enthuse, because it ensures selectivity, such as you've heard of, but never before experienced.

The Lewcos Band-pass Filter actually increases the range of any receiver, because stations which are normally inaudible, due to swamping by local transmissions, now have a place on the dial free from interference.

The ideal response curve is steep-sided and "flat topped," as the diagram opposite illustrates. Note the difference in selectivity (represented by curve "A") and amplification (shown by the height "B") between the Lewcos Band Pass Filter and an ordinary coil of high efficiency.

The phenomenal selectivity of this unique device is apparent on both long and medium wave bands; hence it is infinitely superior to any existing selectivity unit, such as wave-traps, etc.

Write for fully descriptive leaflet, Reference R.73, showing flat-topped response curves.



LEWCOS RADIO PRODUCTS FOR BETTER RECEPTION.
THE LONDON ELECTRIC WIRE COMPANY AND SMITHS LIMITED, CHURCH ROAD, LEYTON, LONDON, E.10

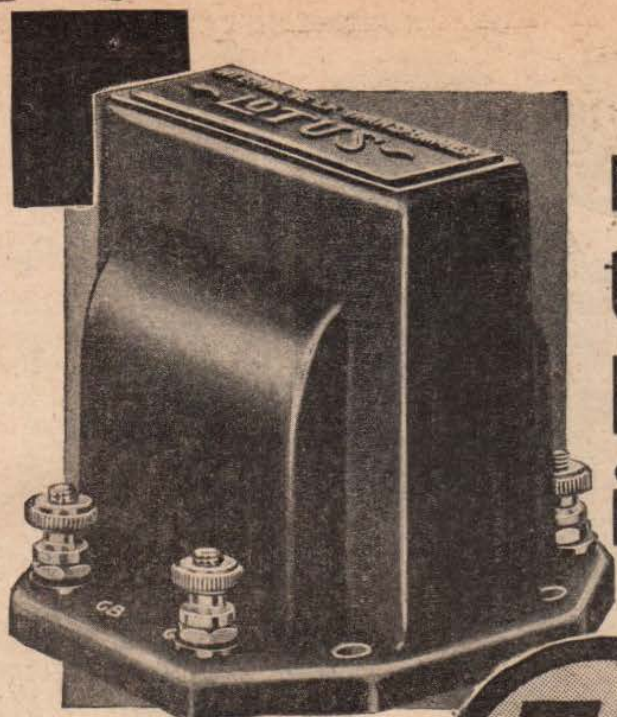

not a cheap
transformer
but a sound
instrument

at a very **5/6** low price

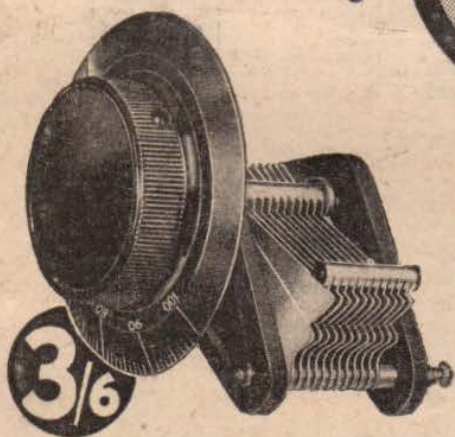

THE LOTUS RIGID DRIVE LOG CONDENSER

An inexpensive, small, but highly efficient condenser with heavy gauge aluminium vanes. The endplates are high-grade bakelite mouldings, and the special method of assembly ensures accurate spacing. One-hole fixing is employed and the highly finished Knob-Dial, engraved 0-100, is supplied in either Black or Mottled Brown Finish.

Capacities { .0003, Type KC/3 } 3/6 each,
 { .0005, Type KC/5 }

**RECOMMENDED FOR THE
"3 STAR 3"**
described in this Number

- One LOTUS Reaction Condenser
- One LOTUS Radio-Gramophone Jack Switch JS, 9
- One LOTUS Transformer

LOTUS RADIO LTD., MILL LANE, LIVERPOOL

All the leading set designers specify Lotus. They know that for reliability and efficiency they are absolutely dependable. Follow the experts' lead; insist on Lotus Components.

This new LOTUS Audio Transformer No. 1 is a particular triumph of value and its performance is equal to many at twice the price. It is designed specially for the use of the home-constructor. While small in size, specially designed windings and core give high efficiency, good reproduction and an exceptional straight-line amplification curve.

It is enclosed in a neat brown bakelite moulding, and the core is earthed through one of the fixing eyelets.

Ratios 3-1 and 5-1. Type AT.1. Price 5/6.

Every home-constructor should have the new LOTUS Component Catalogue. Ask your dealer or write for your copy to-day.



You will Help Yourself and Help Us By Mentioning "A.W." to Advertisers

IMMEDIATE DELIVERY

We are the largest Radio House in the Country, and in sending your orders to us there is no risk of delay. Orders executed on our famous 3-WAY PLAN—C.O.D., CASH or H.P. Send Now.



C.O.D. | CASH | H.P. | unusual

MANUFACTURERS' KITS

COSSOR MELODY MAKER TYPE 234 10/- DOWN

Screened grid, detector, and power. Complete with specified valves and cabinet. Cash Price £6:15:0 Balance in 11 monthly payments of 12/6 **FINISHED INSTRUMENT, Royalties paid. Cash only. £7:10:0**

SIX-SIXTY CHASSIKIT (Battery Model). Complete three-gang band-pass tuning. Screen grid, detector, and pentode. Cash Price, with valves, less cabinet, £8 17 6. Balance in 11 monthly payments of 12/7

Finished Instrument, with cabinet £8 3 0. Royalties paid. Cash only

SIX-SIXTY CHASSIKIT (A.C. Model). Complete as above, with A.C. mains valves. Cash Price, with valves, less cabinet, £7 6 6. Balance in 11 monthly payments of 13/5

Finished Instrument, with cabinet (10/6). Royalties paid, £8 12 0. Cash only.

V3 KIT RADIO FOR THE MILLION 10/- DOWN

Powerful, selective, and ultra modern. Employs screen grid, detector, and power valves. With valves, less cabinet. Balance in 11 monthly payments of 10/10 **Cash Price £5:17:6 FINISHED INSTRUMENT, with valves and cabinet. Royalties paid. Cash only. £7:8:6**

EXPRESS SERVICE FOR EVERYTHING RADIO GUARANTEED

The R. & A. "100" Permanent Magnet Moving Coil Reproducer



is sweeping all before it. For sheer beauty of tone, brilliant response throughout the whole audible range, and remarkable sensitivity, it has been acclaimed the "best yet." Construction and finish are superlative, and the dustproof cover to protect the cobalt steel magnet is a refinement not found in many moving-coil speakers. With multi-ratio input transformer. **57/6** or 12 monthly payments of 5/4.

VOXKIT RADIOGRAM CABINET MODEL 1932 Accommodation for largest of home-built receivers with a full-size speaker as well as mains and battery equipment. Complete with motor board. Dimensions overall 39" high x 22" wide x 17". Internal panel 18" x 7". Baseboard 18" x 14". Speaker chamber 18" x 14" x 16". Panel 12" between moulding. **£4 10 0** or 12 monthly payments of 8/3.



VOXKIT 1932 CONSOLE (Radio only) Almost identical in appearance with the 1932 Voxkit Radiogram designed for radio only. Dimensions 37" x 15 1/2" x 22" wide. Panel 18" x 7". Baseboard 18" x 12". L.S. compartment 18" x 14" x 12". Control panel 12" wide. **OAK £3 15 0** Price or 12 monthly payments of 6/11



PILOT PERMANENT MAGNET MOVING-COIL SPEAKER Matches the requirements of all modern receivers. Includes a Unit designed and built specially for Peto-Scott by Epoch. Handles the smallest to the greatest input, and brings out most minute details of tonal quality with pure, full volume. A multi-ratio input transformer is fitted and provides for matching to all super-power and pentode valves. The handsome hand-polished solid oak cabinet is built to give added depth of tone, and is fitted with ebonised base and side wings and silk-covered fret. **£3 15 0** or 12 monthly payments of 6/11.

SPECIALLY RECOMMENDED

EPOCH A2 PERMANENT MAGNET MOVING-COIL SPEAKER. Fitted with multi-ratio input transformer. Cash price, £3/3-. Balance in 11 monthly payments of 5/8. **Send 5/9 only**

ELIMINATORS

ATLAS A.C. ELIMINATOR, TYPE A.G.244. 3 tapplings—S.G. Send only detector, power. Output 120v. at 20 m/a. Cash price or C.O.D., £2/19/6. Balance in 11 monthly payments of 5/6. **Send 5/6 only**

EKCO K-18 COMBINED H.T. ELIMINATOR AND L.T. TRICKLE CHARGER. Delivers 18 m/a, and suitable for 1- to 5-valve sets. S.G., 50-80v., 120/150. Charges at 25 amp. at 2, 4, or 6 volts. Cash price £4/12/6. Balance in 11 monthly payments of 8/6. **With 8/6 order**

REGENTONE W.5A COMBINED H.T. ELIMINATOR AND TRICKLE CHARGER. One S.G., 1 variable and 1 fixed tapping for H.T. L.T. for 2 and 6 volts. For A.C. mains. Cash price £4/12/6. Balance in 11 monthly payments of 8/5. **Send 8/6 only**

HEAYBERD H.T. UNIT—"D" MINOR—Output 120v. at 12 m/a. Tapped at 80v., 100v., and 120v. Westinghouse rectification. A.C. mains. Cash price £2/17/6. Balance in 11 monthly payments of 5/4. **With 5/4 order**

EKCO H.T. UNIT, Type A.G. 25. For multi-valve sets requiring up to 25 m/a. 3 tapplings, S.G., detector and 120/150 volts. For A.C. Mains. Cash or C.O.D. Price £3/17/6. Balance in 11 monthly payments of 7/1. **Send 7/1 only**

EVERYTHING NEW IN RADIO FROM PETO-SCOTT

See other Peto-Scott advertisements on pages 913 925 953

SPEAKERS

AMPLION M.C.S MOVING-COIL SPEAKER, permanent magnet, with output transformer. Complete. Cash Price £3/7/6. Balance in 11 monthly payments of 6/2 only **Send 6/2 only**

BLUE SPOT SPEAKER UNIT AND CHASSIS, TYPE 100U. Cash or C.O.D. £1 19/6. Balance in 7 monthly payments of 5/5. **Send 5/5 only**

BLUE SPOT PERMANENT MAGNET MOVING-COIL SPEAKER. Complete with input Transformer. Cash price, £3/15/-. Balance in 11 monthly payments of 6/11. **Send 6/11 only**

CELESTION PERMANENT MAGNET MOVING-COIL SPEAKER, Type R.P.M.S. 8 in. Reinforced Diaphragm. In Chassis form without input transformer. C.O.D. or Cash price, £3/10/-. Balance in 11 monthly payments of 6/5. **Send 6/5 only**

B.T.M. R.K. MINOR PERMANENT MOVING-COIL SPEAKER. Capable of handling outputs up to 2 watts. Cash price £2/10/0. Balance in 8 monthly payments of 6/-. **With 6/- order**

EPOCH J.1 PERMANENT MAGNET MOVING-COIL SPEAKER, with multi-ratio input transformer. Cash price, £2/5/-. Balance in 11 monthly payments of 4/2. **Send 4/2 only**

ORMOND PERMANENT MAGNET MOVING-COIL CHASSIS (No. 464). With input transformer. Cash price, £3/5/-. Balance in 11 monthly payments of 5/11. **Send 5/11 only**

ROLA PERMANENT MAGNET SPEAKER. Complete with input transformer. Cash price £2/17/6. Balance in 8 monthly payments of 7/1. **Send 7/1 only**

W.B. PERMANENT MAGNET MOVING-COIL SPEAKER P.M.3. Complete with 3-ratio input transformer. Cash price, £2/12/6. Balance in 11 monthly payments of 4/10. **Send 4/10 only**

ACCESSORIES

GARRARD INDUCTION GRAMOPHONE MOTOR, Model 202. Mounted on 12-in. Nickel Motor Plate with fully automatic electric starting and stopping switch. Cash price, £2/18/6. Balance in 11 monthly payments of 5/4 only. **Send 5/4 only**

EXIDE 120-VOLT W.H. TYPE ACCUMULATOR, in crates. Cash price, £4/13/-. Balance in 11 monthly payments of 8/6. **Send 8/6 only**

NEW B.T.H. "SENIOR" PICK-UP AND TONE-ARM. Complete. Cash price £2/5/-. Balance in 11 monthly payments of 4/2. **Send 4/2 only**

EXPRESS ORDER FORM

TO PETO-SCOTT CO. LTD. Please send me C.O.D., CASH/H.P.

.....

 for which I enclose
 Cash/H.P. Deposit £ s. d.
 Name
 Address

A.W. 7 11 31.

PETO-SCOTT

PETO-SCOTT CO., LTD. Head Office: 77 CITY ROAD, LONDON, E.C.1 Clerkenwell 9406. 62 HIGH HOLBORN, LONDON, W.C.1 Chancery 8266. MANCHESTER: 33 WHITELOW ROAD, CHORLTON-CUM-HARDY, Phone: Chorlton-cum-Hardy 2028. NEWCASTLE, STAFFS., 7 ALBANY RD. Phone: 67190

SEND 3^d POSTAGE FOR NEW CATALOGUE

Amazing fineness of adjustment **Unprecedented perfection of reproduction**

100%
improvement
in tone & volume
on any unit
previously
marketed

Gone can be the artificiality—the “sound thinness” which has hitherto characterised All speakers—the new Undy “8” and “4” pole Units ensure a “human” rendition of voice and music.

It is indeed a marvellous revelation of tone quality and truth. Here's an amazing test that must interest you. *Impartial experts, assembled in a large Hall, could not distinguish natural sounds from the sounds reproduced by the Undy Units.* You, too, can enjoy the same perfect reproduction. The new Undy “8” is fitted with tappings to suit valves of low or high impedance as desired.

GUARANTEED FOR 12 MONTHS.

Go to your dealer and hear it for yourself.

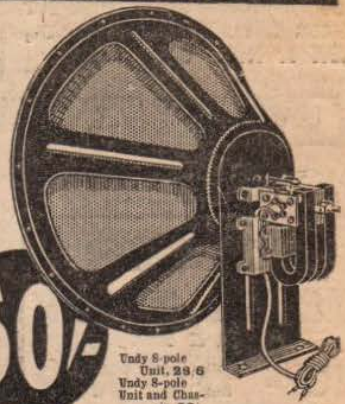

Undy 8-pole Unit, 29/6
Undy 8-pole Unit and Chassis, 50/-

Undy 4-pole Unit and Chassis, 28/6
Undy 4-pole Unit, 15/-
Also a very fine selection of cabinets.

The New **UNDY** *Dynamic* **8 pole**

50/-

28/6

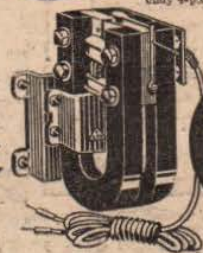

Brit. Pat. 330930

obtainable from all wireless stores

Sole representatives for Great Britain and Ireland
J. HEMELIK, 8 Collingworth Road, LONDON, N.W.13
Telephone—Glad. 2032

WILL DAY LTD.
THE BEST IN THE WEST

Have now a large selection of all-mains and battery receivers in stock, and can give immediate demonstrations and deliveries.

Build your own receivers. Complete kits of parts for all the latest kit sets.

CASH OR EASY PAYMENTS

WILL DAY LIMITED
19 LISLE STREET,
LEICESTER SQUARE,
W.C. 2
Phone: GERRARD 4476

IT'S **THE LIMIT** YOU ARE WANTING



The **PICK-UP** with the **Adjustable Reed.**

Combination Pick-up and arm, 32/6
Pick-up only, with side fitting, 21/-

Obtainable from Dealers or write direct.

LIMIT RADIO Ltd., 15-29 Windsor St., Essex Road, N.1.

PERMCOL

Nothing looks worse than a dull and discoloured panel. Use mirror polished PERMCOL, the new Ebonite which is guaranteed never to discolour; its beauty and polish will delight you, and its cost is less than 1d. per square inch. Don't spoil that set but insist on PERMCOL, the modern permanent colour Ebonite.

From all dealers or direct.
THE BRITISH HARD RUBBER CO., LTD.,
PONDERS END, MIDDLESEX.

5'6 DOWN
IMMEDIATE DELIVERY

**PETO-SCOTT
FIRST
AGAIN**

VICTOR 3
TELSEN

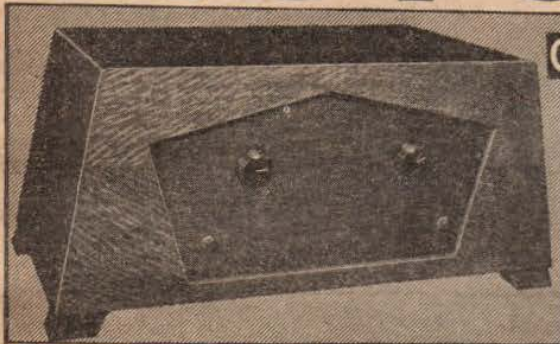

CABINET A 12'6

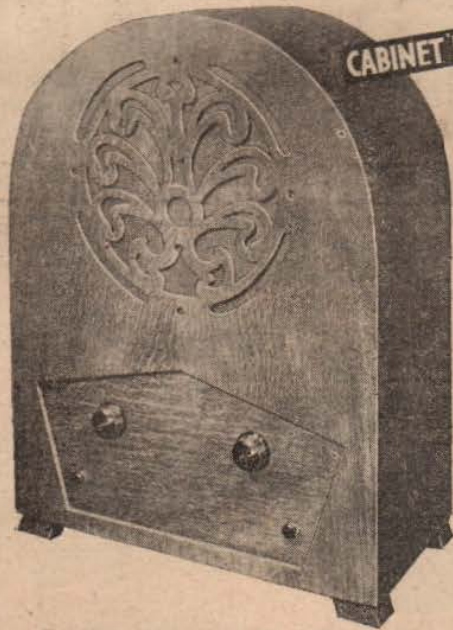

CABINET B 21'

KITA 5/6

Exactly as supplied by Telsen with baseboard, metal panel, flex and terminal connections, as advertised by Telsen on page 925. down, and 7 monthly payments of 5/6.

CASH or C.O.D. £1 19 6

• Fitted 2 Telsen Slow-Motion Dials 5/- extra on each Kit price or 6d. extra on each monthly payment.

KIT B

As KIT A with Valves as specified (Mazda HL2; Mazda L2; Mazda P220A.) Less cabinet.

CASH or C.O.D. £3 10 0
or 12 monthly payments of 6 5.

KIT C

As KIT A with Valves as specified and Cabinet A as illustrated.

CASH or C.O.D. £4 2 6
or 12 monthly payments of 7 7.

FINISHED INSTRUMENT complete in Cabinet "B," fitted Telsen L.S. Unit and Chassis. Batteries as detailed above. Royalties paid, aerial Tested. Cash or C.O.D. £8 9 6. Or 12 monthly payments of 15 6.

KIT C

As KIT A with Valves as specified. Cabinet B as illustrated.

CASH or C.O.D. £4 11 0
or 12 monthly payments of 8 4.

Specialty Recommended Accessories when using P220A Super Power Valve.

- Exide C23 2v.30 actual
- L.T. Accumulator ... 11 0
- Drydex (Orange Triangle)
- H.T. Battery 120v.
- Triple Capacity ... 1 4 0
- Drydex (Green Triangle)
- G.B. Battery 16v. ... 2 6
- C.O.D. or CASH PRICE £1 17 6

or add 3/6ths to monthly payments.

Telsen L.S. Unit and Chassis for Cabinet "B" 11/-

Full details of the Telsen Victor 3 with Circuit Booklet and Catalogue on request.

Fitted with valves and Nothing more to buy.

EXPRESS ORDER FORM

To PETO-SCOTT CO. LTD. Please send me C.O.D. CASH/H.P.

TELSEN VICTOR 3 KIT

For which I enclose Cash/H.P. Deposit £ s: d.

Name

Address

A.W. 7/11/31

PETO-SCOTT

PETO-SCOTT CO. LTD. Head Office: 77, CITY ROAD, LONDON, E.C.1. Clerkenwell 9406. 62, HIGH HOLBORN, LONDON, W.C.1. Chancery 8266. MANCHESTER: 33, WHITELOW ROAD, CHORLTON-CUM-HARDY. Phone: Charlton-Cum-Hardy 2028. NEWCASTLE, STAFFS: 7 ALBANY ROAD.

Don't Forget to Say That You Saw it in "A.W."

PERMANENT MAGNET MOVING-COIL SPEAKERS

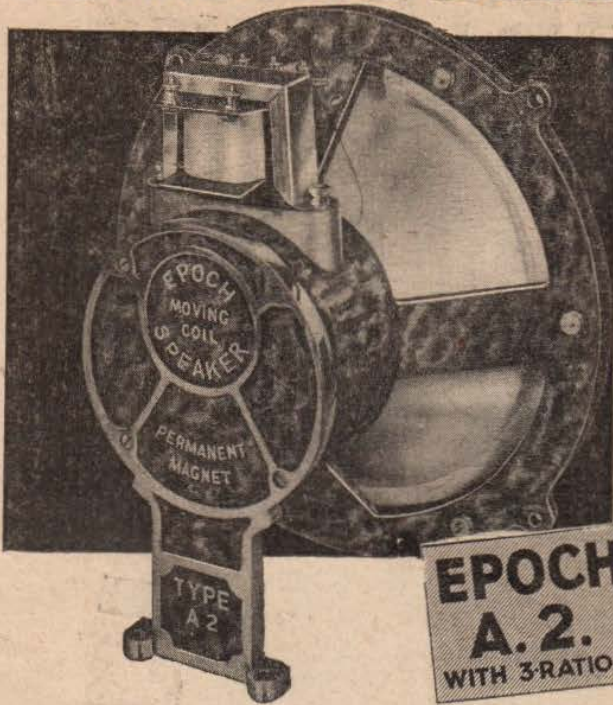

EPOCH 63/-
A.2.
WITH 3-RATIO INPUT TRANSFORMER

EPOCH

THE FINEST PERMANENT MAGNET ANYWHERE NEAR THE PRICE

MODEL A.2. is the climax of years of pioneer experience in scientific acoustics and musical reproduction. This new model carries Epoch's fame for quality reproduction to greater heights. Extremely clear, sharp and brilliant without high-note paper resonance common to most moving-coils. Its magnificent high-note response makes it particularly suitable for balancing the modern Super-Hef. Perfect speech; correctly pitched. No false tone-colouration. No booming or drumming. See what Mr. J. H. Reynier says in "Amateur Wireless," Oct. 10:—"The ideal Speaker for 'Britain's Super.'"

Cobalt Steel Permanent Magnet Epoch Moving-Coil Speaker complete with 3-ratio tapped input transformer ready to connect to practically any set. Fitted with Interchangeable Diaphragm. Ask your Radio Dealer for it. He will gladly demonstrate this or any Epoch Model. If you have any difficulty send for name of nearest dealer or visit our New Demonstration Rooms. Send for our large free art booklet A.S. 5.

EPOCH RADIO MANUFACTURING CO. LTD. EXMOUTH HOUSE, EXMOUTH STREET
At the junction of Farringdon Rd. & Rosbery Av.

YOU CAN'T GO WRONG!

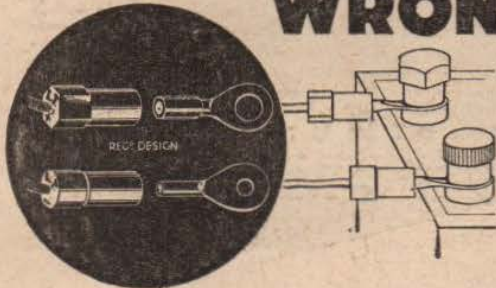

BELLING-LEE ACCUMULATOR CONNECTORS.

The safest and most efficient device for connecting accumulator and radio set.

The lead-plated and non-corrosive eye sockets are permanently fastened to the accumulator terminals and, having different sized holes, it is impossible to attach them wrongly to accumulators with non-interchangeable stems.

The insulated connectors (lettered L.T.+ and L.F.—), attached permanently to the wires from the set, have different sized sockets and cannot be plugged on the wrong eye. Further the positive is red and hexagonal, to conform in shape with the positive terminals in certain accumulators, while the negative is blue and round. Thus under no circumstances, deliberately or accidentally, can a wrong connection be made.

Being completely insulated, even when disconnected, the connectors cannot blow your valves by touching H.T. sockets or wires. The insulators have vaseline-filled cavities to prevent acid creeping back to the wires from the set. Price 9d. per pair.

Extra pairs of non-corrosive eyes for spare accumulators, 3d. per pair.

WRITE FOR LIST

BELLING-LEE
FOR EVERY RADIO CONNECTION

Advert. of Belling & Lee Ltd., Queenway, Man.



- PRICES:**
- 1.0 Mfd. 2/6
 - 2.0 Mfd. 3/3
 - 4.0 Mfd. 5/6
 - 6.0 Mfd. 8/-
 - 8.0 Mfd. 10/6

RESISTS CURRENT LEAKAGE WITH A NEW HIGH INSULATION FACTOR

that has established a record in condenser efficiency

MAINS
HIGH TEST VOLTAGE



CONDENSERS
HIGH WORKING VOLTAGE

Complete Catalogue from—

ARTHUR PREEN & CO., LTD., Golden Square, Piccadilly Circus, London, W.1

Obtainable from all Radio Dealers

Mention of "Amateur Wireless" to Advertisers will Ensure Prompt Attention

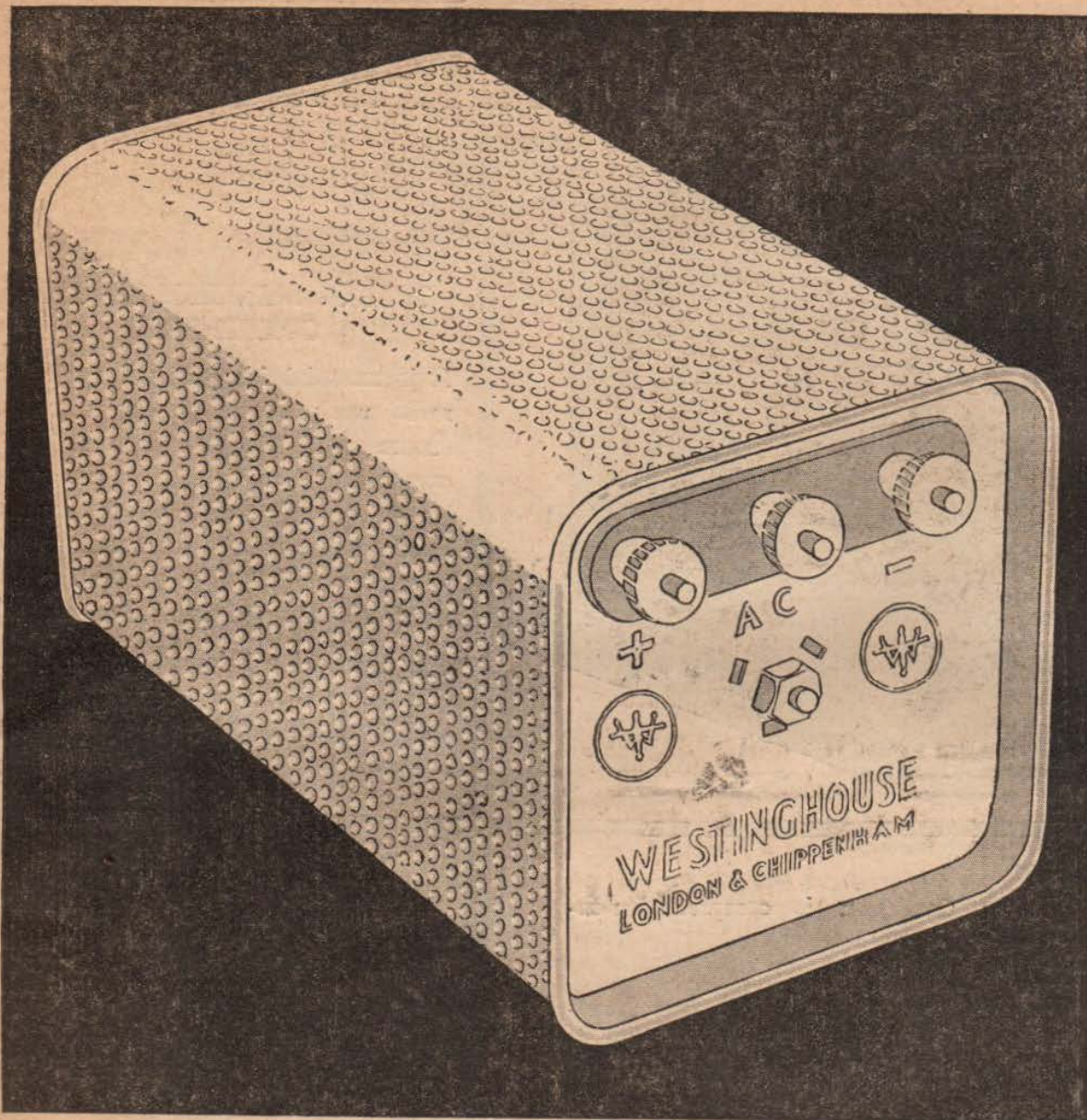

YOU can use this H.T.8, or one of its brothers, for running your radio set from the electricity mains; "The All-Metal Way" tells you how.

The 1932 edition of "The All-Metal Way," which will be sent on receipt of the coupon with 3d. in stamps, gives the information required to build an H.T. eliminator or trickle charger, and details for running moving-coil loud-speakers from A.C. mains. This well-known book has been completely revised, and questions not fully dealt with in our 1931 issue are now discussed in detail.

The H.T.8 has an output of 250 volts 60 m.a. (after smoothing). Its price is 21/-. Other H.T. types are from 12/6.

WESTINGHOUSE
METAL RECTIFIERS

COUPON

 PUBLICITY MANAGER, Westinghouse Brake & Saxby Signal Co., Ltd., 12, York Road, King's Cross, London, N.1. I enclose 3d. in stamps, for which please send me a copy of "The All Metal Way, 1932."
 PLEASE USE BLOCK LETTERS.
 Name
 Address.....
 A.W. 7/11/31

THE WESTINGHOUSE BRAKE & SAXBY SIGNAL CO., LTD., 82, YORK RD., KING'S CROSS, LONDON, N.1. Tel.: North 2415

Please Mention "A.W." When Corresponding with Advertisers

ABSOLUTELY NON-INDUCTIVE

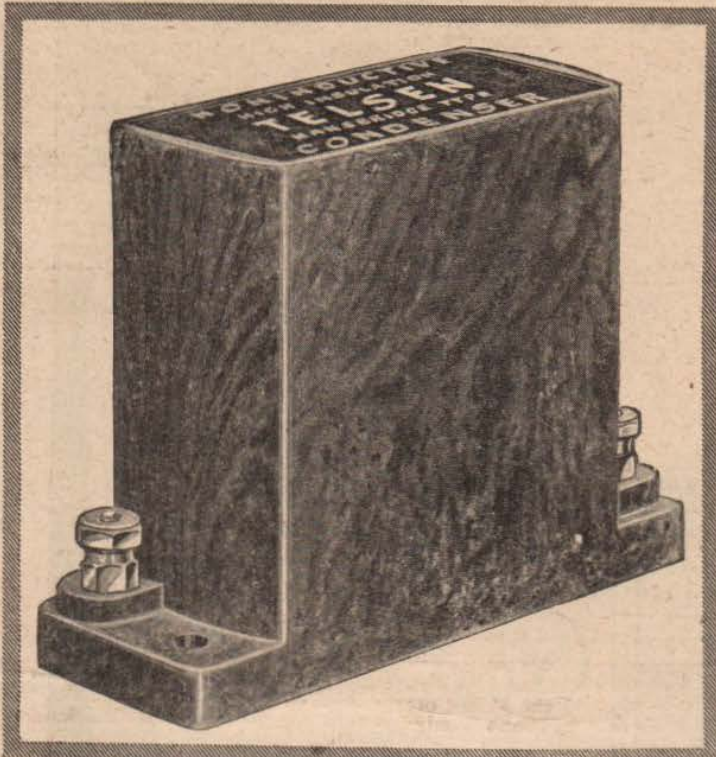

TELSEN MANSBRIDGE TYPE CONDENSERS

It is essential for condensers used in radio work to be non-inductive to ensure negligible resistance to H.F. currents. Telsen Condensers are made by a special process which ensures *hundreds* of points of contact along the edge of each foil, thus preventing the possibility of any inductive effect.

The illustration below shows the base of a Telsen Condenser stripped to show the method of "Nutmeg-grater" contact.

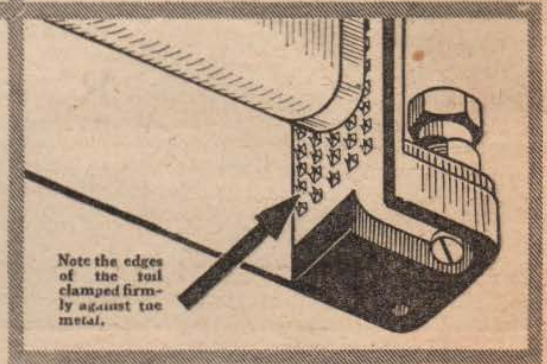

EVERY

Telsen Condenser is completely non-inductive.

EVERY

Telsen Condenser is of the true Mansbridge self-sealing type, dehydrated in vacuo, impregnated and hermetically sealed.

EVERY

Telsen Condenser undergoes five laboratory tests before it is packed.

EVERY

Telsen Condenser is tested to the high insulation standards of the G.P.O.

EVERY

Telsen Condenser is 100% British.

Telsen Mansbridge Type Condensers, made in capacities from .01 to 2.0 microfarad from 1/6

Send for the Telsen Radio Catalogue and the book of "All-Telsen Circuits" to The Telsen Electric Co., Ltd., Aston, Birmingham.

TELSEN

THE SECRET OF PERFECT RADIO RECEPTION



EDITOR:
BERNARD E. JONES.

TECHNICAL EDITOR:
J. H. REYNER. B.S.C. AM.I.E.E.

RESEARCH CONSULTANT:
W. JAMES.

ASSISTANT EDITOR:
H. CORBISHLEY.

NEWS & GOSSIP OF THE WEEK

A NEW SET IDEA

THIS week AMATEUR WIRELESS introduces a new set idea in the "Three Star 3," the first of a really novel series of receivers. The "Three Star" set is made up on a metal chassis and is "A.W.'s" system of enabling home constructors to share in the success which commercial kit manufacturers have had with all-metal radio.

ALL METAL

ALL-METAL construction in sets has been tried before—as witness the "1930 Ether Searcher"—but never to such an entirety as the new all-metal "Three Star." A full-size plan of the set is included in this issue.

THE SCOTTISH SHOW

AS we go to press, elaborate arrangements are being made for the success of the Scottish National Radio Exhibition to be held in the Waverley Market, Edin-

burgh. This exhibition opens on November 11, and the B.B.C. has arranged to fit up a model studio in the centre of the exhibition from which broadcasts will actually be made. Scottish listeners should take advantage of this opportunity to see the new 1932 components.

THE PRINCE'S SET

WINTER-TIME radio enthusiasm is spreading even to the Royal Household! We hear on reliable authority that the Prince of Wales has just bought a new portable set. This is of the long-range type with two S.G. stages, so the Prince obviously does not mean to be confined only to B.B.C. programmes.

RADIO PARIS TROUBLES

RADIO PARIS is having a certain amount of difficulty in getting its new 120-kilowatt on the air. This new big station, the opening of which 5XX listeners have dreaded because of the interference

that may be caused on sets that tune broadly on the long waves, was to have been in full operation a month ago, but a Continental correspondent informs us that for various reasons Radio Paris will not be heard with its full power until about the middle of this month.

A LAND-LINE HITCH

ONE very real reason why the new Radio Paris cannot yet get going is that it cannot get a line through to the studios. The Postal authorities have not yet been able to complete the line between the studio in the centre of Paris and the transmitter which is at Saint Remy-l'Honneur.

NEWSPAPER OWNERSHIP

IN the States it is quite a common thing for big newspaper owners to have a contract with broadcasting chains for radio advertising. W. R. Hearst, the millionaire newspaper proprietor, has already taken over the entire control of WGBS, a New York station and he is now negotiating for a big Pittsburg transmitter which has a far higher power. Apparently, even newspaper magnates find it easier to buy a new big station rather than attempt to persuade the Federal authorities—who correspond to our Post Office in control of licences—to raise the power of an existing station.

"CHOPIN'S" SUCCESS

THE recent play *Chopin* which dealt mainly with the life of the famous composer, has proved such a success, according to the B.B.C.'s postbag, that two similar plays dealing with the lives of Mozart and Haydn are being prepared. *Chopin* will almost certainly be given a repeat performance.

FROM BROADCASTING HOUSE

THE Holt Marvell - George Posford operetta, *Good Night, Vienna*, the first work of its kind to be written specially for broadcasting, will be one of the first productions from the new studios at Broadcasting House. It is also to be produced as a talkie in three languages, English, French and German, by the Herbert Wilcox organisation at Elstree. The broadcasting and film versions will be different.

JACK PAYNE TRIES FLYING



Jack Payne has been spending a few spare hours at a London aerodrome in amateur flying, and members of his band went to see him at it

NEWS · & · GOSSIP · OF THE · WEEK

—Continued

AN AMBROSE BAND

THE Blue Lyres, a new band to the B.B.C., being "O.B.'d" this week, is directed by Ambrose, one of the five leading dance-band conductors at the moment. Ambrose, by the way, was one of the first dance band personalities to figure in the programmes after the Savoy Bands contract ran out, way back in 1929.

PAMPHLET IN BRAILLE

THE value of wireless to blind persons—who already receive from the "Wireless for the Blind" fund a set as a gift and from the Post Office a licence free of charge—is advanced by the publication of a brochure on "The Modern State," the first of the B.B.C.'s pamphlets to be issued in Braille!

BACK FROM ROME

THEY say Rome was not built in a day—nor apparently are wavelength plans! B.B.C. delegates have returned home from their participation in the Broadcasting Union's meeting at Rome without seeing their ambition realised. There is now no possibility of a new wavelength plan to take the place of the out-of-date Prague Plan.

A CONSOLATION

IF the B.B.C.'s best hopes of a new plan have been dashed, their worst fears of chaos have not been substantiated. For

proposals at Rome, it is fortunate that the reception of the home stations, at least, has been safeguarded.

AS OTHERS SEE US

APPARENTLY there is a considerable amount of foreign criticism regarding the unnecessary waste of wavelengths involved in the B.B.C.'s regional scheme of twin transmissions. Foreign broadcasting authorities are pointing out that this is the only country sending out one programme common to three high-power stations. It is contended that we can much more easily give up wavelengths than countries sending out entirely different programmes from their available transmitters.

ELECTION ANNOUNCING

HOW many readers recognised the voices of the team announcing the election results? We heard Admiral Cardenale giving the first results, followed by Roger Eckersley and the Chief Announcer, Mr. Hibberd. Others helping to announce the results throughout the night included Mr. Graves, the Assistant Programme Director, and Messrs. Snagge and Grise-wood, two London announcers. Altogether, a very successful effort!

AN APPLAUSE RECORD

THOSE who helped in the tumultuous applause at the last of the "Prom" concerts will be interested to know that a

MUSIC AUDITIONS

ALTHOUGH suspended until recently auditions for musical artistes were resumed at Savoy Hill on November 3. The immediate job will be to work off four months' arrears. We are asked to state that no foreign talent need apply—there is more than enough material in this country.

A BROADCAST BALET!

LYDIA LOPOKOVA, the Russian dancer, will speak the monologue in the broadcast of the Debussy ballet-suite, "La Boite à Joujou," which is being given this month. The ballet-suite will be presented by E. J. King Bull, who some months ago was responsible for a similar type of broadcast. This new method of presentation is likely to be adopted more frequently in the future among radio producers. In stage presentation the onlooker has the advantage of visual impression as an aid to the interpretation of music. In broadcasting, the aim will be to substitute speaker for dancer to secure the necessary interpretive effect.

NEW DANCE BANDS

AS exclusively forecast in these notes, the Savoy Orpheans will renew their microphone relations with listeners on November 6, when they will be heard in their first relay from the modified dance band dais at the Savoy Hotel.

5SW CHANGES

THE present 5SW schedule of broadcasting the National programme, from Monday to Friday inclusive, will be modified as from November 2, when the B.B.C. proposes to start introducing Regional material to overseas listeners. This will rid these distant listeners of the tiresome educational period that occupies such a large portion of the National's early evening programme. What a pity this idea is not extended to Daventry 5XX. We are sure many out-of-the-way home subscribers would welcome a change to the lighter fare of the Regional.

THE RELAYS

NOW that Rome has finally decided not to introduce a new wavelength plan, the B.B.C. is able to state quite definitely that the Sheffield relay will not be reopened. The B.B.C. has deferred telling Sheffield listeners this until it was quite sure that North National would not go on a synchronised common wavelength.

ECONOMIES

ROGER ECKERSLEY has been busy preparing schemes for balancing his programme budget in the New Year. His plans will be discussed this week. Probably the Bach cantatas will go under the economy scheme and the American relays are almost certain to be abandoned.

The formation of listening groups for the more serious of the B.B.C. talks proceeds apace. In Fife alone, the Education Committee has been instrumental in arranging groups in over twenty centres.



READING THE NEWS FROM BUDAPEST.—The chief announcer, Mr. Arpad Rado, reading the bulletin before the twin Reisz microphones. Budapest gives a news bulletin nearly every day at 6.45 p.m., on 550 metres

Tr

although there will be no concerted European action towards a wider separation between broadcasting stations, a distinct improvement in local B.B.C. reception conditions should follow the decision to clear the wavelengths used by the Brookman's Park and Moorside Edge twin stations.

GREATER SEPARATION

NORTH REGIONAL, North National, London Regional and London National will all make re-adjustments to their wavelengths in the near future, with the object of obtaining a greater frequency separation from adjacent foreign stations. In view of the apathy, and in some quarters definite antagonism, regarding the B.B.C.'s

Blattnerphone record was made of these exciting sounds and from the Blattnerphone a permanent record has been made for use by the Effects Department in broadcast plays.

ALL-BRITISH PIANOS

AT Savoy Hill every well-known make of piano is in use, but for Broadcasting House an all-British type of piano will oust all foreign makes. A British firm has been found capable of building a piano suitable for the peculiar requirements of broadcasting. It should be noted that artistes may still bring their own pianos to Broadcasting House, as is now done sometimes at Savoy Hill.

AT THE B.B.C.

The Behind-the-Scenes facts of Broadcasting Dance Music are here described by KENNETH ULLYETT.

How the Dance Music is Broadcast

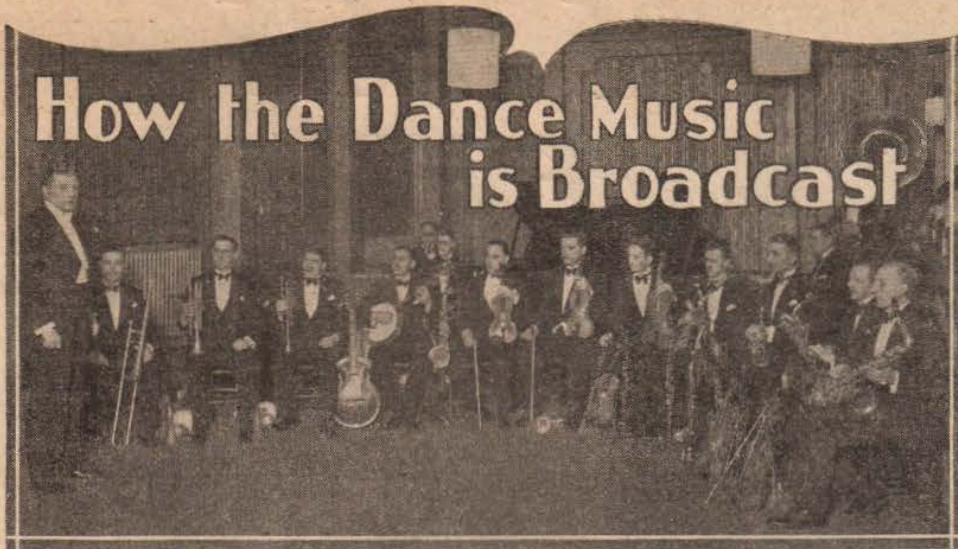

I WAS in Number 7 Studio last week when Jack Payne was just starting one of his 5.15 p.m. broadcasts. The seventeen members of his band were seated round the microphone in an order very unlike that which one sees in a dance band on the stage, and which has been chosen solely because it suits the microphone.

"Right," said Jack, as he stood by the switch which gives the signal down to the control room. The band started the refrain of *Say it with Music*, with which number Jack Payne opens and concludes his broadcasts.

Immediately they had got into the swing of the thing, he touched the switch and downstairs in the control room the engineers "faded in" the studio.

When the red indicator light in the studio was switched on, giving the signal that the bard was then broadcasting, Jack Payne walked up to the microphone and, speaking quite softly, made his opening announcement.

I watched the programme through, inter-

ested at various things which seemed different from ordinary studio practice, and when the broadcast was over I buttonholed Jack for a chat on the broadcasting of dance music.

"You see we have a special microphone, now," he said. "It is one of the condenser microphones and has been fitted up with a baffle board to improve the 'pick-up' of it. Previously we had the ordinary Reisz microphone. I must say that, in my opinion, judging from results obtained on my own set at home, the use of the baffle board results in clearer reception."

I asked him if he did much listening in order to make sure that the balance is right.

"Why, yes," he said. "Every new item I hear in the listening cabinet or else I go along to Room 88 where, on one of the special B.B.C. sets, I can get loud-speaker reception."

"This is important in dance band broadcasts because most of my boys play more than one instrument; some of them as many as four. This doubling, as it is called, makes for economy, but also makes it all the more essential for me to see that the balance of tone is still O.K."

I asked how and when rehearsals of dance music are done, for so many new tunes are given that it is obvious there must be more rehearsals than there are even for the "Proms."

"Rehearsals are done in the mornings, as a rule," I was told, "when there is no gramophone recording to be done. Now, take this day's programme which I have here; a typical one. Gramophone recording from 10 till 1.30; a Palladium matinee from 2.57 till 3.15; broadcasting 3.45 to 4.40; broad-

casting again 5.15 to 6.15; Palladium first and second houses, 7.18 to 7.43 and 9.27 to 9.52; back to Savoy Hill for broadcasting 10.30 till midnight.

"It doesn't leave very much time for rehearsals, you see, and that is our constant difficulty. We frequently have to work fourteen hours a day. Listeners may not realize that there is so much work in

the broadcasting of dance music."

"But still you do get through an immense number of new dance tunes," I ventured.

"Last year," said Jack, "I gave a thousand individual new tunes in 650 hours broadcasts and in the whole past three and a half years there have been three thousand individual new tunes. My hardest day's work in the broadcasting of new tunes was when recently I gave sixty-five newcomers in four and a half hours' broadcasting."

"Is there still a large proportion of British dance music?" I inquired.

"The proportion of British music is increasing," said Jack. "That is to say, I am receiving an increasing number of British tunes which I am able to broadcast. British song writers are gaining experience. The present proportion is 50 per cent. British, 40 per cent. American, and only 10 per cent. Continental."

The Dance Music Studio

"Is this the studio from which you generally broadcast?" I asked, looking round at the panel decorations of the lofty double-decker studio.

"We use No. 7 because it is large enough and because the double-height effect gives the right amount of echo." Sometimes we use Studio No. 1 and for vaudeville broadcasts, Studio No. 4, just above the north entrance.

"At Broadcasting House the studio reserved for our use will be in the sub-basement, near the two vaudeville studios, and has been given the reference B.B. It is about the same size as Studio No. 7 at Savoy Hill and is a double decker.

"We shall still have the same system of 'flicks' (indicator lights) for starting and finishing the programme, but these will be controlled from the engineer's control room at the top of the building."

Before taking charge of the B.B.C. Dance Orchestra, Jack Payne was at the old Hotel Cecil, and he broadcast many times before joining the B.B.C. Listeners may remember that at the start of broadcasting, up till the end of 1925, the only dance music

(Continued at foot of next page)



In No. 7 Studio, from which Jack Payne's band most frequently broadcasts

INSIDE FACTS ABOUT THE WAVELENGTH MUDDLE

By THE "AMATEUR WIRELESS" SPECIAL COMMISSIONER

station's programme heard during the reception of the required station.

The first of these types of interference is not serious because it can be eliminated without greatly impairing the quality of the reproduction.

All that is needed is a filter circuit to cut out the 9,000-cycle note. This can comprise a 1-henry choke in series with a .0005-microfarad variable condenser across the primary of the low-frequency transformer following the detector valve. At one particular setting of the variable condenser the high-note interference will be cut out.

The other two types of interference, due to side-band heterodyning, are far more difficult to eliminate, at least without affecting the quality of the reproduction. It has been found that after nightfall the signal strength of certain high-power foreign stations reaches a maximum of 5 millivolts per metre in the British Isles, the mean value being between one and two millivolts per metre.

Effect of Distance

The farther away from the regional centre the set is used, the greater the seriousness of the foreign station's field strength. It is obvious that we cannot arbitrarily state the degree of selectivity needed to overcome interference from a foreign station produc-

ing a field strength of the order mentioned, because the ratio of this signal to the wanted local signal will vary according to the distance of the set from the local.

Very sharp tuning indeed is implied in the reception of, say, Brookmans Park at eighty miles if that reception is to be perfectly clear of Mühlacker on the adjacent wavelength. The tuning will then have to be so sharp that the quality would be seriously impaired, due to high-note cutting.

Filter Devices

The B.B.C. has been testing out filter circuits in well-known sets to see the effect on the reproduction of cutting off everything above certain definite frequencies. If the cut-off is at 4,000 cycles, the reproduction noticeably lacks brilliance and would not be tolerated by many fastidious listeners. This and other experiments carried out by the B.B.C. have served to confirm the B.B.C.'s original opinion that good-quality reception of adjacent high-power stations can be obtained only by increasing the frequency separation between them.

It is suggested that the present 9-kilocycle separation should give way to a separation of at least 11 kilocycles. This obviously implies a reduction in the number of ether channels. Sacrifices among all European broadcasters would therefore have to follow. The B.B.C. is not prepared to make any sacrifices unless a plan is formulated to provide appreciably better conditions than are prevailing to-day.

LONG-DISTANCE listeners must be sick and tired of the daily increasing chaos in the European ether. So are the engineers of the B.B.C.! It is probably not generally known that in collaboration with the International Broadcasting Union the B.B.C. engineers have been doing a great deal of work on the problem of night-time interference between high-power stations on adjacent wavelengths.

Types of Interference

According to a B.B.C. engineer, the interference experienced by a listener using a high-class set with average selectivity takes three forms: Firstly, a 9,000-cycle heterodyne note, varying possibly in intensity, but remaining constant in pitch.

Secondly, side-band interference taking the form of a high-pitched "swishing." This interference is caused by the side-bands of the adjacent transmitter heterodyning the carrier wave of the wanted transmitter.

Thirdly, a background of the adjacent

"HOW DANCE MUSIC IS BROADCAST"

(Continued from preceding page)

broadcast was that from the Savoy Hotel on three days a week. Then along came other bands, including Jack Hylton, Jack Payne, Debroy Somers, Hal Swaine, Ambrose and many others, who are now so popular. The year 1927 saw the passing of the old Savoy Bands and then we had Batten and Elizalde. Elizalde started the new idea of curious and interesting orchestration specially for the microphone.

Jack Payne's own office section is down at the main entrance, near the band rehearsal studio, and here all the special arranging of the tunes is done by a skilled staff of musicians. Every new tune has to be dealt with in this way, involving many hours work.

PLANNING A RADIO ROUTE

THE civil aviation wireless specialist at the Air Ministry, Flight-Lieutenant R. Durrant, left England on November 2 by air for Cape Town. He is proceeding in an advisory capacity to discuss the wireless problems involved with the Government officials in Egypt, Sudan, Tanganyika, Rhodesia, and South Africa, and to assist in placing the wireless organisation of the new "all red" route from England to the Cape on a similar basis as the European civil aviation network.

From Cairo to Cape Town the following stations will be in action for keeping in continuous touch with the machines during the five-thousand-mile flight: Heliopolis, Wadi Halfa, Khartoum, Juba, Malakal, Port

Bell, Nairobi, Moshi, Dodoma, Mbeya, Mpika, Broken Hill, Salisbury, Bulawayo, Johannesburg, Victoria West, Cape Town. Listeners may care to follow the progress of the flight. Flight-Lieutenant R. Durrant was the wireless officer on board the airship R34 when she accomplished the first flight westwards across the Atlantic and the first double crossing in 1919.

A new series of talks is being introduced by the B.B.C. in Scotland as a kind of accompaniment to the "local" programmes which are being made a feature of the coming winter's arrangements. The talks are to be descriptive of the people in the districts from which the "local" programmes are drawn.

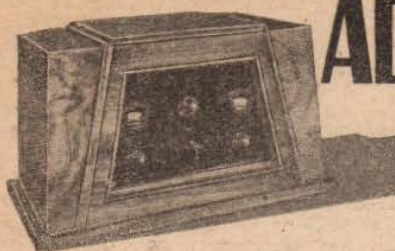

ADAPTING BRITAIN'S "SUPER" FOR THE SHORT WAVES

Together with Instructions for Matching and Mains Operation.

By W. JAMES

IN the aerial circuit of "Britain's Super" is a band-pass tuning coil which may have associated with it a fixed condenser of .01 microfarad.

This is tuned with a two-gang .0005 condenser and both circuits must, of course, tune accurately over the whole range. In order to do this the inductances of the two coils must be of equal values and the capacities across each circuit must also be of equal values. Now, the makers see that the two parts of the coil are properly matched on both long and medium wavelengths.

Circuit Matching

What we have to attend to is the capacity in each circuit. We rely upon the makers of the tuning condensers to see that the two parts of the variable condenser have equal capacities at all tuning points and so we are left with the circuit capacities.

These comprise the capacity of the aerial, of the valve connected to the second coil, and of the wiring of the circuit. We must make the total fixed capacity in the aerial circuit equal with that in the grid circuit.

Normally the two fixed capacities are not of the same values. One is greater than the other and to balance the circuits we must add capacity by means of the trimmer provided to increase the smaller capacity, until both have equal values. Now, it is hard to tell which circuit has the greater fixed capacity. Both parts of the tuning condenser have trimming condensers and we can, therefore, easily add to the capacity of each half.

The procedure is first to tune in a signal and to make it weak enough, by adjusting

Re-tune the circuit if necessary and now slowly screw up the trimmer in the aerial circuit, the one nearest the panel. Keep the circuit in tune and a point may be reached where the volume is the maximum.

You must turn the volume control back

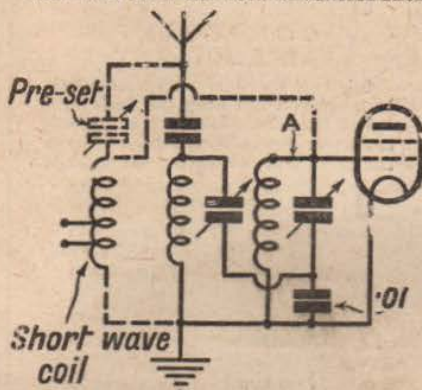

Adding short-wavelength coil. The connections are shown dotted and the wire A is removed

as much as possible as it is easy to detect changes in the strength of weak signals, but not in strong ones.

If the signal is weakened by increasing the value of the aerial circuit trimming condenser, then return this condenser to its minimum value.

Start slowly increasing the value of the grid circuit trimmer (the one farthest from the panel) and note the position of maximum strength. The point to note is that there is no sense in adjusting first one trimmer and then the other in haphazard fashion. If you do the work slowly as described, you will find the balancing of the circuits to be easy enough, but you may well become confused if first one and then the other trimmer is quickly adjusted.

If you have a milliammeter and can connect it in the anode circuit of the second detector, the matching can be carried out more quickly. Remembering that the second detector is of the grid-leak type and that the anode circuit decreases when the signal increases in strength, it is obvious that what you must do is to tune in order to reduce the current as much as possible.

Start with a weak signal as before and carry on as described, but watch the milliammeter as well as listening to the strength.

When you vary the main tuning of the filter circuit condenser you will notice how the needle of the meter falls and returns to its normal value again as the point of tune is passed through. There should be no

suspicion of two tuning points. One point, fairly broad, perhaps, is what is required.

Having got this by adjusting the condensers, a check can be carried out at other wavelengths and a slight correction be made, if necessary. Having found the correct settings the condenser should be left alone and all tuning be carried out by the main tuning controls.

Short-wave Reception

The circuits cover wavelengths between about 200 and 2,000 metres, but the oscillator is provided with a short-wavelength winding. You can, therefore, receive short-wavelength signals by connecting a short-wavelength coil to the aerial circuit in the place of the filter coil. The diagram shows the connections.

Actually, wire 24 is disconnected from the terminal of the filter coil. The end is then taken to the end of the short-wavelength coil. The other end of the short-wavelength coil is joined to the earth terminal of the set and the aerial is taken to a tap on the coil.

It is, therefore, easy enough to join a short-wavelength coil to the receiver. Tuning is carried out in the usual way. The oscillator being set in the short-wavelength position. Only one part of the two-gang condenser is used when receiving the short wavelengths.

A switch could easily be fitted to connect the short-wavelength coil, if desired. The switch would simply connect wire 24 to the terminal on the filter coil or to the short-wavelength coil. It would be necessary to

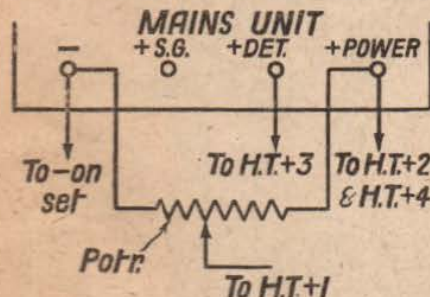

How a mains unit is connected

the volume control, in order that slight changes in the tuning shall produce a noticeable effect. Then the trimmer on the part of the condenser nearest the panel (in the aerial circuit) must be unscrewed. Also unscrew the trimmer on the second part of the condenser.

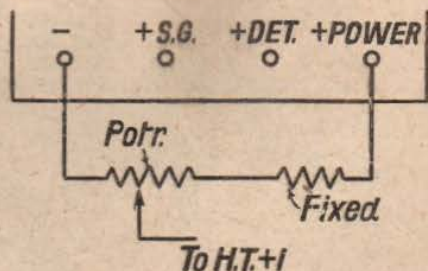

Method of connecting potentiometer for the H.T. + 1 supply

take the aerial from the aerial terminal of the set and to connect it to the short-wavelength coil.

There are usually a number of stations to be received on the short waves. The tuning of the aerial coil is, of course, rather

(Continued on next page)

sharp and practice is needed. Many amateurs regularly receive short-wavelength stations at good strength. It is so easy to connect the short-wavelength coil to the set that I hope all builders of the set will try.

There are several makes of short-wavelength coil. Sometimes the aerial is connected through a condenser of small capacity to the top of the coil, that is, to the end having wire 24 joined to it. If the coil is a plain one of, say, five turns without taps, the aerial had better be joined through a condenser to the grid end to which the wire 24 is joined.

Lowest Wavelength

A pre-set condenser having a very small minimum capacity will be satisfactory. A point to be remembered is that the minimum wavelength to which the set will tune will vary with the capacity added to the circuit by the aerial. The capacity is, in effect, reduced by the added aerial condenser. As this is reduced in value, so the effective capacity of the aerial is reduced, and the set will tune to a lower wavelength. A capacity of 20 to 30 micro-microfarads is probably enough coupling between the aerial wire and the top of the coil. If an adjustable condenser is used the best capacity can be found by experiment.

Sharper Tuning

If you join the aerial to a tap on the coil a condenser in the aerial wire may not be necessary. As the aerial is connected nearer the earthed end of the coil, so the effective capacity is reduced. The tuning becomes sharper. There is no reason why a small condenser should not be joined in the aerial circuit; where a tap is used, however, and by adjusting the condenser and the tapping point, when possible, the best results will be obtained from the particular aerial in use.

Using a Mains Unit

The set can be run from a mains unit provided suitable connections are made. Terminals H.T. +2 and H.T. +4 may be joined and taken to the "power" output tap of the mains unit. Tapping H.T. +3, which is connected to the detector, should be taken to the output tap on the mains unit intended for this circuit.

Output

The output may be adjustable in some makes and fixed in others. If adjustable, you will quickly be able to find the best adjustment as the voltage of the output is not at all critical. In other words, you can vary the voltage over a fairly wide range without much affecting the volume or the quality.

The chief difficulty is with the supply to the H.T. +1 circuit. An anode-bend detector is used here and the usual "screen-grid"

output tap on the mains unit will not be satisfactory in many cases. A detector of this sort ought to be supplied from a potentiometer and the chances are, if your eliminator is a popular type, that the potentiometer circuit must be added.

You will need a potentiometer of about 75,000 ohms. One end is connected to the "power" output tap and the other to the negative. The figure shows this. Wire H.T. +1 is taken to the contact of the potentiometer.

A wire-wound component had better be used. The current passing through it is about 1.6 milliamperes when the total voltage is 120. The output from the potentiometer circuit is, of course, variable from 0 to 120. A by-pass condenser is usually not needed, as there is one across the circuit in the set itself. If a potentiometer of lower value is used, the current flowing through it will naturally be greater. There is no reason why a lower resistance should not be used provided the current is available.

Adding a fixed Resistance

When the mains unit provides more than 120 volts, it is a good plan to add a fixed resistance to the potentiometer circuit. Thus if, for example, the voltage is 150, and the potentiometer is of 75,000 ohms, the fixed resistance can be about 50,000 ohms. The connections are shown in the diagram.

There are some mains units having an adjustable potentiometer included. No addition need be made, therefore, but the H.T. +1 tapping may be taken direct to the appropriate output.

A mains unit that is overloaded may not smooth the output properly. Never fit a large power valve, therefore, unless the output is adequate. The best results are obtained when a big output valve is used, but only if the mains unit can properly supply it.

COMPONENT ARRANGEMENT

Often by carefully placing the parts in a set you can keep the leads very short. Here, for instance, is a coupling condenser placed immediately between the holders of the valves, the circuits

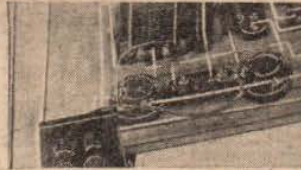

of which it couples. The spaghetti resistance also makes for neatness in layout. This is just one instance of the way in which, with a little care, you can economise in space and make for neater wiring.

PERSONALITIES IN THE WEEK'S PROGRAMMES



SELECTIVITY . . .

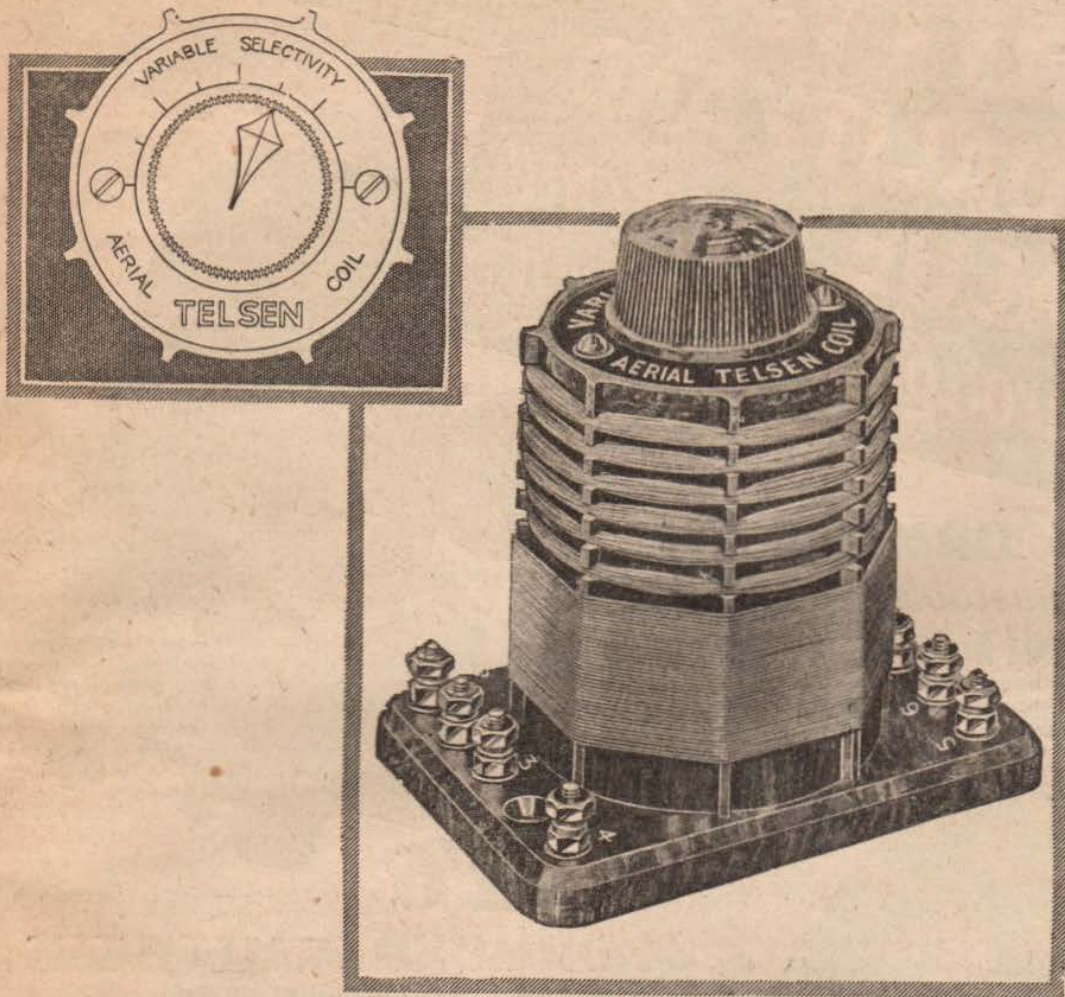

TELSEN AERIAL COILS

Local interference is the bugbear of the home constructor. Many devices have been produced to cope with the problem—wavetraps, bandpass filters, multi-stage H.F. amplification, and “super-hets”—but the simplest and easiest way of dealing with local station interference is to use a TELSEN Dual-range Coil with the variable selectivity device. This allows you, without the least complication, to reduce aerial coupling to the degree demanded by your local conditions.

Apart from this feature the TELSEN Coil is the most efficient and adaptable of its type. Independent primary and secondary windings make it suitable for any position in the circuit where a tuning coil is required. The dual-range construction does away with plug-in coils. Wave-changing is simplicity itself—a switch mounted on the panel—eliminating the need for any skill in mounting, and facilitating the layout.

Telsen Dual Range Aerial Coil. Price 7/6.

Telsen H.F. Transformer and Aerial Coil. Price 5/6.

TELSEN

**ALL-BRITISH
RADIO COMPONENTS**

Send for the “Telsen Radio Catalogue”
and book of “All-Telsen Circuits” to The
Telsen Electric Co., Ltd., Aston, Birmingham.

CVS-80

Please mention “Amateur Wireless” when Corresponding with Advertisers

**BRITISH
QUALITY AND
VALUE.. Supreme
throughout the World!**

The **ORMOND No 1
Adjustable LOUDSPEAKER**

UNIT Typically British, with its sturdy construction, complete dependability and amazing performance, this famous Ormond product has won a well-deserved popularity in every radio circle.

So sensitive that it achieves faithful reproduction over a wide range of frequencies, it is yet capable of handling great volume without a trace of chatter.

The Unit is easily mounted in either cabinet or chassis, only two screws being required. Cat. No. R 450

12/6

Also available for use with high impedance Pentode valves. Cat. No. R 450Z

The **ORMOND SMALL CHASSIS & CONE** Like its companion component, the No. 1 Unit, this chassis and cone is British first and last, in character and in actual manufacture.

The chassis, constructed of aluminium, ribbed and specially strengthened, is provided with two brass pillars complete with locknuts to facilitate assembly of the unit. The cone is of specially selected material secured to the outer ring; screw holes are provided for securing to baffle-board or cabinet. Diameter 11 in.

Cat. No. R 451

7/6

for
**PUNCH
POWER
& PURITY!**



(Registered Trade Mark)

THE ORMOND ENGINEERING Co., Ltd.
ORMOND HOUSE, ROSEBERY AV., LONDON, E.C.1

Telephone: Clerkenwell 5334/5/6 & 9344/5/6
Telegrams: "Ormondengi," Isling

TELSEN

IMMEDIATE DELIVERY

**1932 CIRCUITS
MATCHED COMPONENTS**

CASH - C.O.D. - H.P. *as usual*

SEALED

PILOT AUTHORS KITS

Pilot Author's Kits are backed by Peto-Scott with twelve years' reputation for trustworthiness and fair-dealing. Remember there's no Kit like a Pilot.

Pilot Author's Kits are exactly as specified. No substitute parts are employed and everything fits the Telsen Blueprint.

THE TELSEN "CONQUEROR" THREE

KIT A
Author's Kit less valves and cabinet
39/9

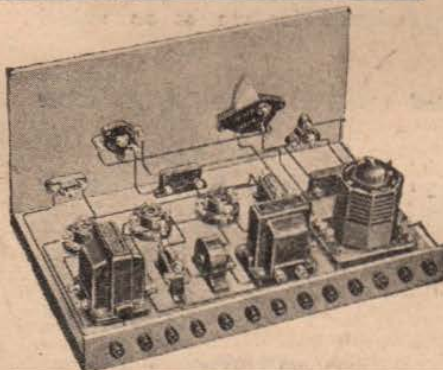

Cash or C.O.D.
or 9 monthly payments of 5/-

Kit contains all parts exactly as specified by Telsen. Also beautifully finished Oak panel ready drilled; aluminium finished baseboard with the position for all components correctly stencilled; ebonite terminal strip; Clix terminals; connecting wire and screws, nuts, bolts, etc.

KIT B with valves less cabinet
Cash or C.O.D. **£3 : 7 : 3**
or 12 monthly payments of 6/2

KIT C with valves and cabinet
Cash or C.O.D. **£4 : 4 : 9**
or 12 monthly payments of 7/9

Any parts supplied separately. If value over 10/-, sent Carriage Paid or C.O.D. We pay all post charges.

THE TELSEN 'SONGSTER' TWO

Kit "A" Author's Kit less valves and cabinet
£1 11 9
or 7 monthly payments of 5/-

THE TELSEN 'EMPIRE S.G. 4'

Kit "A" Author's Kit less valves and cabinet
£4 16 10
or 12 monthly payments of 8/10

Prices of Kit "B" and Kit "C" upon request.

Peto-Scott Cabinets for Telsen Kits

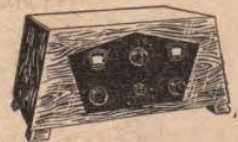

TABLE TYPE (with beautifully finished Oak Panel ready drilled).
Conqueror Three Model or Commodore S.G. Three Model **17/6**



CONSOLETTA TYPE
(with beautifully finished Oak Panel ready drilled. Speaker Compartment takes up to 12 in. diameter cone).
Conqueror Three Model or "Commodore" S.G. Three Model **35/-**

Fitted Telsen L.S. Unit & Chassis 11/- Extra.

TELSEN "COMMODORE" S.G. THREE

KIT A
Author's Kit less valves and cabinet
£4:5:5

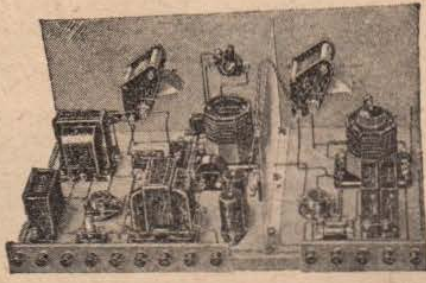

Cash or C.O.D.
or 12 monthly payments of 7/10

Kit contains all parts exactly as specified by Telsen. Also beautifully finished Oak panel ready drilled; aluminium finished baseboard with the position for all components correctly stencilled; ebonite terminal strip; Clix terminals; connecting wire and screws, nuts, bolts, etc.

KIT B with valves less cabinet
Cash or C.O.D. **£6 : 7 : 5**
or 12 monthly payments of 11/8

KIT C with valves and cabinet
Cash or C.O.D. **£7 : 4 : 11**
or 12 monthly payments of 13/3

Any parts supplied separately. If value over 10/-, sent Carriage Paid or C.O.D. We pay all post charges.

TRADE NOTE Telsen 1932 Matched Component Kits are available to the Trade at attractive discounts. Send for terms.

SEND 3d. POSTAGE FOR FREE TELSEN BLUEPRINT GIVING FULL LIST OF PARTS, DIAGRAMS AND LAYOUT OF ABOVE SETS

PETO-SCOTT

PETO-SCOTT CO. LTD. Head Office: 77 CITY ROAD, LONDON, E.C.1, Clerkenwell 9406. 62 HIGH HOLBORN, LONDON, W.C.1. Chancery 8266. MANCHESTER: 33 WHITELOW ROAD, CHORLTON-CUM-HARDY. Phone: Chorlton-Cum-Hardy 2028. NEWCASTLE, STAFFS: 7 ALBANY ROAD.

EXPRESS ORDER FORM

To PETO-SCOTT CO. LTD.
Please send me C.O.D., CASH/H.P.

for which I enclose
Cash/H.P. Deposit £ s. d.

NAME _____

ADDRESS _____

A.W. 7/11/31

To Ensure Speedy Delivery, Mention "A.W." to Advertisers

It is the outstanding performance of each individual type that has made the Mullard 2-volt range pre-eminent. Whatever work there is for a valve to do, there is a Mullard 2-volt valve to do it, and to do it supremely well. For the output stage, there is the P.M.22 — the Mullard pentode. It is designed for use as an output valve in battery operated receivers possessing no other L.F. stage. It gives high output from a comparatively small input voltage, and with characteristic brilliance of tone.



Mullard

THE · MASTER · VALVE

Advt. The Mullard Wireless Service Co., Ltd., Mullard House, Charing Cross Road, London, W.C.2

Arks

Don't Forget to Say That You Saw it in "A.W."

Oh Your Waverack!

FROZEN X'S

AS I write, the weather is pretty cold; but this seems to have had, at any rate, one beneficial effect on wireless: I haven't heard an atmospheric for days and days. Have the frosts nipped them in the bud or put them into cold storage? Every reader who goes in for long-distance work will be overjoyed at the present freedom from crackles, fizzes, and bangs, for never since broadcasting began has there been a year in which atmospherics were so violent or so incessant for months on end as in 1931. The curious part is that we are past the sun-spot maximum, which was previously supposed to be responsible for atmospheric troubles, and yet we have had this record year of ear-splitting interferences. However, let's hope that these troubles are past and that we are now entering upon a period of first-rate X-less reception.

IN THEY COME

"BRITAIN'S SUPER" made its appearance just at the right moment when conditions for foreign-station reception had become really good for the first time since the spring. Or was it perhaps that Dame Nature closed down her firework display in honour of the coming of the wonderful new set? Anyhow, some splendid bags of foreign stations will be made with it during the wireless season on which we have now entered, and readers who make it up are certain to enjoy themselves to the full. Everyone in the wireless swim that I have met is more than enthusiastic about the set; and that's saying a good deal, for praise from other designers is praise indeed.

TAKEN TO TASK

I HAVE received a gentle chiding from an American correspondent living in this country for the criticisms that I have levelled in these columns against American wireless sets. He thinks that I am going a little too far in saying that some, at any rate, are not highly selective according to British standards, even though they contain three tuned high-frequency stages. Well, I don't stand alone in holding such views. Let me quote from the test report on a set, to which my correspondent devotes particular attention, published in the current issue of one of our trade papers, which is noted both for the technical excellence and the complete fairness of its reports. "The selectivity," says this report, "judging from our sample, was by no means the set's outstanding feature, and on the medium waves it seemed no better than a good British single-S.G. set, providing the latter was carefully adjusted . . . the (London) Regional . . . spread from 800 to 950 kilocycles approximately, a total spread of 150 kilocycles. The London National . . . spread from 1,040 to 1,350 kilocycles."

This means that the London National had a total spread of 310 kilocycles; that the Regional occupied no less than sixteen and

two-third channels, and the National the astonishing number of thirty-four and a half.

So with this American set of vaunted selectivity more than forty stations were completely blotted out by the London Regional and the London National. This absolutely confirms my own experience when trying out the set in question; I found that I could get far more foreign stations with a good British three-valver than with an American set which describes itself as a five-valver.

FURTHER POINTS

MY correspondent objects to my saying that an American set with four receiving valves and a valve rectifier for A.C. is really a four-valve set. In the report referred to above I find: "Although the receiver is styled a 'five,' there are, of course, only four receiving valves." My friend tells me that certain British sets are classified in the same way. It is true that since the American invasion one or two of our manufacturers have adopted the practice of adding in the valve rectifier in self-defence. I don't defend them any more than I defend those who compelled them to take this course. A set should be classified by the number of its genuine receiving valves.

QUALITY

THE next point that my correspondent makes is that the quality of the particular American set about which he is writing is, at any rate, not so bad as I said it was. What has the trade paper's test report to say on the matter? "The tone, on the whole was good, and would be described as 'pleasant,' but not outstanding in quality. Though slightly bass-heavy, the tone was not of the woolly 'one-note' bass variety, which is so often encountered in American receivers. The upper register, though not equal to the best modern receivers we have heard, was reasonably well in evidence . . ."

"Pleasant," I take it, is another way of putting "mellow"—and most of us know what that means. I allowed, if you remember, that this set had at least three notes in the bass. I think—don't you?—that the report that I have quoted (and there's a whole lot more that I would like to quote if I had but the space) pretty well bears out my general criticism of American sets. Notice particularly the words just above that I have put in italics. I have not a word to say against the very best American receiving sets, for I know that they are quite first-rate. What I do maintain is that certain comparatively low-priced sets now being offered are far below the British standards of selectivity and quality.

FOR PENTODE-ITES

A GOOD many people who fit pentode valves into the output holder of oldish sets suffer disappointments as regard the low-frequency magnification obtainable.

The reason is that they regard the pentode as an ordinary output valve and connect it straight into the plate circuit of a balanced-armature loud-speaker whose windings provide a low load-impedance. Used like this the pentode cannot do itself justice. Not only is the magnification poor, but the quality is usually hopeless. If you want to get the best out of a pentode you must have either a matching output transformer or a filter circuit containing a tapped choke between it and the average medium-resistance loud-speaker.

ANODE CURRENT

AND if you use a pentode of ordinary kind don't forget that the anode current is likely to be anything from 10 to 20 milliamperes. The windings of your loud-speaker should not be compelled to carry this amount. I mentioned recently that a new pentode had made its appearance which passes a total H.T. current in both plate and screen-grid circuits of only about 5 milliamperes. This is a fine little valve and you can obtain balanced-armature loud-speakers specially wound to suit it exactly. This means that you can get the very best results without the need for a filter circuit or an output transformer.

A QUEER BUSINESS

AND there is another interesting thing that sometimes happens if you put a pentode into a two-valve set or a three-valver containing one high-frequency stage only just selective enough for to-day's requirements. Either by matching the pentode to the loud-speaker by transformer or choke, or by using a special loud-speaker, you get fine low-frequency magnification. But presently you are conscious that something is not quite as it should be. What is that funny little noise that does not appear to be part and parcel of the item to which you are listening? The funny little noise develops presently into faint but unmistakable sounds of an organ, an orchestra, or a jazz band. The moment an interval occurs in the programme to which you are listening you find that another programme is coming through quite strongly; in fact, you succeed in identifying the station and find to your surprise that it is one which previously caused no interference. Has the set suddenly lost its selectivity? It cannot have, you say, for you haven't made any alteration in the H.F. circuits.

THE EXPLANATION

WHAT is going on is rather interesting, and here is the explanation. In pulses from the station causing interference are very feeble when they reach the grid of your detector valve, so feeble, in fact, that when the original output valve of low amplifying power was in use they were never brought up to audible strength. The interference was, so to speak, there, but it was so weak that you heard nothing of it. But now you are using a pentode valve

On Your Wavelength! (continued)

giving vastly greater magnification. Those little interval impulses are brought up to audible strength by the pentode and you now hear them quite plainly. To put it in a nutshell, the amount of low-frequency amplification that you can use successfully depends upon the selectivity of the H.F. circuits. In many sets which are apparently unselective the trouble is due to there being too much magnification between the detector and the loud-speaker.

SOMETHING ATTEMPTED, SOMETHING . . . ?

SO far as one can make out from the reports which are to hand at present, nothing very much has come, or is likely to come, of the International Broadcasting Conference recently held in Rome. Only twenty-two European countries were represented out of a total of something over thirty which signed the Prague Plan agreement. That in itself is sad, for no real progress will be made in the straightening out of the European ether until every country co-operates heartily. The B.B.C. representatives put forward their plan for the reduction of the number of European stations, but this does not seem to have met with any warm welcome. Germany objected that any such reduction would mean the dismissal of broadcasting orchestras.

A GREAT DIFFICULTY

BUT the position in France is probably the greatest stumbling block. Readers may not know that in France there is a duplicate system of broadcasting. The majority of the stations (all those of the PTT class) belong to the Government and are (or should be) strictly controlled. But some of the big stations, including Radio-Paris and Toulouse, amongst others, are the property of private concerns and are in no way under Government control so long as they comply with the rather loose broadcasting regulations in force. France is by far the worst offender in the matter of wavelength wobbling and wavelength wandering. You cannot examine any of the monthly reports of the Brussels Laboratory of the International Broadcasting Union without being struck by the amazing leaps and bounds from one wavelength to almost any other made during the month by numbers of French stations. What we quite definitely want is an international agreement that the broadcasting stations of every country shall be firmly under Government control. Nothing much can be done until we get as far as that.

FUTURE HOPES

THE meeting, however, has decided to carry out certain tests with a view to making possible slight modifications in the existing Plan. We may, therefore, find a few stations exchanging wavelengths in the near future, though it is certain that difficulties will arise here. The most desirable wavelengths are those between 250 and 500 metres, because transmissions using them have bigger and better service areas than

those working on shorter wavelengths. Wavelengths above 350 metres, too, are not so badly affected by fading as those below. It follows that nobody who has acquired a good wavelength will be at all keen on making a swop with another fellow who is down near the bottom of the medium band; and, really, you cannot wonder. The position, then, is not an easy one; but I do believe that before so very long sensible views will prevail, and that we shall have a limitation both of the number of stations that any country may possess and of the output power that they may use.

A RASH PROPHECY ?

PUTTING on the prophetic mantle which I generally reserve for the New Year's number of AMATEUR WIRELESS, I foresee an entire reorganisation of European broadcasting before so very long. If you examine the allocation of wavelengths between 200 and 1,000 metres you will find that, roughly speaking, the broadcast band extends from 200 to 550 metres, and that from 600 to 1,000 metres wavelengths are mainly given up to shipping and aircraft. There is also the shorter commercial wavelength on 300 metres within the broadcast band, and a certain amount of use is made of another wavelength, 450 metres, for wireless telegraphy purposes. This allocation is based largely on the requirements of the old spark transmitter, whose tuning at the best of times was so broad that any transmitter wanted not so much a wavelength as a wave-band to itself.

EXIT THE SPARK

THE spark transmitter is now on its last legs, and in a matter of months the last of them should have been scrapped. In the place of spark apparatus, C.W. and I.C.W. transmitters are being adopted. Both of these tune sharply and they obtain better ranges than the old-fashioned apparatus. The ideal arrangement would be to allocate the whole band from 400 to 1,000 metres to broadcasting and to give the band between 200 and 400 metres to shipping, aircraft, and other telegraphy transmissions. Such an arrangement could, I believe, be made without in the least interfering with Morse communications, and it would, of course, have wonderful effects in clearing ether congestion.

CONDENSER MAKING

I OFTEN wonder if the average man appreciates the amount of care which goes to the making of a fixed condenser. We are accustomed to purchase these commodities for such a relatively small sum that the difficulties of manufacture are often entirely overlooked. This was very forcibly impressed upon me during a most interesting tour of the T.C.C. works the other day, where I saw the whole process from start to finish on various types of condensers. Even with such a small item as a .0001 mica dielectric condenser the amount of detail and attention required is rather remarkable. The mica, of course, has to

be selected and cut to shape of the right size and thickness. The condenser assembly is built up and is then clamped under pressure, ensuring that it will remain constant. After this, connecting tags are spot-welded on to the plates to ensure perfect electrical contact, especially at high frequency. The condenser is now impregnated, after which it is tested, enclosed in a moulded case, tested again, and finally packed.

DETAILED CARE

FAILURE to carry out any of these processes satisfactorily results in an inferior product. Naturally, the omission of some of the processes results in a cheapening of the production, but it will be clear that this is not necessarily good economy. With the meticulous care expended on the various processes I was surprised that these condensers could be sold as cheaply as they were. Paper condensers, of course, require even more attention in manufacture, for they have to be dried out and impregnated with wax in a vacuum so that no trace of moisture can remain in the condenser.

TAMING S.G.'S

MOST people know that unless you shield the screen-grid valve pretty carefully in a sensitive set you are apt to get instability when you ask for big amplification. The metallised valves do the trick for those who use mains-operated sets, but the poor battery user is not so well catered for, or at all events I thought he wasn't until the other day. Then I came across those neat little screening pots made of aluminium which you can buy at almost any wireless shop. The S.G. valve just fits nicely into these and you earth the pot by passing the negative filament pin through a tight-fitting hole in a tag provided for the purpose. I fitted some of these screening pots to the valves in a set which had been rather difficult to control and found that they worked wonders. I could allow a good deal more efficiency in the H.F. stages without there being the slightest trace of instability. If you have a set containing S.G.s which is apt to be a bit wild at times I can recommend these little gadgets to your attention.

WHEN CHANGING VALVES

SPEAKING of valves, one should be careful, before changing-over from one type of L.F. power valve to another, to make certain that an existing H.T. eliminator will stand up to the new conditions. For instance, the eliminator may have been designed to give, say, 200 volts on the maximum voltage tapping when used with a valve of comparatively-limited output. But with a new L.F. amplifier of lower resistance and higher output, the circuit conditions are changed so much that the maximum eliminator voltage may drop to half its original value which will, of course, not produce satisfactory results on a valve calling for a plate potential of 200 volts.

THERMION.

NEW IDEAS IN THE KIT SETS

All Constructors should read this article by SET TESTER

KIT sets are nearly always outstanding sets. This is natural, since they are usually the annual effort of the valve firms, who put into practice as many as possible of the latest circuit and constructional ideas.

Having tried out most of the new season's kit sets, I am in a position to give readers a general view of developments in this particular sphere.

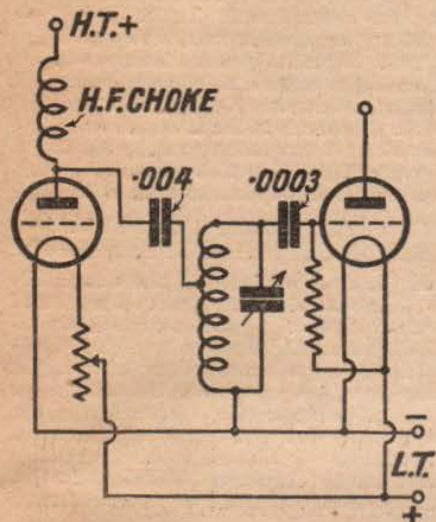

Fig. 1. The coupling employed in the Mullard Kit set

Let us deal firstly with the circuits. As in previous years, the three-valver predominates. The Osram Four is an exception, having two screen-grid stages, a detector and transformer-coupled power output.

Among the three-valvers the popular sequence of high-frequency amplifier, detector and low-frequency amplifier maintains its hold. There is an exception to this rule, for the Zonophone kit utilises a circuit comprising a detector and two resistance-capacity low-frequency stages.

As most of my readers know, the normal three-valver with a screen-grid stage,

employing two tuned circuits, needs careful designing if it is to yield sufficient selectivity to cope with modern conditions.

Band-pass tuning immediately suggests itself as a likely method for the kit-set makers to adopt in achieving this necessary degree of selectivity. As a matter of fact, there is by no means any general tendency to employ band-passing in the new kit sets.

The Zonophone kit, with its two low-frequency amplifying stages, is one of the few exceptions and employs a very efficient band-pass tuning coil, which to a large extent overcomes the omission of a high-frequency tuning circuit.

Another kit set with band-passing is the Six-Sixty Chassikit, a three-valver with a screen-grid stage—one of the most selective kit sets available.

The other kits are by no means unselective, as I have proved by actual experiment. Some achieve selectivity by tapping the aerial coil and also tapping the tuned-grid coil forming the inter-valve coupling.

In the 1932 Mullard kit two very efficient dual-range solenoid tuning coils are used, with trimming devices that are easy to adjust. Here we find the coupling shown by Fig. 1. It will be seen that in the anode circuit of the screen-grid valve is a high-frequency choke and that a .004-microfarad fixed condenser passes on the signals to a tapped tuned-grid winding in the detector circuit.

This choke-fed tuned grid winding is a popular form of high-frequency coupling in kit sets. It is included, for example, in the Radio-for-the-million V3. Some kits still favour the straightforward tuned-anode high-frequency form of coupling, as for example, in the Cossor Melody Maker, Model 234.

All the kit sets I have tried employ reaction, mostly applied through the anode circuit of the detector valve to the high-frequency coupling. Differential reaction is favoured in several of the kits, as for example, in the Osram Four, whose reaction arrangement is shown by Fig. 2.

In the low-frequency amplifying side of

the kit sets there is little to record, as most designers seem to favour the straightforward transformer connections, with, of course, the exception of the Zonophone people.

Kit sets adopting the simplest possible transformer connections include the Osram Four, the Six-Sixty Chassikit, the Radio-for-the-million V3, the Cossor Melody Maker and the Mullard 1932 set.

Some of the kits omit a high-frequency choke between the anode of the detector and the low-frequency transformer. I

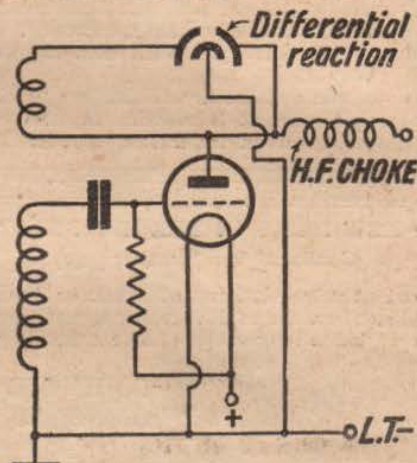

Fig. 2. The differential reaction arrangement of the Osram Four

personally think this is a mistake, owing to the possibility of fierce or "ploppy" reaction. Although the high-frequency choke is sometimes omitted it is now rare to find that a detector by-pass condenser has been left out.

The use of a grid stopper—that is, a grid-leak between the secondary of the low-frequency transformer and the grid of the

(Continued at foot of next page)

COMPONENT FIXING HOLES

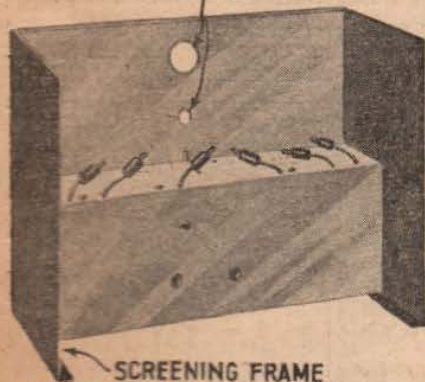

Fig. 4. The Six-Sixty chassis

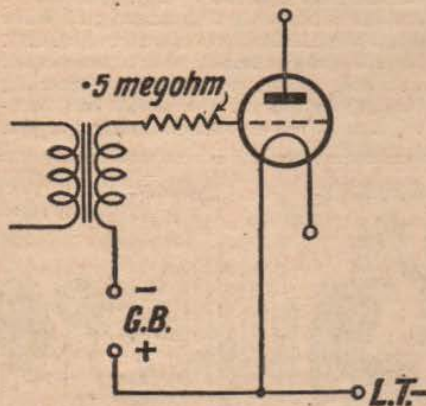

Fig. 3. The grid stopper arrangement of the Cossor Melody Maker

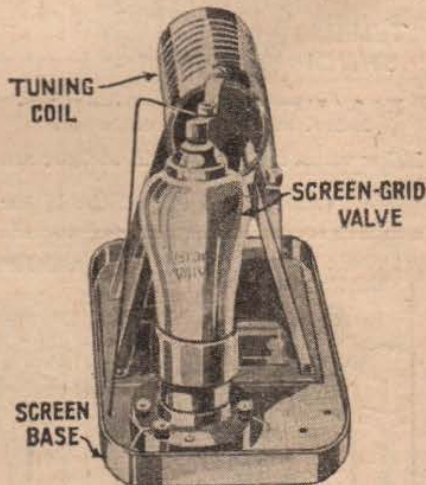

Fig. 5. Coil and valve assembly of the Osram Four

For the Newcomer to Wireless: TESTING THE HIGH TENSION BATTERY

I HAVE asked you a good many questions at one time or another about dry high-tension batteries and now there is one more thing that I would like to know.

And that is: Can you tell me the best method of testing them, for I don't find that the ordinary voltmeter test is of much use?

You mean, I suppose, that before you switch on the wireless set you put a voltmeter across the battery, find that it is showing say, 90 per cent. of its original voltage, feel that all should be well, switch on, and then find in half an hour that distortion is occurring.

Yes, that's just what does happen. Why is it?

You see, the dry-cell battery "picks up" when it is rested. It loses its voltage when under load because the

cells become slowly clogged or polarised. When given a rest of several hours, the depolariser clears the cells, and even an old battery may show temporarily a pretty good voltage.

But it doesn't keep it up. No, as soon as you switch on, polarising sets in rapidly.

Then what do you suggest?

If you are going to rely upon the voltmeter, the only way to make the test with a good high-resistance instrument is to wait until the battery has been under load for at least a quarter of an hour and then to put the meter across the battery whilst the set is still in operation. If you do so you will probably find that the reading you spoke of, 90 per cent. of the original voltage, has dropped to 50 per cent., or even less.

Is that the best method?

Personally, I don't think so, because it means switching on the set and waiting for some time.

What's your test then?

I'm afraid that I'm rather a heretic. You will find that most writers advise you never to use a moving-iron voltmeter because its low resistance means that a great deal of current is passed. After a long experience of high-tension battery testing I find that a good moving-iron meter whose needle comes to rest quickly and doesn't go on wobbling for some seconds, is very good indeed. It probably draws from 100 to 200 milliamperes for a full-scale deflection, and this is really just what you want. Such a load for a second or so doesn't hurt the battery much, but it does give a good idea of what the voltage is when the battery has no work to do.

"NEW IDEAS IN 'THE KIT SETS'"

(Continued from preceding page)

output valve—is favoured in two or three kits. The value of this stopper is generally specified as 100,000 ohms, but considerably

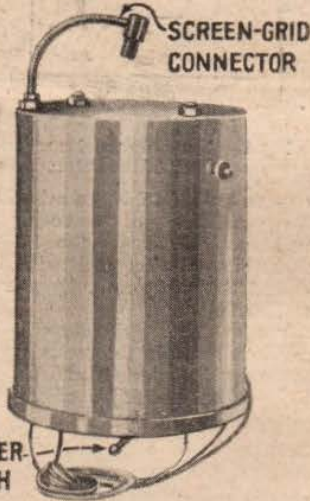

Fig. 6. The anode coil of the Cossor Melody Maker. Note the switch on the base

higher values are employed in at least two of the kits.

The tendency is to cut off the higher

audible frequencies with these grid stoppers and this is an advantage when a pentode output valve is used, because the pentode tends to give undue emphasis to the high notes. The circuit diagram shown by Fig. 3 illustrates the grid-stopper arrangement employed in the Cossor Melody Maker kit.

Turning now to the constructional developments in kit sets, I find that considerable originality has been shown in the various designs. Probably the most outstandingly different construction is that of the Six-Sixty Chassikit, shown by Fig. 4.

This consists of three complete factory-built sections, namely a tuning condenser, a coil assembly and a valve unit carrying the remaining components. The connections between each section are simply done with plugs and sockets.

Screening is widely adopted in nearly all the kit sets of the present season. In the Osram kit the three separate compartments are designed to house the valves and coils. Fig. 5 shows one of the coil and valve compartments of the Osram Four. The sound engineering of this set is admirably illustrated by this screening unit.

Another excellent example of good coil construction is shown by Fig. 6, where we see the anode coil with screen-grid valve connector used in the Cossor Melody Maker. Note the neat tumbler switch underneath this coil, which, with the corresponding tumbler switch on the aerial coil, contributes to the smooth mechanical action

of the coil switching in the Cossor kit.

Minor novelties in construction abound in the kit sets. A good example of simplified construction is shown by Fig. 7, which illustrates the simple fixing of the grid stopper resistance between the transformer and valve holder of the Mullard 1932 kit.

From what I have said, constructors will appreciate that there is a considerable amount of interest to be derived from a study of the various kit sets on the market.

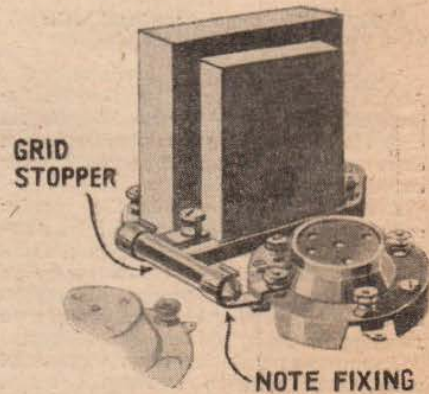

Fig. 7. The neat method of fixing the stopper resistance in the Mullard kit

I think amateurs would gain much useful information by writing to the kit-set makers for further details.



HOW TO DESIGN AND BUILD A MAINS TRANSFORMER

—By F. C. RUTTER

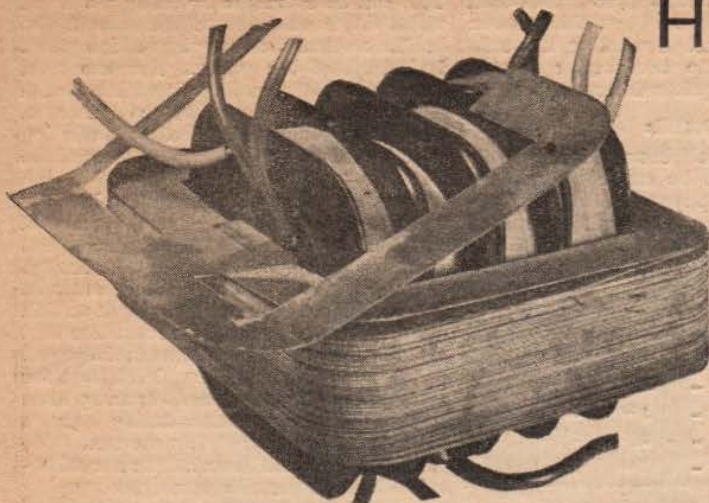

IN these days of A.C. sets, the radio enthusiast finds that one of the components most frequently required is a mains transformer. Most of the radio manufacturers have introduced suitable types, but it is a very simple matter for the amateur to build his own, with the advantage that a considerable saving is effected, any desired output can be obtained, and the windings can be altered at any time to suit changed conditions. This last point is by no means least, for with standardisation of supply voltages and additions and alterations to the receiver, it often happens that a transformer has to be scrapped and replaced by a new one.

We all know that a transformer consists of an iron core, a primary winding to which

The Primary

The primary is enamel-covered copper wire, and the gauge and number of turns are determined from four calculations:—

3. Assuming that the efficiency is about 85 per cent., multiply the output by 1.2 to find the input: $52\frac{1}{2} \times 1.2 = 63$ watts.
4. Divide watts input by supply voltage to find current taken from the mains. $63 \div 240 = .26$ amperes.
5. Refer to table for a gauge of wire capable of carrying this current. No. 28 will do.

6. Multiply $\frac{\text{volts}}{\text{cycles}} \times K$ for the core, to find number of turns.

$$\frac{240}{40} \times 350 = 2,100 \text{ turns.}$$

The Secondaries

We will begin with the 4-volt 6-ampere winding.

7. Refer to the table for a gauge of wire suitable for the current. No. 15 will do for 6 amperes.

8. Multiply $\frac{\text{volts}}{\text{cycles}} \times K$ to find turns.

$$\frac{4}{40} \times 350 = 35 \text{ turns.}$$

The other secondaries are dealt with in exactly the same way:—

7a. For 80 milliamperes use No. 34 S.W.G. (It is inadvisable to use wire finer than No. 36, no matter how small the current, on account of the difficulty in handling.)

8a. $\frac{300 \text{ volts}}{40 \text{ cycles}} \times 350 = 2,625$ turns.

7b. For $\frac{1}{2}$ ampere use No. 24 S.W.G.

8b. $\frac{9 \text{ volts}}{40 \text{ cycles}} \times 350 = 79$ turns.

This completes the design in most cases, but in order to know how much wire to buy, we must find the weight from the number of turns as follows:—

Weight of Wire

9. Starting with the primary winding, by reference to the tables find the number of turns per inch and the length of a layer A hence the number of turns per layer. With No. 28 wire and No. 4 core, $58 \times 2\frac{1}{8} = 120$.

10. Divide total turns by turns per layer

to find number of layers. $2,100 \div 120 = 18$ layers.

11. The depth of winding will be $\frac{\text{No. of layers}}{\text{turns per inch}} + \frac{1}{8}$ in. for insulation between layers.

$$\frac{18}{58} + \frac{1}{16} = \frac{3}{8} \text{ in.}$$

12. Add twice the depth to B (from tables) to find mean length of turn.

$$2 \times \frac{3}{8} + 4\frac{1}{2} = 5\frac{1}{4} \text{ in.}$$

13. Multiply mean length by number of turns to find total length.

$$5\frac{1}{4} \times 2,100 = 300 \text{ yd.}$$

14. Find weight of this length from tables. It is 9.6 oz.

STALLOY

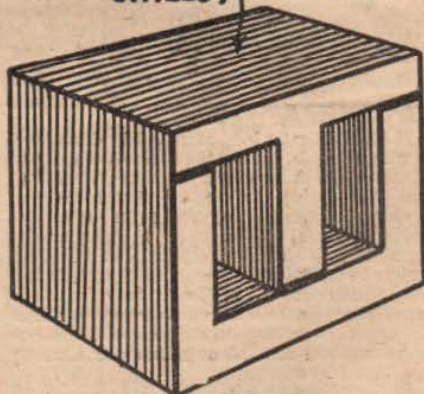

The assembled core

The process can be repeated for the secondary windings, except that the mean length of turn is twice depth of winding + B (Continued on next page)

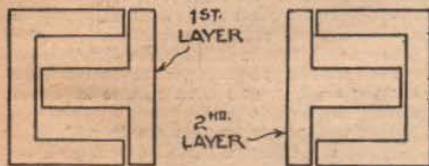

This diagram shows how the stampings are assembled

the input is fed, and one or more secondary windings from which the output is obtained.

The Core

The core is built up of Stalloy stampings .014 in. thick, which are supplied by Messrs. Sankey & Co., in a number of standard sizes, and particulars of a range suitable for radio work are given in the table. The size of core is decided by the output required; as an example, suppose we want 4 volts 6 amperes for filaments, 300 volts 80 milliamperes for H.T., and 9 volts $\frac{1}{2}$ ampere for a moving-coil speaker, and suppose the supply is 240 volts 40 cycles.

1. Calculate the total watts output, thus:

$$4 \times 6 + 300 \times \frac{80}{1,000} + 9 \times \frac{1}{2} = 52\frac{1}{2} \text{ watts.}$$

2. Refer to the table (page 932) for a suitable core. No. 4, rated at 50 watts, could be used, though if there were any likelihood

WIRE TABLE

S.W.G.	Amps.	Turns per Inch	Oz. per yard	Ohms per yd.
14	7.5	12	.932	.0049
15	6.1	13	.755	.0059
16	4.8	15	.596	.0075
17	3.7	17	.456	.0098
18	2.7	20	.355	.0133
19	1.9	23	.233	.0191
20	1.5	26	.188	.0236
21	1.2	29	.148	.0299
22	.93	32	.112	.0391
23	.68	38	.079	.0531
24	.57	41	.066	.0632
26	.39	48	.047	.0945
28	.26	58	.032	.1398
30	.19	70	.022	.1991
32	.14	80	.017	.2625
34	.10	94	.012	.3617
36	.07	110	.008	.5300

"HOW TO DESIGN AND BUILD A MAINS TRANSFORMER"

(Continued from preceding page)

+ four times depth of previous windings underneath. Thus the filament winding will occupy two layers and the mean length of turn will be about $6\frac{1}{2}$ in. The total length will be about $6\frac{1}{2}$ yd., and the weight about 4.9 oz.

Correction for Voltage Drop

There is one other point which sometimes has to be considered. The output voltage will be slightly less than its calculated value due to voltage drop along the wire, and in some cases the voltage must be exact. In the example quoted, a small error in the H.T. or moving-coil voltages would be of no consequence, but the filament value should be accurate. We therefore modify the filament winding as follows:—

15. We have found the length of wire to be about $6\frac{1}{2}$ yd., so by reference to the tables we find its resistance is .038 ohm.

16. Multiply resistance $\times \frac{\text{current}}{\text{cycles}} \times K$ to find the extra turns required to compensate for losses.

$.038 \times \frac{6}{40} \times 350 = \text{approximately } 2 \text{ turns.}$

17. Add this number to the number of

turns originally determined, so that instead of thirty-five turns we have thirty-seven turns. The method of winding the coils and assembling the transformer is well known, but a few points deserve attention.

Constructional Details

The cardboard bobbin on which the coils are wound has to be carefully made to obtain maximum strength whilst occupying minimum space, and should be made of

CORE TABLE

Sankey's Number	Watts	Quantity Required	K.	A.	B.
5	25	5 doz.	650	$1\frac{1}{4}$	$3\frac{1}{2}$
4	50	6 "	350	$2\frac{1}{8}$	$4\frac{3}{8}$
32	75	6 "	300	2	$4\frac{1}{2}$
33	100	6 "	250	$2\frac{1}{2}$	5
31	125	6 "	300	$3\frac{1}{4}$	$4\frac{1}{2}$

thin, tough card. Alternatively, an excellent material is thick porous paper soaked in shellac until it becomes hard and stiff. The stampings are built round the coil from alternate ends in order to interleave the air gaps, and as the bobbin should be a tight fit on the central limb of the core, there is a tendency to tear the inside of the bobbin when forcing the last few stampings in.

This can be overcome by fixing a strip of metal down one side of the hole in the bobbin so that the stampings slide against it instead of the paper. You can then knock the last stampings in with a mallet if necessary! Remember to place a wooden former in the bobbin before winding or it will be deformed by the tension of the wire.

Use short pieces of flex for the leads to terminals, and make sure that they are well anchored to the bobbin, so that if they are pulled there will be no strain on the winding. Using enamelled wire, each layer must be insulated from the next by a layer of thin waxed paper, and care should be taken that no subsequent turns slip beneath the paper.

When a winding is completed, test for continuity with an accumulator and phones and wrap tightly with insulating tape, so that the wire is completely covered. The finished coil should be soaked for a considerable time in paraffin wax (good quality candles will do), and a very professional appearance can be obtained by finally taping with yellow empire cloth.

A transformer can be made on the above lines with every confidence that it will keep cool on continuous running, and, providing no cases of obviously doubtful insulation are ignored, it will be perfectly safe and reliable.

OUR LISTENING POST

By JAY COOTE

Société Belge Radio Électrique in the Belgian capital. The call is "Ici poste Régional de la S.B.R." The station, when ready, is destined to one of the provincial centres.

More Power

By now you will have definitely logged the Prague giant officially opened on October 28; in fact, it is difficult not to pick it up when in the neighbourhood of Midland Régional. The Czech stations for some nights previous to its coming into action were particularly active and they were on the air until the early morning hours. Moravska-Ostrava, Bratislava, and Brno in turn relayed gramophone records from their big brother, and even Kosice at times could be heard quite well.

Talking of power induces me to add that Leningrad and Moscow Popoff now appear to have been re-invigorated. There is still some mystery attached to these Russian transmissions, inasmuch as between 720 and 1,481 metres several newcomers seem to have cropped up. Possibly in view of the greater energy used all round, we are clearly hearing transmitters further afield which hitherto had not been logged with certainty.

THE "LIGHT-O-STAT"

JUST as a thermostat is used to maintain a steady degree of temperature in an incubator, furnace, etc., so the photo-sensitive cell—the electric eye of television—is being employed to ensure a constant level of illumination. During the daytime any unusual falling-off in normal visibility due to fog, a sudden storm, etc., can be counteracted by the "light-o-stat," which automatically switches on the electric light until the period of gloom is over. Similarly it is being used to switch on sky-signs and similar advertisements automatically as darkness comes, or to light up street lamps in the evening, and switch them off again at daybreak.

B. A. R.

I LEARN that a long-standing feud between the Milan studio and the Scala Opera House in that city has now been satisfactorily settled and that during the coming winter we may expect, through Milan, Trieste, Genoa, and Turin, relays of first-class operatic performances from Italy's foremost lyrical stage. This form of entertainment, without doubt, is the staple fare offered to Italian listeners, and it is interesting to note that in sixteen months some 920 operas were broadcast over and above 400 operettas and musical comedies provided by the studios.

New Stations

The Austrian authorities have not yet chosen the definite site of their proposed new high-power station; in the meantime, however, tests are being carried out almost nightly on the long waves with a view to finding a suitable channel. If you care to tune in on 1,255 metres towards 9.30 p.m. you should pick up the Vienna programme simultaneously broadcast on 517 metres. As a rule, it is difficult to hear the long-wave experiments until Moscow (T.U.) and Motala have closed down, as the carrier wave of the latter strongly interferes. In that region also towards 11.30 p.m., when the neighbouring stations have all gone to roost, it is easy to receive transmissions from Reykjavik. I have logged this station several times during the last week, and might add that the dance band heard is on a par with that usually working from Copenhagen. It is a very good one.

Newsreaches me that the Danes also contemplate increasing the power of the Kalundborg transmitter, which since its advent has kept to a modest $7\frac{1}{2}$ kilowatts. Bergen (Norway), which is now relatively an old station, is to have a 25-kilowatt plant.

I observe that the Brussels (No. 1) opening signal has altered its tone; it now consists of a

deep, long-drawn-out hoot, somewhat similar to that of Munich. When the broadcasts start at the full hour the "hoot" is followed by the conventional "pips" or dot-seconds to indicate the exact time. You may have noticed that the announcer—our old friend Bracony—now calls: "Allo! Ici Bruxelles I.N.R." (phonetic, EE-enu-air), the initials indicating the Institut National de Radiodiffusion, the association responsible for the existence of the service.

In my last notes I referred to the Portuguese station CT1AA (Radio Lisboa) on 291 metres. I have been informed that any listener who cares to report reception to the owner, Senhor Abilio Nunes dos Santos Junior, 144 Avenida Antonio Augusto d'Aguiar, Lisbon (Portugal) will be rewarded with an illustrated postcard depicting the transmitter and giving full technical details.

Radio Paris

In anticipation of the birth of its new station, Radió Paris has somewhat pepped up its programmes of late, and now promises relays of some of the finest concerts the French capital has to offer. On Saturdays, at 9 a.m., a relay is carried out of a musical entertainment from the Paris Conservatoire of Music, at 5 p.m. of the famous Lamoureux musical recitals, and on Sundays at 5.15 p.m. of the equally famous Poulet concerts. In future, gramophone records may play a less prominent part in the daily programmes.

At odd times during the day for the next week or so you may tune in Brussels No. 2 and discover that the broadcasts, as regards power, are below par. This is explained by the fact that during the period of the radio exhibition in that city the 1-kilowatt plant is being brought into operation whilst the 20-kilowatt at Velthem (Louvain) is resting.

By the way, look out for tests on about 280 metres. These are being carried out by the

IMPEDANCE . . .

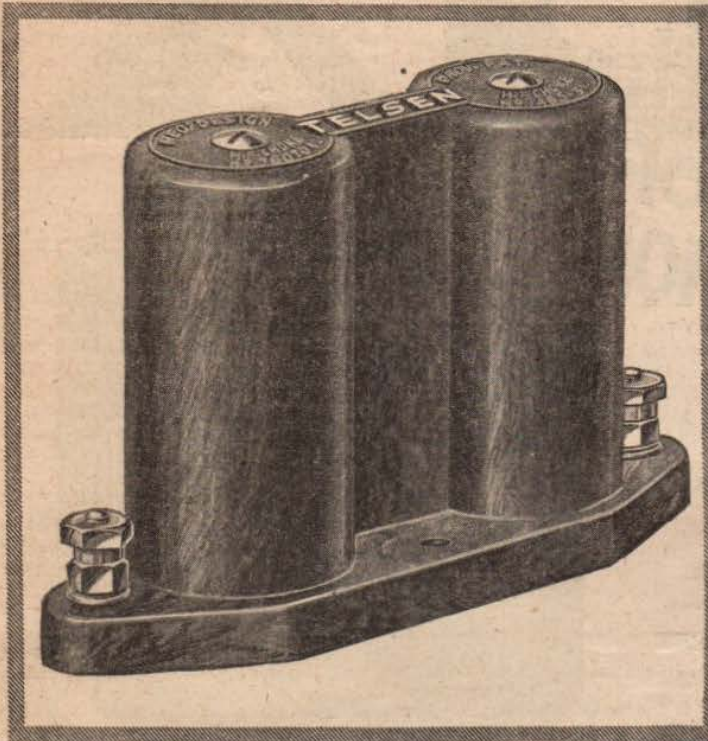

TELSEN BINOCULAR H.F. CHOKES

It is the function of an H.F. Choke to present the highest possible impedance to H.F. currents at all wavelengths. Particularly does this apply to the popular tuned grid arrangement of screened-grid amplification, where the performance of the whole set is limited by the value of the impedance in the anode circuit of the screened-grid valve. It is equally important that this high efficiency should be maintained over the whole broadcast band.

Telsen Binocular H.F. Choke. Price 5/-.

Telsen Standard H.F. Choke. Price 2/-.

The Curve adjoining (published by courtesy of AMATEUR WIRELESS) represents the efficiency over the Broadcast Band, as measured at the Furzehill Laboratories by J. H. Reyner, B.Sc., A.C.G.I., D.I.C., A.M.I.E.E., M.I.R.E., who says: "This curve shows the fine performance of the new Telsen Binocular H.F. Choke . . . the performance factor exceeds 95 per cent. at all points, and there is a distinct freedom from subsidiary resonances. . . . This Choke must be considered as taking its place as the best on the market."

Combined with its "fieldless" properties these figures show that where superlative performance is called for the choice must be the TELSEN Binocular H.F. Choke.

Send for the "Telsen Radio Catalogue" and book of "All-Telsen Circuits" to The Telsen Electric Co., Ltd., Aston, Birmingham.

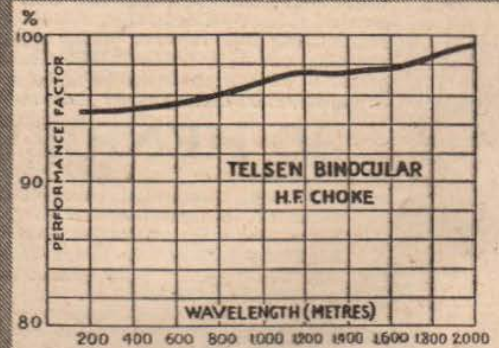

TELSEN

THE SECRET OF PERFECT
RADIO RECEPTION

CVS-81

DUX

COMPLETES the
CIRCUIT of
SATISFACTION

The first selection of
DUX for the
"A.W." "Three Star Three"

set is significant of its *absolute dependability and efficiency*. "DUX" is the indisputably *Best Low Priced Transformer* for every suitable circuit. In less than two months the demand for this fine, British component necessitated immediate and rapid addition of new workshops, more machines and more British labour—a fact that endorses the remarkable test reports of the reputable technical press, by whom "DUX" has been credited with a performance equal to that of transformers costing many times the price.

30 HENRIES

is the remarkable inductance given by "DUX" and, remember, the published technical information and diagrams, given with this transformer as with the highest priced article, *prove before you buy* that "DUX" performance will be pre-eminently satisfactory.

Ratio 1 : 3½ (standard) or 1 : 4½ (auto-connection). Weight 11½ oz. Size, 3½ x 2 x 2½ in. high. List No. DY 29.

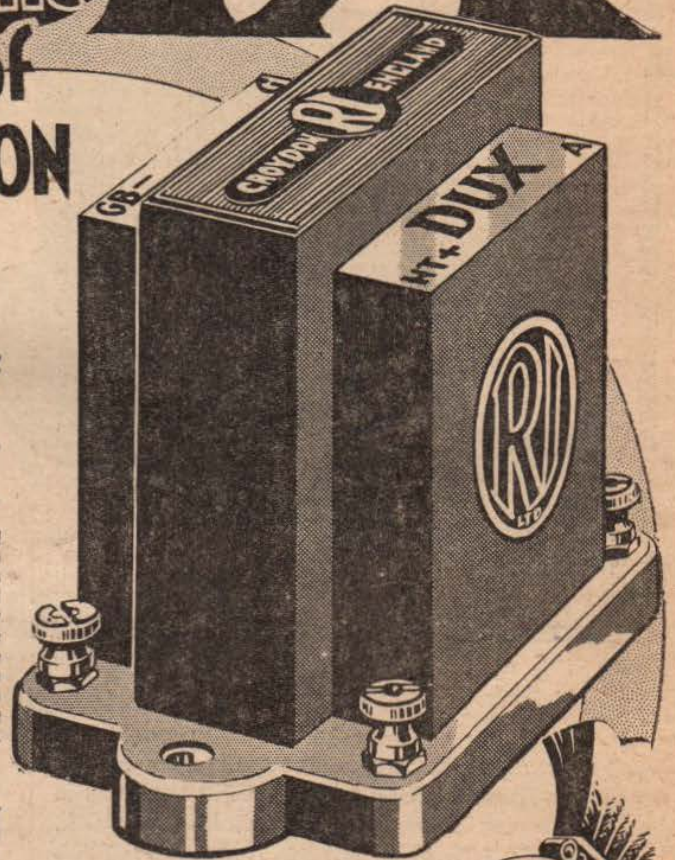

6'9



'DUX' The Leader
in Low Priced
Transformer Efficiency



COMPONENTS ARE BEST
FOR SET BUILDERS!

T.A.

LTD.

Advt. of Radio Instruments Ltd., Croydon, England. Telephone : Thornton Heath 32 11

Advertisers Appreciate Mention of "A.W." with Your Order

THE RADIO FIRE DANGER

Listeners sometimes wonder if there is any real danger of fire in working a set either from batteries or mains. Here the leading points are discussed and hints are given for safe operation

AFTER a fatal fire at Stepney recently the suggestion was made by a fire station official that the wireless set might have been the cause of the trouble. "The wireless set worked from the mains," he said, "and it is also possible to cause a fire by short-circuiting the accumulators."

This may have set a number of listeners wondering how they are placed with regard to the fire danger. There is a popular idea that fire risks are greater when working from the mains than when working from batteries, but really this is a fallacy.

Protection by Fuses

One reason is that most mains sets are protected by a fuse in some way, even if it is only the ordinary lighting fuse, whereas users of battery sets do not realize the same necessity for protection by fuses.

If a short circuit occurs in any of the



Care should be taken when charging an accumulator from the mains that the leads are in good condition and well insulated. A partly corroded wire might easily get hot and set fire to the insulation

mains wiring the fuse blows at once and, unless the wires have already started to smoulder, there is no fire danger.

With batteries there is a greater risk.

An accumulator or even a dry high-tension battery in good condition can stand up to fairly heavy current discharge, and if there are two wires running together with faulty insulation, the silk or cotton may start to smoulder, and there will be nothing to stop the current flow until a fine wire in part of the circuit gets red hot and snaps.

In a set working normally there is no component which should be at a very high temperature, even with a D.C. mains set, where a dropping resistance is used for the filament. The danger comes not in high temperatures, but in inflammable parts.

Sets which are sometimes said to be "struck by lightning" are more often simply set on fire by the passage of a high static current induced by the aerial through the comparatively fine wire of one of the tuning coils. This sets the insulation smouldering and the coil former, if of some impregnated material, will soon start to burn. Ebonite is safer but will melt, of course, if the heat is fairly great.

Danger from the High-tension

This trouble in tuning coils can be caused by a short-circuit in some part of the reaction wiring, causing the H.T. to run through the reaction and aerial coils to the negative side of the circuit.

This may cause a fire if the high-tension battery does not run down and develop a high resistance before the wires smoulder.

Accumulator leads must be kept clean and free from acid or they really do present a certain amount of danger. It is a bad plan to have twisted flex leads clamped directly under the terminal heads. Use proper link or spring connectors for the terminals and preferably untwist the wire for a distance of 6 in. or so. Green corrosion is otherwise apt to spread along the wires and if it rots the insulation will cause a short circuit in time.

Overworked filament transformers in a mains set run hot, but it is very rare to find one that gives any danger of fire. Usually excessive heat causes a break in the windings and the current stops before any damage is done.

There is just a tiny risk, though, that the primary and secondary might short-circuit and cause a sudden rush of current before the mains fuse goes, and in any case one gets bad filament regulation with an overworked transformer.

Many set connections which are regarded as "dangerous" from an electric shock point of view in a set, are not at all dangerous in the way of producing fire. Loud-speakers at a high-tension potential above earth can cause shocks if the terminals are touched, but even if a direct short circuit crops up the loud-speaker windings will break before enough heat is set up to cause a fire.

If an output unit is fitted then the windings of the choke or transformer may fracture, but owing to the resistance of the windings in series with the sharply-increasing resistance of the high-tension battery as it runs down, there is generally not enough current flowing to be dangerous.

High-tension condensers with faulty

insulation will sometimes smoulder, but not when mica is used as an insulation. These condensers are generally confined to mains units, too, where the construction is all metal and an all-metal chassis is used, so that a smouldering condenser would cause no danger. There would be danger if

Twisted leads of which the insulation is poor are always a potential danger



the condenser were screwed to a plywood baseboard, for the smouldering might spread. If one uses condensers well up to their rated values and with mica insulation wherever possible, there should never be any danger from this source.

Provided care is taken in this respect, and in the mounting of low-tension resistances in D.C. mains sets, where there is, as a rule, a fair amount of heat dissipated, the fire risks of a wireless set are negligible.

U.

MOVING-COIL SPEAKERS

IT sometimes happens that after replacing an ordinary speaker by a new moving-coil instrument, one gets an impression that the newcomer is not so sensitive as the old, and for this reason is inclined to be disappointed with the change. Actually, the impression is more subjective than objective—that is to say, it is due more to the listener than to the instrument. The comparatively lower pitch of the moving-coil speaker—even when radiating the same sound intensity—is heard on a less favourable part of the ears' frequency-response curve. In short, allowance must be made for the fact that the human ear is more sensitive to comparatively high-pitched notes than to low.

M. B.

In these times Scottish farmers are naturally anxious to encourage all those qualities in their stock which are the most useful for production. Professor J. A. S. Watson, of the School of Rural Economy at Oxford University, who will talk on the subject of "Judging for Utility" to Scottish farmers on November 18, will outline some of the main rules to be followed by those who wish to encourage the productive qualities in their stock.

THE HOW AND WHY OF TUNING—IX

USING THE TAPPED SOLENOID COIL

Another of a comprehensive series of articles on tuning, specially written for newcomers to wireless.

I HAVE before me the coil shown by the pictorial diagram marked Fig. 1. It is the simplest possible solenoid tuning coil, tapped to provide us with the material for useful experiments. Everyone who is following this series should make up the coil and carry out the simple but instructive experiments detailed in this article.

To make the coil, a $3\frac{1}{2}$ -in. diameter coil former is the first requirement. On this is wound some No. 20-gauge double-cotton-covered wire. Altogether 46 turns will be wound, but after the first 14 turns have been put on the former we have to start a series of taps. These are made every 4 turns after the 14th. The best way to make the taps is to insert a small strip of insulating material along the winding, as is quite clearly indicated in Fig. 1.

A B.B.C. Coil!

The raised turns of wire must then be bared along, say $\frac{1}{2}$ in., so that contact may be made to whichever turn is wanted in circuit. A crocodile clip is useful for making these tapping contacts.

I ought to mention that this particular coil, which can form the basis of many simple sets, was specified by the B.B.C.

Across the two ends of the coil is connected the usual .0005-microfarad variable condenser. Here we must refer to Fig. 2, which explains the different uses of tappings on the coil. Note that at A the aerial lead is shown connected to the tap nearest to the earth end of the coil. The effective aerial circuit, is therefore, the aerial and earth, with 14 turns of wire in series with them. This 14 turns is also common to the main tuning circuit, which consists of the whole coil shunted by the .0005-microfarad variable condenser.

This A circuit is known as auto-coupling, being a form of transformer, with the aerial circuit as the primary and the tuned coil as the secondary. The capacity of the aerial affects only the 14 turns in series with the aerial and earth, so the wavelength-increasing effect of the aerial on the whole coil is reduced.

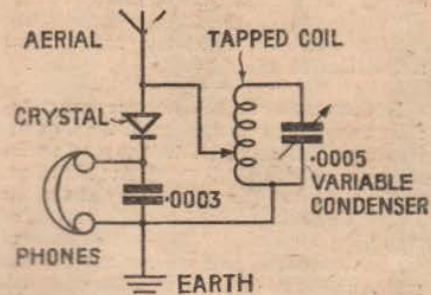

Fig. 3. An efficient and very selective crystal circuit with tapped coil

The aerial is shown connected to the tap that gives the maximum selectivity. Less selective tuning will be obtained as the aerial is taken to taps more remote from the

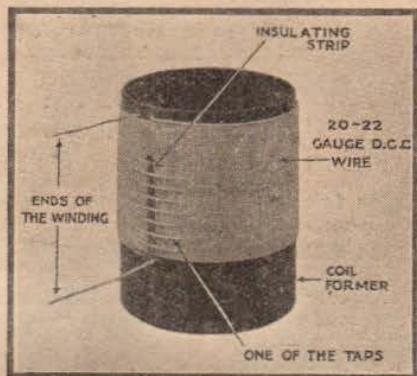

Fig. 1. Constructional details of a tapped solenoid coil

earth end of the coil—that is, as more of the coil is included in the aerial circuit.

Now look at the Fig. 2 B circuit. Here we have another sort of tap, this time affecting the detector. Instead of taking the aerial end, that is, the end of the coil remote

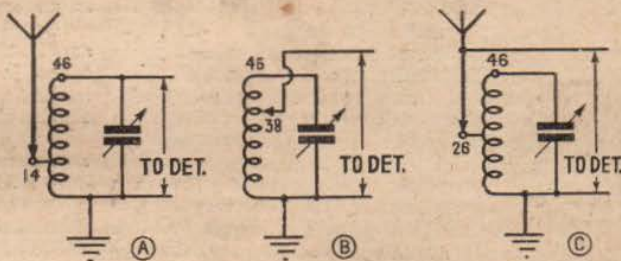

Fig. 2. Methods of tapping a tuning coil

from earth, to the detector, this is connected to the coil say, half-way towards the earth end.

The detector is connected across only a part of the whole coil. The damping effect of the detector, particularly of the leaky-grid detector, is reduced by tapping down in the manner indicated. At B the 38th turn is utilised. This will help to improve the selectivity by reducing the damping across the tuning coil and various degrees can be obtained by altering the taps. Often it is found that tapping down the detector increases the sensitivity.

There is no reason why the two tapping arrangements of A and B should not be combined, as at C in Fig. 2. Quite a common plan is to make use of one tap for the aerial and detector connection, leaving the top end of the coil connected only to the variable condenser.

Here at C is shown how the tapped solenoid can be used with the aerial lead and detector lead taken to a common tapping

point, namely the 26th turn from the earth end. Experiments can be carried out by the reader to see how results are affected by varying this common tap, or the experiment can be elaborated by taking the aerial to one tap, say the 14th turn, and the detector to another tap, say the 38th turn.

An Efficient Crystal Circuit

Fig. 3 shows how the common tap idea can be applied to a simple but extremely effective crystal set. In addition to the coil already described, the constructor of this crystal set will need a .0005-microfarad variable condenser, a crystal detector, preferably of the semi-permanent type, or else one of the proprietary galenas, a .0003-microfarad fixed condenser and a pair of headphones.

The aerial and one side of the crystal are connected to the tap, whichever is chosen, and the other side of the crystal is connected to one side of the phones, the remaining side of which goes to earth and one end of the coil. The other end of the coil is not connected, except to the variable condenser, which, of course, is across the whole coil.

This is the best crystal circuit I have yet tried. It enables twin regional stations to be received at good strength and, what is equally important, it separates the two programmes completely. By the way, the fixed condenser across the phones is not just an extra—it is an essential part of the detection.

Fig. 4 shows how the tapped coil can be applied to a one-valve set, with the grid circuit tapped down the coil and the aerial lead connected to a tap down near the earth end of the coil. This set would give very strong headphone results in the reception of regional programmes, but its usefulness could be considerably extended by adding reaction. That is another story, so next week we will see how to apply reaction to simple tapped solenoid coils, and also to plug-in coils.

HOTSPOT.

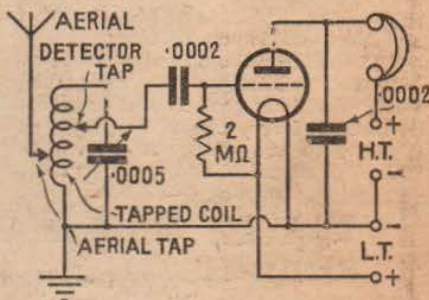

Fig. 4. Tapped coil in a selective one-valve circuit. Values are given, it will be noticed, for the condensers and the grid leak—suitable for a one-valver



OUR BROADCAST CRITIC

TALKS ABOUT—

The WIRELESS SINGERS

MY admiration for the Wireless Singers is growing apace.

To begin with, they sing some very good English music and I do not feel that cheap foreign goods are being dumped on me. I say that because at the time when so many of the madrigals they sing were written, the standard of English choral singing was never greater.

In the days of good Queen Bess choral singing in England was almost part and parcel of the nation's daily routine. Since then we are supposed to have lost the art, but I am beginning to think we are regaining it, for I heard some really fine singing by the Wireless Singers the other night.

I am not suggesting that the choir is perfect; I could point out blemishes. That, however, need not be done here. The point I want to make is that Stanford Robinson has taken an immense amount of trouble over this choir, with which he is effecting, in my judgment, one of the most satisfactory forms of broadcast.

There is something very English about these madrigals and part-songs which appeals to me enormously.

Well, I have taken my second dose of the Ridgeway Parade. It was no worse than the first.

Mr. Ridgeway told us all to prepare for *Sweetheart Night*. All sweethearts, young and old, were to get together and look forward to a jolly evening.

Not being very young, nor yet very old, I rather felt I was not being catered for.

One can always tell when a Ridgeway Parade begins by the noise.

I have now found the composition of these Parades. You take a dozen or more songs and interpolate a few senseless remarks in Cockney English, accompanied by shrieks from the rest of the caste—and there you are.

When I had recovered from "I'll be your Sweetheart," I was completely overcome with emotion when the lady sang, "Could yew be trew, Tew oyes of blew?," and wept copiously.

But how I laughed when the funny gentleman said he couldn't imagine why the last sardine was so desperately anxious to get into the tin because he could easily have caught the next one!

That was a scream; I dried my tears at once!

Never mind; I heard a real jolly song, sung by Keith Faulkener. The song was called "How Jovial is My Laughter," and

the composer was a certain John Sebastian Bach.

Now, of course, a recent correspondent will say: "There he goes again: the man is mad on Bach!" Don't you believe it, but I know a jolly song when I hear one; and that is one of the jolliest songs that I know.

I now want the B.B.C. to have Keith Faulkener in a Vaudeville Hour and in a Ridgeway Parade, and I want him to sing that song.

I am perfectly certain that every listener would agree that it is real good fun. I'm not joking; I mean it.

Did you hear the Strauss concert—the Sunday one, I mean?

I wonder what the general opinion of Strauss is amongst readers of AMATEUR WIRELESS! He appeals to me very much. I think that his music should not be too dissonant to many who are not actually skilled or trained in music.

I did not get to Queen's Hall this week, unfortunately, but I heard bits, here and there, of the concert. Judging from the

sound of it, Queen's Hall gave Strauss a great reception. He deserves it.

I enjoyed the Covent Garden relay of *Butterfly*. I thought Odette de Foras was tip-top. I should like to hear more of her. Can she not be asked to give a recital soon?

I thoroughly enjoyed Leslie Weston the other night. Now, there is a comedian who is really funny!

I managed to listen for a few minutes to Helen Henschel singing Schubert in the Foundations. Hers is a good *lieder* voice. It is not every one who can sing Schubert, by any means.

Wish Wynne, whom I heard in the second presentation of the Vaudeville, amused me very much.

I think I want to suggest to her that she might vary the style of her impersonations a little more.

The Russian singer in the same programme was quite attractive, to my way of thinking. It is a good idea to introduce good singers into Vaudeville.

I tried another sample of Paul Robeson in "God's Trombones." On the whole, I think I got on better with him this time, but I do not feel that I shall ever look forward to this type of broadcast.

Looking back on the lighter side of the week's broadcast, I am inclined to suggest that there shall be less noise in the background. Not everybody has a perfect set, and it is surprising how easily the main theme is lost when too much is going on.

WHITAKER-WILSON.



An impression of Roy Fox
Conductor of the dance band at the
Monseigneur Restaurant

Following a recent visit paid by the Minister of Posts and Telegraphs to the French Riviera, France intends to erect a 60-kilowatt transmitter in the neighbourhood of Nice. The wavelength to be adopted would be that of 286 metres actually used by PTT Montpellier. The transmitter would be connected to studios at Nice, Cannes, and other well-known watering-places on the Mediterranean. It would form part of the French State broadcasting system.

ALL interested in the home construction of wireless sets must have noticed a changed tendency among the set manufacturers, who have nearly all forsaken the simple panel-and-baseboard construction.

In good commercial practice we now find that metal is extensively used, not only for the screening of the separate components, but for the framework upon which the components are fixed.

On looking further into modern factory-built sets we find that above the metal platform supporting the coils and tuning condensers there is practically no wiring. Nearly all the connections are made below the chassis. There are, of course, production reasons for this difference between factory and home-built sets.

A New Type of Home-constructor Set

But in seeking a break-away from the standardised panel-and-baseboard construction we could not help noticing that the technique of the factory offered definite advantages to the amateur. A metal chassis lends itself to scientific engineering. It enables a set to be built up as a more coherent whole than is sometimes possible with existing amateur set-building methods.

In all sets for the home constructor we have to bear in mind the limitations imposed upon the layout by the blueprint. If the set constructor cannot follow the blueprint the set clearly fails as a home constructor's product.

The built-up nature of the factory-built metal chassis, with its somewhat complicated arrangement of wiring, obviously does not lend itself to a simple blueprint interpretation. It occurred to us that this disadvantage of the chassis-built set would be completely overcome if absolutely all the

The THREE

The AMATEUR WIRELESS "Star" series of sets has arrived! Designed and exhaustively tested by the writer, in close co-operation with Mr. S. Rutherford Wilkins, these new sets are the culmination—



By ALAN HUNTER

wiring were done immediately underneath the chassis. Then the blueprint could show the wiring as it really was in the set—namely, in one plane.

The mounting of the tuning coils and condensers, together with other components needing panel control, would have to be arranged so that terminal connections were accessible from underneath the chassis.

It was with these considerations well before us that we set out to design the first of the AMATEUR WIRELESS "Star" sets. We quickly found that our theoretical ideal could be extremely simply put into practice. With the willing and much-appreciated co-operation of several component manufacturers, we assembled the first of the "Star" sets—a three-valver with all the latest circuit improvements.

Chassis Built

Constructionally, as will be seen in next week's issue, the "Three Star 3" is entirely free from snags. The clean layout of the coils and three-gang condenser on top of the metal chassis will inspire an early confidence that further examination will serve to enhance.

At this stage it is only fair to point that the chassis-built set limits the designer somewhat in his choice of components. Once the most suitable components have been chosen, the metal chassis must be stamped out accordingly. The use of alternative components will be explained next week.

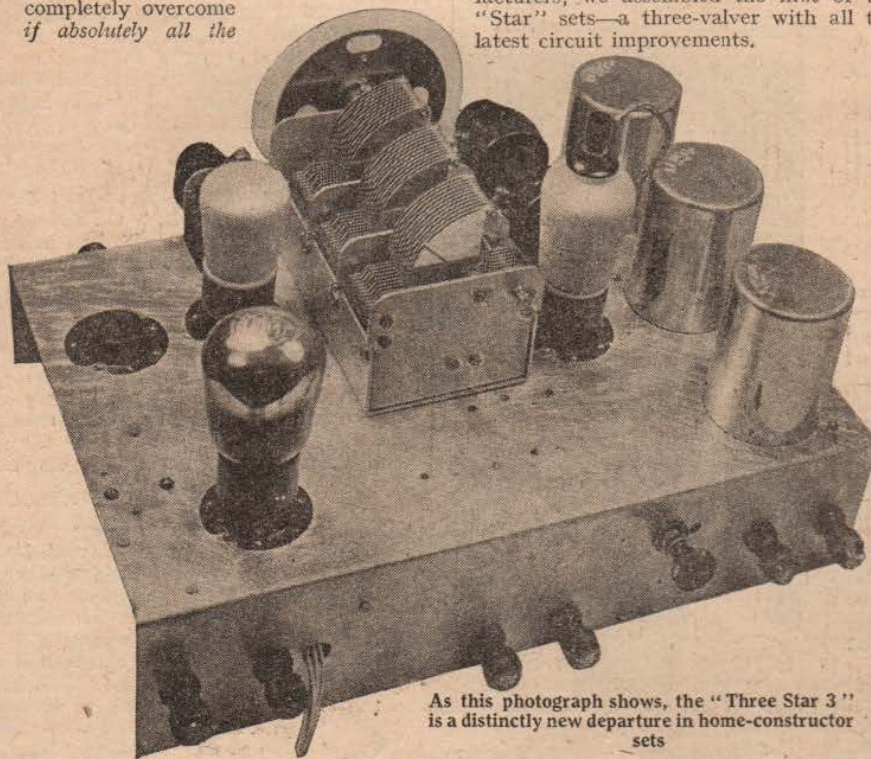

As this photograph shows, the "Three Star 3" is a distinctly new departure in home-constructor sets

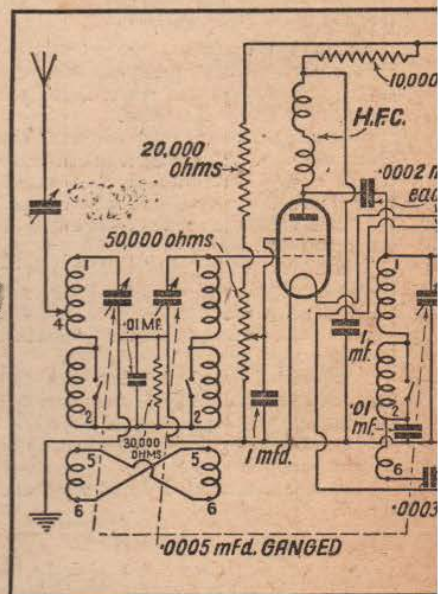

STAR 3

—of a long series of experiments. But there is nothing experimental about the sets finally evolved, which are as perfect as modern technique is capable of making them.

Most constructors of these sets will probably buy a complete kit of parts from one of the firms specialising in this business, such as Ready-Radio or Peto-Scott.

the first of the "Star" sets, which is the "Three Star 3," is absolutely complete down to the last detail. Quite apart from its novel practical interpretation, this three-valver is outstanding because it includes every modern circuit improvement experience has shown worth while.

The Circuit

As we are going to describe the construction of the "Three Star 3" next week, we think readers will be interested in a preliminary discussion of its circuit reproduced with this article.

The sequence of valves is almost inevitable—a screen-grid high-frequency amplifying stage, a leaky-grid detector, and a transformer-coupled pentode output.

Let us examine this three-valve circuit in some detail. The first thing that will strike the reader is the inclusion of band-pass tuning between the aerial and the screen-grid valve. We have had special Lewcos coils designed for these sets, providing excellent band-passing at a moderate cost.

Band-passing

The band-pass tuner consists essentially of two separate tuning circuits, coupled together in two ways, firstly by means of a link coil and secondly by means of a condenser. The number of turns in the link coil has been carefully worked out to provide the best compromise between selectivity and volume. The .01-microfarad fixed condenser provides an even band-pass action over the whole tuning range, both on medium and long waves.

As the moving vanes of the sections of the three-gang condenser are connected to the earthed metal chassis it is necessary to connect the .01-microfarad coupling condenser between the joined ends of the band-pass coils and earth.

In order to achieve accurate matching between the band-pass coils it has been found necessary to include a small variable condenser in series between the aerial lead and the tap on the aerial side of the band-pass coil. One particular setting of this condenser will so adjust the aerial load that perfect matching is obtained.

We have to consider the two band-pass coils in relation to the tuning circuit coming between the screen-grid and detector valves. This grid tuning coil is accurately matched with the band-pass coils and is tuned by means of the third section of the three-gang condenser.

RUTHERFORD WILKINS

The stamped metal chassis is made as adaptable as possible. It will be found that in the three-valve chassis to be described, accommodation has been left for an extra valve-holder, so that the same chassis will do for the four-valver to be described at a later date. Moreover, duplicate fixing holes for the gang-condenser and low-frequency transformer will be provided for later modifications.

We should like to emphasise the fact that

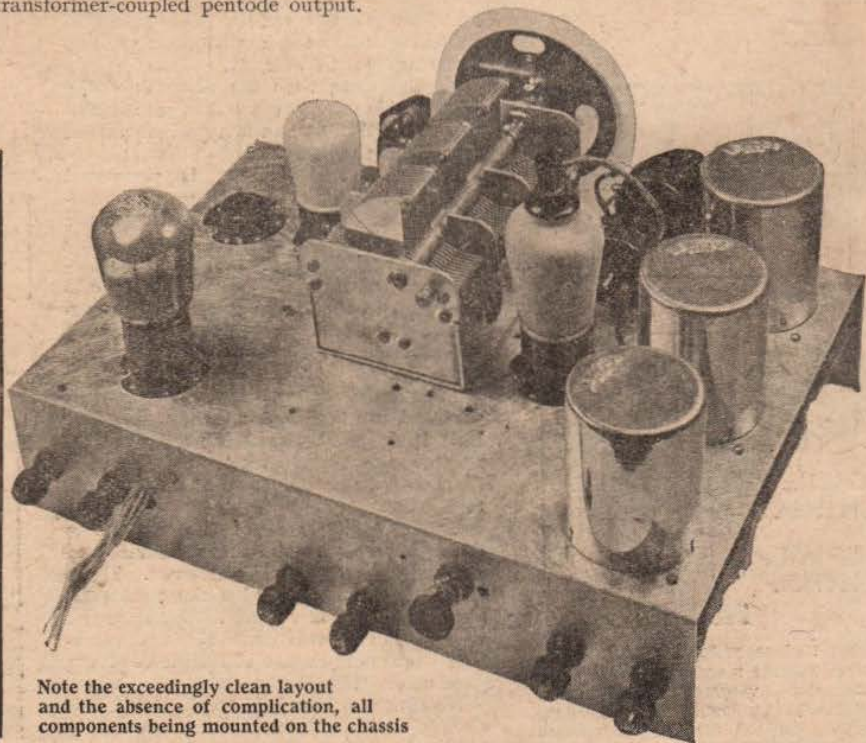
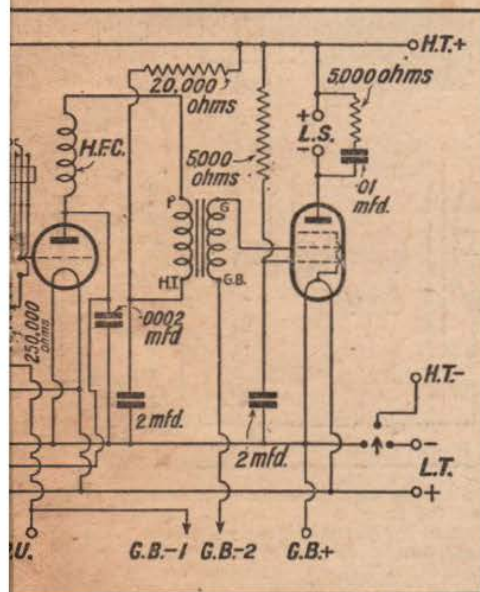

Note the exceedingly clean layout and the absence of complication, all components being mounted on the chassis

"THE THREE STAR 3" (Continued from preceding page)

It will be seen that to balance this inter-valve coil with the two band-pass coils a .01-microfarad fixed condenser is connected between the lower end of the coil and earth.

denser coupling this choke to the tuned circuit in the grid of the detector valve. The anode circuit of the screen-grid valve is decoupled by means of a resistance in series between the choke and high-tension

dual volume control. When the set is used for radio, volume is controlled by means of a potentiometer in the screen circuit of the screen-grid valve. This enables the sensitivity of the screen-grid valve to be varied,

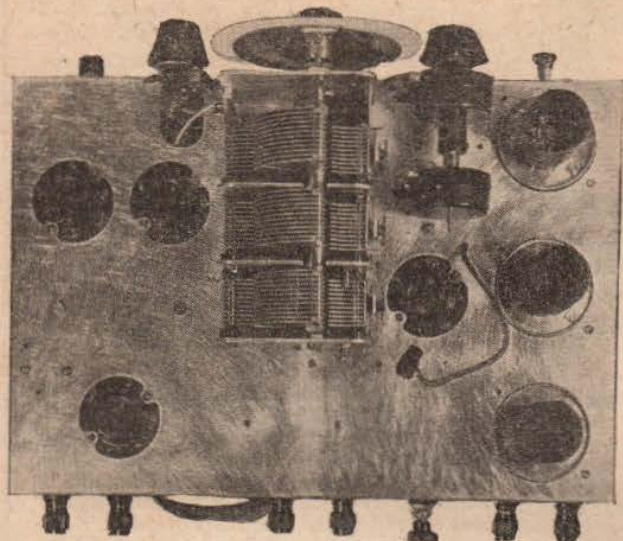

On the left is a plan view which should be compared with the layout diagram. The picture on the right shows the complete receiver in a cabinet specially designed by Messrs. Peto-Scott

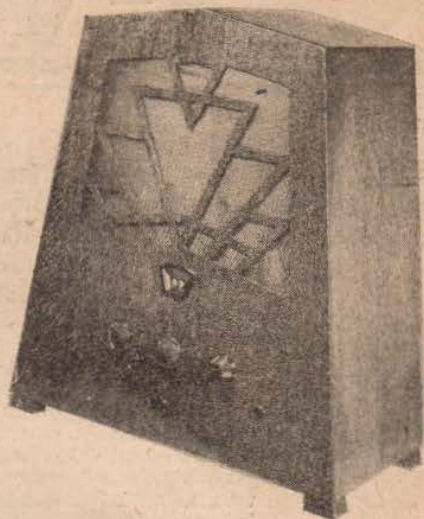

Although there are three separate tuning coils and three .0005-microfarad variable condensers, tuning is entirely a one-knob operation, thanks to the excellent matching of the coils and the three-gang variable condenser.

The coupling between the screen-grid valve and the detector valve consists of a high-frequency choke in the anode circuit of the screen-grid valve, with a fixed con-

supply, and a 1-microfarad by-pass condenser.

At the grid of the detector is inserted a

A FULL-SIZE LAYOUT AND WIRING DIAGRAM OF THE UNDERSIDE OF THE CHASSIS WILL BE GIVEN NEXT WEEK

thus giving a full control of amplification and therefore of volume.

When the set is used for gramophone reproduction, another volume control is brought into circuit by a suitable arrangement of the gramophone pick-up switch. A careful examination of this switching circuit will show that as the grid of the detector is switched for gramophone reproduction it

(Continued on page 944)

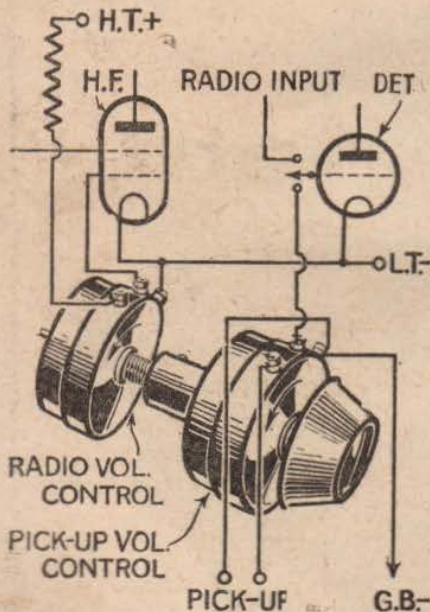

There are two separate volume controls. Control of volume on radio is effected by a potentiometer varying the screen-grid valve grid volts. A potentiometer controlling the pick-up out-put acts as the volume control in gramophone working.

multi-purpose jack switch. This method of switching enables a gramophone pick-up to be brought into circuit.

At the same time the filament of the screen-grid valve is cut out of circuit, and the grid of the detector is negatively biased through the pick-up.

High-frequency current is prevented from passing into the low-frequency amplifying circuit by means of a high-frequency choke in series between the anode of the detector and the primary of the low-frequency transformer. This choke diverts the high-frequency through the .0002-microfarad fixed condenser connected between the anode of the detector and earth.

The pentode output circuit is tone compensated to avoid high-note accentuation. This is done by connecting a 5,000-ohm resistance in series with a .01-microfarad fixed condenser across the loud-speaker terminals.

The screening grid of the pentode is decoupled with a 5,000-ohm resistance and a 2-microfarad fixed condenser. These circuit improvements give the pentode a chance to work at its best. The balanced tone will be a revelation to those who imagine that pentodes are incapable of giving good quality!

Nothing has been left to chance in this circuit. We have mentioned practically everything now except the provision of a

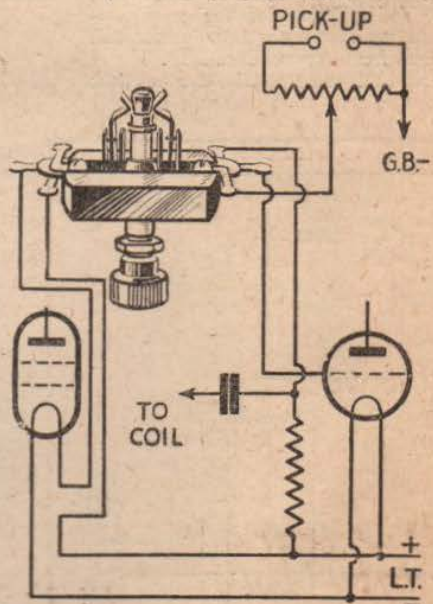

Details of the radio-gramophone switching. When the knob is out the S.G. filament circuit is completed and the radio output is applied to the detector grid. When the knob is in, the S.G. valve filament circuit is broken and the detector grid is switched to the slider of the pick-up volume control.

BROADCAST ARTISTES IN PICTURE



RUTH KEMPER.—The young American violinist and conductor, who gave a recital on October 30



JEAN JACQUES OBERLIN.— Gives weekly talks on French from the Glasgow station



SIDONIE GOOSSENS.— Harpist of the B.B.C. Symphony Orchestra. A noted soloist, as well as orchestral player



LYELL JOHNSTON.—One of the best known and earliest of actor-entertainers, and organizer of the Soldiers' Entertainment Fund



OLGA THOMAS.—Often gives special recitals of foreign music



MARJORIE HAYWARD.—One of the earliest of the classical violinists to broadcast



GEORGE ROTH.—A member of a clever musical family, M. Roth is the 'cellist of the well-known quartet



WILLIAM BARRAND.—One of our finest bass singers, famous for his operatic work with the B.N.O.C.



MARY HAMLIN.— A fine soprano singer, particularly noted for her part in the Bach cantatas on Sundays

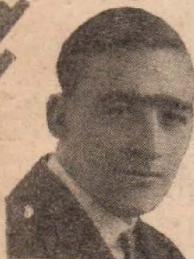

GEORGE PIZZEY.—An early broadcaster, he appeared before the microphones in 1922. Few vocalists have had wider experience



LILLIAN HARRISON.—A great wireless favourite. She is best known on the stage in musical comedy work



REGINALD FOORT.—One of the first organists to broadcast regularly cinema music. He is now at the Regal, Marble Arch



RICHARD STRAUSS.— Composer and conductor. His works are masterpieces of colossal sound



IN MY WIRELESS DEN

Weekly Hints—
CONSTRUCTIONAL & THEORETICAL
BY
W. JAMES

Output Transformer Facts

THE output transformers used to couple the power valve of your set and the speaker ought to be very carefully chosen.

If you make tests of a number of makes of transformers, using a fairly good set and speaker, you will discover that the quality varies by a considerable amount. With some transformers the higher notes will be definitely weak in comparison than when a better make is used.

Then again, the lower notes will be poor when other makes are used.

When the transformer is a very poor one, both the upper and lower notes will be missing. The best plan should be, of course, to buy the transformer recommended by the makers of the speaker. But here, unfortunately, you may not be doing the best thing if the transformer is specially made to sell at a low price.

Tests show that if the transformers supplied with some loud-speakers are removed and the best-made transformers are fitted, the results are greatly improved. Much depends upon the output valve, of course, and the amount of the current flowing. Some transformers will not work properly when the current is above a certain value, as core saturation occurs.

H.F. Amplification Snares

The modern screen-grid valve is a very clever job. With its low anode-grid leakage capacity and its high slope the valve may truly be said to be a fine piece of work.

My own experience is that relatively few faulty valves get out. It is always possible to find one out of half a dozen that gives better results than the average, but I believe the standard of uniformity to be very good.

The characteristics of the valves now being issued are such that considerable magnification can be obtained. Circuits must, of course, be suitable and the screening, in particular, must be good. Many circuits are not properly shielded and the result is that instability occurs before reasonably good amplification is obtained.

With good tuning coils properly shielded and with the usual precaution taken in decoupling the circuit, an amplification of several hundred is easily obtained. A defect in the shielding may reduce the amount obtainable with stability by 30 per cent. Coil covers should always be complete electrically, with no cracks or open joints when the greatest magnification is being aimed at.

The grid and anode circuits should be de-coupled, too, using stopping resistances and condensers. Valves should be shielded, the detector as well as the high-frequency valve, and if a choke is used this ought to be shielded. With complete shielding stability with high amplification is obtained.

Choke Coupling

Some choking coils, having a centre tap or other tapings, have sufficient inductance for them to be connected as indicated in the accompanying diagram, with satisfactory results. Chokes having inductances of over 100 henries may be so connected.

The circuit shows that the high tension is taken to one end of the choke and the

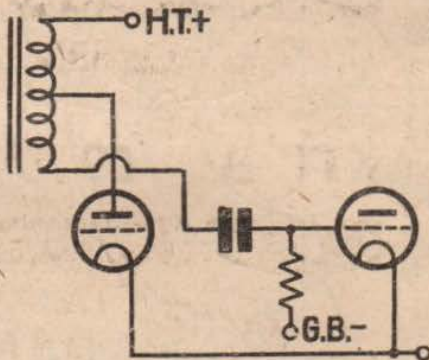

This method of L.F. choke coupling has many advantages. Details are given in the accompanying paragraph

anode of the valve to the tap. A fixed condenser of about .05 microfarad is connected to the remaining end and the circuit completed by adding the grid leak.

When the tap is at the centre point there will be, in effect, a voltage step up which will double the strength. The arrangement is, in fact, an auto transformer having a 2:1 ratio.

Choke coupling is not much used in these days. Transformers are so cheap, but the fact remains that the amplification is not uniform over the useful range of audio frequencies unless a good transformer is used.

There are many cheap transformers that give poor amplification and bad quality and the choke system shown will be better. The choke must have a high inductance if the results are to be satisfactory and the value mentioned of 100 henries could usefully be exceeded as the part included in the anode

circuit with a centre tap will be of only 25 henries.

Tracing Valve Faults

There is always the chance that a fault will develop when a new valve is fitted in a set. Take the detector position, for example.

The valve used during the past year has failed and a new valve of the most effective type for this stage is fitted. Being a better valve, its impedance may be lower than that of the valve formerly used, or its amplification factor may be higher. Thus there is the possibility that the stage will be unstable and motor-boating may occur.

This is usually cured easily enough, but there may not be room in the set for the by-pass condenser which will have to be added. The increased amplification or the better low-note response cannot be taken advantage of until the circuit is improved.

We may fit a new screen-grid valve in the high-frequency position of the set and have a little trouble. The chances are that more amplification will be obtained and the arrangement of the set may be such that the circuits are still quite stable.

On the other hand, the voltage of the screen may have to be reduced a little from the usual value in order to lower the amplification and to stabilise the set.

"THE THREE STAR 3"

(Continued from page 942)

makes contact with the slider of the potentiometer connected across the pick-up. As one side of this goes to grid bias negative this switching automatically makes the detector valve suitable for low-frequency amplification.

We should emphasise the fact that the screen-grid and pick-up volume controls are entirely independent of each other so far as their circuit connections are concerned. But to simplify the operation these two controls have their spindles ganged upon the same knob. We believe this is the first constructor's set to incorporate ganged volume control.

To summarise the circuit of the "Three Star Three," we have a screen-grid, detector and pentode sequence with band-pass tuning, ganged tuning operation, ganged volume control, full provision for gramophone reproduction, tone-compensated pentode output and adequate decoupling throughout.

Matching is Imperative!

Ready Radio

“THREE STAR THREE”
kits are
ACCURATELY MATCHED

APPROVED LIST AT A GLANCE

	£	s.	d.
1 Waldor cabinet by Ready Radio	1	5	0
1 Utility semi-screen three-gang variable condenser with disc drive	1	5	0
1 Lewcos ATG C coil	9	6	
2 Lewcos TBF C coils	19	0	
1 Junit metal chassis, complete with valve holders	10	0	
1 Watmel Binocular H.F. choke	4	0	
1 Telsen H.F. choke	2	0	
1 Readi-Rad .0003-mfd. reaction condenser	3	6	
1 Varley dual-volume control, values 50,000 and 250,000 ohms	14	0	
1 Lewcos .0003-mfd. maximum pre-set condenser	2	0	
2 Lewcos 5,000-ohm spaghetti resistances	2	0	
2 Lewcos 20,000-ohm spaghetti resistances	3	0	
1 Lewcos 30,000-ohm spaghetti resistance	1	6	
1 Lewcos 10,000-ohm spaghetti resistance	1	0	
1 Graham-Farish 2-meg. grid leak with terminals	10		
3 T.C.C. .0002-mfd. fixed condensers, type S	3	9	
3 T.C.C. .01-mfd. fixed condensers, type S	7	6	
1 Lotus Jack switch, type JS0	4	0	
1 Formo multi fixed condenser bank	9	6	
1 Readi-Rad three-point on-off switch	1	6	
1 Readi-Rad fuse and holder	1	3	
1 R.I. Dux L.F. transformer	6	9	
6 Belling-Lee type B terminals, with insulated washers	3	2	
1 Belling-Lee S.G. anode connector	6		
1 Readi-Rad two-point terminal block	6		
5 Belling-Lee wander plugs	10		
2 Spa c terminals	3		
1 Packet Readi-Rad Jiffilinx	2	6	
3 Mullard valves to specification	2	8	6
5 Yards single flex, nuts and bolts	1	2	
	£10.14.0		

RECOMMENDED ACCESSORIES

1 Blue Spot 44R loud-speaker	£2	12	6
1 Pertrix 120-volt standard H.T. battery	15	6	
1 Pertrix 15-volt grid-bias battery	2	6	
1 Pertrix 2-volt 30 amp. accumulator	11	0	

KIT A £7.0.6

OR BY EASY PAYMENTS

Or deposit of 13/- and 11 monthly payments of 13/-

KIT B £9.9.0

OR BY EASY PAYMENTS

Or deposit of 17/6 and 11 monthly payments of 17/6

KIT C £10.14.0

OR BY EASY PAYMENTS

Or deposit of 19/9 and 11 monthly payments of 19/9

G.P. Kendall
B.Sc.

Chief Engineer, Ready Radio. (For many years Chief of Research for "Popular Wireless" and "Modern Wireless.")

DEMONSTRATIONS
at our Showrooms,
159 Borough High St.
(2 minutes from London Bridge Station).

TO INLAND CUSTOMERS.— Your goods are dispatched post free or carriage paid.

TO OVERSEAS CUSTOMERS.— Everything Radio can be supplied against cash. In case of doubt regarding the value of your order, a deposit of one-third of the approximate value will be accepted and the balance collected by our Agent upon delivery of the goods. All goods are very carefully packed for export and insured, all charges forward.

CASH or COD ORDER FORM

To: Ready Radio, Ltd.,
Eastnor House,
Blackheath, S.E.3.

Please dispatch to me at once the following goods.....

for which (a) I enclose (b) I will pay on delivery } (Cross out line not applicable) £.....

NAME

ADDRESS

A.W. 7/11/31

Dept. of Ready Radio, Ltd.

To: Ready Radio, Ltd.,
Eastnor House,
Blackheath, S.E.3.

EASY PAYMENT ORDER FORM

Please dispatch to me the following goods.....

for which I enclose first deposit of £.....

NAME

ADDRESS

A.W. 7/11/31

SETS OF DISTINCTION



COLUMBIA

£5 TWO-VALVER

Makers: Columbia Graphophone Company, Ltd.
Price: £5

ONE of the minor sensations of Olympia was the Columbia set I am about to review. At its inclusive price of £5 this little two-valver is surely the last word in value for money. Look what you get for your "fiver." A complete two-valve set, with medium- and long-wave tuning; two of the latest Osram valves, an HL2 for the detector and an LP2 for the output; a 99-volt high-tension battery; a 2-volt accumulator; a 9-volt grid-bias battery; and on top of all these accessories, a cone loud-speaker, with adjustable unit!

All these parts are contained in a neat, modern-looking cabinet of dark oak. The back of this cabinet conveniently slides up between two grooves, and so enables the operator to get at the valves or batteries. The latter are well packed into the available space behind the cone loud-speaker. I am glad to say the battery leads are clearly marked, not only to distinguish H.T. from L.T., but to indicate the voltages of the high-tension leads, of which there are two.

A Neat Assembly

The chassis of the two-valver is one of the neatest jobs in radio. So compactly is the bakelite valve platform arranged that there is heaps of spare room, even when the valves have been inserted. A solenoid coil is used for the medium waves and by the side of it is a pile-wound coil for the long waves. I see that tuning and reaction condensers have bakelite dielectric hence their compactness.

Looking from the front of the set, the aerial and earth terminal board is mounted on the left-hand side of the cabinet. There are two aerial sockets, A1 for normal reception, giving a fair compromise between selectivity and volume, and A2, giving less selective tuning but greater signal strength, as might be needed if the set were used more than say, thirty miles from a regional station.

The earth connection takes the form of a plug. The advantage of making the aerial connection sockets and the earth connection a plug is not, perhaps, obvious, but a little thought will show that if the aerial lead is connected to a plug to fit the socket and the earth lead is connected to a socket to fit the plug, the aerial can be very conveniently earthed, simply by removing the two leads from the set and joining them together.

Naturally, the simple circuit of the Columbia two-valver comprises a leaky-grid detector, with reaction applied to the

grid tuning, and a stage of transformer-coupled low-frequency amplification. I wonder the makers have not used the new economical pentode, but I expect this working to a five-pound note takes some doing!

Easy Control

The simple controls of the set are mounted at the top of the front of the cabinet. A rotary switch knob at the centre provides the wave-changing and also switches off the battery supply when the set is not wanted.

To the left and right respectively are the knobs for tuning and reaction. I see this reaction is marked "volume," and I refrain from the obvious comment only because I like the set too much to hurt its feelings.

Both these controls work 0-to-180-degree

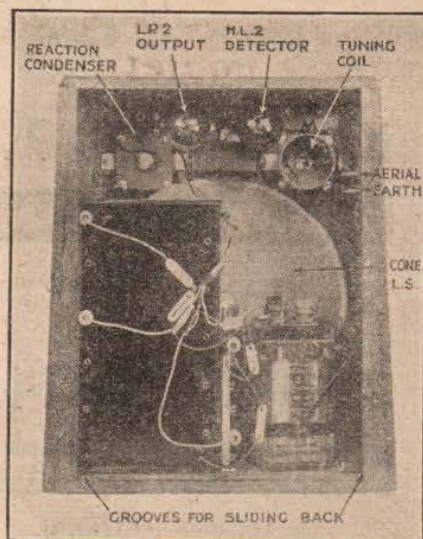

This picture indicates some of the outstanding features of the Columbia Two-valver

dials, so tuning and reaction settings can be noted, a point the non-technical members of the family will appreciate.

At the centre of the loud-speaker grille is the adjusting nut of the loud-speaker unit. This can be turned with the hand. Tests show it is no mere ornament!

Now about running this little set. You can do so very cheaply, for my tests show that the total anode-current consumption—which is the current drawn from the high-tension battery—is only $4\frac{1}{2}$ milliamperes, meaning that the battery will last many months before its voltage drops too low to enable it to provide good reception.

The current taken by the filaments from the accumulator is very small, and this cell will last at least twenty-five hours per charge.

To get the best results from this type of set, you simply must use an efficient aerial, not forgetting the earth, which ought to be made even better than the aerial.

The coil has been designed for connection to an aerial of between 70 and 100 ft., and on my test aerial of 60 ft. it was obvious that I could have included considerably more wire without losing that most precious of assets—selectivity.

Excellent Results

Using the set exactly as instructed by the makers, I was able to get results immediately I put the set in action. London National came in at 50 degrees and London Regional at 95 degrees. Although the makers do not emphasise the fact, this is essentially a local-station set—just as all two-valvers must be, in the nature of things. So the reception of the two regionals really finished the responsibility of this Columbia set.

But their strength was such that I knew I should be able to hear several other stations by careful manipulation of the tuning and reaction. Nor was I disappointed, for I came Midland Regional at 110 degrees and then North Regional at 140 degrees, both at fair strength. I later logged Söttens, Rome, Berlin, and Toulouse, not at good strength, but quite loud enough to identify and hear what was going on.

I ought to mention that the two local stations had each a total spread on the dial of 20 degrees, so there was no trace of interference between them.

On the Long Waves

On the long waves the set behaved exceptionally well. I got Daventry at 105 degrees and at such strength that I was not a bit surprised when I heard Radio Paris at 130 degrees and Eiffel Tower at 90 degrees, both at quite fair loud-speaker strength.

The quality of reproduction? Yes, that is important. Well, in my opinion it is satisfactory. Subject to the limited high-tension supply, which means subject to keeping the volume down to a modest output, the quality is up to the standard to be expected from a small cone worked from a small power valve.

Make no mistake, this is a wonderful way of spending a "fiver."

SET TESTER.

Ready Radio

"Britain's Super" MATCHED Kits

(matched under the supervision of Mr. G. P. Kendall, B.Sc.)

Kit 'A' (Less valves and cabinet) **£7.7.6** OR BY EASY PAYMENTS **Kit 'A'** 12 monthly payments of **13/6**

Kit 'B' (With valves less cabinet) **£10.15.0** OR BY EASY PAYMENTS **Kit 'B'** 12 monthly payments of **19/9**

Kit 'C' (With valves and cabinet) **£12.0.0** OR BY EASY PAYMENTS **Kit 'C'** 12 monthly payments of **22/-**

APPROVED LIST AT A GLANCE

	£ s. d.
1 Ebonite panel, 14 in. by 7 in., drilled to specification	4 6
1 "WALDOR" cabinet, with baseboard, by Ready Radio	1 5 0
1 J.B. two-gang .0005 variable condenser, type R2	1 1 0
1 J.B. single .0005 variable condenser, type R1	12 6
1 Colvern 50,000-ohm variable resistance (three terminal type)	5 6
3 Lewcos super-het coils, one oscillator and two intermediates, types I.F.T.P., I.F.T., Osc. 126	1 17 6
1 Lewcos band-pass filter unit with extension rod, type B.P.F.	12 0
*6 Junit 4-pin valve holders	4 0
1 Junit 5-pin valve holder	10
4 T.C.C. 1-mfd. condensers, type 50	11 4
1 T.C.C. 2-mfd. condenser, type 50	3 10
2 T.C.C. .0002-mfd. fixed condensers, type 34	3 0
1 T.C.C. .0003-mfd. fixed condenser, type 34	1 6
1 Read Rad 1-meg. grid leak and holder	1 4
1 Read Rad Super-het choke	5 6
1 R.I. general purpose L.F. transformer, ratio 7-1	10 6
1 Lewcos 15,000-ohm spaghetti resistance	1 6
1 Lewcos 20,000-ohm spaghetti resistance	1 6
1 Read Rad H.T. fuse and holder	1 3
1 Bulgin toggle switch, type S88	2 9
1 Packet Jiflinx for wiring	2 6
1 Sovereign terminal block	6
2 Belling-Lee insulated terminals	6
8 Belling-Lee wander plugs	1 4
5 Valves as specified	3 6
Screws, flex, and two spade terminals, etc.	10
TOTAL (including valves and cabinet)	£12 0 0

Any of the above specially tested components are obtainable separately.

.01 Band Pass Condenser, T.C.C. Type 40, 1/9 (If ordered with a Kit, add 1/9 to cash price or 2d. per month to the monthly payments).

IMMEDIATE DISPATCH.

READY RADIO LTD.,

Eastnor House, Blackheath, S.E.3.

Phone: Lee Green 5678.

Grams: Readirad, Blackvil.

READY RADIO SHOWROOMS:—

159 Borough High Street, London Bridge, S.E.1.

FREE

Full-size wiring diagram and plan with complete instructions — 19 pages and over 30 illustrations. Free with every Ready Radio "Britain's Super" MATCHED Kit.

ORDER FORMS ON PAGES 945 and 951

RECOMMENDED BATTERY EQUIPMENT

	£ s. d.
1 Complete kit of components, including valves and cabinet (KIT "C")	12 0 0
1 Pertrix 120-volt Super Capacity H.T. Battery	1 5 6
1 Pertrix 2-volt 30-amp. L.T. Accumulator type PXG.3	11 0
1 Pertrix 9-volt Grid Bias Battery	1 6
1 British Blue Spot Cabinet Loud-speaker, type 44R	2 12 6
Total	£16 10 6

Or 12 monthly payments of 30/3

COMPLETE KIT

The complete kit as above, but with completely assembled receiver (including Royalties) ... **£19 0 6**

Or 12 monthly payments of 34/10

RECOMMENDED A.C. MAINS EQUIPMENT

	£ s. d.
1 Complete kit of components, including valves and cabinet (KIT "C")	12 0 0
1 Ready Radio Mains Unit with trickle charger	5 17 6
1 Pertrix 2-volt 30-amp. L.T. Accumulator, PXG.3 type	11 0
1 Pertrix 9-volt Grid Bias Battery	1 6
1 British Blue Spot Cabinet Moving-coil Permanent Magnet Loud-speaker	5 10 0
Total	£24 0 0

Or 12 monthly payments of 44/-

COMPLETE KIT

The complete kit as above, but with completely assembled receiver (including Royalties) ... **£26 10 0**

Or 12 monthly payments of 48/9

READY RADIO MAINS UNIT,
Price £5-17-6

or 12 monthly payments of 48/9

COMPLETELY ASSEMBLED "BRITAIN'S SUPER," with valves and cabinet, aerial tested, royalties paid. Price £14 10 0, or 12 monthly payments of 26/6.

Come and hear it at our Show-rooms:—

159 Borough High Street, London Bridge, S.E.1

Phone: Hop 3000.

(2 minutes from London Bridge Station)

Please Mention "A.W." When Corresponding with Advertisers



A weekly review of new components and tests of apparatus conducted by J. H. Reyner, B.Sc., A.M.I.E.E.

Kinver H.F. Choke

AN interesting component which we have for test this week is the Kinver screened high-frequency choke. This choke is soundly constructed from a small piece of ebonite former having five slots to accommodate the winding. Slots have also been cut along the length of the former, presumably with the idea of reducing capacity effects. The choke is housed in a small brass screening case which is provided with

come this difficulty Messrs. A. F. Bulgin and Co. have recently introduced a special form of this resistance. It is, of course, only made in small values ranging from 500 to 2,000 ohms and the wire employed is distinctly heavier than normal, the current-carrying capacity actually being twice that of the usual samples.

In appearance the component is exactly similar to the normal spaghetti link marketed by this firm, the only difference being that it is slightly thicker. Otherwise it retains the usual advantages of convenience and compactness.

J. B. Drum Dial

THE new J.B. baseboard mounting drum dial is a neat well-made piece of apparatus. The metal framework which carries the drum and the slow-motion gear is quite rigid and is provided with lugs for baseboard mounting, thus enabling the

black metal casing which is provided with lugs for baseboard mounting. Insulated terminals are provided at one end for the input from the supply mains to the primary winding, which is tapped to make the transformer suitable for use on input voltages varying from 200 to 250 volts. Similar terminals are also provided for the secondary windings of which there are two, one designed to give 180 milliamperes at 175 or 200 volts, according to the tap used, and the other 4 volts at 6 amperes, this latter winding being centre tapped.

The transformer has been designed for use with the new Westinghouse HT8 unit, which, as readers will remember, is rated to supply 60 milliamperes at 250 volts smoothed.

A test was conducted on the transformer by wiring it into a rectifying circuit, a Westinghouse HT8 unit being used. The voltage across the 200-volt output terminals was measured with different values of direct current in the load. The attached curve showing the relation between these quantities indicates an unusually good regulation, the voltage drop with load being very small. The figures were obtained with a full load on the 4-volt winding.

In a similar way the 4-volt winding was loaded up and the voltage measured for different values of load current. On open circuit the voltage was 4.4 volts, dropping

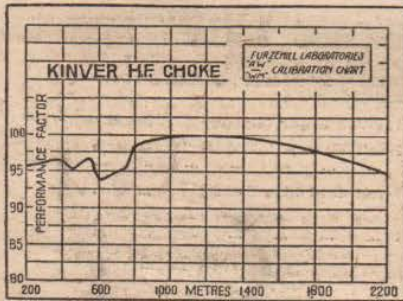

Performance curve of the Kinver screened choke

lugs for fixing, to one of which the earth connection should be made. Insulated lugs protruding through slots in the housing carry small brass terminals for the external connections.

A complete test was conducted on the choke to determine its efficiency in choking back high-frequency currents when bypassed by a .0001-microfarad condenser. The accompanying curve shows the performance figure plotted against wavelength, and it will be seen the factor remains high even at 2,000 metres.

The self inductance of the choke is approximately 118,000 micro-henries, and the distributed self-capacity of the order of 5 micro-microfarads, the D.C. resistance being 700 ohms. At a price of 2s. 9d., this choke is good value.

Bulgin "Super" Spaghetts

THE grid bias in an A.C. mains receiver is an important component, because if it should break down, the grid circuit of the valve becomes free, and various unpleasant effects may result. Apart from the fact that the set will not work properly, there is a possibility that the anode current of the valve will rise to a dangerous value, causing rapid deterioration of the emission.

For this reason some constructors have preferred to fight shy of spaghetti resistances, particularly in heavy-duty sets, where the last valve may carry an anode current of 20 or 40 milliamperes. To over-

whole control to be rigidly fixed, irrespective of the condensers which it is to control.

The slow-motion reduction of approximately 22 : 1 is obtained in two steps, the drive being in both cases of the friction type. This drive is perfectly made and is entirely free from backlash, and should give long service without any fault developing.

The clamping screws for the condenser spindles are held in an insulating sleeve; it is thus possible to use the dial in circuits requiring that there should be no connection between the rotors of the condensers on either side of the dial.

A neat metal window is provided which has an artistic oxidised silver finish.

Heyberd Transformer

THE Heyberd mains transformer, type W30, which we have tested this week, is similar in its external appearance to the other well-known transformers marketed by this firm. It is completely shrouded in a

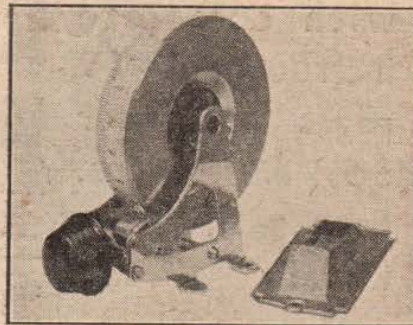

A new J.B. drum dial

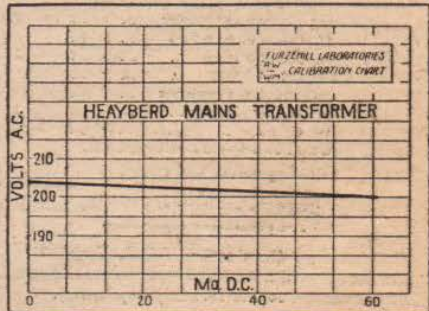

The output of the Heyberd W30 transformer is shown by this curve

to 3.9 volts on a load of 6 amperes. The no-load watts were also measured and found to be 7, thus giving a full-load efficiency exceeding 90 per cent. It will be seen from the above that the transformer is up to its rated standard and quite suitable for use in large power rectifying circuits of the type outlined above.

The overall dimensions are 6 in. by 5 in. by 3 in., and the retail price is 30s., which is good value.

THE NEW TELSEN MAJOR

The **TELSEN Loud-speaker Chassis** has been produced to match the **TELSEN Loud-speaker Unit**, and combines with it to produce an excellent performance. A fully floating cone is employed of special damp resisting material, and the shape and texture have been balanced to give a most pleasing natural mellowness. Holes are provided for the attachment of most Loud-speaker Units.

Telsen "Major" Chassis (Diameter 14½ in.).
Price 10/6.

Telsen "Popular" Chassis (Diameter 11 in.).
Price 5/6.

Send for the *Telsen Radio Catalogue* and the book of "All-Telsen Circuits" to: *The Telsen Electric Co., Ltd., Aston, Birmingham.*



TELSEN

ALL-BRITISH
RADIO COMPONENTS

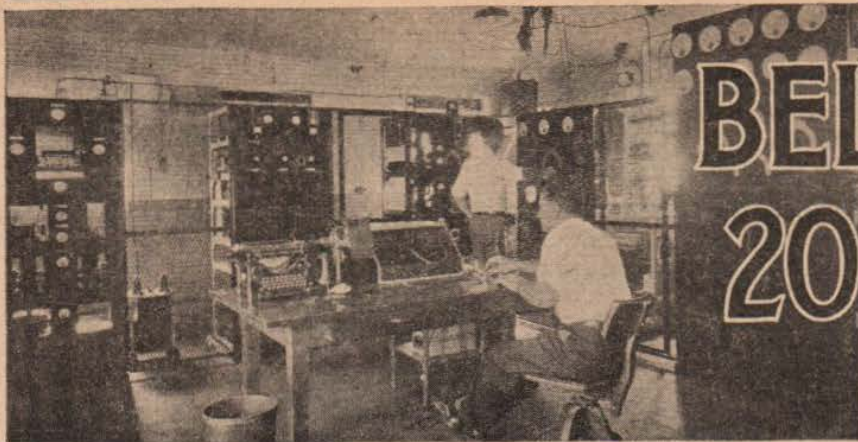

BELOW 20 METRES!

*Practical Hints on Receiving
on the Ultra-short Wave-
lengths.*

THERE is a tendency among short-wave listeners to regard the "low limit" of their sets as being somewhere just below 20 metres. It is usually marked by the General Electric Station, W2XAD, at Schenectady, which comes in at the bottom of the dials with most coils. The smallest size in commercial coil sets, consisting of two or three turns is mainly used by amateurs for coupling purposes on the twenty-forty metre band. If curiosity has ever prompted them to try it in the grid position the results have probably been disappointing and so a very fascinating section of the short waves has been left unexplored.

How to Get the "Wavelets"

In a normal short-wave set a two- or three-turn coil in the grid circuit of the detector will tune down to about 15 metres. If aperiodic aerial coupling is used, the coil in this position will have to be of the same size, as anything smaller is unobtainable except to special order. This is no handicap, however, since we can tap the coil so that just the right amount is included in the aerial-earth circuit. This will usually be half a turn. Even then it will often be necessary to loosen the coupling still further by arranging the coil so that it can be swung away from the grid coil (the old dodge of one fixing screw for the holder secures this) or by using a series condenser of very low capacity (one of the neutralising type). If the aerial is directly coupled, both the series condenser and a very low tapping are necessary. The condenser will have to be set with the plates somewhere between half and full out. The great thing to do is to arrange matters so that the set will oscillate right down to the bottom of the condenser scale. The conditions under which this will happen vary at different parts of the dial. Always aim at the tightest coupling consistent with satisfactory control of oscillation.

Identifying Stations

Now, suppose that you have "got down" there and are ready to tune in signals. At first you will be hopelessly lost and so you must hunt round for a few landmarks to show you where you are. Here a knowledge of morse is useful as the most reliable guides are the commercial telegraphy stations. They may be heard transmitting their call signs for minutes on end, and as

soon as you are really familiar with the characters you will begin to read them. When calling another station they send its call letters first, three or more times, then the letters DE or sometimes V, standing for "from", and finally, their own call.

A station to look out for is Ongar GLS which works on 15 metres with South America. Just above him comes Bandoeng PLE on 15.93 metres. Every Tuesday afternoon this transmitter sends out a musical programme on the same wavelength with a power of 80 kilowatts, and when you hear this romping through on the loud-speaker you will be amply rewarded for any trouble "going down" has cost you. Bandoeng is in Java, as far away as Australia, and yet its programmes come in at remarkable strength week after week. There is another transmitter at Bandoeng in this part of the waveband, namely PLF, on 16.8 metres which works in telegraphy and telephony. It may sometimes be heard transmitting gramophone records for test purposes. Other useful telegraphy stations to use as "pointers" are FTE and FTO, St. Assize, Paris (16.44 metres); SUY, Abu Zabal, Egypt (15.259 metres); VWZ, Kirkee, India (16.286); and DIM, Nauen (17.3 metres).

Many Surprises

This part of the short-wave band is essentially one of surprises. One never knows what one is going to pick up, and new stations are constantly appearing at amazing strength for a few weeks or even days only to fade away into oblivion, sometimes before they have been conclusively identified. The fact that most short-wave lists only show one or two stations below 20 metres does not mean that there is any lack of them. The only trouble is that their comings and goings are hard to keep track of. Another interesting feature of the 15-20-metre band is that it is admirably suited for long-distance daylight reception. In fact, after nightfall signals rapidly fade away to zero.

Low Wavelength Difficulties

And now for the snags! The worst one is hand-capacity effects. You can get over this by screening, but if your set is giving good results on the higher short waves without it you will not want to go to the trouble of altering it. There are various simple remedies that usually prove

effective. The most important is complete decoupling for 'phones or speaker. If you are not already using one, connect a short-wave choke between the plate of the output valve and the 'phones and by-pass it to earth with a .001 fixed condenser. This keeps stray H.F. impulses that have escaped rectification out of the telephone leads where they are apt to upset the tuning every time the listener moves his head.

If you are using aperiodic aerial coupling you will probably find that L.T. negative is connected to the earthed end of the aerial coil. Removal of this connection often makes the set much easier to handle on the very high frequencies. Try it and see.

The position of the tuning coils is an important factor. If they are mounted with their windings in the same plane as the panel, the operator's hands come into their fields every time the controls are operated. It is well worth the trouble of turning them round so that they are at right-angles to the panel. This may, in some cases, upset the set's performance by bringing other components into their fields. Only trial can tell. The necessity of smooth reaction control is so often insisted upon that no more than a passing reminder of this vital point should be necessary to readers of AMATEUR WIRELESS.

You are fairly certain to meet difficulties if your set is not of special design, but you will have the satisfaction of knowing that every useful little tip you find out is bringing ultra-short wave reception nearer to the ordinary listener.

B. K. COOPER.

The post of Aberdeen representative of the B.B.C., which was rendered vacant by the transfer of Mr. Ian Whyte to Scottish Regional headquarters as musical director has been filled by the appointment of Mr. Moultrie R. Kelsall. Mr. Kelsall was formerly connected with the Scottish National Theatre.

Nine broadcasting stations in America have just been granted permits to increase their power to 50 kilowatts by the Federal Radio Commission, the stations are:—WOR, New York; WCAU, Philadelphia; WSM, Nashville; WSB, Atlanta; WCCO, Minneapolis; KOA, Denver; KPO, San Francisco; WHO-WOC, at Des Moines and Davenport

Ready Radio Catalogue CASH OR EASY PAYMENTS

HEAYBERD ELIMINATOR KITS

Model C.150.—H.T. only. 3 tappings, giving a maximum of 150 volts at 25 m.a. **Cash Price 76/-**
Easy Payments : 7/- deposit, 11 monthly payments of **7/-**
Model C.200.—H.T. only. 4 tappings, giving a maximum of 250 volts at 60 m.a. **Cash Price 137/6**
Easy payments : 12/9 deposit, 11 monthly payments of **12/9**
 Full constructional details and wiring plan enclosed with each Kit.

SPECIAL SUPER-HET. COIL KITS

"Britain's Super."—3 Lewcos coils (1 oscillator and 2 intermediates)
 1 Lewcos band-pass filter unit with extension rod (type B.P.F.)
 1 Readi-Rad super-het. choke. **Cash Price 55/-**
Easy Payments : 9/- deposit, 5 monthly payments of **10/3**

"Century Super."—1 set of 4 Lewcos super-het. coils.
Cash Price 50/-
Easy Payments : 9/- deposit, 5 monthly payments of **9/3**

READY RADIO UNIT FOR A.C. MAINS

Type R.I.—120 volts at 20 m.a., 3 H.T. tappings.
Cash Price 23/3 0
Easy Payments : 8/6 deposit, 8 monthly payments of **8/6**

Type B.S. specially designed by Mr. G. P. Kendall, B.Sc., for use with the **"Britain's Super,"** or any receiver not using more than 5 valves, 150 volts 25 m.a., 1/2 amp. trickle charger 2, 4, or 6 volts.
Cash Price 25/17 6
Easy Payments : 10/9 deposit, 11 monthly payments of **10/9**

Special Readi-Rad Walder Cabinet for **"Britain's Super,"** or suitable for any set with baseboard not exceeding 17 in. by 9 1/2 in.
Cash Price 25/-
Easy Payments : 9/- deposit, 2 monthly payments of **9/6**

Varley Square-peak Coil with H.F. transformer and Dubbler .04 condenser. **Cash Price 25/6**
Easy Payments : 9/- deposit, 2 monthly payments of **9/3**

KITS

R. for M. (V.3). **Cash Price 25/17 6**
Easy Payments : 10/6 deposit, 11 monthly payments of **10/6**

Mullard 1932, without cabinet. **Cash Price 28/10 0**
Easy Payments : 12/- deposit, 11 monthly payments of **12/-**

Cossor 1932, No. 234, with cabinet. **Cash Price 26/15 0**
Easy Payments : 12/3 deposit, 11 monthly payments of **12/3**

Cossor A.C. mains. **Cash Price 26/19 6**
Easy Payments : 18/3 deposit, 11 monthly payments of **18/3**

Six-Sixty Chassis Kit. **Cash Price 26/17 6**
Easy Payments : 12/6 deposit, 11 monthly payments of **12/6**

Ooram New Music Magnet 4. **Cash Price 210/15 0**
Easy Payments : 19/8 deposit, 11 monthly payments of **19/8**

BLUE SPOT LOUD-SPEAKERS

44.R.—Cabinet speaker in oak (incorporates 66L unit).
Cash Price 22/12 6
Easy Payments : 8/- deposit, 6 monthly payments of **8/-**

100.D.—Inductor in oak cabinet (moving-coil quality at cheap cost). **Cash Price 23/3 0**
Easy Payments : 8/6 deposit, 7 monthly payments of **8/6**

Goliath 30 P.M. in Walnut cabinet (moving-coil reproduction at its best. Very sensitive). **Cash Price 25/ 0 0**
Easy Payments : 10/- deposit, 11 monthly payments of **10/-**

66.R Unit and special chassis. **Cash Price 22/2 6**
Easy Payments : 7/9 deposit, 5 monthly payments of **7/9**

100.U Inductor Unit chassis. **Cash Price 21/19 6**
Easy Payments : 7/3 deposit, 5 monthly payments of **7/3**

Permanent Magnet Moving-coil Speaker chassis with output matching transformer. **Cash Price 23/15 0**
Easy Payments : 6/9 deposit, 11 monthly payments of **6/9**

INSTAMAT OUTPUT TRANSFORMERS

For all speakers except low-resistance moving coil.
Cash Price 21/7 6
Easy Payments : 10/- deposit, 4 monthly payments of **5/-**

For low-resistance moving-coil speakers. **Cash Price 21/17 6**
Easy Payments : 10/- deposit, 6 monthly payments of **5/-**

FOR CASH ONLY

R.I. Duastatic Band Filter Coil 15/-

Harlie Tone Control 10/-

Readi-Rad Radiogram Volume Control 5/6

Varley Pick-up with tone-arm (new model) 42/-

Special Experimenters Kit of useful "olds and ends" containing flex wire, nuts, screws, terminals, crocodile clips, formers, sleeving and 26 and 34 gauge wire, etc., etc. 7/6

Special Experimenters Kit of Tools, containing hand-wheel brace, set of drills, two screw drivers, 1 pair pliers, 1 soldering iron, flux and solder, scriber, counter-sinking bit, dusting brush 20/-

Westinghouse Rectifier, type H.T.S. (250 volts, 60 m.a.) ... 21/-

R.I. Mains Transformer type E.Y.32 for above 27/6

Write Earth Tube 3/6

Blue Spot Wavetrap 15/-

British General Band-pass Tuning Unit 14/6

Readi-Rad Radiogram Switch 2/9

Readi-Rad Dial Light 2/3

Formo New Indoor Aerial Wire (20 ft.) 4/6

Blue Spot Mains Disturbance Eliminator 10/6

CASH or C.O.D. ORDER FORM **To: Ready Radio, Ltd Eastnro House, Blackheath, S.E.3.**

Please dispatch to me at once the following goods

for which I enclose (Cross out line if I will pay on delivery (not applicable)) £

NAME

ADDRESS

A.W. 7/11/31

To: Ready Radio, Ltd. EASY PAYMENT ORDER FORM
 Eastnro House, Blackheath, S.E.3.

Please dispatch to me the following goods

for which I enclose first deposit of £

NAME

ADDRESS

A.W. 7/11/31

Mention of "Amateur Wireless" to Advertisers will Ensure Prompt Attention

U.S.A. SHOWS THE WAY

WE British sometimes laugh rather scornfully at American methods of broadcasting, but the U.S.A. seems to have the laugh on us—and on Europe generally—in our present pickle over the high-power problem. In Europe, high-power stations are being erected indiscriminately by nearly all the nations, including our own, and the interference consequent upon this ungoverned power-race is becoming alarming. In America they have planned their high-power stations to prevent such a mess.

The United States of America is divided into five radio zones, in each of which only four stations may use the maximum power permitted by law (50 kilowatts). Thus, there are only twenty stations of this power in the entire country, and they are spaced in properly defined zones. They are governed by the Federal Radio Commission, which has recently granted permission to the following stations to operate on the full power: WOR (Newark, N.J.), KPO (San Francisco), WSM (Nashville), KSL (Salt Lake City), WCCO (Minneapolis), WCAU (Philadelphia), WSB (Atlanta), WHO-WOC (Des Moines, Iowa), KOA (Denver).

The following stations have been permitted to use 25 kilowatts: WHAM (Rochester), WAPI (Birmingham, Alabama), KVOO (Tulsa, Oklahoma), WHAS

(Louisville, Kentucky), WBT (Charlotte), KFAB (Lincoln, Nebraska).

There was a time, some years ago, when the International Broadcasting Union received much praise and we all expected that so far as broadcasting was concerned we were to have a "United States of Europe." Have circumstances been too difficult for any authority to govern, or has the International organisation been weak? Whatever the cause, to-day we have a dis-united Europe in this matter.

The B.B.C. is obviously working hard to produce a settlement, but why did not this country, or any other country, bring before Europe the necessity for a plan two or three years ago, when it was already evident that the tendency was going to be towards all-round increases in power?

THE RADIO PIANO

AFTER a great deal of experimenting, the German piano firm of Bechstein, in co-operation with the Siemens works and the scientist Nernst, have succeeded in producing the "radio-piano," in which the tone or musical timbre can be regulated at will by means of an ingenious arrangement of microphones working in conjunction with an amplifier and loud-speaker. A description of the new instrument appears in a recent issue of *Die Umschau*.

As many readers will be aware, the tone of the ordinary grand piano depends entirely on the wood of which the sound-board is made and the particular skill of the workman. The chief thing aimed at is the production of a fundamental tone richly saturated with overtones. A good resonance board has the property of emphasising certain of these overtones and thus producing the typical "tone" of the instrument.

The new radio-piano has no resonance board, but the framework to which the strings are attached has a number of small microphones—one to every five strings.

The keys do not strike the strings direct, but work through a special "micro-hammer" mounted on a small leather strip on the main hammer. This makes the touch very light and completely cuts out the tapping sound audible in ordinary pianos.

The vibrations of the strings are received by electric pick-ups and converted direct from mechanical to electrical vibrations, these being made audible after amplification in the loud-speaker. When the loud-speaker is "off" the piano is silent, as it has no resonance board. A system of variable condensers and filters is incorporated so as to vary the "tone" as desired. The middle register is reproduced normally as in an ordinary grand piano, while the high register has a bell-like tone and the bass is more pronounced than usual.

E. S. H.

A TRIUMPH OF MODERN RADIO PRACTICE

J.B. "R" type Gang Condensers, specified in so many leading circuits, are the very latest in tuning devices. Thoroughly shielded and enclosed, with neat clip-on screens to every stage. Very easily fitted, because only round holes need be cut in panel. Capacity, .0005.

There are Trimmers (for adjustment once only) in each stage. A Vernier Disc Drive, scaled from 0 to 180, with a neat bakelite panel plate, is supplied as standard.

Type 'R' 1 12/6 Type 'R' 2 (2 gang) 21/-

Type 'R' 3 (3 gang) 29/6 Type 'R' 4 (4 gang) 37/-

"R" TYPE GANG CONDENSERS

USED AND SPECIFIED IN "BRITAIN'S SUPER"

Advertisement of Jackson Bros., 72 St. Thomas' Street, London, S.E.1. Telephone: Hop 1837

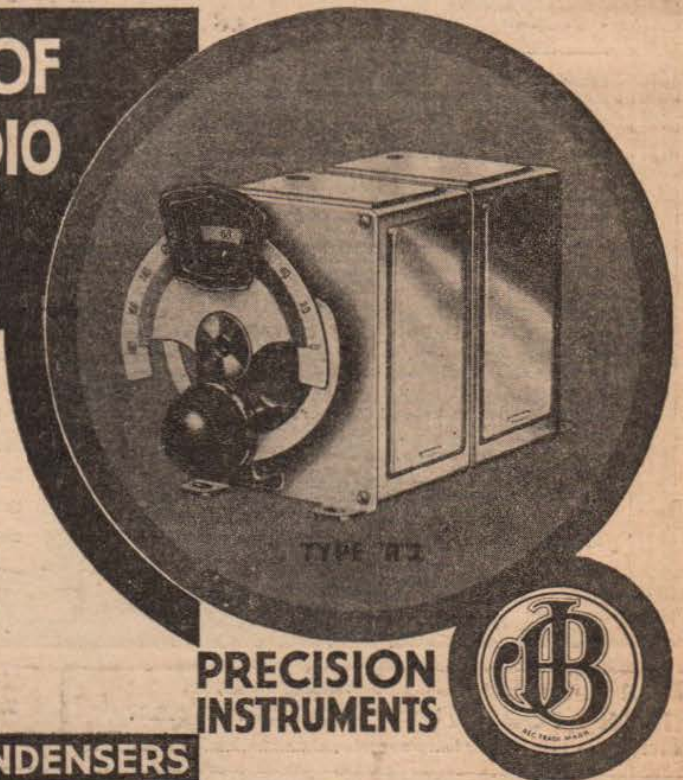

PILOT KITS FOR "A.W." SETS

AUTHOR'S

See other Peto-Scott Advertisements on Pages 911, 913, 925

The No Substitute Kit
IMMEDIATE DELIVERY

- As chosen and first specified by the Technical Department of "Amateur Wireless."
- Officially approved, therefore, by an established technical authority you can trust implicitly.
- Backed by Peto-Scott himself, twelve years' Radio Experience and a world-wide reputation.
- Enables the Author's published Set to be duplicated exactly in every respect. ALL PANELS DRILLED TO AUTHOR'S SPECIFICATION

THERE'S NO KIT LIKE A PILOT "THREE STAR 3"

SPECIAL C.O.D. ITEMS FOR "THREE STAR 3"

You pay the Postman. We pay all post charges on orders over 10/-

Utility 3-gang condenser	1 5 0
Lewcos Set of 3 Coils	1 7 6
1 Junit Metal Chassis with valveholders	10 0
1 Varley Dual Volume Control with ganging equipment	14 0
Telsen L.S. Unit and Chassis	11 0

SPECIAL C.O.D. ITEMS FOR BRITAIN'S SUPER

You pay the Postman. We pay all post charges on orders over 10/-

3. Wearite Super Het Colls (one oscillator, two intermediates) Types 02, 0T2, 0T1	1 17 6
1. Lewcos "B.P.F." Bandpass Filter	12 0
Unit with Extension Rod	1 1 0
J.B. Type R 2 2 Gang Variable Condenser	12 6
J.B. Type R 1 Single Variable Condenser Cabinet as specified	1 5 0
Peto-Scott popular-priced, hand french-polished, Oak Cabinet with lift-up lid to size	19 6
5. Mullard Valves as specified: P.M.1D6, P.M.2D.N., P.M.12, P.M.1H.L., P.M.2A	3 7 6

PRICES AT A GLANCE

1 Utility three-gang .0005-mfd. variable condenser	1 5 0
3 Lewcos coils, types (1) ATG; (2) TBF	1 7 6
1 Telsen Binocular H.F. choke	5 0
1 Junit metal chassis, complete with valve holders	10 0
1 Telsen Ordinary H.F. choke	2 0
1 Rea "a" .0003-mfd. reaction condenser	3 6
1 Varley dual volume control, values 50,000 ohms and 250,000 ohms, with ganging equipment	14 0
1 Lewcos .0002-mfd. (max.) pre-set condenser	2 0
6 Spagheti resistances: (2) 5,000, (2) 20,000, (1) 30,000, (1) 10,000 ohms	4 2
1 Lissen 2-meg. grid leak, with terminals	1 3
3 Dubilier .0002-mfd. fixed condensers, type 670	3 0
3 T.C.C. .01-mfd. fixed condensers, type "S"	7 6
1 Lotus radio-gramophone jack switch, type J.S.9	4 0
1 Formo fixed condenser bank, (2) 1 mfd. and (2) 2 mfd.	9 6
1 Three-point battery switch	1 3
1 Bafign fuse and holder	1 0
1 R.L. "Dux" transformer	6 9
6 Belling-Lee terminals, marked: Aerial, Earth, L.S., L.S., (2) P.U.	1 6
1 Belling-Lee S.G. anode connector	6
1 Terminal block	6
5 Clix wauder plugs, marked: H.T., H.T., G.B., G.B., -1, G.B.-2	7
2 Clix spade terminals, marked: L.T., L.T.	3
Glased covered connecting wire, 6 yds. thin flex, screws	Gratis
CASH or C.O.D. KIT "A" £6 10 9	

Any parts supplied separately. If value over 10/-, sent C.O.D.—all post charges paid.

COMPLETE KIT PRICES KIT A

Author's Kit, less valves and cabinet
£6.10.9
Cash or C.O.D.
or 12 monthly payments of 12/-
KIT B with valves, less cabinet
Cash or C.O.D. **£8.19.3**
or 12 monthly payments of 16/5
KIT C with valves and table-model cabinet
Cash or C.O.D. **£9.14.9**
or 12 monthly payments of 17/10
FINISHED INSTRUMENT. Aerial tested. Royalties paid. Cash or C.O.D. **£11:5:0** or 12 monthly payments of 20 6.
If supplied with Peto-Scott Consolette Cabinet as specified by "Amateur Wireless," add 19/6 to cash price of Kit C or 1/9 to each monthly payment.

BRITAIN'S SUPER

Exactly as specified in every detail by Mr. W. James. No substitute parts

KIT A less valves and cabinet
£7.4.9
Cash or C.O.D.
or 12 monthly payments of 13/3
KIT B with valves, less cabinet
Cash or C.O.D. **£10.12.3**
or 12 monthly payments of 19/5
KIT C with valves and cabinet
Cash or C.O.D. **£11.19.3**
or 12 monthly payments of 21/9
If T.C.C. .01-mfd. Condenser required add 1/9 to each Kit price or to the first monthly payment.

PETO-SCOTT CABINET CHOSEN FOR THREESTAR 3

Illustrated on page 942 of this issue
Designed by Peto-Scott. In handsome Figured Oak with attractive vignette. Front panel ready drilled for fixing.
15/6 CASH
With provision for speaker and batteries. In handsome Oak, French Polished. Accommodates speaker up to 12 in. cone diameter. Front panel ready drilled.
35/- CASH
TRADE SUPPLIED FROM STO K

CASH - C.O.D. - H.P. as usual

Any parts supplied separately. If value over 10/-, sent Carriage Paid. C.O.D.—we pay all Post Charges.

PETO-SCOTT

All orders over 10/- sent carriage paid

PETO-SCOTT CO., LTD. Head Office: 77 CITY ROAD, LONDON, E.C.1. Clerkenwell 9406. 62 HIGH HOLBORN, LONDON, W.C.1. Chancery 8266. MANCHESTER: 53 WHITELOW ROAD, CHORLTON-CUM-HARDY. Phone: Chorlton-cum-Hardy 2928. NEWCASTLE, STAFFS., 7 ALBANY ROAD. Phone: 67119

SEND 3^d POSTAGE FOR NEW CATALOGUE

You will Help Yourself and Help Us by Mentioning "A.W." to Advertisers

EXPRESS ORDER FORM

To PETO-SCOTT CO., LTD.
Please send me C.O.D., CASH/H.P.

NAME.....
ADDRESS.....

for which I enclose
Cash/H.P. Deposit £ s. d.

A.W. 7/11/31

THE SCOTTISH NATIONAL RADIO EXHIBITION

Waverley Market, Edinburgh,
November 11—21

THE Scottish National Radio Exhibition, sponsored by the Radio Manufacturers' Association and supported by the B.B.C., is being held this year in the Waverley Market, Edinburgh, and runs from Wednesday, November 11, to Saturday, November 21.

An interesting display of 1932 products by local dealers and a number of manufacturers has been arranged, and Scottish enthusiasts should take advantage of this opportunity to see all the new season's parts.

The Exhibition is being opened by Mr. David Cleghorn Thomson, the Scottish Regional Director of the B.B.C. and Sir Thomas Whitson, the Lord Provost of Edinburgh. The opening speeches will be broadcast by Northern stations.

Interest naturally centres on the model studio which the B.B.C. has arranged in the centre of the Exhibition, from which broadcasts will be made during the afternoons and evenings.

This studio is cut off from the public by a sheet of plate glass and the interior is fitted out very much on the lines of the No. 2 studio at the Edinburgh Broadcasting House. This studio demonstration is very much on the lines of that organised several years ago at a National Radio Exhibition at Olympia.

During the week the public broadcasts

from the model studio in the Exhibition will continue, and those children who would like to see the "Uncles" and "Aunts" in the flesh may do so during the Children's Hours on November 19, 20, and 21. On November 20, too, they will have an opportunity of meeting "Granny" and "Grandpa Ferguson," who will be seen in a sketch, "Round the Fireside at Knockendoch."

A fitting wind-up to the Exhibition will be the broadcasting of a Scottish Concert from the studio on the evening of November 21. A feature of this concert will be that many of the songs sung will be drawn from the Scottish Students' Song Book.

SUPPRESSING THAT SKY WAVE!

AT a time when severe interference is being caused at night-time through the strength of reflected rays interrupting local radiations, it is interesting to hear from America that the key station of the Columbia system has been specially designed to decrease the so-called sky-wave radiation.

Designed by the Bell Laboratories, station WABC, with a power of 50 kilowatts, started up on September 8 of this year. It is located in New Jersey.

Instead of the usual aerial suspended between two masts, the new station has a single insulated mast as its radiating system. This is a lattice-work steel structure

rising 685 feet from the ground, which is more than 100 feet higher than the famous Washington Monument.

This mast is indeed a curious structure. At the base it is only 18 inches square and rests on a large porcelain insulator, supported on a concrete foundation. The steel work widens out to 28 feet at the 250-foot mark, at which point four guys are fixed. The mast then tapers down almost to a point, on which rests a 14-inch ball.

With this peculiar aerial arrangement, which is the result of long experiments by Bell Laboratories, it is claimed that increased radiation of the wireless waves along the ground plane results and that there is a decrease of the upward or sky-wave radiation.

The wireless-wave radiation from this mast may be likened to the shade on a suspended incandescent lamp, which concentrates the lamp's rays downward and eliminates the useless upward glare.

By the use of this aerial a 40 per cent. gain in local field strength is obtained. To gain an equivalent field strength with an ordinary aerial the power of the transmitter would have to be double its present rating of 50 kilowatts.

In addition to increasing the field strength in the service area of the station, the use of the new mast is expected to lessen fading at the critical distance on the border of the service area.

As is well known, fading is the result of interference between the ground ray and upward ray. It stands to reason that if the upward ray is suppressed there is less likelihood of the ground ray being cancelled out.

A. S. H.

What's inside a FULLER 'SUPER' battery?

A dry battery is still a mystery to most wireless enthusiasts. Yet it plays a most important part in reception. That is why Fuller's have devoted all their energies and resources to improving dry batteries. They have recently installed entirely new automatic manufacturing and testing machinery. They have standardised every component part, every process of manufacture. Here you see the zinc cans, with the 'dolly' being prepared for sealing up—each perfect—identical in size, weight and latent energy. This uniformity and regularity of manufacture gives a dry battery infinitely superior to the hand-made type. Fit a Fuller 'Super' and your wireless will take a new lease of life. Full list of other types and sizes on application.

FULLER

'SUPER' BATTERY

EMISSION UP TO 20 MILLIAMPS

Visit us at the Edinburgh Radio Exhibition, Stands 7 and 8, Block A

FULLER ACCUMULATOR CO. (1926) LTD., CHADWELL HEATH, ESSEX

Telephone: Seven Kings 1200.

Telegrams: Fuller, Chadwell Heath,
Contractors to British and Overseas Government Departments, Railways, etc.

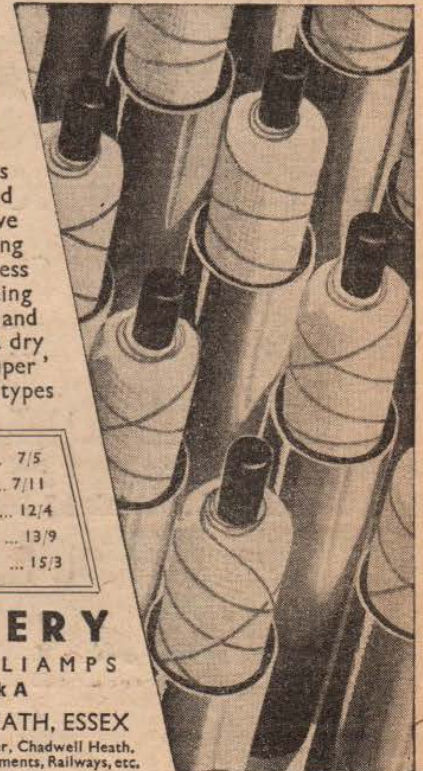

F.1, 60 Volts ...	7/5
F.2, 66 " ...	7/11
F.3, 99 " ...	12/4
F.4, 108 " ...	13/9
F.5, 120 " ...	15/3

HL2

METALISED



Further evidence of the supremacy of the new range of 2-volt Mazda valves is here in the metalised H.L.2. Extreme sensitivity joins with absolute stability, and its high amplification coupled with a comparatively low impedance renders it particularly efficient as a leaky grid detector or intermediate L.F. amplifier. The steep slope of the H.L.2 also makes it suitable for use as an anode bend detector.

Remember — this valve is a product of Mazda resources — Mazda engineering skill — Mazda research.

THE AMAZING

MAZDA
THE
BRITISH
VALVES

EDISWAN RADIO

ANOTHER
BIG
ACHIEVEMENT
IN THE NEW
MAZDA
2-VOLT
RANGE

MAZDA 2-VOLT RANGE

H.210 - 8/6	P.240 - 13/6
H.L.210 - 8/6	PEN.230 20/0
★ H.L.2 - 8/6	PEN.220 20/0
L.210 - 8/6	PEN.220A 20/0
★ L.2 - 8/6	S.G.215 - 20/0
P.220 - 10/6	★ S.G.215A 20/0
P.220A - 13/6	★ S.G.215B 20/0

★ METALISED



THE EDISON SWAN ELECTRIC CO. LTD
RADIO DIVISION:
155 CHARING CROSS ROAD, LONDON, W.C.2

V.144

Advertisers Appreciate Mention of "A.W." with Your Order

READERS IDEAS

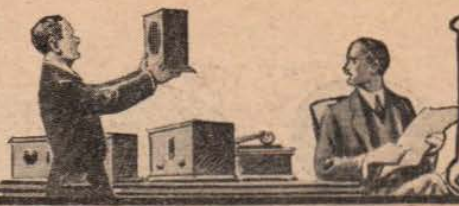

AND QUESTIONS

"Neut" or S.G.

SIR,—I am in agreement with your correspondents regarding neutralised H.F. stages in preference to screen grid, but I would go further and suggest at least six valves, incorporating three stages of neutralised H.F. and three L.F. and band-pass tuning with ganged condensers. In my opinion more valves and less amplification per stage is what should be aimed at to get good quality and selectivity combined, with as few controls as possible.

Hoping you will see your way in the near future to give us something on these lines.

W. H. B. (Renfrew).

"Talkie" Projectors

SIR,—In the article on "The Sound Projector" is the remark, "If, during the showing of a sound-on-disc film, the film itself happens to break, it is quite impossible to save the situation, except by cutting out that reel." Should the film break above the top sprocket, which is due entirely to carelessness in rewinding, the statement is correct.

It is, however, a more common occurrence for the film to break below the top

sprocket. It is then quite a simple matter to thread up the film again without disturbing the pick-up or the top sprocket, thus ensuring that the synchronism is not lost.

When the film is repaired, the damaged portion is replaced by the same length of black spacing, keeping the film the same length as before.

C. H. H. (Birmingham).

Electric Railway Interferences

SIR,—Now for electric railway interference elimination.

Reading in a recent issue of AMATEUR WIRELESS of the sporting action of the L.U.E. Tramways in fitting interference eliminators on all their trolley cars, I am wondering whether something similar could not be done with the motors on the Underground Railway. As I live alongside the District Railway at Earls Court and have also the Piccadilly tube running underneath my house, you can imagine what kind of reception I get, as even with the "Century Super" working on the Wearite frame, reception is completely blotted out as soon as a train gets within several

hundred yards, and the crackling is, of course, terrible. As trains are passing every few seconds, one sometimes feels it is hardly worth while having a set at all.

SEVEN YEARS READER (Kensington).

Station Interference

SIR,—I have noticed a peculiar effect in reception. It takes the form of excessive sibilants in speech and seems most pronounced when one of my local stations is jammed by a foreigner. Why is this?

W. S. (Surrey).

Preponderance of the sibilants in reception is mainly due to over modulation at the transmitter and is accentuated by heterodyning. —ED.

Kit Sets and the Amateur

SIR,—Does the "kit set" idea take away the true amateur spirit? Having lately built a kit set, I fail to regard the set as my work, but as factory built. I prefer to buy my components separate and construct a set from a theoretical diagram, after which I feel some pride for the completed article. My opinion is that a man who

(Continued on page 958)

FOR SILENT AMPLE SAFE POWER

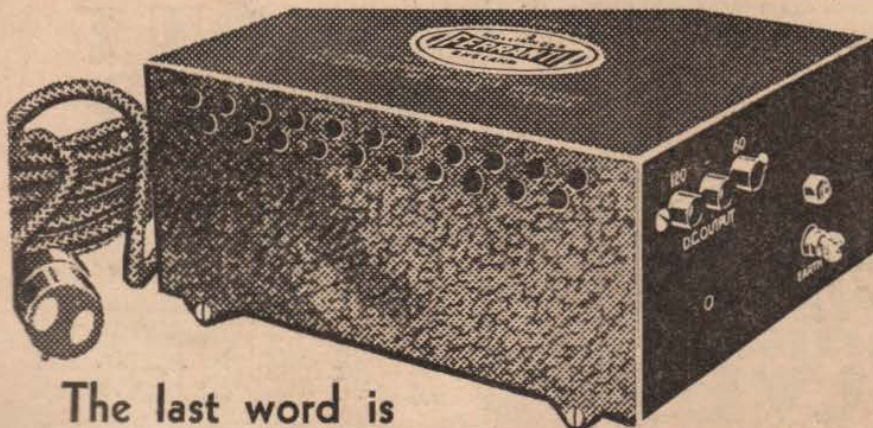

The last word is

FERRANTI

New H.T. units for all needs. Your surest way to better radio. Settle your H.T. problem with a Ferranti H.T. Unit.

E1.	115 m/a	200 volts	£11 11 0
E2.	15 m/a	120 volts	£3 10 6
E3.	25 m/a	150 volts	£4 16 6
E4.	70 m/a	240 volts	£8 11 6
and 4 volts 5 amps. A.C. for indirectly heated, & 4 volts 1 amp. for Output Valves ...			

FOR ALTERNATING CURRENT ONLY.

The Eliminator type E4 has been designed specially for Super Hets.

FERRANTI LTD. Head Office & Works
HOLLINWOOD, LANCASHIRE
LONDON: Bush House, Aldwych, W.C.2

RADIO TIMES

(Cont

THE DAY

5 The Children's
'Frightfulness at the T
(S. G. Hulme
Another Toytown
With Incident
THE GERSHWIN PA

6.0 'The F
WEATHER FORECAST
BULLETIN; London
and Bulletin for
Time Sig

6.30 The F
BEETHOVEN'S
Played
Sonata in A
Andante
Marcha f

6.50 Mr.
Sparrow
7.20 L.
'The N

7.30 Mr.
Spirit of
duction to
MR. DESMOND
the most popul
over the wireles
literary critica
every fortnight
dramatic and literary
of that enterpri
Letters, now in its fourth
He will introduce
Literature
of the

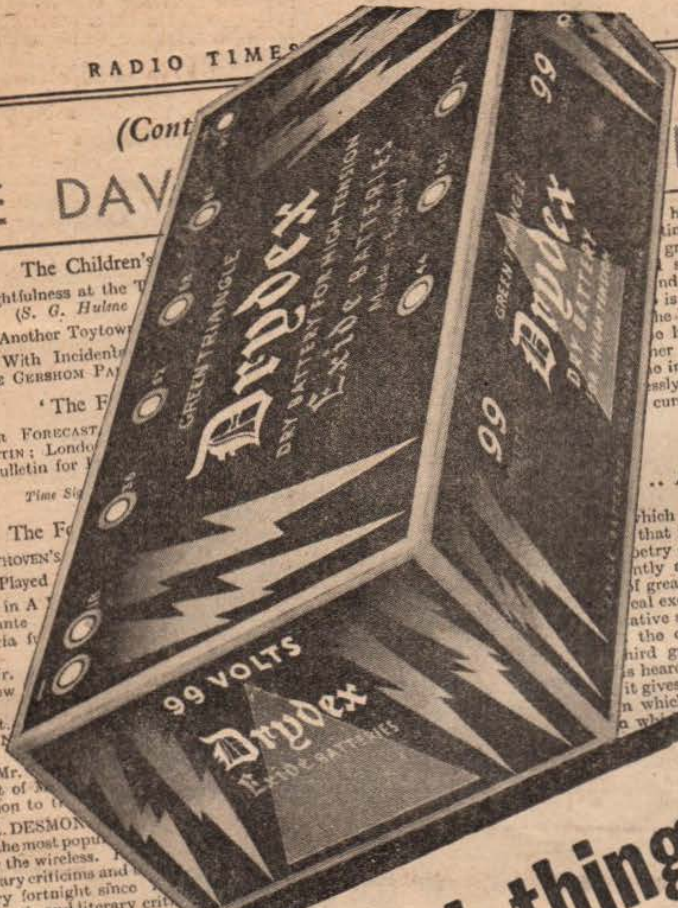

Get the good things good
Get a Drydex

PROGRAMME

9.55 Shipping Forecast; New York Stock Mar
Report
Time Signal, Greenwich, at 10.0

10.0 'MOSAIC'-I
It seems possible—to judge from the vio
criticism of past broadcasts of poe
readings—that wireless is not a suitable med
for poetry, or at least that some other for
presentation might be more successful. A
from any question of the destruction of
intimate quality of poetry or of the difficul
finding suitable readers, it is doubtful wh
fifteen or twenty minutes of continuous poe
likely to appeal to any but confirmed
of poetry. It has, therefore, been decided
a new variation in the form in
poetry is broadcast. 'Mosaio
title of which is suggested by M
definition of music as 'mosaic
air'—is an experiment in which
and poetry are to be combi
express and interpret various
Lyric poems or short excerpts
by continuity of subject or feeling.
with pieces of music o
bl appeal into a single w

.. Mussolov
which follows,
that it is full
poetry of which
ntly a master.
of great energy.
cal excitement,
ative section in
the chief say.
third great tune
is heard again in
it gives way soon
in which th

DANCE MU
and his BAND,
MONSIEUR
v, Greenwich, at 11

ONAI
AMM
egion
61.:

by the Bair
m. Vision; 201.

National

ROSSOLOV, though he
any-one, has already made a nam
for even in that land of shatter
artistic revolutions, he has found a method
revolting which is all his own. This work, con
posed in 1928, is in the form of an overtur
and its programme is simply the steady rhyth
of a factory working at full pressure; thou
behind the mere picture there is conveyed
sense of awe and exaltation which cannot
to possess the men of imagination confron
with the powerful weapons of attack and defe
man has set up under the very nose of an
onistic nature.

Symphony, No. 4, in F Minor (Op. 36)
Moderato con ar

Makers of world
famous Exide
offer greatest
dry battery value

Obtainable everywhere from
all good dealers in sizes and
types to suit every wireless
set. Also for torches, pocket
lamps, cycle lamps and bells.

Branches at London, Manchester, Birmingham, Bristol, Glasgow, Dublin and Belfast.



ORCHEST.
Song of t.
HAROLD W. and Orchestra
Song of the Plea.....Mussorgsky
SOLOMON and Orchestra
Concerto, No. 2, in C Minor, for Pianoforte and
.....Rachmaninov;
.....Zella. marcia);

Exide Batteries, Exide Works. Clifton Junction, near Manchester.

Advertisers Appreciate Mention of "A.W." with Your Order

"READERS' IDEAS AND QUESTIONS"

(Continued from page 956)

builds kit sets is not a true amateur. Give the kit-set man components and no diagram and tell him to concoct a receiver, and ten to one he is beaten.

S. W. (Bentham).

Fitting a Pentode

SIR.—It has been suggested that fitting a pentode will give me more volume. Can you advise me whether this is correct?

A. J. P. (London, N.).

A pentode does not give, and is not designed to give, more power output from a given input signal than is possible from a power or super-power valve. The pentode is essentially a power amplifying valve which gives a large volume output from a small input signal. If the input signal is large, then it will overload the pentode.—Ed.

Radio Criticism

SIR.—Will you allow me further to trespass on your space to address the following remarks to your critic, Mr. Whitaker Wilson, as my final protest.

You and I, Mr. W.-W., have each had published in AMATEUR WIRELESS a supporting letter in connection with my expressed dissatisfaction with your criticisms of syncopated music. You will, I am sure, have noticed that "S. C.," whose views coincide with mine, is also a tolerant individual who tries to understand your friends, Bach and Wagner, as well as Jack Payne and Co.

I gather from the tone of your reply that

you do not take kindly to criticism of your criticisms.

You know, sir, you're getting really impossible; your latest remarks on Ridgeway's Parade might have been written by a man with a grudge against life. Don't you realise that some of the old songs which Mr. Ridgeway revives give some of our elders a real thrill; do you honestly object to hearing, for a couple of bars, the patter of dancing feet, just to give the impression of a music hall?

Fie on you, Mr. W.-W., you even want to spoil our own Jetsam by making him sing Bach (can't get away from that chap Bach, can you?) as if there are not enough groaners and moaners on Sundays making life miserable without adding to our troubles in these anxious times.

May I, as a humble amateur critic, offer you some advice? Ask Mr. Stone, the B.B.C. record critic, to introduce you to Mr. Edgar Jackson (late of the Melody Maker), and if this gentleman cannot broaden your mind on the subject of piano syncopation and the like then you may continue to fill your little page with all the Bachisms and Wagnerisms you please.

Good-bye, Mr. Bach Wilson, but remember, although you switch off because you do not like Hindemith's music, I shall always read your criticisms with, I trust, tolerance and broadmindedness.

S. J. L. (London, N.W.).

A Fuse Puzzle

SIR.—I find that with a fuse in position, the receiver howls terribly, but as soon as I bridge the terminals of the fuse-holder

everything is quite in order. Why is this?

P. M. (Cardiff).

The fuse you are using has a high resistance, and owing to being inserted in the common negative H.T. lead it introduces a common resistance in the battery supply circuit. This gives rise to back-coupling between the valves through the H.T. supply. Replace the fuse with another type which has a low resistance.—Ed.

Tracing a Noise

SIR.—My portable has developed a crackling noise which I cannot cure. I have renewed the H.T. batteries, tried an outside speaker, and gone over all connections for a fault. I have even replaced the grid-bias battery.—L. P. T. (London, S.W.).

Possibly the primary winding of one of your transformers has become broken. Replace your transformers, or have both tested through for continuity. If you have only one transformer and one R.C. coupling for your two L.F. stages, possibly the insulation of the coupling condenser in the R.C. unit may be defective.—Ed.

On the Long Waves

SIR.—No matter how I try, I do not seem to be able to get satisfactory results on the long waves with my 1930 "Ether Searcher." I can just hear Daventry 5XX. Does this suggest a faulty coil?

A. H. (Streatham).

This points to an unsuitable switch for wave-changing. It would seem that one of the leaves in your switch is in direct contact with the metal bush. Such a switch prevents changing over one of the coils from medium waves to long waves. Both switch leaves must be insulated from the metal bush, but the metal bush itself must be in good electrical contact with the metal panel.—Ed.

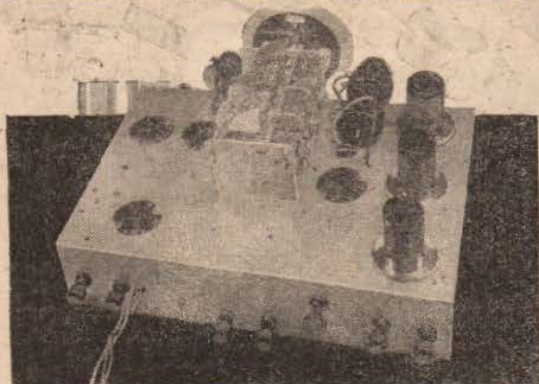

JUNIT CHASSIS
Specified in the
"THREE STAR 3"

THIS Aluminium chassis, complete with valve holders, is made exclusively by Junit to the instructions of the designer of the "Three Star 3."

You will therefore be quite sure of getting the designed performance from your set by using this chassis. Everything is standard to specification. Whether you live in Kent or Kircaldy, the Junit chassis you buy will be exactly as in the original design, and so—you can't go wrong. Buy it from your usual dealer.

Chassis complete for assembly, including 4 valveholders... **10/-**

JUNIT

Junit Manufacturing Co., Ltd.,
2, Ravenscourt Square,
London, W.2.

M.C.132

Lanchester
MOVING COIL
Speakers
COBALT STEEL PERMANENT MAGNET
High Sensitivity
Full Musical Response
Speech Perfect

Designed by F. W. Lanchester (the originator of the Lanchester Car) and produced under his personal supervision.

BEAUTIFULLY ILLUSTRATED CATALOGUE

Free & Post Free WRITE FOR IT

WE SELL DIRECT TO PUBLIC ONLY

14
DAYS FREE TRIAL

Moving-coil Speakers
From £1:10:0 to £3:3:0
Complete in Cabinet
From £2:10:0 to £4:15:0

LANCHESTER'S LABORATORIES
TYSELEY LIMITED BIRMINGHAM

THE THREE STAR THREE

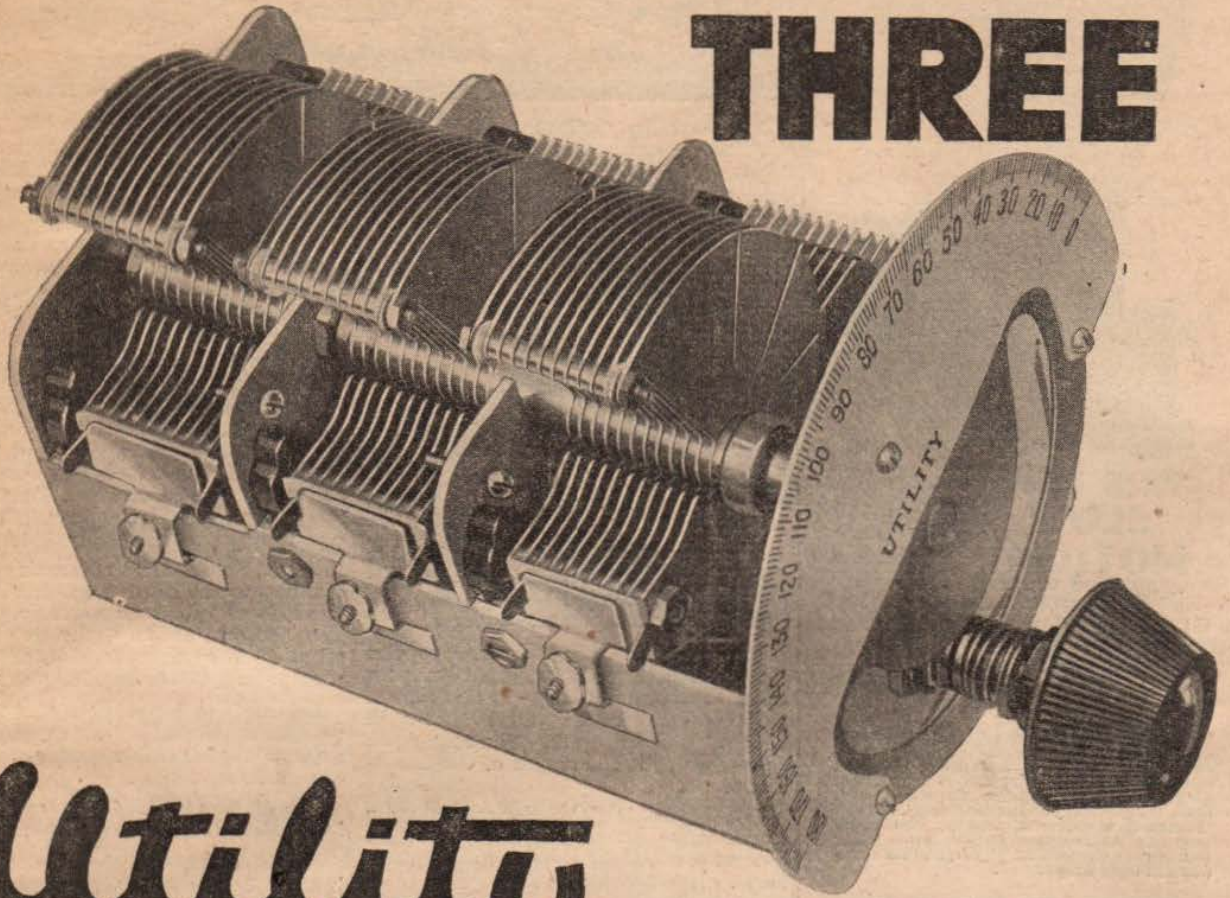

Utility

... the very last word in both design and performance. That will be the unanimous opinion of all impartial experts.

But we remind all the thousands of constructors who will be building this set that if successful results are to be assured the Utility ganged condenser should be used. The sensitivity is there, the selectivity is there, but only Utility can give you the full benefit of both. Therefore trust the "Amateur Wireless" designer, he knows, and insist on the Utility W305/3, the fully screened gang condenser.

TUNED

W 305/3

Complete

with Dial 25'

WILKINS & WRIGHT, LIMITED

"UTILITY" WORKS, HOLYHEAD RD., BIRMINGHAM

AGENTS—London: E. R. Morton, Ltd., 22 Bartlett's Buildings, Holborn Circus, E.C.1. Scottish: E. B. Hammond, 113 Vincent Street, Glasgow. Lancashire and Cheshire: J. R. Lister, 93 Old Road, Blackley, Manchester. Westmorland, Cumberland, Durham, Northumberland, Yorkshire and Derbyshire: H. C. Rawson, Ltd., 100 London Road, Sheffield. Lawrence Fraser, Chelsea House, Lansdowne Road, Bath.

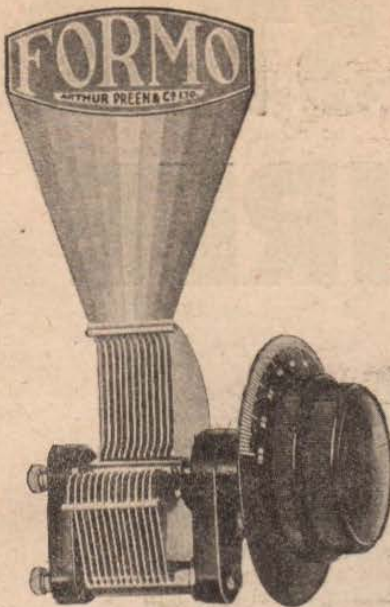

**THIS NEW
"SLOW
MOTION"**
IS AMAZING VALUE
AND QUALITY
FOR ONLY

6/-

The Formo Company, with their great experience in construction of variable condensers, introduce this new model fast- and slow-motion condenser, confident that this is the highest quality instrument available. The slow-motion drive is silky and permits the tuning of close stations to a degree of accuracy that vastly improves the reception of your set. Other features are the internal pigtail, and its small size and light weight.

THE FAMOUS FORMO - DENSOR

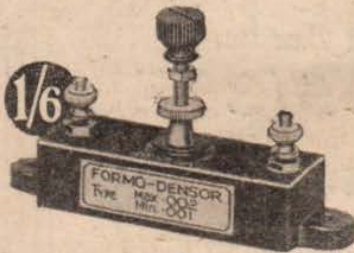

This product is the pioneer of small compression-type condensers, and for all purposes where some flexibility in capacity is required, the Formo-Densord is a product of assured reliability and precision.
Type F, J, and G, 1/6. Type H, 2/3.

Write for New Complete Catalogue from:

ARTHUR PREEN & Co., Ltd.,
Golden Square, Piccadilly Circus,
London, W.1.

Works address: Crown Works, Southampton.
See also pages 914 and 964.



ON November 17 Clapham and Dwyer, the former now recovered from his illness, come back to Savoy Hill, with Cicely Courtneidge and Maurice Cole.

Isobel Elsom and Harold French will give the third of their series of Famous Faux Pas in the National vaudeville programme of November 10, with a repeat performance on Regional on November 12.

Another performance by the Roosters Concert Party will be given for Midland Regional listeners on November 20.

A French programme arranged by a Frenchman, Rene Thibault, will be given from a Birmingham studio on November 18. There will be dramatic recitals with music and some French songs sung by Georgette Bleckly.

Some unusual little pieces are included in the Philharmonic Midday Concert programme to be relayed from Queen's College, Birmingham, on November 19.

Jelly d'Aranyi is one of the most popular soloists in the City of Birmingham Orchestra series of Symphony Concerts this season. On this occasion she will be heard in Brahms' Concerto in D. The concert on November 19 is the second of the broadcast series.

The North Regional programmes for November 8 will open with a brass band concert provided by the Penketh Tannery Band.

North Regional listeners to the midday programmes on November 9 will have their first opportunity of hearing the organ of the College of Technology, Manchester.

Arthur Wilkes on November 9 will sing some of the songs from Schubert's "Fair Maid of the Mill" cycle.

STATION IDENTIFICATION

AMATEUR WIRELESS has organised a new service of the greatest importance to all listeners. This Station Identification Service is available for identifying stations from information supplied by readers, and will be conducted by J. Godchaux Abrahams in conjunction with "A.W." The fee is 6d. for identifying any one station, but if three identifications are required at a time the fee is only 1s. A stamped addressed envelope must be enclosed.

Address your inquiry to Station Identification Service, "Amateur Wireless," 58-61 Fetter Lane, E.C.4, and give fullest possible details. State type of set used, date and time when station was heard, wavelength, call or interval signal, and details of any programme heard.

The long-promised broadcast of Mr. J. L. Hodson's play, *Red Night*, has been fixed for November 9. It is the dramatised version of *Grey Dawn, Red Night*, a novel dealing with the War.

Neukomm's fantasy, "Concert on a Lake with Thunderstorm," is to be played by Herbert Westerby in his weekly organ recital from the Grosvenor Hall, Belfast, on November 27.

Arthur Bliss will conduct his famous work, "Morning Heroes," at the Sheffield Musical Union's concert on November 12. Other works to be performed, which will be conducted by Sir Henry Coward, are Sir Hamilton Harty's "The Mystic Trumpeter" and a scene from Berlioz's *Faust*. The relay to the Northern Region will last from 7.30 to 9.45 p.m.

Frank Pursall will lend an air of added lightness to the North Regional "Do You Remember?" programme on November 14. The Northern Studio Orchestra will play selections from the musical comedies that were popular at the beginning of 1900.

Belfast is to broadcast a Scottish programme on November 26, by which it is hoped a real Scotch atmosphere will be created in the studio.

The Western Studio Orchestra takes part in an afternoon concert on November 18.

A Bristol concert will be given on November 20. The artistes taking part are Brian Gaye, Phyllis Smale, Beryl Tichbon, and Norman Jones.

The date of Alfred Barker's violin recital has been changed from November 2 to November 9.

It was a matter for regret that, when the organ recitals were given during the summer from York, it was not possible to include one by Dr. E. C. Bairstow, the organist at the Minster. However, on November 10, Dr. Bairstow will be heard in a three-quarters of an hour's recital.

The Rev. R. G. Berry will give a talk entitled "Welsh Parodies" during the Welsh Interlude on November 16.

A Welsh programme will be given on November 17, when the Cambrian Colliery Male Voice Party conducted by W. J. Hughes will sing.

Recent relays of Berlin concerts specially destined to the United States of America for re-transmission over the National Broadcasting network have been carried out by the Zeeser station on 19.72 metres (15,210 kilocycles), simultaneously with the normal transmission on 31.38 metres. In this manner the programmes have been perfectly received on the other side of the Atlantic with minimum fading effect.

'ATLAS' WON 'W.W.' OLYMPIA BALLOT 1930

★
**HERE'S THE NEW
MAINS UNIT WINNER
FOR THIS YEAR**



SPECIFICATION	CLARKE'S ATLAS
I Variable Tapping	0/100 V.
I " "	0/120 V.
I Fixed "	150 V.
Output at 150 V.	25 m.A.
L.T. Trickle Charger	2,4 & 6 V.
Charging Rate	0.5 A.
4 Grid Bias Tappings	1½, 3, 9, 16 V.
Guarantee	12 months
Price	£6-10-0
Yours for	10/- down

"ATLAS" AGAIN!

**ALL-MAINS UNIT MODEL A.C. 290
H.T., L.T., & G.B. from A.C. Mains**

Registered Design No. 765,640

For the second year in succession "ATLAS" have won the big "Wireless World" Ballot as the finest Mains Units at Olympia. Thousands of experts have voted this new "ATLAS" Unit absolutely unequalled for sheer excellence of design and value.

Ask your dealer for a demonstration and insist on "ATLAS," the expert's choice.

The new "ATLAS" Super Model A.C. 290 includes four Grid Bias tappings which are entirely independent of the H.T. supply, and perfectly smoothed by Electrolytic Condensers. Moreover, an exclusive "ATLAS" L.T. safety switching arrangement isolates the Receiver when Trickle Charging. A Double Adaptor combining a two-pin plug and lamp plug is fitted and a Tapped Input ensures the highest efficiency on 200/210, 220/230, and 240/250-volt mains. Incorporating Westinghouse Metal Rectifiers and fully guaranteed for twelve months.

Size 10½ in. by 6 in. by 3½ in. **£6 10 0**
Cash Price
or 10s. down and 9 monthly payments of 15s. each.

4 OTHER NEW MODELS

2 new "ATLAS" H.T. Units at 52/6 and 59/6 and 2 new "ATLAS" All-Mains Units at 77/6 and 90/- respectively, are introduced for A.C. Mains. They include many remarkable features and are undoubtedly the finest value ever offered.

Write for free booklet, "Power from the Mains," containing many valuable hints on converting your Battery Set to Mains operation.

**H. CLARKE & CO. (M/CR) LTD.
OLD TRAFFORD, MANCHESTER**
London Office: Bush House, W.C.2
Phone: Temple Bar 7130

**"CLARKE'S
ATLAS"**

THE UNBEATABLE MAINS UNITS

You will Help Yourself and Help Us by Mentioning "A.W." to Advertisers

CHOOSING YOUR ACCUMULATOR

By J. H. Reyner, B.Sc., A.M.I.E.E.

UNLESS one is fortunate enough to be able to run off the mains, an accumulator is, of course, necessary. We may spend many weeks making up our minds as to the set we are going to use for the season. We may reckon up the high-tension current consumption, and decide upon an economical size of high-tension battery. We will make all arrangements necessary and then suddenly remember the accumulator. Really, an accumulator requires choosing with the same discrimination as an H.T. battery. If it is to last for a certain time at a certain rate of discharge, there must be a certain definite amount of paste in the plates. The larger the current or the longer the time for which the current is required, the larger must be the plates, and therefore we rate an accumulator in terms of its capacity to deliver the energy we require, and we must estimate what our requirements are and then choose an accumulator capable of fulfilling them.

Discharge Rates

The usual method of rating is in the terms of ampere-hour capacity. This is the product of the current and the time for which the current is required. For example, a 10-ampere-hour capacity means that we can obtain 1 ampere for ten hours, 2 amperes for five hours, or $\frac{1}{2}$ ampere for twenty hours. This rating is not strictly accurate, but it is near enough for practical purposes. For radio purposes we require perhaps three hours' use every night, and we do not wish to recharge the accumulator every week. It is preferable to arrange matters so that one charge lasts three weeks or a month.

Some manufacturers prefer to base their figures on a 100-hour discharge rate, so that a 40-ampere-hour battery would only be discharged at a little less than $\frac{1}{2}$ ampere (.4 ampere, to be precise), which, of course, is a value more representative of usual conditions. Generally speaking, then, it is wise to assume a 100-hour discharge rate.

The method of procedure, therefore, is as follows. Add up the filament currents of the various valves in the set. A three-valve set, for example, using an S.G., detector, and power valve, might take .15 ampere on the S.G. valve, .1 for the detector, and .2 for the power valve, giving us a total current of .45 ampere. On a

100-hour basis this requires an accumulator having a capacity of 45 ampere-hours. With such a cell a life of at least one month would be obtained assuming three hours use every night.

Possibly the particular make of accumulator you wish to purchase is not made in the 45-ampere-hour size, in which case the nearest approach to this value can be used.

A smaller capacity could be used for a shorter time. In the case just considered, for example, it is theoretically possible to use a 20-ampere-hour accumulator and to recharge it every ten or twelve days. This is not such good practice, however, particularly where the mass plate construction is used, since this type of plate gives its best service with a relatively slow discharge.

The plate type of accumulator is suitable for a more rapid discharge rate. Most manufacturers make both types, and the user, therefore, can take his choice. In any case, when using a multi-valve set with a total filament consumption of over 1 ampere, the plate type of accumulator is generally more suitable.

AROUND THE SHORT-WAVE DIAL

CONDITIONS on the short-wave bands have been extremely bad during the last few weeks, the writer having been able to pick up signals from W2XAD only once during the last seven days! Perhaps by the time this is in print, conditions will have improved again. Even the giant RW59 at Moscow, on 50 metres, has been very poor, generally good in the early evenings, but getting very much worse after about 8 o'clock. This station appears to have extended its working hours lately, and is sometimes to be heard at various hours after midday.

The 48-50 metre American stations have on the whole been rather better and now, with the arrival of winter conditions, we may expect some good results from these stations; it is nearly always possible when conditions are bad below 45 metres to turn to the longer wave stations.

The progress of short-wave broadcasting during the last few years is really one of the most amazing feats of progress since

research in radio began. Whereas but five years ago, although there was certainly a large amount of work being done in short-wave research, there were practically no stations actually broadcasting speech and music. To-day there are over 200 such stations situated in various parts of the globe, whilst a very large percentage of the world's commercial telegraphy transmissions take place below 50 metres. When the transatlantic telephone was opened, this service took place on the long waves, but it was soon found that the demand for this service needed the upkeep of more than one two-way communication channel and, in plain words, there just wasn't room for them on the long waves, so investigations were commenced on the short waves, with the result that several new channels were opened. After this, of course, came the two-way channel to Australia, incorporated now as a regular telephone service, whilst during the past eighteen months, many new channels of communication with various parts of the world have been opened. This has all been made possible by the properties of the short waves, for it would be impossible to accommodate many channels on the long-wave bands.

Short waves are not only responsible for the transmission and reception of the human voice, for they are now being used for television transmissions, and even for transmitting still pictures across the Atlantic. It may interest some readers who possess picture receivers to know that there is a certain station operating on about 15 metres, which quite frequently transmits still pictures. I have not been able to trace the call sign or location of this station but he is very often to be heard in the daytime.

MANDER BARNETT.

DANGEROUS TRANSMISSIONS

A POWERFUL wireless transmitter is quite capable of inducing strong currents in any metallic conductors near by. This fact has been recognised in America where—as in this country—aircraft transmission takes place on short wavelengths, by an official recommendation that short-wave wireless transmitters should not be located close to petrol stores or near aircraft fuelling stations. For the same reason an aircraft pilot is forbidden to transmit wireless messages when another machine is being refuelled in the near vicinity.

B. A. R.



CAMCO give you "SOUND"

"Sound"—in looks and performance. Camco Cabinets are in step with set and speaker design and represent astonishing value. Here are two from their extensive range. On the left is the "Windsor," a Midget Cabinet for Set and Speaker. The Cabinet is removable from the stool. In shaded walnut, 75/-. On the right is the "Truetone," a small Cabinet for moving-coil speakers. It combines attractive appearance with sound design. In shaded walnut, 30/-. Write for FREE copy of the 1932 24-page Radio Cabinet Catalogue.

Cabinets



CARRINGTON
MFG. CO., LTD.,
Showrooms:
24 Hatton Garden,
London, E.C.1.
Phone: HOL 8202
Works: S. Croydon.

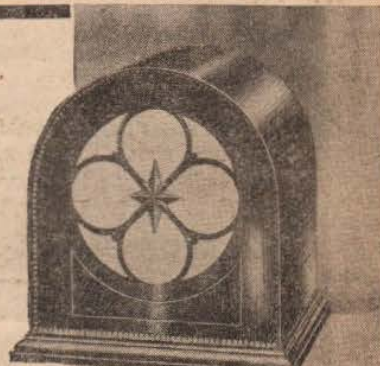

Name.....

Address.....

A.W.19

**Do you want
your radio**

**LOUDER
CLEARER?**

**HOW TO GET
MORE OUTPUT
WITHOUT ALTERING RECEIVER
AND WITHOUT EXTRA
DRAIN ON BATTERIES**

The output of any radio receiver can be increased in volume and improved in quality by replacing the power valve with a Lissen Power Pentode. The magnification factor of this valve is 90—it makes a 2-valve set behave like a three and a 3-valve bring in distant foreigners at full strength like a four. Yet the current consumption of a Lissen Power Pentode is only 7 m/A—so that you get the extra volume without increasing the drain on H.T. batteries at all—that is why it is called the Lissen *Economy* Power Pentode.

Anybody can use a Lissen Power Pentode on any set—no alteration of wiring is necessary. Simply ask your radio dealer for a Lissen P.T.225, price 12/6. You will never again use an ordinary power valve once you have tried the Lissen *Economy* Power Pentode.



12/6
P.T.225

**LISSEN ECONOMY
POWER PENTODE**

LISSEN LIMITED, WORPLE ROAD, ISLEWORTH, MIDDLESEX

Please mention "A.W." when Corresponding with Advertisers

Join the new Radio Cult!



CONVERTS YOUR OLD BATTERY SET INTO AN ALL-MAINS RADIO

COSTS ONLY
1d. A WEEK
TO RUN



ANY MODEL DELIVERED TO YOU FOR ONLY 10/6 DOWN
Balance in Easy Monthly Payments.

BATTERY ELIMINATORS

"MULTIVO"

H.T. Output: 25 milliamperes.
1 variable tapping 0/100 volts.
1 tapping .. 50/90 ..
1 tapping .. 150 ..
Trickle charger for 2-, 4-, and 6-amp accumulators at 5 drops
CASH PRICE £5 5 0

"VOLTEX"

For indirectly heated valves.
H.T. Output: 25 milliamperes.
1 variable tapping 0/100 volts.
1 tapping .. 50/90 ..
1 tapping .. 150 ..
L.T. Output: 4 volts 4 amperes.
(Raw A.C.)
CASH PRICE £5 5 0

"MINIVO"

H.T. only.
Output: 120 volts at 20 milliamperes.
1 tapping .. 50/90 volts.
1 tapping .. 90/100 ..
1 tapping .. 120/150 ..
CASH PRICE £3 3 0

ASK YOUR DEALER TO DEMONSTRATE OR WRITE NOW FOR

Fully illustrated Catalogue "B" to:

ARTHUR PREEN & CO., LTD.,

GOLDEN SQUARE, PICCADILLY CIRCUS, LONDON, W.1. Crown Works, SOUTHAMPTON
see also - ages 914 and 960.

100% BRITISH MADE

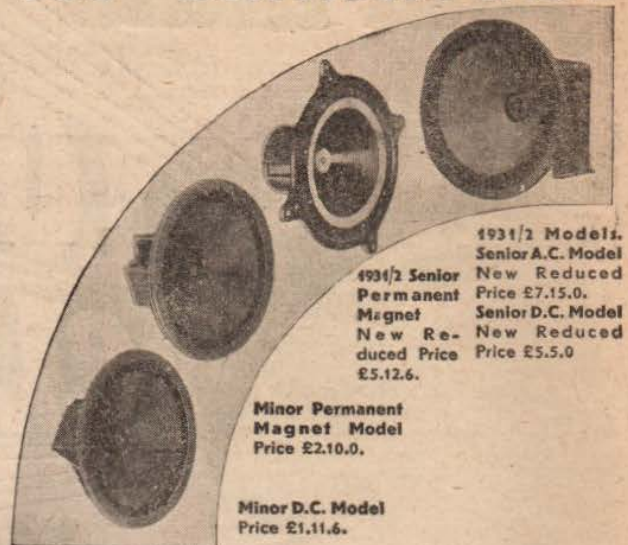

1931/2 Models.
Senior A.C. Model
New Reduced Price £7.15.0.
Senior D.C. Model
New Reduced Price £5.5.0
£5.12.6.

Minor Permanent Magnet Model
Price £2.10.0.

Minor D.C. Model
Price £1.11.6.

-and it costs less

If you must have the best possible reproduction it means a B.T.H. R.K. There are many new models available now. In the R.K. range, from the "Minors" at 31/6 (field excited model) and 50/- (permanent magnet) to the Senior A.C. R.K. at £7:15:0, there is a model specially suited to your requirements.

Ask your dealer for a demonstration and full particulars.

GREENWICH TIME FROM THE MAINS



Have you seen the Ediswan A.C. Mains Electric Clock? Ask your radio dealer. Prices from 45/-

B.T.H.



MOVING COIL REPRODUCER

EDISWAN RADIO



THE EDISON SWAN ELECTRIC CO. LTD.
Radio Division: 155 Charing Cross Road, London, W.C.2

W.177

To Ensure Speedy Delivery, Mention "A.W." to Advertisers

Postcard Radio Literature

GET THESE CATALOGUES FREE.

Here "Observer" reviews the latest booklets and folders issued by well-known manufacturers. If you want copies of any or all of them FREE OF CHARGE, just send a postcard giving the index numbers of the catalogues required (shown at the end of each paragraph) to "Postcard Radio Literature," "AMATEUR WIRELESS," 58-61, Fetter Lane, E.C.4. "Observer" will see that you get all the literature you desire.

Easy Terms

I FEEL that every set constructor will want to have a copy of the new 112-page catalogue issued by the New Times Sales Co. Every leading component on the market is included in this and there are quite a number of kits and complete sets, too. The easy payment system is available, for the parts catalogued, on the special New Times Sales Co. plan. **605**

B.G. Parts

The British General Triumph transformer now sells at only 5s. and is exceptional value. You can get particulars of this and of other British General parts in literature just issued. **606**

New Dubilier Parts

A new Dubilier catalogue has just reached me which shows the alterations which have been made for 1932. Among the newcomers are type 9200 special non-inductive paper condensers which are very useful on the H.F. side of a set. **607**

Increasing Selectivity

Special models of the popular Ferranti rejector are available for North Regional, Midland Regional, 5XX, Dublin, and London National and Regional. Write for a free folder which describes this handy way of increasing selectivity. **608**

New Resistances

I am interested to see that Le Carbone, Ltd., have just brought out some new resistances made of a vitrified material, called Givrite. A folder is available giving the wattage dissipation of these resistances in various shapes, rods, tubes, and flat discs. **609**

New Eta Valves

I have just received leaflets giving details of new Eta valves, the D3-50B, a full-wave rectifier; the BY1210, a detector valve; the BY2020 H.F. valve; and the BX604 super-power valve. These leaflets should be in the possession of every valve user. **610**

W.B. Permanent Magnets

Permanent-magnet moving-coil speakers which really are permanent so far as their magnetism goes, are a feature of the Whiteley Electrical Radio Co., Ltd., programme. The PM1, PM2, and PM3 permanent-magnet speakers and the new four-pole balanced-armature jobs are described in the latest catalogue called "Speaking of Speakers." **611**

OBSERVER **611**

New Times Sales Co

CHOOSE FROM THE NEW 1932 RADIO AND BUY IT ON EASIEST OF EASY TERMS

MANUFACTURERS' KITS

V3 RADIO FOR THE MILLION

10/- DOWN AND 11 MONTHLY PAYMENTS OF 10/10
Screened-grid, Detector, and Power. With valves, less Cabinet. **CASH PRICE £5.17.6**

MULLARD 3 1932 TYPE

Screened-grid, Detector, and Pentode. With valves less cabinet. **CASH PRICE £6.10s. 0d.**
Balance in 11 monthly payments of 11/11. WITH ORDER Finished Instrument, with Valves and Cabinet. Royalties Paid. **£7 17s. 6d.** Cash, or **£2** deposit and 11 monthly payments of 11/9.

SIX-SIXTY CHASSIKIT BATTERY MODEL

Complete three gang band-pass tuning, S.G., Detector and Pentode. With valves less cabinet. **CASH PRICE £6 17s. 6d.** WITH ORDER Balance in 1 monthly payments of 12/7.

ELIMINATORS

EKCO K.18 COMBINED H.T. ELIMINATOR AND L.T. TRICKLE CHARGER. Delivers 18 m/a. and suitable for 1- to 5-valve sets. S.G., 50/80 volts, 120/150. Charges at 25 amp. at 2, 4, or 6 volts. **Cash price £4 12s. 6d.** Balance in 11 monthly payments of 8/6.

ATLAS A.C. ELIMINATOR TYPE A.C.244. Three tappings, S.G., Detector, and Power. Output, 120 volts at 20 m/a. **Cash price £2 19s. 6d.** Balance in 11 monthly payments of 5/6.

SPEAKERS

W.B. PERMANENT MAGNET MOVING-COIL SPEAKER, TYPE P.M.3. With 3 Ratio input transformer. **Cash price £2 12 6** Balance in 11 monthly payments of 4/10.

AMPLION MOVING-COIL SPEAKER, TYPE M.C.6. Permanent magnet, with output transformer. Complete. **Cash price £3 7s. 6d.** Balance in 11 monthly payments of 6/2.

B.T.H. R.K. MINOR PERMANENT MOVING-COIL SPEAKER. Handles outputs up to 2 watts. **Cash price £2 10s. 0d.** Balance in 8 monthly payments of 6/.

EPOCH PERMANENT MAGNET MOVING-COIL SPEAKER, Type A.2. **Cash price £3 3s. 0d.** Balance in 11 monthly payments of 5/9.

R.&A. "100" MOVING COIL REPRODUCER. Complete with tapped Input Transformer. **Cash price £2 17s. 6d.** Balance in 11 monthly payments of 5/4.

COSSOR 234 EMPIRE MELODY MAKER

Screened-grid, Detector, and Power. With valves and cabinet. **CASH PRICE £6 15s. 0d.** Balance in 11 monthly payments of 12/6. WITH ORDER Finished Instrument. Royalties Paid. **£7 10s. 0d.** Cash, or **£2** deposit and 11 monthly payments of 11/.

OSRAM NEW MUSIC MAGNET 4

Two Screened-grid, Detector, and Power. With valves and cabinet. **CASH PRICE £10 15s. 0d.** Balance in 11 monthly payments of 19/8. WITH ORDER Finished Instrument. Royalties Paid. **£11 15s. 0d.** Cash, or **£2** deposit and 11 monthly payments of 19/6.

SIX-SIXTY CHASSIKIT A.C. MODEL

Complete as above with A.C. Mains Valves. With valves less cabinet. **CASH PRICE £7 6s. 6d.** Balance in 11 monthly payments of 13/5. WITH ORDER

EKCO A.C.25 H.T. ELIMINATOR. Tappings—S.G. 50/80 volts, 100/150 volts at 25 m/a. **Cash £3 17s. 6d.** Balance in 11 monthly payments of 7/1.

HEAYBERD H.T. UNIT—"D" MINOR—Output 120v. at 20 m/a.—Tapped at 80v., 100v., and 120v. **Cash price £2 17s. 6d.** Balance in 11 monthly payments of 5/4.

EXIDE 120-VOLT TYPE W.H., H.T. ACCUMULATOR, in crates. **Cash price £4 13s. 0d.** Balance in 11 monthly payments of 8/6.

ORMOND PERMANENT MAGNET MOVING-COIL CHASSIS (No. 464). With tapped input transformer. **Cash price £3 5s. 0d.** Balance in 11 monthly payments of 6/.

CELESTION PERMANENT MAGNET MOVING-COIL SPEAKER, Type R.P.M.8, with 5" reinforced diaphragm. Excluding input transformer. **Cash Price £3 10s. 0d.** Balance in 11 monthly payments of 6/5.

BLUE SPOT DYNAMIC TYPE SPEAKER UNIT AND CHASSIS, Type 100 U. **Cash Price £1 19s. 6d.** Balance in 7 monthly payments of 5/5.

ROLA PERMANENT MAGNET MOVING-COIL SPEAKER. Complete with input transformer. **Cash Price £2 17s. 6d.** Balance in 8 monthly payments of 7/1.

EPOCH J.I. PERMANENT MAGNET MOVING COIL SPEAKER. In Chassis form with multi-ratio input transformer. **Cash price £2 5s. 0d.** Balance in 11 monthly payments of 4/2.

SEND 3d. IN STAMPS FOR NEW CATALOGUE We can supply any line, and component advertised in this journal can be supplied on H.P. Make out your requirements and let us quote by return.

ESTABLISHED IN 1924—FIRST WITH EASY TERMS

NEW TIMES SALES CO., 56 LUDGATE HILL, LONDON, E.C.4. Phone: CENTRAL 2716.

(a) Please send me further particulars of.....

(b) I enclose.....s.....d. as first payment for.....

NAME

ADDRESS

A.W. 7/11/31.

“EXPRESSLY WRITTEN FOR THE BEGINNER”

2/6
NETT

“The How and Why of Radio,” by Alan S. Hunter, has been expressly written for beginners.

It provides a clear conception of the general theory and practices of wireless reception in simple, non-technical terms, and contains over ninety clearly defined illustrations. It has been mainly compiled from the series of articles in AMATEUR WIRELESS:—“The How and Why of Radio”—which proved so popular during the past twelve months.

Get this indispensable book NOW. Of all Newsagents and Booksellers, or 2/9, post free,

from

“AMATEUR WIRELESS,”

58, Fetter Lane,

London, E.C.4

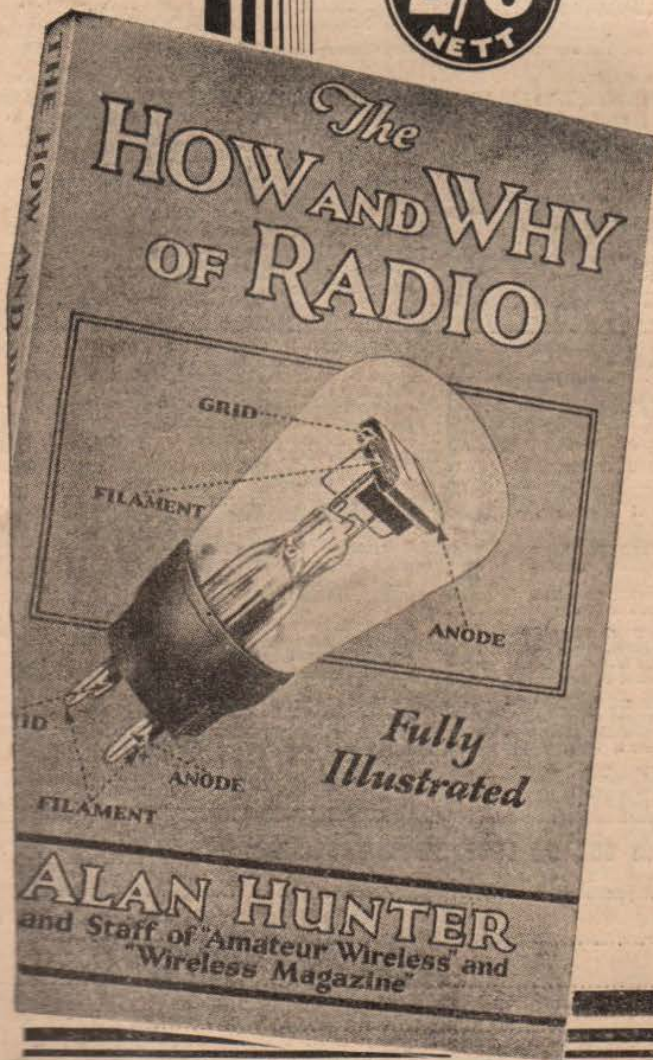

BEHIND THE SCENES AT THE B.B.C.



Nothing is more fascinating than to know what happens behind the scenes. Here, you are taken into every department of the B.B.C. connected with the preparation and production of programmes. You are told the story of broadcasting from an angle which is rather new to us.

You are shown how the stations are linked together by land lines and are given an insight into the novel and remarkable organisation for which the B.B.C. executive is responsible.

A well-illustrated supplement of real interest this . . . comprising 16 pages and given in the "Wireless Magazine" now on sale.

WIRELESS MAGAZINE

THE BEST SHILLINGSWORTH IN RADIO

148
PAGES

GET YOUR COPY TO-DAY
OF ALL NEWSAGENTS &
BOOKSTALLS. PRICE

1/-



W OUT OF THE BLUE

From the "Puretone" Loudspeaker unit there comes music and speech as clear as a bell and without a trace of distortion. The reproduction is free from crackle and harshness. Every intonation is picked up—the deep bass notes are as perfectly reproduced as the higher frequencies of speech.

"Puretone" is All-British and we have such faith in this new unit that we guaranteed it for one year.

Price **7/6**

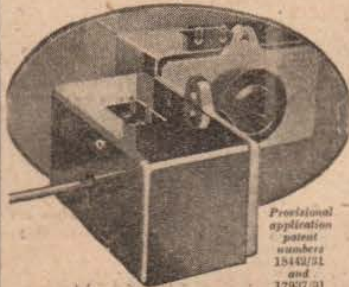

Patent application numbers 18442/31 and 17937/31

- BRITISH MADE THROUGHOUT.
- HIGHLY SENSITIVE.
- A VERY TRUE TO LIFE REPRODUCTION.
- VERY ROBUST—NOT A SCREW OR BOLT IN ITS CONSTRUCTION.
- AND GUARANTEED FOR ONE YEAR.
- SPECIALLY CONSTRUCTED CONE FOR USE WITH THE PURETONE.

Price 2/6 (not essential)

Ask your local dealer to let you hear one. It's a blueunit! you can't miss it and "SPEAKS FOR ITSELF."

Orders dealt with promptly.

Puretone has only been on the market for a short time and we have naturally not got complete retail coverage. If you will, however, write direct to us giving the name of your local dealer we will see that you obtain a unit by return of post.

BUY BRITISH COMPONENTS.

The WALTER PURETONE loudspeaker unit

J. & H. WALTER, LTD.
25a, FARM LANE, FULHAM, S.W.6.
Telephone: Fulham 5645.
Trade Enquiries Invited.

(M.C.100)

ATLAS ON SHOW

LONDON readers will be interested to know that Messrs. H. Clarke & Co. (Manchester), Ltd., have opened new show-rooms in Bush House, Strand. These new premises will serve as a centre for the southern half of England and will be in the charge of Mr. A. H. Freeman, the London sales manager. Provision is made for testing and demonstrating units on A.C. and D.C. mains, and the most complete service is offered.

WIRELESS FOR THE BLIND

THE annual report of the National Institute for the Blind embodies an encouraging report on the progress of the British "Wireless for the Blind" Fund which was inaugurated on Christmas Day, 1929. The object of this fund was to provide every blind person in Great Britain and Northern Ireland with a wireless set, and investigations showed that about 20,000 sightless people were then equipped.

The Committee of the fund appealed for help only to wireless listeners and only through the microphone. Apart from financial assistance given by members of the public, generous subscriptions have been received from the wireless trade.

At the time of compiling the National Institute's report, 13,000 sets had been distributed, and it is hoped that the remaining 7,000 blind persons would be provided with sets at an early date.

TONAX ADAPTORS

IN the test report on Tonax adaptors, in "A.W." No. 488, it was perhaps not clearly explained that the washers supplied with the adaptor are not of silk, but are of a special flexible type which results in a good grip on the speaker cone. These speaker adaptors are supplied by Messrs. Garratt Stores, 193 Garratt Lane, S.W.18, and are suitable for every type of single and double-cone speaker.

"POCKET GUIDE TO CONTINENTAL STATIONS"

LISTENERS to foreign stations will be interested to know that a limited number of copies are available of the handy booklet, "Pocket Guide to Continental Stations," which was so popular with visitors to the "A.W." Stand at Olympia. Copies may be obtained, post free, for 2d. in stamps from the AMATEUR WIRELESS Office, 58-61 Fetter Lane, E.C.4. Details such as call signs, times of transmissions, interval signals, and programme arrangements are given of fifty of the best Continental stations.

The Concert for Schools to be broadcast on November 20 will have an audience of over two thousand children, for it is being broadcast from the Usher Hall, Edinburgh, and is the third of a series which has been arranged by the B.B.C. in co-operation with the Edinburgh Corporation Education Committee.

"THERE'S NO PLACE LIKE HOLMES"
Send us a list of anything you require for Wireless and we will quote you Easy Terms to suit your convenience.
H. W. HOLMES, 29 Foley St., Gt. Portland St., London, W.1
Museum 1414

USE ALL THE POWER YOU PAY FOR!

Don't let cell-to-cell leakage rob your Set of the energy it needs . . .

IF you use smooth top H.T. Accumulators your charging bill is too heavy. Day in and day out power is leaking away—a direct electrical connection is provided between its terminals—and charging becomes more frequent. In the Lively 'O' H.T. Accumulators each 2 volt cell is isolated by an air-gap—electrical leakage cannot take place. Every bit of power paid for at the charging station is available to work your Set. You can buy the Lively 'O' at any Wireless Shop.

TWO TYPES

- | | |
|---|------------|
| Standard 10-volt Unit (2,750 milliamps) | 5/6 |
| Extra large capacity (5,500 milliamps) per 10-volt Unit | 6/9 |



The 'Lively O'



LIVELY 'O' H.T. ACCUMULATORS

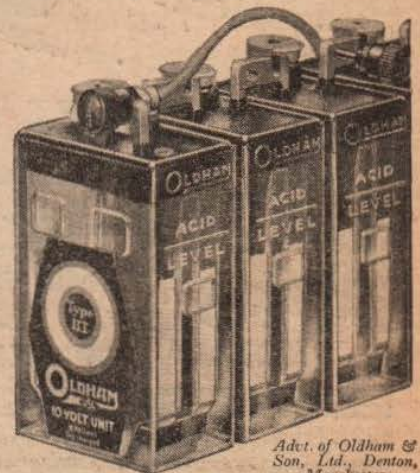

Advt. of Oldham & Son, Ltd., Denton, Manchester

4276

AMPLION OFFER YOU

FOR

25/-

the A.C.6

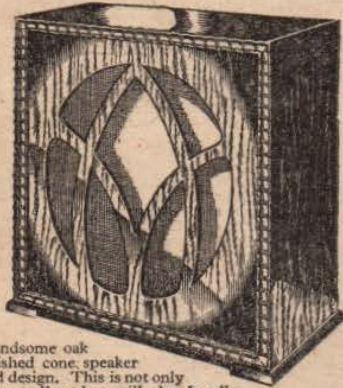

A.C.6.—Contained in a handsome oak cabinet, this beautifully finished cone speaker embodies a unit of improved design. This is not only constructed to work with a small set but will also handle the output of powerful receivers without distortion.

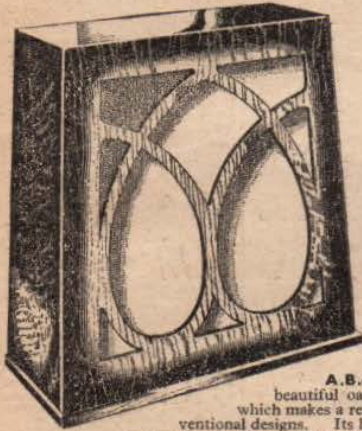

FOR

50/-

the A.B.4

A.B.4.—The modern lines of this beautiful oak cabinet have a severity which makes a refreshing change from conventional designs. Its handsome exterior houses a highly efficient speaker—a balanced armature model with provision for matching to power or pentode outputs. Fifty shillings is indeed a small price for such volume and crisp reproduction. Same model in Walnut 59/6.

And FOR

67/6

the M.C.6

M.C.6.—An extremely efficient moving coil unit, a permanent magnet which is quite as sensitive as a balanced armature speaker, and thus quite suitable to work with ordinary 2, 3, or 4 valve receivers. The matching transformer, fitted as standard, enables the unit to be correctly matched to any output.

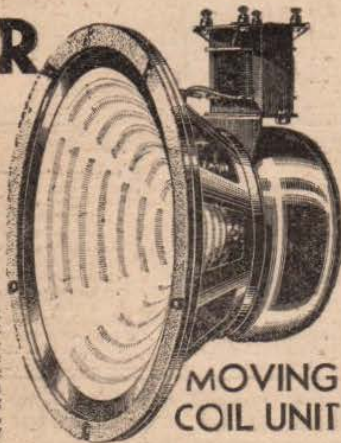

MOVING
COIL UNIT

GRAHAM AMPLION LTD., 76, Savile Row, LONDON, W.1

royds

KNIFE-EDGE SELECTIVITY

Chops
off
the
Stations



HUIZEN

ROME

FRANKFURT

NATIONAL

OSLO

HEILSBURG

MADRID

SIMPLY, easily, you can now get one station after another—clear cut and cleanly separated—by fitting this wonderful new ganged condenser.

IDEAL TUNING

The British Radiophone Ganged Condenser will give you accurate tuning—firm and smooth with no slipping—holding the programmes with absolute rigidity.

An entirely new and novel method of construction assures a very high degree of accuracy.

OUR GUARANTEE is for a maximum error of only half a millionth part of a microfarad plus 1/2%!

- 2-Gang Condenser 18 - Dustproof Metal Cover 3/-
- 3-Gang Condenser 28 - Dustproof Metal Cover 3/6
- 4-Gang Condenser 38 - Dustproof Metal Cover 4/-
- Oxidised Silver Escutcheon and Drive Assembly complete with pilot lamp attachment 5/-

Write for Illustrated Descriptive Brochure to

**THE
BRITISH RADIOPHONE Ltd.**
Aldwych House, Aldwych, W.C.2

Telephone: HOLBORN 6743

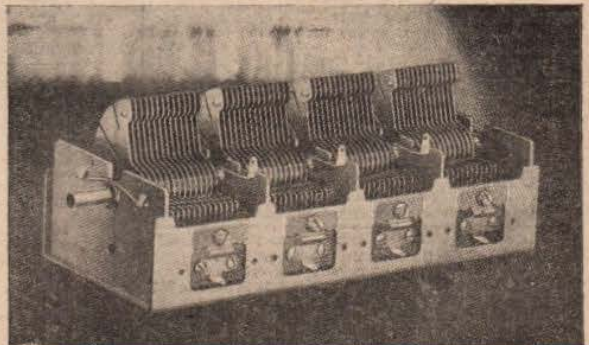

RADIOPHONE GANGED CONDENSERS

Mention of "Amateur Wireless" to Advertisers will Ensure Prompt Attention

ONE MILLION SOLD ANNUALLY

That fact indicates their quality and extreme reliability. They are World-famous. Write to-day for the new illustrated lists and new low prices.



VALVE HOLDERS AND SWITCHES

Made by the makers of the Famous W.B. Permanent Magnet Moving Coil Speakers

WHITELEY ELECTRICAL RADIO CO., LTD., NOTTINGHAM RD., MANSFIELD, NOTTS. Irish Free State Distributors: Kelly & Shiel, Ltd., 47, Fleet Street, Dublin.

EASY TERMS

WE SUPPLY ALL GOOD QUALITY RADIO RECEIVERS, COMPONENTS AND ACCESSORIES ON DEFERRED TERMS. WE CARRY ADEQUATE STOCKS AND CAN GIVE PROMPT DELIVERY

NEW HEAYBERD A.G. ELIMINATOR KIT C.150.—Complete kit of parts for building an H.T. Eliminator, including steel case. Output, 25 m.a., 150 volts, 3 H.T. Tappings, one variable. **Cash Price, £3/15/-** or 7/6 with order and 11 monthly payments of 7/6.

EXIDE W.H. HIGH-TENSION ACCUMULATORS (120 volts, 5,000 m/a.). Higher voltages if desired. **Cash Price, £3/15/-** or 7/6 with order and 11 monthly payments of 7/6. Carriage charged on all orders from Scotland.

H.K. FARRAND INDUCTOR LOUD-SPEAKER UNIT.—Quality of reproduction almost equal to a moving-coil speaker. **Cash Price, £3/10/-** or 5/6 with order and 11 monthly payments of 6/6.

SET OF THREE VALVES, S.G., DET. AND POWER, MULLARD OR COSSOR. **Cash Price, £1/10/0** or 6/- with order and 7 monthly payments of 6/4.

NEW BLUE SPOT 66R UNIT.—The finest balanced-armature movement on the market. Complete with large Cone and Chassis. **Cash Price, £2/10/-** or 5/- with order and 10 monthly payments of 5/-.

NEW CELESTION MOVING COIL L.S. UNIT (PERM. MAGNET), with Transformer. **Cash Price, £4/5/-** or 13/6 with order and 10 monthly payments of 8/-. Send list of requirements and quotation will be sent by return.

LONDON RADIO SUPPLY CO.
11 Oat Lane, Noble Street, London, E.C.2
Telephone: National 1977

"THERE'S NO PLACE LIKE HOLMES"
BLUE SPOT 66 R Unit and Chassis 5/6 and 0 monthly payments of 4/6
H. W. HOLMES, 29 Foley St. St. Giles, London, W.1
Museum 1414

BROADCAST TELEPHONY

Broadcasting Stations classified by country and in order of wavelengths. For the purpose of better comparison, the power indicated is *aerial energy*.

Kilo-Metres	Kilo-cycles	Station and Call Sign	Power (Kw.)	Kilo-Metres	Kilo-cycles	Station and Call Sign	Power (Kw.)	Kilo-Metres	Kilo-cycles	Station and Call Sign	Power (Kw.)
GREAT BRITAIN											
25.53	11,751	Chelmsford (G5SW)	16.0	328.2	914	Grenoble (PTT)	3.0	LITHUANIA			
242.3	1,238	Belfast	1.2	328.9	914	Poste Parisien	1.2	1,955	555	Kaunas	7.0
261.3	1,148	London Nat.	68.0	345.2	869	Strasbourg (PTT)	15.0	NORTH AFRICA			
288.5	1,040	Newcastle	1.2	369.4	812	Radio LL (Paris)	0.5	364.5	823	Algiers (PTT)	13.0
288.5	1,040	Swansea	0.16	447.1	671	Paris (PTT)	2.0	416	721	Radio Maroc (Rabat)	10.0
288.5	1,040	Plymouth	0.16	466	644	Lyons (PTT)	2.3	1,350	222.2	Tunis	0.5
288.5	1,040	Edinburgh	0.4	1,445.7	207.5	Eiffel Tower	15.0	NORWAY			
288.5	1,040	Dundee	0.16	1,724.1	174	Radio Paris	85.0	235.5	1,274	Kristiansand	0.6
288.5	1,040	Bournemouth	1.2								
288.5	1,040	Aberdeen	1.2								
301.5	995	North National	70.0								
309.9	963	Cardiff	1.2								
355.8	843	London Regional	70.0								
376.4	797	Glasgow	3.2								
398.9	752	Midland Regional	38.0								
480	625	North Regional	70.0								
1,554.4	193	Daventry (Nat.)	35.0								
AUSTRIA											
218.5	1,373	Salzburg	0.6								
245.9	1,220	Linz	0.6								
283.5	1,058	Innsbruck	0.6								
352.1	852	Graz	9.5								
453.2	666	Klagenfurt	0.6								
517.2	580	Vienna	20.0								
also testing on 1,255 m. from 8.0 p.m. (Mon. Wed. Sat.)											
BELGIUM											
506	1,456	Antwerp	0.4								
215.3	1,397	Chateaufort	0.2								
216	1,389	Bruxelles	0.6								
Conference 0.2											
238.5	1,258	Binche	0.1								
245.9	1,220	Schaerbeek	0.2								
337.8	888	Brussels (No. 2)	20.0								
500.3	589	Brussels (No. 1)	20.0								
BULGARIA											
318.8	941	Sofia (Rodno Radio)	1.0								
CZECHO-SLOVAKIA											
263	1,439	Moravskava-Ostrava	11.0								
279.3	1,074	Bratislava	14.0								
289	1,022	Kosice	2.0								
341.7	878	Brunn (Brno)	34.0								
488.0	614	Lieblitz (test)	100.0								
DENMARK											
281	1,067	Copenhagen	1.0								
1,153	260	Kalundborg	7.5								
ESTONIA											
296.3	1,012	Tallinn	0.7								
465.8	644	Tartu	0.5								
FINLAND											
291	1,031	Vilpuri	13.2								
368.1	815	Helsinki	13.2								
559.7	536	Tampere	1.0								
1,796	167	Lahti	54.9								
FRANCE											
223	1,345.2	Fecamp	5.0								
237.2	1,260	Beziers	0.6								
238.5	1,258	Bordeaux-Sud-Ouest	2.0								
249.6	1,202	Juan-les-Pins	0.5								
255	1,175	Toulouse (PTT)	1.0								
265.4	1,130	Lille (PTT)	2.0								
272	1,103	Rennes	1.2								
288	1,049	Montpellier	2.0								
287.4	1,043.7	Radio Lyons	30.0								
294.6	1,018	Klagenfurt (PTT)	0.5								
304	936	Bordeaux (PTT)	15.0								
312.6	960	Natan-Vitus (Paris)	0.5								
315	950	Marseilles (temporary)	0.3								
GERMANY											
31.38	9,560	Zeesen	15.0								
217.1	1,382	Königsberg	1.7								
218.5	1,373	Flensburg	0.6								
227.4	1,319	Cologne	1.7								
227.4	1,319	Munster	0.6								
227.4	1,319	Aachen	0.3								
232.2	1,292	Kiel	0.31								
239.4	1,253	Numberg	2.3								
245.9	1,220	Gassel	0.3								
253.4	1,184	Celwitz	5.6								
259.3	1,157	Leipzig	2.3								
269.8	1,112	Bremen	0.2								
274.2	1,094	Heidelberg	75.0								
283	1,060	Magdeburg	0.6								
283	1,060	Berlin (E)	0.6								
283	1,060	Stettin	0.6								
318.8	941	Dresden	0.3								
325	923	Breslau	1.7								
360.6	832	Mühlacker	75.0								
372.3	805	Hamburg	1.7								
390	770	Frankfurt	1.7								
410	716	Berlin	1.7								
439.2	662	Danzig	0.6								
472.4	635	Langenberg	17.0								
532.9	563	Munich	1.7								
559.7	539	Kaiserslautern	1.7								
559.7	536	Augsburg	0.3								
556	530	Hanover	0.3								
560.3	527	Freiburg	0.3								
1,020	185	Norddeich	10.0								
1,034.9	183.5	Zeesen	75.0								
2,525	119.3	Königs-wusterhausen (press)	15.0								
2,900	103.5	Königs-wusterhausen (press)	15.0								
HOLLAND											
31.28	9,569	Eindhoven (PCJ)	30.0								
206.1	1,013	Hilversum	8.5								
208.8	1,004	Radio Idzera (The Hague)	8.0								
275.1	1,053	Kootwijk (testing)	10.0								
1,081	280	Scheveningen-Haven	10.0								
1,875	160	Huizen	8.5								
HUNGARY											
550	545	Budapest	23.0								
ICELAND											
1,200	250	Reykjavik	16.0								
IRISH FREE STATE											
224.4	1,337	Cork (6CK)	1.5								
413	745	Dublin (2RN)	1.5								
ITALY											
25.4	11,751	Rome (3RO)	9.0								
247.7	1,211	Trieste	15.0								
298.8	1,064	Turin (Torino)	8.5								
315.5	951	Genoa (Genova)	10.0								
331.5	905	Naples (Napoli)	1.7								
441	680	Rome (Roma)	75.0								
453.2	662	Bolzano (IBZ)	1.5								
501.7	593	Milan (Milano)	8.5								
541.5	554	Palermo	3.7								
LATVIA											
525.4	572	Riga	13.0								
PORTUGAL											
290.5	1,033	Lisbon (CTAA)	2.0								
also on 42.9 m.											
ROMANIA											
394	761	Bucharest	16.0								
RUSSIA											
426	704.5	Khar'kov	4.0								
720	416.6	Moscow (PTT)	20.0								
937.5	320	Khar'kov (Rv20)	25.0								
967.7	310	Alma-Ata	10.0								
1,000	300	Leningrad	100.0								
1,034.5	290	Kiev	36.0								
1,078	279.6	Tiflis	10.0								
1,117.3	268.5	Moscow Popoff	75.0								
1,304	235	Moscow (Trades Unions)	165.0								
1,481	202.5	Moscow (Kom.)	100.0								
SPAIN											
252.7	1,187	Barcelona (EAJ15)	1.0								
268.9	1,115.6	Valencia (tests)	5.0								
348.8	860	Barcelona (EAJ1)	8.0								
368.1	815	Seville (EAJ5)	1.5								
404	741	Madrid Espana	2.0								
424	707	Madrid (EAJ7)	2.0								
451	665	San Sebastian (EAJ8)	0.6								
SWEDEN											
230.6	1,301	Malmö	0.75								
257.3	1,166	Hörby	15.0								
307	977	Falun	0.65								
321.5	932	Göteborg	15.0								
435.4	680	Stockholm	75.0								
541.5	554	Sundsvall	15.0								
770	389	Ostersund	0.7								
1,229.5	244	Boden	0.75								
1,348.3	222.5	Motala	40.0								
SWITZERLAND											
244.1	1,229	Basle	0.65								
246	1,240	Berne	0.5								
403	743	Sölets	25.0								
459	653	Beromünster	75.0								
TURKEY											
1,204.8	249	Istanbul	5.0								
1,517.4	197.7	Ankara	7.0								
YUGOSLAVIA											
307	977	Zagreb (Agram)	0.7								
430.4	697	Belgrade	3.0								
574.7	542	Ljubljana	2.8								

WHEN SUBMITTING QUERIES

Please write concisely, giving essential particulars. A Fee of One Shilling (postal order), a stamped addressed envelope, and the coupon on the last page must accompany all letters. The following points should be noted.

Not more than two questions should be sent with any one letter.

The designing of apparatus or receivers cannot be undertaken.

Modifications of a straightforward nature can be made to blueprints, but we reserve to ourselves the right to determine the extent of an alteration to come within the scope of a query. Modifications

to proprietary receivers and designs published by contemporary journals cannot be undertaken.

Readers' sets and components cannot be tested at this office. Readers desiring specific information upon any problem should not ask for it to be published in a forthcoming issue, as only queries of general interest are published and these only at our discretion. Queries cannot be answered by telephone or personally.

Readers ordering blueprints and requiring technical information in addition, should address a separate letter to the Query Department and conform with the rules.



"THE TRUE ROAD TO RADIO"

FERRANTI'S GUIDE TO ENTHUSIASTS of interest to all who put quality first in radio reproduction—From all dealers or direct from

FERRANTI Ltd. Head Office & Works: HOLLINWOOD, LANCASHIRE. LONDON: Bush House, ALDWYCH, W.C.2.



Send for these CIRCUITS FREE

Watmel coils can be adapted to all the popular and leading circuits such as the Mullard, Gossor, etc. Just drop us a line and we will send you these circuits free of charge.

These coils may be adapted to nearly any circuit and if you have any difficulty just send us your circuit and we will advise you.

THE ADVANTAGE OF WATMEL COILS

This range of coils has been specially developed in view of modern broadcasting conditions. A high degree of selectivity is assured by using these coils as they are specially screened to prevent direct pick-up or interaction between the various units.

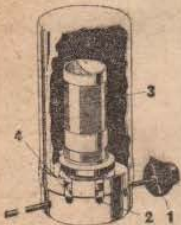

Type S.A.1.—Screened aerial tuner with aperiodic aerial tapping for high selectivity. This tuner can be adapted for any type of receiver. Price

8/6

Type S.A.2.—Similar, but for use where reaction is not to be used. Price **8/6**

Type S.S.3.—H.F. tuner with reaction winding. Price **8/6**

Type S.S.4.—H.F. tuner without reaction winding. Price **8/6**

1. Wave-change switch.
2. All contacts are gold silver alloy which does not oxidise, therefore resulting in perfect low-resistance contacts and reliable switching.
3. The medium-wave winding is carried on a high-grade paxolin tube and wound with silk covered wire.
4. The screens are aluminium with a spring contact between top and bottom.

BAND PASS AERIAL UNITS

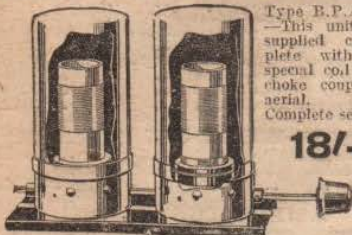

Type B.P.A.1.—This unit is supplied complete with a special coil for choke coupling aerial. Complete set, Price

18/-

Type B.P.A.2.—The same as above, but with extra H.F. tuner, with reaction winding suitable for screen-grid H.F. receivers. Complete with choke coupling unit. Price **28/6**

Write for component catalogue.

N.B.—These coils have been specified by the leading wireless magazines for use in their sets.

If you have any difficulty in obtaining these coils, write direct to us.

Watmel

GETS THE BEST OUT OF ANY SET.

WATMEL WIRELESS CO., LTD.
IMPERIAL WORKS, HIGH STREET, EDGWARE.
Telephone: Edgware 0323.

TRADE ENQUIRIES INVITED.

BUY



BRITISH

(M.C.46)

BATTERY SETS MADE ALL-ELECTRIC

FOR 9/2

and 11 payments of 8/8 or

CASH PRICE £4:15:0

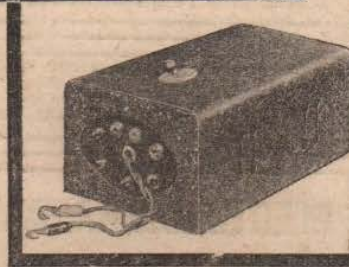

60 m.a. at 250 Volts



A meteoric rise of popularity has been achieved by the new Heyberd W30 Mains Transformer, designed expressly for use with the latest Westinghouse Rectifier H.T.s. Provided with two secondary windings of 175 v. and 200 v. rectified outputs are obtained of 200 v. at 60 m.a. or 250 v. at 60 m.a.

Price **22/6**

Model W31, with similar H.T. windings to Model W30, and incorporating L.T. 4 v. 6 amp. for A.C. Valves. **30/-**

POST THIS TO-DAY

I enclose 3d. stamps for List 948 giving full details, circuit diagrams, and suggested Kit of Components incorporating the new Transformer and Rectifier.

Name.....
Address.....

HEYBERD

MASTERS OF THE MAINS.

10 FINSBURY STREET, LONDON, E.C. 2

"THERE'S NO PLACE LIKE HOLMES"

EXIDE 120v H.T. 2,500 m/a, 6/- and 9 monthly payments of 6/8.

H. W. HOLMES, 29 Foley St., G. Portland St., London, W.1
Museum 1414

LET "A.W." SOLVE YOUR
WIRELESS PROBLEMS.

Advertisers Appreciate Mention of "A.W." with Your Order

TYPE G.B.1

H.T. 150 v. at 15m/a. or 120 v. at 20 m/a. Also S.G. and Det. Tappings.

G.B. 3 Tappings up to 12 v. Independent of H.T.

L.T. 2, 4 or 6 v. Trickle Charger.

Similar to above but larger output.

—TYPE G.B.3

TANNOY mains units incorporate independent G.B. Pat. No. 353375.

Write for particulars

TANNOY

PRODUCTS

Dalton St. :: West Norwood

Tel.: STREATHAM 6731/2

CLIX

Specified and required for the
"THREE STAR THREE"

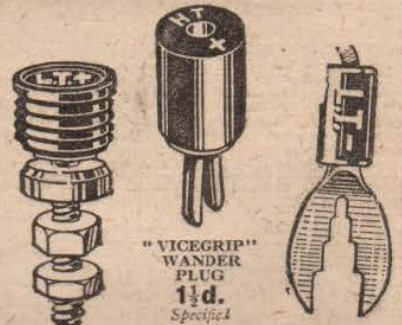

"VICEGRIP"
WANDER
PLUG
11d.
Specified

"FIT-ALL"
SPADE
TERMINAL
2d.
Specified

PANEL
TERMINAL
3d.

Clix—from
all dealers
or direct



ANODE
CONNECTOR
Horizontal or Vertical
3d.

Folder Free
on request

Cheapest PERFECT Contact

Lectro Linx, Limited - 254, Vauxhall Bridge Road, S.W.1

EVERYMAN'S WIRELESS

By ERNEST H. ROBINSON (5 Y.M.)

A handy book telling in plain, non-technical language all that the average man needs to know about Wireless.

CASSELL'S

3/6 net.

PREPAID ADVERTISEMENTS

Advertisements under this head are charged **THREEPENCE PER WORD**, minimum charge **THREE SHILLINGS. DEPOSIT SYSTEM**
As the Publishers cannot accept responsibility for the bona fides of advertisers in this publication, they have introduced a system of deposit which it is recommended should be adopted by readers when dealing with persons with whom they are unacquainted. It is here explained.
Intending purchasers should forward to the Publishers the amount of the purchase money of the article advertised. This will be acknowledged to both the Depositor and the Vendor, whose names and addresses must necessarily be given. The deposit is retained until advice is received of the completion of the purchase, or of the article having been returned to and accepted by the Vendor. In addition to the amount of the Deposit, a Fee of 6d. for sums of £1 and under, and 1s. for amounts in excess of £1, to cover postage, etc., must be remitted at the same time. In cases of persons not resident within the United Kingdom, double fees are charged.
The amount of the Deposit and Fee must be remitted by Postal Order or Registered Letter (Cheques cannot be accepted), addressed to
"AMATEUR WIRELESS" ADVERTISEMENT DEPARTMENT,
58/61 FETTER LANE, LONDON, E.C.4

VERT WIRING CLIP.—No soldering. Fits any component. Perfect contact. Tested and approved "A.W." Quarter gross, 1/2; half gross, 2/; gross, 3/9.—Green & Sons, Redclyffe, Horley, Surrey.
LARGE QUANTITY UNUSED VALVES, transformers, condensers, resistances, etc., less than half price; write for list.—44 Claremont Road, W.13.

THE "TONIC" SELF-GENERATING TRICKLE-CHARGER KIT will help you to economise by keeping your 2-v. L.T. accumulators fully charged at home. A boon to town or country dwellers. 7/- each, postage 9d.—Williams, Netherend, Cradley, Birmingham.

BETTER ACCUMULATOR CHARGING.—Complete H.T. and L.T. Hire Services. Collection and Delivery.—Aneloy Radio, 36 Hindmans Road, East Dulwich. Official Oldham Service Station (Trade supplied), and Charging Contractors to Camberwell Borough Council.

ELIMINATOR COMPONENTS for home constructors. Stamped addressed envelope brings Eliminator Diagrams, with prices of complete range of mains components.—Mains Power Radio, Broadway Works, Eastern Road, Romford, Essex.

AGENTS, ACTIVE ENTHUSIASTS sell "Brookman British Ebonite Panels," cabinets, and specialities, suppliers of all makes of radio apparatus. Send for particulars of our system of trading.—Brookman Rapid Radio Service, 105 Spencer Street, Birmingham.

1932 OSRAM FOUR MUSIC MAGNET KIT, unopened. Cash wanted.—Write, 120 Matlock Road, E.10.

OAK CABINETS, hand polished, 12 in. and 14 in. by 7 in. by 10 in., 6/-; 16 in. and 18 in. by 7 in. by 10 in., 6/6; 21 in. by 10 in., 8/-. Baseboards, 6d. extra. C.W.O. Refunded unsatisfied. Carriage 1/6. State nearest station. Send for price of type of cabinet required. Panels supplied, etc.—E. S. Gibson, 99 Burnley Road, Ainsdale, Dept. A.W.

RADIO AND TALKIE INDUSTRIES NEED TRAINED MEN. Get particulars of unique home-study courses for "Certificate of Proficiency" from Radio Training Institute, Union Buildings, St. John Street, Newcastle-on-Tyne.

REPAIRS to Loud-speakers, Transformers, and Head-phones, 4/- each; Blue Spots, 5/-. Prompt Service; twelve months' guarantee. Discount to trade.—Loud-speaker Repair Co., 2 Shipka Road, Balham, London.

CABINETS for "Amateur Wireless" Receivers.—Longley, Radio Manufacturing Co., 63 Longley Road, Harrow.

ELECTRICAL ENGINEERS, WIREMEN, ACCUMULATOR SERVICE MEN.—The T.E.C. will train you at home for a better job; why not start a battery-charging service of your own? Prospectus and "Guide to Success," post free.—W. S. Ibbotson, B.Sc., A.M.I.E.E., Technical Engineering College, 16 Speenham Road, Stockwell, London, S.W.8.

25/- MOVING-COIL LOUD-SPEAKERS. 6-volt Marooni-phone pots; 10-in. cones. Unrepeatable bargains.—Hillier, 22 Cork Street, W.1.

KITS.—"Britain's Super," £6; "Dual Ranger," £3/8/-; "Century Super," £3/15/-; "Comet Three," £2/2/-. Anything wireless supplied at keenest prices. Send your lists of requirements for quotation.—Servwell Wireless Supplies, 74 Gough Street, London, E.14.

BANKRUPT BARGAINS.—List free with 3-valve diagram. Let me quote for any kit or component. Stal transformers, 2/9. Differentials, 1/5. Wavemaster, 2/-; Telsen, 1/9. 0005, 2/2. Wavemaster, 2/6. Dual coils, baseboard or panel, 4/-. Slow-motion dials, 1/6. Fixed, 5d. Valve holders, 5d. Speaker units from 4/-. Kits from 10/6, with nice cabinet. Tungsten valves, 4/6. D.C. eliminators, 22/6. A.C., 40/-. Kits, Century Super, 78/-; £3/3/- Four, 47/6. Two-valve, with cabinet, 24/-; Three, with cabinet, 32/6. You can rely on goods being of good quality. Though prices are low, I sell no rubbish. Quotes by return.—Butlin, 143B Preston Road, Brighton.

HOME CONSTRUCTORS.—Send for lists of cabinets and components. Special terms that save money.—Imperial Radio, 15 Summerhill Street, Birmingham.

COILS, SUPER DUAL RANGE, 200 to 2,000 metres. Selectivity power, quality. Definitely increases foreigners. Sample, 3/9 post free.—Imperial Radio, 15 Summerhill Street, Birmingham.

"THERE'S NO PLACE LIKE HOLMES"
WUFA Unit and Chassis 4/6.
and 9 monthly payments of 4/5.
H. W. HOLMES, 23 Foley St., Gt. Portland St., London, W.1
Museum 1414

"Amateur Wireless and Radiovision." Price Threepence. Published on Thursdays and bearing the date of Saturday immediately following. Post free to any part of the world: 3 months, 4s. 6d.; 6 months, 8s. 9d.; 12 months, 17s. 6d. Postal Orders, Post Office Orders, or Cheques should be made payable to "Bernard Jones Publications, Ltd."

General Correspondence is to be brief and written on one side of the paper only. All sketches and drawings to be on separate sheets.

Contributions are always welcome, will be promptly considered, and if used will be paid for.

Communications should be addressed, according to their nature, to The Editor, The Advertisement Manager, or The Publisher, "Amateur Wireless," 58-61 Fetter Lane, London, E.C.4.

"THERE'S NO PLACE LIKE HOLMES"
AMPLION CONE 4/6. Speaker 15/-
and 3 monthly payments of 4/-
H. W. HOLMES, 23 Foley St., Gt. Portland St., London, W.1
Museum 1414

ELECTRADIX BARGAINS
WONDERFUL OPPORTUNITY
IN MOVING-COIL
LOUD-SPEAKERS

220-volt Magnavox with input Transformer in Chassis 35/-
220-volt B.T.H. Rice Kellogg with input Transformer 40/-

MIKES FOR HOME RECORDS
Sensitive Gramo Solo Mikes in cast metal case on Pedestal 12/6

Our new Sale List now ready.
ELECTRADIX RADIOS,
218 Upper Thames St., London, E.C.4
Telephone: CITY 0191.

TAYLEX WET H.T. BATTERIES
New Prices: Jars 1/3. Sacs 1/2. Zincs 10/-, Sample doz. 18 Volts complete with leads and electrolyte 4/- 1 post 9d.
Sample unit 6d. illus. booklet free. Bargain list free.
AMPLIFIERS, 30/-. 3 VALVE ALL-STATION SET 5s.
A. TAYLOR, 57, Studley Road, Stockwell, LONDON.

YOU CAN BUILD A GRAMO. PHONE WITH OUR SCALE DRAWINGS FOR 40/-
Book of instructions 3d. Catalogue of Motors, Tonearms, Soundboxes, latest internal amplifiers, Gramophones and Cabinets Free. Cash or Terms.
W. BURT, 185 High St., Deptford

SET CRACKLING IS ANNOYING!

IF IT'S YOUR SWITCH
"BUSCO" SWITCH
FIT THE
and ensure perfect switch contact! There is no contact point to turn round, and when you "switch on" you have contact like a power switch.
They are as cheap as the inferior type but far superior in operation.
From your local dealer, Halford's Cycle Stores, or
BUSBY & CO., LTD. (Patentees)
Dept. A.W., PRICE ST., BIRMINGHAM

FULL-SIZE BLUEPRINTS

When ordering, please send Postal Order, NOT STAMPS.
CRYSTAL SET (6d.)
1931 Crystal Set AW308
ONE-VALVE SET (1s.)
Easy to Build One.. .. . AW304
TWO-VALVE SETS (1s. each)
Talisman Two (D, Trans) AW194
No-battery Gramo-radio 2 (D, Trans) AW238
Forty-five-shilling Two (D, Trans) AW250
Twenty-shilling Two (D, Trans) AW274
The Room-to-Room 2 (D, Trans) AW298
Big-volume Two (D, Pentode) AW309
Gleaner Two (D, Trans) WM201
Merlin Two (A.C. Set) WM213
Five-point Two (D, Trans) WM220
Brookman's A.C. Two (D, Trans) WM225
Aladdin Two (D, Trans) WM231
Ever Tuned Regional Two (D, Trans) WM241
Station-finder Two (D, Trans) WM253
Music Lover's Two (D, Trans) WM260

THREE-VALVE SETS (1s. each)
1931 Ether Searcher (SG, D, Trans) AW271
1931 Ether Searcher (A.C. model) AW276
"Mains Unit AW277
1931 Ether Searcher (D.C. model) AW284
Mains Unit AW285
Square Peak Three (SG, D, Trans) AW293
B.B.C. Selective Three (D, RC, Trans) AW289
Universal Short-wave Three (SG, D, Trans) AW301
Olympian Three (SG, D, Trans) AW306
Brookman's Three (SG, D, Trans) WM161
Five-point Three (SG, D, Trans) WM212
New Brookman's Three (SG, D, Trans) WM218
Five-point Short-waver (D, RC, Trans) WM223
Plug-in-coil Three (D, Trans) WM232
Regional Three (SG, D, Trans) WM236
Band-pass Inceptor-dyne (SG, D, Trans) WM244
Ether Marshal (SG, D, Trans) WM247
Meridian Short-waver (D, RC, Trans) WM256
Five-advantage Three (D, RC, Trans) WM257
Everybody's Radiogram (SG, D, Trans) WM258
Double Band-pass Three (SG, D, Trans) WM259
Everybody's Radiogram (with Automatic Grid-bias) WM262

FOUR-VALVE SETS (1s. 6d. each)
The £3 3s. Four (SG, D, RC, Trans) AW303
The £3 3s. Four (Improved Model) AW303A
Everybody's Radio-gramophone AW310
Regional Band-pass Four (SG, D, RC, Trans) WM211
Five-Point Four (SG, D, RC, Trans) WM216
Regional A.C. Four (SG, D, RC, Trans) WM222
Brookman's Three-plus-one (SG, D, RC, Trans) WM233

FIVE-VALVE SETS (1s. 6d.)
Britain's Super (Super-het) AW311
Regional D.C. Five (SG, D, RC, Push-pull) WM252

SIX-VALVE SETS (1s. 6d. each)
Century Super (Super-het) AW287
A.C. "Century Super" (Super-het) AW295
Mains Unit (1/-) AW295A
Super 60 (Super-het) WM229
A.C. Super 60 Radio Gramophone (Super-het) WM239
A.C. Super 60 (Table Model) WM245
Super 60 (with Wearite base) WM249
Super 60 (with Lewcos base) WM251

SEVEN-VALVE SET (1s. 6d. each)
Super Senior (Super-het) WM256
Super Senior (with Wearite base and Lewcos coils) WM261

AMPLIFIERS (1s. each)
High Quality Amplifier for A.C. Mains AW275
2-Watt Amplifier for A.C. Mains AW283
Add-on H.F. Screened-grid Unit AW296
Universal Push-pull Amplifier AW300
D.C. Fader WM242

PORTABLE SETS
Portable "Century Super" (Super-het) AW297 1/6
Super 60 Portable (Super-het) WM238 1/6
Home and Garden Three (D, RC, Trans) WM246 1/-

MISCELLANEOUS (1s. each)
Our H.T. Unit for A.C. Mains AW262
Gramophone Tone Control AW264
Short-wave Super-het Adaptor AW268
H.T. Unit and Trickle Charger for D.C. Mains AW272
Booster Speaker (6d.) AW286
"A.W." Tone changer (6d.) AW288
"A.W." Selectivity Unit (6d.) AW290
A.C. Trickle Charger AW305
Amateur's Linen Speaker AW307
D.C. H.T. Unit AW312
Big H.T. Unit for A.C. Mains WM230
Loud-speaker Tone Control WM234
"W.M." Linen Diaphragm Loud-speaker WM235
Two-Minute Adaptor for Short Waves WM240
Super 60 A.C. Oscillator WM248
Simple Neon Oscillator WM256

Copies of the "Wireless Magazine" and of "Amateur Wireless" containing descriptions of any of these sets can be obtained at 3s. 6d. and 4s. respectively, post free. Index letters "A.W." refer to "Amateur Wireless" sets and "W.M." to "Wireless Magazine".
Address letters:

Amateur Wireless Blueprints Dept., 58-61 Fetter Lane, London, E.C.4.

Amateur Wireless
INFORMATION BUREAU
COUPON
Available until Saturday
FEE 1/-
NOVEMBER 14, 1931

100 U

MOUNTED TO
CHASSIS
INDUCTOR
TYPE

Owing to its extreme sensitivity the input should not exceed 1200 milliwatts.



BRITISH
MADE

A TRULY WONDERFUL UNIT

B LUE SPOT 100U is the equal of the most expensive Dynamic Speakers. That is a big claim but it is justified. Severe tests by experts have but served to prove the exceptional merit of this truly wonderful unit. There is nothing like it at anywhere near its price. Every radio enthusiast who has not heard 100U should make a point of doing so at once. It can be used with any type of receiver and also with Pentode Valves since no matching transformer is required. Its sensitivity is such that perfect reproduction with good volume is ensured from very small inputs. In the difficult bass notes particularly, its performance is genuinely remarkable. Distortion, muffling, rattle and discordancy are unknown to 100U. But hear it for yourself.

Price complete mounted : : to chassis : : **39/6**

THE BRITISH BLUE SPOT COMPANY LTD
BLUE SPOT HOUSE - 94/96, ROSSMAN STREET - ROSEBERY AVENUE - LONDON - E.C.1
Telephone : Clerkenwell 3570. Telegrams : "Bluospot, Isling London."
Distributors for Northern England, Scotland and North Wales :
H. C. RAWSON (Sheffield and London), LTD., 100 London Road, Sheffield; 22 St. Mary's Parsonage, Manchester; 183 George Street, Glasgow.



Read. Trade Mark.

Say
Player's
please



They always do!

N. C. C. 60

BE SURE TO GET YOUR "DAILY MAIL" RADIO CHART

HOW TO LOCATE AND IDENTIFY 76 BROADCASTING STATIONS, AND GET THEM WHENEVER YOU WANT THEM.

684 FACTS TO BE GIVEN BY THE SINGLE TURN OF A POINTER.

NO BOOK REFERENCE. NO LABORIOUS TURNING OVER LEAVES.

Ask to see other At-a-glance Charts at all Stationers, Booksellers, Radio Stores—or if any difficulty write to F. PITCHFORD & CO., LTD., Well Street, London, E.C.1.



A WONDERFUL
LITTLE
WIRELESS
FRIEND

2 SIDED
(in colours)
Diameter 9 1/2"

"At-a-Glance" 1/-

THE TEST OF TIME



**BECOL REAL
EBONITE**

has stood this and is the most reliable

Formers tested electrically before Despatch, 26 Types

REDUCED PRICES
PANELS TUBES RODS British Made

LOOK FOR TRADE-MARK

THE BRITISH EBONITE CO., LTD.
HANWELL, W.

You will Help Yourself and Help Us by Mentioning "A.W." to Advertisers

New Ekco Power Units

..... in performance and appearance
beyond comparison

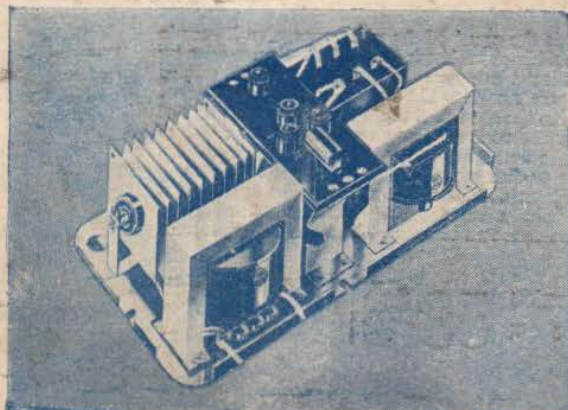

EKCO NEW H.T. UNITS

(For A.C. Mains)

Model A.C. 12.	For 1 to 3 valve sets	£2 15 0
	(12 milliamperes output)	
Model A.C. 15.	For 1 to 5 valve sets	£3 7 6
	(15 milliamperes output)	
Model A.C. 25.	For multi-valve sets	£3 17 6
	(25 milliamperes output)	
Model D.C. 15/25.	H.T. Unit for D.C.	£1 19 6
Mains	(15 or 25 milliamperes output)	

EKCO NEW COMBINED

H.T. & L.T. CHARGER UNITS

(For A.C. Mains)

(Supply H.T. and also keep your accumulator constantly charged)

Model K 12.	For 1 to 3 valve sets	£3 19 6
	(12 milliamperes output)	
Model K. 18.	For 1 to 5 valve sets	£4 12 6
	(18 milliamperes output)	
Model K. 25.	For multi-valve sets	£5 7 6
	(25 milliamperes output)	

All obtainable on **EASY PAYMENT TERMS** from as little as 3 3 per month!

In three minutes you can rid yourself of all battery worries and expense for ever. An Ekco Unit will give you more power, better power, constant power, at a cost of only a few pence a month. All you have to do is to fit the appropriate Ekco Unit in place of your battery, and plug in—that's all. No alterations to your set, valves or wiring.

There is an Ekco Power Unit for *your* set—post coupon now for full details.



To E. K. Cole, Ltd. (Dept. K.15.), EKCO Works, Southend-on-Sea.

Please send me full descriptions of EKCO Power Units with which I can finish with batteries for ever and obtain permanently perfect radio at a cost of only a few pence a month.

Name

Address

(If you require details of Easy Payment Terms put a cross here.....)