

270

OUR BIG-VOLUME TWO-VALVER
EVERYBODY'S RADIO-GRAMOPHONE

Amateur Wireless

Usual Price **3^d**

and
Radiovision

Vol. XIX. No. 486

Saturday, October 3, 1931

The BIG-VOLUME 2



A TWO-VALVE RECEIVER—SPECIALLY
DESIGNED TO GIVE LARGE VOLUME

The **NEW** **LEWCOS** BAND PASS FILTER



PRICE
12/-
(Screen 2/6
Extra.)

Perfect selectivity—the aim of all radio enthusiasts—can at last be achieved!

The New Lewcos Band Pass Filter, the product of exhaustive experiments in our laboratories, gives maximum efficiency on both wavelength ranges (235/550 and 1,000/2,000). This has been achieved by the production of a Filter which is capable of giving a steep-sided and flat-topped response curve—ideal for super-selectivity and quality performance.

Try this new Lewcos component in your set; you will be astounded at the results.

Send for fully descriptive leaflet, Reference R.73.

LEWCOS RADIO PRODUCTS FOR BETTER RECEPTION

THE LONDON ELECTRIC WIRE COMPANY AND SMITHS LIMITED, CHURCH ROAD, LEYTON, LONDON, E.10

To Ensure Speedy Delivery, Mention "A.W." to Advertisers

"Ever since I bought this Regentone Mains Unit I get twice as much pleasure out of my radio."

"In what way?"

"Well, it's so convenient—no batteries to think about, no hiking to the charging station with my accumulator, and on top of it, results are ever so much better."

"Yes, but look at the expense."

"Well, this one cost me just over three pounds and I have nearly saved that already on H.T. Batteries and charging fees."

"This is obviously worth looking into. I must get a Regentone catalogue somehow."

"That's easy. Call on any of the wireless shops in the town, or if that is too much of an effort for you, drop a card to Regentone."

Write for Free Art Booklet to:—REGENTONE, LIMITED, Regentone House, 21 Bartlett's Buildings, E.C.4. Tel. Central 8745 (5 lines).

Irish Free State Distributors: Kelly & Shield, Ltd., 47 Fleet Street, Dublin.

E.W.G.

Don't Forget to Say That You Saw it in "A.W."

WONDERFUL RESULTS WITH THESE "WEARITE" COMPONENTS !

"WEARITE" H.F. CHOKE

A first-class component with a very fine performance. Specified for the "Loud-speaker 2-Valver." It covers efficiently the remarkable range from 10 to 2,000 metres without any marked resonances. Self-capacity very low. Type H.F.O. 6/6



HFO

"WEARITE" FILAMENT SWITCH

On-and-Off Battery Switch; extremely small and compact. Push-pull action with single-hole fixing. Self cleaning. G.22. Price 1/-



G22

"WEARITE" GRID-LEAK HOLDER

Has new type contact spring clips. Fits any size grid-leak. Price 6d.



"WEARITE" THREE-POINT SHORTING SWITCH

Push-pull action; Sound self-cleaning contact. With insulated spindle, as specified for the "Loud-speaker 2-Valver." Price 1/6



G23

No sets can give the best results without a good earth and the only earth that can be fitted without trouble is the "Wearite" all copper earth tube, complete with solder and flux. Price 3/6

"WEARITE" POTENTIOMETER

This Potentiometer is specified for the "Olympian 3." Wire wound, it will carry up to 5 milliamps. Designed for panel mounting. 50,000 ohms. Price 4/-

WEARITE COMPONENTS

WRIGHT & WEARE, LTD., 740 High Rd., Tottenham, N.17. TOTTENHAM 3847-5-9 Phone:

You will Help Yourself and Help Us by Mentioning "A.W." to Advertisers

"WE CONGRATULATE Varley ON THEIR NOTABLE DEVELOPMENTS"

"We congratulate Varley on their notable developments," says AMATEUR WIRELESS, in reviewing the new Varley Components illustrated on this page.

They are technically suitable products to meet present-day requirements . . . and present-day pockets.

Build Varley quality into your set.



NICHOKE II

The latest addition to the range of Varley L.F. Chokes, Compact, highly efficient and suitable for all ordinary purposes — as Smoothing Choke, Output Filter Choke, etc.

Inductance, no D.C., 20 Henries. With 50 m/A D.C., 14 Henries. D.C. Resistance, 450 ohms. List No. DP.23.

Price 10/6

WORTHY COMPANIONS OF THE "SQUARE PEAK" [REGD. TRADE MARK] COIL

JUNIOR MULTI-CELLULAR H.F. CHOKE

Chokes efficiently on both wavebands, either in Detector or H.F. stages. Inductance 120,000 microhenries. D.C. Resistance, 350 ohms.

List No. BP2

Price 3/6



"TAG RESISTANCE"

Spiral wire-wound. Compact. Can be soldered direct to receiver wiring. 22 different values from 100 to 100,000 ohms.

Prices 1/- to 2/-

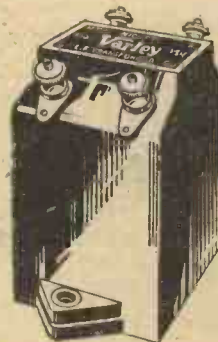

NICLET L.F. TRANSFORMER

Primary inductance 45 Henries with no D.C. Ratio 3½ to 1. Primary will carry current up to 3 m/A D.C. When resistance-fed, ratios of 2.5, 3.5 and 4.5 to 1 are obtainable.

List No. DP21

Price 7/6

Varley

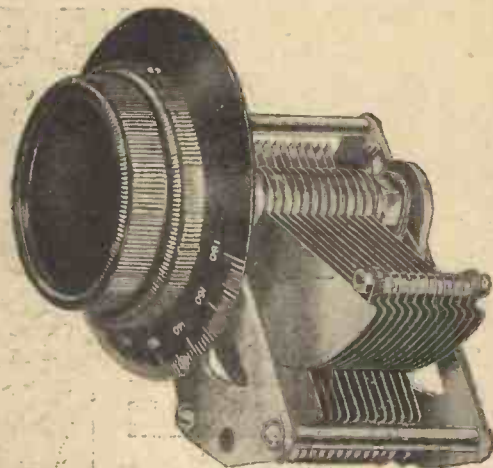

THESE
NEW

LOTUS

COMPONENTS ARE SPECIFIED FOR THE
"BATTERY-OPERATED RADIOGRAM"
and
"BIG-VOLUME 2"
described in this number

BINOCULAR DUAL-WAVE COIL

Long- and short-wave windings on separate formers, silent wave-change switch. These coils are all accurately matched and can be ganged. Completely and compactly screened. Designed by J. Sieger, for Hair-line Selectivity.

10/6

These new LOTUS components are the last word in design and efficiency. They fully uphold the enviable LOTUS reputation for reliability and sound manufacture.

SLOW-MOTION CONDENSER

Exceptionally sturdy construction with integral ball-bearing slow-motion device. Complete with Knob-dial. Capacities .0003 and .0005 mfd.

6/6

Intensive production allows them to be sold at keenly competitive prices. They are certainly the finest value ever offered to the home constructor. That is why all the leading set-designers specify LOTUS components. They know they are absolutely reliable, and will give the best performance. Follow the experts' lead. Insist on LOTUS components. Ask your dealer or write direct to the makers for your copy of the LOTUS Component Catalogue.



MINIATURE REACTION CONDENSER

A small but highly efficient condenser with brass vanes, interleaved with bakelite and flexibly mounted to ensure accuracy. .00015 and .00035.

2/6

2-GANG CONDENSER WITH DISC DRIVE

Each Unit is totally screened and precision matched, and sturdy construction ensures lasting accuracy.

25/-

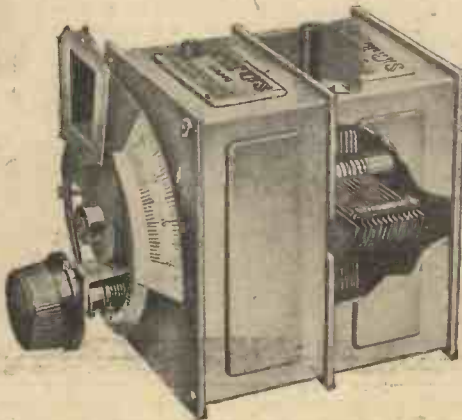

AUDIO TRANSFORMER No. 1

An inexpensive instrument for the home-constructor. It is remarkably efficient and has a good straight-line amplification curve. Ratios 3-1 and 5-1.

5/6

LOTUS RADIO, LTD.
© Mill Lane, LIVERPOOL

The Reliable Low Priced Transformer

6'9

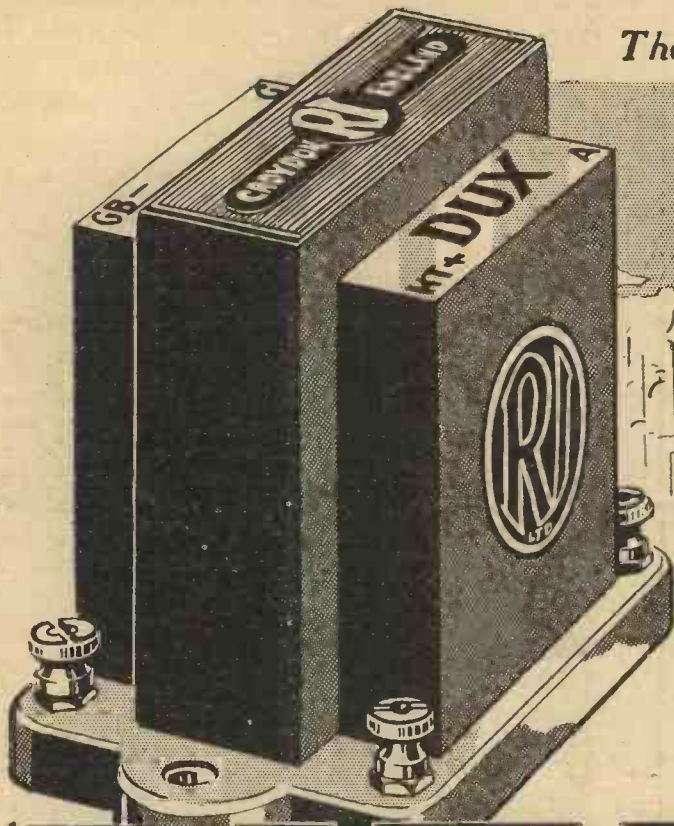

DUX

WINS SUCCESS AFTER SUCCESS

in the British fight for supremacy in Radio

Efficiency gains the day on the battlefield of price competition.

The public appreciation of the remarkable value and performance of this new low-priced transformer is amply demonstrated by the enormous demand and the stream of letters testifying to the excellent results obtainable by the use of this splendid British component.

The fact that full technical information is available with "Dux," as with highest-priced transformers, enables every purchaser to know exactly, before he buys, what "Dux" will do for his set. There is no uncertainty as with cheap, foreign transformers and other unreliable makes.

The test reports of the Technical Press are unanimous in their praise — "Dux" is the safe transformer consistent with economy.

TECHNICAL DATA:

PRIMARY INDUCTANCE 30 HENRIES

Ratio 1 : 3½ (standard) or 1 : 4½ (auto-connection). Weight 11½ oz. Dimensions 2 x 3½ x 2½ in. List No. D.T.29.

Ask your dealer or write to us for a copy of the "Dux" Technical Information Leaflet and the R.I. 1931-32 Catalogue—the finest component reference obtainable.

COMPARE the power of these ATLAS MAINS UNITS

The Highest Output at the Minimum Price



MODEL A.K.22



MODEL A.K.260



MODEL A.C.188

For 1, 2, and 3- VALVE SETS

Incorporating Westinghouse rectifier. 1 tapping 60/80 V., 1 tapping 90/100 V., 1 tapping 120/150 V. Output 12 m/A. Trickle charger for 2-V. L.T. accumulators at .3 amps. 77/6 or 10/- down and 9 monthly payments of 8/6 each.

For Sets up to 4 VALVES

Incorporating Westinghouse rectifier. 1 tapping 60/80 V. (max. and min.), 1 tapping 50/90 V. (max. med. and min.), 1 tapping 120/150 V. Output 20 m/A. at 120 V. Trickle charger for 2-, 4-, and 6-V. L.T. accumulators at .3 amps. 90/- or 10/- down and 9 monthly payments of 10/- each.

For Sets up to 5 VALVES

This amazingly successful Unit was voted the finest Mains Unit at Olympia, 1930. Incorporating Westinghouse rectifier. 2 variable tappings 0/100 and 0/120 V., 1 fixed 150 V. Output 25 m/A at 150 V. Trickle charger for 2-, 4- and 6-V. L.T. accumulators at .5 amps. £6 or 10/- down and 7 monthly payments of 15/6 each and one of 14/6.

ALL THE ABOVE FOR A.C.

You will find that the claims made for "ATLAS" MAINS UNITS are fulfilled *absolutely* in use. If you require 25 m/A at 150 volts, and the "ATLAS" specification gives this output, then you can be sure you will get it. An "ATLAS" MAINS UNIT has been designed for conversion of every type of Battery Set. Send for a price list of the full range to the address below.

All Units are guaranteed for 12 months.

"CLARKE'S" ATLAS MAINS UNITS

H. CLARKE & CO. (M/CR) LTD., Old Trafford, MANCHESTER
LONDON OFFICE: Bush House, W.C.2
Phone: Temple Bar 7130

TEST then Rest



The SHERLOCK HOLMES of RADIO

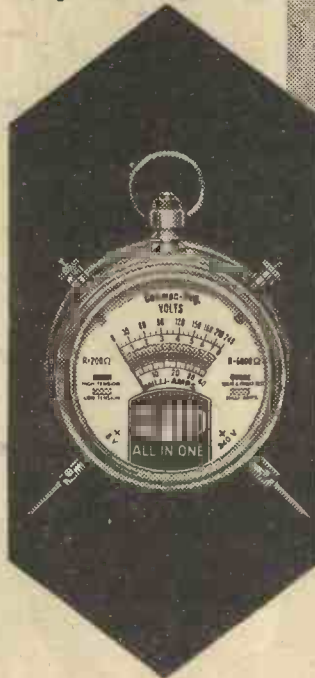

Assured

With the "All-in-One" Radiometer you can instantly check the performance and efficiency of any Valve, Circuit, Battery, or Component. This little instrument tests everything—in a few minutes—with absolute certainty. If the "All-in-One" Radiometer says such a thing about any part of a set—then it is so!

Think of the time, trouble and money you could save if you had an "All-in-One" Radiometer of your own. Then look at the amazingly low price—12/6. You'd save that over and over again in a year, by entirely cutting out costly guesswork and also being independent of the need for expensive expert assistance. Ask your Radio Dealer to demonstrate the "All-in-One" Radiometer. See how efficient it is—how speedy—how economical.

Obtainable from all Stores and good-class Radio Dealers. Booklet free from Patentees: PIFCO LTD., High Street, MANCHESTER.

TESTS VALVES
FILAMENT · ·
ANODE & GRID
COMPONENTS
AND CIRCUITS
H.T. AND L.T.
MILLIAMPS
Everything!

PIFCO ALL IN ONE RADIOMETER



Standard Model shown above on left. For Battery Operated Sets only. Price 12/6.

De-Luxe Model shown above on right. For Battery Operated Sets, Electric Receivers and Mains Units. Price, £2 2s.

© P1a

Don't Forget to Say That You Saw it in "A.W."

2 VOLT MAZDA MASTERPIECES

TYPE	PRICE
H.210 - - -	8/6
HL.210 - - -	8/6
★ HL.2 - - -	8/6
L.210 - - -	8/6
★ L.2 - - -	8/6
P.220 - - -	10/6
P.220A - - -	13/6
P.240 - - -	13/6
PEN.230 - - -	20/0
PEN.220 - - -	20/0
PEN.220A - - -	20/0
S.G.215 - - -	20/0
★ S.G.215A - - -	20/0
★ S.G.215B - - -	20/0

★ METALLISED

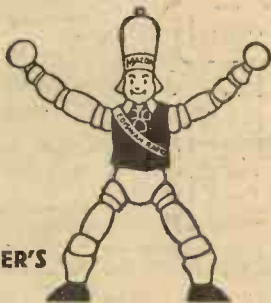

LOOK FOR
"EDDY" IN
YOUR DEALER'S
WINDOW



Since 2-volt valves were made, never has there been so amazing a range as this — so much evidence of brilliant engineering — so many valves with outstanding characteristics. Instance the Pen. 220; or pentode, which at once presents the solution to the output stage problem in portable sets, for it gives an astonishingly large output for a combined screen and anode current of under 5 mA. It is a valve H.T. dry battery users have longed for. It is typical of all Mazda 2-volt valves. Mazda 2-volt valves, both metallised and clear bulb types, are sold by all good radio dealers.

THE AMAZING

MAZDA PEN. 220

Characteristics:

Filament Voltage - - 2.0 volts Anode Current (Max) - 12 mA
 Filament Current - - 0.2 amps. Screen Voltage (Max) - 150 volts
 Anode Voltage (Max) - 150 volts Mutual Conductance - 2.5 mA/V
 At Ea - 100; Es - 100; Eg - 0.

PRICE 20/=

MAZDA

THE
BRITISH
VALVES

The Edison Swan Electric Co. Ltd.



155 Charing Cross Road, London, W.C.2

V135

Advertisers Appreciate Mention of "A.W." with Your Order



TO ASSURE ACCURACY AND RELIABILITY!

NOTHING is left to chance by T.C.C. every possible test is employed to be sure that only perfect condensers find their way to the stock room. Tests for true capacity. Tests for insulation, for mechanical strength, indeed tests covering every likely condition under which a condenser may be used. Because of this systematic series of tests, because of the use of only the best materials, and because of the unique experience of a quarter of a century's specialisation in condenser manufacture, T.C.C. can and do, guarantee every condenser to be up to specification. That is your safeguard—Whatever your condenser need insist on the condenser with a reputation—T.C.C.

T.C.C. CONDENSERS

TELEGRAPH CONDENSER CO., LTD., N. ACTON, W.3.

♡ 9009



**NEW 1932 MODELS
HIGHER SENSITIVITY
SPEECH PERFECT
FULL MUSICAL
RESPONSE**

The **Lanchester**

PERMANENT MAGNET MOVING-COIL SPEAKERS

You cannot afford to be without our new 1932 CATALOGUE, beautifully illustrated and containing full particulars and prices of our Season's products now available. It contains in addition a mine of useful information, and is **FREE and POST FREE.**

Our 14 DAYS' FREE TRIAL OFFER. Lanchester Speakers are sold direct to public only on 14 DAYS' FREE TRIAL against cash with order or C.O.D. Their compact dimensions readily permit their incorporation in Portable Receivers, and the fascia board simplifies attachment.

PRICES:

CHASSIS from £1 10s. 0d. to £3 3s. 0d.

Complete in Cabinet from

£2 10s. 0d. to £4 15s. 0d.

Output Transformers required: ext.a
See Catalogue.

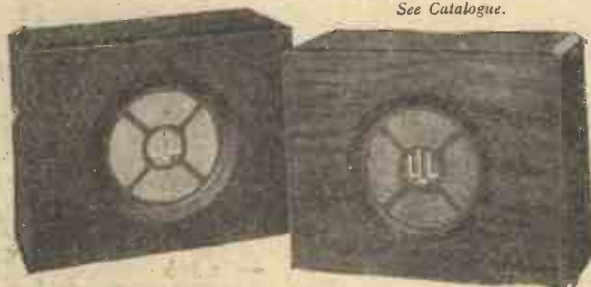

Rexine Covered Cabinet.

Solid Mahogany Cabinet.

LANCHESTER'S LABORATORIES
TYSELEY ... LIMITED BIRMINGHAM

The Outstanding
feature of
the show



BRITISH GENERAL BAND PASS IOKC TUNING UNIT

At last—a Tuning Unit which gives the separation of 10 Kilocycles as laid down by the International Radio Convention, and yet gives full strength throughout the entire wave-band between 230 and 550 and from 800 to 2,000 metres.

From all dealers of repute or direct from the manufacturers:—

**BRITISH GENERAL MANUFACTURING CO.
Ltd.**

Brockley Works, London, S.E.4

PRICE
14/6
INCLUDING
COUPLING
CONDENSER.

Please Mention "A.W." When Corresponding with Advertisers

THERE'S FORTY YEARS' EXPERIENCE BEHIND EVERY PERTRIX ACCUMULATOR



When you buy a PERTRIX Accumulator—as you certainly will—you can rest assured that you are not buying an unknown and untried product. Radio was undreamt of at a time when the designers of PERTRIX had had many years experience in the manufacture of good storage batteries. Add to this experience the best materials and good workmanship and you have an accumulator that is the best that money can buy and one that will give you years of sterling service. Your dealer has PERTRIX Accumulators and will only be too glad to tell you the type most suitable for your set. Prices range from 4/6 to 17/- according to type and capacity.

Made by BRITANNIA BATTERIES, Limited at Redditch who also make:

Batteries for Central Stations • Batteries for Country House Lighting • Emergency and Stand-by Lighting Batteries for Theatres, Cinemas, Hospitals, etc. • Batteries for the Starting and Lighting, and Lighting and Ignition of Motor Cars, Motor Cycles, Buses and Coaches • Batteries for Electric Vehicles, Trucks, Locomotives, Ships and Yachts • The only Nickel-Iron Alkaline Battery on sale in Britain that is entirely made in this country • PERTRIX Super Life Dry Batteries for Radio.

PERTRIX SUPER LIFE ACCUMULATORS

TELSEN VARIABLE CONDENSERS

TELSEN BAKELITE DIELECTRIC CONDENSERS

These Condensers are of a new and improved type and of exceptionally compact dimensions. The moving vanes, which are interleaved with finest quality bakelite, are keyed on to the spindle so that they cannot be pushed out of line, and there is a definite stop at each end of the travel. The connection to rotor is made by means of a phosphor-bronze pigtail so that there is no crackling due to rubbing contacts. The connection to the stator vanes is absolutely positive—a very important point.

- Telsen Bakelite Dielectric Differential Condenser—
Made in capacities of .0003, .00015, .0001 Price 2/-
- Telsen Bakelite Dielectric Reaction Condenser—
Made in capacities of .0003, .00015, .0001 Price 2/-
- Made in capacities of .00075, .0005 Price 2/6
- Telsen Bakelite Dielectric Tuning Condenser—
Made in capacities of .0005, .0003 Price 2/-

TELSEN LOGARITHMIC VARIABLE CONDENSERS

The Telsen Logarithmic Variable Condenser is of robust construction and high insulation. The H.F. losses are very low and the frame is braced at three points, so that the possibility of distortion and short circuiting is negligible. Substantial terminals are provided with alternative connection to the stator.

- Telsen Logarithmic Variable Condenser—
Made in capacities of .0005, .00035, .00025 Price 4/6

TELSEN PRE-SET CONDENSERS

These Condensers have been carefully designed to give proper separation of vanes when the adjustment is unscrewed, which results in a very low minimum capacity, giving a wide range of selectivity adjustment when used in the aerial circuit.

- Telsen Pre-set Condenser—
Made in capacities of :

Maximum capacity	Minimum capacity		Price
.00200025	1/6
.00100004	1/6
.0003000005	1/6
.0001000001	1/6

TELSEN

THE SECRET OF PERFECT
RADIO RECEPTION

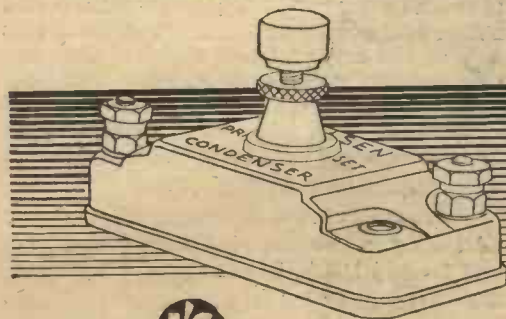

1/6

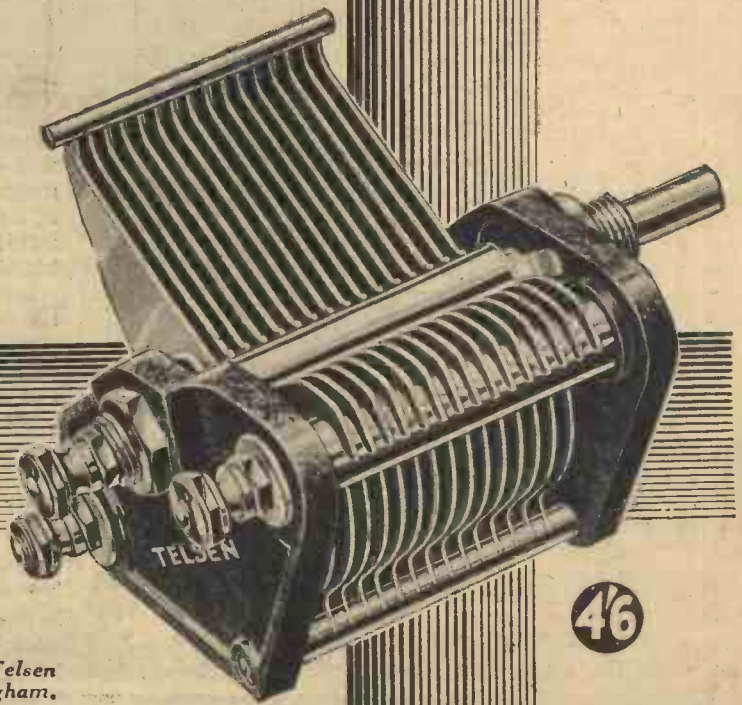

4/6

Send for the "Telsen Radio Catalogue" and book of "All-Telsen Circuits" to—The Telsen Electric Co., Ltd., Aston, Birmingham.

CVS-56

Mention of "Amateur Wireless" to Advertisers will Ensure Prompt Attention



BRITAIN'S LEADING RADIO WEEKLY FOR CONSTRUCTOR, LISTENER & EXPERIMENTER

EDITOR:
BERNARD E. JONES

TECHNICAL EDITOR:
J. H. REYNER, B.Sc., A.M.I.E.E.

RESEARCH CONSULTANT:
W. JAMES.

ASSISTANT EDITOR:
H. CORBISHLEY.

NEWS & GOSSIP OF THE WEEK

OLYMPIA AND RESULTS

THE Show is over, and now it is up to all keen amateurs to take advantage of the new parts and new designs. AMATEUR WIRELESS is leading the field with the set specially produced for the Exhibition, the "Olympian Three," with a fine super-power, easy-to-build two-valver, and a four-valve radio-gram, which can be worked off batteries if need be. Details of these three sets are in this issue.

OTHER SHOWS

SO far as exhibitions are concerned at this time of year, it is a case of "the Show is over, long live the Show." No sooner does one start to digest the material offered at Olympia than the Northern National Exhibition opens in the City Hall, Manchester, on October 7, and runs for ten days. After this is the Edinburgh Radio Exhibition, from November 11 to 21. This is held in the Waverley Market, Edinburgh.

THE WELSH ORCHESTRA

THE free concerts in the National Museum of Wales are now an established feature of Cardiff life, and many people have regretted the prospect of losing the concerts by the disbandment of the National Orchestra of Wales. It has been found possible, however, to arrange for the Western Studio Orchestra to carry on at the Museum on the same days and at the same time as the former National Orchestra of Wales concerts. The first of the new series, all of which will be broadcast, will be given on October 12.

THE NEW "PARADES"

RIDGEWAY'S new series of "Parades" begins on October 7, and listeners will hear one of these shows every fortnight until the end of the year. In his search for fresh talent, Ridgeway leaves no stone unturned. Quite recently he tuned in to a German station and heard a relay from a Berlin theatre. The voice of one of the artistes struck him as being exactly the type he wanted, and he immediately wrote to the station for information. He had absolutely nothing to guide him in describing her—he did not even know her name—

but from his idea of what she sounded like the German station officials were able to identify her; but it is not certain whether she will be able to come to London.

RADIO WEEKS

CARDIFF is having a Radio Week from October 24 to November 1. Under the auspices of the B.B.C., a Radio Week Committee has been formed, the Lord Mayor of Cardiff being the president. There are nine ambitious schemes for making the Radio Week an outstanding success, and Cardiff readers should look out for developments in their district.

STUDIOS AT BROADCASTING HOUSE

AT last the decorators' schemes of the studios at Broadcasting House have



At work on one of the big amplifier panels which flooded Olympia with music during the National Radio Exhibition

been approved and passed. Work is now in hand. Contract dates for the completion of several of the studios start as early as November 1. It is now fully anticipated that Jack Payne will be broadcasting from No. 8a Studio at Broadcasting House during November. Many members of the staff are changing over to the new offices this week.

A GIANT VALVE

HAVE you ever thought of a valve which can be taken to pieces with a spanner when the filament burns out, and in which no glass is used? There is such a valve, but it won't do for receivers! It handles 500 kilowatts. All the time it is working there is a pump working which maintains the vacuum. This huge valve has been built by Metropolitan Vickers for Rugby and is on show in connection with the Faraday Centenary celebrations.

"FAMOUS FAUX PAS"

ON October 10 a new series, known as "Famous Faux Pas," will begin in the vaudeville programmes. They are written by Harold French, who will appear in them with Isobel Elsom. The first will be comedy, but others will be on dramatic lines, as, for instance, historical *faux pas*, one of which is based on the French Revolution. The programme of October 10 also marks the return to the studio of Jeanne de Casalis. Other well-known faces round the microphone this evening will be those of Bransby Williams, who has long been absent from the studio, and Doris and Elsie Waters, fresh from their summer concert party.

B.B.C. ECONOMY

FOLLOWING its sacrifice of £200,000, the B.B.C. is now seeking ways and means of cutting down the expense of running the broadcasting service. Quite definitely, the revenue cut has ended all possible extensions of the service. Unfortunately, this includes the proposed American relays.

NEWS · & · GOSSIP · OF THE · WEEK —Continued

REGIONAL PROGRAMMES

WE understand that while the B.B.C. does not intend to curtail the programmes from the studios, it has decided that greater use must be made of the "S.B." system, whereby regional centres such as Brookmans Park and Moorside Edge will be expected to share such outside broadcast material as tea-time, lunch-time, and organ music.

WASHFORD CROSS DEFINITE!

WASHFORD CROSS, in the parish of Williton, has now definitely become the site of the proposed West Regional station. Apparently the long drawn-out discussions between the B.B.C. and the tenant-farmer have at last resulted in terms acceptable to both parties. Work on the new station has now started and probably it will be "on the air" before Christmas, 1932.

FALKIRK GROWS

WHILE on the subject of regional stations, readers are probably wondering what is happening at Falkirk. We hear that the roof is almost completed, that the fencing is up, and that the engine bed has already been floated. The next job is to get in the machinery. This will be installed before Christmas. Foundations for the masts are also set.

LICENCE ROUND-UP

EQUIPPED with several new "pirate-sleuthing" vans, the Post Office is preparing for a big drive against those who are listening without a licence. This time the Post Office is tackling the problem through wireless dealers, whose charging plant and battery sales are thought likely to lead to the tracking down of many pirates.

600,000 WANTED

IF only the B.B.C. could increase its licences by 600,000, the additional revenue would automatically wipe out the effect of the recent cut of £150,000. The Post Office estimates that there are no less than one million pirates in this country.

It is interesting to note that in 1930 the licence increase was 450,000.

DAVENTRY'S BREAKDOWN

THE other day Daventry broke down for 45 minutes, and so did Midland Regional, due to a failure at the Daventry power station. This kind of breakdown would, of course, be impossible at Moorside Edge or Brookmans Park, where the power is made on the premises. It is thought that when Daventry is reconstructed it will have its own power plant.

A MATTER OF TASTE

WE expect that when the relief figures are disclosed at each end of the balcony at Broadcasting House, recently sculptured for the B.B.C. by that very modern sculptor Eric Gill, there will be quite a song and dance. At present the figures are shrouded—except for a pointing hand! This is grotesque enough to make us fear that the rest of the figures will be rather too modern for orthodox art lovers. Let us hope we are not to have another monstrosity added to London's growing gallery.

CRISIS TALKS

WHILE the National crisis continues, the B.B.C. has arranged for a weekly crisis talk. Following Sir Arthur Steel Maitland's talk on "How You Can Help," Sir Eric Geddes will be heard on Friday, October 2, in another talk relevant to the crisis. These talks are upsetting the plans of the talks department. R. H. Eckersley himself has had to stand down to make way for Sir Eric!

TRAMWAY INTERFERENCE

THE Post Office and United Tramways have been hard at work for several months trying to eliminate the interference to broadcast reception caused by the tramway system. Results are so good that

sufferers from this particular source of interference may expect considerable relief in the near future. We believe that the transmissions from the London Regional and National stations heard in the early hours of the morning, between 4 and 4.30 a.m., have played an important part in these tramway experiments.

MORE STATION JAMMING

ONE cannot help being a trifle pessimistic about the sort of interference we shall most probably get during the winter. New European stations are springing up, and International Congresses get us nowhere. People who own band-pass sets and super-hets are the only ones who can expect interference-free winter reception. It is because of this that super-hets have sprung into popularity. The Exhibition this year proved that "A.W." was right in fostering super-hets, for nearly every leading firm had one on show.

SUPER-HET CHANGES

OLYMPIA showed, too, a number of constructional gadgets for making super-het building an even simpler matter. There seems to be a big need for a really satisfactory way of working a "super" on an outdoor aerial, thereby gaining in initial pick-up without losing selectivity. 1932 is going to be a boom year for "super-het" enthusiasts and "A.W." has some startling schemes in hand in this connection. Keep your eyes open for developments in the very near future!

TOO MANY VALVES

SOME super-het designs have erred in having too many valves. Others have had too few; only one I.F. stage is not enough. A five- or six-valve super-het capable of working with an outdoor wire is the sort of thing demanded by reception conditions to-day. In certain circumstances frame aerials are a nuisance, despite their helpful selectivity.



"How British listeners get their programmes." This was the keynote of the B.B.C. exhibit at Olympia which comprised a large model map showing how our stations are arranged

"THERMION" LOOKS BACK AT THE SHOW

EVERY year the Editor asks me to look back at the Exhibition, and I am grateful to him for so doing, for it is the only way of obtaining a clear idea of what that gigantic display at Olympia means for us wireless folk. At the show itself you are interested, you are thrilled, you are amazed. But as you trot from stand to stand, adding catalogue after catalogue to your paper bag, you collect impressions at such a rate that a kind of mental indigestion sets in. Look back at the show, though, from an easy chair when it is all over and everything clears itself up. Only the things that really matter remain. The stunts and the unimportant things vanish without a trace and you can assess the Exhibition at its proper value.

Looking back on the 1931 show, I can say at once that it was by far the most important that we have ever had; and I am not referring to its size. It provided none of the surprise bombshells that we have had in some former years; there was, for instance, no "sensation" such as those which accompanied the introduction of the screen-grid valve, of the pentode, or of the moving-coil loud-speaker in popular form.



One of the most elaborate equipments at the Show. It is a complete home talkie apparatus, entirely self contained with the exception of the screen

Unless you had the seeing eye, you might, in fact, have come away from the Exhibition with the impression that the progress made between September, 1930, and September, 1931, had been sure and steady, but not spectacular.

A Definite Advance

And there, if you will forgive me for saying so (because quite possibly you came to that conclusion), you would be wrong. Actually, this year's Exhibition demon-

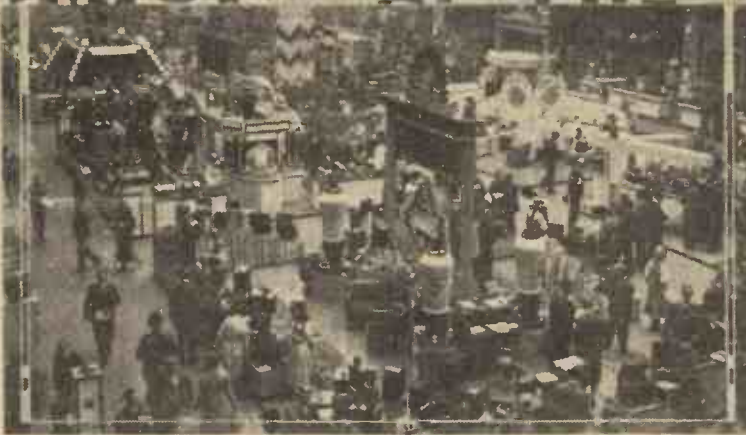

Now that the Radio Exhibition of 1931 is over it is possible to obtain a true perspective of recent developments. In this article "Thermion" gives his personal impressions

strated an advance in the technique of reception far more important than any of the sensations of previous years.

"Oh, yes," the reader may say, "I know what's coming. This fellow is going to say that prices were cut in two and that sets were more compact; that their operation was immensely simplified; that wireless had, in fact, become both cheap and foolproof."

That, though, isn't in the least what I am going to say. What I do want to point out is that you can purchase or build, as you could not this time last year, a set that will give you the best of service, whether you use it for long-distance work or for the reception of your local station. Last year, after the first round of our struggle with high-power home broadcasting stations, it almost seemed that two different sets were needed by anyone who wished to be able to receive his local station with first-rate quality and to indulge, when he felt like it, in the fascinating pastime of "bagging" foreign stations.

The "quality" set was not selective enough for long-distance work, nor had it the necessary amplification. On the other hand, the real long-distance set might be too selective to give fine quality from the local, whilst its big amplification might introduce distortion, due to overloading, as well as giving far too much volume. Foreign listening, in fact, seemed to be threatened, and had it gone by the board wireless would have lost one of its most absorbing sides.

We should take off our hats to the British designers who have tackled the problem so

nobly and so successfully. In the smaller sets, band-pass tuning and local-distance switching, or some other satisfactory form of volume control, have cured the spread of the high-power stations at short range and enabled the volume to be toned down as required, whilst leaving the set sensitive enough to bring in foreign stations with first-rate quality. Reaction control, too, has been improved out of all recognition.

In big sets ganging is now almost perfect, so that single-knob tuning can be used without loss of efficiency. Real selectivity without loss of quality has been achieved, and there are monsters con-

taining up to nine valves that will deal just as well with "Raucous Reg" at a dozen miles as with Rome at over seven hundred. The order of the last sentence is intentional; with the big set until this year it has been easier to obtain high-quality reception from Rome than from Brookmans Park at fifteen miles or so.

Band-Pass and Super-Het

The production of a sound general-purpose set fitted for both short- and long-distance reception is a wonderful achievement, as so many factors have contributed to it. Band-pass tuning is widely used. Thanks to some of this year's coils, you can obtain astonishing selectivity with only one H.F. stage, or without any H.F. at all. Band-pass tuning can also be applied to big sets, as was shown in the AMATEUR WIRELESS "Century Super." Here, again, it enables quality and selectivity to go hand in hand.

And, talking of super-heterodynes, I predicted many months ago that we should shortly see a revival of this kind of set in very much improved form. Well, we have done so. There were some beautiful super-hets, to be seen at the show. The old "mushy" background is gone; good design and good valves have removed the distortion that we used to associate with any kind of super-heterodyne receiver; the old idea that the super-het was no use on the long waves has been proved false; it has been shown that the super-het is not too costly to operate from batteries.

American Sets

After the show I spent a little time in pondering over the problem of the American sets, which at the moment are making such a tremendous effort to capture our markets. Will they or will they not succeed? Well, I believe that a good many people will buy them and that a large proportion of these will subsequently wish that they had not done so.

It is no good telling me that a set built for the 10-kilocycle separation that prevails

"THERMION'S IMPRESSIONS OF THE SHOW" (Continued from preceding page)

over there and designed for medium-wave reception only can be turned by the mere adding of a wave-change switch into something perfectly satisfactory for European conditions. Not a few will be attracted into parting with their money by the feeling that they are getting more valves for the same amount than they can obtain in a set of British manufacture. Two points occur here. First of all, some of these sets use valves, as opposed to metal rectifiers, for converting mains A.C. into D.C. In our receivers we count only the *wireless* valves; that is, the H.F. and L.F. amplifiers and the detector. Americans, though, include the current-rectifying valve in the total by

tion to the loud-speaker displays and demonstrations. The loud-speaker is an essential part of the receiving equipment, and you want to have the very best. There were two very striking points about the loud-speakers exhibited. Designers had realised that the wireless public was neither made of money when it came to purchasing loud-speakers, nor prepared to squander a huge tale of watts when using them. The public, they saw, wanted something really good, and it wanted that something at reasonable cost.

Speaker Developments

The man-in-the-street using batteries for his wireless set was not going to be attracted by a loud-speaker of the moving-coil type requiring half an ampere at 6 volts—that is, 3 watts—to energise the magnets alone, when the input from the receiving set to the loud-speaker was, in most cases, 1 watt or less. Nor was he going to pay pretty well as much for his loud-speaker as for the whole of the rest of his receiving equipment. They saw again, coming right down to brass tacks, that he was not going to be content with mediocre quality when he paid a reasonable price for his loud-speaker.

The balanced-armature and dynamic loud-speakers have been developed in the way that I foretold would occur. Both of these instruments are theoretically capable of extraordinary fidelity in reproduction, and one of their virtues is that they cost nothing at all to

run. Real scientific work has been put into the development of these kinds of loud-speaker, with the result that the quality of their reproduction has been improved in the most astonishing way. They have, too, been made more sensitive—a very important point. The more sensitive your loud-speaker, the smaller is the grid-voltage swing needed on the output valve and the less, therefore, the liability to that appalling kind of distortion due to over-loading of the last valve.

In the department of moving-coil loud-speakers astonishing things have happened. The permanent-magnet type has been developed so satisfactorily that first-class results can be obtained without the use of any field current at all. And the prices! You can buy a good unit, including the drive and chassis and the cone, for £2, or even less. Allow five shillings for a home-made baseboard-mounting block and baffle board, and you have a high-grade loud-speaker at something like half the cost of

a similar instrument twelve months ago.

Valves? Space prevents me from dealing with more than just the outstanding features of the 1931 valves. I am not going to talk about G.P. valves or even about the very important "toobs" whose functions are detection, low-frequency amplification, and output supply. I want, though, to say a little about the terrific improvements made in screen-grid valves.

The Modern S.G. Valve

The screen-grid valve has been a real friend ever since it flashed upon our startled world some years ago. But it has had its drawbacks. You cannot, for example, use it successfully as a high-frequency amplifier in front of the first detector in the super-het. You cannot ask it to perform really well the dual functions of either combined oscillator-detector in a super-het, or of oscillator-L.F. amplifier in a straight set. You cannot obtain from it in its familiar form the selectivity that its high impedance would appear to indicate. Many readers have written to me to ask why the screen-grid valve should be apparently so unselective. The whole trouble is caused by the fact that the ordinary screen-grid valve has a very high amplification factor, a moderate mutual conductance, and a distinctly bent characteristic curve. Another



Making sound films in the home. The apparatus consists of an ordinary film camera, a miniature microphone, and a recording instrument resembling a portable gramophone. Recording or projecting is done with the same instrument, the camera or the projector being attached as required

which the set is described—a process which to me is not unlike adding in the date on the bill! Don't forget, too, that American designers pride themselves on the fact that they look for small amplification per stage. My experience is that the first-rate British three-valver is in every point of performance as good as an American set containing four wireless "toobs" and one mains rectifier. We expect our valves to work for their living. Think it over.

Components

The components this year are really admirable. Gone are the days when a coil designed by the office boy sold like hot cakes just because it was cheap. You had only to visit the stands belonging to the coil people to realise that coils and transformers nowadays are real engineering jobs, involving in their production long research, first-rate design, and precision methods of manufacture. You must have been struck by the compactness of the 1931 coils, by the completeness of the screening used, and by the excellence of the wave-change switching systems.

Of course, you paid a good deal of atten-



A new note in radio-gramophones: a miniature instrument seen at the Exhibition

query, too, concerns the difference between the theoretical amplification factor and the actual amplification obtainable. We cannot obtain the big amplification that should be there largely because the ordinary S.G. is prone to oscillate if we go beyond a certain point.

This year the S.G. valve has been properly put in its place. It has been tamed by metallising the bulb, so that screening is, so to speak, automatic. This is an enormous advance.



A BATTERY-OPERATED RADIO-GRAMPHONE

This is an economical and cheap-to-build radio-gramophone outfit which will appeal to discerning constructors. This set can be used without the gramophone side if desired

PRICES of commercial radio-grams have dropped considerably, but the enthusiast who is willing to go to the trouble of making up his own outfit can still effect a considerable saving.

Several people who would otherwise at present be the proud owners of home-built radio-grams have been bothered by the knowledge that most outfits up till now need to be mains driven in order to get an adequate power output.

For Battery Operation

As there is still a large proportion of listeners without electric light mains, or who for one reason or another do not want to install mains drive, the big need is for a radio-gramophone which is economical enough in its current demands to be battery fed if necessary. It must also be of straightforward design so that when the electric light mains do come along it will not be difficult to change over to mains drive.

Here is an outfit which exactly fills the bill. Construction is not at all difficult and the set can be used without the gramophone side if desired. It is basically a good four-valve set with ganged tuning and one screen-grid stage.

The detector is resistance-coupled to the first L.F. valve and straight-forward transformer L.F. coupling with a decoupling circuit follows. An output circuit in series with the power valve anode makes the set safe for mains working and also makes it easy to change the tone. So much for technical features. Further details can be gauged from the circuit diagram.

Receiver and Radio-GRAM

The set must be considered as a separate unit, for it slides into the cabinet on the middle shelf immediately below the turntable equipment.

It can be made up in a separate cabinet if desired by those who do not want at present to go in for the gramophone side and later it can be used with a pick-up for electrical reproduction of records. The layout of the panel is straightforward, the centre control being that of the two-gang condenser. On the right is the volume control, which works equally well on radio and gramophone working, and the on-off switch for all four valves. On the left is the reaction condenser, and the rotary wave-change switch for the twin coils.

These are the main controls and as the centre tuning condenser knob and that of

the volume control are the ones which, generally speaking, will need attention, it is quite obvious that operation of this set is well suited to family needs.

On the baseboard at the back is a small variable condenser in series with the aerial lead. If you want to sharpen up the tuning, then slack off the knob of this. In most localities one setting of this suffices and it is not necessary to make frequency adjustment. When the set is used in its gramophone cabinet, two wires are taken to a switch on the turntable platform.

This cuts off the filament supply to the detector and screen-grid valves when the set is used as a gramophone amplifier. Only the low-frequency and power valves are used for gramophone amplification and this prevents waste of filament current by running the first two valves when they are not required.

Easy Construction

In next week's issue a scale drawing will be given of the layout of the set and a full-size blueprint is in course of preparation.

(Continued at foot of next page)

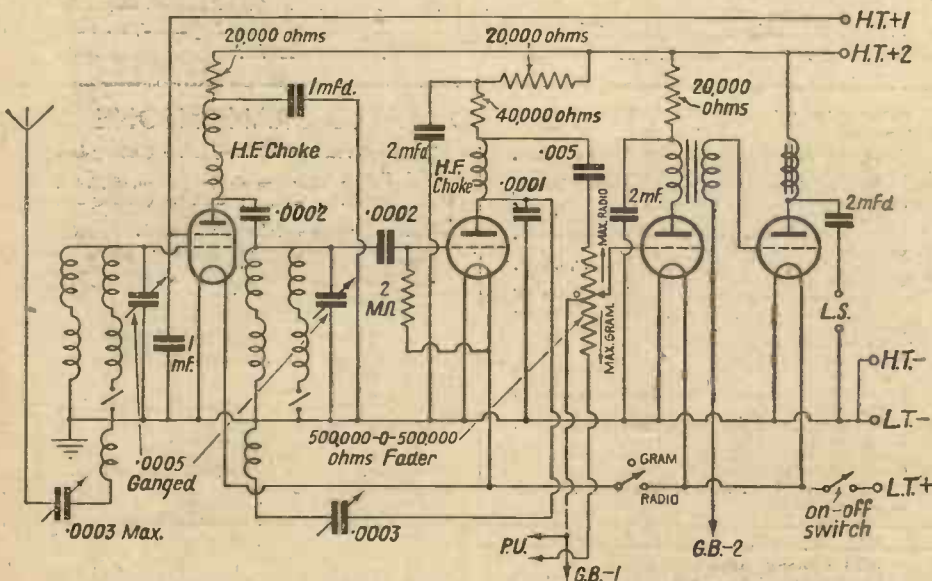

The aerial and H.F. circuits are ganged by a .0005 dual condenser, giving one-knob tuning. The second filament switch cuts out the H.F. and detector valve filaments, leaving the L.F. and power valves for gramophone working. Anti-motorboating circuits are in the detector and L.F. valve anode leads



The entire instrument, including the cabinet, can easily be made at home

MORE EXHIBITION CAMEOS

(Continued from last week)

[He has been dragged around by his nephew, an enthusiastic radio-fan, and for three solid hours has been on a conducted tour to umpteen stands where the most expensive radio receivers are exhibited. He has not yet been pinned down to any definite purchase, but in view of the economic situation and its resulting consequences he has come to the conclusion that a visit to say, the Grocers' Exhibition or even a Trade Show by Manufacturing Confectioners would have afforded fewer temptations. Or had it been some display by the Boot and Shoe Trades. Mentally, he takes a drastic decision.]

HE (good humouredly to his nephew): "My dear Herbert shall we say 'light refreshment'?"

HIS NEPHEW (whose eyes are still glued on an attractive multivalver): "Yes, Uncle, if you like, but just look at . . ."

HE (gently dragging him away): "Later my boy, later. The fact is that it seems to me that in the present circumstances—ahem—you know, the Budget, taxes, and all that (he plucks up courage) we should retrench. (Pompously) We should, for the time being, at least, make do with what we possess and . . ." (Nephew sees a catch in this piece of avuncular advice, but listens respectfully.)

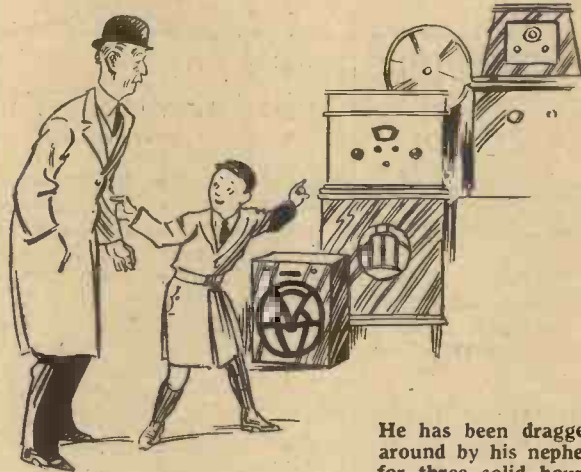

He has been dragged around by his nephew for three solid hours.

HE: "What I was saying was—ahem—I promised you a nice present of your own choosing as a fitting reward for your last term's work and I intend to give it to you, but . . ." (His nephew's face lights up until he hears the last word and he gives to his Uncle's words a greater percentage of attention.)

That's splendid. All you have to do is to tell me—er—well, what book would you like? I leave it to you. (Cheerfully) Come now, what is to be?"

HIS NEPHEW (innocently): "A cheque book, Uncle!"

Overheard in the tea room.

"My dear chap, you should give it more juice."

"Two lumps, darling? And milk?"

"What I want is an alternating programme and I don't want Bach."

"My dear sir, on my honour as an Advertising Agent, I can assure you . . ."

"Some parts of the programme I don't like; some parts I do like and don't get. I'd like to build a set which would get band parts frequently. I like music, I do. What's that? Band-pass frequency. Whatever's that?"

"Four yards of the most exquisite crepe-de-chine at three-eleven-three per and you know, Sweetest, you can't get it at any West End shop under four shillings."

"Margery 'phoned me to say that you had told her what I had asked you not to tell her, that Fred had given me a wireless set. Oh, yes, I know you can keep a secret, dear, and that she promised you faithfully that she would not tell me that you had told her. What a cat! Why, she also asked me not to tell you that she had told me that you had told her."

"A BATTERY-OPERATED RADIO-GRAMPHONE"

(Continued from preceding page)

This can be obtained, price 1s. 6d., post free, from the Blueprint Department, AMATEUR WIRELESS, 58-61 Fetter Lane, London, E.C.4. This is a great help in construction and shows all the parts in their proper positions and gives all the wiring.

job of the construction, but also cut down the cost. Last year one would have had to use elaborate wire-wound resistances in holders, but now a neat spaghetti resistance between the points across which a voltage drop is required does all that is necessary.

Ganged tuning of the screen-grid and detector circuits cut down the cost, because a ganged condenser is cheaper than two separate components and the connections

are simplified.

The coils used are covered completely by aluminium screening cases and the only important point is that you should keep the spacing between these exactly as shown on the photographs.

Constructional details and hints on getting the best from this outfit, both as a radio set and as a gramophone amplifier, will be given in next week's issue.

COMPONENTS REQUIRED FOR THE BATTERY-OPERATED RADIO-GRAMPHONE

Ebonite panel, 16 in. by 8 in. (Camco, Peto-Scott, Readi-Rad).
Baseboard, 16 in. by 12 in. (Camco, Peto-Scott, Readi-Rad).
Two screened dual-range coils (Lotus).
Two-gang .0005-mfd. condenser (Utility "Semi-screened" J.B., Lotus, Polar).
.0003-mfd. reaction condenser (Readi-Rad, Lotus, Telsen, Polar).
Pre-set aerial condenser, .0003-mfd. max. (Formo, Sovereign, Lewcos, R.L., Ormond).
Radio-gram switch (Bulgin Gripso).
Filament switch (Bulgin, Graham-Farish).
Telsen, Wearite, Busc, Sovereign).
Four valve holders (Telsen, Junit, W.B., Readi-Rad, Wearite, Graham-Farish).
Two high-frequency chokes (one binocular) (Telsen, Lissen, Wearite, Igranic, Lewcos, Goltone, R.L., Bulgin, Burton, Varley, Sovereign, Graham-Farish).
Three fixed condensers, .0002-mfd., .0001-mfd., .005-mfd. (Dubilier, Telsen, Lissen, T.C.C., Readi-Rad, Graham-Farish).

Three 2-mfd. fixed condensers (Lissen, Telsen, Dubilier, T.C.C., Formo, Ferranti).
Two 1-mfd. fixed condensers (Lissen, Telsen, Dubilier, Goltone, T.C.C., Formo, Ferranti).
.0002-mfd. grid condenser (Dubilier, upright-type, T.C.C., Lissen, Telsen, Goltone, Readi-Rad, Graham-Farish).
2-me. grid leak (Telsen, T.C.C., Dubilier, Lissen, Goltone, Readi-Rad, Graham-Farish).
Low-frequency transformer (Varley "Nicore 1", Telsen, Lissen, Lotus, Igranic, Lewcos, Graham-Farish, R.L.).
Output choke (Atlas C.P.S.).
500,000-0-500,000-ohm fader (A.E.D.).
Four spaghetti resistances—three 20,000-ohm and one 40,000-ohm (Lewcos, Telsen, Lissen, Bulgin, Graham-Farish).
Two terminal blocks (Junit, Sovereign, Lissen, Belling-Lee).
One terminal block for horizontal mounting (Lissen, Belling-Lee).
Four terminals marked: A, E, L.S. (2) (Belling-Lee, Eelex, Burton).

Two spades marked: L.T.—, L.T.+ (Belling-Lee, Eelex, Clix).
Six wander plugs marked: H.T.—, H.T.+1, H.T.+2, G.B.—, G.B.—1, G.B.—2 (Belling-Lee, Eelex, Clix).
Connecting wire and sleeving (Lewcos).
Valve screen (Six-Sixty, Peto-Scott).
Four yards thin flex (Lewcoflex).
Pair of bias battery clips (Bulgin).

ACCESSORIES

Accumulator (C.A.V., Exide, Fuller, Ever Ready).
H.T. battery (Drydex, Pertrix, Ever-Ready, Lissen, Fuller).
G.B. battery (Drydex).
Pick-up (Zonophone, Marconi, B.T.H., H.M.V., Graham-Farish).
Motor (Garrard, Collaro, Apollo).
Twin needle-cup (Bulgin).
Permanent magnet moving-coil speaker (W.B., Amplion, H.M.V., Epoch).
Cabinet (Borst).

Cost of construction in this radio-gram has been cut down by reducing to a bare minimum the number of parts needed and a full list is given in the accompanying panel. Spaghetti resistances and similar new components not only make a much easier

Further details of the Radio-Gramophone together with the layout and wiring diagram in next week's issue

Rugger topics will be dealt with by Mr. Rowe Harding, the ex-Welsh International captain, in a Cardiff talk on October 17. Mr. Harding will give an opinion on club form and will talk about the South African team.

TELSEN TRANSFORMERS & CHOKES

TELSEN L.F. & OUTPUT TRANSFORMERS

Telsen transformers have achieved fame in the radio world on account of the high standard of their quality and performance. Designed and built on the soundest engineering principles, these robust, full-size transformers will give not only efficient but enduring service.

TELSEN L.F. TRANSFORMERS

- Telsen "Ace" Transformer, Ratios 3-1, 5-1 Price 5/6
- Telsen "Radiogrand" Transformer, Ratios 3-1, 5-1... .. Price 8/6
- Telsen "Radiogrand" 7-1 Super Ratio Transformer ... Price 12/6
- Telsen Intervalve Transformer, Ratio 1.75-1... .. Price 12/6

TELSEN OUTPUT TRANSFORMERS

- Telsen Multi-Ratio Output Transformer, giving three Ratios of 9-1, 15-1, 22.5-1 ... Price 12/6
- Telsen Output Transformer, Ratio 1-1 Price 12/6
- Telsen Pentode Output Transformer Price 12/6

TELSEN L.F. CHOKES

Telsen L.F. Intervalve Coupling Choke, 40, 100, and 125 henrys Price 5/-

TELSEN OUTPUT CHOKES

- Telsen Output Choke (Plain), 20 henrys Price 8/-
- Telsen Output Choke (Tapped), 20 henrys Price 8/6
- Telsen Heavy Duty Power Grid L.F. Choke, 40 henrys Price 8/-

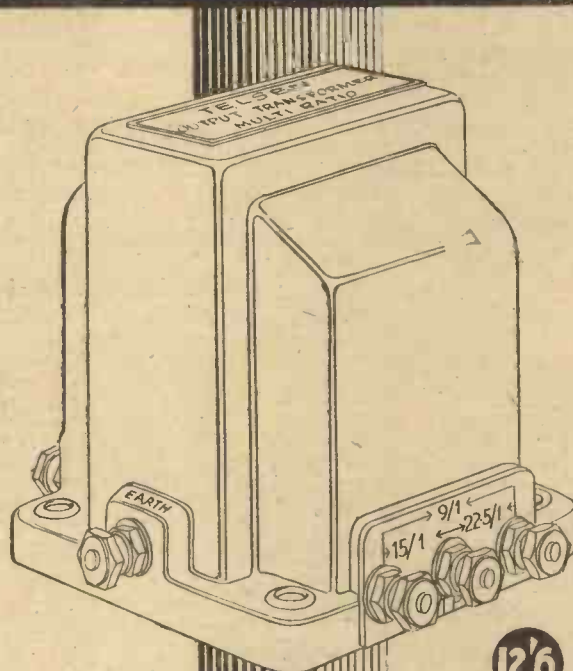

12/6

ACE
5/6
RADIOGRAND
8/6

TELSEN

ALL-BRITISH
RADIO COMPONENTS

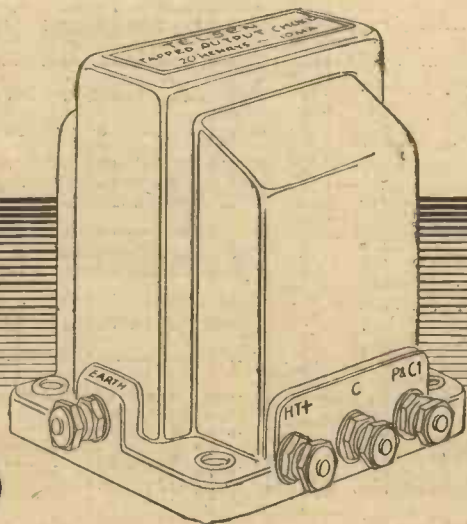

8/6



Send for the "Telsen Radio Catalogue" and book of "All-Telsen Circuits" to—The Telsen Electric Co., Ltd., Aston, Birmingham.

CVS-56

To Ensure Speedy Delivery, Mention "A.W." to Advertisers

IMMEDIATE DELIVERY

EVERYTHING NEW IN RADIO

**C.O.D.
CASH
H.P.**
as usual

We are the largest Radio House in the Country, and in sending your orders to us there is no risk of delay. Orders executed on our famous 3-WAY PLAN—C.O.D., CASH or H.P. Express Service for everything Radio Guaranteed. New 116-page catalogue 6d., post free.

MANUFACTURERS' KITS

COSSOR MELODY MAKER, Type 234. Screened grid, detector, and power. Complete with screened valves and cabinet. Cash Price £6 15 0. Balance in 11 monthly payments of 12/6. **Send 10/-**

Finished Instrument. Royalties paid. £7 10 0. Cash only.

OSRAM NEW MUSIC MAGNET. Improved version of this famous 4-valve set. 2 screen grid, detector, and power. With valves and cabinet. Cash Price £10 15 0. Balance in 11 monthly payments of 19/8. **Send 19/8**

Finished Instrument. Royalties paid. £11 15 0. Cash only.

EKCO H.T. UNIT, TYPE A.C.25 Send
For multi-valve sets requiring up to 25 m/a. Three tappings—S.G., detector, and 120/150 volts. For A.C. mains. Cash or C.O.D. £3 17 6. **7/1**
Balance in 11 monthly payments of 7/1 only

ATLAS A.C. ELIMINATOR, TYPE A.C. 244. Three tappings—S.G., detector, power. Output, 120 volts at 20 m.a. Cash Price or C.O.D., £2 19 6. **5/6**
Balance in 11 monthly payments of 5/6 only

EKCO K.12 A.C. COMBINED H.T. ELIMINATOR AND L.T. TRICKLE CHARGER 12 m/a suitable for 1- to 3-valve sets. S.G. 80v. 120/150v. charging rate 1/2 amp. at 2, 4 or 6v. Cash or C.O.D. £3 : 19 : 6. **7/4**
Balance in 11 monthly payments of 7/4. **Send 7/4** only

EXIDE 120-VOLT W.H. TYPE ACCUMULATOR, in crates. Cash Price, £4 13 0. **8/6**
Balance in 11 monthly payments of 8/6. **Send 8/6** only

AMPLION MC.6 MOVING-COIL SPEAKER. Permanent magnet. With output transformer. Complete. Cash Price £3 : 7 : 6. **6/2**
Balance in 11 monthly payments of 6/2. **Send 6/2** only

CELESTION PERMANENT-MAGNET MOVING-COIL SPEAKER. Type RPM8. 8in. reinforced diaphragm. Chassis form without input transformer. Cash Price £3 : 10 : 0. **6/5**
Balance in 11 monthly payments of 6/5. **Send 6/5** only

LAMPLUGH OR FARRAND INDUCTION SPEAKER NEW MODEL for perfect reproduction. Unit and chassis complete, ready mounted. Cash Price or C.O.D., £3 10 0. **6/5**
Balance in 11 monthly payments of 6/5. **Send 6/5** only

BLUE SPOT PERMANENT MAGNET MOVING-COIL SPEAKER. Complete with input transformer. Cash Price, £3 15 0. **6/11**
Balance in 11 monthly payments of 6/11. **Send 6/11** only

WEARITE OR LEWCO SUPER-HET COILS. For Super 60, Century Super, Super Senior. Cash Price £2 10 0. **6/2**
Balance in 8 monthly payments of 6/2. **Send 6/2** only

NEW B.T.H. "SENIOR" PICK-UP AND TONE-ARM. Complete. Cash price £2 5s. 0d. **4/2**
Balance in 11 monthly payments of 4/2. **Send 4/2** only

REGENTONE W.5 COMBINED H.T. ELIMINATOR AND TRICKLE CHARGER. One S.G., 1 variable and 1 fixed tapping for H.T. L.T. for 2, 4, and 6 volts. For A.C. mains. Cash Price £5 : 17 : 6. **10/9**
Balance in 11 monthly payments of 10/9. **Send 10/9** only



VOXKIT RADIOGRAM CABINET MODEL 1932. Accommodation for largest of home-built receivers with a full-size speaker and mains or battery equipment. Complete with motor board. Dimensions overall: 39 in. high by 22 in. wide by 17 in. Internal Panel, 18 by 7 in.; baseboard, 18 by 14 in.; speaker chamber, 18 by 14 by 16 in. Panel, 12 1/2 in. between moulding. Oak. Cash Price £4-10-0. **£4-10-0**
Or 12 monthly payments of 8/3.

PILOT PERMANENT MAGNET MOVING-COIL SPEAKER. Matches the requirements of all modern receivers. Includes Unit designed and built specially for Peto-Scott by Epoch. Handles the smallest to the greatest input and brings out most minute details of tonal quality with pure, full volume. A multi-ratio input transformer is fitted and provides for matching to all super-power and pentode valves. The handsome hand-polished solid oak cabinet is built to give added depth of tone, and is fitted with ebonised base and side wings and silk-covered fret. **£3-15-0**
Cash Price £3-15-0
Or 12 monthly payments of 6/11.



VOXKIT 1932 CONSOLE (Radio only). Another attractive addition to the famous Voxkit range. Accommodates the largest home built receiver and bulkiest speaker, mains or battery supply. Almost identical with the 1932 Voxkit Radiogram. Dimensions: 37 in. high by 22 in. wide by 13 1/2 in. Panel, 18 by 7 in. Baseboard, 18 by 12 in. Speaker compartment, 18 in. wide by 14 in. high by 12 in. deep. Front panel, 12 1/2 in. Oak. Cash Price £3-15-0. **£3-15-0**
Or 12 monthly payments of 6/11.

KELSEY SHORT-WAVE ADAPTOR

Add more stations to your set. Plugs direct into your battery or eliminator operated receiver. Complete with instructions. Sent C.O.D. Postage free. Pay the postman. Mahogany Cabinet 7/6. **37/6**
Nothing more to buy no valves or any extras.

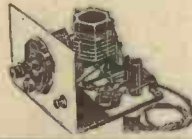

SPECIALLY RECOMMENDED

EPOCH J.1 PERMANENT MAGNET MOVING-COIL SPEAKER. Item No. 29, with multi-ratio input transformer. Cash Price, £2 12 6. **4/10**
Balance in 11 monthly payments of 4/10. **Send 4/10** only

GARRARD INDUCTION GRAMOPHONE MOTOR. Model 202. Mounted on 12-in. Nickel Motor Plate with fully automatic electric starting and stopping switch. Cash Price, £2 18 6. **5/3**
Balance in 11 monthly payments of 5/3. **Send 5/3** only

ROLA PERMANENT MAGNET SPEAKER. Complete with input transformer. Cash Price, £2 17 6. **7/1**
Balance in 8 monthly payments of 7/1. **Send 7/1** only

ROLA A.C. MOVING-COIL SPEAKER. Complete with input transformer. Cash Price, £4 5 0. **7/10**
Balance in 11 monthly payments of 7/10. **Send 7/10** only

COSSOR 4-VALVE ALL-ELECTRIC RECEIVER. Built-in Moving-coil Speaker. Two screened-grid valves, detector and power. Pick-up terminals. For A.C. Mains. Cash, £16 16 0. **36/-**
Balance in 11 monthly payments of 36/-. **Send 36/-** only

BROWNIE DOMINIONS GRAND 3-VALVE. All-electric for A.C. mains with built-in Cone Speaker, Mains Aerial. Cash Price, £13 13 0. **33/-**
Balance in 11 monthly payments of 24/-. **Send 33/-** only

Finished Instrument. Royalties paid. £11 15 0. Cash only.

MULLARD 3 1932 RECEIVER. Screen grid, detector, and pentode. With valves less cabinet. Cash Price £6 10 0. **11/11**
Balance in 11 monthly payments of 11/11. **Send 11/11** only

Finished Instrument, with valves and cabinet. Royalties paid. £7 17 6. Cash only.

V.3 RADIO FOR THE MILLION. Powerful, selective, and ultra modern. Screen grid, detector, and pentode. With valves, less cabinet. Cash Price £5 17 6. **10/9**
Balance in 11 monthly payments of 10/9. **Send 10/9** only

Finished Instrument, with valves and cabinet. Royalties paid. £7 8 6. Cash only.

SIX-SIXTY CHASSIKIT (Battery Model). Complete three-gang band-pass tuning. Screen grid, detector, and pentode. Cash Price, with valves, less cabinet, £6 17 6. **12/7**
Balance in 11 monthly payments of 12/7. **Send 12/7** only

Finished Instrument, with cabinet (10/6). Royalties paid. Cash only. £8 3 0.

SIX-SIXTY CHASSIKIT (A.C. Model). Complete as above, with A.C. mains valves. Cash Price, with valves, less cabinet, £7 6 6. **13/5**
Balance in 11 monthly payments of 13/5. **Send 13/5** only

Finished Instrument, with cabinet (10/6). Royalties paid. £8 12 0. Cash only.

C.O.D. ITEMS

B.T.H. SYNCHRO - BLUE GRAMOPHONE MOTOR. For A.C. mains. C.O.D. 39/6

MAGOM UNIVERSAL GRAMOPHONE MOTOR. For A.C. or D.C. mains. C.O.D. 52/6

TELSEN SPEAKER UNIT AND CHASSIS. C.O.D. 11/-

WEARITE "POPULAR TYPE" FRAME AERIAL. C.O.D. 32/6

WEARITE SET OF SUPER-HET COILS. C.O.D. 50/-

BLUE SPOT DYNAMIC TYPE SPEAKER UNIT AND CHASSIS TYPE 100 U. C.O.D. 39/6

PIFCO "ALL-IN-ONE" RADIOMETER. C.O.D. 12/6

EXPRESS ORDER FORM

TO PETO-SCOTT CO. LTD.
Please send me C.O.D., CASH/H.P.

.....

.....

.....

.....

.....

.....

.....

.....

.....

.....

.....

.....

.....

.....

.....

.....

.....

.....

.....



PETO-SCOTT CO. LTD. Head Office: 77 CITY ROAD, LONDON, E.C.1. Clerkenwell 9406. 62 HIGH HOLBORN, LONDON, W.C.1. Chancery 8266. MANCHESTER: 33 WHITELOW ROAD, CHORLTON-CUM-HARDY. Phone: Chorlton-Cum-Hardy 2028. NEWCASTLE, STAFFS: 7 ALBANY ROAD. Phone: 67190.

EXPRESS KIT SERVICE

CONSTRUCTORS!
Build "Authors" Sets with
100% SUCCESS

Pilot Author's Kits remove all doubt. Containing components "First Specified" in the list of parts and as used by the Author himself in the original Set, you are able to duplicate exactly the set as constructed by the Author. No other Kit of Parts offers you this wonderful safeguard against disappointment.

Let the **AUTHOR** be your Surety and the **PILOT** your Guide
PILOT AUTHOR'S KIT
C.O.D. CASH, H.P. as usual

1 FOUR-VALVE RADIO GRAMOPHONE

Check this list of parts with the Author's specification

	£ s. d.		£ s. d.
1 Peto-Scott ebonite panel, 16 in. by 8 in.	7 0	2 Belling-Lee spades marked: L.T.+, L.T.-	1 0
1 Peto-Scott baseboard, 16 in. by 12 in.	1 6	6 Belling-Lee wander plugs marked: H.T.-, H.T.+1, H.T.+2, G.B.-1, G.B.-2	1 0
2 Lotus screened dual-range coils	1 1 0	1 Six-Sixty valve screen	1 3
1 Utility semi-screened 2-gang .0005-mfd. condenser with friction dial	1 0 0	4 Bulgin grid-bias battery clips, one pair	3 0
1 Ready Radio .0003-mfd. reaction condenser	3 6	4 Yards thin flex, connecting wire, sleeving, etc.	3 0
1 Formo pre-set aerial condenser, .0003 mfd. max.	1 6		
1 Bulgin radio-gram switch	2 0		
1 Bulgin filament switch	1 9		
2 Telsen H.F. chokes, binocular and standard types	7 0		
3 Dubilier fixed condensers, .0002-mfd., .0001-mfd. and .005-mfd.	5 7		
3 Lissen 2-mfd. fixed condensers	10 6		
2 Lissen 1-mfd. fixed condensers	5 0		
1 Dubilier .0002-mfd. grid condenser	1 8		
1 Telsen 2-meg. grid leak	9		
1 Varley Nicore 1 L.F. transformer	17 6		
1 Atlas output choke, type C.P.S.	1 1 0		
1 A.E.D. 500,000-ohm-500,000 ladder	9 6		
4 Lewcos spaghetti resistances, 3 20,000 ohms and 1 40,000 ohms	6 0		
2 Junit terminal blocks	1 4		
1 Lissen terminal block	1 0		
4 Belling-Lee terminals marked: Aerial, Earth, L.S.+, and L.S.-	8		

Kit "A," Cash or C.O.D. **£7 11 10**

C.O.D. LINES

2 LOTUS SCREENED DUAL-RANGE COILS. Item No. 22, each	10/6
1 UTILITY SEMI-SCREENED, 2-gang CONDENSER AND FRICTION DIAL, Item No. 23	£1 0 0
1 VARLEY "NICORE I" L.F. TRANSFORMER, Item No. 24	17/6

KIT "A" less valves and cabinet. Cash or C.O.D. **£7:11:10** Or 12 monthly payments of **13/11**
Kit "B" with valves less cabinet. Cash or C.O.D. **£10-2-4** Or 12 monthly payments of 18/7.
Kit "C" complete with valves and cabinet, less batteries, pick-up, motor and speaker. Cash or C.O.D. **£13-5-4** Or 12 monthly payments of 24/4.

PILOT RADIO KITS PRICE CHART

Item No.	SET	KIT "A" less Valves and Cabinet	KIT "B" with valves, less cabinet	KIT "C" complete
2	OLYMPIAN 3 AUTHOR'S KIT	CASH or £6-1-11 C.O.D. Or deposit 11/2 and balance in 11 monthly payments of 11/2	CASH or £8-0-11 C.O.D. Or deposit 14/9 and balance in 11 monthly payments of 14/9	CASH or £11-15-11 C.O.D. Or deposit 21/7 and balance in 11 monthly payments of 21/7
3	A.W. 2-VALVE LOUDSPEAKER SET AUTHOR'S KIT	CASH or £3-4-5 C.O.D. Or deposit 5/11 and balance in 11 monthly payments of 5/11	CASH or £4-12-11 C.O.D. Or deposit 8/6 and balance in 11 monthly payments of 8/6	CASH or £5-5-5 C.O.D. Or deposit 9/8 and balance in 11 monthly payments of 9/8
4	CENTURY SUPER BATTERY MODEL without Frame Aerial	CASH or £4-17-4 C.O.D. Or deposit 9/11 and balance in 11 monthly payments of 9/11	CASH or £8-12-9 C.O.D. Or deposit 15/11 and balance in 11 monthly payments of 15/11	
5	CENTURY SUPER BATTERY MODEL with Frame Aerial	CASH or £5-17-4 C.O.D. Or deposit 10/9 and balance in 11 monthly payments of 10/9	CASH or £9-12-9 C.O.D. Or deposit 17/9 and balance in 11 monthly payments of 17/9	CASH or £10-7-9 C.O.D. Or deposit 19/2 and balance in 11 monthly payments of 19/2
6	ETHER SEARCHER	CASH or £5-14-6 C.O.D. Or deposit 10/6 and balance in 11 monthly payments of 10/6	CASH or £7-13-6 C.O.D. Or deposit 14/1 and balance in 11 monthly payments of 14/1	CASH or £8-14-6 C.O.D. Or deposit 16/- and balance in 11 monthly payments of 16/-

Any parts for the above PILOT RADIO KITS sold separately. Orders value over 10/- sent Carriage Paid or C.O.D. All post charges paid.

EXPRESS ORDER FORM

To PETO-SCOTT CO., LTD.

Please send me C.O.D., CASH/H.P.

for which I enclose
Cash/H.P. Deposit: £ s. d.

ADDRESS.....

A.W. 3/10/31

2 OLYMPIAN THREE

As described in A.W. Sept. 26th.

CHECK this list of parts with the Author's specifications, photographs and diagrams.

	£ s. d.
Three-ply wood panel 16" x 8", and 7-ply baseboard, 16" x 10"	2 6
1 J.B. .0005-mfd. triple-gang condenser with slow-motion dial	1 9 6
1 Lotus .0003-mfd. reaction condenser	4 0
1 Sovereign 50,000-ohm potentiometer	4 6
1 Varley Dual-range Square Peak Aerial Coil, and Dual-range H.F. Intervalve Coil	1 3 6
1 Dubilier .04-mfd. fixed condenser	2 0
1 Peto-Scott S.G. valve screen	2 6
1 Telsen binocular H.F. choke	5 0
3 Lissen .0002-mfd. fixed condensers	3 0
1 Ready Radio grid-leak holder	6 6
1 Dubilier 2-meg. grid leak	1 9
1 Busco filament switch	1 3
1 Ready Radio high-frequency choke	4 6
1 Telsen low-frequency transformer	8 6
1 Formo condenser bank comprising two 2-mfd. and two 1-mfd. fixed condensers	9 6
2 Lewcos 10,000-ohm, two 20,000-ohm and one 30,000-ohm spaghetti resistances	7 6
1 Bulgin fuse and holder	1 3
1 Lotus JK5 gramophone jack	3 0
7 Glix wander plugs (marked)	10
2 Glix marked spade terminals	4
4 Belling-Lee marked terminals	1 0
1 Belling-Lee anode connector	6 6
2 Sovereign terminal blocks	1 0
1 Siemens 9-volt G.B. cell	1 0
4 Yards Lewcoflex, Lewcos connecting wire and Lewcos sleeving, screws, etc.	3 0

Kit "A," Cash or C.O.D. **6 1 11**

ACCESSORIES

1 Camco cabinet (Windsor Model)	2 5 0
1 Camco stool for cabinet	1 10 0
1 8G215, HL210, P220, or PM12, PM11L, PM12 Valves	1 19 0

C.O.D. LINES

VARLEY SQUARE-PEAK COIL

Pay the postman. C.O.D. 15/-

DUBILIER .04 NON-INDUCTIVE CONDENSER

Pay the postman. C.O.D. 2/-

VARLEY H.F. INTER-VALVE COIL

For use with Square-peak Coil. C.O.D. 8/6

J.B. TRIPLE-GANG SLOW-MOTION CONDENSER

Pay the postman. C.O.D. £1 9 6

PETO-SCOTT S.G. VALVE SCREEN

Beautifully finished. Pay the postman. C.O.D., each 2/6

PETO-SCOTT

PETO-SCOTT CO., LTD. Head Office: 77 CITY ROAD, LONDON, E.C.1. Clerkenwell 9406. 62 HIGH HOLBORN, LONDON, W.C.1. Chancery 8266. MANCHESTER: 33 WHITELOW ROAD, CHORLTON-CUM-HARDY. Phone: Chorlton-cum-Hardy 2028. NEWCASTLE, STAFFS., 7 ALBANY ROAD. Phone: 67100

Don't Forget to Say That You Saw it in "A.W."

THE A.W. RADIOGRAM *Utility* TUNED

In this week's issue our condensers are again specified, this time for the "A.W." 4-valve Radiogram. Once again the experts confirm our claim by using Utility condensers.

W 305/2, the model specified, is our latest semi-screened condenser and represents the best of both modern radio theory and engineering practice. The scientific construction prevents torsional stresses during

tuning. Specially designed trimmers ensure perfect balance of capacity over the whole tuning range. The ball-bearing spindle gives a dead smooth action with a positive control free from backlash. The sections are matched within 1%, this we guarantee.

W 305/2 Two-gang with friction dial as specified, 20/-.

Three other condensers are included in this new range

Semi-Screened

W 305/3, 3-gang, 22/6

Totally Screened

W 306/2, 2-gang, 22/6

W 306/3, 3-gang, 27/6

Disc Dial 2/6 extra.

Always insist on Utility condensers and switches, the finest in the world. Write for the new catalogue showing the complete range.

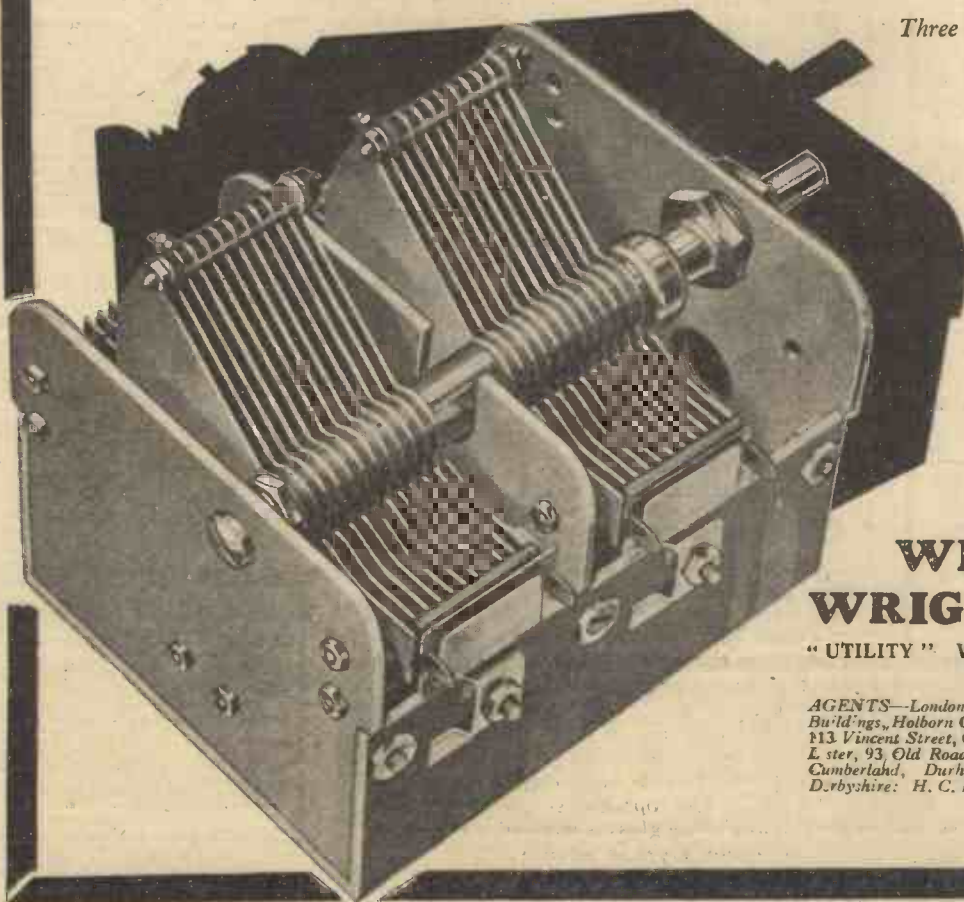

WILKINS & WRIGHT LIMITED

"UTILITY" WORKS, HOLYHEAD ROAD,
BIRMINGHAM.

AGENTS—London: E. R. Merton, Ltd., 22 Bartlett's Buildings, Holborn Circus, E.C.1. Scottish: E. B. Hammond, 113 Vincent Street, Glasgow. Lancashire and Cheshire: J. R. Lester, 93 Old Road, Blackley, Manchester. Westmorland, Cumberland, Durham, Northumberland, Cheshire, and Derbyshire: H. C. Rawson, Ltd., 100 London Rd., Sheffield.

Belmont

Mention of "Amateur Wireless" to Advertisers will Ensure Prompt Attention

On Your Wavelength!

A COMPLIMENT

FOUR years ago I had the pleasure of accompanying a very distinguished member of the American wireless industry to the Exhibition at Olympia; this year I went with him again. My companion on these two visits was Dr. C. F. Burgess, head of the great Burgess Battery Company. As we wandered round the stands it was clear that he was becoming more and more impressed. "What astonishing progress," he said; "I can hardly believe that your radio industry has developed in this wonderful way in just four years. When you last took me round your Wireless Exhibition it was a small affair; now it is about the biggest thing of its kind!" Dr. Burgess was very complimentary, too, about the neatness and attractiveness of our receiving set designs as well as about the beautiful quality of the components displayed on the stands.

WELL DESERVED

AND I cannot help saying that we do deserve compliments like these, for in the short history of broadcasting the progress that has been made in this country is little short of miraculous. We are much more hampered than are American manufacturers by two extremely important factors. In the first place, all our sets have to be designed to operate on two wavebands and, secondly, as I have pointed out before, we have not yet anything like standardisation in mains supplies. It is A.C. here and D.C. there, the voltages may be almost anything; and if it is A.C. the same remark applies to the frequencies.

GREATER DIFFICULTIES

WE have, too, to deal—and this is a point that is not fully realised over here—with infinitely greater congestion of the ether than is the case in America, which means that greater selectivity is needed. To begin with, America has a 10-kilocycle separation as against nine, and, more important still, the Federal Radio Board jolly well sees that stations do not deviate from their allotted wavelengths. If they wobble they get one straight-from-the-shoulder warning, and a repetition of the offence means that the station is closed down. Our manufacturers have surmounted all difficulties in a very wonderful way, and I have not the slightest hesitation in saying that no country in the world can show receiving sets so efficient or which give such good value for money as ours do. I have tried out a good few foreign sets, so that I am not just talking airily.

NOT TOO FAST

I THINK, though, that some makers are perhaps in danger of rushing too rapidly into something like specialisation in all-electric sets. There is undoubtedly a big demand for these, and it will become very much bigger when the regional electricity scheme is completely in being. At present, though, the percentage of homes

which have mains supply is surprisingly small, and for a good many years battery-operated sets must outnumber other types. The battery set is capable, as AMATEUR WIRELESS has shown, of long range and excellent quality. There were plenty of good battery sets at the Exhibition, but I hope that firms will not try to drop this class of receiving set prematurely. In my view, they should instead concentrate on turning out sensitive battery-operated sets capable of the highest quality, but showing modest running costs.

THINK IT OVER

POLITICS are completely out of my line, and I don't want to talk 'em. But there is just one thing that I would like to mention in these present rather stirring times. If we could make a sterling resolve to purchase foreign-made goods *only* in cases where nothing of the kind is made in Britain, the foreign exchange problem would very soon solve itself. Now, if there is one department in which our country can be absolutely self-supporting it is that of wireless. We can make every single bit and piece that we require, and there is no reason for us to spend a penny on foreign-made stuff. Every penny that we do so spend helps to lower the value of the pound sterling. If wireless folk would just remember this when they are buying sets, batteries, valves, loud-speakers, and components, it would make a heap of difference, for the amount of money spent on wireless runs to amazing figures. This does not, of course, apply to articles which, though originally of foreign invention and design, are now manufactured over here.

AN INTERESTING PROCESS

I WAS inquiring the other day how the metallising of the bulbs of the new S.G. valves is done. You know, of course, that the "silvering" on the inside comes about during the exhaustion of the bulb whilst the valve is being made. A little piece of magnesium is spot-welded on to the plate. After it has been pumped and sealed off there is still always a tiny residue of gases, particularly in the pores of the metal parts. These gases would be released if they were not got rid of, as the metal portions within the bulb heat up in use, thus spoiling the vacuum and making the valve soft. Here is how they are got rid of. The valve is placed in a strong high-frequency field, which induces in its metal parts currents that suffice to make them very hot. When the plate reaches a certain high temperature the little blob of magnesium volatilises—it is shattered into molecules. Each of these picks up gas atoms, which it nails down when it settles on the glass. As the bulb never becomes very hot, there is no fear of these atoms being released. Metallising the outside is done in a different way. The glass is covered, first of all, with a thin layer of adhesive. On to this is blown a spray of finely divided particles of zinc or some other metal.

These are held firmly in place and form an excellent conducting coat, which is connected to an earthed point.

LOOK OUT FOR THEM

THERE are one or two newcomers amongst foreign stations just now which you should look out for if you have not heard them. The biggest voice amongst these is that of Trieste on 247.7 metres, and unless your set is completely swamped by the London National on that part of the band you can hardly fail to pick him up. Warsaw No. 2, on 214.2 metres, is also to be heard on occasion, and another experimental station is Lodz, on 235 metres. On the long waves, Vienna Experimental is to be found at work at times on a wavelength half-way between Kalundborg and Motala. I don't know exactly what the wavelength is, for I have not heard it given out. Austria badly needs a new high-power station, for her listeners are suffering rather badly from the wipe-out effects of the big Polish transmitters and others that are getting to work in central Europe. Whether Austria will manage to get hold of a wavelength on the long-wave band I don't know, but it seems rather doubtful, owing to its present crowded state.

WORTH TRYING

IF ever you are engaged in trimming a set with ganged H.F. tuned stages, you will find it very well worth while to put a milliammeter temporarily into the high-tension positive lead of the detector valve. The instrument, by the way, should be on the battery side of the decoupling circuit, if there is one. You probably know that if the detector is of the anode-bend type the plate current goes up when resonance is reached. It goes down with the leaky-grid condenser detector. For the average anode-bend detector a 0.2 milliammeter is about right; I find that the average leaky-grid condenser detector with a decoupling resistance in circuit takes from 2 to 4 milliamperes, so that you want about a 0.5 instrument.

HOW TO PROCEED

HERE is the way to use it. Remember that the deflection of the milliammeter should be as big as possible when you have tuned a station in as sharply as you can. Set your trimmers, first of all, on a station like Hamburg, in about the middle of the band, and note the change in the milliammeter reading when you tune him in. Now try, say, Nuremberg, down near the bottom. See what deflection you get with your trimmers with their original setting and then how much you can get by making slight alterations. Re-trim on Hamburg and tune in Milan or Budapest, up near the top. Again see what is the difference between the deflection with the Hamburg setting of the trimmers and the best setting that you can make for Budapest. You may find that there are very big

On Your Wavelength! (continued)

differences all round. The next process is to try to find a setting which will give you a good average deflection from all three stations. Your "gang" is then adjusted for the best results all over the band.

ANOTHER IDEA

IF you like to keep the milliammeter in the plate circuit of the detector you will find it most useful in a heap of ways. First of all, there is, for instance, a no more useful help when you are making a calibration chart for your set. By ear alone it is often very hard to decide what is the exact setting for a rather powerful station. The milliammeter shows you, for the exact setting is that which produces the biggest deflection of its needle. You can thus make up much more accurate tuning charts or calibration curves than is possible in any other way. You can also keep in your log an exact record of the strength of stations night after night if you note down the amount of deflection that each produces. You will soon find out what is the minimum deflection for good loud-speaker volume, so that you know whether any station is worth bothering about almost as soon as you tune it in. There is another interesting point, too. The milliammeter used in this way shows up the amount of fading when this unpleasant phenomenon is occurring. By watching the needle you can actually time the swings from maximum to minimum and back again.

JELLY ACCUMULATORS

SPLENDID as they are for use in portable sets—and in stationary sets, too, for that matter—accumulators with their electrolyte in jelly form do occasionally go wrong in a rather disconcerting way. One of mine did so the other day. Though the plates appeared to be in quite good condition, the wretched thing suddenly refused to hold its charge properly. However, I tried various simple expedients, but none of these had any effect; the accumulator, in fact, ran down faster and faster after each charge. Then it occurred to me that the jelly itself might be responsible, and I resolved to see what effect a change would have. It was rather a messy job, and I think I shall have it done for me another time. Still, I took off the top of the case, removed the plates, washed all the jelly off them, and scraped the rest out of the case. Then I put the works back again, filled up with liquid electrolyte, and charged. I am not going to say that it is as good as new, but this accumulator, though no longer unspillable, does hold a good percentage of its charge now. I have no doubt that at a service station the old jelly would be removed and replaced with a fresh supply. It seems to me that this ought to be done every now and then.

FLASHES AND CRACKLES

THE flashing-sign problem is growing very rapidly worse; in fact, I know places where interference due to these signs pretty well puts a sensitive set out of action. And the worst of it is that our authorities are doing nothing about it,

except to say in a vague kind of way that they are carefully watching or exploring avenues and things of that kind. We shall, I suppose, take no action until it has become so bad that it would cost enormous sums to set the matter right. This is a thousand pities, for if only it were made as illegal to operate a radiating sign as it is to operate a radiating wireless set we could nip the trouble in the bud. My own experience is that a great deal of the interference is caused by rotary or other automatic switches which spark as they make and break contact. The cure is simple and obvious, and local authorities should certainly have powers to deal with the menace to broadcasting now furnished by the rapid growth of these signs. One of the worst bits of interference that I have ever had come from a flashing sign erected, of all places, over the door of a wireless shop!

P.M.G. ON THE WAR PATH

THE postal authorities announce that after the end of the present month there will be no mercy for any listener who is found using a wireless set without a licence. For the moment, official suspicion is centred on the Greater London area, where 662,000 licences out of a total population of over ten million are considered to be well below the proper mark. But other parts of the country are also listed for closer investigation, and unless statistics improve considerably we may expect a pretty thorough and extensive "drive" for defaulters. By the way, each Post Office is to be provided with the following notice: "Warning! Is your wireless set licensed?" So that there will be no excuse on the ground of absent-mindedness.

VALUE FOR MONEY

I KNOW that some people, particularly crystal-users, object to the present licence system on the ground that they have to pay just as much tax as the owner of a multi-valve set, which will not only work a loud-speaker, but also bring in foreign stations as well as the B.B.C. programmes. But it seems to me that the real point is whether or not the crystal user is getting good value for the money he is called upon to pay. Somebody else may be doing better, but both his set and its upkeep cost him more—and these are points which must be taken into account—

but meantime I do not think that any reasonable person can object to ten shillings a year as too much to pay for a seven-days-a-week service. Personally, I do not like the idea of using detective vans to "smell-out" the backsliders; but, of course, if everybody paid who ought to there would be a good deal more money available for improving the present programmes.

SIGHT FOR THE BLIND

THERE seems to be no end to the possibilities of the photo-electric cell, which has already been christened the "electric eye" in television. It is now being applied to alleviate the affliction of total blindness. I remember some years ago that an instrument called the Optophone was designed which enabled a blind person to read by interpreting the different sounds produced by passing a photo-sensitive cell over a sheet of printed matter. The latest application makes use of much the same principle. A blind person fitted with the new "electric eye" is able to distinguish between different degrees of illumination by the musical note produced. For instance, he can locate the direction of different windows in a room and can even walk in a straight path towards an open door.

DETECTOR BY-PASSING

WE are all familiar to-day with the necessity for by-passing the detector, but the full significance of this in an H.F. set is often missed. I had a case the other day where the set, which was quite unstable without a detector by-pass became manageable at once when I put the by-pass in. Of course, the use of the by-pass makes the detector more efficient and therefore at first sight it might seem that the set would be even more unstable.

Actually, however, if there is no by-pass, H.F. floats about in the anode circuit of the detector and produces sufficient radiation to cause instability. Even with a by-pass this trouble is sometimes experienced, particularly with a transformer having a rather high primary capacity, because the effect of the by-pass is nullified by the transformer self-capacity. In such cases it is necessary to insert an H.F. choke in the anode lead in the customary position after the by-pass condenser, but before the transformer.

THE POPULAR H.F. CHOKE

THE old idea that the use of a by-pass condenser renders an H.F. choke unnecessary, does not seem to be tenable in the light of present-day practice. For, with increasing H.F. amplification, coupled with the tendency to use inexpensive L.F. transformers, this question of H.F. in the L.F. stages is again becoming troublesome. The H.F. choke, therefore, looks like coming back into more popular use and this time it will be essential to use a high-grade component. If the choke does not really work well it will not overcome the difficulties. Fortunately, however, there are a number of chokes now on the market at around five shillings, which will fill the bill.

THERMION.

FREE

STATION FINDER AND LOG
also BEGINNERS' KEY TO
SYMBOLS with the October
Double Number of WIRELESS
MAGAZINE. This issue is the
largest and most outstanding
yet produced.

Get your copy NOW, price 1s.

WIRELESS MAGAZINE
OCTOBER ISSUE

WITH THE O.B. ENGINEERS — ORGAN BROADCASTS

The B.B.C. Outside Broadcasts engineers have tackled many difficult problems in relaying programmes from places outside the studios and here an "Amateur Wireless" Special Commissioner describes the arrangements for Organ Broadcasts



Reginald Foort, one of the most popular organ broadcasters

AFTER describing, in AMATEUR WIRELESS No. 473, the experiences of the B.B.C. Outside Broadcast engineers at some popular cinemas from which relays are made, the "O.B." official whom I interviewed said that in order to make the story complete there ought to be some reference to cinema organ broadcasts.

When you come to think of the number of cinema organ broadcasts which are given, generally at lunch-times, he is right; and what is more, I am assured that of all the trying things for the engineers, cinema organs are the worst.

When you sit in a cinema and listen to the throbbing, reedy tones of the organ, it seems as though this should be easy to broadcast. The snags are several.

At several big cinemas the organ is divided and the console at which the organist plays down in the orchestra pit is connected by cables to sets of pipes on both sides of the stage opening.

Separate "Mikes"

This complicates matters at the outset because it means having a separate microphone for each side, and the input from each microphone must be balanced up so that one side of the organ does not predominate. With modern cinema organs, such as that at the London "Trocadero," the organ is divided fairly equally, but with older organs some of the drums and other effects and the larger pedal pipes are often placed to one side, and the smaller reeds in the swell boxes are at the other side. This makes it difficult for the engineers to

match up the volume of input from each half.

Then there is the old trouble of echo. Most American-type organs have nearly all the pipes enclosed in swell boxes with shutter openings which control the volume of sound, and where a broadcast is made from a cinema with an organ of this kind, a microphone is hung down in front of the organ grille in the hall itself; but with organs where the pipes are not grouped together it is sometimes necessary to have a pick-up microphone at the back of the pipes and then, of course, reflecting echoes are a bugbear.

Suiting the Cinema

At the "Trocadero" (which, they tell me, is the only cinema from which broadcasts are made both of the organ and of the café orchestra) holes have been specially cut in the elaborate ceiling and special mounting arrangements are made in each of these so that the microphones can be altered in position if found necessary.

If you look carefully you may see the slender cables, one on each side, which carry the "mikes." It has been found necessary to have the left-hand microphone a little lower down than that on the right.

There is a potentiometer fader connected between each so that one side of the organ does not predominate. This is hardly ever

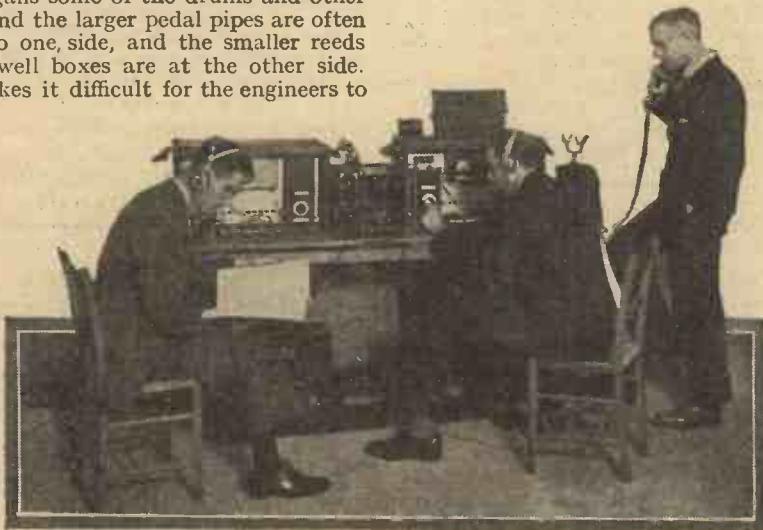

Here are the control engineers who, following the musical score, increase or decrease the volume of the organ music to prevent overloading the amplifiers

altered and the control engineer at the cinema just makes an occasional test to see that the tone balance is O.K., as he hears it through his 'phones connected to the "A" amplifier. Quentin McLean plays here, of course, and, owing to his big experience in gramophone record making of cinema organs, he is a good broadcaster.

The organ of Tussaud's cinema, from which we often hear Edward O'Henry, is an easier job for the B.B.C. engineers, for it is only on one side of the cinema and there is only one microphone.

A Difficult Task

At one well-known Northern cinema from which relays are often made, there is a very awkwardly-placed organ above the stage, for there is not room for it at the side of the stage opening. In order to get a good volume of sound in the theatre there is a sort of acoustic horn reflector carried down over the top of the stage, and hidden, of course, behind a grille. The B.B.C. engineers found that they could not put their microphone in front of this opening, as they would have done were the pipes immediately behind it, but they had to find by calculation a position in the horn itself which was free from resonance and echo.

Cinema organs make tricky work for the control engineers because there is such a large difference between full organ and pianissimo playing. The meters in the grid and anode circuits of the dual amplifiers at the cinema end have to be watched to see that there is no overloading, and back at the Savoy Hill control room the engineer in charge keeps a watchful eye on the volume control and modulation meter.

It is reported in Paris that the Bordeaux-Sud-Ouest station will be shortly transferred to Lagor, in the neighbourhood of Pau, as interference to its transmissions has been caused by the more powerful transmitter at Bordeaux-Lafayette. In the event of this change taking place the station would install studios both at Pau and at Biarritz.



The OLYMPIAN-THREE



Detailed operating instructions for our fine Exhibition three-valve. These also apply in many points to other "Amateur Wireless" band-pass three-valve sets

THERE are three chief things which must be observed in getting the most out of the "Olympian Three." These are choice of correct valves and of correct battery values and operating voltages, and strictly correct ganging. It is almost impossible to over-emphasize the importance of proper valves and voltages.

In old sets almost any kind of medium-performance valve would do as a detector and any fairly hard valve of low impedance was suitable in the output stage, but with modern high-efficiency circuits it is just as important to use the right valves as it is to choose a good oil for a high-efficiency motor-car engine. Given suitable valves, then, correct battery voltages are indispensable.

Modern valves are rather critical and this is particularly noticeable in the screen-grid

and you are most strongly advised to adhere to these recommendations, which have been thoroughly tried out in the AMATEUR WIRELESS laboratory.

There are three H.T. tapings in the "Olympian Three," and these enable you to get just the right voltage on every anode. The H.T. +1 tapping supplies the anode of the screen-grid valve, the H.T. +2 the detector valve, and the H.T. +3 the power valve anode and the screen grid of the H.F. valve.

A special method of supplying this biasing voltage is provided. The full high-tension voltage on the H.T. +3 tapping is cut down by a 20,000-ohm resistance and a 50,000-ohm potentiometer winding. The slider arm of the potentiometer is taken to the screening grid of the H.F. valve and is also earthed to a 1-microfarad condenser.

These special anode-feed arrangements make it very easy to get the right voltages for the "Olympian Three." The maximum voltage must be applied to the H.T. +3 tapping and, where possible, this should be 150 volts. A battery or mains eliminator of 120 volts is quite suitable, however. The H.T. +1 tapping should not exceed 120 volts, and if you have only a 120-volt battery or eliminator, the H.T. +3 and H.T. +1 tapings should be connected together.

The flex lead terminating in the wander plug H.T. +2, which feeds the detector valve, should be taken to a tapping point of 80 to 100 volts, depending on the detector valve chosen; the instruction leaflet issued by the manufacturers of your detector

valve should be studied. Where a mains unit with one variable control is used this should be taken to the H.T. +2 tapping, so that various detector voltages can be tried.

The H.F. volume control on the panel is the potentiometer already referred to in the screening-grid circuit and control of this alters the screening-grid voltage and regulates the H.F. amplification.

	Screen-grid	Detector	Power
Mazda ...	SG215	HL210	P220
Mullard	PM12	PM1HL	PM2a
Cossor ...	215SG	210Det.	220P
Marconi	S215	HL2	LP2
Osram ...	S2/C	HL2/C	LP2
Six-Sixty	215SG	210HL	220PA
Eta ...	BY6	BY1814	BY1304
Fotos ...	BC150	BC18	BD9
Dario ...	SG	HF	Power
Tungram	S210	L210	P215

The grid-bias negative tapping should be taken to about 1½ volts negative on the grid-bias battery and this comes into use only when the set is being used as a gramophone amplifier. The main grid-bias tapping, G.B. -2, should be taken generally to 7½ or 9 volts, but here again you must study the valve manufacturers' recommendations.

With valves plugged in and batteries or eliminator, aerial, earth, and speaker connected up, you can then make a preliminary test. Set the volume control on the panel at about the half-way value and then with the reaction condenser, with its vanes apart, tune in the local station. The three trimmers may then be roughly adjusted.

October 28 is the date provisionally fixed by the Italian broadcasting authorities for the official opening of the new Florence (20 kilowatt) station.

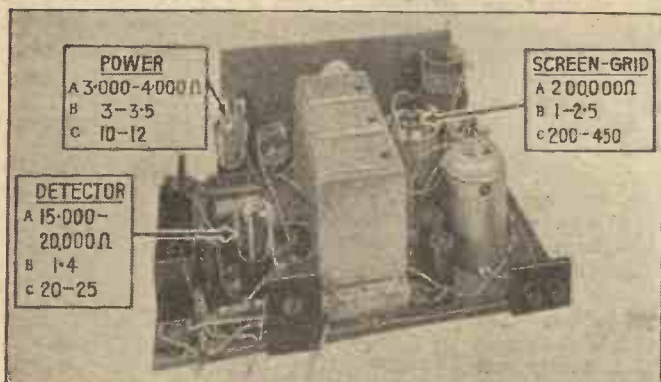

This will guide you in choosing correct valves for the "Olympian Three." A represents the impedance, B the mutual conductance and C the amplification factor. Average values are shown

stage, where a slight alteration of the anode and screening-grid voltages may make all the difference between good H.F. amplification and bad.

Suitable 2-volt valves of all the leading makes are given in an accompanying table

COMPONENTS REQUIRED FOR THE "OLYMPIAN THREE"

- Three-ply wood panel, 11½ in. by 7 in., and seven-ply baseboard, 16 in. by 10 in. (Camco, Peto-Scott, Read-Rad).
- .0005-mfd. triple gang variable condenser with slow-motion-dial (J.B., Utility, Lotus, Polar).
- .0003-mfd. reaction condenser (Lotus, Telsen, Read-Rad, Polar).
- 50,000-ohm potentiometer (Sovereign, Watmel, Lissen, Colvern, Wearite).
- Three valve holders (Wearite, Telsen, Lotus, Galtone, Lissen, W.B., Formo, Graham-Farish, Benjamin, Clix).
- Dual range Square Peak aerial coil, and dual range H.F. inter-valve coil (Varley).
- Special .04-mfd. fixed condenser (Dubilier).

- S.G. valve screen (Peto-Scott).
- Binocular high-frequency choke (Telsen, Watmel).
- Three .0002-mfd. fixed condensers (Lissen, Telsen, T.C.C., Goltone, Dubilier, Formo, Graham-Farish).
- Grid leak holder (Read-Rad, Wearite, Bulgin, Goltone, Lissen, Dubilier).
- 2-meg. grid leak (Dubilier, Telsen, Lissen, Sovereign).
- Filament switch (Busco, Bulgin, Telsen, Graham-Farish, Goltone, Read-Rad).
- High-frequency choke (Read-Rad, Telsen, Goltone, Lissen, Bulgin, Lewcos, Wearite, R.I., Graham-Farish, Sovereign, Burton, Varley).
- Low-frequency transformer ratio 7 to 1 (Telsen "Radiogrand," Lissen, Gra-

- ham-Farish, R.I., Burton, Ferranti, Varley, British General).
- Condenser bank comprising two 2-mfd. and two 1-mfd. fixed condensers (Formo).
- Two 10,000, two 20,000, and one 30,000-ohm spaghetti resistances (Lewcos, Telsen, Bulgin, Lissen, Read-Rad, Goltone, Graham-Farish, Tunewell, Sovereign).
- Fuse and holder (Bulgin, Telsen, Read-Rad)
- Gramophone jack (Lotus JKS).
- Seven wander plugs marked: H.T. -1, H.T. +1, H.T. +2, H.T. +3, G.B. +, G.B. -1, G.B. -2 (Clix, Belling-Lee, Ealex).
- Two spade terminals, marked: L.T. +, L.T. - (Clix, Belling-Lee, Ealex).
- Four terminals, marked: A, E,

- L.S. - L.S. + (Belling-Lee type R, Ealex, Bulgin, Burton).
- S.G. Anode connector (Belling-Lee, Clix).
- Two terminal blocks (Sovereign, Junit).
- .9-volt S.G. bias cell (Siemens).
- Four yards thin flex (Lewcoflex).
- Connecting wire (Bulgin Quickwire).
- Cabinet (Camco "Windsor" model).
- L.S. unit (Hegra, Blue Spot, Telsen, Undy).
- Cone and chuck (Weedon).
- Accumulator (Exide IZ3, C.A.V., Drydex, H.T. battery, Ever Ready).
- H.T. battery (Petrrix, Ever-Ready, Fuller, Palaba, Lissen).
- G.B. battery (Petrrix, Ever Ready, Fuller, Palaba, Lissen).

TELSEN DUAL-RANGE COILS

TELSEN DUAL-RANGE AERIAL COIL

The Telsen Aerial Coil is the very latest development in dual-range aerial coil design. It incorporates a variable series condenser which can be set to give any desired degree of selectivity, making the coil suitable for all districts whatever reception conditions may be. It has been tested in various parts of the country, and down to distances of five miles from Regional stations, a single tuned circuit will definitely separate the Regional programmes. This adjustment also acts as an excellent volume control and is equally effective on long and short waves. The waveband change is effected by means of a three-point switch. A reaction winding is provided and the primary and secondary windings are separated so that the aerial circuit can be isolated in mains driven or screened-grid receivers.

Telsen Aerial Coil with Variable series Condenser incorporated ... Price **7/6**

TELSEN H.F. TRANSFORMER AND AERIAL COIL

This Coil is primarily designed for H.F. amplification in conjunction with screened-grid valves. It is arranged so that it can be connected as a tuned-grid or tuned-anode coil, or alternatively as an H.F. Transformer.

It also makes a highly efficient aerial coil where the adjustable selectivity feature is not required. A reaction winding is incorporated. When used as an H.F. Transformer the wave-change is effected by means of a two-pole (four-point) switch. When connected otherwise a three-point switch should be used.

Telsen H.F. Transformer and Aerial Coil ... Price **5/6**

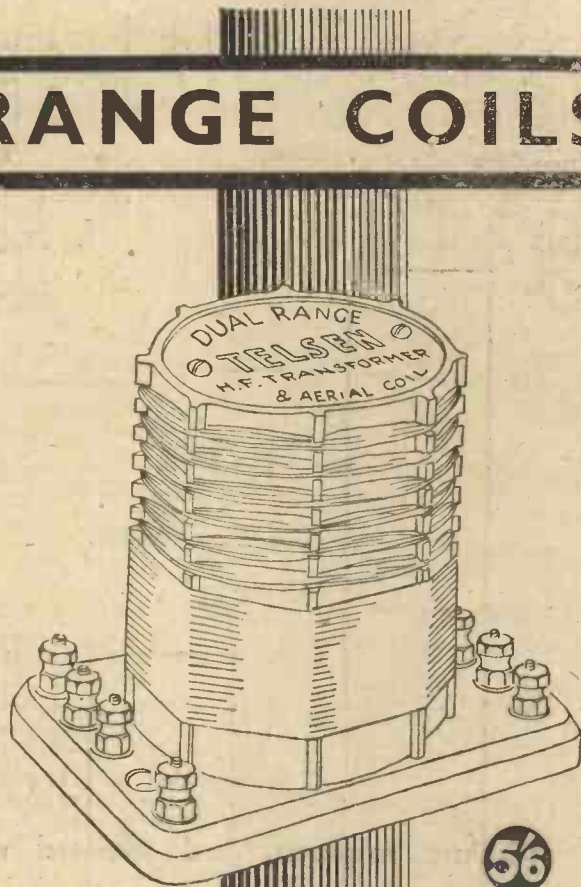

TELSEN

THE SECRET OF PERFECT RADIO RECEPTION

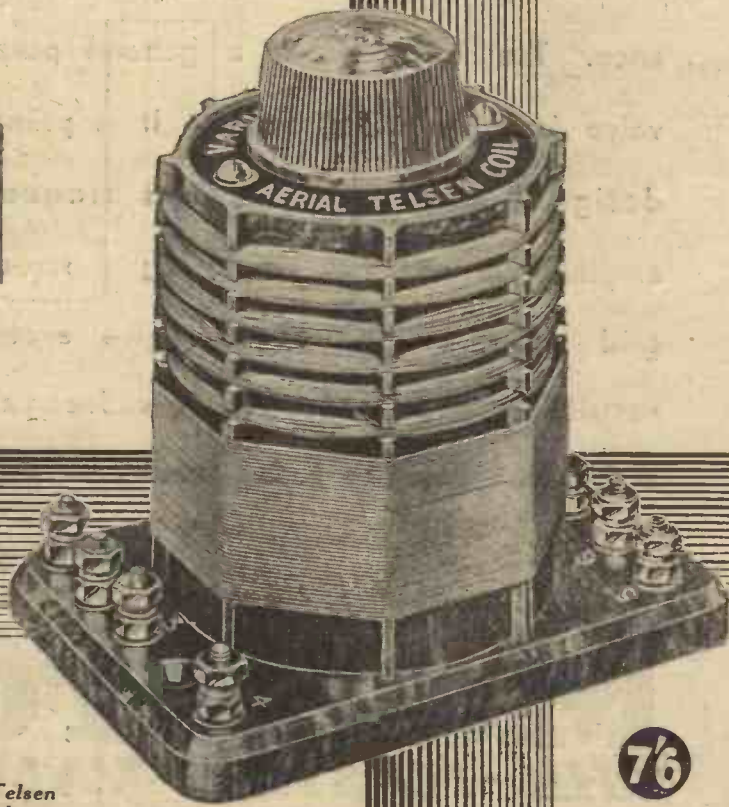

Send for the "Telsen Radio Catalogue" and book of "All-Telsen Circuits" to the Telsen Electric Co., Ltd., Aston, Birmingham.

CV3-5

Please mention "A.W." when Corresponding with Advertisers

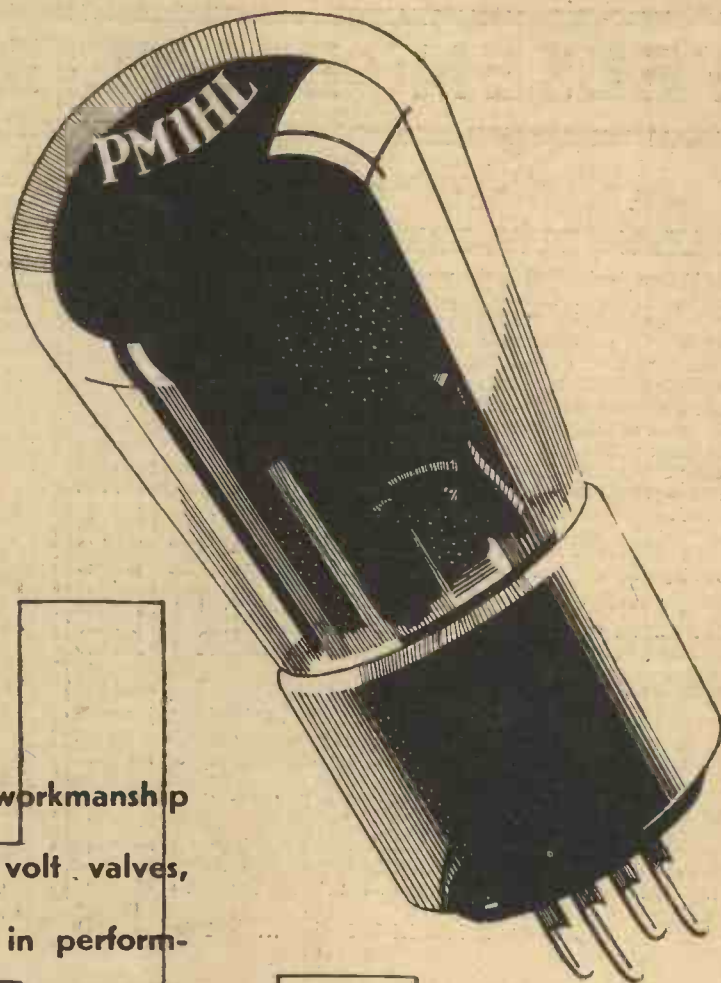

Mullard research, and Mullard workmanship have produced a range of 2 volt valves, flawless in construction, supreme in performance. The P.M.1 HL is a general purpose valve from the 2-volt range. It is primarily designed for use as a high frequency amplifier in sets not employing a screened grid valve, but it will also give excellent results as a detector or low frequency amplifier. Buy one today from your dealer.

Price 8/6

Mullard

THE · MASTER · VALVE

Advt. The Mullard Wireless Service Co. Ltd., Mullard House, Charing Cross Road, London, W.C. 2

Arks

Please mention "A.W." when Corresponding with Advertisers

VIA TATSFIELD—

HOW YOU
WILL HEAR

THE AMERICAN
PROGRAMMES

AT the time of writing, the B.B.C.'s plans for relaying American programmes on an entertainment scale are rather in the melting pot, owing to the general cry for economy in all departments at Savoy Hill.

The B.B.C. Listening Post

Unless the plans are definitely abandoned, the idea is to relay America once a month between 11 and 12 at night as an alternative to the late dance music. As this would mean an extension of broadcasting hours for whichever regional station closes down during dance music, the need for economy

The entire station at Tatsfield is being renovated at the present time. It will be interesting to see whether the extraordinarily good super-het short-waver used for the past six years will be scrapped. Although so old, this particular super-het is very stable and will hold a short-wave station very much more satisfactorily than will many of the later sets.

The B.B.C. has just installed at Tatsfield two elaborate short-wave super-het sets, which we understand were used at Tarling during the ill-fated spaced-aerial experiments.

The most interesting development at

may over-rule present Tatsfield ambitions.

As many readers probably know, Tatsfield is the B.B.C.'s listening post in Kent. In addition to continuous experiments in short-wave reception of American and other distant stations, the engineers at Tatsfield are responsible for checking the wavelengths of all the stations subscribing to the Prague plan, that is, practically all European broadcasters.

Tatsfield is the erection of an extensible aerial-mast arrangement. A special directional aerial supported on two 120-foot masts has also been erected recently. Fitted with suitable reflectors, this aerial will probably be used for the reception of the American short-wave stations, notably 2XAD, 2XAF, and 8XK.

Tatsfield Experiments

Too much importance must not be attached to the suggestion that, when the B.B.C. wants a reliable American relay, it uses the G.P.O. short-wave beam!

The fact is that the commercial beam service is useful only for the long-distance transmission of intelligible speech. It is useless for the handling of music or even really good speech.

For this reason the experiments at Tatsfield are by no means ignored by the B.B.C. In fact, for the relay of entertainment-value programmes radiated by distant short-wave stations, the type of reception at Tatsfield is by far the most satisfactory.

It will be a great pity if the B.B.C. decides to cut out the proposed American relays via Tatsfield, for much good work has been going on during the summer months and there is every reason to expect that this winter's reception of the American short-wavers will be as good as any we have yet heard.

Following the installation of new cables, Denmark, Sweden, and Finland will exchange broadcast programmes at regular intervals; the first of these S.B. transmissions will take place early this month.

OUR LISTENING POST

By JAY COOTE

BY now, no doubt, you will have heard the new Prague giant, for during the last few days this station has been carrying out intensive tests, sometimes in the early morning, sometimes towards 10 p.m., and again in the later hours of the night. On some occasions it has been heard broadcasting gramophone records between 3 and 4 a.m., an excellent time at which to make the necessary experiments. Announcements are put out liberally in Czech, English, French, and German. In the native language the call reads: "Halo! Zde nova vysilani stanice v Liblice Cesky Brod," which informs you that this is the new broadcasting station at Lublice (Lieblitz), near Czesky Brod. It works on the same wavelength as the present Prague transmitter.

Now for the usual dose of "mystery." Do you ever tune in to Leningrad? I know that the station works on an awkward wavelength and that it is badly jammed at times by morse from wireless fog beacons and direction finders, but now and again you may find sufficiently long spells of fair reception to enable you to log its position. Very well, then. Set your condenser roughly midway between that Russian station and Oslo, or just below the position on the dial at which you find the Dutch commercial transmitter at Scheveningen Haven.

On various nights I have picked up on about 1,060 metres another high-power Russian transmitter. It is not Leningrad, for I have passed frequently from one to the other in order to secure confirmation. The only station reported on that wavelength is Tiflis (U.S.S.R.), a 10-kilowatt, and I feel certain

that no station of that medium power situated in the Caucasus could possibly give me that strength of signal. I am under the impression that it is one of the newcomers—say, Kolpino or the new Leningrad—but up to time of writing I have not been lucky enough to secure the call. The best time to hear it is towards 9 p.m. B.S.T.; it does not work late. The Brussels official measuring station in its reports mentions such a Russian transmitter in that portion of the band, but does not reveal its identity.

STATION IDENTIFICATION

AMATEUR WIRELESS has organised a new service of the greatest importance to all listeners. This Station Identification Service is available for identifying stations from information supplied by readers, and will be conducted by J. Godchaux Abrahams in conjunction with "A.W." The fee is 6d. for identifying any one station, but if three identifications are required at a time the fee is only 1s. A stamped addressed envelope must be enclosed.

Address your inquiry to Station Identification Service, "Amateur Wireless," 58-61 Fetter Lane, E.C.4, and give fullest possible details. State type of set used, date and time when station was heard, wavelength, call or interval signal, and details of any programme heard.

Tallinn, which, owing to Turin's presence on its wavelength, has left 296 metres to seek another location, appears to have abandoned its unsuccessful attempts to sit on top of Rome and has been discovered hovering around—but mostly above—Milan. As you know, there is no room for anybody between the Italian and Brussels No. 1, and I expect the Estonian will be found in another spot ere long. By the way, although for the present the Belgian station somewhat swamps the Milan broadcasts, the situation may undergo a drastic change in the near future, as Northern Italy will soon possess a high-power transmitter. It is to be hoped that some alteration in wavelength may be made, for programmes from Milan are too good to lose. Genoa also will soon burst forth as a 10-kilowatt; in fact, it is due to come on the air on October 28 with a rejuvenated Bolzano. At present, both Cracow and Vitus are badly affected; so here, again, some readjustment is needed.

A contract for the purchase of a 100-kilowatt "super" has now been signed by the Ravag authorities, and Viennese listeners are patting themselves on the back at the idea of competing with Prague and others. Economic conditions, however, will not permit further expense on a new broadcasting house for the moment, but to be prepared for eventualities the technical director intends to visit England, France, and Germany to see what these countries are doing.

I notice that news and commercial bulletins are alternately broadcast from Rome, Milan, Turin, and their associated relays in various European languages. I have heard English, French, German, and Spanish, and understand that Magyar is being added to this list. On some nights towards 7.30 p.m.—namely, before the evening programme of music—you may hear short talks in one of these tongues, and of which the subject is usually of interest to foreign tourists in Italy.



THE PICK OF THE MONTH'S RECORDS

A GUIDE TO THE BEST OF THE LATEST RELEASES.

The records reviewed below are a careful selection of the best of the recent issues. It will be noted that criticism is chiefly devoted to the treatment of the music and quality of recording rather than the actual composition.

ORCHESTRAL RECORDS

- Blonde or Brunette and Tales of Autumn**, 2s. 6d. H.M.V. B3829
Two Waldteufel Waltzes played by the Marek Weber Orchestra. This composer has done many better things, which may account for the suspicion that the performance lacks a little of its customary sparkle.
- Ballet Music from "Faust,"** 1s. 6d. WIN 5239
Only four movements, unfortunately, for the Pall Mall Players (musicians from Lloyds Bank) give a very pleasing rendering.
- The Barber of Seville Overture**, 4s. PARLO E11148
First-class. Nearly everybody likes most of this cheery opera of Rossini, and new recruits will be enrolled when they hear the Berlin State Opera Orchestra on this record.
- The Bartered Bride (Fantasia)**, 4s. H.M.V. C2241
I am inclined (heretically) to think that the plot is better than the music. But those who hear it at Covent Garden (or via radio) can buy this record with confidence if they disagree with me.
- Liebesleid and Liebesfreud**, 2s. 6d. PARLO R981
These two Kreisler compositions do not suit the style of the excellent Orchestra Mascotte.
- Entrance of the Little Fauns and Bolero**, 4s. COL DX273
I plump for the first. Anyway, Jack Payne's Orchestra shows very conclusively that jazz isn't their only trump. A splendid performance which deserves support.
- Voices of Spring**, 4s. COL DX266
You have one of Strauss's best, played by the British Symphony Orchestra conducted by Weingartner. So, of course, with faultless recording, the whole piece is simply delightful.
- Carmen Selection**, 2s. 6d. STERNO 8013
A "Städtischen" 12-inch record. Excellent value for money.
- Liebestraume and Albumblatt**, 4s. H.M.V. C1480
De Groot and Orchestra again. The first piece and the leader's popularity will certainly sell this record.
- Count of Luxemburg and Merry Widow**, 4s. H.M.V. C1392
Played by the International Concert Orchestra. I would have liked this record better if the rendering had been less massive. But that is only a matter of personal taste; the performance is really good and more than justifies the purchase.

BAND RECORDS

- Three Meet and The Butterfly**, 2s. 6d. COL DB569
The National Military Band gives two excellent folk dances. Quite a welcome change.
- King Cotton and National Emblem**, 1s. 6d. BRDCST 3066
The Band of H.M. Welsh Guards give a good performance of these well-known marches. The second is the better.
- Funeral March of a Marionette and Rustle of Spring**, 4s. COL DX269
The B.B.C. Military Band are at their best, especially in the first. It is well known, but I recommend it as a fine example of a composition which tells its story. The "Frühlingsrauchen" is really a piano piece (of ancient portfolio fame!) and does not suit a military band so well.

DANCE RECORDS

- If You Can't Sing, Whistle and If You Haven't Got Love**, 1s. 6d. PANACHORD 25057
For the excellent performance of the first (by the Carolina Club Orchestra) I cordially recommend this record.
- Come and Have a Cuddle on the Common and Good Friends**, 1s. 6d. ZONO 5920
Ancient titles, but the splendid performance by the Orpheus Dance Band makes it well worth while hearing them again.
- The Birthday of a Kiss and Dancing with the Daffodils**, 2s. 6d. BRUNS 1172
The first title is actually a real tune! It is so rare to be able to write so of modern dance music that I feel quite elated at the discovery. A very good record.

- Bells of Normandy and 'Tis I, Myself**, 1s. 6d. WIN 5324
Two waltzes effectively played. The second number is the "Londonderry Air," which makes about the 300th version.
- If You're Really and Truly in Love and I'll Always Be True**, 1s. 1d. PIC 810
A good fox-trot, with a good vocal refrain, well played; whilst the second number is not quite so good.
- Mara and O, Cara Mia**, 1s. 6d. WIN 5325
Tangos, straightforwardly played. Quite good value.
- El Entrerriano and Buen Amigo**, 2s. 6d. BRUNS 1164
Straight from their native land, these two tangos; which means much concertina playing in the staccato fashion. Not so good as "Jueves," but impressive.
- Mama, Yo Quiero un Novio and Adios, Juventud**, 1s. 1d. PIC 807
Another pair of indigenous samples (from Saragossa).
- Two Heads in the Moonlight and Wedding of the Garden Insects**, 1s. 6d. DEC F2395
Arthur Lally and the Million-airs put over these novelties very well indeed.
- Springtime Reminds Me of You and Sally**, 2s. 6d. FILMO 263
Quite a good performance of these two "hits." These flexibles are best on an electrical reproducer.
- Faithfully Yours and We're All Good Pals At Last**, 2s. 6d. FILMO 259
By Arthur Lally and his Orchestra. Well played. The first has a tune; the second an asinine vocal refrain.

INSTRUMENTAL RECORDS

- Duo for Piano and Violin (Schubert, op. 162), 18s.** H.M.V. DB1465-7
These three records will doubtless acquire fame, for Rachmaninoff and Kreisler are the performers. I commend the finale (allegro vivace) to non-lovers of chamber music—they will be surprised!
- Intermezzo and Nocturne in E Flat**, 1s. 6d. ZONO 5925
Here is value. Bram Martin's 'cello solos are generally good, but these especially so.
- Other Days**, 2s. 6d. H.M.V. B3899
Cinema organ performance without "effects." I think this record will be popular: it is "different."
- La Capricieuse (Elgar) and Waltz in C Sharp Minor (Chopin)**, 6s. COL LX137
Violin solos by Huberman. An outstanding example of delicate and brilliant playing. The first piece will, I am sure, delight everyone.
- Standchen (Heykens) and Dernière Serenata**, 1s. 1d. PIC 803
By the Rowley Quartet. A very pleasing performance. One could not wish for better value for money.

VOCAL RECORDS

- Your Heart is Fairer than the Stars and To-day I am still in Heaven**, 2s. 6d. PARLO R926
Sung in Italian (from "Fra Diavolo") by Tino Pattiera. Little-known airs, but this record is impressive. Try it against an old Caruso; you will see why.
- Figlia! Mio Padre and Gia da Trehune, "Rigoletto,"** 4s. H.M.V. C1486
The many lovers of Verdi's opera may safely buy this record for the moving performance of the scene between Rigoletto and Gilda in Act I.
- Eileen Oge and Terence's Farewell**, 1s. 6d. WIN 5318
Denis O'Neil sings these in first-rate style. A good recording, too.
- Elizabeth and I Surrender, Dear**, 1s. 6d. DEC F2397
There is no doubt that Carl Brisson can sing. But surely these numbers are rather ancient by now.
- Without a Song and Life is a Dream**, 4s. H.M.V. DA1206
Lawrence Tibbet, the famous film-opera star shines again. But this couple are not so good as the ones reviewed last month.
- Free and Young and I'm in Love; so Deep in Love**, 4s. PARLO-ODEON R020150
No. 1, Tauber and Gitta Alpar; No. 2, Gitta Alpar. A most delightful record sung in German.

"RECORDER"



That 20,000 Cut

ALAN HUNTER outlines the effect upon B.B.C. plans likely to be brought about by the recent sacrifice of ten per cent. of the B.B.C. share of licence revenue.

WHEN the B.B.C. recently announced its willingness to share in the financial sacrifices of the country and the Chancellor of the Exchequer accepted with thanks the B.B.C.'s contribution of £50,000 for the present year and £150,000 for next year, most listeners must have wondered which part of the broadcasting service would suffer.

The financial cut in B.B.C. revenue was not made without a struggle. Opinion may have been divided on the general policy of the cut, which was quite voluntary and not a sequel to the May Report recommendations. But all are agreed at Savoy Hill that the public service must not suffer.

The question of the moment, and it is one that is still being discussed, is how the cut can be made effective without harming the present service. Apparently, the staff are to bear the brunt of the economies. Whether this will be through reduction in numbers or reduction in pay has not been disclosed.

Taking the activities of the B.B.C. as a whole, we can see several possible ways and means of economising, and without particular detriment to the ordinary listener.

For a start we can rule out any extension in the service so far as broadcasting time is concerned. The present two shifts of engineers will certainly not be augmented to meet the demands for early morning broadcasting, nor will any general addition to broadcasting time be possible.

It can be said quite definitely that the Regional Scheme will go forward according

to plan. Falkirk and Watchet will rise as regional centres of broadcasting for Scotland and Wales as promised. This is because such extensions are considered to be in the public service, and that is the one thing not to be deteriorated by the financial stringency.

Naturally, the B.B.C. Orchestra will be an open target for the economy sharpshooters! Already there is a considerable body of opinion among ordinary listeners against the expense of this orchestra. It is maintained by many that the B.B.C. has no real excuse for spending lavishly on the formation of an orchestra of 117 players; that the value of such an orchestra on the average set is as often as not a negative quantity, because the average set is unable to reproduce the terrific volume of sound created in Queen's Hall when this mammoth orchestra is playing and only incidentally broadcasting.

Whatever the *pros* and *cons* of this argument may be, the fact remains that the B.B.C. is under contract with its orchestral players for a year, so nothing by way of pruning could be done for at least nine months from now.

As befits the pick of the country's players, the members of the orchestra are very well paid. If the B.B.C. subsequently tried to reduce the wages scale, it might come up against the Musicians' Union. A more practicable scheme, and one that is almost certain to be acted upon, is a reduction in the number of players. While this would not suit the book of the *elite* patronis-

ing Queen's Hall, it would certainly not worry the average listener, who would, in fact, be only too glad to relieve his power valve of the necessity of being overloaded!

Another possible source of economy that immediately suggests itself is Broadcasting House. As a matter of fact, apart from sundry furnishings, and certain elaborate decorations, the new headquarters of the B.B.C. does not offer much scope for economy. What can be done to cut down expense will be done, but the total saving will not be considerable.

We come back to the B.B.C. staff, who, as already stated, are at present the only immediate hope of the economy sleuths at Savoy Hill. Contraction in staff would seem inevitable unless a wholesale cut in salaries is to be made.

There is a silver lining to the present economy cloud hanging over Savoy Hill. Broadcasting is not stagnant; every month there is an increase in the number of licences; so every month the B.B.C. can anticipate further revenue. On the present percentage allowance, an increase in licences of half a million would mean an additional £100,000 B.B.C. revenue.

Add this to the ever-growing revenue from B.B.C. publications and you have a sum not much less than the cut for next year. No doubt this potential increase in revenue was fully explored before the offer to the Treasury was made. At all events, the resources of the B.B.C. should not be much less in a year's time than they have been for the past year.

BUYING A LOUD-SPEAKER

IT is always safer before purchasing a loud-speaker to have the instrument tested on the actual set with which it is to be used. The quality of reproduction is, in all cases, determined as much by the set as by the speaker, and it is desirable if the best results are to be obtained to see that both are well matched. A loud-speaker which may perform excellently in the retailer's shop may not do at all well when coupled up to the set at home. Certain receiving sets, for instance, are deliberately designed to favour a certain range of frequencies. In other words, the valve circuits introduce a type of distortion which may be corrected by using one type of loud-speaker, though it will be accentuated on another.

M. B.

DO YOU KNOW—

THAT a worn gramophone needle gives a "boomy" bass because it cuts off the high notes? Long pick-up leads also have the same effect.

THAT in an R.C. stage good values for the coupling resistance, condenser and grid-leak are 100,000-ohms, .01 microfarad and 2-megohms respectively? These values, however, depend on the valves used in the R.C. stage and the subsequent stage and vary according to the valve characteristics.

THAT you must treat spaghetti resistances carefully when wiring these in a set? Some early types were not made with very secure connections and as the terminals are tightened down there is a possibility of the wire ends being broken.

FRENCH BROADCASTING

The General Ferrié commission which has been dealing with a plan for the reorganisation of the French broadcasting system has decided that two 100-kilowatt transmitters will be required for the Paris district if an adequate service is to be established. The scheme calls for the inclusion of the Eiffel Tower in this net, and the construction of a new PTT station. Moreover, six further transmitters with a power varying between 60 and 80 kilowatts are planned for Lille, Rennes, Bordeaux, Toulouse, Lyons, and Limoges as well as a 20 kilowatt for Grenoble. It may also be found necessary to establish a small chain of weaker stations to link up outlying districts.

THE HOW AND WHY OF TUNING-IV

HOW AN OSCILLATORY CIRCUIT WORKS

Another of a short series of articles on tuning, specially written for newcomers to Wireless. Here the first ideas about tuning are presented. In the articles that follow, "Hotspot" will deal with all the difficulties about tuning that the beginner is likely to meet

TO understand the action of a tuning circuit we can study an analogous mechanical action. Look at the mechanical oscillator shown by Fig. 1. Here we see a horizontally fixed spring, with a small weight attached to the free end, as at A. If we pull the spring to the left and then release it, from position B it will return to position A and will then continue to position C on the right.

Why does this happen? Because in

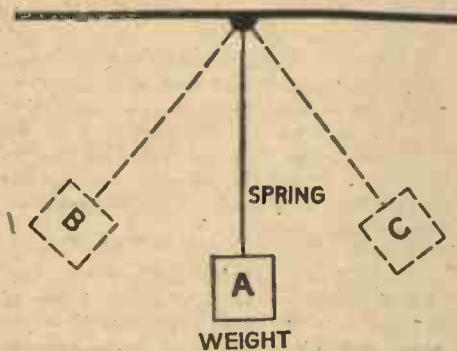

Fig. 1. The weight-loaded spring is a good mechanical analogy of a tuning circuit

bending the spring to the left we stored up potential energy. On releasing the spring, its potential energy set it in motion, thereby gathering kinetic energy. This form of energy—that is, energy of motion—then expended itself in taking the spring to position C, where the spring had the potential energy of the B position. The only reason the mechanical vibration ceases is that the friction caused by the spring moving gradually uses up the energy originally conferred upon the spring by the exertion of the first pull to the left.

Mechanical Action

This simple mechanical action has helped many thousands of students to visualise tuning. It has the merit of being an exact analogy. There are two things determining the rate of the mechanical vibration just illustrated. One is the weight on the end of the spring and the other is the length or flexibility of spring. A given weight will obviously oscillate more rapidly with a short spring than with a long spring. Similarly, a heavy weight will slow down the oscillations more quickly than a light weight.

If we consider the mechanical action of Fig. 1 equivalent to an oscillatory circuit, we must think of the weight as the inductance and the spring as the capacity. The change from potential to kinetic energy in the mechanical sequence can then be compared with the changed state of the electrical energy, when the energy as represented by a flow of current is turned into electric and magnetic fields, consisting of lines of

force built up round the coil and the condenser, as explained in previous articles in this series.

Step by step, we must now see how the changes in the mechanical action of Fig. 1 are effected electrically by the simple tuning circuit of Fig. 2.

The incoming signal may be compared for a moment to the initial energy imparted to the spring by pulling it to the left. If we start at the point where the condenser of Fig. 2 is charged, we have the electrical equivalent of the B position of the weight in Fig. 1.

The charge on the condenser will cause a current to flow through the coil, so that the energy stored around the condenser plates as an electric field will be changed into a magnetic field around the coil; just as the potential energy of the spring in its B position was changed to kinetic energy by releasing the weight.

We saw that the weight over-shot the mark when released and stored up potential energy in the opposite direction, that is, at the C position of Fig. 1. In a similar way, the discharge of the condenser through the coil causes the opposite plate to become charged. Then, just as the spring, after its initial pull to the left, vibrated for some time, so the current through the coil continues to flow backwards and forwards in turn charge and discharge.

We saw that friction eventually stopped the vibration of the spring. So resistance, which is electrical resistance to the flow of electrons, eventually stops the electrical oscillation in the Fig. 2 circuit.

So far we have considered only one application of energy; only one pull of the spring; and only one charge applied to the condenser. But now suppose we imagine the Fig. 1 arrangements to consist of a weight suspended vertically by a string; an initial tap will set the pendulum swinging, and if we correctly time our subsequent taps the pendulum will go on swinging with very little expenditure of effort on our part. In other words, if the frequency of our taps is correct, the force behind the taps can be almost negligible.

Oscillating Currents

Similarly, consider an oscillating voltage applied to the Fig. 2 tuning circuit; if the

circuit constants are correctly arranged, a very small input energy will be sufficient to keep the circuit oscillating. This condition will be obtained when the natural frequency of the tuning circuit is the same as the frequency of the incoming signal. From the formula $f = \frac{1}{2\pi\sqrt{LC}}$, where L is inductance in henries and C is capacity in farads, we see that the natural frequency of the oscillatory circuit, such as Fig. 2, varies inversely with the square root of the product of the capacity and inductance. This LC value is called the oscillation constant.

Wavelength and Frequency

Knowing that wavelength equals velocity divided by frequency, we can readily find the connection between the oscillation constant and its wavelength. This is expressed in the well-known formula wavelength = $1885\sqrt{LC}$, where L and C are in the units most practicable for radio circuits, namely, microhenries and microfarads respectively.

As it is not my intention to deal only with the theoretical side of tuning, the next article will start on the practical difficulties of tuning, with special reference to modern selectivity problems.

HOTSPOT.

"GAIN" REGULATION

WHEN extra strong signals are being received, the detector valve is liable to be overloaded and produce distortion. The obvious remedy is, of course, to cut down the input by means of a volume control. It is, however, possible to do this automatically by using an auxiliary gain-control valve. In this arrangement, a part of the



Fig. 2. An electrical counterpart of Fig. 1

total output current is diverted through the control valve and utilized to apply an automatic grid bias in one of the high-frequency amplifying valves. When signal strength becomes excessive, the current through the control valve rises, and increases the potential drop across a series resistance, which, in turn, applies a larger negative bias on the H.F. valve, so as to reduce its sensitivity. When the output drops, the negative bias is reduced so that the H.F. valve increases in sensitivity, and maintains the output at constant strength.

B. A. R.

**NEXT WEEK:
MORE ABOUT THE
"BIG-VOLUME 2"**



OUR BROADCAST CRITIC

TALKS ABOUT—

HUMOUR

IT has been said more than once that humour is always a safe card to play. I am beginning to think that someone must have lost all the court cards in the pack, for the humour of the vaudevilles recently has left me cold.

I listened to one on the Regional the other night with rather mixed feelings. Gillie Potter seemed to be the one bright spark in it.

Gillie Potter, to my way of thinking, is about the most successful comedian on the wireless. There are others, of course; Tommy Handley and Clapham and Dwyer cannot be passed over. All the same, I think the type of broadcast that Gillie Potter gives is essentially suitable for microphone work.

The whole question of humour on the wireless is that of *amusing dialogue*, not of *dialogue plus action*. Gillie Potter appeals to me as having written down his text and as delivering it carefully so that I shall not miss a word.

Until the comedians realise that they must not depend upon anything except the actual intrinsic quality of their matter we shall have to submit to humour that misss on at least one cylinder.

The Omnibus Romance was a case in point. It might possibly have been faintly amusing could we have seen the omnibus and the people in it.

As it was, we had to imagine the scene for ourselves, and though by reason of practice we are getting quite good at that sort of thing, we found ourselves wondering when the fun was going to begin.

Honestly, and without the least idea of disparaging anything, there was not a line in that sketch that was really funny. Nothing can ever compensate for poor lines.

Then there was the miniature play called *The Captain*. Here, again, we were treated to an attempt, not at being funny, but at being dramatic. The grandfather made much ado about nothing, and seemingly lost his life over it; he died talking about a cricket match he once played in.

Something ought to be done at Savoy Hill about these plays. I do not know who judges them, but all I can say is that the standard is surprisingly low.

Half those I have heard recently have been boring in the extreme. The B.B.C. should remember that people in these days are not easily amused. Humour in 1931 has to be of a very high standard indeed if it is to get home.

The Legend of Silence was another of these small plays that appealed to me as being badly written. In this case, the scene was supposed to be Bagdad a thousand years ago.

Beyond some amount of Arabian Nights type of speech, nothing reminded me even faintly of such a period, nor had the music anything in it that was even remotely Eastern.

On the other hand, I thought the Russian Quartet excellent. I heard the bass descend to a low D-flat frequency of about 67!

I suppose some of the technicians will try to persuade me that I could not actually hear a note of that depth. I shall adhere to my opinion. *The note was sung and I heard it.*

I want something done about the position of the pianos at Queen's Hall. They are broadcasting much too heavily.

Granted that we have had several pianists recently who have developed what I call *crashbangococcus*, I am beginning to have a little more sympathy for them than I have had until recently.

I have made a practice of going to Queen's Hall for some of the Proms, and listening at home to others. My first suspicions were aroused after hearing Arthur Catterall on two successive nights.

I have heard him play so often that I can carry the tone of his violin in my memory quite easily. Having heard him one night at Queen's Hall, and the very next at home,

I felt that the microphone was a little too near him.

However, I let it pass without comment. Then I heard Cyril Scott (piano) loud-speakerwise. The ornaments on my mantelshef actually rattled. I am not exaggerating. When I toned him down I lost the harmonies in the orchestra.

A few nights later I was in Queen's Hall listening to Katherine Goodson playing the Delius Concerto. She certainly *looked* as though she were hitting, but I could not quarrel with the tone she produced, and as the orchestral accompaniment was far too heavily scored for a *concerto* I thought she did exceedingly well.

When I said so at home the following day, I was assured that her tone sounded hard in the extreme. All of which seems to me to prove that the microphone arrangements at Queen's Hall need the attention of an expert. These pianists are being penalised.

Going back to the question of plays, I was delighted with *To See Ourselves*. I thought its humour very delicate and refined, and the story certainly held me. May we have more of the kind!

There have been some good singers this week. Roy Henderson, Dora Labbette, Dorothy Silk, Arthur Cranmer, Maggie Teyte, and Muriel Brunskill were amongst them.

Stuart Robertson, in the Bach Prom., was superb; I enjoyed every note of his rendering of "Slumber Now, Ye Weary Eyelids" which I heard in the hall itself.

The Gershom Parkington Quintet seem very successful in whiling away the hour now and again. I think if Mr. Gershom Parkington realises that his music is a good go-between the actual "highbrow stuff" and "lowbrow stuff," he will be more and more successful.

There is something to be said for his work; it is doing a little towards educating those who are really ready and willing to be educated. I have the greatest respect for what he does for that very reason.

Several people have told me recently that they are annoyed at the fact that plays are repeated in the programmes—one night in the National and the next in the Regional.

There are two sides to that. If you chance to hear that a play is considered good, but have missed it, you may be glad to have a second chance.

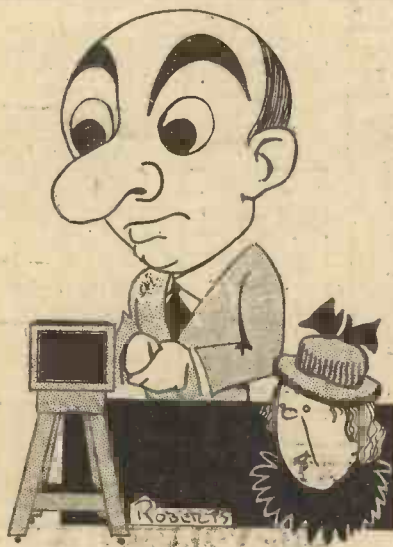

An impression of Fred Spencer

WHITAKER-WILSON

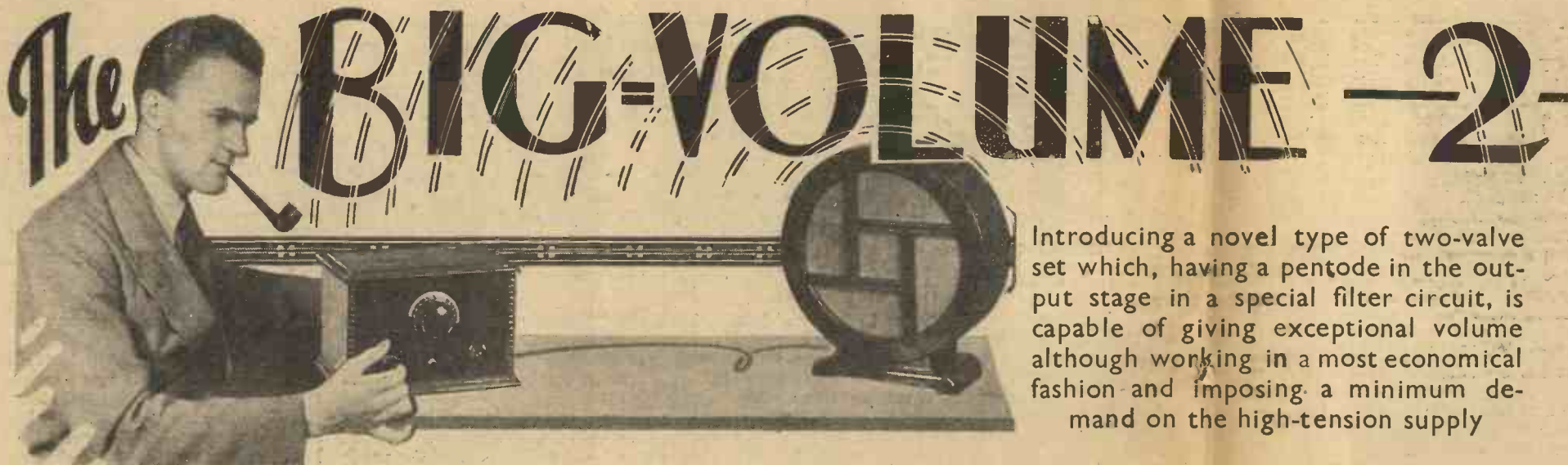

Introducing a novel type of two-valve set which, having a pentode in the output stage in a special filter circuit, is capable of giving exceptional volume although working in a most economical fashion and imposing a minimum demand on the high-tension supply

NOW that the new valves and components have been introduced at Olympia, it is time we revised our old ideas as to the limitations of various types of set. We have, in view of the new parts, very likely a too conservative estimate of what popular "twos," "threes," and "fours" can do.

It has previously been taken for granted that a two-valver will give satisfactory loud-speaker reception of two or three local stations, provided that the aerial used is good. A one-valver will give somewhat the same style of reception (on 'phones, of course, and not on the loud-speaker) and, in addition, will bring in a dozen or more foreign stations at ordinary 'phone strength.

The popular screen-grid three-valver, with ordinary detector and power output arrangements, is generally supposed to get twenty or thirty stations, but new sets of this kind, such as the "Olympian Three," are bettering these results by, in some cases, a 100 per cent.

A "Two" with a Big Output

The limit of a two-valver has generally been the output stage. With no H.F. amplification preceding the detector one naturally cannot expect to get big grid swings for the power valve and in cases where, in order to put up the loud-speaker strength, high-ratio intervalve transformers have been used, this has made it difficult to get really good tone. The pentode has always been a solution to this difficulty, but up till now it has not been a very popular solution for several very material reasons.

There has been a suspicion that pentodes are extravagant valves; that they cannot be used with less than 200 volts H.T. and that they take about double the anode current of an ordinary power valve.

With certain types of 6-volt pentode this was true, but in several AMATEUR WIRELESS sets it has been shown how to make economical use of pentodes, working them on only 120 volts and cutting down the H.T. consumption.

Economical Running

New pentodes produced for 1932 give the question quite a different angle. The new pentodes have a power output in the neighbourhood of 250 milliwatts and this is given with an anode consumption of well under 10 milliamperes. This puts the pentode, from the consumption point of view, on equal footing with the new battery-fed power valves.

For the ordinary amateur a valve of this kind is, you see, a much better proposition than a pentode which takes as much as 20 milliamperes high-tension current and gives a 500-milliwatts output. Such an output is far too great for an ordinary room and 200 or 250 milliwatts is much more what we need.

In this new two-valver use is made of one of the new pentodes and the rest of the circuit is virtually "built round" the power stage. This is really necessary, as you will see on examination of the circuit.

Without wishing to make any extravagant claims for performance, it must be stated quite definitely that this present set marks a new step forward in two-valver design. It is nearly as sensitive as an old type of three-valver and has a much greater power output than any ordinary two-valver used with a triode power valve.

The Circuit

The tuning circuit is very selective and it is, therefore, safe to use this set in reception localities where the average plain detector set is hard put to it to separate local stations.

The tuning has not that knife-edge precision given by band-pass circuits with H.F. amplification, but on account of the special coupling coil used it is far above the average.

The detector is very efficient (and if you use one of the new detector valves you will be surprised at the sensitivity) and the output is improved by the use of a 7 to 1

coupling transformer to the pentode.

No distortion results from this high step-up ratio in this particular set, although indiscriminate use of high-ratio detector L.F. step-ups does produce poor tone. The tone of this set is really first-rate.

The circuit may appear to be a trifle more complicated than that of a straight-forward two, but that is only because the coil connections are shown in detail, whereas these are actually part of the coil and do not complicate the construction.

Easy to Build

That the set is quite simple and very compact you can see from the photographs. The coil has a series aerial condenser mounted at the top of it and it is, therefore, unnecessary to buy a pre-set. The three-point wavechange switching arrangement is commendable and the fact that the aerial is not directly connected to the grid coil, but is magnetically coupled to it, makes for sharper tuning.

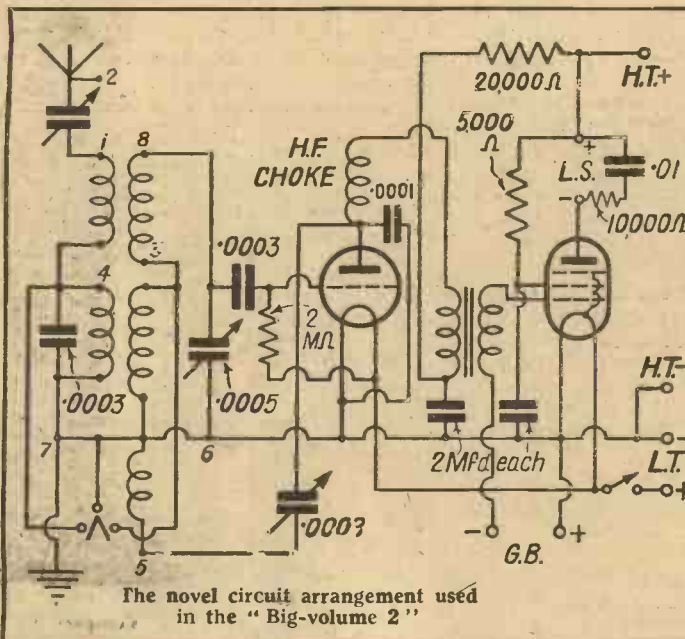

COMPONENTS REQUIRED FOR THE "BIG-VOLUME 2"

Ebonite panel, 9 in. by 6 in. (Bacol, Trelleborg, Peto-Scott).

.0005-mfd. slow-motion variable condenser (Formo, Lotus, J.B., Utility, Telsen, Polar).

.0003-mfd. reaction condenser (Readi-Rad, Graham-Farish, Formo, Lotus, Bulgin, J.B., Utility, Telsen, Polar).

Three-point shorting switch (Telsen, Busco, Bulgin, Readi-Rad, Lissen).

Filament switch, (Bulgin, Wearite, Busco, Telsen, Readi-Rad, Goltone, Lissen).

Baseboard, 9 in. by 8 in. (Camco, Readi-Rad, Peto-Scott).

Dual-range aerial tuning coil, (Telsen, Lotus, Formo, Bulgin, Tunewell, Goltone, Sovereign).

Two five-pin valve holders (W.B., Wearite, Telsen, Graham-Farish, Formo, Lotus, Lissen, Benjamin, Clix, Goltone).

Low-frequency transformer (Telsen, Lissen, R.L., Ferranti, Burtoz, Lotus, Varley, British General, Graham-Farish).

Two .0003-mfd. and one .0001-mfd. fixed condensers (Dubilier, type 670, Telsen, Lissen, T.C.C., Formo, Goltone, Graham-Farish).

.1-mfd. fixed condenser (T.C.C., Dubilier, Graham-Farish, Lissen, Telsen, Formo).

Two 2-mfd. fixed condensers (T.C.C., Telsen, Dubilier, Lissen, Goltone, Formo).

Grid-leak holder (Lissen, Wearite, Bulgin, Readi-Rad, Dubilier).

2-meg. grid leak (Dubilier, Telsen, Goltone, Lissen, Sovereign, Graham-Farish).

High-frequency choke (Lewcos, Graham-Farish, Lissen, Telsen, Dubilier, Watmel, Varley, Peto-Scott).

Three spaghetti resistances—one 5,000, one 10,000, and one 20,000-ohm (Graham-Farish, Lewcos, Bulgin, Telsen, Varley, Lissen, Readi-Rad, Goltone, Sovereign, Tunewell).

Two terminal blocks (Belling-Lee, Sovereign, Junit, Lissen).

Four terminals marked Aerial, Earth, L.S.+, L.S.— (Belling-Lee, Clix, Eelex, Burton).

Four wander plugs marked: H.T.—, H.T.+ , G.B.—, G.B.+ (Belling-Lee, Clix, Eelex).

Two spade terminals marked: L.T.+ , L.T.— (Belling-Lee, Clix, Eelex).

Two yards of thin flex (Lewcoflex).

Connecting wire (Glazite).

Cabinet, 9 in. by 6 in., with 6-inch baseboard (Camco, Peto-Scott, Readi-Rad).

ACCESSORIES

120-volt high-tension battery (Ever-Ready, Pertrix, Drydex, Palaba, Fuller).

9-volt grid-bias battery (Ever-Ready, Palaba, Fuller, Pertrix, Drydex).

2-volt 30-amp.-hour accumulator (Exide, C.A.V., Pertrix, Fuller, Ever-Ready).

Reinartz type reaction, with a .0003 condenser and the reaction winding between terminals 5 and 6 on the coil is a feature, while on the other side of the anode circuit is an H.F. choke.

The 7-to-1 coupling transformer has a feed circuit of 20,000 ohms and a 2-microfarad decoupling condenser. This prevents motor-boating. A pentode calls for several resistances and condensers in its screening grid and output circuits. Flexible resistances are used in the set and, therefore, the cost is kept down to a minimum.

The output of the pentode is shunted by a 10,000-ohm resistance and .01 condenser. This circuit cuts off some of the excessive high notes and prevents the reproduction from being shrill.

One-knob Control

There is nothing, you see, very difficult about the connections of the set, and although the AMATEUR WIRELESS Technical Staff has spent a deal of time trying out various resistance and condenser values and component layouts in order to get the finished set as compact as possible, there is nothing at all complicated about the final product.

Although this is a set which will appeal to knowledgeable amateurs, it is fine for use by members of the family who are concerned only by the number of knobs there are to twiddle on the panel.

This is virtually a one-knob set, the reaction condenser being, in most localities, nothing more or less than a volume control, and, unless a very poor aerial is used, critical reaction is not necessary.

Cheapness is a feature which has been achieved by the use of the fewest possible parts. All the components needed are given in the accompanying panel, and many of these are small parts, such as fixed condensers and resistances which you may already have on hand.

Low Cost

The total cost is low. Alternatives are given, these having as near as possible the same electrical values as the first-mentioned parts, which of course, are those used in the set shown by the photographs. The use of alternatives in place of the first specified parts may necessitate slight alteration of the mounting centres, but this will not be serious.

Do not upset the layout of a set by parts of your own choosing, for this may result in detector instability or low-frequency oscillation.

Detailed constructional hints will be given in

next week's issue, but quite a large part of the constructional work can be carried out right away if you have all the parts and a copy of the full-size blueprint, which can be obtained, price 1s., post free, from the Blueprint Department, AMATEUR WIRELESS, 58-61 Fetter Lane, London, E.C.4. The use of the full-size print makes child's play of the job of assembly, but the small scale layout given here is a help in placing the parts.

The set can be seen this week in the radio department windows of Messrs. Selfridge

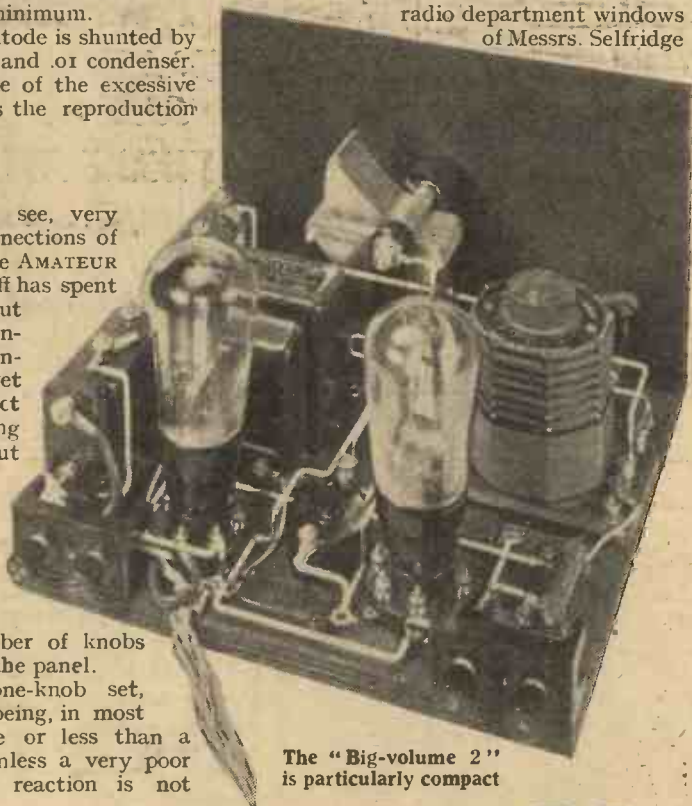

The "Big-volume 2" is particularly compact

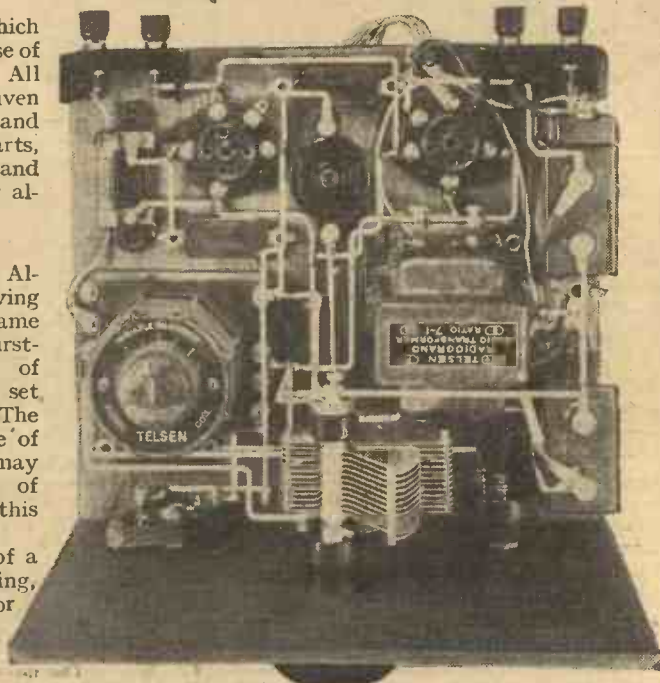

Compare this plan view with the layout diagram overleaf

THE "BIG-VOLUME 2" (Continued from preceding page)

and Co., Ltd., Oxford Street, London, W.1, and London readers should avail themselves of this opportunity to see what is undoubtedly one of the most interesting two-valvers ever produced.

The feature which will most probably

impress you on first examining the set is its compactness. The parts are neatly arranged and without undue crowding on the 9 in. by 8 in. baseboard. Front of panel appearance is pleasing, too and the simple control is obvious.

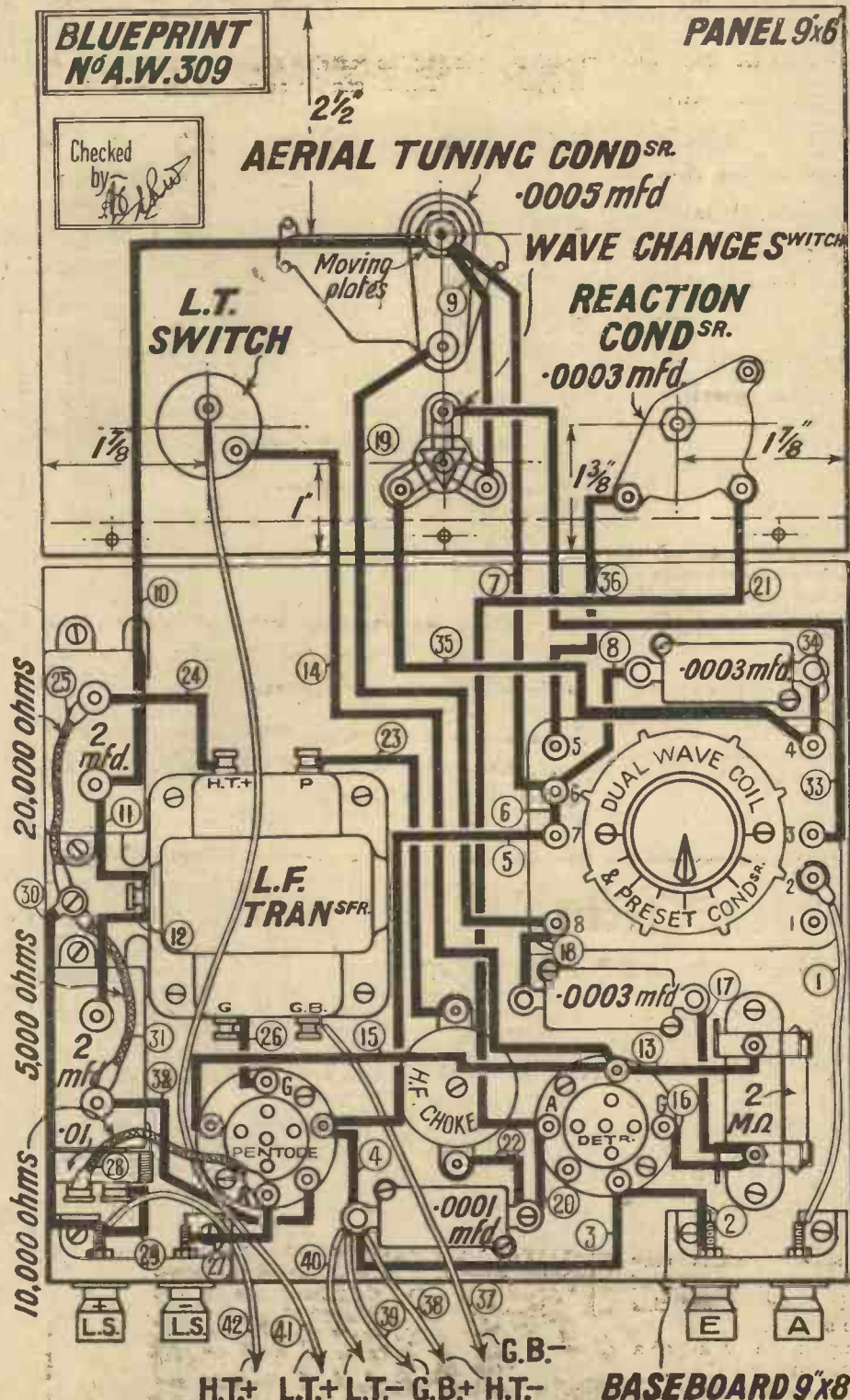

The layout and wiring diagram of the "Big-volume 2." A full-size blueprint can be supplied, price 1/-

THE "DANSE MACABRE"

The Story of Saint-Saens' Orchestral Fantasy

THE story of the *Dance of Death* is, of course, an old one. I spent some time in the British Museum, recently, examining Holbein's pictorial record of it.

Hans Holbein was born about 1457 and died in 1543. He was principal painter to Henry VIII. Holbein depicted several scenes of the medieval legend of dancing skeletons who apparently amused themselves by making sudden (and, I imagine, inconvenient) appearances to artists, physicians—even to kings and emperors—whom they lured to lonely churchyards to be a kind of audience to their ghastly death dances.

Saint-Saens was evidently taken with the legend, but his orchestral fantasy *Danse Macabre* has stretched a point where he allows Death to accompany his own dance by playing on a violin.

Evidently his opinion of Death's powers as a violinist were not high, because he directs the solo violinist to tune his top string to E flat instead of to E natural, but the effect of the A natural and the E flat (as a supposed perfect fifth) is very sinister.

Saint-Saens has a little programme for his fantasy. It is something as follows: Midnight strikes. This is effected by means of a single note plucked twelve times by a solo harp to the accompaniment of the same note held by a solo horn. At the fourth bar the strings enter very softly, which certainly adds an effect of mystery.

The composer uses waltz rhythm for the dance, and it is not difficult to picture the figure of Death gyrating round the tombstones. Then a breeze springs up and more skeletons appear, the atmosphere being now that of a ghostly revel.

The *Dies Irae*—a melody of an ecclesiastical nature well known in France—is heard, but it is slightly parodied. This seems to excite Death and his skeleton friends, for they begin to jump the tombs in their fervour.

Just as the dance is at its height a cock crows. This is cleverly effected by a solo oboe. It is dawn and, of course, no self-respecting skeleton is even seen in a churchyard after cockcrow. The work finishes with a scutter as the dancers make for their homes underground.

If you will imagine this scene the next time you hear Saint-Saens' *Danse Macabre* you can hardly fail to appreciate the cleverness of it. It is perhaps one of the best known of his works. W.W.

The Unity Quartet, whose members are all well-known Midland players, will give a concert of chamber music from the Society of Artists' Gallery on October 6.

A debate of more than usual topical interest will be relayed from the Athenaeum Club, Manchester, on October 7. Sir Francis Joseph and Mr. F. J. Marquis, who is well known as the head of a great Northern store, will debate the question, "That no business man should take part in local or national government."

MORE ABOUT THIS BIG-VOLUME SET NEXT WEEK

READY RADIO TESTED KITS

Every Ready Radio Kit is composed of chosen components which have been tested and passed for despatch under the supervision of Mr. G. P. Kendall. By building your receiver with a Ready Radio Tested Kit you are consequently assured of the finest possible results obtainable from the circuit of your choice.

OVERSEAS—Everything Radio can be supplied against cash. In case of doubt regarding the value of your order, a deposit of one-third of the approximate value will be accepted and the balance collected by our Agent upon the delivery of the goods. All goods are very carefully packed for export and insured. All charges forward.

TO INLAND CUSTOMERS—Your goods are despatched Post Free or Carriage Paid.

THE "OLYMPIAN THREE"

KIT "A" (Less Valves and Cabinet.) **£6 : 4 : 9**
or 12 equal monthly instalments of **11/6**

KIT "B" (With Valves, less Cabinet.) **£8 : 3 : 9**
or 12 equal monthly instalments of **15/3**

KIT "C" (With Valves and Cabinet.) **£10 : 8 : 9**
or 12 equal monthly instalments of **19/3**

RECOMMENDED ACCESSORIES

	£	s.	d.
1 Fuller 120-volt Super Capacity H.T. Battery	15 3
1 Fuller 9-volt G.B. Battery	1 0
1 Fuller 2-volt 30-amp. L.T. Accumulator	10 3
1 Blue Spot L/S Unit, 66K	1 5 0

We can also supply kits of parts for the "A.W." 4-valve Radio Gramophone. Send for price lists.

If you do not need the complete kit you can buy any of the parts you require separately.



*
Mr. G. P. Kendall, B.Sc., has joined the staff of Ready Radio as Chief Engineer. He was for many years the well-known Chief of Research for "Popular Wireless" and "Modern Wireless" and is the designer of many famous sets.

ORDER FORM

CASH ORDER Please despatch to me at once the goods specified for which I enclose payment in full of £

C.O.D. ORDER Please despatch to me at once goods specified for which I will pay the sum of £

EASY PAYMENT ORDER Please despatch my Easy Payment order for the goods specified for which I enclose first deposit of £

Name.....

Address.....

Kit required.....



READY RADIO LTD., Eastnor House, Blackheath. Phone: Lee Green 5678. Showroom: 159 Borough High St. Hop. 3000

Mention of "Amateur Wireless" to Advertisers will Ensure Prompt Attention



IN MY WIRELESS DEN

Weekly Hints —
CONSTRUCTIONAL & THEORETICAL
BY
W. JAMES

Tracing Motorboating

MOTORBOATING and poor quality are sometimes experienced when a resistance-fed transformer is used. In this circuit arrangement, of course, a resistance is joined between the high-tension and the anode of the valve and there is a condenser between the anode and the primary winding of the transformer.

As a rule the size of the condenser is such that good amplification of the low notes is obtained. The result is that motorboating is likely to occur. This may be avoided, at the expense of an amount of low-note amplification, by reducing the value of the coupling condenser.

As the value of the condenser is reduced, so the amplification of the lower notes falls off.

In many instances the set is made to deal with lower notes than the loud-speaker can reproduce and so nothing is gained. The capacity of the condenser should be reduced until the point is reached where any further reduction affects the quality.

Proper motorboating stopping circuits may often be fitted, but there is no sense in having a larger coupling condenser than necessary.

Stopping H.F. "Strays"

I have noticed that the recommendation is made to add choking coils in the main leads to a mains set or unit for the purpose of stopping high-frequency currents entering the apparatus.

Special high frequency chokes are, in fact, made for this purpose. There is a point of importance, however, to which attention is rarely drawn and that is to the fall in voltage which takes place across the chokes.

If the two chokes, one in each wire, have a resistance of 200 ohms apiece, and the current is 50 milliamperes, the fall in voltage is 20. Therefore, the output from the set or unit will be reduced.

It might be possible to compensate for this by altering the connections of the mains at the input to the set or unit, but if this cannot be managed, then one must either put up with the lowered output or fit chokes of lower resistance.

The current may easily exceed the value of 50 milliamperes quoted. Thus if the unit supplies heater current as well as high-tension, the current may be 200 milliamperes from the mains. A current of this value would burn out most types of high-frequency choke and the voltage lost would be far too great.

Using a Mains Unit

A mistake that is often made in using a mains unit is to connect an anode-bend detector to a tapping having an adjustable resistance instead of a potentiometer.

There have been several instances in connection with the "Century Super." In this set the first detector is of the anode-bend type. Therefore its anode current varies during reception.

When setting this stage the current must be adjusted to .1 or .2 milliampere with the oscillator tuning condenser short circuited. When the short circuit is removed, the anode current of the first detector will increase.

If it does not increase the oscillator may be faulty, but it is possible that the resistance of the potentiometer in the mains unit may be of too high a resistance. Good results will not be obtained unless the current passed by the potentiometer is several times greater than the normal working current of the detector.

A current of 4 milliamperes would be about right for the potentiometer. I feel that this is a point overlooked by many users of mains units, and better results would be obtained by paying attention to this.

Moving-coil Speakers

Moving-coil speakers having permanent magnets are now obtainable at very low prices. Some types have a transformer fitted.

I have used an inexpensive type for some months and find the results to be quite satisfactory considering the price. They are not quite as sensitive as good electromagnetic types, but many amateurs will find the quality and volume good enough considering the low prices.



SAFETY FIRST

In your mains unit there is nothing like having shielded terminals for the power transformer and short insulated leads linking up with a fuse holder in each mains wire. Attention to these little details makes mains working as safe as battery working.

A Question of H.T.

There are signs that the average receiver will have more valves than formerly or will be fitted with valves passing a heavier anode current. It is, therefore, important that attention be paid to the anode-current supply. When this is a dry battery all that we can do is to use the best size for the set.

High-tension accumulators have their advantages when the current is rather greater than can be obtained with economy from dry batteries, but only when they can be kept in good condition by regular attention. If a battery or accumulator can be obtained under a service scheme by which it is regularly charged, the battery may be expected to be a satisfactory supply.

Failing a good maintenance service, you should think twice before investing in accumulators. If you have mains, the most satisfactory supply is, of course, a mains unit.

These are cheaper than ever this season. A good one should be purchased, instead of one only just able to do the work. Sooner or later you will want a bigger set and the mains unit will be able to supply it if it has a good output.

Metal Panel Matters

The metal panel is not much used at present. At one time it was thought that there was a saving and a simplification in fitting parts to metal instead of ebonite or wood, as various earthing wires were avoided and the panel itself earthed.

In practice, however, there are usually difficulties, some parts having to be insulated. Many parts do not fit properly unless spacers or bushes are used and so the metal panel has gradually fallen into disuse.

When this type of panel is used great care must be taken that the circuit is so arranged that the parts mounted upon it may be earthed, or suitable insulating bushes must be fitted. In some circuits the high-tension would be short-circuited were a particular part to be fastened directly to the panel, and so care is necessary.

Reaction circuits, in particular, should be watched. In some the reaction coil is earthed and so the reaction condenser must be insulated from the panel. Certain makes of switches, too, have the spindle connected to one of the contacts and this type is rendered non-effective if fastened to the metal panel.

KENDALL WROTE THIS BOOK FOR YOU



10 HOWS for Modern Radio Constructors

By G. P. KENDALL, B.Sc.

A new wonderfully useful book which should be read by every constructor. Full of useful information and copiously illustrated

DO YOU KNOW

- How a Radio Receiver Works.
- How to Use a Blueprint.
- How to Get Real Quality.
- How to Increase your Selectivity.
- How to Convert your Set for Mains Working.
- How to Add a Gramophone Pick-up.

Over 15,000 copies were sold at the Radio Exhibition. Get your copy at once and save disappointment. Price 6d.

Coupon To : Eastnor House, Blackheath, S.E.3

I enclose + 1½d. stamps; please send me a copy of "10 Hows for Modern Radio Constructors" by return.

Name.....

Address.....

THE "CENTURY SUPER"

Those who did not build this wonder set when it was first designed, still have an opportunity to do so, for Ready Radio have decided to continue to assemble Kits for this ever-popular receiver.

KIT A (Less Valves and Cabinet, but including Wound Frame Aerial) **£6:18:6**

or 12 equal monthly instalments of 12/8

KIT B (Including Valves, Wound Frame Aerial, but less Cabinet) **£10:14:6**

or 12 equal monthly instalments of 19/8

KIT C (Including Valves, Cabinet, and Wound Frame Aerial) **£11:9:6**

or 12 equal monthly instalments of 21/-

Completely assembled with valves, Cabinet and wound frame aerial, ready for use and aerial tested. Price **£14:10:0**

or 12 monthly payments of 26/6

READY RADIO FRAME AERIAL

Suitable for use with any Super-Heterodyne or any other receiver for which a frame aerial is specified. Two separate centre-tapped windings, stranded silk-covered wire, accurate spacing. Covers medium and long waves. Strongly made, handsome appearance, easy rotation.

20/- each

With rotary change-over switch

25/- each

Mr. Kendall's wide experience is at the service of every purchaser of a Ready Radio Kit. Should you be in difficulties with your set or fail to obtain the results you anticipate write to Mr. Kendall about it and he will give your enquiry his personal attention. By building your receiver with a Ready Radio Kit you are consequently assured of the best possible results of which the circuit is capable.



We Test For You

A weekly review of new components and tests of apparatus conducted by J. H. Reynier, B.Sc., A.M.I.E.E.

R.I. Unigrad Volume Control

THE new Unigrad volume control just placed on the market by Messrs. Radio Instruments Ltd., Purley Way, Croydon, is small, neat, and totally enclosed in a housing of black moulded bakelite.

The construction is interesting. The resistance element, which is graphitic in nature, is deposited by a special process on

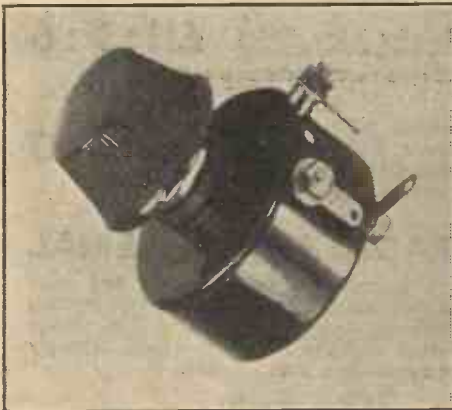

The R.I. Unigrad volume control

a track which is actually a part of the housing itself. The makers claim that the method employed for forming this track renders it impervious to climatic variation, and ensures constant resistance under widely differing conditions.

The moving contact is of a similar substance to the resistance track, and is pressed lightly but firmly into contact with it by means of a spring arm, this arrangement giving a smooth and silky control. Due to the fact that there are no moving metal parts in contact with the resistance track, this should last almost indefinitely, as it is impossible for it to be scored or in any way damaged. The end connections to the track are of brass, and are on a level with the track itself; thus at each end of its movement, the contact arm can rest on these connections, thus ensuring a very small minimum resistance. One hole fixing is employed, a hole $\frac{1}{8}$ in. in diameter being required. The overall dimensions of the body of the control are $1\frac{1}{2}$ in. by $1\frac{1}{2}$ in. by $1\frac{1}{2}$ in.

A complete range of these controls is marketed having values from 1,000 ohms to 5 megohms. The sample tested was rated at 500,000 ohms, the actual measured value being 400,000 ohms. This discrepancy is, however, immaterial for the class of work for which the control is intended. The minimum resistance was approximately 60 ohms. Used with our standard pick-up and amplifier, this component gave a very

smooth control, and was perfectly silent in operation. The Unigrad retails at 5s. 6d. for all values of resistance.

Utility Three-gang Condenser

THE new Utility three-gang condenser which we have tested this week is neatly and compactly made. It is housed in a screening case, the body of which is built up from aluminium sheet; a cover of aluminium is also provided which completely encloses the condenser. Each set of fixed vanes is held in position by means of three bakelite insulating pieces which are themselves screwed to the respective partition screen. The three sets of moving vanes are mounted on a shaft which is extended at both ends for a length sufficient to accommodate a dial. A small trimming condenser consisting of two metal plates with a sheet of mica between, is provided on each condenser, the adjustment being effected by means of a

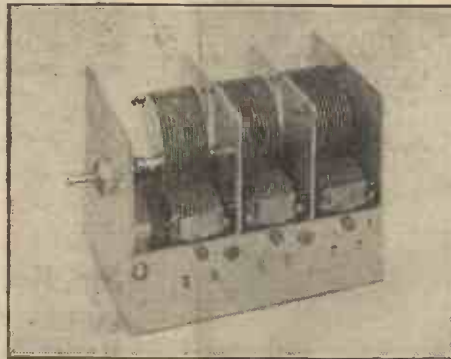

The Utility three-gang condenser with the cover removed

small screw which can be turned with the help of a screwdriver.

With the condenser in the maximum position the sets of vanes are prevented from coming into contact over each other by means of small insulation pieces fastened to the moving vanes. In the minimum position, however, no such precaution seems to have been taken, and the vanes actually do come into contact when the condenser is moved slightly beyond the minimum position. We think this point could be altered with advantage.

On test the condenser showed up well, the capacity of the three units remaining very closely in step over the whole range. A high-frequency resistance test was also conducted on the condenser with the object of determining the equivalent series resistance which would be introduced into a tuned circuit using this condenser. The values obtained were 1.3 ohms at 400 metres and 2.8 ohms at 250 metres. These figures are

quite up to the average and the condenser should give excellent service. The component is marketed by Wilkinson Wright, Ltd., Birmingham, and retails at 27s. 6d.

Ferranti A.C. Meters

GOOD instruments for measuring A.C. are not easy to obtain, and the serious experimenter will welcome the new Ferranti moving-iron instruments which have just been introduced. These are put up in similar form to the well-known Ferranti radio meters with $2\frac{1}{2}$ -in. dial, the only outward difference being a small bulge at the back which is necessitated by a slightly greater depth of movement than with the moving-coil type.

An extensive range of these meters is marketed. In the current-measuring range there are meters from 100 milliamperes to 30 amperes full scale, while voltmeters from 5 to 500 volts full scale may be obtained. There is also a series of two-range voltmeters, one very convenient one being 7.5 and 300 volts.

An A.C. meter never has a uniform scale, the tendency being for the readings to increase as the square of the quantity being measured. This crowds the smaller readings into a very short part of the scale and greatly restricts the effective part of the



One of the new range of Ferranti A.C. meters

scale over which accurate readings can be taken. By suitable design some of this crowding can be minimised, and in the Ferranti instrument a particularly open scale has been achieved. In the case of the instrument received for test, the maximum voltage was 300 and the smallest calibrated voltage was 20. Moreover, by skilful design of the shape of the mechanism the scale is uniform throughout, which is an excellent achievement.

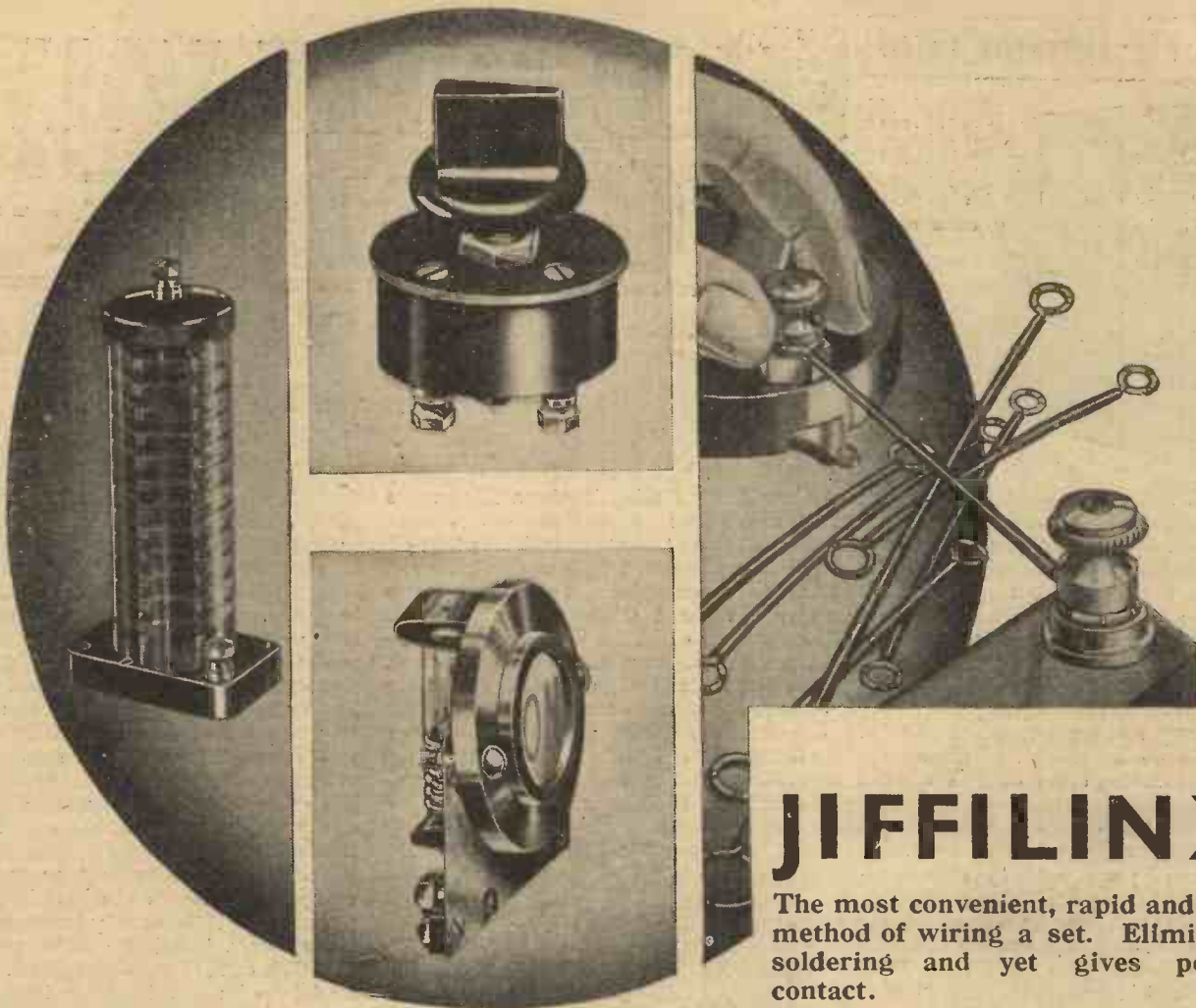

JIFFILINX

The most convenient, rapid and neat method of wiring a set. Eliminates soldering and yet gives perfect contact.

READI RAD SUPER HET CHOKE

Specially designed for use in the modern type of Super Het frequency for excluding the intermediate frequency circuits from the low frequency circuits. Should also be used wherever a Choke of extra high inductance is advisable. Price **5/6**

READI-RAD STANDARD H.F. CHOKE

Price **4/6**

READI RAD SNAP SWITCH

Almost instant action, the elimination of all noises and the instant suppression of arcing with exceptional positive and direct contact. Made in two types—"Radio-Gram" (single pole change over) and "On-Off."

Price **2/9**

READI RAD PANEL LIGHT

Shows the word "ON" in glowing red when the set is switched on. Adds a distinctive touch to the set and prevents battery wastage. For battery-operated and mains sets.

Price **2/3**

Jiffilinx consist of lengths of high conductivity wire covered with special insulation properties which ensure absolute freedom from "short circuit." Both ends are terminated with shake-proof connectors designed to fit the terminals of all components. They can be bent easily with the fingers to any desired angle.

Each packet contains 40 Jiffilinx in many various lengths—ample to wire a large set. Jiffilinx are indispensable to the experimenter as they can be used over and over again. Changes in connections can be made instantly and errors in wiring easily rectified without wastage.

Try Jiffilinx for your next set—or rewire your present set and make sure of perfect electrical contact everywhere. Once you have used them you will never use any other form of wiring. Send for a packet to-day.

2/6 per packet.

**159 BOROUGH HIGH STREET
LONDON BRIDGE S.E.1**
HEAD OFFICE AND WORKS
EASTNOR HOUSE · BLACKHEATH
PHONE: LEE GREEN 5678
(SHOWROOMS, PHONE N0P 3000 GRAMS: READIRAD, SEDIST)

Advt. of Ready Radio, Ltd.

You will Help Yourself and Help Us by Mentioning "A.W." to Advertisers

SETS OF DISTINCTION

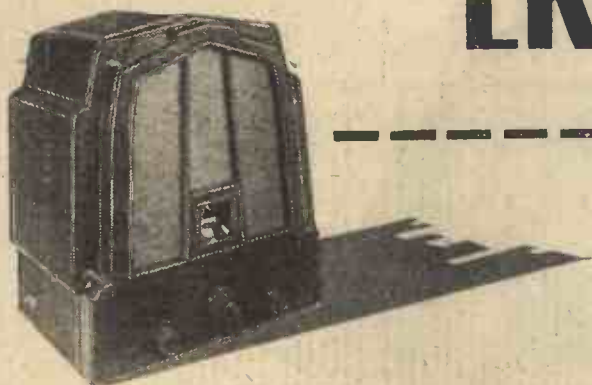

EKCO THREE-VALVE CONSOLETTA

Makers: E. K. Cole, Ltd.

Price: 15 guineas.

CONSOLETTA—the word is attractive, besides being quite descriptive. But E. K. Cole, Ltd., can do more than coin useful names for their sets; they have this year placed themselves in the front rank of British set manufacturers. The new range of Ekco consolettes and radio gramophones compels interest. At the popular price of 15 guineas the three-valve consolette to be reviewed in this article is, in my opinion, likely to appeal to a wide public.

The makers have housed within a very attractive bakelite table cabinet all the essentials of satisfying radio. How all the facilities offered in this set can be included at the price is something to wonder at.

What, would you say, are "all the essentials of satisfying radio?" To begin with, surely, absolute freedom from power supply worries. In other words, power from the mains. Well, that is given in the Ekco consolette, and it does not matter whether the supply is A.C. or D.C., for there are models for all supplies.

Simple Voltage Panel

I should explain the model supplied to me works from the A.C. mains. Underneath the cabinet is an accessible voltage panel, so that it is a matter of seconds to set the plug to the voltage reading nearest to that of the home supply. I must say that although the instruction book is crammed with hints and tips for installation, the set connections are so obvious that even without referring to the book it is quite easy to put the consolette in operation.

Mounted on the back of the case are three small terminal blocks. One is for the connection of the aerial and earth leads, which may be modified if desired, so that the mains form the aerial. Yet another aerial connection provides for the use of a small wire fitted on the inside of the case.

The other terminal panels are for the connection of the gramophone pick-up and an external loud-speaker, if an additional reproducer is wanted.

Excellent Combination

A useful point about the installation is that the three valves can be inserted in their correct sockets without unscrewing the back. The correct positions of the valves are clearly marked on the adjacent screen. Mullard valves are used. There is a Mullard S4VA screen-grid high-frequency amplifying valve, a Mullard 354V detector, and a Mullard PM24 pentode output valve.

An excellent combination for a three-valve A.C. mains set!

Few will resist the temptation to take off the back and look at "the works." Well, I have to congratulate the makers on a really clean and efficient chassis layout. The screened coils, the neat two-gang condenser, the substantial mains equipment, with the metal rectifier poised above the input transformer—all this inspires confidence in the ability of the set to give a good account of itself. The top part of the interior is taken up with the large balanced-armature cone loud-speaker.



A rear view of the Ekco Three-valve Consolette. Note the accessible valve compartment

I believe in first impressions; and as soon as I switched on the Ekco Consolette I gained a strong impression that everything was as it should be. Plenty of clear-cut volume, knobs that responded lightly to control, a complete manageability—that is how the Ekco set reacted on me during the first few minutes.

Let me detail the controls, which are arranged as controls should be—for the convenience of the operator. First, I like the way all the knobs are arranged along the bottom of the front of the case. The tuning is done with one central knob, having mounted on top of it a compensator. This system has the advantage that *easy-looking* tuning control is achieved, without sacrificing volume on distant stations

through mis-ganging of the two sections of the condenser. In my tests I found that tuning is essentially a one-knob job, and the compensator could be left entirely alone.

Immediately below the tuning knob is a lever for switching over from medium to long wavelengths. To the left this gives 200 to 550 metres and to the right 1,000 to 2,000 metres. The dial is marked in wavelengths: medium waves in steps of 50 metres and long waves in steps of 100 metres. The combined selectivity and volume control on the left of the tuning knob works better than most of its kind, due possibly to an exact choice in the matter of capacity.

For example, Hamburg on 372 metres was perfectly clear of London Regional on 356 metres. This is really exceptional for a three-valver. Strasbourg on 345 metres was also clear of the London Regional. Söttern, another of my selectivity test stations, came in absolutely clear of the Midland Regional, which usually swamps the Swiss station on three valves. Quite the most spectacular feat of this set was the complete separation of Zeesen on 1,635 metres from Daventry on one side and Radio Paris on the other.

Moreover the exceptional selectivity of the Ekco Consolette is not obtained at the expense of volume. The log of foreign stations should satisfy the most hard-bitten "DX" enthusiast. I counted no less than twenty-one stations on the medium waves worth listening to as picked up on this set. On the long waves I got nine stations at full strength.

The self-contained cone loud-speaker works well with the pentode power valve. SET TESTER.

"LINEN"

A FIRM quite innocently sold as linen for use in making linen-diaphragm speakers a material which proved on test to be cotton. Under the Merchandise Marks Act it is mis-representation to sell any material other than a flax product under the name of "linen." This point should be borne in mind by readers who might in all innocence be led into a position in which they would find themselves open to proceedings. The Irish Linen Merchants' Association remind us that in the making of linen speakers the best Irish linen is the best possible material.

TYPICAL OF TELSEN VALUE

TELSEN VALVE HOLDERS (Prov. Pat. No. 20286/30)

The Telsen four and five-pin valve holders embody patent metal spring contacts, which are designed to provide the most efficient contact with split and non-split valve legs, and are extended in one piece to form soldering tags. Low capacity and self-locating.

- Telsen 4-pin Valve Holder Price 6d.
- Telsen 5-pin Valve Holder Price 8d.

TELSEN FIXED MICA CONDENSERS (Prov. Pat. No. 20287/30)

Telsen Fixed Mica Condensers are made in capacities from .0001 microfarad to .002 microfarad. They can be mounted upright or flat and the .0003-microfarad Telsen fixed mica condenser is supplied complete with patent grid-leak clips to facilitate series or parallel connections. All Telsen fixed mica condensers are tested at 500 volts.

- Telsen Fixed Mica Condensers Price 6d.

TELSEN GRID-LEAK HOLDER

The Telsen Grid-leak Holder will hold firmly any standard size or type of grid-leak. Ample clearance is provided between the terminal screw leads and the baseboard (underneath), preventing any surface leakage upsetting the value of the grid-leak. The terminals and fixing holes are accessible without removing the grid-leak.

- Telsen Grid-leak Holder Price 6d.

TELSEN SPAGHETTI FLEXIBLE RESISTANCES

These are made in a range of values from 300—200,000 ohms with a maximum current varying from 42 m/a. to 1½ m/a. The terminal tags are firmly fixed to the wire and clearly marked with their respective resistance values; they are impregnated with special insulating compound which renders them proof against corrosion.

- Telsen Spaghetti Flexible Resistances from 6d.

TELSEN FUSE HOLDER

This is a neat and inexpensive device which should be incorporated in every set as a precaution against burnt-out valves.

The Telsen Fuse Holder firmly grips the standard radio fuse giving a perfect contact.

- Telsen Radio Fuse Holder Price 6d.

TELSEN GRID-LEAKS

Telsen Grid-leaks are absolutely silent and non-microphonic, and practically unbreakable. They cannot be burnt out, and are unaffected by atmospheric changes. Telsen Grid-leaks are not wire wound and therefore there are no capacity effects. Their value is not affected by variation in the applied voltage. Made in capacities ranging from ¼—5 megohms.

- Telsen Grid-leak Price 9d.

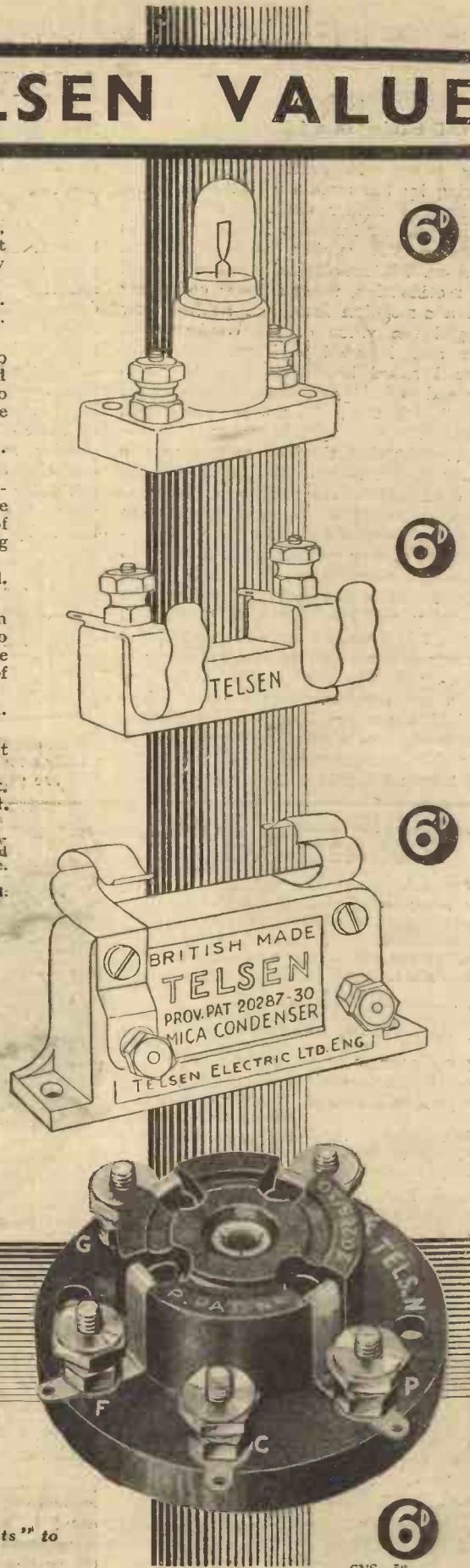

TELSEN

ALL - BRITISH RADIO COMPONENTS

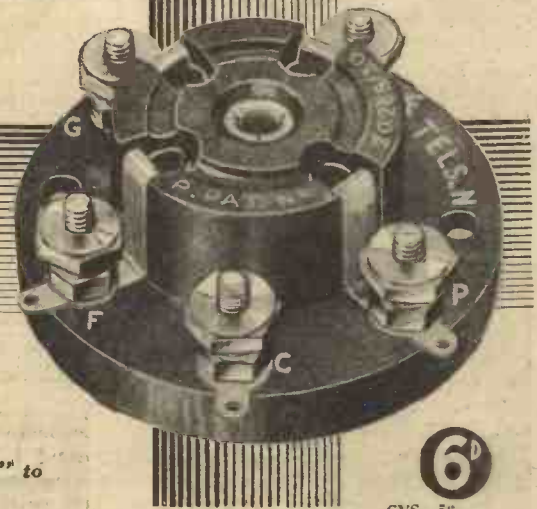

Send for the "Telsen Radio Catalogue" and book of "All-Telsen Circuits" to The Telsen Electric Co., Ltd., Aston, Birmingham.

Mention of "Amateur Wireless" to Advertisers will Ensure Prompt Attention

THIS "POWER-GRID" BUSINESS

By J. H. Reyner, B.Sc., A.M.I.E.E.

I WAS talking to a fellow the other day who proudly informed me that he was using power-grid detection in his set. Judging by the results which were being obtained, I rather doubted it, and on making further inquiries I found that his ideas on the subject were somewhat nebulous. He had originally used the usual grid rectification, using a .0003 condenser with a 2-megohm leak, and he had now changed the value of the condenser to .0001 and inserted a 1/4-megohm leak. When I asked him what good this was supposed to do he looked at me astonished. "But," he said, "that is power-grid detection."

I thought that the best answer was to modify his set to real power-grid working and demonstrate the difference. In view of the fact that many sets at Olympia were using this form of detection (or were supposed to), it may perhaps be of interest to explain the matter here.

The essential change in going from the customary grid rectification to power-grid detection is a matter of anode volts. The ordinary grid rectifier of which a circuit is shown by the diagram, is intended to work with a small voltage on the anode. The grid leak is connected to L.T. + and under these conditions a permanent grid current flows. The resistance from grid to filament then becomes considerably lower than the

grid leak and, indeed, is usually between 50,000 and 100,000 ohms, as I showed in an article some months back.

Grid Rectifier Action

The action of the grid rectifier is well known. The arrival of the signal causes the grid condenser to charge up, thereby reducing the grid voltage, and causing a decrease in the anode current. If the strength of the signal increases, due to an increase in the modulation, the condenser charges up to a greater extent, and the anode current falls still more. On the other hand, if the signal decreases, the voltage on the condenser is required to fall in proportion, so that the anode current follows out the changes in the modulation as faithfully as possible. The only way in which the voltage on the condenser can fall is by the leaking away of the charge

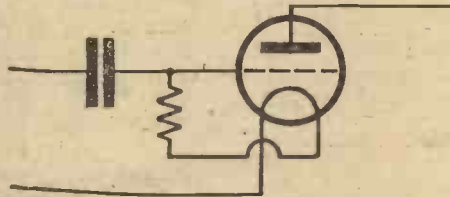

The circuit of an ordinary grid rectifier. Values for this and for power-grid detection are given in the accompanying article

through the grid leak (hence the name). If this resistance is not low enough in value, then the charge cannot leak away quickly enough, and the anode current will not follow the modulation properly.

In a similar manner, if the grid condenser is not of the right size it will not charge up rapidly enough, and there is relationship between the values of condenser and leak which gives the correct proportions for best reproduction.

Now we have seen that with the ordinary grid rectifier the grid-filament path of the valve has a resistance much lower than that of the leak, and therefore the effective value of the leak is practically 50,000 ohms only, and not 2 or 3 megohms. With a value of .0003 this is reasonably satisfactory from the point of view of quality and gives us a rectifier which is very sensitive to weak signals, but has two serious disadvantages. The first of these is that it will not handle any appreciable input without overloading, and, secondly, due to the very low value of the resistance between grid and filament, the tuned circuit in front of the detector is heavily damped and thus flatly tuned.

The power-grid detector overcomes both these difficulties by increasing the voltage on the anode of the valve. At least 100 volts should be applied to the anode of a

(Continued on page 624)

BELLING-LEE RADIO CONNECTIONS

For safety, neatness and ease of connection. The patented loading device used in all Belling-Lee Plugs and Sockets, Anode Connectors, etc. Grips the whole flex neatly—wire, fray and rubber.

SAFETY PLUG AND SOCKET, both parts completely insulated, 6d.

S.G. ANODE CONNECTOR for safe connections to S.G. or Pentodes, tapped coils, etc., 6d.

BELLING-LEE BATTERY CORDS. Complete with engraved Wander Plug and Spring Grip Spade Terminal. 5, 6, 7, 8, 9 and 10-wire. 54 in. cords 4/- to 6/6. 30 in. cords, 2/6 to 5/-. With fuse 1/- extra.



THE ENGRAVED WANDER PLUG WITH THE SPRING GRIP—FITS EVERY RADIO SOCKET

Powerful three-spring contact. Grips ANY battery socket, because each plug is tested in sockets larger and smaller than those of any battery made. Twelve permanent engravings to choose from. The whole flex neatly gripped—wire, rubber and fray.

BELLING-LEE
FOR EVERY RADIO CONNECTION

Advertisement of Belling & Lee Ltd., Queenway Works, Ponders End, Middlesex

YOU CAN'T GO WRONG WITH BELLING-LEE FUSES

Made in two sizes, 1/2 in. long for H.T. leads (60 m/a, 150 m/a and 1/2 amp.) and 1 1/2 in. long for Mains leads (1, 2 and 3 amp.).

WANDERFUSE. Combined Wander Plug and Fuse, with 60 m/a fuse, 1/6 BASEBOARD FUSEHOLDER, with 1/2 amp. fuse, 1/3.

FLEXIBLE LEAD FUSEHOLDER, short type, with 1/2 amp fuse, 1/-. (Longer type, with mains fuse, 1/-.)

TWIN BASEBOARD FUSEHOLDER for mains fuses (Regd. design pending), complete with two 1-amp fuses. Price 3/6.

SPARE FUSES, all sizes, 6d. each.

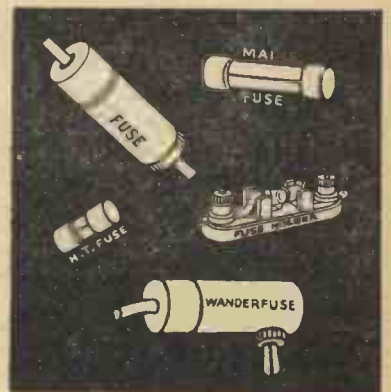

Dx. 93

40

RADIO TIMES

THURSDAY

DAVENTRY
193 kc/s (1,554.4 m.)

PROGRAMME

Get the best out of
this week's programmes

Get a Drydex

10.15 a.m. THE DAILY

10.30 TIME SIGNAL, G.F.E.
Forecast

10.45-11.0 THE CHURCH
IN SUMMER
Mrs. Fry

12.0 REGINA
AT THE ORGAN

Time Signal

1.0 A Concert

- ALEC FEELERMAN'S QUINTET
- Selection, Three Musketeers Friml
- Birthday Serenade Lincke
- En La Alhambra (Serenata)..... Breton
- Fairy Pipers..... Brewer
- Mozart Selection..... Urbach
- Waltz, Moonlight on the Alster .. Petras
- Don Juan (Serenade)..... Tchaikovsky

2.0-2.30 Gramophone Records

3.0 EVENSON
From W...

3.15



Makers of the world
famous Exide offer
greatest dry battery
value

Obtainable everywhere from all good dealers in
sizes and types to suit every wireless set. Also
for torches, pocket lamps, cycle lamps and bells.

Exide Batteries, Clifton Junction, near Manchester. Branches at London, Manchester, Birmingham, Bristol, Glasgow, Dublin and Belfast

Foundations of Music

Hilliers, Green Guards, a
VINE, ERNEST DE
BELLENDEN PONT
A. BRANDON-CR
A. NORMAN SHELL
WALTER SCHOFF
GROOME

Time Signal, Greenwich

'The Second'
WEATHER FORECAST, S.
NEWS BULLETIN

0.15 Shipping Forecast;
Market Report

9.20 IDLE THOU
Lady DIANA

9.35 GERSHOM P
and his SAXOPH
And, if possible,
THE LONDON

10.30-12.0 DAN
BILLY MASON and
BAND, from the

- HUBERT LESLIE
- ALAN BLAKELOCK
- IVAN SAMSON
- BREMER WILLS
- FREDERICK W LLOYD
- ANDREW LEIGH
- WALTER HUDD
- J. SEBASTIAN SMITH
- WILFRID GRANTHAM
- Ravenswater, Green

Mention of "Amateur Wireless" to Advertisers will Ensure Prompt Attention

"THIS 'POWER-GRID' BUSINESS"

(Continued from page 622)

power-grid detector, and preferably more. Under these conditions the operation of the circuit alters. Even though the grid leak is still connected to L.T.+, the very much higher voltage on the anode greatly restricts the grid current flowing. In fact, grid current only flows during those very small portions of the cycle in which the signal strength makes the grid slightly positive. During these portions a small amount of current is drawn from the valve which charges up the condenser, and makes the grid more and more negative as the signal strength increases. The operation of this detector is of a similar nature, though actually it is different in certain essentials, but the fact remains that the grid condenser must charge and discharge in strict accordance with the modulations from the transmitter, so that the anode current may rise and fall in an exactly proportional manner. The criterion of this is the same as before, namely, that the values of grid condenser and grid leak shall be suitably related.

Component Values

In this instance, due to the fact that little grid current is flowing, the grid-to-filament path of the valve has a high resistance and not a very low resistance, as in the previous case. Consequently, the constants of the circuit are really determined by the value of the condenser and grid leak themselves, and are only slightly affected by the valve. In such circumstances a change in the values is necessary, and the customary .0001 condenser and

1/4-megohm leak usually associated with power-grid detection are chosen for this reason.

It is most emphatically to be noted that the change in the values of the components does not in itself constitute power-grid detection. The advantages of the system arise from the increase in the anode voltage, and the change in the values is a secondary effect necessary in order to obtain good quality of reproduction under the altered conditions. The values just quoted are sufficiently good for practical approximation, but, strictly speaking, there is an optimum value for both condenser and leak, which can be calculated if the conditions are known.

Power-grid Advantages

The advantages of power-grid detection are twofold. Firstly, due to the high anode voltage the grid swing which the valve will handle before it commences to overload is considerably increased. This is the primary reason for using power-grid detection, and inputs of several volts high-frequency may be handled quite satisfactorily. In fact, it may be taken as a rough guide that the grid-swing input which a valve will handle as a power-grid detector is approximately one-half the input voltage which the same valve will handle as a properly adjusted amplifier working at the same anode voltage.

This is a property of great value, because with strong signals applied to the grid to-day, following the efficient high-frequency amplifying stages we use, overloading on the detector is very prevalent. Moreover, the rectification under such conditions is practically linear, that is to say, there is no distortion arising over the rectification. The power-grid detector constitutes a very close approach to the ideal.

The second advantage of power-grid detection is that, owing to the high anode voltage, as just explained, the resistance of the grid to filament path is high and, therefore, the valve damping imposed on the preceding tuning circuit is smaller. Admittedly this damping is more than in the case of the anode grid, but nothing like as serious as the customary grid rectifier.

These advantages have, naturally, to be paid for, the expense being on two counts. First of all, the sensitivity to weak signals is not so good as the ordinary grid detector, although it is better than the anode-bend arrangement. Secondly, the anode current is high, for we are applying a small positive voltage to the grid of a valve which may, perhaps, be designed to operate as an L.F. valve with a negative bias. The anode current, in fact, is about twice the value which the valve will take as a properly biased amplifier. Therefore, one should be cautious in choosing a valve for power-grid work. An H.L. valve is usually satisfactory and will stand up to the anode current required. If an L. valve is being used, however, the anode current may be excessive for the valve, particularly if the anode voltage is over 100 and the life of the valve may suffer accordingly.

NEXT WEEK:
**MORE ABOUT THE
"BIG-VOLUME 2"**

NEW PERMANENT MAGNET MOVING COIL SPEAKERS



P.M.1. The original, but with new chassis. Extremely sensitive. No hum, boom or resonance. Massive Darwin Cobalt Steel Magnet weighs 11 1/2 lbs. Chassis only £5.5.0. Three-ratio output Transformer extra 15/-.



P.M.2. Identical with P.M.1 except that weight of Sheffield-made Cobalt Steel Magnet is 6 lbs. Has sold in thousands this summer. Chassis only. £3.10.0. Three-ratio output Transformer extra 15/-.



P.M.3. Entirely new model at astonishing price. Gives true moving coil reproduction from any receiver capable of working an ordinary cone speaker. Weight of Cobalt Steel Magnet 5 lbs. **45/-**. Chassis only. Three-ratio output Transformer extra 7/6.

Give your set the speaker it deserves—a modern moving coil speaker. Give it the most practical form of moving coil reproduction—**PERMANENT MAGNET**. Give it "W.B." "W.B." are pioneers in this field. These three new models are the most reliable and efficient **PERMANENT MAGNET** Moving Coil Speakers that radio has known. **Write for Art Booklet "Speaking of Speakers"—FREE.**



Made by the makers of the famous W.B. Valveholders and Switches.

Hear them at your Radio dealer's.

WHITELEY ELECTRICAL RADIO CO., LTD., NOTTINGHAM RD., MANSFIELD, NOTTS

Irish Free State Distributors: Kelly & Shiel, Ltd., 47 Fleet Street, Dublin

-the newest in Radio

SIX-SIXTY CHASSIKIT

Has created most extraordinary interest at the National Radio Exhibition, Olympia



A prominent journal says: "A production which combines the advantages both of the complete factory-built receiver and the home constructor's kit, with the attendant freedom of choice in cabinet style . . . undoubtedly very successful . . . a wonderful show on the Stand."

AND FITTED WITH THE FAMOUS **SIX-SIXTY (B.V.A.) Valves**

£6-17-6

Complete Chassikit. 3-gang improved band-pass tuning, with 2-volt battery valves, S.G.-Det. (both metallised)-PENTODE output. If with A.C. Valves, £7. 6s. 6d. Cabinets from 10/6 to 12 gns.

Get the **FREE** folder - YOU WILL BE GLAD - **COUPON**

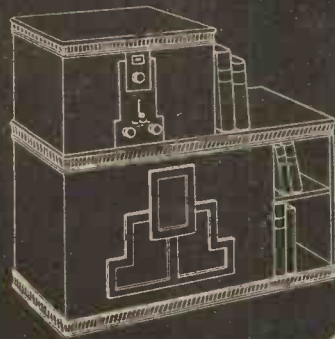
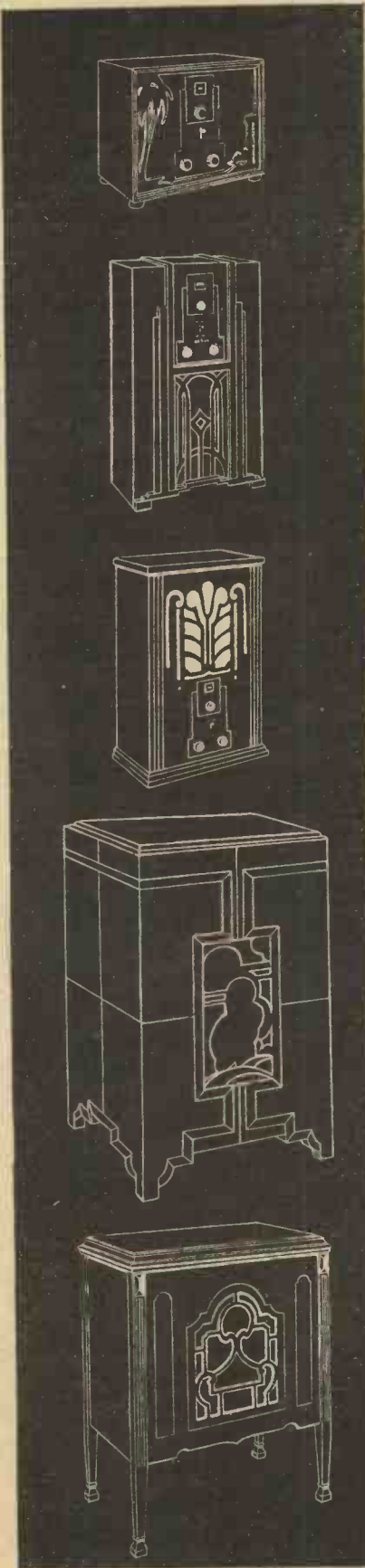

A.W.

To Six-Sixty Radio Co., Ltd.,
Six-Sixty House,
17/18 Rathbone Pl., Oxford St., London, W.1.
Please send me **FREE** and **POST FREE** the
Chassikit illustrated and descriptive Folder.

NAME _____
ADDRESS _____

You will Help Yourself and Help Us by Mentioning "A.W." to Advertisers

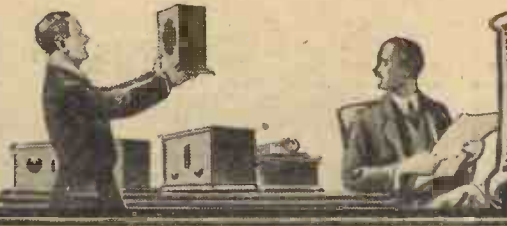

Old Sets

SIR,—I notice that "Thermion" recently mentioned a wireless set which has been in use since 1925 and asks if any reader has an older one. I have one which does duty remarkably well, which was constructed in the end of 1922 or at the beginning of 1923. It is a four-valve set, and I can get at good loud reception strength about thirty stations. I may also mention that I have had a DEP₂₁₅ valve in action since 1925. I have tried a new one in its place to see if I could get any better results, but the one I mention is equal to any.

J. M. (Ivergordon).

Grid Bias and S.G. Valves

SIR,—I have seen it stated that by applying grid bias to a screen-grid H.F. valve, cross-modulation will be set up. In a note recently published in AMATEUR WIRELESS exactly the opposite was stated. How does one reconcile these two apparently contradictory statements?

W. M. (Bristol).

These apparently contradictory statements are due to opinions from different contributors at different times. No doubt, the first writer had in mind the earlier types of S.G. valves and their normal characteristics. The latest S.G. valves are inclined to give rise to cross-

modulation without bias. The correct amount of bias for the latest valves varies between .5 and .9 volt. Any excess of this is likely to upset the general working of the valves.—Ed.

Triode or S.G. ?

SIR,—Referring to an article in a recent issue of AMATEUR WIRELESS on neutralising, I and one or two friends of mine are still staunch adherents to this form of H.F. amplification and would not think of changing over to screen grid, as the purity received from our type of set is all that could be desired. The only snag nowadays is that this form of H.F. amplification is not quite so selective as one would wish. I would like to suggest that, if your programme would permit, your staff set to work and devise a neutralised H.F. four set, using band-pass tuning.

W. S. (Chatham).

Use a Milliammeter

SIR,—Being constantly recommended to try decoupling circuits, I recently invested in suitable resistances and by-pass condensers. After having wired these in circuit, as advised by a technical journal, I find I am unable to get reception. My accumulator, H.T. and L.T. batteries have been freshly charged, so I know these are

in order. I have even gone to the trouble of cutting out the decoupling circuits, and the receiver works quite well. Can you account for non-reception with these added refinements?

A. L. (Essex).

It seems fairly certain that one of your decoupling resistances is faulty, but at the same time you may have introduced resistance totally unsuited to the valves. You are advised to get a milliammeter and to test the current consumption of each individual valve. Should one or more valves be not getting current at all, you may be sure the decoupling resistance in its plate circuit is faulty. These components may have been broken during handling. A milliammeter is not a costly addition to an amateur's kit, because it may be used for a multiplicity of duties, even when not testing any particular circuit of a receiver. It may be connected permanently in the anode circuit of the last valve. In this position it will denote approximately the state of the H.T. supply, and it will also indicate distortion during reception. A first-class instrument is not necessary, and is not even desirable when it is employed as a distortion indicator.—Ed.

Adding Choke Filter Output

SIR,—My dealer advises me to fit a choke-filter output to my receiver to save burning out my speaker. This latter

(Continued on page 628)

RADIO-GRAM ENTHUSIASTS!

Here's the way to the best possible reproduction

A well-designed amplifier, a good moving-coil speaker and—a B.T.H. Pick-up and Tone Arm. These are the ingredients for the finest reproduction of records. The recipe is recognised by leading Radiogram experts. And there's no need now to forego your B.T.H. Pick-up on the score of cost. The new B.T.H. "Minor" is a product of the same engineering principles that have made the "Senior" Model the standard of excellence where Pick-ups are concerned. **Ask your dealer for a demonstration.**



PICK-UP and Tone Arms



THE EDISON SWAN ELECTRIC CO. LTD.
155 Charing Cross Road, London, W.C.2

"Minor" B.T.H. Pick-up and Tone Arm. Price complete 27/6



"Senior" B.T.H. Pick-up and Tone Arm. Price 45/-



"Senior" B.T.H. Pick-up only with adaptors. Price 27/6



H.T. from L.T. accumulator!

Sensation at Radio Show. Crowds flock to see S.G. Brown

“BATTERY SUPERSEDER”

Visitors to Olympia last week saw that Mr. S. G. Brown had done it again! The maker of the first loudspeaker and inventor of the Microbox and a host of other devices had added yet another to his long list of triumphs. His BATTERY SUPERSEDER does away once and for all with the bother and expense of using H.T. batteries. By connecting the SUPERSEDER to your present accumulator you can obtain both H.T. and L.T. from it and you will be consuming very little more current! In short, this is how the SUPERSEDER works; it takes the 2 or 4 volts of your accumulator, converts it into A.C., steps up the voltage with a transformer, and then rectifies and smooths the current with chokes and T.C.C. condensers. The SUPERSEDER was tested and retested and run continuously for weeks on end before we announced it, and every model carries our twelve months' guarantee. The BATTERY SUPERSEDER shown here is designed for home cabinet sets. When connected to your existing 2-volt accumulator it consumes half an amp. and gives an output of 85 volts at 6 milliamps, which is ample for most ordinary 2 or 3 valve sets. If greater output is desired the BATTERY SUPERSEDER can be connected to a 4-volt accumulator and will then give 112 volts at 10 milliamps. It should be emphasised that the above readings are constant, whereas the finest dry batteries very quickly drop below their nominal voltage. Complete, this model costs £3 15s. 0d. (or it can be purchased by 9 easy monthly payments of 10/- from any S. G. Brown dealer). Other models for use with portables and others giving higher output are in course of construction and will be announced later. The SUPERSEDER will shortly be shown in all good radio shops. If you care to send your name and address to S. G. Brown, Ltd., 19, Mortimer Street, London, W.1, we will gladly send full particulars of this and all the other new Brown models.

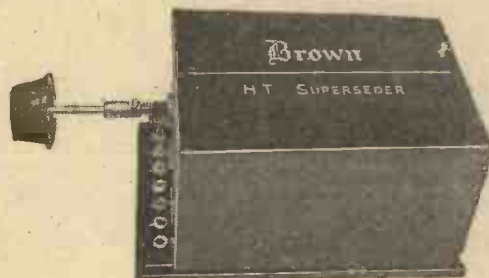

This photograph shows the neat exterior of the S. G. Brown BATTERY SUPERSEDER. One switch controls both set and SUPERSEDER.

Other S. G. Brown Models.

KIT CABINET AND SPEAKER IN ONE!

Thinking of buying a kit set? An excellent idea! But not quite perfect until you've got a speaker worthy of your set, and a hiding place for your batteries. Well, you can get both in an S. G. Brown KIT-CABINET SPEAKER.

MODEL 1. For Mullard 1932 3 valve Kit or Radio for the Million V.3 Kit (incorporates S. G. Brown SOLO speaker). Price 47/6 (or 6 monthly payments of 10/-)

MODEL 2. Stand-on kit-cab. for 1932 Melody Maker, Osram 1932 Music Magnet, etc. Price (with Brown SOLO SPEAKER), 39/6 (or 6 monthly payments of 8/-)

MOVING COIL SPEAKERS MAKE ALL THE DIFFERENCE.

Are you strangling your set with an out-of-date speaker? A speaker that was the last word two years ago, to-day is definitely old-fashioned, such have been the developments in speaker design. Take the new S. G. Brown permanent magnet, moving-coil speaker, for instance. It costs only £4 19s. 6d. (or 9 monthly payments of 13/6), and yet it will get the very best from any set. Ask your dealer for a demonstration.

ANOTHER FAITHFUL PRODUCT MADE BY

Yours faithfully

S.G. Brown

FAITHFUL RADIO

To Ensure Speedy Delivery, Mention "A.W." to Advertisers

"READERS' IDEAS AND QUESTIONS"

(Continued from page 626)

trouble has already been experienced once and I wish to avoid it in the future. Would you please explain how I should connect the choke and the condenser with which I have been supplied? I. F. (London).

The advice given you by your dealer is sound, and we advise you to wire up your two components as follows. Join one terminal of the choke to the negative L.S. terminal on the receiver and also to one terminal of the 2-microfarad condenser. Now join the other terminal of the choke to the positive L.S. terminal on the receiver. The other terminal of the condenser should then be connected to one of the actual speaker terminals, whilst the other speaker terminal should be joined to negative H.T. The choke and condenser should be arranged inside the receiver or as near to the receiver cabinet as possible.—Ed.

Record Making and Tracking

SIR,—We believe that an authoritative reply to the letter appearing in your columns from "J. C. B. (Glasgow)" recently, regarding the above subject, will be of interest to your readers.

Our records, when being made, are cut by the recorder moving laterally across the disc. It can be appreciated that this is obviously the best method for cutting a record, as it would be extremely difficult to gear a swinging arm in such a way that the grooves cut in the wax would be the same distance from one another. As the recorder is actually geared to a worm rod, it will be realised that no vibration is present.

In order that no undue wear may take place when reproducing a record, this com-

pany has spent many thousands of pounds and thirty years in satisfying themselves as to which is the best method to adopt in order that the pick-up or soundbox may traverse the record satisfactorily.

From the experiments conducted by our research laboratories, we have definitely established that the most satisfactory method for mounting the pick-up or soundbox is to attach it to a swinging arm.

It is interesting to note that with a free armature or stylus movement, tracking errors of five degrees may be tolerated without noticeable effect on either record wear or quality of reproduction. As all our gramophones and radio gramophones have a tracking error of not greater than two degrees, it will be seen that no undue record wear or scratch is present when playing records on our instruments.

It is not generally realised that the design of a tone-arm or pick-up carrying arm is no simple task, for it is necessary that the natural frequency of the carrier should be below the lower limit of audibility, or at any rate below the frequency limit of the amplifier and loud-speaker system, say at about 40 cycles per second; or that its natural frequency is sufficiently high in the range of audible frequencies to give an extremely small amplitude, so that with a pick-up having a comparatively free movement, the effect of the resonance is negligible.

It is of the utmost importance that these points should be taken into consideration when designing a carrier arm, for it must be borne in mind that any resonance arising in the arm will be reflected in the response curve of the pick-up. It must also be

appreciated that when designing a carrier arm every precaution should be taken to ensure that no vibration is present, that is, the pick-up should be rigidly attached to the arm.

From tests we have conducted, we believe there is no lateral tracking carrying arm on the market at the present time in which the pick-up is so attached that no vibrations are present.

If any of your readers should desire to test for themselves that vibration of the pick-up head has an effect on record wear, we suggest that they should attach a pick-up loosely to an arm and then play a loud record. After a few playings the record will be irretrievably ruined.

THE GRAMOPHONE CO., LTD.
(London, W.).

FOR LINEN-SPEAKER BUILDERS

CONSTRUCTORS of the "New Amateur Linen Speaker," described in AMATEUR WIRELESS Nos. 484 and 485, should note that materials and kits of parts for making this and similar linen-diaphragm speakers are available from Messrs. S. Weeden, 196 The Avenue, London, N.17. Special chucks, tensioners, and speaker drive extension rods are available which greatly facilitate construction.

A feature of the Exhibition was the demonstration by Slekton Products, Ltd., on Stand 208, of coil winding and transformer building. Slekton transformers were shown actually in the making.

THE FULLER LIFE PRESERVER does lengthen battery life

Immediately you discharge a battery below a certain point you shorten its life. How are you to tell when this point is reached? It is simple with the Fuller Life Preserver. When the red ball sinks you should charge your battery. Fuller Batteries have more points of superiority than any other. They are dry charged, and have Fuller micro-porous plates to ensure long life, patent double grease-cup terminals to guard against acid corrosion, red and blue collars and embossed polarity signs on the nuts to prevent incorrect connection. Patented free carrier. Prices lower than ever. Standard plate types available in glass (S.W.G.H.), in celluloid (S.W.X.H.), or in ebony (S.W.E.H.) containers.



Enlarged view of LIFE PRESERVER

2 VOLT		
STANDARD PLATE TYPES SWGH—SWXH —or SWEH		
† Amp.	Hours	Price
20	...	8/3
30	...	10/3
40	...	12/3
50	...	14/3
60	...	16/3

† Actual at 20 hour rate.



FULLER SUPER BATTERIES

Full list of H.T. Dry Batteries and L.T. and H.T. Accumulators on request, FULLER ACCUMULATOR CO. (1926) LTD., CHADWELL HEATH, ESSEX

*Phone: Seven Kings 1200. *Grams: "Fuller, Chadwell Heath." Contractors to British and Overseas Government Departments, Railways, etc.

Outstanding features of this remarkable Receiver:



COMPLETELY SCREENED COILS

The coils used in the Cossor Empire Melody Maker are completely screened in metal "pots" entirely eliminating direct pick-up, thus further improving selectivity.



EXTERNAL WAVE-CHANGE SWITCH

Wave Change Switching is effected by operating the switch at the end of the cabinet—"in" for long—"out" for short.



COSSOR METALLISED SCREENED GRID VALVE

Even better performance is ensured by the use of a Cossor Metallised Screened Grid Valve with its record low inter-electrode capacity and its ability to eliminate stray coupling effect between anode and nearby components.



SERIES AERIAL CONDENSER

The variable Series Aerial Condenser permits adjustment of selectivity to give the fine tuning necessary to cut out powerful local stations.



ALL-METAL BASEPLATE

Construction is simpler than ever, due to the Metal Baseplate, which is supplied with every hole drilled thus automatically positioning every component.



Use this Coupon

To Messrs. A. C. Cossor, Ltd., Highbury Grove, London, N.5
 Please send me free of charge one of your Constructional Charts No. C. 12 which tells me how to build the Cossor Empire Melody Maker.
 Name.....
 Address.....

A.W. 3/102911

More Powerful Longer Range Sharper Tuning

yet even lower in price!

For as little as £6. 15. 0 you can now buy an "All-Europe" Receiver—the Cossor Empire Melody Maker Model 234—a powerful 3 valve Screened Grid Wireless Set of outstanding performance.

Its range and selectivity are remarkable. It will cut out completely the powerful transmissions of nearby stations and bring in the programme you want to hear. All the main European Stations are within its reach. Due largely to the excep-

tional efficiency of its Cossor Valves the Cossor Empire Melody Maker is equal in performance to the most costly factory-built 3-valve S.G. Receiver.

For all its efficiency the Cossor Empire Melody Maker is so simple that anyone can assemble it—no Wireless knowledge is necessary—in a very short time the veriest Radio novice can build it and get results equal to an expert. Send at once for large Constructional Chart—use the coupon.

Cossor EMPIRE Melody Maker

Model 234

HIRE PURCHASE TERMS
 You can obtain the Cossor Empire Melody Maker for only 15/- down and nine monthly payments of 15/-



Price includes Cabinet, Valves and all the parts necessary for rapid assembly.

♥ 9054

You will Help Yourself and Help Us by Mentioning "A.W." to Advertisers

POLAR GIVES YOU FINER REACTION

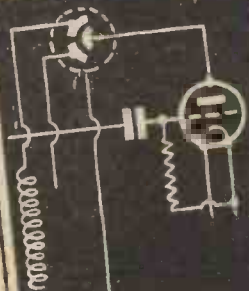

Polar Differential



Polar "Compax"



"COMPAX" CONDENSER

A solid dielectric specially designed for use as Reaction or Tuning condenser. Perfect action. Bonded rotor vanes. Finely built. Price includes knob.

- | | |
|---------------------------------------|-----|
| .0003, .00015, .0001 | 2/6 |
| .00005 | 2/9 |
| .0005 | 3/9 |
| REACTION No. 4, .0001, .00015, .00025 | 3/9 |

Fully Illustrated Catalogue—Free

WINGROVE & ROGERS, LTD.

188-189 STRAND, LONDON, W.C.2

Polar Works, Old Swan, Liverpool



DIFFERENTIAL CONDENSER

Direct Drive. Constructed of highest quality materials. Smooth action gives very accurate control. Insulated spindle. Supplied with Knob.

- | | |
|----------------------------------------------|-----|
| .0001, .00015, .0003 | 3/- |
| Slow Motion Type in same capacities as above | 6/6 |



PRICES

- 1.0 Mfd. 2/6
- 2.0 Mfd. 3/3
- 4.0 Mfd. 5/6
- 6.0 Mfd. 8/-
- 8.0 Mfd. 10/6

RESISTS CURRENT LEAKAGE
WITH A NEW
HIGH INSULATION FACTOR
that has established a record in condenser efficiency.
MAINS CONDENSERS
HIGH TEST VOLTAGE



Catalogue from:—
ARTHUR PREEN & CO., LTD., Golden Square, Piccadilly Circus, London, W.1.

A FIRST-CLASS RADIO-GRAM CABINET



The Camco "Waverley" Radio-Gram Cabinet is appealing tremendously to the public. A beautifully-finished and handsome piece of furniture, it represents astonishing value at only £5.10.0. There are two models, Junior and Senior, and in each ample space is provided for batteries, etc., and clearance allowed for gramophone motor. Write now for the 24-page Camco Radio Cabinet Catalogue, giving full details of Camco's fine range.



**AT A
SURPRISINGLY LOW PRICE!**

**CARRINGTON
MFG. CO. LTD.**

21, Hatton Gdn., London, E.C.1. Phone: Hol 8202.
Works: S. Croydon.

Name _____
Address _____
A.W. 15

Don't Forget to Say That You Saw it in "A.W."

REMARKABLE WIRELESS EXPERIENCE IN MANCHESTER

Local experts perplexed

Mr. T. A. Kennedy's own story of Battery Record

Everybody who owns a wireless set will be interested in the following letter received from Mr. T. A. Kennedy, of Willington, Manchester, whose experience surprised and puzzled even local experts.

"Dear Sirs :

As I write I am listening to the Wireless on a McMichael Screened 3-valve Pentode employing two EVER READY super-capacity batteries, which yesterday completed their 56th week (14 months) continuous use. Surely this is a very exceptional length of time for any battery to last.

I wrote you on their completion of 8—9 months never expecting a further 5 months' use. Local dealers here are perplexed and say I am mistaken but I know positively that the batteries were put into commission on June 5th, 1930."

(This letter can be inspected at the office of the Company.)

When a set is adequately powered, and only then, it is economically powered! That is the secret of Mr. Kennedy's success. There is an EVER READY Battery made to fit every type of set, portables included; and Mr. Kennedy chose the EVER READY battery made for his. Result: 14 months of trouble-free wireless for two guineas! Why not fit *your* set with the battery made by an exclusive process and guaranteed to give satisfaction by the firm that has been making reliable batteries for over 29 years? Write to the address below for a free list of popular wireless sets and the EVER READY Battery specially recommended for each of them.



THE EVER READY
CO. (GT. BRITAIN)
LTD., HERCULES PLACE,
HOLLOWAY, LONDON, N.7.

**THE BATTERY
THAT LASTS A
LONG TIME**

Please Mention "A.W." When Corresponding with Advertisers

EVERYTHING **The G.E.C.** ELECTRICAL
your guarantee

A HIGHLY SPECIALISED FACTORY KIT

DESIGNED AND MANUFACTURED TO BE AND TO LOOK LIKE A HIGH CLASS RADIO SET AND NOT LIKE A HOME MADE JOB

THE NEW CONSTRUCTOR'S CIRCUIT DEVELOPMENT

note the choice Walnut cabinet work

The OSRAM "FOUR" Constructor's Instruction Chart, sent POST FREE for coupon, gives you the fullest advice and information.

MADE IN ENGLAND

Sold by all Wireless Dealers.



Osram "FOUR"

NEW MUSIC MAGNET

The OSRAM "FOUR" NEW MUSIC MAGNET is the best circuit with the best valves and the best components —made entirely in England

Previous models of the OSRAM MUSIC MAGNET kit sets have earned a world-wide reputation for outstanding radio performance, range, selectivity and quality of reproduction. This new model surpasses its predecessors in performance while exterior appearance has been completely changed by the provision of a magnificent walnut cabinet of modern design.

**A BRITISH PRODUCT
DESIGNED FOR BRITISH
RADIO CONDITIONS**

The OSRAM "FOUR" introduces an entirely new and improved conception of home-assembled circuits. In appearance, in performance, it represents high-class, super-efficient radio. At the remarkably low price of £10-15-0 it introduces, as well, a standard of radio value never before attained.

It embodies all essential features required for modern broadcasting conditions, and which are incorporated in the highest-class manufactured sets. Results—GREAT SELECTIVITY which enables you to get any station you want, GREAT POWER when the full output of the set is required, GREAT PURITY at any strength. These are the results you want. This is real, satisfying radio enjoyment, obtainable only from a powerful set such as the OSRAM "FOUR."

Many more stations, much more selectivity, much more volume, much more purity are qualities that particularly commend the OSRAM "FOUR." It is the world's best circuit and assembly kit, with the best valves (OSRAM), the best components (GECOPHONE), and gives the best rendering of all that is broadcast. It is MADE IN ENGLAND at the Coventry works of The General Electric Co., Ltd.—your guarantee of reliability and satisfaction.

SUPREMACY IN RADIO

Advt. of the General Electric Co., Ltd. Head Office and Public Showrooms: Magnet House, Kingsway, London, W.C.2

Don't Forget to Say That You Saw it in "A.W."

**The position of every component is fixed
— all you have to do is to wire up**

**Easy to assemble
Easy to operate
Easy to get the
world's best stations**

You will find absolutely no difficulty in assembling the various parts of the OSRAM "FOUR" together. The position of every component is fixed—all you have to do is to wire up, directed step by step by the full-size Constructor's Instruction Chart. Wherever you live you can be sure of the utmost of radio enjoyment with this latest radio marvel.

WRITE for the OSRAM "FOUR" Constructor's Instruction Chart, and learn all about this radio sensation. **FILL IN THE COUPON BELOW.** The clear directions given in these instructions will enable you to assemble the OSRAM "FOUR" without the possibility of mistake. It is crammed full of useful hints and tips, and contains a rapid guide for getting practically all Home and Continental stations. **SEND FOR A COPY TO-DAY.**

SPECIAL FEATURES OF THE OSRAM "FOUR"

- 1 The two Screen Grid high frequency stages give extreme selectivity and sensitivity with an unrivalled range.
- 2 Enormous amplification with perfect stability is given by the complete shielding of H. F. circuits.
- 3 Equal efficiency guaranteed on both wavelength bands.
- 4 Change of wavelength is effected by an external switch and the set need not therefore be opened.
- 5 Maximum ease in tuning with single knob controlling triple gang condenser.
- 6 Assembly is the essence of simplicity.
- 7 Volume control is provided not only to act as such, but to secure extreme selectivity.
- 8 Two terminals provided for connection to Gramophone Pickup.
- 9 Attractive Walnut Constructor's Cabinet of modern design with front panel to match.

HIRE PURCHASE You can either buy your OSRAM "FOUR" for cash or on these attractive **HIRE PURCHASE** terms—Deposit 25/- and 12 monthly payments of 17/-.
Your dealer will give you full particulars.

**NOTE
THE LOW
PRICE
ONLY**
£10.15.0
Including OSRAM VALVES
GECOPHONE COMPONENTS
& POLISHED HEAVY WALNUT
CONSTRUCTORS CABINET

**A. C. MAINS
OPERATION**

The OSRAM "FOUR" can be built for A.C. All-mains operation by means of the new GECOPHONE A.C. All-Power Unit and Conversion parts. This Unit can also be used to convert last season's "Osram Music Magnet 4."



POST FREE
Instruction Chart

POST COUPON TO-DAY!
Please send me particulars of the OSRAM
"FOUR" NEW MUSIC MAGNET.

Name _____
Address _____

The General Electric Co. Ltd.,
Magnet House, Kingsway,
London W.C.2
A.W.

Cut out and paste on postcard, or enclose in unsealed envelope.
Halfpenny postage in either case.

G.E.C. RADIO

Branches and Public Showrooms throughout Great Britain.

Advertisers Appreciate Mention of "A.W." with Your Order



EDGAR WALLACE is expected to start a new feature on October 10 with the first of a series of broadcasts entitled "Stories for Broadcasting."

A twenty-minute crook play, *Traitor*, is to be put "on the air" on October 8 (National) and 10 (Regional).

A particularly attractive vaudeville programme will be heard by National listeners on October 6 and Regional listeners on October 8. Harry Tate presents a funny sketch called *How Are You?*; Estelle Brody, the film star, comes to Savoy Hill from America, via Paris, to sing; and Wish Wynne returns the same night.

Wee Georgie Wood comes back to the microphone in a *Wee McGregor* sketch on October 3 (Regional). Ann Penn and Harry Hensley are other artistes in this "bill."

Ania Dorfmann will be the soloist in a concert by the Lockier String Orchestra, which will be relayed from the Victoria Rooms, Bristol, to the Cardiff transmitter on October 15.

Greta Keller is now back in London, and will make her reappearance before the microphone on October 1. The Wireless Singers will also be heard and a light comedy sketch by Peter Cresswell, entitled *Ways and Means*.

From the little parish of St. Hilary, at Marazion, Cornwall, which gives National listeners the Nativity play at Christmas, comes a new play by Father Walke, entitled *The Little Ass*, on October 7. It will be acted, as the Nativity play is, by villagers of St. Hilary. The producer will be Mr. Filson Young, of the B.B.C.

The National Orchestra of Wales will broadcast its final performance on October 7, and will be succeeded by a small musical combination, to be known as the Western Studio Orchestra, which will give its first performance on October 8.

Two small private Belgian broadcasting stations have altered their wavelengths; Binche now works on 232.5 metres and Courtrai on 248 metres. Their individual power does not exceed 150-200 watts.

C. H. Brewer's show, *All the Fun of the Fair*, proved so popular when it was given from the Birmingham station last February that it is to be repeated on October 9.

The second of the Midland Towns and Cities programmes will be heard on October 10, when a programme is relayed from Leicester, following a concert by the Leicester Imperial Band.

On October 13 *Prunella*, or *Love in a Dutch Garden*, will be broadcast to the Western Region. *Prunella* is a little fantasy by Laurence Housman and Granville Barker.

The first concert of the season to be given from the studio by the City of Birmingham Orchestra takes place on October 7. Sibelius's First Symphony in E minor is the main orchestral work.

The programme for the concert on October 4 in the North Regional programme will consist of selections from some of the best known operas.

A talk of a somewhat unusual nature will be given by Mr. F. E. Doran on October 5. His subject is "Northern Dishes—Food for Thought." It is his intention to describe several unusual Northern dishes and the places where he obtained them.

The Edgar Knight Trio has been responsible for many chamber-music concerts from the Leeds studio, and they will add another to their list on October 4.

On October 6 the first concert of the Liverpool Philharmonic Society will be relayed. The Philharmonic Orchestra will be conducted by Adrian Boult.



PRICE
12/6

READINGS:
0-150 VOLTS.
0-6 VOLTS.
0-30 MILLIAMPS.
3-3000 OHMS.

WATES UNIVERSAL TEST METER

Perfect control of your radio set is ensured with this handy test meter. It is fitted with a small battery and special leads with contacts for testing valve filament.

Supplied in neat polished black case with full instructions.

From all radio dealers. Literature direct from:—

THE STANDARD BATTERY CO., 184-8, SHAPTESBURY AVE., LONDON, W.C.2.

HAVE YOU GOT YOUR "DAILY MAIL" RADIO CHART?

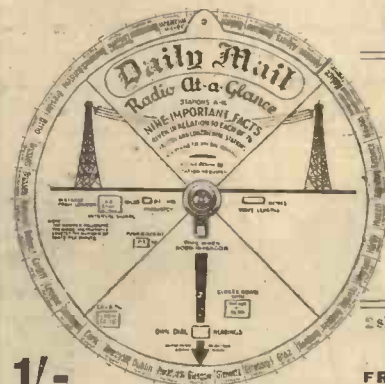

"... the cleverest thing of its kind ever devised ..."

HOW TO IDENTIFY RADIO STATIONS AND GET THEM AS YOU WANT THEM

EVERYBODY'S USING IT. GET YOURS TO-DAY.

2-sided. Diameter 9 1/2 ins. In Colours. On Sale at Radio Stores, Booksellers, Stationers, Etc., or direct from—**FRANK PITCHFORD & CO., LTD., WELL STREET, LONDON, E.C.1.**

1/-

A NEW "AMATEUR WIRELESS" HANDBOOK

The HOW & WHY OF RADIO

By **ALAN HUNTER**
2/6 NETT.

This book has been expressly written for beginners. It provides a clear conception of the general theory and practice of wireless reception in simple non-technical terms. It has been mainly compiled from the series of articles in "Amateur Wireless"—"The How and Why of Radio"—which proved so popular during the past twelve months.

Of all Newsagents and Booksellers, or 2/9, post free, from "Amateur Wireless," 58/61 Fetter Lane, London, E.C.4

CHALLENGING
 INTERESTING
 HELPFUL
 CRITICAL
 SCATHING
 TRENCHANT
 CONSTRUCTIVE
 ENTERTAINING
 FORCEFUL
 EXPERT
 UNIQUE
 VIGOROUS
 BLUNT
 VIRILE
 LIVE
 OUTSPOKEN
 PROVOCATIVE
 FRANK
 BRIGHT
 USEFUL
 TOPICAL
 INTRIGUING
 INSTRUCTIVE
 CHALLENGING



Read Capt. P.P.
Eckersley's
Radio Feature

every Wednesday in The

DAILY MAIL

World-famous as one of the pioneers of broadcasting, both with the Marconi Co. and the B.B.C., Captain P. P. Eckersley is now Wireless Editor of *The Daily Mail*.

To Ensure Speedy Delivery, Mention "A.W." to Advertisers

"RED DIAMOND" SWITCHES

TRADE MARK

RED DIAMOND

Robust Construction. Definite "on" and "off" positions. No shaking. Perfect contacts. Large terminals for easy fitting.

REGG

RD39 2 point	1/3	1/6
RD49 dead spindle	1/3	1/6
RD37 3 point	1/6	1/9
RD47 dead spindle	1/6	1/9
RD44 Radio-gram 3 point	2/-	2/3

By post

Can be mounted on brackets or through panel. Once-set always ready. Not affected by vibration. Each one is tested on broadcast before dispatch.

"RED DIAMOND" DETECTOR

As specified for Crystal Set for 1932

RD43 2/-

By insured Post 2/3 or 2/9 with shield.

Of all high-class Radio Dealers or Sole Makers;

JEWEL PEN CO., LTD.
(Radio Dept. 45), 21-22, Great Suffolk Street, LONDON, E.C.1

GRAHAM-FARISH PARTS

A MATEURS who were not able to go to Olympia and who were therefore unable to examine the new Graham-Farish parts on Stand 32, should get the new literature which describes the several interesting components included in the new range. The type A.C.4 chassis speaker has a waterproof fabric cone and is built up on an aluminium chassis. There are fixed condensers at 6d. each, valve



One of the new Graham-Farish speakers, the type A.C.4

holders at 9d., and standard grid leaks with terminal ends at 10d. These are indicative of the low prices now obtaining. A new pick-up and tone-arm have been brought out of rather striking design, while the range of Audion L.F. chokes now includes 25-henry 15-milliamperes, 20-milliamperes and 30-henry 50-milliamperes jobs. Full details of all these parts can be obtained from Messrs. Graham-Farish, Ltd., Bromley, Kent, on mention of "A.W."

Electradix Bargains

T.V.T. High Tension Generator and Rectifier for supply of H.T. D.C. from 6-volt Battery, 25/- pair with Valves. Wireless Telephones: Brown "A" reed, single, 4/-, for speaker units. Single Earpieces for Gramo Pick-ups, 1/3. Sullivan L.R. Phones, 3/6 pair; 8,000 ohm, 4/3. Morse Keys—1,000 in Stock—Lucas, 2/6; R.A.F. No. 1, 6/-; S.G. Brown Treble Contact, 7/6. Buzzers: Townsend Wavemeter High Note, 3/6; Power, 4/6; Cheap Practice Type, 1/6. Practice Buzzer Sets with Buzzer and Key on Panel, 7/6; Heavy Type, 10/-. Microphones: Public Address Wireless Mikes, 15/-; Hand Type, 4/6; Standard Insets Carbon Diaphragm, 2/-.

Write for Catalogue.

Electradix Radios

218 Upper Thames St., E.C.4.

BUY THROUGH THE POST—THE MODERN WAY!
YOU WANT ADVERTISED GOODS—we have all of them IN STOCK and can give you IMMEDIATE DELIVERY. The Advertisement columns of this publication are our catalogue—free delivery at LIST PRICES (no extra postage).

INTERNATIONAL RADIO BUREAU
BRADAY HOUSE, HENRY STREET, BLACKPOOL (Lancs) CASH WITH ORDER or C.O.D.



YOU CAN BUILD A £40 GRAMOPHONE WITH OUR SCALE DRAWINGS FOR 40/-

Book of instructions 3d. Catalogue of Motors, Tonearms, Soundboxes, latest internal amplifiers, Gramophones and Cabinets Free. Cash or Terms.

W. BURT, 185 High St., Deptford

BRITAIN'S BEST RADIO SETS



FREE! Our 1932 Catalogue free to callers. By post 6d. Allowed off first order.

WILL DAY LTD.
19 Lisle Street, Leicester Square, LONDON, W.C.2
Phone: Gerrard 4476

At Will Day's Show-rooms you can see a complete range of all the latest in Radio. Sets — Components — Radio-gramophones and Eliminators. Spacious Demonstration rooms are provided for the convenience of Customers. Immediate delivery—Easy payment terms if required.

TANNOY RADIO



MIDGET SUPER-HET RECEIVER
Comprising a high-grade chassis which embodies pre-detector H.F. amplification multi band-pass tuning, with corrected L.F. amplifier.

Housed in an attractive walnut figured veneer domed cabinet with single dial tuning. Incorporating Radio and Gramo switching with independent volume control and moving-coil speaker.

Price (complete) Mains Operated 28 gns. Battery Operated 25 gns.

SUPER-HET RADIO GRAMOPHONE (Junior Model)

This Radio receiver and Gramophone combined has a high-grade chassis which embodies a pre-detector H.F. multi band-pass tuning super-het receiver and corrected L.F. amplifier.

Radio and Gramo switching are provided. Automatic brake on Gramo Motor which works on any make or size of record without independent setting.

Housed in a beautifully-figured polished walnut cabinet of Tudor design. This instrument is not mass produced, but is individually built for a discerning buyer. All models incorporate specially matched moving-coil speakers.

Price - Mains Operated 45 gns. Battery Operated 43 gns.

SUPER-HET RADIO GRAMOPHONE (Senior Model)

Similar in appearance to the Junior Model but incorporating a considerably larger Radio and Gramophone output.

Price - Mains Operated 55 gns.

TANNOY PRODUCTS
Dalton Street :: West Norwood, S.E.27



Phone: Streatham 6731/2

The
LISSEN
ECONOMY
POWER
PENTODE

How to get **MORE VOLUME**
 and better quality reproduction
 without paying more for it!

If you would like your radio louder—if you would like to get the Continental stations at fuller loudspeaker strength—if you have a two-valve set and would like to have it perform like a three—if you have a three-valve set and would like it to perform as a four—replace the last power valve with a Lissen Power Pentode. Immediately you will notice a tremendous step-up in volume on all stations.

The valve to get is the Lissen P.T.225—the Economy Power Pentode—so called because, although its magnification factor is over 90, its power consumption is only 7mA. That means you can work it off the same batteries as the power valve it replaces and get **IMMENSELY INCREASED VOLUME** without adding to running cost.

P.T.225. PRICE

12'6

USE ALSO
THE LIVELY
LISSEN

DETECTOR VALVE

TYPE H.L.210

PRICE

5'6

Other Types

- H.210 5/6
- L.210 5/6
- P.220 7/3
- P.X.240 8/-
- S.G.215 12/6

4-volt and 6-volt types also available.

Lissen Valves are British and Best

LISSEN LIMITED, WORPLE ROAD, ISLEWORTH, MIDDLESEX

Advertisers Appreciate Mention of "A.W." with Your Order



VALVE HOLDERS

ANTIPHONIC TYPE

9^{D.}

RIGID 5 PIN

8^{D.}

RIGID 4 PIN

6^{D.}



2/3

HEAVY DUTY

OhmitE

ANODE RESISTANCES



LITLOS VARIABLE AND DIFFERENTIAL CONDENSERS

2/-



OhmitE SPAGHETTI RESISTANCES

1,000 to 20,000 ohms 1/-

25,000 to 100,000 ohms 1/6

GRAHAM FARISH

LTD.

BROMLEY : KENT

PHONE: RAVENSBOURNE 3377

EVERYBODY at Olympia realised the value of our eleven years' experience in component manufacture.

Only experience and enormous production can enable components to be so low in price and yet so high in efficiency and finish.

Write for free brochure of our new lines.

COUPON

To GRAHAM FARISH, Ltd.,
BROMLEY, KENT

Orders exceeding 2/6 in value bearing this coupon are sent Carriage Paid.

Name
BLOCK LETTERS

Address

EVERYTHING **G.E.C.** ELECTRICAL
your guarantee

**THE WORLD ASKED FOR A
BETTER LOUD SPEAKER
AT A LOW
PRICE!**

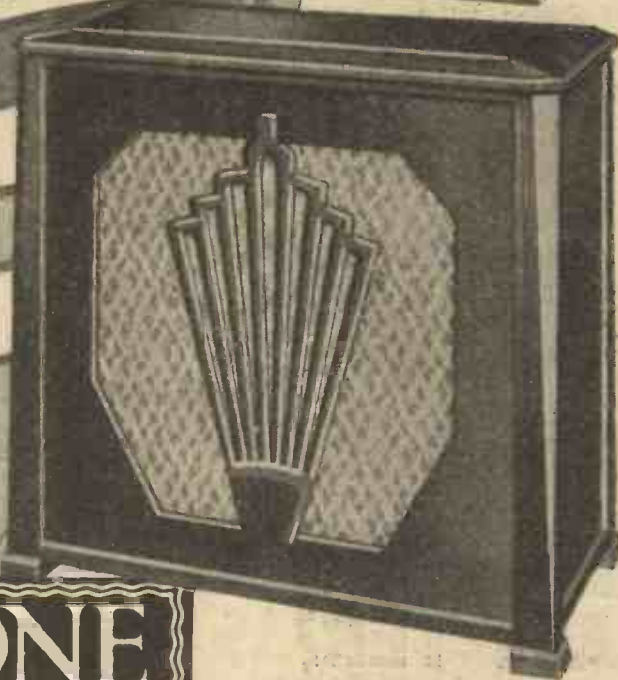

The **GECOPHONE**

**INDUCTOR DYNAMIC
LOUD SPEAKER**
now fills the demand

(Farrand Inductor Patent)

MADE IN ENGLAND

*Sold by all
Wireless Dealers*

Only the finest loud speaker movement is good enough to reproduce the natural tones of instruments and voices in a manner to suit modern standards of quality. The GECOPHONE Inductor Dynamic Loud Speaker raises the quality of home entertainment to a higher level than ever before obtained. Its low price only adds to the marvels of this brilliant loud speaker.

Cat. No. BC1850
Chassis only. Price
£3.10.0

Cat. No. BC1855
complete in wal-
nut cabinet. Price
£5.10.0

WRITE for folder BC5958 which fully describes and illustrates in colours the complete range of GECOPHONE Radio Receivers and Loud Speakers. **SENT POST FREE.**

HIRE PURCHASE:
(BC1855) Deposit £1
and 12 monthly pay-
ments of 8,-



SUPREMACY IN RADIO — G.E.C. Radio

Advt. of The General Electric Co. Ltd., Magnet House, Kingsway, London, W.C.2.

You Will Help Yourself and Help Us by Mentioning "A.W." to Advertisers

TUNEWELL COILS— GREATLY REDUCED PRICES

TWO-PIN COILS reduced 3d per Coil.

M4 Six-pin Fitting from 7/9 to 6/- M4 Base Fitting from 8/3 to 6/6

M4 Six-pin Fitting Enamelled Wire 5/9 to 4/6

M4 Base Fitting Enamelled Wire 5/6

MARVEL DUAL AERIAL ANODE 2/6

M4 PANEL Mounting from 10/6 to 8/6

DUAL X Mounting 10/6 to 8/6 BINOCULAR DUALS 10/6 to 8/6

POP VOX Coils. Prices 6/6 per pair. P.W. DUAL 10/6 to 8/6.

TUNEWELL ULTRA SELECTIVE DUAL RANGE COILS—AERIAL or ANODE 7/9 (6-pin base 2/-). With "BLUNTER" tuning tapping 1/- extra. PANEL MOUNTING 10/6. (3-pt. switch 1/3). SHORT WAVES, 3/11

Write for lists of the full range of TUNEWELL COILS, TRANSFORMERS, SPEAKERS, RESISTANCES, and the great new range of OUTPUT CHOKES from 12/6 to 55/-.

TURNER & CO., 54 STATION ROAD, LONDON, N.11

EASY TERMS

WE SUPPLY ALL GOOD QUALITY RADIO RECEIVERS, COMPONENTS AND ACCESSORIES ON DEFERRED TERMS. WE CARRY ADEQUATE STOCKS AND CAN GIVE PROMPT DELIVERY

NEW COSSOR 1932 EMPIRE KIT No. 234.—A remarkable advance on last season's model.

Cash Price, £6/15/0 or 10/- with order and 11 monthly payments of 12/4.

NEW HEAYBERD A.C. ELIMINATOR KIT C.150.—Complete Kit of Parts for building an H.T. Eliminator, including steel case. Output, 25 m.a., 150 volts, 3 H.T. Tappings, one variable.

Cash Price, £3/16/- or 7/6 with order and 11 monthly payments of 7/-.

12 EXIDE W.H. HIGH-TENSION ACCUMULATORS (120 volts, 5,000 m.a.). Higher voltages if desired.

Cash Price, £3/15/- or 7/6 with order and 11 monthly payments of 7/-.

Carriage charged on all orders from Scotland.

N.K. FARRAND INDUCTOR LOUD-SPEAKER UNIT.—Quality of reproduction almost equal to a moving-coil speaker. Cash Price, £3/10/-.

or 5/6 with order and 11 monthly payments of 6/0.

SET OF THREE VALVES, S.G., DET. AND POWER, MULLARD OR COSSOR.

Cash Price, £1/19/0 or 6/- with order and 7 monthly payments of 5/4.

NEW BLUE SPOT 6ER UNIT.—The finest balanced-armature movement on the market. Complete with large Cone and Chassis.

Cash Price, £2/10/- or 5/- with order and 10 monthly payments of 5/-.

NEW CELESTION MOVING COIL L.S. UNIT (PERM. MAGNET), with Transformer.

Cash Price, £4/5/- or 13/6 with order and 10 monthly payments of 8/-.

Send list of requirements and quotation will be sent by return.

Any Radio Goods sent C.O.D. We pay carriage and all C.O.D. charges.

LONDON RADIO SUPPLY CO. 11 OAT LANE NOBLE STREET, LONDON, E.C.2 Telephone: National 1977

BROADCAST TELEPHONY

Broadcasting Stations classified by country and in order of wavelengths. For the purpose of better comparison; the power indicated is aerial energy.

Table with columns: Kilo-Metres cycles, Station and Call Sign, Power (K.w.), Kilo-Metres cycles, Station and Call Sign, Power (K.w.), Kilo-Metres cycles, Station and Call Sign, Power (K.w.). Rows include Great Britain, Austria, Belgium, Bulgaria, Czechoslovakia, Denmark, Estonia, Finland, France, Italy, Ireland, Latvia, Lithuania, Germany, North Africa, Norway, Poland, Portugal, Romania, Russia, Spain, Sweden, Switzerland, Turkey, Yugoslavia.

WHEN SUBMITTING QUERIES

Please write concisely, giving essential particulars. A Fee of One Shilling (postal order), a stamped addressed envelope, and the coupon on the last page must accompany all letters. The following points should be noted. Not more than two questions should be sent with any one letter. The designing of apparatus or receivers cannot be undertaken. Modifications of a straightforward nature can be made to blueprints, but we reserve to ourselves the right to determine the extent of an alteration to come within the scope of a query. Modifications

to proprietary receivers and designs published by contemporary journals cannot be undertaken. Readers' sets and components cannot be tested at this office. Readers desiring specific information upon any problem should not ask for it to be published in a forthcoming issue, as only queries of general interest are published and these only at our discretion. Queries cannot be answered by telephone or personally. Readers ordering blueprints and requiring technical information in addition, should address a separate letter to the Query Department and conform with the rules.

According to a Milan "daily" the total number of registered licence holders in Italy, despite the number and power of the broadcasting stations does not yet exceed 137,000. What is expected to be one of the most interesting Scottish broadcasts will take place on October 2. This is the presentation of The Lost Cause, a wireless drama by Compton Mackenzie.

Postcard Radio Literature

A New L.T. Supply

THE Standard Battery Co. has produced a new type of low-tension supply known as the A.D. Radio Cell which should make a big appeal to amateurs who are not within easy reach of accumulator charging stations. The A.D. Cell works for eighteen months or two years without any attention at all, and should provide a very cheap L.T. source. A free folder can be had describing the idea. **571**

Radio without the "Owe"

That is the slogan which Hustler, Simpson & Webb, Ltd., have adopted for their new four-guinea two-valve set. This is a battery-operated job in a fine table-type cabinet. It is well described in a new leaflet just issued. **572**

The Osram Valve Guide

Every year the General Electric Co., Ltd., brings out the Osram Valve Guide, a handy little book of interest to all valve users. I strongly advise every owner of a valve set to get a free copy of the new issue of this, because not only is it a catalogue of the latest Osram valves, but it also gives many hints and tips on reception and handy tuning logs. **573**

"On Choosing a Voice"

This does not mean choosing a voice for yourself, but for your set! It is the slogan adopted by Blue Spot emphasising the necessity for choosing a speaker of good tone. It is also the title of a new folder, a copy of which I advise you to get, giving details of the popular 70R, 44R, 45R, and 30P.M. speakers. **574**

Good Testing Meters

A loose-leaf folder of Park Royal Miniature Testing Meters, moving-coil and moving-iron types, should be on the workbench of every keen amateur. Copies can be had free and it is advisable to state the range and types of meter which will most generally be used. **575**

GET THESE CATALOGUES FREE.

Here "Observer" reviews the latest booklets and folders issued by well-known manufacturers. If you want copies of any or all of them FREE OF CHARGE, just send a postcard giving the index numbers of the catalogues required (shown at the end of each paragraph) to "Postcard Radio Literature," "AMATEUR WIRELESS," 58-61, Fetter Lane, E.C.4. "Observer" will see that you get all the literature you desire.

It should be noted that the "Life Preserver" type of charge indicator incorporated in Fuller accumulators, described in "A.W." 483 is a feature of the current range of accumulators and is not only included in the productions for 1932. It is incorporated in all the present Fuller accumulators, with the exception of the jelly-acid and high-tension wet types.

New Times Sales Co

We can supply any accessory advertised in "Amateur Wireless" on EASY TERMS. Send us your next order. We guarantee you every satisfaction.

NEW TIMES SALES PERMANENT MAGNET MOVING COIL SPEAKER. In handsome oak french polished cabinet with specially designed Epoch Chassis giving glorious tone and volume. With multi-ratio transformer. Cash price £3 15s. 0d. Balance in 11 monthly payments of 6/11.

With 6/11 order

AMPLION MOVING-COIL SPEAKER, TYPE M.C.6. Permanent magnet, with output transformer. Complete. Cash price £3 7s. 6d. Balance in 11 monthly payments of 6/2.

With 6/2 order

BLUE SPOT PERMANENT MAGNET MOVING-COIL SPEAKER. Complete with input transformer. Cash price £3 15s. 0d. Balance in 11 monthly payments of 6/11.

With 6/11 order

EPOCH PERMANENT MAGNET MOVING-COIL SPEAKER. Type A.I. Cash price £3 3s. 0d. Balance in 11 monthly payments of 5/9.

With 5/9 order

B.T.H. R.K. MINOR PERMANENT MOVING-COIL SPEAKER. Capable of handling outputs up to 2 watts. Cash price £2 10s. 0d. Balance in 8 monthly payments of 6/-.

With 6/- order

W.B. PERMANENT MAGNET MOVING-COIL SPEAKER, TYPE P.M.3. With 3-ratio input transformer. Price £2 12s. 6d. Balance in 9 monthly payments of 5/10.

With 5/10 order

R.&A. "100" MOVING-COIL REPRODUCER. Complete with tapped Input Transformer. Cash price £2 17s. 6d. Balance in 11 monthly payments of 5/4.

With 5/4 order

ORMOND PERMANENT MAGNET MOVING-COIL SPEAKER. With input transformer. Cash price £3 5s. 0d. Balance in 11 monthly payments of 6/-.

With 6/- order

LAMPLUGH, FARRAND, BLUESPOT, FERRANTI DYNAMIC INDUCTOR SPEAKER for perfect reproduction. Unit and chassis complete, ready mounted. Cash price £3 10s. 0d. Balance in 11 monthly payments of 6/5.

With 6/5 order

NEW N & K INDUCTOR DYNAMIC SPEAKER. Unit and Chassis complete. Cash price £3 10s. 0d. Balance in 11 monthly payments of 6/5.

With 6/5 order

EPOCH J.I. PERMANENT MAGNET MOVING COIL SPEAKER. In Chassis form with multi-ratio input transformer. Cash price £2 12s. 6d. Balance in 11 monthly payments of 4/10.

With 4/10 order

GARRARD INDUCTION GRAMOPHONE MOTOR MODEL 202. Mounted on 12-inch Nickel Motor Plate with fully automatic electric starting and stopping switch. Cash price £2 18s. 6d. Balance in 11 monthly payments of 5/4 only.

With 5/4 order

DELIVERIES OF NEW RADIO STOCK ON REALLY EASY TERMS FROM

ELIMINATORS

ATLAS A.C. ELIMINATOR TYPE A.C.244. Three tappings, S.G., Detector, and Power. Output, 120 volts at 20 m/a. Cash price £2 19s. 6d. Balance in 11 monthly payments of 5/6.

With 5/6 order

EKCO K.18 COMBINED H.T. ELIMINATOR AND L.T. TRICKLE CHARGER. Delivers 18 m/a, and suitable for 1- to 5-valve sets. S.G., 50/80 volts, 120/150. Charges at .25 amp. at 2, 4, or 6 volts. A.C. Mains. Cash price £4 12s. 6d. Balance in 11 monthly payments of 8/6.

With 8/6 order

REGENTONE ELIMINATOR, TYPE W.1F. Three tappings, S.G., Detector, and Power. Output 120 volts at 12 m/a. A.C. Mains. Cash price £2 7s. 6d. Balance in 5 monthly payments of 8/4.

With 8/4 order

EKCO H.T. UNIT, TYPE A.C.25. For multi-valve sets requiring up to 25 m/a. 3 tappings. S.G., detector and 120/150 volts. For A.C. Mains. Cash or C.O.D. Price £3 17s. 6d. Balance in 11 monthly payments of 7/1.

With 7/1 order

HEYBERD H.T. UNIT "D" MINOR—Output 120v. at 12 m/a—Tapped at 80v., 100v., and 120v. Westinghouse rectification. A.C. Mains. Cash price £2 17s. 6d. Balance in 11 monthly payments of 5/4.

With 5/4 order

EXIDE 120-VOLT TYPE W.H., H.T. ACCUMULATOR, in crates. Cash price £4 13s. 0d. Balance in 11 monthly payments of 8/6.

With 8/6 order

MANUFACTURERS' KITS

COSSOR 234 EMPIRE MELODY MAKER Screened-grid, Detector, and Power. With valves and cabinet. CASH PRICE £6 15s. 0d. 10/- Balance in 11 monthly payments of 12/6. WITH ORDER

MULLARD 3 1932 TYPE Screened-grid, Detector, and Pentode. With valves less Cabinet. CASH PRICE £6 10s. 0d. 11/11 Balance in 11 monthly payments of 11/11. WITH ORDER

OSRAM NEW MUSIC MAGNET 4 Two Screened-grid, Detector, and Power. With valves and cabinet. CASH PRICE £10 15s. 0d. 19/8 Balance in 11 monthly payments of 19/8. WITH ORDER

V.3 RADIO FOR THE MILLION Screened-grid, Detector, and Power. With valves less cabinet. CASH PRICE £5 17s. 6d. 10/9 Balance in 11 monthly payments of 10/9. WITH ORDER

SIX-SIXTY CHASSIS KIT BATTERY MODEL Complete three gang band-pass tuning, S.G. Detector and Pentode. With valves less Cabinet. CASH PRICE £6 17s. 6d. 12/7 Balance in 11 monthly payments of 12/7. WITH ORDER

SIX-SIXTY CHASSIS KIT A.C. MODEL Complete as above with A.C. Mains Valves. With valves less cabinet. CASH PRICE £7 6s. 6d. 13/5 Balance in 11 monthly payments of 13/5. WITH ORDER

ESTABLISHED IN 1924. FIRST WITH EASY TERMS

NEW TIMES SALES CO., 58 LUDGATE HILL, LONDON, E.C.4. Phone: CENTRAL 2715.

(a) Please send me further particulars of.....

(b) I enclose..... d. as first payment for.....

NAME.....

ADDRESS.....

A.W. 3/10/31.

GET THE BEST OUT OF RADIO

The B.B.C. transmissions are worthy of the best possible reproduction. You cannot obtain the best possible reproduction unless your receiver comprises a good circuit, incorporates the best possible components, and operates a good speaker. Recognising this, FERRANTI from the outset produced the best possible components, and a receiver built on FERRANTI lines will give profound and lasting satisfaction.

Charts showing the construction of Receivers, Amplifiers, and Eliminators, free on request accompanied by 1½d. stamp to cover postage.

AUDIO-FREQUENCY TRANSFORMERS, OUTPUT TRANSFORMERS, and PUSH-PULL TRANSFORMERS, CHOKES, CONDENSERS, and RESISTANCES. MEASURING INSTRUMENTS, A.C. & D.C. BATTERY ELIMINATORS FROM £3 10 6 TO £11 11 0. SPEAKERS: PERMANENT MAGNET MOVING COIL, A.C. MAINS ENERGISED, D.C. MAINS ENERGISED

Also Available in Chassis form.

Fully descriptive pamphlets available on request.

The third Edition of "The True Road to Radio" is now available.

FERRANTI FOR TRUE REPRODUCTION

FERRANTI Ltd. Head Office & Works: Hollinwood, Lancs.
London: Bush House, Aldwych, W.C.2.

FORMO
ARTHUR PREEN & CO. LTD.

6/-

S-L-O-W
MOTION
THAT MEANS
QUICK
STATION
FINDING

3/-

1/6

FORMO
ARTHUR PREEN & CO. LTD.

DIFFERENTIAL
CONDENSER

For reaction, the Formo differential condenser achieves the smoothest possible control. Complete with moulded knob.

THE FAMOUS
FORMO-DENSOR

The product is the pioneer of small compression-type Condensers, and for all purposes where some flexibility in capacity is required, the Formo-Densor is a product of assured reliability and precision. TYPE F, J, G, 1/6. TYPE H, 2/3.

ARTHUR PREEN & CO. LTD.
GOLDEN SQUARE, PICCADILLY CIRCUS, W.1.
CROWN WORKS, REGENTS PARK, SOUTHAMPTON

At last! A panel guaranteed NEVER TO DISCOLOUR

PERMCOL *The Perfect Ebonite Panel*

Specified by the leading technical journals and recognised as the only Ebonite Panel that will never discolour. Neither chips nor splinters. Easy to cut and drill. Splendid insulation. Low in price.

Such is PERMCOL, the Panel with the mirror-like surface. Black or Mahogany. Ask your Dealer, or direct, cash or C.O.D.

BRITISH MADE.

PERMCOL MIRROR-POLISH 1/2" PANELS

Size,	Black Polished.	Mahogany Finish.
7" x 14"	3/6	4/3
7" x 18"	4/6	5/6
7" x 21"	5/3	6/4
8" x 16"	4/7	5/6

BRITISH HARD RUBBER CO. LTD. (Dept. A),
Wharf Road Works :: Ponders End, Middlesex.

POWER—DEPENDABILITY

The cheapest and best method of obtaining dependable power for your mains receiver.

PHILIPS "MINIWATT" RECTIFYING VALVES the result of patient and extensive research in the best equipped and largest valve laboratories in Europe.

Type	Full Wave	m.A.	List Price
1821	250 v.	60	15/-
1807	350 v.	120	17/6
1561	500 v.	120	22/6
Type	Half Wave	m.A.	List Price
1562	750 v.	110	30/-

PHILIPS PIONEERS OF ALL-ELECTRIC RADIO

PHILIPS LAMPS LTD.,
Philips House, 145 Charing Cross Rd., London, W.C.2.

Get a Thrill!

BREAK AWAY FROM THE TIES OF ORDINARY BROADCAST AND RECEIVE WORLD-WIDE TRANSMISSIONS DIRECT WITH THIS

No Soldering. No Technical knowledge required. MODERN SHORT-WAVE ASSEMBLY



Blueprint and full details, 1/- post free

Free from hand capacity. Perfectly smooth reaction. Absolute simplicity in erection and control.

Price for complete assembly, with coils for 15.55 metres ... £3 16 0

(Individual parts obtainable)

STRATTON & Co., Ltd., WEBB'S RADIO STORES,
Bromsgrove Street, 164 Charing Cross Road, W.C.2,
Birmingham. Tel.: Temple Bar 2944.

SCIENTIFIC
AN "EDDYSTONE" PRODUCT.

Constructors!

CAN YOU BUILD BETTER THAN H. L. O'Heffernan (The World Champion) WHO USES ONLY

FRANKLIN THE CHAMPION CONDENSER



All capacities available, tested 500 volts or 1,500 volts D.C.

Mr. H. L. O'Heffernan, winner of the International Relay Competition, chose FRANKLIN Condensers for his set because by every test they were superior. You cannot afford to ignore this evidence. It stamps FRANKLIN as the CHAMPION Condenser—the condenser for all constructors who desire absolute reliability.

Go to your dealer now and insist upon having FRANKLIN. In case of difficulty, send direct for complete list and name of nearest stockist.

FRANKLIN ELECTRIC CO., LTD.
Franklin House, 150 Charing Cross Road :: London, W.C.2

CLIX "OLYMPIAN THREE" KIT

Contains all Clix fitments as specified by "Amateur Wireless"

- 7 Wander Plugs
 - 2 Spade Terminals
 - 4 Panel Terminals
 - 1 S.G. Anode Connector
- 2/6

All correctly engraved. Save time and trouble.

From your dealer, or direct from us, Post Free.



PANEL TERMINAL 3d.



"FIT-ALL" SPADE TERMINAL 2d.

Folder "A" on request.

Cheapest PERFECT Contact

Ledro, Linx, Ltd., 254 Vauxhall Bridge Road, S.W.1

You will Help Yourself and Help Us by Mentioning "A.W." to Advertisers

PREPAID ADVERTISEMENTS

Advertisements under this head are charged THREEPENCE PER WORD, minimum charge THREE SHILLINGS. DEPOSIT SYSTEM

As the Publishers cannot accept responsibility for the bona fides of advertisers in this publication, they have introduced a system of deposit which it is recommended should be adopted by readers when dealing with persons with whom they are unacquainted.

Intending purchasers should forward to the Publishers the amount of the purchase money of the article advertised. This will be acknowledged to both the Depositor and the Vendor, whose names and addresses must necessarily be given. The deposit is retained until advice is received of the completion of the purchase, or of the article having been returned to and accepted by the Vendor.

The amount of the Deposit and Fee must be remitted by Postal Order or Registered Letter (Cheques cannot be accepted), addressed to

"AMATEUR WIRELESS" ADVERTISEMENT DEPARTMENT, 58/61 FETTER LANE, LONDON, E.C.4

NEW ELECTRIC GRAMOPHONE MOTORS, 5-guinea models, suit A.C. or D.C., complete with 12-in. turntable, switch, regulator, etc., blueprint instructions, money return guarantee; 40/- each.—King, 1 Kingsley Road, Hounslow, Middlesex.

HIRE A MICHAEL PORTABLE SET, 15/- weekly. Sets visited, repaired, overhauled.—Alexander Black, Wireless Consultant, 55 Ebury Street, S.W.1 Sloane 1655.

CABINETS.—New illustrated lists; keen prices; immediate delivery.—Imperial Cabinets, 18 Summerhill Street, Birmingham.

MOVING-COIL SPEAKERS. "Acouston" 4-v., 20/- Marconiphone Pots, 6-v., 15/- Tapped L.F. Chokes, 4/6.—Hillier, 22 Cork Street, W.1.

HALF PRICE.—New, All-Electric Radio-Gram., S.G.3, A.C. 200-240 volts, complete with valves and speaker. Listed £48, sell £24.—J. Terry, 200 Lordship Lane, London, S.E.22.

VERT WIRING CLIP.—No soldering. Fits any component. Perfect contact. Tested and approved "A.W." Quarter gross, 1/2; half-gross, 2/-; gross, 3/9.—Green & Sons, Reddiffe, Horley, Surrey.

"UNIVERSAL" RADIO BARGAINS.—Valves, 3/11. Six-pin Dual Coils, 3/11. Differentials, 1/9. H.F. Chokes, 1/3. Transformers, 2/9. Postage extra. Thousands of other bargains. Send for list.—"Universal," 20 Victoria Road, Peckham, S.E.15.

"ETHER SEARCHER" COILS, switch, Colvern, 24/-; 4 Colvern screens, 11/6; Ferranti Push-pull Input, 15/-.—Clough, 21 Swaine Street, Bradford.

LINEN SPEAKERS (as described page 390, "Amateur Wireless," Sept. 19). Complete set of machined woodwork, including nickel-plated Tension Bolts, 10/6, carriage paid.—Croftons, 408 High Street, Lewisham, S.E.13.

CABINETS.—We specialise in specials. Send sketch and details. No lists issued.—Croftons, 408 High Street, Lewisham, S.E.13.

LOUD-SPEAKER CABINETS.—Unpolished, 14 in. by 14 in. by 8 1/2 in. deep, 5/- post free. State size of cone.—Croftons, 408 High Street, Lewisham, S.E.13.

A TRICKLE-CHARGER FOR 7-1 Postage -/9. The "Tonic" self-generating trickle-charger kit will help you economise, by keeping your 2-volt accumulators fully charged at home. A boon to town or country dwellers.—Williams, Netherend, Crodley, Birmingham.

PERSONS REQUIRED immediately to make Leather Matting: regular work supplied, cash paid weekly.—Write E. 87, "Everlast" Leather Matting Co., Wellington-Brook.

OAK CABINETS, hand polished, 14 in., 16 in., or 18 in. by 7 in. by 10 in., 8/6; 21 in. by 7 in. by 10 in., 10/- C.P. Baseboards, -/6 and -/9. C.W.O. Rebound unsatisfied. Send for price list of type of cabinet required, state nearest station.—F. S. Gibson, 99 Burnley Road, Ainsdale, Dept. A.W.

"CENTURY SUPER" PORTABLE COMPONENTS, complete, new, H.B. cabinet, aerial, valves, speaker, £8/10.—31 Morton Avenue, W.7.

SET WEARITE CENTURY COILS, Lewcos Frame Aerial, 65/-.—25 Beaufort Mansions, S.W.3.

MAKE YOUR OWN SPEAKER UNIT.—Simple inexpensive Cone L.S. Unit easily made in an hour for a few pence. Improved compensated armature movement (Prov. pat. 455/81), "crystal set" tonal balance. No chassis required. Complete illustrated instructions P.O. 1/- and stamped addressed envelope.—W. S. Osborn, 63 Abbots Park Road, London, E.10.

LIQUIDATION STOCK of Brand New Components. Wearite Superhet Coils, 38/- set; Polar 3-gang, with dial, 21/- Speakers, Square-peak Coils, Transformers, etc.—6 Cyprus Avenue, N.3.

PARTS CENTURY SUPER, half cost price. Guaranteed. Deposit.—Write Box A.T., c/o "Amateur Wireless," 58 Fetter Lane, E.C.

WIRELESS PARTS AND SETS exchanged for new. Up to 50% or more allowed for modern parts in good condition. Apparatus can be sent for valuation.—W. Burns, Wireless Factor, 4 Loanda Street, Haggerston, E.8.

COMPONENTS.—Send for particulars, special offer to home constructors.—Magradio, 112a Warstone Lane, Birmingham.

BANKRUPT BARGAINS.—List free with 3-valve diagram. Kits for all circuits. Straight 2, 24/-; Straight 3, 32/6; Century Super, 82/-; £33/3—Four, 57/6; all with cabinets. Transformers, 2/8; Selector alloy core, 4/3; Telsen Ace, 4/9; Radiogram, 7/6; Wavemaster variables, .0005, 2/6; Differentials, 2/-; Telsen Differentials, 1/9; Zeico Bakelite S.M. .0003 and .0005, 4/-; Wavemaster, 5/-; Astra, 5/-; all with dials. Midget, 0005, 1/9; H.F. Chokes, 1/3; Telsen, 1/9; Dual coils, 4/-; Telsen, 4/9; Plug-in from 1/-; fixed condensers, 2-mid., 2/-; 1-mid., 1/8; .0001 to .002, -/5; .01, -/9; leaks, -/3; pre-sets, 1/3; switches, -/6; 3-point, 1/-; valveholders, -/3; panels, 14in. x 7in., 2/6; 18in. x 7in., 3/-; Cabinets, oak, 12in. x 8in., 9/6; 14in. x 7in., 8/-; 18in. x 7in., 10/-; Speaker, 5/-; Speaker units, Zeico, 4/-; Telsen, 4/9; Triton, 9/6; also Motor, etc. Speaker kits from 40/6. Eliminators, A.C. with Westinghouse, £2, D.C., 22/6. Keen prices for all types. Valves, Tungram, Triton, 4/6; power, 5/6; S.G., 10/- Sets, 3-valve in cabinet, 37/6, or complete Tungrams, H.T., L.T., G.B., 62/6. Varley electric A.P.1., £16/10/- set, A.C.; Mazda £5/10/-; screened-grid portable complete, £5/10/-; Marconi 3-valve S.G., secondhand, 25/- Get my price for anything radio first. Quotations by return. State your requirements. Satisfaction or money back. Cash or C.O.D. No H.P. All goods new.—Butlin, 143B Preston Road, Brighton.

EXPERIMENTER has for sale A.C. Century Super, fully decoupled, Wearite frame, cabinet, Regentone; cost £30, accept £22 10s. View Singer's, 397a Edgware Road, W.2.

MODERN THREE-VALVE SETS with valves, £3/15/- Century Super kits, £3/15/- Anything wireless supplied at keepest prices. Send list of requirements for quotation.—Servwell Wireless Supplies, 74 Gough Street, London, E.14.

PHOENIX THREE-VALVE KITS, complete with cabinet £1/17/6. Ditto with valves, £2/15/- Ditto with H.T. and L.T. batteries and speaker, £4/10/6. Three-valve S.G. kits, 30/- extra. H.P. terms on kit; 10/5 deposit 2/7 per week.—Phoenix, 314 High Road, Lee, S.E.13.

"OLYMPIAN THREE," "Wireless Magazine," "Music Magnet," Corsor and Mullard kits—Immediate delivery from stock. Any Receiver, Moving-coil Speaker, etc., supplied. Send us your enquiry.—The Jupiter Radio Service, 9 Sansom Street, London, S.E.5.

"STANDUP" Wet Battery replacements. All sizes up to 30,000 milliamperes capacity. Lists free.—Scottish Batteries, Braeside, Uphall Station.

FULL-SIZE BLUEPRINTS

When ordering, please send Postal Order, NOT STAMPS.

CRYSTAL SET (6d.)

1931 Crystal Set AW308

ONE-VALVE SETS (1s. each)

Easy to Build One AW304
Hartley One WM198

TWO-VALVE SETS (1s. each)

Talisman Two (D, Trans) AW194
No-Battery Gramo-radio 2 (D, Trans) AW238
1930 Talisman 2 (D, Trans) AW239
Arrow Two (D, Trans) AW249
Forty-five-shilling Two (D, Trans) AW250
Searcher Short-wave 2 (D, Trans) AW259
Everybody's All-in 2 (D, Trans) AW273
Twenty-shilling Two (D, Trans) AW274
B.B.C. Selective Two (D, Trans) AW292
The Room-to-Room 2 (D, Trans) AW298
Big-volume Two (D, Pentode) AW309
Cleaner Two (D, Trans) WM201
Merlin Two (A.C. Set) WM213
Five-point Two (D, Trans) WM220
Brookman's A.C. Two (D, Trans) WM225
Aladdin Two (D, Trans) WM231
Ever-Tuned Regional Two (D, Trans) WM241
Station-finder Two (D, Trans) WM253

THREE-VALVE SETS (1s. each)

1931 Ether Searcher (SG, D, Trans) AW271
1931 Ether Searcher (A.C. model) AW276
Mains Unit AW277
Ultra-selective Straight Three (SG, D, Trans) AW282
1931 Ether Searcher (D.C. model) AW284
Mains Unit AW285
Square Peak Three (SG, D, Trans) AW293
B.B.C. Selective Three (D, RC, Trans) AW289
Universal Short-wave Three (SG, D, Trans) AW301
Olympian Three (SG, D, Trans) AW306
Brookman's Three (SG, D, Trans) WM161
Five-point Three (SG, D, Trans) WM212
New Brookman's Three (SG, D, Trans) WM218
Five-point Short-waver (D, RC, Trans) WM223
Baffle-board Three (D, RC, Trans) WM226
Plug-in-coil Three (D, 2 Trans) WM232
Regional Three (SG, D, Trans) WM236
Band-pass Inceptrordyne (SG, D, Trans) WM244
Ether Marhall (SG, D, Trans) WM247
Meridian Short-waver (D, RC, Trans) WM256
Five-advantage Three (D, RC, Trans) WM257
Everybody's Radiogram (SG, D, Trans) WM258

FOUR-VALVE SETS (1s. 6d. each)

The £3 3s. Four (SG, D, RC, Trans) AW303
The £3 3s. Four (Improved Model) AW303A
Everybody's Radio-gramophone AW
Regional Band-pass Four (SG, D, RC, Trans) WM211
Five-Point Four (SG, D, RC, Trans) WM216
Regional A.C. Four (SG, D, RC, Trans) WM222
Supertone Four (SG, D, Push-pull) WM227
Brookman's Three-plus-one (SG, D, RC, Trans) WM233

FIVE-VALVE SETS (1s. 6d. each)

Regional D.C. Five (SG, D, RC, Push-pull) WM252

MISCELLANEOUS (1s. each)

Our H.T. Unit for A.C. Mains AW262
Gramophone Tone Control AW264
Short-wave Super-het Adaptor AW268
H.T. Unit and Trickle Charger for D.C. Mains AW272
Booster Speaker (6d.) AW286
"A.W." Tone changer (6d.) AW288
"A.W." Selectivity Unit (6d.) AW290
A.C. Trickle Charger AW305
B.B.C. Official Selectivity Unit (6d.) AW294
Amateur's Linen Speaker AW307
Big H.T. Unit for A.C. Mains WM230
Loud-speaker Tone Control WM234
"W.M." Linen Diaphragm Loud-speaker WM235
Two-Minute Adaptor for Short Waver WM240
Super 60 A.C. Unit WM248
Simple Neon Oscillator WM250

Copies of the "Wireless Magazine" and of "Amateur Wireless" containing descriptions of any of these sets can be obtained at 1s. 3d. and 4d. respectively, post free. Index letters "A.W." refer to "Amateur Wireless" sets and "W.M." to "Wireless Magazine."

Amateur Wireless Blueprints Dept., 58-61 Fetter Lane, London, E.C.4

SEND FOR FREE CATALOGUE
GODWINEX
H.T. ELIMINATORS
Here's the greatest Eliminator value ever offered
S.G.A./12 (for screened grid valves) Output 12 ma. 3 positive tappings —50 S.G., and 50- POWER
S.G.A./12 as above, with 12-T. Triode Chatter Models for every type of set. For A.C. or D.C. supplies. Deferred terms. J. DYSON & CO., Ltd. (Dept. A.9), 54-7 Godwin St. BRADFORD

MAKE OR BUY A GRAMOPHONE AT a quarter shop price. Or buy Cabinet for Wireless. British double spring motor, 12 in. velvet turntable, swan arm, metal sound-box, amplifier, needle cups, for £1-16-0 p.p., and build your own Cabinet. Portable Gramophones from 15/8, postage 1/6. Motors from 7/6. Lists free. 64 pp. 1931 Catalogue No. 220 with Reduced Prices, Drawing and How to Make Gramos, 3d. Established 27 years.
Regent Fittings Co., A.W. 120 Old St., London, E.C.1

GRIPSO
PATENT SHROUDED
PLUG & SOCKET
SUPERIOR AND MORE
CONVENIENT THAN TERMINAL
4 1/2 COMPLETE
THE GRIPSO COY.
52 VICTORIA ST. LONDON, W.1

B4 U. BUY your Moving Coil Speaker WRITE NOW FOR
42 pages of valuable information on how to secure REALISTIC REPRODUCTION
BAKER'S
Selhurst
CROYDON SURREY.

TAYLOR WET H.T. BATTERIES
New Prices: Jars 1/3. Sacs 1/2. Zincs 1 Od. Sample doz. 18 Volts complete with bands and electrolyte 4/1 post 9d. Sample unit 6d. illus. booklet free. Bargain list free.
AMPLIFIERS, 30/- 3 VALVE ALL-STATION SET £1.
A. TAYLOR, 57, Studley Road, Stockwell, LONDON.

"Amateur Wireless and Radiovision." Price Threepence. Published on Thursdays and bearing the date of Saturday immediately following. Post free to any part of the world: 3 months, 4s. 6d.; 6 months, 8s. 9d.; 12 months, 17s. 6d. Postal Orders, Post Office Orders, or Cheques should be made payable to "Bernard Jones Publications, Ltd."
General Correspondence is to be brief and written on one side of the paper only. All sketches and drawings to be on separate sheets. Contributions are always welcome, will be promptly considered, and if used will be paid for. Communications should be addressed, according to their nature, to The Editor, The Advertisement Manager, or The Publisher, "Amateur Wireless," 58-61 Fetter Lane, London, E.C.4.

Amateur Wireless
FEE 1/-
INFORMATION BUREAU
COUPON
Available until Saturday
OCTOBER 10, 1931

FIDELITY
VOLUME
PRICE

The R. & A. "100" requires a suitable Output Transformer.

The R. & A. multi-ratio Output Transformer to suit all power valves, including Pentode, is available. Price 12,6



45/-

There is no questioning the superlative merits of the R. & A. "100." Ask your dealer to demonstrate, and compare it with any other permanent-magnet moving-coil speaker. The result will amaze you and convince you that it is impossible to buy a speaker of its type at any price, to equal its performance.

Every detail of design and construction combines to produce the ideal reproducer; a musical instrument in the highest sense of the word, which is so sensitive that perfect results are achieved with inputs from small as well as large receivers.

The more critical you are, the more you will appreciate its beauty of tone, its brilliant response, its remarkable sensitivity and fidelity.

Write us for descriptive literature. Your dealer can supply. If any difficulty, inform us,



REPRODUCERS & AMPLIFIERS LTD.
 FREDERICK ST., WOLVERHAMPTON.

DUBILIER

announce additional capacities now available in their

TYPE 9200 NON-INDUCTIVE CONDENSER



ALL DUBILIER PRODUCTS ARE BRITISH MADE

This Condenser originally designed expressly for use with the Varley Constant Square Peak Coil has proved so popular that we have decided to manufacture it in a range of capacities from .01 to 2 mf. It is definitely non-inductive and is the finest reasonably-priced condenser for use in High Frequency Circuits.

PRICES :

.01 mf. ..	2/-	.25 mf. ..	2/3
.04 mf. ..	2/-	.5 mf. ..	2/6
.1 mf. ..	2/-	1.0 mf. ..	2/9
		2.0 mf. ..	3/9

Working Voltage 250 Volts D.C. Tested 500 Volts D.C.

We are exhibiting at—
THE NORTHERN NATIONAL RADIO EXHIBITION
 MANCHESTER, OCTOBER 7 to 17
 STANDS Nos. 46 and 60

DUBILIER

CONDENSER CO. (1925) LTD.

DUCON WORKS, VICTORIA ROAD, N. ACTON, LONDON, W.3

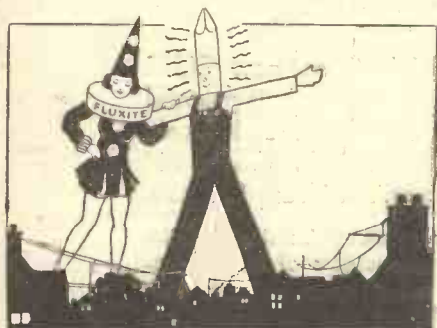

"We're Fluxite and Solder, The reliable pair, Famous for Soldering—Known everywhere! We've soldered all connections, And here's the reward—Good Programmes come clearly, From Home and Abroad!"

See that Fluxite and Solder are always by you—in the house, garage, workshop—anywhere where simple, speedy, soldering is needed. They cost so little, but will make scores of everyday articles last years longer! For Pots, Pans, Silver, and Brassware; RADIO; odd jobs in the garage—there's always something useful for Fluxite and Solder to do.

All Hardware and Ironmongery Stores sell Fluxite in tins, 8d., 1/4 and 2/8.

NEW "JUNIOR" SIZE, 4d. per tin
FLUXITE SOLDERING SET
 Simple to use and lasts for years in constant use. Contains special "small-space" soldering iron with non-heating metal handle; pocket blow-lamp. Fluxite, Solder, etc.; and full instructions
 COMPLETE, 7/6, or LAMP only, 2/6.
FLUXITE, LTD.
 (Dept. 326)
 ROTHERHITHE, S.E.16



ALL MECHANICS WILL HAVE
FLUXITE
 IT SIMPLIFIES ALL SOLDERING

Advertisers Appreciate Mention of "A.W." with Your Order

A pleasure to look at ...
A joy to listen to!

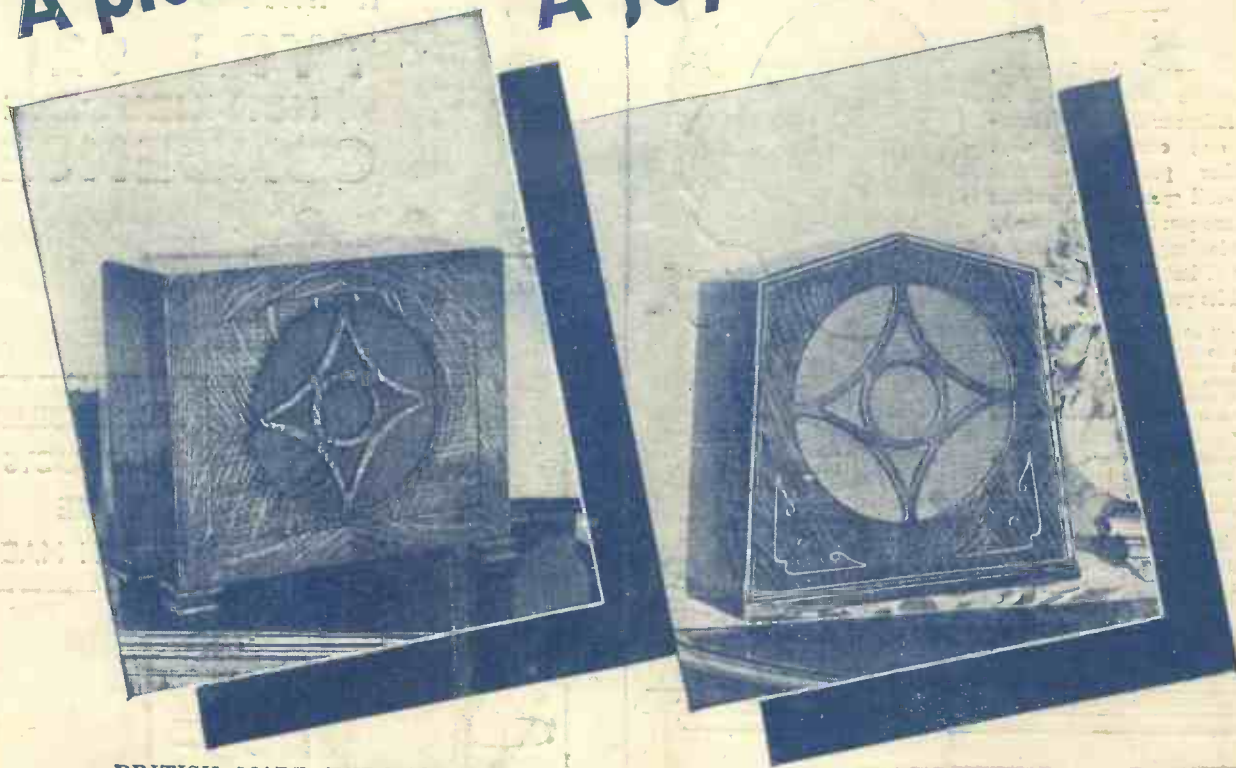

BRITISH MADE THROUGHOUT

Illustrated above on the left is the
BLUE SPOT SPEAKER (in-
ductor type) 100D in Oak.
Price complete 63/-

Illustrated above on the right is the
BLUE SPOT SPEAKER 44R
also in Oak. Price complete 52/6

Write for catalogue A.W. 10 showing complete
range of speakers.



Regd. Nos. 515639 & 516160.

ARENT they beautiful—these new **BLUE SPOT** Loud Speakers with their graceful lines, delightful proportions and lovely graining of fine quality woods. They will enhance any room, harmonise with any furniture.

And the beauty of their appearance is reflected in the beauty of their tone, the faultlessness of their reproduction. Harshness is a word meaningless in their presence, distortion and blurring are unknown to them. Their reproduction is life-like, unbelievably, astonishingly life-like. They make listening-in a pleasure—even the most exacting critic will admit their perfection.

Your dealer is proud to sell these speakers. He will demonstrate them with pleasure. Ask him to do so to-day.

Ask to hear the New **BLUE SPOT RECEIVERS**
—a triumph of modern technical skill. Ask for descriptive leaflet.

THE BRITISH BLUE SPOT COMPANY LTD.

BLUE SPOT HOUSE, 94/96 ROSOMAN ST. ROSEBERY AV., LONDON, E.C.

Telephone: Clerkenwell 3570. Telegrams: "Bluospot, Isling, London."
Distributors for Northern England, Scotland and North-Wales: H. C. RAWSON (Sheffield and London) Ltd., 100, London Road, Sheffield: 22, St. Mary's Parsonage, Manchester; 183, George Street, Glasgow.

240

HOW TO CUT YOUR H.T. COSTS—BY W. JAMES

BUILDING OUR "BIG - VOLUME 2"

Amateur Wireless

Every Thursday 3^d

and Radiovision

Vol. XIX. No. 487

Saturday, October 10, 1931



EVERYBODY'S

BATTERY-OPERATED

RADIO -

GRAMOPHONE

HOW TO MAKE IT - FULL DETAILS

174
174
174
154
22

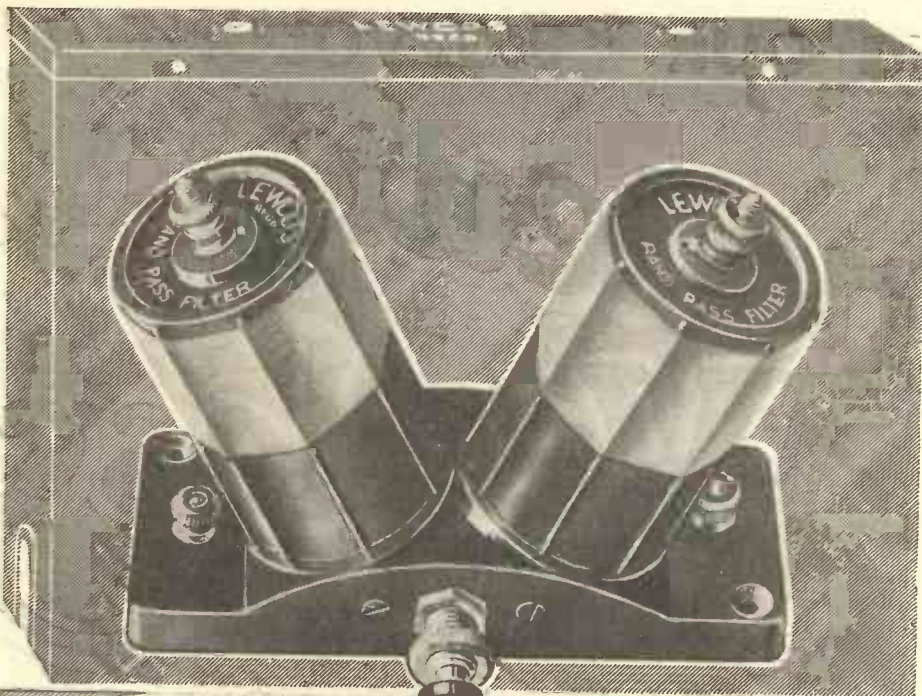

*The
Selectivity
Problem*
**SOLVED by
LEWCOS**

The
LEWCOS
REGD.
BAND PASS FILTER
Price 12/- (Screen 2/6 extra)

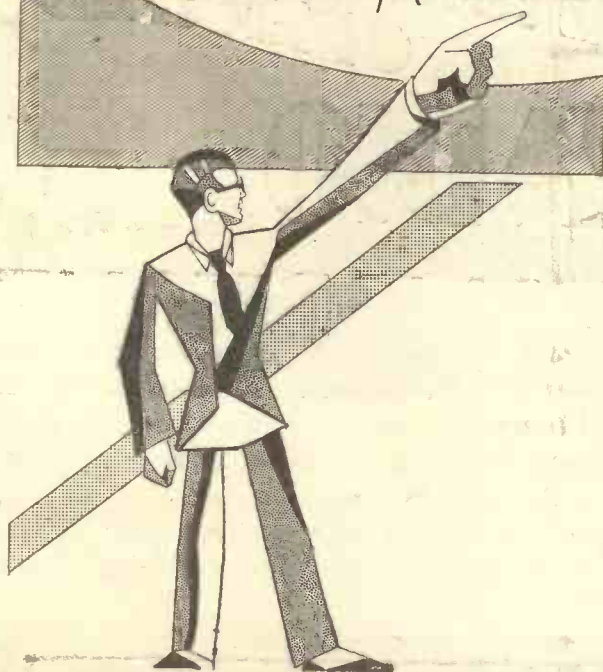

Here, at last, is a component over which you will naturally enthuse, because it ensures selectivity, such as you've heard of, but never before experienced.

THE LEWCOS BAND-PASS FILTER actually increases the range of any receiver because stations which are normally inaudible, due to swamping by local transmissions, now have a place on the dial free from interference.

The phenomenal selectivity of this unique device is apparent on both long and medium wave bands; hence it is infinitely superior to any existing selectivity unit, such as wavetraps, etc.

Write for fully descriptive leaflet, Reference R73, showing flat-topped response curves.

LEWCOS RADIO PRODUCTS FOR BETTER RECEPTION

THE LONDON ELECTRIC WIRE COMPANY AND SMITHS LIMITED, CHURCH ROAD, LEYTON, LONDON, E.10

To Ensure Speedy Delivery, Mention "A.W." to Advertisers

**V3
KIT**

THE GREATEST "RADIO FOR THE MILLION" RECEIVER YET DESIGNED

ENGLAND'S ECONOMY KIT

£5.17.6

COMPLETE WITH VALVES



Get a copy of "Radio for the Million" from your dealer . . . if difficulty send 4½d. in stamps direct.

Modern All-metal Chassis. Three great Mullard valves give terrific power. Exceedingly high degree of selectivity. Control amazingly simple. Performance, supremely efficient; at its price unapproachable. Read "Radio for the Million" and build this receiver, the design of which has been based on the experience gained by bringing wonderful radio to half a million homes.

RADIO FOR THE MILLION

UNITED RADIO MANUFACTURERS, Ltd., 63 LINCOLN'S INN FIELDS, LONDON, W.C.2

Don't Forget to Say That You Saw it in "A.W."

HELPFUL
CRITICAL
OUTSPOKEN
ENTERTAINING
FORCEFUL
UNIQUE
LIVE
FRANK
BRIGHT
CONSTRUCTIVE
TOPICAL
USEFUL
EXPERT



**Capt. P.P.
Eckersley**

—world-famous as one of the pioneers of broadcasting with the Marconi Co. and the B.B.C.—is now Wireless Editor of *The Daily Mail*. His brilliant and outspoken article every Wednesday is one outstanding feature of the day-to-day service for the listener provided by The

**DAILY
MAIL**



That reminds me. have a

PLAYER

The Quality and Quantity Cigarette

**RADIO FOR THE
MILLION**



**The V.3
KIT SET**

complete with valves,
less cabinet

£5 : 17 : 6

IMMEDIATE DELIVERY!

CABINETS, table models, from 11/6

CABINETS, with speaker compartment,
from 22/-

AN ALL-METAL CHASSIS. NO SOLDERING.

WILL DAY, LTD.

19, Lisle St., Leicester Sq., LONDON, W.C.2

'Phone: Gerrard 4476.

AN ENTIRELY NEW RANGE



MULTI-GRID VALVES

An entirely new range of Tungram Multi-grid Valves—the first of the new Tungram series. Of unique construction, they supersede entirely the pentodes at present on the market; they are so arranged internally that the electron stream is *twice* controlled by the grid.

These new valves can be used in any existing pentode receiver without any circuit alteration whatsoever; in ordinary receivers only one extra connection is necessary. Three types of Multi-grid Valves have been introduced: PP230 (2 volt), PP415, and PP430 (4 volt). PP230 will very materially increase the output of the small receiver, although the anode current consumption will in most cases be below that of the ordinary power valve. PP415 and PP430 will be found extremely efficient for the output stage of A.C. Receivers. All Tungram Multi-grid Valves can be supplied with a 5-pin base or 4-pin base with side terminal.

For characteristic curves and other technical information write to Dept. ST4.

Prices: Multi-grid Valves Type PP230, 16/-; PP415, 16/-; PP430, 19/-. Other types from 5/6 to 19/-. Tungram Barium Valves are manufactured under one or more of the following Patent Nos.: 289,762, 289,763, 311,705, and 313,151.

TUNGSRAM ELECTRIC LAMP WORKS (GT. BRITAIN), LTD.
Radio Department, Commerce House, 72 Oxford Street, London, W.1.

Makers of the famous Tungram Electric Lamps,

Branches in Birmingham, Bristol, Glasgow, Leeds, Manchester, Newcastle, Nottingham, Southampton Lamp, Valve and Glass Factories: Austria, Czechoslovakia, Hungary, Italy and Poland. I.F.S. Organisation, Tunggram Lamps & Radio, Ltd., 11 Burgh Quay, Dublin.

Tunggram photo-electric cells: Nava "E" (for scientific measurement), £2 17s. 6d.; Nava "R" Red sensitive cell (for colour matching devices), £3 3s.; Nava "EH" (for public address work), £3 13s. 6d.

3125

TUNGSRAM

You Will Help Yourself and Help Us by Mentioning "A.W." to Advertisers

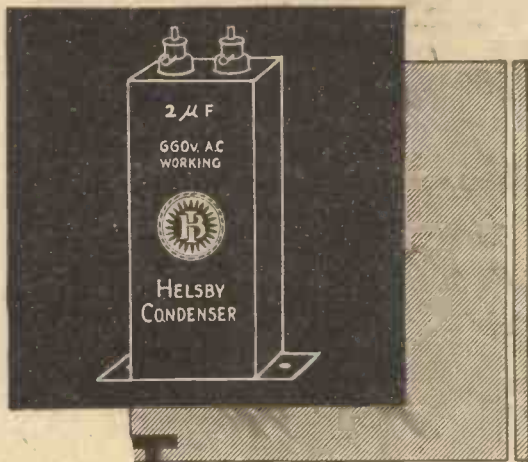

TESTED TO DOUBLE WORKING PRESSURE

Helsby Condensers have been supplied to the G.P.O. and to large manufacturers for thirty years. They are engineer-built, with plates of pure foil, non-hygroscopic, fully tested, and the capacity rating is guaranteed. A boon to the experimenter, for their reliability is unailing.

TWO POPULAR SIZES:

Type 209T. Working voltage, 250 D.C.	
1 mfd. ..	2/7
2 mfd. ..	3/6
Type 212. Working voltage, 400 D.C.	
1 mfd. ..	3/7
2 mfd. ..	4/9

Ask for Helsby Condensers by name—there is a full range to cover every purpose. Types 212 and 212 T are particularly suitable for eliminator circuits.

HELSEBY CONDENSERS

BEST FOR THE CONSTRUCTOR.

If any difficulty in obtaining from your local dealer, please send us his name and address.

BRITISH INSULATED CABLES LTD
PRESCOT... LANCASHIRE
MAKERS OF B. I. CABLES

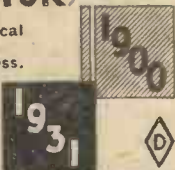

AMPLION MOVING COILS

for Home Constructors

NOW no home constructors need be without the very finest reproductive equipment, with **AMPLION** Moving Coil units at such modest figures. These super-sensitive units will make a world of difference to your results on any circuit; there are many handsome cabinet models, or you can easily fit one to your existing cabinet.

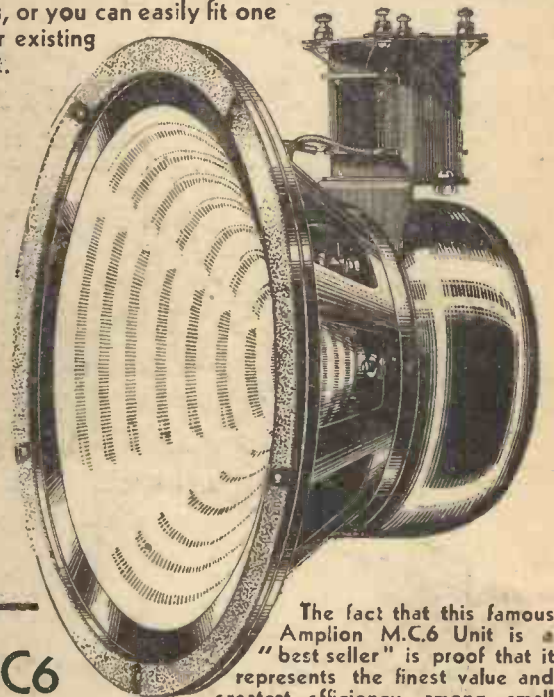

MC6

UNIT, complete with Transformer,

67/6

The fact that this famous Amplion M.C.6 Unit is a "best seller" is proof that it represents the finest value and greatest efficiency among small permanent-magnet moving coil speakers. Its reproduction and sensitivity are really remarkable, and it will handle without distortion adequate volume for all normal requirements. The universal transformer which is fitted enables the speaker to be correctly matched to either Power, Super Power or Pentode output from standard British 2, 3 or 4 valve receivers, and provision is made for push-pull.

D.C. ENERGISED MODEL (E.M. 644)

A MOST efficient unit for D.C. Voltages: 100/110, 200/240, very suitable for inclusion in A.C. sets. Full details of alternative methods of operation supplied with each model

UNIT ONLY **29/6**

UNIT WITH matching transformer **42/-**

M.C.9 UNIT

THIS is a permanent magnet type but larger and more powerful than the M.C.6. A matching transformer can be supplied at an extra cost of 15/-.



M.C.9 UNIT ONLY £6

(or on deferred terms)

GRAHAM AMPLION LTD., 26, Savile Row, W.1

royds

Only ORMOND could produce so perfect a Condenser!

The ORMOND No 6 SLOW MOTION



NEAT
RIGID
ROBUST
PRECISE

Here again is manifested Ormond's intimate knowledge of modern radio requirements. In such a precision instrument, necessitating supreme care in its production, the Ormond high standard of manufacture is fully proved.

This new Ormond condenser is constructed of brass and is very robust. The vanes are perfectly rigid, being firmly secured to slotted spindles. Di-electric losses are reduced to a minimum by the special mounting of the fixed vanes support. The moving vanes are connected to the frame, thus eliminating stray capacity effects.

A slow-motion device, ratio approximately 9 to 1, is incorporated in the condenser and is controlled by the upper small knob, direct drive being obtained on the dial, which is engraved 0 to 180 degrees.

Easy to mount, "one-hole" fixing. Terminals and soldering tags for connections. Complete with 2½ in. dial and slow-motion control knob.

Cat. No.	Capacity	Price
R/484	.00025	6/6
R/485	.00035	6/6
T/486	.0005	6/6

This condenser is also available constructed of aluminium without slow-motion movement, and less dial, in similar capacities at 4/- each.



THE ORMOND ENGINEERING CO., LTD.
Ormond House, Rosebery Avenue, London, E.C.1
Telegrams—"Ormondengi," Isling. Telephone—Clerkenwell 5334/5/6 and 9344/5/6

Instantly popular— THE NEW H.T.8

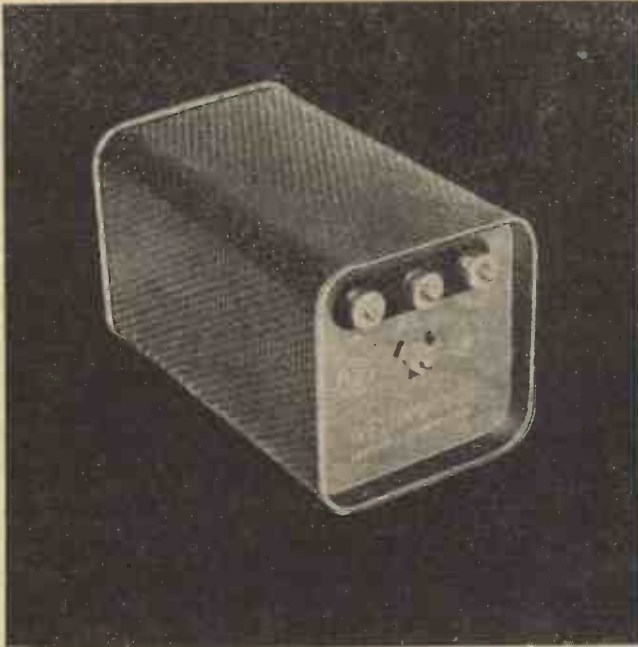

THE H.T.8 Metal Rectifier has become instantly popular for the conversion of three- and four-valve battery-run sets into mains sets; and for incorporating in amateur-built sets of similar design. It has an output of 250 volts, 60 milliamps, after smoothing with an input of 200-210 volts A.C., using the voltage doubler circuit (*described in "The All-Metal Way"). The price of the H.T.8 is 21/-.

Other metal rectifiers for amateurs' use are the H.T.5—D.C. output 120 v., 20 m.a. — price 12/6 ; H.T.6—D.C. output 175 v., 25 m.a.

—price 15/- ; and H.T.7—D.C. output 200 v., 28 m.a.—price 17/6 ; and various low-tension types.

**The 1932 edition of "The All-Metal Way," which will be sent on receipt of the coupon below with 3d. in stamps, gives all the information required to build an H.T. eliminator or trickle charger, and also full details of running moving-coil loud-speakers from the A.C. mains. This well-known book has been completely revised, and many questions which were not fully dealt with in our 1931 issue are now discussed in detail. Westinghouse Metal Rectifiers are shown at Stand 76, City Hall, Manchester, October 7-17.*

WESTINGHOUSE Metal Rectifiers

The Westinghouse Brake & Saxby Signal Co. Ltd.,
York Rd., King's Cross, London, N.1. 'Phone : North 2415.

-----COUPON-----

PUBLICITY MANAGER, W.B. & S.S. Co., 82 York Rd., King's Cross, London, N.1
I enclose 3d. in stamps, for which please send me a copy of "The All-Metal Way, 1932."

NAME _____

ADDRESS _____

A.W.10/10/31

To Ensure Speedy Delivery, Mention "A.W." to Advertisers

MAINS RADIO FOR EVERY TYPE OF BATTERY SET



FOR
10/-
DOWN
AND BALANCE
IN EASY
MONTHLY
PAYMENTS

NO ALTERATIONS TO SET
CONNECTED IN A MOMENT

There's no need to scrap your Battery Receiver to enjoy all the tremendous assets of "Mains Radio."

An "ATLAS" All-Mains Unit converts your old set to All-Mains operation, and endows it with a bigger range, greater volume, and better quality reproduction.

No alterations whatsoever are required to either Set or Valves. Connection and operation are as simple and safe as with dry batteries.

"ATLAS" All-Mains Units form the cheapest and most reliable source of Radio power yet devised. They ensure a constant and never-failing supply of H.T. Current and automatically recharge your accumulator between the periods of reception.

The "ATLAS" Model A.C. 188 won outright the 1930 Olympia Ballot for the best Mains Unit on the market. Since when it has never been equalled. Suitable for Sets up to 5 Valves, it provides 2 Variable H.T. Tappings of 0/100 and 0/120 Volts respectively, and one Fixed of 150 Volts. Output 25 m/A at 150 Volts. L.T. Trickle Charger for 2, 4 and 6 Volt Accumulators at .5 Amps. Size 10" x 5 1/4" x 3 1/2" to fit the space provided in portable and standard receivers. Incorporating the Westinghouse Rectifier, and fully guaranteed for 12 months.

Cash price, £6, or 10/- down and 7 monthly payments of 15/6 each, and one of 14/6.

Ask your dealer or write for full details of the complete range. There are models to suit every requirement.



MODEL A.C. 244.
H.T. UNIT for Sets up to 4 Valves. Output 20 m/A at 120v. 59/6 each or 10/- down and 8 payments of 7/- each.



MODEL A.K. 260.
ALL-MAINS UNIT for Sets up to 4 Valves. Output 20 m/A at 120v. Trickle Charger for 2, 4, and 6 v. accumulators. 90/- cash or 10/- down and 9 payments of 10/- each.

H. CLARKE & CO. (M/CR) LTD.,
Eastnor St., Old Trafford, Manchester. Trafford Park 1744-5-6.
Southern Offices & Stores: Bush House, London, W.C.2. Temple Bar 7130.

**"CLARKE'S
ATLAS"**

THE BIGGER OUTPUT, LOWER PRICED
ALL BRITISH

MAINS UNITS

You will Help Yourself and Help Us by Mentioning "A.W." to Advertisers

This machine - made battery will improve your set

A dry battery consists of a number of small inter-connected cells hermetically sealed in an insulated case. Once the battery is finished no adjustments can be made, no faults can be rectified. That is one reason why you should insist on a Fuller 'Super' H.T. Battery. This battery is machine-made and machine-tested. Here you see the zinc cans with the machine-measured supply of electrolyte. All parts and components are standardised. Nothing can go wrong. Any cell which deviates in the slightest degree from standard is automatically rejected. Therefore every Fuller 'Super' gives exactly the power which is marked on it. Fit one now and your wireless will take on a new lease of life. Full list of all sizes and other types on application.

Type F.1, 60 VOLTS, Price 7/5. Type F.2, 66 VOLTS, Price 7/11
 Type F.3, 99 VOLTS, Price 12/4. Type F.4, 108 VOLTS, Price 13/9
 Type F.5., 120 VOLTS, 15/3.

FULLER 'SUPER' BATTERY
 EMISSION UP TO 20 MILLIAMPS

Visit us at the Manchester and Edinburgh Radio Exhibitions:
 The Motor Show, Stand No. 316, National Hall Gallery

FULLER ACCUMULATOR CO. LTD., CHADWELL HEATH, ESSEX

Telephone: Seven Kings 1200. Telegrams: Fuller, Chadwell Heath.
 Contractors to British and Overseas Government Departments, Railways, etc.



**THE EVEN
 AMPLIFICATION
 AND TONAL
 BALANCE**

The Varley Niclet L.F. Transformer used in the V.3 Kit Set, has the high primary inductance of 45 henries with no D.C. Ratio 3½ to 1.

Primary carries current up to 3 m/a. D.C.

When resistance fed, ratios of 2.5, 3.5, and 4.5 to 1 are obtainable. List No. DP21.

Price . . . 7/6

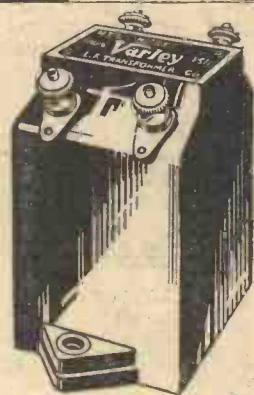

IN V.3 RADIO FOR THE MILLION

**V.3
 KIT SET**

is largely due to the Varley Niclet L.F. Transformer

BUILD QUALITY INTO YOUR SET WITH THE GREAT NEW "SQUARE PEAK" (REG. TRADE MARK) RANGE OF COMPONENTS

Varley

Write for section D of catalogue to—Varley, (Oliver Pell Control, Ltd.), 103, Kingsway, London, W.C. 2.

Advertisers Appreciate Mention of "A.W." with Your Order

EVERYTHING *The* **G.E.C.** ELECTRICAL
your guarantee



*Cuts across all existing
2-volt valve standards!*

The Osram 2-volt battery Valve
with the **NEW, LONGER**

WEMBLEY FILAMENT

★
**10% more
for
your
money**

10% GREATER ELECTRON EMISSION
THAN ANY OTHER 2-VOLT FILAMENT OBTAINABLE

This is the latest discovery of the G.E.C. Research Laboratories at Wembley. The "Wembley" filament means, that without loss of amplification, valves of amazing efficiency can be made with adequate electrode clearances. The avoidance of close electrode clearances results in:

- 1. Greater consistency between valve and valve.
- 2. Cutting out internal contacts and valve troubles.
- 3. Production of non-microphonic valves even under most exacting conditions of use.

Osram
2 VOLT BATTERY
Valves

Write for the Osram Wireless Guide (1931 Edition) and also Station Indicator card sent post Free on Request.

SOLD BY ALL WIRELESS DEALERS

THE NEW "WEMBLEY"
FILAMENT MEANS
MORE RELIABLE
WIRELESS, PURER
TONE AND MORE
FOREIGN STATIONS.

BRITISH PRODUCTS DESIGNED FOR BRITISH RADIO CONDITIONS

Asst. of The General Electric Co., Ltd., Magnet House, Kingsway, London, W.C.2

Please Mention "A.W." When Corresponding with Advertisers

TELSEN H.F. CHOKES

TELSEN BINOCULAR H.F. CHOKE

Hailed unanimously by the leading experts as the perfect H.F. Choke. The Telsen Binocular Choke is called for wherever highest efficiency is desired. Especially in H.F. amplification is the performance of the Choke of supreme importance.

Its highest inductance (180,000 micro-henrys) and exceptionally low self-capacity (.000002 microfarad) ensure a very high impedance at all wavelengths, and its excellent efficiency curve is free from parasitic resonances. These qualities, together with the restricted field due to the binocular formation, make it the ideal choke for a high-class circuit.

Telsen Binocular H.F. Choke Price 5/-

TELSEN STANDARD H.F. CHOKE

The Telsen Standard H.F. Choke utilises the minimum base-board space. It is designed to cover the whole broadcast band and has an extremely low self-capacity. The inductance is 150,000 microhenrys and the resistance 400 ohms.

It has proved very popular and has been incorporated by set designers in many of the leading circuits.

Telsen Standard H.F. Choke Price 2/-

TELSEN
THE SECRET OF PERFECT
RADIO RECEPTION



2/-



5/-

Send for the "Telsen Radio Catalogue" and book of "All-Telsen Circuits" to—The Telsen Electric Co., Ltd., Aston, Birmingham.

CVS-57

Mention of "Amateur Wireless" to Advertisers will Ensure Prompt Attention



BRITAIN'S LEADING RADIO WEEKLY
FOR CONSTRUCTOR, LISTENER & EXPERIMENTER

EDITOR:
BERNARD E. JONES

TECHNICAL EDITOR:
J. H. REYNER, B.Sc., A.M.I.E.E.

RESEARCH CONSULTANT:
W. JAMES.

ASSISTANT EDITOR:
H. CORBISHLEY.

NEWS & GOSSIP OF THE WEEK

DON'T MISS THIS!

THE 100-station "Century Super" created a new field for AMATEUR WIRELESS readers. Nothing like it had ever been designed before; no set had ever been guaranteed to give 100-station performance. W. James, the well-known set designer, spent weeks in perfecting the "Century," and independent tests all over the country proved that the design was right. Now AMATEUR WIRELESS is introducing a new super-het even better than the "Century."

"BRITAIN'S SUPER"

THIS new set is going to revolutionise reception because it is so easy to build, so cheap to run, and so effective in working. It is a five-valver, and does not need a frame aerial. First details are given on page 674, and constructional details and plans will be included in a special feature in next week's issue.

SECRET HISTORY!

AS with all successful productions, there is a story attached to the production of the new "Britain's Super." The AMATEUR WIRELESS Technical Staff realised that successful as certain super-het designs have been in the past they have been handicapped by too many—or too few—valves, and by having to work on a frame aerial to prevent interference with neighbour's reception. Work during the past weeks has been devoted to a new set having five valves, working at three-valve running cost and operating on an ordinary outdoor wire. Many designs passed through the AMATEUR WIRELESS Laboratory, tested and modified in one way or another. The "Britain's Super" is the finished product, and AMATEUR WIRELESS offers it with every confidence. Turn now to page 674 for a preliminary description.

LEONARD HENRY AGAIN

LEONARD HENRY and John Derwent have prepared a revised version of *Peep-bo-hemia*, which will be produced on October 13 (National) and October 15

(Regional) by the indefatigable Gordon McConnel. The original version of this revue was by the late Clifford Seyler. Another forthcoming production is the operetta *Good-night, Vienna*, by Holt Marvell and George Ponsford, one of the first specially written radio productions to be screened. It will shortly be filmed by Herbert Wilcox at the Elstree studios.

RELIGIOUS SERVICES

WE find that 41 services have so far been arranged for broadcasting during the first half of next year. Of these, 17 will be Church of England services, 5 will be Roman Catholic, 6 will be St. Martins, 2 Presbyterian, 3 Congregational, 3 Wesleyan, and 2 Baptist. Something for everybody.

OUR RECORD ISSUE!

ON this page a fortnight ago we claimed a record for our Big Show Number. Indeed, it was an extraordinary record, but we overlooked the fact that our esteemed contemporary, *The Wireless World*, makes its Second Show Number its big issue, whereas most wireless publications, including ourselves, put their greatest effort into their First. We therefore must express our regret that we inadvertently did our contemporary an injustice, inasmuch as its Second Show Number, which was not published when we wrote our announcement, and some of its second Show Numbers of previous years, contained more pages than we claimed; but in fairness to ourselves we must make it clear that the real purpose of our paragraph was to point out that we had made an absolute record for a 3d. wireless weekly published any time and anywhere, in producing an issue of 116 pages, including no less than 78 pages of advertisements, the most profound evidence of the wireless trade's complete confidence it is possible to conceive.

MOSAIC!

THE experiment of mixing poetry and music tried out by the B.B.C. in its recent "mosaic" broadcast was a success, so much so that the subjects of Rebellion, Time, Music, and Friendship are to be

A GIANT FOR RUGBY

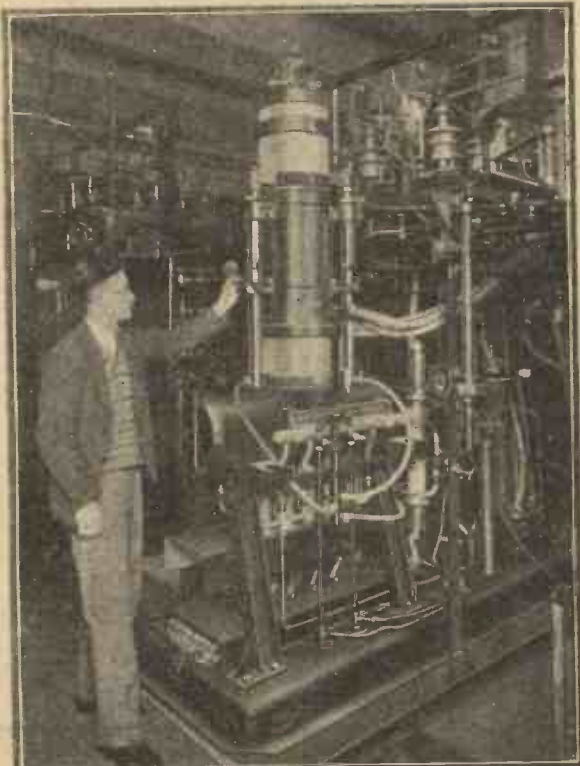

This huge 500-kilowatt valve has no glass in its construction and the vacuum is maintained all the time it is working by a rotary pump. It can be taken to pieces for repair and overhaul and will be used at Rugby

A SPECIAL NUMBER NEXT WEEK—READ THE ANNOUNCEMENT ON PAGE 660

NEWS · & · GOSSIP · OF THE · WEEK —Continued

treated similarly to the initial experiment with the subject of romance. If we must have broadcast poetry, by all means let them say it with music!

WELSH PROGRAMMES

AT last the regular broadcasting of Welsh programmes from the Daventry National station is to be inaugurated. Starting on October 30, and regularly every Friday after that date, Daventry National will broadcast in the Welsh tongue from 6.30 to 6.50 p.m.

MORE TO COME?

THAT this Welsh programme item is only a start may be assumed from the fact that the Welsh Regional Director is now consulting Welsh representatives. This weekly Welsh item will take the place of the Foundations of Music item now broadcast. We understand that the delay in introducing Daventry to the Welsh people in their own tongue was due to the desire to arrange for Mr. Lloyd George to open the feature. As he will probably not be well enough for some time, the feature has been finally fixed up.

B.B.C. "GOES DRY"

IT has been the practice up to the present time to offer eminent artistes and speakers arriving at the broadcast studios a little alcoholic refreshment. In future, the B.B.C. is to "go dry," as part of the general plan of economising. As the Americans would say, the economy sleuths at Savoy Hill have "put the wets on the spot."

STILL BRITISH

IN spite of all the rumours to the contrary, everything at Broadcasting House is of British make. Determined efforts by some of the decorators to introduce foreign material have been strenuously contested by the B.B.C. A slip was made in a certain specification for some material, in which a foreign firm was mentioned. This was immediately cancelled when it was discovered, but it may account for the many rumours.

IN RESIDENCE

ALREADY, 140 members of the B.B.C. staff have moved into Broadcasting House, which will eventually house the whole staff of 600. It is interesting to note that the present staff at work in Broadcasting House is distributed over the whole building, from the first to the seventh floors.

OFFICIAL INSPECTION

DUE to the trickling-in of the different B.B.C. departments to Broadcasting House, there will, as already explained, be no grand opening. It is hoped that when everybody is safely installed, and Broadcasting House is in working order, a Royal inspection will be arranged; H.M. the King or H.R.H. The Prince of Wales?

U.I.R. AT ROME

AT the forthcoming meeting in Rome of the International Broadcasting Union, the B.B.C. will be strongly represented. Admiral Carpendale will preside, and the rest of the B.B.C. team will comprise Mr.

Noel Ashbridge, chief engineer, Major C. F. Atkinson, the B.B.C.'s foreign director, and Mr. Hayes, the B.B.C.'s foreign liaison engineer.

QUEER!

IN the name of economy, the long-awaited filling of the Saturday gap in the B.B.C.'s programmes has been shelved. Yet an extension of broadcast time has been made for religion! A mid-week service from 10.30 p.m. to 10.45 p.m. was started on October 1 from St. Michael's. Surely listeners' interests would have been better served with the promised Saturday afternoon broadcasting extension than with the new religious extension?

CUTTING DOWN ORCHESTRAS

IT has been suggested that the provincial orchestras might be cut down as a B.B.C. economy move. As a matter of fact, Cardiff, Birmingham, Scottish Regional and North Regional studio orchestras are already pruned down to only nine members! Belfast has an orchestra of 32, so there may be some saving in this direction. Much depends on improvement in the landline quality. A considerable improvement would enable relays from home centres to be taken by Belfast.

SUNDAY NIGHT CONCERTS

STARTING on October 18, the B.B.C. symphony concerts, given by its orchestra of eighty, will continue each Sunday evening until next May. At first, the concerts will be played in No. 10 studio, but after Christmas it is expected that they will be given from the Concert Studio at Broadcasting House.

AT MANCHESTER

ON page 673 you will find an account of the Northern National Radio Exhibition now in progress in the City Hall, Deansgate, Manchester. This runs on till next Saturday, October 17. It is open daily from 11 a.m. to 10 p.m., and the admission every day is 1s. 6d. Arrangements have been made with the Railway Companies for reduced-fare vouchers for distances within 60-miles radius of Manchester and provincial readers should take advantage of these.

PRIZES FOR SET BUILDERS

THE Manchester Evening Chronicle is offering £150 in cash prizes for amateur built sets at the Northern National Show. These make an interesting section of the Exhibition and should be seen by all set builders. Make sure you pay us a visit at Stand 18, the home of AMATEUR WIRELESS and the WIRELESS MAGAZINE. Here is a display of the latest AMATEUR WIRELESS winners, including the new "Britain's Super."

THE SET FOR YOU

First details on page 674
of our new five-valver

THEIR NEW HOME!



Over a hundred members of the Savoy Hill staff have moved this week to the new headquarters. Many of the engineers are installed, and broadcasts should soon be heard from Broadcasting House



CLOCKS ALWAYS RIGHT BY WIRELESS

How the Time Signals can be Made to Correct Errors

has not thought that there ought to be a means by which any discrepancy in our thousands of clocks, made apparent to us by the time signal, could be automatically put right?

Foremost among inventors on this problem is Mr. Alfred E. Ball, of Leicester, whose experiments in making wireless time signals actually correct his clocks if fast or slow, began in the distant pre-war days of the first Paris time signal. He was attracted by the idea of utilising the

Fig. 2 shows the ratchet wheel *D* that provided the solution. When the sensitive relay (to be described) makes contact every time one of the first five warning impulses is received, an electro-magnet *A* attracts the armature and releases it on each occasion.

The pawl *C* is made to thrust five teeth forward, but on the sixth impulse there is a contact pin *E* ready to touch the contact spring *G*. The diagram shows how the circuit of the battery *H* is complete except for a gap between *J* and *I*.

When, therefore, on the sixth attraction of the armature *B* to the magnet *A* there is contact between *I* and *J*, current flows

on to the synchronising magnet *M*. Synchronisation of the clock, or a series of clocks, is then effected in a way to be described and successful action is announced by a bell in the circuit.

A further service of the toothed wheel *D* is to break the circuit of the relay, extinguishing the valves and so excluding any further signals from interfering with the system. In the illustration Fig. 2 the pin *E* is seen to have cleared the spring *G*. During that sixth and last movement forward of the ratchet wheel the other pin *E'* passed over the ivory tip of the spring *P*, forcing it out of contact with *Q* and breaking the circuit of the relay. Were this not done an additional and undesirable movement of the counter might be caused by intruding signals

or atmospherics and the working of the counter would be out of gear for subsequent reception of time signals. The valve set for receiving time signals is best reserved exclusively for this purpose so that it may be kept permanently tuned-in. It is better also to install a separate aerial.

The four-valve set Mr. Ball employs has one H.F. stage, detector and two L.F. stages, and is designed to give strong signals, as there is nothing to fear from distortion.

As the H.T. battery is permanently connected to the set there is a reduced

chance of leakage by using only about 60 volts.

The relay to be used for these experiments should be sensitive to small current changes.

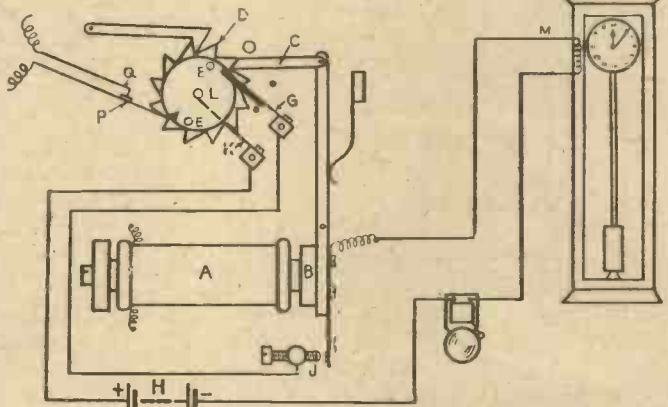
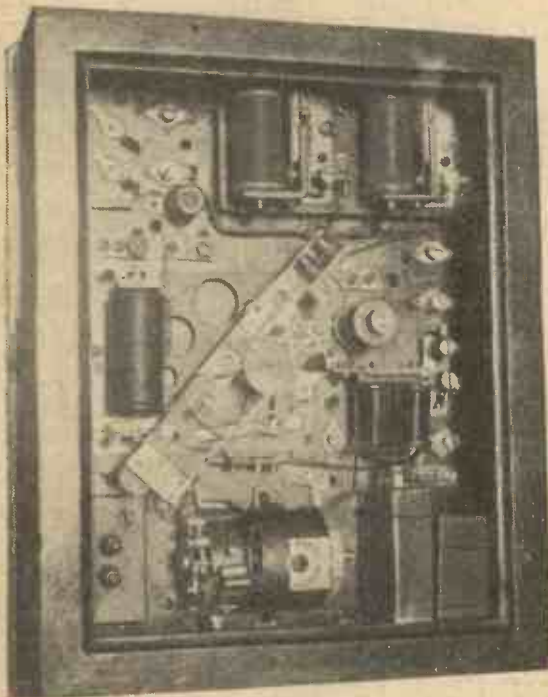

Fig. 2. The means adopted for eliminating the effect of the first five dots

The best type is the moving-coil relay, in Mr. Ball's opinion; it is shown in the photograph Fig. 3. The principle of operation is familiar, the magnetic fields of the permanent magnet reacting upon the magnetic field that is produced in the coil by the incoming signal. The moving-coil is made of many turns of fine insulated wire, wound upon an aluminium hoop and lightly suspended. Any movement of the coil is passed on to a light contact arm moving between two stops.

The Moving-coil Relay

In the diagram Fig. 4, AA represents a powerful permanent horseshoe magnet. The moving-coil is BB, suspended pivotally in the magnetic field. Two hairsprings, C and C1, are connected to terminals 1 and 2 of the moving-coil, whose light contact



A view of the apparatus used on the Daventry signals

wireless signals to control time-pieces.

Using the Daventry Signals

After first working out a system for using the Paris time signals Mr. Ball commenced experiments with the Daventry signals (see Fig. 1). With these it was necessary that the automatic switching on of the valves in readiness for correction by the clock, should not take place until about four seconds before the transmission. All dots but the sixth had to be discounted, and a "selector" designed that counted the impulses and made contact only on the sixth dot.

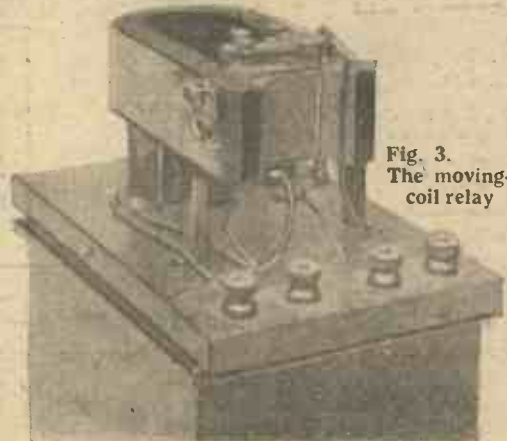

Fig. 3. The moving-coil relay

arm is shown at c. A magnetic field in the direction NI—SI is produced within the coil by current entering through terminals 1 and 2. The coil turns as shown by the direction of the arrow, side SI being attracted to pole N. The result is that the contact arm c falls upon the screw D, thus closing any battery circuit that might be applied to the terminals E and F.

In operation, the windings of the moving-coil are included in the plate circuit of the last valve, i.e. at the position of the loud-

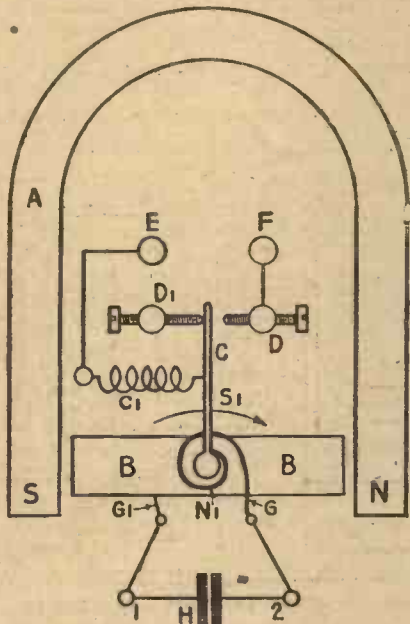

Fig. 4. Connections of moving-coil relay

speaker (Fig. 5). By using the fine spring G (Fig. 4) as a spring pull against the pull of the plate current, the relay is rendered more sensitive and more stable. Set thus any time-signals, or intensive speech for that matter, would cause the relay to act.

Correcting the Clock

We have now to consider apparatus for the synchronisation of the clock. The clock begins the first stage by switching in the set, allowing the warning signals to

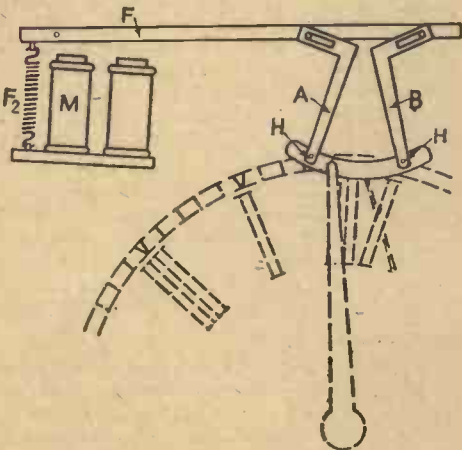

Fig. 6. The device for correcting the hands

be received, though all of them have been eliminated except the final impulse, which has now to be used as a check against the clock. There are three principal ways of achieving this:

- (1) Forcible pushing of the hands, backwards or forwards.
- (2) Giving the clock a slight gaining rate, and on arriving at the moment for correction the hands are momentarily stopped and only set going again at the precisely correct instant.
- (3) Mechanical alteration of the clock pendulum according as the wireless time signal finds the clock fast or slow.

The forcible setting method is easily understood from Fig. 6 where A and B are two levers having pins H projecting through a slot in the dial. The electromagnets M, which become energised by reception of the time signal, cause the armature F to be attracted downwards and the pins already mentioned move inwards, like a closing finger and thumb, to a common centre at the sign XII. Thus, the minute hand is pulled to the exact hour mark, provided the error of the hand is not more than two minutes before or after the exact time, else it would not come within reach of the "electrical fingers." A clock that had an error greater than two minutes per day would not be worth using. A second method of forcible setting makes use of a heart-shaped cam, as in Fig. 7.

If, at the moment of the time signal, when the whole of lever J is drawn by the magnet M to the left, the small roller in the arm j finds the cam in such a position that when the stop is opposite it no alteration takes place, for this is the proper position for correct time. If, however, the cam is found at that instant with any other part of its heart-shape directed towards the roller then the cam, and with it the wheel, will be swung round to the correct zero position. Fig. 8 represents the synchroniser in conjunction with a Pulsynetic electric clock movement.

There is another form of synchroniser, tested by Mr. Ball for over two years, which adds or takes away a small weight from the pendulum, thus altering the clock rate from day to day as required.

GET FRAME-AERIAL SELECTIVITY ON AN OUTDOOR AERIAL!

Build the new Britain's Super, and see what real range and selectivity can be

The musical interlude which formerly filled in the gaps in the National programme has now been replaced in certain parts of the programme of the Scottish Region by short thumb-nail sketches of forgotten Scotsmen. These only last three minutes.

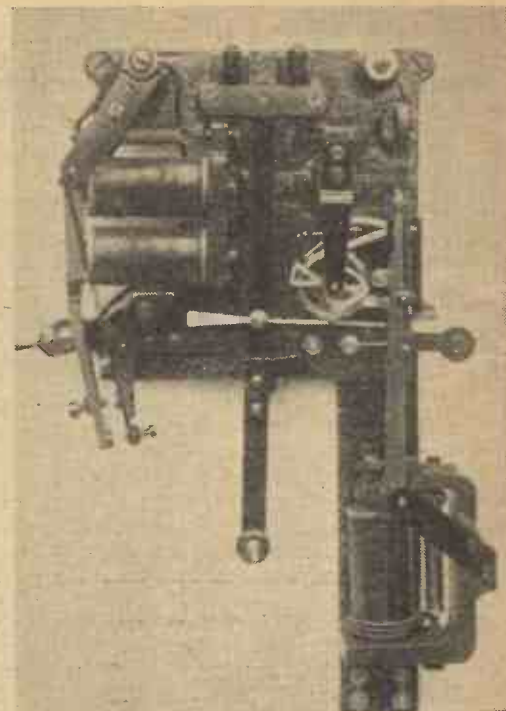

Fig. 8. Synchroniser with Pulsynetic clock movement

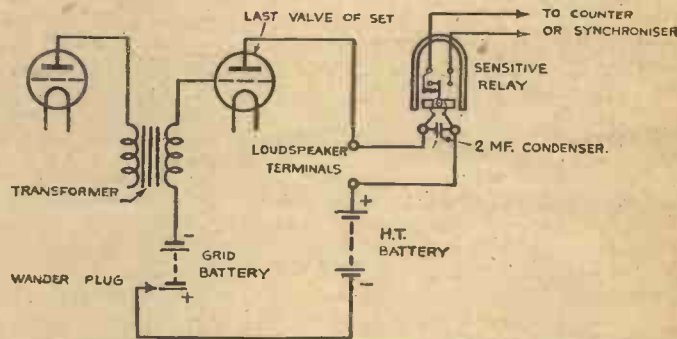

Fig. 5. Diagram showing how the relay is connected to the receiver

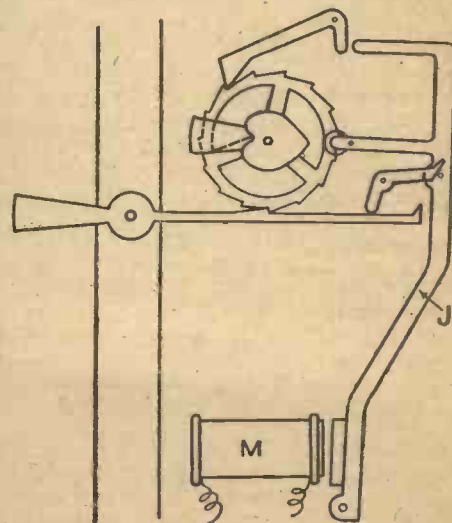

Fig. 7. Another method of correcting the clock

On October 11 Dr. Dennis Chapman will give a recital on the organ at the College of Technology, Manchester. This organ is one of the finest in the country.

SOME NEW COMPONENTS -AND HOW YOU CAN MAKE THE BEST USE OF THEM

HOW many times I went round the Exhibition at Olympia it would be difficult to say; but on one occasion I went round specially to see the new components, because I wanted to see how the amateur constructor would be affected by the new developments.

anode voltage, otherwise distortion due to overloading the detector in its function of low-frequency amplifier is produced.

We can avoid transformer saturation, and at the same time apply full volts to the anode of the detector, by adopting the choke-feed method of coupling shown by

the Varley-ganged volume control used for just this combination of jobs. When the radio is switched in the volume control on the pick up is, of course, inoperative, and when the gramophone-arrangement is in circuit, the pick-up volume control works and the screen-grid control is out of action.

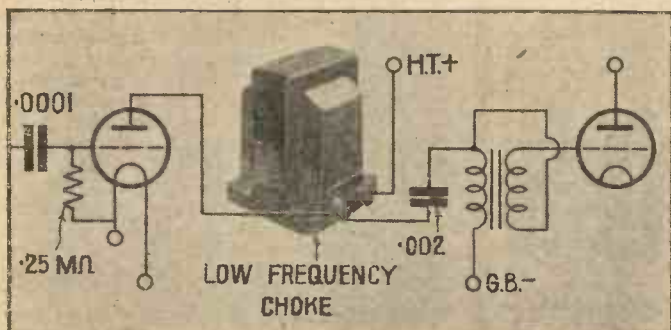

Fig. 1. Avoid transformer saturation by using choke-feed coupling. This is a useful method when following power-grid detection, where high anode voltage tends to upset the coupling

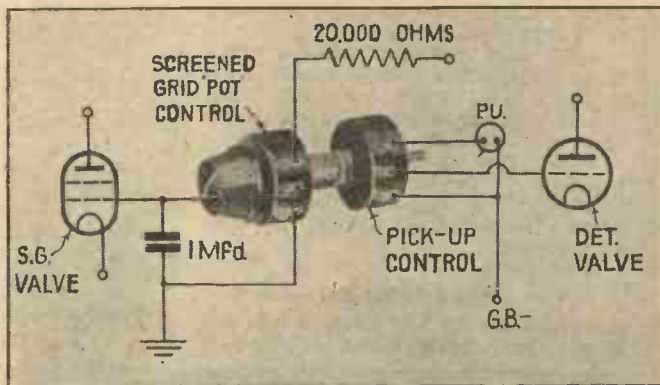

Fig. 2. A system of ganged volume control

If he takes full advantage of all I saw, he will indeed have a busy time this winter. In this article I want to explain the use of several of the more outstanding components. Properly used, they will greatly improve results—and at very small expense.

First of all, let me mention the new Telsen power grid choke, which, as its name suggests, is designed for use in power-grid detector circuits, where, in addition to low values of grid leak and condenser, a high voltage is applied to the anode of the valve.

Choke-feed Coupling

This high voltage means that, with an "L" type of detector valve, the anode current is at least 5 milliamperes, and may quite easily be even more. Following the detector is some form of low-frequency coupling, in these days usually a transformer. Unless its primary is of very generous proportions it certainly will not stand up to the anode current of a power-grid detector. Its impedance will drop through saturation of the core; then the good effect of power-grid detection will be nullified by the distortion produced by the overloaded transformer.

The obvious thing to do is to prevent the anode current flowing through the primary, by using some form of parallel feed. The popular resistance-feed circuit suggests itself, but there is a disadvantage often overlooked. For when the resistance is connected in the anode of the detector instead of the primary of the transformer it cuts down quite a lot of the applied anode voltage. Now one of the most important needs of a power-grid detector is a high

Fig. 1. The circuit follows the well-known resistance-feed connection, with a choke in place of the resistance. The new Telsen choke, price 8s., is just the sort of heavy-duty choke needed for this work. It has an inductance of 40 henries with 6 milliamperes current flowing through it. For power-grid detection it is very useful.

D.C. MAINS VALVE FILAMENTS

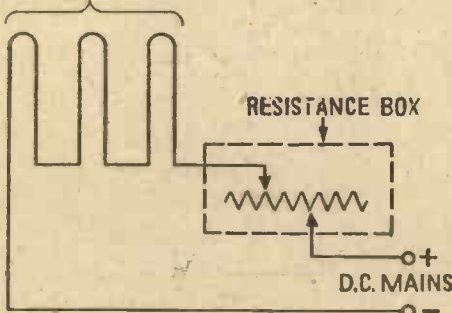

Fig. 3. A convenient series resistance for D.C. mains filament heating

A component that should interest all keen constructors is the ganged volume control introduced by Varley. With this useful gadget the amateur can equal the professional in simplifying volume control. The ganged volume control enables two entirely separate volume control circuits to be wired up in the set and worked from a single knob.

Think how useful this would be in a set with, say, screen-grid volume control and pick-up volume control! At Fig. 2 is shown

Other uses for ganged volume controls will readily occur to the constructor; such as controlling the aerial input and the screen-grid voltage.

At present, these Varley controls for ganging are supplied in three resistance values. These are 25,000 ohms, 50,000 ohms and 250,000 ohms, the last-named being for pick-up control. The price in any value is 6s. 6d., and the ganging equipment is 1s.

Valves on D.C. Mains

One of the new components demanded by the development of the indirectly-heated mains valve for D.C. mains is a suitable dropping resistance, to connect in series with the supply and the filaments of the set. This resistance must be designed so that it will safely dissipate the heat caused by the mains current flowing through it.

With the Mazda valves the dissipation is 100 watts on a 200-volt supply, so a considerable amount of heat is developed in the series resistance. The new Marconi and Osram D.C. valves which have 8-volt filaments taking .25 ampere each, take a total wattage of only 50 watts on a 200-volt supply, so less heat is generated.

A Useful Unit

Whichever type of D.C. mains valve filament is eventually standardised, there will always be the need for a reliable series resistance, and the most convenient construction seems to be that adopted in the new Bulgin universal resistance, price 18s. 6d. in types A, B, and C, for all existing filament ratings.

The convenience of this unit lies in the

THE TRIUMPH OF THE "SUPER"

OUR SPECIAL ISSUE NEXT WEEK!

THIS year has seen the triumph of the super-het. What does that statement really mean? Just this: AMATEUR WIRELESS and its companion publication, *Wireless Magazine* (monthly, 1s.), have given new life to the super-het. They have produced two famous sets—respectively the "Century Super" and the "Super 60"—which have been the most successful home-constructor sets ever introduced. These two sets have started a new fashion, as a glance round the exhibits at Olympia proved conclusively.

Next week we go forward, and present our readers with the James super set of the season—

"BRITAIN'S SUPER"

How does it compare with the "Century Super"? It has one valve less; it meets a popular requirement by working with an ordinary aerial and earth instead of with a frame aerial, although its selectivity is not impaired; it incorporates band-pass tuning, giving freedom from "mush" or background effect and improving long-wave reception; it uses a new type of valve developed especially for use with the new types of super-het; it is simple to build, as indeed was the "Century," and its components are relatively few.

It will get as

MANY STATIONS

as any set that has ever preceded it in this or any other publication, and not only does

it get them, but it gets them better than any previous super-het.

Now, that is the new set Mr. James will give you next week. The issue will be a special one, considerably enlarged and containing not only the special James feature, but in particular a most interesting section appealing to every reader and presenting

"A HUNDRED HINTS AND TIPS"

that every practical wireless amateur will be glad to have.

A very special point is that the issue will contain in itself *absolutely full-size working drawings* of "Britain's Super," in all respects the same as the ordinary blue-print drawings except that they will be printed in black lines on white paper.

We already know by the forward demand of the trade what is going to happen next week. In spite of our best efforts we shall very soon run out of print, and I want to make this point to every regular reader: Will you please place your order definitely for your next week's copy and will you do a good turn both to us and to your wireless friends by telling them of the advent of the new James' set and of our Special Number of next week in which we present it to the public?

A Wonderful Issue of "Amateur Wireless," Next Week. Usual Price 3d.

OUR LISTENING POST

By Jay Coote

WHEN listening to Budapest a few nights ago, on the occasion of a relay by this station of a Belgrade programme, I noticed that both studios possessed lady announcers. It would, however, appear to be an innovation with the Hungarian; for, so far as I can recall, a mere man always fulfilled these functions. Bucharest, which also may be picked up at odd times just above Frankfurt-am-Main, is favouring us with a new feminine voice. Investigation has revealed that Margaretti Marinescu, who presided at the mike from the opening date, has been promoted and that the newcomer is Magda Cretsoiu, whose call is equally melodious. The final "good-night to all" before the wave is switched off is heard phonetically as: "Boona see-ar-ah too-too-roar."

Listeners to broadcasts on short waves may be interested to learn that, apart from using its usual wavelength of 31.38 metres, Zeesen is trying out a new channel, namely, 19.72 metres (15,205 kilocycles). For the interchange of German and American programmes it has been found that the old wave is perfectly suitable for the night hours, but that 19.72 metres is the most favourable one for transmitting the German entertainments to the United States during the afternoon and early evening. It is most likely that it will be adopted.

The reception of the Milan programme is still badly marred by Tallinn, which, in its endeavour to find a comfortable spot, is roaming around the Italian and Belgian allotments. The result of this interference is that Tallinn, Milan, and Brussels all suffer equally, although as a rule the 20-kilowatt Belgian manages to break through.

"SOME NEW COMPONENTS"

(Continued from preceding page)

fact that the necessary tappings on the resistance are brought out to large and clearly marked terminals on the two sides. As will readily be appreciated from a glance at Fig. 3, the voltage of the D.C. mains

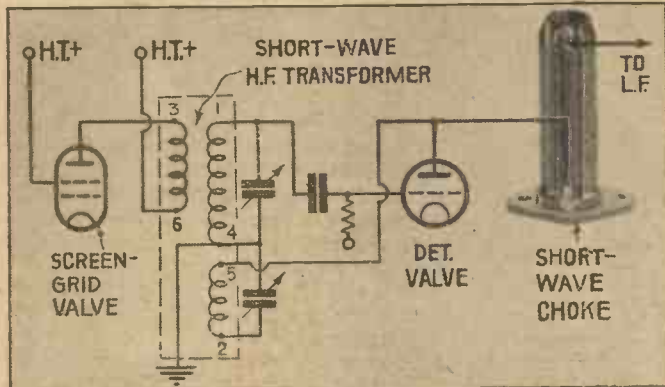

Fig. 4. A good short-wave circuit

supply and the number of filaments connected in series will determine the value.

For a given mains voltage, the smaller the number of valves the greater must be the value of the series resistance; and for a given number of valves, the higher the mains voltage the higher must be the series resistance. The many possible values of series resistance have been carefully worked out by the makers of the Bulgin D.C. mains resistance, so that it can be accommodated to any set. A further advantage is that should the number of valves be altered, all one has to do is to change the terminal connection of the unit.

Among the developments on the short

waves, the increasing popularity of sets with interchangeable coils and a high-frequency stage is being met with several new short-wave components, among which I ought to make a special mention of the six-pin high-frequency transformer with reaction, price 5s., made by Eddystone, one of the pioneers of short-wave apparatus and sets.

There is not the slightest doubt that the short-waver of the future will be a set with at least one stage of high-frequency amplification. The stability of reaction and the ease of holding stations on sets so fitted is becoming generally appreciated. The circuit shown by Fig. 4 shows how the Eddystone six-pin high-frequency transformer can be used with a screen-grid valve preceding the detector.

Note that the primary is untuned, and that coupled to the tuned secondary winding is an independent reaction winding. The advantage of this type of coil is that it is interchangeable with coils tuning on the normal medium and long wavelengths.

Thus the construction of a real all-waver, efficient from 12 to 2,000 metres is quite a simple job.

Another Eddystone product shown by Fig. 4 is the new short-wave choke, price 3s. This is designed exclusively for short-wave reception, and is space wound on a ribbed former, covering the 9-to-100 metre band.

As the diameter of the winding is only 1 inch the external field is very small. The self capacity is less than 1 micro-microfarad. This choke should greatly improve the reaction control, especially in simple short-wavers relying solely on an efficient detector for results.

The last component I have space to mention in this article is of special interest to mains users. I refer to the new Westinghouse HT8 metal rectifier, price one guinea. This provides the extremely generous output of 250 volts at 60 milliamperes—enough and to spare for all mains sets.

This unit is connected up on the voltage-doubling principle, as shown by Fig. 5.

VOLTAGE DOUBLING RECTIFIER

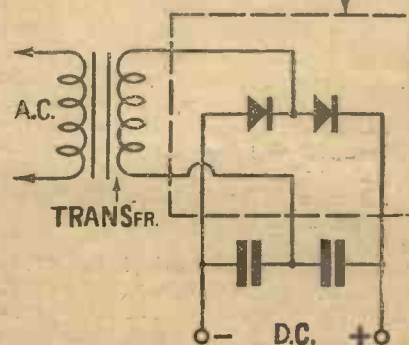

Fig. 5. How a metal rectifier is connected up for voltage doubling

It is likely to be very popular, especially as there are several makes of mains transformers costing little more than £1. There is no excuse now for under-powering the mains set!

TELSEN SWITCHES AND DIALS

TELSEN PUSH-PULL SWITCHES

(Prov. Pat. No. 14125/31) From **1/-**

The Telsen Push-Pull Switches employ a proper electrical knife switch contact and are soundly constructed on engineering principles. The centre plunger is wedge-shaped, so that as it is pulled out it forces the inner fixed contacts outwards, tightly gripping the moving contacts. There is no fear of crackling with Telsen Push-Pull Switches. Their low self-capacity makes them suitable for use in H.F. circuits.

Telsen Push-Pull Switches—

Two-point	Price 1/-
Three-point	Price 1/3
Four-point (2-pole)	Price 1/6

TELSEN SLOW-MOTION DIAL

The Telsen Slow-motion Dial has an exceptionally smooth action with an approximate ratio of 8-1. There is no toothed gearing, so that it is impossible to strip the dial. The figures are clear and arranged to provide for right and left-hand condensers.

Telsen Slow-motion Dial Price **2/6**
Supplied in Black or Brown Bakelite

TELSEN

ALL-BRITISH RADIO COMPONENTS

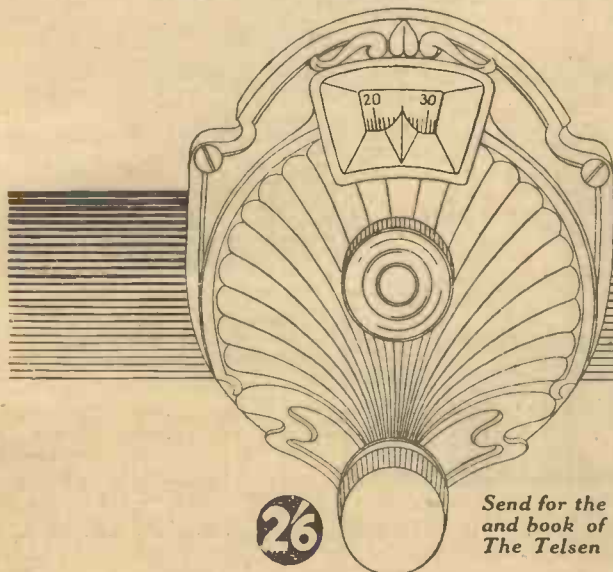

Send for the "Telsen Radio Catalogue" and book of "All-Telsen Circuits" to—
The Telsen Electric Co., Ltd., Aston, Birmingham.

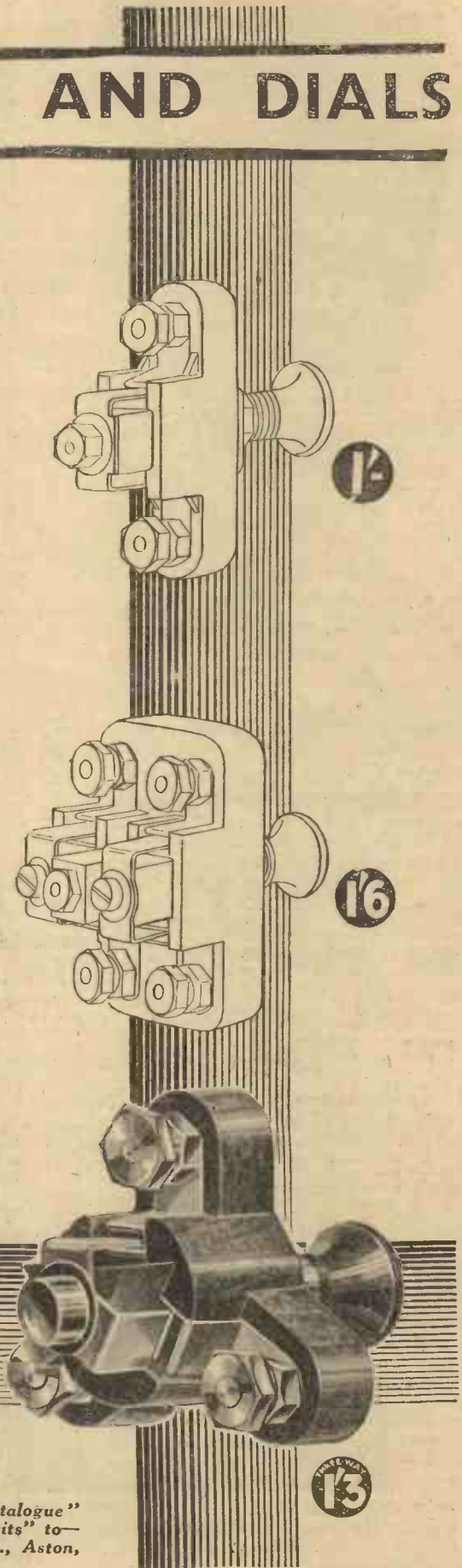

IMMEDIATE DELIVERY

EVERYTHING NEW IN RADIO

C.O.D.
CASH
H.P.
as usual

We are the largest Radio House in the Country, and in sending your orders to us there is no risk of delay. Orders executed on our famous 3-WAY PLAN—C.O.D., CASH or H.P. Express Service for everything Radio Guaranteed. New 116-page catalogue 6d., post free.

MANUFACTURERS' KITS

- COSSOR MELODY MAKER**, Type 234. Screened grid, detector, and power. Complete with specified valves and cabinet. Cash Price £6 15 0. Balance in 11 monthly payments of 12/6. **Send 10/-**
- Finished Instrument. Royalties paid. £7 10 0. Cash only.
- OSRAM NEW MUSIC MAGNET**. Improved version of this famous 4-valve set. 2 screen grid, detector, and power. With valves and cabinet. Cash Price £10 15 0. Balance in 11 monthly payments of 19/8. **Send 19/8**
- Finished Instrument. Royalties paid. £11 15 0. Cash only.
- MULLARD 3 1932 RECEIVER**. Screen grid, detector, and pentode. With valves less cabinet. Cash Price £6 10 0. Balance in 11 monthly payments of 11/11. **Send 11/11**
- Finished Instrument, with valves and cabinet. Royalties paid. £7 17 6. Cash only.

EKCO H.T. UNIT, TYPE A.C.25 Send
For multi-valve sets requiring up to 25 m/a. Three tappings—S.G., detector, and 120/150 volts. For A.C. mains. Cash or C.O.D. £3 17 6. **7/1**
Balance in 11 monthly payments of 7/1 only

ATLAS A.C. ELIMINATOR, TYPE A.C. 244. Three tappings—S.G., detector, power. Output, 120 volts at 20 m.a. Cash Price or C.O.D., £2 19 6. **5/6**
Balance in 11 monthly payments of 5/6 only

EKCO K.12 A.C. COMBINED H.T. ELIMINATOR and L.T. TRICKLE CHARGER 12 m/a suitable for 1- to 3-valve sets. S.G. 80v. 120/150v. charging rate 1/2 amp. at 2, 4 or 6v. Cash or C.O.D. £3 : 19 : 6. Balance in 11 monthly payments of 7/4. **7/4**
only

EXIDE 120-VOLT W.H. TYPE ACCUMULATOR, in crates. Cash Price, £4 13 0. Balance in 11 monthly payments of 8/6. **8/6**
only

AMPLION MC.6 MOVING-COIL SPEAKER. Permanent magnet. With output transformer. Complete. Cash Price £3 : 7 : 6. Balance in 11 monthly payments of 6/2. **6/2**
only

CELESTION PERMANENT-MAGNET MOVING-COIL SPEAKER. Type R.P.M.8. 8in. reinforced diaphragm. Chassis form without input transformer. Cash Price £3 : 10 : 0. Balance in 11 monthly payments of 6/5. **6/5**
only

LAMPLUGH OR FARRAND INDUCTION SPEAKER NEW MODEL for perfect reproduction. Unit and chassis complete, ready mounted. Cash Price or C.O.D., £3 10 0. Balance in 11 monthly payments of 6/5. **6/5**
only

BLUE SPOT PERMANENT-MAGNET MOVING-COIL SPEAKER. Complete with input transformer. Cash Price, £3 15 0. Balance in 11 monthly payments of 6/11. **6/11**
only

WEARITE OR LEWCO'S SUPER-HET COILS. For Super 60, Century Super, Super Senior. Cash Price £2 10 0. Balance in 8 monthly payments of 6/2. **6/2**
only

NEW B.T.H. "SENIOR" PICK-UP AND TONE-ARM. Complete. Cash price £2 5s. 0d. Balance in 11 monthly payments of 4/2. **4/2**
only

REGENTONE W.5 COMBINED H.T. ELIMINATOR AND TRICKLE CHARGER. One S.G., 1 variable and 1 fixed tapping for H.T. L.T. for 2, 4, and 6 volts. For A.C. mains. Cash Price, £5 : 17 : 6. Balance in 11 monthly payments of 10/9. **10/9**
only



VOXKIT RADIOGRAM CABINET MODEL 1932. Accommodation for largest of home-built receivers with a full-size speaker and mains or battery equipment. Complete with motor board. Dimensions overall: 39 in. high by 22 in. wide by 17 in. Internal Panel, 19 by 7 in.; baseboard, 18 by 14 in.; speaker chamber, 18 by 14 in. by 16 in. Panel, 12 in. between moulding. Oak. Cash Price £4-10-0. Or 12 monthly payments of 8/3.

PILOT PERMANENT MAGNET MOVING-COIL SPEAKER. Matches the requirements of all modern receivers. Includes Unit designed and built specially for Peto-Scott by Epoch. Handles the smallest to the greatest input and brings out most minute details of tonal quality with pure, full volume. A multi-ratio input transformer is fitted and provides for matching to all super-power and pentode valves. The handsome hand-polished solid oak cabinet is built to give added depth of tone, and is fitted with ebonised base and side wings and silk-covered fret. Cash Price £3-15-0. Or 12 monthly payments of 6/11.



VOXKIT 1932 CONSOLE (Radio only). Another attractive addition to the famous Voxkit range. Accommodates the largest home built receiver and bulkiest speaker, mains or battery supply. Almost identical with the 1932-Voxkit Radiogram. Dimensions: 37 in. high by 22 in. wide by 15 in. Panel, 18 by 7 in. Baseboard, 18 by 12 in. Speaker compartment, 18 in. wide by 14 in. high by 12 in. deep. Front panel, 12 in. Oak. Cash Price £3-15-0. Or 12 monthly payments of 6/11.

KELSEY SHORT-WAVE ADAPTOR

Add more stations to your set. Plugs direct into your battery or eliminator operated receiver. Complete with instructions. Sent C.O.D. Postage free. Pay the postman. Mahogany or Oak Cabinet ... 7/6. **37/6**
Nothing more to buy no valves or any extras.



SPECIALLY RECOMMENDED

EPOCH J.1 PERMANENT MAGNET MOVING-COIL SPEAKER with multi-ratio input transformer. Cash Price, £2 12 6. Balance in 11 monthly payments of 4/10. **4/10**
only

GARRARD INDUCTION GRAMOPHONE MOTOR. Model 202. Mounted on 12-in. Nickel Motor Plate with fully automatic electric starting and stopping switch. Cash Price, £2 18 6. Balance in 11 monthly payments of 5/3 only. **5/3**
only

ROLA PERMANENT MAGNET SPEAKER. Complete with input transformer. Cash Price, £2 17 6. Balance in 8 monthly payments of 7/1. **7/1**
only

ROLA A.C. MOVING-COIL SPEAKER. Complete with input transformer. Cash Price, £4 5 0. Balance in 11 monthly payments of 7/10. **7/10**
only

COSSOR 4-VALVE ALL-ELECTRIC RECEIVER. Built-in Moving-coil Speaker. Two screened-grid valves, detector and power. Pick-up terminals. For A.C. Mains. Cash, £16 16 0. Balance in 11 monthly payments of 30/-. **36/-**
only

BROWNIE DOMINIONS GRAND 3-VALVE. All-electric for A.C. mains with built-in Cone Speaker. Mains Aerial. Cash Price, £13 13 0. Balance in 11 monthly payments of 24/-. **33/-**
only

Powerful, selective, and ultra modern. Employs screen grid, detector, and power valves. With valves, less cabinet. **12/7**
only

Balance in 11 monthly payments of 10/10. **Cash Price £5 : 17 : 6**

FINISHED INSTRUMENT, with valves and cabinet. Royalties paid. **Cash only. £7 : 8 : 6**

SIX-SIXTY CHASSIKIT (Battery Model). Complete three-gang band-pass tuning. Screen grid, detector and pentode. Cash Price, with valves, less cabinet, £6 17 6. Balance in 11 monthly payments of 12/7. **12/7**
only

Finished Instrument, with cabinet (10/6). Royalties paid. Cash only £3 3 0.

SIX-SIXTY CHASSIKIT (A.C. Model). Complete as above, with A.C. mains valves. Cash Price, with valves, less cabinet, £7 6 6. Balance in 11 monthly payments of 13/5. **13/5**
only

Finished Instrument, with cabinet (10/6). Royalties paid. £8 12 0. Cash only.

EXPRESS ORDER FORM

TO PETO-SCOTT CO. LTD.
Please send me C.O.D., CASH/H.P.

.....
.....
.....
.....

for which I enclose
Cash/H.P. Deposit £ s. d.

Name

Address

A.W. 10.10.31.

All orders over 10/- sent carriage paid



PETO-SCOTT CO. LTD. Head Office: 77 CITY ROAD, LONDON, E.C.1. Clerkenwell 9406. 62 HIGH HOLBORN, LONDON, W.C.1. Chancery 8266. MANCHESTER: 33 WHITELOW ROAD, CHORLTON-CUM-HARDY. Phone: Chorlton-Cum-Hardy 2028. NEWCASTLE, STAFFS: 7 ALBANY ROAD. Phone: 67190.

EXPRESS KIT SERVICE

CONSTRUCTORS!
Build Authors Sets with
100% SUCCESS

Pilot Author's Kits remove all doubt. Containing components "First Specified" in the list of parts and as used by the Author himself in the original Set, you are able to duplicate exactly the set as constructed by the Author. No other Kit of Parts offers you this wonderful safeguard against disappointment. New 116-page Catalogue 6d., post free.

C.O.D.
CASH
H.P.
as usual

Let the **AUTHOR** be your Surety and the **PILOT** your Guide

PILOT AUTHOR'S KIT

PILOT RADIO KITS . . . PRICE CHART

Item No.	SET	KIT "A" less Valves and Cabinet	KIT "B" with valves, less cabinet	KIT "C" complete
1	FOUR-VALVE RADIO-GRAMOPHONE AUTHOR'S KIT	CASH or C.O.D. £7-11-0 Or 13/11 down and 11 monthly payments of 13/11	CASH or C.O.D. £10-2-4 Or 18/7 down and 11 monthly payments of 18/7	CASH or C.O.D. £13-5-4 Or 24/4 down and 11 monthly payments of 24/4
2	OLYMPIAN 3 AUTHOR'S KIT	CASH or C.O.D. £6-1-11 Or 11/2 down and 11 monthly payments of 11/2	CASH or C.O.D. £8-0-11 Or 14/9 down and 11 monthly payments of 14/9	CASH or C.O.D. £11-15-11 Or 21/7 down and 11 monthly payments of 21/7
3	A.W. 2-VALVE LOUDSPEAKER SET AUTHOR'S KIT	CASH or C.O.D. £3-4-5 Or 5/11 down and 11 monthly payments of 5/11	CASH or C.O.D. £4-12-11 Or 8/6 down and 11 monthly payments of 8/6	CASH or C.O.D. £5-5-5 Or 9/8 down and 11 monthly payments of 9/8
4	CENTURY SUPER BATTERY MODEL without Frame Aerial	CASH or C.O.D. £4-17-4 Or 8/11 down and 11 monthly payments of 8/11	CASH or C.O.D. £8-12-9 Or 15/11 down and 11 monthly payments of 15/11	PETO-SCOTT CENTURY FRAME AERIAL as specified by Author, Wavechange Switch, Rotating Base £1 C.O.D.
5	CENTURY SUPER BATTERY MODEL with Frame Aerial	CASH or C.O.D. £5-17-4 Or 10/9 down and 11 monthly payments of 10/9	CASH or C.O.D. £9-12-9 Or 17/9 down and 11 monthly payments of 17/9	CASH or C.O.D. £10-7-9 Or 19/2 down and 11 monthly payments of 19/2
6	ETHER SEARCHER	CASH or C.O.D. £5-14-6 Or 10/8 down and 11 monthly payments of 10/8	CASH or C.O.D. £7-13-6 Or 14/1 down and 11 monthly payments of 14/1	CASH or C.O.D. £8-14-6 Or 16/- down and 11 monthly payments of 16/-
7	THREE GUINEA FOUR	CASH or C.O.D. £3-1-6 Or 5/9 down and 11 monthly payments of 5/9	CASH or C.O.D. £5-9-0 Or 10/1 down and 11 monthly payments of 10/1	CASH or C.O.D. £6-6-6 Or 11/8 down and 11 monthly payments of 11/8

2 OLYMPIAN THREE

AS described in A.W. Sept. 26th. CHECK this list of parts with the Author's specifications, photographs and diagrams.

Three-ply wood panel 16" x 8", and 7-ply baseboard, 16" x 10"	£ s. d.
1 J.B. 0005-mfd. triple-gang condenser with slow-motion dial	1 9 6
1 Lotus 0003-mfd. reaction condenser	4 0 0
1 Sovereign 50,000-ohm potentiometer	4 6
1 Varley Dual-range Square Peak Aerial Coil, and Dual-range H.F. Intervalve Coil	1 3 6
1 Dubilier .04-mfd. fixed condenser	2 0
1 Peto-Scott 8.G. valve screen	2 6
1 Telsen binocular H.F. choke	5 0
3 Lissen 0002-mfd. fixed condensers	3 0 0
1 Ready Radio grid-leak holder	6
1 Dubilier 2-meg. grid leak	1 9
1 Busco filament switch	1 3
1 Ready Radio high-frequency choke	4 6
1 Telsen low-frequency transformer	8 6
1 Formo condenser bank comprising two 2-mfd. and two 1-mfd. fixed condensers	9 6
2 Lewcos 10,000-ohm, two 20,000-ohm and one 30,000-ohm spaghetti resistances	7 6
1 Bulgin fuse and holder	1 3
1 Lotus J K5 gramophone jack	3 0
7 Clit wandler plugs (marked)	10
2 Clit marked spade terminals	4
4 Belling-Lee marked terminals	1 0
1 Belling-Lee anode connector	6
2 Sovereign terminal blocks	1 0
1 Siemens 9-volt G.B. cell	1 0
4 Yards Lewcoflex, Lewcos connecting wire and Lewcos sleeving, screws, etc.	3 0

AUTHOR'S KIT "A," Cash or C.O.D. **£5 1 11**

ACCESSORIES

1 Camco cabinet (Windsor Model)	2 5 0
1 Camco stool for cabinet	1 10 0
1 SG215, HL210, P220, or PM12, PM1HL, PM2 Valves	1 19 0

C.O.D. LINES

VARLEY SQUARE-PEAK COIL	
Pay the postman. C.O.D.	15/-
DUBILIER .04 NON-INDUCTIVE CONDENSER	
Pay the postman. C.O.D.	2/-
VARLEY H.F. INTER-VALVE COIL	
For use with Square-peak Coil. C.O.D.	8/6
J.B. TRIPLE-GANG SLOW-MOTION CONDENSER	
Pay the postman. C.O.D.	£1 9 6
PETO-SCOTT S.G. VALVE SCREEN	
Beautifully finished.	
Pay the postman. C.O.D., each	2/6

SPECIAL C.O.D. LINES FOR "A.W." SETS

Pay the Postman. We pay all post charges on orders over 10/-.

B.T.H. SYNCHRO-BLUE GRAMOPHONE MOTOR. For A.C. mains.	C.O.D. 39/6
MACOM UNIVERSAL GRAMOPHONE MOTOR. For A.C. or D.C. mains.	C.O.D. 52/6
TELSEN SPEAKER UNIT AND CHASSIS.	C.O.D. 11/-
WEARITE "POPULAR TYPE" FRAME AERIAL.	C.O.D. 32/6
WEARITE SET OF SUPER-HET COILS.	C.O.D. 50/-
BLUE SPOT DYNAMIC TYPE SPEAKER UNIT AND CHASSIS TYPE 100 U.	C.O.D. 39/6
PIFGO "ALL-IN-ONE" RADIOMETER.	C.O.D. 12/6

SET OF VALVES FOR "3-GUINEA FOUR" as specified.	C.O.D. 47/6
SET OF VALVES FOR "OLYMPIAN 3" as specified.	C.O.D. 39/-
ONE PETO-SCOTT SCREEN, 1 TELSEN DUAL-RANGE COIL, 1 TELSEN H.F. TRANSFORMER, and 1 TELSEN H.F. CHOKE for "3-Guinea Four."	C.O.D. 16/6
BLUE SPOT PICK-UP WITH TONE ARM AND VOLUME CONTROL.	C.O.D. 63/-
EPOCH J.I. PERMANENT MAGNET MOVING COIL SPEAKER, CHASSIS MODEL WITH TAPPED INPUT TRANSFORMER.	C.O.D. 52/6

Any parts for the above PILOT RADIO KITS sold separately. Orders value over 10/- sent Carriage Paid or C.O.D. All post charges paid.

EXPRESS ORDER FORM

To PETO-SCOTT CO., LTD.

Please send me C.O.D., CASH/H.P.

for which I enclose
Cash/H.P. Deposit £ s. d.

NAME _____

ADDRESS _____

A.W. 10/10/31

PETO-SCOTT

PETO-SCOTT CO., LTD. Head Office: 77 CITY ROAD, LONDON, E.C.1. Clerkenwell 9406. 62 HIGH HOLBORN, LONDON, W.C.1. Chancery 8266. MANCHESTER: 33 WHITELOW ROAD, CHORLTON-CUM-HARDY. Phone: Chorlton-cum-Hardy 2028. NEWCASTLE, STAFFS., 7 ALBANY ROAD. Phone: 67190

To Ensure Speedy Delivery, Mention "A.W." to Advertisers

REASONS WHY YOU SHOULD USE MAZDA INDIRECTLY HEATED RECTIFIERS



MAZDA INDIRECTLY HEATED RECTIFIERS

TYPE	PRICE
Full wave	
UU.30/250 - - -	12/6
UU.2 - - - - -	15/-
UU.60/250 - - -	15/-

THE AMAZING
MAZDA
 THE
 BRITISH
VALVES

THE EDISON SWAN ELECTRIC CO. LTD.
 RADIO DIVISION:
 155 CHARING CROSS ROAD, LONDON, W. C. 2



If you are using rectifying valves in your A.C. mains receiver there is a definite advantage to be gained by using **Mazda indirectly heated Rectifying Valves**. You are safeguarding the condensers, chokes and valves of your receiver. When you switch on an ordinary rectifying valve, operating temperature is reached considerably before that of the receiving valves. A surge is caused and damage is frequently done.

Mazda indirectly heated Rectifiers heat up with the receiving valves, and so afford you absolute protection.

EDISWAN RADIO

V136

On Your Wavelength!

A NEW BIG NOISE

DID you know that Toulouse Midi, the 385-metre station that we all know so well, was building a huge new transmitter? He is, and when this comes into operation you can expect to hear something. The present power of Toulouse is 8 kilowatts; and that gives full loud-speaker strength with quite a small set. He is going up to no less than 85 kilowatts before very long. What interests me particularly in the letter that I have just had from Toulouse about himself is the statement that an entirely new system of modulation is to be used by the new station, which is guaranteed to be unsurpassed for quality. In the past, Toulouse has rather fallen down at times in the matter of modulation, and his quality has suffered accordingly. In the future his transmissions, if all goes well, will be quite beyond criticism from this point of view. The present station has a wonderful record, and something like world-wide range is expected from the new one.

WHY SHOULDN'T WE INVADE?

IHAVE just come across a point of extreme interest in the editorial of one of the best American trade papers. The writer explains that what are called midget sets over there (that is, sets with three or four valves only!) were tried out this year and proved an immediate success. American engineers, as you no doubt know, have always worked on the lines of making each "tube" do very little in the way of amplification, whilst ours have adopted just the opposite policy. Now, American designers are following in the footsteps of ours, and a great deal is being published on increasing the magnification per stage. There are considerable difficulties about doing so in America because most of their screen-grid valves have much smaller amplification factors than ours. Why shouldn't our makers carry the war into the enemy's country by invading the States with the first-rate three, four, and five-valve all-electric sets that they produce? Owing to the exchange rates, the moment is particularly favourable for such an invasion, and I believe that our sets would meet with enormous success over there; owing to their simplicity and their efficiency. Anyhow, it's worth thinking over.

WIRELESS WAR DECLARED

MEANTIME, one of our own trade papers discloses that there may be some fun over here. Imported American sets, it is stated, are not paying royalties to the British owners of some of the most important patents. Such royalties as they do pay go to an American concern which owns another set of patents. Now, according to the laws of this country, three sets of people can be blamed if patents are infringed: the manufacturer, the retail dealer, and the purchaser. Writs have already been issued by the owners of the British patents, and, at any rate, until the

position is cleared up in the courts, dealers and prospective purchasers should think things over carefully. Some American made sets possibly do pay British royalties, but most of them certainly do not.

THE WIRELESS GUIDE FOR ANGLERS

I WAS talking the other day with a very eminent personage in the world of medicine about the weird weather conditions that we have had in 1931. I mentioned that wireless reception was adversely affected, since atmospherics had been almost incessant for months. He agreed that the atmosphere had been in a state of electrical disturbance and showed that this had had far-reaching effects upon the health not only of human beings, but also of plants and animals. An angler who joined us at this point said that he had never known fish "take" so badly and that the proportion of those which showed poor condition was abnormally high. He also told us something which will interest those readers who are fishermen. This was that your wireless set will always tell you if it is a poor or bad fishing day. Switch it on before you start out, and if you find atmospherics bad you can be pretty sure that your catch will be small.

FILAMENT AND CATHODE

I WAS asked the other day why it is that mains-operated valves could be made so much more efficient than those run from batteries. Amongst screen-grids, for example, I don't know of any battery valve with an amplification factor greater than about 300, and the majority have μ 's round about 200. When you come to the mains S.G.'s with indirectly-heated cathodes, amplification factors of 1,000 are common, and there are many which go a great deal beyond this figure. The key to the problem is to be found in the difference between the filament and the cathode.

I haven't pulled an S.G. to pieces lately, but the filament of the six-volt type is probably at least three inches in length if stretched out straight. When we apply a voltage from the battery there is a regular fall in potential from the positive to the negative end of the filament; that is to say, the potential at the positive end is 6 volts above that at the negative end, and at every half-inch along it is one volt less. Plate voltages are, of course, measured in relation to the negative end of the filament. Thus, supposing that we have 100 volts H.T., the plate is 100 volts positive to the negative end of the filament, but only 94 volts positive to the other end. Every part of the cathode of an indirectly-heated valve is at earth potential: so, you see, there is a big difference.

DO IT NOW

I HAVE called attention before to the growing menace to wireless reception caused by interference from electrical

machinery, flashing signs, and so on. Even in small country towns it is growing rapidly worse, and unless a simple law is passed pretty soon making it an offence to instal or operate apparatus of this kind it may assume such proportions that it will be difficult to take effective measures. It seems to me that it should be quite easy to do all that is necessary, for, by virtue of the Wireless Telegraphy Act, it is already illegal to use a radiating wireless receiving set. Why not make the clause apply to all electrical apparatus, for the interference that we experience is caused by radiation? Several foreign countries have introduced measures to stop radiation by machinery, and so on and these have in most cases been completely successful. I am only afraid that we may let it go on too long and that when the powers that be do realise the seriousness of the position the expense involved may be so huge that it will be difficult to do anything at all.

A QUALITY POINT

NOT infrequently do I come across sets whose quality is spoilt by quite unexpected reaction effects, produced, as a rule, by back couplings between valves. The symptoms are not difficult to recognise.

There is, as a rule, a very marked peak in the tuning, even on a powerful local station. Speech is woolly and throaty, whilst music seems to have lost most of the brilliance of its treble notes. The effect of back couplings is to make one or more of the high-frequency circuits tune too sharply, with the result that the bass is over-emphasised at the expense of the treble. The cure is simple; use decoupling arrangements in your plate circuits wherever they are required. Good decoupling entirely prevents feed-back effects, due to battery or eliminator resistance, and has nearly always a remarkable effect on the quality.

DO WE WANT IT?

SPEAKING of quality leads me on to the subject of volume, about which there are two entirely different sets of opinions. Some people hold that no set can claim good quality in its reproduction unless its loud-speaker can produce something like "realistic volume." Hence you see sets designed for an output of from three to five watts, and when you attend demonstrations you will hear them operated at terrific volume without a trace of distortion. Other people contend that the average user of a wireless set does not want big volume. What he requires is a kind of reproduction in miniature of the sounds made in the studio.

I must say that I agree with this opinion, and I don't believe, myself, that anyone except the owner of huge rooms, needs more than one watt at the outside from his loud-speaker; half a watt is ample in most cases. Half a watt will give absolutely all the volume needed in the average room. I hear wireless sets in many homes, and it is

On Your Wavelength! (continued)

very seldom that I find a desire for big volume. Nearly always when the local station is coming in on a big set the volume control is turned well back, so that the amount of sound produced by the loud-speaker is comparatively small.

DO YOU AGREE?

SINCE I believe that there is no great demand for enormous volume, I don't hold with the idea that you cannot get just as good quality from the battery-operated set as from the all-electric receiver. One of the strong points of the all-electric set is that you needn't bother about the milli-amperes; you can thus use any low-impedance output valve or have two in push-pull if you want to without being faced with a terrific bill for current. So long, though, as you are content—as I think most people are—with moderate loud-speaker volume, the battery set should be capable of just as good quality. Most medium-power valves can tackle an output of half a watt without distortion, and from some of the lower impedance types, like the 625As, you can get the best part of a watt without going beyond a couple of hundred volts on the plate or putting a greater drain than some 20 milliamperes on to the battery.

A DIFFERENCE

AN American friend came to my house the other day, and we spent a considerable part of the evening in trotting round Europe with various sets, as he was particularly anxious to have practical experience of the range and selectivity of those of British manufacture. He was very much surprised both at the results that three valves could show in the way of distance-getting, and at the remarkable selectivity of our band-pass sets. Every now and then, though, we came across some foreign station a long way off its wavelength which was badly heterodyning one or more neighbours. "If that fellow was in America," he said, "as we came across the first of these wanderers, 'he'd be off the air before he knew where he was.'" Over there the Federal Radio Board stands no nonsense at all. If a station doesn't keep to its wavelength it is just closed down, and that is that. It is a pity that we cannot have a central authority in Europe with similar powers.

GLARING EXAMPLES

THE damage that one station, even of low power, can do by wavelength wandering is something perfectly astonishing. There is, for example, a small station at Barcelona (not our old friend EAJ13) which during the month of August ruined the transmissions of three other stations. At the beginning of the month he was right on top of Hoerby. Then he moved down to a variety of positions in between Gleiwitz and Trollhaettan, heterodyning both of them every night. A small Swedish relay, Oerebroe, rated at only 250 watts, absolutely wrecked Bordeaux's transmissions for a whole month, whilst other little relays played havoc with sta-

tions such as Cork, Kiel, Sundsvall, Paris PTT, Lyons Doua, and Belgrade. It seems to me that the coming International Radio Conference will have some clearing up to do.

FROM SMALL BEGINNINGS

IT HAPPENED to go round the other day to the Faraday Exhibition at the Albert Hall. This was really a rather wonderful piece of work, and was well worth seeing. It demonstrated the development of electrical engineering from Faraday's discovery in 1831 of electromagnetic induction, a principle which underlies all our generators, transformers, and even wireless apparatus, of to-day. Side by side with the very simple material available for Faraday's experiments were the very latest productions of engineering technique. One which is of particular interest to wireless enthusiasts was a 500-kilowatt transmitting valve.

This is the largest valve ever made, and it is interesting in that there is not a single piece of glass anywhere in it. It is built up of metal and porcelain in such a manner that it can be dismantled just as if it were a motor engine, minor repairs can be made, and the whole thing reassembled in a few hours only. It is sufficient to supply, without further assistance, the complete output to the aerial of the main transmitter at Rugby. The magnitude of the valve is more easily understood when we consider that the best super-power valve used in ordinary practice will not deliver more than about 15 watts; so that this valve is delivering 100,000 times as much.

EDDY CURRENTS

IN the same exhibition a number of experiments were demonstrated showing the effects of the principles which Faraday discovered. One of these was the effect of eddy currents. We all know that if a continuous sheet of metal or a short-circuited turn of wire is placed near a coil, circulating

currents called eddy currents are induced in the metal. In fact, we use this principle for screening in radio receivers.

It is not always appreciated, however, that there is an appreciable force set up. The metal objects to these eddy currents being produced and endeavours to get away from the cause thereof. There is consequently a strong repulsion between the two, dependent, of course, upon the strength of the magnetic field. At the exhibition in question a large electro-magnet consisting of an iron core with a coil wound round it was made to produce a strong alternating field. Over the end of the magnet pole was placed a ring of aluminium. On switching on the current the repulsion was so violent that the ring was shot several feet into the air!

This principle, of course, is used in many alternating-current motors, and some of my readers may remember a proposal for a railway based on this principle many years ago. The car was to be constructed of aluminium and the track consisted of a large number of electro-magnets of this type. The strength of the current was so adjusted that the car was kept just off the ground, thereby eliminating all friction, and the carriage was then pulled along by electro-magnetic forces. I believe an actual model of this was constructed and worked reasonably well, but apparently it would not prove economical on a large scale. At any rate, nothing more was heard of it.

ABSURD—ISN'T IT?

POLITICS are quite outside my line, but it really does seem ridiculous that when we can make in this country all that we do want for our wireless needs, and when our radio industry is one of the few fortunate enough to be in a sound condition, we should allow foreign sets and parts to come in quite free of duty. If things made abroad were better than ours I should be the first to agree that it would be right to welcome them, for their coming would put our own makers on to their mettle. But they certainly are not better. The only attraction about American sets, so far as I can see, is that they offer more valves for less money than British; but when you remember that each American valve does about three-fifths of the work of one of ours, you see that you get better value for money by purchasing a British set. What is so sad is the thought that much of the stuff that comes in from America and from other countries is dumped material that cannot be sold in its homeland because it is out of date. It is unloaded on to our unsuspecting population, which rushes to purchase because the imported sets seem so cheap—and is not long before it wishes it hadn't.

THERMION.

In a recent talk the Cologne studio informed its listeners that work on the new 75-kilowatt station at Langenberg was nearing completion and that the first tests would probably be carried out in November.

FIXING THE PANEL

You will find it much easier to fix the panel at right angles to the base-board if you do this before mounting



any of the panel parts. With a large panel it is a good plan to have a pair of right-angle brackets to take the weight.

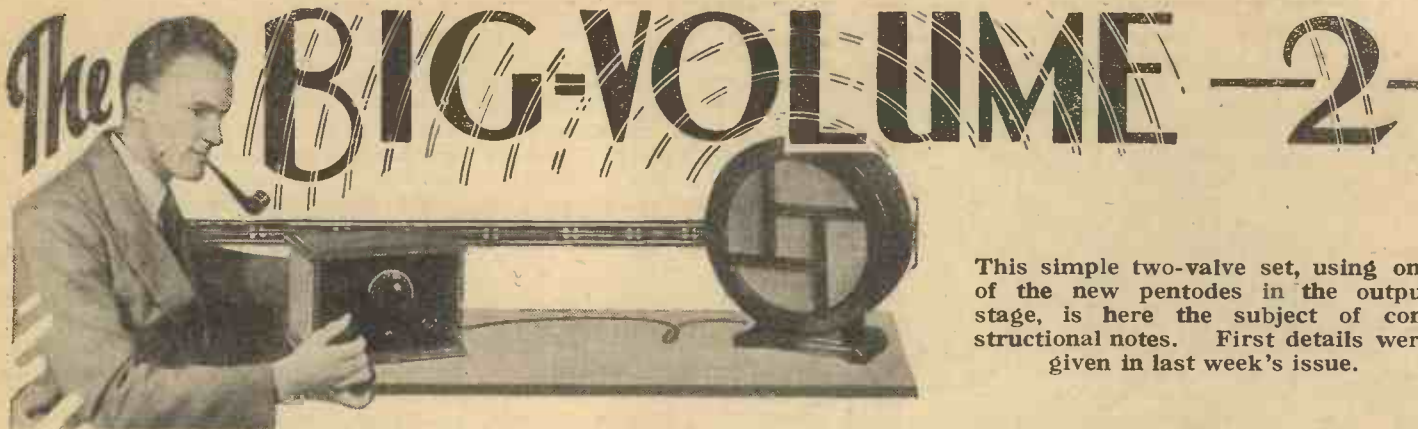

This simple two-valve set, using one of the new pentodes in the output stage, is here the subject of constructional notes. First details were given in last week's issue.

IN introducing the "Big Volume 2" it was emphasised that although the circuit is a little out of the ordinary, and although a pentode valve is used in the output stage, the construction is quite straightforward, and the average home-constructor should have the whole set working in an evening.

Although, too, the baseboard design is compact, the overall dimensions being only 9 in. by 8 in., there is no undue crowding of components, and wiring is really quite easy.

Wiring

The best way is to work with a copy of the full-size blueprint which can be obtained, price 1s. post free, from the Blueprint Department, Bernard Jones Publications, 58-61 Fetter Lane, E.C.4. A scale drawing of the layout was given last week, and if you prefer it you can measure off the drilling and mounting centres from this.

There are altogether seven holes in the panel, three along the lower edge for the fixing screws and one each for the tuning condenser, reaction condenser, three-point wavechange switch and filament on-off switch. In some kits of parts the panel is supplied ready drilled, but if you have the full-size print then it is quite an easy matter to paste the corners to the back of the panel and, after lightly punching the centres, drill through.

Be careful when each hole is nearly drilled, for the surface of the panel can easily be spoiled if the point of the bit

pushes its way through the polished surface.

Get the panel exactly at right angles to the baseboard, and taking care not to split the plywood, do the three fixing screws up very tightly so that there is no chance of the panel working loose after the set has been in use for some while. Movement might work some of the wires loose, which would cause crackling noises, and, a still more important trouble, one of the panel components such as the tuning condenser might be moved backwards touching another metal part and causing a short-circuit.

The two little terminal strips are supplied with fixing and terminal holes ready drilled, but may be cut from strip ebonite if you have any scrap material handy. These terminal blocks have two fixing screws each and are mounted exactly at the corners of the baseboard at the back. When the panel is fixed to the baseboard you must mount the reaction condenser, on-off switch and filament switch. Then the coil, low-frequency transformer, and the

made with rigid wire, except for the short flex lead, which, terminating in a spade tag, goes to the aerial terminal. This can be connected at will to terminals 1 or 2 and it is when the spade tag is clamped under terminal No. 2 that the incorporated series condenser is connected in the aerial lead.

When the lead is taken to the terminal No. 1 then the control knob on top of the coil has no effect. With these parts mounted and wired you can now connect up the other parts, including the valve

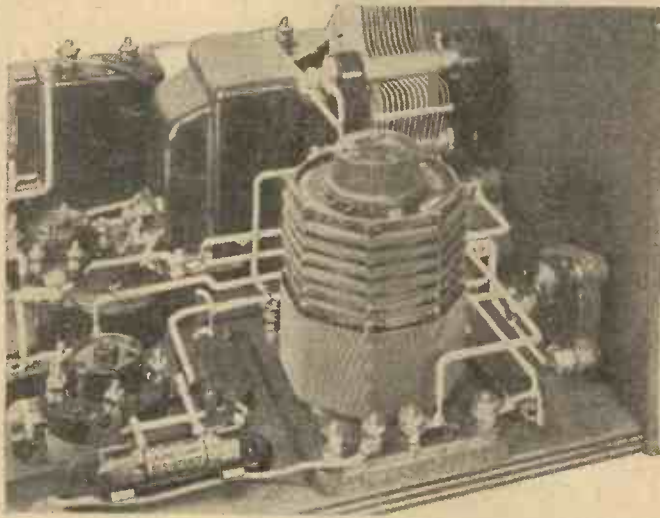

This picture shows clearly the arrangement of the detector stage

COMPONENTS FOR THE "BIG-VOLUME 2"

Ebonite panel, 9 in. by 6 in. (Becol, Trelleborg, Peto-Scott).

.0005-mfd. slow-motion variable condenser (Formo, Lotus, J.B., Utility, Telsen, Polar).

.0003-mfd. reaction condenser (Readi-Rad, Graham-Farish, Formo, Lotus, Bulgin, J.B., Utility, Telsen, Polar).

Three-point shorting switch (Telsen, Busco, Bulgin, Readi-Rad, Lissen).

Filament switch, (Bulgin, Wearite, Busco, Telsen, Readi-Rad, Goltone, Lissen).

Baseboard, 9 in. by 8 in. (Camco, Readi-Rad, Peto-Scott).

Dual-range aerial-tuning coil, (Telsen, Lotus, Formo, Bulgin, Tunewell, Goltone, Sovereign).

Two five-pin valve holders (W.B., Wearite, Telsen, Graham-Farish, Formo, Lotus, Lissen, Benjamin, Clix, Goltone).

Low-frequency transformer (Telsen, Lissen, R.I., Ferranti, Burton, Lotus, Varley, British General, Graham-Farish).

Two .0003-mfd. and one .0001-mfd. fixed condensers (Dubilier, type 670, Telsen, Lissen, T.C.C., Formo, Goltone, Graham-Farish).

.01-mfd. fixed condenser (T.C.C., Dubilier, Graham-Farish, Lissen, Telsen, Formo).

Two 2-mfd. fixed condensers (T.C.C., Telsen, Dubilier, Lissen, Goltone, Formo).

Grid-leak holder (Lissen, Wearite, Bulgin, Readi-Rad, Dubilier).

2-meg. grid leak (Dubilier, Telsen, Goltone, Lissen, Sovereign, Graham-Farish).

High-frequency choke (Lewcos, Graham-Farish, Lissen, Telsen, Dubilier, Watmel, Varley, Peto-Scott).

Three spaghetti resistances—one 5,000, one 10,000, and one 20,000-ohm (Graham-Farish, Lewcos, Bulgin, Telsen, Varley, Lissen, Readi-Rad, Goltone, Sovereign, Tunewell).

Two terminal blocks (Belling-Lee, Sovereign, Junit, Lissen).

Four terminals marked Aerial, Earth, L.S.+, L.S.— (Belling-Lee, Clix, Eelex, Burton).

Four wander plugs marked: H.T.—, H.T.+ G.B.—, G.B.+ (Belling-Lee, Clix, Eelex).

Two spade terminals marked: L.T.+ , L.T.— (Belling-Lee, Clix, Eelex).

Two yards of thin flex (Lewcoflex).

Connecting wire (Glazite).

Cabinet, 9 in. by 6 in., with 8-inch baseboard (Camco, Peto-Scott, Readi-Rad).

ACCESSORIES

120-volt high-tension battery (Ever-Ready, Pertrix, Drydex, Palaba, Fuller).

9-volt grid-bias battery (Ever-Ready, Palaba, Fuller, Pertrix, Drydex).

2-volt 30-amp.-hour accumulator (Exide, C.A.V., Pertrix, Fuller, Ever-Ready).

2 - microfarad blocking condenser near the panel can be screwed down.

Wire up these parts as far as possible and then mount the tuning condenser on the panel.

You will see that had this part been mounted first it would have been difficult to have made the connections to the panel.

The terminal on the side of the 7-to-1 transformer is, you see, connected to both three-point wave-change switch. The coil connections, by the way, are

holders and coupling condensers.

The small coupling condensers have no terminals and are of the midget type which are screwed to the baseboard. One .01-microfarad condenser (in the filter circuit of the pentode valve) stands upright and is supported only by the rigid wire at the bottom and by the flexible resistance at the top.

The 5,000 and 20,000 spaghetti, decoupling resistances for the pentode screen grid and detector anode circuit respectively, are connected from one side of each of two 2-microfarad bypass condensers to H.T.+ . The end tags of these two resistances and of the spade tag which goes to the L.S. positive terminal, are clamped down to the baseboard as is clear in the wiring diagram.

The terminal on the side of the 7-to-1 transformer is, you see, connected to both three-point wave-change switch. The coil connections, by the way, are

It is very important to see that the terminals are tight on the panel components, for if they work loose it is not an easy

"THE 'BIG-VOLUME 2'"
(Continued from preceding page)

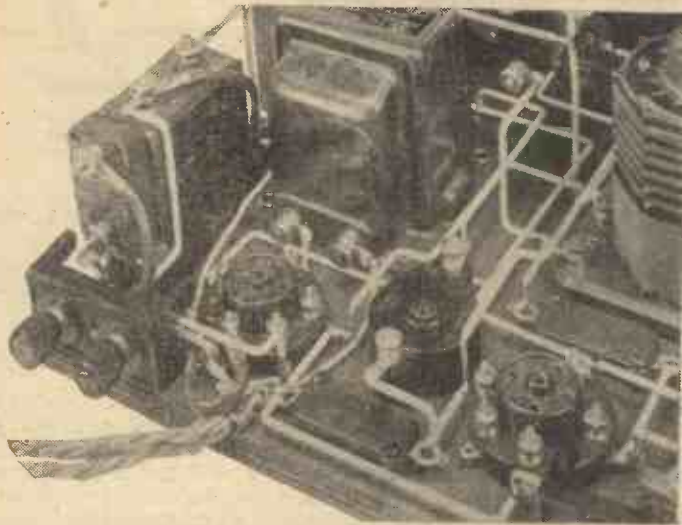

matter, without removing a part from the baseboard, to get at the connections.

The battery flexes are taken direct from the various points and are clamped under an insulated staple at the rear edge of the board. You must put the wander plug and spade tags on the high-tension grid-bias and low-tension leads respectively, before they are twisted in three separate groups.

There is only one high-tension positive

lead and the voltage for the detector is cut down by the resistance in this anode lead.

The special PEN220 pentode valve should not be worked with more than 150 volts on the anode and will give really fine loud speaker volume when working from 100—120 volts. This set, besides giving exceptional volume, is, you see, really economical in battery consumption.

We have found on test in the AMATEUR WIRELESS Laboratory that when the grid-bias is —3 volts and the H.T. 120, the anode current is approximately 5 milliamperes. The power output, under these conditions, can reach as much as 250 milliwatts.

Other pentode valves, such as the Cossor 230PT, Marconi or Osram PT240, Mullard PM22, or Six Sixty 230PP, may be used and the grid-bias should be chosen according to the valve makers' recommendations. The H.T. consumption may then be greater, but there will be a corresponding increase in wattage output.

Here is a close-up of the L.F. stage of the "Big-Volume 2"

NORTH REGIONAL PROGRAMMES

Mr. E. G. D. Liveing, the North Regional Director, on the new plans for the winter season

LAST week the North Regional director, Mr. E. G. D. Liveing, broadcast an account of the plans in hand for northern programmes during the winter.

"The main outline of timings, from October onwards," he said, "will remain the same as for the summer months, although considerable changes in programme material will be taking place in the course of the next few weeks. The mid-day programmes will continue as before, from 12 to 3 p.m., on all weekdays except Saturdays, the Regional Children's Hour will run from 5.15 to 6 p.m., and the regional service will continue from 6 to 10.30 at night.

"Many outstanding concerts will be available at night. We are arranging with the Hallé Society for the broadcasting of ten of their concerts during the season, all of which will be conducted by Sir Hamilton Harty. The Liverpool Philharmonic Society has secured for its winter season an attractive list of conductors and artistes and some interesting new works.

"There will be three evening talks a week, the times of which will, to some extent, have to be slightly altered from week to week in order that listeners may have the opportunity of a suitable alternative, should they desire it, on the National wave-length. 'The Event of the Week' feature

will be discontinued as from mid-October and its place taken by a special programme item between 6.30 and 6.45 on Saturday evenings. This short period will be left open until the last moment in order to provide listeners with something in the nature of a surprise, whether it happens to be a topical talk on some event of outstanding importance which has taken place, or the engagement of a famous theatrical star visiting the north, or an interview, or an 'outside broadcast' of an unusual nature.

"We shall be producing several plays in various northern studios. I would mention *The Northerners*, by Harold Brighouse, *The Pageant of York*, by L. Du Garde Peach, and a radio version of *Hobson's Choice*, the Lancashire play. We also hope to continue to relay excerpts of musical comedies and revues from certain theatres in the north region."

MR. FLEX'S ENQUIRY ABOUT A POLE—



—LEADS TO A LITTLE MISUNDERSTANDING



TELSEN CONDENSERS

TELSEN MANSBRIDGE TYPE CONDENSERS

Telsen have installed the most advanced plant in the world for the manufacture of Mansbridge Type Condensers. Only genuine Mansbridge foil paper and the finest linen tissue are employed in the exclusive method of manufacture. Every Telsen Mansbridge Type Condenser is hermetically sealed from the atmosphere and Post Office standards of insulation are adopted throughout. The preliminary research, the most modern plant in the world, the finest raw materials, the latest methods of manufacture and the final test, all combine to give Telsen Mansbridge Type Condensers a high insulation through years of service with freedom from breakdown. The type of construction employed makes them genuinely non-inductive.

The following values are guaranteed within 5 per cent :—

Cap. mfd.	500 Volt Test			1,000 Volt Test		
	Price			Price		
.01	1/6			2/6		
.04	1/9			2/9		
.1	1/9			2/9		
.25	2/-			3/-		
.5	2/3			3/3		
1.0	2/3			3/6		
2.0	3/-			5/-		

TELSEN FIXED MICA CONDENSERS

(Prov. Pat. No. 20287/30)

Telsen Fixed Mica Condensers are made in capacities from .001-microfarad to .002-microfarad. They can be mounted upright or flat and the .0003-microfarad Telsen fixed mica condenser is supplied complete with patent grid leak clips to facilitate series or parallel connections. All Telsen fixed mica condensers are tested at 500 volts.

Telsen Fixed Mica Condenser Price **6d.**

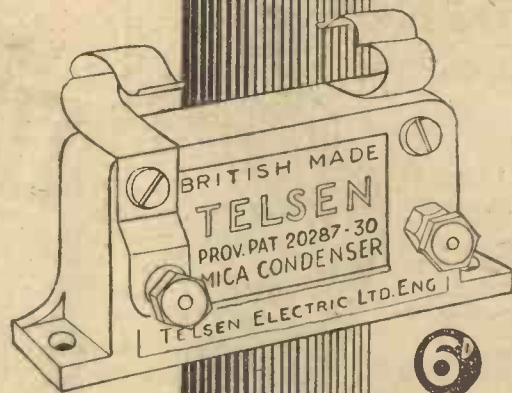

TELSEN

THE SECRET OF PERFECT RADIO RECEPTION

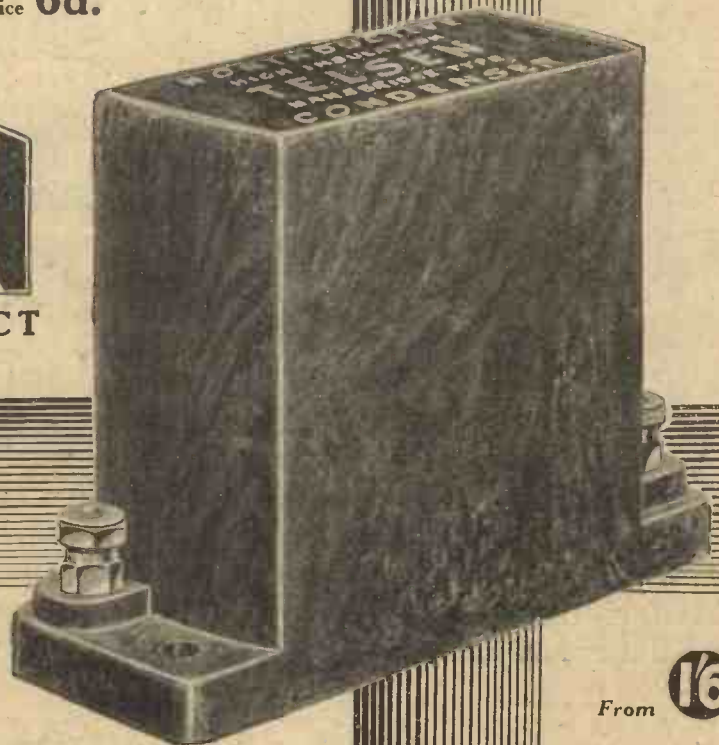

From



Send for the "Telsen Radio Catalogue" and book of "All-Telsen Circuits" to The Telsen Electric Co., Ltd., Aston, Birmingham

CVS-57

You will Help Yourself and Help Us by Mentioning "A.W." to Advertisers

Specified for the R for M.V. 3 THEY ASSURE SUCCESS

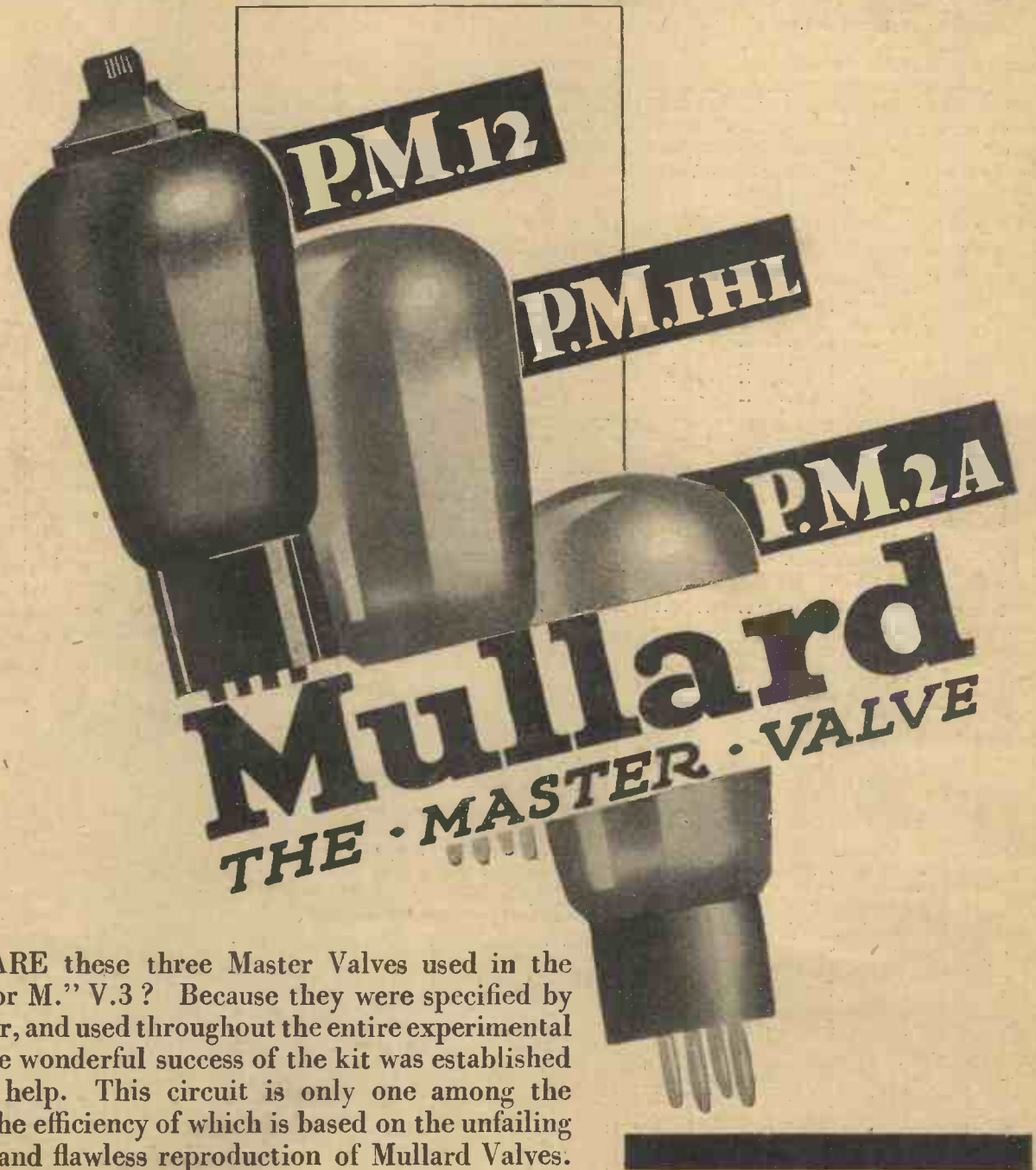

WHY ARE these three Master Valves used in the "R for M." V.3? Because they were specified by the designer, and used throughout the entire experimental stages. The wonderful success of the kit was established with their help. This circuit is only one among the hundreds the efficiency of which is based on the unfailing reliability and flawless reproduction of Mullard Valves.

Adv. The Mullard Wireless Service Co., Ltd., Mullard House, Charing Cross Road, London, W.C.2.

Arks

Advertisers Appreciate Mention of "A.W." with Your Order

SETS OF DISTINCTION

The RADIO for the MILLION V3



Makers : United Radio Manufacturers. Price : £5 17s. 6d.

EVERY once in a while a good circuit comes along and is universally approved; every once in a while a good practical layout of this circuit is designed, and is acclaimed on all sides; such a circuit is the sequence of high-frequency amplifier, detector and low-frequency amplifier; such a design must surely be the "V3" kit now to be reviewed.

I find it easy to praise the "V3", but not easy to praise it enough! On all counts

it is a classic example of a collection of parts selected from many factories made to work so harmoniously together that each part might have been designed specially for this kit! This is, indeed, a triumph of selection, and every component manufacturer whose part is used must be congratulating himself on his contribution to such a successful kit.

I was supplied with a complete kit of parts and a copy of "Radio for the Million,"

I will not go into the details of the assembly; save to mention that it is completed in six easy stages, starting with the fixing of parts on the metal chassis and ending with the wiring of the condensers. Apart from the battery-cord connections, there are only 23 connections to be followed.

The tuning coils, of which there are two, are mounted at right angles to each other on the top of the chassis, with the two-gang tuning condenser coming between. The

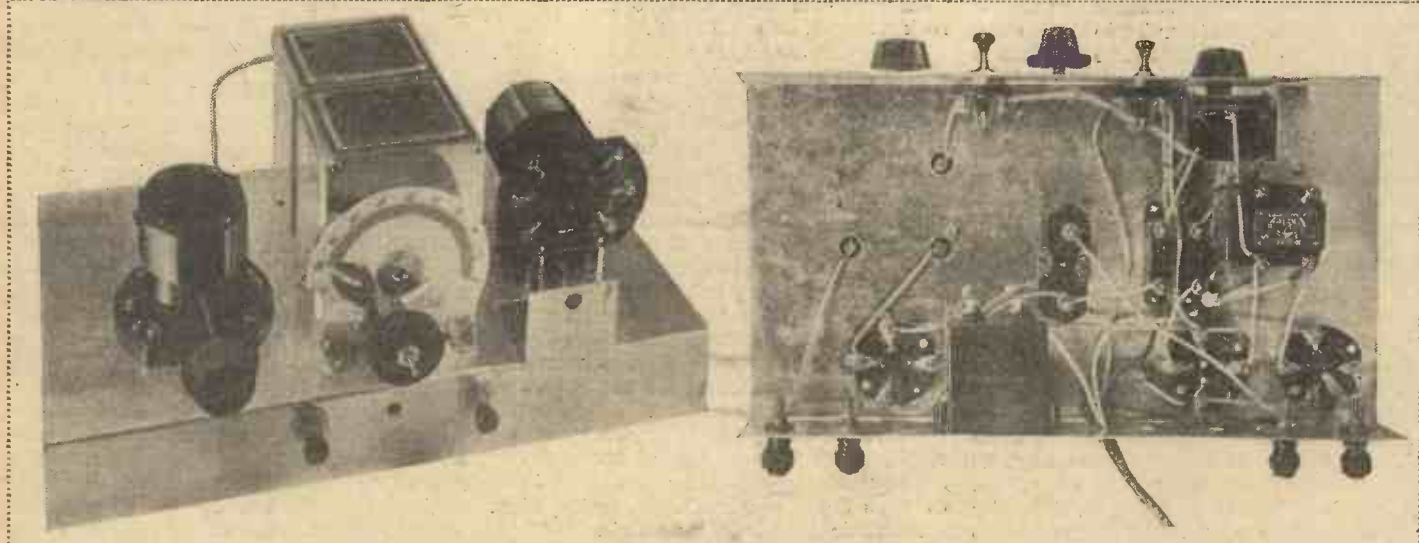

These two pictures show the upper and under sides of the assembled chassis

this is a "winner." Its three valves are arranged in a circuit that is beyond criticism. Its layout is conceived on brilliantly simple and yet extraordinarily effective lines. "The layout is extremely modern and therefore extremely simple." I quote the designers' own pointed sentence.

The outstanding feature of the design is the use of a metal chassis, which not only definitely ensures constancy of layout in all the models assembled by constructors, but reduces the amount of wiring and effectively shields the tuned circuits from the other components.

The raised metal base-plate is already stamped and drilled to take the specified parts, which are all supplied in kit form. Many of our most famous component makers have a personal interest in the "V3", for

in which are included full instructions and blueprint. The whole job took just one and a half hours—and thanks to the explicit instructions I was never in the slightest doubt about any point, either in component fixing or in the wiring.

three valve holders are sunk into the chassis, so that their connections are made below, although the valves are inserted in the usual way. All the rest of the parts are fixed on the underside of the chassis, with the result that a very simple surface layout is obtained; nor is this all, for the under-chassis connections are short and the associated parts are well screened from the tuning coils and condenser.

In addition to the tuning knob, which projects from the centre of the chassis-mounted condenser, there are two other main knobs on the front, these being for reaction, on the right, and for volume, on the left. Then between the row of three control knobs comes the coil switch knob to the left and the on-off switch to the right.

(Continued on page 700)

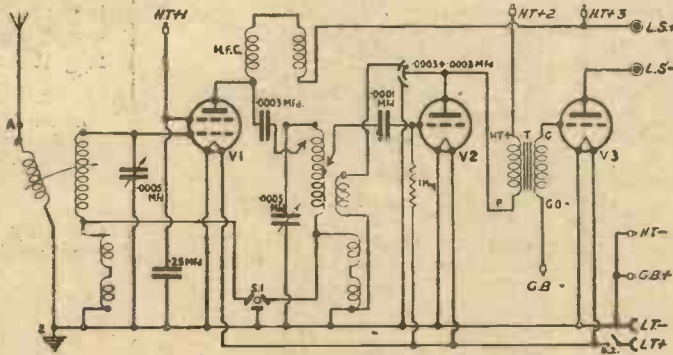

The circuit is quite straightforward

CUTTING YOUR H.T. BATTERY COSTS



W. JAMES explains in this article some useful methods of making the H.T. battery last longer.

MOST people desire to make their high-tension batteries last for as long a time as possible. A battery user is faced with the expense every few months of replacement, and anything which can conveniently be carried out to reduce this item in running costs is welcome. Performance must not suffer. The volume must not be reduced, the sensitivity cut down and the quality must not be affected.

Tests show that it is sometimes possible to effect a considerable saving in the current with the result that the high-tension batteries last much longer.

Let us take as an example a three-valve set, having a screen-grid stage, a detector, and a power valve. The first valve, the screen grid, may take a total of 5 or 6 milliamperes of which from 1 to 1.5 passes in the screen circuit.

Screen Voltage and H.T. Current

This can be reduced by lowering the screen voltage, from 75 to 60 for example, reducing the total currents about 3 milliamperes. If the grid is biased .9 volt negative the current is still further reduced to about 2 milliamperes.

The saving in current is considerable to battery users, but what has happened to the results? First, the impedance of the valve is increased by adding grid bias or by lowering the screen voltage. This tends to improve the sharpness of tuning.

The second effect is that the valve is not so well able to deal with strong signals without distortion. This may not matter at all and in any case, attention to the aerial circuit will remove this difficulty. With a pre-set condenser connected in the aerial lead to the set, for instance, the input can be varied in strength, a reduction being effected by reducing the capacity.

The third point is that owing to the increased impedance of the valve the magnification of the high-frequency stage may be less. Perhaps a little reaction will compensate for this and in the case of the local stations the reduction will not matter. When a screen-grid potentiometer is fitted and is used as a volume control, the current taken by the valve is varied when the setting is changed and when receiving the local station the current is very small as the control is set near the minimum. This is not always a satisfactory control from the point of view of distortion.

An input control is also needed, but it ensures that when listening to the local

station the full amplification of the set is not used, and the current is no greater than necessary.

Screen-grid valves often pass a much greater current than is thought. Some types are very extravagant and when purchasing a new valve of this type the current consumption should be considered. The makers make a point nowadays of obtaining the desired results with the minimum of current and so the various makes should be considered.

In the detector stage a valve of the H.L. class may be used, taking a current of about 3 milliamperes with 100 volts. As this voltage is reduced so the current falls off. But the voltage cannot be reduced to below a certain value or the results suffer.

Distortion may be introduced as the result of overloading in this stage. The voltage must be increased to avoid this as far as possible. Then again, the desired reaction effects may not be obtained when the voltage is less than a certain value. All the amateur can do with this stage is to use no more voltage than is necessary for the desired results. To use a greater voltage than this is wasteful.

Valves of the H type take from 1 to 1.5 milliamperes with about 100 volts. They are not always suitable for detection, however, as their impedances are rather high.

As a rule there is little waste in the power stage, most amateurs increasing the bias to the fullest amount. An increase in the bias reduces the current flowing, but it

must not be overlooked that with too much bias distortion is introduced.

Power Valves and Bias

Some power valves take much less current than others, and they are not equally sensitive to changes in bias as you would expect as their amplification factors and impedances are different. With a bias of — 6 volts the anode current of a well-known power valve is about 7 milliamperes with 120 volts and increases to 12 milliamperes when the bias is reduced to — 4.5.

Anyone listening might not notice a difference in the quality or volume, but there is a relatively considerable difference in the current.

In the case of another and larger power valve the current changes from 10 to 14 milliamperes when the bias is reduced from — 10.5 to 9. Here again the current changes appreciably with small grid-bias voltages, and too much care cannot be taken to see that the fullest use is made of negative bias.

The examples show how easy it is to vary the current and it is conceivable that one amateur may be getting certain results with a current of, say, 9 milliamperes and another will be using 15 or more. The life of a dry battery usually increases rapidly as the current is reduced and so it is beneficial to use as small a current as possible.

If a big power valve must be used in order to deal properly with the volume, then the current is bound to be greater than when a more modest valve is fitted. But both can be carefully adjusted to provide the best results with the greatest economy.

Obviously the grid battery plays an important part. This battery should be tested at regular intervals and not be forgotten as so often is the case.

With a view to a direct relay of Paris concerts, Radio Strasbourg proposes to open its own studio on the Boulevard Haussmann in the French capital. Some difficulty has been experienced in securing the services of well-known artistes at provincial studios, and this can be overcome by engaging musicians and singers from the Paris concert platform and opera houses. In this manner, artistes would not be compelled to leave Paris to fulfil microphone engagements.

STATION IDENTIFICATION

AMATEUR WIRELESS has organised a new service of the greatest importance to all listeners. This Station Identification Service is available for identifying stations from information supplied by readers, and will be conducted by J. Godchaux Abrahams in conjunction with "A.W." The fee is 6d. for identifying any one station, but if three identifications are required at a time the fee is only 1s. A stamped addressed envelope must be enclosed.

Address your inquiry to Station Identification Service, "Amateur Wireless," 58-61 Fetter Lane, E.C.4, and give fullest possible details. State type of set used, date and time when station was heard, wavelength, call or interval signal, and details of any programme heard.



The

NORTHERN NATIONAL EXHIBITION

AT MANCHESTER

City Hall, Deansgate, Wednesday, October 7 to Saturday, October 17

WHAT YOU SHOULD SEE

LISTENERS in Manchester and the North are even keener than they were when the Exhibition was held last year. Since then North Regional has come into full operation and Manchester, as the programme-providing centre, is a keen area of radio enthusiasts.

The Northern National Exhibition following on immediately after Olympia, is a natural reflection of all the new parts and developments at the National Radio Exhibition, and Northern listeners who found it impossible to come down to London have an excellent chance of seeing the latest products of leading firms at the City Hall, Deansgate.

Low cost of components is as evident at Manchester as it was at Olympia and pioneer

firms in this direction of low cost, such as Telsen (Stand 41), Lissen (Stand 77), Radio Instruments (Stand 66), and others are attracting crowds of set builders.

Complete sets are on many stands, Brownie Wireless (45), Lotus Radio (42), Kolster-Brandes (33), Pye Radio (32), Rolls-Caydon (7 and 9), McMichael (84), Murphy Radio (29), and Lissen having outstanding exhibits. On the Marconiphone Stand 86 there is a fine range of console and cabinet type sets.

Mains units are well in evidence, the new Ekco chassis-built A.C. and D.C. units on Stand 74, the Heyberd kits on Stand 50, the Junit units on Stand 28, and the Regentone eliminators on Stands 88 and 89, being representative of modern practice.

A number of other firms have components

for home-built mains eliminators, Telsen, Westinghouse (Stand 76), R.I., Pye, Lissen, H. Clarke & Co., (Stand 52), Varley (82-83), and Igranic being among those specialising in this type of apparatus.

Valves are well in evidence, there being the full range on the Cossor Stand 31, together with the new Cossor sets and kits. New pentodes and other valves are on the Edison Swan Stand 44 and the Mullard kits and variable muM.M.4V valve on Stand 30. Osram valves are on the G.E.C. Stands 79-81.

New parts such as ganged condensers, band-pass coils, special switches and condensers are to be found on the Dubilier Stands 64 and 78, the Lotus Stand 42, the Harlie Stand 130, Igranic Electrical Co., Ltd., Sovereign Products (5), R.I., and the Varley Stands 82 and 83.

There are useful coils on the Colvern Stand 61 and a varied display of speakers and valve holders on the Whiteley Electrical Stand 40. Here, too, you will find the new W.B. permanent-magnet speaker used in the new AMATEUR WIRELESS "Battery-operated Radio-Gram." Other firms showing speakers of the permanent-magnet type, or incorporating some unusual feature, are Telsen, Lissen, Ferranti, (Stand 65 and 106-108), Epoch (Stand 94), and Celestion (Stand 85).

The new Varley wire-wound resistances should be seen and the new Formo condensers on Stand 91 of Arthur Preen & Co., Ltd. There are some new speakers, cone and moving-coil,

(Continued at foot of next page)

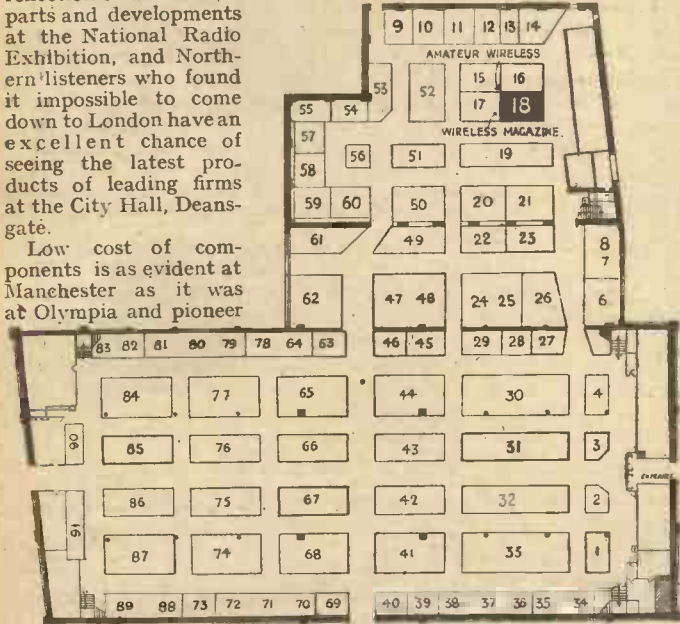

Plan of Ground Floor

"AMATEUR WIRELESS" AND "WIRELESS MAGAZINE" STAND No. 18

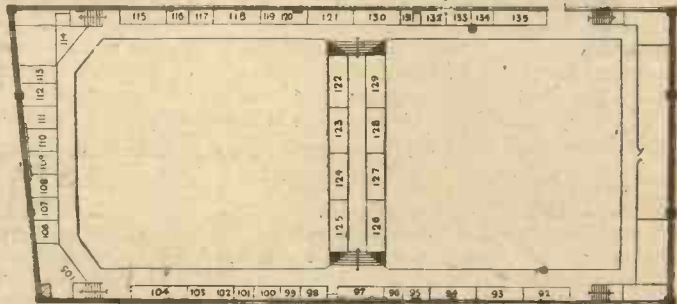

Plan of Gallery

LIST OF EXHIBITORS AND STAND NUMBERS

Name	Stand No.	Name	Stand No.	Name	Stand No.	Name	Stand No.
Allied Newspapers, Ltd.	34, 35	Edison Bell, Ltd.	57	Hobday Bros., Ltd.	21	Oilham & Sons, Ltd.	43
Automatic Coil Winder & Electrical Equipment Co., Ltd.	16	Edison Swan Electric Co., Ltd.	44	Halcyon Wireless Co., Ltd.	9-10	Preen, A., & Co., Ltd.	91
Bernard Jones Publications, Ltd.	18	Ever Ready Co. (Great Britain), Ltd.	75	Iltona Products, Ltd.	20	Partridge & Mee, Ltd.	73
Brownie Wireless Co. of Great Britain, Ltd.	45	Econasign Co., Ltd.	85	Ilife & Sons, Ltd.	23	Pell Control, Ltd., Oliver Varley	32-3
Brown Bros., Ltd.	53	Epoch Radio Mfg. Co., Ltd.	94	Igranic Electric Co., Ltd.	67	Partridge, Wilson & Co.	46
Belling & Lee, Ltd.	69	Electrical & Radio Products	49	Junat Mfg. Co., Ltd.	28	Pye Radio, Ltd.	32
Push House,	98	Fulltone Gramophones (1929), Ltd.	15	Kolster-Brandes, Ltd.	33	Petrix, Ltd.	1
Burrows, R. L., & Co.	86	Ferranti, Ltd.	106-8	Lotus Radio, Ltd.	42	Phillipson & Co., Ltd.	132
Cossor, A. C., Ltd.	31	Fuller Accumulator Co. (1928), Ltd.	2	Lissen, Ltd.	77	Pegasus, Ltd.	77
Clarke, H., & Co., Ltd.	52	Fink, L., Ltd.	134	McMichael, L., Ltd.	84	Reifner's Rubber Works, Ltd.	86
Chloride Electrical Storage Co., Ltd.	87	Garnetts	4	Marconiphone Co., Ltd.	86	Regentone, Ltd.	29
Cole, E. K., Ltd.	74	General Electric Co., Ltd.	79-81	Murphy Radio, Ltd.	29	Richardsons	39
Celestion, Ltd.	85	Garrard Engineering & Mfg. Co.	56	Mullard Wireless Service Co., Ltd.	30	Radio Instruments, Ltd.	24-5
Collie, J. H., & Co.	189	Garratt Stores, Ltd.	128	New London Electron Works, Ltd.	115	Rawson, H. C., Ltd.	92
Colvern Ltd.	61	Hathaway, S., & Co., Ltd.	135	Northern Steel & Hardware Co., Ltd.	92	Rolls-Caydon, Ltd.	68
Craufurd Wireless	115	Howards, Ltd.	135	National Accumulator Co., Ltd.	68	Roberts, John	51
Diziel, A., & Co.	100	Harlie Bros. (Edmonton), Ltd.	130	Osborn, Chas. A.	50	Standard Wet Battery Co.	27
Dullier Condenser Co. (1925), Ltd.	64-78	Heyberd, F. C., & Co.	50	Osborn Engineering Co., Ltd.	8	Siemens Bros. & Co., Ltd.	70-2
		Hollindrake & Son, Ltd.	6	Olympia Radio, Ltd.	17	Sovereign Products, Ltd.	5
		Hardman & Co., Ltd.	17			Great Britain	97



INTRODUCING

"BRITAIN'S SUPER"

THE BAND-PASS SUPER-HET

An important development in set construction, to be fully described by W. James next week

WE approach another milestone in AMATEUR WIRELESS set development. In next week's issue W. James discloses his latest set design, aptly named "Britain's Super." This is a set that will create a new standard not merely in performance, but in broadcast entertainment value.

It is no idle claim that "Britain's Super" set will provide more programmes of entertainment value than any sets preceding it. In view of recent claims, this latest claim must be examined in the cold light of a technical analysis.

Firstly, "Britain's Super" is a super-het, with all the well-known advantages in selectivity and none of the lesser-known evils! It is a five-valver, and each valve pulls its weight magnificently.

We start with a new type of valve, specially developed for super-hets. This bi-grid valve, as it is called, acts as the first detector. It is preceded by a normal aerial and earth, and not a frame aerial.

The aerial, which need be only a few feet of wire, is coupled to the bi-grid valve by means of a band-pass tuning coil. Although the directional advantage of a frame aerial is thus sacrificed in the new set, the pre-selection of incoming signals through the band-pass circuit is more than a mere compensation.

One of the most important advantages of band-pass tuning at the beginning of the super-het is the great freedom from mush and from multiplication of logging points for any given station. The band-pass tuning of "Britain's Super" definitely ensures that *only two oscillator settings will be found for each station.*

As in the original "Century Super," a separate oscillator valve is used in "Britain's Super." The oscillations from this valve are fed into the first detector circuit by connecting the grid of the local oscillator

to the second grid of the bi-grid valve. By this means the local oscillations mix with the incoming signal oscillations, but are not radiated into the aerial circuit.

Experience has shown that one good stage of high-frequency amplification between the first and second detectors is sufficient to load the final valve with all signals of any entertainment value. A further advantage of having only one intermediate-frequency valve is that great stability is obtained, with freedom from high-frequency distortion.

ALL DETAILS WITH
FULL-SIZE LAYOUT PLAN
NEXT WEEK

The second detector and the power output valve of "Britain's Super" have quite conventional connections. The second detector works on the leaky-grid condenser system and full precautions are taken to prevent high-frequency from this valve getting into the low-frequency circuit.

The above brief analysis of the five-valve circuit incorporated in W. James' "Britain's Super" clearly shows that the new set will be a significant development.

With the elimination of mush and the limitation of oscillator settings to only two for each station received, the new set is bound to add greatly to the growing army of super-het enthusiasts. When it is realised that the band-passing at the first detector stage not only confers the advan-

tages already mentioned, but also greatly improves long-wave reception, little more need be said to convince readers that "Britain's Super" is a "winner."

As anyone who has seen the original model in the laboratory would be forced to admit, the new set is extraordinarily simple



The original "Century Super" shown above and described in the April 25 issue of "A.W." created a record and still ranks as one of the most famous sets in the country

in its construction, in spite of the many developments it incorporates. The circuit, although so advanced, is absolutely free from snags. It is for this reason that we have so much confidence in recommending "Britain's Super" to the serious attention of all readers wanting a set capable of coping with the very difficult reception conditions now prevailing.

"THE NORTHERN NATIONAL RADIO EXHIBITION"

(Continued from preceding page)

on the Ormond Stand 27, side by side with the new Ormond condensers.

Batteries are well in evidence as there is still a large proportion of Northern listeners who have yet to change over to mains operation. Chloride Electrical Storage Co. (Stand 87), Fuller Accumulator Co. (2), Ever Ready (75), Edison Swan Electric (44), National Accumulator Co., (68), General Electric Co. (79-81), Standard Wet Battery Co. (63), Pertrix (1), and others having H.T. and L.T. accumulators and dry H.T. and grid-bias batteries. Lissen Ltd., too, have a fine display of H.T. batteries.

Belling & Lee, Ltd., on Stand 69 are showing the new terminals with non-rotating heads and on the Stand of Charles A. Osborn (51), there are some fine cabinets for home assembly. Partridge & Mee, Ltd., (73), wind L.F. and power transformers and chokes for every

purpose and they have a representative range of these components on show.

We want to see you at the "Amateur Wireless" Stand 18. Here representatives of "Amateur Wireless" and the "Wireless Magazine" will be in attendance to deal with your radio problems and to show "A.W." and "W.M." sets. Avail yourself of this opportunity to see the new "Britain's Super."

An ingenious scheme has been devised by the W.R.C. studio at Washington (U.S.A.) for warning speakers that they are approaching the time limit allotted to them for their talks. It consists of two triangular prisms with a brass sign on each face. It is the duty of the announcer to place these on the reading desk when time is running short. The signs run in sequence, namely, five minutes, three minutes, one minute, and "please stop," thus silently conveying the message to orators at the microphone.

AT THE PROMS.

THE Haydn and Mozart concert on Tuesday was of mixed quality. Haydn's Symphony No. 7 was dull, but both Frank Merrick and the orchestra played Mozart's 23rd piano concerto with spirit. The "Jupiter" Symphony of Mozart was good in parts. The last movement was played with insight, but the minuet was hopelessly dragged.

Beethoven's Fifth Symphony on September 25 was brassy, which was a pity, because Sir Henry Wood and the Proms. Orchestra are usually at their best with Beethoven. In my opinion, they play Tchaikowski second best, and then come Mozart and Wagner. Bach is never played with precision, but this must be expected of any orchestra with such a limited time for rehearsal.

L. R. J.



OUR BROADCAST CRITIC

TALKS ABOUT— TALKS

I AM coming to the conclusion that the talks are amongst the best broadcast features.

I do not know when I enjoyed anything more than Eric Parker on the migratory habits of birds and butterflies.

I am by no means a naturalist, but I keenly appreciated the fact that Mr. Parker's talk was packed with information delivered in an intensely interesting form.

Many of these talks that are broadcast in series are really well worth hearing. Miss Sackville-West has certainly made a success of her talks on new books.

She addresses herself—or appears to address herself—to busy people who have no time to find what to read for themselves. A very useful type of broadcast. I listened to James Agate on matters theatrical with great interest.

I have very little time for theatre-going—I wish it were otherwise—but I find myself inclined to consult him, via my loud-speaker, before making my next decision in that respect.

Vernon Bartlett, who is back in London, apparently, is another talker whom I try never to miss; I thought he presented the situation in Manchuria in a clear and concise form.

Flotsam and Jetsam were really excellent this week. Jetsam sang so beautifully—a strange term for an entertainer, perhaps—that I began wishing he would sing a little Wagner.

Jeanne de Casalis and Melville Cooper, in *Feathers Fine*, only strengthened my conviction that unless the text of sketches be subjected to close scrutiny such broadcasts as these are likely to fall flat.

I think they were very amusing here and there; but, here and there, they were not amusing. The dialogue was not good enough.

Ronald Gourlay is an entertainer for whom I shall watch in future; his imitations were good. The burlesque of Czerny's exercises amused me very much.

I was amazed at his whistling technique; he reached the top B flat on the piano and his compass seems to be not less than two octaves and a fourth.

The Two Pairs are usually quite good, but I am sick of that *Hallo, Mike!* business with which they begin. Will somebody ask them to do something else?

There was a vaudeville later in the week

which I thought very well up to standard.

I missed Mabel Constanduros, and also Clapham and Dwyer, but I think I may take them for granted. I was pleasurably surprised that the others were so good. I think no one will dispute the fact that we have had, often enough, to endure much rubbish before people of their standard come on.

The Friday vaudeville was consistently good—the first I have ever heard that was. Norman Long, on "National Economy," was really clever.

Bryan Powley's farmyard imitations are worth repeating. May we have him again soon? I adored the bit where he threw bread to the ducks. I have never heard anything more realistic than the noises he made in imitation of the eating the crumbs.

Thinking of ducks, Our Bill's account of duck-shooting was told in excellent brogue and proved to be something really original. I think we might have more of him, also.

Altogether a brilliant vaudeville. I trust the B.B.C. will not think me ungrateful if I venture to ask if we shall have to suffer for it in the next two or three vaudevilles.

I was greatly interested in Joanna Goff, who sang while she played her violin. I have wondered why that has not been done

more often; it is quite a feat, but one which need not be thought mere musical gymnastics.

The difficulty is to sing well with a fiddle stuck in your neck; the tendency is to cause the singing to be a little on the sharp side.

I feel tempted to point out that one really needs to see a performance of that kind to appreciate it. Miss Goff will, no doubt, present a charming picture when television comes.

The Foundations were quite up to standard this week. Edward Isaacs is a good Beethoven player. One word to you, sir! Your tone is a little too brilliant for the microphone.

I listened to the Wireless Singers in their programme of glees. The programme was a little dull, I thought; not quite enough variety.

And, Mr. Robinson, may I ask you to make them sing their words better? Those I did not know I missed.

Another thing, also; the key was too high in Steven's "It was a Lover and his Lass." A-flat major was too much for the sopranos, who sharpened under the strain.

The same thing applied to "Hand in Hand." I do not think there is anything to be gained by broadcasting glees in very high keys.

Did you listen to the "The Song of the Volga Boatmen," in the Russian Prom? It was a lovely noise. I do not think I shall ever want to hear it again on a small orchestra.

If you did hear it, you may have heard the Music of the Machines. It is, of course, a piece of hideousness, but it is amazingly clever.

I went to Queen's Hall for the English night Prom to hear Holst's "Planets" again.

The refinement of his dissonances and the wealth of his melodies convinced me that modern music is only safe in the hands of very level-headed people who have some scholarship behind them.

I have rarely seen greater enthusiasm amongst the audience; this must have been obvious to all listeners.

Marian Anderson's voice is certainly one of the richest contraltos I have heard. She sang in the Saturday-night Prom.

WHITAKER-WILSON.



An impression of Rex Evans



EVERYBODY RADIO-GRAM

Preliminary details were given for the four-valve radio-gramophone.

LAST week the new four-valve radio-gramophone was introduced and it was explained how the set unit of this can be used without the gramophone amplification side, if one wants just a good four-valver for local and distant-station reception.

The set has a fine low-frequency power side and it is ideal for use as a gramophone amplifier. It is so decoupled and stabilised that it can quite easily be worked off dry batteries. A large capacity high-tension battery is advised for economical working. The total H.T. consumption of the set is about 10 milliamperes as a gramophone amplifier and 14 milliamperes when all four valves are working on radio reception.

General Design

The screen-grid side is quite normal, the anode of the screen-grid valve being coupled to the grid of the following detector by a .0002 fixed condenser. The aerial is coupled to the grid coil of the screen-grid valve by a .0003 maximum preset condenser, alteration of which controls the aerial damping and therefore has a fine effect on selectivity.

The detector, which has the R.C. coupling resistance in its anode, is adequately stabilised by a 20,000-ohm resistance and a 2-mfd. fixed condenser. The first low-frequency valve is coupled up by a .005 fixed condenser and the potentiometer

tion with a further 2-mfd. condenser, forms a decoupling circuit.

Choke-capacity feed to the loud-speaker is a good feature because it ensures that when the set is driven from the mains there will not be any danger in extending the

COMPONENTS REQUIRED FOR "EVERYBODY'S"

Ebonite panel, 16 in. by 8 in. (Camco, Peto-Scott, Readi-Rad).
Baseboard, 16 in. by 12 in. (Camco, Peto-Scott, Readi-Rad).
Two screened dual-range coils (Lotus).
Two-gang .0005-mfd. condenser (Utility "Semi-screened," J.B., Lotus, Polar).
.0003-mfd. reaction condenser (Readi-Rad, Lotus, Telsen, Polar).
Pre-set aerial condenser, .0003-mfd. max. (Formo, Sovereign, Lewcos, R.I., Ormond).
Radio-gram switch (Bulgin, Gripso).
Filament switch (Bulgin, Graham-Farish, Telsen, Wearite, Busco, Sovereign).
Four valve holders (Telsen, Junit, W.B., Readi-Rad, Wearite, Graham-Farish).

Two high-frequency chokes (one binocular) (Telsen, Lissen, Wearite, Igranic, Lewcos, Goltone, R.I., Bulgin, Burton, Varley, Sovereign, Graham-Farish).

Three fixed condensers, .0002-mfd., .0001-mfd., .005-mfd. (Dubilier, Telsen, Lissen, T.C.C., Readi-Rad, Graham Farish).

Three 2-mfd. fixed condensers (Lissen, Telsen, Dubilier, T.C.C., Formo, Ferranti).

Two 1-mfd. fixed condensers (Lissen, Telsen, Dubilier, Goltone, T.C.C., Formo, Ferranti).

.0002-mfd. grid condenser (Dubilier, upright type, T.C.C., Lissen, Telsen, Goltone, Readi-Rad, Graham-Farish).

2-meg. grid leak (Telsen, T.C.C., Dubilier, Lissen, Goltone, Readi-Rad, Graham-Farish).

Low-frequency transformer (Varley "Nicore I," Telsen, Lissen, Lotus, Igranic, Lewcos, Graham-Farish, R.I.).

winding of the volume control acts as the grid leak. There is plain transformer coupling to the power valve, but the primary of this transformer is in series with a 20,000-ohm resistance, which in conjunc-

tion with the speaker leads for all direct current is entirely isolated from the speaker windings.

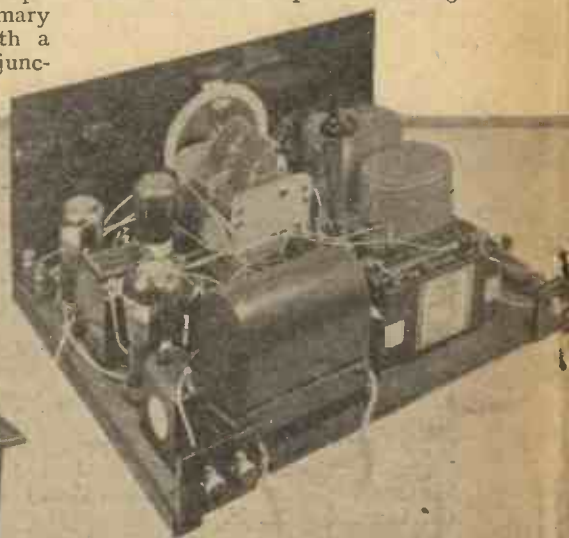

These four photographs show practically every aspect of the "Battery-operated Radio-gramophone."

YS' BATTERY-OPERATED GRAMOPHONE

re given last week for building a fine
phone. The construction of this outfit
is here described

The general layout of the components behind the panel can be seen from the scale drawing given overleaf and the photographs. There is a full-size blueprint available which can be had from the Blueprint Department, price 1s. 6d. post free. The

in the list are those actually used in the set illustrated by the photographs, the others being alternatives which have approximately the same electrical values and as near as possible the same dimensions and drillings centres.

BATTERY-OPERATED RADIO-GRAMOPHONE "

Output choke (Atlas C.P.S.).
500,000-0-500,000-ohm fader (A.E.D.).
Four spaghetti resistances—three 20,000-ohm and one 40,000-ohm (Lewcos, Telsen, Lissen, Bulgin, Graham-Farish).
Two terminal blocks (Junit, Sovereign, Lissen, Belling-Lee).
One terminal block for horizontal mounting (Lissen, Belling-Lee).
Four terminals, marked: A, E, L.S. (2) (Belling-Lee, Eelex, Burton).
Two spades, marked: L.T.—, L.T.+ (Belling-Lee, Eelex, Clix).
Six wander plugs, marked: H.T.—, H.T.+1, H.T.+2, G.B.—, G.B.—1, G.B.—2 (Belling-Lee, Eelex, Clix).
Connecting wire and sleeving (Lewcos).
Valve screen (Six-Sixty, Peto-Scott).

Four yards thin flex (Lewcoflex).
Pair of bias battery clips (Bulgin).

ACCESSORIES

Accumulator (C.A.V., Exide, Fuller, Ever Ready).
H.T. battery (Drydex, Pertrix, Ever Ready, Lissen, Fuller).
G.B. battery (Drydex).
Pick-up (Zonophone, Marconi, B.T.H., H.M.V., Graham-Farish).
Motor (Garrard, Collaro, Apollo).
Twin needle-cup (Bulgin).
Permanent magnet moving-coil speaker (W.B., Amplion, H.M.V., Epoch).
Cabinet (Borst).

address is AMATEUR WIRELESS, 58-61
Fetter Lane, London, E.C.4.

To prevent any trouble in making up the set it is advisable to adhere rigidly to the list of components. The parts given first

No matter whether you are working from the full-size blueprint or from the scale drawing, the first job is to get the panel drilled if the panel is not already supplied

with the holes cut. In some kits of parts, ready drilled panels are provided. Holes must be drilled for the main tuning condenser, volume control, reaction condenser, on-off switch, and wave-change switch. Three holes must be drilled on the lower edge for woodscrews in order to clamp the panel at right angles to the baseboard and the small window for the tuning condenser dial must be cut.

This is best done by drilling small holes around the outline of this window and punching out the centre portion. Alternatively, a much neater job can be made if you are handy with a fretsaw.

There is a small flange around the ebonite faceplate, so that any small inaccuracies in cutting the hole in the panel will not show. But be careful not to let the drill or saw slip and spoil the panel's polished surface. The two-ganged condenser is not mounted direct on the baseboard, but on small supports. These keep it approximately an inch above the level of the board so that wiring can pass underneath.

Wiring

Note that one earthing connection is made to one of these supports at the back of the condenser and you must take care that this gives good electrical contact. The special screen aerial and screen-grid coils must be placed exactly in the positions shown. There is a ganged switch rod connecting up the two units and there is a small extension through the panel to the wavechange knob in front.

The reaction condenser, volume control, and on-off switch have one-hole fixing and may be clamped to the panel when the panel has been fixed to the baseboard. The rest of the baseboard parts may then be mounted. There is nothing very difficult in this, the positions of the valve holders and fixed condensers being quite obvious. Take care to keep the coils the right way round.

It is best to use the point-to-point system in wiring up a set of this description and bare wire should be enclosed in the

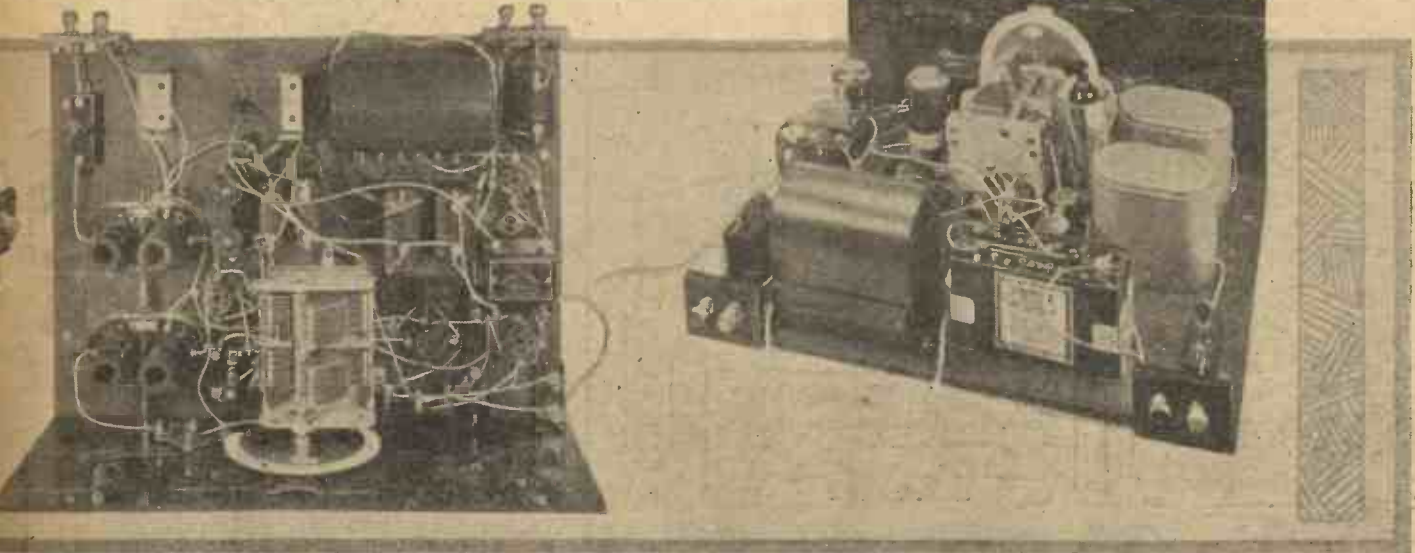

hone," from the turntable arrangement to the details of the receiver and amplifier portion

“EVERYBODY’S RADIO-GRAMPHONE” (Continued from preceding page)

insulated sleeving. The grid-bias battery is carried in clips on the baseboard and this saves long leads.

The gramophone turntable and pick-up are mounted on the turntable board of the radio-gram cabinet, together with the switch which cuts out the screen-grid and detector valves when the set is used as a gramophone amplifier. Keep the pick-up leads as short and direct as possible and if an electrically-driven gramophone motor is used, then keep the mains lead well away from the pick-up and battery wiring of the set.

The special Borst cabinet houses the set, turntable, speaker and batteries, and makes a very neat job of the whole outfit. There are no special points to note in mounting the motor of the turntable drive, for most motors are provided with a template which makes it an easy matter to get the drilling centres right for the mounting bolts and the drive spindle.

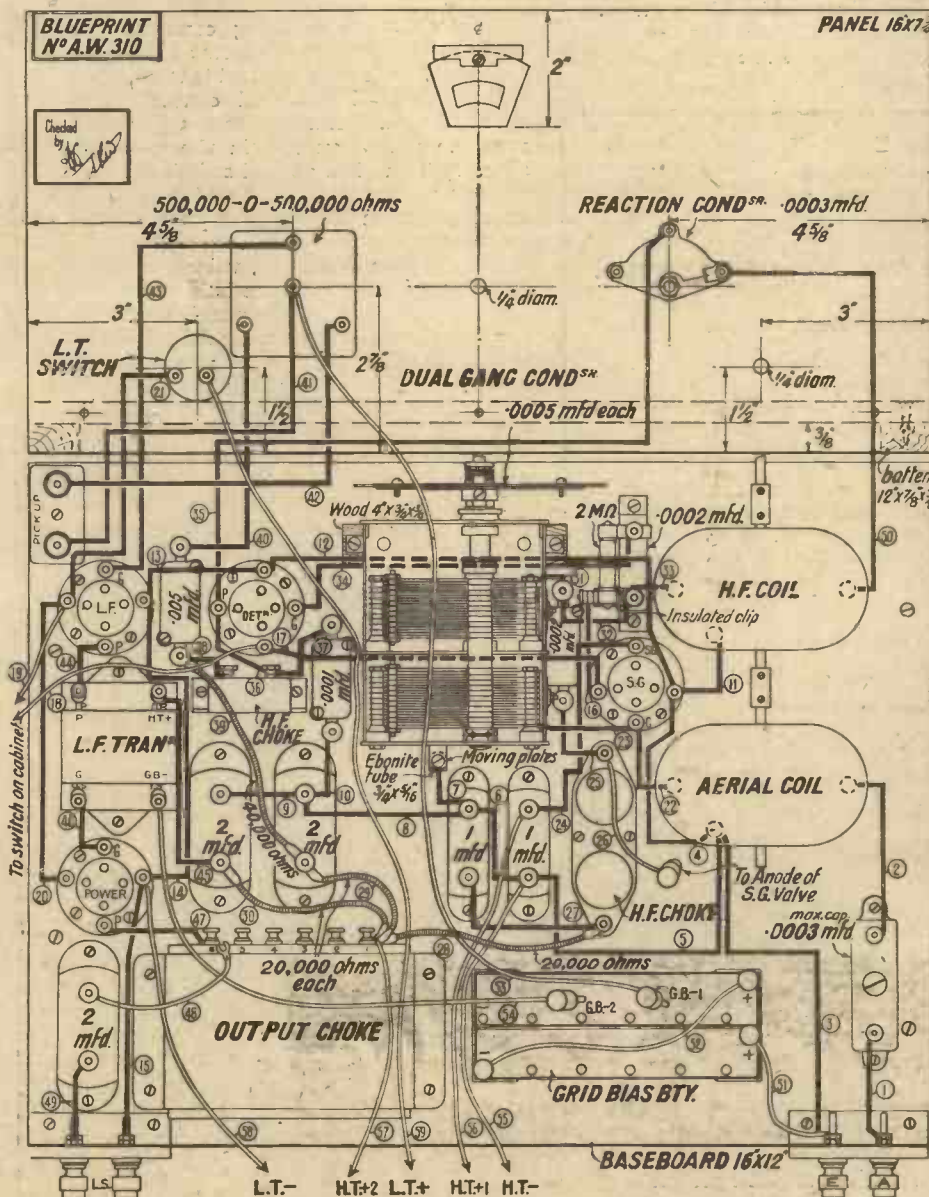
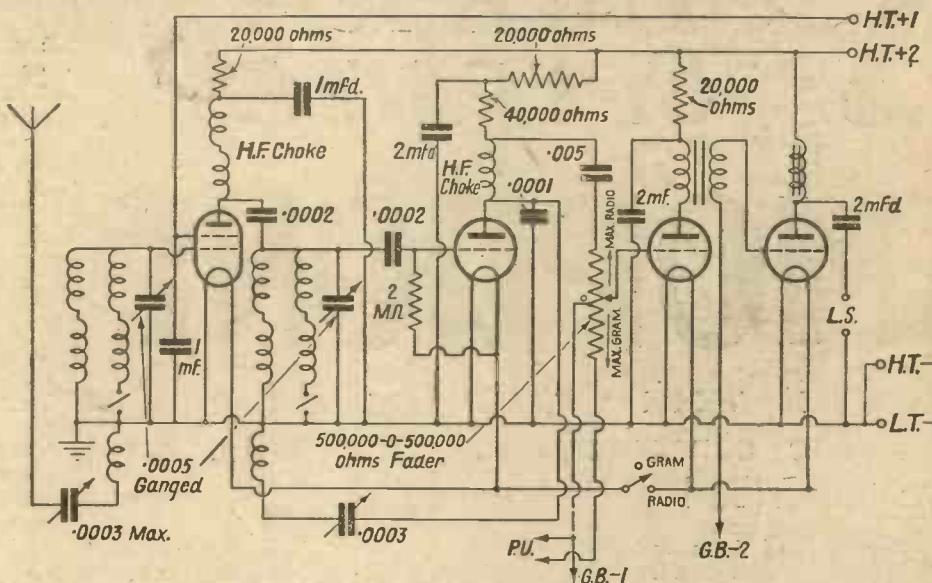

The layout and wiring diagram, A full-size blueprint can be supplied, price 1/6

Pick-up mounting is vitally important, of course, for while a fixed-arm carrier can give accurate tracking to within three or four degrees if the centres are right, the tracking error can be enormous if one simply guesses at the proper mounting positions. This means that good records will be ruined after a dozen or so playings. It always pays to take the greatest care in setting the pivoting point of the carrier.

At the side of the pick-up arm is the rotary switch marked "Radio-Gram," which is connected by two flex leads to the filament circuit of the set. When working the set on radio, this switch must be turned to the "Radio" position, switching on all

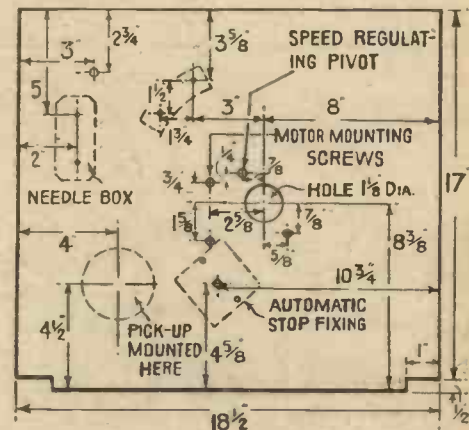

A dimensioned drawing of the motor board

four valves, and the volume control should be set to the maximum "radio" position.

The volume control must be turned over to the other side when the set is worked as a gramophone amplifier, and to save filament current the switch on the motor board should be clicked over so that the screen-grid and detector valves are switched off.

For economical battery operation a triple-capacity battery should be used, and a 120-volt unit is advisable. Two 60-volt triple-capacity units should be connected in series. The volume will be considerably

(Continued on page 701)

READY RADIO TESTED KITS

THE "OLYMPIAN THREE"

KIT A £6:4:9

(Less Valves and Cabinet.)

Or 12 monthly instalments of **11/6**

KIT B £8:3:9

(With Valves, less Cabinet.)

Or 12 monthly instalments of **15/3**

KIT C £10:8:9

(With Valves and Cabinet.)

Or 12 monthly instalments of **19/3**

RECOMMENDED ACCESSORIES

1 Fuller 120-volt Super Capacity	£ s. d.
H.T. Battery	15 3
1 Fuller 9-volt G.B. Battery	1 0
1 Fuller 2-volt 30-amp. L.T. Accumulator	10 3
1 Blue Spot L/S Unit, 66K	1 5 0

THE "CENTURY SUPER"

KIT A £6:18:6

(Less Valves and Cabinet, but including Wound Frame Aerial)

Or 12 monthly instalments of **12/8**

KIT B £10:14:6

(Including Valves, Wound Frame Aerial, but less Cabinet)

Or 12 monthly instalments of **19/8**

KIT C £11:9:6

(Including Valves, Cabinet and Wound Frame Aerial)

Or 12 monthly instalments of **21/-**

Completely assembled with valves, Cabinet and wound frame aerial, ready for use and aerial tested. Price **£14:10:0**

Or 12 monthly payments of **26/6**

If you do not need the complete kit you can buy any of the parts you require separately.

TO INLAND CUSTOMERS—Your goods are despatched Post Free or Carriage Paid.

OVERSEAS—Everything Radio can be supplied against cash. In case of doubt regarding the value of your order, a deposit of one-third of the approximate value will be accepted and the balance collected by our Agent upon the delivery of the goods. All goods are very carefully packed for export and insured. All charges forward.

READY RADIO FRAME AERIAL

Suitable for use with any Super-Heterodyne or any other receiver for which a frame aerial is specified. Two separate centre-tapped windings, stranded silk-covered wire, accurate spacing. Covers medium and long waves. Strongly made, handsome appearance, easy rotation each **20/-**

With rotary change-over switch **25/-**

Mr. G. P. Kendall, B.Sc., has joined the staff of Ready Radio as Chief Engineer. He was for many years the well-known Chief of Research for "Popular Wireless" and "Modern Wireless" and is the designer of many famous sets.

ORDER FORM

CASH ORDER Please despatch to me at once the goods specified for which I enclose payment in full of £

C.O.D. ORDER Please despatch to me at once goods specified for which I will pay the sum of £

EASY PAYMENT ORDER Please despatch my Easy Payment order for the goods specified for which I enclose first deposit of £

Name.....
Address.....
Kit required.....



READY RADIO LTD., Eastnor House, Blackheath, S.E.3 Phone: Lee Green 5678.
A.W. Showrooms: 159 Borough High Street, S.E.1 Phone: Hop. 3000. Grams: Readirad, Sedist.

To Ensure Speedy Delivery, Mention "A.W." to Advertisers

Every Ready Radio Kit is composed of chosen components which have been tested and passed for despatch under the supervision of Mr. G. P. Kendall. By building your receiver with a Ready Radio Tested Kit you are consequently assured of the finest possible results obtainable from the circuit of your choice.



IN MY WIRELESS DEN

Weekly Hints — THEORETICAL
CONSTRUCTIONAL & BY
W. JAMES

Unstable S.G.'s

IT seems to be not very well known that a screen-grid valve will oscillate under certain conditions, even when the coils and condensers are well shielded.

There is, of course, a tiny coupling between the grid and anode. Modern screen-grid valves are well made and the capacity of the grid and anode is exceedingly small, but still, a measurable capacity is there. When a signal is tuned in, varying voltages are applied to the grid circuit. In the absence of other couplings, because of good screening of the parts and proper decoupling of the batteries, we should expect to find that the strength of the signals applied to the grid would not be changed by connecting or disconnecting the high-tension supply to the screen and anode circuits.

But this is not the case, and when the anode circuit is tuned, the voltage applied to the grid circuit will vary. This shows that the anode circuit is affecting the grid circuit.

If the two tuned circuits, connected to the anode and the grid of the valve are good ones, it is possible that the stage will oscillate.

The feed-back or reaction effect is of help in certain circumstances in strengthening the signals, but when oscillation occurs it is not possible to obtain satisfactory results. Too good coils are, therefore, useless.

Why These Rheostats ?

I was looking at an old set the other day and tried to think of the reasons why we had a filament resistance for each valve.

Nowadays we do not often use filament resistances, but five years ago they were fitted to many sets. The object was to avoid over-running the valves and also to save filament current.

We used to give the valves no more current than was necessary to provide the desired results. And in looking back it seems that we went to an amount of trouble and expense in order that each valve should be worked to the greatest advantage.

Present-day valves are, of course, much superior to the valves of five years ago, but we now take a little less trouble to save filament current and to extract the very last from the valves.

A filament resistance in the circuit of a screen-grid valve will be found a useful control on occasions. When the current through the filament is reduced by increas-

ing the amount of the resistance in circuit, the selectivity is usually improved and the amplification falls off. In fact, the filament resistance is a convenient and cheap volume control.

Easy to Gang

It is really so easy to gang a circuit, that I am surprised at the difficulty experienced by some amateurs to fix the tuning of the circuits.

A typical case is that represented in the accompanying diagram, which shows a

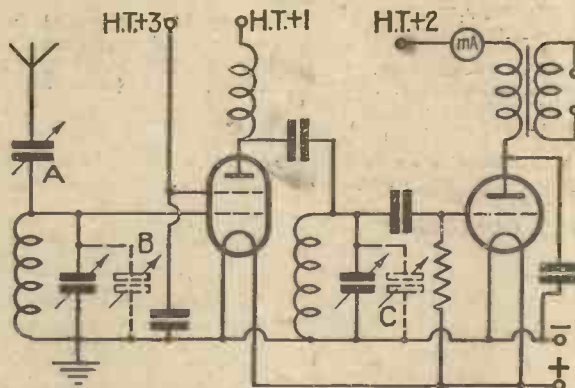

A ganged circuit, the operation of which is described by W. James

tuned aerial circuit connected to a screen-grid valve having a further tuned circuit joined to it in the usual way.

In the aerial circuit is a pre-set condenser A. The aerial tuning condenser is marked B and the anode condenser C. A milliammeter is shown in the plate circuit of the detector.

The two parts of the gang condenser are fitted with trimming condensers. Assuming that the two coils have equal inductances and that the tuning condensers are alike, all that we must do is to make the fixed capacities of the two circuits equal.

We have trimming condensers for this purpose. We can, therefore, start by tuning to the local station. The needle of the meter will move back when the station is tuned.

Now unscrew both trimmers or condensers B and C. Then adjust A until the signal is the strongest, adjusting the gang condenser at the same time to keep the circuits in tune.

A setting of A will be found where the signal is the strongest. If now further selectivity is needed, A may be reduced and C increased.

But if the signals are too weak and the tuning seems too sharp, A may be increased and C increased. Changes in the strength are easily noted by watching the meter.

Glowing Fuses

When a set having several 1- or 2-microfarad condensers is provided with a 60-milliampere bulb as a fuse in the negative high-tension circuit, it will probably glow for a moment when the switch of the set is moved on and off.

This is normal and does not indicate a fault. It is possible that the fuse will blow and I think that a 60-milliampere bulb is too small.

A bulb of a little greater capacity, say 100 milliamperes, will protect the circuit and not be so likely to blow as the result of the condenser currents passing during switching.

Cutting Down Record Noise

Comparatively few people use a scratch filter for the purpose of reducing the noise when playing records through a pick-up and amplifier.

They often find that there is very little scratch from an ordinary pick-up. Some pick-ups are much more sensitive than others to the higher frequencies and the effect of connecting a potentiometer-type volume control is to lessen the noise.

As the resistance of the volume control is reduced, so the noise usually decreases. This means, in effect, that as the resistance is reduced so the response to the higher frequencies is reduced.

If you connect an adjustable resistance across a pick-up and listen for changes in the quality as the resistance is varied, you will probably be surprised at how easily the higher notes are reduced in strength. If, then, the potentiometer volume control has a fairly low resistance, such as 50,000 ohms, the higher frequencies will usually be much weaker than when the control is of 100,000 ohms or more.

A few experiments in this direction will soon show the most favourable value of resistance for the best all-round results.

BRITAIN'S "SUPER"
The set for you! Range,
power and selectivity

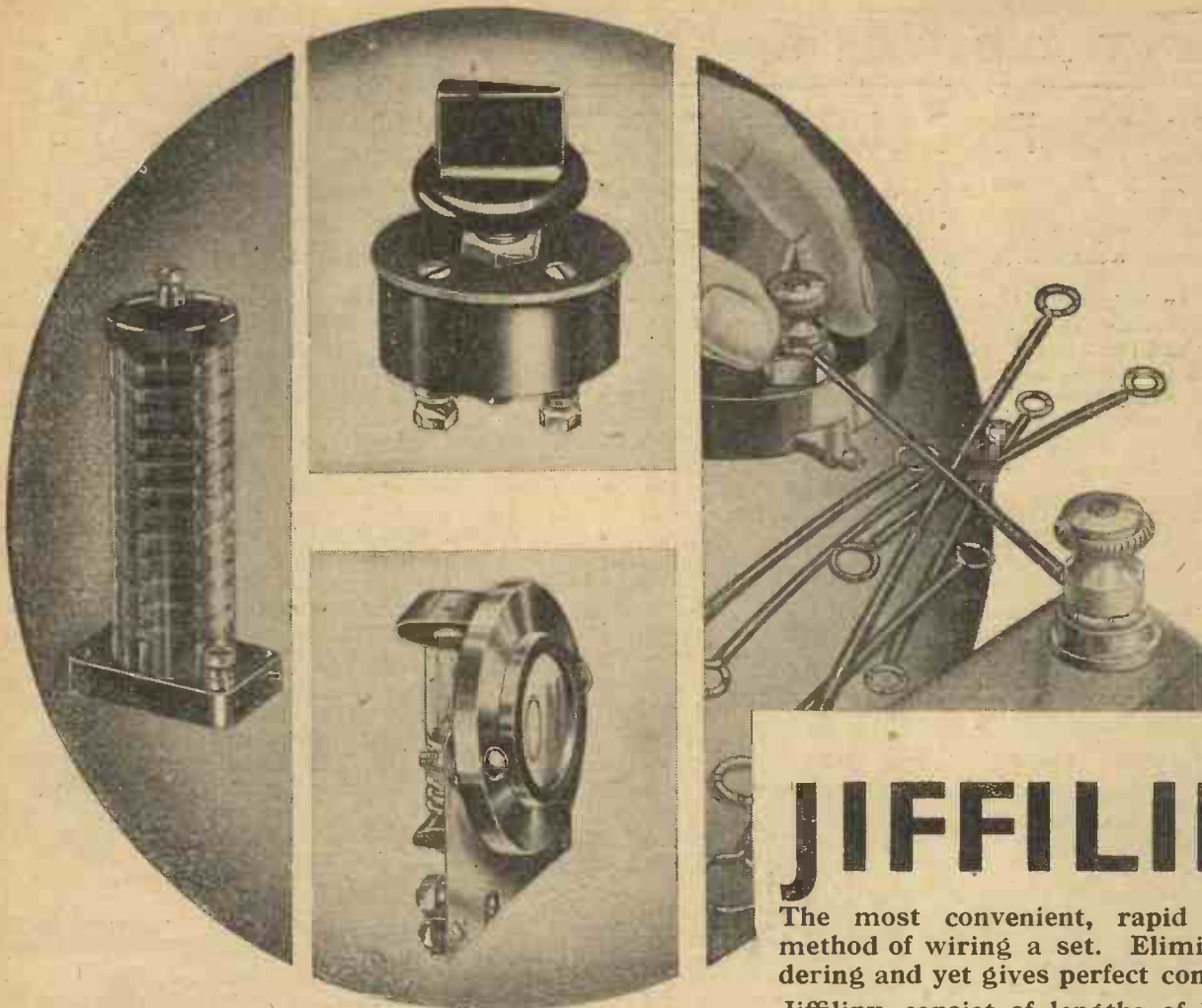

READIRAD SUPER HET CHOKE

Specially designed for use in the modern type of Super Het circuits for excluding the intermediate frequency currents from the low frequency circuits. Should also be used wherever a Choke of extra high inductance is advisable. Price **5/6**

READIRAD STANDARD H.F. CHOKE
Price **4/6**

READIRAD SNAP SWITCH

Almost instant action, the elimination of all noises and the instant suppression of arcing with exceptional positive and direct contact. Made in two types—"Radio-Gram" (single pole change over) and "On-Off." Price **2/9**

READIRAD PANEL LIGHT
Shows the word "ON" in glowing red when the set is switched on. Adds a distinctive touch to the set and prevents battery wastage. For battery-operated and mains sets. Price **2/3**

JIFFILINX

The most convenient, rapid and neat method of wiring a set. Eliminates soldering and yet gives perfect contact.

Jiffilinx consist of lengths of high conductivity wire covered with special insulation properties which ensure absolute freedom from "short circuit." Both ends are terminated with shake-proof connectors designed to fit the terminals of all components. They can be bent easily with the fingers to any desired angle.

Each packet contains 40 Jiffilinx in many various lengths—ample to wire a large set. Jiffilinx are indispensable to the experimenter as they can be used over and over again. Changes in connections can be made instantly and errors in wiring easily rectified without wastage.

Try Jiffilinx for your next set—or re-wire your present set and make sure of perfect electrical contact everywhere. Once you have used them you will never use any other form of wiring. Send for a packet to-day.

JIFFILINX **2/6** per packet.

Ready Radio

Have you got your copy of Kendall's new book "10 Hows for Modern Radio Constructors"? Over 15,000 sold at Olympia. Price 6d. post free.

Coupon

To Ready Radio Ltd.,
Eastnor House, Blackheath, S.E.3.

Please send (a) Copy of Kendall's Book for which I enclose four 1½ stamps. (b) 1 packet of Jiffilinx for which I enclose 2/6. (c) Catalogue of Readirad Components. (Cross out items not required.)

Name

Address

A.W.

Please mention "A.W." when Corresponding with Advertisers

THE HOW AND WHY OF TUNING—V

PROBLEMS OF TUNING

Another of a short series of articles on tuning, specially written for newcomers to wireless. Here the first ideas about tuning are presented. In the articles that follow, "Hotspot" will deal with all the difficulties about tuning that the beginner is likely to meet

THE first real analysis of a tuning circuit shows that, although we introduce only capacity and inductance, as at Fig. 1A, there is, in addition to these two constituents, a third, which is the combined resistance of the condenser and the coil. This resistance can be considered as being in series with the capacity and the inductance, as at Fig. 1B.

The effect of an alternating voltage on a circuit containing inductance, resistance and capacity in series is not easy to explain fully, unless one resorts to vector diagrams and a little mathematics generally.

Nevertheless, it can readily be appreciated that the incoming signal has to contend with (1) the resistance, through which a current must be driven (2) overcome the counter E.M.F. of the inductance, and (3) overcome the counter E.M.F. of the capacity (see previous articles).

Now it so happens that we can readily arrange the circuit so that the counter E.M.F.s of the inductance and the capacity, set up by the application of the signal voltage, *cancel out*. This condition applies when the circuit is adjusted to the same frequency as the incoming signal. When this condition, known as electrical resonance, is achieved, the circuit shown at Fig. 1B behaves as if it comprised resistance only—that is with respect to the applied voltage.

Effect of Resistance

From this elementary argument, it is clear that the only thing that limits the current flowing round the tuning circuit at the point of tune is its resistance. So if we lower the resistance we shall expect to get an increased current. If the circuit is "de-tuned," the counter E.M.F.s of the inductance and the capacity do not entirely cancel out and so the current is reduced.

In practice, we are seldom interested in the tuning circuit by itself, for we have to remember that its characteristics are greatly modified by the valve to which it is connected.

Apart from the aerial circuit, the tuning circuit is usually considered in conjunction with an amplifying valve. The behaviour of such tuning circuits will determine how much of the maximum possible valve amplification is actually obtained.

The measure of a tuning circuit's efficiency, either alone or with an amplifying valve can be measured or calculated by comparing the output voltage with the input voltage. The great thing to remember is that at the signal frequency this ratio of output to input voltage depends on the resistance of the tuning circuit.

A simple resonance curve, such as that shown at Fig. 2, can be drawn by plotting amplification against frequency. Note that at the resonant point the amplification

is at its maximum. Note also that a low resistance means a higher amplification of the applied voltage than does a high resistance.

On this basis, it would seem very desirable to make the resistance of the tuning circuit as low as possible; which reflection brings us to one of the biggest problems of tuning, which is to find the best compromise between tuning circuits that will give

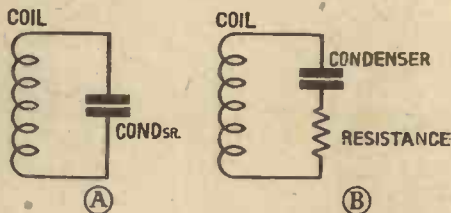

Figs. 1a and 1b. The characteristics of a tuning circuit

good amplification and tuning circuits that will do more than merely this—that will also ensure good quality of reproduction.

Frequencies

For although we have so far considered the incoming signal as only one particular frequency, we now come up against the fact that an incoming signal bearing speech and music is not just one frequency, but a group of frequencies. These are created at the transmitting station by the process of modulation, by which we can assume we mean the super-imposition of the frequencies of speech and music—all frequencies in the audible range—upon the tremendously high frequencies of transmission.

The carrier wave is the fundamental frequency; if we send out a pure note on this carrier wave by the process of modulation, we create three separate frequencies of transmission; one is the fundamental

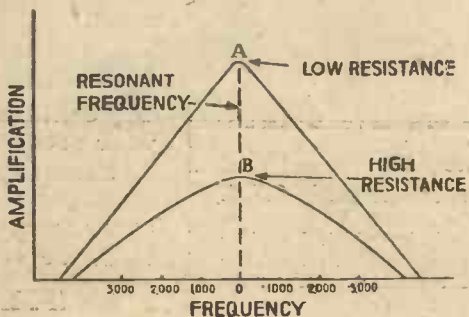

A simple resonance curve

frequency, the second is the fundamental plus the frequency of the pure note, and the third is fundamental frequency minus the frequency of the pure note. The two extra frequencies are known as side bands, and one is above the fundamental frequency while the other is below it.

When speech, or more particularly music is transmitted, we have to deal with as many pairs of side bands as there are audible frequency components. According to the frequency of the original sounds, the side bands formed by addition or subtraction with the carrier will vary in frequency, often as much as 5,000 cycles above or below the fundamental. This complication sets us the main problem of tuning, which is to deal faithfully with all the frequencies associated with the carrier frequency, but at the same time to make the tuning unresponsive to adjacent carriers and their associated frequencies.

Quality and Selectivity

Good quality selectivity is always a contradiction of terms when we consider only one tuning circuit; it is impossible to make a single circuit at once selective and capable of dealing with all the side bands. This is a fact often overlooked by many who should know better—such as enthusiastic set designers who claim "knife-edge" selectivity for sets with only one, or even two, tuning circuits.

We can readily see why sharp tuning and good quality are conflicting requirements of a circuit by referring again to Fig. 2. The circuit corresponding to resonance curve A is of low resistance, so that the current rises sharply at the point of resonance, but falls rapidly away as this resonant point is passed. This means that only frequencies within two or three thousand cycles of the fundamental appreciably affect the circuit when it is tuned to that fundamental. Which, in turn, means that the outer side bands, which correspond to the higher audible frequencies, are entirely cut off.

The circuit corresponding to resonance curve B in Fig. 2 deals with more of the side bands than curve A, because it provides something like a level response over, say, 5,000 cycles. Even this cuts off many of the frequencies needed for good reproduction. From which it is now clear that tuning is inseparably connected with the needs of quality in reproduction. Next week we shall have to define this problem more fully.

HOTSPOT.

FOR SET BUILDERS

READY RADIO, LTD., have just brought out a useful 48-page book called "Ten 'Hows' for Modern Radio Constructors." It is by G. P. Kendall, B.Sc., and deals with interesting subjects, such as choosing a circuit, adjusting ganged sets, operating a super-het, fitting a gramophone pick-up and increasing the selectivity. It is well illustrated with circuits and pictorial diagrams, and copies can be obtained, price 6d., from Ready Radio of 159 Borough High Street, S.E.1.

TELSEN LOUD-SPEAKERS

TELSEN LOUD-SPEAKER UNIT

The Telsen Loud-speaker Unit is pleasing to the most sensitive ear. The deep notes of the bass, the brilliance of the soprano, and the crispness of diction are clearly reproduced without any distortion. It employs cobalt steel magnets, and the detachable rod which carries the cone is fitted with cone washers and clutch. The entire unit is enclosed in a beautifully moulded bakelite dust cover.

Telsen Loud-speaker Unit Price 5/6

TELSEN LOUD-SPEAKER CHASSIS

The fully floating cone mounted on a flexible felt surround renders the Telsen Loud-speaker Chassis very sensitive, giving perfect balance of tone. It is unaffected by damp conditions because the cone material is practically non-hygroscopic. The Telsen Loud-speaker Chassis is substantially made and it is light in weight. Holes are provided for easy attachment to most of the popular makes of loud-speaker units. The Chassis may be readily fixed to a baffle board or cabinet by three or more wood screws.

Telsen Loud-speaker Chassis Price 5/6

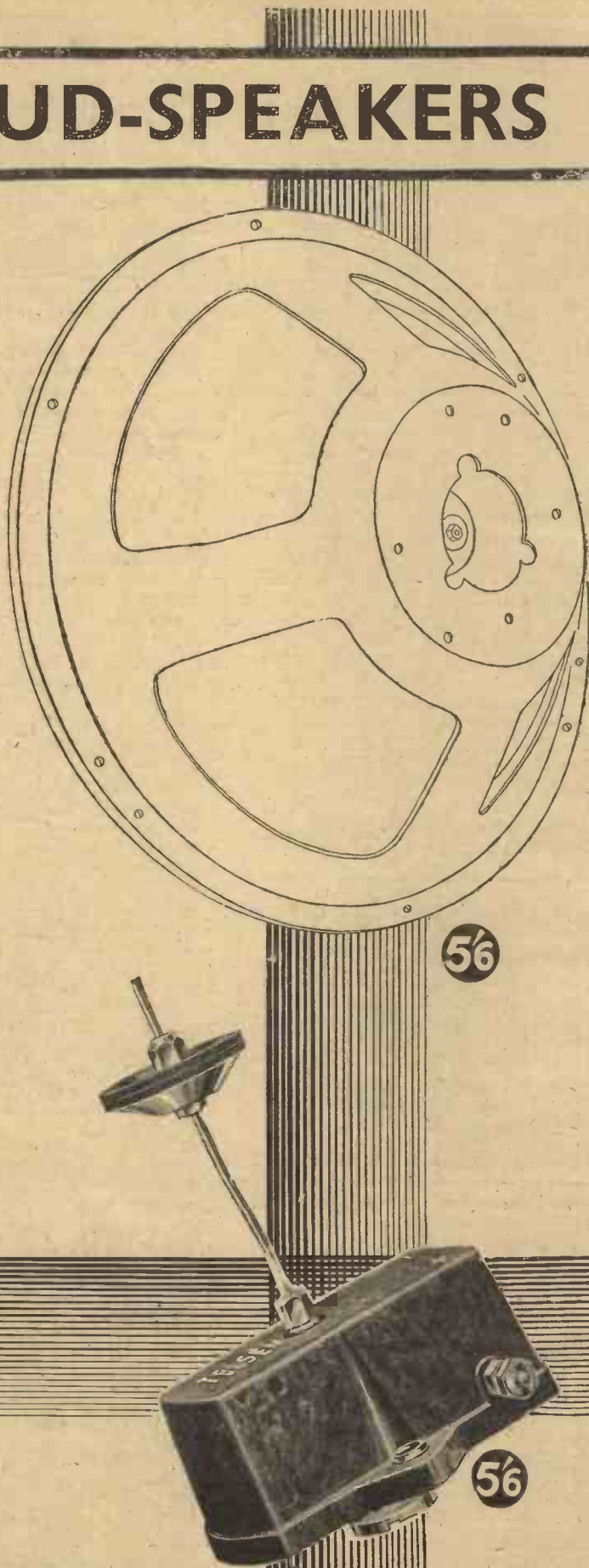

TELSEN

ALL-BRITISH
RADIO COMPONENTS

Send for the "Telsen Radio Catalogue" and book of "All-Telsen Circuits" to The Telsen Electric Co., Ltd., Aston, Birmingham.

CVS-57

Mention of "Amateur Wireless" to Advertisers will Ensure Prompt Attention



A weekly review of new components and tests of apparatus conducted by J. H. Reyner, B.Sc., A.M.I.E.E.

Epoch A2 Speaker

THE new Epoch type A2 permanent-magnet loud-speaker which we are reviewing this week belongs to the class of small, light instruments now becoming so popular with the manufacturers and listening public alike.

This speaker employs a small moving-coil approximately $\frac{3}{4}$ in. in diameter. The coil is suspended from a 100-degree paper diaphragm, which is itself supported at the outer edge by a white leather surround. This latter surround is strongly held between two cardboard rings which are bolted to the framework of the speaker. The centring device employed is fixed to the moving coil behind the diaphragm and allows ample movement from the axis of the cone, at the same time exercising a good control in the radial direction.

The magnet employed is completely copper-plated and is of the familiar cross type which proves so successful in use. The whole speaker is assembled in a crystalline finish metal chassis, which completely sur-



A new Epoch permanent-magnet speaker, the type A2

rounds the magnet, the whole unit making a very neat and light job.

On test the speaker gave a good account of itself and appeared to be able to handle a generous input without any signs of distress. The quality of reproduction was very brilliant, but the output appeared perhaps a little restricted below 200 cycles. It was, however, free from the papery quality often found in small moving-coil speakers and with the modern type of receiver which is so prone to cut off the higher frequencies, this speaker should give excellent results. It is very good value for money.

Dixon Aconometer

ANYONE who experiments with A.C. mains equipment is bound to feel sooner or later the need of a good A.C. voltmeter. Messrs. Leslie Dixon & Co., who

have for a considerable period marketed their Onemeter for D.C. measurements, a comparatively inexpensive moving-coil meter with a number of multipliers to extend the range, have followed this up with the Aconometer, which, as the name implies, is a somewhat similar instrument intended to A.C. working.

The instrument is of the moving-iron type and is thus suitable for A.C. or D.C. It is not possible to obtain the same sensitivity with moving-iron meters, but this instrument nevertheless only consumes 10 milliamps at full scale deflection. The scale is not uniform, as is unavoidable with an A.C. instrument, but the design of the moving system can be arranged partially to overcome this defect, and on the present instrument the minimum reading marked is 30 volts on a 150-volt scale, which gives a wide enough range for most purposes.

The instrument is finished in the same style as the D.C. Onemeter, a large scale being provided, with a mirror behind to obviate "parallax" errors. This is important for accurate work, for if the eye is not directly over the pointer, the apparent reading on the meter will be slightly different from the true one.

The instrument is made in two ranges, having 15, 30, and 60 volts tapplings, and the other range 150, 300, and 600. It would, we think, be more convenient if a meter could be marketed having one low range and two high ranges, such as 15, 150, and 600 volts, as with the present system an instrument suitable for the L.T. voltages cannot be used for the high-tension voltages and vice versa.

There is the customary push-button which connects the movement up through a series resistance first of all as a precaution against accidental overload. Pushing the button right home then brings the meter into proper operation. This button has to be held home all the time, which means that both hands are not free, and this is apt to be awkward when exploring a set with test prods.

True Volts	Meter Reading	
	D.C.	A.C.
28	28	28
64.5	66	66.5
102	105	106
125	128	129.5

The meter was checked for accuracy on both D.C. and A.C. The results are given in the accompanying table and will be seen to be correct to within 3 per cent.

The movement is nicely damped, and altogether the instrument, at a price of 50/-, complete with case, is an attractive proposition.

Varley Thermal Delay Switch

AN interesting component which we have tested this week is the new Varley thermal delay switch. This switch



The Varley thermal delay switch

has been specially designed for use with the mercury vapour rectifying valve type GU1. It is essential to use a delay switch of some kind in the anode circuit of this type of rectifier valve if the full output of the valve is to be obtained. This switch is, of course, suitable for use with any circuit where a similar delayed action is required.

The switch consists of a strip of special bimetal, pivoted at each end on a knife edge, around which, but insulated therefrom, is wound the heater winding. A small disc of metal in the centre of the strip forms one H.T. contact, the other being fixed to the body of the switch. When the heater current is switched on, one side of the strip expands more than the other, so that the strip becomes bowed, and the two contacts come together to complete the H.T. circuit.

The body of the switch is of black moulded material.

On test the necessary 4 volts were applied across the heater winding, and the delayed action of the switch timed. The time taken to operate was 90 seconds. It must be remembered that due to the fact that the strip does not cool down at once when the heater current is switched off, the H.T. contacts will remain closed for a small period. It must also be remembered that the delay period will be considerably shortened if the heater circuit is opened and closed with no suitable cooling period between. For example, after a cooling period of one minute, the switch reoperated in 52 seconds instead of the 90 seconds previously required. Another point is that as the switch heater winding is permanently across the low-tension supply of the receiver this must therefore be capable of supplying the extra load (approximately 1 ampere at 4 volts). The overall dimensions are 3 in. by $1\frac{1}{2}$ in. by $\frac{7}{8}$ in., and the retail price is 12s. 6d.

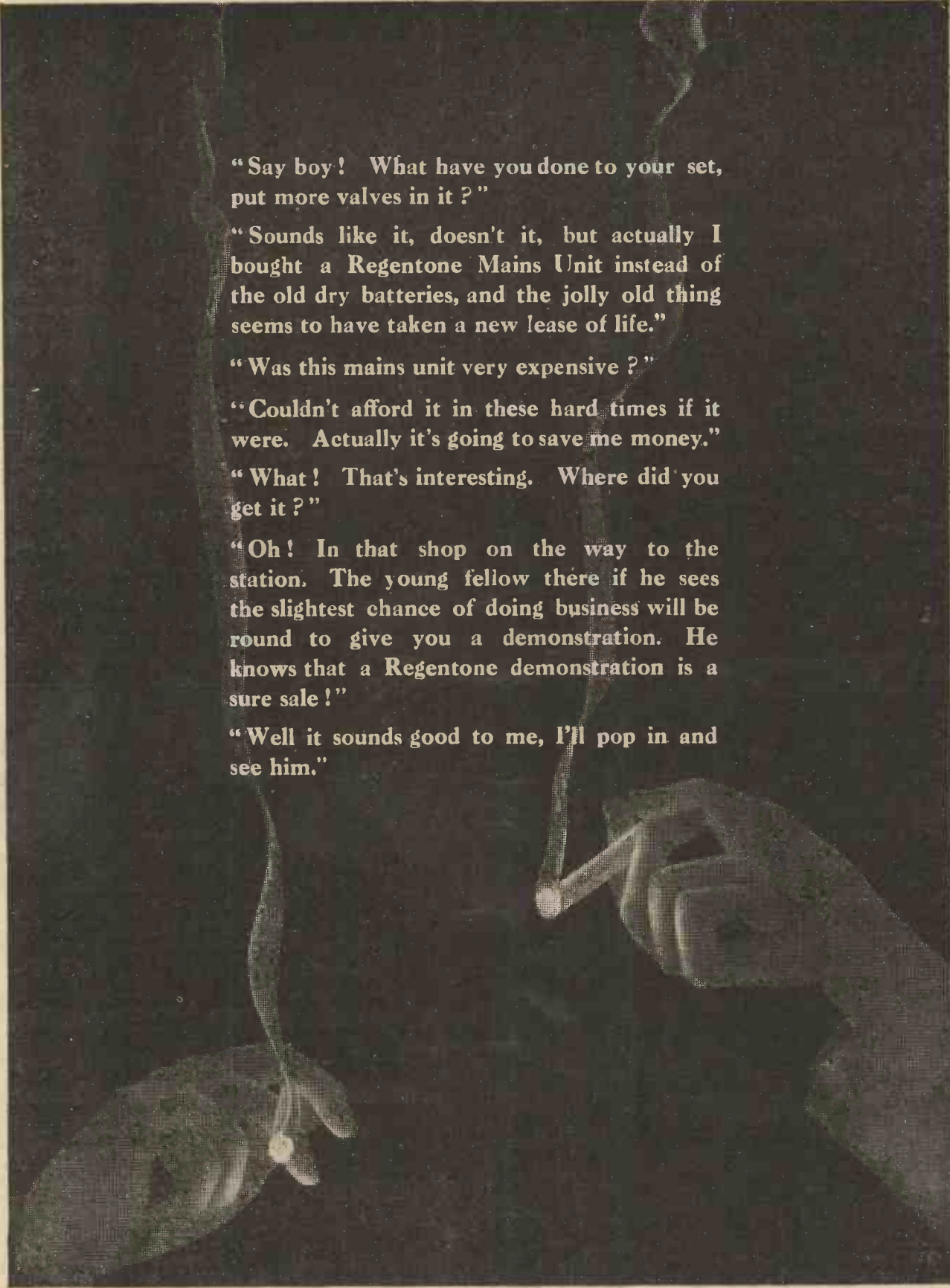

"Say boy! What have you done to your set, put more valves in it?"

"Sounds like it, doesn't it, but actually I bought a Regentone Mains Unit instead of the old dry batteries, and the jolly old thing seems to have taken a new lease of life."

"Was this mains unit very expensive?"

"Couldn't afford it in these hard times if it were. Actually it's going to save me money."

"What! That's interesting. Where did you get it?"

"Oh! In that shop on the way to the station. The young fellow there if he sees the slightest chance of doing business will be round to give you a demonstration. He knows that a Regentone demonstration is a sure sale!"

"Well it sounds good to me, I'll pop in and see him."

Write for Free Art Booklet to:—REGENTONE, LIMITED, Regentone House, 21 Bartlett's Buildings, E.C.4. Tel. Central 8745 (5 lines).

Irish Free State Distributors: Kelly & Shiel, Ltd., 47 Fleet Street, Dublin.

You will Help Yourself and Help Us by Mentioning "A.W." to Advertisers

THE BEST METHODS OF VOLUME CONTROL

By J. H. REYNER, B.Sc., A.M.I.E.E.

I SEE that Varley's have introduced a form of volume control which is capable of being ganged. Several of the manufactured sets at the Show made use of ganged volume controls, for it is often convenient to be able to control two circuits at once, or at any rate with the same knob even if they come into operation under different conditions.

One of the simplest applications of this principle comes within the latter category. Most of us have experienced trouble at one time or another with the question of radiogram volume control. If we can find a suitable position for controlling the radio volume, then this does not control the gramophone volume satisfactorily, and vice versa. The problem indeed is so troublesome that in many cases a separate volume control is provided on the pick-up itself.

This device is quite satisfactory and admittedly obviates providing an extra knob on the panel, but it is rather a quibble, because the extra control is still there although we have moved it to the pick-up instead of placing it on the main panel. The use of a ganged volume control enables us to use two entirely separate resistances, one placed in a convenient position on the receiver and the other connected across the pick-up in the ordinary manner.

Another application of this principle is to high quality radio receivers. Where the

high-frequency amplifier is of considerable power, the volume obtained from the local station is much too strong for ordinary purposes, and it is necessary to reduce the amplification very considerably in order to obtain reasonable volume. It is well known that this control must be before the detector, because if the full amplification is allowed to operate with a powerful input,

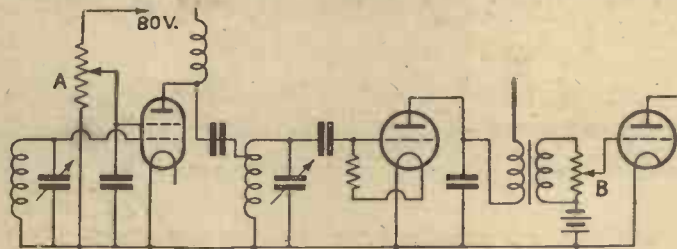

A typical arrangement of linked volume controls

not only the detector, but the H.F. valve or valves will overload.

The usual forms of pre-detector volume control, however, whilst reasonably satisfactory for small changes in volume are not good for large reductions in strength. There are two reasons for this. Firstly, the characteristics of the amplifying valves have to be altered so considerably that distortion is introduced. The use of the new multi-mu valve certainly overcomes some of this difficulty, but there are still

many sets operating on these standard lines, and it is by no means certain the multi-mu valve will come into general use. The second point is that the detector also is operating under different conditions from those for which it was designed, so that distortion is introduced here again.

We can either design the set to use a grid detector requiring a small input, or as a power-grid detector taking a large input. The latter is becoming almost universal because of its freedom from distortion, the output being almost directly proportional to the input, provided that the signal is reasonably strong. If we reduce the volume too much, however, we begin to get distortion again, and the combination of the distortion in the detector and in the H.F. amplifying system renders the quality thin and unpleasant.

The problem is aggravated because most of the listening even on a powerful set is done on local stations; the times when one really requires to use the amplification on the H.F. side and listen to foreign reception are limited, so that one has built an expensive and elaborate receiver which over the

(Continued on page 688)

THE PM3 for the V3



Recommended by RADIO FOR THE MILLION

PERMANENT MAGNET Moving Coil Speaker

Read what the Editor of "Radio for the Million" writes:—



"Our Technical Department have tested your speaker in conjunction with the set and compared it with other speakers that have been submitted to us, and we can tell you that it is the best Permanent Magnet Speaker we have yet tried, and that we are thoroughly satisfied with the results and can recommend it without fear or hesitation to anyone who uses the V.3 Kit."

Owing to the low-resistance winding of Permanent Magnet M.C. Speakers a step-down transformer is necessary. P.M.3 has our three-ratio transformer fitted—7/6 extra.

Get that wonderful rich tone from your V.3 (or any other receiver on the market to-day) by using the W.B. P.M.3.

Write for Art Booklet "Speaking of Speakers," FREE

WHITELEY ELECTRICAL RADIO CO., LTD., NOTTINGHAM ROAD, MANSFIELD, NOTTS

How to get **MORE VOLUME** and better quality reproduction **WITHOUT PAYING MORE FOR IT!**

WHEN you replace your power or super-power valve with a Lissen Power Pentode you increase the amplification of the last stage of your receiver to an enormous degree. For instance, the amplification factor of an ordinary power valve is seldom more than 10—while that of the Lissen Power Pentode is never less than 90! Think of the difference that makes to your set—how it converts a whispering foreign station to fine, full loud-speaker strength, and makes the “local” give you a torrent of pure sound.

GETTING PENTODE OUTPUT FROM BATTERY SETS

No need to alter your receiver at all. Simply replace your power valve with a Lissen Power Pentode. *The same battery drives this powerful valve*—no increase in current consumption takes place at all. That is why this valve is called the **LISSEN ECONOMY POWER PENTODE**—it gives you more volume for the same money!

The valve to ask for is the Lissen P.T.225—the

LISSEN ECONOMY POWER PENTODE

OTHER TYPES AND PRICES:—

H.L.210-5/6 H.210-5/6 L.210-5/6 P.220-7/3 P.X.240-8/-
S.G.215-12/6 4-volt and 6-volt types also available.

LISSEN LIMITED, WORPLE ROAD, ISLEWORTH, MIDDLESEX

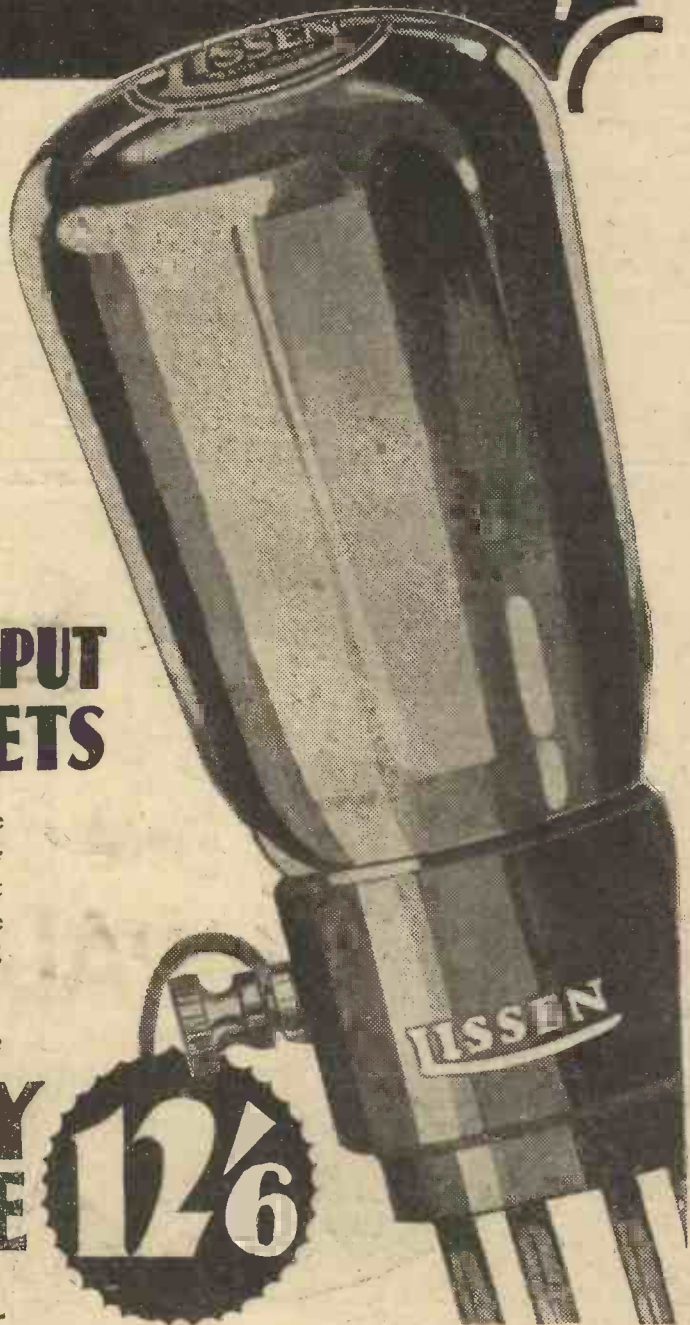

Advertisers Appreciate Mention of "A.W." with Your Order

"THE BEST METHODS OF VOLUME CONTROL"

(Continued from page 686)

greater part of the time gives bad quality.

Linked Controls

The remedy is to control the volume after the detector as well as before it. All that is necessary is to see that the detector does not overload, and sufficient volume control should be introduced in the H.F. stages to ensure that this is the case. A volume control after the detector is then introduced, such as a control across the secondary of the L.F. transformer and this also helps to cut down the signal strength. With such an arrangement good quality is obtained even on very low volume.

Hitherto, two separate controls have had to be used, but now that volume controls can be linked up various possibilities are introduced. The diagram illustrates a typical arrangement using the two volume controls, although it is not necessary to use the same methods as are shown in the figure.

For example a very convenient method of volume control is to shunt a resistance of about 1,000 ohms across the aerial tap of the first coil. You will find that gives a very sweet control of volume with very little distortion of quality, for it does not alter the characteristic of the set in any way but merely limits the input. It cannot be used, of course, in any set that does not use a tapped or coupled aerial circuit, or one that uses a frame aerial.

Then again a very good method of volume control, provided the detector is not being overloaded, is to introduce a resistance in series with the loud-speaker. The maximum value of this resistance should be about twenty times that of the speaker resistance, so that with a 10-ohm speaker a 200-ohm resistance will suffice, while with the normal high resistance speaker of about 2,000 ohms, a resistance of 40,000 to 50,000 ohms is required. Full volume, of course, is obtained with the resistance cut out, while as the resistance is introduced in the circuit the volume is progressively decreased.

No Loss of Quality

No deterioration of quality results, because all the time we are making the external resistance in the anode circuit larger and larger. Provided that the loud-speaker is operating in the first case under such a condition so that no serious amount of distortion arises, then any increase in the anode resistance will only reduce the distortion, while at the same time it will reduce the volume.

You will, indeed, find that this is a very convenient method of volume control, particularly as it can be used as a remote control. As we are dealing with low-frequency currents there is no objection to having a long lead in the loud-speaker circuit which could be terminated in a volume control given on the arm of a chair or any convenient position, and the volume

can be cut right down to a whisper or brought up to a maximum as required.

It is essential, of course, that even at full volume the set must not be overloaded, and if the set is one having a high H.F. amplification a pre-detector volume control must be used, and this, of course, must be situated in the set itself.

The device also should not be used without due forethought where the output stage is a pentode. If the external resistance in the anode circuit of a pentode valve is increased too much, very high voltages are built up and if there are any live terminals on the side of the volume control, there will be some danger of shock.

A final possibility which must be borne in mind is that of controlling reaction and volume on the same spindle. Messrs. Burne Jones & Co. market a device incorporating a special form of condenser and resistance, both operating on the same spindle. Rotation in one direction increases the volume, while in the other direction it increases the volume by the application of reaction. With a little thought somewhat similar results can be obtained using ordinary components, provided the two devices can be linked together in suitable fashion. Indeed schemes have been put forward whereby two resistances were used for the purpose. One of these resistances controlled the volume by cutting down the amplification in the usual way, while the other resistance increased the reaction effect.



Make a
new circle
of friends

BY USING

ETA VALVES

A laugh . . . a whisper . . . a song will come over
the air to you rich and true when you're using ETA Valves.
Years of care went into the making of the ETA range, that's
why you had to wait . . . but now . . . insist on ETA Valves.

THE ELECTRICAL TRADING ASSOCIATION, LTD., Aldwych House, W.C.2
Telegrams: Eltradox, Strand, London. Telephone: Holborn 8139.
Irish and Scottish Agents: W. J. BYRNE, 91, Temple Lane, Dublin.
R. G. JACKSON NISBET, 132, Renfrew Street, Glasgow.

A Valveless Amplifier!

—well-known inventor's brilliant achievement

The "Microbox" is one of the latest inventions of Mr. S. G. Brown, F.R.S., inventor of the very first loudspeaker, and a host of other devices, including the already famous Battery Superseder, which he introduced at this year's Radio Show. The "Microbox" is no bigger than the ordinary pick-up, yet it is a self-contained amplifier producing all the volume and rich tone of an expensive multi-valve reproducer. All you have to do is to change your present gramophone tone-arm and sound-box for the "Microbox" and connect it up to your loudspeaker. The little power required (10 volts at ½ amp.) can easily be supplied by a small accumulator. The only other component required—a transformer—is supplied with the "Microbox." The price of the two complete is 3 gns.



The MICROBOX combines pick-up and amplifier on the microphone principle. Price (with transformer) 3 Gns. (or 9 payments of 8/6). Mains unit. A.C. £3/15/0. D.C. £2/3/0.



KIT-CABINETS.

MODEL 1. For Mullard 1932 3-valve Kit or Radio for the Million V.3 Kit (incorporates S. G. Brown SOLO Speaker). Price 47/6 (or 6 monthly payments of 10/-).

MODEL 2. Stand-on KIT-CAB. for 1932 Melody Maker, Osram 1932 Music Magnet, etc. Price (with Brown SOLO Speaker), 39/6 (or 6 monthly payments of 8/-)

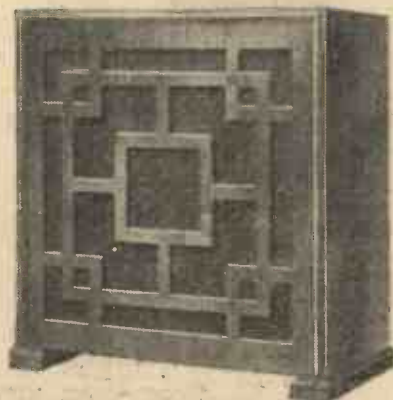

S. G. BROWN PERMANENT MAGNET MOVING COIL UNIT costs £4/7/6. Complete with handsome cabinet shown it costs £4/19/6 (or 8 monthly payments of 13/6).

Is yours a popular 'kit'?

—if so, here's something to interest you!

Excellent idea—the Kit. But not quite perfect unless you get a speaker worthy of the set, and a hiding place for your batteries. Well, you can get both in an S. G. Brown Kit-Cabinet Speaker. These S. G. Brown KIT-CABINET SPEAKERS are definitely built to save you time and trouble—and money. Scarcely worth while to make your own when you can walk away with one of ours having spent so little. They are priced from only 39/6. (See photograph and full description on right.)

Is your set 'muffled' by your loudspeaker?

—ten to one you'll answer 'No'—but are you sure?

Improvements in loudspeaker design have recently been so rapid that speakers which were the last word three years ago sound amazingly inefficient when heard beside such speakers as the new S. G. Brown permanent magnet moving coil (which costs only £4/7/6). Nine people out of every ten "muffle" perfectly good sets with old-fashioned speakers—and don't realise it. Are you quite sure you are not one of them? Go to your dealer and hear the new S. G. Brown Speakers for yourself. You'll know then whether you are doing your set justice, or not.

Send to 19 Mortimer Street, W.1, for free leaflet describing the FAITHFUL MODELS MADE BY

Yours faithfully

S. G. Brown

FAITHFUL RADIO

You Will Help Yourself and Help Us by Mentioning "A.W." to Advertisers

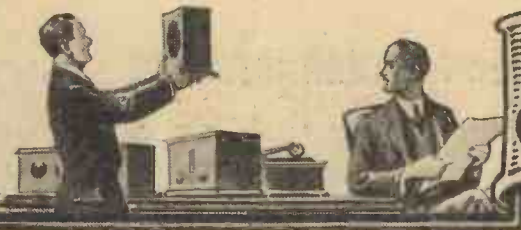

Record Making and Tracking
SIR,—With regard to the letter from "J. C. B. (Glasgow)," published on page 360 of your issue of the September 12, I think your correspondent may safely be assured that in the making of gramophone records the recording stylus operates along a radius. It follows, therefore, that for minimum record wear the needle of the pick-up should move in a radial line—an ideal which, in the normal case of a tone-arm fitting, is impossible to attain, although by careful design the error may be reduced to a few degrees.

Apart, however, from the rectification of the track alignment error, there are a number of other factors upon which depend the life of a record and its capability of faithful reproduction, whether such reproduction is through the medium of an acoustic sound-box or of an electrical pick-up. Of these, unequal side pressure, excessive weight of pick-up, and the use of needles which are too flexible are, perhaps, of even more importance than needle track alignment.

If your correspondent is interested in these matters I would recommend him to read "Modern Gramophones and Electrical Reproducers," by P. Wilson, M.A. and

G. W. Webb, published by Cassell & Co., Ltd., at 6s. 6d. Here he will find a positive mine of information as well as many avenues of interesting and necessary research.
 J. L. C. (Forest Hill).

Selectivity

SIR,—In these days, when the condition of the ether demands far sharper selectivity than was required only twelve months ago, it is interesting to observe that, notwithstanding the various advances made in the knowledge of methods by which selectivity may be secured, it is, in the writer's view, obtained in the large majority of commercial sets available at the present day merely by the expedient of using a speaker that does not reproduce the upper register.

The sets may be fitted with all sorts of elaborate tuning arrangements, but one has only to observe the effect of their selectivity with the use of a good moving-coil speaker reproducing up to say, 8,000 cycles, or over.

This seems to throw a rather interesting sidelight on the question of selectivity and quality, and will doubtless be of interest to your readers.
 J. B. (Manchester).

Poor Earth Connections

SIR,—I have a simple two-valve receiver which gives me good reception of the local stations. I have never been able to get more than a whisper of a distant station, even with the locals closed down. Whilst experimenting with the set late last night, I found I could get several stations with my earth wire disconnected. As soon as I replaced the earth and tried retuning I could only just hear the stations. Is this as it should be?
 T. W. (Congleton).

The experiment you have tried proves conclusively that your aerial and earth system combined possesses a high resistance. Disconnecting the earth wire, which is the greatest source of resistance, reduces the effective aerial-earth resistance and improves reception. You are advised to find another earth connection. A sheet of copper about 2 ft. square and buried about 3 ft. in the ground will make an efficient earth connection. The earth wire or lead should be soldered to this sheet of copper. Multi-stranded copper wire is recommended for both the aerial and the earth wires. A long aerial is not an advantage unless the wire is erected in one vertical length; in other words, a high single wire vertical aerial is far better than a low aerial with a long overhead part to it.—Ed.

(Continued on page 692)

A.C. New A.C. Mains Unit for 52/6
 150 volts at 20 m/a.



Eliminate H.T. Batteries with this new Climax H.T. Unit—specially designed for the V.3 Kit, and equally suitable for use with practically any receiver on the market. Output 20 m/a at 150 volts—price 52/6—a new standard of value in British A.C. Mains Units. Complies with all I.E.E. regulations.

THE CLIMAX

"BIJOU" H.F. CHOKE



Developed to meet this year's demand for an inexpensive H.F. Choke of high efficiency. It is similar to the original Climax H.F. Choke except that winding is subdivided into eight instead of sixteen sections. One hole fixing Type CH.272. Price 3/6.

is the basis of the **AMAZING STABILITY** OF THE

"RADIO FOR THE MILLION"

CLIMAX



CLIMAX

D.C. "Autobat" D.C. Mains Unit for 34/-
 50 m/a from Power Supply.



If you are on D.C., this new Climax Autobat D.C. Mains Unit is what you want to eliminate H.T. Batteries in "Radio for the Million" V.3 Kit or practically any other British receiver of to-day. Once again Climax is well ahead in design—but the price remains 34/-—outstanding value in a high-class British product. Complies with all I.E.E. regulations.

Get the Climax 1931-32 literature from your Dealer; if in difficulty, write to us direct—

CLIMAX RADIO ELECTRIC LTD., Haverstock Works, Parkhill Road, Hampstead, London, N.W.3.

Telephone: Primrose 1171-2.

£6.6.0!

**An astounding
Olympia Success —**

ZONOPHONE Home Constructors KIT SET



FAMED ALIKE FOR RADIO AND RECORDS

Seven Points of vital importance

- 1** Self-contained Loud-Speaker.
- 2** Band-Pass Tuning and Pentode Output giving astonishing selectivity and power.
- 3** Economical Battery consumption.
- 4** Full Broadcast range and easy operation.
- 5** Entirely new and simple colour-coded assembly without soldering.
- 6** Fixed Pick-up Sockets.
- 7** Compact Walnut Cabinet.

And ZONOPHONE BATTERIES

HIGHEST EFFICIENCY

GREATEST ECONOMY

THE ZONOPHONE PICK-UP

The finest Pick-up value in the world



Output 1½ Volts
Weight 130 grs.

15/-

- High Tension 14/-
(108 v. Standard Capacity)
- Grid Bias (9 v. Standard Capacity) 1/6
- Low Tension
GLASS Accumulators, Mass Plate Type
- Size 1 . . . 20 amp. hour 4/6
- Size 2 . . . 45 " " 8/6

These Prices do not apply in the Irish Free State

Mention of "Amateur Wireless" to Advertisers will Ensure Prompt Attention

"READERS' IDEAS AND QUESTIONS"

(Continued from page 690)

Wiring-up a Fuse

SIR,—I have purchased a bulb fuse for my receiver, but I am sure I have made some mistake in its connections. Each time I switch on my receiver the fuse lamp lights up brilliantly and then burns out. When I take out the fuse holder and rewire without it, the set works satisfactorily. Can you help please?

F. H. (Kettering).

The fuse should be connected in series between the negative socket of your H.T. battery and the actual negative H.T. terminal on the receiver. If you arrange the fuse inside the receiver, connect a wire from the negative H.T. terminal on the receiver to one terminal of the fuse holder and then take another wire from the other terminal of the fuse holder direct to the negative socket of the H.T. battery.—Ed.

Thanks!

SIR,—I feel, after a visit to Olympia, that a letter of appreciation is due to the wireless press and the trade in general. On all sides I was met with courtesy and efficient service.

The technical experts of AMATEUR WIRELESS, Ready Radio, Ltd., Heayberds, and Wright & Weaire put themselves to endless trouble to overcome my difficulties.

Please accept my congratulations on your publication, and thanks for many interesting hours spent in a most delightful hobby.

W. S. L. (Hounslow).

Radio Criticism

SIR,—It has always been my belief that a music critic should endeavour to be at least tolerant of every style, or type, of music; otherwise he will only be in a position properly to criticise the particular form of music which he favours—his criticism of other forms mainly consisting of unhelpful and sarcastic remarks.

This is where Mr. Whitaker-Wilson falls short of my previous ideas of him and I find several useless remarks directed at one performer or another in connection with that most heinous of all musical offences, syncopation. As an experienced musician, why should Mr. Whitaker-Wilson take sides against the modern form and display his partiality for Bach and Wagner and sneer at a really good exponent of modern piano renderings. I can boast a fair collection of records of really "hot" syncopated numbers by the best-known American and English exponents of modern rhythm music and play them often, but my pick-up often travels across Bach's "Aria" and Chopin's "Nocturne in E" and I aim to listen to and try to appreciate all forms of music.

There is no doubt of this fact, that music in its lighter—perhaps lightest—form brings more amusement and distraction and is more popular than anything which Bartok, Bach, or Stravinsky ever gave to the world and as dance music and syncopation are intended to make us enjoy life a little more, they should be treated at least with toleration by those people whom we expect to know something about matters musical.

If Mr. Whitaker-Wilson's musical diges-

tion is such that he cannot face syncopated works he must be out of pitch with several million people in this country and also with some of the greatest composers of all time, as syncopation has been made frequent use of by composers of fame, as Mr. Whitaker-Wilson very well knows.

S. J. L. (N.W.8).

Startled by America

SIR,—It appears that the night watchman at the H.M.V. display opposite Olympia had an extraordinary experience in the early hours of the morning. As there were some thousands of pounds' worth of instruments in the Gramophone Company's Hall, it was thought advisable that a watchman should remain on the premises during the hours the place was closed to the public.

On Saturday night, after the last visitor had departed from the hall, the watchman took a seat in a comfortable chair in one of the main gangways and settled down to read. At about 12.30 he was startled to hear a voice making an announcement with a nasal American twang! The sound appeared to be coming from the soundproof room, the door of which was open. Entering the room cautiously, he was amazed to find that it was empty. The sound was coming from the model 531 super-heterodyne. Apparently the last visitor had failed to switch the instrument off, and as members of the public were allowed to operate the instruments themselves, he or she must have, by chance, tuned the receiver to the wavelength of an American station!

The Gramophone Co. (W.1).

Stations all round the dial ..

RADIO FOR THE MILLION

V.3
KIT SET

the smooth control
& clean-cut separation

is due to this J.B. condenser

Type RM Screened Dual Condenser (.0005) used in the V₃ Kit Set. Thoroughly shielded. Baseboard mounting. Both stages fitted with trimmers, one trimmer being controlled from the panel. Complete with Disk Drive and moulded Bakelite Panel Plate, 22/-.

Type R3, specified for the "Amateur Wireless" "Olympian Three," 29/6

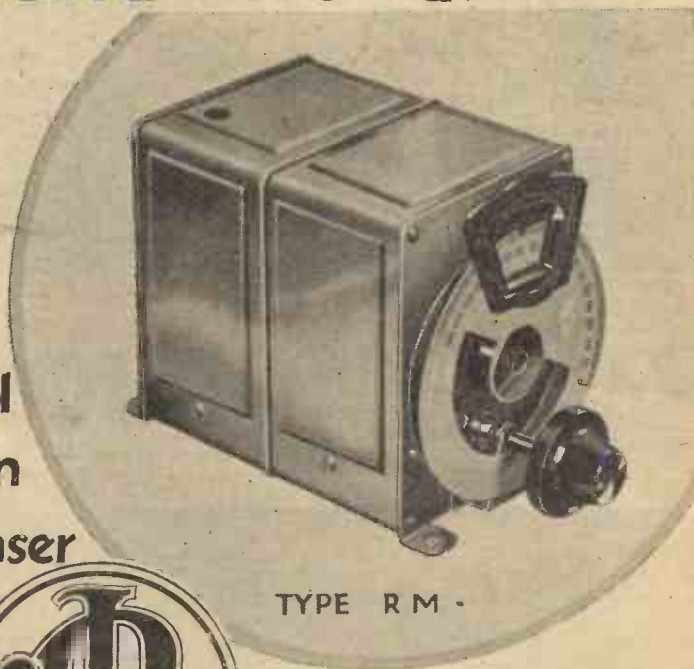

TYPE R M



PRECISION INSTRUMENTS

Have **YOU** joined the new Radio Cult?

Converts your old
Battery Set into a
LIVE UP-TO-DATE
ALL-MAINS
RECEIVER
at the Fractional cost of
ONLY 1^d PER WEEK

OBTAINABLE FROM ALL RADIO DEALERS

This model illustrated is the "MULTIVO"

All Formo Eliminators incorporate **WESTINGHOUSE METAL RECTIFIERS** and are, therefore, absolutely trouble-free and super-efficient.



BATTERY ELIMINATORS

"MINIVO" MODEL

Suitable for 1-, 2-, and 3-valve sets. H.T. only.
H.T. Output: 120 volts at 20 milliamperes.
1 tapping 50/90 volts.
1 tapping 90/100 ..
1 tapping 120/150 ..
Housed in attractive metal box, with coloured jacks.
Size, 9 in. by 5 in. by 3½ in. Fits any portable set.
PRICE £3 3 0

"MULTIVO" MODEL

Suitable for multiple valve sets, employing super power or pentode valves. Combined H.T. and L.T. trickle charger.
H.T. OUTPUT: 25 milliamperes.
1 variable tapping .. 0/100 volts.
1 tapping 50/90 ..
1 tapping 150 ..
Trickle charger for 2-, 4-, and 6-volt accumulator at 5 amps. Housed in attractive metal box, with coloured jacks and ample control knob. Size, 10 in. by 5 in. by 3½ in. Easily fitted into transportable sets.
PRICE £5 5 0

"VOLTEX" MODEL

Suitable for multiple valve sets. Combined H.T. and L.T. (raw A.C.), for indirectly heated valves.
H.T. OUTPUT: 25 milliamperes.
1 variable tapping .. 0/100 volts.
1 tapping 50/90 ..
1 tapping 150 ..
L.T. OUTPUT: 4 volts 4 amps (raw A.C.), for indirectly heated valves.
Housed in attractive metal box, with coloured jacks and ample control knob. Size, 10 in. by 5 in. by 3½ in. Easily fitted into transportable sets.
PRICE £5 5 0

ALSO OBTAINABLE ON DEFERRED TERMS (See also page 707).

ARTHUR PREEN & CO., LTD., GOLDEN SQUARE, PICCADILLY CIRCUS, W.1. Crown Works, SOUTHAMPTON.

SEE THESE ELIMINATORS ON STAND 81 AT THE MANCHESTER RADIO EXHIBITION

Don't Forget to Say That You Saw it in "A.W."

TELEVISION — THE POSITION TO-DAY

By H. J. BARTON CHAPPLE, Wh.Sch., B.Sc.

THE subject of television is such an intriguing one that it is not surprising to find it associated with all sorts of rumours; from time to time, therefore, it becomes necessary to examine the position and give the facts. In this country interest in television from the public angle is increasing, while there is an ever-growing band of enthusiastic amateurs who voluntarily testify to the new lease of life it has given to their pioneering spirit. To be able to see people and events by means of vision apparatus, although the transmitting station is located many miles away, produces a thrill which has to be experienced to be appreciated!

New Programme Arrangements

Since March 31, 1930, the Baird Company have maintained a regular television programme service of sound and vision through the medium of the twin Brookmans Park stations of the B.B.C. Up till recently the times of these transmissions have been from 11 to 11.30 each morning from Monday to Friday together with two midnight transmissions of half an hour's duration on Tuesdays and Fridays. In addition to this, we have had the broadcasting of an occasional novelty such as the parade of horses and finish of the Derby and the televising of a radio drama.

Arrangements have now been completed between the Baird Company and the B.B.C. for a development of these broadcasting facilities. Recently the times of the five morning transmissions have been changed from 11.30 to noon. A more important concession, however, is found in the B.B.C. agreeing to admit television within the recognised programme hours. In place of the two midnight transmissions there will be a broadcast from the No. 10 B.B.C. studio at 10.30 one evening each week.

The Portable Transmitter

As was described in AMATEUR WIRELESS of September 5, a Baird portable trans-

Mr. J. L. Baird, demonstrating the new mirror-drum scanning device

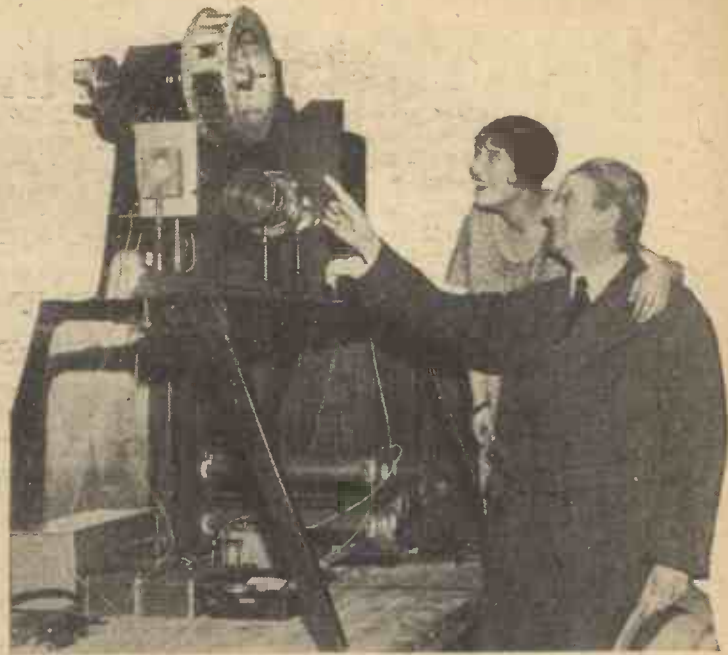

mitter has been installed in No. 10 studio and to date a number of very successful transmissions have been made with this apparatus. It is this transmitter which will be brought into play for the evening transmissions and the subjects televised will be B.B.C. artistes. This innovation is scheduled to commence early this month and it will then be possible for owners of Televisors to see on the television screen some of their wireless favourites. It is hoped to make Jack Payne conducting his B.B.C. dance orchestra the first subject of this weekly feature series and undoubtedly the more convenient time for looking-in will further stimulate the interest already displayed.

Another development of great importance is the announcement that experiments are being carried out by the Baird Company in conjunction with B.B.C. engineers to ascertain whether the land-line

link can be used to convey the television signals in sufficient strength and purity to enable the North Regional station at Slaithwaite to repeat the television transmissions of Brookmans Park. If these transmissions prove satisfactory it will enable owners of Televisors in the North to secure much better reception of the television broadcasts than they have had up till now owing to their being outside the normal "service area" of the London Regional station.

Full-length Images

What has happened at the transmitting end? Undoubtedly, very big strides have been made. There are now two transmitters in operation at the Long Acre Studio, one for close-ups (head and shoulders) and one for extended scenes (full-length views). This latter type of transmission was once regarded as almost impossible, but now forms part of the normal television programme. Full-length images of the artistes are shown and because of this the nature of the programme has been extended to embrace small plays and sketches, ballet and cabaret dancing, demonstrations of tennis and cricket strokes, physical culture, Ju-jitsu, piano playing, etc.

"A.W.'S" NEW SUPER-HET
DESIGNED BY W. JAMES

Full constructional details
next week

THE DIFFERENTIAL CONDENSER AND GRID LEAK

IN V.3 KIT SET

RADIO FOR THE MILLION IS

Write for Complete List of the famous Pye Components and Pye Portable Receivers.

Pye Radio Ltd., Sales Organisation, Paris House, Oxford Circus, London, W.1.

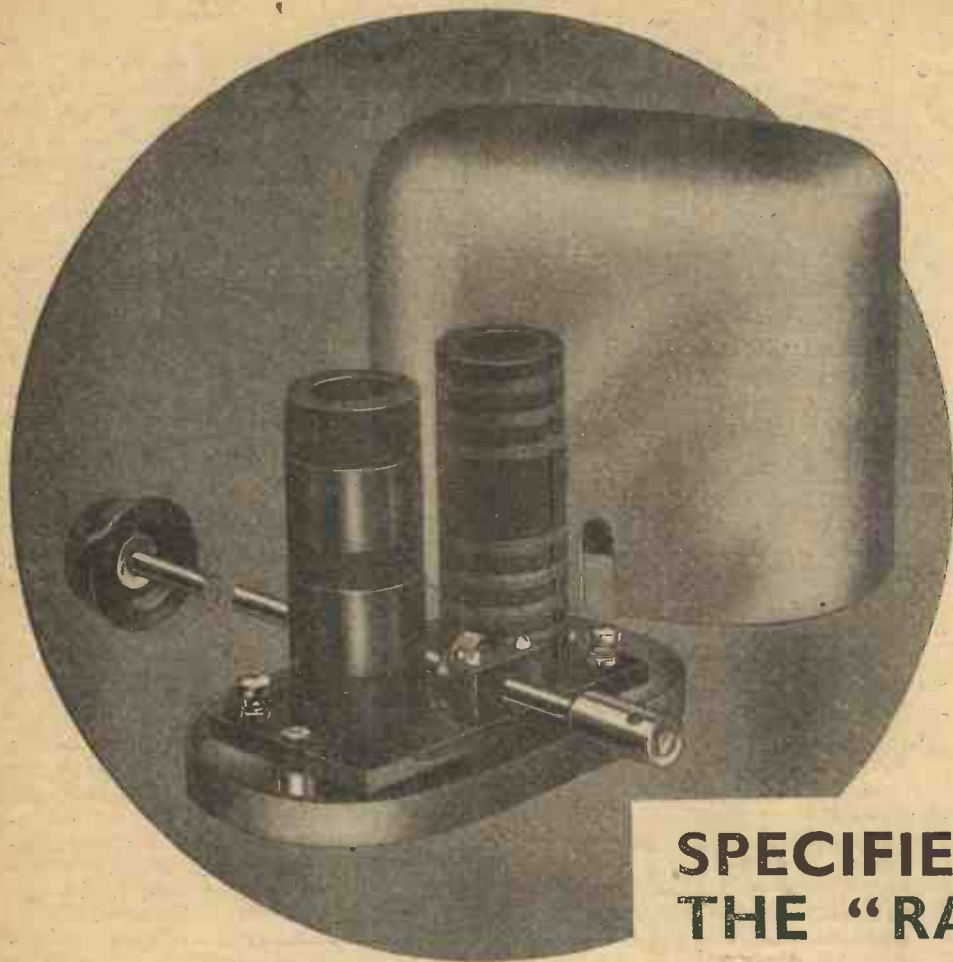

SPECIFIED & USED IN THE "RADIO-GRAM 4"

described in this issue

MODERN conditions of broadcasting call for highly selective tuning without loss of quality. Only with the most accurate matching and balancing can ganged tuning circuits work at the greatest possible efficiency on all wavelengths.

These new LOTUS Components are designed by J. Sieger, the noted radio engineer. Manufactured with the unequalled resources and experience of the Lotus Works, they are the perfected result of years of research and test.

The new LOTUS Binocular Dual-wave Coil and Ganged Condensers are the last word in precision instruments. They form the ideal combination wherever ganging is required. By their use "One Knob Tuning" is made accurate, efficient, and reliable.

THE LOTUS BINOCULAR DUAL-WAVE COIL

An extremely efficient component designed for the utmost selectivity on both long and short wavelengths.

The coils are astatically wound and the different windings are on separate formers. All coils are accurately matched and any two coils obtained can be relied upon to have equal inductance.

The silent wave-change switch is arranged for ganging several units.

Each coil unit is completely screened by a very compact pressed brass case. Type BC/1

10/6

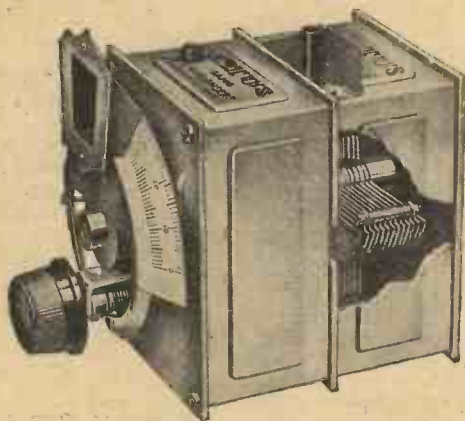

Specially heavy vanes and endplates ensure a permanent accuracy of matching of 1 per cent. between units. Trimmers are accessibly placed and are easily adjusted by fingers or screw-driver. Each unit is completely screened from the others, and pressed aluminium covers also protect the condensers from dust. These assemblies are smaller than most other gang condensers and are simple to assemble in all types of receivers. 2 GANG with DISC DRIVE **25/-**

LOTUS RADIO LTD., MILL LANE, LIVERPOOL

MANCHESTER
RADIO EXHIBITION

STAND 42

Oct. 7th to Oct. 17th



RADIO COMPONENTS

Don't Forget to Say That You Saw it in "A.W."



A RUNNING commentary by W. J. Howcroft on the water-polo international, in which England and France are competing, will be relayed to National programme listeners on October 17.

"Ships and their Builders," a talk by Mr. John Masfield, will be relayed from Salter's Hall on October 22, when the Livery Banquet of the Shipwright's Company takes place.

A pianoforte recital by James Ching is the outstanding feature in the Midland Regional programme on October 18.

During a concert by the Creswell Colliery Band from the Birmingham studios, on October 19, Laura Mann will entertain at the piano.

Harold Brighouse's drama, *The Northeners*, has been selected to open the season's dramatic productions in the Northern Region. The date is October 12.

The programme of Holst's music which the Huddersfield Glee and Madrigal Society are performing on October 13, will be re-

layed in the Northern Region. Gustav Holst himself will conduct.

George Clarkeson, leading saxophonist in the B.B.C. Theatre Orchestra, will play saxophone solos in the vaudeville programme on October 14 (Regional) and 17 (National). This programme also includes several well-known broadcasters, the Hulbert Brothers, Stanley Holloway, and Muriel George and Ernest Butcher.

Virginia MacLean will give a pianoforte recital at the Leeds University Midday Society's concert on October 15.

A new concert party, "The Od-Ditties," are making their appearance before the North Regional microphone on October 15.

On October 15 the first Hallé concert of the season will be broadcast in its entirety. The programme is entirely orchestral and, in addition to Beethoven's Seventh Symphony, will include Delius' "The Walk to the Paradise Garden" and Gershwin's "An American in Paris."

On October 17 the first recital on the

organ of St. George's Hall, Liverpool, will be relayed.

A bonfire of old wireless sets will be a feature of Cardiff Radio week, October 25 to 31. This method of disposing of antiquated sets, an illuminated procession, and a radio ball are among the many novelties which are being arranged.

Starting from the fact that a surprising number of well-known artistes have some connection with Bristol, Mr. F. E. Robins has written a play around their gramophone records. It is called *Wax Tracks*, and will be heard from Cardiff on October 20.

A Welsh programme on October 19 will include the Gwaun-cae-Gurwen Silver Band, with Furness Williams and David Brazell as the vocalists.

The Rev. J. J. Williams will give a talk for the Western Region on the "Humour of Glamorgan" on October 19.

One of Bantock's famous "Sappho Songs" is to be broadcast by Muriel Sotham during a symphony concert by the City of Birmingham Orchestra on October 13.

The third midland towns and cities programme on October 15 will be given by artistes from Nottingham.

R.A.F. Wireless School.—The annual re-union and dinner for officers, past and present, of the Wireless School, R.A.F., will be held this year at the Criterion Restaurant, Piccadilly Circus, on Saturday, October 24, at 7 p.m. Tickets and all information from the Hon. Secretary, J. F. Herd, Ditton Corner, Datchet, Windsor.

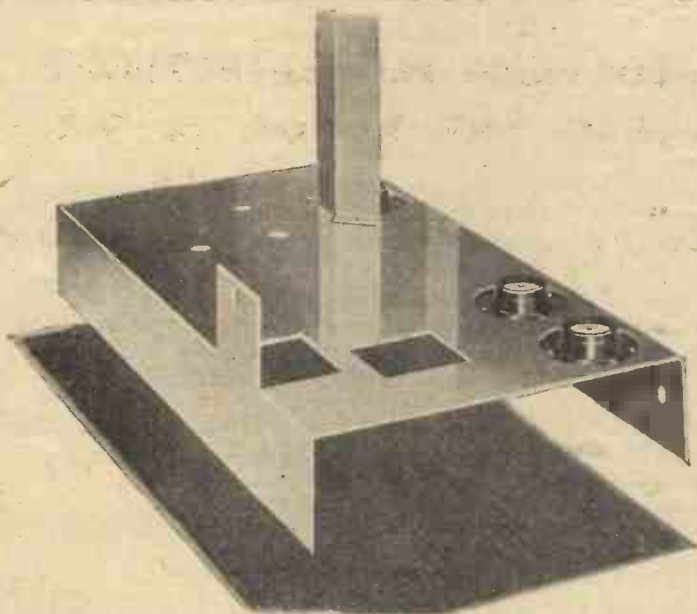

V3 Chassis by Junit

"THOROUGHLY efficient screening—rigid and simple assembly—a certain earth for earth potential components—clean, neat finish"—these are the points the designer of the "Radio for the Million" V3 receiver emphasised when discussing the chassis with us. Now here it is—a standard part of your V3 kit, or 10s. 6d. complete with 5-pin valveholders and screen if you buy it separately. Two Junit push-pull switches are also included in the V3 at 1s. each.

For mains operation of the V3 A.C. model you should use the Junit type 150/4 H.T. Unit, giving 25 mA. at 150 volts, with a 4-volt A.C. centre-tapped winding for indirectly heated valves.

PRICE COMPLETE £5

The V3 battery model should be worked off the mains with a Junit type 120/18 Trickle Charger Unit at £4 12s. 6d.

JUNIT

The Junit Manufacturing Co., Ltd., 2 Ravenscourt Square, London, W.6. Riverside 0274

It's such a simple
step to better
Radio Service



With

SIEMENS

FULL O'POWER
RADIO BATTERY

*the only Battery with one piece
(seamless) pure zinc cells
As specified in "Radio for the Million"*

FOR THE "R FOR M" V3 BATTERY MODEL USE EITHER 100 VOLTS SIZE V2-12/- OR TWO 60 VOLTS SIZE V4 12/- EACH

Advt. of SIEMENS ELECTRIC LAMPS AND SUPPLIES LIMITED. 38/9, Upper Thames Street, London, E.C.4.

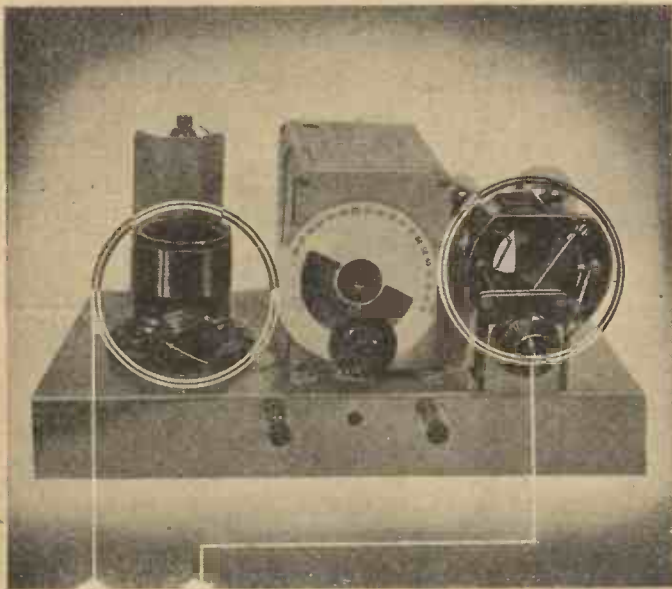

**COLVERN PUT SELECTIVITY
INTO THE R. FOR M. V.3.**

Every component in the R. for M. V.3 Kit had to be perfect—that's why the coils had to be Colvern. Their place in the wonder set of the year was assured—assured by their unfailing reliability and perfect performance. This is another great tribute to the excellence of Colvern products, which are again and again specified by all the greatest radio set designers.

SEND FOR THE COLVERN
BOOKLET—LIST No. 6.

COLVERN
LIMITED.

Advt. of Colvern Ltd., Mawneys Road, Romford.

There's a place for
Colvern in every radio
set.

Don't Forget to Say That You Saw it in "A.W."

HOW THE HOME CONSTRUCTOR IS CATERED FOR

FROM the point of view of interest to home constructors, an exhibit of outstanding interest at the recent Radio Exhibition at Olympia was that staged by the Peto Scott Company Limited, the well known suppliers of kits of parts.

The scheme of the background was a

Super," "Century Super Portable," "Olympian Three," and also the original *Wireless Magazine* "Super 60." All these kits were on view in a special form described by Messrs. Peto Scott as Pilot Author's Kits, which as this company's advertisements state is strict adherence to the

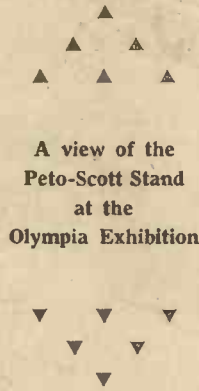

A view of the Peto-Scott Stand at the Olympia Exhibition

colourful representation of a cottage through the window of which could be seen a typical home constructor busily assembling some of the famous receivers that have appeared in recent issues of AMATEUR WIRELESS.

Great interest was noted in such AMATEUR WIRELESS sets as the "Century

AN AMAZING NEW SET IS COMING

See first details on page 674

specified list of parts. This policy undoubtedly removes any complications in obtaining the actual parts specified.

A large number of inquiries were devoted to A.C. receivers, especially the "A.C. Super Century," which revealed that the home constructor is taking an increased interest in mains-operated sets.

THE "A.W." LINEN SPEAKER

LINEN-SPEAKER enthusiasts who want to make up the new "Amateur's Linen Speaker," described in AMATEUR WIRELESS, No. 484, should note that complete kits of parts, including special linen and birch-ply board frames, are available from Weedon & Co., Ltd., of 26a Lisle Street, Leicester Square, W.C.2. This speaker can also be obtained ready assembled for 25s., carriage paid, without the unit, of course.

Messrs. Weedon make a number of useful accessories which are a great help in making up almost any type of speaker, no matter whether it is of the normal cone or linen diaphragm variety. A self-centering drive rod is available which embodies a universal joint, relieving the driving rod of all side stresses and chatter and automatically aligning the rod.

In the Belting-Lee announcement in AMATEUR WIRELESS for September 19, the prices of certain types of terminal were given incorrectly. The type R costs 3d. each, the type M 4½d., and the type B, 6d. each.



CARRINGTON MFG. CO., LTD.

24 HATTON GARDEN, LONDON, E.C.1

Phone: Hol. 8202. Works: S. Croydon

SPECIFIED CABINETS FOR THE V3 KITS

Here is news of great interest to all who are building the V3 Kits. These beautiful Camco Cabinets have been CHOSEN AND SPECIFIED by the Editor of "Radio for the Million" as the STANDARD cabinets for the V3 Kits.

On the left is the "Windsor," a graceful cabinet for set, speaker and batteries. The cabinet is removable, leaving the stool available for occasional use. This feature makes the "Windsor" ideal where space is limited. Finished in fine shaded walnut, only 75/-. When ordered for the V3 Kit it is supplied with panel drilled according to specification. Baffle board, etc., 3/- extra.

On the right is the cabinet for set only. It is supplied with front panel drilled and finished in handsome shaded walnut, 16/-. Camco Cabinets are obtainable from your dealer. Insist on having a Camco Cabinet. Write now for FREE copy of the new 24-page Camco Radio Cabinet Catalogue.

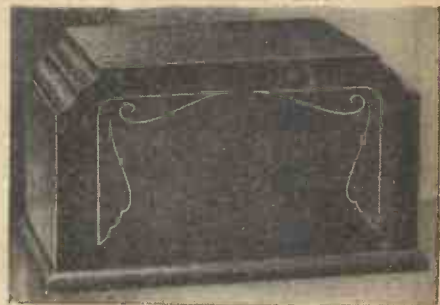

NAME

ADDRESS

100% BRITISH MADE

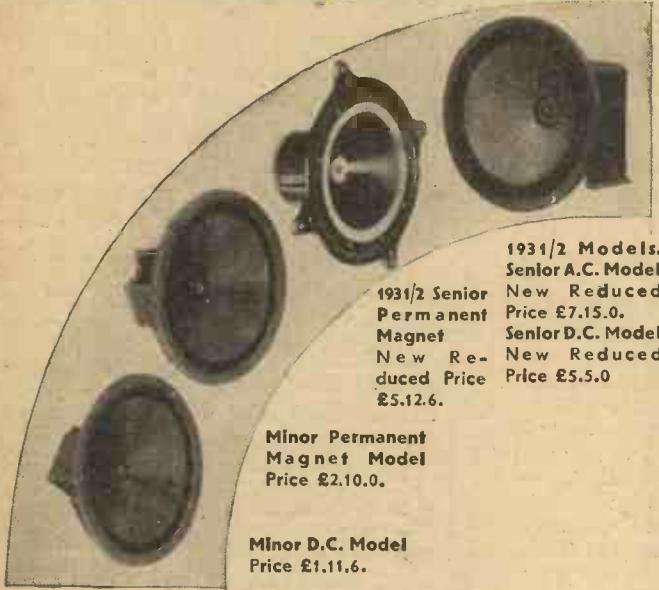

1931/2 Models.
 Senior A.C. Model
 New Reduced Price £7.15.0.
 Senior D.C. Model
 New Reduced Price £5.5.0

Minor Permanent
 Magnet Model
 Price £2.10.0.

Minor D.C. Model
 Price £1.11.6.

**-and it
 costs
 less**

If you must have the best possible reproduction it means a B.T.H. R.K. There are many new models available now. In the R.K. range, from the "Minors" at 31/6 (field excited model) and 50/- (permanent magnet) to the Senior A.C. R.K. at £7:15:0, there is a model specially suited to your requirements.

Ask your dealer for a demonstration and full particulars.

**GREENWICH
 TIME FROM THE
 MAINS**



Have you seen the Edison A.C. Mains Electric Clock? Ask your radio dealer. Prices from 45/-

B.T.H.



**MOVING COIL
 REPRODUCER**

EDISWAN RADIO



THE EDISON SWAN ELECTRIC CO. LTD.
 Radio Division: 155 Charing Cross Road, London, W.C.2

W.177

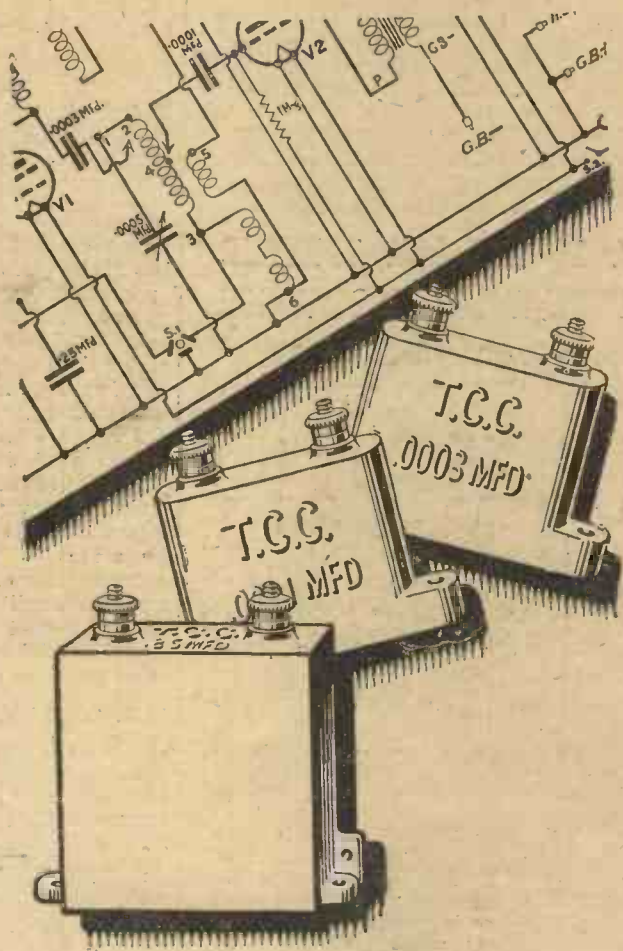

CHOSEN
 for the
"R for M" v 3
 —and for
**ALL THE BEST
 RECEIVERS**

for any
 set—use
 the con-
 denser in
 the green
 case

**T.C.C.
 CONDENSERS**

The Telegraph Condenser Co., Ltd., Wales Farm Rd., N. Acton, W.3

9178

Advertisers Appreciate Mention of "A.W." with Your Order

IN GREAT DEMAND
WATMEL'S LATEST

A SQUARE LAW TAPERED WIRE-WOUND RESISTANCE



OUR latest product—the Watmel 50,000 ohms wire-wound potentiometer was very favourably commented upon at the Exhibition. This resistance is specially wound on a tapered former which gives a perfect square law reading. This is the first resistance of its kind.

NOTE THE POINTS—

- 1—Polished pointer-knob.
- 2—Engraved Bakelite front plate.
- 3—Wire-wound Former.
N.B.—The resistance is WIRE, NOT compound with wire contacts. It is specially wound on a tapered former.
- 4—Insulating bush to insulate spindle from panel.
- 5—Contact finger. Phosphor-Bronze.
- 6—One-hole fixing—Brass bearing bush resulting in perfect bearing
- 7—Bakelite case—protects winding.
- 8—Back self-cleaning contacts.
- 9—Large contact plate.
- 10—Stops at end of wiring.

Every part is made from the finest materials.



ANY RESISTANCE UP TO 50,000 ohms
Standard winding **5/6**
Square Law ... **6/6**

BUY BRITISH

Ask your dealer for full particulars or write to us. Try Watmel components in your new sets this season. Write for Catalogue.

TRADE ENQUIRIES INVITED.



“GETS THE BEST OUT OF ANY SET”

WATMEL WIRELESS CO. LTD.,

Imperial Works, High Street, Edgware.

Telephone: Edgware 0323 (M.C.42)

“RADIO FOR THE MILLION V.3”

(Continued from page 671)

If we look at the circuit diagram, reproduced on page 671, we can see how the various knobs work. Simple, efficient, and entirely devoid of freakish elaborations, the circuit of the “V3” is a fine example of all that is best and most permanent in modern radio practice.

The three Mullard valves follow the popular sequence of screen-grid high-frequency amplifier, detector, and transformer-coupled power valve. The circuit has been skilfully engineered, as an examination of the various valves clearly proves. Note, for example, the .0001-microfarad grid condenser and its associated grid leak of 1 megohm. These values are in keeping with modern valves, and ensure true reproduction of the high notes—which are very apt to be mutilated with the old values of grid leak and condenser.

A very important feature of this “V3” circuit is the variable aerial coupling, giving a good control of selectivity and of volume, by means of the knob mounted at the extreme left of the chassis. This knob moves a small rotor inside the aerial coil through a 90-degree variation, thus loosening the aerial coupling as the demands of selectivity dictate.

H.F. Coupling

The high-frequency amplifying valve is coupled to the detector valve by means of the choke-feed system. That is to say, the anode circuit of the high-frequency valve consists of a high-frequency choke, the anode end of which is coupled through a fixed condenser to the tapped tuned-grid circuit of the detector.

Coupled to the grid tuning in the detector circuit is the reaction coil, and reaction is varied by means of a differential condenser. This has the advantage that, whatever the setting of the reaction may be, the anode to earth by-pass at detection is always the same. This by-pass improves quality and prevents instability.

The rest of the circuit is conventional; but note the simple coil switching and the on-off switch in the positive filament lead.

As soon as I had finished assembling my model of the “V3,” I hastened to put it through its paces. I used the specified Mullard screen-grid valve, PM12, the Mullard PM1HL detector, and the Mullard PM2A small power output valve. The high-tension was a 100-volt battery.

Within a few seconds of connecting the neat battery cord to the appropriate batteries, I was listening to London Regional, which came in with a strength and quality that promised well for the rest of the test. The calibration provided by the designers in “Radio for the Million” was 101 degrees for this station; this I actually tuned-in at 105 degrees.

The tuning control knob is very satisfactory. Its dual working ensures accuracy throughout the scale, and the initial adjustment of the trimmer on top of the condenser screen is very easily done.

I liked the “feel” of the controls of the “V3.” Each knob did its job smoothly and well. The volume control on the left exercised a remarkable effect on the

(Continued on next page)

BELLING-LEE BATTERY CORDS



Complete with engraved Wander Plugs and Spade Terminals

AND TERMINALS

the world's best—give the final touch to the performance convenience and finish of the



RADIO FOR THE MILLION V3 KIT SET

Advt. of Belling & Lee, Ltd., Queensway, Ponders End, Middlesex



GREATEST IN CONE! SPEAKERS!

Never before has there been such a wonderful Speaker. Never before have you heard such amazing Tonal Purity and Volume.

42/-

Retail complete
Unit only, 12/- Unit and Chassis, 16/6
Full details from:—
The LOEWE RADIO Co., Ltd.,
4 Fountayne Road—Tottenham, N.15
Phone: Tottenham 3911/2



general performance of the set. Its position for any given compromise between selectivity and volume was readily determined.

I next found London National at 48 degrees. On a midway position of the volume control knob—that is with the set still in a very sensitive condition—I had no difficulty in eliminating the powerful local in 8 degrees. By following the calibrations, I soon located all my favourite foreign stations, which came in with a strength seldom heard on a three-valve battery set. The separation between those really worth hearing—about 17° on the night of the test—was certainly the most remarkable aspect of the whole performance.

As I used the new Marconiphone moving-coil loud-speaker (the model selling at £4 19s. 6d.) I was able to gauge the reproduction possibilities under good conditions. It seemed almost impossible that such good tone could be obtained, with such volume, from a small power valve. The Mullard PM2A is certainly a good little valve.

This "V3" kit should command a very wide attention. It has merits above the ordinary. It is easy to make, easy to operate; cheap to run, and it is backed by the united efforts of many of our leading component manufacturers.

SET TESTER.

"EVERYBODY'S BATTERY-OPERATED RADIO-GRAMPHONE"

(Continued from page 678)

less with only 100 volts. The exact amount of high-tension current taken will vary, as you know, on the type of valve you use in the power stage. In this set, too, the choice of L.F. valves makes an appreciable difference.

The accompanying table gives a selection of two-volters. Put the maximum available voltage on the H.T. positive 2 tapping.

	Screen-grid	Detector	L.F.	Power
Mullard...	PM12	PMrHL	PM1LF	PM202
Mazda ...	SG215	HL210	L210	P220
Cossor ...	215SG	210Det.	210LF	220P
Marconi	S215	HL2	HL2	LP2
Osram ...	S2/C	HL2/C	HL2	LP2
Six-Sixty	215SG	210HL	210LF	220PA
Eta ...	BY6	BY1814	BY2010	BW303
Fotos ...	BC150	BC18	BC9	BD9
Dario ...	SG	HF	LF	Power
Tungsram	S210	L210	L210	P215

and connect the H.T. positive 1 to about 75 or 80 on the battery. If you have a mains unit, then connect the H.T.2 to the maximum power tapping, and put H.T.1 on the variable tapping so that the screen-grid valves grid voltage can be adjusted. The grid-bias 1 tapping goes to 1½ or 3 on the grid battery, and the tapping 2 to 7½ or 9 volts, depending on the power valve.

A PM202 is specified for the power stage, but a PM2 or PM2a could be used, giving a smaller output.

If you want to see how easy it is to make a really good-looking radio-gramophone at home, then see this set in the Radio Department windows of Messrs. Selfridge & Co., of Oxford Street.

NEW DARIO RADIO VALVES
with
The Very Steep Slope

Made in one of the most modern factories in the world under a special secret process, Dario valves incorporate the new Radio Micro Dull Emitter Filament which ensures great sensitivity, unequalled performance and utmost current economy.

- DARIO UNIVERSAL BIVOLT - 5/6
- DARIO SUPER H.F. BIVOLT - 5/6
- DARIO SUPER POWER BIVOLT 7/6

etc., etc.

Also 4 volts and A.C. Mains type.

Write for illustrated folder giving full particulars.

TRANSFORMERS

Dario Transformers are made under a special process of wiring and insulating the different circuits. Notwithstanding their very low price they give marvellous results.

Ratios 1-3 and 1-5.

- Constructor ... 4/6
- Normal ... 5/-
- Super ... 6/-

Also available extensive range of mains transformers and Filter Chokes.

DARIO SILVER OXIDE CHARGER

the best in the world. Enables you to charge your accumulators in your own home. 17/6

DARIO SETS

The Dario S.G.3 Battery Type Receiver now reduced to £5 17s. 6d. complete with Dario Valves, represents amazing value. Highly sensitive, gives wonderful volume. Renowned for its purity of reception.

The Dario Regional Straight 3 Transportable housed in an attractive modern oak cabinet complete with Dario valves and matched speaker. £4 17s. 6d.

Inside frame aerial 10/- extra



Some Notes on Present-

day Short-wave Conditions

Around the Short-wave Dial



By M.
BARNETT

NOW that the Olympia Radio Exhibition for 1931 has "been and come and gone," we have an opportunity of reviewing the field of new components and receivers which are of particular interest to the short-wave amateur. Until the present season, it has been an open fact that the British short-wave amateur has been very badly catered for, both as regards components and complete outfits. Whether this is due to a complex on the part of the manufacturer, who does not regard the short-wave field as a money-making market is not for me to say, but it is a certain fact that most of our leading manufacturers have fought shy of the short-wave field and have left the greater part of the trade open to the foreign manufacturer. There are a few notable exceptions, of course, but when one comes to examine the position in other countries, one is at once struck by the fact that far more attention is being paid there to short-wave matters and that the manufacturers are apparently making a financial success of it.

However, it is very pleasant to be able to record the fact that the British manufac-

turer seems to have awoken to the fact that there really is something in the short-wave field after all. Quite a number of short-wave convertors were to be seen at this year's Show, some of them making use of one valve only, others using two, whilst some of them made use of the super-heterodyne method of reception; others provided just a plain short-wave tuner to be used in conjunction with the L.F. amplifying portions of the broadcast receiver.

Mains Short-wavers

Until a very short time ago it was thought impossible to use a short-wave receiver on A.C. mains owing to excessive humming and other troubles, but now these drawbacks have been overcome and a number of short-wave receivers and convertors have been brought out for use entirely on A.C. mains. The more ambitious receivers used a stage of H.F. amplification, sometimes using a tuned circuit for this stage and sometimes a plain impedance coupled circuit.

A stage of untuned H.F. amplification ahead of the detector valve in a short-wave receiver can certainly be very helpful to

the general operation of the receiver and although it does not increase the actual signal strength to a very great extent, it provides a number of other advantages, the chief of which is the fact that there are no loop-holes or "dead spots" on the tuning dial.

One receiver shown at the Exhibition used a tuned stage of H.F. amplification, complete with single-dial tuning. A small trimmer is connected across the aerial-tuning condenser. Ganging two tuned circuits on the short waves is a fairly easy matter—much easier than one would assume. The aerial tuning is, of course, generally comparatively flat compared with that of the detector stage and an approximate setting of the aerial condenser will generally suffice to keep the two circuits in tune.

Amongst the short-wave components, some very excellent tuning condensers were shown of various types and it can certainly be said that the general state of excellence in component parts, as far as the short-waves are concerned, at any rate, has certainly improved tremendously during the last twelve months.

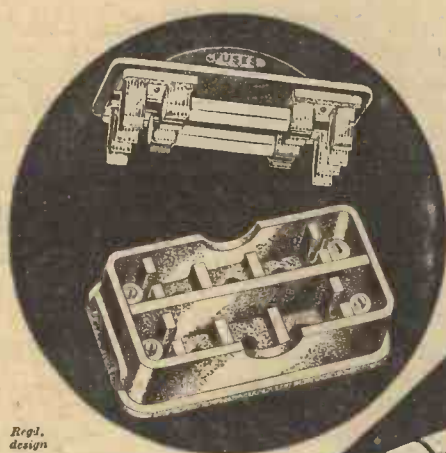

- Regl. design*
- TWIN BASEBOARD FUSEHOLDER, with two 1-amp. fuses for mains leads (illustrated above) ... 3/6
 - WANDERFUSE, combined wander plug and fuse, with 60 m/a. fuse. 1/6
 - FLEXIBLE LEAD FUSEHOLDER, short type, with 1/2-amp fuse ... 1/- (Longer type with mains fuse, 1/-).
 - SINGLE BASEBOARD FUSEHOLDER, with 1/2-amp. fuse. The best method of mounting a fuse inside a set or mains unit ... 1/3

Dealers will exchange fuses for other ratings at the time of purchasing any Belling-Lee Fuseholders.

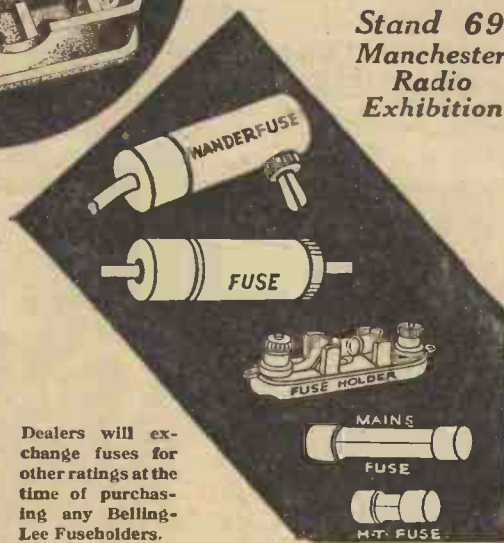

A COMPLETE RANGE OF FUSES for EVERY REQUIREMENT

TECHNICAL REASONS

A fuse in a mains lead is a totally different proposition from a fuse in a H.T. or G.B. lead. In the mains lead it is unsound to use a lower rating than 1 amp, because the mere switching on and off of current creates a surge which might easily blow a fuse of lower rating. Further, in a mains lead fuses should always be more than 1 in. long, to make arcing impossible. In H.T. and G.B. leads and rectifier circuits, on the other hand, it is unnecessary for fuses to go beyond 1/2 amp, even with multi-valve sets. Nor need they be any longer than 5/8 in., even with a powerful H.T. supply. H.T. fuses should be kept as short as possible, for the fine high-resistance wire is liable to act as a coupling between the circuits and to set up "motor-boating" if too long.

That is why Belling-Lee now make their fuses in two lengths: H.T. ratings, 60 m/a., 150 m/a., and 1/2 amp, 5/8 in. long; mains ratings, 1, 2, and 3 amp, 1 1/4 in. long.

Spare fuses of all ratings are sold at 6d. each

BELLING-LEE
FOR EVERY RADIO CONNECTION

Advt. of Belling & Lee, Ltd., Queensway, Ponders End, Max.

Postcard Radio Literature

Tested Components

I HAVE just had from Readi Rad a very useful folder which describes eighteen well-known lines, such as the Instamat transformer, switches, variable condensers and the Jiffilnx wiring system. **576**

Good Power Chokes

Tunewell have just brought out a list which should be in the possession of every constructor, for it deals with power and pentode chokes. Characteristic curves are given showing the inductance at various frequencies and with specified small D.C. currents flowing. **577**

For Short-wave Work

There should be a good market for the short-wave super-het adaptor made by the Radio Development Company. It is in a neat cabinet and can be hooked up to practically any set. It works from 15 to 60 metres. **578**

A Lissen Two-valver

I like the look of the Lissen two-valve all-A.C. set. It has illuminated drum-dial control and a very good speaker enclosed in the set's moulded cabinet. This outfit is described in a new leaflet. **579**

A Benjamin Booklet

There is a very useful booklet just produced, giving details of popular Benjamin lines, double-pole rotary switches, single-pole double-throw push-pull switches, valve holders of various types, and so on. Some useful pictorial circuits showing how Benjamin parts may be used are given in this book, copies of which may be had free. **580**

For Battery Users

Battery users should make a point of writing to Pertrix for the new folder which gives voltages, capacities and dimensions of H.T., grid-bias batteries and L.T. accumulators. The accumulators are in glass boxes and have grease cups in the terminals to prevent acid creeping. **581**

A New Dual-wave Coil

I see that Igranic have just brought out three new types of dual-wave coil, the "A" for use in aerial circuits, the S.G. for use in tuned-anode or tuned-grid circuits, with screen-grid valves, and the H.F. as a transformer in a screen-grid circuit. Leaflet 6510 describes the three types. **582**

OBSERVER.

GET THESE CATALOGUES FREE

Here "Observer" reviews the latest booklets and folders issued by well-known manufacturers. If you want copies of any or all of them FREE OF CHARGE, just send a postcard giving the index numbers of the catalogues required (shown at the end of each paragraph) to "Postcard Radio Literature," "AMATEUR WIRELESS," 58/61, Fetter Lane, E.C.4. "Observer" will see that you get all the literature you desire. Please write your name and address in block letters.

New Times Sales Co

We can supply any accessory advertised in "Amateur Wireless" on EASY TERMS. Send us your next order. We guarantee you every satisfaction.

SECURE THE NEWEST RADIO TO-DAY ON REALLY EASY TERMS

MANUFACTURERS' KITS • ELIMINATORS

- COSSOR 234 EMPIRE MELODY MAKER**
Screened-grid, Detector, and Power. With valves and cabinet. CASH PRICE £6 15s. 0d. **10/-**
Balance in 11 monthly payments of 12/6. WITH ORDER
- MULLARD 3 1932 TYPE**
Screened-grid, Detector, and Pentode. With valves less cabinet. CASH PRICE £6 10s. 0d. **11/11**
Balance in 11 monthly payments of 11/11. WITH ORDER
- OSRAM NEW MUSIC MAGNET 4**
Two Screened-grid, Detector, and Power. With valves and cabinet. CASH PRICE £10 15s. 0d. **19/8**
Balance in 11 monthly payments of 19/8. WITH ORDER
- V.3 RADIO FOR THE MILLION**
Screened-grid, Detector, and Power. With valves less cabinet. CASH PRICE £5 17s. 6d. **10/9**
Balance in 11 monthly payments of 10/9. WITH ORDER
- SIX-SIXTY CHASSIKIT BATTERY MODEL**
Complete three gang band-pass tuning, S.G., Detector and Pentode. With valves less cabinet. CASH PRICE £6 17s. 6d. **12/7**
Balance in 11 monthly payments of 12/7. WITH ORDER
- SIX-SIXTY CHASSIKIT A.C. MODEL**
Complete as above with A.C. Mains Valves. With valves less cabinet. CASH PRICE £7 6s. 6d. **13/5**
Balance in 11 monthly payments of 13/5. WITH ORDER
- ATLAS A.C. ELIMINATOR TYPE A.C.244.** Three tappings, S.G., Detector, and Power. Output, 120 volts at 20 m/a. CASH PRICE £2 19s. 6d. **5/6**
Balance in 11 monthly payments of 5/6. order
- EKCO K.18 COMBINED H.T. ELIMINATOR AND L.T. TRICKLE CHARGER.** Delivers 18 m/a. and suitable for 1- to 5-valve sets. S.G., 50/80 volts, 120/150. Charges at .25 amp. at 2, 4, or 6 volts. A.C. Mains CASH PRICE £4 12s. 6d. **8/6**
Balance in 11 monthly payments of 8/6. order
- REGENTONE ELIMINATOR, TYPE W.1F.** Three tappings, S.G., Detector, and Power. Output 120 volts at 12 m/a. A.C. Mains CASH PRICE £2 7s. 6d. **8/4**
Balance in 5 monthly payments of 8/4. order
- EKCO H.T. UNIT. TYPE A.C.25.** For multi-valve sets requiring up to 25 m/a. 3 tappings. S.G., detector and 120/150 volts. For A.C. Mains. Cash or C.O.D. Price £3 17s. 6d. **7/1**
Balance in 11 monthly payments of 7/1. order
- HEAYBERD H.T. UNIT—"D" MINOR**—Output 120v. at 12 m/a.—Tapped at 80v., 100v., and 120v. Westinghouse rectification. A.C. Mains. CASH PRICE £2 17s. 6d. **5/4**
Balance in 11 monthly payments of 5/4. order
- EXIDE 120-VOLT TYPE W.H., H.T. ACCUMULATOR, in crates.** CASH PRICE £4 13s. 0d. **8/6**
Balance in 11 monthly payments of 8/6. order

- NEW TIMES SALES PERMANENT MAGNET MOVING COIL SPEAKER.** In handsome oak french polished cabinet with specially designed Epoch Chassis giving glorious tone and volume. With multi-ratio transformer. CASH PRICE £3 15s. 0d. **6/11**
Balance in 11 monthly payments of 6/11. order
- AMPLION MOVING-COIL SPEAKER, TYPE M.C.6.** Permanent magnet, with output transformer. Complete. CASH PRICE £3 7s. 6d. **6/2**
Balance in 11 monthly payments of 6/2. order
- BLUE SPOT PERMANENT MAGNET MOVING-COIL SPEAKER.** Complete with input transformer. CASH PRICE £3 15s. 0d. **6/11**
Balance in 11 monthly payments of 6/11. order
- EPOCH PERMANENT MAGNET MOVING-COIL SPEAKER. Type A.2.** CASH PRICE £3 17s. 6d. **7/1**
Balance in 11 monthly payments of 7/1. order
- B.T.H. R.K. MINOR PERMANENT MOVING-COIL SPEAKER.** Capable of handling outputs up to 2 watts. CASH PRICE £2 10s. 0d. **6/-**
Balance in 8 monthly payments of 6/- order
- W.B. PERMANENT MAGNET MOVING-COIL SPEAKER, TYPE P.M.3.** With 3 Ratio input transformer. CASH PRICE £2 12 6 **5/10**
Balance in 9 monthly payments of 5/10. order
- R.&A. "100" MOVING COIL REPRODUCER.** Complete with tapped Input Transformer. CASH PRICE £2 17s. 6d. **5/4**
Balance in 11 monthly payments of 5/4. order
- ORMOND PERMANENT MAGNET MOVING-COIL SPEAKER.** With input transformer. CASH PRICE £3 5s. 0d. **6/-**
Balance in 11 monthly payments of 6/- order
- LAMPLUGH, FARRAND, BLUESPOT, FERRANTI DYNAMIC INDUCTOR SPEAKER** for perfect reproduction. Unit and chassis complete, ready mounted. CASH PRICE £3 10s. 0d. **6/5**
Balance in 11 monthly payments of 6/5. order
- NEW N&K INDUCTOR DYNAMIC SPEAKER.** Unit and Chassis complete. CASH PRICE £3 10s. 0d. **6/5**
Balance in 11 monthly payments of 6/5. order
- EPOCH J.I. PERMANENT MAGNET MOVING COIL SPEAKER.** In Chassis form with multi-ratio input transformer. CASH PRICE £2 12s. 6d. **4/10**
Balance in 11 monthly payments of 4/10. order
- GARRARD INDUCTION GRAMOPHONE MOTOR MODEL 202.** Mounted on 12-inch Nickel Motor Plate with fully automatic electric starting and stopping switch. CASH PRICE £2 18s. 6d. **5/3**
Balance in 11 monthly payments of 5/3 only. order

Communicate your Radio needs to us. We are certain to satisfy.

ESTABLISHED IN 1924. FIRST WITH EASY TERMS

NEW TIMES SALES CO. 56 LUDGATE HILL, LONDON, E.C.4. Phone: CENTRAL 2716.

(a) Please send me further particulars of.....

(b) I enclose.....d. as first payment for.....

NAME

ADDRESS

A.W. 10/10/31.

BROADCAST TELEPHONY

Broadcasting Stations classified by country and in order of wavelengths. For the purpose of better comparison, the power indicated is aerial energy.

To get
the
best

results

from the

V.3

use

Exide

and

Drydex

BATTERIES

Obtainable everywhere from all good dealers

Exide Batteries, Clifton Junction, near Manchester.
Branches: London, Manchester, Birmingham,
Bristol, Glasgow, Dublin, Belfast

Kilo-Metres cycles	Station and Call Sign	Power (Kw.)	Kilo-Metres cycles	Station and Call Sign	Power (Kw.)	Kilo-Metres cycles	Station and Call Sign	Power (Kw.)		
GREAT BRITAIN			328.2	914	Grenoble (PTT)	3.0	NORTH AFRICA			
25.53	11.75f	Chelmsford (G5SW)	328.9	912	Poste Parisien	1.2	303.4	825.3	Algiers (PTT)	13.0
242.3	1,238	Belfast	345.2	860	Strasbourg (PTT)	15.0	416	721	Radio Maroc (Rabat)	10.0
261.3	1,148	London Nat.	385	779	Radio Toulouse	8.0	NORWAY			
288.5	1,040	Newcastle	447.1	671	Paris (PTT)	2.0	236	1,271	Kristiansand	0.03
288.5	1,040	Swansea	406	644	Lyons (PTT)	2.3	240.6	1,247	Stavanger	0.025
288.5	1,040	Plymouth	1,445.7	207.5	Eiffel Tower	15.0	304	824	Bergen	1.35
288.5	1,040	Edinburgh	1,724.1	174	Radio Paris	77.0	308.9	814	Frederiksstad	0.8
288.5	1,040	Dundee	1,724.1	174	" "	15.0	453.2	662	Porsgrund	0.8
288.5	1,040	Bournemouth	(testing)				493.4	603	Trondheim	1.35
288.5	1,040	Aberdeen	GERMANY				560	536	Hamar	0.3
301.5	995	North National	31.38	9,560	Zeesen	15.0	1,083	277	Oslo	75.0
309.9	968	Cardiff	217.1	1,382	Königsberg	1.7	POLAND			
356.3	842	London Reg.	218.5	1,373	Flensburg	0.0	214.2	1,400	Warsaw (2)	1.0
376.4	797	Glasgow	227.4	1,319	Cologne	1.7	234	1,283	Lodz	2.2
398.9	732	Midland Reg.	227.4	1,319	Münster	0.6	244.1	1,229	Wilno	21.0
479.2	626	North Regional	227.4	1,319	Aachen	0.3	312.8	959	Cracow	1.5
1,554.4	193	Daventry (Nat.)	232.2	1,292	Kiel	0.31	335	896	Poznan	1.9
AUSTRIA			239	1,256	Nürnberg	2.3	381	788	Lvov	21.0
218.5	1,373	Salzburg	245.9	1,220	Cassel	0.3	409	734	Katowice	10.0
245.9	1,220	Linz	253.4	1,184	Gleitwitz	5.0	1,411.3	212.5	Warsaw	153.0
283.5	1,053	Innsbruck	259.3	1,157	Leipzig	2.3	—Raszyn 153.0			
352	851	Graz	260.8	1,112	Bremen	0.2	PORTUGAL			
453.2	665	Klagenfurt	270.5	1,085	Heilsberg	75.0	290.5	1,033	Lisbon (CTIAA)	2.0
517.3	581	Vienna	283.6	1,058	Magdeburg	0.6	also on 42.0 m.			
also testing on 1,255 m. from 8.0 p.m. (Mon. Wed. Sat.)			283.6	1,053	Berlin (L)	0.6	ROMANIA			
BELGIUM			318.8	941	Stettin	0.6	304	761	Bucharest	10.3
206	1,456	Antwerp	325	923	Dresden	0.3	RUSSIA			
223.5	1,340	Brussels (No. 1)	350.1	833	Breslau	1.7	427	702.5	Kharkov	25.0
245.1	1,231.0	Brussels (No. 2)	372.3	805	Mühlacker	75.0	407	603.5	Moscow	1.2
338.2	887	Brussels (No. 1) 20.0	419	716	Hamburg	1.7	511	585	Archangel	1.2
608.5	590	Brussels (No. 1) 20.0	453.2	662	Frankfurt	1.7	720	416.6	Moscow (PTT)	20.0
BULGARIA			472.4	635	Berlin	1.7	800	375	Kiev	20.0
318.8	941	Sofia (Rodno Radio) 1.0	532.9	563	Danzig	0.6	840	357	Nijni Novgorod	1.8
CZECHO-SLOVAKIA			559.7	535	Langenberg	17.0	937.5	320	Kharkov (RV20)	25.0
203	1,139	Moravska-Ostrava 11.0	559.7	536	Munich	1.7	1,000	301	Leningrad	100.0
279	1,076	Bratislava 14.0	560	530	Kaiserslautern	1.7	1,000	283	Tiflis	10.0
293	1,022	Kosice 2.5	569.3	527	Augsburg	0.3	1,073	279.0	Rostov Don	4.0
341.7	873	Brunn (Bruno) 34.0	1,020	185	Hanover	0.3	1,103	272	Moscow Popoff	75.0
486.2	617	Prague (Praha) 5.5	1,034.9	183.5	Freiburg	0.3	1,304	230	Moscow (Trades Unions)	165.0
486.2	617	Liebitz (test) 60.0	2,525	119.3	Norddeich 10.0		1,481	202.5	Moscow (Kom)	40.0
DENMARK			2,900	103.5	Zeesen (press)	75.0	SPAIN			
281	1,067	Copenhagen 1.0	Konigswusterhausen 15.0 (press)				252.7	1,187	Barcelona (EA J15)	1.0
1,153	260	Kalundborg 7.5	HOLLAND				208.8	1,116	Valencia (tests)	5.0
ESTONIA			31.23	9,599	Eindhoven (PCJ)	30.0	349	860	Barcelona (EA J1)	8.0
405.8	644	Tartu 0.5	293.8	1,004	Hilversum 8.5		306.0	817.7	Seville (EA J5)	1.5
504.2	595	Tallinn 0.7	285	1,053	Radio Idzerda (The Hague) 3.0		421.9	711	Madrid (EA J7)	2.0
FINLAND			285	1,053	Kootwijk 10.0		449.1	668	San Sebastian (EA J3)	0.0
201	1,031	Tampere 1.0	1,071.4	280	Scheveningen-Haven 10.0		SWEDEN			
201	1,031	Viipuri 13.2	1,875	160	Huizen 8.5		230.3	1,304	Malmö 0.75	
368.1	815	Helsinki 13.2	550	545	Budapest 23.0		257.3	1,166	Hörby 15.0	
1,790	167	Lahti 54.0	HUNGARY				307.5	975.5	Faján 0.6	
FRANCE			224.4	1,337	Cork (CKK) 1.5		322	932	Göteborg 15.0	
222.9	1,346	Fecamp 5.0	413	725	Dublin (2RN) 1.5		436	689	Stockholm 75.0	
237.2	1,260	Béziers 0.6	IRISH FREE STATE				512	554	Sundsvall 15.0	
238.5	1,258	Bordeaux-Sud-Ouest 2.0	25.4	Rome (3RO) 9.0		770	389	Ostersund 0.75		
249.6	1,202	Juan-les-Pins 0.5	247.7	1,211	Trieste 15.0		1,229.5	244	Boden 40.0	
255	1,175	Toulouse (PTT) 1.0	206.1	1,013	Turin (Torino) 8.5		244.1	1,229	Basle 0.65	
265.4	1,130	Lille (PTT) 2.0	312.8	959	Genoa (Genova) 10.0		246	1,220	Berna 0.5	
272	1,103	Rennes 1.2	332	905	Naples (Napoli) 1.7		403.5	743	Sittens 25.0	
284.9	1,053	Montpellier 2.0	441	680	Rome (Roma) 75.0		459	653	Beromuenster 75.0	
287	1,045.5	Radio Lyons 30.0	453.2	662	Bolzano (IBZ) 1.5		700	395	Genova 1.5	
294.7	1,017.7	Limoges (PTT) 0.5	501	599	Milan (Milano) 8.5		TURKEY			
304	936	Bordeaux (PTT) 15.0	541.5	554	Palermo 3.7		1,204.8	249	Istanbul 5.0	
314.3	954.5	Natan-Vitus (Paris) 0.5	LATVIA				1,538	195	Ankara 7.0	
316	950	Marseilles (temporary) 0.3	525	572	Riga 13.0		YUGOSLAVIA			
			LITHUANIA				307	977	Zagreb (Agram)	0.7
			1,035	155	Kaunas 7.0		430.4	697	Belgrade 3.0	
							574.7	523	Ljubljana 2.8	

WHEN SUBMITTING QUERIES

Please write concisely, giving essential particulars. A Fee of One Shilling (postal order), a stamped addressed envelope, and the coupon on the last page must accompany all letters. The following points should be noted.
Not more than two questions should be sent with any one letter.
The designing of apparatus or receivers cannot be undertaken.
Modifications of a straightforward nature can be made to blueprints, but we reserve to ourselves the right to determine the extent of an alteration to come within the scope of a query. Modifications

to proprietary receivers and designs published by contemporary journals cannot be undertaken.
Readers' sets and components cannot be tested at this office. Readers desiring specific information upon any problem should not ask for it to be published in a forthcoming issue, as only queries of general interest are published and these only at our discretion. Queries cannot be answered by telephone or personally.
Readers ordering blueprints and requiring technical information in addition, should address a separate letter to the Query Department and conform with the rules.

Entering into the spirit of the season, the Midland Studio Orchestra gives an autumn programme on October 12. Every item will reveal some aspect of the season expressed in music. The soloist for the occasion is Charles Dean.

Miss Eleanor E. Helme, the well-known golfer, will describe to listeners, in an eye-witness account broadcast on the National wavelength on October 10, play in the Great Britain v. France ladies' golf match at Oxhey.

For
IMMEDIATE
DISPATCH
 of
BRITAIN'S
SUPER
 order from
READY
RADIO

Huge stocks of **READY RADIO TESTED KITS** are now being prepared. There is sure to be a big demand, but you can make sure of your kit by ordering from **Ready Radio**.

See our special announcement in next week's issue.



EASTNOR HOUSE, BLACKHEATH, S.E.3
 Telephone: Lee Green 5678
 Telegrams: "Readirad, Sedist"
 Showrooms: 159 BOROUGH HIGH ST., LONDON BRIDGE, S.E.1. Telephone: Hop 3000

CLIX

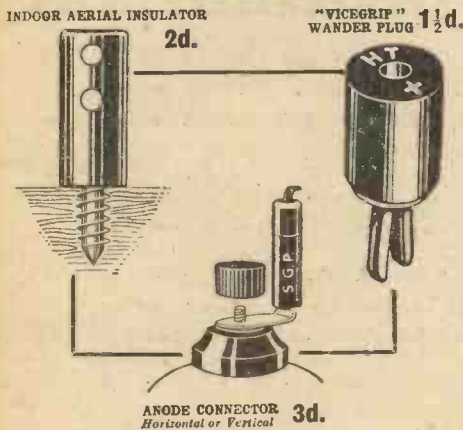

CLIX KIT
 for the
"OLYMPIAN THREE"
 Contains all Clix Fitments as specified by "Amateur Wireles"

7 Wander Plugs
 2 Spade Terminals
 4 Panel Terminals
 1 S.G. Anode Connector
2/6
 All correctly engraved. From your dealer or direct
 Save time and trouble. from us, Post Free.
 Folder "A" on request.

Cheapest PERFECT Contact
 Lectro Linx, Ltd., 254 Vauxhall Bridge Road, S.W.1

- SPRINGS POSITIVELY SECURED
- NICKEL SILVER SPRING CONTACTS
- POSITIVE SNAP ACTION
- POLISHED CONTACTS
- TAPERED SLEEVE
- THICK SPINDLE WITH LONG BUSH

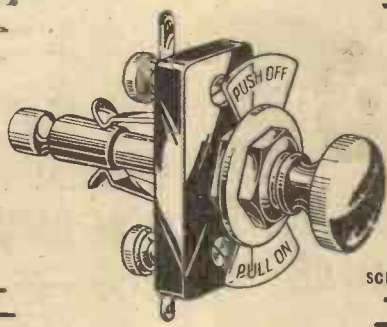

- OPTIONAL CONNECTIONS
- INDICATING FRAME
- BUSH ADJUSTABLE TO PANEL
- BLACK OR MAHOGANY FINISH KNOB
- SCREWHEADS COUNTERSUNK
- BAKELITE BASE

Bulgin originated the Push-Pull Radio Switch in 1924, and every year has seen improvements incorporated, both in design and operation. No other push-pull switch incorporates all the good points enumerated above. Numerous imitations only serve to emphasise the superiority of Bulgin Switches, which are increasingly popular.

Push-Pull Switch (above)	S.22	1/6
Three Spring Wave-change (bottom right)	S.36	1/9
Quick Make and Break "On-Off" (bottom left)	S.15	1/9





A. F. BULGIN & Co., Ltd.
 Abbey Road, Barking, Essex
 Telephones: Grangewood 3266 and 3267

London Showrooms: 9, 10, 11 Cursitor Street, Chancery Lane, E.C.4.
Telephone: Holborn 2072

Please Mention "A.W." When Corresponding with Advertisers

MAKE YOUR SET UNIVERSAL

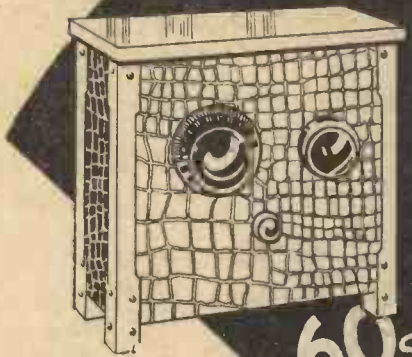

ELEX SHORT WAVE CONVERTOR

60s. Complete

A remarkable invention that converts your set into an "all station receiver." Enables your existing set to be used on the ultra-short wavebands. It is an indispensable addition giving you the choice of a wide range of programmes. Housed in handsome "Byldurone" cabinet with nickel corners, it has a pleasing appearance.

It covers the 16-60 metres band, price 60/- . An additional coil for the 140-190 metres waveband is available at 5/-

BYLDURONE

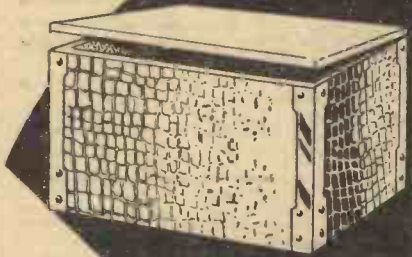

CABINETS

As used and recommended to constructors for the Mullard V.3 Set in "Radio for the Million," Super 60, Century Super, and many other sets. Anyone can construct these cabinets. All that is required is a saw, screwdriver, "Byldurone" corner pieces and a supply of 5-ply wood.

Write for list B.3.

J. J. EASTICK & SONS
Eelex House
118 Bunhill Row . . London, E.C.1.

Phone: Metropolitan 0314/5/6

For Sharpest Tuning and Minimum Disturbance fit the

SANAX High Conductivity Copper Earth Tube
2/3 post free. Illustrated List Free. Trade Supplied.
Makers—"SannaRay" Electrical Co., 135 Deritend, Birmingham

BUY THROUGH THE POST—THE MODERN WAY!
YOU WANT ADVERTISED GOODS—we have all of them IN STOCK and can give you IMMEDIATE DELIVERY. The Advertisement columns of this publication are our catalogue—free delivery at LIST PRICES (no extra postage).

INTERNATIONAL RADIO BUREAU
CASH WITH ORDER or C.O.D.
CARADAY HOUSE
HENRY STREET
BLACKPOOL
(Lancs)

B.4.U. BUY your Moving Coil Speaker WRITE NOW FOR

42 pages of valuable information on how to secure REALISTIC REPRODUCTION

BAKER'S Selhurst RADIO CROYDON SURREY.
PHONE: CROYDON 1518

CAN YOU PAINT A HOUSE, MEND CHINA, ENAMEL A BATH, REPAIR HOT WATER PIPES?

A copy of "The Handyman, 1,000 Practical Receipts," will explain to you clearly the simplest methods of dealing with these and hundreds of other household problems, 1/9 post free from the Publishers or 1/6 from any newsagent or bookseller.

CASSELL & CO., LTD.,
La Belle Sauvage, London, E.C.4

A NEW "AMATEUR WIRELESS" HANDBOOK

The HOW AND WHY OF RADIO

By ALAN HUNTER
2/6 NETT.

This book has been expressly written for beginners. It provides a clear conception of the general theory and practice of wireless reception in simple non-technical terms. It has been mainly compiled from the series of articles in "Amateur Wireless"—"The How and Why of Radio"—which proved so popular during the past twelve months.

Of all Newsagents and Booksellers, or 2/9, post free, from "Amateur Wireless," 58/61 Fetter Lane, London, E.C.4.

AN AMAZINGLY EFFICIENT OUTPUT CHOKE

Inductance 70 henries at 25 m/a. 4 tappings and 9 ratios making it ideal for use with Pentode valves 15/6

Let us send you the new Tunewell list giving Charts of our latest output chokes, mains transformers, resistances, etc.

NEW TUNEWELL PRICE REDUCTIONS

TWO-PIN COILS reduced 3d. per Coil.
MARVEL DUAL AERIAL ANODE 2/6.
M4 PANEL Mounting from 10/6 to 8/6.
DUAL X Mounting 10/6 to 8/6.
BINOCULAR DUALS 10/6 to 8/6.
POP VOX Coils price 6/6 per pair.

TUNEWELL EXTRA SELECTIVE DUAL RANGE COILS—AERIAL or ANODE 7/9 (6-pin base 2/-). With "BLUNTER" tuning tapping 1/- extra. PANEL MOUNTING 10/6 (3-pt. switch 1/3). Short Waves 3/11.

SEND FOR THE TUNEWELL S.G.3 CIRCUIT and further particulars of the new coil prices.

TURNER & CO.,
54 STATION RD., LONDON, N.11.

The DIXOHMETER

is an Ohmeter or Insulation and Voltage Tester for High-Resistance Values. It has a Moving-coil Voltmeter, and is a valuable aid to all engaged in electrical work

Model No. 1. Insulation and voltage tester for testing at 500 volts and reading from .01 to 50 megohms.

Model No. 2. Has the same features as No. 1, but in addition, the voltmeter can be used on either D.C. or A.C. by turning a knob to switch in a dry rectifier. Model No. 2 is ideal for engineers dealing with a variety of voltage and insulation tests.

PRICES:

Model No. 1 - £8:10:0

Model No. 2 - £9:10:0

Write for Special Leaflet and Catalogue of Laboratory Instruments and Apparatus, Dynamos, Motors, Relays, Switches, Regulators, Switchboards, Telephones, etc., all at specially low prices.

LESLIE DIXON & CO.

ELECTRADIX HOUSE,
218 UPPER THAMES STREET, E.C.4

Phone: City 0191

Grams: "Electradix, Cent, London"

CIRCUITS. SOMETHING NEW!

Benjamin All Mains Three, a reasonably high powered set capable of a selection of at least 12 stations at loudspeaker strength.

The Benjamin Super Four—a super selective set and the Local Station Two. Full details and diagrams of these original circuits given in our 1932 catalogue. Write for your free copy to-day.

THE BENJAMIN ELECTRIC Ltd.,
Tariif Road, Tottenham, N.17.

BENJAMIN

Charge Your Own Accumulator at Home

There is no need to send your accumulator to a service station. Install the latest Heayberd Trickle Charger, Model A.C.2 and switch on to the Mains. Charging rate 1/4 amp on 2, 4 or 6 volts accumulators. Fitted with Cover case and incorporating Westinghouse Rectifier this excellent Charger has been used and recommended by "Amateur Wireless."

Price 35/-
POST THIS TO-DAY.
I enclose 3d. stamps for full lists of Heayberd Mains products with circuit diagrams and valuable hints on their usage.

M.....
Address.....



MASTERS OF THE MAINS.

10 FINSBURY STREET, LONDON, E.C. 2

EASY TERMS

WE SUPPLY ALL GOOD QUALITY RADIO RECEIVERS, COMPONENTS AND ACCESSORIES ON DEFERRED TERMS. WE CARRY ADEQUATE STOCKS AND CAN GIVE PROMPT DELIVERY

NEW HEAYBERD A.C. ELIMINATOR KIT C.150.—Complete Kit of Parts for building an H.T. Eliminator, including steel case. Output, 25 m.a., 150 volts. 3 H.T. Tappings, one variable. Cash Price, £3/18/-

or 7/6 with order and 11 monthly payments of 7/-
12 EXIDE W.H. HIGH-TENSION ACCUMULATORS (120 volts, 5,000 m.a.). Higher voltages if desired. Cash Price, £3/15/-

or 7/6 with order and 11 monthly payments of 7/-
Carriage charged on all orders from Scotland.

N.K. FARRAND INDUCTOR LOUD-SPEAKER UNIT.—Quality of reproduction almost equal to a moving-coil speaker. Cash Price, £3/10/-

or 5/6 with order and 11 monthly payments of 6/6.
SET OF THREE VALVES, S.G., DET. AND POWER, MULLARD OR COSSOR. Cash Price, £1/19.0

or 6/- with order and 7 monthly payments of 5/4.
NEW BLUE SPOT 66R UNIT.—The finest balanced-armature movement on the market. Complete with large Cone and Chassis. Cash Price, £2/10/-

or 5/- with order and 10 monthly payments of 5/-.
NEW CELESTION MOVING COIL L.S. UNIT (PERM. MAGNET), with Transformer. Cash Price, £4/5/-, or 13/6 with order and 10 monthly payments of 8/-.
Send list of requirements and quotation will be sent by return.

LONDON RADIO SUPPLY CO.
11 Oat Lane, Noble Street, London, E.C.2
Telephone: National 1977



PAULETTE ALL WAVE TUNER

250-2,000 metres. No coils to change. Greatly improved selectivity and range. PRICE, with Switch, 7/- post paid. Send stamp for FREE WIRING DIAGRAMS OF PAULETTE 3-VALVE SET. Easy to construct. Parts cost £2.12.6.

PAULLS WIRELESS STORES,
43, Caroline Street, Cardiff.



YOU CAN BUILD A £40 GRAMOPHONE WITH OUR SCALE DRAWINGS FOR 40/-

Book of instructions 3d. Catalogue of Motors, Tonearms, Soundboxes, latest internal amplifiers, Gramophones and Cabinets Free. Cash or Terms.

W. BURT, 185 High St., Deptford

TAYLEX WET H.T. BATTERIES

New Prices: Jars 1/3. Sacs 1/2. Zincs 10d. Sample doz. 18 Volts complete with bands and electrolyte 4/1 post 9d. Sample unit 6d. Illus. booklet free. Bargain list free. AMPLIFIERS, 30/-. 3 VALVE ALL-STATION SET £1. A. TAYLOR, 57, Studley Road, Stockwell, LONDON.

SEE THESE NEW



PRODUCTS ON STAND 81

AT THE MANCHESTER SHOW

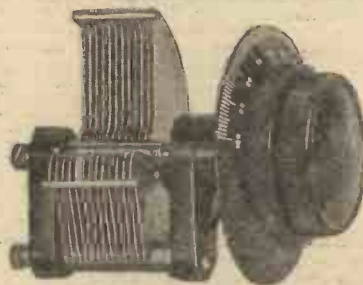

SLOW MOTION CONDENSER

The slow-motion drive is silky and permits the tuning of close stations to a degree of accuracy that vastly improves the reception of your set. Other features are the Internal Pigtail and its small size and light weight. Price 6/-

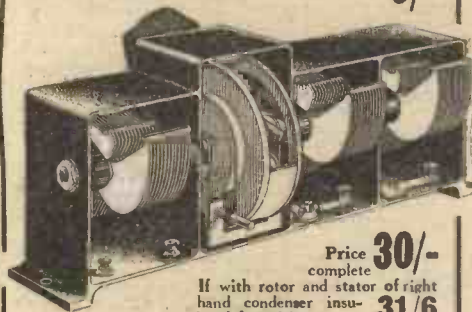

TRIPLE GANG (COMPLETELY SCREENED)

The Condenser can be made up in several different arrangements. There are two controlling knobs. The right-hand knob controls all the rotor vanes on all three condensers simultaneously.

The left-hand knob controls the stators of the two left-hand Condensers and the position of the stators is indicated on the celluloid drum by a shadow thrown from a hidden pointer.

The two left-hand Condensers are provided with small balancing condensers for balancing the stray capacities in the circuit of the Band-pass.

The Complete Range of FORMO Condensers

DUAL GANG

Embodying similar features to the Triple Gang, with stator indication by means of the shadow on the dial. Specially adaptable for use with screened grid 3 and Super Het. circuits. Price 18/6

Midget Reaction Price 2/9
Formo Densors Price 1/6, 2/3
Mains Price from 2/6

Obtainable from all Radio Dealers. Ask us to send you the complete Catalogue of Formo products including the new Battery Eliminators and the 7 in 1 Aerial.

ARTHUR PREEN & Co., Ltd.

Golden Square, Piccadilly Circus, London, W.1. Crown Works, Southampton.

SEE ALSO PAGE 693

SET CRACKLING IS ANNOYING!



IF IT'S YOUR SWITCH

1/3

each
1 6
Post
Free

Patents
Pending



FIT THE "BUSCO" SWITCH

and ensure perfect switch contact! There is no contact point to turn round, and when you "switch on" you have contact like a power switch.

They are as cheap as the inferior type but far superior in operation.

From your local dealer,
Hatford's Cycle Stores, or

BUSBY & CO., LTD. (Patentees)
Dept. A.W., PRICE ST., BIRMINGHAM

CUT OUT THAT INTERFERENCE by FITTING the

"SPIRANIC"

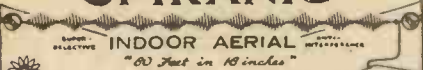

INDOOR AERIAL

"30 Feet in 10 inches"

Just fits that available space!

From all Dealers or Post Free Cash Price 2/- Send for Descriptive Leaflet

Makers: "SANA-RAY" ELECTRICAL CO., 185, DERITENO, BIRMINGHAM.

MAKE OR BUY A GRAMOPHONE AT



a quarter shop prices. Or buy Cabinets for Wireless. British double spring motor, 12 in. velvet turntable, swan arm, metal sound-box, amplifier, needle cups, for £1-18-0 p.p., and build your own Cabinet. Portable Gramophones from 15/8, postage 1/6. Motors from 7/8. Lists free. 64 pp. 1931 Catalogue No. 220 with Reduced Prices, Drawing and How to Make Gramos, 3d. Established 27 years.

Regent Fittings Co., A.W., 120 Old St., London, E.C.1

RADIO FURNITURE DE LUXE!

PICKETTS

Usual Price	Makers Price	Saves
£8-15-0	£6-18-0	You
£7-7-0	£5-10-0	Money.
£2-3-0	£2-7-0	

Famous expert, B.E.C., 3,000 clientele. Sent ON APPROVAL FREE!—return at OUR expense if not delighted. Deferred Terms 10/- or £1 monthly.

Photographs and List FREE!
PICKETTS Radio-Furniture (A.M.)
Albion Road, Bexleyheath.

Mention of "Amateur Wireless" to Advertisers will Ensure Prompt Attention

PREPAID ADVERTISEMENTS

Advertisements under this head are charged THREEPENCE PER WORD, minimum charge THREE SHILLINGS. DEPOSIT SYSTEM

As the Publishers cannot accept responsibility for the bona fides of advertisers in this publication, they have introduced a system of deposit which it is recommended should be adopted by readers when dealing with persons with whom they are unacquainted. It is here explained. Intending purchasers should forward to the Publishers the amount of the purchase money of the article advertised. This will be acknowledged to both the Depositor and the Vendor, whose names and addresses must necessarily be given. The deposit is retained until advice is received of the completion of the purchase, or of the article having been returned to and accepted by the Vendor. In addition to the amount of the Deposit, a Fee of 6d. for sums of £1 and under, and 1s. for amounts in excess of £1, to cover postage, etc., must be remitted at the same time. In cases of persons not resident within the United Kingdom, double fees are charged.

The amount of the Deposit and Fee must be remitted by Postal Order or Registered Letter (Cheques cannot be accepted), addressed to

"AMATEUR WIRELESS" ADVERTISEMENT DEPARTMENT, 58/61 FETTER LANE, LONDON, E.C.4

HIRE A MCMICHAEL PORTABLE SET, 15/- weekly. Sets visited, repaired, overhauled.—Alexander Black, Wireless Consultant, 55 Ebury Street, S.W.1 Sloane 1655.

PERSONS REQUIRED immediately to make Leather Matting; regular work supplied, cash paid weekly.—Write E. 37, "Everlast" Leather Matting Co., Wellingborough.

HALF PRICE.—New, All-Electric Radio-Gram., S.G.3, A.C. 200-240 volts, complete with valves and speaker, Listed £48, sell £24.—J. Terry, 200 Lordship Lane, London, S.E.22.

VERT WIRING CLIP.—No soldering. Fits any component. Perfect contact. Tested and approved "A.W." Quarter gross, 1/2; half-gross, 2/-; gross, 3/0.—Green & Sons, Redcliffe, Horley, Surrey.

MODERN THREE-VALVE SETS with valves, £3/15/-. Century Super kits, £3/15/-. Anything wireless supplied at keenest prices. Send list of requirements for quotation.—Servwell Wireless Supplies, 74 Gough Street, London, E.14.

WIRELESS PARTS AND SETS exchanged for new. Up to 50% or more allowed for modern parts in good condition. Apparatus can be sent for valuation.—W. Burns, Wireless Factor, 4 Loanda Street, Haggerston, E.8.

UNUSED BANKRUPT STOCK.—P.M. Loudspeakers Baker, £2 15s.; Epoch, £1 12s. 6d.; Triton, 15s. units, 7s. 9d.; Siemens, 1500-v. condensers, 2Mfd., 3s., 4Mfd., 5s. 3d.; Wavemaster 0.0005SM, 4/6. Quotations. Catalogues Free.—Pepper, Wakegreen Road, Birmingham.

TO LET.—Premises very suitable Radio Stores, situated Hoxton Street, N.1.—Full particulars from J. Tubb, 25 Parkway, Seven Kings. Phone: Seven Kings 1347.

ENGINEERS.—Seriouly, if you are earning less than £10 per week you cannot afford to carry on without reading "ENGINEERING OPPORTUNITIES." Whether you are an old hand or a budding apprentice, this 200-page volume will point to a worth-while future. Among other things the book explains the methods of our unique Appointments Department, gives details of all leading Eng. Exams. (A.M.I.Mech.E., A.M.I.E.E., B.Sc., G.P.O., etc.) and outlines modern Home Study Courses in Civil, Mech., Elec., Motor, Aero., Radio, "Talkie," and all other branches of Engineering. This book will alter your entire outlook and earning power. It is quite FREE. Send for your copy now. British Institute of Engineering Technology, 109 Shakespeare House, 29-31 Oxford Street, London.

16-in. SPEAKER CHASSIS, any unit easily fitted. Money back guarantee. Price 4/6, postage and packing, 1/-.—Bannister, 14 Pembroke Street, Cowley Road, Oxford.

AGENTS, ACTIVE ENTHUSIASTS sell "Brookman British Ebonite Panels," cabinets, and specialities, suppliers of all makes of radio apparatus. Send for particulars of our system of trading. Brookman Rapid Radio Service, 105 Spencer Street, Birmingham.

"CRAFTLEASE" CABINETS are supplied "ready to assemble" or "assembled." Write for catalogue.—D. Craftlease Works, Winscombe.

PHOENIX THREE-VALVE KITS, complete with cabinet £1/17/6. Ditto with valves, £2/15/-. Ditto with H.T. and L.T. batteries and speaker, £4/10/6. Three-valve S.G. kits, 30/- extra. H.P. terms on kit; 10/5 deposit 2/7 per week.—Phoenix, 314 High Road, Lee, S.E.13.

"STANDUP" Wet Battery replacements. All sizes up to 30,000 milliamperes capacity. Lists free.—Scottish Batteries, Braeside, Uphall Station.

LOWEST QUOTATIONS any parts per return. Also bargain list. Everything at very lowest prices. State requirements. "Quality 5" complete £10. "Super 60" to specification, with valves and aerial £8 10s. Fishpool, Fountain Place, Waltham-Abbey.

RADIO VISION REC-TORS. Parts supplied for experimenters. John Salter, Featherstone Buildings, Holborn, W.C.

BANKRUPT BARGAINS.—List free with 3-valve diagram. Century Super kit, 7/6; 3-valve kit with cabinet, 32/0; 2-valve, 24/-. Any kit supplied. Wavemaster .0005, 2/6; Diff., 2/-; Transformers, 2/9; Ace, 4/9; Radiograms, 7/6; Dual coils, 4/-; Telsen, 4/9; Triton units, 9/6; Tungram, Triton valves, 4/6; Power, 5/6; SG, 10/-. Save money. Get my price first. Butlin, 1439 Preston Road, Brighton.

MOVING-COIL LOUD-SPEAKERS. Marconiphone 6v. units, 10 in. cones, complete 25/-. Unrepeatable bargain. Hillier, 22 Cork Street, W.1.

CENTURY SUPER with speaker, no batteries, want cash. Sacrifice, £5. Bamford, 29 Oakfield Road, E.5.

"Amateur Wireless and Radiovision." Price Threepence. Published on Thursdays and bearing the date of Saturday immediately following. Post free to any part of the world: 3 months, 4s. 6d.; 6 months, 8s. 9d.; 12 months, 17s. 6d. Postal Orders, Post Office Orders, or Cheques should be made payable to "Bernard Jones Publications, Ltd."

General Correspondence is to be brief and written on one side of the paper only. All sketches and drawings to be on separate sheets.

Contributions are always welcome, will be promptly considered, and if used will be paid for.

Communications should be addressed, according to their nature, to The Editor, The Advertisement Manager, or The Publisher, "Amateur Wireless," 58-61 Fetter Lane, London, E.C.4.

ELECTRADIX MICROPHONES

FOR HOME TALKIES

Pulpit Pedestal, 12/6; Pedestal Broadcaster, as illustrated, 18/6; Microphones with handle, 15/-; powerful Public Address Models, 55/-; Transformers, 4/6 and 7/6; Couplers, 15/-; Valve Amplifiers, 55/-; for Band Repeater or Public Address work, Home Recorder for Gramo. New Carbon Insets, 2/2 each. A very sensitive pendant model in cast aluminium case with brass front and flex cord is only 4 6.



THE DIXOHMETER

is an OHMETER or Insulation and Voltage Tester for High Resistance values. It has a moving-coil Voltmeter and is a valuable aid to all engaged in electrical work.

For testing at 500 volts and reading from .01 Megohm to 50 Megs. Terminals for use as a Voltmeter; D.C. 0-250 volts and 0-500 volts, price £8 10s. No. 2 has the same features as No. 1 above but in addition the Voltmeter can be used on either D.C. or A.C., price £9 10s.

METERS. 20 m/a 1 1/2 in. Panel, 7/6. Moving Coil milliammeters, 12/6 to 21/6. 0-500 volts, 45/-. Weston Meters, 2 1/2 in. to 8 in. dial, 50 per cent. off list. Testing Sets, Elliott, E.108, 4 ranges amps and volts, 45/-. A.C. Hot Wire, 1/2 amp, 5/-. Cell Testers, pocket, 15/- with spikes, 30/-. Bridges, 10,000 ohm 4-dial, Whatstone, with Galvo, £10, G.P.O. type, £7 10s. Mirror Galvos Reflecting Beam, by Paul, Gambrell, Sullivan, and Tinsley, £3. Standard Resistance Boxes and Universal Shunts, 35/-. Electrostatic Volt meters to 2,000 volts, £2. Silvertown Galvos, 7/6. Various Testing Sets cheap. Red Meggers, 100 to 1,000 at half-price. Photo Electric Cells and Selenium.

H.T. MAINS UNITS.—Pye-Westinghouse. Fine brand new five-guinea units, output 120 volt 20 m/a D.C. from 200/250 volts A.C. Fit any portable set. Clearing at 60/-. Post 1/-.

FELLOWS D.C., Type "A." List price £3 10s. New for 30/-. Ditto, A.C. model, 15 m/a, with valve, 45/-. STEP-DOWN MAINS TRANSFORMERS, for use on 200/250 volts. A.C. Mains. Output 3, 5 and 8 volts at 1 amp., 5/6; 8, 12, 20 volts at 2 amps., 7/6. Parmeko Trans. and Chokes.

PHILLIPS 200 to 240 volts A.C. to 2-0-2 volts or 4 volts 5 amps for lighting A.C. valves, working models and tests, new 27/6 model with flex and plug or adaptor for 15/-.

SWITCH GEAR.—Mains Set Glass Fuses, 2 amps., 3d.; Porcelain, 2-pin Plug, 3d., fuses 4d. Slow-motion Geared-Slide Rheos., 7/6. 147 S.P. Plug Boards, 9-way, 10 amp., 2/-; Lucas 8-way Switch Boxes, mahogany, Brass Cover, 6 S.P., 1 D.P., 1 C.O., 3/6. S.P.C.O. Switches, 1/6.

TRANSMITTERS.—R.A.F., 1-in. spark, with A.T.1. and all fittings in polished mahogany case. Cost £15. Sale 15/-. 100 watts, 25/-; 250 watts, 50/-; 2-valve Aircraft ditto, with Osram valves; speech or Morse, 30/- each. No. 1 Tapping Keys, open type, with massive contacts, 6/- each. No. 51KD with aluminium cover, double contact, fine work, 7/6 each. Morse Practice Sets, with buzzer and key on mahogany panel, 8/6 each. Morse Sounder, 15/-.

POWER, AMPLIFIER, OR TRANSMITTING VALVES, 6-volt, 40 watts, 4/6. Receiving, 3/-. WAVEMETERS, by Townsend, Paul, Silvertown, Cambrell, and Marconi, from 10/-.

HEADPHONES, Sullivan LR, 2/9; HR, 4/3; Browns A, 7/6 and 12 6.

October Sale List Post Free.

ELECTRADIX RADIOS

218 UPPER THAMES STREET, LONDON, E.C.4.

Let "AMATEUR WIRELESS" solve your wireless problems

FULL-SIZE BLUEPRINTS

When ordering, please send Postal Order, NOT STAMPS.

CRYSTAL SET (6d.)

1931 Crystal Set AW308

ONE-VALVE SETS (1s.)

Easy to Build One AW304

TWO-VALVE SETS (1s. each)

- Talisman-Two (D, Trans) AW194
No-battery Gramo-radio 2 (D, Trans) AW238
1930 Talisman 2 (D, Trans) AW239
Arrow Two (D, Trans) AW249
Forty-five-shilling Two (D, Trans) AW250
Everybody's All-in 2 (D, Trans) AW273
Twenty-shilling Two (D, Trans) AW274
The Room-to-Room 2 (D, Trans) AW298
Big-volume Two (D, Pentode) AW309
Gleaner Two (D, Trans) WM201
Merlin Two (A.C. Set) WM213
Five-point Two (D, Trans) WM220
Brookman's A.C. Two (D, Trans) WM225
Aladdin Two (D, Trans) WM231
Ever Tuned Regional Two (D, Trans) WM241
Station-finder Two (D, Trans) WM253

THREE-VALVE SETS (1s. each)

- 1931 Ether Searcher (SG, D, Trans) AW271
1931 Ether Searcher (A.C. model) AW276
Mains Unit AW277
Ultra-selective Straight Three (SG, D, Trans) AW282
1931 Ether Searcher (D.C. model) AW284
Mains Unit AW285
Square Peak Three (SG, D, Trans) AW293
B.B.C. Selective Three (D, RC, Trans) AW289
Universal Short-wave Three (SG, D, Trans) AW301
Olympian Three (SG, D, Trans) AW306
Brookman's Three (SG, D, Trans) WM161
Five-point Three (SG, D, Trans) WM212
New Brookman's Three (SG, D, Trans) WM218
Five-point Short-waver (D, RC, Trans) WM223
Baffle-board Three (D, RC, Trans) WM226
Plug-in-coil Three (D, 2 Trans) WM232
Regional Three (SG, D, Trans) WM236
Band-pass Inceptordyne (SG, D, Trans) WM244
Ether Marshal (SG, D, Trans) WM247
Meridian Short-waver (D, RC, Trans) WM256
Five-advantage Three (D, RC, Trans) WM257
Everybody's Radiogram (SG, D, Trans) WM258

FOUR-VALVE SETS (1s. 6d. each)

- The £3 3s. Four (SG, D, RC, Trans) AW303
The £3 3s. Four (Improved Model) AW303A
Everybody's Radio-graphophone AW310
Regional Band-pass Four (SG, D, RC, Trans) WM211
Five-Point Four (SG, D, RC, Trans) WM216
Regional A.C. Four (SG, D, RC, Trans) WM222
Supertone Four (SG, D, Push-pull) WM227
Brookman's Three-plus-one (SG, D, RC, Trans) WM233

FIVE-VALVE SETS (1s. 6d.)

Regional D.C. Five (SG, D, RC, Push-pull) .. WM252

SIX-VALVE SETS (1s. 6d. each)

- Century Super (Super-het) AW287
A.C. "Century Super" (Super-het) AW295
Mains Unit (1/-) AW295A
Super 60 (Super-het) WM229
A.C. Super 60 Radio Graphophone (Super-het) WM239
A.C. Super 60 (Table Model) WM245
Super 60 (with Weatrite base) WM249
Super 60 (with Lecwoc base) WM251

SEVEN-VALVE SET (1s. 6d. each)

Super Senior (Super-het) WM256

AMPLIFIERS (1s. each)

- High Quality Amplifier for A.C. Mains .. AW275
2-Watt Amplifier for A.C. Mains .. AW283
Add-on H.F. Screened-grid Unit AW296
Universal Push-pull Amplifier AW300
D.C. Fader WM242

PORTABLE SETS

- Portable "Century Super" (Super-het) .. AW297 1/6
Super 60 Portable (Super-het) .. WM238 1/6
Home and Garden Three (D, RC, Trans) .. WM246 1/-

MISCELLANEOUS (1s. each)

- Our H.T. Unit for A.C. Mains AW262
Graphophone Tone Control AW264
Short-wave Super-het Adaptor AW268
H.T. Unit and Trickle Charger for D.C. Mains .. AW272
Booster Speaker (6d.) AW286
"A.W." Tone changer (6d.) AW288
"A.W." Selectivity Unit (6d.) AW290
A.C. Trickle Charger AW305
Amateur's Linen Speaker AW307
Big H.T. Unit for A.C. Mains WM230
Loud-speaker Tone Control WM234
"W.M." Linen Diaphragm Loud-speaker WM235
Two-Minute Adaptor for Short Wave WM240
Super 60 A.C. Unit WM248
Simple Neon Oscillator WM250

Copies of the "Wireless Magazine" and of "Amateur Wireless" containing descriptions of any of these sets can be obtained at 1s. 3d. and 4s. respectively, post free. Index letters "A.W." refer to "Amateur Wireless" sets and "W.M." to "Wireless Magazine." Address letters:

Amateur Wireless Blueprints Dept., 58-61 Fetter Lane, London, E.C.4.

Amateur Wireless INFORMATION BUREAU COUPON Available until Saturday OCTOBER 17, 1931 FEE 1/-

MAKE YOUR OWN RADIO-GRAM !



THE British Ideal "DAPTACON" PICK-UP obtains remarkable results even when used on a ONE Valve circuit. It is supplied with three leads, giving low, medium and high output for use with different power sets. Supplied absolutely complete, straight-arm shape as illustrated, or with Patent Carrier Arm which ensures dead straight "tracking" across record.

Price 32/6
either type

WITH "DAPTACON" PRODUCTS

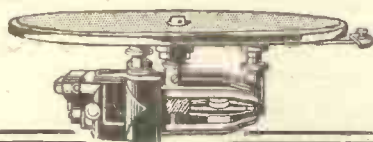

THE "DAPTACON" UNIVERSAL ELECTRIC GRAMPHONE MOTOR for both A.C. and D.C., covers voltages 100 to 200, and 200 to 250 A.C. or D.C. Can therefore be used anywhere by merely plugging into nearest electric-light socket. When used in Radio-gramophone, electrical interference is eliminated by a small condenser, supplied free. Price, with 12-in. plush-covered Turntable and geared Speed Indicator ... **55/-**

The well-known "DAPTACON" products are on sale at leading dealers everywhere.

Trade inquiries to: BRITISH IDEAL PATENTS, LTD., Green St., Brimsdown, Middlesex.
Phone: Enfield 1741-1898, Or to the usual Factors.

THE TEST OF TIME



BECOL REAL EBONITE

has stood this and is the most reliable

Formers tested electrically before Despatch. 26 Types

REDUCED PRICES

PANELS TUBES RODS British Made

LOOK FOR TRADE-MARK

THE BRITISH EBONITE CO., LTD.

HANWELL, W.

IT'S THE LIMIT YOU ARE WANTING



The PICK-UP with the Adjustable Reed.

Combination Pick-up and arm, 32/6
Pick-up only, with side fitting, 21/-

LIMIT RADIO Ltd., 15/29 Windsor St., Essex Road, N.1.

Obtainable from Dealers or write direct.

SWITCH ON to all Europe

BLUE SPOT Receivers have a selectivity which is razor keen. The programmes of most of the European stations are therefore literally at your finger tips. Reception, moreover, is particularly sharp and clear, devoid of background or interference.

Since the reproduction is entrusted to a BLUE SPOT Speaker it is beyond reproach, making voices and music beautifully clear and distinct. The receiver is operated from the mains and is very economical on current. The mains can be used as an aerial, although provision is made for an outside aerial if preferred.

The receiver illustrated is WS400 and is sold complete (with Inductor Type Speaker, B.V.R.M.A. Valves and Marconi Royalty Paid) for 20 gns.

OTHER MODELS

Upright Grand - - - 27 gns.
Table Grand - - - 25 gns.

W400 - £18

Send for illustrated catalogue A.W.11



Registered Trade Mark



THE BRITISH BLUE SPOT COMPANY LTD
BLUE SPOT HOUSE · 94/96 ROSOMAN STREET · ROSEBERY AVENUE · LONDON · E C1

You Will Help Yourself and Help Us by Mentioning "A.W." to Advertisers

New Ekco Power Units

... never before such amazing performance, such outstanding design



Surpassing all previous achievements triumphs of efficiency embodying exclusive features combining highest efficiency with greatest simplicity.

Immediately adjustable for different output voltages by a method which eliminates all variable resistances and their attendant defects. All the controls compactly arranged, readily accessible, clearly marked. Cleverly recessed, too, so that they do not protrude above the surface of the cabinet. Measuring 9 ins. by 5 ins. by 3½ ins. ideal for portable sets and for all other

receivers. Banish all battery worries, renewals and expenses for ever and give you better radio permanently for only a few pence a month.

Worth knowing more about!
Post coupon now for full details.



EKCO NEW H.T. UNITS

(For A.C. Mains)

Model A.C.12 for 1 to 3 valve sets	£2 15 0
(12 m/a output)	
Model A.C.18 for 1 to 5 valve sets	£3 7 6
(18 m/a output)	
Model A.C.25 for multi-valve sets	£3 17 6
(25 m/a output)	
Model D.C.15/25 H.T. Unit for D.C. Mains	£1 19 6
(15 or 25 m/a output)	

EKCO NEW COMBINED H.T. AND L.T. CHARGER UNITS

(For A.C. Mains)

Supply H.T. and also keep your accumulator constantly charged).

Model K.12 for 1 to 3 valve sets	£3 19 6
(12 m/a output)	
Model K.18 for 1 to 5 valve sets	£4 12 6
(18 m/a output)	
Model K.25 for multi-valve sets	£5 7 6
(25 m/a output)	

All obtainable on **EASY PAYMENT TERMS** from as little as 3/8 per month!

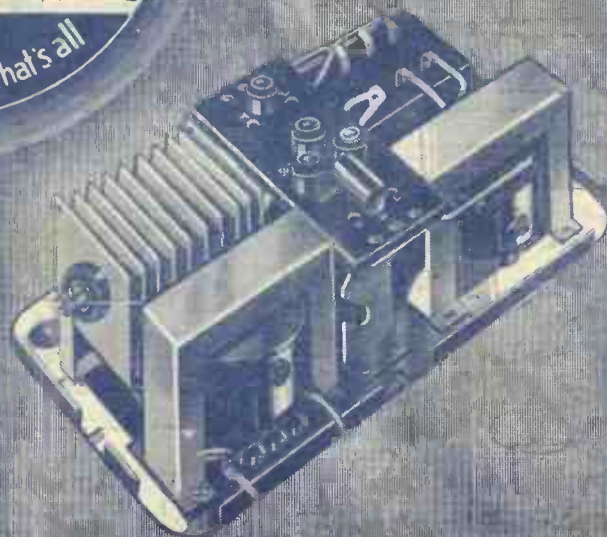

To E. K. Cole, Ltd., Dept. K.13, EKCO Works, Southend-on-Sea.

Please send me full descriptions of Ekco Power Units with which I can finish with batteries for ever and obtain permanently perfect radio at a cost of only a few pence a month.

Name

Address

(If you require details of Easy Payment Terms put a cross here.....)

CONTAINS FULL-SIZE PRINTS — WORLD'S BEST HOME-BUILT SET

BY W. JAMES.

Amateur Wireless

and Radiovision:

Every Thursday

3^d

Vol. XIX. No. 488

Saturday, October 17, 1931

BRITAIN'S "SUPER"

In This Issue also

"100 GOOD HINTS & TIPS"





Another **LEWCOS** Regd. "All-British" Triumph

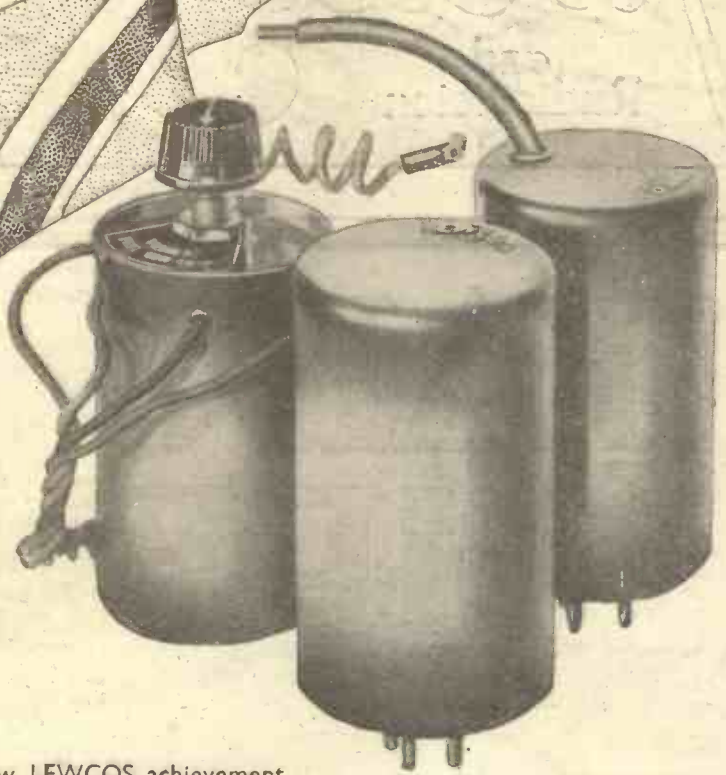

The
**Super-Het
Coil Kit**
(Ref. SHK No.3)

PRICE 37/6

Comprising:

- I OSCILLATOR COIL
Ref. O.S.C./126
- I INTERMEDIATE FREQUENCY
TRANSFORMER (*without pigtail*)
- I INTERMEDIATE FREQUENCY
TRANSFORMER (*with pigtail*)

This new LEWCOS achievement—the Super-Het Coil Kit—which has a nine Kilo-Cycle Wave-band separation and consists of one Oscillation Coil, one I.F. Coil with "Pigtail" and one I.F. Coil without, marks a new epoch in Radio reception.

The small space available is completely inadequate to give even a short description of these wonderful new LEWCOS Coils, but you are invited to write for an illustrated explanatory leaflet, Reference R.71.

HAVE YOU TRIED
THE NEW LEWCOS
H.F. CHOKE, PRICE
2/6?
SIZE 2½" LONG BY
1½" WIDE BY ½"
HIGH.

The Lewcos Super-Het Coil Kit is specified for the "Britain's Super" Receiver described in this issue.

*Buy British and
Keep British
Labour Employed.*



LEWCOS RADIO PRODUCTS FOR BETTER RECEPTION

THE LONDON ELECTRIC WIRE COMPANY AND SMITHS LIMITED, CHURCH ROAD, LEYTON, LONDON, E.10

Please mention "Amateur Wireless" when Corresponding with Advertisers

*The
Selectivity
Problem*
**SOLVED BY
LEWCOS**

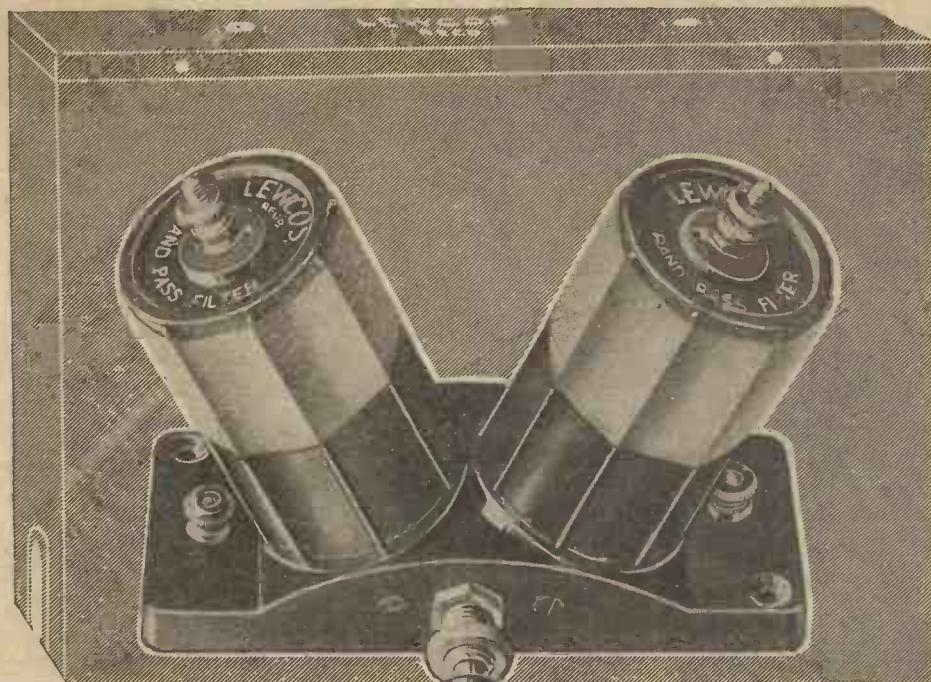

The
LEWCOS
REGD.
BAND PASS FILTER
Price 12/- (Screen 2/6 extra)

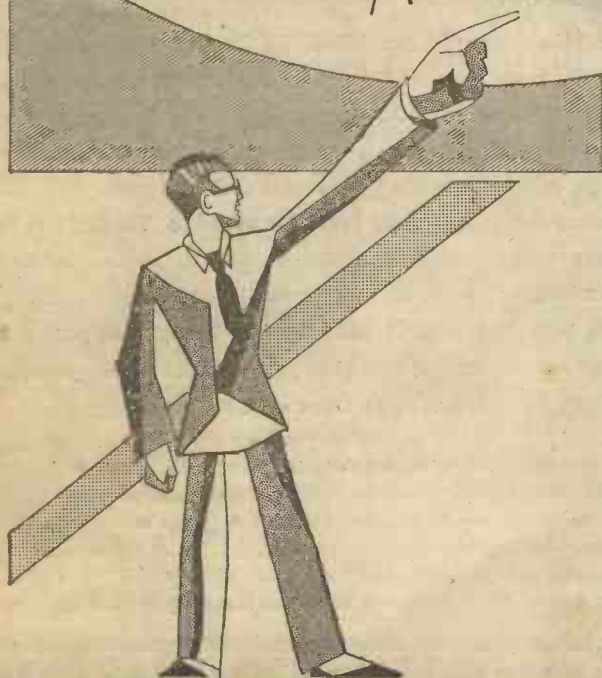

Here at last is a component over which you will naturally enthuse because it ensures selectivity such as you've heard of but never before experienced.

THE LEWCOS BAND PASS FILTER actually increases the range of any Receiver because stations which are normally inaudible, due to swamping by local transmissions, now have a place on the dial free from interference.

The phenomenal selectivity of this unique device is apparent on both long and medium wave bands; hence it is infinitely superior to any existing selectivity unit, such as wave traps, etc.

Write for fully descriptive leaflet, Reference R.73, showing flat-topped response curves.

THE LEWCOS BAND PASS FILTER IS EXCLUSIVELY SPECIFIED FOR THE "BRITAIN'S SUPER" described in this issue

LEWCOS RADIO PRODUCTS FOR BETTER RECEPTION

THE LONDON ELECTRIC WIRE COMPANY AND SMITHS LIMITED, CHURCH ROAD, LEYTON, LONDON, E.10

You will Help Yourself and Help Us by Mentioning "A.W." to Advertisers

THERE'S A LEADER
IN EVERY LINE



And the leader in the PERTRIX line of Accumulators is undoubtedly the 'PLb' types • No separators . . . sturdy, well-built plates . . . grease cups in the terminals to prevent acid creeping . . . charge indicator . . . these, and many other outstanding features make this type of PERTRIX Accumulator absolutely ideal for radio • They can be had from your dealer in three capacities, 25 a.h. for 8/6, 50 a.h. for 12/3, 75 a.h. for 16/6 • Get one to-day—you will find that it will cost you less per ampere hour than any other and will give you years of sterling service.

Made by BRITANNIA BATTERIES, Limited
at Redditch who also make:

Batteries for Central Stations • Batteries for Country House Lighting • Emergency and Stand-by Lighting Batteries for Theatres, Cinemas, Hospitals, etc. • Batteries for the Starting and Lighting, and Lighting and Ignition of Motor Cars, Motor Cycles, Buses and Coaches • Batteries for Electric Vehicles, Trucks, Locomotives, Ships and Yachts • PERTRIX Super Life Dry Batteries for Radio • The only Nickel-Iron, Alkaline Battery on sale in Britain that is entirely made in this country.

PERTRIX

SUPER LIFE
ACCUMULATORS

YOU HEAR BETTER WITH PERTRIX

Advert. of PERTRIX LTD., Britannia House, 233 Shaftesbury Avenue, London, W.C.2. Phone: Temple Bar 7971(5 lines) Works: Redditch, A.S.

To Ensure Speedy Delivery, Mention "A.W." to Advertisers

EVERYTHING **The G.E.C.** ELECTRICAL
your guarantee

**OWNERS of the
OSRAM MUSIC MAGNET 4
AND THIS YEAR'S OSRAM FOUR (New Music Magnet)
can now convert their sets to
ALL-ELECTRIC (A.C.)
with the new**

**GECOPHONE
A.C. ALL POWER UNIT
and Conversion Parts**

**TENS OF THOUSANDS OF USERS CAN NOW
ECONOMISE AND ENJOY
ALL-ELECTRIC RECEPTION**

MADE IN
ENGLAND.

Sold by all Wireless Dealers

Conversion of the OSRAM MUSIC MAGNET 4 or this year's OSRAM FOUR (New Music Magnet) to A.C. operation is extremely simple—merely a few readjustments, a set of OSRAM A.C. Mains Valves and the GECOPHONE A.C. ALL POWER UNIT—then, consistent results, long range reception and ample power are always available.

WRITE for the ALL-ELECTRIC Constructor's Instruction Chart (which gives full particulars of the method of converting your OSRAM Music Magnet to A.C. operation). **SENT POST FREE ON REQUEST.**



GECOPHONE A.C. ALL POWER UNIT	£	s.	d.
Complete with Conversion Parts.			
PRICE	6	1	6
Set of OSRAM A.C. MAINS VALVES			
comprising 2 MS.4 OSRAM Valves			
1 MH.4 OSRAM Valve			
1 ML.4 OSRAM Valve			
PRICE	3	17	6
Hire Purchase Terms : Deposit			
£1 5 0, 12 monthly payments 16/-	9	19	0

SUPREMACY IN RADIO — G.E.C. Radio

Advt. of The General Electric Co. Ltd., Magnet House, Kingsway, London, W.C.2.

Advertisers Appreciate Mention of "A.W." with Your Order

THE NEW TUNGSRAM HIGH POWER OUTPUT VALVES

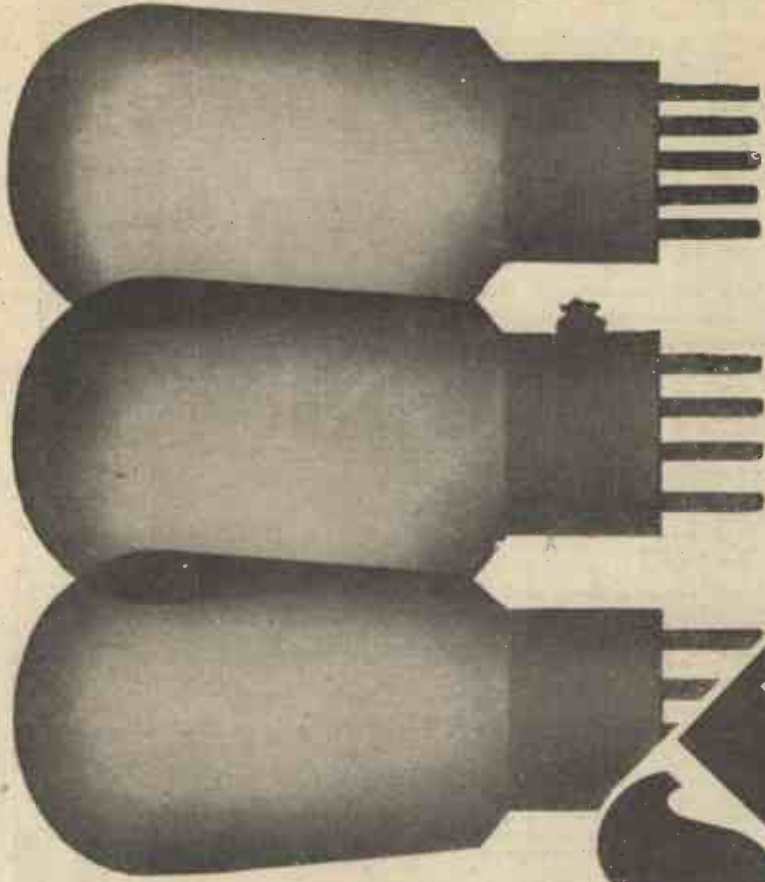

TUNGSRAM

The four new Tunggram High Power Output Valves, P414, P430, P400, and P4100, are particularly useful to constructors of gramophone amplifiers where immense volume is required.

Using these four types, an undistorted output of the amplifier ranging from 500 to 4,500 milliwatts can be obtained. The filaments can be operated from a 4-volt accumulator, or from the secondary winding of a suitable transformer.

P414, P430, and P400 are suitable for operation at an anode voltage of 200, 250, and 220 volts respectively. The anode current consumption is 18, 25, and 50 mA respectively at grid bias voltages of 20, 25, and 35 volts. P4100 can be operated at an anode voltage of 400 volts, the grid bias at this voltage being 35 volts and it consumes 30 mA. It has an undistorted output of 4,500 milliwatts. By connecting two or more valves in push-pull or parallel, even greater output can be obtained. Write for further particulars to Dept. S.T.I.

Prices: P414, 8/-; P430, 11/-; P400, 16/-; P4100, 17/-. Other types from 5/6 to 19/.

Tunggram-Barium Valves are manufactured under one or more of the following British patents: 289,762, 289,763, 311,705, and 313,151.

TUNGSRAM ELECTRIC LAMP WORKS (Gt. Britain) Ltd.
Radio Department, Commerce House, 72 Oxford Street, London, W.1.
Makers of the famous Tunggram Electric Lamps

Birmingham, Bristol, Cardiff, Glasgow, Leeds, Manchester, Newcastle, Nottingham, Southampton.
Lamp, Valve, and Glass Factories in Austria, Czechoslovakia, Hungary, Italy, and Poland.

I.F.S. Organisation, Tunggram Lamps & Radio, Ltd., 11 Burgh Quay, Dublin.

Tunggram Photo Electric Cells: Nava "E" (for scientific measurement), £2 17s. 6d.; Nava "R" red sensitive cell (for colour matching devices), £3 8s. 0d.; Nava "EH" (for talkie work), £3 13s. 0d.



Please Mention "A.W." When Corresponding with Advertisers

Recommended for the A.W. "BRITAIN'S SUPER"



Recommended for use with the A.W. "Britain's Super" and other circuits employing high ratio amplification, the 7 to 1 model now intro-

duced by **RI** gives exceptionally high amplification with amazing uniformity over all wanted frequencies, whilst all interference frequencies are eliminated, thus ensuring utmost perfection in reception.

The technical information supplied as with all **RI** transformers is the guarantee, before you buy, that the 7 to 1 will do its job—there's no speculation about R.I. productions.

THERE'S AN R.I. TRANSFORMER FOR EVERY CIRCUIT AT LOWEST PRICE FOR GUARANTEED PERFORMANCE

THE "PARAFEED" L.F. TRANSFORMER gives the acknowledged best performance in all circuits employing the parallel feed system of amplification and operates with a condenser and a resistance, ensuring brilliancy of reception.

Ask your dealer or us for the "Parafeed" book containing full working diagrams and astonishing straight N.P.L. curves
25 TO 8,000 CYCLES

"DUX" the Transformer for the Million, a low-priced component with an inductance of 30 henries, described by the Technical Press as giving a performance equal to many transformers four times the price.

Ask your dealer or us for the full technical data which proves, before you buy, that "DUX" will give complete satisfaction.

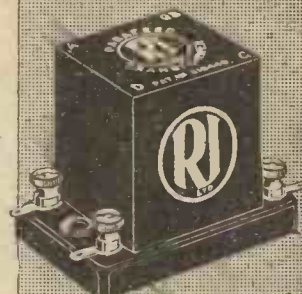

The PARAFEED

Primary Inductance
100 HENRIES
Turns Ratio 1:3. Ratio of 1:4 obtainable by 'auto-connection.'
Weight 3½ oz.
Dimensions: 2½ x 1½ x 1½ ins. **8/6**



The DUX

Primary Inductance
30 HENRIES
Ratio 1 to 3½ (Standard) or 1 to 4½ (auto-connection).
Weight 1½ oz.
Dimensions: 2 x 3¼ x 2½ ins. **6/9**



7-1

L.F. INTERVALVE TRANSFORMER

Highest Efficiency at Lowest Price!

10/6

"BRITAIN'S SUPER"

WITH WEARITE COMPONENTS MAKES A SUPER RECEIVER

VALVE HOLDERS

Fitted with sprung sockets.



1 4-pin,
6 5-pin.
8/9
per set.

PAXOLIN PANEL 14" x 7"
In black, walnut or mahogany finish. Drilled to specification. 6/-

Insulated Sleaving up to 2 m/m
internal dia., will take 16 gauge base wire.
Per dozen yards, 2/-

SUPER-HET COILS

BRITISH MANUFACTURE

Made in London
under British
Patent No. 349403

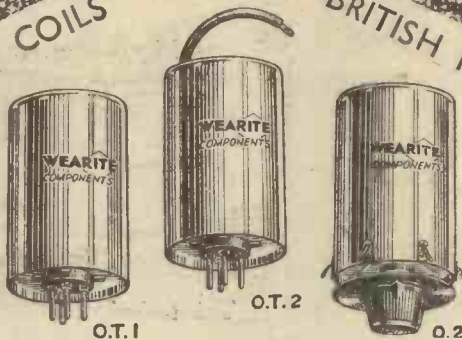

PRICE, PER SET
OF THREE COILS,
37/6

SPECIFIED BY Mr. W. JAMES

FOR
"BRITAIN'S SUPER"



SUPER-FRAME AERIAL

Dual range, centre tapped, in oak or mahogany.
Price 42/-

NOTE

Special coil 8 valve chassis complete with grid leak clips and all essential wiring for Britain's Super. Price 8/-



SUPER-HET H.F. CHOKES

For all "Amateur Wireless" and "Wireless Magazine" Super-Het circuits, range from 15-2,500 metres. D.C. Resistance 310 ohms. Inductance 400,000 M.H. List No. H.F.S. Price 6/6



**GRID LEAK
HOLDER**
Price 6d.



Your Earth must be perfect for "Britain's Super." The Wearite earth tube deserves your attention.
Price 3/6

WEARITE COMPONENTS

Write for free lists **WRIGHT & WEAIRE, LTD., 740 High Rd., Tottenham, N.17.** TOTTENHAM

Phone: 3847-8-9

To Ensure Speedy Delivery, Mention "A.W." to Advertisers

EVERYTHING **The G.E.C.** ELECTRICAL
your guarantee

**NEW
 WEMBLEY
 FILAMENT**

**LONGEST 2-VOLT
 VALVE FILAMENT
 IN THE WORLD**

**STRIKING
 2-volt VALVE
 IMPROVEMENT**

**10% MORE
 FOR YOUR
 MONEY**

After extensive research and experiment, a new 2-volt filament has been evolved giving:

10% GREATER ELECTRON EMISSION
 THAN ANY OTHER 2-VOLT FILAMENT OBTAINABLE

This is the latest discovery of the G.E.C. Research Laboratories at Wembley. The "Wembley" filament means, that without loss of amplification, valves of amazing efficiency can be made with adequate electrode clearances, which result in:

- 1 Greater consistency between valve and valve.
- 2 Avoidance of internal contacts and valve troubles.
- 3 Production of non-microphonic valves even under most exacting conditions of use.

THE NEW "WEMBLEY" FILAMENT MEANS MORE RELIABLE WIRELESS, PURER TONE AND MORE FOREIGN STATIONS.

Osrām
 2 VOLT BATTERY
Valves

SOLD BY ALL
 WIRELESS
 DEALERS.

**BRITISH PRODUCTS DESIGNED
 FOR BRITISH RADIO CONDITIONS**

Write for the Osrām Wireless Guide (1931 Edition) and also Station Indicator Card, Sent POST FREE on request.

SUPREMACY IN RADIO - G.E.C. Radio

Advt. of The General Electric Co. Ltd., Magnet House, Kingsway, London, W.C.2

Don't Forget to Say That You Saw it in "A.W."

WIRELESS BATTERY CELEBRATES A "BIRTHDAY"

London Owner Amazed

Are you interested in longer life for your wireless batteries? If so, read this letter from Mr. Harris, of London.

Dear Sirs,

On the occasion of the first birthday of my 105 volt EVER READY POWER Battery put into use on the 21st March, 1930, I should like to congratulate you on its remarkable performance.

It has had an average use of 5½ hours per day on a 3-valve set—the majority of the time on the highest voltages for Continental reception.

My friends are all amazed at the clarity of reception and the length of service compared with other makes. I feel I owe you something more than the 24/- I originally paid over a year ago—and so this letter of congratulation and thanks:

Yours faithfully

F. W. HARRIS, London.

(This letter may be inspected at the offices of the Company.)

Twelve months—40 hours a week—and still in use! Magnificent proof of the message that the EVER READY Company has been proclaiming for years past! The most economical wireless set is the adequately powered set. And the most economical way to power your set adequately is to power it with EVER READY batteries—made by an exclusive process to suit every wireless set, including portables. Write for the free Ever Ready chart and get the battery that is made for your set—guaranteed to give satisfaction by the Company that has been making reliable batteries for over twenty-nine years.

**THE BATTERY
THAT LASTS
A LONG TIME**

THE EVER READY CO.
(GT. BRITAIN) LTD.,
HERCULES PLACE,
HOLLOWAY, LONDON, N.7



Mention of "Amateur Wireless" to Advertisers will Ensure Prompt Attention

**GREAT
WIRELESS
JOURNALS
USE THEM IN THEIR
EXHIBITION
SETS**



"SQUARE PEAK" COILS

[REGD TRADE MARK]

AMATEUR WIRELESS

Sept. '19. Olympian Three.

MODERN WIRELESS

Oct. 1931. Super Quad.

WIRELESS CONSTRUCTOR

Oct. 1931. Exhibition Four.

WIRELESS MAGAZINE

Oct. 1931. Super Senior.

Make your set selective with the Varley "Square Peak" Coil ...

"Gives amazing selectivity . . . is fine for distance-getting . . . no interference from local stations."—*Amateur Wireless*.

"There cannot be many existing sets into which it could not be fitted."—*Modern Wireless*.

"With the Varley Coil there is substantially a square-peak resonant curve nine kilocycles in width."—*Wireless Constructor*.

"Cuts off interfering stations in a surprising manner."—*Wireless Magazine*.

NEW EXTENSER MODELS NOW READY, fitted with terminals in place of wave-change switch. Same prices as above—15/- and 8/6. Booklet on application.

Varley

Advt. of Oliver Pell Control, Ltd., Kingsway House 103, Kingsway, London, W.C.2. Telephone: Holborn 5303.

Don't Forget to Say That You Saw it in "A.W."

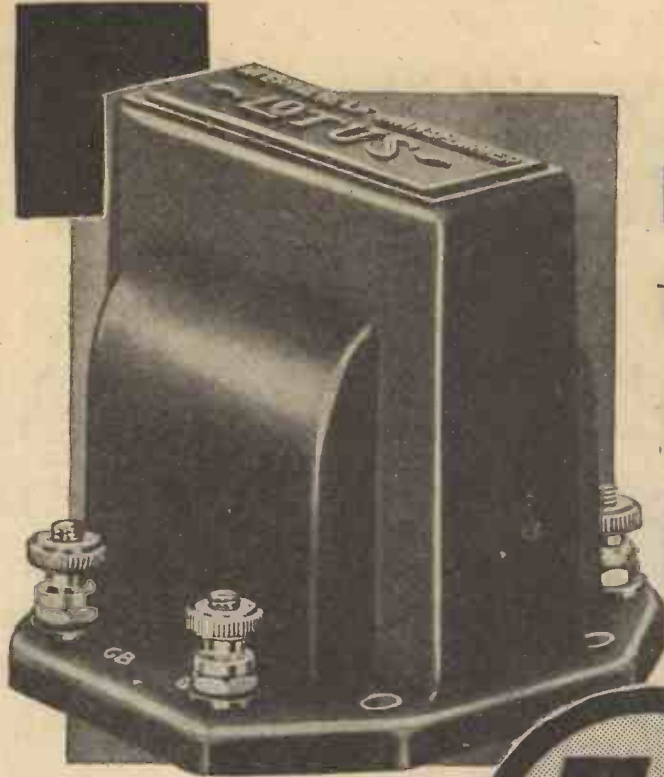

not a cheap
transformer
but a sound
instrument

at a very **5/6** low price



THE LOTUS RIGID DRIVE LOG CONDENSER

An inexpensive, small, but highly efficient condenser with heavy gauge aluminium vanes. The endplates are high-grade bakelite mouldings, and the special method of assembly ensures accurate spacing. One-hole fixing is employed and the highly finished Knob-Dial, engraved 0-100, is supplied in either Black or Mottled Brown Finish.

Capacities { .0003, Type KC/3 } 3/6 each.
 { .0005, Type KC/5 }

**RECOMMENDED FOR THE
"BRITAIN'S SUPER"**
described in this Number

One LOTUS 2 Gang Condenser.
One LOTUS Variable Condenser.
Seven LOTUS Valve Holders.
One LOTUS Audio Transformer.

LOTUS RADIO LTD., MILL LANE, LIVERPOOL

All the leading set designers specify Lotus. They know that for reliability and efficiency they are absolutely dependable. Follow the experts' lead; insist on Lotus Components.

This new LOTUS Audio Transformer No. 1, is a particular triumph of value and its performance is equal to many at twice the price. It is designed specially for the use of the home-constructor. While small in size, specially designed windings and core give high efficiency, good reproduction and an exceptional straight-line amplification curve.

It is enclosed in a neat brown bakelite moulding, and the core is earthed through one of the fixing eyelets.

Ratios 3-1 and 5-1. Type AT/1. Price 5/6.

Every home-constructor should have the new LOTUS Component Catalogue. Ask your dealer or write for your copy to-day.

LOTUS
RADIO COMPONENTS

Please Mention "A.W." When Corresponding with Advertisers

REASONS WHY YOU SHOULD USE MAZDA INDIRECTLY HEATED RECTIFIERS



MAZDA INDIRECTLY HEATED RECTIFIERS

TYPE	PRICE
Full wave	
UU.30/250 - - -	12/6
UU.2 - - -	15/-
UU.60/250 - - -	15/-

THE AMAZING

MAZDA THE BRITISH VALVES

THE EDISON SWAN ELECTRIC CO. LTD.
RADIO DIVISION:
155 CHARING CROSS ROAD, LONDON, W.C.2



If you are using rectifying valves in your A.C. mains receiver there is a definite advantage to be gained by using **Mazda indirectly heated Rectifying Valves**. You are safeguarding the condensers, chokes and valves of your receiver. When you switch on an ordinary rectifying valve, operating temperature is reached considerably before that of the receiving valves. A surge is caused and damage is frequently done.

Mazda indirectly heated Rectifiers heat up with the receiving valves, and so afford you absolute protection.

EDISWAN RADIO

V136

TELSEN VARIABLE CONDENSERS

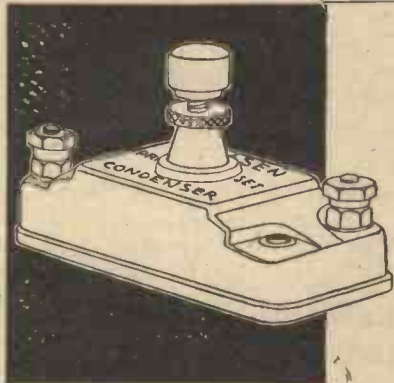
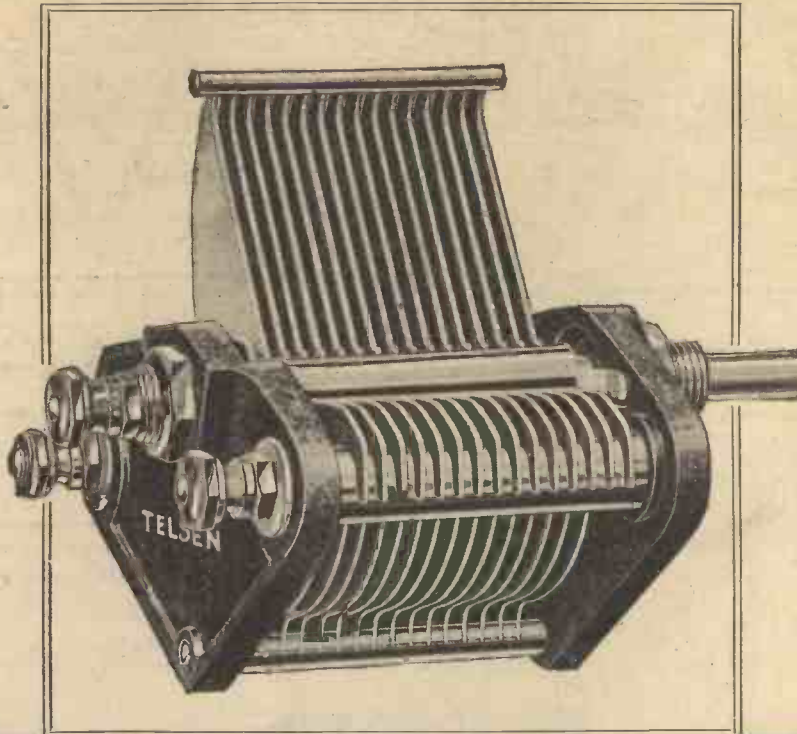

TELSEN LOGARITHMIC VARIABLE CONDENSERS

The Telsens Logarithmic Variable Condenser is of robust construction and high insulation. The H.F. losses are very low and the frame is braced at three points, so that the possibility of distortion and short circuiting is negligible. Substantial terminals are provided with alternative connection to the stator.

Telsens Logarithmic Variable Condenser—
Capacities of .0005, .00035, .00025 ... Price 4/6

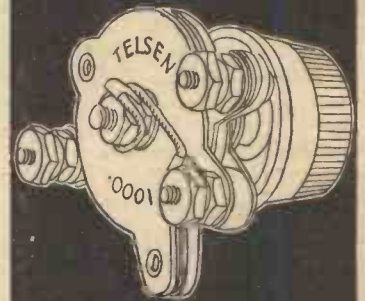

TELSEN BAKELITE DIELECTRIC CONDENSERS

These Condensers are of a new and improved type and of compact dimensions. The moving vanes are keyed on to the spindles so that they cannot be pushed out of line, and there is a definite stop at each end of the travel. The connection to rotor is made by means of a phosphor-bronze pigtail so that there is no crackling due to rubbing contacts. The connection to the stator vanes is absolutely positive—a very important point. All Telsens Bakelite Condensers are supplied complete with knob.

Differential Condenser—capacities of .0003, .00015, .0001 ... Price 2/-
Reaction Condenser—capacities of .0003, .00015, .0001 ... Price 2/-
Capacities of .00075, .0005 ... Price 2/6
Tuning Condenser—capacities of .0005, .0003 ... Price 2/-

TELSEN PRE-SET CONDENSERS

These Condensers have been carefully designed to give proper separation of vanes when the adjustment is unscrewed, which results in a very low minimum capacity, giving a wide range of selectivity adjustment when used in the aerial circuit.

Telsens Pre-set Condenser—
Made in capacities of :

Maximum capacity	Minimum capacity	Price
.002	.00025	Price 1/6
.001	.00004	Price 1/6
.0003	.000005	Price 1/6
.0001	.000001	Price 1/6

TELSEN

THE SECRET OF PERFECT RADIO RECEPTION

Send for the "Telsens Radio Catalogue" and book of "All-Telsens Circuits" to—The Telsens Electric Co., Ltd., Aston, Birmingham.

Don't Forget to Say That You Saw it in "A.W."



**BRITAIN'S LEADING RADIO WEEKLY
FOR CONSTRUCTOR, LISTENER & EXPERIMENTER**

EDITOR:
BERNARD E. JONES

TECHNICAL EDITOR:
J. H. REYNER, B.Sc., A.M.I.E.E.

RESEARCH CONSULTANT:
W. JAMES.

ASSISTANT EDITOR:
H. CORBISHLEY.

NEWS & GOSSIP OF THE WEEK

"BRITAIN'S SUPER"

THIS amazing new super-het introduced in last week's issue is described this week and we are giving absolutely full-size black and white prints of the panel and layout, which you will find on subsequent pages. Just detach these and put them on your panel and baseboard to show the component mounting and wiring. We are convinced that "Britain's Super" is an ideal set and these free full-size prints make it possible for any amateur to do the constructional work.

THE DESIGNER PLEASED!

MR. W. JAMES, who designed the "Super," is immensely pleased with the tests which his new "baby" has passed with flying colours. "Britain's Super" is even better than the 100-station "Century Super"; what is more, it has one valve less and works without a frame aerial. Read the description on pages 750-752.

A BUMPER NUMBER

THIS is a bumper number of "A.W.," apart from the "Super" plans and description. There is a special illustrated feature, "100 Hints and Tips," the start of a new series on B.B.C. matters and many other articles and features for amateurs. Altogether, a really good threepenceworth!

MANCHESTER KEENNESS

THE Northern National Exhibition now on in the City Hall, Deansgate, Manchester, closes this Saturday. "A.W." representatives on our Stand 18 report that there is exceptional keenness this year and that every hour the Exhibition has been open there have been crowds of enthusiasts coming for advice in connection with the exhibits and to see the special displays of popular "A.W." sets, including the new "Britain's Super."

IN THE DARK

THE change-over from British summer time to G.M.T. means better reception—unless station jamming gets too fierce. With the extra hours of darkness stations come in much louder and are apt to spread a trifle more on the dials because of the greater signal energy. A really selective set is needed these days to cut out one from t'other!

ENGLISH OPERA

IF you like opera, you will be sorry. If not...! Anyway, the English season of opera broadcasts from Covent Garden is drawing to a close. The last to be heard are Act I of *Madame Butterfly*, on October 20, for Regional listeners, and Act III of *Tosca*, on October 24, for National listeners.

DOUBLING THE POWER

HEILSBERG, which is at present working with 75 kilowatts, is contemplating putting up its power to well over the 100-kilowatt mark. Field strength measuring-kit is now touring the district to see if this power increase will be justified. It will, of course, mean more swamping for British listeners. Just to add to German jamming, too, comes news that plans are in hand for a new station at Hamburg.

AT 5SW

SHORT-WAVE listeners who have noticed a slight increase in the strength of 5SW must put this down to the new aerial which is now being used in place of the old Franklin type aerial. This is one of the new developments designed to increase 5SW's range for winter reception abroad.

AT THE CONTROLS

AN Italian correspondent tells us that at Barcelona there is a lady engineer in charge of the control room at the transmitter end. She was appointed not on the grounds of her technical qualifications, but because she is expected to keep a careful watch on the quality, depth of modulation, and so on.

RADIO MILAN TO B.B.C.

THE new play, *Stop Thief*, on the National on November 5 and Regional on November 7, has been adapted into English by Creswell from a translation of an Italian play, *The Ring of Teodosio*. It was the first Italian work written especially for broadcasting and has already been broadcast with considerable success from the Milan and Turin stations. It is described by Chiarelli himself as a "radio comedy in thirty phono-tableaux."

JACK PAYNE TELEVISED

STARTING from October 15, the extended television service will come into effect. The London National station, which would normally close down for the dance-music period, will send out these vision signals of Jack Payne and his band. For this broadcast the portable television apparatus, which has been used in No. 10 studio for the past few weeks, has been



The great licence round-up. Getting ready the direction-finding vans which track radio "pirates" who have oscillating sets.

WE MAKE A SPECIAL ANNOUNCEMENT—TURN TO PAGE 734

NEWS · & · GOSSIP · OF THE · WEEK —Continued

moved to Savoy Hill. The Baird people certainly cannot blame the B.B.C. now for holding up "perfected television."

REGIONAL COMPETITION

MANY listeners are contending that North Regional programmes are now superior to all other B.B.C. programmes. Letters are being received in Manchester from appreciative listeners as far away as Kent and Devonshire. The B.B.C. thinks that the competitive spirit between regional programme organisations is all to the good, but no doubt Savoy Hill will have to "pull its socks up" if North Regional continues to evoke such widespread praise!

PAUL ROBESON

OWING to financial difficulties, the proposed broadcast of "Emperor Jones," with Paul Robeson in the title role, will not take place. Instead, a repeat performance of "God's Trombones" and a new item, "Negro Genesis," will be the subject of Paul Robeson's broadcasts on October 23 and 24.

PRIME MINISTER AGAIN

IN broadcasting his election manifesto the other night, Mr. Ramsay Macdonald once again showed his faith in radio as a means of getting in touch with the public. The Prime Minister made his speech from the Royal Suite at Covent Garden.

RADIO'S GROWING IMPORTANCE

OTHER recent examples of the use of broadcasting in acquainting the public with affairs of national significance are

worth recording. In Germany the workers in the Ruhr coal basin first heard of a reduction of 7½ per cent. in their wages through the medium of broadcasting. In America broadcasting was utilised for the first announcement of Dr. Curtius's visit to the White House, Washington.

JEANETTE WAS PLEASED

THE film star Jeanette Macdonald was full of admiration for the wireless male chorus, who accompanied her in the "Grenadier" song during her recent broadcast. The performance was regarded as even better than in the original talkie version of *The Love Parade*.

SAVOY ORPHEANS AGAIN!

ALL dance enthusiasts will be pleased to hear that the re-constituted Savoy Orpheans dance band will once again broadcast regularly from the Savoy Hotel. The first of the new series will be heard on November 6. The bandstand on which the Orpheans play has been entirely re-built and the acoustics greatly improved specially for broadcasting.

AMERICAN VISITORS

ON October 14 an important group of American broadcasting representatives arrived in England. Among them was Mr. Hanson, the chief engineer of the National Broadcasting Company, the famous American organisation. Mr. Hanson was responsible for the design of the fine studios at the N.B.C.'s headquarters on Fifth Avenue, New York. The famous "Roxy" is among the party and he has tentatively arranged to do a B.B.C. programme on October 16.

BROADCASTING HOUSE

VISITS to the studios in Broadcasting House have been suspended, ostensibly to let the decorators get on with their work! Actually, the engineers are making acoustic tests to determine the frequency response of the studios. The control room is rapidly approaching completion and will be ready just as soon as the studios.

RELAY PROGRAMMES

SOME subscribers to the 288-metre B.B.C. relay group have recently suggested that the London Regional programme would be more entertaining than the present National programme sent over the relays. It appears that the policy of confining all the talks to the National stations between 6 and 8 p.m. is displeasing listeners who have no Regional programme alternative, such as those confined to the 288-metre relays and the Daventry 5XX.

B.B.C. DENIAL

THE B.B.C. denies that there is any intention of altering the present relay programme arrangements. Apparently it is still sore with Newcastle listeners for rejecting its offer of North Regional programmes through the Newcastle relay!

LISTENING GROUPS

THOSE who cavil at the amount of broadcasting time given to adult educational work may be surprised to know that there are no less than 2,000 listening groups throughout the country, compared with the total of 1,000 groups last year. Some country towns are so keen about the educational broadcasting facilities offered to them that they get out special posters indicating where group-listener meetings are held. Life to these villagers and small townsmen is no longer only real—it is very earnest!

CONDENSER "MIKES"

IN one or two studios at Savoy Hill we notice that the condenser microphones have been fitted with large baffle boards. The exact function of the baffle is not disclosed by the B.B.C. engineers carrying out the experiments. We seem to remember that this idea was tried in some of the N.B.C. studios two or three years ago.

ENGLAND VERSUS IRELAND

ON October 17 the football match between England and Ireland will be relayed from Windsor Park, Belfast. Mr G. F. Allison will be the commentator. This broadcast is done through the courtesy of the Irish Footballers' Association and will last from 2.50 to 4.40 p.m.

BUSY RESEARCH SECTION

MISS ALLEN, of the B.B.C.'s programme research section, has now returned from a three-weeks' visit to Russia. The material she has gathered will be used in a special Russian programme. Lance Sieveking, also of the research section, launches out into opera with his "Voyage to Lilliput," on October 15.

A BIRD'S-EYE VIEW



A special Aerofilm picture of Broadcasting House, taken by a 'plane flying low over the West End



100 GOOD HINTS and TIPS

DESCRIBED BY TEXT AND IN PICTURE ; CONSTRUCTION, MAINTENANCE AND OPERATION.

To Increase Selectivity

IF your aerial coil or H.F. transformer has a rotary primary winding or aperiodic coupling coil then try this in various positions. There will be



Do not put H.F. components, such as the aerial coil and condenser, too close to L.F. components

one position where selectivity is vastly improved, but the H.F. coupling and step-up will not be seriously impaired.

Short Wiring

Don't forget that a slight alteration of the parts on the baseboard may enable you to connect small components, such as coupling condensers, directly beneath the grid and anode circuits. In some cases it may even be possible to put the tags of the coupling condenser under the terminal heads of the valve holders in the coupled stages.

A Dial Hint

Make sure that when the vanes of the tuning condenser are at zero, the dial indicator is pointing to 0 and at the maximum end, similarly, that movement of the dial does not restrict the full range of movement of the condenser vanes. In some sets the tuning range is a little restricted because the dial is not properly fixed to the condenser shaft and restricts its 180 degree movement.

Grid Leak Wiring

Do take care when connecting leads directly to the end caps

of grid leaks and wire-wound resistances. The heat of the soldering iron may loosen the internal wiring and make intermittent contact. Leaks and resistances with terminal ends should be used in circuits where direct wiring is needed.

Transportable Set Building

Keep the tuning coil and H.F. components well away from the low-frequency side of the set and the speaker in your home-built transportable set, otherwise a whistle may be set up owing to H.F. interaction.

Good Insulation

Although it is possible to dispense with ebonite insulation in many parts of the set it is a good plan to have ebonite terminal strips or terminals insulated with ebonite bushes on the H.F. side. Even in a super-het it is a good plan to have the best possible insulation for the frame aerial connections.

Super-het Coils

Make sure that your plug-in H.F. coil and I.F. transformers

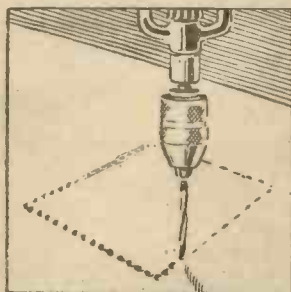

Square holes in ebonite can be cut by drilling adjacent small holes around the edge of the marked rectangle

effect a good contact with their valve holders. It may be necessary to open the pins at the base a trifle to prevent crackling noises.

Bandpass Switching

When two coils have to be ganged together, in a bandpass

set, for example, make sure that the switch rod allows both switch contacts to open properly on the long waves and also, when in the other direction, causes the switches of both coils to make good contact so that there is efficient medium-wave switching.

Broken-down Resistances

If your set crackles and you suspect a faulty flexible resistance, then temporarily short-circuit the ends. If the noise stops, then a new resistance should be fitted.

Pick-up Wiring

Jacks used for pick-up connections generally have four or five leaf connections and it is generally necessary to solder connections to these. Make sure that small blobs of solder do not drop down between the leaves and form a short circuit in the pick-up wiring.

Care with Connections

Take care when tightening up terminals on H.F. chokes. With some types the frail wire makes direct connection to the terminal



Terminals mounted on plywood panels may be insulated by allowing a clearance for the shank and having an ebonite washer on each side

shank and if the head is forced so that the shank rotates, the fine wire may be broken off.

Five-pin Holders

Most five-pin valve holders for A.C. mains valves are of a sturdy type, but as it is much

more difficult to get a good contact with five pins than with four, you must take the greatest care that all five pins make good contact, particularly the central pin.



Small components such as coupling condensers can sometimes be connected directly between valve holders

Five-pin or Four?

Some amateurs think that five-pin valve holders have different centres from the four-pin type. Of course this is not so, and five-pin holders can be used with battery valves. A four-pin valve holder can also be used in the power stage of a mains set if a 4-volt battery valve is used in the power stage.

Touching Condenser Vanes

If rotation of a 2- or 3-gang condenser causes crackling noises and shorting vanes in one section is expected, disconnect the three mains leads going to the three ganged sections. Replace each in turn and it will then be obvious which section has touching vanes.

Earthing Transformers

Many new low-frequency transformers have a fifth terminal for earthing the core. Be careful in using this, though, for an otherwise stable set is often made to show interaction if the core is connected to some part on the low-tension negative side.

When Connecting a Pick-up

If your set motor-boats when the pick-up plug is inserted and

(Continued overleaf)

"100 GOOD HINTS AND TIPS" (Continued from preceding page)

does not give any results at all, then it is a fair sign that there is a break in the pick-up lead, in the pick-up winding, or a fault in the jack connections.

Solid-dielectric Condensers

When choosing small solid-dielectric condensers, avoid types which have bearings showing end play. These will cause variation of capacity when the knob is lifted up and down, and not rotated.

Illuminated Dials

When fitting leads to the dial illuminating bulb behind a condenser scale take care to keep these away from the actual condenser wires which, of course, are at a high-frequency potential. Poor tuning is sometimes caused

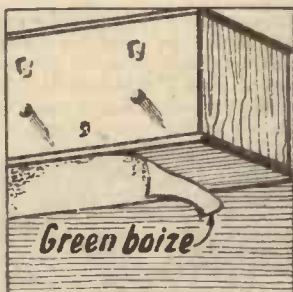

Thin green baize may be glued beneath the set to prevent the table being scratched if any screw points project



In the connection of mains apparatus the shielded sockets should be on the mains side and the projecting pins on the set or unit side

by loosely-fitted dial illuminating bulb wires.

H.F. Grid Bias

Many sets with an S.G. valve are fitted with a little .9 or 1.5-volt cell giving negative grid bias. Check this occasionally, because as the voltage drops, so the S.G. valve will become more wasteful of milliamperes.

Earthed Connections

Earth connections in a set are sometimes made to L.T. points such as the bases of valve screens and ganged condensers. Put spade tags or soldering tags on the ends of the wires which go to these points and screw them down tightly so that there is good contact.

Fitting Gang Condensers

Many new ganged condensers have adjustable feet with 6 or 8 holes for various heights. Make



Do not use too much heat when soldering connections to the ends of grid leads

sure that all the feet are adjusted equally, for otherwise there will be side strain on the supports of the two- or three-ganged sections.

Broad Tuning

Some sets tune broadly because there are shorted turns in the aerial or anode coils or because one of the wave-change switches does not open properly.

Super-hets and Tuning

If your super-het gives rise to harmonics, then check up the oscillator valve anode voltage, which may be too great.

Multiple Condensers

Some of the new multiple blocking condensers fitted with short flex leads instead of terminals are very convenient, but when connecting them up see that the flex connections are not pulled too hard. This may break one of the leads away from the condenser plates underneath the layer of insulation.

Adjusting Linen Speakers

Adjust the diaphragm of your linen speaker so that there is no side-strain. This causes the speaker unit to go out of adjustment.

A Universal Joint

It is a good plan to have one of the new cone chucks and universal joints on your linen speaker (or even on a cone speaker if the diaphragm is very large), as this prevents any side-thrust on the driving rod.

Pigtail Connections

See that the stranded pigtail connections used on the back of some reaction condensers do not break away from the centre fixing point, or that there is no looseness between the point and the spade tag at the end of the flexible pigtail connections.

Preventing Speaker Rattle

Valve rubber may be slipped over the driving rod of the speaker to prevent resonance. This is sometimes a cure for

"burr" experienced on loud notes.

Trimming Ganged Condensers

Never attempt to trim up the sections of a two- or three-gang condenser, while the covers are removed. The covers, in some types, greatly affect the capacity to earth of each section.

Fitting a Wavetrap Coil

If you have to use a wavetrap in order to keep your set selective, then fix the coil so that it is nowhere near the tuning side of the receiver. Mutual coupling would upset the wavetrap action.

Speaker Frames

It is well worth while using oak or some similar hardwood for the framework of a linen-diaphragm speaker. Stout 7-ply wood should be used for the main diaphragm and tensioner, too, as the strain is fairly considerable.

A Decoupling Unit

A 20,000-ohm resistance and a 2-mfd. condenser should be used in a decoupling unit intended for a transformer coupled stage. A higher resistance, 30,000 or 50,000 ohms, should be used with an R.C. stage.

R.C. Valves as Detectors

Last year many sets had R.C. valves as detectors, owing to the high magnification factor. Now it is bad practice to have an R.C. valve in this stage, as generally it cannot handle a broad grid swing.

Chokes for Decoupling

You need not have a resistance in a decoupling unit. An L.F. choke is often quite satisfactory, and now that they are so cheap there are many advantages. One is that a choke does not cut down the H.T. voltage so much as a resistance.

Illuminating Dials

Ordinary flash-lamp bulbs used as dial illuminators often burn out quickly, as they are



Keep the screen-grid anode lead as short as possible

rated at 3.5 volts. Special dial bulbs or car sidelamp bulbs rated at 4 or 6 volts should be used.

Choosing an L.T. Transformer

L.T. transformers for A.C. filament circuits are rated by the amperage output. Don't choose a type giving too great an output for your set, or the valves will be overloaded and the set will be unstable.

Doping Linen Speakers

Do not put too much dope on the diaphragm of your linen speaker for it may not tension properly. Excessive doping, too, sometimes results in a very deep tone.

Fitting a Station Log

Why not fit a station log? It is a good plan to have a small ivory panel on top of the cabinet on which stations and

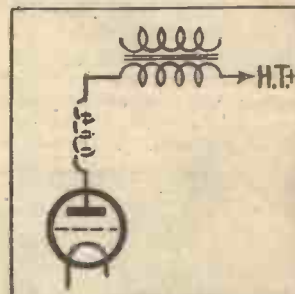

An H.F. choke may be connected in series with the primary of the first low-frequency transformer if the H.F. choking effect of the transformer is not sufficient

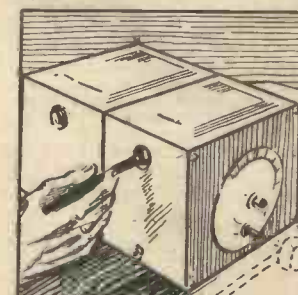

A short length of ebonite strip may be used to adjust trimmers and is better than a metal shaft screwdriver, the capacity of which may upset the adjustment

dial degrees may be recorded.

Radio-gram Turntables

If your radio-gram works from A.C., then it is an easy matter to fit a 6-volt power sidelamp bulb, working off a 4-volt filament supply so that one can see to put the needles properly in the pick-up grip. This also shows when the mains are switched on.

Fitting an Output Transformer

Many new moving-coil speakers are fitted with an output transformer, as an integral part of the chassis. When one of these is used at a distance from the set it is advisable to move the transformer from the speaker, and wire it up near the set itself,

“ 100 GOOD HINTS AND TIPS ” (Continued)

putting the extended leads on the secondary side.

Scraping the Screens

When making connections to metal screening or metal foil in a set, always scrape away any lacquer or oxide from the part to which the connection is made or a high resistance joint may result, leading to poor results from the set. For the same reason it is always advisable to clean the undersides of terminal heads and nuts before screwing wires down under them.

Sharp Tools

The business end of the screwdriver used for wood-screws should always be kept square and sharp at the corners, otherwise there will be a tendency for the screwdriver to jump out of the slot in the screws, resulting in damaged screw heads with their unworkmanlike appearance. Keep the points of drills clean and sharp—a few seconds work with a small oilstone or

face will not be spoiled by scratches.

Flat Boards

See that the baseboard is



Keep H.T., L.T., and G.B. battery leads in separate groups

reasonably flat before beginning the construction of a set. A warped plywood baseboard is

discs into the holes with a small mallet or hammer under which a piece of wood is held to prevent marking the surface of the panel.



Good insulation is essential for the terminals connecting up with a frame aerial as poor insulation will cause loss of signal strength and may broaden tuning

Bad Contacts

Switches are often the cause of trouble in a set due to bad contacts being made, owing to the oxidation, dirtiness, or looseness of the contacts. Due attention should therefore be paid periodically to all switch contacts in a set, including the switches inside

earthed metal conductors, such as water and gas pipes and electric light wiring conduits. Generally there will be found one place at which better results will be obtained than in any other part of the room.

Risky Work !

It is very risky to do any work with metal tools on a set which is switched on, as a slip, or metal part dropped into the interior of the receiver, may cause a short circuit and damage expensive valves or components. In the case of a mains set the procedure is very dangerous.

Remote-control Speakers

Speakers which are worked at a distance from the set should be fed either through a choke output feed or through an output transformer, otherwise the high-tension current will have to pass through the long leads. These may have a high resistance and there will be a risk of short-circuiting the high tension current



The air gap between the speech coil and the pot magnet of a moving coil speaker should be watched as chattering will be set up if it is not enough

slip will save minutes or even hours of unnecessary labour.

Scribing Panels

A scribe should be used for marking the position of the holes in a panel for drilling—the use of a pencil may lead to high resistance leaks between com-



Take care that the adjustment of condenser dials does not restrict the 180 degree movement of the condenser vanes

ponents. A useful scribe can easily be made by forcing a gramophone needle, blunt-end first, into a piece of wood rod. When drilling the panel always lay a sheet of thick paper between the ebonite and the bench, so that the polished sur-

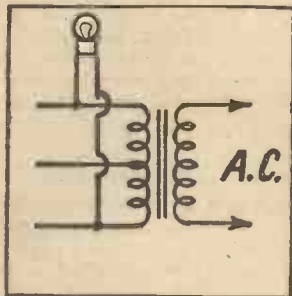

Connections for a car sidelamp bulb across the secondary of a four-volt filament transformer

extremely difficult to correct and gives a poor appearance to the completed receiver, besides making the set unsteady when tuning or operating panel switches.

Cutting Square Holes

The easiest way to make the rectangular shaped holes in a panel for escutcheon plates is to drill a small hole and complete the cutting with an ordinary fretsaw. If a fretsaw is not available a series of 1/8-in. or 3/16-in. holes must be drilled inside the edges of the piece to be removed, afterwards knocking the piece out and trimming up the rough edges with a file.

To prevent risk of breaking the panel the holes must be drilled practically touching each other and a 1/8-in. round file may be used for removing the material left standing between the holes.

Plugging Panel Holes

Unwanted holes in a panel may easily be made invisible by cutting discs of ebonite with a fretsaw from a piece of material the same colour and thickness as the panel and lightly driving the

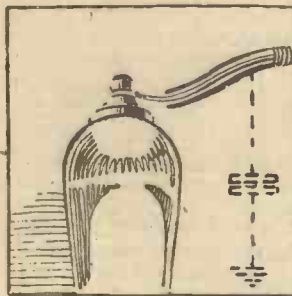

Do not have too great a length of screen grid anode lead covered with metal braiding for this sets up stray capacity as shown by the dotted condenser

or underneath coils and panel switches for low-tension or pick-up switching.

The contacts may be cleaned with a magneto file.

“ Dangerous ” Wiring

Flexible rubber covered wires passing through holes in a metal screen are a potential source of danger. The holes should either be bushed with ebonite tube or a piece of thick rubber tubing may be slipped over the flexible wire and pushed into an enlarged hole in the screen.

Short Earths

It is advisable to make the earth lead to a set as short an of as low resistance as possible. The wire used should therefore be of thick stranded copper wire the same as is used for the aerial. The earth lead should be connected either to a cleaned main water pipe or to a 2-ft. square copper plate buried at least 3 ft. below the surface of the ground.

Working a Frame

To get the best results from a frame aerial set the aerial should be kept as far as possible from

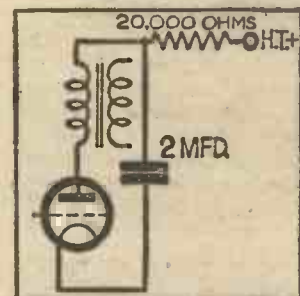

Good values for the resistance and condenser of an anti-motor-boating unit to stop low-frequency oscillation are shown by this sketch

if one of the leads happens to be broken or the insulation damaged and the wire touches anything connected to earth.

Tone Correction

A .01-microfarad condenser and a 10,000-ohm resistance in series across the speaker forms a



Adjustment of the rotary primary winding or aperiodic coil will sometimes improve selectivity

useful filter circuit for tone correction when it is too high. The resistance can be a spaghetti.

Three-point Switches

It is a much more difficult job (Continued on page 770)

600,000 MORE LICENCES?

This is a question raised by the B.B.C. in expressing the hope that the present intensive "drive" against licence dodgers will materially add to its revenue

EVERY listener knows that the B.B.C. has voluntarily sacrificed £50,000 of its share of the current year's revenue and that a further £150,000 cut is to be made on behalf of the Treasury next year. What is less understood, perhaps, is the means whereby the B.B.C. hopes to make good the deficit.

The truth is that the present Post Office drive, lately so sensationally described in the newspapers, was originally inspired by the B.B.C.'s cry for more revenue—long before the present cut was even contemplated. The detection vans we hear so much about have been in process of construction for many months past.

Half-a-million Pirates

The B.B.C. has been at pains to point out to the Post Office that the mundane job of collecting licences is nothing to do with Savoy Hill, where, of course, the great idea is to *spend* money! Then the Post Office, recovering from the shock of realising that in London alone there must be something like half a million licence dodgers, began to spend some of its 12½ per cent. licence takings on fitting out a fleet of detection vans.

The B.B.C. blandly expressing itself willing to continue to give microphone publicity to court convictions following the detection of "pirates," began to visualise a really fat increase in its revenue. Now that the Treasury cut has intervened the B.B.C. is naturally taking a keen interest in the latest campaign.

Experienced wireless amateurs must have been bewildered, and not a little incredulous, at some of the newspaper accounts of the detecting powers of the new Post Office vans. More particularly, those who know something of the difficulties involved will

have been amused at the suggestion that wireless sets could be detected *even when they were not working.*

So far as can be ascertained, the Post Office engineers are making use of more or less standard direction-finding gear of a sensitive nature. This will, of course, enable them quite easily to track down an oscillating set, but there are no technical grounds for believing that a non-oscillating set, much less a switched-off set, can in any way be detected by means of the direction-finding apparatus.

It would be out of place here to discuss the ethics of the Post Office in countenancing statements attributing these miraculous powers to their detection vans. Probably the general attitude of the licence-paying listening fraternity will be approval of the Post Office action, although many will make a mental reservation that it is somewhat unbecoming for a Government Department to permit itself such "poetic licence" in describing the use of the vans.

At the moment the outstanding result of the Post Office campaign in the London area is a tremendous rush to buy licences. During the first three days of the campaign new licences were taken out at the rate of 10,000 a day. The B.B.C.'s hope of a 600,000 licence increase is, therefore, coming within the bounds of actual possibilities.

Increased Revenue

Such a licence increase would mean a total additional revenue of £300,000, of which the B.B.C.'s share would be £150,000. The B.B.C. wants the campaign to be extended outside the London area; such localities as St. Albans and Reigate would come within a radius of exploration likely to lead to still further licences.



There is a feeling that licence evasion is by no means confined to large towns. Some readers may recall the classic example of the village in Oxfordshire, where two years ago it was discovered that not a single inhabitant had taken out a licence, the plea being ignorance of the law—which excuses no man, not even a listener to Bach cantatas!

Monthly Licences!

There is no doubt that the main function of the Post Office detection vans is to scare people into taking out licences. However unbecoming this method may be, no one can question its effectiveness during the present campaign.

We are led to wonder whether the collection of licences as practised in this country might not be altered with advantage. Could we not follow the German plan, for example, of paying the postman a monthly "sub" for the annual licence fee? Or there is the Canadian plan of issuing licences through recognised radio set dealers. There the dealer has every incentive to sell a licence with the set, as he gets a commission on every licence!

ALAN HUNTER.

"LOCAL STATION" CONTROLS

ON the more selective receivers it is now becoming common practice to bring a special control into operation when receiving the local station so as to reduce the overall sensitivity of the set and prevent distortion due to overloading. The signal pick-up from a distant station may be less than a millivolt, whilst that from the local station may amount to several volts. This difference is too big to be overcome by means of an ordinary volume control. The "local station" control is used either to switch in a special damping-resistance in the aerial or intervalve coupling, or else to short-circuit a part of the H.F. input.

M. A. L.

The N.B.C. has filed with the Federal Radio Corporation an application for a new experimental television station to operate on the ultra-high frequencies and determine their practicability for visual broadcasting. The new application requests an "anchored station" of high power of about 5 kilowatts.

IDEAL FOR "LOCALS" AND DISTANCE

The new W. James' five-valve super-het which works on an outdoor aerial. Constructional details on pages 750-752

TELEVISION IN ROME

THE Italian Broadcasting authorities do not appear to be over-optimistic as regards television. In reply to a petition for the establishment of a special theatre for producing plays to be broadcast through the ether, the official view is taken that in the present state of development the suggestion is altogether premature. The reply goes on to state that although such a theatre could at present serve no useful purpose, a close watch is being kept on the trend of events, and television transmissions will be made as soon as the art is sufficiently developed to warrant the expense involved. M. B.

The Northern artiste of the week who will give a recital on October 19 is John Dunn.

TELSEN TRANSFORMERS & CHOKES

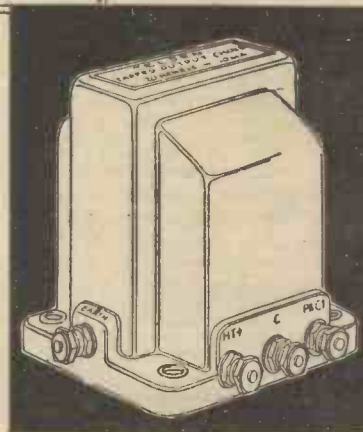
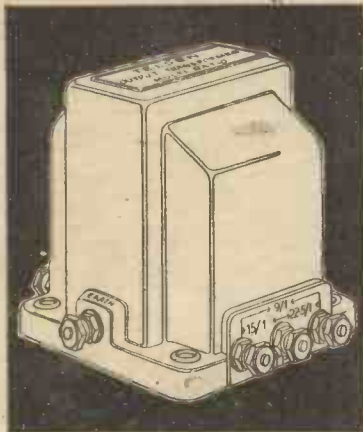
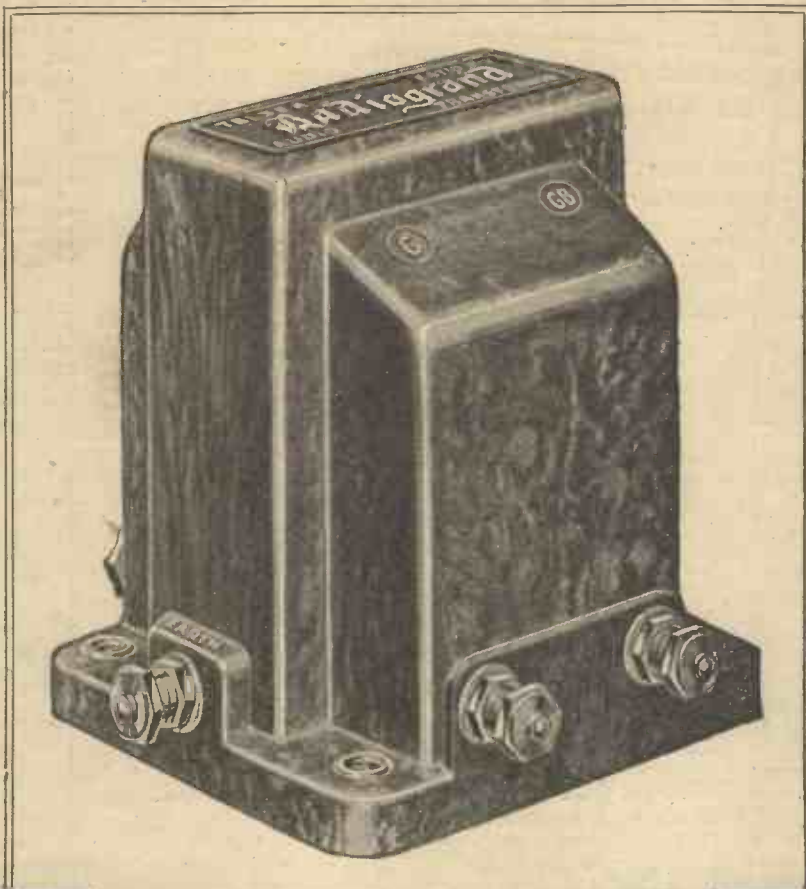

TELSEN L.F. & OUTPUT TRANSFORMERS

Telsen transformers have achieved fame in the radio world on account of the high standard of their quality and performance. Designed and built on the soundest engineering principles, these robust, full-size transformers will give not only efficient but enduring service.

TELSEN L.F. TRANSFORMERS

- Telsen "Ace" Transformer, Ratios 3-1, 5-1 Price 5/6
- Telsen "Radiogrand" Transformer, Ratios 3-1, 5-1 Price 8/6
- Telsen "Radiogrand" 7-1 Super Ratio Transformer Price 12/6
- Telsen Intervalve Transformer, Ratio 1.75-1 Price 12/6

TELSEN OUTPUT TRANSFORMERS

- Telsen Multi - Ratio Output Transformer, giving three Ratios of 9-1, 15-1, 22.5-1 Price 12/6
- Telsen Output Transformer, Ratio 1-1 Price 12/6
- Telsen Pentode Output Transformer ... Price 12/6

TELSEN L.F. CHOKES

- Telsen L.F. Intervalve Coupling Choke, 40, 100, and 125 henrys Price 5/-
- TELSEN OUTPUT CHOKES**
- Telsen Output Choke (Plain), 20 henrys Price 8/-
- Telsen Output Choke (Tapped), 20 henrys Price 8/6
- Telsen Heavy Duty Power Grid L.F. Choke, 40 henrys ... Price 8/-



ALL-BRITISH RADIO COMPONENTS

Send for the "Telsen Radio Catalogue" and book of "All-Telsen Circuits" to—The Telsen Electric Co., Ltd., Aston, Birmingham.

CVS-58

Please Mention "A.W." When Corresponding with Advertisers

IMMEDIATE DELIVERY

EVERYTHING NEW IN RADIO

**C.O.D.
CASH
H.P.
as usual**

We are the largest Radio House in the Country, and in sending your orders to us there is no risk of delay. Orders executed on our famous 3-WAY PLAN—C.O.D., CASH or H.P. Express Service for everything Radio Guaranteed. New 116-page catalogue 6d., post free.

MANUFACTURERS' KITS

- COSSOR MELODY MAKER, Type 234.** Screened grid, detector, and power. Complete with specified valves and cabinet. Cash Price £6 15 0. Balance in 11 monthly payments of 12/6. **Send 10/-**
- Finished Instrument. Royalties paid. £7 10 0. Cash only.
- OSRAM NEW MUSIC MAGNET.** Improved version of this famous 4-valve set. 2 screen grid, detector, and power. With valves and cabinet. Cash Price £10 15 0. Balance in 11 monthly payments of 19/8. **Send 19/8**
- Finished Instrument. Royalties paid. £11 15 0. Cash only.
- MULLARD 3 1932 RECEIVER.** Screen grid, detector, and pentode. With valves less cabinet. Cash Price £6 10 0. Balance in 11 monthly payments of 11/11. **Send 11/11**
- Finished Instrument, with valves and cabinet. Royalties paid. £7 17 6. Cash only.

EKCO H.T. UNIT, TYPE A.C.25. Send For multi-valve sets requiring up to 25 m.a. Three tappings—S.G., detector, and 120/150 volts. For A.C. mains. Cash or C.O.D. £3 17 6. Balance in 11 monthly payments of 7/1. **Send 7/1**

ATLAS A.C. ELIMINATOR, TYPE A.C. 244. Three tappings—S.G., detector, power. Output, 120 volts at 20 m.a. Cash Price or C.O.D., £2 19 6. Balance in 11 monthly payments of 5/6. **Send 5/6**

REGENTONE W.5 COMBINED H.T. ELIMINATOR AND TRICKLE CHARGER. One S.G., 1 variable and 1 fixed tapping for H.T. L.T. for 2, 4, and 6 volts. For A.C. mains. Cash Price £5 : 17 : 6. Balance in 11 monthly payments of 10/9. **Send 10/9**

AMPLION MC.6 MOVING-COIL SPEAKER. Permanent magnet. With output transformer. Complete. Cash Price £3 : 7 : 6. Balance in 11 monthly payments of 6/2. **Send 6/2**

CELESTION PERMANENT-MAGNET MOVING-COIL SPEAKER. Type RP18. 8in. reinforced diaphragm. Chassis form without input transformer. Cash Price £3 : 10 : 0. Balance in 11 monthly payments of 6/5. **Send 6/5**

BLUE SPOT PERMANENT MAGNET MOVING-COIL SPEAKER. Complete with input transformer. Cash Price, £3 15 0. Balance in 11 monthly payments of 6/11. **Send 6/11**

W. B. PERMANENT MAGNET MOVING-COIL SPEAKER P.M.3. Complete with 3-ratio input transformer. Cash Price, £2 12 6. Balance in 11 monthly payments of 4/10. **Send 4/10**

R. & A. PERMANENT MAGNET MOVING-COIL SPEAKER. Complete with multi-ratio input transformer. Cash Price, £2 17 6. Balance in 11 monthly payments of 5/4. **Send 5/4**

EPOCH A2 PERMANENT MAGNET MOVING-COIL SPEAKER. Fitted with multi-ratio input transformer. Cash Price, £3 3 0. Balance in 11 monthly payments of 5/9. **Send 5/9**

WEARITE OR LEWCOS SUPER-MET COILS. For Super 60, Century Super, Super Senior. Cash Price £2 10 0. Balance in 8 monthly payments of 6/2. **Send 6/2**

NEW B.T.H. "SENIOR" PICK-UP AND TONE-ARM. Complete. Cash price £2 5s. 0d. Balance in 11 monthly payments of 4/2. **Send 4/2**



VOXKIT RADIOGRAM CABINET MODEL 1932. Accommodation for largest of home-built receivers with a full-size speaker and mains or battery equipment. Complete with motor board. Dimensions overall: 39 in. high by 22 in. wide by 17 in. Internal Panel, 18 by 7 in., baseboard, 18 by 14 in., speaker chamber, 18 by 14 by 16 in. Panel, 12 in. in. between moulding. Oak. Cash Price £4-10-0. Or 12 monthly payments of 8/3. **£4-10-0**

PILOT PERMANENT MAGNET MOVING-COIL SPEAKER. Matches the requirements of all modern receivers. Includes Unit designed and built specially for Peto-Scott by Epoch. Handles the smallest to the greatest input and brings out most minute details of tonal quality with pure, full volume. A multi-ratio input transformer is fitted and provides for matching to all super-power and pentode valves. The handsome hand-polished solid oak cabinet is built to give added depth of tone, and is fitted with ebonised base and side wings and silk-covered fret. Cash Price £3-15-0. Or 12 monthly payments of 6/11. **£3-15-0**



VOXKIT 1932 CONSOLE (Radio only). Another attractive addition to the famous Voxkit range. Accommodates the largest home built receiver and bulkier speaker, mains or battery supply. Almost identical with the 1932 Voxkit Radiogram. Dimensions: 37 in. high by 22 in. wide by 15 in. Panel, 18 by 7 in. Baseboard, 18 by 12 in. Speaker compartment, 18 in. wide by 14 in. high by 12 in. deep. Front panel, 12 1/2 in. Oak. Cash Price £3-15-0. Or 12 monthly payments of 6/11. **£3-15-0**

KELSEY SHORT-WAVE ADAPTOR

Add more stations to your set. Plugs direct into your battery or eliminator operated receiver. Complete with instructions. Sent C.O.D. Postage free. Pay the postman.

37/6

Nothing more to buy—no valves or any extras.

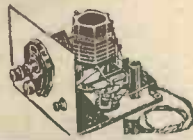

SPECIALLY RECOMMENDED

EPOCH J.1 PERMANENT MAGNET MOVING-COIL SPEAKER with multi-ratio input transformer. Cash Price, £2 5 0. Balance in 11 monthly payments of 4/2. **Send 4/2**

GARRARD INDUCTION GRAMOPHONE MOTOR. Model 202. Mounted on 12-in. Nickel Motor Plate with fully automatic electric starting and stopping switch. Cash Price, £2 18 6. Balance in 11 monthly payments of 5/4 only. **Send 5/4**

ROLA PERMANENT MAGNET SPEAKER. Complete with input transformer. Cash Price, £2 17 6. Balance in 8 monthly payments of 7/1. **Send 7/1**

ROLA A.C. MOVING-COIL SPEAKER. Complete with input transformer. Cash Price, £4 5 0. Balance in 11 monthly payments of 7/10. **Send 7/10**

COSSOR 4-VALVE ALL-ELECTRIC RECEIVER. Built-in Moving-coil Speaker. Two screened-grid valves, detector and power. Pick-up terminals. For A.C. Mains. Cash, £16 16 0. Balance in 11 monthly payments of 30/-. **Send 36/-**

BROWNIE DOMINIONS GRAND 3-VALVE. All-electric for A.C. mains with built-in Cone Speaker. Mains Aerial. Cash Price, £13 13 0. Balance in 11 monthly payments of 24/-. **Send 33/-**

SIX-SIXTY CHASSIKIT (Battery Model). Complete three-gang band-pass tuning. Screen grid, detector, and pentode. Cash Price, with valves, less cabinet, £6 17 6. Balance in 11 monthly payments of 12/7. **Send 12/7**

Finished Instrument, with cabinet (10/6). Royalties paid. Cash only £8 3 0.

SIX-SIXTY CHASSIKIT (A.C. Model). Complete as above, with A.C. mains valves. Cash Price, with valves, less cabinet, £7 6 6. Balance in 11 monthly payments of 13/5. **Send 13/5**

Finished Instrument, with cabinet (10/6). Royalties paid. £8 12 0. Cash only.

EXPRESS ORDER FORM

TO PETO-SCOTT CO. LTD.
Please send me C.O.D., CASH/H.P.

for which I enclose
Cash/H.P. Deposit £ s. d.

Name

Address

A.W. 17/10/31.



PETO-SCOTT CO. LTD. Head Office: 77 CITY ROAD, LONDON, E.C.1. Clerkenwell 9406. 62 HIGH HOLBORN, LONDON, W.C.1. Chancery 8266. MANCHESTER: 33 WHITELOW ROAD, CHORLTON-CUM-HARDY. Phone: Chorlton-Cum-Hardy 2028. NEWCASTLE, STAFFS: 7 ALBY ROAD. Phone: 67190.

Hear Britain's Super demonstrated at our Showrooms:
77, CITY ROAD,
LONDON, E.C.1.
62, HIGH HOLBORN,
LONDON, W.C.1.



This is the Set the Author Built

the Season's greatest hit

**EXPRESS
KIT
SERVICE**

Any reputable Dealer will gladly supply you with a **PILOT AUTHORS KIT** for Britain's Super. Do not trust a substitute Kit made up of substitutes.

BRITAIN'S SUPER

This is the Kit the Author Used

PILOT AUTHORS KIT

Check this Pilot Author's Kit of parts for "Britain's Super" with the Author's specification in this week's issue of "A.W." £ s d.

1 Ebonite Panel 14" x 7". Drilled to Author's specification	4 6
1 Baseboard 17" x 9"	1 6
J.B. Type R2 Two-gang .0005-mfd. Variable Condensers	1 1 0
J.B. Type R1 Single .0005-mfd. Variable Condenser	12 6
1 Varley 50,000-ohm Variable Resistance	6 6
3 Wearite Super-hot Coils (one Oscillator and two Intermediates, Types O2, OT2 and OT1)	1 17 6
1 Lewcos "BPF" Bandpass Filter Unit, with extension rod	12 0
4 T.C.C. 1-mfd. Fixed Condensers	11 4
1 T.C.C. 2-mfd. Fixed Condenser	3 10
2 Telsen .0002-mfd. and one .0003-mfd. Fixed Condensers	1 6
1 Telsen one-megohm Grid Leak	9 9
1 Ready Radio Grid-leak holder	4 4
1 Ready Radio Super-hot Choke	5 6
1 Telsen Low-frequency Transformer (7-1)	12 6
2 Lewcos Spaghetti Resistances, one 15,000-ohm and one 20,000-ohm.	3 0
1 Bulgin Fuse holder and Fuse	1 0
1 Junit Terminal Block	8 8
1 Bulgin Type 588 Double-pole Toggle Switch	2 9
4 Lengths of sleeving: connecting wire 20-gauge bare tinned copper, 6 yards of thin flex all screws and nuts	3 6
2 Belling-Lee terminals—Aerial and Earth	9 9
8 Belling-Lee marked Wander Plugs	1 4
2 Spade Terminals	4 4
AUTHOR'S KIT "A" Cash or C.O.D.	£7 4 9

Any of the above items supplied separately. If order over 10/- sent carriage paid. C.O.D. we pay post charges.

KIT A Author's Kit less Valves and Cabinet
CASH or C.O.D. **£7.4.9**

KIT B Author's Kit with Valves but less Cabinet
CASH or C.O.D. **£10.12.3**

KIT C Author's Kit complete with valves and cabinet
CASH or C.O.D. **£11.17.3**

SPECIAL C.O.D. ITEMS
Pay the Postman We pay all Post charges

1 Lewcos "B.P.F." Bandpass Filter Unit with Extension Rod	£ s. d. 12 0
J.B. Type R2 2 Gang Variable Condenser	1 1 0
J.B. Type R1 Single Variable Condenser	12 6
Cabinet as specified	1 5 0
Peto-Scott popular priced hand french polished Oak Cabinet with lift-up lid to size	19 6
5 Mullard Valves as specified: P.M.1DG, P.M.2DX, P.M.12, P.M.1HL, P.M.2A.	3 7 6

DOMINATING FEATURES OF PILOT AUTHOR'S KITS

Chosen and first specified by the Technical Department of Amateur Wireless, and used by Mr. W. James

Officially approved, therefore, by an established technical authority you can trust implicitly.

Backed by Peto-Scott himself, twelve years Radio Experience and a world-wide reputation.

Enables the Author's published Set to be duplicated exactly in every respect.

EXPRESS ORDER FORM
To PETO-SCOTT CO. LTD.
Please send me C.O.D., CASH/H.P.

for which I enclose
Cash/H.P. Deposit £ s. d.
NAME.....
ADDRESS.....

A.W. 17/10/31

C.O.D. CASH H.P. unusual

PETO-SCOTT

PETO-SCOTT CO., LTD. Head Office: 77 CITY ROAD, LONDON, E.C.1. Clerkenwell 9406.
62 HIGH HOLBORN, LONDON, W.C.1. Chancery 8266. MANCHESTER: 33 WHITELOW ROAD,
CHORLTON-CUM-HARDY. Phone: Chorlton-cum-Hardy 2028. NEWCASTLE, STAFFS.: 7 ALBANY RD.

Advertisers Appreciate Mention of "A.W." with Your Order

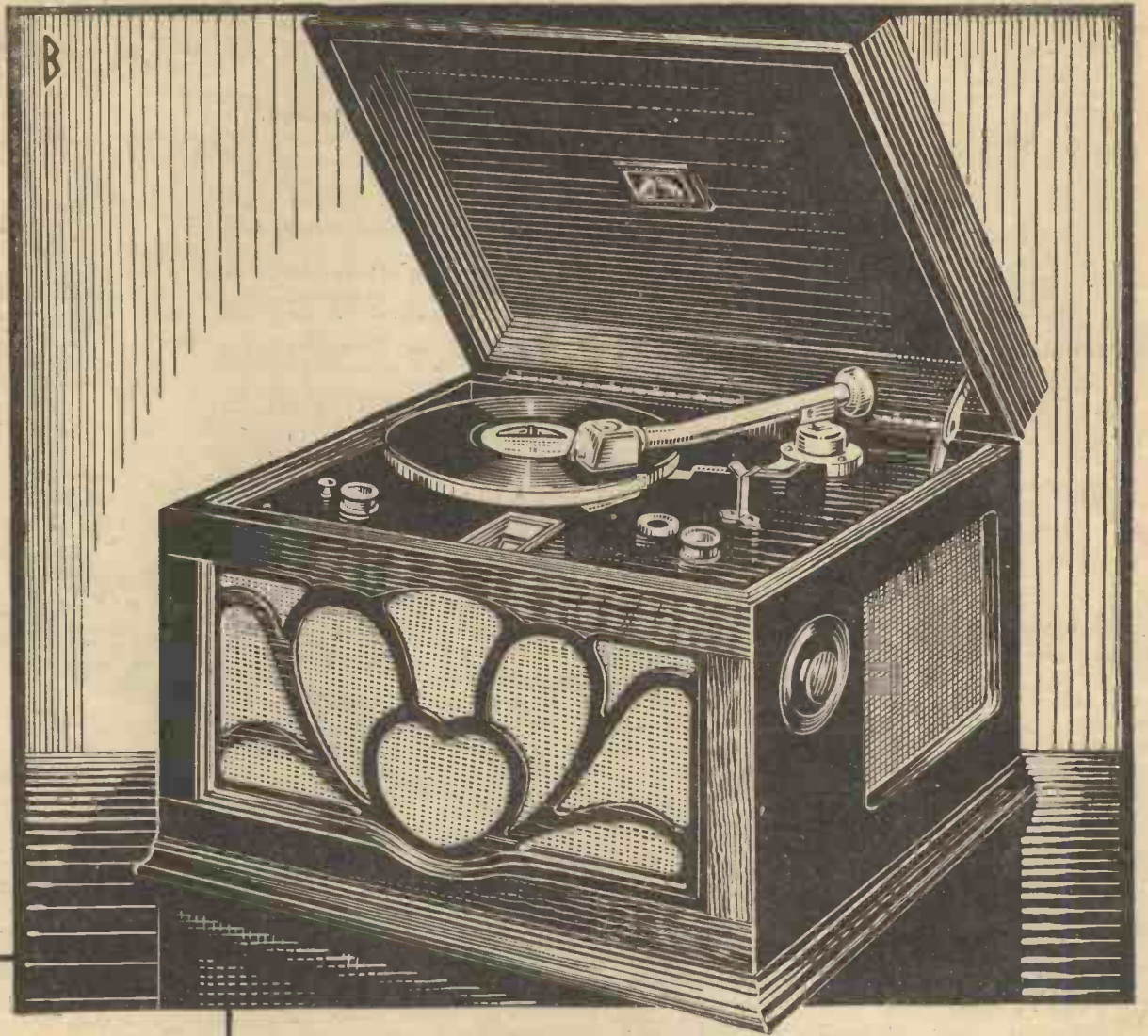

29 GNS.—A RADIO-GRAMOPHONE and made by "HIS MASTER'S VOICE"

All-Electric (A.C. or D.C.). Band pass tuning and super-power output valve ensure selectivity, volume and tone unequalled in any other 3-valve set. Built-in moving coil loudspeaker of the latest type. One operating switch. One tuning knob. One volume control. Aerial trimming device. Illuminated wave-length scale. Mains aerial. Electric gramophone pick-up—new horizontal type with reversible head—operating automatic brake. Plugs for two additional loudspeakers. In walnut cabinet with felt-lined lid. Model 501.

THE GREATEST VALUE IN MOVING COIL LOUDSPEAKERS MODEL LS7, 5 GNS.

A new type permanent magnet moving coil loudspeaker in an arched walnut cabinet of attractive design. It is extremely sensitive and will handle up to 3 watts without difficulty. A special loaded cone ensures an even response at all frequencies. A universal input transformer incorporated in the instrument enables it to be matched to receivers with triode, pentode or push pull output.

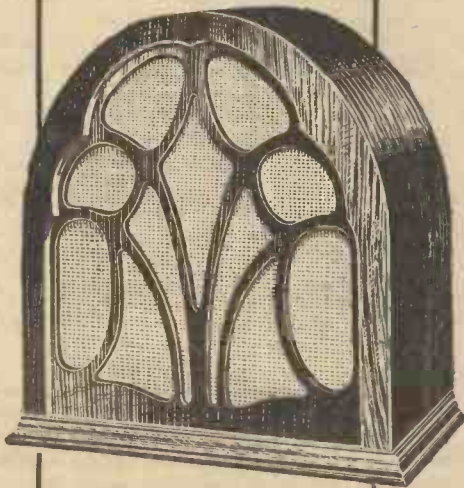

The Gramophone Co. Ltd.
London, W.1

"His Master's Voice"

Mention of "Amateur Wireless" to Advertisers will Ensure Prompt Attention

On Your Wavelength!

SADDER BUT WISER

A FEW weeks ago a friend of mine told me that I was talking drivel when I criticised American sets in comparison with our own. To show that he was a man of deeds rather than words he went and bought one of the things to replace his last season's British set. On the morning after he had installed it he was almost lyrical about the marvellous quality from the local station. "Just you wait a bit," I suggested and when he asked me what I meant I refused to say anything but "wait and see." The other evening I called on him to see how things were going. I learnt that after a little practical experience he was distinctly not pleased with the quality, though for the life of him he didn't know why.

TOO MUCH OF A GOOD THING

HE switched on the set and we listened for a little while to a concert from the London National. "I don't know what it is about its reproduction," he said, "it sounded all right at first, but somehow it gets on my nerves now." Then I pointed out just what was happening. I cannot say whether it is the same with all of them, but that loud-speaker has a positively filthy resonance at about 150 cycles, and when you listened carefully you found that the bass was mainly made up of one constantly repeated note or at the outside two or three. What at first hearing sounds like richness in reproduction becomes after some experience nothing but a succession of nerve-racking "woomphs."

MORE EXPERIMENTS

WE found, too, after listening carefully that there was virtually nothing at all of the high treble in the reproduction. The quality was, in fact, an illusion and nothing more. But what was even more interesting was to try the thing out on foreign stations. My friend, who is not a long-distance man, had not bothered much about this. "This set, though, makes big claims for selectivity," he said, "and with five valves you ought to be able to bring in a good few." "Four valves, you mean." For answer my friend showed me the inside of the set. "One, two, three, four, five," he counted. I smiled. "You probably don't know," I said, "that this one isn't a wireless valve at all. It is simply a mains rectifier. By British rating this is a four-valve set. You can use a metal rectifier in place of this valve; in fact, heaps of our own sets do so."

A POOR PERFORMANCE

I SAT down at the controls and had a try round. Selectivity!!! With quite a modest aerial we could not get the Midland Regional absolutely free of the London Regional—and the Midland Regional is ten channels away from London. In a word, the London National and the London Regional occupy between them considerably more than half the single tuning dial. We could not separate Rome

from Stockholm and the total bag of foreign stations was only just over half a dozen on the medium band. On the long waves Warsaw ran into the Eiffel Tower, 5XX into Koenigswusterhausen, and Koenigswusterhausen into Radio-Paris. No, somehow I don't think that these performances compare *very* well with those of an honest British three-valver. Do you? You, at any rate, are, I hope, one of the wiser and not the sadder.

SEE HOW THEY RUN

IT was quite amusing during the last two weeks or so to see the queues outside some of the London Post Offices waiting their turn to purchase wireless licences. It was the raid made by the Post Office vans which had this sudden wholesale effect upon consciences. It was believed before the van started their smelling out campaign that there were something like 400,000 unlicensed wireless sets in use in London and the figures to date seem to show that the estimate was not very far out. It was, I think, the advent of the portable set that produced the present wave of "piracy." As a comedian once put it: "Some people buy wireless licences and others use portables." It was not realised that a portable set, at any rate if you ever let it oscillate, could be detected by sensitive apparatus. A year or two ago I suppose it was pretty safe from discovery, but the new vans have such sensitive apparatus that even if there is no visible aerial the presence of a set can be tracked down.

INDOOR AERIALS

SPEAKING of indoor aerials reminds me that I still come across heaps of people who are using far more wire in their collectors than is necessary. Time and again some friend tells me that his set is hopelessly unselective and when I take a look at it I find that it is being worked off an old-fashioned aerial with a roof 50 or 60 feet long and consisting often of two parallel wires. With a very small set a large aerial is sometimes an advantage. I think that with most kinds of set it is a positive drawback if you are anywhere near one of the giant broadcasting stations. This is particularly the case if you use a screen-grid high-frequency valve. A high aerial containing a lot of wire brings in impulses of such magnitude that the valve cannot deal with them without distortion. You are simply asking, too, for cross modulation, which means that the big station will push its way through all over the place. My own experience is that if you cut down the size of the aerial better results generally follow. Often you will find that you can receive not less, but more foreign stations, owing to the reduced spread of the home stations on your doorstep.

FOR THE LOCALS

THE "quality" receiver which I use for my two locals (the London National and

London Regional) and for nothing else has a screen-grid H.F. amplifier, a power-grid detector and an output stage that will handle all the volume that I want without distortion. The distance from my place to Brookmans Park is just fifteen miles as the wave waggles. The aerial I use is hanging above my head at the moment. This is a ground-floor room and the aerial consists of 15 feet of No. 20 double-cotton-covered wire stretched between the curtain pole at one side of the room and the door frame at the other. Even this makes the volume greater than I usually want, so a variable resistance with a value of 50,000 ohms is connected across between the aerial and the earth terminals of the set.

FOR DISTANCE

FOR my four-valve set designed for long-distance work I use a rather longer aerial in an upstairs room. The big super-heterodyne generally works from a frame, but for picking up American stations I help this out with a yard or two of suspended wire. You can never tell how an indoor aerial is going to work in any particular house, but if you do get considerably more volume than you want from a local station and a bigish spread I advise you to try a few experiments with indoor collectors next time you have an hour to spare.

A WARNING

REMEMBER, though, that you can absolutely ruin the efficiency of an indoor aerial if you place it too near the ceiling or walls or if you try to make the lead-in look nice by stapling it on to the woodwork of the door or something of that kind. The reason is that by doing this kind of thing you make the capacity of the aerial unduly large and that is just what you do not want. Avoid at all costs the indoor wire made invisible by fixing it round a picture rail.

THE MANCHESTER SHOW

JUDGING by a preliminary tour of the stands at City Hall, Deansgate, which I made during a flying trip to the North the day before the Northern National Exhibition opened, this is the brightest and biggest radio show yet held outside London.

This year, as many readers will recall, the Manchester Exhibition has been organised jointly by the Radio Manufacturers' Association and Provincial Exhibitions, Ltd. According to one of the organisers with whom I was chatting, there is 30 per cent. more floor space at this year's show.

A great feature is the bridge connecting the gallery stands and flung across the main floor. The illuminations are well up to Olympia standard and the individual stands, although conforming to certain general limitations in decoration, present a pleasing variety of ideas.

THE HOME CONSTRUCTOR

ONE of my outstanding impressions after touring the chief stands was the

On Your Wavelength! (continued)

extraordinary interest that is maintained in home constructor parts. Almost every other stand seemed to be devoted exclusively to such components as band-pass coils, ganged tuning condensers, and low-frequency transformers.

The excellence of the valve-makers' kit sets was also readily appreciated. These add still further to the strength of amateur constructor interest.

One prominent exhibitor advanced to me a very interesting argument. He contended that as the factory-built sets had been so cut down in price, due to intensive competition, they must of necessity have sacrificed something in the quality of the components. For this reason the amateur-built set utilising first-class components would probably give better quality of reproduction than most of the competitively priced factory-built sets.

It seems to me that the amateur-built set will always be ahead in general performance of the factory-built set, because the amateur can incorporate new ideas as they come along, whereas the manufacturer has to decide on his season's programme and leave it at that.

WORTH KNOWING

BY the way, some of the old Fultograph apparatus for the reception of still pictures by wireless is still on sale by dealers who specialise in wireless bargains. The prices asked are very low and you can get a great deal for your money if you buy one of these outfits, and simply use the parts available. On the valve panel, for instance, there is a 0.5 moving-coil milliammeter, which is a real good'un. I didn't realise how good until the other day, when I put one into service. It is absolutely dead-beat and besides being very accurate has a good open scale. It is marked off clearly into divisions of .1 milliampere. Then there is a very good switch which will answer for filament purposes in the biggest of sets. There is also a quarter-microfarad fixed condenser of a useful sort. The leads have some very useful plugs and you can cut the sockets out of the instrument. I use one of the six-point plugs for connecting my battery distributor panel to the receiving set. The reproducing part of the apparatus contains a really good gramophone motor which is just the thing if you are thinking of making a radio gramophone.

AN EXPERIENCE WITH A FUSE

I TAKE it that you use a flash-lamp fuse when you are experimenting. At any rate you do if you are wise because there is a curious psychology connected with these matters. I find that if ever I leave my fuse out when I am experimenting I almost at once make a wrong connection or drop a wire about which results in blowing up a valve, whereas if I have a fuse in circuit I can do the most wild things without even causing the fuse to blow.

However, this is beside the point. What started me on this subject was an effect I observed a short time ago just after I had wired a high-tension supply to my den.

This had two or three tappings taken round to several terminal boards, and each point was condensed, there being, in all, nine 1-microfarad condensers. I wired a flash-lamp fuse permanently in circuit in the negative lead, and all went well until I blew the fuse up. The cause of the trouble was a high-tension lead which was dropped on to an L.T. connection, and I realised what had happened as soon as I did it. I cleared the fault at once, and then walked over to replace the fuse.

A SURPRISE

WHEN I did so it promptly blew up in my hand. I went carefully over the set, but could find nothing wrong. However, I disconnected the set from the battery entirely, and then tried again, with exactly the same result! I therefore thought it was time to do a little quiet thinking. Having with some difficulty got the grey matter to work I realised what was happening. The set had been left on and had, therefore, discharged all the condensers across the various tappings. On reinserting the fuse a sudden rush of current was drawn from the battery to charge these condensers again. The momentary value of this current exceeded half an ampere, which was quite beyond the capabilities of my poor little 60-milliampere fuse.

I therefore fitted a small short-circuiting key in series with a 2,000-ohm resistance. This was connected across the flash-lamp holder, and was kept depressed while the flash lamp was being screwed in, after which it was released, leaving the flash lamp in control of the circuit as usual. The 2,000-ohm resistance, of course, was to limit the current in the event of the fault not having been cleared. 2,000 ohms across 120 volts would only take 60 milliampere anyhow, which would not damage the valves even if they were short circuited across the H.T. battery.

FARADAY AND HENRY

BBRITISH scientists have been busy celebrating the centenary of Michael Faraday's epoch-making discovery of the laws of electro-magnetism. His name is, of course, preserved for all time in the

standard unit of capacity—the Farad. His contemporary Joseph Henry, of New York, is similarly associated with the recognised unit of inductance—the Henry. I suppose it would be fair to say that wireless is the one science, more than any other, which has brought those two illustrious names into common parlance. At one time they were known only to the electrical engineer, but now microfarads and millihenries slip easily from the mouths of wireless "experts" not yet in their teens.

It is an interesting fact that Henry, working along independent lines at the New Jersey College (now Princeton), made the discovery of the fundamental relation between electricity and magnetism in the same year, 1831, as Faraday—though he did not publish his results until some time later. Although Henry was born in New York he came from Scottish stock and spent many years of his early life in Galway.

HOW GREAT MINDS THINK ALIKE

IT is remarkable how often important discoveries or inventions come to light more or less simultaneously in different quarters and as the outcome of independent research. The history of wireless is full of such instances. Marconi and Popoff in connection with aeriols. Marconi and Branly with coherers. Dunwoody and Pickard with crystal detectors. Fleming and De Forest with the valve, and so on. Usually, it is possible to establish a difference of a few days or weeks—a vital matter when it comes to patent rights—but very often the facts are not so clear-cut and then there is a long drawn-out battle in the Courts to decide who was first in the field. Apropos of this, it would be interesting to know which single wireless invention has earned most in the way of royalties. I should place the "reaction" patent pretty high on the list, with, perhaps the "eliminator" as used on mains-driven sets not far behind.

A PATENT WAR?

THERE seems to be renewed activity just now in connection with wireless patents. Big guns are being fired off in the form of advertisements warning all and sundry not to infringe this patent and that. It all sounds rather ominous, though I sincerely hope no blood will be spilt! Among other things I notice that it is intended to apply for an extension of the "eliminator" patent. This means that it must be at least sixteen years old, which is rather surprising, because the all-mains set has only been in general use for the last four or five years at most.

THERMION.

The Columbia Broadcasting Company have completed arrangements for a regular interchange of programmes between the United States and five European countries, England, France, Austria, Hungary, and Czecho-Slovakia. The service is expected to commence this autumn. In addition one-way German-American relays have been arranged.

A FREE LOG!

Have you had your October issue of the WIRELESS MAGAZINE? It is an Autumn double number (usual price 1s.) in which is given free a useful Station Log with wavelengths and call signs. The special features include articles on Radio and Crime, B.B.C. Matters, and new "W.M." sets including the "Super Senior" and the "Five-advantage Three."

Keen amateurs are looking forward to next month's issue, on sale next week, which will contain, among other good things, a 16-pp. supplement giving the whole practical story of the B.B.C. organisation, and called Behind the Scenes at the B.B.C. Make sure of your copy!



DESIGNING YOUR OWN RECEIVER

This is the first of two articles by an ex-B.B.C. engineer describing in detail the theoretical considerations which arise in the design of a high-class modern receiver

THERE must be a large number of readers of AMATEUR WIRELESS who have thought, from time to time, that they would like to design their own receivers, but who have hesitated to attempt this from lack of knowledge of the correct procedure. The following notes have been compiled to assist, in some measure, those who feel that the scientific design of a receiver may not be beyond their abilities.

The First Consideration

Before thinking out the nature of the set, we should first consider the requirements of volume. These requirements should be modified by our source of power. That is, if we are compelled to use battery supply to the anodes, economy of consumption should be emphasised, and our requirements in the matter of loud-speaker output must be tempered accordingly. Of course, if mains are available, such considerations of economy need not be entered into, and a reasonably large output may be contemplated. Having decided on our power source, then, we must select our output valve, or valves. Valve manufacturers supply a great deal of data with their products, and the output of a super-power valve in milliwatts should be easy to ascertain. An output sufficient to fill a normal sized room comfortably without overloading on the peaks is (measured in milliwatts) of the order of 750 to 1,000. This is really necessary to work a moving-coil loud-speaker to the best advantage. If it is considered that a valve giving this output has too large a consumption for batteries, then a compromise must be made, and one chosen with a smaller output, and a correspondingly lower consumption.

What Stages?

Having determined, then, the output valve and, of course, the loud-speaker, for these two should be considered side by side, we should decide what is to precede it. We can determine this as follows. The valve data sheet will tell us the grid swing which can be accommodated. That is, if the valve requires, say, 30 volts grid bias at normal H.T. volts, then we can give it an input signal voltage of 30 volts peak without overload. If the output stage is composed of two valves in push-pull, then an input signal voltage of 60 can be dealt with.

The problem, then, is to deliver a signal voltage of a certain value to the output stage. If a transformer be decided on as the method of coupling, it follows that this

voltage must be delivered across the ends of the secondary winding. If the ratio is 1-3, this means that a voltage of a third of this value must be delivered to the primary. We are now faced with the question: shall the valve delivering this signal be an L.F. amplifier, or shall it be the detector? This depends upon the method of rectification to be used. We have a choice of three practical methods—conventional leaky grid, anode-bend, or power-grid detection. The first is definitely not capable of delivering a signal voltage of 10. The second can do this if supplied with a large input which would, in practice, be provided probably only by the local station. The last method will supply this voltage, though its use will probably assume the mains as a source of H.T., since high anode voltage and current

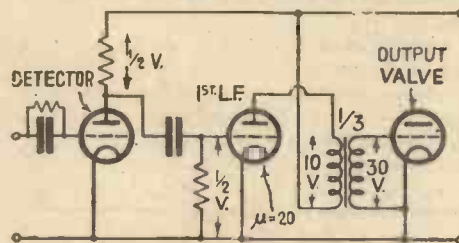

Fig. 1. Diagram showing numerical treatment of the signal of an amplifier

are the chief requirements of power-grid detection. Generally speaking, then, it would appear that a stage of low-frequency is required between the detector and the output stage. (This would not be the case if a pentode were used in conjunction with, say, a 6-1 transformer.)

The Intermediate Stage

It is necessary to know the approximate output of the detector before we can design the intermediate stage. A grid rectifier will deliver no more than about $\frac{1}{2}$ volt of undistorted signal voltage. An anode-bend rectifier can give 5 volts, with normal operation, while the power grid detector is capable of still more. Assuming $\frac{1}{2}$ volt output from the detector, we have to provide an amplification of 20 to deliver 10 volts to the primary of the intervalve transformer. Let us examine Fig. 1. It will be seen that a detector is resistance-capacity coupled to the first L.F. stage, which is transformer-coupled to the output valve. The $\frac{1}{2}$ volt output of the detector which is transferred from the anode resistance to the grid-filament of the next valve, has to be amplified to twenty times its value, that is 10 volts. This will be effected

by choosing for the first L.F. a valve with an amplification factor of 20. We now have a detector which will fully load the output stage, via an intermediate stage.

The question now arises as to whether any H.F. amplification is required. If the receiver is to be used for local station working only, and is reasonably close to the transmitter, then, assuming a good aerial, no H.F. will be necessary, as a very small amount of reaction will compensate for the damping of the grid detector. If, however, distant listening is intended, one or more stages of H.F. will be required, depending on the needs of the listener. Here it should be remarked that a pre-detector volume control will be necessary as it will be very easy to overload the detector on strong signals. We now have the nucleus of a receiver, one or more H.F. stages, a detector, and a two-valve L.F. amplifier, and we are assured that the detector, fully loaded, will give the amplifier just the right signal input. The question of frequency distortion now arises. This may occur in the amplifier, in the detector, and in the H.F. side.

The Amplifier

Taking the amplifier, the points to watch are as follows: The coupling between the output valve and the loud-speaker must be correct. That is, the impedance of the speaker must match that of the last valve. Keep the impedance of the valve as low as possible, use as much H.T. as you can afford (within the limits indicated by the valve maker), and, if you can, use a choke-condenser output, or a transformer—or both. Providing that this is done, and, in the case of a transformer, that the ratio is correct (the makers of the loud-speaker will advise here), then the low notes may be assumed to be sufficiently looked after—in this part of the set at least. Another place where low-note attention may be expected is in the first L.F. stage. If the impedance of the first L.F. valve (in the anode circuit of which is the transformer primary) is too high, the low notes will suffer.

As far as the detector is concerned, the main trouble to be expected is high-note loss. Keep the impedance of the valve low, and do not use too high a value of anode resistance. The resistance of the grid-leak to the first L.F. grid should not be too low. To ensure efficient detection, it is usual to connect a by-pass condenser from the detector anode to earth. This should be no larger than necessary, as the larger

(Continued at foot of next page)

A STEP-BY-STEP PICTORIAL GUIDE FOR THE HOME-CONSTRUCTOR

WHAT a help it would be to home-constructors if they could see an "A.W." set built up from the blueprint to the finished job by our expert men! How the knowledge gained would assist them in saving time and improving both appearance and results! We are getting as near as possible to making such a demonstration as that to every reader of next week's "A.W." With that issue we shall present a special supplement printed on tinted paper and bearing the title

"SET-BUILDING MADE EASY"

Its chief feature is a series of "How-to-do-it" photographs which, with accompanying text written in the simplest possible terms, are almost a practical demonstration of set building. Our supplement is a veritable

STEP-BY-STEP PICTORIAL GUIDE FOR HOME-CONSTRUCTORS

Every week we tell our readers how to build sets, but manifestly we cannot give in every issue all those elementary details of practical procedure which a newcomer to radio would like to know.

But in our supplement next week we shall demonstrate the job from start to finish. We start at the beginning, with a blueprint or other full-size drawing in our hands. We illustrate every job and every stage of the work. We explain in simple language anything which the illustrations do not make clear. Under your very eyes the set is built up and assembled step by step. We show you the two or three tools you must have—they cost so little—and illustrate their use. We mark out the panel, drill the holes, use a fret saw, assemble the components, cut and bend the wire, build the set under your very eyes. The newcomer will find in our supplement a key and a complete guide to the construction of a set, the most fascinating piece of home work that can come the way of anybody. The old hand will compare our methods with his own.

We shall have a big issue next week, even apart from the special supplement. We promise our readers a first-class number in every respect.

Pass the word along, will you, please. Pass it to two different persons, your newsagent for one, and any likely home-constructor for another.

USUAL
PRICE
3^d.

A GREAT ISSUE AND A FINE
SUPPLEMENT NEXT WEEK

USUAL
PRICE
3^d.

"DESIGNING YOUR OWN RECEIVER" (Continued from preceding page)

it is, the greater will be the high-note loss.

Coming to the H.F. stage, we find that unless special precautions are taken, the greater part of the high-note loss is here. A sharply tuned circuit will cut off the sidebands, and the more H.F. stages there are, the more pronounced will be this effect. It may be offset by the use of a suitably designed filter between the aerial and the first H.F. valve. This will give a double-humped tuning curve in the filter circuit, which in conjunction with a narrow single-humped curve in the H.F. circuit, will give us a more or less square-topped resonance curve, showing all frequencies in equal proportion, up to a sharply defined cut-off about 8,000 cycles/sec. Any small high-note loss will be compensated for by using a transformer in the L.F. amplifier. This will tend to give a rising characteristic. The use of excessive reaction will sharpen the tuning to such an extent that sideband attenuation becomes severe. The use of reaction should be limited to the neutralisation of detector grid damping.

Screening

We now have a receiver which should be reasonably free from low- or high-note cut-off. There are still, however, one or two points to watch. Firstly, inter-stage interaction, and "motor-boating." The cure, of course, is adequate decoupling of anode circuits, and, if grid bias is obtained from the mains, of grid circuits. On the H.F. side, more or less screening will be required, depending on the number of H.F. stages, the valves in use, and the type of tuning coils. If indirectly-heated A.C. valves are used, fairly complete screening will be

necessary, owing to their high efficiency. Similarly, the use of low-loss coils will necessitate greater care in screening. The design of filters and automatic grid bias arrangements, cannot be dealt with adequately in the scope of this article—information is published from time to time in the pages of AMATEUR WIRELESS.

NEXT WEEK:—

THE PRACTICAL DESIGN OF A RECEIVER

THE RETURN TO G.M.T.

THE return to Greenwich mean time from B.S.T. is responsible for a number of alterations of which you will do well to make a special note in your log. All Central European countries such as Germany, Switzerland, Italy, Scandinavia, Austria, and so on are now again one hour ahead of us. If, therefore, you want to hear dance music, say, from Berlin or Copenhagen, you must switch over to these stations before 10 p.m. Spain, Algeria, and Morocco remain as they were, but Leningrad with its Eastern European Time is two hours fast on us. Bear in mind that for Moscow you shoot forward a further 60 minutes or three hours in all. The Kremlin bells peal out the hour of midnight, but if you wish to try for them now on 1,304 metres (or on 50 metres), you must tune in just before 9 p.m. In these International broadcasts mention is only made of these two wavelengths, although invariably on a short-wave super-het it is possible to get the same transmissions on both 50 and 46.6 metres; in fact, over and above these there is a very useful harmonic on 25 metres.

TRAMWAY INTERFERENCE

EXPERIMENTS carried out on the causes of tramway interference with broadcast reception go to show that most of the mischief can be cured by transposing the field-coils from the low to the high potential side of the motors, so that the coils act as chokes between the motor and the overhead lines. This cuts off the motors from the overhead network, and prevents the latter from acting as a radiator for any high-frequency disturbances that may occur in the motor. Strangely enough, the actual "collector" system, i.e., the trolley wheel, is only responsible for a relatively small proportion of the total disturbance. This can in turn be cut down practically to zero by fitting a small "shoe" in the rear of the wheel, which preserves contact with the line when the wheel passes a suspension clip and so prevents sparking.

B. A. R.

A Saturday night sing-song by the Wireless Male Chorus, conducted by Stanford Robinson, will be heard by London Regional listeners on October 31. Their programme will consist of chancies and sea-songs.

A symphony concert is to be relayed from the Cheltenham Town Hall on October 26. The programme will contain a novelty—Goetz' Symphony in F.

On October 29, a little comedy entitled *Pink Paint* will be presented by Charles Brewer.

A special programme of Spanish music is to be relayed by the Regal Cinema Orchestra on October 30, in the Midland Regional programme.

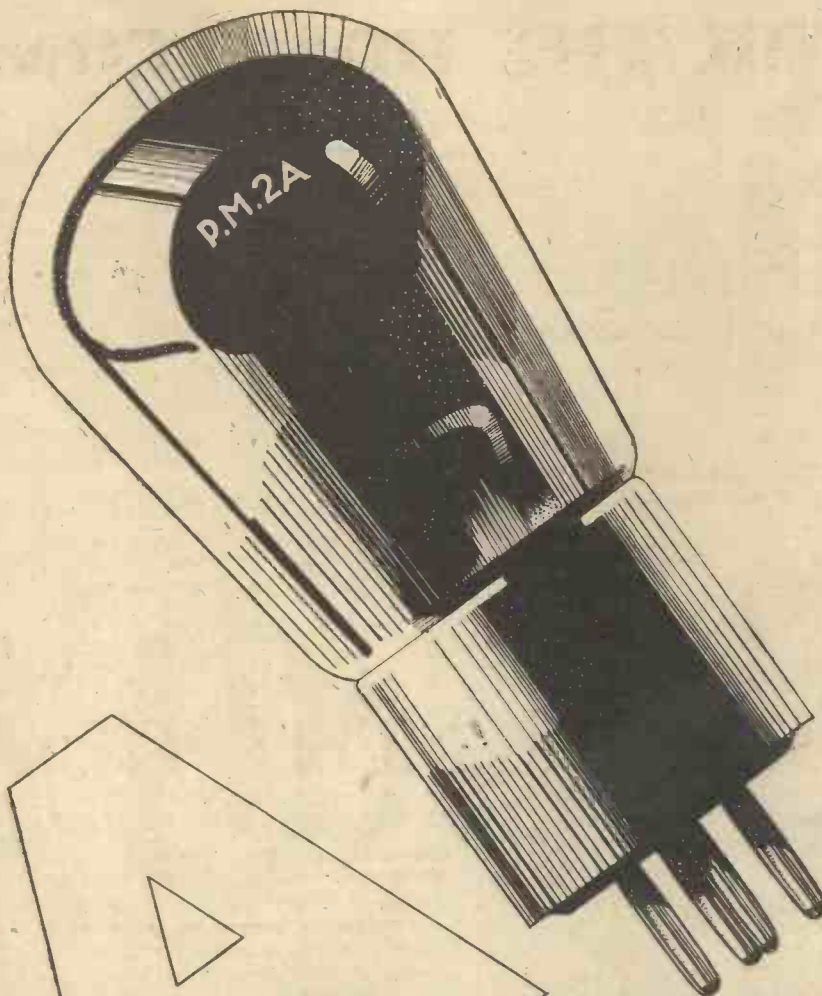

Performance has established the supremacy of Mullard valves. Every type in the Mullard 2-volt range does its job in the most efficient manner, and thus definitely improves the performance of your receiver. The P.M.2A, for example, the 2-volt power valve, has an amplification factor of 12.5, combined with a "slope" of 3.5mA./volt, giving an impedance of 3,600 ohms—an unusually low figure for a valve of this class. It thus makes the very most of even the weakest signals. Discover its effectiveness by fitting one in your receiver.

Price 10/6

Mullard

THE · MASTER · VALVE

Adv. The Mullard Wireless Service Co. Ltd., Mullard House, Charing Cross Road, London, W.C. 2

Arks

Mention of "Amateur Wireless" to Advertisers will Ensure Prompt Attention



TYPE "R"1.

TYPE "R"2.

J.B. Precision Instruments, chosen for still another Star Circuit—this time the Amateur Wireless "Britain's Super."

The J.B. "R" type Gang Condensers specified are the very latest in tuning devices, thoroughly shielded and enclosed, with neat clip-on screens to every stage. Very easily fitted, because only *round* holes need be cut in panel.

There are Trimmers (for adjustment once only) in each stage. A Vernier Disc Drive, scaled from 0 to 180 with a neat bakelite panel plate, is supplied as standard.

Start building "Britain's Super" to-day, and build for best results by following the lead of the designers.

Use J.B. Gang Condensers Type "R"1 12/6. Type "R"2 21/-.

USED AND SPECIFIED IN "BRITAIN'S SUPER"



Kendall says:

“HEAD AND SHOULDERS ABOVE ALL OTHERS”

A model of "Britain's Super" has been built in my laboratory, using the selection of components which I have specially chosen for use in the Ready Radio kits, and submitted to careful tests. The first tests were confined to detail matters of performance, to check up the complete suitability of the chosen components to the circuit. When I had satisfied myself that they enabled the design to give the best possible results, further extended tests were undertaken to investigate the general powers of the receiver.

My general conclusion was that this instrument marks an important advance in the technique of the design of super-heterodynes. Selectivity, range, and quality of reproduction were found to be of such a high order as to place it head and shoulders above any set I have yet heard.

The stability and general "manners" of the receiver are above reproach. To this admirable condition, the use of an efficient super-heterodyne choke no doubt contributes in no small measure, but due credit must also be given to the excellence of the general design.

I should mention that I was much impressed by the exceptional ease of construction of this receiver, especially when its considerable size is remembered. In the Ready Radio kit model whose construction I watched, of course, the work was somewhat simplified by the choice of components which I have made, and wiring was made easier by the use of "Jiffilix." I am left with the positive conviction that "Britain's Super" will become the standard high-power receiver for the season.

**The
BRITAIN'S
SUPER**

tested by Mr. Kendall
was built with a
**READY RADIO
TESTED KIT**

Ready Radio
SHOWROOMS:
 159, BOROUGH HIGH STREET
 LONDON BRIDGE S.E.1.
**EASTNOR HOUSE,
 BLACKHEATH S.E.3.**

See also pages

738	757	765
743	759	767
744	763	771



PRICE LIST AT A GLANCE

	£	s.	d.
1 Ebonite Panel, 14 in. by 7 in., drilled to specification ...		4	6
1 "EASTNOR" Cabinet with baseboard, by Ready Radio	1	5	0
1 J.B. two-gang .0005 variable condenser, type R2 ...	1	1	0
1 J.B. single .0005 variable condenser, type R1 ...	12		6
1 Colvern 50,000-ohm variable resistance (three terminal type) ...	5		6
3 Lewcos super-het coils, one oscillator and two intermediates, types I.F.T.P., I.F.T., Osc.126 ...	1	17	6
1 Lewcos band-pass filter unit with extension rod, type B.P.F.	12		0
*6 Junit 4-pin valve holders ...	4		0
1 Junit 5-pin valve holder ...			10
4 T.C.C. 1 mfd. condensers, type 50 ...	11		4
1 T.C.C. 2-mfd. condenser, type 50 ...	3		10
2 T.C.C. .0002-mfd. fixed condensers, type 34 ...	3		0
1 T.C.C. .0003-mfd. fixed condenser, type 34 ...	1		6
1 Readi-Rad 1-meg. grid leak and holder ...	1		4
1 Readi-Rad Super-het choke ...	5		6
1 R.I. general purpose L.F. transformer ratio 7-1 ...	10		6
1 Lewcos 15,000-ohm spaghetti resistance ...	1		6
1 Lewcos 20,000 ohm spaghetti resistance ...	1		6
1 Readi-Rad H.T. fuse and holder ...	1		3
1 Bulgin toggle switch, type S88 ...	2		9
1 Packet Jiffilix for wiring ...	2		6
1 Sovereign terminal block ...			6
2 Belling-Lee insulated terminals ...			6
8 Belling-Lee wander plugs ...	1		4
5 Valves as specified :-			
Mullard PM1DG, PM2DX, PM12, PM1HL, PM2A ...	3	7	6
Screws, flex and two spade terminals, etc. ...			10
TOTAL (including valves and cabinet)	£12	0	0

* NOTE:—5-pin holder is provided for the first detector. This is a universal type and allows for either a 4-pin or 5-pin double grid valve.

BUILD BRITAIN'S SUPER with CHOSEN COMPONENTS

Every Ready Radio Kit is composed of chosen components which have been tested and passed before despatch under the supervision of Mr. G. P. Kendall, B.Sc. By building your receiver with a Ready Radio Tested Kit, you are consequently assured of the finest possible results obtainable from the circuit of your choice.

Any part may be obtained separately if desired.

See also pages

737	757	765
743	759	767
744	763	771

ORDER FORM ON PAGE 744

Ready Radio
SHOWROOMS:
159, BOROUGH HIGH STREET
LONDON BRIDGE S.E.1.
**EASTNOR HOUSE,
BLACKHEATH S.E.3.**

Showrooms: Hop 3000

Grams: Readirad, Sedist.

Phone: Leo Green 5678.

Advt. of Ready Radio Ltd

To Ensure Speedy Delivery, Mention "A.W." to Advertisers

THE SOUND PROJECTOR

Some interesting details of the apparatus used for sound pictures

By BERNARD BROWN, B.Sc.

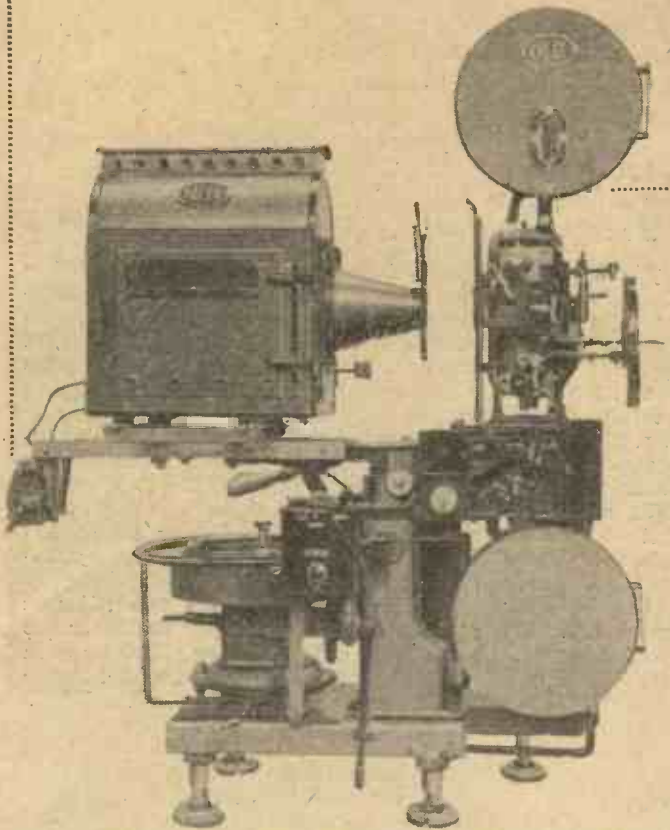

An example of an up-to-date talkie projector; either sound-on-film or the disc system can be used

MOST of us are familiar with the underlying principles of the modern talking picture, but still wonder what the machines high up in the operating box really look like. There seems to be an idea prevalent that they consist of a glorified magic lantern combined with a radio set and gramophone, but this is very wide of the mark. The modern sound projector, as it is called, is a unit mechanism designed specifically for the purpose of showing sound pictures and bears no resemblance at all to our domestic gramophone or radio set.

In the photograph we see a really fine example of sound projector, which incidentally is British throughout. To the right of the figure we see the cinema mechanism proper, the function of which is simply to pull the strip of film down in a series of little jerks corresponding to the miniature pictures. Right at the top we see what is called the upper spool box which contains the reel of film to be shown. Reels usually contain about fourteen-hundred feet of film, and as it is shown at the rate of about eighteen inches a second we see that a reel lasts a quarter of an hour. As a matter of fact, however, the parts of a feature film are rarely as long as this, usually being about one-thousand feet, which runs for eleven minutes.

At the bottom right hand corner we find the lower spool box, the duty of which is to wind up the film as it passes through the mechanism.

To the left we find the lamp house which contains a mirror arc lamp, producing an illuminating value equal to many thousands candle power and all within a space of one-eighth of a square inch.

during recording. These interrupted light waves then fall upon the photo-electric cell to the right of the sound unit which converts them into electrical impulses which are passed to the grid of a large valve amplifier which is an entirely separate unit and quite apart from the projector itself.

Disc Recording

But all talking pictures do not owe their being to "sound-on-film" recording. Quite a large percentage use discs, very similar to those of the ordinary gramophone. To the left and slightly to the rear in the photograph we note a heavy turntable which is used for "sound-on-disc" reproduction. The reason for the heavy casting is that all minor irregularities of turning shall be eliminated as these produce what is known as "flutter" or rise and fall in pitch as heard in the auditorium. The turntable itself is driven through gearing and flexible couplings from the main driving motor which also supplies power to the mechanism of the cinema proper and to the little sprocket wheel in the sound unit.

On the turntable the pick-up will be seen resting. While for home purposes the great object of manufacturers is to produce an instrument which will give the maximum voltage, this is not the case in connection

The Sound Unit

Just above the lower spool case we see what is known as the "sound unit"; this contains three major items—the exciting lamp, the lens tube and gate, and the photo-electric cell. The exciting lamp is a special type of incandescent electric-light bulb which throws a small beam of light through the lens assembly directly on to the side of the film containing the sound track which is, of course, a photographic record of the sound waves which impinged upon the microphone

with cinema work. We are quite prepared to sacrifice electrical impulses if, by this means, we may attain greater perfection in reproduction. It is a relatively easy matter to increase volume by means of another set of valves, and considering the size of the equipment this is no particular hardship.

It is sometimes asked which is the better, sound on disc or sound on film, and a year ago the question might have been a difficult one to answer. However, it must be remembered that photographic recording of sound was then a relatively new branch of science and perfection had not been attained in the early days of talking pictures. Thus it was that disc reproduction was decidedly better, but now conditions are completely reversed and we are safe in saying that sound on film is distinctly superior to that recorded in the ordinary manner on flat records.

Disc versus Film

But quite apart from the question of reproduction, sound on film possesses another great point in its favour. If, during the showing of a sound on disc film, the film itself happens to break it is quite impossible to save the situation except by cutting out that reel, which is, of course, distinctly annoying to the audience. When one considers the factors involved, the reason for this will be only too apparent. We have here one-thousand feet of film, every inch of which bears a certain relationship to the immensely long spiral on a sixteen-inch diameter disc record. It is far worse than looking for a needle in a haystack to endeavour to match them up once synchronism has been lost.

Cinema operators rejoice in the day of sound on film, for it lightens their work and provides them with a feeling of security never to be experienced when disc was the rule. Had it not been for the experience gained over a long period of years by the gramophone companies it is very doubtful if talking pictures would have attained the popularity they have to-day and thus it seems something of a pity that the record itself will shortly be a back number.

A QUESTION OF SIZE

THE small and compact type of set is for the moment gaining in popularity. To some extent it is an outcome of the higher efficiency of the modern valve. Improvements in screening, in coil design, and in condenser ganging have all tended to reduce the size of circuit components without any appreciable loss in efficiency. On the low-frequency side, the new "high-mu" transformers form another notable contribution towards compactness. B.

**SUPER-HET RECEPTION AT
THREE-VALVE COST**

By W. James' new super-het.

First details on pages 750-752

THE HOW AND WHY OF TUNING—VI

WHAT WE MEAN BY SELECTIVITY

Another of a short series of articles on tuning, specially written for newcomers to wireless. Here the first ideas about tuning are presented. In the articles that follow, "Hotspot" will deal with all the difficulties about tuning that the beginner is likely to meet

WE cannot delve far into the problems of tuning without coming right up against the property known as selectivity. Loosely defined, we might say that selectivity is the property of selecting with a tuning circuit, or circuits, one programme to the total exclusion of all others.

If the tuning does indeed select only one programme, without the slightest trace of those on each side of it in the wavelength range, we say that the tuning is very selective. If, on the other hand, we find that, when the circuit is tuned to one programme, it also permits others to be heard, we say that the tuning is unselective.

I have purposely referred to programmes and not to frequencies; for, as mentioned last week, when a broadcast signal is tuned in we deal not with just the fundamental frequency corresponding to its wavelength but with a host of side-band frequencies. At least, we should deal with these side bands! If we cut them off, by making the selectivity too good, we lose the high audible notes that make speech crisp and music brilliant.

Quality and Selectivity

By now, it is clear that any attempt to define selectivity must also embrace a definition of quality, since the one attained regardless of the other is quite useless.

Two very sensible definitions for selectivity and quality are given in the latest Ferranti book, "The True Road to Radio." Selectivity is there defined as the ratio of a tuned signal to that received when the set is de-tuned 10,000 cycles from the funda-

mental frequency. Selectivity is therefore a number greater than 1.

Quality is defined as the ratio of the signal received when the set is detuned 5,000 cycles from the fundamental frequency to that received when at the point of tune. This quality figure is, of course, always something less than 1, although it must always be the aim to approach that figure, for then all the side-band frequencies up to 5,000 cycles will be reproduced.

Taking a single tuned circuit of high resistance, it is found that the selectivity figure on the basis of the above definition is very poor—not much above 1. On the other hand, this high-resistance tuning circuit has a commendable quality figure—approaching 1.

Using a low-resistance tuning circuit we find that the selectivity figure is greatly improved, but only by making the quality figure bad!

The Side-band Question

As the broadcasting stations of Europe are at present separated by only 9 kilocycles, it follows that we can only afford to consider the side-band frequencies up to 4,500 cycles away from the fundamental frequency of the carrier wave, even though the station may be sending out side-band frequencies up to 10,000 cycles on each side of the fundamental.

As an aside, it might be mentioned that 9 kilocycles, that is 9,000 cycles, is the minimum separation that can be tolerated between adjacent stations if reasonably good

quality is to be preserved. If the carriers are brought closer together than 9 kilocycles, the side-band frequencies set up an audible heterodyne note. This note is, of course, still produced when the carriers are 9 kilocycles apart, but it is then above audible frequency.

Listeners must have noticed how sometimes a very high-pitched whistle has developed on the edge of the local station tuning, due to the slight wavering of the adjacent station, which may have come temporarily closer than the specified 9 kilocycles to the local.

The closer together the two adjacent stations come in frequency the lower the pitch of the note; many will have tuned in the very low grumbling note caused by the synchronised 288-metre relays being slightly off, say a few cycles, the allotted frequency.

There is one school of thought contending at the present time that the best way to tackle the problem of quality and selectivity is this: make the tuning of very low resistance, so that really selective tuning is obtained, with a cut-off at, say, 2,500 cycles on each side of the carrier. Then compensate for the consequent loss of high notes, through the ruthless cutting of the side-band frequencies, by "doctoring" the low-frequency amplifier after the detector.

At present, this idea is not generally accepted as a solution, but it must certainly not be overlooked when considering the more orthodox methods of making the tuning at once selective and capable of passing all the wanted side-band frequencies. Briefly, the present method is to use a series of tuning circuits that are individually unselective but that collectively give the required 9 kilocycle separation of stations without loss of quality.

Coupled Circuits

There is a limit to the number of circuits that can be coupled together; usually after two circuits amplification must be introduced to make up for the loss of energy that occurs during the transfer of the signal from one tuning circuit to the next. The modern tendency is to use two loosely coupled tuning circuits between the aerial and the first valve, which in a three-valve set would be a high-frequency amplifier.

These two circuits pass only one band of frequencies, restricted by the design of the coils to a total width of 9 kilocycles. This band-pass tuning, as it is called, therefore pre-selects the incoming signal before any amplification takes place. This is an advantage when there are interfering stations on adjacent frequencies, for there is less chance of the interference being amplified if two tuning circuits precede the amplifier than when only one tuning circuit precedes it.

Next week we will consider some simple tuning circuits, later working up to band-pass tuning.

HOTSPOT.



To make ships safe in fog. An official of the Port of London has designed this directional microphone to guide vessels by means of sound. It is being tried out on Thames shipping noises near the Tower Bridge and uses a wireless-type power amplifier

AMATEUR PUBLIC-ADDRESS WORK



A giant voice to address several hundred people can be carried comfortably! The complete equipment ready for operation

PUBLIC address to the amateur conjures up visions of huge mobile equipment (such as the new Marconiphone truck they have doubtless seen in action at some large functions), giant loud-speakers on big masts and turrets, as used at racetracks and airports, or some such similar elaborate equipment quite beyond their reach. But, to the advanced amateur, group address and sound reproducer work is quite within his capabilities and it offers very interesting problems not met with in everyday domestic radio work; it particularly appeals to those interested in such matters as talking pictures or similar branches of radio where electrical amplification is utilised.

The equipment about to be described, and earlier models of a bulkier nature, have been in frequent demand for sports meetings, impromptu dances at clubs, political meetings and similar events, and the construction of the equipment and the solving of the many problems involved in the design of a truly lightweight and efficient portable equipment has proved of absorbing interest. The nominal charges made for the use of the equipment at the various functions attended have certainly helped towards the cost of the work, which has been a change from the normal activities of radio work in its more usual branches.

A Lightweight Portable

There is no need to have a motor van or any elaborate and expensive transport facilities if nothing very ambitious is attempted. Illustrated here, for instance, is a lightweight portable equipment developed by the writer after four years spent on exceedingly interesting spare-time research work on the subject, which probably represents the last word in portability and compactness. It consists of a three-stage high-gain amplifier, assembled in a light fibre suitcase, the complete amplifier unit weighing only some 25 lb. The amplifier is

second stage transformer-coupled (parallel fed) to the output valve. Eighty volts grid bias for the output valve and bias for the first and second stage amplifiers is derived from dry batteries in the case, which also has accommodation for the microphone (a high quality recording type with a big output and a very wide "pick-up" range), and all connecting leads, which are of heavy rubber-covered flexible cable with solid metal-end tags.

High tension up to 50 milliamperes at 400 volts comes from an anode convertor, made up as a separate unit with its filter circuit. This part of the equipment is of open construction so that in the event of a condenser breakdown a spare can be fitted with the minimum of delay, the choke and condenser of the output stage also being easily accessible for the same reason. Low tension comes from two six-volt accumulators in series or, in emergency, from the battery of the "baby" car which is used to transport the equipment.

For normal purposes the speakers used are exponential horns of 40 in. air column, with balanced-armature units. These are very sensitive, but as the air-column is short they are unsuitable for musical reproduction owing to poor bass-note response, but they are ideal for public address where speech only is required. When these speakers, which have a maximum safe handling capacity of 2 watts, are in use, the L.T. input to the convertor is reduced to 8 volts, giving about 220 volts input to the amplifier, under which conditions speech is clearly audible over a distance of 200 yards and more under favourable conditions.

Exponential horns are, of course, ugly and cumbersome, but they have the important advantages of high efficiency and directional properties, which enable the sound to be directed just where it is wanted, and, provided the microphone is always at least six feet back from the mouth of the horn, of preventing any possibility of

This article by a keen amateur indicates a lucrative sideline for those who make a hobby of wireless

of the mixed type, i.e., first stage resistance-capacity coupled (with a variable 500,000-ohm resistance as the grid resistor acting as a variable gain control), and a

howling due to feed-back from the loud-speaker into the microphone.

For music as well as speech an eight-foot air column exponential horn and/or ordinary moving-coil speakers on baffles are used with the full output of the amplifier available to do justice to the bass notes.

A second case the same size as the amplifier contains a double-spring gramophone motor and turntable (one of the new 4-volt electric motors is being experimented with just now). A pick-up and volume control, and a record-carrying case with twenty-five records, enough for a 2½-hour programme, completes the equipment.

Portability

The use of a motor-generator for high-tension supply makes the equipment entirely portable, and it can be set up in the middle of a field as, for instance, to direct gliding operations, and be entirely independent of outside power supply. The weight of the batteries and convertor, however, necessitates a small car.

Where A.C. is available, as, for instance, in a hall where a public speaker or lecturer wishes to use the equipment, an A.C. power-supply unit can be slipped into the microphone compartment of the amplifier.

(Continued in second column of next page)

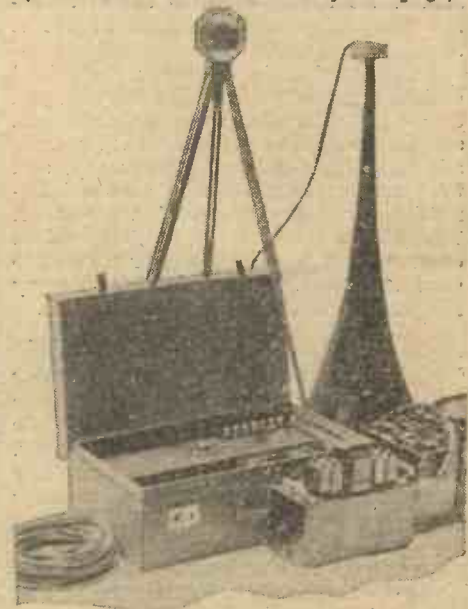

The complete portable public-address equipment with speaker, convertor, microphone on tripod, and batteries

STUDIO CHATS WITH BROADCAST STARS



"MRS. BUGGINS"— MABEL CONSTANDUROS

THE last thing that Mabel Constanduros dreamed about six years ago was broadcasting, and yet to-day she ranks among the ten most popular B.B.C. artistes. A good many listeners think that in her Buggins family sketches she is our leading comedienne.

She told me that it was way back in 1925, after she had written a number of monologues and character studies just for her own amusement, a friend advised her to go

and try them on the Savoy Hill officials.

She did, and never will she forget it!

She got microphone fright through having to wait before her audition, forgot her part, and started on something which was not down on the list for her to give as a test piece!

The audition official said, "Thank you very much," in the sort of tone that implies, unsaid, "Good-bye and good riddance."

But it was only the official's way, and within a few days she had a letter asking her to broadcast. March, 1925, was her first broadcast and within a few months she made the acquaintance of Michael Hogan, that being the start of "Farver" of the Buggins family. Together, Mabel Constanduros and Michael Hogan have written several plays, apart from their humorous stuff for the microphone. Probably you recall *The Survivor*.

The Buggins family, including Grandma, Mrs. Buggins, and Alfie, have broadcast approximately 250 times and it is no exaggeration to say that this has been a severe test on Mabel Constanduros's acting and vocal powers. They have made gramophone records as well as broadcast

and are the subject of an interesting book.

There is never a very big audience in the studio when the Bugginses are due to broadcast, for Mabel Constanduros likes to be able to concentrate in these parts.

In this respect she is unlike other popular broadcasters, such as Philip Ridgeway and Tommy Handley, who generally like a background of studio laughs while they are broadcasting.

The manuscripts of the radio sketches are made out at all kinds of odd moments and Mabel Constanduros has a little notebook in which she jots down any events of the day which later can be "worked" in a radio sketch. The sheets have to be carefully typed out and sub-edited, which Miss Constanduros and Michael Hogan do together. Then the parts are learned (sometimes in an incredibly short space of time) and the cues marked, so that when standing before the microphone there are no anxious waits while "Farver" finds his part.

The Buggins family gave a running commentary on the last Royal Command Performance which was quite a new idea and, as it was chiefly impromptu, was quite a feather in "Mrs. Buggins's" cap!

SHORT-WAVE ADAPTORS

THERE are so many short-wave broadcasting stations now on the ether that one needn't know Morse to find plenty of entertainment below the 50-metre mark. The simplest method of getting loud-speaker reception on these wavelengths is to couple a single-valve detector, fitted with short-wave tuning coils, to the first low-frequency stage of a standard broadcast receiver.

Another plan is to use a combined oscillator and detector as the adaptor, and couple it to the high-frequency stages of a standard broadcast set. The H.F. circuits are tuned to the "beat" frequency, and they act in the same way as the intermediate-frequency stages of a super-het. The merit of this plan is that all the valves of an existing broadcast receiver are used to good advantage, which makes for economy in operation of the whole outfit. M.B.

AN ALL-MAINS COMBINATION

THE most modern form of timekeeper is the clock which is plugged into the mains to be driven and regulated by the frequency of the alternating-current supply. Since the A.C. frequency is carefully standardised at 50 cycles, the all-mains clock can be regarded as on the same footing as a certified chronometer, so far as accuracy is concerned. One of the latest developments is the combination of mains-driven clock of this type with a permanent-magnet moving-coil speaker. The speaker is mounted below the clock-face, and is fitted with a variable tone-

control. The whole forms an effective combination which makes a particular appeal to those who like a note of novelty.

M. A. L.

"AMATEUR PUBLIC ADDRESS WORK"

(Continued from preceding page)

This delivers 400 volts plate current from a



The equipment in use to direct "crowd" scenes outdoors for amateur movie-making

rectifying valve and 4 amperes at 4 volts for the heaters of the A.C. valves. Incidentally, indirectly heated A.C. valves are often used with the batteries and anode converter, because of their high performance factor, more robust construction and freedom from hum or microphonic disturbances, although where a long run is anticipated 6-volt valves are substituted to reduce the heavy drain on the batteries which the A.C. valves impose. With the A.C. power unit, however, the equipment becomes transportable by hand, the single 25 in. by 15 in. by 8 in. suitcase and the 40 in. air-column speaker constituting a complete portable public-address system which will comfortably cover 600-700 people in a hall!

J. ROBINSON.

MASS PRODUCTION

ONE of the most interesting sideshows at Olympia was a practical demonstration of modern mass-production methods. A mains-eliminator unit was shown under process of assembly on the moving-belt system. As the conveyer belt moved slowly along, each operator in turn placed a particular component into position before the belt passed under the hands of the next operator. Apart from the apparent ease and facility with which the whole operation was carried out, one had an interesting object lesson in the art of circuit assembly, as well as a useful insight into the number of different parts that go to form the complete "make-up" of a mains unit.

B. A. R.

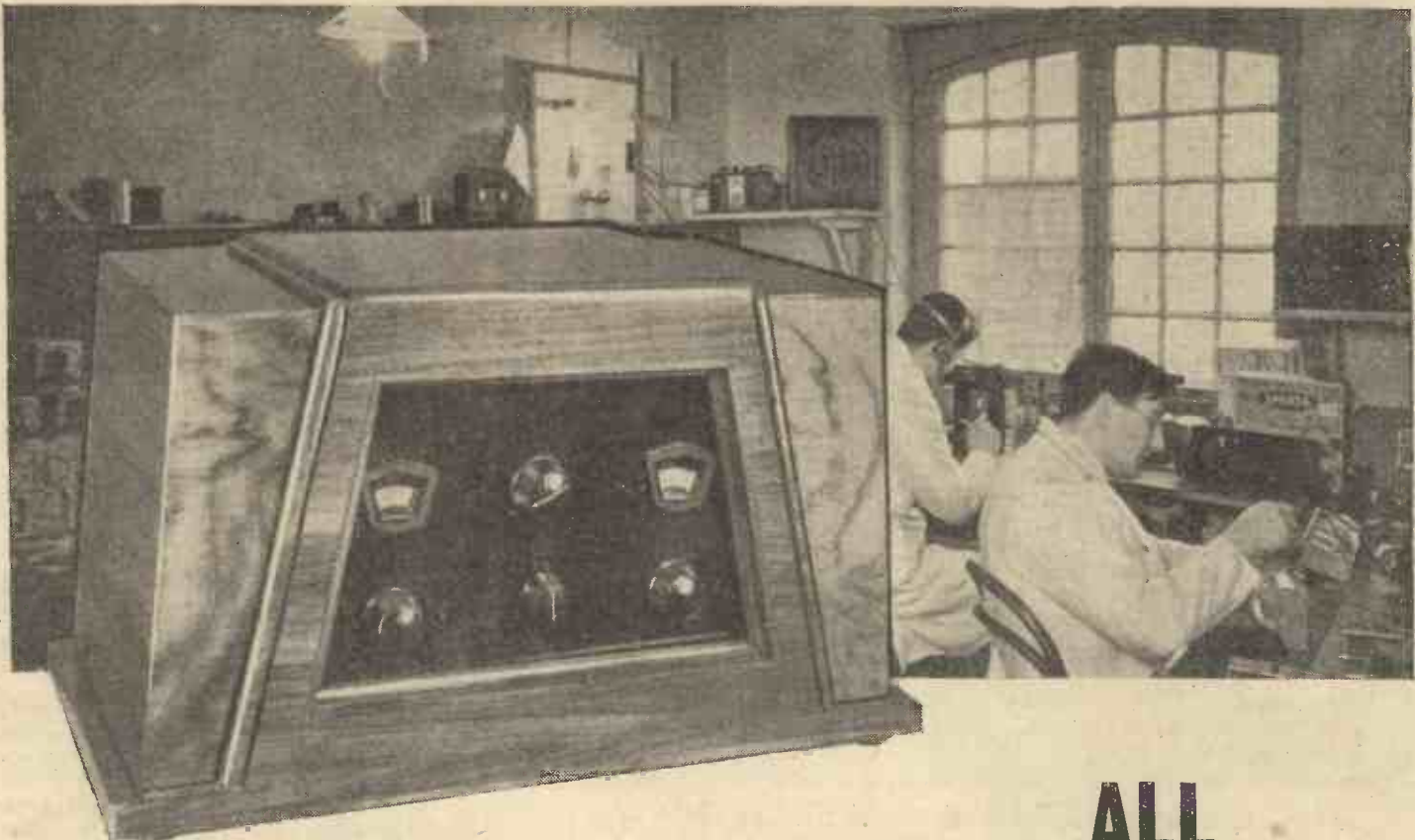

The beautiful 'Waldor' Cabinet, used for Britain's Super, was designed specially by the Ready Radio artists at the request of "Amateur Wireless."

ALL READY RADIO KITS

ARE TESTED
AND PASSED
BEFORE
DISPATCH

G.P. Kendall
CHIEF ENGINEER, READY RADIO

READY RADIO KITS FOR BRITAIN'S SUPER

Kit "A" (Less valves and cabinet) or 12 monthly payments of 13/6 **£7.7.6**

Kit "B" (With valves less cabinet) or 12 monthly payments of 19/9 **£10.15.0**

Kit "C" (With valves and cabinet) or 12 monthly payments of 22/- **£12.0.0**

COMPLETELY ASSEMBLED RECEIVER, including valves and cabinet, aerial tested, Royalties paid .. **£14.10.0**
or 12 monthly payments of 26/6.

IMMEDIATE DISPATCH—ORDER FORM ON PAGE 744.

See also pages

737	757	765
738	759	767
744	763	771

Ready Radio
SHOWROOMS:
159, BOROUGH HIGH STREET
LONDON, BRIDGE S.E.1.
EASTNOR HOUSE,
BLACKHEATH S.E.3.

Showrooms : Hop 3000.

Grams : Readirad, Sedist.

Phone : Lee Green 5678.

Advt. of Ready Radio, Ltd.

Don't Forget to Say That You Saw it in "A.W."



There is sure to be a huge demand for Britain's Super Components. Thousands of Sets will be built. You cannot be sure of getting the parts you need—unless you order from Ready Radio.

In anticipation of the demand we have purchased over £25,000 worth of Britain's Super Components. They are now in stock ready for immediate dispatch.

Whether you want a single component or a complete Kit for your Britain's Super you can be sure of getting it from Ready Radio.

Post Your Order Now!

IMMEDIATE DISPATCH OF BRITAIN'S SUPER

ORDER FORM

To **READY RADIO LTD.**, Eastnor House, Blackheath, S.E.3

CASH ORDER Please dispatch to me at once the payment in full of ... goods specified for which I enclose ... £ _____

C.O.D. ORDER Please dispatch to me at once pay the sum of ... goods specified for which I will ... £ _____

EASY PAYMENT ORDER Please dispatch my Easy Payment order for the goods specified for which I enclose first deposit of ... £ _____

Name.....

Address.....

.....

Kit required.....

A.W. 17/10/31.

TO INLAND CUSTOMERS
Your goods are dispatched post free or carriage paid.

TO OVERSEAS CUSTOMERS
Everything Radio can be supplied against cash. In case of doubt regarding the value of your order, a deposit of one-third of the approximate value will be accepted and the balance collected by our Agent upon delivery of the goods. All goods are very carefully packed for export and insured, all charges forward.



SEE ALSO PAGES :—
737, 738, 743, 757,
759, 763, 765, 767, 771

Advt. of Ready Radio Ltd.

Mention of "Amateur Wireless" to Advertisers will Ensure Prompt Attention

AT THE B·B·C.

The BROOKMANS PARK CONTROL DESKS

Listeners who have wondered what goes on "behind the scenes" at Savoy Hill, Broadcasting House and the transmitters will be interested in this new series by **KENNETH ULLYETT**

WHILE at Brookmans Park recently, I was lucky enough to have a chat with one of the engineers in charge. I say "lucky enough" because after all a giant transmitter is not very different from a receiver; there are high-tension, low-tension and grid-bias to be switched on, and tuning to be done; I had often secretly wondered how this was all done at a B.B.C. transmitter, and many other listeners must have wondered the same thing.

The actual job of switching on is not done solely from the control desk and is carried out according to a schedule which takes about ten minutes to perform in detail. Diesel engines are started up by compressed air engines, the big generators switched on and the valves turned on in turn.

While all these operations are not carried

out by remote control from the control desks in the middle of the room, the operators here can, in cases of emergency, switch off all the heavy-duty circuits.

At Brookmans Park and Slaithwaite there are each two control desks, the control gear for each National and Regional transmitter being entirely separate.

I examined one of the desks at Brookmans Park with its huge control knobs and large scale meters. The transmitter was running and there was an immense feeling of responsibility in that an accidental turn of one of these knobs might mean the blowing of a power valve and consternation in the homes of perhaps a million listeners!

The desk, a robot-like affair, was slightly warm and I asked what the various controls are for.

"The five knobs," said the engineer, "control the field current of the large generators, and the resistances in the ventilating boxes at the sides of the desk control the output from the generators.

"These knobs do not have to be touched often, but occasionally during a programme the load alters and one of the controls has to be moved up a degree to keep the oscillator and last stage modulator voltages steady. If anything drastic should happen then the field currents of all generators can be cut down here and although they will continue to run the output will, in effect, be switched off and the damage will not spread. The five meters in front, of course, show any change made by the five field strength regulators."

At the end of the transmitter hall is a large black switchboard, literally covered with meters and control knobs. I asked what they were for and was told that here the voltage in practically every circuit can be read and there are knobs for some of the "auxiliaries"—that is, the small generators supplying grid-bias and some of the filament circuits.

The batteries are controlled from the accumulator room, of course. In a separate room is a little desk which is the actual termination of the landlines between the London control room and the transmitter.

"We have five lines going back to London," said the engineer, "and these five switches"—he pointed to a row of keys similar to those on a Post Office switchboard—"control the input to the 'B' amplifiers on each of the five lines. The two switches on the left-hand side are in the output circuits of these amplifiers and are in the leads which go off to the first modulator stages in the transmitter hall."

Checking the Tone

A loud-speaker was working at the side of this landline desk and I asked if this is connected to one of the amplifiers.

"No," I was told, "that is connected to one of the side-tone receivers so that we can get a genuine radio reproduction of the out-going signals. If the speaker were connected to one of the 'B' stage amplifiers we should get an idea only of what comes to us by line from London. At the same time the operator can plug in a pair of 'phones and listen to his landline signals as they arrive, or after amplification by the R.C.-coupled amplifier.

"The big control knobs, to the right and left, are potentiometers controlling the step-up (on the output side) of the amplifier."

Four meters above the control switches show technical factors such as peak voltage, modulation, and volume by a "slideback" galvanometer. They tell me that the Brookmans Park engineers are putting in spare time in experimenting with new controls and indicators for this switchboard. All the time the National and Regional transmitters are working there is a Brussels wavemeter switched on in a separate room.

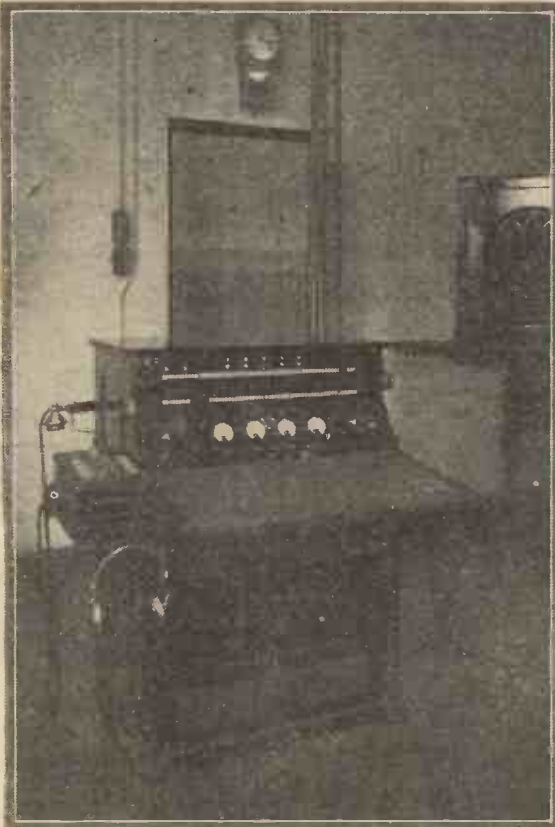

This is the desk carrying the controls for the five lines between London and Brookmans Park

“BRITAIN’S SUPER”

THE BAND-PASS SUPER-HET

FULL-SIZE LAYOUT and WIRING GUIDE for PANEL
 (BASEBOARD LAYOUT IS GIVEN ON PAGES 748 AND 753)

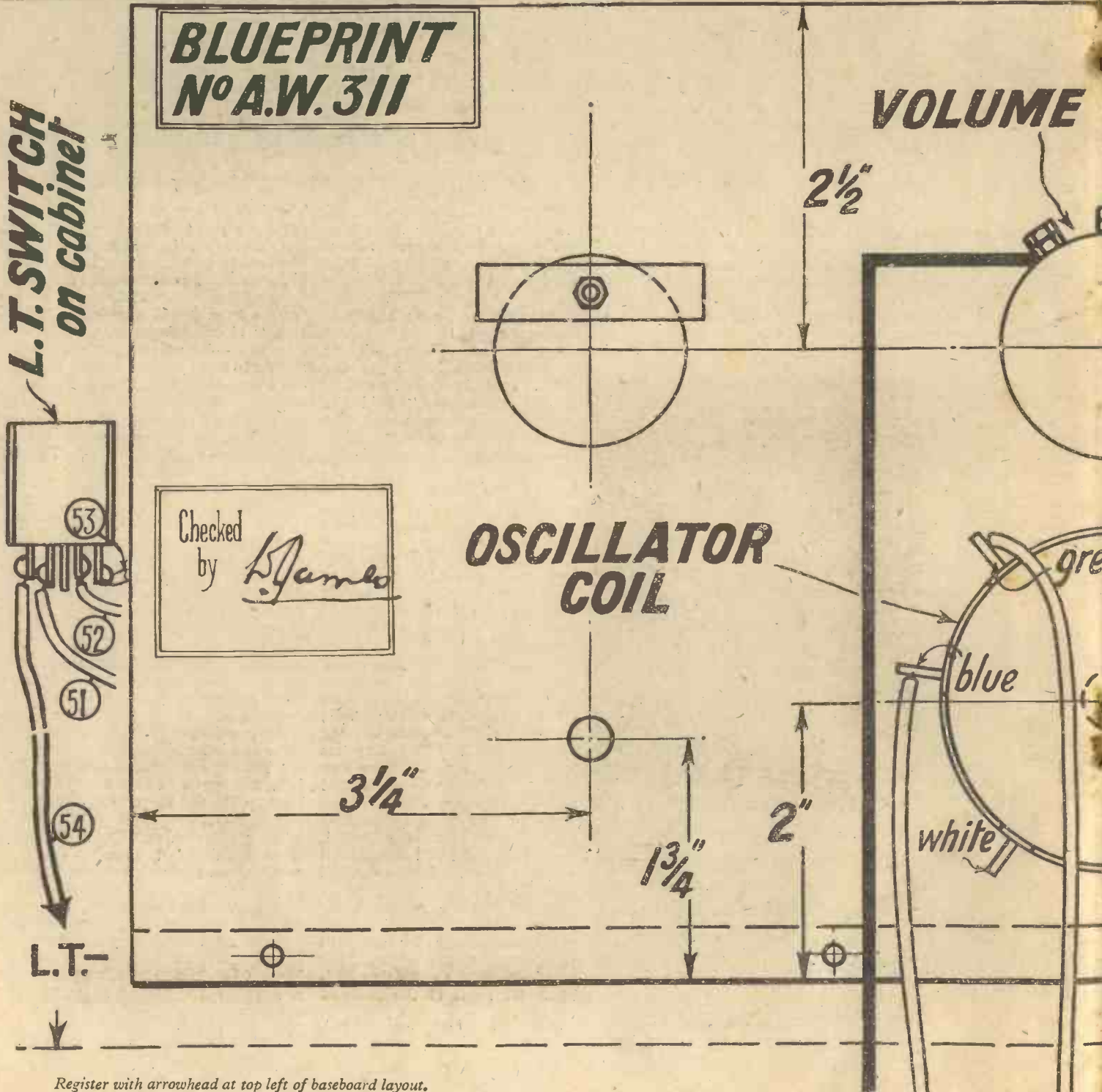

Register with arrowhead at top left of baseboard layout.

COMPONENTS REQUIRED FOR "BRITAIN'S SUPER"

Ebonite panel, 14 in. by 7 in. (Permcot, Peto-Scott, Danipad, Becol, Readi-Rad, Goltone).

Cabinet, with baseboard, 17 in. by 9 1/2 in (Readi-Rad "Waldor," Peto-Scott, Camco).

Two-gang .0005-mfd. variable condenser (J.B. type R2, Lotus, Utility, Polar).

Single .0005-mfd. variable condenser (J.B. type R1, Lotus, Utility, Polar).

50,000-ohm variable resistance (Varley, Bulgin, Sovereign, Colvern, Lissen, Regentstat, Igranic, Watmel).

Three super-het coils, one oscillator and two intermediates (Wearite, types O2, OT2, and OT1, or Lewcos).

Bandpass filter unit, with extension rod (Lewcos "BPF").

Seven valve holders (W.B., Lotus, Lissen, Goltone, Telsen, Benjamin, Graham-Farish, Wearite, Junit).

Four 1-mfd. fixed condensers (T.C.C., Dubilier, Telsen, Lissen, Formo).

2-mfd. fixed condenser (T.C.C., Formo, Dubilier, Telsen, Lissen).

Two .0002-mfd., and one .0003-mfd. fixed condensers (Telsen, Dubilier, Graham-Farish, Goltone, T.C.C., Ormond, Formo, Lissen).

One-megohm grid leak (Telsen, Dubilier, Goltone, Lissen, Readi-Rad, Graham-Farish, Bulgin).

Grid-leak holder (Readi-Rad, Bulgin, Lissen, Goltone, Dubilier, Graham-Farish).

Super-het choke (Readi-Rad).

Low-frequency transformer (Telsen, R.L.

Lewcos, Lotus, Lissen, Varley, Ferranti, Bulgin, Igranic, Graham-Farish, Burton).

Two spaghetti resistances, one 15,000-ohm and one 20,000-ohm (Lewcos, Telsen, Bulgin, Graham-Farish, Readi-Rad, Lissen, Sovereign, Goltone, Tunewell).

Fuse holder and fuse (Bulgin, Telsen, Readi-Rad, Belling-Lee).

Terminal block (Junit, Sovereign, Belling-Lee).

Two terminals marked Aerial and Earth (Belling-Lee, Bulgin, Clix, Eelex).

Double-pole toggle switch (Bulgin, type S.88).

Connecting wire (Jiffilinx).

Six yards of thin flex (Lewcoflex).

Eight wander plugs marked: H.T.—, H.T.+1, H.T.+2, H.T.+3, H.T.+4, G.B.—, G.B.—2 (Belling-Lee, Clix, Eelex).

Two spade terminals marked: L.T.—, L.T.— (Belling-Lee, Clix, Eelex).

ACCESSORIES

Loud-speaker (Amplion, H.M.V., Blue Spot, W.B., Celestion, B.T.H.).

H.T. battery (Drydex, Ever-Ready, Fuller, Palaba, Pertrix).

G.B. battery (Drydex, Ever-Ready, Fuller, Palaba, Pertrix).

L.T. accumulator (C.A.V., Ever-Ready, Exide, Fuller, Pertrix).

PANEL 14x7

CONTROL
50,000 ohms

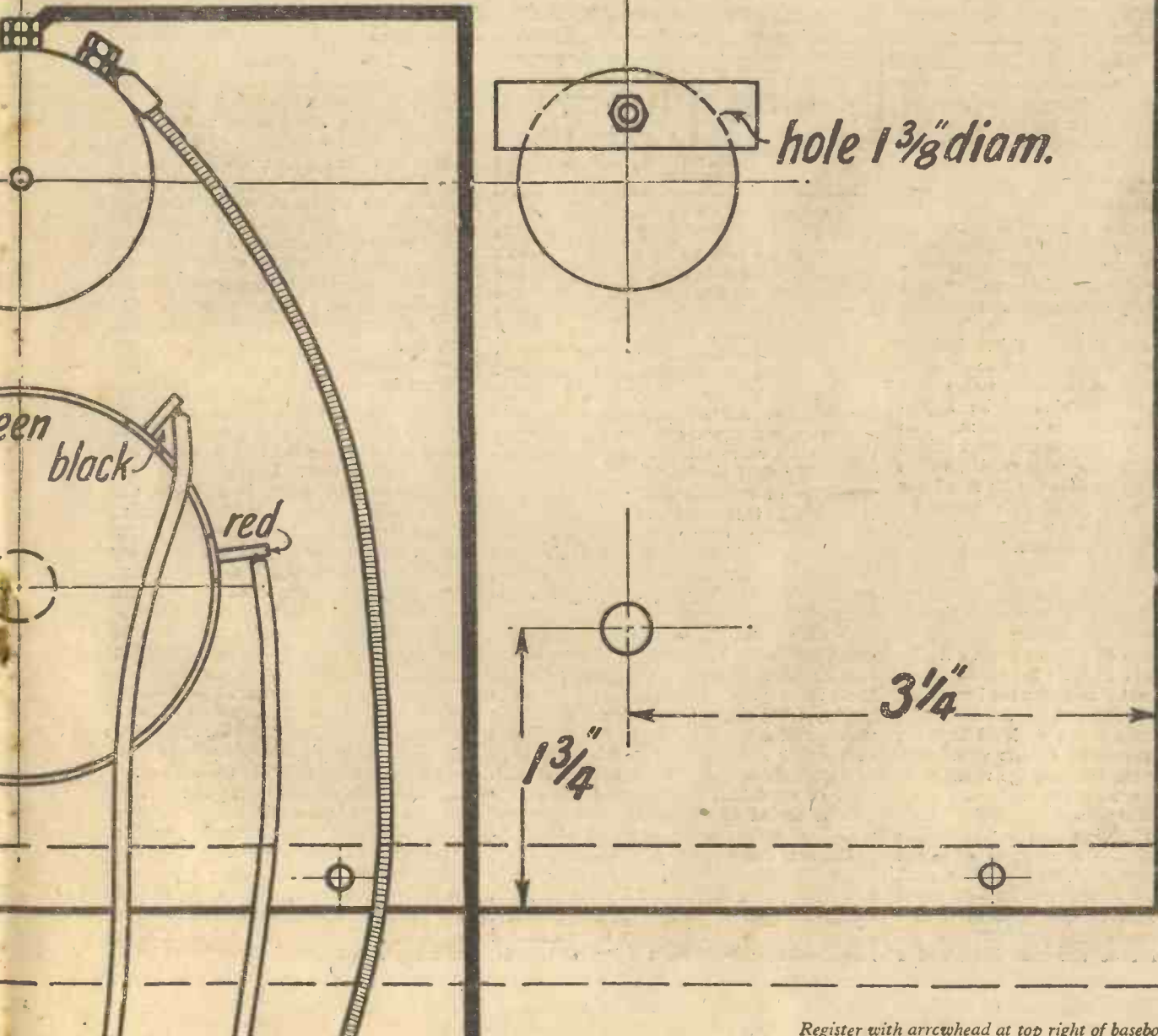

Register with arrowhead at top right of baseboard layout.

BAND PASS FILTER COIL

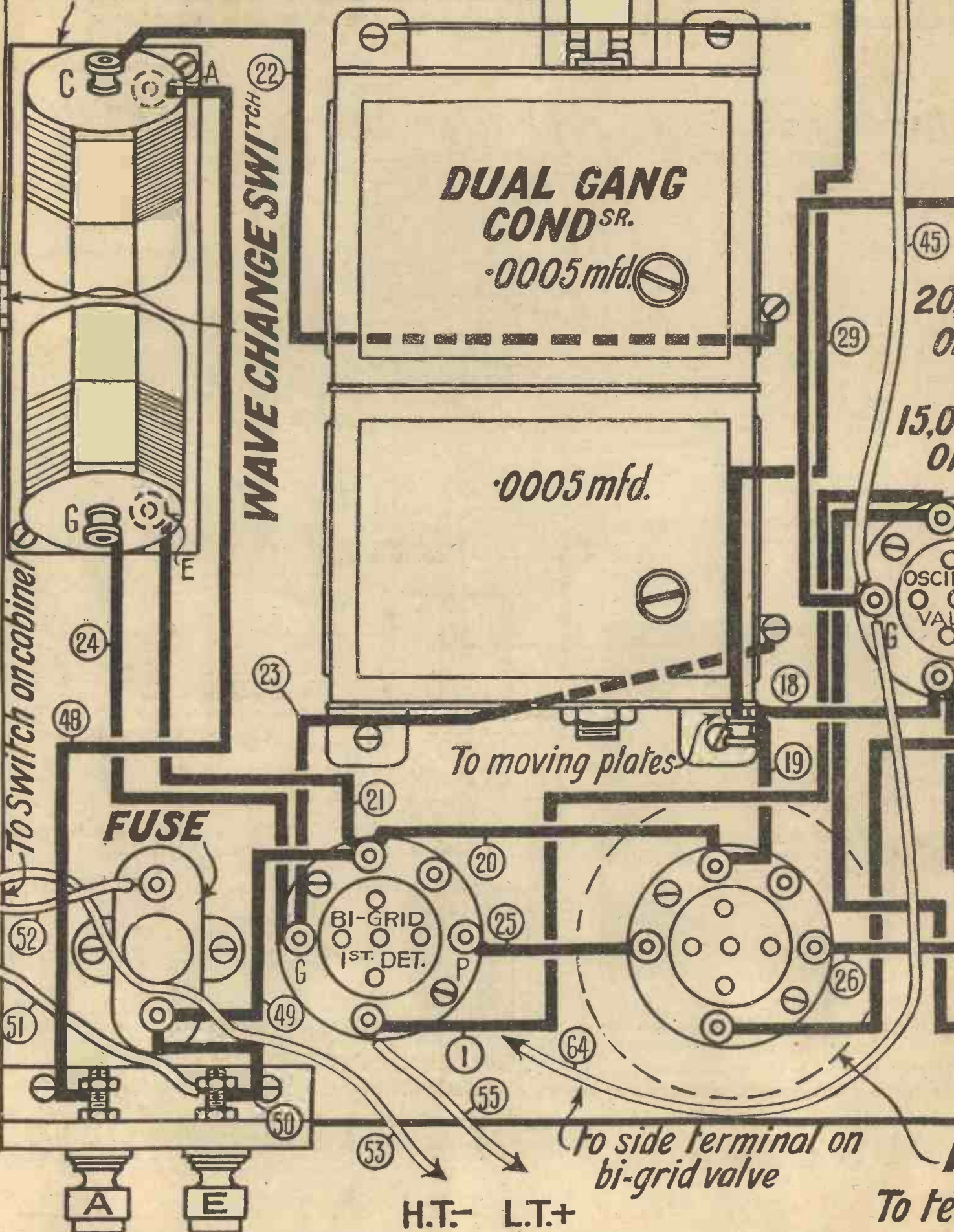

"BRITAIN'S SUPER"—FULL-SIZE LAYOUT FOR BASEBOARD

BASEBOARD 17" x 9 1/2"

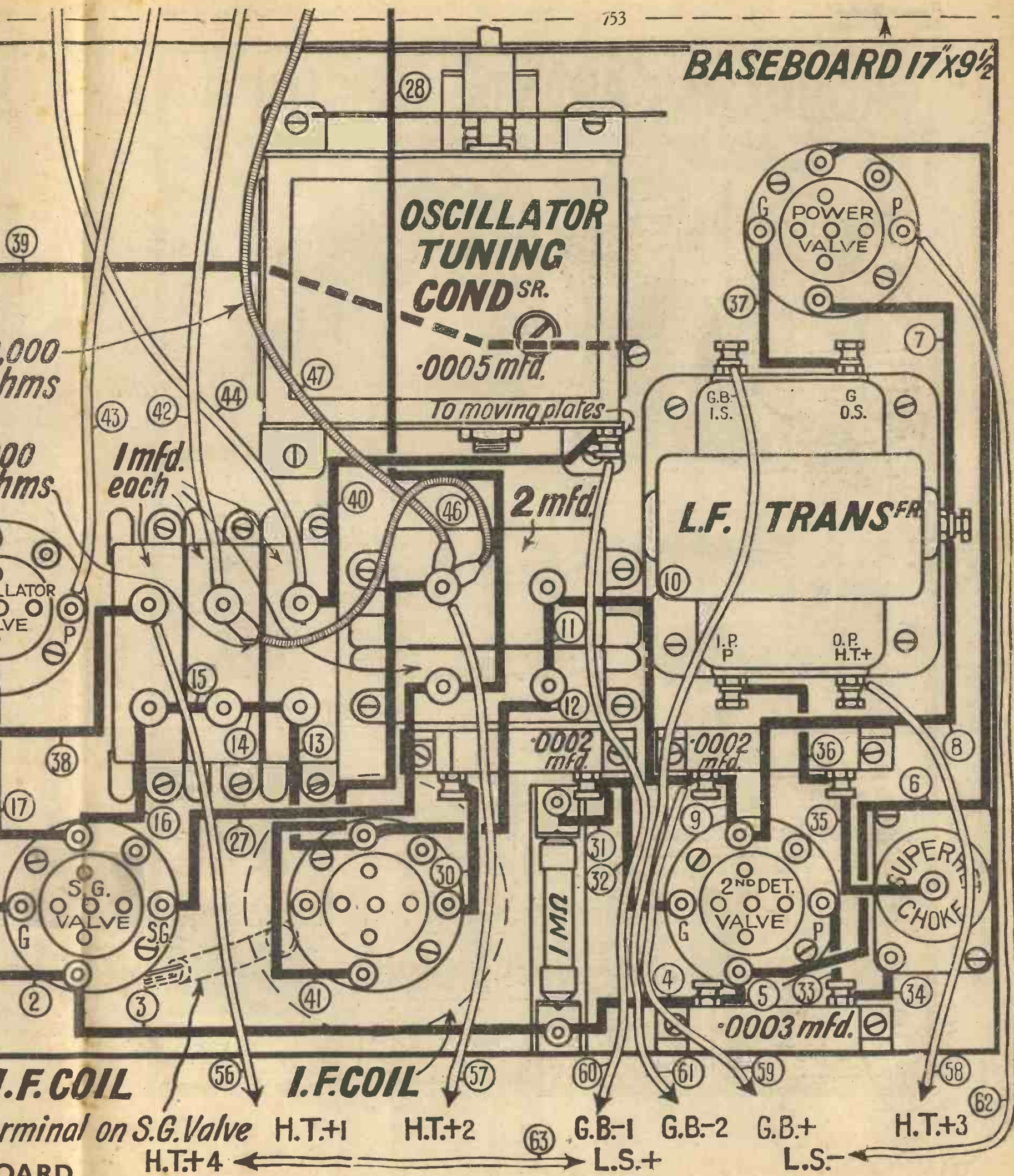

**OSCILLATOR
TUNING
COND^{SR.}**

.0005 mfd.

To moving plates

L.F. TRANS^{FR.}

G.B.
I.S.

G
O.S.

I.P.
P

O.P.
H.T.+

.0002 mfd.

**2ND DET.
VALVE**

**SUPERREG.
CHOKE**

.0003 mfd.

I.F. COIL

I.F. COIL

Terminal on S.G. Valve

H.T.+1

H.T.+2

G.B.-1

G.B.-2

G.B.+

H.T.+3

BOARD

H.T.+4

L.S.+

L.S.-

TELSEN DUAL-RANGE COILS

TELSEN DUAL-RANGE AERIAL COIL

The Telsen Aerial Coil is the very latest development in dual-range aerial coil design. It incorporates a variable series condenser which can be set to give any desired degree of selectivity, making the coil suitable for all districts, whatever reception conditions may be. It has been tested in various parts of the country, and down to distances of five miles from Regional stations, a single tuned circuit will definitely separate the Regional programmes. This adjustment also acts as an excellent volume control and is equally effective on long and short waves. The waveband change is effected by means of a three-point switch. A reaction winding is provided and the primary and secondary windings are separated so that the aerial circuit can be isolated in mains driven or screened-grid receivers.

Telsen Aerial Coil with Variable Series Condenser incorporated. Price **7/6**

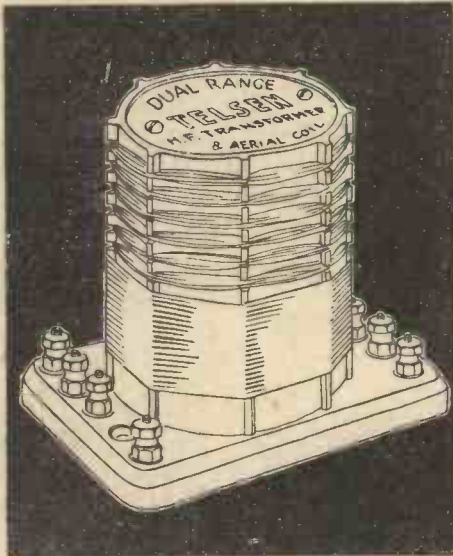
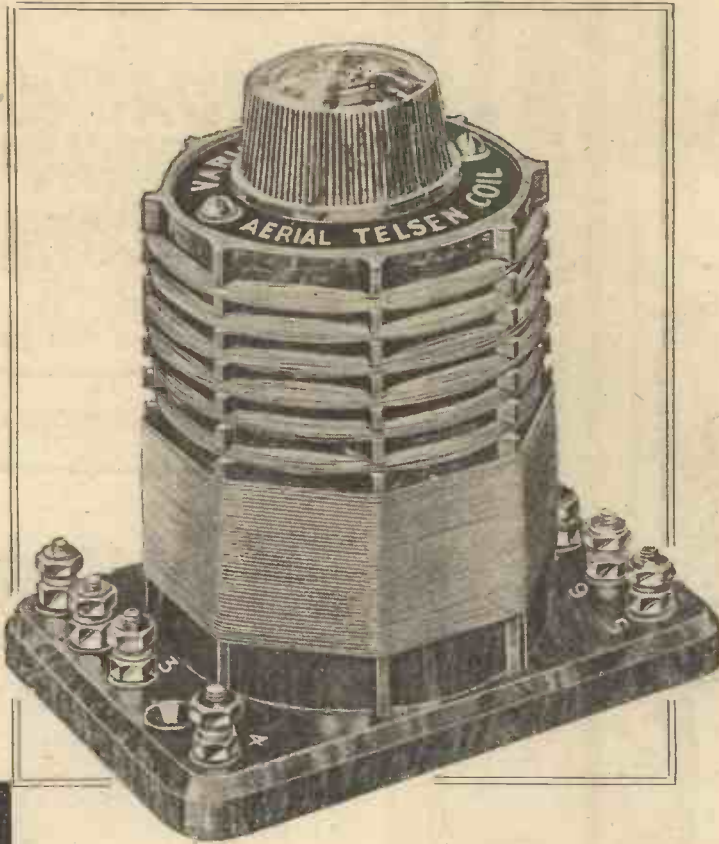

Send for the "Telsen Radio Catalogue" and book of "All-Telsen Circuits" to The Telsen Electric Co., Ltd., Aston, Birmingham.

TELSEN H.F. TRANSFORMER AND AERIAL COIL

This Coil is primarily designed for H.F. amplification in conjunction with screened-grid valves. It is arranged so that it can be connected as a tuned-grid or tuned-anode coil, or alternatively as an H.F. Transformer.

It also makes a highly efficient aerial coil where the adjustable selectivity feature is not required. A reaction winding is incorporated. When used as an H.F. Transformer the wave-change is effected by means of a two-pole (four-point) switch. When connected otherwise a three-point switch should be used.

Telsen H.F. Transformer and Aerial Coil ... Price **5/6**

TELSEN

THE SECRET OF PERFECT
RADIO RECEPTION



OUR BROADCAST CRITIC

TALKS ABOUT— POPULAR BACH

I HAVE been to all the Bach Proms. this season and am perfectly satisfied regarding his unquestionable popularity at Queen's Hall. Not even Haydn or Mozart or Beethoven has equalled him in the matter of drawing capacity.

I must have been to some hundreds of concerts in Queen's Hall, but I never beheld such a sight as at the last of the Bach Proms.

The Prom. itself was packed to suffocation and every seat was sold.

The enthusiasm that greeted the superb playing by Ethel Bartlett and Rae Robertson of the C Major Concerto for two pianofortes and strings was certainly exceptional—even for a Prom. audience—and it was thoroughly deserved.

What delighted me was the fact that neither of them overdid the tone and both showed their refined musical upbringing by their judicious use of the pedal.

I have no use for people who play Bach without pedal.

A word to the good Robert Murchie, whose flute-playing is so splendid in the technical sense.

May I say, sir, that you have played that Suite too many times?

The next time you play it I shall expect to hear something different in the way of interpretation.

And don't hurry some of those passages in the last movement!

Nevertheless, I enjoyed it.

I happened to be in at lunch-time one day and heard an excellent concert from the Prince's Ballroom, Midland Hotel, Bradford.

I am glad to think that mid-day listeners are so well catered for.

The playing of Norman Rouse and Edgar Knight in the Brahms and Faure piano and violin sonatas was very pleasing.

Thus encouraged, I switched into the other programme and caught Cunningham playing on the organ at Birmingham Town Hall.

I was a trifle disappointed to hear some variations on "Drink to Me Only with Thine Eyes," as I have always disliked the tune, but I thought the tone of the organ sounded attractive.

I listened for some time to the school transmission and thought Mr. Mais was splendid in the literature talk.

His voice is always pleasant and micro-

phonically useful; his matter was of the best and calculated to thrill any youngster.

The Thursday-night vaudeville was certainly a departure from the usual procedure.

Farr and Farman "upset the programme" according to plan; once or twice I wished them as far as their names suggested; on the whole they were entertaining, but there were some very poor lines.

"Those Four Chaps" ought to put their four heads together and think hard.

Some of their matter was very amusing; some of it was filling-in material.

There is no place in a wireless programme, in my opinion, for padding of any sort or kind. We must have the goods *and nothing but the goods*. I shall make a practice of quoting poor jokes if we continue to have them at the rate we have had them recently.

I listened to Ernest Newman for the first time for some months.

I think he should appeal to music enthusiasts who themselves understand a little, but he misses the general public by miles.

However, I do think that a little time spent in listening to the views of a music critic are well spent, though I found myself quarrelling with him on Hindemith.

Stanley Holt's Dance Orchestra is one that is well worth hearing; I thought the balance of tone was all that it should have been and that the rhythmic quality of the playing was exceptionally good.

I listened to the Gershom Parkington Quintet again on a Saturday afternoon. I think there is a tendency for this kind of quintet to degenerate into a café band.

Having little to offer in the constructive sense, I honestly suggest to Mr. Gershom Parkington that he strikes out on some new line of thought. It all sounded a little stale to me. On the other hand, I recognise that the quintet does a good deal of broadcasting and is entitled to every respect on that account.

Harold Williams sang splendidly in the military band programme on Sunday afternoon. His rendering of Schubert's *Erlik* was very ingenious. His is a fine voice.

The Lutenist Music broadcast was quite entertaining.

I think a Sunday afternoon is an ideal time for experiments of that kind.

I have always been definitely against too much religious matter in the Sunday programmes and I think that old-world music, such as was given by Rudolph and Millicent Dolmetsch, Diana Poulton, and John Armstrong, strikes a reasonably dignified note.

The B.B.C. might do worse than arrange more programmes of music-with-a-history-to-it, so to speak, during the winter months.

The final Prom. went off with a bang as usual. The Promsters thoroughly enjoyed themselves.

The hall was, of course, packed to suffocation.

As I looked down into the Prom. from the circle I found myself wondering whether any of us were there honestly for the music alone.

Sir Henry gives practically the same programme every year and the same amusing incidents generally repeat. There was one extra this year; his conducting desk fell into the piano, which was none too good for the piano. Unfortunately, it knocked several notes out of tune and, in consequence, Irene Scharrer's playing of the Liszt concerto suffered considerably.



Foster Richardson in Cartoon

WHITAKER-WILSON.

BRITAIN'S

A Band-pass Five-valve Super-het for
Specially Designed for AM



**CHEAP TO BUILD
AND
RUN**

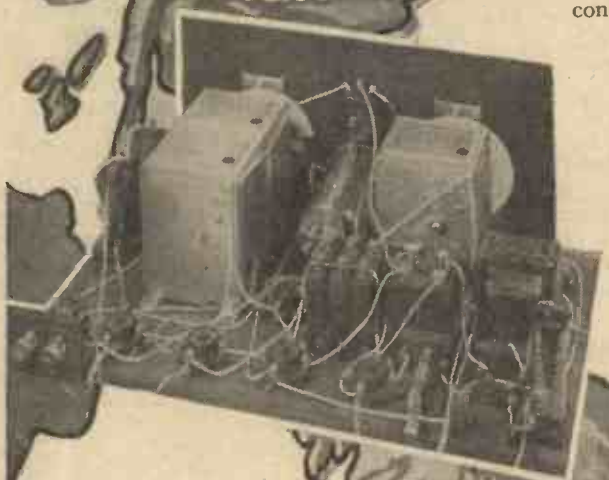

**UNEQUALLED
RANGE AND
SELECTIVITY**

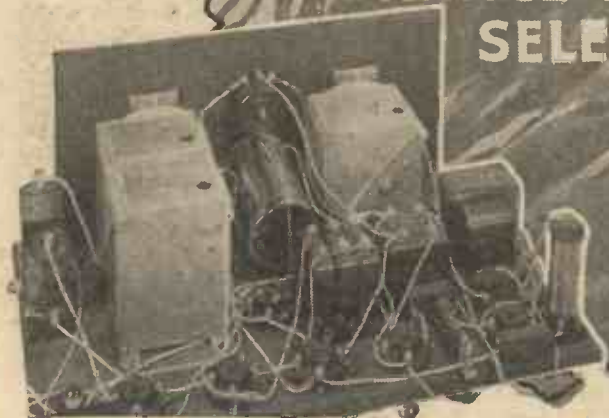

THIS is a five-valve super-heterodyne receiver for use with an open aerial and earth.

There are six tuned circuits, but four of them are tuned to a definite wavelength by the manufacturers. The other two are connected between the aerial circuit and the first valve. They form a highly efficient band-pass tuner, with one control for tuning.

If you look at the circuit diagram you will see that the aerial is connected to a fixed condenser. This is included in the Lewcos band-pass tuner and it has a very small capacity. Its effect is to reduce the load of the aerial and earth circuit upon the tuner. The tuning is, therefore, more consistent and sharp. No other condenser is needed in the aerial wire to the set.

A single aerial coil is shown connected between the aerial condenser and earth, but

actually this is of the double-range type. For tuning a .0005-microfarad variable condenser is used. This tuning condenser is one half of a two-gang condenser. The second half tunes the second coil, which is coupled to the one included in the aerial circuit. Thus the two coils and the two condensers form a tuning unit.

This circuit has the correct band-pass

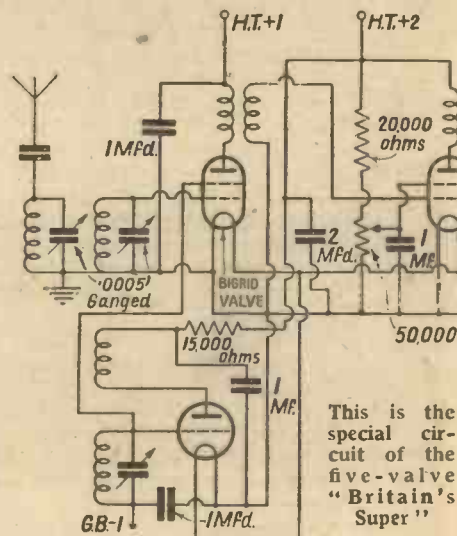

characteristics over both medium and long wavelengths. Tuning is sharp, but the signals are not distorted because the circuit is designed to pass a band of frequencies.

Selectivity

The width of the band is fairly constant over the whole tuning range and so the aerial circuit tuner is selective over the whole range. At the same time the signal strength applied to the first valve does not suffer material reduction for the reason that the coils are suitably coupled. The design of the band-pass aerial-grid circuit is, in fact, such that the necessary selectivity is obtained and signal strength is not sacrificed.

With such a good input circuit we have a good chance of keeping unwanted signals out of the rest of the set. But here we are helped by the super-heterodyne action. The

Full-size layouts and wiring
with the list of components a

"SUPER"

or use with an ordinary Aerial and Earth.

ATEUR WIRELESS by W. JAMES

first valve is of the four-electrode type and the input circuit is connected between one of the grids of the negative side of the filament circuit.

To the other grid is joined the oscillator. The oscillations applied to the grid are of a strength found by experiment to be sufficient for a valve of this sort. The operation will be better understood if the whole

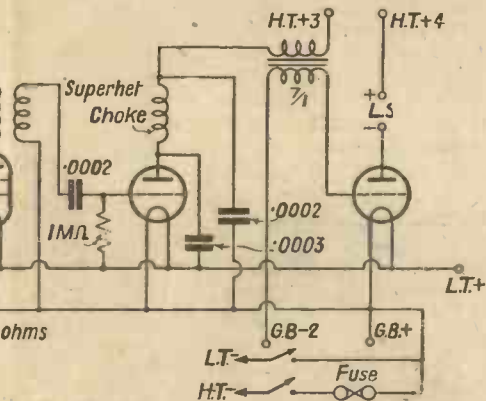

valve and its circuits are considered. In the anode circuit is a band-pass coil having a natural frequency of 126 kilocycles. The primary and secondary coils are tuned and coupled, and the complete unit passes a band of frequencies. This is fixed by the makers and no further adjustment is required.

The complete band filter is fitted in a copper shield and has definite characteristics.

To the end of the primary, at terminal H.T.+1, we apply such a voltage from the high-tension battery that the four-electrode valve is working as a rectifier.

If the current is measured with the oscillator disconnected or the oscillator valve out, the current flowing in the anode circuit will be about .1 of a milliamp. The exact value is not of much importance, provided the current is small and of the order of .1 milliampere. When the oscillator is connected, however, the current increases. It increases, perhaps, to .75 milliampere, according to the strength of the oscillations produced by the oscillating circuits. The incoming signal

is, therefore, efficiently rectified and combines with the locally-produced oscillations to create a signal having the mean frequency of 126 kilocycles. This is the frequency of the long wavelength amplifier.

We, therefore, have passed to the screen-grid valve signals of this frequency. The action of the oscillator when tuned is to produce signals of the frequency of the long wavelength amplifier and to improve the selectivity.

The "Mixer"

There is no direct connection between the oscillator and the aerial or anode circuits. The oscillator is connected to one grid and the aerial circuit to the other. Both circuits affect the current flowing in the anode circuit, and for this reason the four-electrode valve is usually referred to as the mixing valve.

Both sets of oscillations are applied to the grids and in the anode circuit appears the signal received, but having a different wavelength. The idea, briefly, is that the signal may be effectively filtered and magnified at a fixed wavelength.

There are four fixed-tuned circuits, two comprising the first band-pass filter, connecting the mixing valve and the grid circuit of the screen-grid valve, and two in the second band-pass filter, which couples the anode circuit of the screen-grid valve and the grid of the second detector.

These two band-pass filters are accurately made by the manufacturers. They are totally screened in copper pots and have bases with pins, in order that they may be plugged into ordinary valve holders. One of the units has a flexible lead for connection with the anode of the S.G. valve.

A leaky-grid detector is used to rectify the long wavelength signals. A grid condenser of .0002 microfarad is used with a grid leak of 1 megohm. These are usual values for effective detection with good quality.

In the anode circuit we have a good filter to prevent the passage of the high-frequency oscillations into the low-frequency circuits. It comprises, first, a .0003-microfarad condenser between the anode of the detector and the filament. Then comes the special high-frequency choking coil. This choke acts at a longer wavelength than most standard products.

H.F. Filtering

After the choke is a .0002-microfarad fixed condenser, which passes to the filament circuit any slight amount of high frequency that passes the choke. This effective high-frequency stopping circuit is of great assistance in allowing the maximum amplification to be obtained and in preserving the good quality.

Following this is a high-ratio transformer to the power valve. A separate high-tension tapping is provided for the detector, at H.T.+3. There is also a tapping for the screen-grid and oscillator valves, at H.T.+2, and the power valve may be joined to this tap as well. It is shown connected to H.T.+4, as this may help those who will use a mains unit, but in the case of battery users, H.T.+2 and H.T.+4 may well be connected together.

The volume is controlled by a potentiometer joined to the screen-grid valve. We have a 20,000-ohm fixed resistance connected to a 50,000-ohm potentiometer. The screen of the screen-grid valve is joined to the contact of the potentiometer, which also has a 1-microfarad condenser connected to it.

With a 120-volt supply of high tension the leakage current from the battery through the potentiometer circuit is 1.7 milliamperes. We, therefore, provide a switch, which breaks both the high- and the low-tension circuits when the set is "off." The volume control is satisfactory in that the

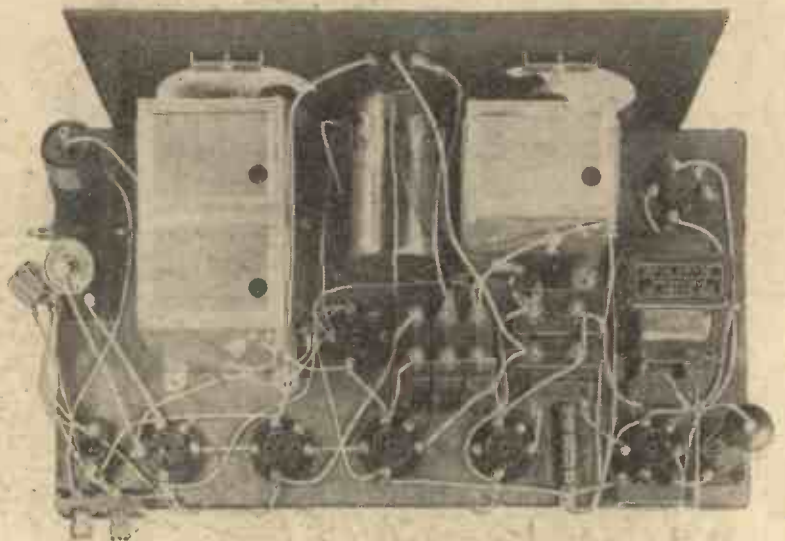

This plan view will be helpful in following the wiring diagram of the baseboard given on pages 748 and 753

guides for panel and baseboard, together are given on pages 746, 748, 753 and 755

“BRITAIN’S SUPER”—A New James Set (Continued from preceding page)

signals can be reduced in strength from the maximum to a whisper. Too much pressure cannot be applied to the screen of the valve owing to the 20,000-ohm fixed resistance.

There is a fuse in the high-tension circuit which will protect the valves in the event of the high tension being applied by accident to the filaments of the valves.

This fuse normally glows for a moment

The strength of the oscillations depends upon the valve and the coils. To an extent the setting of the tuning condenser affects the strength, but the anode circuit resistance has a levelling effect. If the resistance is reduced in value the oscillations are increased in strength, but the value given is a good average one and need not be altered.

the oscillator and long wavelength filter coils.

It is not necessary to shield the aerial filter unit, and ordinary valves may be used. The aerial filter coil is arranged at one side of the set and the spindle attached to the wave-range switch is arranged to project through the side. Near it is the battery switch.

Controls

On the front panel are the controls of the aerial-filter circuit condenser, the oscillator condenser, the oscillator coil wavelength switch, and the volume control. These can be seen in the photographs and the full-size diagrams printed in this issue. The full-size layout of the panel shows the exact positions of the parts.

In the centre, but at the bottom, is the oscillator coil unit. Just above it is the volume control potentiometer. Then on each side are the tuning condensers, having windows through which the scales are seen.

The second full-size diagram is of the parts upon the baseboard. At one end is the aerial-filter coil and next to it the two-gang tuning condenser. In a row at the back are the valve holders for the valves and the two plug-in band-pass coils, but the oscillator valve is nearer the panel and the power valve is between the low-frequency transformer and the panel. All parts are easily fixed, as there is ample room.

Here are two points which will interest the constructor. First, the set has been tested with Mullard valves, types PM1DG, PM2DX, PM12, PM1HL and PM2A. Alternatives will be given next week. Second, a “Britain’s Super,” built from a REDI-RAD kit of parts, is on show in the Radio Department windows of Messrs. Selfridge, of Oxford Street, London, W.

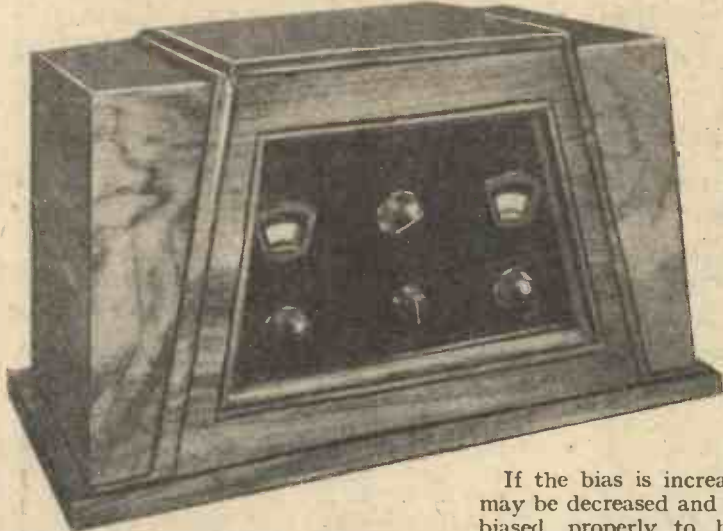

The complete “Britain’s Super.” This particular cabinet was specially designed by Ready Radio, Ltd.

when the set is switched, owing to the charging of the condensers.

The connections of the oscillator are interesting. A shielded unit with switch is used and is connected to the grid and plate of the valve. Bias is applied to the oscillator, at G.B.—1, and the anode current is restricted by the 15,000-ohm fixed resistance joined in the anode circuit.

Both the bias and the anode resistance are shunted with 1-microfarad condensers.

If the bias is increased the oscillations may be decreased and the valve should be biased properly to have oscillations of suitable strength with the minimum of anode current.

Oscillator Connections

You will notice that the grid of the oscillator is connected to the second grid of the four-electrode valve. Therefore the bias is applied to both valves.

No shielding is used, apart from that included in the parts themselves. The tuning condensers are shielded, and so are

MR. FLEX WANTS TO UPLIFT HIMSELF—



—AND MRS. FLEX BRINGS HIM DOWN WITH A BANG



BROADCAST ARTISTES IN PICTURE



NORMAN BAYNES.—Best known for his afternoon talks on World History



PETER HOWARD.—One of the most popular of B.B.C. baritones, Mr. Howard has been heard at many important studio concerts



EILEEN TUNBRIDGE.—A charming soprano heard on the London Regional on Sept. 25



STUART WILSON.—A famous tenor, he was chosen for the last but one of the Promenade Beethoven programmes to sing the famous song cycle, "To My Sweetheart"



MAY BLYTHE.—One of the best known operatic stars from Covent Garden



STANLEY KAYE.—A pianist with a wonderful technique and an inexhaustible range of compositions at his command



HORACE PRIESTLEY.—A well-known provincial tenor, Mr. Priestley most often broadcasts in Midland Regional programmes



LESLIE HEWARD.—A brilliant pianist, played recently at the Philharmonic Midday Concert from Birmingham



WYNNE RICHMOND.—A comparatively newcomer to wireless, she has a wide comedy experience



L. DU GARDE PEACH.—Playwright and journalist, has broadcast and written more than a hundred radio plays



HARRY HOPEWELL.—A baritone popular at all stations, he is also a student of the Royal Academy, solo baritone of Manchester Cathedral



MABEL CONSTANDUROS.—Mrs. "Buggins" of the "Buggins" family fame. Over 250 of the "adventures" have been broadcast and recorded!



ERNEST SEFTON.—One of the best known of revue artistes who has been especially connected with the Charles Brewer revues

For the Newcomer to Wireless : 'PHONES AND "DX"

INDULGE, as you know, a good deal in long-distance reception. Don't you think that I should receive many more stations if I used telephones whilst searching?

I'm 'quite sure that you would and I feel pretty certain about another point. And that is?

Just this. However skilled and careful you may be it is almost impossible when you are tuning in direct on to the loud-speaker to avoid oscillating occasionally for a moment when you are searching for weak and distant transmissions.

Why exactly?

Because you cannot hear the signs of incipient oscillation. You don't know what is happening until the set suddenly howls.

I'd like to know more about that.

If you search with telephones you can keep the set just a little below the oscillation point, which is its most sensitive condition. You hear a weak signal from some distant or low-powered broadcasting station. Can it be worked

up to respectable strength? You move the reaction control knob very slowly and signal strength shows an increase. But presently your ears are conscious of a slight rustling noise rather like that made by the wind playing upon dead leaves. You know immediately that the set is on the verge of oscillation and that you can go no further. Tune direct on to the loud-speaker and the odds are heavily against your hearing this premonitory symptom.

Why do you say that I shall find more stations with telephones?

Simply for this reason. With a multi-valve set it is not easy to keep the tuning condensers exactly in step and even a moderately powerful station may provide only a very weak signal when it is first heard. Strength, in fact, may be so small that it will not be audible if you use the loud-speaker. With the telephones, though, you can hear it and you can bring it up to strength by fine tuning.

I follow that; what sort of 'phones shall I use?

Here you are up against two rather important points.

What are they?

First of all the modern loud-speaker has usually a rather low resistance, whilst the average 'phones have a resistance of from 2,000 to 4,000 ohms. Secondly, do you work off the mains?

My broadcast receiver is mains-operated but I work my short-wave set from batteries.

Well, it is certainly inadvisable to connect telephones directly to a mains-operated set, unless it incorporates an output transformer.

What would you advise?

It is not half a bad idea to have a separate output transformer wound specially for telephones outside the set altogether. The 'phones are kept connected permanently to the secondary and you can arrange on your set a pair of 'phone terminals to which the primary is also connected. By means of a switch you can throw either 'phones or loud-speaker into operation.

IN this country we used to be—and to some extent we still are—rather frightened of any receiving set containing more than two or three valves. We still regard four- and five-valvers as big sets, whilst receivers with six or seven valves are giants. In the United States, on the other hand, wireless reception has developed on quite different lines. If there were such a thing as a four-valver it would be classed as a midget, for the standard American set (by which I mean the receiver in general home use) incorporates from seven to eleven valves.

What it all comes to is this. British listeners are demanding of valve makers and set designers that every valve and every amplifying stage shall be super-efficient; the last possible ounce must be got out of each. Very different from this is the attitude of the American public, which says to those responsible for its receiving equipment: "Use heaps of valves, and let each stage, whether high or low frequency, give just a little amplification."

Which is Right?

We have, then, two sets of opinions diametrically opposed to one another on the different sides of the Atlantic. Which party is right and which wrong?

Myself, I do not think that for broadcast reception there is any call for the best part of a dozen valves; but I do hold that for the very best all-round results we should do well to increase the average number of valves in use in our receivers.

At first sight the advantages of the highly efficient set containing but a few valves are overwhelming. But some of these advantages are more apparent than real. Put the question to the first half-dozen of your wireless friends that you meet and probably five out of the six would answer it by telling you that the initial cost of a

USE MORE VALVES!

little set with few valves must always be much lower than that of a big set with many. But is this really a fact? I don't think it is. To get the utmost out of your few valves you must use couplings in the form of coils or transformers of the highest excellence and these things are costly. With many valves, though, you have so much in hand that less efficient and therefore less costly components will do all that is necessary. AMATEUR WIRELESS, always a pioneer, has already shown that you can build a six-valve set for less than a £10 note. My first single-valver, built before the days of broadcasting, cost me more than double this amount.

Valves are cheap nowadays, whilst components of high efficiency are relatively expensive. In initial costs, therefore, money may actually be saved by the use of more valves.

Next comes the question of running costs, and here again the advantages of the small set over those of the big fellow are apt to be illusory. If you work direct from the mains, using either A.C. valves or battery valves and a trickle charger, the total cost of running a six- or seven-valve set is in any case trifling. If you compare it with that of operating a two- or three-valver over a period of twelve months you will find that you are concerned with pence and shillings rather than with pounds.

For those who use batteries the case is a little different, though here again the running expenses of the big set are not nearly as great as is often supposed. I run a seven-valve set off batteries myself,

so I can speak from first-hand experience. Since I am something of a quality maniac I use a very low impedance valve for the output with a high plate voltage. For this reason the total H.T. consumption is about 40 milliampères, which means that a 5.5 ampere-hour accumulator H.T.B. gives me about seven weeks of beautiful reception for each refill. The filament accumulator has just about the same story to tell. Add up the total charging costs for a year and divide it by the number of hours of pleasure that you have had from your wireless set and you will be astonished to find how small the cost is.

Where it Scores

The big set scores in many important ways. The more valves you use the more likely are you to obtain really sharp tuning without distortion. Reaction, with all its attendant drawbacks, is cut clean out; instead of working *up* signal strength you have in most cases to work it *down* by means of the volume control in order to avoid overloading both the output valve and your own ear-drums by excessive volume. There is always something in hand. Your whole equipment is working well within itself and this to my mind is the condition of affairs which makes for the greatest possible pleasure in reception.

The more valves you use the less troubled are you by instability, for it is an axiom of wireless that any amplifying stage becomes more and more difficult to hold down to earth as it approaches the possible limit of its magnifying powers.

Quality, too, is distinctly better, for the smaller the number of valves and the greater the work demanded from each the more liable is distortion to creep in. Get rid of the two-valve complex. Become multi-valve-minded. Use more valves and march with the times!

H.



BATTERY EQUIPMENT

	£	s.	d.
consisting of:			
1 Complete kit of components, including valves and cabinet (KIT "C")	12	0	0
1 Pertrix 120-volt Super Capacity H.T. Battery	1	5	6
1 Pertrix 2-volt 30-amp. L.T. Accumulator type PXG.3	11	0	
1 Pertrix 9-volt Grid Bias Battery	1	6	
1 British Blue Spot Cabinet Loud-speaker, type 44R	2	12	6
Total	£16	10	6

Or 12 monthly payments of 30/3

The complete kit as above, but with completely assembled receiver (including Royalties).

Everything you need for perfect radio reception ... **£19 0 6**

Or 12 monthly payments of 34/10

A.C. MAINS EQUIPMENT

	£	s.	d.
consisting of:			
1 Complete kit of components, including valves and cabinet (KIT "C")	12	0	0
1 Ready Radio Mains Unit with trickle charger	5	17	6
1 Pertrix 2-volt 30-amp. L.T. Accumulator, type PXG.3	11	0	
1 Pertrix 9-volt Grid Bias Battery	1	6	
1 British Blue Spot Cabinet Moving-coil Permanent Magnet Loud-speaker	5	10	0
Total	£24	0	0

Or 12 monthly payments of 44/-

The complete kit as above, but with completely assembled receiver (including Royalties).

No re-charging worries. Everything for mains operation **£26 10 0**

Or 12 monthly payments of 48/9

IMMEDIATE DISPATCH

READY RADIO MAINS UNIT

Specially designed by Mr. G. P. Kendall, B.Sc., Chief Engineer of Ready Radio, Ltd., for use with the "Britain's Super." Fully decoupled with four separate positive tapplings specially adjusted to suit the receiver. Gives ample output and adequate voltage. Price

£5 17 6

CASH OR EASY PAYMENTS

ORDER FORM ON PAGE 744

Ready Radio
 SHOWROOMS:
 159, BOROUGH HIGH STREET
 LONDON BRIDGE S.E.1.
 EASTNOR HOUSE,
 BLACKHEATH S.E.3.

See also pages

737	744	765
738	759	767
743	763	771

Showrooms: Hop 3000.

Grams: Readirad, Sedist.

Phone: Lee Green 5678.

Advt. of Ready Radio Ltd.

Don't Forget to Say That You Saw it in "A.W."

MAKING A RECTIFIER METER

By J. H. REYNER, B.Sc., A.M.I.E.E.

FEW people who have occasion to use a milliammeter will question its undoubted utility. One is able to diagnose troubles much more quickly if the currents in various parts of the circuit can be checked up and their values compared with normal. When we are dealing with A.C., however, ordinary D.C. instruments are quite unsuitable for the purpose.

The metal rectifier, of the same type as is used for providing H.T. supply, affords

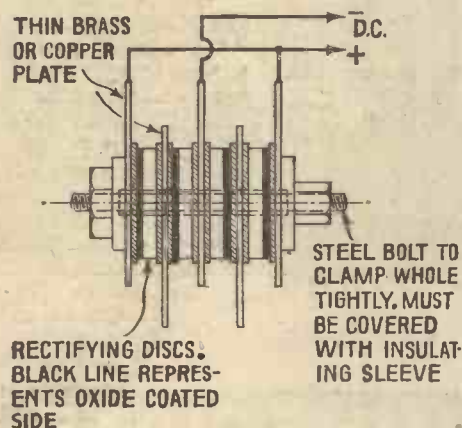

Fig. 1. The connections of the meter rectifier bridge

a convenient solution of the problem if one is prepared to take a little trouble. If the alternating current can be rectified and the meter supplied with the rectified current, the same instrument as is used for D.C. measurements can be used with this converter attached for A.C.

I propose in this article to discuss one or two points in connection with the use of rectifiers for measurement purposes, because there must be numbers of readers who are prepared to spend a little time in making up a converter of this sort. All that is necessary for the rectifier is a simple bridge arrangement comprising one rectifying disc in each arm. Fig. 1 shows just how such a bridge is made up, and how the connections are arranged. The Westinghouse people supply these special meter bridges housed in a small bakelite containing case. Three models are made, to carry 1, 5, and 10 milliamperes respectively, the price being 25s. in each case.

A Metal Rectifier

Alternatively, if the reader has a metal rectifier which is not being used, he can dismantle it and build up a number of small bridge rectifiers. The assembly will be clearly understood from the diagram and, of course, if one has an old rectifier handy, this way of doing it is more economical although it involves a little more trouble.

Assuming that we have a rectifier, it is now necessary to connect it to the circuit as shown in Fig. 2. The alternating current will now be converted into uni-directional pulses which are passed through the meter. No form of smoothing condenser must be used as this is quite unnecessary for one

thing, and for another it will introduce difficulties into the calibration. If this rectified output is passed through the meter, a reading will be obtained proportional to the average value of the current.

Meter Readings

The reading on the meter will be approximately the same as before. Thus if the D.C. meter reads 2 milliamperes full-scale deflection then we shall obtain a full-scale deflection with an alternating current of which the average value is 2 milliamperes. In alternating current practice, however, we do not measure the average value of the current, but what is known as the R.M.S. value. In order to compare an alternating current with a direct current we set both currents to do certain work, and say that the two currents are equal if they both do it equally well. Such work might be the heating of a wire. Now the heating effect of a current is proportional to the square of the current and the resistance of the wire. Therefore, if we pass an alternating current through the wire, the average heating action must be the same as that produced by the D.C. In other words, the average or mean value of the square of the current over the whole cycle must be the same as the square of the D.C. and the effective value of the alternating current is the square root of this Mean Square—or the R.M.S. for short.

This minor digression is necessary to show why the effective value of the current as taken for normal purposes is not the same as the mean value of the rectified currents. It is in fact slightly larger, being 1.1 times the mean value for a pure cycle. Therefore, from this point of view if we have an alternating current of which the average value is 2 milliamperes, its effective or R.M.S. value would be 2.2 milliamperes and this effect has to be taken into account when calibrating the instrument as is discussed later.

There is another precaution to be taken with these rectifiers. The matter is not a serious one if the measurements are not intended to have a high order of accuracy,

DO YOU KNOW—

THAT when batteries are used throughout, the grid bias value should be watched? If the bias is set correctly at 120 volts H.T. it will be too great when the H.T. battery drops to 100 volts.

THAT an improvement in the tone obtained with a pentode can sometimes be effected by connecting a grid-leak across the secondary of the transformer? A .5-megohm leak is often suitable.

THAT a choke used in an output unit should have an inductance of at least 20 henries when, say, 10 milliamperes H.T. current is flowing? In an output unit one should always choose a choke which has a sufficiently high inductance when the normal anode current of the power valve is flowing. Some chokes drop considerably in inductance with a steady D.C. current.

or if one's methods of calibration are not very reliable. The fact is that the metal rectifier exhibits an appreciable variation in rectifying properties with temperature so that the calibration of a simple rectifier meter changes according to whether the room in which it is used is hot or cold.

Fortunately, there is a solution to this difficulty as was pointed out by E. H. W. Banner (*Electrical Review*, May 10, 1929). This remedy lies in shunting some of the current so that only part of it goes through the meter, the proportions being about two-thirds through the meter and one-third through the shunt. A shunt for this purpose can conveniently be made up in the following manner.

Operation

Connect the meter across the rectifier as shown in Fig. 2 and pass a small alternating current through it sufficient to give a full-scale deflection. This may conveniently be done by connecting the meter in series with a variable resistance of several hundred ohms across the 4-volt heater winding of a transformer. Having adjusted the current to the full-scale reading, connect a resistance across the A.C. input terminals of the rectifier, and adjust this resistance until the reading on the meter is about two-thirds the full scale deflection.

The resistance will, usually, have to be a few hundred ohms. If the resistance is too small, then an undue proportion of the current is shunted, and the reading on the

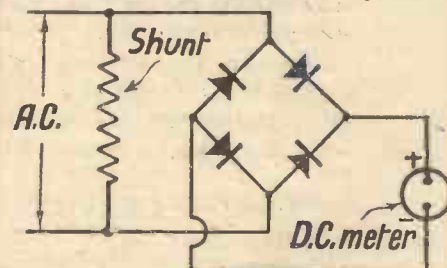

Fig. 2. How the bridge is connected in circuit

meter will be reduced too much. If the resistance is too large it will not have enough shunting action, and the reading on the meter will not be reduced sufficiently.

It is only necessary to adjust this shunt approximately since the experimental error in the remainder of the stages will amount to one or two per cent. so that absolute correction for temperatures is impracticable for the average user.

We are now in possession of a rectifier with an appropriate shunt connected to the meter and the net results of the shunting coupled with the difference in the average values already mentioned, is that the meter now gives a full scale deflection on an alternating current of about fifty per cent. more than the full D.C. scale value. Thus the 2-milliamperer meter referred to previously will give a full-scale deflection with about 3 milliamperes A.C.

It only remains to calibrate the meter.

(Continued on page 760)

Jiffilinx were used exclusively by Mr. James in the assembly of the original "Britain's Super."

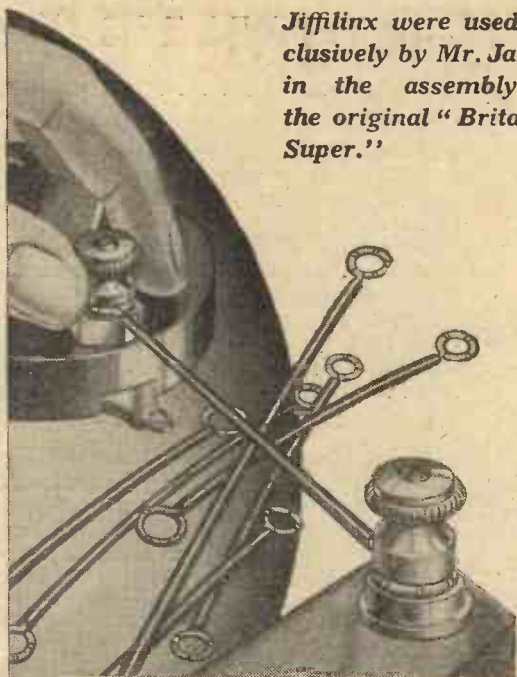

JIFFILINX

The most convenient, rapid and neat method of wiring a set. Eliminates soldering and yet gives perfect contact.

Jiffilinx consist of lengths of high conductivity wire covered with special insulation properties which ensure absolute freedom from "short circuit." Both ends are terminated with shake-proof connectors designed to fit the terminals of all components. They can be bent easily with the fingers to any desired angle.

Each packet contains 40 Jiffilinx in many various lengths—ample to wire a large set. Jiffilinx are indispensable to the experimenter as they can be used over and over again. Changes in connections can be made instantly and errors in wiring easily rectified without wastage.

Once you have used them you will never use any other form of wiring. Send for a packet to-day.

PRICE PER PACKET **2/6**

To Ready Radio Ltd.,
Eastnor House, Blackheath, S.E.3.

Please send me one packet of JIFFILINX for which I enclose 2/6.

NAME.....

ADDRESS.....

A.W. 17/10/31

Showrooms : Hop 3000.

Grams : Readirad, Sedist.

Phone : Lee Green 5678.

Advt. of Ready Radio Ltd.

THE NEW CHOKE



Readi Rad Super-het Choke, designed solely for modern Super-heterodyne circuits.

By **G. P. KENDALL**
B.Sc.

And used for the first time in the **BRITAIN'S SUPER**

By **W. JAMES**

The Readi Rad Choke is essential in Britain's Super

Price - **5/6**

Ready Radio
SHOWROOMS:
159, BOROUGH HIGH STREET
LONDON BRIDGE S.E.1.
**EASTNOR HOUSE,
BLACKHEATH, S.E.3.**

"MAKING A RECTIFIER METER"*(Continued from page 758)*

If an A.C. meter is available the two should be placed in series and the new meter calibrated side by side with the old. The same circuit as was used for the shunting operation may be employed, and the alternating current should be adjusted to a number of definite points throughout the scale. The reading of the new meter can be observed and the calibration chart drawn up.

If an alternating current meter is not available, calibration may be done on D.C. in the following manner. Connect a meter up in series with a D.C. milliammeter, a variable high resistance such as a potentiometer, and a 2-volt accumulator. The reading on the new (A.C.) meter is adjusted to certain fixed points on the scale, and the D.C. milliamperes corresponding to these points are noted. This process is carried out for five or six points on the scale.

The connections to the battery are now reversed, which also requires that the connections to the D.C. meter should be reversed, so that this meter can read the right way round, but *the connections to the A.C. meter must be left as before.* The object of this changeover is to pass the current through the other half of the rectifier bridge, and the same procedure should be adopted with the altered connections.

It will be found that the value of D.C. for a given reading on the meter is now slightly different from before. The true value of D.C. must be taken as the average of the two readings taken in both directions.

This then gives us the mean value of the current, but we have seen that the A.C. measurements are usually made in terms of R.M.S. value, which requires that all these readings shall be multiplied by 1.1. This then completes the calibration of the meter, and a curve may be drawn up and kept for reference so that the D.C. meter may be used for A.C. measurements by the addition of a converter as and when required.

The methods described are only applicable to milliammeters not taking more than 15 milliamperes. If it is required to measure voltages use a converted milliammeter with a suitable series resistance included. For example, supposing we have a 2-milliamperes meter converted to read 3 milliamperes A.C. as just discussed. If we put in series with this a 2,000-ohm resistance, we shall have a meter reading 30 volts full scale, and so on. Provided the full-scale deflection is over 10 volts the milliammeter calibration already obtained may be used, being multiplied by a suitable factor as required.

Another band concert of interest is to be given on October 24, when the Banknock Colliery Silver Prize Band will play.

AN AMAZING STATION-GETTER

W. James' new five-valve outdoor aerial super-het

WIRELESS DRAMA

DURING recent months the B.B.C. seems to have concentrated on the shorter drama or play for broadcast purposes. Plays of long duration do not seem to have gripped the imagination of listeners nor that of the broadcasting stations. They were too long and needed too much concentration.

But the shorter plays and dialogues have come more into their own, for one hears sketch and skit and short play almost daily if one turns from one station to another.

"Reg." or "Nat."

And the local stations are concentrating more on these short plays than the National. The West Regional station has broadcast one play a fortnight of recent weeks in the evening programme, and as often as three and four times a week a short play has been broadcast during the Children's Hour. In the main, these short plays are straight stories with as little complication as possible. There is nothing problematic or even modern about them. They teach history by making it real and vivid.

There is no formula for these short plays—the longest of which is no more than forty-five minutes—no general plan. They cannot be easily analysed, except they are the presentation of history with plenty of sound effects and good incidental music. It may be that wireless will create a taste for drama, but it will be in playlets rather than in large plays.

E. B. R.

All Portable Sets need a spare -

Perfect
for all
Portables

C.A.V. Jelly Acid Cells are now offered at greatly reduced prices with still further improvements in design and additional types suitable for the latest popular sets. Buy a C.A.V. replacement cell for use whilst yours is being recharged and enjoy continuous reception. There is a C.A.V. type suitable for every Popular Portable.

Examples of batteries for Popular Portables.

Pye Q and Marconiphone 55 - Type 2VN9/3 **12/6**
Pye Twintriple B4D - - Type 2VN11/1 **14/-**
McMichael Type 2VN11/2 **14/-**

C.A.V. BATTERIES Ltd.,
WELL STREET, BIRMINGHAM.

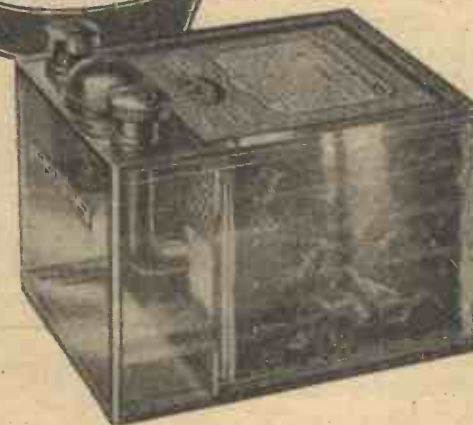
C.A.V.**JELLY
ACID****NON - SPILLABLE**

TYPICAL OF TELSEN VALUE

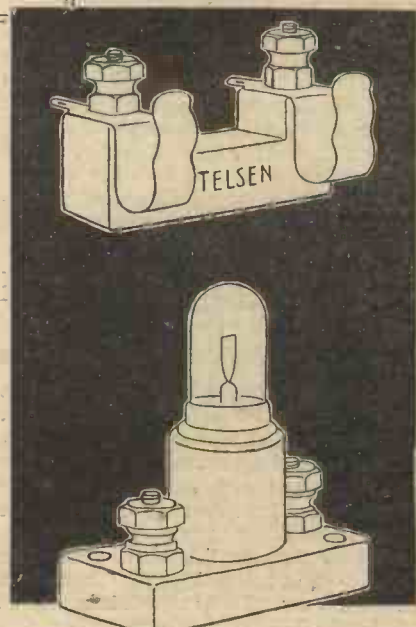
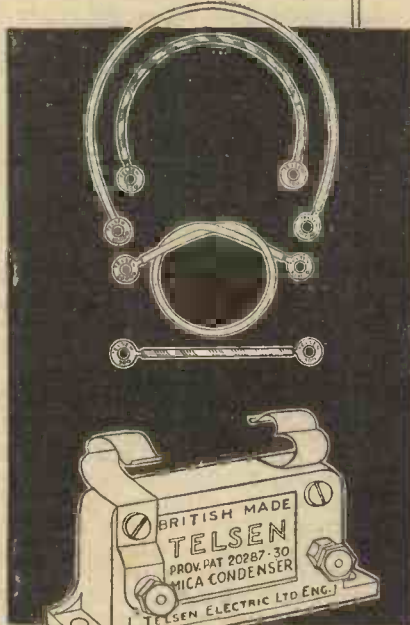
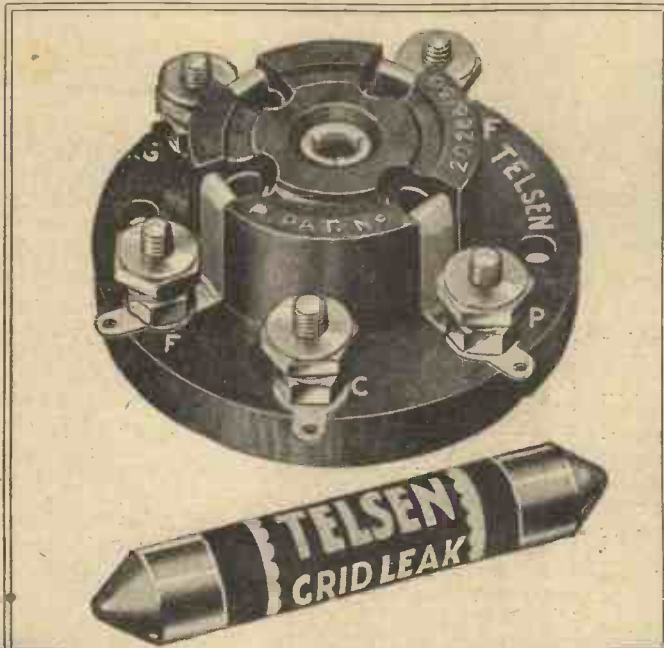

TELSEN VALVE HOLDERS

(Prov. Pat. No. 20286/30).

The Telsen four- and five-pin valve holders embody patent metal spring contacts, which are designed to provide the most efficient contact with split and non-split valve legs, and are extended in one piece to form soldering tags. Low capacity and self-locating.

- Telsen 4-Pin Valve Holder Price 6d.
- Telsen 5-pin Valve Holder Price 8d.

TELSEN GRID LEAKS

Telsen Grid Leaks are absolutely silent and non-microphonic, and practically unbreakable. They cannot be burnt out and are unaffected by atmospheric changes. Telsen Grid Leaks are not wire wound, and therefore there are no capacity effects. Their value is not affected by variation in the applied voltage. Made in capacities ranging from 1-5 megohms.

- Telsen Grid Leak Price 9d.

TELSEN SPAGHETTI FLEXIBLE RESISTANCES.

These are made in a range of values from 300-200,000 ohms, with a maximum current varying from 42 m/a to 1 1/2 m/a. The terminal tags are firmly fixed to the wire and clearly marked with their respective resistance values; they are impregnated with special insulating compound which renders them proof against corrosion.

Telsen Spaghetti Flexible Resistances. From 6d.

TELSEN FIXED MICA CONDENSERS

(Prov. Pat. No. 20287/30). Telsen Fixed Mica Condensers are made in capacities from .0001 microfarad to .002 microfarad. They can be mounted upright or flat, and the .0003 microfarad Telsen fixed mica condenser is supplied complete with patent grid leak clips to facilitate series or parallel connections. All Telsen fixed mica condensers are tested at 500 volts.

Telsen Fixed Mica Condensers, Price 6d.



ALL-BRITISH RADIO COMPONENTS

Send for the "Telsen Radio Catalogue" and book of "All-Telsen Circuits" to The Telsen Electric Co., Ltd., Aston, Birmingham.

TELSEN GRID LEAK HOLDER

The Telsen Grid Leak Holder will hold firmly any standard size or type of Grid Leak. Ample clearance is provided between the terminal screw leads and the baseboard (underneath), preventing any surface leakage upsetting the value of the Grid Leak. The terminals and fixing holes are accessible without removing the Grid Leak.

- Telsen Grid Leak Holder Price 6d.

TELSEN FUSE HOLDER

This is a neat and inexpensive device which should be incorporated in every set as a precaution against burnt-out valves.

The Telsen Fuse Holder firmly grips the standard radio fuse, giving a perfect contact.

- Telsen Radio Fuse Holder Price 6d.

TELSEN SCREENS

- Price 2/- and 2/6

Mention of "Amateur Wireless" to Advertisers will Ensure Prompt Attention



IN MY WIRELESS DEN

Weekly Hints —
CONSTRUCTIONAL & THEORETICAL
BY
W. JAMES

Speaker Current

MOVING-COIL loud-speakers having an electro-magnet must be supplied with direct current that is fairly well smoothed.

It therefore follows that when the supply of current is alternating a rectifier must be used. Sometimes a transformer must be connected as well, for the purpose of supplying a voltage suitable for the rectifier and loud-speaker.

A smoothing condenser is nearly always necessary. One of the electrolytic pattern may be used. It is connected across the field coil as shown in the diagram.

The capacity should be as high as possible. Four microfarads will usually be sufficient in the case of a 200-volt field coil.

Eight microfarads would be better and when the field coil is a low-resistance one, taking current at about 6 volts, 1,500 microfarads or more may be needed.

It is necessary to join an electrolytic condenser in a certain direction. Its terminals are always marked positive and negative and should be properly joined. The diagram shows a mains transformer, metal rectifier, and electrolytic condenser.

Iron-cored Chokes

Some iron-cored choking coils have a piece of cardboard between the joints. Do you know what this is for?

It has been found that the inductive value of an iron-cored choke can be made more nearly uniform over a range of direct currents when the iron path is broken.

Chokes for carrying fairly heavy currents nearly always have an air gap. To make a choke with a completely closed iron circuit would be foolish in many instances and experiments are usually carried out by the makers to determine the best size of gap with economy of materials.

The cardboard or other material is placed at the joints in order that the whole core may be firmly fixed and the thickness of the spacing pieces also determines the size of the air gap. A constant inductance is usually obtained at the expense of more copper wire or a bigger core.

Rigid Holders

The valve holders generally used nowadays are of the rigid type. Spring holders are not popular.

Many faults have in the past been traced to poorly sprung valve holders and amateurs were glad enough to go back to solid holders as soon as good valves were available.

It may not be generally realised what an improvement has been effected in valves. Microphonic valves are very few and far between. Even the most highly efficient detector valves are free, as a whole, from this trouble and so solid holders are satisfactory.

It is a good idea to tighten each connection on the holder before screwing it down. The act of soldering or of tightening a terminal nut tends to loosen the contact. If this loosening is not spotted, trouble will, no doubt, sooner or later be experienced. Therefore go over each valve holder before

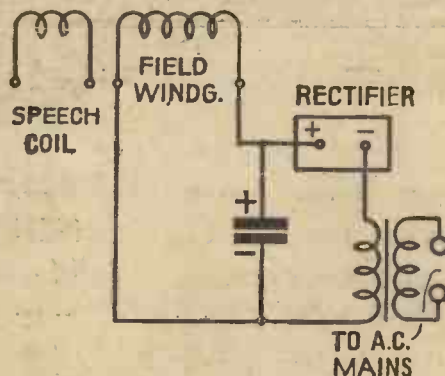

Connections for a simple A.C. rectifier circuit to supply a moving-coil speaker

it is placed in position. This also applies to all other parts having connections. Try them before fitting the part.

Choosing the Favourite!

Some amateurs have their own favourite values for the grid condenser and leak of the detector. It may be that .0003 microfarad is chosen with 2 megohms.

Others may prefer .0002 microfarad with 1 megohm. The quality would certainly be different. When the lower values of grid condenser and leak are used the higher notes are not weakened to such an extent as with the former values. If the condenser is still further reduced to .0001 microfarad, the quality will be better still.

If you have a few condensers and grid leaks to try in the detector circuit, notice the effect upon the quality and volume. An interesting hour or two can be profitably spent in simple experiments of this sort.

Those Strays

It is surprising what a little stray coupling in a set will produce instability.

Sometimes a poor joint in a screen is

sufficient. The screen may not be earthed properly.

There may be leakage between two tuning condensers, or there may be a coupling between a part and a screen-grid valve. High-frequency chokes are sometimes a nuisance and in many sets are better screened. They often have large fields and are able to cause an amount of trouble.

There is no doubt that the ideal set having high-frequency stages is well shielded. In the "Century Super," for example, all coils are very well shielded, with the result that great magnification is obtained with stability.

Badly fitting shields are a nuisance and so are those not making a good electrical contact. One may easily assume that the shielding is good when in fact it is not. Valves must be shielded when the maximum magnification is needed. The earthing of shields is something of a problem when there are a number of separate parts. It is easy enough when a metal chassis is used. But when a wire must be connected to each part for earthing, care is necessary or the set will not be stable. Various earthing wires should be tried.

Varying Metal Rectifiers

Those who use a mains unit having a metal rectifier may have noticed that the full output is not obtained when the unit is first switched on.

The output usually increases as the rectifier warms up and reaches a maximum value after a considerable time has passed. It is, therefore, not wise to adjust the input transformer of a home-built unit to obtain the full output when first switching on. An hour or so must pass before the output is measured.

If the full output is obtained when the rectifier has reached its normal working temperature, then the results are satisfactory. The output may be 5 or 10 per cent. less than the maximum at the time of switching on.

All electrical apparatus tends to increase in temperature from the time of switching on, but many of the transformers and chokes used in mains units are of such a capacity that the rise in temperature is very small. The resistance of the windings does not vary very much, therefore, and so the output is not materially affected. Metal rectifiers may increase in temperature by an amount sufficient to alter the output, however, and a proper allowance for this should be made.

Don't let it worry you —

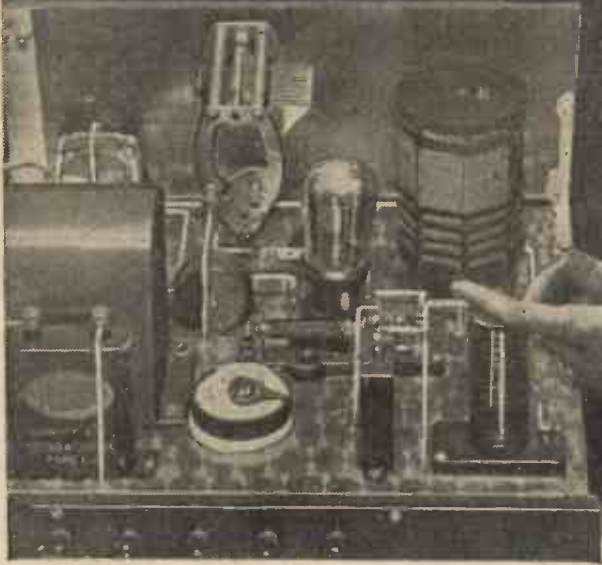

Every purchaser of a Ready Radio Kit is entitled to free technical advice by Mr. G. P. Kendall, B.Sc. Should you ever be in difficulties with your set, all you have to do is to write to Mr. Kendall about it and avail yourself of his wide and experienced technical knowledge.

Because every Ready Radio Kit is composed of chosen components which are tested and passed before dispatch, you can build your set with complete confidence of it being equal in performance to the original model. But, in addition, you have the satisfaction of knowing that Mr. G. P. Kendall's services are at your command.

“HOW TO OPERATE A SUPER-HETERODYNE”

This is one of the chapters in Mr. Kendall's new book entitled “10 Hows for Modern Radio Constructors.” Nearly 20,000 words; full of useful information; copiously illustrated.

Contains special chapters of particular help to all users of Britain's Super or other super-heterodyne receivers.

Over 15,000 copies were sold at the Radio Exhibition. Post coupon below **6D.** for your copy now. Price, post free

Our 1932 100-page General Illustrated Catalogue is now ready. Contains details of all modern radio products. Price 1/- post free.

Ready Radio
SHOWROOMS:
 159, BOROUGH HIGH STREET
 LONDON BRIDGE S.E.1.
**EASTNOR HOUSE,
 BLACKHEATH S.E.3.**

COUPON

To: Ready Radio, Ltd., Eastnor House, Blackheath, S.E.3

I enclose (a) four 1½d. stamps for copy of “10 Hows for Modern Radio Constructors.” (b) Eight 1½d. stamps for copy of General Catalogue. (Cross out item not required).

NAME.....

ADDRESS.....

.....A.W. 17/10/31

Showrooms: Hop 3000

Grams: Readirad, Sedist.

Phone: Lee Green 5678.

Advt. of Ready Radio Ltd.

Please mention “A.W.” when Corresponding with Advertisers

OUR LISTENING POST

By JAY COOTE

A FEW days ago although Rome advertised a very ordinary orchestral programme I was pleased to find that an eleventh hour alteration took us over to Livorno for an open-air operatic performance. Had I not been told that it was *al fresco* I should have had difficulty in believing that the relay was not in the usual way secured from the Teatro Reale or from the Naples Opera House. It is true that the audience was an exceptionally noisy one, but then, Italian spectators are always exuberant and boisterous. Probably I might have been affected in the same way had I been present. To think that the weather was so fine in Italy that an evening performance could take place in the open air! When it is fine in Livorno, it is still a wet week-end over here. Anyhow, watch Rome every night; turn to that station at about 8.50 p.m. There is often an agreeable surprise in store for you.

From Radio Rome

It is a remarkable fact, but none the less true, that apart from a few tangos culled from gramophone records, Rome does *not* transmit any syncopated dance music. Pietro Mascagni, the well-known composer, as artistic director of the broadcasting company, is an "anti-jazzist" and notwithstanding requests from listeners refuses to allow this class of composition to appear in the programmes. I think that Rome must be the only European station to maintain this veto against fox trots, one steps, and the more fashionable class of dance tunes.

By the way, Radio Trieste is still testing every evening from about 10 p.m.; sometimes

you will find it on the air at an earlier hour. The call is repeated at every opportunity as well as the words *Prove tecniche di trasmissione* (technical transmission tests). The new Radio Paris station may also be picked up on most days either at about 4 p.m. or at the end of the day's programme, but in this case, no announcements are made.

Puzzled by Regulars

It is very curious how listeners are puzzled by transmissions of which details are regularly

STATION IDENTIFICATION

AMATEUR WIRELESS has organised a new service of the greatest importance to all listeners. This Station Identification Service is available for identifying stations from information supplied by readers, and will be conducted by J. Godchaux Abrahams in conjunction with "A.W." The fee is 6d. for identifying any one station, but if three identifications are required at a time the fee is only 1s. A stamped addressed envelope must be enclosed.

Address your inquiry to Station Identification Service, "Amateur Wireless," 58-61 Fetter Lane, E.C.4, and give fullest possible details. State type of set used, date and time when station was heard, wavelength, call or interval signal, and details of any programme heard.

published in the weekly programme papers. Last week I received several letters in which correspondents referred to a variety show in the English language broadcast after the London station had closed down and "almost where we get the National programme." These were, of course, the experimental television transmissions by the Baird process, which start at midnight and of which the sound broadcast is actually picked up on 261.3 metres. If, on these occasions, or at 11.30 a.m., you care to turn your condenser dial to London Regional, you may hear the peculiar noise made by a vision broadcast.

Genoa Testing

The new Genoa 10-kilowatt transmitter may be heard testing almost nightly on 312.8 metres after the day's work is over. You will find the signals very powerful, and I very much doubt whether Italian and Pole can continue to share that wavelength amicably. Towards 11.30 p.m. the volume of the Genoa broadcast is so great on my receiver that I can only compare the strength to that of Mühlacker.

The change-over carried out by the Huizen and Hilversum studios spells a definite loss in good programmes, for, whichever station broadcasts on 298 metres, it is always subject to a background from Turin. Have you also noticed how much better the 1,875-metre wave is received during the day than it is when the darker hours have set in? At lunch-time I can always secure that transmission; in the later hours of the day it wants a certain amount of boosting to be enjoyable.

By the way, both Vienna and Munich are regaining their former strength, and on most evenings the Austrian programme can be relied upon as a sure thing. As an alternative to Munich, Nürnberg still remains a star turn, and on occasion it is possible to hear the Bavarian entertainments fairly well through the Augsburg-Kaiserslautern common-wave relays.

"FOR THE 'HOTTED-UP' CIRCUIT"

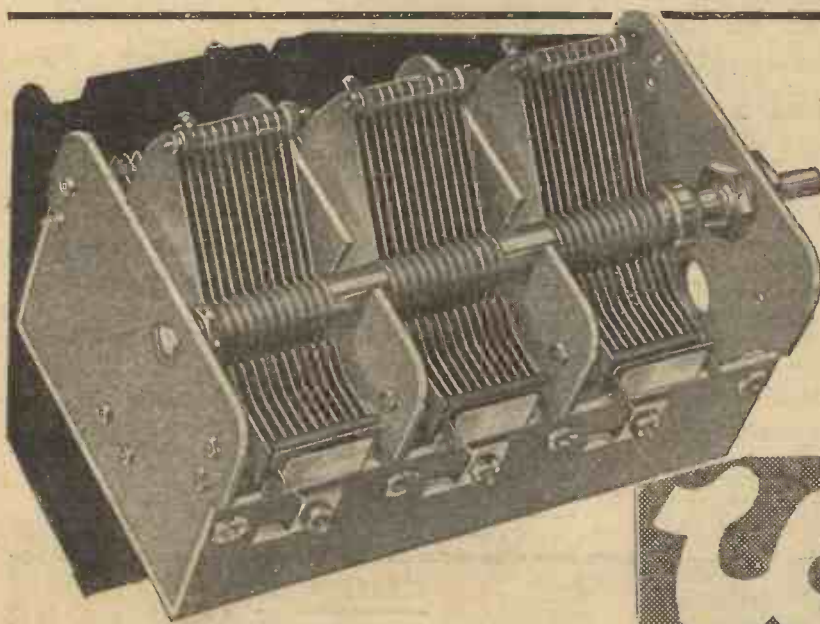

If you are building one of the new "Hotted-up" circuits and want the results obtained by the designers you *must* have the right condenser. Our new range of semi- and fully-screened condensers have been specially produced to enable you to get the "last ounce" out of the new circuits. These condensers are guaranteed matched within 1%. Insist therefore on Utility condensers and ensure complete success with your new set.

Write for our new catalogue which gives full details of these special condensers.

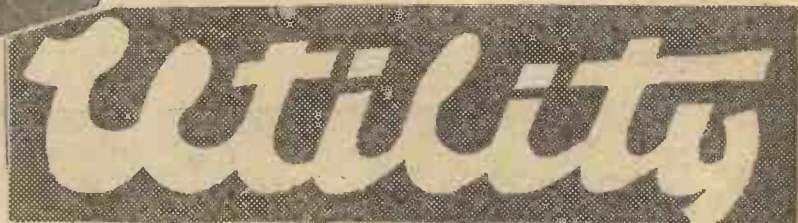

SEMI-SCREENED				
W 305/2	2 Gang	17/6
W 305/3	as Illustrated	22/6
W 305/4	4 Gang	40/0
FULLY SCREENED				
W 306/2	2 Gang	22/6
W 306/3	3 Gang	27/6
W 306/4	4 Gang	42/6
Disc Dial 2/6 extra				

WILKINS & WRIGHT LIMITED
UTILITY WORKS, HOLYHEAD ROAD, BIRMINGHAM

AGENTS—London: E. R. Morton, Ltd., 22, Bartlett's Buildings, Holborn Circus, E.C.1. Scottish: E. B. Hammond, 113, Vincent Street, Glasgow. Lancashire and Cheshire: J. R. Lister, 93, Old Road, Blackley, Manchester. Westmorland, Cumberland, Durham, Northumberland, Yorkshire and Derbyshire: H. C. Rawson, Ltd., 100, London Road, Sheffield. Lawrence Fraser, Chelsea House, Lansdown Road, Bath.

Come and hear "BRITAIN'S SUPER"

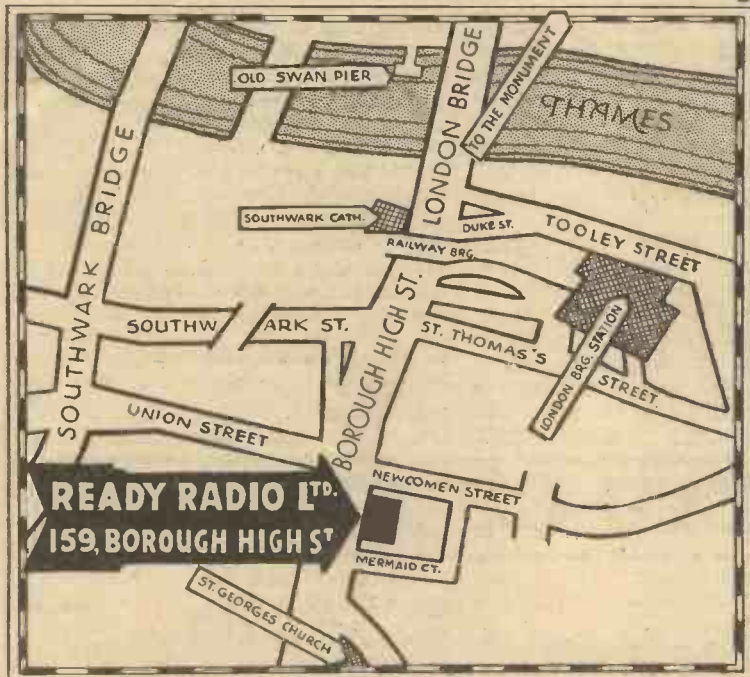

Hear for yourself the wonderful performance of "Britain's Super." See how easy it is to build. Then you will understand why Mr. Kendall says that "Britain's Super" is "Head and shoulders above all others." Come to our Showrooms at **159 BOROUGH HIGH STREET, LONDON BRIDGE.** (Two minutes from London Bridge Stations)

The Instamat Output Transformer is also demonstrated in conjunction with the "Britain's Super" at our Showrooms.

SEE ALSO PAGES :-

737	744	763
738	757	767
743	759	771

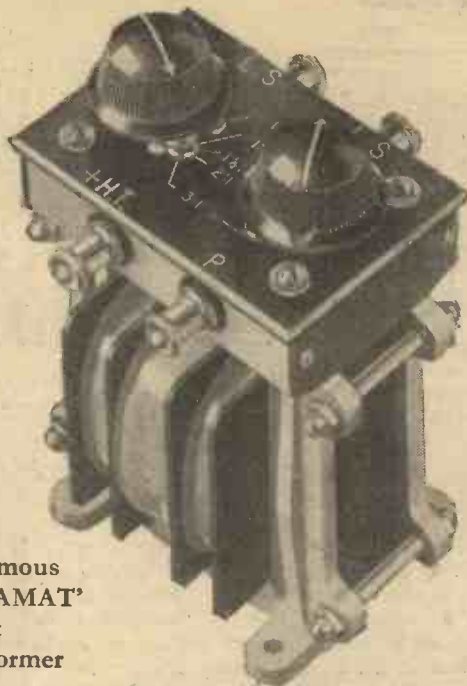

The famous
'INSTAMAT'
Output
Transformer

MAKE SURE OF QUALITY

Accurate matching between output valve and loud-speaker is essential for good quality reproduction from any set. The easiest, quickest and most certain way of obtaining accurate matching is to use an INSTAMAT with which you can switch instantly from one ratio to another until you obtain the one which matches your valve with loud-speaker perfectly.

The INSTAMAT is an Output Transformer of the very highest grade. It is exceptionally robust in construction and will carry heavy current without overloading. It is connected between output valve and loud-speaker and different ratios are obtained simply by turning the switches.

INSTAMAT Output Transformer (Guaranteed for 5 years).

For all types except moving-coil loud-speakers. Five different ratios all clearly marked, 1-2, 1-1, 1½-1, 3-1. Price 27/6

INSTAMAT MAJOR

For low-resistance moving-coil speakers. Six ratios, 10-1 up to 25-1. PRICE 37/6

SHOWROOMS:
159, BOROUGH HIGH STREET
LONDON BRIDGE S.E.1.

**EASTNOR HOUSE,
BLACKHEATH S.E.3.**

SETS OF DISTINCTION

H.M.V. MODEL 501 TABLE RADIO GRAMOPHONE

Makers : The Gramophone Co., Ltd.

Price : 29 Guineas



IN H.M.V. Model 501 we have something entirely new—a complete radio-gramophone equipment compactly contained within a table cabinet. At the Radio Exhibition this instrument attracted a great deal of attention. Many set-buyers



A picture of the motor showing the controls

have realised that here is an opportunity to take advantage of the latest H.M.V. technique in an inexpensive form.

Probably the first question one would ask about the H.M.V. table radio-gramophone is whether the compactness in any way detracts from the performance. From my recent tests I can say quite emphatically that results are remarkably good and I can find absolutely nothing to complain of; on the contrary the compactness of this instrument strikes me as a great attraction.

Neat Layout

An examination of the interior of the cabinet shows how well the various components have been fitted in. On the top is mounted the induction-type gramophone motor, with H.M.V. pick-up near by. The front of the cabinet forms the fret of the moving-coil loud-speaker. Some of the controls are mounted on the motor-board and the remaining controls on the sides of the cabinet.

The basis of Model 501 is a modern three-valve A.C. chassis, the main circuit details of which can be seen from the circuit diagram reproduced herewith. I am interested to note that the tuning works on the band-pass principle. This must be one of the first commercial sets to adopt this very selective form of tuning.

Between the screen-grid high-frequency amplifying valve and the leaky-grid detector is an efficient high-frequency coupling comprising a choke-fed auto-transformer. It will be seen that the low-frequency transformer coupling between the detector valve and the pentode output valve employs the latest principles, also that the pentode valve is transformer coupled to the moving-coil loud-speaker.

The three valves, comprising a Marconi MS₄B for high-frequency amplification, Marconi MH₄ for power-grid detection and Marconi MPT₄ pentode, get their anode current through a Marconi U₁₀ rectifying valve. The low-tension supply is also derived from the A.C. mains, by means of a filament winding on the mains power transformer.

The undistorted power output is 1.4 watts, corresponding to a volume of sound more than enough to fill a large room.

In incorporating this excellent circuit in the handsome dark walnut table-cabinet, the makers have used considerable skill. They have the advantage of being able to match the pick-up with the amplifier and the amplifier with the loud-speaker, resulting in an over-all balance of tone that has to be heard to be appreciated.

The layout of the controls is quite convenient. On lifting the shallow lid of the cabinet, we find the gramophone turntable and pick-up, which are both brought into action by setting the combination knob in the extreme right-hand corner to the "gram" position. The automatic stop device on the pick-up enables the turntable to be brought in and out of action by swinging over the carrier arm of the pick-up.

Other positions for the combination knob just mentioned give medium or long-wave tuning for radio and there is also an "off" position. For ease of control this knob is extremely useful.

A corresponding knob in the left-hand corner actuates the tuning condensers and a well-marked tuning dial showing beneath the centrally mounted escutcheon plate.

As the set is switched on the calibrated tuning dial is illuminated. The medium waves are calibrated from 260 to 540 metres in steps of 20 metres and the long waves from 1,100 metres to 1,900 metres in steps of 100 metres.

In addition to the controls already mentioned there are two further knobs, one on the left-hand of the cabinet and the other on the right-hand side. The left-hand control is operated in conjunction with the main tuning control knob and provides a fine tuning adjustment—very useful when receiving distant stations.

Special Volume Control

The right-hand knob is a combination volume control. When the radio is in action the volume control knob varies the screen-grid volts, but during gramophone reproduction this control knob works a separate potentiometer resistance connected across the pick-up.

During test we found that the insertion of the valves and the adjustment of the mains transformer were simple jobs. During radio reception the total consumption

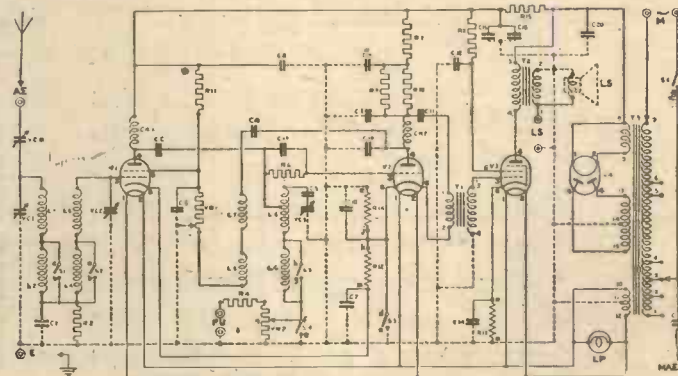

The circuit of the H.M.V. Model 501 Table Radio Gramophone

from the A.C. mains is only 30 watts, while the consumption during gramophone reproduction is 60 watts, due to the power required to drive the motor.

Tests soon proved the excellence of the Model 501 radio-gramophone under working conditions. All the laboratory staff agreed with me that the quality of reproduction is outstandingly good. This applies to loud and soft settings of the volume control.

(Continued on page 768)



ETHER SEARCHER

- KIT A (less valves and cabinet) £5 14 6
Or 12 monthly payments of 10/6
- KIT B (with valves, less cabinet) £7 13 6
Or 12 monthly payments of 14/-
- KIT C (with valves and cabinet) £8 14 6
Or 12 monthly payments of 16/-

ULTRA-SELECTIVE STRAIGHT THREE

- KIT A (less valves and cabinet) £5 4 6
Or 12 monthly payments of 9/7
- KIT B (with valves less cabinet) £7 3 6
Or 12 monthly payments of 13/2
- KIT C (with valves and cabinet) £8 3 6
Or 12 monthly payments of 15/-

CENTURY SUPER

- KIT A (less valves and cabinet) £6 18 6
Or 12 monthly payments of 12/8
- KIT B (with valves less cabinet) £10 14 6
Or 12 monthly payments of 19/8
- KIT C (with valves and cabinet) £11 9 6
Or 12 monthly payments of 21/-

CENTURY SUPER PORTABLE

- KIT A (less valves and cabinet) £8 0 0
Or 12 monthly payments of 14/8
- KIT B (with valves less cabinet) £11 16 0
Or 12 monthly payments of 21/8
- KIT C (with valves and cabinet) £14 1 0
Or 12 monthly payments of 25/9

Ready Radio
Kits for
"Amateur
Wireless"
popular Sets

**Immediate
Dispatch**

Ready Radio hold huge stocks of all makes of Components, Receivers, Loud-Speakers, Mains Units and other Radio accessories. Everything for Radio can be obtained from Ready Radio. Detailed price list can be had on application, as well as particulars of any set not listed here.

**Cash or Easy
Payments**

1931 BRITAIN'S FAVOURITE THREE

- KIT A (less valves and cabinet) £3 12 6
Or 12 monthly payments of 6/9
- KIT B (with valves less cabinet) £5 0 0
Or 12 monthly payments of 9/3
- KIT C (with valves and cabinet) £6 0 0
Or 12 monthly payments of 11/-

UNIVERSAL SHORT-WAVE THREE

- KIT A (less valves and cabinet) £4 18 0
Or 12 monthly payments of 9/-
- KIT B (with valves less cabinet) £6 17 0
Or 12 monthly payments of 12/6
- KIT C (with valves and cabinet) £8 2 0
Or 12 monthly payments of 15/-

£3-3-0 FOUR

- KIT A (less valves and cabinet) £3 11 0
Or 12 monthly payments of 6/6
- KIT B (with valves less cabinet) £5 18 6
Or 12 monthly payments of 11/-

OLYMPIAN THREE

- KIT A (less valves and cabinet) £6 4 9
Or 12 monthly payments of 11/6
- KIT B (with valves less cabinet) £8 3 9
Or 12 monthly payments of 15/3
- KIT C (with valves and cabinet) £10 8 9
Or 12 monthly payments of 19/3

Ready Radio
SHOWROOMS:
159, BOROUGH HIGH STREET
LONDON BRIDGE S.E.1.
EASTNOR HOUSE,
BLACKHEATH S.E.3.

ORDER FORM ON PAGE 744

See also pages

737	738	743
744	757	759
763	765	771

Showrooms: Hob 3000

Grams: Readirad, Sedist.

Phone: Lee Green 5678.

Advt. of Ready Radio Ltd.

To Ensure Speedy Delivery, Mention "A.W." to Advertisers



A weekly review of new components and tests of apparatus conducted by J. H. Reyner, B.Sc., A.M.I.E.E.

W.B. Valve Holder

THERE are many sets which lend themselves to an under baseboard wiring. Indeed, apart from the slight extra trouble involved in checking the wiring across, the result is often so much more convenient than surface wiring, that one wonders why the principle is not more universally used. Most manufactured sets to-day are wired in this manner, and some of the examples at the recent exhibition showed what can be done in this direction.

The new W.B. valve holder illustrated herewith has been specially designed to



New W.B. five-pin valve holder

facilitate this class of construction. It consists of a small diamond-shaped panel carrying the five sockets required. The four principal sockets are in a small recess, while the centre cathode socket is slightly raised. This is a very convenient arrangement for the insertion of the valve. The sockets themselves are of a slightly sprung character, there being a spring projection on one side of the socket which grips the leg of the valve, so that even with solid pins good contact is ensured.

To fit, a hole $\frac{7}{8}$ -in. to 1 in. diameter is required to be drilled in the baseboard. The socket is then fitted into this hole only projecting $\frac{1}{8}$ -in. above the baseboard, and being held in position by two screws. All wiring is then carried out by soldering to the tags which project through on the underside, these tags being an integral part of each socket, so that any danger of poor contact is obviated. The space occupied by the socket on the baseboard is only $1\frac{3}{4}$ -in. by $1\frac{1}{4}$ -in., and the overall depth underneath is less than $\frac{1}{2}$ -in. allowing for the customary $\frac{3}{8}$ -in. baseboard.

Tonax Adaptors

READERS who are building the new AMATEUR WIRELESS linen-diaphragm speaker will be interested in the latest Tonax adaptor. The complete assembly comprises two metal cones with silk washers for interleaving. One cone and silk washer is fitted on each side of the diaphragm, and the centre fixing piece placed through and

locked up with a small nut. Through the centre of this fixing is a tapered hole carrying a small spring chuck which grips the rod of the loud-speaker unit. It is only necessary to pass the rod through the hole and to tighten up the nut on the end of the chuck in order to obtain a secure grip.

Two models are supplied, one for single cones and the other for double cones, such as the "New Amateur's Linen Speaker," at prices of 1s. and 1s. 6d. respectively, the latter including two sets of cones and washers.

The outfit also includes two flexible washers (four in the case of the double-cone type) which may be used instead of felt between the metal cone and the paper. This gives a slightly different tone which some users prefer.

This outfit is also supplied with two extra chucks for 6 and 8 B.A. rods, instead of the usual 10 B.A., so that the device is of wide-spread application and should be of considerable help to those who are building their own speaker.

New Climax H.T. Unit

WE are reviewing this week the new Climax mains unit which has been designed to supply high-tension current from A.C. mains to small-power radio equipment of a type employing one screen-grid valve, a detector and an output valve.

The unit is housed in a neat metal casing which is finished in a dark-brown colour. Output connections from the unit are by means of plugs and sockets, the latter being arranged on a neat little panel at the top of the unit.

A flex lead 5-ft. long is provided, complete with plug for the input connections of the mains. An adjustment is provided to enable the unit to be used on mains with voltages varying from 200 to 250 volts A.C. Tappings are available for three high-

tension voltages, one suitable for use with the screening grid of an H.F. valve, one suitable for the detector valve and a power tapping for the output stage. Single-wave rectification is employed, the rectifying unit being one of the well-known Westinghouse type.

The unit is rated to give between 80 and 100 volts on the detector tap with a load of about 2 milliamperes and 150-volts at 20-milliamperes load on the power tap. It will be understood that the unit should be suitable for small receivers having an

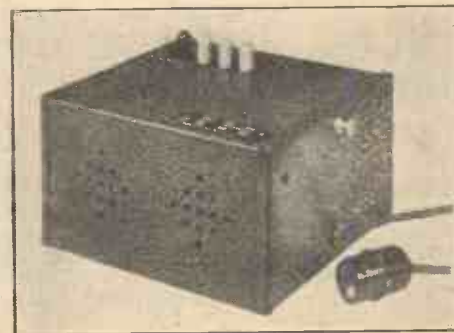

One of the new Climax A.C. H.T. units with a 20-milliamp output

H.T. current drain of the order of 20 milliamperes. The overall dimensions are 6-in. by $5\frac{3}{4}$ -in. by $3\frac{1}{2}$ -in. and the unit retails at £2 12s. 6d.

"H.M.V. TABLE RADIO-GRAMOPHONE"

(Continued from page 766)

On the radio side it was evident that selectivity, even with a fairly long aerial, is above the average. I found the wavelength calibrations quite accurate enough to locate distant stations, of which a large number have been logged.

The London National station on 261 metres was entirely cut out at 255 and 270 metres, a total spread of only 15 metres. This I consider is very creditable.

London Regional on 356 metres was cut out at 348 metres and 370 metres, a total spread of only 22 metres.

In every way the H.M.V. three-valve table model radio-gramophone is a notable achievement, and in my opinion it will command a very wide appeal among set buyers on the look-out for a first-class radio-gramophone at a reasonable price.

SET TESTER.

In the test report of the Electradix A.C. meter in last week's issue the price was given incorrectly. The price of the meter tested is 75s. complete with case.

"Amateur Wireless and Radiovision." Price Threepence. Published on Thursdays and bearing the date of Saturday immediately following. Post free to any part of the world: 3 months, 4s. 6d.; 6 months, 8s. 9d.; 12 months, 17s. 6d. Postal Orders, Post Office Orders, or Cheques should be made payable to "Bernard Jones Publications, Ltd."

General Correspondence is to be brief and written on one side of the paper only. All sketches and drawings to be on separate sheets.

Contributions are always welcome, will be promptly considered, and if used will be paid for.

Communications should be addressed, according to their nature, to The Editor, The Advertisement Manager, or The Publisher, "Amateur Wireless," 58-61 Fetter Lane, London, E.C.4.

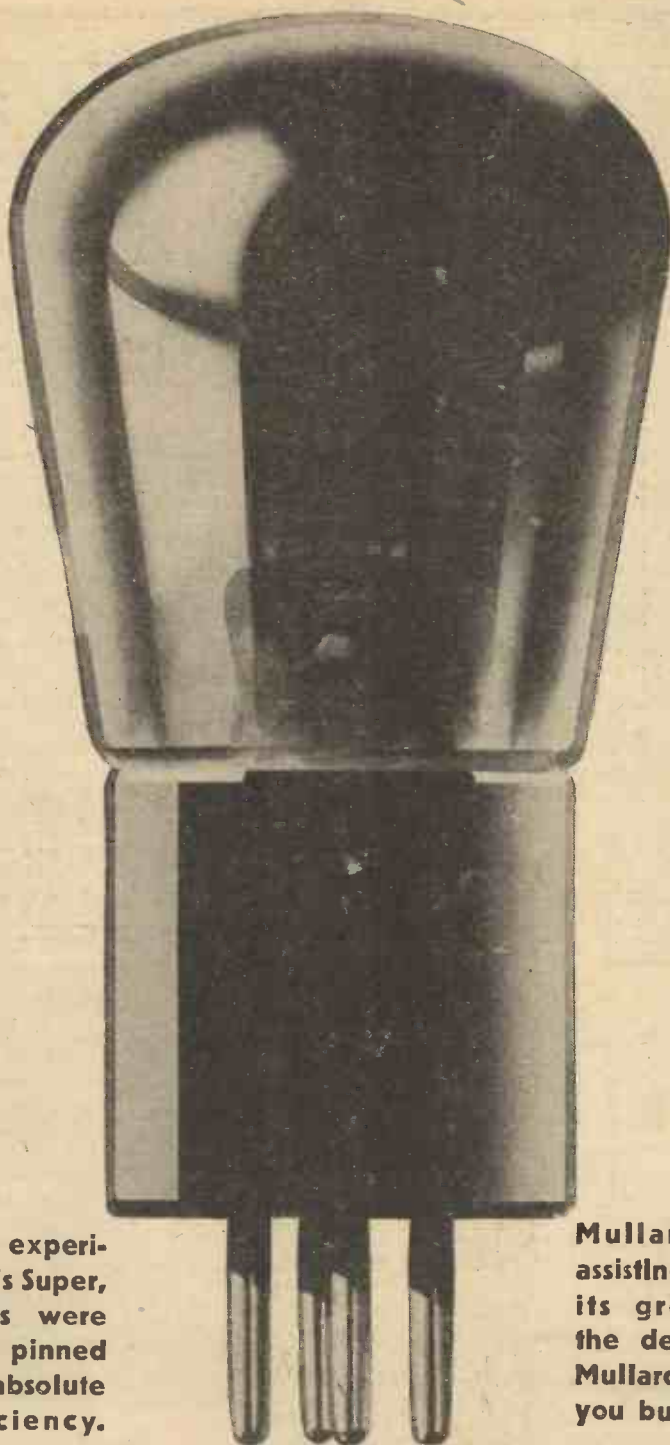

Throughout the entire experimental stages of Britain's Super, Mullard 2-volt valves were used. The designer pinned his faith to their absolute reliability and efficiency.

Mullard Valves are now assisting this set to obtain its great results. Follow the designer's lead by using Mullard 2-volt valves when you build your Britain's Super.

"BRITAIN'S SUPER" USES
Mullard
THE · MASTER · VALVE

Advt. The Mullard Wireless Service Co., Ltd., Mullard House, Charing Cross Road, London, W.C.2

To Ensure Speedy Delivery, Mention "A.W." to Advertisers

“100 GOOD HINTS AND TIPS” (Continued from page 725)

to get good contact with three spring leaves on a switch shaft than two. As three-point



Watch wires passing through small holes in metal screens. A short length of thin rubber tubing slipped over the wire acts as extra protection

switches are now popular for wave-changing, you must make sure that each leaf makes good contact with the metal end of the shaft.

Battery Connections

In most sets nowadays battery terminals are dispensed with and the leads taken direct by means of long flexes to the H.T., L.T., and G.B. supplies. Never twist the grid bias and H.T. leads together, if these run for any considerable distance, as this may result in L.F. howling.

Choosing Valves

In the average three-valve set the screen-grid valve should have an amplification factor of 200 to 450, a mutual conductance of 1 to 2.5, and an impedance of 200,000. The detector valve should have an amplification factor of 20 to 25, a mutual conductance of about 1.4, and an impedance of 15,000 to 20,000. Different detector values will be necessary, of course, if power-grid detection is used.

Fitting an H.F. Choke

In a good many sets H.F. interaction is caused because there is no high-frequency choke, the choking effect of the low-frequency transformer primary being relied on. It is often much better to have a choke on the anode side of the detector valve.

Screening Valve Anodes

Be careful when using metal-covered wire for the anode leads of screen-grid valves. Sometimes the capacity between the wires and the metal covering upsets the anode circuit. In many sets it is better to have insulated wire with no metal sheathing.

Shortening the Aerial

Shortening the aerial and putting a series condenser in series

with it are both methods of sharpening up tuning, but they do not both always act in the same way. A short aerial with no series capacity is often better than a long aerial with a series .0001 condenser.

Stabilising the Output Stage

If you are not satisfied with the tone of your set, then try putting a .001 condenser between the anode and filament of the power valve. This will bypass the stray H.F. currents that get through to the L.F. side. The condenser must be capable of standing up to the full H.T. voltage, of course.

When Wiring

Looped ends of wires which go under terminal heads should always be made in a clockwise direction, so that when the terminal is cut there is no tendency for the wire to be forced away from the shank. Try two wires, one looped in a clockwise direction and the other looped in an anti-clockwise direction, and you will soon see the difference in the joint made.

Detector Stabilising

It is often a good plan to put a .0001 condenser between the anode and filament of the detec-

tor valve in order to by-pass stray H.F. currents. If your reaction is plop-plop, then try fitting one of these by-pass condensers.

Radio-gramophone "Strays"

Some radio gramophones with electrically driven turntables are noisy because of motor induction. Some motors cannot be "quietened," electrically speaking, by shunting the brushes with fixed condensers and a much better plan is to use

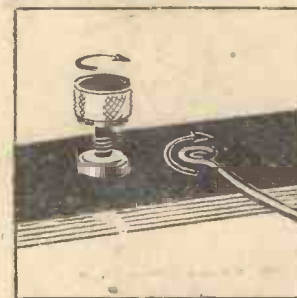

Loop ends of wires to be clamped under terminal heads should be always made in a clockwise direction as indicated

fairly thin lead-covered cable (as used for house wiring) for the connections between the pick-up (Continued on page 772)

RADIO-GRAM ENTHUSIASTS!
Here's the way to the best possible reproduction

A well-designed amplifier, a good moving-coil speaker and—a B.T.H. Pick-up and Tone Arm. These are the ingredients for the finest reproduction of records. The recipe is recognised by leading Radiogram experts.

And there's no need now to forego your B.T.H. Pick-up on the score of cost. The new B.T.H. "Minor" is a product of the same engineering principles that have made the "Senior" Model the standard of excellence where Pick-ups are concerned. **Ask your dealer for a demonstration.**



PICK-UP and Tone Arms

THE EDISON SWAN ELECTRIC CO. LTD.
155 Charing Cross Road, London, W.C.2



"Minor" B.T.H. Pick-up and Tone Arm. Price complete 27/6



"Senior" B.T.H. Pick-up and Tone Arm. Price 45/-

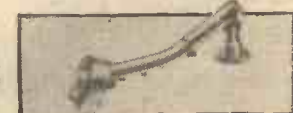

"Senior" B.T.H. Pick-up only with adaptors. Price 27/6



DESIGNED & PASSED

BY

G.P. Kendall

READIRAD

READIRAD



SNAP SWITCH

Instantaneous action. Positive contact. Entirely enclosed self-cleaning points.

The "on-off" type is suitable for mains breaking up to 3 amperes at 250 volts.

Please indicate whether "On-off" or "Radio-gram" type required.

2/9 each

PANEL LIGHT

Shows the word "ON" in glowing red when the set is switched on, prevents current wastage through forgetfulness to switch off. Equipped with a special quick release clip holder for the bulb.

Battery or A.C. Mains Models 2/3 each



TESTED COMPONENTS

TESTED COMPONENTS



ON AND OFF SWITCH

Exceptionally "clean" design and robust construction.

Heavily nickel-plated and polished. One-hole fixing. Attractive knob.

10d. each

BROOKMAN'S

VARIABLE CONDENSER

The original British solid dielectric variable condenser. One-hole fixing. Small dimensions and light weight. Complete with bakelite pointer-knob. Capacities .00075, :0005, :0003 3/6 each :0001 microfarad 2/6 ea.

3-pt. WAVE-CHANGE SWITCH

Particularly suitable for use in circuits employing dual-range coils. Designed on low loss principles, giving certain contact, smooth action and reliable service.

1/6 each

H.T. FUSE

Should be fitted in every receiver. The cheapest and most satisfactory method of protecting valves against damage due to accidental wrong connections.

Fuse (with bulb) 1/3 ea: Extra Bulbs 6d. each



READIRAD

READIRAD



GRID LEAK

Extremely accurate within very fine limits of the rated resistance. Permanent reliability is secured by the use of a special element manufactured under a high-pressure process. In resistances ranging from .25 megohms to 5 megohms.

Grid Leak 10d. each
Holder 6d. extra

Slide POTENTIOMETER

Very small and compact; easily connected; particularly smooth, accurate and noiseless adjustment; in the higher resistances forms an excellent variable grid-bias resistor. In resistances ranging from 200 ohms to 2000 ohms:

From 2/9 each

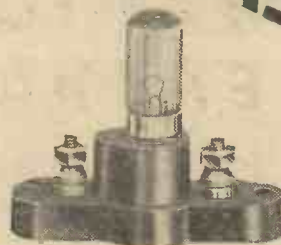

TESTED COMPONENTS

TESTED COMPONENTS



SEE ALSO PAGES

737	744	763
738	757	765
743	759	767

READIRAD

READIRAD

Ready Radio

SHOWROOMS:
159, BOROUGH HIGH STREET
LONDON BRIDGE S.E.1.

EASTNOR HOUSE,
BLACKHEATH S.E.3.

Showrooms: Hop 3000

Grams: Readirad, Sedist.

Phone: Lee Green 5678.

Advt. of Ready Radio Ltd

Please mention "A.W." when Corresponding with Advertisers

"100 GOOD HINTS AND TIPS" (Continued from page 770)

and the set. A small condenser across the pick-up leads at the set end often by-passes strays caused by motor induction.

Gramophone Reproduction

Unless special needles are used, never use a needle more than once in a radio gramophone. Worn needles give a boomy bass because they cut off the high notes. Pick-up leads which are too long also have the same effect.

S.G. Bias

All screen-grid valves do not need negative bias and if you are dissatisfied with the amplification of your set on the H.F. side, then try it with the .9-volt bias battery disconnected and with the lead taken to negative low tension.

Reaction Condensers

Don't use too large a reaction condenser. A .00015-microfarad job is ample in many sets and a condenser larger than .0003 is seldom needed.

Increasing Sensitivity

If you want to make your set more sensitive for distant stations and do not mind a slight alteration in tone, then try a higher grid leak than normal

3 or 5 megohms. This is a good tip for a short-wave set, too.

Adjusting Trimmers

Although most ganged condensers have trimming knobs of ebonite, there is sometimes a difficulty in getting accurate ganging if a metal-shafted screwdriver is used for adjust-

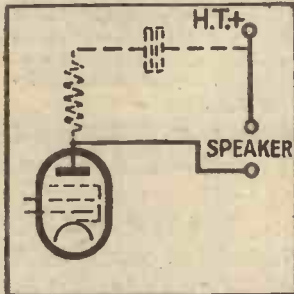

Here are the connections for a resistance and condenser to improve the tone of a speaker in a pentode output circuit

ment of the knob, particularly if these are awkwardly placed and there is a fair amount of stray capacity present when the screwdriver is used. A little strip of ebonite filed to a chisel edge is better.

H.F. Stabilising

A 600-ohm resistance, with a

1-microfarad condenser to earth, is sometimes useful in the screening grid circuit of an S.G. valve in order to keep it stable.

Transportable-set Hum

Humming in transportable sets is frequently caused by induction between one of the power chokes and the magnet

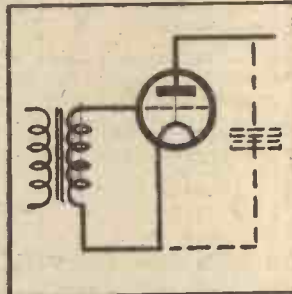

A condenser may be shunted between anode and filament of a power valve to by-pass H.F. "strays"

system of the speaker. This is particularly troublesome with moving-coil speakers. The only remedy is to change the position of the power components.

Regulating Pick-up Voltages

Some pick-ups give so great a voltage that the first valve is overloaded. Where economy is

a consideration, you need not have a variable volume control. Simply connect two grid leaks or spaghetti resistances together, take the joining point to the grid of the first valve and the two outside ends to the pick-up, one end also being taken to earth or negative bias. The total value of the two resistances in series should be about 100,000 ohms.

When Wiring

Leads made with bare wire, covered with insulated sleeving, should always be cut about an inch longer than is needed to connect from one point to the other. A loop should be made at one end, the insulated sleeving cut to length, and the second loop then made.

Jack Connections

Watch the leaf contacts of jacks used for a gramophone pick-up. The tiny contacts may get dirty after a while and may affect the radio performance of the set.

H.T. Tappings

If your set has separate tappings for screen-grid, detector, and power and you wish to use it with an eliminator having only one fixed and one variable tapping, then it is generally safe to (Continued on page 774)

7 W.B. VALVE HOLDERS
Specified in the A.W.'s
"BRITAIN'S SUPER"

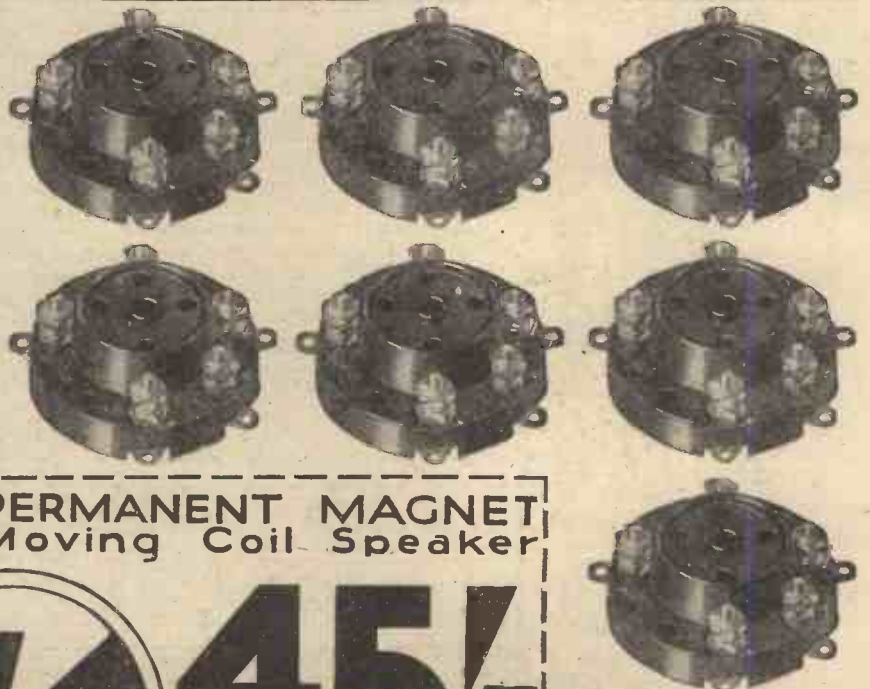

PERMANENT MAGNET
Moving Coil Speaker



W.B. 4 or 5 Pin RIGID VALVE HOLDER gives continuous spring contact along the pins. Diameter 1 1/2". All contacts clear of 8d. base

Owing to the low-resistance winding of Permanent Magnet M.C. Speakers a step-down transformer is necessary. P.M.3 has our three-ratio transformer fitted—7/6 extra.

Recommended by the Editor of "Radio for the Million" for use with the V.3. The P.M.3 for the V.3.

Write for Art Booklet "Speaking of Speakers," FREE

WHITELEY ELECTRICAL RADIO CO., LTD., NOTTINGHAM ROAD, MANSFIELD, NOTTS

Irish Free State Distributors: Kelly & Sheil, Ltd., 47 Fleet Street, Dublin

"I've got to study economy now old chap and stay at home in the evenings."

"Oh! well you've got your radio, although you are always grumbling about it."

"Not now! I've made my set all-electric with a Regentone Mains Unit and you wouldn't believe the difference it's made."

"In what way?"

"I never have to bother with batteries or accumulators—I just plug in to the electric light and I get tip-top reception every time I switch on. My set is far more powerful now and I've finished with all this battery expense and trouble."

"Would it be difficult to make my set All-Electric?"

"Not with Regentone—these people specialise in this Mains business and you can take it from me their units take some beating. Why don't you ask your Wireless Dealer about it, or write to Regentone for their latest catalogue."

Write for Free Art Booklet to:—REGENTONE, LIMITED, Regentone House, 21 Bartlett's Buildings, E.C.4. Tel. Central 8745 (5 lines).
Irish Free State Distributors: Kelly & Shiel, Ltd., 47 Fleet Street, Dublin.

Advertisers Appreciate Mention of "A.W." with Your Order

“100 GOOD HINTS AND TIPS” (Continued from page 772)

put the screening grid on the variable tapping and to link the others together on the maximum voltage.

Testing Valves

With dull emitters it is sometimes a difficult job to see whether a valve is blown out or not. A rough test can be made by putting the valve in series with the loud-speaker directly across the low-tension battery. If clicks are heard when contact is made then the filament is at least electrically O.K.; but emission may have dropped off, of course.

H.F. Choke Working

A resonance point in the H.F. choke may be the cause of poor working of a set on the long waves. Some chokes show a big drop-off in impedance when working in a set tuned to over 1,200 metres or thereabouts.

Mains Connections

Never have any bare metal parts exposed in plugs and points used to connect the mains with a set or H.T. unit. The two pins should be on the unit and the recessed part on the mains lead.

S.G. Valve Condensers

It is sometimes possible to dispense with the condenser con-

nected between the screening grid and earth in an S.G. valve set, but if this is done care must be taken to choose the right screening grid voltage.

Choosing Resistances

An anode resistance or feed resistance to a normal detector valve may be called upon to pass

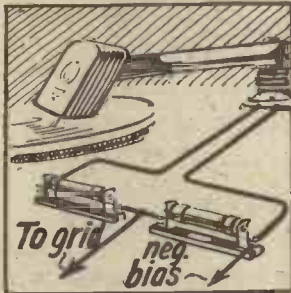

Two resistances in series can be used to cut down the pick-up voltage

as much as 4 or 6 milliamperes. That for the first L.F. valve may have to carry up to 8 milliamperes.

Tune Slowly

With any band-pass set, super-het or other very selective outfit you must tune slowly. Otherwise stations are lost. Tuning dial reduction of at least 5 to 1 is needed.

Ploppy Reaction

If your reaction is “ploppy,” then try lowering the detector H.T. voltage a little. Signal strength will not be lost.

Potentiometers

Use a fairly high value of potentiometer in a battery-

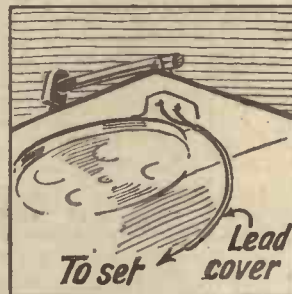

Lead-covered wire may be used for pick-up wiring underneath the motor-board to prevent induction

driven set, or the consumption will be extravagant.

Radio-gram Switching

If your radio-gram is not wired so that the H.F. valve is not cut out when the set is working as a gramophone amplifier, then put a separate switch in the S.G. valve L.T. circuit.

More Volume

Don't use two power valves joined anode to anode and grid to grid in order to get more volume. Use a push-pull circuit.

Speaker Baffle

When a baffle board is used on a speaker, make sure that the speaker is firmly screwed to it, otherwise a rattle may be set up.

Long-Wave Reaction

If a dual-range coil does not oscillate on the long waves, try a few more turns on the reaction winding.

H.F. “Strays”

A grid leak in the grid circuit of the L.F. or power valve sometimes improves tone by keeping out stray H.F. currents. A 100,000-ohm leak is often big enough.

Record Scratch

A fixed condenser connected directly across the pick-up terminals will reduce surface noise.

Fitting a Pre-set

Why not put the aerial pre-set condenser on the panel of the set so that it can be adjusted without fumbling inside the cabinet. But keep the wiring short,

FERRANTI SPEAKERS

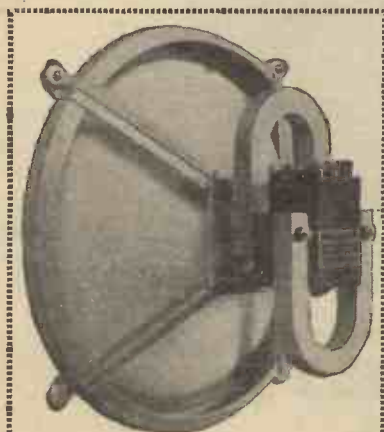

THE NEW FERRANTI INDUCTOR SPEAKER

and the Moving Coils now available provide a range which will enable every listener to secure the best reproduction of which his Set is capable. It's well worth while to use a better speaker.

PRICES: Chassis only.

Moving Coil, M1	£9 10 0
" " M2	£5 10 0
" " M3	£3 15 0
Inductor	£3 10 0

Cabinets from £2 extra.

Visitors to Olympia were captivated by the life-like reproduction afforded by Ferranti Speakers—a quality which is attained only by intense research, careful selection of the materials used, and unrivalled experience in true reproduction.

The Ferranti Standard Moving Coil Speakers are established as the finest reproducers of radio music and speech that science has yet devised, and they maintain that position by consistent excellence of workmanship.



FERRANTI LTD.,
Head Office & Works, HOLLINWOOD, LANCASHIRE
London: Bush House, Aldwych, W.C.2

from all dealers, or direct



BATTERY MODEL
£6.15

Price includes latest types of Cossor Metallised Screened Grid, Cossor Detector and Power Valves, handsome oak cabinet and all parts necessary for home assembly of the complete Receiver (as illustrated at left) which is so simple that it can be easily built by anyone—even if they know nothing about Wireless.

Hire Purchase terms
15/- deposit and 9 monthly payments of 15/-



ALL-ELECTRIC MODEL
£9.19.6

Price includes handsome oak cabinet, latest type Cossor Metallised Screened Grid Mains Valve, Cossor Metallised Mains Detector, Cossor Mains Power Valve and Cossor Rectifier, Cossor Heavy-duty Mains Transformer, all the parts necessary for assembling the complete Receiver (as illustrated above) and full size Constructional Chart.

Hire Purchase terms:
20/- deposit and 10 monthly payments of 20/-

All-British
— latest
Screened
Grid circuit

NO matter how much you pay you cannot buy a more powerful 3-valve Receiver than the Cossor Empire Melody Maker.

This remarkable Set incorporates all the most up-to-date features of design—latest screened grid circuit—completely screened coils—series aerial condenser—external wave-change switch and all-metal baseplate. Its range is enormous. Its selectivity

is remarkable. It will bring in all the main European programmes even while your local station is working.

The Cossor Empire Melody Maker is available in two types—Model 234 for use with batteries and accumulator and Model 235 which works from the electric light mains. Send at once for full particulars of the model that interests you—use the coupon below.

COSSOR
EMPIRE
Melody Maker

MODELS 234 & 235

A. C. COSSOR LTD.,
Highbury Grove, London, N.5.
Depots at Birmingham, Bristol,
Glasgow, Leeds, Liverpool,
Manchester, Newcastle
Sheffield and Dublin.

Use this coupon

To Messrs. A. C. Cossor, Ltd., Highbury Grove, London, N.5
Please send me free of charge a Constructional Chart which tells me how to assemble the Cossor Melody Maker.
(Fill in type required, viz. Battery operated or All-Electric).
Name
Address

A.W. 17/10/31

9153

You will Help Yourself and Help Us by Mentioning "A.W." to Advertisers

"RADIO FOR THE MILLION V3" KIT

As an example of the development of the "kit" type of set it is interesting to note that no less than nine of our leading manufacturers collaborated in the production of the "Radio for the Million V3" set which was described in last week's issue. These are Belling & Lee, Climax, Colvern, Jackson Bros., Junit, Mullard, Pye, T.C.C., and Varley. Each of the products of these manufacturers play their part in contributing to the marked efficiency of this remarkable kit, and readers will be interested in learning how each product contributed to the success of the V3 kit. Looking through last week's issue we find that the three Mullard valves used, i.e., PM12, PM1HL, and PM2A give terrific power and that the wonderful success of the kit was established with their help. The Varley Niclet transformer with its high primary inductance of 45 henries is largely responsible for the even amplification and tonal balance, while the basis of the amazing stability of the V3 is due to the Climax H.F. choke. The J.B. condenser (type RM) ensures the smooth control and clean-cut separation. Pye, a great name in British radio, supply the differential condenser and grid leak for this famous kit, while the V3 chassis is by Junit, whose efficient and reliable valve-holders and push-pull switches are also used. Colvern put selectivity—selectivity of an amazingly high order—into the V3 kit. T.C.C. condensers are used, while the final touch of convenience and finish is added by Belling-Lee terminals.

The Whiteley Electrical Radio Co., Ltd., are responsible for the permanent-magnet moving-coil speaker PM3, which has been tested by the Editor of "Radio for the Million" and found entirely satisfactory. The cabinet is by the Carrington Manufacturing Co., Ltd., and last but not least, there are such famous names as Exide, Drydex, and Siemens for batteries.

The complete kit can be built by anyone in less than two hours and it retails at £5 17s. 6d., inclusive of valves—it is, as the United Radio Manufacturers style it, "Britain's Economy Kit."

SOUND FROM THE CEILING

THERE is much to be said for the plan of mounting the loud-speaker in a self-contained set so that the diaphragm faces upwards towards the ceiling instead of being vertical. It often happens that the set is so placed that reflection from the walls tends to spoil reproduction, particularly when in order to get the best direc-

tional effect, the receiver has to be rotated into an awkward position. Generally speaking, sound reflected downwards from a flat ceiling is more likely to give a well-balanced distribution than when it is reflected from converging walls. B. A. R.

CARDIFF'S RADIO WEEK

SPECIAL programmes are being arranged in connection with the Radio Week being held in Cardiff. On October 25, at 4 p.m., the first of the Radio Week programmes will include the Band of the Welsh Guards. At 6 p.m., Mr. E. R. Appleton will tell another "Joan and Betty" Bible Story.

The Rt. Hon. the Lord Mayor of Cardiff (Alderman R. G. Hill Snook) will broadcast an appeal on behalf of the Cardiff Royal Infirmary at 8.45 p.m., and at 9.5 p.m. on the same day the Herbert Ware Symphony Orchestra and the Cardiff University Students' Madrigal Society will be heard in an orchestral and choral concert.

The band of the Welsh Guards will be heard from the Ideal Homes Exhibition in Cardiff on October 26 and 28.

WHEN SUBMITTING QUERIES

Please write concisely, giving essential particulars. A Fee of One Shilling (postal order), a stamped addressed envelope, and the coupon on the last page must accompany all letters. The following points should be noted.

Not more than two questions should be sent with any one letter.

The designing of apparatus or receivers cannot be undertaken.

Modifications of a straightforward nature can be made to blueprints, but we reserve to ourselves the right to determine the extent of an alteration to come within the scope of a query. Modifications

to proprietary receivers and designs published by contemporary journals cannot be undertaken.

Readers' sets and components cannot be tested at this office. Readers desiring specific information upon any problem should not ask for it to be published in a forthcoming issue, as only queries of general interest are published and these only at our discretion. Queries cannot be answered by telephone or personally.

Readers ordering blueprints and requiring technical information in addition, should address a separate letter to the Query Department and conform with the rules.



**NEW 1932 MODELS
HIGHER SENSITIVITY
SPEECH PERFECT
FULL MUSICAL
RESPONSE**

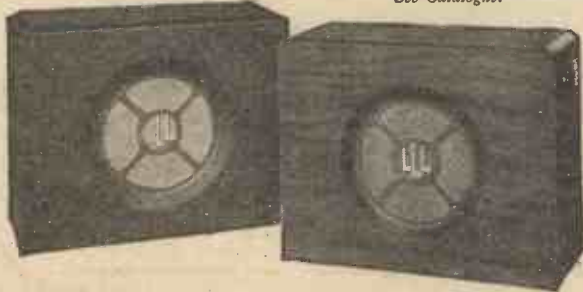

Rexine Covered Cabinet.

Solid Mahogany Cabinet.

LANCHESTER'S LABORATORIES
TYSELEY . . . LIMITED . . . BIRMINGHAM

The Lanchester

PERMANENT MAGNET MOVING-COIL SPEAKERS

You cannot afford to be without our new 1932 CATALOGUE, beautifully illustrated and containing full particulars and prices of our Season's products now available. It contains in addition a mine of useful information, and is

FREE and POST FREE.

Our 14 DAYS' FREE TRIAL OFFER. Lanchester Speakers are sold direct to public only on 14 DAYS' FREE TRIAL against cash with order or C.O.D. Their compact dimensions readily permit their incorporation in Portable Receivers, and the fascia board simplifies attachment.

PRICES:

CHASSIS from £1 10s. 0d. to £3 3s. 0d.

Complete In Cabinet from

£2 10s. 0d. to £4 15s. 0d.

Output Transformers required: extra
See Catalogue.

WILL DAY LTD.

have all the latest receivers, Radiograms and components in stock.

SEE them in our showrooms then

HEAR them in our demonstration rooms.

WEST END AGENTS

We are the West End Agents For all Ferranti receivers and components.

Immediate delivery given of all models from stock, here are two examples of the wonderful value offered.

Ferranti Inductor Console reduced from 22 gns. to **15 gns.**
Ferranti Moving Coil Console reduced from 28 gns. to **18 gns.**

WILL DAY LTD.

19, LISLE STREET,
LEICESTER SQ. :: LONDON, W.C.2
Phone: Gerrard 4476.

EVERYTHING **The G.E.C.** ELECTRICAL
your guarantee

YOU GET STATIONS

YOU'VE ONLY READ ABOUT BEFORE!

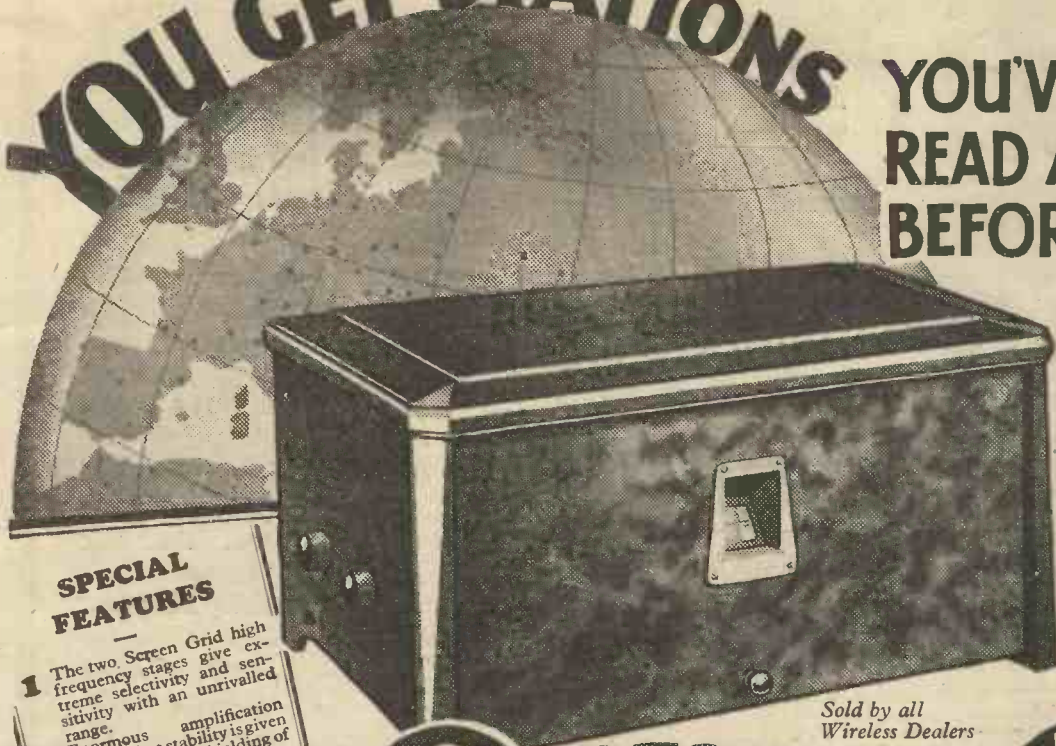

SPECIAL FEATURES

- 1 The two Screen Grid high frequency stages give extreme selectivity and sensitivity with an unrivalled range.
- 2 Enormous amplification with perfect stability is given by the complete shielding of H.F. Circuits.
- 3 Equal efficiency guaranteed on both wavelength bands.
- 4 Change of wavelength is effected by an external switch and the set need not therefore be opened.
- 5 Maximum ease in tuning with single knob controlling triple gang condenser.
- 6 Assembly is the essence of simplicity.
- 7 Volume control is provided not only to act as such, but to procure extreme selectivity. Two terminals provided for connection to Gramophone Pick-up.
- 8 Attractive Walnut Constructor's Cabinet of modern design with front panel to match.

Sold by all Wireless Dealers

OSRAM "FOUR"

NEW MUSIC MAGNET

PRICE £10.15s
Including OSRAM VALVES
GECOPHONE COMPONENTS
AND POLISHED HEAVY
WALNUT CONSTRUCTORS
CABINET

Stations without limit coming in all round the dial... each perfectly separated... at full volume and with amazing purity. All the usual easily-found stations, and besides—those stations which as a rule cannot be reached. The greater is the thrill when you get them on the OSRAM "FOUR" at full loud-speaker strength. This is the performance of this wonder set—the set that introduces an entirely new and improved conception of home-assembled circuits.



A BRITISH PRODUCT DESIGNED FOR BRITISH RADIO CONDITIONS

HIRE PURCHASE. You can either buy your OSRAM "FOUR" for cash or on these attractive HIRE PURCHASE terms—Deposit 25/- and 12 monthly payments of 17/-. Your dealer will give you full particulars.

ALL-MAINS OPERATION. The OSRAM "FOUR" can be built for A.C. All-mains operation by means of the new GECOPHONE A.C. All-Power Unit and Conversion parts. This Unit can also be used to convert last season's "Osram Music Magnet 4."

WRITE for the OSRAM "FOUR" Constructor's Instruction Chart, and learn all about this radio sensation. FILL IN THE COUPON BELOW. The clear directions given in these instructions will enable you to assemble the OSRAM "FOUR" without the possibility of mistake. It is crammed full of useful hints and tips, and contains a rapid guide for getting practically all Home and Continental stations. SEND FOR A COPY TO-DAY.

SUPREMACY IN RADIO S.E.C. Radio

POST THIS COUPON
Please send me Constructor's Instruction Chart for the OSRAM "FOUR" NEW MUSIC MAGNET.
Name _____
Address _____
The General Electric Co., Ltd.
Magnet House, Kingsway
London, W.C.2
A.W.

Cut out and paste on postcard, or enclose in unsealed envelope. Halfpenny postage in either case.

Advt. of The General Electric Co., Ltd. Head Office & Public Showrooms: Magnet House, Kingsway, London, W.C.2

To Ensure Speedy Delivery, Mention "A.W." to order

Longer Life

for LESS MONEY

The GUARANTEE OF LONGER BATTERY/LIFE

LONGER lasting power has been put into the Improved Lissen H.T. Battery—and a LIFE GUARANTEE is printed on the side of every Improved Lissen Battery you buy.

Prices, too, have been greatly reduced so that today when you buy a Lissen H.T. Battery you get much longer lasting battery for much less money than before.

Look for the Lissen Longer Life Guarantee—buy only at the reduced prices. Ask for "the improved Lissen H.T. Battery"—stocked by all good radio dealers.

- | | |
|-------------------------------------------|---------------------------------------------|
| 60v. Standard Reduced from 7/11 to 5/6 | 36v. Grid Bias Reduced from 4/6 to 4/- |
| 100v. Standard Reduced from 12/11 to 9/3 | 99v. Portable Reduced from 12/6 to 9/- |
| 120v. Standard Reduced from 15/10 to 11/- | 60v. Portable Reduced from 7/11 to 5/6 |
| 9v. Grid Bias Reduced from 1/6 to 1/- | 60v. Super Power Reduced from 13/6 to 12/- |
| 16v. Grid Bias Reduced from 2/9 to 1/9 | 100v. Super Power Reduced from 22/- to 20/6 |

IMPROVEMENTS INCORPORATED IN THE LISSEN BATTERY ENABLE US TO GIVE THE FOLLOWING

Guarantee

This Lissen battery is definitely guaranteed to have a much longer life than a 100 volt Lissen battery bought prior to August 1st, 1931.



← **LOOK FOR THIS WHEN YOU BUY**



60 VOLT

5/6

100 VOLT

9/3

LISSEN LTD., WORPLE RD., ISLEWORTH, MIDDLESEX.

You will Help Yourself and Help Us by Mentioning "A.W." to Advertisers

A Valveless Amplifier!

—well-known inventor's brilliant achievement

The "Microbox" is one of the latest inventions of Mr. S. G. Brown, F.R.S., inventor of the very first loudspeaker, and a host of other devices, including the already famous Battery Superseder, which he introduced at this year's Radio Show. The "Microbox" is no bigger than the ordinary pick-up, yet it is a self-contained amplifier producing all the volume and rich tone of an expensive multi-valve reproducer. All you have to do is to change your present gramophone tone-arm and sound-box for the "Microbox" and connect it up to your loudspeaker. The little power required (10 volts at ½ amp.) can easily be supplied by a small accumulator. The only other component required—a transformer—is supplied with the "Microbox." The price of the two complete is 3 gns.



The MICROBOX combines pick-up and amplifier on the microphone principle. Price (with transformer) 3 Gns. (or 9 payments of 8/6). Mains unit. A.C. £3/15/0. D.C. £3/3/0.

Is yours a popular 'kit'?

—if so, here's something to interest you!

Excellent idea—the Kit. But not quite perfect unless you get a speaker worthy of the set, and a hiding place for your batteries. Well, you can get both in an S. G. Brown Kit-Cabinet Speaker. These S. G. Brown KIT-CABINET SPEAKERS are definitely built to save you time and trouble—and money. Scarcely worth while to make your own when you can walk away with one of ours having spent so little. They are priced from only 39/6. (See photograph and full description on right.)



KIT-CABINETS.

MODEL 1. For Mullard 1932 3-valve Kit or Radio for the Million V.3 Kit (incorporates S. G. Brown SOLO Speaker). Price 47/6 (or 6 monthly payments of 10/-).

MODEL 2. Stand-on KIT-CAB. for 1932 Melody Maker, Osram 1932 Music Magnet, etc. Price (with Brown SOLO Speaker), 39/6 (or 6 monthly payments of 8/-).

Is your set 'muffled' by your loudspeaker?

—ten to one you'll answer 'No'—but are you sure?

Improvements in loudspeaker design have recently been so rapid that speakers which were the last word three years ago sound amazingly inefficient when heard beside such speakers as the new S. G. Brown permanent magnet moving coil (which costs only £4/7/6). Nine people out of every ten "muffle" perfectly good sets with old-fashioned speakers—and don't realise it. Are you quite sure you are not one of them? Go to your dealer and hear the new S. G. Brown Speakers for yourself. You'll know then whether you are doing your set justice, or not.



S. G. BROWN PERMANENT MAGNET MOVING COIL UNIT costs £4/7/6. Complete with handsome cabinet £4/19/6 shown it costs (or 8 monthly payments of 13/6).

Send to 19 Mortimer Street, W.1, for free leaflet describing the FAITHFUL MODELS MADE BY

Yours faithfully

S. G. Brown

FAITHFUL RADIO

Please mention "A.W." when Corresponding with Advertisers

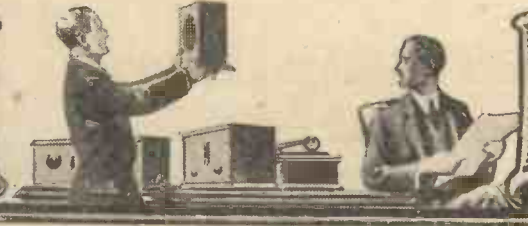

Screen-grid or Triode?

SIR,—I was much interested in the letter by W. S. (Chatham) under the heading "Triode or S.G." I should like to endorse all that he says. As a user of the Lodestone Four I am wondering if one of the new bandpass coils could not be used instead of the Binowave A coil whilst still using the D coil, but in any case I should like to see a set worked out as he suggests.

W. H. D. (Dalston).

The "Century Super"

SIR,—I have what I think is the world's finest "Century Super." This is the battery model working with a Regentone W1A eliminator. I have had 70 stations on the medium waves, and 8 American stations on the ultra-short wave band. The set is so easily controlled that my family have no difficulty in tuning in foreign programmes. The valves used are as specified, except that the last stage is a PM252 and a Ferranti AF5 transformer. In my opinion it is a jolly fine set and the lucid descriptions and wiring plans make its construction, as with any other AMATEUR WIRELESS set, very simple.

G. W. O. (Wallington).

An Amateur Transmitter

SIR,—Perhaps this may catch the eye of the gentleman who broadcasts regularly every Sunday between 11.30 a.m. and 1.30 p.m. on a wavelength of about 374 metres. I received his transmission of gramophone records very clearly at very good loud-speaker strength, amongst them being "Lily of Laguna," "If I Were King," "Absent," and "Bunkey-doodle-I-do." My only criticism being his announcements, which are not very clear. He says he would welcome reports from listeners, but I cannot quite make out his call sign, which I think is 2AVH. If my unseen friend should see this, I hope he will let me know who he is and where his transmitter is situated.

CHARLES VINCENT,

24 Bell Road, Seacombe, Wallasey, Cheshire.

Linen Speakers

SIR,—I have had in working order for the last eighteen months a 3-ft. model of your double linen speaker. It is a big improvement on the old type.

Wishing a big success to the latest model, which I feel sure will be what it deserves.

W. H. C. (Southend-on-Sea).

"How the Repair was Made"

SIR,—With reference to Thernion's note in AMATEUR WIRELESS, September 25, regarding "The Instrument Repair," we beg to state that owing to the relative balance of the springs being upset by the repair the scale calibration will be in error. Also a "short" that breaks a control spring often softens it and a shop repair is the cheapest by far.

We find from experience that the Weston Electric Instrument Co. generally charge 30s. for a burn-out replacement.

ELECTRADIX RADIOS,
(London, E.C.).

Screen-grid or Triode?

SIR,—I quite agree with W.S., of Chatham. I am using an old circuit, one neutralised H.F. detector and two L.F., and find, in my own opinion, the purity much better than the S.G. valve. I would welcome a new four-valve set using the neutralised stage and would like to see "A.W." favour us with one or a super-hot four using the same coils as the "Century Super."

E. D. (Cardiff).

(Continued on page 782)

PERFECTION — Given an undistorted input the R. & A. '100' reproduces speech and music with a fidelity more nearly approaching the ideal than has yet been attained by any type of speaker. The sensitivity is such that perfect results are obtained with two-valve receivers, and also with large power amplifiers. Compare the R. & A. '100' with any speaker you may choose, and you will agree it is unequalled for sheer beauty of tone and brilliant response throughout the whole audible range. The R. & A. Multi-ratio Output Transformer to suit all power valves including Pentodes is modestly priced at 12/6.

Your Dealer can supply full particulars Write us for
REPRODUCERS & AMPLIFIERS LTD.
Frederick Street
Wolverhampton.

The R & A "100" PERMANENT MAGNET MOVING COIL REPRODUCER

SAVE MONEY!
—the "Waverley" is fine value
at £5 10s.

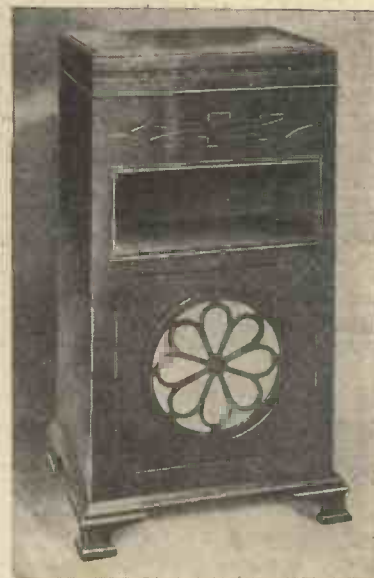

The "Waverley" is well within your reach and is ideal for those who require a high-class Radio-Gramophone cabinet at a very moderate price. It is a beautifully-designed piece of furniture, finely finished and built with typically good Camco workmanship. Two models are made, a Junior and Senior, space being provided in each for speaker, batteries and eliminators. Post this coupon now for FREE copy of the 1932 Camco 24-page Radio Cabinet catalogue.



Name _____
Address _____

CARRINGTON MFG. CO. LTD.

Showrooms:
24, Hatton Gdn., London, E.C.1. Phone: Hol 8202.
Works: S. Croydon.

A.W. 17

DX 49

RADIO TIMES

DAVENTRY

1023 kc/s (1,554.4 m.)

PROGRAMME

THE REVUE CHORUS and ORCHESTRA
Conducted by
STAFFE

Every item's a better item
if you've a **Drydex**

1.15 a.m.

1.30 TIME
cast

1.45-11.0

2.0

12.45

(Organist to the Society)
Relayed from ALL SAINTS',
MARGARET STREET
Introduction and Passacaglia
Reger
(Note on page 12)
Adagio Lemaro
Grand Choeur (7th) Guilman
Intermezzo }
Finale } Sonata }
Nocturne Bonnet
Minuet Scherzo Jongen
Fantasy—Toccata Leslie Woodgate



Some
Written, composed
produced by
ERNEST

Additional

1.30-2.30 Light Music
FRASCATI'S ORCHESTRA
Directed by GEORGES H.
From THE REVE

3.30 Symph
Relayed from
Bo
THE BOURNE
Conductor,
EDA K
Persian Dan
Violin Conce
Allegro; A
Irish Symphony
Allegro; Allegro;

4.45
REGINALD NEW
At THE ORGAN OF THE BEAUFORT CINEMA
Relayed from WASHWOOD HEATH, BIRMINGHAM
Coronation March, The Prophet Meyerbeer
Selection, The Desert Song Romberg
Sanctuary of the Heart Kotelbey
Introduction, Act III, Lohengrin Wagner

5.15
The Children's Hour
by ETHEL MALDEN



★
Makers of the world
famous Exide offer
greatest dry battery
value

Obtainable everywhere from all good dealers in
sizes and types to suit every wireless set. Also
for torches, pocket lamps, cycle lamps and bells.

Exide Batteries, Clifton Junction, near Manchester. Branches at London, Manchester, Birmingham, Bristol, Glasgow, Dublin and Belfast.

You will Help Yourself and Help Us By Mentioning "A.W." to Advertisers

"READERS' IDEAS AND QUESTIONS"

(Continued from page 780)

Olympia Reproduction

SIR,—As one who had considerable occasion to listen to the musical reproduction provided through the loud-speakers on various stands at the Olympia Radio Exhibition through the kindness of the B.B.C., may I be permitted to point out that the reproduction so provided was, almost without exception, abominable, and quite unfit to enable anyone to judge the respective merits of the speakers of the various types and prices shown.

To any critical listener, it was obvious that the output provided by the B.B.C. was almost entirely absent below about 150 cycles and above 2,500, with the result that the difference in the performance provided by the most expensive speakers and little cone units selling at about 8s. 6d. was negligible.

On a great occasion such as the National Radio Exhibition, one would think that the first consideration of the B.B.C. would be to provide unexampled reproduction, to show people how really good radio can be, and so encourage them to instal it, whereas, in this case, they seem to have used apparatus quite incapable of giving high quality reproduction; in fact, it was observed that the B.B.C. engineers actually used the old Western Electric cone type of speaker in checking up their various connections. This may have been good enough a few years ago, but it is obviously not adequate at the present day. J. B. (New Moston).

Radio Criticism

SIR,—The only part of your correspondent's letter worth my while to answer is the last paragraph. If he imagines that syncopation as employed by classical composers bears any relation to what passes for syncopation in a vaudeville programme, he merely shows complete ignorance of the meaning of syncopation.

I am sorry I have fallen in his estimation; if I were dishonest enough to condone what I really detest for its vulgarity, I should fall in my own estimation, which I am not anxious to do.

I am a great deal more on the side of the man-in-the-street than S.J.L. thinks; it is only when I feel that a form of music is definitely and fundamentally bad that I take it upon myself to be satirical. There is no case against good light music; neither do I intend to attempt to bring one.

WHITAKER-WILSON (London, N.).

The "£3 3s. Four"

SIR,—I would just like to mention that I have just completed the £3 3s. Four, the design which appeared in "A.W." in the August 22 number.

This set was built without adding the extra decoupling and by-passing arrangements. I have an indoor aerial and a small one at that, my earth is just a poker driven underneath the window from inside; we are also on the ground floor.

LET "A.W." SOLVE YOUR WIRELESS PROBLEMS.

The results from this set under such conditions are splendid, the volume is great, some foreign stations come in quite clear and distinct. If I could only get a better aerial and earth connection this wonderful circuit would make some of my four-valve friends study the "£3 3s. Four."

W. F. (Shoreditch).

"Century Super" and Volume Control

SIR,—I have built the "Century Super" and results are all that you claim, but there is one peculiarity regarding the set about which I would welcome your advice. This relates to the setting of the volume control. If I try to adjust the knob to the maximum position, the volume is considerably reduced from that when the potentiometer knob is placed in about the central position. I have an idea that if I could get the volume control to work in the maximum position I should get even better results than at present. Can you help me in this matter?

R. A. (Kent).

The volume-control potentiometer only acts as a volume control as an incidental part of its work. Its main duty is to regulate the voltage that is applied to the screening grid of each S.G. valve. When the voltage applied to the screening grids is of a certain value, the valves will work at maximum efficiency and give greatest magnification. Adjustment of the supply voltage either side of this value will reduce the magnification. The voltage regulator, therefore, acts as a volume regulator. Your experience with the potentiometer knob adjustment is, therefore, quite in accordance with what is to be expected and there will be no gain in results by endeavouring to work the potentiometer knob at its maximum position of rotation.—Ed.

LARGER AND BETTER THAN EVER!

THE NEW "LANGMORE" RADIO-GRAMPHONE CABINETS (No. G1)



These cabinets are very strongly constructed of selected Oak. Size overall, 3 ft. 4 in. high by 21 in. wide by 15 in. deep.

THE TOP SECTION. Size, 4½ in. high by 18 in. wide by 14 in. deep, gives ample accommodation for gramophone or pick-up.

THE CENTRE SECTION. Size, 10 in. high by 18 in. wide by 14 in. deep, is for the Wireless Set, to take a panel either 18 in. by 7 in. or 18 in. by 8 in.

THE BOTTOM SECTION. Size, 16 in. high by 18 in. wide by 13½ in. deep, gives accommodation for Loud-speaker and Batteries.

Wooden Panels to fit, with oval aperture, 12 in. by 5½ in. 3/6 extra.

The whole of the back is enclosed by double doors, so that all parts are easily accessible. ALL are fitted with hinged top, heavy platform to take a 12-in. turntable for the Gramophone, and a substantial baseboard for the Wireless Set.

Price 49/6 each

Packed FREE and sent Carriage Paid to any address in Gt. Britain.

Trade Inquiries Invited.

BEAUTIFULLY FINISHED
:: JACOBAN OAK ::

THE MISCELLANEOUS TRADING Co. Ltd.
13 & 17, NEW OXFORD STREET, LONDON, W.C.1
Phone: Holborn 4894.

TANNOY RADIO



MAINS UNITS
Make your Set Completely Electric—

TYPE G.B.1. Pat. No. 353375
H.T. 150 v. at 15 m/a. or 120 v. at 20 m/a. Also S.G. and Det. Tappings.

G.B. 3 Tappings up to 12 v. Independent of H.T.

L.T. 2, 4 or 6 v. Trickle Charger

TYPE G.B.3.
Similar to above but with larger outputs—
Write for particulars.

SUPER-HET RADIO GRAMPHONE
This Radio receiver and Gramophone combined has a high-grade chassis which embodies multi bandpass tuning super-het receiver and corrected L.F. amplifier. Housed in a beautifully-figured polished walnut cabinet of Tudor design. This instrument is not mass produced, but is individually built for a discerning buyer. All models incorporate specially matched moving-coil speakers.

Price - - Mains Operated **45 gns.**
Battery Operated **43 gns.**

TANNOY PRODUCTS
Dalton Street :: West Norwood, S.E.27

Phone: Streatham 6731/2

THE FAMOUS FULLER "NON-SPILL" RANGE

also reduced
in price



THIS WONDERFUL range of jelly-acid accumulators has become a great favourite with owners of portable receivers. The demand has increased ever since they were introduced, and because of the increased output Fuller are now able to reduce the prices of the whole range. All non-spill accumulators are now fitted with the Fuller patent double grease-cup terminals, and all are fully charged.

In every detail the Fuller "Non-Spill" accumulators are unchanged. The meticulous care taken in manufacture is at once apparent in every one sold. The plates are micro-porous pasted, finer and smoother in texture than the ordinary type, but much stronger in wear; they never crumble or break down. The separators are indestructible and there are large non-spill vents. Fuller 'Sparta' 2-volt "Non-Spill" Accumulator for Portable Receivers, Type JUA9 11/6. Capacity 22 amp. hours. Overall size $4\frac{3}{4} \times 2\frac{9}{16} \times 3\frac{1}{2}$ ". Standard on well known portables. Other sizes from 9/- upwards.

There are 16 different types in all sizes and capacities and suitable for all popular suitcase and transportable receivers. Full list of H.T. Dry Batteries and L.T. and H.T. Accumulators on request.

Visit us at the Manchester and Edinburgh Radio Exhibitions.
Also at the Motor Show, Stand 316, National Hall Gallery

FULLER

SUPER BATTERIES

Contractors to British and Overseas Government Departments, Railways, etc.

FULLER ACCUMULATOR CO (1926) LTD., CHADWELL HEATH, ESSEX. Telephone: Seven Kings 1200. Telegrams: 'Fuller,' Chadwell Heath.



CAR AND M/CYCLE BATTERIES

Acid proof patent double grease cup terminals—Micro-porous pasted plates—high capacity—long life—exceptional strength. Models for every Car and Motor Cycle.—List M.2.

SUPER H.T. DRY BATTERIES

Machine made and tested throughout—long life—emission up to 20 M/amps. From 60 to 120 volts. Prices 7s. 5d. to 15s. 3d. also complete ranges of Standard, Triple, Portable, and Grid Bias Dry Batteries, etc.—List D.S.



LONDON AND PROVINCIAL DEPOTS:

- LONDON: Hanover House, 73-78, High Holborn, W.C. 'Phone: Chancery 7453.
- BIRMINGHAM: 29, Guildhall Buildings, Navigation St. 'Phone: Midland 3103.
- MANCHESTER: 19, Chapel Walks, Cross St. 'Phone: City 0857.
- GLASGOW: 101, West Nile St. 'Phone: Douglas 4367.
- BRISTOL: 28, Cumberland St. 'Phone: Bristol 7958.
- LEEDS: 9, Mill Hill. 'Phone: Leeds 22865.
- SHEFFIELD: 48, Sandford Grove Rd. 'Phone: Sheffield 51187.
- HULL: 69, Ryde Street. 'Phone: 592Yz.
- NEWCASTLE: 59, Side. 'Phone: Central 24068.
- SWANSEA: 10-11, St. Helen's Road. 'Phone: Swansea 3208.
- BELFAST: 23a, University Rd. 'Phone: Belfast 5566.
- DUBLIN: 17, Pearse Street, 'Phone: Dublin 44977.



Build this Amazing Receiver for Winter Reception

The Dynaplus—the first commercial kit-set to adopt the tuned-grid principle—is acclaimed by experts as the finest Screened 3 on the market! Consider this in your selection of a new receiver. Consider also the simple construction, neat appearance and compact layout—features every home constructor who builds the Dynaplus applauds. Then compare values! You will find that only the Dynaplus gives such good reception, at long range, at such a remarkably low price! All the components that make the Dynaplus are Voltron designed; Voltron made and Voltron tested. The Voltron guarantee covers them all. Everything about the Dynaplus is explained at length in the Constructional Folder No. D.3. Ask your dealer for it or write to the address below. Then build a receiver of which you can be proud.

VOLTRON DYNAPLUS SCREENED 3



Advt. of VOLTRON ELECTRIC LTD., Queensway, Ponders End, Middx.

The HORNET 2

A sound 2-valve receiver employing a detector and one L.F. stage of amplification. Designed specially to meet modern Regional reception demands. The twin Brookman's Park transmitters separated with ease. Foreign stations at good loud speaker strength. Simple to construct and tune. Ideal for subsidiary use with a super receiver. Constructional Folder No. H.2.B. Price—Complete Kit of Parts, including Cabinet

29/6

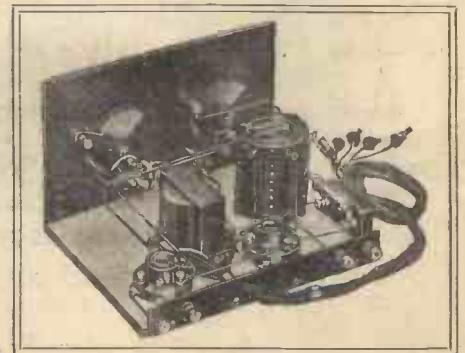

A Few Opinions expressed by owners of the DYNAPLUS SCREENED 3.

Clapton, E.S.

"The set is wonderful. I have logged 24 stations—British and foreign, all at loud-speaker strength."

Bournemouth.

"My house is a quarter of a mile from the local transmitter, but in spite of this I have been able to log over 40 stations without a wave-trap. Strasbourg, Barcelona, Mühlacker, Algiers, Toulouse, Frankfurt, Katowice, Prague, Rome, Langenberg, Milan, Brussels, Vienna, Budapest, Oslo, Kalundborg, Moscow, Motala, Warsaw, Eiffel Tower, Königswusterhausen, Radio Paris and Hilversum, all come in with enormous volume."

East London, S. Africa.

"I wish to convey to you how pleased I am with your Dynaplus S.G.3 Kit Set. I hear all three stations in S. Africa at loud-speaker strength, good volume and tone."



Neat modern cabinet

Complete kit of parts, *ex* valves and cabinet ... **£3.12.9**

Complete Kit of parts, including oak cabinet ... **£4.7.0**

Complete kit of parts, including oak cabinet and valves **£6.6.0**

To Ensure Speedy Delivery, Mention "A.W." to Advertisers

How to get **MORE VOLUME** and better quality reproduction **WITHOUT PAYING MORE FOR IT!**

WHEN you replace your power or super-power valve with a Lissen Power Pentode you increase the amplification of the last stage of your receiver to an enormous degree. For instance, the amplification factor of an ordinary power valve is seldom more than 10—while that of the Lissen Power Pentode is never less than 90! Think of the difference that makes to your set—how it converts a whispering foreign station to fine, full loud-speaker strength, and makes the “local” give you a torrent of pure sound.

GETTING PENTODE OUTPUT FROM BATTERY SETS

No need to alter your receiver at all. Simply replace your power valve with a Lissen Power Pentode. *The same battery drives this powerful valve*—no increase in current consumption takes place at all. That is why this valve is called the **LISSEN ECONOMY POWER PENTODE**—it gives you more volume for the same money!

The valve to ask for is the Lissen P.T.225—the

LISSEN ECONOMY POWER PENTODE



12 1/2

OTHER TYPES AND PRICES:—

H.L.210-5/6 H.210-5/6 L.210-5/6 P.220-7/3 P.X.240-8/-
S.G.215-12/6 4-volt and 6-volt types also available.

LISSEN LIMITED, WORPLE ROAD, ISLEWORTH, MIDDLESEX

Advertisers Appreciate Mention of "A.W." with Your Order



UP to the present the German broadcasting stations have relayed the official time signals from Nauen; in future a new method on the "six-dot" system is to be adopted as it is considered that the ONOGO signals are too complicated for the general public.

Radio Conference et Concerts is the call of a small private broadcasting station at Brussels which has now resumed its daily transmissions on 216 metres. The power does not exceed 150 watts in the aerial.

Some of the later evening broadcasts from Radio Toulouse can be picked up on most days on 44 metres; this transmission is carried out by an amateur experimental station at Oporto (Portugal).

The Soviet authorities officially state that they have started work on the 100-kilowatt transmitter at Novosibirsk destined to serve all Siberia and the Far East. Transmissions are to be made daily in the Russian, Chinese, Japanese, and English languages.

Every Sunday, Wednesday, and Satur-

day night from 10 p.m. G.M.T. Radio Strasbourg relays dance music played by the "Hot Syncopators" at the Savoy restaurant in that city.

The French Posts and Telegraphs administration has expressed the intention of installing a high-power broadcasting station in the Island of Corsica. With a view to finding a suitable site tests are to be made in the vicinity of the towns of Ajaccio, Calvi, and Bastia. The station will be linked up with the French official broadcasting net by submarine cable.

The Reykjavik broadcasting station is owned and operated by the Icelandic State. Although it has now been in operation for many months the number of registered subscribers does not exceed 3,600. The licence fee charged works out at roughly £1 12s. per annum.

Immediate steps are to be taken to increase the power of the Ecole Supérieure (Paris PTT) station; a complete overhaul of the plant, it is stated, will produce 10 kilowatts in the aerial. Later, if the new

re-organisation scheme is accepted, the Posts and Telegraphs will erect a 100-kilowatt transmitter.

For communication with the Belgian Congo and the United States of America the Ruyssedele (Belgium) short-wave station will work on 15.62 metres (9 kilowatts) during the day and on 29.04 metres (12 kilowatts) at night.

Scottish material, as compared with London material, is stated to occupy the large proportion of 45 per cent. of the broadcast programmes north of the Tweed. It has to be explained, however, that a large part of that percentage is devoted to the afternoon programmes, and that in the evening much more has its source in London than in Scotland.

Listeners may have noticed in the Scottish programmes recently that the Studio Orchestra is now under the direction of Mr. Guy Daines, who was in the musical show, *Waltzes from Vienna*.

"The Surprise" Symphony (No. 94, in G), by Hadyn, is to be the most important item in the orchestral concert from Belfast on October 20.

Wednesday, October 21, is the date provisionally fixed for the inauguration of the 85-kilowatt Radio Paris transmitter recently completed at Essarts-le-Roi. Listeners will be given an opportunity of hearing a running commentary of an official visit to the station during the morning and the speeches at a dinner given to the Minister of Posts and Telegraphs at 1 p.m.

(INDOOR) **FORMO** (LOW-LOSS)

7 in 1 AERIAL

STAND No. 81 MANCHESTER SHOW

has eliminated unsightly, inefficient and costly outdoor aerials.

LABORATORY TESTS PROVE 25% INCREASE IN SIGNAL STRENGTH

Have you ever considered the fact that aerials are the only remaining parts of modern wireless reception that have lagged behind in the swift development of wireless?

Do not waste any more money on repairing your outdoor aerial. Simply place the FORMO Low-Loss Aerial around the picture-rail or other convenient place, and enjoy improved and trouble-free reception of stations you may never have heard before.

Price—15 ft., 3/9
20 ft., 4/6

Packed in Strong Carton ready for use. Obtainable from all Radio Dealers. Catalogue from:

ARTHUR PREEN & CO., LTD., Golden Square, Piccadilly Circus, London, W.1
Crown Works, Southampton.
See also page 790.

GET YOURS TO-DAY!

A WONDERFUL LITTLE WIRELESS FRIEND

Answers nine of the most frequently asked questions concerning each of the 76 BRITISH and CONTINENTAL STATIONS.

1/- Each, 2 sided. Diameter 9 1/2 in.

ON SALE AT RADIO STORES, BOOKSELLERS, ETC. IF ANY DIFFICULTY, WRITE DIRECT TO F. PITCHFORD & Co., Ltd., WELL ST., LONDON, E.C.1

DAILY MAIL RADIO CHART

High-Grade RADIO GRAMOPHONE CABINET

of exclusive modern design, hand made and polished, on Queen Anne legs.

Figured Oak £5-5-0
Figured Walnut or Mahogany £5-19-6
Carriage paid.

THE ACME OF CRAFTSMANSHIP.
Radio-Gram Cabinets from £3:19:6 to £21
Wireless Cabinets - - - - - from £2

Photographs and 30-page illustrated catalogue free.

Cabinets made to order a speciality. Furniture at Maker's prices.

GILBERT, CABINET MAKER, SWINDON.

Estimates free. Estd. 1866



HELPFUL
 CRITICAL
 OUTSPOKEN
 ENTERTAINING
 FORCEFUL
 UNIQUE
 LIVE
 FRANK
 BRIGHT
 CONSTRUCTIVE
 TOPICAL
 USEFUL
 EXPERT

Capt. P.P. Eckersley

—world-famous as one of the pioneers of broadcasting with the Marconi Co. and the B.B.C.—is now Wireless Editor of *The Daily Mail*. His brilliant and outspoken article every Wednesday is one outstanding feature of the day-to-day service for the listener provided by The

DAILY MAIL

AN ADDITION TO A FAMOUS RANGE OF DUBILIER CONDENSERS

A 4 mfd. Type BB

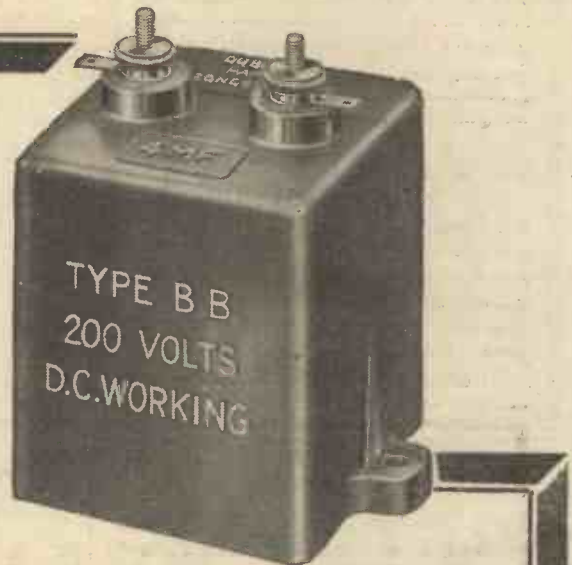

With the addition of this new 4 mfd. model the need for paper condensers suitable for wireless receivers can now be met from the range of Type BB Dubilier Condensers.

This range of condensers has already been used by many thousands of constructors of wireless receivers with entire satisfaction. They are built with all that precision which ensures unfailing reliability in any Condenser bearing the name Dubilier.

NORTHERN NATIONAL RADIO EXHIBITION MANCHESTER Oct. 7th to Oct. 17th we are exhibiting at STANDS 64 & 78

PRICES (Type BB):

1 mfd. - 2/6 2 mfd. - 3/6 4 mfd. - 6/3
 (Working Voltage 200 D.C. Tested at 400 V.D.C.)

DUBILIER

CONDENSER Co. (1925) Ltd.
 DUCON WORKS, VICTORIA ROAD, N. ACTON, LONDON, W.3

Don't Forget to Say That You Saw it in "A.W."

60 m.a. at 250 Volts



This is the power you want to run your Receiver with success. The latest Heayberd Transformer has been designed expressly for use with the new Westinghouse Rectifier H.T. 8.

Model W. 30.

Rectified Outputs:—
250 v. at 60 m.a. using Tapping 200v.
200 v. at 60 m.a. using Tapping 175v.
L.T. 4v. 6 amp. for Price 22/6
A.C. Valves 7/6 extra.

Send 3d. stamps for lists giving full details suggested Kits of Parts and circuit diagrams incorporating this new Transformer.

M.....Address.....



10 Finsbury Street, London, E.C. 2.

Write for Our

OCTOBER SALE LIST

Saves you Pounds!

Crammed with illustrations and details of all sorts of fascinating and useful gear, at very reasonable prices.

MICROPHONES AND TELEPHONES
RADIO AND ELECTRICAL
INSTRUMENTS : : SWITCHGEAR
MOTORS : GENERATORS.

Just Send a Stamped Envelope.

ELECTRADIX RADIOS

218 Upper Thames St., London, E.C.4
City 0191. Electradix, Cent, London

You MUST have the
"WIRELESS MAGAZINE"

Every Month

Price 1/-

TAYLEX WET H.T. BATTERIES

New Prices: Jars 1/3. Sacs 1/2. Zincs 1 Od. Sample doz. 18 Volts complete with bands and electrolyte 4/1 post 9d. Sample unit 6d. illus. booklet free. Bargain list free.
AMPLIFIERS, 30/- 3 VALVE ALL-STATION SET £1.
A. TAYLOR, 57, Studley Road, Stockwell, LONDON.

BROADCAST TELEPHONY

Broadcasting Stations classified by country and in order of wavelengths. For the purpose of better comparison, the power indicated is *aerial* energy.

Kilo-Metres	Station and Call Sign	Power (Kw.)	Kilo-Metres	Station and Call Sign	Power (Kw.)	Kilo-Metres	Station and Call Sign	Power (Kw.)
GREAT BRITAIN								
25.53	Chelmsford (G5SW)	16.0	328.2	Grenoble (PTT)	3.0	NORTH AFRICA		
242.3	Belfast	1.2	328.9	Poste Parisien	1.2	363.4	Algiers (PTT)	13.0
261.3	London Nat.	08.0	370.4	Strasbourg (PTT)	15.0	416	Radio Maroc (Rabat)	10.0
288.5	Newcastle	1.2	447.1	Radio LL (Paris)	0.5	NORWAY		
288.5	Swansea	0.16	466	Paris (PTT)	2.0	236	Kristianssand	0.63
288.5	Plymouth	0.16	471.1	Lyons (PTT)	2.3	240.6	Stavanger	0.625
288.5	Edinburgh	0.4	1,445.7	Eiffel Tower	15.0	364	Bergen	1.35
288.5	Dundee	0.16	1,724.1	Radio Paris	17.0	368.0	Frederiksstad	0.8
288.5	Bournemouth	1.2	1,724.1	(testing)	85.0	453.2	Porsgrund	0.8
288.5	Aberdeen	1.2	GERMANY			493.4	Trondheim	1.35
301.5	North National	70.0	31.39	Zeesen	15.0	560	Hamar	0.3
309.9	Cardiff	1.2	217.1	Königsberg	1.7	1,083	Oslo	75.0
356.3	London Reg.	70.0	218.5	Flensburg	0.6	POLAND		
376.4	Glasgow	1.2	227.4	Cologne	1.7	214.2	Warsaw (2)	1.9
398.9	Midland Reg.	38.0	227.4	Münster	0.6	234	Lodz	2.2
479.2	North Regional	70.0	227.4	Aachen	0.3	244.1	Wilno	21.0
1,554.4	Daventry (Nat.)	35.0	232.2	Kiel	0.31	312.8	Cracow	1.5
AUSTRIA			239	Nürnberg	2.3	335	Poznan	1.9
218.5	Salzburg	0.6	245.9	Cassel	0.3	381	Lvov	21.0
245.9	Linz	0.6	253.4	Gleiwitz	5.6	408	Katowice	16.0
283.5	Innsbruck	0.6	269.3	Leipzig	2.3	1,411.8	Warsaw	158.0
352	Graz	9.5	209.8	Bremen	0.2	PORTUGAL		
453.2	Klagenfurt	0.6	276.5	Heilsberg	75.0	200.5	Lisbon (CTIAA)	2.0
517.3	Vienna	20.0	283.6	Magdeburg	0.6	also on 42.9 m.		
also testing on 1,255 m. from 8.0 p.m. (Mon. Wed. Sat.)			283.6	Berlin (L)	0.6	ROMANIA		
BELGIUM			283.6	Stettin	0.6	394	Bucharest	10.0
206	Antwerp	0.4	318.8	Dresden	0.3	RUSSIA		
216	Bruxelles	0.2	325	Breslau	1.7	427	Kharkov	25.0
Conference			360.1	Mühlacker	75.0	497	Moscow	1.2
223.5	Binche	0.1	372.3	Hamburg	1.7	497	Archangel	1.2
245.1	Schaerbeek	0.2	390	Frankfurt	1.7	511	Moscow (PTT)	20.0
338.2	Brussels (No. 2)	20.0	419	Berlin	1.7	515	Kiev	20.0
608.5	Brussels (No. 1)	20.0	453.2	Danzig	0.6	720	Nijni Novgorod	1.8
BULGARIA			472.4	Langenberg	17.0	840	Kharkov (RV20)	25.0
318.8	Sofia (Rodno Radio)	1.0	532.9	Munich	1.7	937.5	Leningrad	100.0
CZECHO-SLOVAKIA			559.7	Kaiserslautern	1.7	1,000	Tiflis	10.0
263	Moravska Ostrava	11.0	559.7	Augsburg	0.3	1,034.5	Rostov Don	4.0
279.3	Bratislava	14.0	566	Hanover	0.3	1,073	Moscow Popoff	75.0
293	Kosice	2.5	569.3	Freiburg	0.3	1,304	Moscow (Trades Unions)	165.0
341.7	Brunn (Brno)	34.0	1,620	Norddeich	10.0	1,481	Moscow (Kom)	40.0
486.2	Prague (Prahá)	5.5	1,634.0	Zeesen	75.0	SPAIN		
486.2	Lieblitz (test)	60.0	2,525	Königswusterhausen	15.0	252.7	Barcelona (EAJ15)	1.0
DENMARK			2,900	Königswusterhausen	15.0	269	Valencia (tests)	5.0
281	Copenhagen	1.0	(press)			349	Barcelona (EAJ1)	8.0
1,163	Kalundborg	7.5	HOLLAND			366.9	Seville (EAJ5)	1.5
ESTONIA			31.28	Bindhoven (PCJ)	30.0	425.7	Madrid (EAJ7)	2.0
465.8	Tartu	0.5	208.8	Hilversum	8.5	449.1	Sau Sebastian	0.6
501.7	Tallinn	0.7	298.8	Radio Idzerda (The Hagus)	3.0	SWEDEN		
FINLAND			285	Kootwijk	10.0	230.3	Malmö	0.73
291	Tampers	1.0	Haven			257.3	Hörby	15.0
291	Viipuri	13.2	1,875	Huizen	8.5	307.5	Falun	0.6
368.1	Helsinki	13.2	HUNGARY			322	Göteborg	15.0
1,796	Lahti	54.0	550	Budapest	23.0	436	Stockholm	75.0
FRANCE			ICELAND			642	Sundsvall	15.0
220	Fécamp	5.0	1,200	Reykjavik	16.0	770	Ostersund	0.7
237.2	Béziers	0.6	IRISH FREE STATE			1,229.5	Boden	75.0
238.5	Bordeaux	2.0	224.4	Cork (8CK)	1.5	1,348	Motala	40.0
Sud-Ouest			413	Dublin (2RN)	1.5	SWITZERLAND		
249.6	Juan-les-Pins	0.5	ITALY			244.1	Basle	0.65
255	Toulouse (PTT)	1.0	25.4	Rome (3RO)	9.0	246	Berne	0.5
265.4	Lille (PTT)	2.0	247.7	Trieste	15.0	459	Beromünster	75.0
272	Rennes	1.2	296.1	Turin (Torino)	8.5	760	Söldens	25.0
286	Montpellier	2.0	312.8	Genoa (Genova)	10.0	TURKEY		
287	Radio Lyons	30.0	332	Naples (Napoli)	1.7	1,204.8	Istanbul	5.0
294.7	Limoges (PTT)	0.5	441	Rome (Roma)	75.0	1,538	Ankara	7.0
304	Bordeaux (PTT)	15.0	453.2	Bolzano (IBZ)	1.5	YUGOSLAVIA		
314.3	Natan-Vitus (Paris)	0.5	501	Milan (Milano)	8.5	307	Zagreb (Agram)	0.7
316	Marseilles (temporary)	0.3	541.5	Palermo	3.7	430.4	Belgrade	3.0
			LATVIA			574.7	Ljubljana	2.8
			525	Riga	13.0			
			LITHUANIA					
			1,935	Kaunas	7.0			

THIS EARTH TUBE WILL NEVER CORRODE

Gives Perfect Earthing.

When the earth corrodes, reception falls off in volume and quality. Copper earth tubes quickly corrode. The

"GODWINEX"

Earth Tube is definitely non-corroding. It will give perfect results or yars.



The tube, giving 180 sq. in. of earthing surface is of heavy gauge steel heavily coated inside and out with lead. Earth wire sinks into lead coating on tightening thumbscrew giving perfect electrical connection, without soldering. From your radio dealer, individually boxed or direct (Postage 6d.) from

3/6

J. DYSON & Co., Ltd. (DEPT. A D)
5 & 7, Godwin Street, BRADFORD
2, Coleman Street, LONDON, E.C.2.

THE "KINVA" SCREENED H.F. CHOKE

The latest addition to screening practice. Designed for effective choking up to 3,000 metres for all "STRAIGHTS" and "SUPERS." Absence of external fields assists circuit stability and compact "LAYOUT." Incorporates multi-slot high-inductance coil. No other choke offers these points.

PRICE 2/9

WRITE FOR DESCRIPTIVE LIST. IN STOCK AT MOST DEALERS. IF ANY DIFFICULTY WRITE DIRECT TO MANUFACTURERS.

POSTLETHWAITE BROS., KINVER : : STOURBRIDGE



EASY TERMS

WE SUPPLY ALL GOOD QUALITY RADIO RECEIVERS, COMPONENTS AND ACCESSORIES ON DEFERRED TERMS. WE CARRY ADEQUATE STOCKS AND CAN GIVE PROMPT DELIVERY

NEW HEAYBERD A.C. ELIMINATOR KIT G.150.—Complete Kit of Parts for building an H.T. Eliminator, including steel case. Output, 25 m.a., 150 volts. 3 H.T. Tappings, one variable. Cash Price, £3/16/-

or 7/6 with order and 11 monthly payments of 7/-
12 EXIDE W.H. HIGH-TENSION ACCUMULATORS (120 volts, 5,000 m.a.). Higher voltages if desired. Cash Price, £3/15/-

or 7/6 with order and 11 monthly payments of 7/-
Carriage charged on all orders from Scotland.

N.K. FARRAND INDUCTOR LOUD-SPEAKER UNIT.—Quality of reproduction almost equal to a moving-coil speaker. Cash Price, £3/10/-

or 5/6 with order and 11 monthly payments of 6/8.
SET OF THREE VALVES, S.G., DET. AND POWER, MULLARD OR COSSOR. Cash Price, £1/19/0

or 6/- with order and 7 monthly payments of 5/4.
NEW BLUE SPOT 66R UNIT.—The finest balanced-armature movement on the market. Complete with large Cone and Chassis. Cash Price, £2/10/-

or 5/- with order and 10 monthly payments of 3/-
NEW CELESTION MOVING COIL L.S. UNIT (PERM. MAGNET), with Transformer. Cash Price, £4/5/-

or 13/6 with order and 10 monthly payments of 8/-
Send list of requirements and quotation will be sent by return.

LONDON RADIO SUPPLY CO.
 11 Oat Lane, Noble Street, London, E.C.2
 Telephone: National 1977

EVERYMAN'S WIRELESS

By ERNEST H. ROBINSON (5 Y.M.)

A handy book telling in plain, non-technical language all that the average man needs to know about Wireless.

CASSELL'S 3/6 net.

BULGIN PAT. PEND.

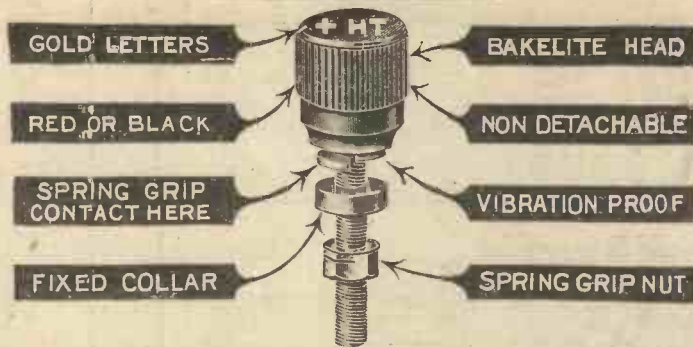

VIBRATION-PROOF TERMINALS

This new and unique Bulgin terminal represents an enormous advance over all existing types. The insulated heads of these terminals are of moulded-bakelite, non-detachable, and incorporate a special spring grip device which ensures strong and definite connections.

A spring grip nut ensures that each terminal is firmly locked to the panel.

The bakelite heads are in two colours, Polished Black and Brilliant Red, and the terminals are available with the undermentioned gold-filled engravings:—

RED

Aerial, Aerial 2,
 L.T.+, H.T.+,
 H.T.+1, H.T.+2,
 L.S.+, Mains+,
 Plain.

Price 3d. each.

Send for new 75-page illustrated Catalogue and Manual which also describes the new Bulgin Technical Service. Enclose 2d. postage.



BLACK

Earth, L.T.—,
 H.T.—, L.S.—,
 Pick-up, Mains—
 Plain.

Price 3d. each.

A. F. BULGIN & CO., LTD., ABBEY ROAD, BARKING, ESSEX
 Telephones: Grangewood 3266 and 3267.

London Showrooms: 9, 10, 11 Cursitor Street, Chancery Lane, E.C.4.

Telephone: Holborn 2072

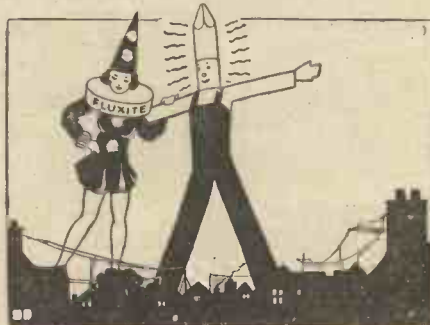

"We're Fluxite and Solder, The reliable pair, Famous for Soldering—Known everywhere! We've soldered all connections, And here's the reward—Good Programmes come clearly, From Home and Abroad!"

See that Fluxite and Solder are always by you—in the house, garage, workshop—anywhere where simple, speedy, soldering is needed. They cost so little, but will make scores of everyday articles last years longer! For Pots, Pans, Silver, and Brassware; RADIO: odd jobs in the garage—there's always something useful for Fluxite and Solder to do.

All Hardware and Ironmongery Stores sell Fluxite in tins, 8d., 1/4 and 2/8. ANOTHER USE FOR FLUXITE Hardening Tools and Case Hardening. Ask for Leaflet on improved method.

NEW "JUNIOR" SIZE, 4d. per tin
FLUXITE SOLDERING SET

Simple to use and lasts for years in constant use. Contains special "small-space" soldering iron with non-heating metal handle; pocket blow-lamp. Fluxite, Solder, etc.; and full instructions

COMPLETE, 7/6, or LAMP only, 2/6.

FLUXITE, LTD.
 (Dept. 326)
 ROTHERHITHE, S.E.16

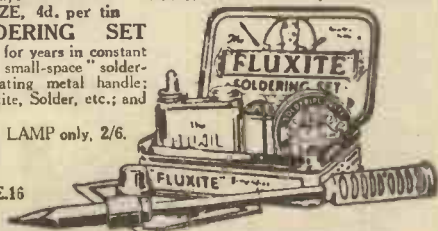

ALL MECHANICS WILL HAVE
FLUXITE
 IT SIMPLIFIES ALL SOLDERING

SUPER-TUNING

However fashion may change in receiver design, this famous British General Tuning Unit still retains its popularity. The old-fashioned coils are entirely superseded by this tuning device which covers the whole waveband between 200 and 2,000 metres on one dial. Fixing is easy, tuning is simple—and full wiring instructions are supplied.

Price 14/6 from all reputable dealers or direct from the manufacturers.

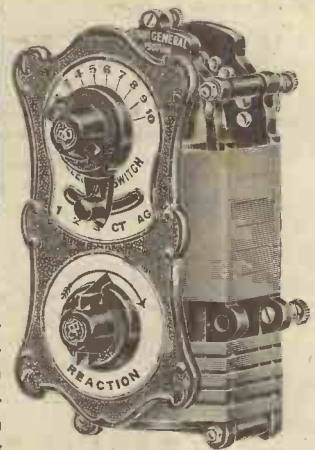

14/6

BRITISH GENERAL MANUFACTURING CO., LTD.
 BROCKLEY WORKS, LONDON, S.E.4.

BRITISH GENERAL A.T.U.

To Ensure Speedy Delivery; Mention "A.W." to Advertisers

**Do
You
Know?**

Historical Signs—No. 1



*The Sign of
St. Crispin*

CRISPIN, a Christian martyr and shoemaker of Soissons, because of his goodness to the poor in making their shoes without payment, was, after his martyrdom in 286 made the patron saint of the shoemakers. In the middle-ages and onwards the sign of St. Crispin was used by all true craftsmen among leatherworkers.

To-day, in the same way, "the green case" is a recognised sign of condenser efficiency—indicating as it does the product of experience and skill. For every T.C.C. Condenser is the result of a quarter of a century's specialised experience—that of designing and making condensers—and condensers alone. Be sure your next condenser has this backing—be sure its T.C.C.

Look for the initials
T.C.C.
on the condenser
in the green case

T.C.C.
CONDENSERS

The Telegraph Condenser Co. Ltd., Wales Farm Road, N. Acton, W.3
0167

**THE SHADOW
ON THE DIAL**
clearly shows the position of the Stators

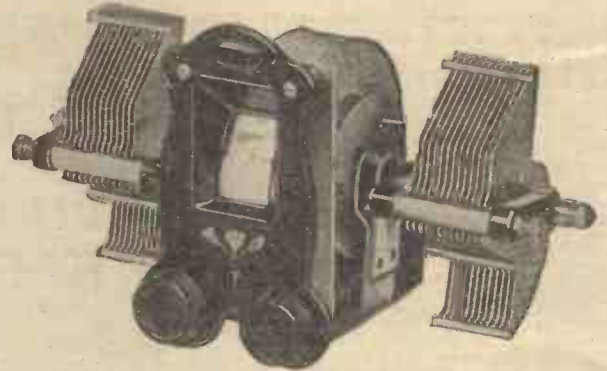

DUAL GANG

It has been so arranged that the two Condensers are completely insulated one from the other. If the frame of the drum dial is connected to earth, it makes a perfect metallic screen between the two Condensers. The position of the stators can easily be seen as there is a hidden pointer behind the celluloid drum which throws a shadow on to the drum. Price **18/6**



TRIPLE GANG (Completely Screened)

The left-hand knob controls the stators of the two left-hand Condensers and the position of the stators is indicated on the celluloid drum by a shadow thrown from a hidden pointer. The two left-hand Condensers are provided with small balancing Condensers for balancing the stray capacities in the circuit of the band-pass. Price **30/-**
If with rotor and stator of right-hand condenser insulated from the wiring. Price **31/6**

**THE FAMOUS
FORMO - DENSOR**



The product is the pioneer of small compression-type condensers, and for all purposes where some flexibility in capacity is required, the Formo-Densor is a product of assured reliability and precision.

TYPE F, J, G **1/6**
TYPE H ... **2/3**

Obtainable from all Radio Dealers.

Complete Catalogue from:

ARTHUR PREEN & Co., Ltd.

Golden Square, Piccadilly
Circus - LONDON, W.1.

Crown Works,
Southampton.

(See also page 786)

Postcard Radio Literature

GET THESE CATALOGUES FREE.

Here "Observer" reviews the latest booklets and folders issued by well-known manufacturers. If you want copies of any or all of them FREE OF CHARGE, just send a postcard giving the index numbers of the catalogues required (shown at the end of each paragraph) to "Postcard Radio Literature," "AMATEUR WIRELESS," 58-61, Fetter Lane, E.C.4. "Observer" will see that you get all the literature you desire.

Igranic Alterations

I HAVE just had from Igranic advance details of the new catalogue which will announce many new parts and price revisions. You should have your name put down for a copy of this new catalogue so soon as it is issued. **583**

A Safety Device

I see that the price of the Spa safety aerial fuse has just been reduced. This is a useful component comprising a good lightning arrestor and full details can be had on request. **584**

A Good H.T. Unit

I have just had details of the new Climax H.T. unit for A.C. mains. It works on 200-250-volt supply and gives a 20-milliampere output with three tapplings. As it incorporates a Westinghouse rectifier and costs only £2 12s. 6d., I think it is remarkable value. Literature describing it can be had free. **585**

H.M.V. Outfits

The Gramophone Co. interest me with their new folder, which is an abbreviated form of catalogue of the new sets, radiograms, playing desks, and gramophone accessories. This is well worth getting. **586**

H.T. Battery Recommendations

From Oldham & Son, Ltd., you can get a free list of H.T. battery recommendations giving the voltage and dimensions of batteries suitable for all popular portable sets on the market. **587**

Wavemaster Condensers

There are many technical points about Wavemaster condensers, air-dielectric and solid dielectric, which will appeal to technical enthusiasts. A new catalogue has just been brought out. **588**

The "V3" Kit

If you want full details of the Radio for the Million "V3" kit described last week by "Set Tester," then send 4½d. in stamps for a copy of the "Radio for the Million" book which describes this new three-valve all-metal chassis. Address your inquiry to the "A.W." Post Card Radio Literature Service. **589**

OBSERVER.

New Times Sales Co

We can supply any accessory advertised in "Amateur Wireless" on EASY TERMS. Send us your next order. We guarantee you every satisfaction.

ENJOY THE NEWEST IN RADIO THROUGH OUR REALLY EASY TERMS

MANUFACTURERS' KITS

10/- DOWN AND 11 MONTHLY PAYMENTS OF 10/10
V3 RADIO FOR THE MILLION
Screened-grid, Detector, and Power. With valves, less Cabinet. CASH PRICE **£5.17.6**

COSSOR 234 EMPIRE MELODY MAKER
Screened-grid, Detector, and Power. With valves and cabinet. CASH PRICE **£6 15s. 0d.** 10/-
Balance in 11 monthly payments of 12/6. WITH ORDER

MULLARD 3 1932 TYPE
Screened-grid, Detector, and Pentode. With valves less cabinet. CASH PRICE **£6 10s. 0d.** 11/11
Balance in 11 monthly payments of 11, 11. WITH ORDER

OSRAM NEW MUSIC MAGNET 4
Two Screened-grid, Detector, and Power. With valves and cabinet. CASH PRICE **£10 15s. 0d.** 19/8
Balance in 11 monthly payments of 19, 8. WITH ORDER

SIX-SIXTY CHASSIKIT BATTERY MODEL
Complete three gang band-pass tuning, S.G., Detector and Pentode. With valves less cabinet. CASH PRICE **£6 17s. 6d.** 12/7
Balance in 11 monthly payments of 12/7. WITH ORDER

SIX-SIXTY CHASSIKIT A.C. MODEL
Complete as above with A.C. Mains Valves. With valves less cabinet. CASH PRICE **£7 6s. 6d.** 13/5
Balance in 11 monthly payments of 13/5. WITH ORDER

ATLAS A.C. ELIMINATOR TYPE A.C.244. Three tapplings, S.G., Detector, and Power. Output, 120 volts at 20 m/a. CASH PRICE **£2 19s. 6d.** 5/6
Balance in 11 monthly payments of 5, 6. order

EKCO K.18 COMBINED H.T. ELIMINATOR AND L.T. TRICKLE CHARGER. Delivers 18 m/a. and suitable for 1- to 5-valve sets. S.G., 50/80 volts, 120/150. Charges at .25 amp. at 2, 4, or 6 volts. A.C. Mains CASH PRICE **£4 12s. 6d.** 8/6
Balance in 11 monthly payments of 8/6. order

REGENTONE ELIMINATOR, TYPE W.1F. Three tapplings, S.G., Detector, and Power. Output 120 volts at 12 m/a. A.C. Mains CASH PRICE **£2 7s. 6d.** 8/4
Balance in 5 monthly payments of 8/4. order

EKCO H.T. UNIT. TYPE A.C.25. For multi-valve sets requiring up to 25 m/a. 3 tapplings. S.G., detector and 120/150 volts. For A.C. Mains. Cash or C.O.D. Price **£3 17s. 6d.** 7/1
Balance in 11 monthly payments of 7/1. order

HEYBERD H.T. UNIT—"D" MINOR—Output 120v. at 12 m/a.—Tapped at 80v., 100v., and 120v. Westinghouse rectification. A.C. Mains. Cash price **£2 17s. 6d.** Balance in 11 monthly payments of 5/4. order

EXIDE 120-VOLT TYPE W.H., H.T. ACCUMULATOR, in crates. CASH PRICE **£4 13s. 0d.** 8/6
Balance in 11 monthly payments of 8/6. order

NEW TIMES SALES PERMANENT MAGNET MOVING COIL SPEAKER. In handsome oak french polished cabinet with specially designed Epoch Chassis giving glorious tone and volume. With multi-ratio transformer. Cash price **£3 15s. 0d.** With 6/11 order
Balance in 11 monthly payments of 6, 11.

AMPLION MOVING-COIL SPEAKER, TYPE M.C.6. Permanent magnet, with output transformer. Complete. Cash price **£3 7s. 6d.** Balance in 11 monthly payments of 6, 2. With 6/2 order

BLUE SPOT PERMANENT MAGNET MOVING-COIL SPEAKER. Complete with input transformer. Cash price **£3 15s. 0d.** Balance in 11 monthly payments of 6/11. With 6/11 order

EPOCH PERMANENT MAGNET MOVING-COIL SPEAKER. Type A.2. Cash price **£3 3s. 0d.** Balance in 11 monthly payments of 5/9. With 5/9 order

EPOCH J.I. PERMANENT MAGNET MOVING COIL SPEAKER. In Chassis form with multi-ratio input transformer. Cash price **£2 5s. 0d.** Balance in 11 monthly payments of 4/2. With 4/2 order

B.T.H. R.K. MINOR PERMANENT MOVING-COIL SPEAKER. Capable of handling outputs up to 2 watts. Cash price **£2 10s. 0d.** Balance in 8 monthly payments of 6/-. With 6/- order

W.B. PERMANENT MAGNET MOVING-COIL SPEAKER, TYPE P.M.3. With 3 Ratio input transformer. Cash price **£2 12 6** Balance in 9 monthly payments of 5/10. With 5/10 order

R.&A. "100" PERMANENT MAGNET MOVING COIL REPRODUCER. Complete with tapped Input Transformer. Cash price **£2 17s. 6d.** Balance in 11 monthly payments of 5/4. With 5/4 order

ORMOND PERMANENT MAGNET MOVING-COIL SPEAKER. With input transformer. Cash price **£3 5s. 0d.** Balance in 11 monthly payments of 6/-. With 6/- order

LAMPLUGH, FARRAND, BLUESPOT, FERRANTI DYNAMIC INDUCTOR SPEAKER for perfect reproduction. Unit and chassis complete, ready mounted. Cash price **£3 10s. 0d.** Balance in 11 monthly payments of 6/5. With 6/5 order

NEW N&K INDUCTOR DYNAMIC SPEAKER. Unit and Chassis complete. Cash price **£3 10s. 0d.** Balance in 11 monthly payments of 6/5. With 6/5 order

GARRARD INDUCTION GRAMOPHONE MOTOR MODEL 202. Mounted on 12-inch Nickel Motor Plate with fully automatic electric starting and stopping switch. Cash price **£2 18s. 6d.** Balance in 11 monthly payments of 5/4 only. With 5/4 order

CELESTION PERMANENT MAGNET MOVING-COIL SPEAKER. Type R.P.M.8, with 8" reinforced diaphragm. Chassis only, without input transformer. Cash Price **£3 10s. 0d.** Balance in 11 monthly payments of 6/5. With 6/5 order

ESTABLISHED IN 1924. FIRST WITH EASY TERMS

NEW TIMES SALES CO., 56 LUDGATE HILL, LONDON, E.C.4.

Phone: CENTRAL 2716.

(a) Please send me further particulars of.....

(b) I enclose.....s.....d. as first payment for.....

NAME

ADDRESS

A.W. 17/30/31.

PREPAID ADVERTISEMENTS

Advertisements under this head are charged THREEPENCE PER WORD, minimum charge THREE SHILLINGS. DEPOSIT SYSTEM
As the Publishers cannot accept responsibility for the bona fides of advertisers in this publication, they have introduced a system of deposit which it is recommended should be adopted by readers when dealing with persons with whom they are unacquainted. It is here explained.
Intending purchasers should forward to the Publishers the amount of the purchase money of the article advertised. This will be acknowledged to both the Depositor and the Vendor, whose names and addresses must necessarily be given. The deposit is retained until advice is received of the completion of the purchase, or of the article having been returned to and accepted by the Vendor. In addition to the amount of the Deposit, a Fee of 6d. for sums of £1 and under, and 1s. for amounts in excess of £1, to cover postage, etc., must be remitted at the same time. In cases of persons not resident within the United Kingdom, double fees are charged.
The amount of the Deposit and Fee must be remitted by Postal Order or Registered Letter (Cheques cannot be accepted), addressed to
"AMATEUR WIRELESS" ADVERTISEMENT DEPARTMENT, 58/61 FETTER LANE, LONDON, E.C.4

NEW ELECTRIC GRAMOPHONE MOTORS, 5-guinea models, suit A.C. or D.C., complete with 12-in. turntable, switch, regulator, etc. Blueprint instructions. Money return guarantee. 40/- each.—King, 1 Kingsley Road, Hounslow, Middlsex.

PERSONS REQUIRED immediately to make Leather Matting; regular work supplied, cash paid weekly.—Write E. 87, "Everlast" Leather Matting Co., Wellingborough.

VERT WIRING CLIP.—No soldering. Fits any component. Perfect contact. Tested and approved "A.W." Quarter gross, 1/2; half-gross, 2/-; gross, 3/9.—Green & Sons, Redcliffe, Horley, Surrey.

WIRELESS PARTS AND SETS exchanged for new. Up to 50% or more allowed for modern parts in good condition. Apparatus can be sent for valuation.—W. Burns, Wireless Factor, 4 Loanda Street, Haggerston, E.8.

"CRAFTTEASE" CABINETS are supplied "ready to assemble" or "assembled." Write for catalogue.—D. Crafttease Works, Winscombe.

AGENTS, ACTIVE ENTHUSIASTS: sell "Brookman British Ebonite Panels," cabinets, and specialities, suppliers of all makes of radio apparatus. Send for particulars of our system of trading. Brookman Rapid Radio Service, 105 Spencer Street, Birmingham.

ENGINEERS.—Seriously, if you are earning less than £10 per week you cannot afford to carry on without reading "ENGINEERING OPPORTUNITIES." Whether you are an old hand or a budding apprentice, this 200-page volume will point to a worth-while future. Among other things the book explains the methods of our unique Appointments Department, gives details of all leading Eng. Exams. (A.M.I.Mech.E., A.M.I.E.E., B.Sc., G.P.O., etc.) and outlines modern Home Study Courses in Civil, Mech., Elec., Motor, Aero., Radio, "Talkie," and all other branches of Engineering. This book will alter your entire outlook and earning power. It is quite FREE. Send for your copy now. British Institute of Engineering Technology, 109 Shakespeare House, 29-31 Oxford Street, London.

CORRESPONDENCE COURSES of instruction in radio. Specialised courses, moderate fees. Particulars from Correspondence Course Department of the R.M. College, 26-27 St. Mary Street, Cardiff.

EXCEPTIONAL BARGAINS.—Very latest All-mains Receivers, in beautiful cabinets, 5, 8, and 8 valves, self-contained, with moving-coil speakers. Fully guaranteed. Must clear, from £5 cash. Call and inspect.—Morgan Hastings, Ltd., 212 New Kings Road, Fulham, S.W.6 (opposite Putney Bridge Station).

R.K. SPEAKERS.—Modern Components in part exchange.—Scott, 10 East Parade, Ilkley.

"UNIVERSAL" RADIO BARGAINS of Bankrupt Stock.—Transformers: Triumph, 3/11; Telsen Ace, 4/7; Grand, 7/3; Dynaplus, 3/9; Stal, 3/3. Valves: Triotron, Dario, 4/3; Power, 5/3; Radvaco, 3/11; Power, 4/11. Speaker Units: Ormond, 6/3 and 9/3; Triotron "W", 8/3; Telsen, 4/6; Zelec, 3/3. Nassak Var. Condensers, 3/3; with vernier, 4/3. Differentials, 1/6. Ormond, 3/3. Six-pin B.B.C. Coils, 1/11; Dual, with Switch, 3/11. Compressions, 1/- Sutra Double-reading Voltmeters, 3/11. N. & K. Speakers, 49/6. Telsen Output Chokes, 6/8. Burndett Pickups, 10/6. Sovereign Volume Controls, 3/6. All goods in original sealed cartons. Thousands of other bargains. Request our price any component.—"Universal," 20 Victoria Road, Peckham, S.E.15.

ELECTRIC CLOCKS.—Assembled parts for easy construction, £2. Complete Clocks in oak case, £3/15/-. Accurate time, no winding; runs two years on two bell batteries.—A. Keith, 12a Lullington Road, S.E.20.

"MAKE YOUR OWN SPEAKER UNIT."—Efficient chassis-less Cone Unit easily constructed in an hour for few pence. Gives excellent quality and incorporates compensated armature movement. Prov. Pat. 455/31. Complete illustrated instructions (submitted to "A.W."), 1/- and stamped envelope.—W. S. Osborn, 53 Abbots Park Road, London, E.10.

PHOENIX THREE-VALVE KITS, complete with cabinet, £1/17/6. Ditto with valves, £2/15/-. Ditto with H.T. and L.T. batteries and speaker, £4/10/8. Three-valve S.G. Kits, 30/- extra. H.P. terms on kit; 10/5 deposit, 2/7 per week.—Phoenix, 314 High Road, Lee, S.E.13.

"STANDUP" Wet Battery replacements. All sizes up to 80,000 milliamps capacity. Lists free.—Scottish Batteries, Braeside, Uphall Station.

MOVING-COIL LOUD-SPEAKERS. Marconiphone 6v. units, 10 in. cones, complete 25/-. Unrepeatable bargains. Hillier, 22 Cork Street, W.1.

UNUSED BANKRUPT STOCK.—P.M. Loudspeakers Baker, £2 15s.; Epoch, £1 12s. 6d.; Triotron, 15s. units, 7s. 9d.; Siemens, 1500-v. condensers, 2Mid., 3s., 4Mid., 5s. 3d.; Wavemaster 0.0005SM, 4/6. Quotations. Catalogues Free.—Pepper, Wakegreen Road, Birmingham.

SET CHALLENGE 4 COILS 23/-, will exchange for Ether Searcher coils, 32 Canal Road, Mile End, London, E.

BANKRUPT BARGAINS.—List free with 3-valve diagram. Hundreds of bargains. Kits supplied for any circuit at keen prices. Transformers from 2/9; Dual Coils, 4/-; 0005 wavemasters, 2/6; Diffs., 2/-; Valve holders, 5d.; Fixed, 5d.; 2mfd., 2/-; Speaker unit, Triotron, 9/6; Zelec, 4/-; Telsen, 4/9; Eliminators, D.C., 22/8; A.C., 40/-. Get my list and save money. Quotations by return. Butlin, 143b Preston Road, Brighton.

MODERN THREE-VALVE SETS with valves, £3/15/-. Century Super kits, £3/15/-. Anything wireless supplied at keenest prices. Send list of requirements for quotation.—Servwell Wireless Supplies, 74 Gough Street, London, E.14.

THE LATEST AID TO WIRELESS! Ask your Dealer to show you a SCREW GRIP. JUST add a SCREW GRIP to your screwdriver and you will be able to put in the most awkwardly placed screw with the utmost ease. Saves time and temper, nothing to get out of order, easy to operate. Cheapest and best. Price with full instructions 6d., or post free, 9d. The Screw Grip Company, 105 Osborne Rd., Ramford

MAKE OR BUY A GRAMOPHONE AT a quarter shop prices. Or buy Cabinet or Wireless. British double spring motor, 12 in. velvet turntable, swan arm, metal sound-box, amplifier, needle cups, for £1-10-0 p.p., and build your own Cabinet. Portable Gramophones from 15/6, postage 1/6. Motors from 7/6. Lists free. 64 pp. 1931 Catalogue No. 220 with Reduced Prices, Drawing and How to Make Gramos, 3d. Established 27 years. Regent Fittings Co., A.W., 120 Old St., London, E.C.1

GRIPSO INDOOR AERIAL HOOK INSULATORS (SUPPORTS WIRE AWAY FROM WALL) 6 DOZEN THE GRIPSO COY. 52 VICTORIA ST. LONDON, S.W.1

BUY THROUGH THE POST—THE MODERN WAY! YOU WANT ADVERTISED GOODS—we have all of them IN STOCK and can give you IMMEDIATE DELIVERY. The Advertisement columns of this publication are our catalogue—free delivery at LIST PRICES (no extra postage). INTERNATIONAL RADIO BUREAU FARADAY HOUSE HENRY STREET BLACKPOOL (Lancs) CASH WITH ORDER OR C.O.D.

B.A.U. Buy your Moving Coil Speaker WRITE NOW FOR 42 pages of valuable information on how to secure REALISTIC REPRODUCTION BAKER'S 'Selous' A.C. CROYDON SURREY. PHONE CROYDON 1618

YOU CAN BUILD A £40 GRAMOPHONE WITH OUR SCALE DRAWINGS FOR 40/- Book of Instructions 3d. Catalogue of Motors, Tonearms, Soundboxes, latest internal amplifiers, Gramophones and Cabinets Free. Cash or Terms. W. BURT, 185 High St., Deptford

FULL-SIZE BLUEPRINTS

- CRYSTAL SET (6d.) 1931 Crystal Set ... AW308 ONE-VALVE SETS (1s.) Easy to Build One ... AW304 TWO-VALVE SETS (1s. each) Talisman Two (D, Trans) ... AW194 No-battery Gramo-radio 2 (D, Trans) ... AW238 1930 Talisman 2 (D, Trans) ... AW239 Arrow Two (D, Trans) ... AW249 Forty-five-shilling Two (D, Trans) ... AW250 Everybody's All-in 2 (D, Trans) ... AW273 Twenty-shilling Two (D, Trans) ... AW274 'The Room-to-Room 2 (D, Trans) ... AW298 Big-volume Two (D, Pentode) ... AW309 Gleaner Two (D, Trans) ... WM201 Merlin Two (A.C. Set) ... WM213 Five-point Two (D, Trans) ... WM220 Brookman's A.C. Two (D, Trans) ... WM225 Aladdin Two (D, Trans) ... WM231 Ever Tuned Regional Two (D, Trans) ... WM241 Station-finder Two (D, Trans) ... WM253

- THREE-VALVE SETS (1s. each) 1931 Ether Searcher (SG, D, Trans) ... AW271 1931 Ether Searcher (A.C. model) ... AW276 Mains Unit ... AW277 Ultra-selective Straight Three (SG, D, Trans) ... AW282 1931 Ether Searcher (D.C. model) ... AW284 Mains Unit ... AW285 Square Peak Three (SG, D, Trans) ... AW293 B.B.C. Selective Three (D, RC, Trans) ... AW289 Universal Short-wave Three (SG, D, Trans) ... AW301 Olympian Three (SG, D, Trans) ... AW306 Brookman's Three (SG, D, Trans) ... WM161 Five-point Three (SG, D, Trans) ... WM212 New Brookman's Three (SG, D, Trans) ... WM218 Five-point Short-wave (D, RC, Trans) ... WM223 Baffle-board Three (D, RC, Trans) ... WM226 Plug-in-coil Three (D, 2 Trans) ... WM232 Regional Three (SG, D, Trans) ... WM236 Band-pass Inceptor-dyne (SG, D, Trans) ... WM244 Ether Marshal (SG, D, Trans) ... WM247 Meridian Short-wave (D, RC, Trans) ... WM256 Five-advantage Three (D, RC, Trans) ... WM257 Everybody's Radiogram (SG, D, Trans) ... WM258

- FOUR-VALVE SETS (1s. 6d. each) The £3 3s. Four (SG, D, RC, Trans) ... AW303 The £3 3s. Four (Improved Model) ... AW303A Everybody's Radio-gramophone ... AW310 Regional Band-pass Four (SG, D, RC, Trans) ... WM211 Five-Point Four (SG, D, RC, Trans) ... WM216 Regional A.C. Four (SG, D, RC, Trans) ... WM222 Supertone Four (SG, D, Push-pull) ... WM227 Brookman's Three-plus-one (SG, D, RC, Trans) ... WM233

- FIVE-VALVE SETS (1s. 6d.) Britain's Super (Super-het) ... AW311 Regional D.C. Five (SG, D, RC, Push-pull) ... WM252

- SIX-VALVE SETS (1s. 6d. each) Century Super (Super-het) ... AW287 A.C. "Century Super" (Super-het) ... AW295 Mains Unit (1/-) ... AW295A Super 60 (Super-het) ... WM229 A.C. Super 60 Radio Gramophone (Super-het) ... WM239 A.C. Super 60 (Table Model) ... WM245 Super 60 (with Weirite base) ... WM249 Super 60 (with Lewcos base) ... WM251

- SEVEN-VALVE SET (1s. 6d. each) Super Senior (Super-het) ... WM256

Copies of the "Wireless Magazine" and of "Amateur Wireless" containing descriptions of any of these sets can be obtained at 1s. 3d. and 4s. respectively, post free. Index letters "A.W." refer to "Amateur Wireless" letters and "W.M." to "Wireless Magazine."

Amateur Wireless Blueprints Dept., 58-61 Fetter Lane, London, E.C.4.

EASY PAYMENTS "There's no place like Holmes." The first firm to supply wireless parts on easy payments. Seven years since our first advertisement appeared in "Amateur Wireless." Thousands of satisfied customers. COSSOR 1932 Kit. Cash £6/15/-, or 10/- with order and 11 monthly payments of 12/6. Also Osrain, Mullard Kits, etc. EXIDE 120-volt H.T. Accumulator. Cash £3, or 6/- with order and 9 monthly payments of 6/8. Also Oldham, etc. BLUE SPOT 66R Unit, with Cone and Chassis. Cash 42/6, or 5/6 with order and 9 monthly payments of 4/6. Also Wufa, etc. ESKO Eliminator, A.C.18, 1- to 5-valve sets. Cash £3/7/-, or 7/5 with order and 9 monthly payments of 7/5. Other models and Atlas, Regentone, etc. New Goods Obtained for Every Order. Send us a list of the parts you require and the payments that will suit your convenience, and we will send you a definite quotation. Anything Wireless. H. W. HOLMES, 29 Foley Street, Gt. Portland St, London, W.1. Museum 1414.

At last!

THE PERFECT ALL MAINS SET with the perfect Speaker



The receiver shown above is The BLUE SPOT "UPRIGHT GRAND," in a handsome cabinet of Walnut, Complete with stand **Price 27 Gns.**



Blue Spot Receivers are designed for mains currents (A.C.) 100-250 volts. A five valve circuit is employed, comprising two screened grid valves, one detector valve, one power output valve and one rectifying valve.

Alternative design of stand for BLUE SPOT "Upright Grand Receiver."



TRADE MARK
Regd. Nos. 515639 & 516180

SUPER RECEIVERS

Hutchens

THE BRITISH BLUE SPOT COMPANY LTD.
BLUE SPOT HOUSE, 94 / 96 ROSOMAN ST. ROSEBERY AV., LONDON, E. C. 1

Telephone: Clerkenwell 3570. Telegrams: "Bluospot, Isling, London."
Distributors for Northern England, Scotland and North Wales: H. C. RAWSON (Sheffield and London) Ltd., 100, London Road, Sheffield; 22, St. Mary's Parsonage, Manchester; 183, George Street, Glasgow.

Mention of "Amateur Wireless" to Advertisers will Ensure Prompt Attention

In Days of Economy...



FOTOS 'CONCERT' VALVES

Best for reception, best for the pocket. The initial cost is low and the period of effective service prolonged. That is why wireless enthusiasts insist upon Fotos Valves in every set

FROM

5/6

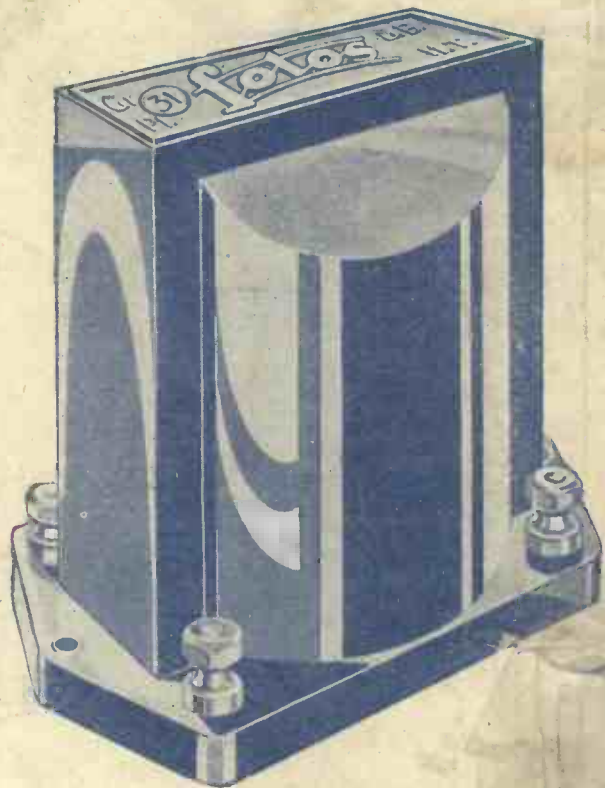

FOTOS 'NIPPER' TRANSFORMER

A grand little instrument for portable or wherever space is of special value. Slightly smaller than the 'super' model, but of same high quality and accuracy in operation

PRICE

4/6

ASK FOR

ACCEPT NO OTHER

CONCERTON RADIO
AND ELECTRICAL CO., LTD.

fotos
PRODUCTS
PROVE BEST.

256/7 BANK CHAMBERS
329 HIGH HOLBORN, LONDON,
W.C.1 'Phone: Holborn 8667

Morris Vibber

270

FREE SPECIAL SUPPLEMENT — SET BUILDING
UP-TO-DATE
YOUR OWN
PICTORIAL
GUIDE

Amateur Wireless

and
Radiovision:

Every
Thursday

3^d

Vol. XIX. No. 489

Saturday, October 24, 1931

**BRITAIN'S
"SUPER"**

W. JAMES'
**GREAT
SUCCESS**

*FREE
SUPPLEMENT
FOR
CONSTRUCTORS*



Another **LEWCOS** Regd. "All-British" Triumph

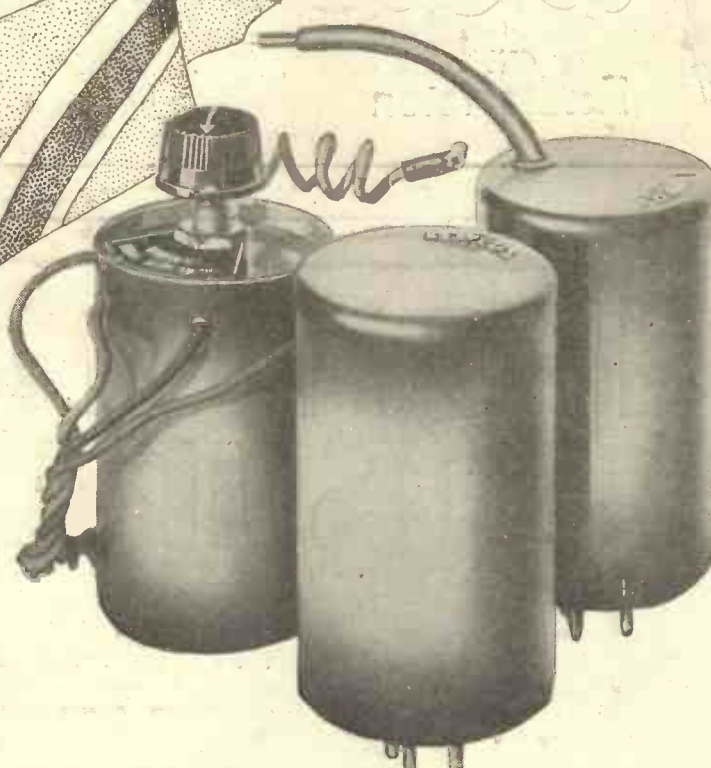

The Super-Het Coil Kit

(Ref. SHK No.3)

PRICE 37/6

Comprising:

- I OSCILLATOR COIL
Ref. O.S.C./126

- I INTERMEDIATE FREQUENCY
TRANSFORMER (without pigtail)

- I INTERMEDIATE FREQUENCY
TRANSFORMER (with pigtail)

This new LEWCOS achievement—the Super-Het Coil Kit—which has a nine Kilo-Cycle Wave-band separation and consists of one Oscillation Coil, one I.F. Coil with "Pigtail" and one I.F. Coil without, marks a new epoch in Radio reception.

The small space available is completely inadequate to give even a short description of these wonderful new LEWCOS Coils, but you are invited to write for an illustrated explanatory leaflet, Reference R.71.

HAVE YOU TRIED
THE NEW LEWCOS
H.F. CHOKE, PRICE
2/6
SIZE 2 1/8" LONG BY
1 1/8" WIDE BY 1 1/8"
HIGH.



The Lewcos Super-Het Coil Kit is specified for the "Britain's Super" Receiver described in this issue.

*Buy British and
Keep British
Labour Employed.*

LEWCOS RADIO PRODUCTS FOR BETTER RECEPTION
THE LONDON ELECTRIC WIRE COMPANY AND SMITHS LIMITED, CHURCH ROAD, LEYTON, LONDON, E.15

To Ensure Speedy Delivery, Mention "A.W." to Advertisers

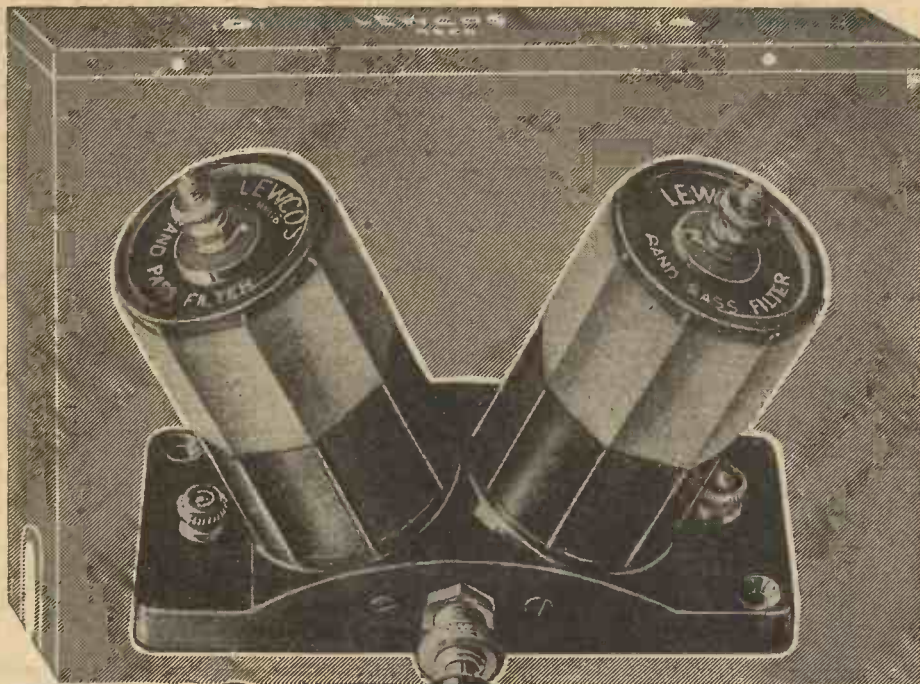

*The
Selectivity
Problem*
**SOLVED BY
LEWCOS**

The
LEWCOS
REGD.
BAND PASS FILTER
Price 12/- (Screen 2/6 extra)

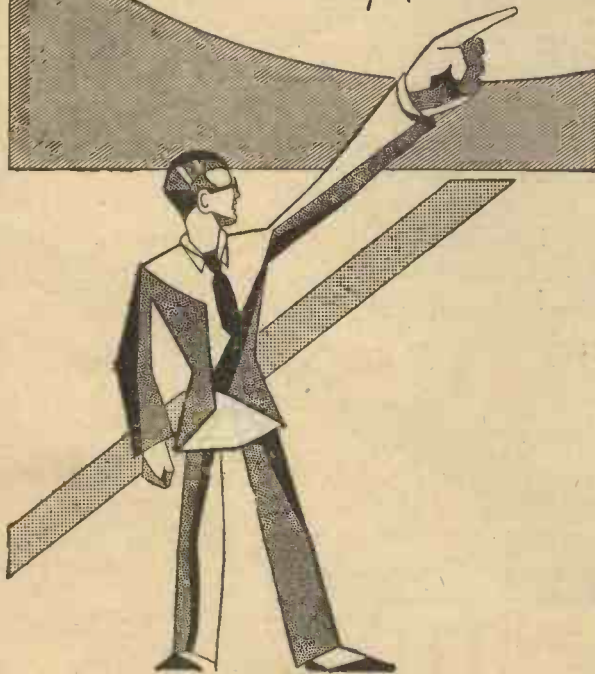

Here at last is a component over which you will naturally enthuse because it ensures selectivity such as you've heard of but never before experienced.

THE LEWCOS BAND PASS FILTER actually increases the range of any Receiver because stations which are normally inaudible, due to swamping by local transmissions, now have a place on the dial free from interference.

The phenomenal selectivity of this unique device is apparent on both long and medium wave bands; hence it is infinitely superior to any existing selectivity unit, such as wave traps, etc.

Write for fully descriptive leaflet, Reference R.73, showing flat-topped response curves.

THE LEWCOS BAND PASS FILTER IS EXCLUSIVELY SPECIFIED FOR THE "BRITAIN'S SUPER" described in this issue

LEWCOS RADIO PRODUCTS FOR BETTER RECEPTION
THE LONDON ELECTRIC WIRE COMPANY AND SMITHS LIMITED, CHURCH ROAD, LEYTON, LONDON, E.10

Please Mention "A.W." When Corresponding with Advertisers

"BRITAIN'S SUPER"
 WITH
WEARITE COMPONENTS
 MAKES A
SUPER RECEIVER

VALVE HOLDERS
 Fitted with sprung sockets.

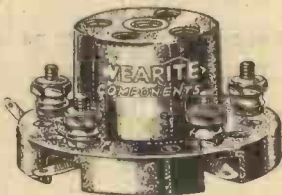

1 4-pin,
 6 5-pin.
 8/9
 per set.

PAXOLIN PANEL 14" x 7"
 In black, walnut or mahogany finish. Drilled to specification, 8/-
 Insulated Sleeving up to 2 m/m internal dia., will take 16 gauge base wire.
 Per dozen yards, 2/-

SUPER-HET COILS

BRITISH MANUFACTURE

Made In London
 under British
 Patent No. 349403

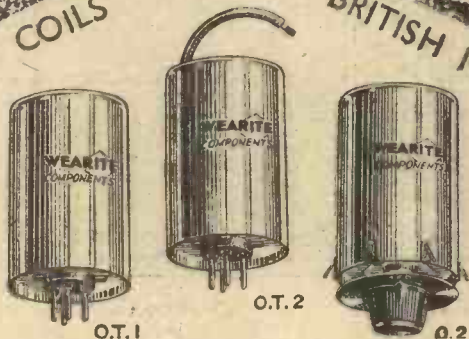

PRICE, PER SET
 OF THREE COILS,
 37/6

SPECIFIED BY Mr. W. JAMES
 FOR
"BRITAIN'S SUPER"



SUPER-FRAME AERIAL
 Dual range, centre tapped, in oak or mahogany.
 Price 42/-

NOTE

Special coil and valve chassis complete with grid leak clips and all essential wiring for Britain's Super. Price 8/-

"WEARITE"
SUPER-HET H.F. CHOKE

This choke has been recommended for all "Amateur Wireless" Super-Het Circuits. It has a range from 15-2,500 metres and a D.C. resistance of 3,100 ohms. Inductance 400,000 M.H. List No. HFS.

Price 6/6

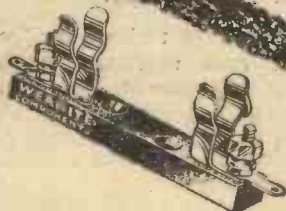

GRID LEAK HOLDER
 Price 6d.



Your Earth must be perfect for "Britain's Super." The Wearite earth tube deserves your attention.
 Price 3/6

WEARITE
COMPONENTS

Write for free lists **WRIGHT & WEAIRE, LTD., 740 High Rd., Tottenham, N.17.** Phone: **TOTTENHAM 3847-8-9**

Mention of "Amateur Wireless" to Advertisers will Ensure Prompt Attention

**An
instantaneous
Success**

**For
high Quality
& Brilliant
Performance**

**The ORMOND
MOVING COIL
LOUDSPEAKER**

Here, again, Ormond offer the home constructor the opportunity to make for himself a "speaker," equal to the most expensive products on the market, at a price well within reach of the slender purse. Gloriously natural tone is ensured by the perfectly balanced frequency response.

The construction is extremely robust, the whole being mounted as a complete chassis. The cone, speech coil and suspension are arranged to give a truly parallel action, to handle a heavy input without distress.

A speech transformer is incorporated, terminals being provided with alternative ratios for matching with the valve used in the output stage.

£3:5:0

Cat. No. R/464.

Also available complete in handsome figured oak cabinet. Height 16½ in. Width 16½ in. Depth 10½ in. Cat. No. R/466. Price £4 19s. 6d.

THE ORMOND ENGINEERING CO., Ltd.
Ormond House, Rosebery Avenue, London, E.C.1

Telephone: Clerkenwell 5334-5-6.
Telegrams: "Ormondengi, Isling."

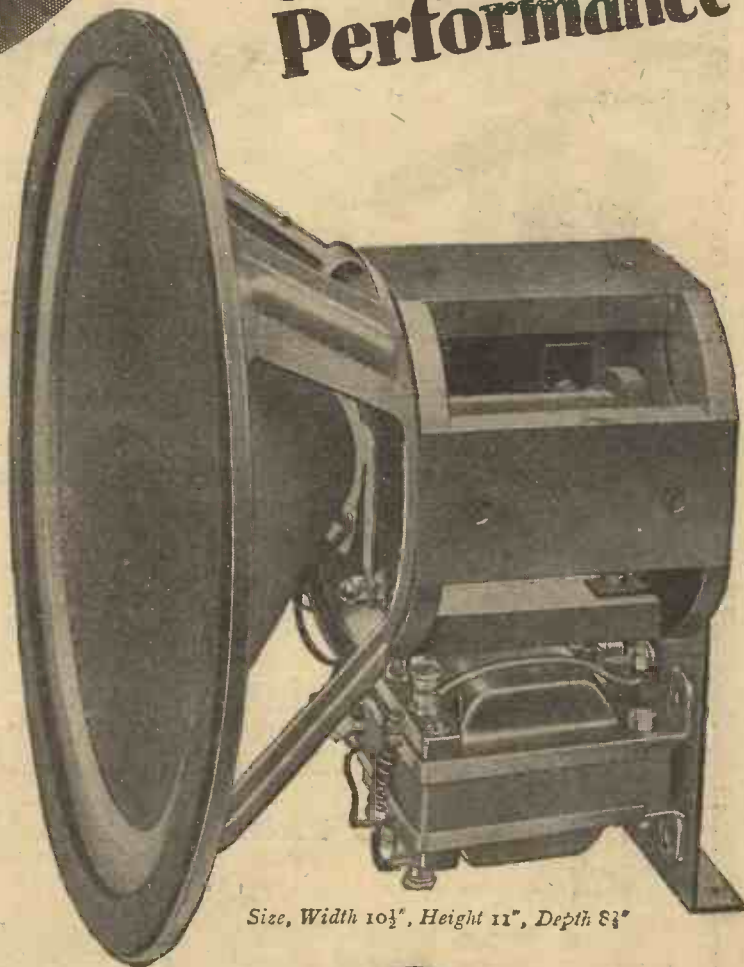

Size, Width 10½", Height 11", Depth 8½"



PUNCH POWER & PURITY !

Don't Forget to Say That You Saw it in "A.W."

Amazing fineness of adjustment **Unprecedented perfection of reproduction**

100%
improvement
in tone & volume
on any unit
previously
marketed

Gone can be the artificiality—the “sound thinness” which has hitherto characterised all speakers—the new Undy “8”- and “4”-pole Units ensure a “human” rendition of tone, quality and trust. Here’s an amazing test that must interest you. Impartial experts, assembled in a large hall could not distinguish natural sounds from the sounds reproduced by the Undy Units. You, too, can enjoy the same perfect reproduction. The new Undy “8” is fitted with tappings to suit valves of low- or high-impedance as desired.

Go to your dealer and hear it for yourself.

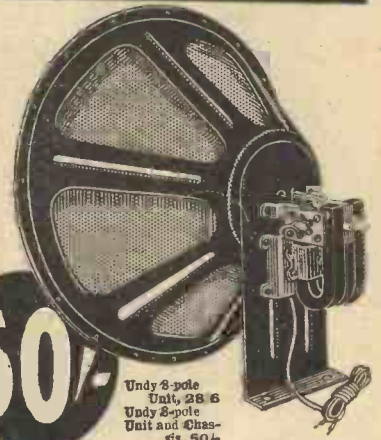

Undy 8-pole Unit, 28/6
Undy 2-pole Unit and Chassis, 50/-
Undy 4-pole Unit and Chassis, 28/6
Undy 4-pole Unit, 15/-

Also a very fine selection of cabinets.

The New **UNDY** Dynamic 8 pole

50/-

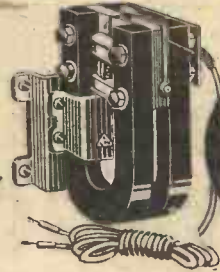

28/6

Brit. Pat. 330930

obtainable from all wireless stores

Sole representative for Great Britain and Ireland

J. HEMELAK, 8 Cullingworth Road, LONDON, N.W.10
Telephone—Glad. 2932



A reliable instrument in the plate circuit of the output valve is a valuable aid to true radio reproduction.

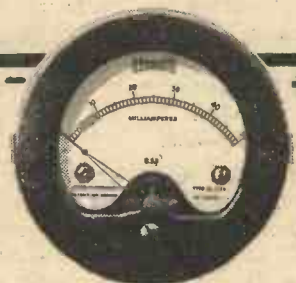

A Ferranti Radio Meter in the circuit:

- 1 Shows the milliamps flowing in the anode circuit, so that the correct current can be determined.
- 2 Gives indications enabling the correct H.T. and G.B. voltages to be applied.
- 3 Enables any overloading in the output stage to be corrected.
- 4 Its use may prevent damage or destruction of costly valves, and—
- 5 —its readings give an indication of the condition of the H.T. and L.T. Batteries.

FERRANTI RADIO METERS

FERRANTI LTD. HEAD OFFICE & WORKS: HOLLINWOOD, LANCS.
LONDON: BUSH HOUSE, ALDWYCH, W.C.2.

H.T. +

EVERYTHING *The* **G.E.C.** ELECTRICAL
your guarantee



The Osram 2-volt battery Valve with the **NEW, LONGER**

WEMBLEY FILAMENT

10% more for your money

10% GREATER ELECTRON EMISSION
THAN ANY OTHER 2-VOLT FILAMENT OBTAINABLE

This is the latest discovery of the G.E.C. Research Laboratories at Wembley. The "Wembley" filament means, that without loss of amplification, valves of amazing efficiency can be made with adequate electrode clearances. The avoidance of close electrode clearances results in:

1. Greater consistency between valve and valve.
2. Cutting out internal contacts and valve troubles.
3. Production of non-microphonic valves even under most exacting conditions of use.

Osram
2 VOLT BATTERY
Valves

Write for the Osram Wireless Guide (1931 Edition) and also Station Indicator card sent post free on request.

SOLD BY ALL WIRELESS DEALERS

THE NEW "WEMBLEY"
FILAMENT MEANS
MORE RELIABLE
WIRELESS, PURER
tone AND MORE
FOREIGN STATIONS.

BRITISH PRODUCTS DESIGNED FOR BRITISH RADIO CONDITIONS

Adv. of The General Electric Co., Ltd., Magnet House, Kingsway, London, W.C.2

Please mention "A.W." when Corresponding with Advertisers

AMPLION OFFER YOU

FOR
25/-

the A.C.6



A.C.6.—Contained in a handsome oak cabinet, this beautifully finished cone speaker embodies a unit of improved design. This is not only constructed to work with a small set but will also handle the output of powerful receivers without distortion.

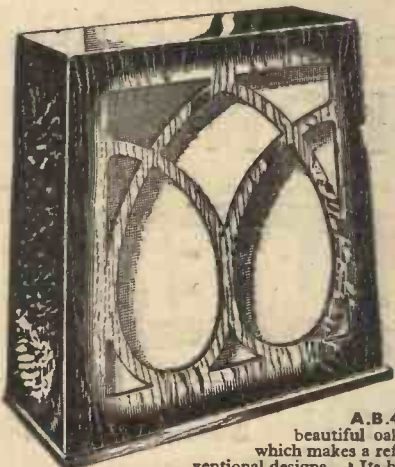

FOR
50/-

the A.B.4

A.B.4.—The modern lines of this beautiful oak cabinet have a severity which makes a refreshing change from conventional designs. Its handsome exterior houses a highly efficient speaker—a balanced armature model with provision for matching to power or pentode outputs. Fifty shillings is indeed a small price for such volume and crisp reproduction. Same model in Walnut 59/6.

And FOR

67/6

the M.C.6

M.C.6.—An extremely efficient moving coil unit, a permanent magnet which is quite as sensitive as a balanced armature speaker, and thus quite suitable to work with ordinary 2, 3, or 4 valve receivers. The matching transformer, fitted as standard, enables the unit to be correctly matched to any output.

GRAHAM AMPLION LTD., 26, Savile Row, LONDON, W.1



MOVING
COIL UNIT

royds

One of these will RUN YOUR RADIO SET FROM THE MAINS

If you have electricity in your house, you have the perfect power for running a radio set.

Electricity from the mains is cheap, reliable, and available whenever you want it. The conversion of the alternating current—usually supplied—to direct current, suitable for radio purposes, necessitates the use of certain units, including a rectifier; and of the various types obtainable, the Westinghouse Metal Rectifier gives the most satisfactory service.

Initially it is not expensive; its all-metal construction makes renewals unnecessary. As to its length of life, exhaustive tests so far have been unable to fix a limit.

Let us send you our booklet, "The All-Metal Way, 1932." It fully describes our high- and low-tension units required for building battery eliminators and trickle chargers, and for running moving-coil loudspeakers. The accompanying coupon, with 3d. in stamps, will bring you the booklet by return of post.



TYPE H.T.5
Provided with three terminals and suitable for use in the "Voltage Doubler" circuit for obtaining full or half-wave rectification. Output 120 volts at 20 milliamps. Each 12/6

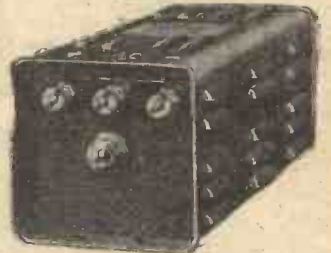

TYPE H.T.6
Output 175 volts at 25 milliamps. Each 15/-



TYPE H.T.7
Output 200 volts at 25 milliamps. Each 17/3



TYPE H.T.8
Output 250 volts at 60 milliamps (after smoothing). Each 21/-

WESTINGHOUSE

METAL RECTIFIERS

THE WESTINGHOUSE BRAKE & SAXBY SIGNAL Co., Ltd.
82 York Road, King's Cross, London, N.1.
Telephone: North 2415

COUPON

PUBLICITY MANAGER, W.B. & S.S. Co., 82 York Road, King's Cross, London, N.1.—I enclose 3d. in stamps for which please send me a copy of "The All-Metal Way, 1932."

PLEASE USE BLOCK LETTERS.

NAME

ADDRESS

A.W.24.10

You will Help Yourself and Help Us By Mentioning "A.W." to Advertisers

2 VOLT MAZDA MASTERPIECES

TYPE	PRICE
H.210 - - -	8/6
HL.210 - - -	8/6
★ HL.2 - - -	8/6
L.210 - - -	8/6
★ L.2 - - -	8/6
P.220 - - -	10/6
P.220A - - -	13/6
P.240 - - -	13/6
PEN.230 - - -	20/0
PEN.220 - - -	20/0
PEN.220A - - -	20/0
S.G.215 - - -	20/0
★ S.G.215A - - -	20/0
★ S.G.215B - - -	20/0

★ METALISED



LOOK FOR
"EDDY" IN
YOUR DEALER'S
WINDOW

THE AMAZING

MAZDA PEN. 220

Characteristics:

Filament Voltage - 2.0 volts Anode Current (Max) - 12 mA
 Filament Current - 0.2 amps. Screen Voltage (Max) - 150 volts
 Anode Voltage (Max) - 150 volts Mutual Conductance - 2.5 mA/V
 At $E_s = 100$; $E_s = 100$; $E_g = 0$.

PRICE 20/=

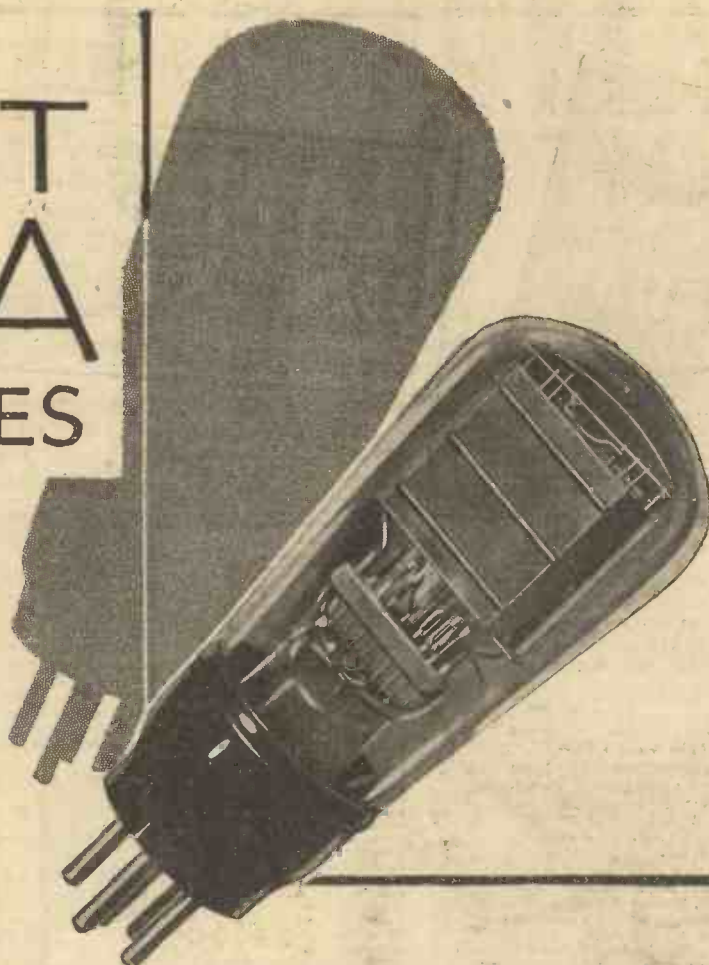

Since 2-volt valves were made, never has there been so amazing a range as this — so much evidence of brilliant engineering — so many valves with outstanding characteristics. Instance the Pen. 220; or pentode, which at once presents the solution to the output stage problem in portable sets, for it gives an astonishingly large output for a combined screen and anode current of under 5 mA. It is a valve H.T. dry battery users have longed for. It is typical of all Mazda 2-volt valves. Mazda 2-volt valves, both metallised and clear bulb types, are sold by all good radio dealers.

MAZDA THE BRITISH VALVES

The Edison Swan Electric Co. Ltd.



155 Charing Cross Road, London, W.C.2

7135

Please Mention "A.W." When Corresponding with Advertisers

EVERYTHING NEW IN RADIO

IMMEDIATE DELIVERY

**C.O.D.
CASH
H.P.**
as usual

We are the largest Radio House in the Country, and in sending your orders to us there is no risk of delay. Orders executed on our famous 3-WAY PLAN—C.O.D., CASH or H.P. Express Service for everything Radio Guaranteed. New 116-page catalogue 6d., post free.

MANUFACTURERS' KITS

COSSOR MELODY MAKER Send
Type 234. Screened grid, detector, and power. Complete with specified valves and cabinet. Cash Price £6 15 0 **10/-** only
Balance 11 monthly payments of 12/6. Finished Instrument, Royalties paid, £7 10 0. Cash only.

OSRAM NEW MUSIC MAGNET. Send
Improved version of this famous 4-valve set. 2 screen grid, detector, and power. With valves and cabinet. Cash Price £10 15 0. **19/8** only
Balance in 11 monthly payments of 19/8.

Finished Instrument. Royalties paid. £11 15 0. Cash only.

MULLARD 3 1932 RECEIVER. Send
Screen grid, detector, and pentode. With valves less cabinet. Cash Price £6 10 0. **11/11** only
Balance in 11 monthly payments of 11/11.

Finished Instrument, with valves and cabinet. Royalties paid. £7 17 6. Cash only.

EKCO H.T. UNIT, TYPE A.C.25 Send
For multi-valve sets requiring up to 25 m/a. Three tappings—S.G., detector, and 120/150 volts. For A.C. mains. Cash or C.O.D. £3 17 6. **7/1** only
Balance in 11 monthly payments of 7/1

SPECIAL FOR "BRITAIN'S SUPER"

Lewcos "B.P.F." Band Pass Filter Unit, 12/-; Lewcos or Wearite Super Het Coils (types 02, 0T1, and 0T1), 37/6; J.B. 2-gang Condenser, 21/-; J.B. Single Condenser, 12/6. Cash or C.O.D., £4 3 0. Complete parcel. **7/7** only
Or 12 monthly payments of 7/7.

ATLAS A.C. ELIMINATOR, TYPE A.C. 244. Send
Three tappings—S.G., detector, power. Output, 120 volts at 20 m/a. Cash Price or C.O.D., £2:19:6. **5/6** only
Balance in 11 monthly payments of 5/6

REGENTONE W.5 COMBINED H.T. ELIMINATOR AND TRICKLE CHARGER. Send
One S.G., 1 variable and 1 fixed tapping for H.T. L.T. for 2, 4, and 6 volts. For A.C. mains. Cash Price £5:17:6. **10/9** only
Balance in 11 monthly payments of 10/9.

REGENTONE ELIMINATOR, TYPE W.1F. Send
Three tappings, S.G., Detector, and Power. Output 120 volts at 12 m/a. A.C. Mains. Cash Price £2:7:6. **8/4** only
Balance in 5 monthly payments of 8/4.

AMPLION MC.6 MOVING-COIL SPEAKER. Send
Permanent magnet. With output transformer. Complete. **6/2** only
Cash Price £3:7:6. Balance in 11 monthly payments of 6/2.

CELESTION PERMANENT-MAGNET MOVING-COIL SPEAKER. Send
Type RP18. 8in. reinforced diaphragm. Chassis form without input transformer. Cash Price £3:10:0. **6/5** only
Balance in 11 monthly payments of 6/5.

BLUE SPOT PERMANENT MAGNET MOVING-COIL SPEAKER. Send
Complete with input transformer. Cash Price, £3 15 0. **6/11** only
Balance in 11 monthly payments of 6/11.

W. B. PERMANENT MAGNET MOVING-COIL SPEAKER P.M.3. Send
Complete with 3-ratio input transformer. Cash Price, £2 12 6. **4/10** only
Balance in 11 monthly payments of 4/10.

R. & A. PERMANENT MAGNET MOVING-COIL SPEAKER. Send
Complete with multi-ratio input transformer. Cash Price, £2 17 6. **5/4** only
Balance in 11 monthly payments of 5/4.

EPOCH A2 PERMANENT MAGNET MOVING-COIL SPEAKER. Send
Fitted with multi-ratio input transformer. Cash Price, £3 3 0. **5/9** only
Balance in 11 monthly payments of 5/9.

NEW B.T.H. "SENIOR" PICK-UP AND TONE-ARM. Send
Complete. Cash price £2 5s. 0d. **4/2** only
Balance in 11 monthly payments of 4/2.

PILOUS PERMANENT MAGNET MOVING-COIL SPEAKER. Matches the requirements of all modern receivers. Includes Unit designed and built specially for Peto-Scott by Epoch. Handles the smallest to the greatest input and brings out most minute details of tonal quality with pure, full volume. A multi-ratio input transformer is fitted and provides for matching to all super-power and pentode valves. The handsome hand-polished solid oak cabinet is built to give added depth of tone, and is fitted with ebonised base and side wings and silk-covered fret. **£3-15-0**
Cash Price
Or 12 monthly payments of 6/11.



VOXKIT RADIOGRAM CABINET MODEL 1832. Accommodation for largest of home-built receivers with a full-size speaker and mains or battery equipment. Complete with motor board. Dimensions overall: 39 in. high by 22 in. wide by 17 in. internal Panel, 18 by 7 in., baseboard, 18 by 14 in., Speaker chamber, 18 by 14 by 16 in. Panel, 12 1/2 in. between mouldings. Oak. Cash Price **£4-10-0**
Or 12 monthly payments of 8/3.



VOXKIT 1932 CONSOLE (Radio only). Another attractive addition to the famous Voxkit range. Accommodates the largest home built receiver and bulkiest speaker, mains or battery supply. Almost identical with the 1932 Voxkit Radiogram. Dimensions: 37 in. high by 22 in. wide by 15 1/2 in. Panel, 18 by 7 in. Baseboard, 18 by 12 in. Speaker compartment, 18 in. wide by 14 in. high by 12 in. deep. Front panel, 12 1/2 in. Oak. Cash Price **£3-15-0**
Or 12 monthly payments of 6/11.

KELSEY SHORT-WAVE ADAPTOR

Add more stations to your set. Plugs direct into your battery or eliminator operated receiver. Complete with instructions. Sent C.O.D. Postage free. Pay the postman.

37/6

Nothing more to buy—no valves or any extras.



SPECIALLY RECOMMENDED

EPOCH J.1 PERMANENT MAGNET MOVING-COIL SPEAKER Send
with multi-ratio input transformer. Cash Price, £2 5 0. **4/2** only
Balance in 11 monthly payments of 4/2.

GARRARD INDUCTION GRAMOPHONE MOTOR. Model 202. Mounted on 12-in. Nickel Motor Plate with fully automatic electric starting and stopping switch. Cash Price, £2 18 6. **5/4** only
Balance in 11 monthly payments of 5/4.

FORMO "MINIVO" MAINS UNIT. For 1-, 2- and 3-valve sets. H.T. Output, 120 Volts at 20 Milliamperes. 1 Tapping, 50/80 Volts; 1 Tapping, 90/100 Volts; 1 Tapping, 120/150 Volts. Cash or C.O.D. £3 3 0. **5/9** only
Balance in 11 payments of 5/9.

ORMOND PERMANENT MAGNET MOVING COIL CHASSIS (No. 464). With tapped input transformer. Cash Price, £3 5 0. **5/11** only
Balance in 11 monthly payments of 5/11.

KINGSTON-WEARITE HOME RECORDER. Complete with all equipment including Microphone for recording own voice. Cash Price, £5 9 6 **10/-** only
Balance in 11 monthly payments of 10/-.

V3 KIT RADIO FOR THE MILLION 10/- DOWN

Powerful, selective, and ultra modern. Employs screen grid, detector, and power valves. With valves, less cabinet.

Balance in 11 monthly payments of 10/10

Cash Price £5:17:6

FINISHED INSTRUMENT, with valves and cabinet. Royalties paid. **£7:8:6**

SIX-SIXTY CHASSIKIT (Battery Model). Complete three-gang band-pass tuning. Screen grid, detector, and pentode. Cash Price, with valves, less cabinet, £6 17 6. **12/7** only
Balance in 11 monthly payments of 12/7.

Finished Instrument, with cabinet (10/6). Royalties paid. Cash only £8 3 0.

SIX-SIXTY CHASSIKIT (A.C. Model). Send
Complete as above, with A.C. mains valves. Cash Price, with valves, less cabinet, £7 6 6. **13/5** only
Balance in 11 monthly payments of 13/5.

Finished Instrument, with cabinet (10/6). Royalties paid. £8 12 0. Cash only.

DYNAPLUS SCREENED THREE. Send
Screened-grid, Detector and Pentode. Kit "A" (less valves and cabinet). Cash or C.O.D., £3 12 9. **6/10** only
Balance in 11 monthly payments of 6/10.

EXPRESS ORDER FORM

TO PETO-SCOTT CO. LTD.
Please send me C.O.D., CASH/H.P.

.....
.....
.....
.....

for which I enclose
Cash/H.P. Deposit £ s. d.

Name

Address

A.W. 24/10/31.

All orders over 10/- sent carriage paid



PETO-SCOTT CO. LTD. Head Office: 77 CITY ROAD, LONDON, E.C.1. Clerkenwell 9406. 62 HIGH HOLBORN, LONDON, W.C.1. Chancery 8266. MANCHESTER: 33 WHITELOW ROAD, CHORLTON-CUM-HARDY. Phone: Chorlton-Cum-Hardy 2028. NEWCASTLE, STAFFS: 7 ALBANY ROAD. Phone: 67190.

Mention of "Amateur Wireless" to Advertisers will Ensure Prompt Attention

Hear Britain's Super demonstrated at our Showrooms:
 77, CITY ROAD,
 LONDON, E.C.1.
 62, HIGH HOLBORN,
 LONDON, W.C.1.

This is the Set the Author Built

the Season's greatest hit



DOMINATING FEATURES OF PILOT AUTHOR'S KITS

Chosen and first specified by the Technical Department of Amateur Wireless, and used by Mr. W. James. Officially approved, therefore, by an established technical authority you can trust implicitly. Backed by Peto-Scott himself, twelve years Radio Experience and a world-wide reputation. Enables the Author's published Set to be duplicated exactly in every respect.

**EXPRESS
 KIT
 SERVICE**

IMMEDIATE DELIVERY

BRITAIN'S SUPER

This is the Kit the Author Used

PILOT AUTHOR'S KIT

Any reputable dealer will gladly supply you with a PILOT AUTHOR'S KIT for Britain's Super. Do not trust a substitute kit made up of substitutes.

Check this Pilot Author's Kit of parts for "Britain's Super" with the Author's specification in this week's issue of "A.W." £ s d.

1 Ebonite Panel 14" x 7". Drilled to Author's specification	4 6
1 Baseboard 17" x 9 1/2"	1 6
J.B. Type R2 Two-gang .0005-mfd. Variable Condensers	1 1 0
J.B. Type R1 Single .0005-mfd. Variable Condenser	12 6
1 Varley 50,000-ohm Variable Resistance	6 6
3 Wearite Super-het Coils (one Oscillator and two Intermediates, Types O2, OT2 and OT1)	1 17 6
1 Lewcos "B.P.F." Bandpass Filter Unit, with extension rod	12 0
4 T.C.C. 1-mfd. Fixed Condensers	11 4
1 T.C.C. 2-mfd. Fixed Condenser	3 10
2 Telsens .0002-mfd. and one .0003-mfd. Fixed Condensers	1 6
1 Telsen one-megohm Grid Leak	9
1 Ready Radio Grid-leak holder	6
1 Ready Radio Super-het Choke	5 6
1 Telsen Low-frequency Transformer (7-1)	12 6
2 Lewcos Spaghetti Resistances, one 15,000-ohm and one 20,000-ohm.	3 0
1 Bulgin Fuse holder and Fuse	1 0
1 Junite Terminal Block	8
1 Bulgin Type S88 Double-pole Toggle Switch	2 9
4 Lengths of sleeving: connecting wire 20-gauge bare tinned copper, 6 yards of thin flex all screws and nuts	3 6
2 Belling-Lee terminals—Aerial and Earth	9
8 Belling-Lee marked Wander Plugs	1 4
2 Spade Terminals	4
1 T.C.C. .01 mfd. Fixed Condenser upright type	3 0

AUTHOR'S KIT "A" Cash or C.O.D. £17 7 9

Any of the above items supplied separately. If order over 10/- sent carriage paid. C.O.D. we pay post charges.

COMPLETE KIT PRICES

KIT A Author's Kit less Valves and Cabinet
 CASH or C.O.D. **£7.7.9**
 or 13/7 down and 11 monthly payments of 13/7

KIT B Author's Kit with Valves but less Cabinet.
 CASH or C.O.D. **£10.15.3**
 or 19/9 down and 11 monthly payments of 19/9

KIT C Author's Kit complete with Valves and Cabinet.
 CASH or C.O.D. **£12.0.3**
 or 22/- down and 11 monthly payments of 22/-

SPECIAL C.O.D. ITEMS

Pay the Postman We pay all Post charges

3 Wearite Super Het Coils (one oscillator and two intermediates) Types O2, OT2, OT1	£ s d
1 Lewcos "B.P.F." Bandpass Filter Unit with Extension Rod	12 0
J.B. Type R2 2 Gang Variable Condenser	1 1 0
J.B. Type R1 Single Variable Condenser	12 6
Cabinet as specified	1 5 0
Peto-Scott popular priced hand french polished Oak Cabinet	19 6
5 Mullard Valves as specified: P.M.1DG, P.M.2DX, P.M.12, P.M.1HL, P.M.2A.	3 7 6

SPECIALLY DESIGNED PETO-SCOTT CABINETS

Britain's Super Popular Cabinet



CASH PRICE **19/6**

Takes 14" x 7" Panel and 17" x 9 1/2" Baseboard. Attractive vignettted front. Removable back. In handsome French Polished Oak with ebonised feet.



Britain's Super Consolette Takes 14" x 7" Panel, 17" x 9 1/2" Baseboard and any type of Speaker up to 12" Cone Diameter. Fitted with shelf for batteries or Main equipment. Back fretted to ensure perfect acoustic conditions. Hand French Polished Oak with silk gauze. Ebonised feet. Complete with baffle board cut to requirements. Cash **35/-**

TRADE SUPPLIED. DELIVERY FROM STOCK

EXPRESS ORDER FORM
 TO PETO-SCOTT CO. LTD.
 Please send me C.O.D., CASH/H.P.

.....

 for which I enclose
 Cash/H.P. Deposit £ s. d.
 NAME.....
 ADDRESS.....

 A.W. 24/10/31

C.O.D | CASH | H.P. | as usual

PETO-SCOTT

PETO-SCOTT CO. LTD. Head Office: 77 CITY ROAD, LONDON, E.C.1. Clerkenwell 9406. 62 HIGH HOLBORN, LONDON, W.C.1. Chancery 8266. MANCHESTER: 33 WHITELOW ROAD, CHORLTON-CUM-HARDY. Phone: Chorlton-cum-Hardy 2028. NEWCASTLE, STAFFS.: 7 ALBANY RD.

To Ensure Speedy Delivery, Mention "A.W." to Advertisers

TELSEN H.F. CHOKES

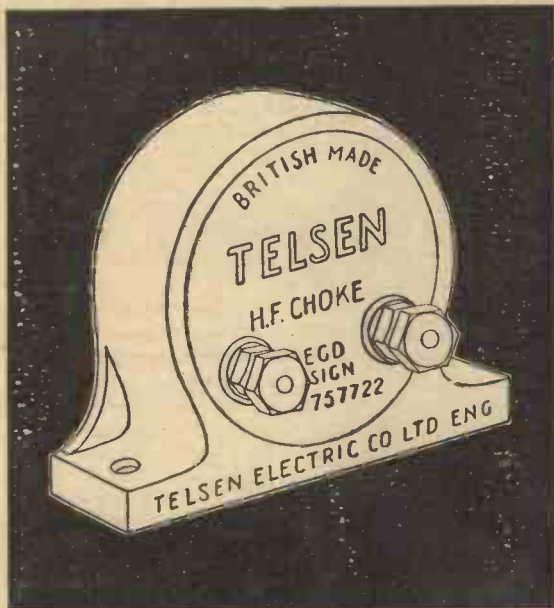
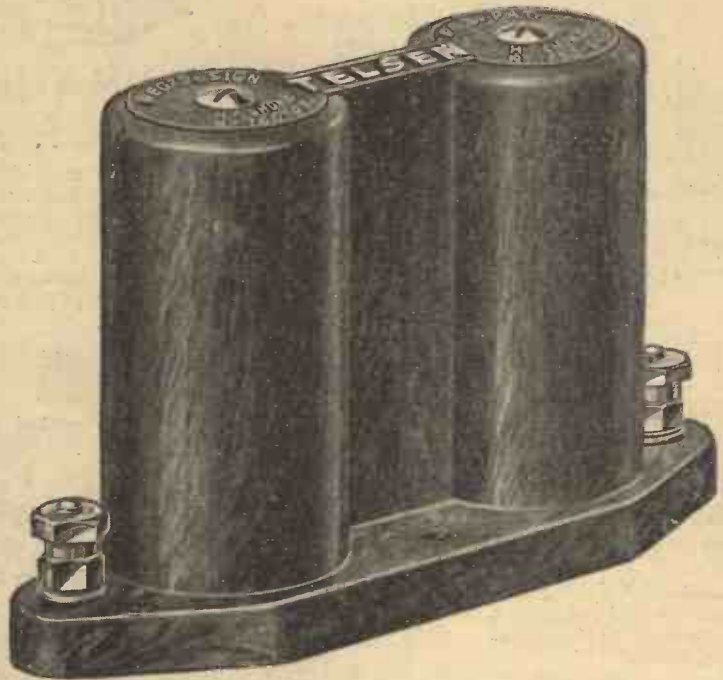

TELSEN STANDARD H.F. CHOKE

The Telsen Standard H.F. Choke utilises the minimum baseboard space. It is designed to cover the whole broadcast band and has an extremely low self-capacity. The inductance is 150,000 microhenrys and the resistance 400 ohms.

It has proved very popular and has been incorporated by set designers in many of the leading circuits.

Telsen Standard H.F. Choke Price **2/-**

Send for the "Telsen Radio Catalogue" and book of "All-Telsen Circuits" to The Telsen Electric Co., Ltd., Aston, Birmingham.

TELSEN BINOCULAR H.F. CHOKE

Hailed unanimously by the leading experts as the perfect H.F. Choke. The Telsen Binocular Choke is called for wherever highest efficiency is desired. Especially in H.F. amplification is the performance of the Choke of supreme importance.

Its highest inductance (180,000 microhenrys) and exceptionally low self capacity (.000002 microfarad) ensure a very high impedance at all wavelengths, and its excellent efficiency curve is free from parasitic resonances. These qualities, together with the restricted field due to the binocular formation, make it the ideal Choke for a high-class circuit.

Telsen Binocular H.F. Choke Price **5/-**

TELSEN

THE SECRET OF PERFECT
RADIO RECEPTION

CVS-50

You Will Help Yourself and Help Us by Mentioning "A.W." to Advertisers



Amateur Wireless & RADIOVISION

**BRITAIN'S LEADING RADIO WEEKLY
FOR CONSTRUCTOR, LISTENER & EXPERIMENTER**

EDITOR: BERNARD E. JONES **TECHNICAL EDITOR:** J. H. REYNER, B.S.C. AM.I.E.E. **RESEARCH CONSULTANT:** W. JAMES. **ASSISTANT EDITOR:** H. CORBISHLEY.

NEWS & GOSSIP OF THE WEEK

THE "SUPER'S" SUCCESS

B RITAIN'S SUPER" ranks among the best sets which AMATEUR WIRELESS has ever produced. This week the designer himself describes the construction of the set and in addition a special feature of this issue is the 12-page supplement, "Set Building Made Easy," which will appeal to every home constructor and is of particular interest in view of the construction of the "Super."

GOOD THINGS

I N addition to this helpful free supplement, which marks a new step in radio journalism, this issue contains many other interesting features; for the builder an article on designing your own set, for the listener articles on broadcasting from Downing Street; the B.B.C.'s own receivers and our Broadcast Critic's review of the week's programmes. These are only a few features among the many.

ELECTION RESULTS

T HE B.B.C. will be on the air until 4 o'clock in the morning broadcasting the election results, which will start to come in soon after 10.30 p.m. on October 27. Special arrangements have been made with the news agencies to enable this "hot" election news to be broadcast.

ANNOUNCING ?

W HO is to read these election results? Last time, listeners will remember, Sir John Reith took over the job. We are assured that Eric Dunstan's recent visit to Savoy Hill has no connection with the announcing of these results! It will be recalled that Eric Dunstan resigned from the B.B.C. as the result of some disagreement over the announcing at the last election.

SAYING IT WITH MUSIC

W HOEVER is finally given the job of reading the election results will have the satisfaction of knowing that, during the inevitable pauses between each batch of results, the Gershom Parkington Quintet will provide music of a light nature. The B.B.C. considers dance music unsuitable for the occasion.

OLD-TIME SONGS

A CCORDING to the B.B.C. post bag, there is an increasing demand for old-time songs as a sort of relief to straight dance music, which, generally speaking, does not please middle-aged listeners. 'Miss Bertha Willmott is one of the 'stars' of the Parades who is specialising in this kind of thing," says our B.B.C. Correspondent, "and the other day I saw her in one of the studios going through a pile of old song

manuscripts to find some new successors to the 'Daisy, Daisy' type of thing."

THE "CLAUQUE"

A PPARENTLY the B.B.C. has no intention yet awhile of abating the amount of noise caused by a studio audience. There is a long waiting list of people anxious to get into the studios to see vaudeville turns, and every application is dealt with in strict rotation. When the vaudeville broadcasts are given from the basement studios of Broadcasting House, then the larger studio accommodation given by the galleries will enable the waiting list to be worked off in a few months.

INSTRUCTIONS!

V ISITORS to current vaudeville shows will find the following instructions given them on a printed slip. "The announcer will call for silence when he makes the full announcement of the programme to be broadcast. After that the audience can express their appreciation as they feel inclined. We suggest that you receive the artistes in the same way as you would at a music-hall. Do not allow yourselves to be affected by the rather curious atmosphere created in a studio."

DISAPPOINTED POLITICIANS

A LTHOUGH no less than ten politicians have been billed in B.B.C. programmes during electioneering period, many others have been denied the chance of airing their views before the microphone, including Lord Beaverbrook, Sir Oswald Mosley, the Communist Party, and the Scottish Nationalists. Not all the politicians broadcasting during the election have come to Savoy Hill. Lloyd George, for example, was relayed from his Surrey home at Churt, the Chancellor of the Exchequer from Downing Street, and Mr. Stanley Baldwin from Knowsley.

THOSE TROLLEY-BUSES

A LL listeners who suffer from the electrical interference of nearby trolley-bus services will hail with delight the news that the United Tramways people have decided to fit suitable devices to their entire fleet of 60 buses. This action follows the successful tests recently carried out between the B.B.C. and the tramways company.



A new "snap" of Senatore Marconi with his wife and baby daughter Elettra, named after his famous yacht in the laboratory of which many important radio experiments have been carried out

NEXT WEEK: A SPECIAL "HOME RADIO" FEATURE

NEWS · & · GOSSIP · OF THE · WEEK —Continued

ONLY A BEGINNING?

THE B.B.C. sees no reason why every trolley-bus concern should not follow the good example of United Tramways and thus relieve a menace to broadcast reception that is reaching serious proportions as the trolley-bus idea develops throughout the country. The B.B.C. hopes that suitable stopper circuits will be included in the original design of the buses and thus save the expense of subsequent modification.

"VILLON"

A STRANGE character is Ezra Pound, the modern poet, who is responsible for the play about François Villon, which is soon to be broadcast. He is an American—his "Villon" play has dialogue in the gangster lingo—has spent a considerable part of his life in France and Spain, and now lives in Italy. When Ezra Pound first started composing music, he had to dictate it note by note; but he has since learnt to write it himself. He once explained why he had chosen a combination of certain notes for one of his compositions by saying: "I listened to the noise they made."

"SILENT UNCLE" LEAVES

MR. A. G. D. ALDERSON, known at Savoy Hill as the "silent uncle," because he has maintained a human note in the official correspondence under his charge, has been forced to retire owing to ill health. The B.B.C. tells us that Mr. Alderson has been handling no less than 35,000 letters every year and that his grand total is a quarter of a million letters. It is perhaps a sign of the times that the gap caused by the retirement of the silent uncle will not be filled by a new man. Economy dictates a reshuffling of the staff!

ABOUT FOOTBALL

REALLY, there is nothing to be done now about broadcast football, due to

the uncompromising attitude taken by the Football Association. The only bright spot will be the relay on April 9 of the England versus Scotland international match at Wembley.

B.B.C.'s WATER SUPPLY

AT Broadcasting House an artesian well has been sunk 650 feet deep, but our information is that the B.B.C. does not propose to make use of it. Apparently the Metropolitan Water Board has come to very reasonable terms to supply all the B.B.C.'s water requirements. Possibly the presence

EMPIRE BROADCASTING

OWING to the economy campaign at Savoy Hill, the B.B.C. is wondering how it can make the proposed Empire broadcasting station pay for itself. The B.B.C. is very reluctant to abandon the idea of a new high-power short-wave transmitter at Daventry working on two separate wavelengths, but it may come to this unless financial support can be obtained. We should not be surprised to find the Empire station supported by advertising sponsors.

TO DECORATE LONDON

One of the new sculptures by Eric Gill which adorns Broadcasting House. It depicts "Ariel learning celestial music"



of the well accounts for this sweet reasonableness!

VAUDEVILLE NEWS

ALEXANDER AND MOSE will appear with Albert Whelan during the Vaudeville programmes to be given on November 3 and 6. The B.B.C.'s Vaudeville Producer tells us he has discovered two excellent soloists among the Theatre Orchestra. These are Lambert Flack, flautist, and George Clarkson, saxophonist. They will be heard in future vaudeville programmes, so look out for them.

AGHA KHAN AT LAST!

TWICE already the Agha Khan's talk in the "What I Would Do with the World" series has had to be postponed; once because the Agha Khan was commanded to dine with His Majesty the King and on the second occasion because of a political talk. The Agha Khan is now definitely billed for November 5.

Coming . . . Coming . . .!

Next week an announcement of the greatest importance to all set-builders will be made. "A.W." has something really good in store for anybody who is interested in home radio construction. Don't miss next week's issue.

RADIO ON THE STAGE



Radio is being used as a topic by many modern playwrights. In "Late Night Final" this set features in the plot



Stage Photo

BOTTLED RELIGION

A NEW use for Blattnerphone records may be found if Adrian Boulton and other music chiefs at Savoy Hill are satisfied with experiments now in progress. It is possible that, if the musical quality of the Blattnerphone is satisfactory, the epilogues and morning services may be recorded and broadcast at suitable times. There seems to be no end to the uses of the Blattnerphone at Savoy Hill.

IN THE HOME

IN next week's issue you will find a special feature "Home Radio," which, as its name implies, will give a wealth of information for the family man who is anxious to make the most of his radio at home. This feature will create a big demand, so make sure of your copy by placing an order with the newsagent now.

A NEW TELEVISION INVENTION

THE BAIRD MODULATED ARC :: ENORMOUSLY MORE BRILLIANT PICTURES

By H. J. BARTON CHAPPLE, Wh.Sch., B.Sc.

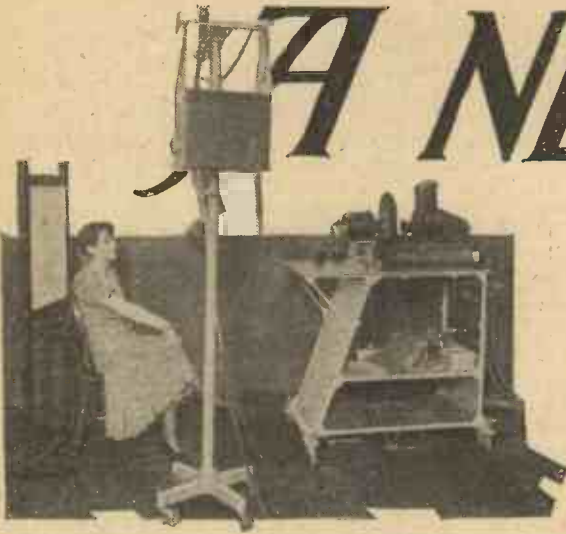

IT is one thing to postulate a theory, but quite another matter to put it into practice. This remark applies particularly to television, where the outstanding cry seems to be for larger images. At first sight the question appears merely one of optical enlargement, but, as we shall see later, if the matter is studied a little more

electrical currents, of varying intensity, a process which involves the use of photo-electric cells. After this, the minute currents have to be amplified and transmitted to the receiving end, where they are reconverted into a light, whose intensity varies in strict accordance with the strength of the current, and fluctuates at the same frequency. Finally, it is necessary to build up this modulated light into an image of the original object, by the aid of a rotating spirally-perforated disc or a mirror drum.

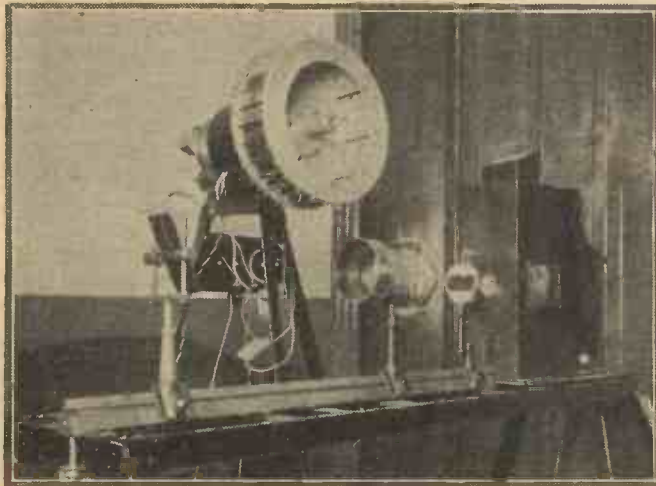

The housing for the modulated arc (right) and the mirror drum

closely, problems of a far more difficult nature are involved.

The first particulars of a new invention of Mr. J. L. Baird are, therefore, doubly interesting, especially as it is claimed that the system gives by far the most brilliant television light source known. It was demonstrated publicly for the first time at the British Association Meeting in the section devoted to Mechanical Aids to Learning. There were four shows daily, from September 22 to September 29, and the possibilities opened up created an enormous amount of interest.

Main Principles

To appreciate the full significance of the invention, let me recall to readers the essential principles involved in televising an object, assuming for the moment that we have at the transmitting end a light spot transmitter. First of all, the object has to be scanned with a beam of light, spot by spot, or what is better known as strip by strip. Then comes the conversion of the light reflected from each spot into

bright pictures for television purposes has been the comparatively small amount of light available for this purpose. Only two forms of light have previously been used for television with any success. These are the neon tube, and a device known as the Kerr cell. The neon tube gives only a comparatively faint red glow, the glow with which we are so familiar in advertising signs. The Kerr cell, the other device used for television, is also extremely inefficient in its present stage of development, since something like 80 per cent. of the light is absorbed by the Nicol prisms and solution.

Hitherto, the chief difficulty which has had to be overcome in obtaining large and

Now the most intense light-source known is the electric arc, and this form of illumination immediately suggests itself, but when one tries to put it into practice, it is found that the ordinary arc lamp is not capable of varying its intensity with anything like sufficient rapidity for television purposes. The work of Duddell and Ruhmer in connection with varying the light of an arc in proportion to speech currents from a microphone is, of course, well known, but it has remained for the staff of the Baird Television Laboratories to modulate an arc over a sufficiently wide frequency band, and with the necessary consistency and accuracy to make it satisfactory for television purposes. This has now been attained, and it is possible with the modulated arc to obtain a brilliantly illuminated image which can be projected successfully on to a large screen.

A Demonstration

At the demonstration mentioned previously the audience was seated several feet from the screen set in black as indicated in an accompanying illustration. The large image—a man's head and shoulders—addressed the audience from the screen, the voice being heard from the loud-speaker seen in the foreground.

(Continued at foot of next page)

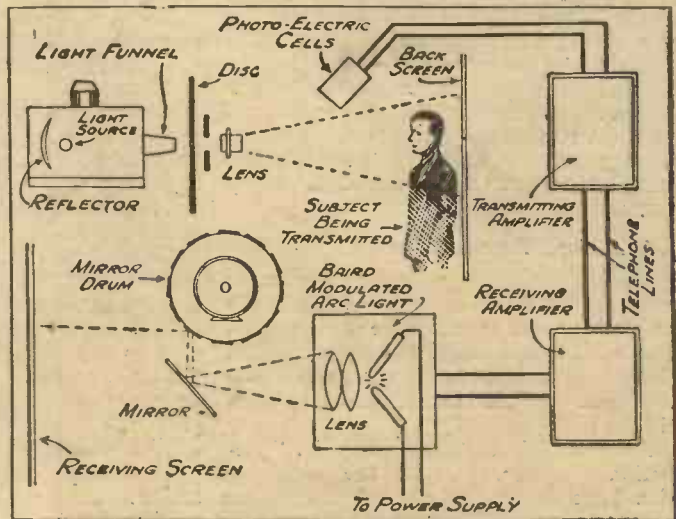

Schematic diagram of television system using modulated arc and mirror drum

STUDIO CHATS WITH BROADCAST STARS



"I'M FLOTSAM—HE'S JETSAM"

composition; when he was not actually engaged in more bellicose pursuits he busied himself by writing songs for Elsie Janis. Success soon came, and he decided to leave journalism and take definitely to composing.

Flotsam first met Jetsam (Malcolm McEachern) in New York. They sang together a few times for charity and achieved considerable success.

After that they seem to have drifted apart, but eventually met again in London. McEachern was singing at Queen's Hall and Hilliam went to see him and to suggest collaboration in the matter of lighter music.

Jetsam must have weighed the matter well in his mind; no artiste who is capable of singing serious music ever takes to light music without some heartburning and Jetsam had toured the world with Dame Nellie Melba for two years.

That he made a good decision is, in my opinion, true enough. I think so well of his voice and of the way he uses it that I should like to hear him sing Bach and Wagner; on the other hand, there are so

few really good voices amongst the singers of light music that I dare not suggest anything else for him.

Jetsam's voice is a pleasure to listen to, and I think Flotsam can never write too many low notes for him. In fact, I am going to ask him to write a song for Jetsam which takes the low A natural at least!

To meet them was to me a distinct pleasure; I found them unassuming and quiet in manner, but both seemed to have an eye for anything amusing.

The type of broadcast they give is, in my view, sadly needed. It is a great relief to have songs properly sung in vaudeville in these days when comedians seem to have lost the real art of singing.

WHITAKER-WILSON.

GRAMOPHONE MOTORS

AT the new and reduced level of prices, the electric gramophone motor is coming into more effective competition with the ordinary spring-wound motor. The fact of being on an A.C. supply is a distinct advantage to the prospective purchaser, since it enables him to use an inductor model. This type is free from noise, which cannot always be said of the universal or commutator motor which must be used with D.C. mains. In the inductor models the motor is usually mounted on the turntable shaft, which permits a relatively slow armature movement. Generally speaking, the inductor motor is cheaper as well as more satisfactory in operation than any other type.

B. A. R.

AS far as I was concerned, it was a case of, "I'm Jetsam—he's Flotsam," for Jetsam introduced me to Flotsam.

Flotsam, whose real name is B.C. Hilliam, was at one time a journalist at Scarborough. Later he went out to Canada and at the time when the war broke out was editing the *Vancouver Province*.

He joined up with the Canadian Army and came to Europe. It was then that he began seriously thinking of musical

FOR THE FAMILY MAN—

A special "Home Radio"

:: feature next week ::

On October 28, the Scottish Concert will contain a number of songs sung by Miss Christian Henderson.

"A NEW TELEVISION INVENTION"

(Continued from preceding page)

Having explained the principles involved and pointed out how the invention in this form opened up a new field in education, since a lecturer complete with demonstrable apparatus could be located in one central studio and his image seen and voice heard at various remote points linked by wire or wireless, the announcer disappeared from the screen, his place being taken by a lady singer. After the demonstration, the audience was invited to inspect both the transmitting and receiving apparatus, the former being located in a small studio some twenty yards away.

A Standard Transmitter

At the transmitting end the apparatus took the form of a standard light-spot transmitter seen in one of the photographs. The stand in the foreground supported the photo-electric cell amplifier; the cell case and part of the microphone are also visible.

The third illustration depicts the "projection" scheme. Around the periphery of a large drum thirty small mirrors are arranged, each mirror being set at a slightly different angle from the preceding one. In front of this drum is a lens concentrating the light from the Baird Modulated

Arc on to the mirrors. As the drum revolves, this light spot is caused to traverse a screen in a succession of 30 parallel lines.

The light from the arc lamp, flickering in and out, corresponds to the light and shade of the picture, being bright at the high lights and dim at the shadows, and the spot moves so rapidly that the picture appears instantaneously to the observer. The whole process is, in principle, very similar to that in operation in the ordinary Baird Televisor sold to the public.

Since the arc equipment was arranged parallel to the screen it was necessary to include a large mirror to turn the light beam through an angle of ninety degrees and this is shown in the schematic diagram accompanying this article.

Having solved the very acute problem of a powerful light source which can be modu-

lated successfully for television purposes, it is reasonable to hope that further development will be rapid, for the brilliancy question is one which has hitherto stood in the way of effectively projecting television images *directly* upon a large screen.



The use of the modulated arc allows the televised image to be projected directly on to a screen. As will be seen from the photograph, a dark surround is provided for the screen and the moving-coil speaker is placed a little to the front



THE PRACTICAL DESIGN OF A RECEIVER

This is the second article by an ex-B.B.C. Engineer on amateur receiver design. The first, published last week, dealt with theoretical considerations, this one deals with the practical design of an actual receiver

THE theoretical side of receiver design was dealt with in detail in last week's issue and it is now proposed to go into the design of an actual receiver on those lines.

We shall assume that we have A.C. mains at our disposal and that a signal output of 1 watt will be required. This will be utilised to work a moving-coil loud-speaker. The speaker has a step-down transformer incorporated and it is proposed to choke capacity couple it to the output valve. Having A.C. mains, we shall use indirectly heated valves and shall choose a Mazda AC/PI for the output stage. This requires a bias of 30 volts at an anode voltage of 200, and will deliver 1 watt of undistorted power. It is required to deliver 30 volts signal energy to the valve. Using a 1 to 3½ transformer, we shall require about 8½ volts across the primary. This can be delivered by a power-grid detector, having in its anode circuit a 20,000-ohm resistance to filter the D.C. current from the transformer primary. The presence of D.C. in the primary would reduce the amplification of the low notes. The coupling condenser may be 2 microfarad. Using a condenser of 1 microfarad would tend to accentuate the lower frequencies. The detector to work as a power-grid detector, should have an actual anode voltage of at least 150 volts. That is, as the 20,000-ohm resistance will absorb that amount, an H.T. voltage of 300 must be used initially. With regard to the L.F. transformer, it is connected as in Fig. 2, which shows the circuit of the complete receiver. This connection gives an added step-up, in this case of 1 to 3½ + 1, i.e. 1 to 4½. This is useful for distant stations and will not necessarily overload the output valve on local transmissions, as the input to the detector can be lowered sufficiently by the aerial input control, mentioned later. A milliammeter of 0 to 15-milliampere range is connected in the detector plate circuit, as this facilitates tuning, especially in conjunction with the input filter.

The Detector Stage

A differential reaction condenser is used, as this, by keeping the by-pass capacity constant between anode and earth, ensures smooth control. An additional by-pass condenser of .0005 is used to ensure efficient rectification. This is not large enough to give any appreciable high-note loss. The grid leak and condenser have values of .15 megohm and .0001 microfarad respectively, these being the most satisfactory for this method of detection.

Turning to the H.F. coupling, a tuned H.F. transformer, parallel fed, has been chosen. Theoretically for the H.F. valve in use (a Mazda AC/SG) the primary turns should be equal in number to those of the secondary. In practice, however, if the secondary is a low-resistance winding, then instability may result, and it is advisable to make the primary turns somewhat fewer than the secondary. In this case the secondary winding is composed of Litz wire. The H.F. valve is thoroughly decoupled, the value of resistances, etc., being shown in Fig. 2. The anode resistance serves as a voltage absorber, besides fulfilling its function of decoupling, as the total anode voltage of 300 is more than is required by this valve. Similarly the 4,000-ohm resistance in the anode circuit of the output valve absorbs the surplus 100 volts

30 volts, and is to be dropped across the biasing resistance. By the same formula,

$$\frac{16}{1000} = \frac{30}{R} \text{ i.e. } R = 1,875 \text{ ohms.}$$

This leaves 4,375 ohms for the anode-voltage absorbing resistance. A practical commercial value is 4,000 ohms, which is near enough. Similarly, a suitable value for the grid-bias resistance is 2,000 ohms. The grid circuit is decoupled by a 100,000-ohms resistance and a 2-microfarad condenser. The voltage-dropping and decoupling resistance in the H.F. anode circuit is found by a further use of Ohm's Law. The AC/SG, with an anode potential of 150 volts, passes a current of 3.5 milliamperes. The screen grid draws, perhaps, ½ milliampere, and the S.G. potentiometer say, 2 milliamperes. Therefore the total current

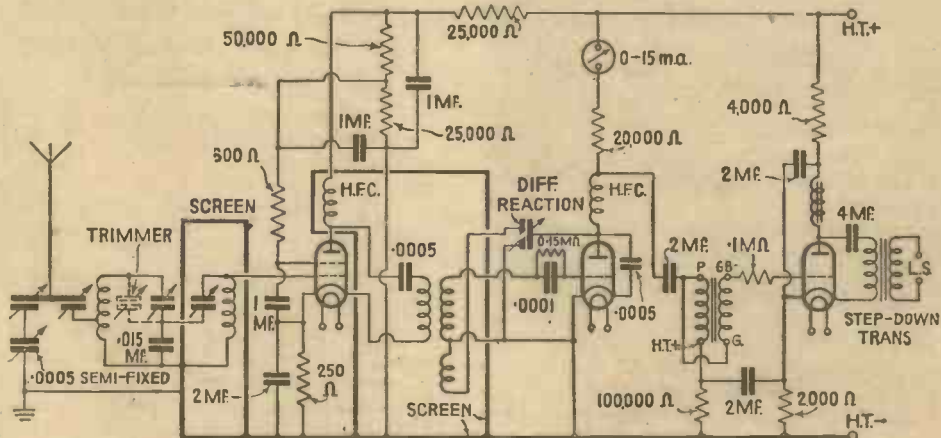

Fig. 2. The circuit of the A.C. mains-operated receiver of which the design is dealt with in this article

not required. The resistances are calculated as follows:

According to the maker's curves, the output valve with 30 volts G.B. and 200 volts H.T. passes 16 milliamperes. As the total volts available are 300, it is required to absorb 100 volts. According to Ohm's Law, the current is equal to the volts to be dropped divided by the resistance of the absorber:

$$\frac{16}{1000} = \frac{100}{R} \text{ i.e. } R = 6,250 \text{ ohms.}$$

Now the output choke has a D.C. resistance of some 750 ohms. That leaves 5,500 ohms. By interposing a resistance in the negative H.T. lead, we can provide automatic bias. The required bias is

passing through the anode resistance is 6 milliamperes:

$$\frac{6}{1000} = \frac{150}{R} \text{ i.e. } R = 25,000 \text{ ohms.}$$

The screen-grid potentiometer, connected across 150 volts, is to supply the screen grid with 60 volts at ½ milliampere. The potentiometer should pass at least three times this current, say 2 milliamperes. Therefore a convenient value of total resistance is given, again by Ohm's Law, as

$$R = \frac{150 \times 1000}{2} = 75,000 \text{ ohms.}$$

This has to be divided in the ratio of 60/120, which gives us 25,000 ohms and (Continued in 3rd column of next page)



The Prime Minister has great faith in the influence of broadcasting

POLITICAL changes have made a "run" on broadcasts by leading politicians and many of these have been made direct from No. 10 Downing Street, where the Prime Minister can chat to the microphone in the seclusion of his own study.

Some of these recent political broadcasts have been dramatic. On the night of the formation of the late National Government rush arrangements were made for Mr. Ramsay Macdonald to broadcast an appeal for unity at a time of National danger, and matters were so urgent that there was not even time to fix up a studio for Mr. Macdonald.

Sir John Reith was on holiday at the time and the Chairman of the B.B.C., Mr. J. H. Whitley, was in charge. He is, of course, an ex-Speaker of the House of Commons, and he personally made the arrangement with the Prime Minister for the late-night broadcast.

In an Emergency

At seven o'clock that evening B.B.C. engineers went round in the "O.B." van to Downing Street and rigged up the microphone, portable amplifier and cables. Just an hour-and-a-half later, having had to keep listeners waiting for a few minutes because of a traffic hold-up, the Prime Minister dashed back from the House to Downing Street and broadcast an account of his policy.

Both No. 10 Downing Street and the office of the Chancellor of the Exchequer next door, are permanently wired to Savoy Hill, that is to say, a special Post Office telephone line with tone correctors is kept open so that when a broadcast is needed in a hurry all that has to be done is to bring round the portable amplifier and banks of H.T. accumulators. An ordinary Reisz type microphone is stood on the Prime Minister's desk on top of a bank of sponge rubber.

After a recent broadcast, Mr. Macdonald said that the readiness with which the country responded to the gold standard change was largely due to the steadying influence of broadcasting, and he said that he was very grateful for the opportunity to broadcast on the very night of the crisis because it did more good than columns of printed matter.

Facts for the present election cannot be known yet, of course, but in the general election of 1929, when speeches were made

consisted of more than twenty million people and broadcasting brought the election issues to at least one house in every three in the country.

It is a significant fact that everybody listens when the Prime Minister broadcasts. I was up at Savoy Hill when Mr. Macdonald broadcast his election manifesto speech on October 7, and on the National a vaudeville hour had been displaced in the programme till very late in the evening so that Mr. Macdonald could speak before going back to the House.

All the artistes for the vaudeville programme, dressed in their fancy dance costumes, hurried over a rehearsal and crowded, together with a large audience, into the No. 4 studio waiting room, where, for their special benefit, a moving-coil speaker was switched on to the control room below. So far as I could gather everyone at Savoy Hill, except the commissionaire, that evening, was listening to the broadcast!

Most of our leading politicians have broadcast in turn, Mr. Arthur Henderson, Sir Austen Chamberlain, Sir Herbert Samuel, Sir John Simon, Mr. Baldwin, Mr. Winston Churchill, and, of course, Mr. Philip Snowden.

From Geneva

Mr. Snowden gave a rush broadcast when immediately on his return from the Hague conference, he was dashed off to the Downing Street microphone, to talk about the Young Plan which was revised in favour of Britain. Apart from his Downing Street broadcasting, Mr. Macdonald has also spoken at a League of Nations meeting at Geneva, and this was relayed by the B.B.C. via the special cross-Channel cable.

Downing Street broadcasts are among those which do not always come within the ordinary scheme of B.B.C. censorship because there is often not time to go through the manuscript. Frequently the Prime Minister has had to make last-minute

BROADCASTING FROM No. 10 DOWNING ST.

Our Special Commissioner tells how political broadcasts are made

from Downing Street and by Mr. Lloyd George, Mr. Baldwin and others at Savoy Hill, the "constituency"

alterations in his notes before going down to his study to broadcast.

The B.B.C. gear, comprising a large stack of H.T. accumulators and dual three-valve amplifiers, in a wooden case, is generally taken to No. 11, and a line switched through to the study next door.

"THE PRACTICAL DESIGN OF A RECEIVER"

(Continued from preceding page)

50,000 ohms. The S.G. decoupling resistance may be the usual 600 ohms. The grid bias of $1\frac{1}{2}$ volts for the H.F. valve is



The portable amplifier in the basement at Downing Street

obtained by connecting a resistance between the cathode and negative H.T., and shunted by a condenser. The value of resistance is found by the usual formula. The current passing through the resistance is composed of the anode current, 3.5 milliamperes, the S.G. current, $\frac{1}{2}$ milliamperes, and the S.G. potentiometer current, 2 milliamperes, a total of 6 milliamperes:

$$R = \frac{1.5 \times 1000}{6} = 250 \text{ ohms.}$$

The H.F. tuned circuits are completely enclosed in a screening box, as are the grid circuits of the H.F. valve (i.e. half the filter). The filter is of the capacity-coupled type, though there is no reason why ohmic coupling should not be used. The aerial input is controlled by a differential condenser connected as in the diagram. This, while varying the input, keeps the capacity to earth of the input coil fairly constant, especially if used in conjunction with a semi-fixed condenser, as shown. This constant capacity is essential, so as not to upset the tuning of the filter, which is effected by two ganged condensers.

TELSEN SWITCHES & DIALS

TELSEN PUSH-PULL SWITCHES

(Prov. Pat. No. 14125/31) ... From 1/2

The Telsen Push-Pull Switches employ a proper electrical knife switch contact and are soundly constructed on engineering principles. The centre plunger is wedge-shaped, so that as it is pulled out it forces the inner fixed contacts outwards, tightly gripping the moving contacts. There is no fear of crackling with Telsen Push-Pull Switches. Their low self-capacity makes them suitable for use in H.F. circuits.

Telsen Push-Pull Switches—

- Two-point Price 1/-
- Three-point Price 1/3
- Four-point (2 pole)... .. Price 1/6

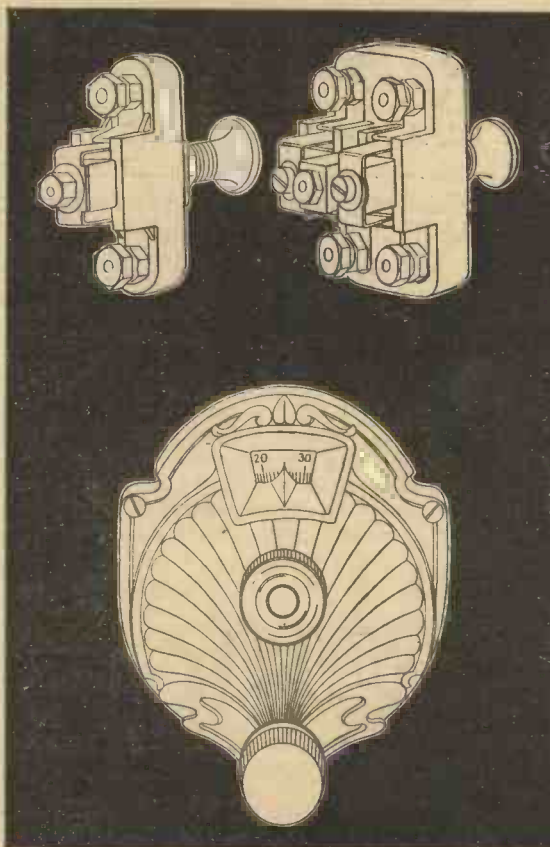
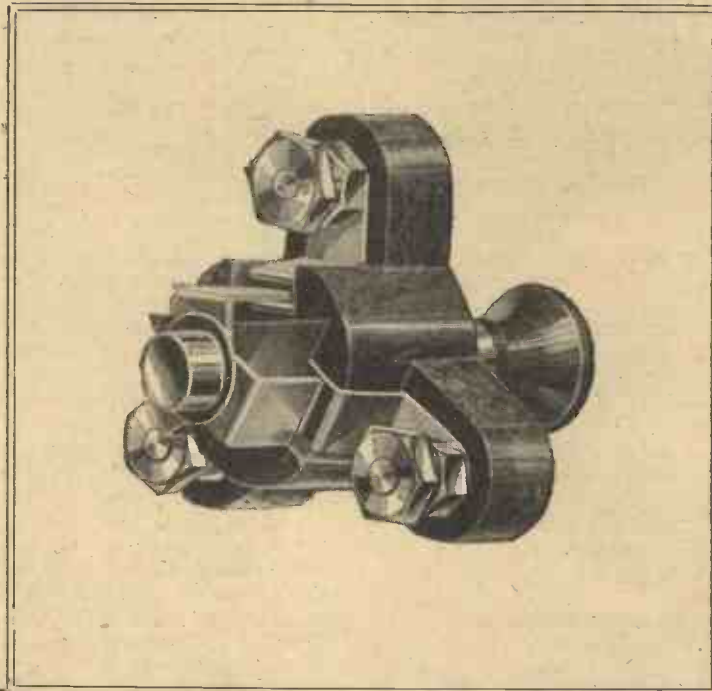

TELSEN SLOW-MOTION DIAL

The Telsen Slow-motion Dial has an exceptionally smooth action with an approximate ratio of 8-1. There is no toothed gearing, so that it is impossible to strip the dial. The figures are clear and arranged to provide for right- and left-hand condensers.

Telsen Slow-motion Dial Price 2/6
Supplied in Black or Brown Bakelite.

Send for the "Telsen Radio Catalogue" and book of "All-Telsen Circuits," to The Telsen Electric Co., Ltd., Aston, Birmingham.

TELSEN

ALL-BRITISH RADIO COMPONENTS

CVS-59

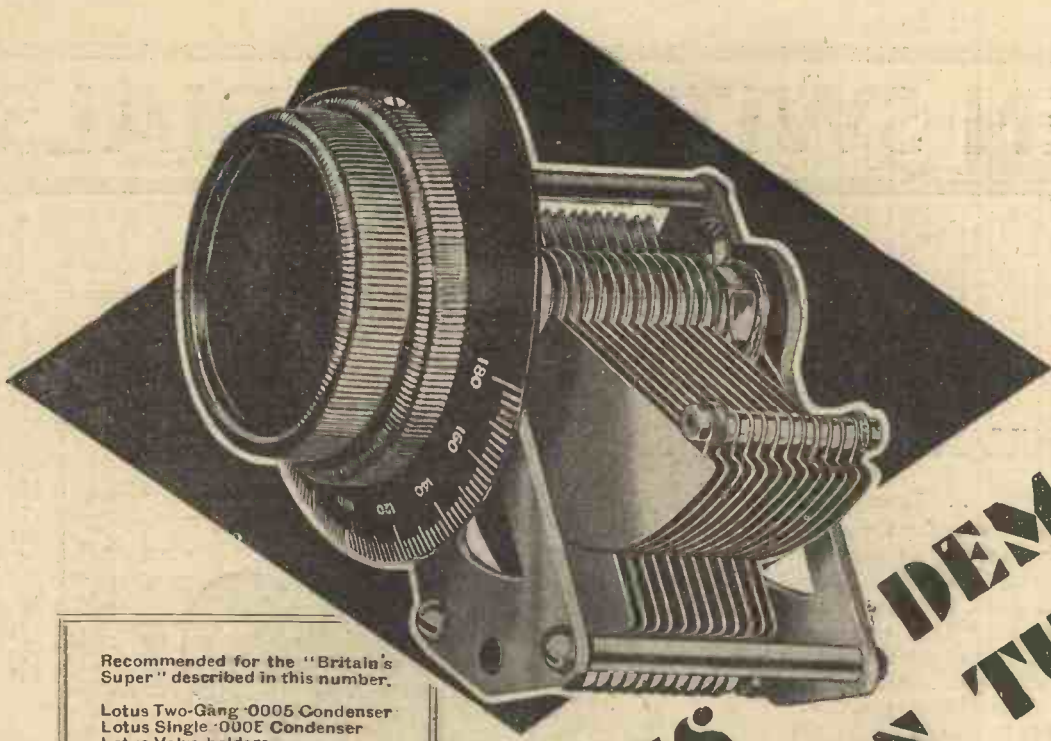

Recommended for the "Britain's Super" described in this number.
 Lotus Two-Gang .0005 Condenser
 Lotus Single .000E Condenser
 Lotus Valve-holders
 Lotus L.F. Transformer

MODERN SETS DEMAND PRECISION TUNING

SLOW MOTION LOG CONDENSER

6/6

.0003 & .0005 CAP.

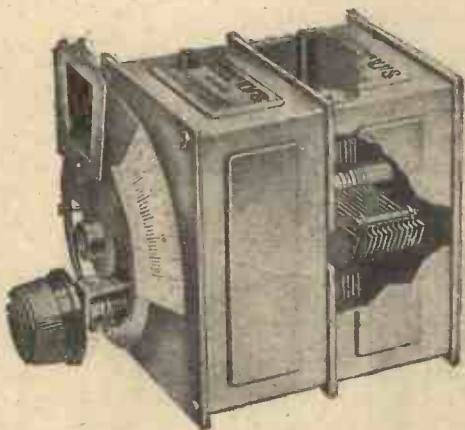

GANGED CONDENSERS

Specially heavy vanes and end plates ensure a permanent accuracy of matching of 1% between units. Trimmers are accessibly placed and are easily adjusted by fingers or screw-driver. Each Unit is completely screened from the others, and pressed aluminium covers also protect the condensers from dust. These assemblies are smaller than most other gang condensers and are simple to assemble in all types of receivers.

TWO-GANG with Disc Drive.
 Type DS/CH.3. 25/-



MODERN SETS DEMAND PRECISION TUNING

LOTUS Condensers afford the last word in precision tuning.

Control is delightfully smooth and absolutely silent, while sturdy construction ensures lasting accuracy and unfailing reliability.

Ask or write to-day for your copy of the LOTUS Component Catalogue. It is full of interest to the home constructor.

SLOW-MOTION LOG CONDENSER

Constructed throughout of aluminium, this component is highly efficient, perfectly smooth and noiseless in operation. A ball-drive integral vernier device is concealed in the spindle and both direct and slow drives are controlled by the double knob-dial supplied with the condenser. With braided pigtail connection to rotor. Specially suitable for Super-hets. The reduction gear is 7-1. Capacities .0003, type SM/3, and .0005, type SM/5, 6s. 6d. each



RADIO COMPONENTS

LOTUS RADIO LTD., MILL LANE, LIVERPOOL

Don't Forget to Say That You Saw it in "A.W."

EVERYTHING **G.E.C.** ELECTRICAL
your guarantee

**THE WORLD ASKED FOR A
BETTER LOUD SPEAKER
AT A LOW
PRICE!**

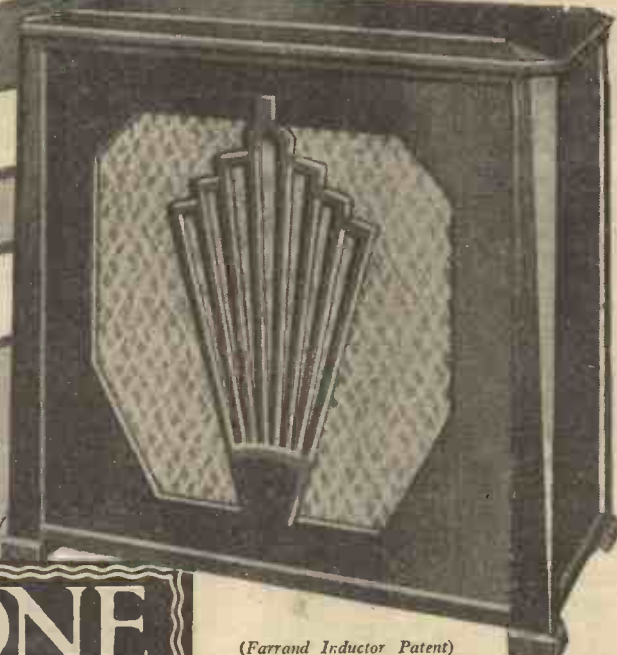

The **GECOPHONE**

(Farrand Inductor Patent)

INDUCTOR DYNAMIC LOUD SPEAKER *now fills the demand*

**A BRITISH PRODUCT
DESIGNED FOR BRITISH
RADIO CONDITIONS**

*Sold by all
Wireless Dealers*

Only the finest loud speaker movement is good enough to reproduce the natural tones of instruments and voices in a manner to suit modern standards of quality. The GECOPHONE Inductor Dynamic Loud Speaker raises the quality of home entertainment to a higher level than ever before obtained. Its low price only adds to the marvels of this brilliant loud speaker.

Cat. No. BC1850
Chassis only. Price
£3.10.0

Cat. No. BC1855
complete in wal-
nut cabinet. Price
£5.10.0



WRITE for folder BC5958 which fully describes and illustrates in colours the complete range of GECOPHONE Radio Receivers and Loud Speakers. **SENT POST FREE.**

HIRE PURCHASE:
(BC1855) Deposit £1
and 12 monthly pay-
ments of 8/-

SUPREMACY IN RADIO — G.E.C. Radio

Advt. of The General Electric Co. Ltd., Head Office and Public Showrooms: Magnet House, Kingsway, London, W.C.2

To Ensure Speedy Delivery, Mention "A.W." to Advertisers

These
TWO VALVES
make any 2 valve circuit

**BETTER FOR RANGE
AND
VOLUME**

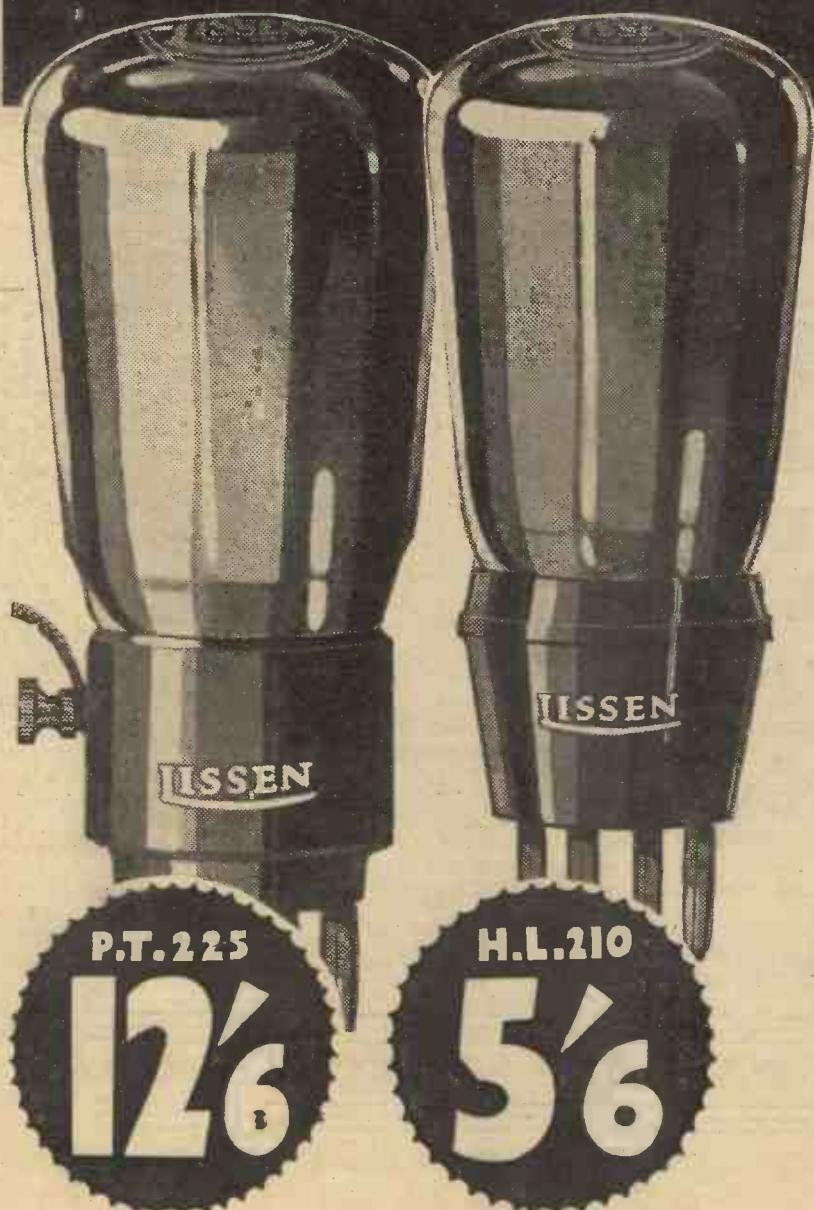

IF you would like your radio louder—if you want to get the Continental stations at fuller loud-speaker strength—if you have any two-valve set and would like to have it perform like a three—*replace the detector valve with a lively Lissen Detector and the power valve with a Lissen Power Pentode.* Immediately you will notice a tremendous step-up in volume on all stations—far greater liveliness in tuning, longer range and finer quality of reproduction.

To get these improved results you do not have to alter your receiver at all. Simply buy a Lissen Detector Valve H.L.210 price 5/6 and a Lissen Power Pentode P.T.225 price 12/6, and plug them in. The Lissen Power Pentode takes only 7m/A of H.T. current and can therefore be run off ordinary batteries. With these valves you get **IMMENSELY INCREASED VOLUME AND GREATER RANGE WITHOUT PAYING MORE FOR IT.**

LISSEN
VALVES

OTHER TYPES AND PRICES:—

H.210-5/6 L.210-5/6 P.220-7/- P.X.240-8/-
S.G.215-12/6 4-volt and 6-volt types also available.

LISSEN LIMITED, WORPLE ROAD, ISLEWORTH, MIDDLESEX

You Will Help Yourself and Help Us by Mentioning "A.W." to Advertisers

On Your Wavelength!

MOVING-COIL SPEAKERS

ALTHOUGH the permanent-magnet moving-coil speaker is a real boon to listeners who are not "on the mains," the balance of advantage is with the pot-driven speaker for an all-mains set. Once the problem of supplying the extra current has been solved, the "pot" is cheaper to make. Also, given the necessary current, the magnetic flux density can be pushed up to a very high figure, with a corresponding increase in efficiency.

A MATTER OF CHOICE

IF one's pocket does not run, at the moment, to a moving-coil instrument, there is much to be said in favour of the moving-iron speaker. Even the cheaper models in this class now give surprisingly good results, especially when compared with their predecessors of a year or two ago. It is interesting to note that several well-known firms have recently adopted the inductor-dynamic movement for the first time. In this model the armature swings to and fro parallel with the pole faces, instead of moving vertically up and down. Owing to its self-restoring action, the response of the armature is very similar to that of a moving-coil. In fact, the inductor movement is really a compromise between the moving-coil and moving-iron types and has many of the advantages of both.

DON'T BLAME THE SPEAKER

THE other day I was asked to advise a friend on the purchase of a good make of moving-coil loud-speaker, as the one he had was, as he said, now no good. On inquiry as to his actual meaning, he explained that his set, which was worked from an A.C. eliminator, and his permanent-magnet moving-coil loud-speaker had been giving excellent service for the last eighteen months or so, but that recently volume had dropped off noticeably, and the quality was now very poor, chiefly owing, he thought, to the fact that the set had to be pushed to its utmost in order to get any noise from the speaker at all.

His diagnosis of the trouble was that the magnet of the speaker must have become partially de-magnetised, as nothing was apparently wrong with the receiver. He had accordingly sent the speaker to the makers, who had subsequently returned it as being in perfect condition. However, results were no better, they were, if anything, worse, so that he had decided to scrap the speaker, it being an old model, and get an up-to-date model of a different make.

Somehow there seemed to me to be something missing in this account, so I suggested that I should visit him and have a look round. On making a brief inspection of the apparatus nothing was obviously wrong to the eye, although to the ear there was nothing very much right. I noticed, however, that there was rather a high grid

voltage on the small power valve being used in the output stage. Decreasing this voltage gave a very marked improvement in quality, a very significant fact. Using my hand as a rough volt-meter I found that the H.T. volts were certainly not greater than 50 or 60. Accordingly I suggested a new rectifying valve for the eliminator. This was obtained and everything in the garden was lovely, both volume quality being right up to their former standard.

AT THE CROSS ROADS

I SEE the valve is now being used in America to solve the traffic problem. It is done in this way. A hollow box containing a microphone is set a foot or so below the surface of a by-road, about a hundred feet before it crosses the main stream of traffic. The box acts as a resonator to pick up the sound of any car passing over it. The microphone currents so produced are passed through a valve amplifier and are then used, after a definite interval of time, to operate a signal which stops the traffic in the main road and gives the emerging vehicle the right to cross. After another definite interval of time the signals are automatically reset in favour of the main traffic stream—until such time as another car appears on the by-road. If this kind of thing goes on, the world will soon be run by valve "robots" in different shapes and forms.

PUTTING IN THE BASS

IT is queer to notice how many people there are who still do not realise the enormous value of the parallel-feed method of coupling L.F. stages. Here is an instance. When I was trying out a cheapish ready-made set the other day at a friend's house we found that it was pretty good as regards selectivity and sensitivity, but that the reproduction suffered from having absolutely no bass whatever. The loud-speaker which we yoked up is one which is capable of dealing splendidly with low notes when I put in the last holder of the set the output valve which gives the best results with it. There still wasn't any bass, so that the fault was clearly in the set.

A glance over its internal arrangements showed that it was a three-valver (S.G., Det., L.F.), but the coupling between the detector and the output valve was by means of a small transformer whose primary, wired directly into the plate circuit, was carrying all the steady H.T. current. You probably know that to bring out the low audio-frequencies you must have a good primary inductance in a transformer so used. The trouble is that, though the no-load inductance may be fairly high, it often goes down to a surprising extent when a current is passed through the windings. This is where parallel-feed comes in, and we decided to see what difference it would make.

CHANGING OVER

THE procedure is simple. You disconnect the primary of the transformer as a start. Between the plate of the detector valve and H.T. positive connect a resistance. About 50,000 ohms answers well with the detector valve, and very often you can simply use a spaghetti instead of a lead. Connect the plate terminal of the valve holder also to that of the low-frequency transformer through a fixed condenser of about .25 microfarad. The H.T. positive terminal of the transformer you simply connect to that marked G.B. That's all.

A GREAT IMPROVEMENT

WELL, we carried out these small alterations in a few minutes and then tried the set again. The difference in the reproduction was almost incredible. Instead of thin reedy music and "edgy" speech, we got very decent quality in both with quite a pleasant amount of bass. You see what happens? By using parallel feed you relieve the primary windings from all D.C. load, for which reason the inductance keeps right up to its no-load value. This means that, even if the transformer is not a particularly good one, it can often be made to give very respectable results. You have seen how easy the alterations are to make. The cost is quite small, for the parts required are simply a spaghetti resistance and a .25-microfarad condenser; quite likely you already have these parts available. If you are not satisfied with your present reproduction it is well worth your while to try changing over to parallel-feed, supposing that your set has L.F. transformer coupling. Anyhow, if you do not like the results produced by the change you can always go back again to where you were in a few minutes.

NEW PENTODES

I AM very much struck with the new two-volt pentodes, which will be welcomed by battery users. They are economical enough in all conscience in the matter of H.T. The total current needed from the H.T.B. can be made as low as 4 milli-amperes, and under the best operating conditions it is not much over 5. Since the output from one of these valves is ample for working a loud-speaker in the average living-room, this means that the three-valve set can definitely be brought within the economic load of a standard-capacity high-tension battery. This is a very big step forward, for with the coming of economical pentodes there is no need to shy at the expense of running a three-valve set off batteries. Taking in the charging of accumulators and the renewal of H.T.B.'s as required, this need not now exceed a total of about thirty shillings a year, or about a penny a day.

A LAST TRY?

BY the time that you read this Mr. Noel B. Ashbridge, Chief Engineer of the

On Your Wavelength! (continued)

B.B.C., and one or two of his colleagues, will be in Rome attending the meeting of the International Broadcasting Union. It is sincerely hoped that at this meeting something may be done to decrease the mutual interference which is at the present time causing so much trouble in certain parts of the broadcast band. The difficulty is that every country wants a lot of broadcasting stations and wants good wavelengths for them. Nobody is inclined to give up what he has already grabbed and every country is suspicious of its neighbours' designs on the ether.

WHAT SEPARATION? •

THERE are already too many stations in operation, and I understand that the B.B.C. is going to strive for a reduction in the numbers. As I urged long ago, it is likely that it will offer to give up one of our wavelengths if others will do the same. There are those who maintain that we shall not get ether peace until we have a 13-kilocycle separation between stations instead of the present 9-kilocycles. I cannot say that I agree with this. I believe that if stations would stick closely to their allotted channels we could get on quite well with a 10-kilocycle separation. This is what they have in the States, and it seems to work pretty well over there. But it is absolutely essential that there should be no wavelength wandering. Station engineers should be ashamed of wobbling off their wavelengths.

FEWER STATIONS?

DOES anybody really believe that we shall see a reduction of the broadcasting stations in Europe? I am afraid that I don't, though it would be an excellent thing if something of the sort could be done. What I would like to see, too, is a lowering of the maximum power at present allowable, which is, I believe, 100 kilowatts. The trouble about setting a limit as high as this is that every country regards it as the minimum to be attained, if possible, rather than as the maximum permissible. In these days of good valve receiving sets the service areas of 10-kilowatt stations are surprisingly large, and I honestly believe that results would be better all round if the maximum permissible power was reduced.

A FUNNY BUSINESS

THE practice of counting a mains rectifying valve as a wireless valve in the description of sets seems to be growing, which is rather unfortunate. In this country large numbers of sets use not a valve, but a metal rectifier, which does exactly the same work and lasts longer. Their makers will be rather badly handicapped if this absurd system of classification really catches on, for by no stretch of the imagination can you describe a metal rectifier as a valve. There is no question that the only fair way of describing a set is by the number of its valves used exclusively for wireless purposes. That is to say, for high-frequency amplification, detection, and low-frequency amplification. Another point that may lead to misunderstandings is that the terms rectifier and detector used

to be employed as alternatives to describe the valve which converts radio-frequency into audio-frequency impulses. It would be a good thing if all writers made a firm resolution to speak of this valve in future as the detector and to reserve the term rectifier for the valve or the metal appliance which irons out A.C. from the mains.

THE PENDULUM SWINGS

BEFORE now I have pointed out how often in wireless some system or component or circuit goes through regular cycles of popularity. It comes in; we all hail it as a fine idea; everybody uses it; then we discover defects, and it goes clean out of fashion. Nothing is heard of it for a year or two, and then suddenly it is revived in a slightly different form and off we go again. The canned or screened coil is a case in point. These were first brought in six or seven years ago, when they were all the rage. They went out because in the form in which we then had them they were not particularly efficient. Now you will find them forming part and parcel of the up-to-date receiving set. What has happened is that designers have tackled the question of canning coils scientifically, and have been able to give us something which works efficiently as a coil and is at the same time splendidly screened from outside impulses. Everything depends upon the shape and size of the coil and its relation to the screening box.

OUR BIG BROTHER

AS you know, I am occasionally privileged to see a copy of WIRELESS MAGAZINE before publication. I cannot refrain from making some comments on the November issue, which seems to me to

be in many respects even more interesting than the fine October number. For one thing the tinted-paper supplements have been started again; these are always worth looking at. The new one is called "The Practical Story of British Broadcasting" and deals very thoroughly with those B.B.C. activities that are particularly concerned with the preparation and "putting over" of programmes.

All super-het enthusiasts will be interested in an article entitled "Hotting-up the 'Super 60'," for it contains a number of hints of value to the owners of any modern super-het receivers. Another special article draws attention to the questionable "scare" methods employed by the Post Office during the recent campaign against pirates in London and its suburbs.

From these comments you will see that WIRELESS MAGAZINE is still the "Best Shillingsworth in Radio"—and it is likely to be for many years to come!

DO YOU REMEMBER?

DO you recall how a good many years ago experts girded up their loins and conducted a fierce onslaught against the grid-leak-and-condenser detector? They told us that it must be unselective and that it must distort. Like one man we hurled our grid leaks into the nearest dustbin and all of us went anode-bend mad. It was not for a considerable time that somebody showed that the average anode-bend detector could and frequently did distort very much worse than its leaky-grid condenser counterpart. Then power-grid detection put the original system right back on its pedestal.

Another interesting pendulum swing was seen when low-frequency transformers went clean out of fashion in favour of resistance-capacity coupling. There were many who believed that this kind of coupling simply could not distort; but it did, and the transformer came back again for two reasons. First of all, detector valves of low impedance but high magnification were produced and, secondly, the transformer people designed instruments with something like perfect response curves over all the audio range that we want for wireless reproduction.

IS IT NEW?

A GOOD many people think that ganged tuning of circuits is a comparatively new thing and that two or three-gang condensers were first made only a year or two ago. I pulled out of my spare parts drawer the other day a J.B. condenser which I must have acquired in 1924. It was called a dual variable condenser, and the fact that it was a pretty early type is shown by the shape of its vanes, which are of the original semi-circular or straight-line capacity type. I used it, I remember, on a set containing two H.F. valves with tuned-plate coupling, and it worked pretty well, though it was essential to match not only the coils, but also the valves, and even the wiring of the two circuits exactly. That's where the modern logarithmic ganged condenser scores. There is no need to match your circuits very closely. THERMION.

DO YOU KNOW—

THAT it is sometimes worth while earthing a choke used in a choke-output circuit, or the transformer of an output transformer unit? But be careful of interference between the choke or transformer and any metal-cored parts in the set itself.

THAT in a set which has an unstable detector stage, the trouble can sometimes be cured by fitting a by-pass condenser of .0001 microfarad between the detector, anode and earth? This condenser must have a high insulation factor because it has to withstand practically the full high-tension voltage.

THAT in a short-wave set the tuning condenser should not have a value of more than .0003 microfarad or tuning will be very critical? Most coils can be adequately tuned, in fact, by a .00015 or .0002 microfarad variable condenser.

THAT in a single-valve set intended only for long-distance reception, or in any distance-getting set, not preceded by an H.F. stage, good values for the grid condenser and leak are .0001 microfarads and 3-megohms respectively? Values in an ordinary set should be approximately .0003 microfarad and 2-megohms. A change of grid leak value generally alters the tone as well as up-setting the sensitivity of the detector.



A SET WITH UNEQUALLED RANGE & SELECTIVITY

"Britain's Super" is Tested in South London

I HAVE spent a couple of exciting hours trying out "Britain's Super," the new five-valve super-het, and the results have definitely proved that this set is a great step forward.

When the "Century Super" was first introduced I was among those who were literally astounded to think that so many stations could be received with such ease. I have no hesitation in saying that I consider "Britain's Super" to be even better, and that means a lot!

A list of stations I received between 8 and 10 p.m. on October 12 will be found below. This will give you in brief the capabilities of this new set. Although I logged only a matter of forty-five stations or thereabouts, it is certain that double this number could be easily obtained without any difficulty. This is surely a great incentive for the keen amateur to build this remarkable receiver!

A great point is the clarity with which these stations can be heard. *There was no background noise or mush, as it is called, and the quality leaves nothing to be desired.*

Selectivity is really uncanny. Every pair

of high-power stations, London Regional and Mühlacker for example, could be separated without any trace of overlap. Even on the long waveband the high-power bunch, with Daventry as a centre, could be easily separated—a feat even the best commercial sets seldom accomplish. Zeesen was quite clear of Radio Paris and Daventry, and there was no vestige of interference between Eiffel Tower and Warsaw.

Having done all these marvellous things, it is essential that I should give some indication of the way it was accomplished. Firstly, I took advantage of the band-pass coupling condenser, which vastly improves strength, and I strongly advise readers to do the same.

Mullard valves were used throughout for this test, a PM₁DG for the first detector, PM₂DX for the oscillator, in the I.F. stage a PM₁Z, for the second detector a PM₁HL, and in the power stage a PM₂A.

With the H.T. +1 wander plug in the 72-volt tapping on the high-tension battery, H.T. +2 at 108 volts, H.T. +3 at 80, and one side of the loud-speaker in 120 volts,

the total battery consumption was only 12 milliamperes.

This is a very low figure for a five-valver, being only equivalent to an average three-valve set. Double-capacity batteries are advisable in order that the set may be run economically.

When the Editor asked me to give an independent test report on this set, he also asked me to compare its general performance with that of the well-known "Century Super." Even taking into consideration that "Britain's Super" has one screen-grid valve less and also that an outdoor aerial is used instead of the frame pattern, I am certain that the all-round results of the new set are superior.

Both strength and quality are better.

It is interesting to note that the station log was compiled when the set was only using a 50-ft. outdoor aerial and this was badly shielded.

If you want a good set that can overcome as far as possible the prevailing chaos in the European ether, "Britain's Super" is the set that will do it!

T. F. HENN.

LOG OF STATIONS RECEIVED ON "BRITAIN'S SUPER"

MEDIUM WAVEBAND				LONG WAVEBAND			
Wave-length. Metres.	Station.	Dial Readings.		Wave-length. Metres.	Station.	Dial Readings.	
		Oscillator.	Aerial.			Oscillator.	Aerial.
376.4	Glasgow.....	113	109	253.4	Gleiwitz.....	53	54
372	Hamburg.....	111	107	227	Cologne.....	34	36
360.1	Mühlacker.....	109	105				
356.3	London Regional.....	107	103				
349	Barcelona.....	104	100				
345.2	Strasbourg.....	100	96	1,875	Huizen.....	176	154
338	Brussels (No. 2).....	98	94	1,724	Radio Paris.....	168	144
325	Breslau.....	93	95	1,635	Zeesen.....	163	135
304	Bordeaux.....	83	84	1,554.4	Daventry.....	159	127
301.5	North National.....	81	79	1,445.7	Eiffel Tower.....	152	118
298.8	Hilversum.....	79	78	1,411	Warsaw.....	148	114
296	Turin.....	78	77	1,348	Motala.....	144	106
281	Copenhagen.....	70	70	1,304	Moscow.....	137	97
279	Bratislava.....	69	69				
276.5	Heilsberg.....	66	66				
261.3	London National.....	58	58				
257	Hörby.....	55	56				

These readings will not be exactly the same for every model of "Britain's Super," but variations will be slight.

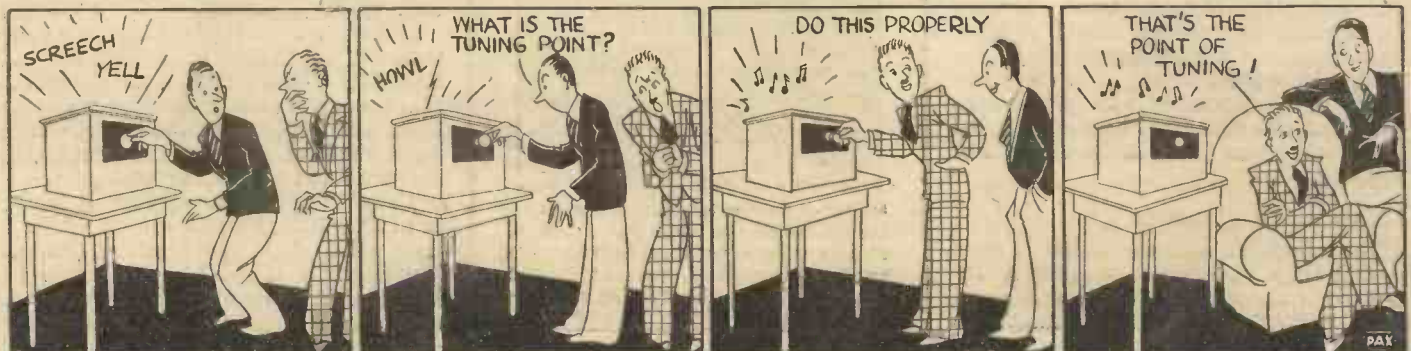



IN MY WIRELESS DEN

Weekly Hints —
CONSTRUCTIONAL & THEORETICAL
BY
W. JAMES

WHEN crackling noises are heard from the loud-speaker and tests show the batteries and valves to be satisfactory, you might well look to the inter-valve transformer.

The proportion of breakdowns is certainly very small, but the cheaper transformers, being more hurriedly produced, perhaps, or having coils of not the finest quality of wire, do give a little trouble.

Burn outs are rare. It is very seldom that the windings will not carry a current much heavier than the normal anode current passed by an amplifying valve. A break may occur through poor winding or at a joint.

The wire may have been stretched at a place during the winding process or the wires may have taken up positions such that, after a little use, the strains have broken the wire. Transformer coils are usually wound on high-speed machines and as a rule the turns are placed accurately into position. Occasionally the wire will be crowded to one side of the bobbin or former and a weak coil results.

Continuity Tests

Coils are usually tested for short-circuited turns as well as continuity and this test shows up a fault which reduces the amplification and the strength of the windings.

The adjustable resistances used in mains units are designed to pass no more than a certain value of current, usually a few milliamperes.

If this current is exceeded for a short period the chances are that the resistance will overheat and burn out. You must, therefore, not connect to a tap controlled by a resistance, a circuit passing more than the safe value of current.

Do not connect a power valve to such a tap as this valve will probably pass a current in excess of that which the resistance will deal with in safety. If the voltage of the mains unit is too high a separate resistance for reducing the voltage should be used. This resistance should be joined to the power tap of the unit and be of the power type. A condenser of two microfarads should also be connected between the end of the resistance taken to the circuit and negative.

Mains-unit Resistances

The adjustable resistances fitted in most mains units carry enough current for detector circuits and for the screens of screen-grid valves. Heavier currents should

not be taken through them unless they are definitely designed to carry greater currents.

A pentode valve, especially when connected to a high-ratio inter-valve transformer, usually shows up slight overloading very badly.

The overloading may, of course, be avoided by carefully adjusting the set. But as a rule, the set is so adjusted that the louder passages do produce overloading.

High-ratio Transformers

In many circuits the detector valve is coupled to a pentode output valve by means of a 5 to 1 or 7 to 1 transformer. The idea is to obtain the maximum amplification from the circuit which is, indeed, very sensitive. At the same time, the general quality may not be very good.

Part of the trouble may usually be traced to the high-ratio transformer and in many instances better results will be obtained when a lower ratio transformer is fitted. The effect of connecting a grid leak of from .1 to .5 megohm across the secondary winding may be tried as the quality may be greatly improved. A little magnification may be lost, but the results may be much better. Often the effect is to reduce the relative strength of the higher notes, which cause the trouble.

Distortion and interference troubles are

EASY CONSTRUCTION

Often you will find it easy to connect a few short leads to the panel parts so that when the panel is attached to the baseboard there will be no difficulty in



following out the terminal connections. Do not mount the panel parts, though, if there are many of these or if they are weighty components, such as ganged condensers or panel-mounting coils.

easily produced by wrongly adjusting a screen-grid valve.

S.G. Voltage

The mistake usually made is to use too little voltage on the screen and this is more dangerous when grid bias is used. Some valves will only just take a bias of -1.5 volts when the full screen voltage is employed and it is fatal to good results to use lower screen voltages.

The trouble is met with more especially when the volume is controlled by means of a potentiometer joined to the screen of the valve. There is no difficulty in hearing the distortion produced when a strong signal is reduced in volume by moving the control to the minimum position. This form of control is, therefore, not always a safe one to use.

When there is no grid bias on the screen-grid valve, the circuit being completed to the negative of low tension, the danger of distortion is, perhaps, not quite so great. But at the same time a strong signal may be difficult to deal with by means of the volume control alone and the input is usually reduced a little by detuning.

These Stopping Resistances

There seems to be a doubt in some people's minds regarding the value of grid stopping resistances. Some people will always connect a 100,000-ohm grid leak in the grid circuit following the detector.

It is joined between the grid terminal of the valve holder and the grid terminal of the transformer. The object in connecting the high-resistance in this position is to minimise the strength of high-frequency voltages which might reach the grid of the valve and affect the results.

There is no doubt that a high resistance is an effective stopper when connected in this position. It does minimise the strength of the high-frequency currents in this circuit.

If the resistance is of a fairly high value, however, and the valve to which it is connected has a large capacity, the chances are that the higher audible notes are weakened. Thus, when a pentode valve is used and the resistance is of 100,000 ohms or more, the higher notes are definitely weakened.

This may not matter very much, but the overload characteristics are likely to be such that slight overloading produces harshness. A simple test will prove this and for this reason many people prefer not to use a stopping resistance at all.

TELSEN CONDENSERS

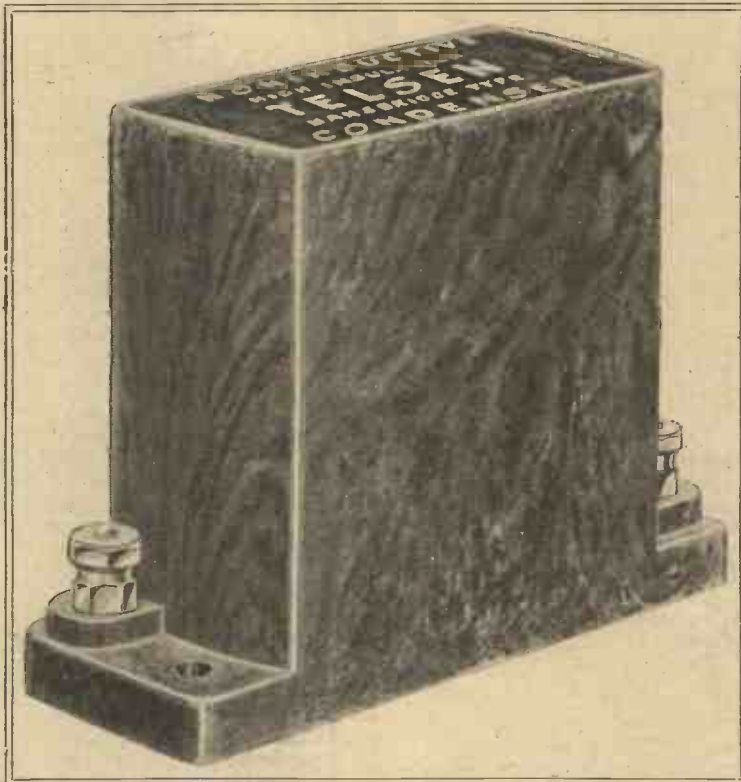

TELSEN MANSBRIDGE TYPE CONDENSERS

Telsen have installed the most advanced plant in the world for the manufacture of Mansbridge Type Condensers. Only genuine Mansbridge foil paper and the finest linen tissue are employed in the exclusive method of manufacture. Every Telsen Mansbridge Type Condenser is hermetically sealed from the atmosphere, and Post Office standards of insulation are adopted throughout. The preliminary research, the most modern plant in the world, the finest raw materials, the latest methods of manufacture and the final test, all combine to give Telsen Mansbridge Type Condensers a high insulation through years of service with freedom from breakdown. The type of construction employed makes them genuinely non-inductive.

The following values are guaranteed within 5 per cent. :-

Cap. mfd.	500-volt test.		1,000-volt test.	
	Price		Price	
.01	1/6	...	2/6	...
.04	1/9	...	2/9	...
.1	1/9	...	2/9	...
.25	2/-	...	3/-	...
.5	2/3	...	3/3	...
1.0	2/3	...	3/6	...
2.0	3/-	...	5/-	...

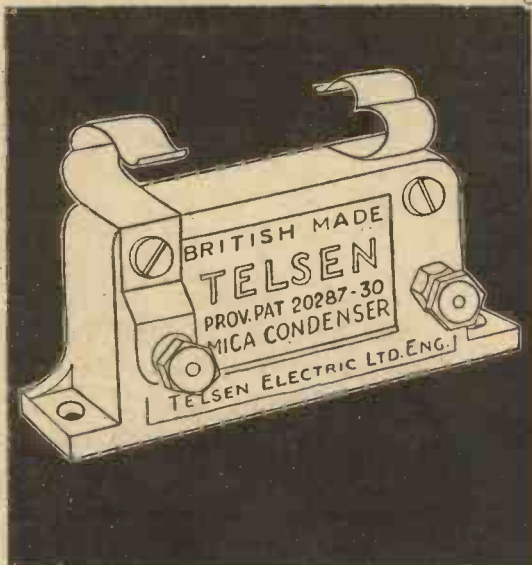

TELSEN FIXED MICA CONDENSERS

(Prov. Pat. No. 20287/30)

Telsen fixed mica condensers are made in capacities from .0001 mfd. to .002 mfd. They can be mounted upright or flat, and the .0003-mfd. Telsen fixed mica condenser is supplied complete with patent grid-leak clips to facilitate series or parallel connections.

Telsen Fixed Mica Condensers. Price **6d.**

Send for the "Telsen Radio Catalogue" and book of "All-Telsen Circuits" to The Telsen Electric Co., Ltd., Aston, Birmingham.

TELSEN

THE SECRET OF PERFECT RADIO RECEPTION

CVS-50

To Ensure Speedy Delivery, Mention "A.W." to Advertisers

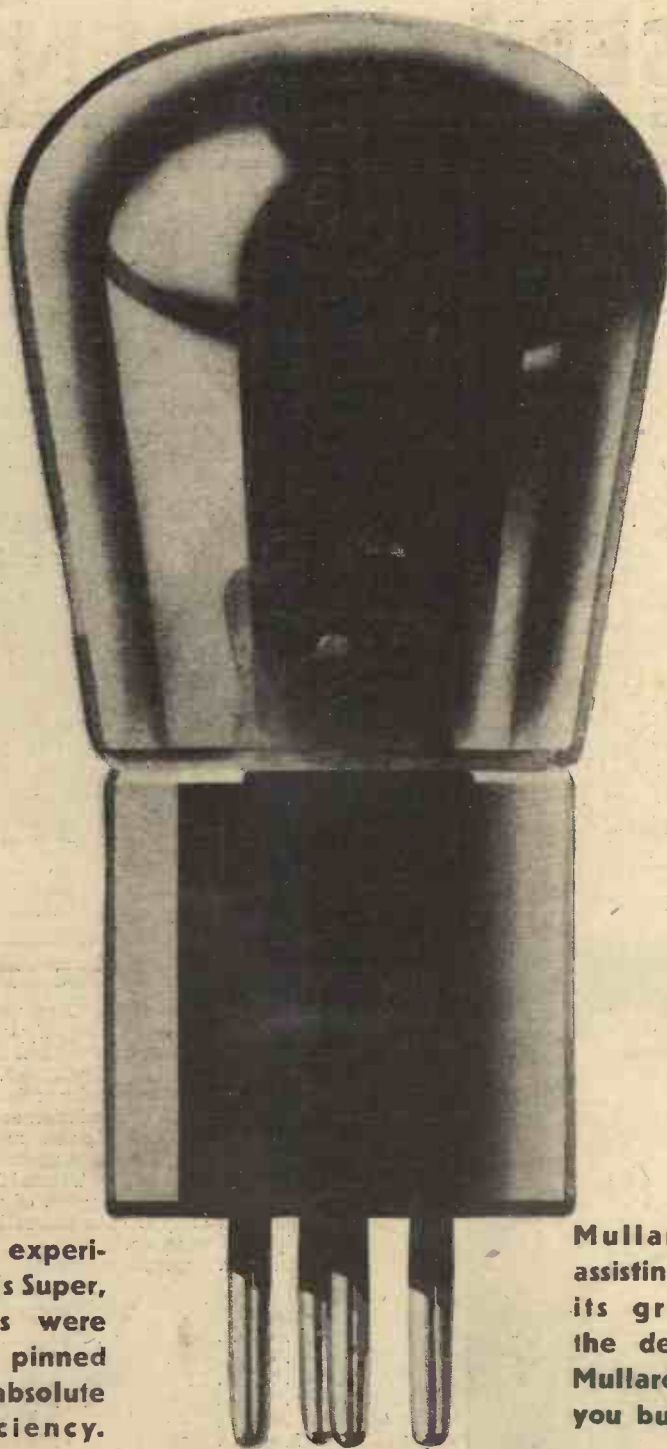

Throughout the entire experimental stages of Britain's Super, Mullard 2-volt valves were used. The designer pinned his faith to their absolute reliability and efficiency.

Mullard Valves are now assisting this set to obtain its great results. Follow the designer's lead by using Mullard 2-volt valves when you build your Britain's Super.

"BRITAIN'S SUPER" USES
Mullard
THE · MASTER · VALVE

Advt. The Mullard Wireless Service Co., Ltd., Mullard House, Charing Cross Road, London, W.C.2

Please Mention "A.W." When Corresponding with Advertisers

AT THE B.B.C.

The B.B.C.'S OWN RECEIVERS

KENNETH ULLYETT interviews members of the B.B.C. engineering staff and tells how reception is carried out

A PART from the giant set in the Science Museum at South Kensington, which was designed by the help of B.B.C. engineers, ordinary listeners have very little opportunity of seeing what kind of gear the B.B.C. believes in for reception.

While there may not be much connection between amateurs' requirements and the relaying, wavelength and quality checking which has to be done with the B.B.C. receivers, I have often wondered, in common with, no doubt, a large number of listeners, exactly what kind of gear is used. Arrangements were made to see some of the receivers at Broadcasting House and at various reception and checking points, and I think there is little doubt but that amateurs and home constructors can learn much from B.B.C. practice.

Tatsfield is undergoing reorganisation at the moment and of the two main sets at present in use, one is several years old, but is extremely reliable and remarkably stable. It is a super-het with three I.F. stages (not screen grids) and the circuit arrangement is quite straightforward.

This is usually coupled up to a three-valve R.C. coupled L.F. amplifier which can be switched on to any other receiver if desired. The other receiver is a rather more special short-wave super-het which came from the Terling experimental station. It is a rack-mounted affair and is actually two receivers in one, being designed for spaced aerial reception. The receivers now work on two vertical aerials of a special type.

Now in manufacture are two receivers

for quality and long-distance reception, and these will be used for relaying and wavelength checking. These will have two S.G. stages and generally will be on rather more up-to-date lines than some of the old-stock B.B.C. gear, but battery valves will be used throughout.

"Quality" checking sets are now being built for Broadcasting House. These will be installed in the new Control Room on the eighth floor and will be coupled up to aerials on the three 30-ft. masts on the roof. These masts will not be just dummies, therefore, as was first thought. Long speaker leads will go down-stairs to various reception rooms and to a special news room where Press officials and others will be able to listen to important broadcasts.

The old six-valve rebroadcast sets used at provincial stations and permanently tuned to 5XX, so that the National programme can be relayed if the wires break down, have twice been redesigned.

First of all a six-valver with two choke-coupled three-electrode H.F. valves, was used, the aerial being loosely coupled, and followed by R.C. stages and transformer output.



The whole affair was made up in a wooden cabinet. Then one choke-coupled H.F. stage was scrapped and a screen-grid tuned anode stage substituted. Now the sets at the more important stations are being redesigned and built up with metal panels for mounting on steel racks.

The rack system is being adopted in as much B.B.C. apparatus as possible and they are getting the idea of interchangeable units, so that if a "dis" occurs in an L.F. unit, a complete stage can be slipped into the rack. The check set at Brookmans



The new check receiver at Brookmans Park, in its metal rack



The one-valve short-wave set used with a standard three-valve R.C.-coupled amplifier for rebroadcasting in conjunction with the B.B.C.'s 100-watt transmitter



Adjusting the short-wave receiver shown in greater detail above. Large accumulators are used for high tension

Park is a good example of a B.B.C. receiver.

Special sets are used for field strength measurements and these generally are not made by the B.B.C., but are supplied by contractors who make the field strength measuring equipment. One of the sets which was used in tests for choosing the Washford Cross Western Regional site, was made up in two aluminium cabinets, with the frame aerial (box type) mounted on top. Post Office type plugs and jacks are used for cutting out L.F. stages.

(Continued at foot of next page)

A CURE FOR TROLLEY-BUS INTERFERENCE

WITH the wholesale scrapping of rail tramway systems and the installation of trolley-buses in their place, many districts are suffering from severe interference with broadcast reception. Particular attention has been focused on the troubles of listeners in the Kingston district, where the recent installation of a trolley-bus service created a good deal of interference to the reception of listeners along the trolley-bus route.

As a cure has now been found for the interference in this district, other harassed listeners in all parts of the country will want to know how it is done and whether the cure has a universal application.

Extensive Experiments

Let me briefly run over the experiments that have been conducted with the object of suppressing trolley-bus interference during the last year or so. The Post Office, in collaboration with tramway officials in Blackpool and Birmingham, carried out extensive experiments in order to determine what part of the system was creating the most trouble.

The Blackpool tests showed that, although interference in the form of clicks could be cut down by using a plate type of collector, the general problem of interference was more deep-seated. It appeared that the bulk of the interference was due to a collective effect of all the cars running at any given time.

Then a stopper circuit, tuned to a long wavelength, was inserted in the down lead from the collector to the motor and this appreciably reduced the interference. Other experiments, notably in the transposition of the series coils of the motors,

again effected a reduction in the interference.

These early experiments proved that interference due to collector clicks was a negligible percentage of the trouble and that the greater part of the interference could be eliminated by a suitable adaptation of the motors so as to include a choke.

The Cause of the Interference

As soon as the trolley-bus system was started in the Kingston district three or four months ago, listeners all along the route complained of severe interference.

The tramways company, to its credit, immediately got in touch with the B.B.C. and the Post Office. It was found that, in common with other trolley-bus systems, the Kingston system was causing a general background noise to reception and crashes during the passing of each trolley-bus.

As a result of tests by the Post Office in conjunction with the B.B.C., during the middle of September, the entire effectiveness of inserting a choke coil between the pick-up and the electrical gear, that is between the trolley pole and the motor controller, was proved to the satisfaction of all concerned.

Using a Choke

For this important test twelve chokes were made up and six trolley-buses were fitted with them. During the test, which was conducted during the early hours of the morning, while London Regional and London National stations were transmitting special signals, six trolley-buses were run fitted with chokes and six trolley-buses without them.

In this way the improvement due to the



fitting of the chokes was conclusively proved. Reception was done on a four-valve portable, comprising screen-grid, detector and two low-frequency amplifiers. A portable was taken in a saloon car along various sections of the route. In addition to these radio reception tests an oscillograph was used to record the amount of interference.

The tests were made during dry and wet weather and under both conditions it was found that the very heavy interference of the trolley-buses was completely eliminated.

The B.B.C. is naturally glad the tramway experiments in the Kingston district have been so successful and they look upon the efforts of United Tramways, Ltd., as the beginning of a country-wide move to eliminate interference.

"HOW THE B.B.C. RECEIVES"

(Continued from preceding page)

For boat-race broadcasts and stunts where a radio link is needed, a one-valve short-waver is used to receive the 100-metre signals from the 100-watt short-wave portable transmitter. This is quite a straightforward affair with a semi-Reinartz circuit and loose coupling to the aerial. Two of these sets are used at each reception point and they work off accumulator high- and low-tension batteries.

High Quality

It is admitted that this is not an ideal circuit for short-wave reception, but under the special circumstances where the strength from the 100-metre transmitters is relatively great and where all that is needed is an outfit which gives high quality and is very stable, this is very practicable.

Sometimes a super-het short-waver is used for special purposes and the circuit of one of the B.B.C. outfits is shown here.

This consists of the oscillator, first and second detectors and the three I.F. stages and coupled up to an L.F. amplifier which is an ordinary R.C. coupled low-frequency amplifier, just as you might have in a radio-gramophone, but having six-volt battery valves.

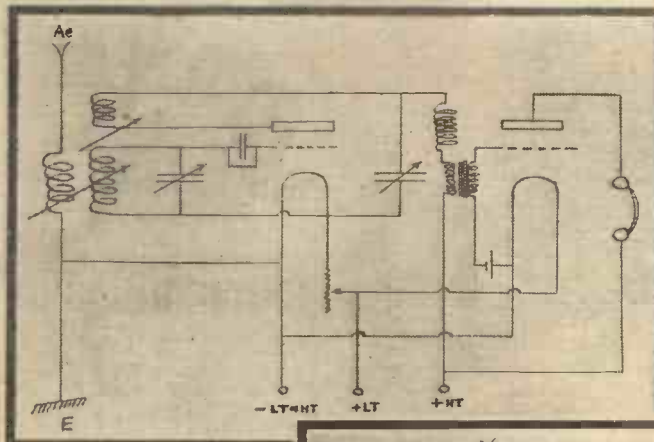

Two typical circuits of B.B.C. receivers, the short-wave super-het and the short-wave relay receiver. In the super-het circuit the intermediate stages are shown "commoned" in only one valve, but actually there are three I.F. valves

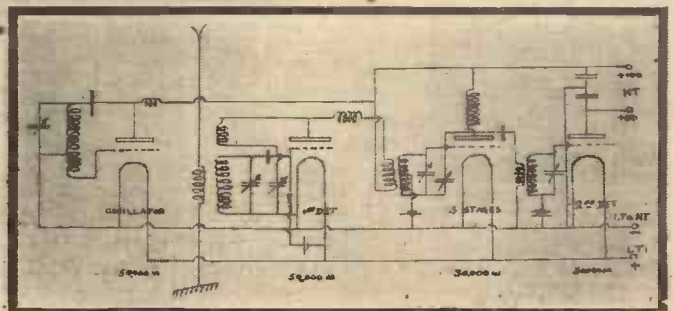



OUR BROADCAST CRITIC

TALKS ABOUT—THE "PARADES"

IN my opinion, the Ridgeway Parade was the direst show ever. Not a funny line in it.

Oh, I forgot the one about celery being bloodshot rhubarb—or was it the other way round? There was one other, now I come to think of it.

Oh, yes; I have it. It was about the man who held an egg in his hand for three minutes while he boiled his watch.

Those were the two screams of the production which, by the way, was described as a Song and Dance Show.

Dance shows are just the thing for broadcasting. I wonder the B.B.C. has not thought of it before. Dancing is absolutely fascinating when you cannot see it.

I do hope Savoy Hill will broadcast a series of ballets and general spectacular effects; plenty of good scenery with them, and gorgeous costumes for the dancers.

As for the songs in the Parade under review, I hardly noticed them, they were so wishy-washy.

Perhaps my sense of humour is not equal to this sort of thing. That does not matter. The whole cast roared with mirth at nearly every line that was spoken; also they vigorously applauded all the songs.

I am sorry I cannot say anything about the voices; I did not notice any. More please! Only can it be on a night when I am out?

The Foundations this week seem to have been up to standard. Debussy's songs are by no means easy to sing, but I thought Claire Croiza sang them extraordinarily well.

I was rather taken with the singing of Leslie Holmes in a Parkington Quintet broadcast. I liked his voice and I appreciated the trouble he took over his words.

I do not listen to too much dance music—I hear enough of it when reviewing records—but Maurice Winnick and his band (Piccadilly Hotel) struck me as being pleasantly rhythmical. I shall take the first opportunity I get of hearing them again.

Some of these midday concerts are well worth listening to—if you can manage it, that is. Quite a good one came through from Manchester on Tuesday.

I thoroughly enjoyed Norman Fulton's singing of Schumann. If he will forgive my punning on his name, I thought his voice had a very "full tone" about it. Good name for a singer!

In the same programme Marjorie Blackburn played a Partita for piano by Karg-Elert. According to the programme, it was the first performance in England. Please let it be the last.

I was quite amused at Harry Tate in *How Are You?* All the same, I have heard him far funnier. I cannot say I think it was really up to his form.

Harold Nicolson has a delightful way of expressing himself. His talks on modern literature are well worth hearing.

There has been a good deal of hot air about the Bach Cantata Club. I hear that many people were indignant because they broadcast three cantatas in succession.

Rather silly, surely? What on earth did they expect the Bach Cantata Club to do? Gilbert and Sullivan?

I enjoyed that broadcast immensely. *Sleepers, Wake!* was especially good. More please—and heaven bless the lowbrows!

The two opera relays were splendid. I thought well of Parry Jones in *Lohengrin*. He handled the part almost to perfection.

Josephine Wray, as Elsa, was by no means amiss; her voice has a very attractive quality about it.

How did you like *Traitor*? I was thrilled to bits with it. There is no doubt in my mind that the wireless lends itself to thrillers. The very fact that the action cannot be seen lends an air of mystery.

I like being thrilled. In this instance I suspected each of the four crooks in turn. As I write I note that it is on again; I shall listen carefully in order to see what effect it has on second hearing.

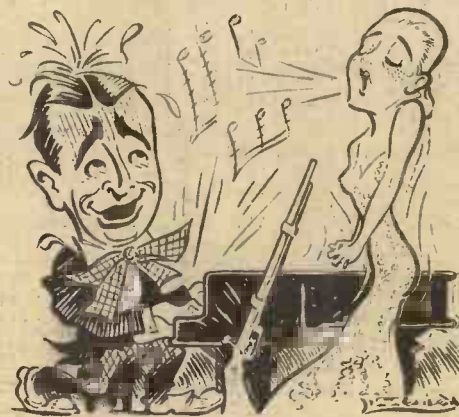

Al Trahan and Miss T. Cameron in cartoon

The Saturday-night vaudeville was an improvement on some I have heard recently.

Flack the Flautist seems to have a good technique. Like all flute players, he is rather inclined to choose works that display virtuosity rather than expression. All the same, his playing was good.

I thought the "Famous Faux Pas" (No. 1) was well written. I found myself agreeing with many of its sentiments.

Doris and Elsie Waters are always well worth hearing; we can do with more of them, in my opinion.

Bransby Williams is one of the successes of wireless, undoubtedly. His voice—I mean his natural voice—is excellent, and his character voices seem to have the faculty of holding the attention. I thoroughly enjoyed him.

In order to hear *Traitor* a second time—which, by the way, I think I enjoyed even more than the first—I was a minute or two early, or else the Chamber Orchestra Concert was late.

Anyhow, I fell on a concerto by Hindemith. Four bars quite satisfied me; I switched off again. Never will I willingly listen to Hindemith in any shape or form. He is too dissonant for the likes of me.

Earlier in the evening I was fortunate enough to catch Doris Vane singing with a choir. Very pleasant, too! Hers is a splendid voice and thoroughly suited to the needs of the microphone.

Four o'clock on a Sunday afternoon seems to me to be the right time for a chamber-music concert.

I was delighted with the Brosa String Quartet; their tone in the Beethoven quartet was superb in places. There is no doubt in my mind as to where they stand in the world of chamber-music players.

I made a point of hearing the song cycle "In a Persian Garden."

I am never keen on Liza Lehmann at any time, neither did the music impress me in any way, but I thought the singing exceptionally good.

Megan Thomas, Esther Coleman, Herbert Thorpe, and Foster Richardson made a splendid foursome.

The last time I heard Megan Thomas she was penalised by being made to sing a dramatic aria. The sooner the B.B.C. realises that she is a pure lyric soprano, the sooner shall we have the best out of her. I thought she sounded very fine. A word of thanks to Miss Coleman also.

WHITAKER-WILSON.

THE parts to be used in the set should be examined very carefully before they are fitted into position.

Take the two-gang condenser, for example, and see that the moving plates do not touch the fixed at any point over the range. The movement should be smooth and free from jerks.

Go over the valve holders, too, and see that the contacts are good. The make recommended is particularly satisfactory, but you may use alternatives that are not so good electrically.

You should always examine the parts from the mechanical point of view as a minute or two spent in tightening a terminal may save many minutes later on when the part has to be taken from the set before it can be put right. The choke is a little fragile in the sense that the connections may be broken if the terminals are turned too tightly, so do not use great force here.

The construction had better be commenced by putting the parts upon the front panel. In the centre is the oscillator coil unit. A single hole is drilled to take the screwed bush of the unit and the nut provided is fitted. Turn the coil into the correct position for the switching to match with the markings upon the indicator. Fit the knob and turn the coil itself until the hand upon the knob is opposite the centre of the indicator.

As the coil switch has two positions, the right position when making this adjustment is in the centre. Then, when the knob is turned to the right or left the indications will be correct.

Above the oscillator is the volume control. This has three terminals which should be at the top or a little to one side for convenience in wiring. The illustrations show this part clearly. Fit the knob carefully and see that the movement is quite free.

It is easy enough to arrange for the

controls of the tuning condensers, which should be screwed down to the baseboard in the right positions. The scales and knobs will move freely and any tightness should be rectified to obtain smooth control of the set.

By the side of the two-gang tuning condenser is the aerial filter coil. This must be screwed down in the position shown in the drawings. It is arranged at the edge of the baseboard in order that the switch may be worked from the side without difficulty. Do not place the filter coil closer to the tuning condenser than necessary.

Switching

A further control is arranged at the side as well. This is the battery switch, but it is first wired to the circuit, using flexible insulated wire, and is afterwards fitted to the side of the cabinet, which has a fixing hole provided.

It is advisable to fit the panel to the baseboard when checking the position of the oscillator valve holder and other parts in order that there shall be room for the oscillator coil. Also see that the two band-

More about BRITAIN'S

“SUPE

USEFUL CONSTRUCTIONAL HINTS :: TESTING THE SET

filter coil units clear when plugged into their valve holders.

You must be particularly careful if different parts are used, such as fixed condensers and the transformer. A little rearranging may be necessary if many different parts are being used. It cannot be said that different fixed condensers of good make will affect the results, but they may take a little more room.

Wiring

The wiring is easily carried out and there are no difficult points excepting perhaps the

COMPONENTS REQUIRED FOR THE "BRITAIN'S"

Ebonite panel, 14 in. by 7 in. (Permol, Peto-Scott, Danipad, Becol, Readi-Rad, Goltone).

Cabinet, with baseboard, 17 in. by 9 1/2 in. (Readi-Rad "Waldor," Peto-Scott, Camco).

Two-gang .0005-mfd. variable condenser (J.B. type R2, Lotus, Utility, Polar).

Single .0005-mfd. variable condenser (J.B. type R1, Lotus, Utility, Polar).

50,000-ohm variable resistance (Varley, Bulgin, Sovereign, Colvern, Lissen, Regentstat, Igranic, Watmel).

Three super-het coils, one oscillator and two intermediates (Wearite, types O2, OT2, and OT1, or Lewcos).

Band-pass filter unit, with extension rod (Lewcos "BPF").

Seven valve holders (W.B., Lotus, Lissen, Goltone, Telsen, Benjamin, Graham-Farish, Wearite, Junit).

Four 1-mfd. fixed condensers (T.C.C., Dubilier, Telsen, Lissen, Formo).

2-mfd. fixed condenser (T.C.C., Formo, Dubilier, Telsen, Lissen).

.01 fixed condenser (only required for modified construction) (T.C.C., Sovereign, Dubilier).

Two .0002-mfd., and one .0003-mfd. fixed condensers (Telsen, Dubilier, Graham-Farish, Goltone, T.C.C., Ormcnd, Formo, Lissen).

One-megohm grid leak (Telsen, Dubilier, Goltone, Lissen, Readi-Rad, Graham-Farish, Bulgin).

Grid-leak holder (Readi-Rad, Bulgin, Lissen, Goltone, Dubilier, Graham-Farish).

Super-het choke (Readi-Rad).

Low-frequency transformer (Telsen, R.I., Lewcos, Lotus, Lissen, Varley, Ferranti, Bulgin, Igranic, Graham-Farish, Burton).

Two spaghetti resistances, one 15,000-ohm and one 20,000-ohm (Lewcos, Telsen, Bulgin, Graham-Farish, Readi-Rad, Lissen, Sovereign, Goltone, Tunewell).



A rear view of the "Super" with valves and coils inserted

A Band-pass Five-valve Super-het for use with Earth. Specially Designed for AMATEUR V

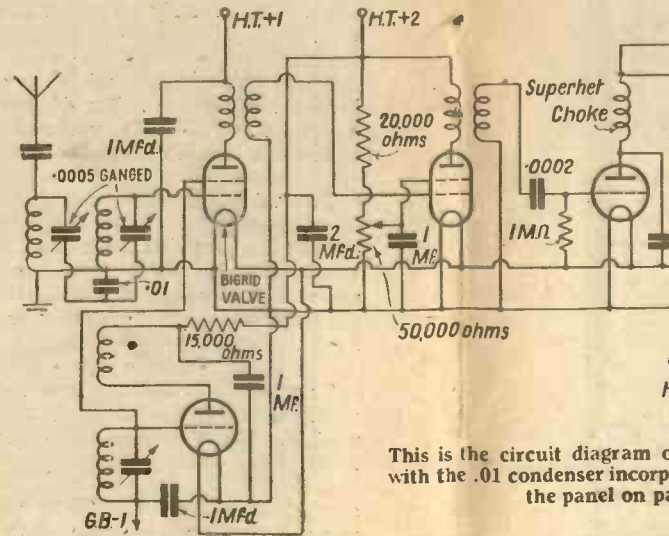

This is the circuit diagram of the set with the .01 condenser incorporated into the panel on the



oscillator. One make has flexible leads coming from the coil, the coverings being coloured.

The white wire is not used and should be cut-off near the coil, and the end be covered with a little insulating tape.

In another construction special tags are used and the insulating bushes are coloured. Take no notice of the connecting tag with a white insulating bush as this is not used. Remove the panel and fit wires to the connecting tags. Use

flexible wires having rubber coverings, if possible, and having cleared the ends, fit them to the tags.

It is important that good tight connections be made and see that no ends are left, as they might rest upon the metal cover. Leave the wires joined to the tags and fit the panel again. Afterwards the wires can be taken to the other connecting points. The colours are fairly readily distinguishable, but do not mistake blue for black.

The Fuse

Be careful of the wiring of the fuse, for if you get this joined in the low-tension circuit the fuse will blow when the set is switched on.

Note particularly the connections to the

GETTING MORE VOLUME

"Britain's Super" builders who want to get the most volume from the set, and who do not mind sacrificing a little of the selectivity, should see the simple modification which can be made. Only one extra small condenser is needed. Full details are given in the panel on page 826, and a reproduction of part of the wiring diagram is shown, making it quite clear where the condenser is added.

"BRITAIN'S SUPER"

Fuse holder and fuse (Bulgin, Telsen, Readi-Rad, Belling-Lee).

Terminal block (Unit, Sovereign, Belling-Lee).

Two terminals marked Aerial and Earth (Belling-Lee, Bulgin, Clix, Eelex).

Double-pole toggle switch (Bulgin, type S.88).

Connecting wire (Jiffilinx).

Six yards of thin flex (Lewcoflex).

Eight wander plugs marked: H.T.—, H.T.+1, H.T.+2, H.T.+3, H.T.+4, G.B.—, G.B.—1, G.B.—2 (Belling-Lee, Clix, Eelex).

Two spade terminals marked: L.T.—, L.T.— (Belling-Lee, Clix, Eelex).

ACCESSORIES

Loud-speaker (Amplion, H.M.V., Blue Spot, W.B., Celestion, B.T.H.).

H.T. battery (Drydex, Ever-Ready, Lissen, Fuller, Palaba, Pertrix).

G.B. battery (Drydex, Ever-Ready, Fuller, Lissen, Palaba, Pertrix).

L.T. accumulator (C.A.V., Ever-Ready, Exide, Fuller, Pertrix).

oscillator valve holder. Make good loops in the wires so that they will fit the terminals properly and be held nicely by the terminal nuts.

The flexible resistances may be fitted last and the only precaution to be taken here is that the ends do not make contact with neighbouring parts. Some contact ends are rather long and may touch a second terminal unless they are placed in the right position and securely fastened. The values are clearly indicated in the diagrams.

It is better to test the set before fitting it

With an ordinary Aerial and WIRELESS by W. JAMES

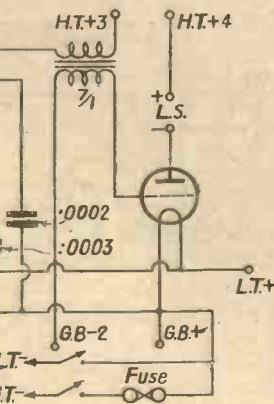

of "Britain's Super" operated as explained in page 826

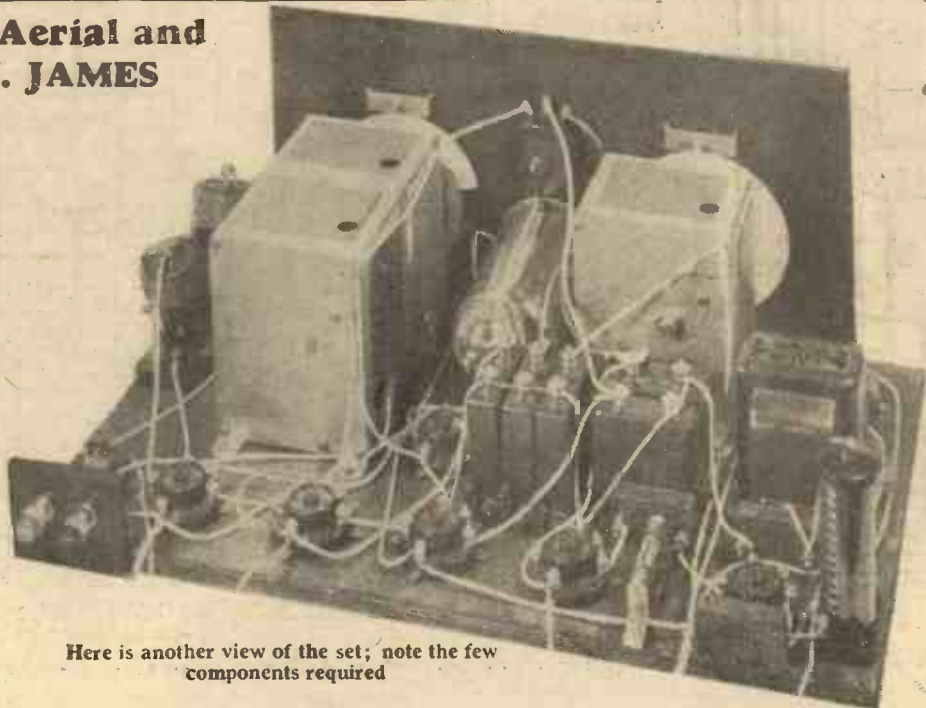

Here is another view of the set; note the few components required

“BRITAIN’S SUPER” (Continued from preceding page)

in the cabinet. The right valves are a Mullard double grid PM1DG, in the first stage, a PM2DX in the oscillator position, a PM12 in the long wavelength amplifiers, a PM1HL in the second detector stage, and a PM2A in the power stage.

The grid bias battery may be of 9 volts and the high-tension a 120-volt battery. Plug the G.B.—1 plug into negative 3 volts to commence with and use negative 6 volts

for the power valve through G.B.—2. Connect H.T.+1 to about 75 volts, H.T.+2 to 120 volts, H.T.+3 to 90 volts, and H.T.+4 also to 120 volts.

Testing

If now the aerial and earth are connected and the set is switched on to the medium waves, a station will be tuned in fairly easily. But there are several adjustments

to be made before the best results can be obtained. The first is the first detector, having the four-electrode valve. The working of this valve is affected a little by the grid bias applied to the oscillator, but chiefly by the value of the high-tension.

With the local station tuned in, therefore, turn the volume control to reduce the strength to a whisper. Then adjust the high-tension at H.T.+1 and obtain the

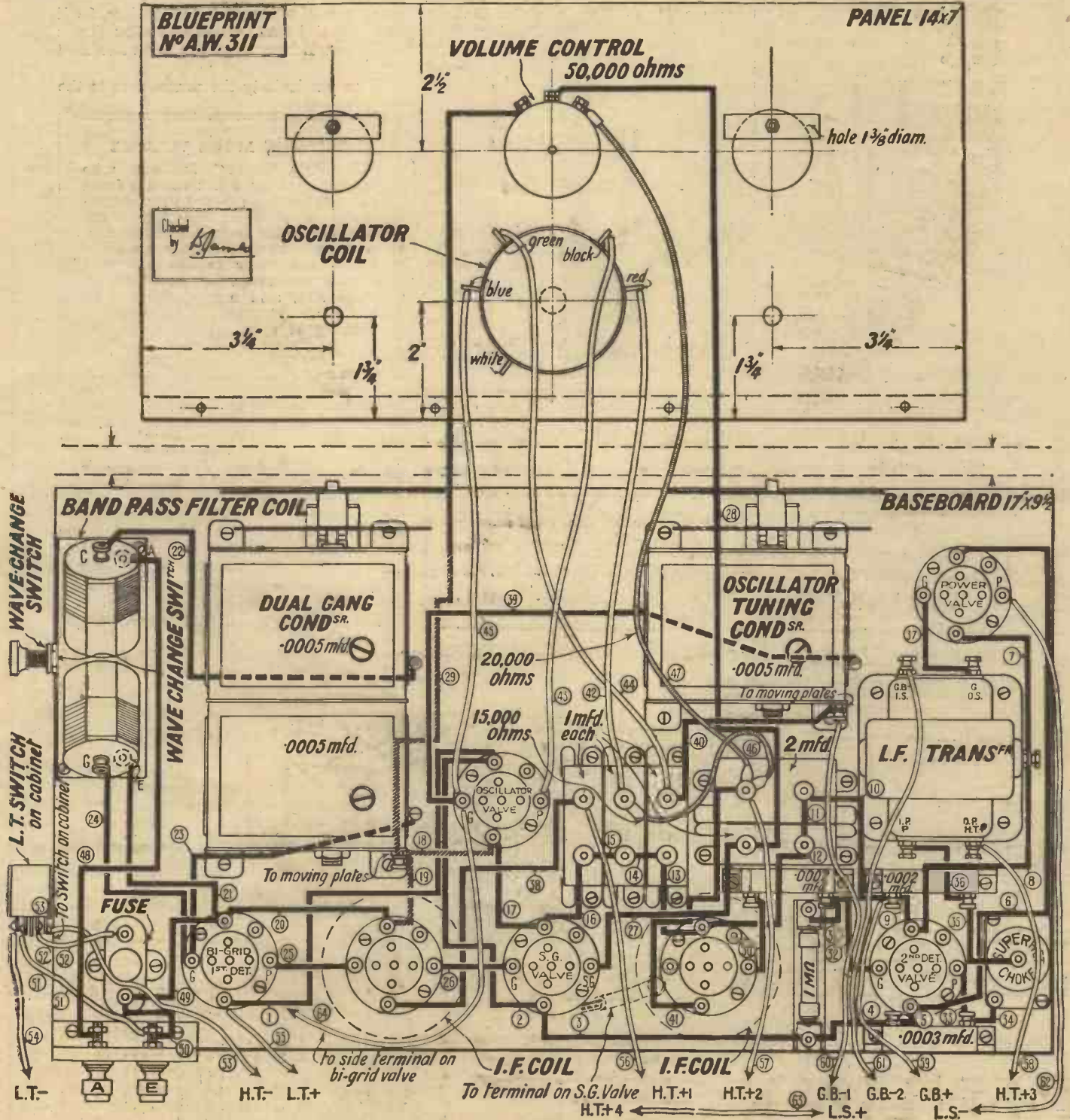

The modified layout and wiring diagram for inclusion of .01 fixed condenser. Lines shown "cross-hatched" denote wires to be altered when fixed condenser is connected in band-pass circuit, as shown in supplementary blueprint

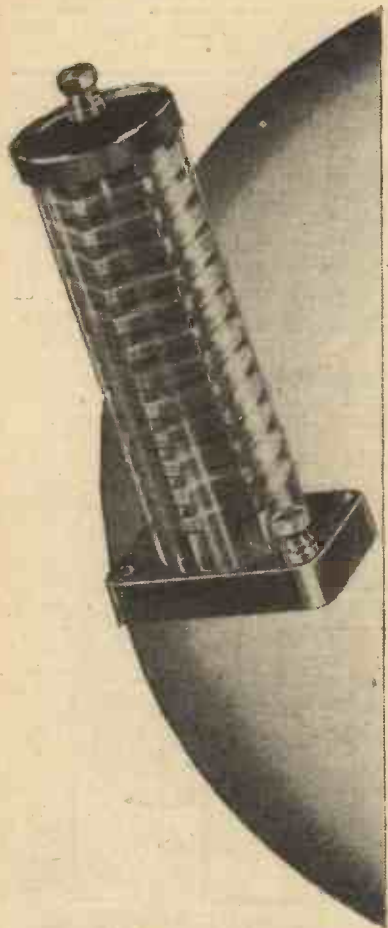

You
MUST
have a
**SUPER-HET
CHOKE**

You
SHOULD
have an
INSTAMAT
for your
"Britain's Super"



READIRAD SUPER-HET CHOKE, designed by G. P. KENDALL and chosen for "BRITAIN'S SUPER" by W. JAMES.

PRICE ... **5/6**

The Instamat is recommended by "Amateur Wireless" for connecting between the output terminals of your "Britain's Super" and your loudspeaker. It gives you all the benefits of an output transformer of the most perfect design, with the unique advantages of being able to select, *instantly*, the current ratio necessary for the best quality reproduction.

READIRAD INSTAMAT Output Transformer
Five ratios, operated by switches—1-2, 1-1, 1½-1, 2-1, 3-1
PRICE ... **27/6**
(For all Speakers except low resistance moving coils.)

INSTAMAT MAJOR
For low resistance moving-coil Speakers. Ratios of 10-1 to 25-1.
PRICE ... **37/6**

See also pages

iv v
viii ix



Order Forms on pages v ix

Head Office and Works: Eastnor House, Blackheath, S.E.3.
Phone: Lee Green 5678. Grams: Readirad, Sedist.
Showrooms: 159 Borough High St., London Bridge, S.E.1. Phone: Hop 3000.

WIRE YOUR SET WITH JIFFILINX

Advt. of Ready Radio Ltd.

The most convenient, rapid and neat method of wiring a set. Eliminates soldering and yet gives perfect contact. Jiffilinx were used exclusively by Mr. James in the assembly of the original "Britain's Super."

Price per packet ... **2/6**

To Ready Radio Ltd.,
Eastnor House, Blackheath, S.E.3.
Please send me one packet of JIFFILINX for which I enclose 2/6.
NAME
ADDRESS
..... A.W.24/10/31.

Advertisers Appreciate Mention of "A.W." with Your Order

“BRITAIN’S SUPER” (Continued from page 824)

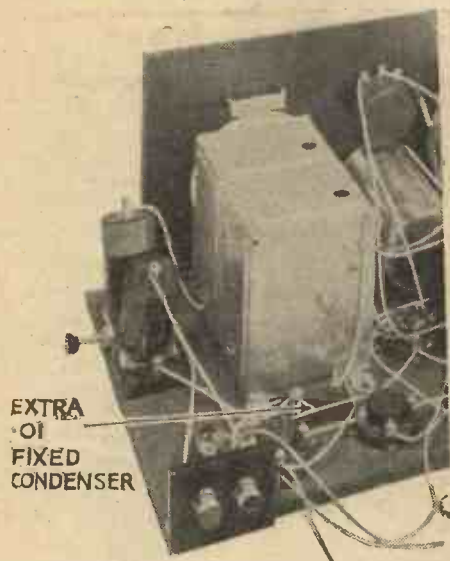

EXTRA .01 FIXED CONDENSER

Close-up showing the position of the .01 fixed condenser

GETTING MORE VOLUME!

Constructors of “Britain’s Super” requiring more volume from long-wave stations—and greater “punch” generally—can afford to sacrifice a little of the amazingly high degree of selectivity of the standard arrangement by making a very simple adaptation to the wiring of the band-pass coils.

This consists of the addition of a .01-microfarad coupling condenser. That shown by the illustration is a T.C.C. type “S” condenser.

This alternative scheme of connecting is clearly indicated by reference to the main and supplementary blueprints. It will be seen that in the main blueprint the wires numbered 29, 18 and 19 are “cross-hatched.” These are the three wires that have to be removed to make the band-pass coil alteration.

Wire No. 29 is altered to wire A in the supplementary blueprint; wire No. 18 to wire B; and wire No. 19 to wire C. In addition to these alterations an extra wire D is needed.

Looking at the supplementary blueprint, it will be seen that wire A goes from one side of the potentiometer volume control to the filament negative connection of the oscillator valve.

Wire B goes from filament negative of the oscillator valve to the intermediate coil holder on the right of the bi-grid valve.

Wire C goes from the earthing terminal of the variable condenser to one side of the .01-microfarad fixed condenser.

Wire D, that is the extra wire, goes from the remaining side of the .01-microfarad fixed condenser to the filament negative of the bi-grid valve.

The extra fixed condenser can be fitted just behind the two-gang variable condenser as shown on the supplementary blueprint on this page.

strongest signals. This is only a temporary adjustment as it is best carried out when listening to a distant station.

But first the two-gang condenser had better be set. There are two tuning condensers. Unscrew both by turning the knobs in an anti-clockwise direction in order to make the capacities as small as possible.

Tune in the local station properly again

Next try adjusting the second trimmers, but do not screw both down. One should be screwed down a little and this is usually the one in the aerial circuit, that is, the one nearest the panel. Final adjustments are best made when listening to a distant station. Therefore tune in a weak signal by adjusting the two condenser controls and with the volume control in the position of

This is the small supplementary blueprint showing altered connections when .01-mfd. fixed condenser is connected in band-pass circuit. The hatched lines in the main blueprint on page 824, show wires which must be altered, as explained in the accompanying panel

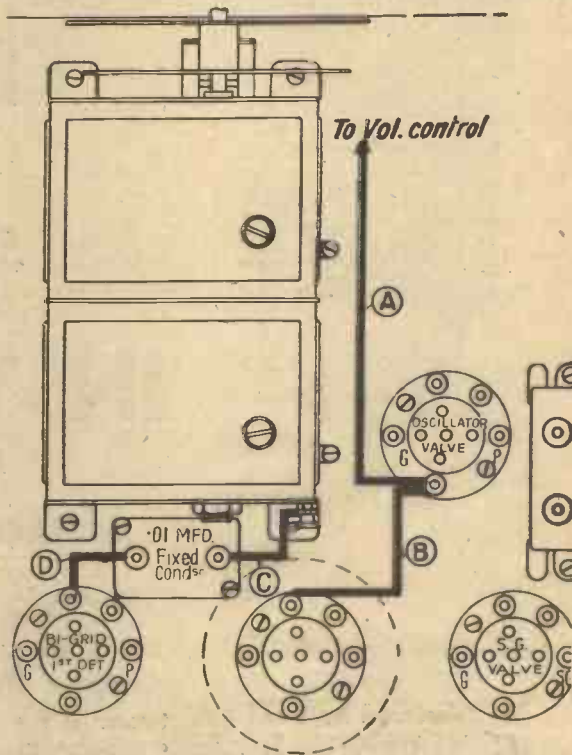

and turn the first trimmer knob (the one nearest the panel) in a clockwise direction. Keep the circuit in tune and you will find a position where the strength is the maximum.

maximum strength. Then slightly adjust one of the trimmers and obtain the strongest signals.

Also try the effect of different voltages at H.T. +1 and you might see the effect of altering the grid bias at G.B.—1 from —3 volts to —1.5 and —4.5. Actually the gang tuning condenser can be set in a few minutes and then it need not be altered.

Try the tuning upon both wavebands. The filter circuit tunes quite sharply and there must be no double humps in this circuit. This aerial circuit tunes sharply enough to cut out a lot of interference. The two coils of the filter unit, being accurately matched must be tuned with a two-gang condenser having sections of the right capacity and the trimmers enable us to fix the value of the fixed capacities in the aerial and grid circuits.

When the trimmers are properly set the circuit will tune quite sharply, but it will be noticed that the tuning of the oscillator is even more sharp.

ADJUSTING CONDENSER HEIGHT

Some of the new right-angle panel-mounting condensers have feet which are adjustable for height. This is often a convenience when wiring has to be



carried underneath the condenser and a gap of half an inch or so between the condenser and the baseboard is needed. Take care to adjust all four fixing screws equally.

Once again the B.B.C. is to relay in the coming winter season excerpts from the concerts arranged by the Glasgow Choral and Orchestral Union, and the Reid Symphony Orchestra. It is being stipulated that in sixty per cent. of these an opportunity will be afforded for the performance of a work by a Scots composer.

TELSEN LOUD-SPEAKERS

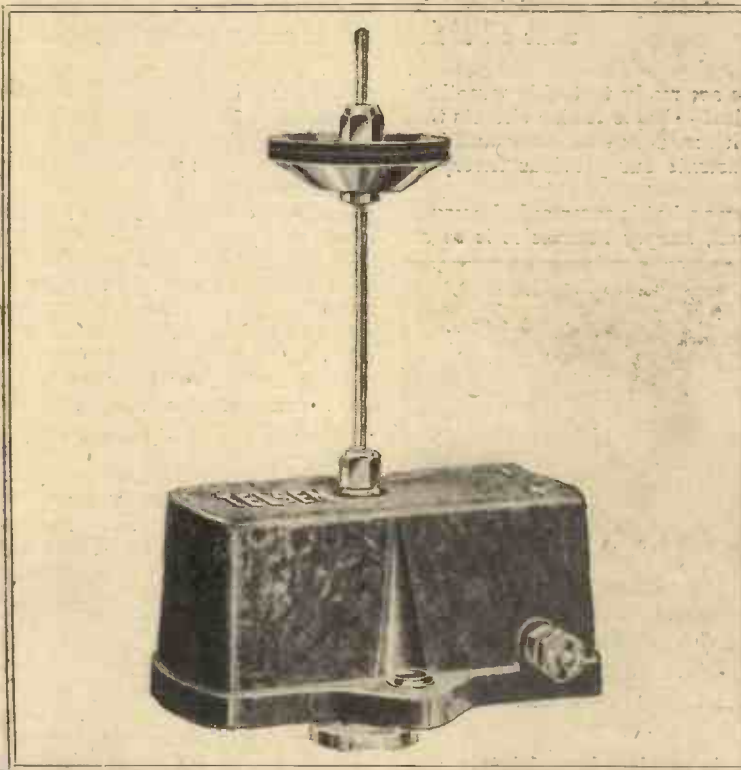

TELSEN LOUD - SPEAKER UNIT

The Telsen Loud-speaker Unit is pleasing to the most sensitive ear. The deep notes of the bass, the brilliance of the soprano, and the crispness of diction are clearly reproduced without any distortion. It employs cobalt steel magnets, and the detachable rod which carries the cone is fitted with cone washers and clutch. The entire unit is enclosed in a beautifully moulded bakelite dust cover.

Telsen Loud-speaker Unit Price **5/6**

Send for the "Telsen Radio Catalogue" and book of "All-Telsen Circuits" to The Telsen Electric Co., Ltd., Aston, Birmingham.

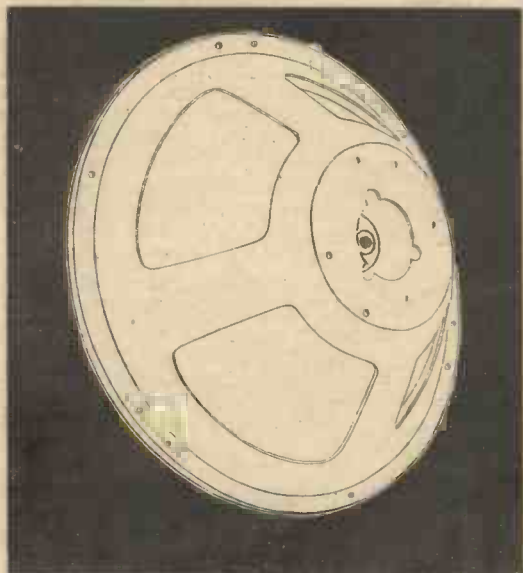

TELSEN LOUD - SPEAKER CHASSIS

The fully floating cone mounted on a flexible felt surround renders the Telsen Loud-speaker Chassis very sensitive, giving perfect balance of tone. It is unaffected by damp conditions because the cone material is practically non-hygroscopic. The Telsen Loud-speaker Chassis is substantially made and it is light in weight. Holes are provided for easy attachment to most of the popular makes of loud-speaker units. The Chassis may be readily fixed to a baffle board or cabinet by three or more wood screws.

Telsen "Popular" Loud-speaker Chassis (Diam. 11") Price **5/6**

Telsen "Major" Loud-speaker Chassis (Diam. 14 1/2") Price **10/6**

TELSEN

ALL-BRITISH
RADIO COMPONENTS

CVS-50

Advertisers Appreciate Mention of "A.W." with Your Order

THE HOW AND WHY OF TUNING—VII

SIMPLE TUNING CIRCUITS

Another of a short series of articles on tuning, specially written for newcomers to wireless. Here the first ideas about tuning are presented. In the articles that follow, "Hotspot" will deal with all the difficulties about tuning that the beginner is likely to meet

NOW we are ready to tackle something practical—simple tuning circuits that will cope with modern conditions and incidentally illustrate our previous theory on tuning!

Fig. 1 shows what is commonly known as a plug-in coil, simply because it is so ar-

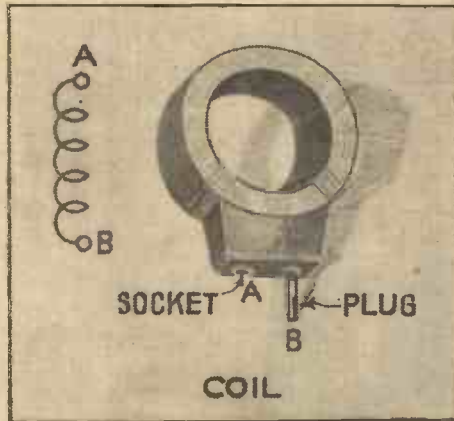

Fig. 1. Simple plug-in coil and theoretical symbol

ranged that it can be plugged into a convenient socket. The socket will be wired in the tuning circuit and the coil will then make contact with the circuit when it is inserted. Why should we use plug in coils? Just because it is impossible to design one coil that will, with a standard maximum capacity of tuning condenser, cover all the required wavelengths between the limits of 200 and 2,000 metres.

True, we might use a very high maximum condenser, and so increase the LC constant by additional capacity, but in practice it will be found that a coil that requires more than a maximum of .0005 microfarad to tune it to a required wavelength results in an inefficient ratio of capacity to inductance. If we try to make up wavelength with too much capacity we lose signal strength.

So we compromise, as always in radio, by using several coils with different inductance values, and thus for any given wavelength there is never more than a maximum parallel capacity of .0005 microfarad. For example, a plug-in coil might provide a wavelength range with a .0005 microfarad tuning condenser of 220 to 420 metres; while with this same condenser, another plug-in coil, in place of that just mentioned, might tune from 400 to 550 metres. Thus by making the inductances across the tuning condenser interchangeable we could, with the two coils exemplified, tune from 220 to 550

metres, and for most of these wavelengths the ratio of inductance to capacity would favour good signal strength.

Of course, it is possible to wind a single coil to tune from 220 to 550 metres with the variation from minimum to maximum of a .0005 microfarad variable condenser, but it is not generally quite so efficient as using interchangeable coils. This point is of more importance to the small set user than the user of a multi-valver, in which type of set the difference in the efficiency over the various sections of the wavelength range under consideration would possibly not be noticed.

About 300 metres is the maximum wavelength range on the medium waves of an inductance tuned by a .0005-microfarad variable condenser. Thus in commercial sets we find that one set of coils tunes from 250 to 550 metres. To bring in the so-called long-wave band needs an entirely separate coil, or set of coils.

On the long waves it is possible to tune with one coil from 1,000 to 2,000 metres with the variable condenser specified. Wavelength differences on the long-wave band mean smaller frequency differences than on the medium-wave band. The frequency difference between 220 and 550 metres is 819 kilocycles, whereas the frequency difference between 1,000 and 1,935 metres is only 150 kilocycles.

I mention this because many radio novices wonder how it is that we can provide a wavelength range of 1,000 metres with a .0005-microfarad condenser and a suitable coil, and yet we cannot cover more than 300 metres when we go down to the medium waves!

A somewhat comic nomenclature has been assigned to these plug-in coils we are discussing. Really, the thing that matters about a coil is its inductance, which is

measured in microhenries. The best coil is the one with the greatest inductance for a given high-frequency resistance. But to the unlearned amateur inductance is something rather intangible, so he naturally fastens on the number of turns to distinguish one coil from another.

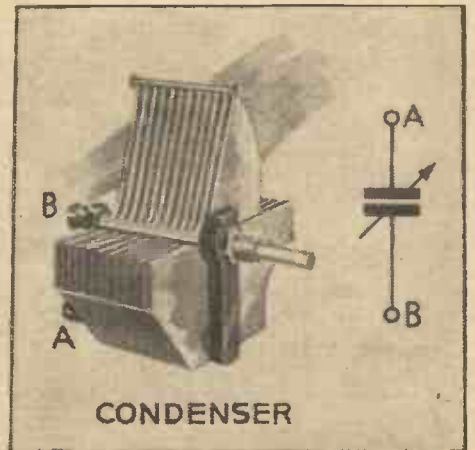

Fig. 2. A typical variable condenser and its symbol

Now while it is true that, in a general way, the greater the number of turns the greater is the inductance, there are many other factors affecting the inductance, such as the diameter of the coil former, or the gauge of wire, to take but two factors.

Still, custom now decrees that plug-in coils of the interchangeable construction shall be distinguished by their turn numbers, so it is no use kicking now! Suppose we take a No. 40 coil for example; in the Lewcos range this plug-in coil has an inductance of 79 microhenries. That is the fixed quantity, and the wavelength range will depend on the tuning condenser, which will vary in capacity from as near zero capacity as possible up to .0005 microfarad.

Taking the minimum capacity across this coil as .00003 microfarad, the wavelength of the combination is 126 metres. With a parallel capacity of .00025 microfarad, corresponding to the moving vanes half way in, this Lewcos No. 40 plug-in coil has a wavelength of 269 metres. With the maximum .0005 microfarad capacity across it, the coil tunes to a wavelength of 377 metres. It is important to note that the wavelengths mentioned apply only to the coil-and-condenser circuit, and not to its insertion in a set as the aerial tuning, for example. The effect of connecting

(Continued on page 830)

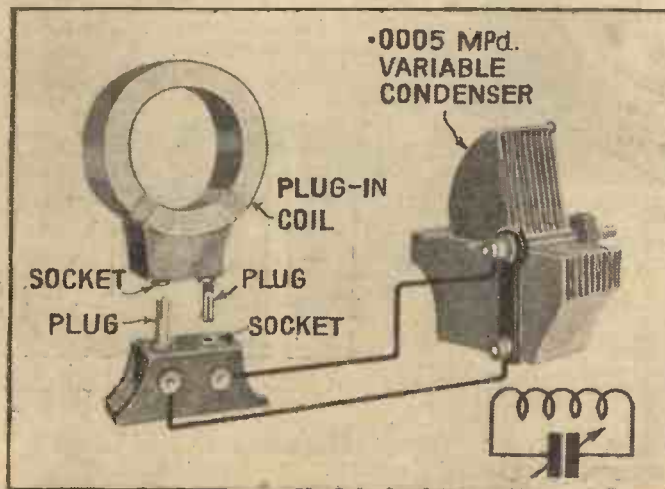
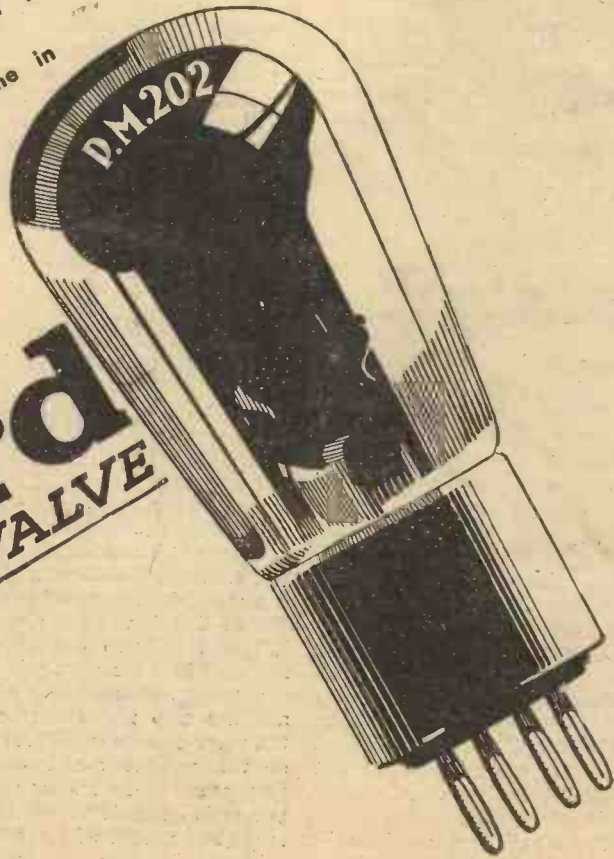

Fig. 3. The simplest tuning circuit with theoretical symbol

The Mullard range of 2-volt valves provides a valve for every stage. An important addition to the range is the P.M.202, a super-power valve, specially designed for economy in low tension current consumption. It gives super-power output, with a filament consumption of only 0.2 amp. — no more than that of an ordinary power valve. It is thus particularly suitable for use in the output stage of portables and small battery-operated sets. Fit one in your receiver to-day. Price 13/6

202

Mullard
THE MASTER VALVE



Advt. The Mullard Wireless Service Co., Ltd., Mullard House, Charing Cross Road, London, W.C.2

Arks

Advertisers Appreciate Mention of "A.W." with Your Order

SETS OF DISTINCTION



COSSOR EMPIRE

MELODY MAKER

Makers: A. C. Cossor, Ltd.

Price: £6 15s.

AS soon as I saw the new "Cossor Empire Melody Maker" I knew it was a winner. The clean layout, the simplicity of the construction and the inclusion of all the essentials for modern broadcasting conditions are points about this set that must impress everyone. Let me explain that this Cossor set is a kit set, supplied as a box of components that can easily be assembled into the finished product I was asked to test.

I have been looking through the large and clearly illustrated instruction sheet. Verily, the novice should have no trouble in understanding the very clear stage-by-stage assembly details. There are three complete stages in the construction. The first is the assembly and wiring of the base plate. On this metal base are mounted the Cossor aerial and anode coils. These are dual-range coils and are completely screened in metal cans. I am glad to see that the wave-band changing is now done by means of an external switch lever, later mounted on the side of the cabinet.

When the base plate has been assembled and wired, the panel is tackled. On the panel are mounted the two slow-motion variable tuning condensers, the reaction condenser, the on-off switch, and the rheostat for controlling the volume. All this is very straightforward and quite easy to follow.

Then the base and panel are wired together. This also is an easy job if the point-to-point wiring chart is followed. As already mentioned, I was supplied with a completed kit, but from past experience of Cossor kits I am sure this latest model is easy to make.

A Sound Circuit

Circuits always interest me, as they must the constructor. In the Cossor-kit set is a very sound circuit embodying many modern ideas. The three valves are arranged in the popular sequence of high-frequency amplifier, detector, and transformer-coupled low-frequency amplifier. The coupling between the first two valves is by means of a tapped tuned anode coil. To this is coupled the reaction coil from the anode circuit of the detector.

I see that the aerial and anode coils make use of the usual shorting of the long-wave portion for medium-wave reception. This is a well-tried system and certainly works well in this model.

There is no high-frequency choke in the anode circuit of the detector, so the primary of the low-frequency transformer has to be relied upon to divert high-frequency current through the reaction

system. To prevent any of this current from getting into the power valve circuit, I see a .5-megohm grid leak is inserted. This is between the secondary of the transformer and the grid of the power valve.

There is also a .0001-microfarad condenser across the anode and filament of the detector valve. This increases the efficiency of detection and also prevents the high-frequency anode current from getting into the last valve circuit.

Other circuit details include a pre-set condenser in the aerial lead. This is most useful for increasing the selectivity, but it also helps as a pre-detector volume control.

The Valves

The valves in this kit set play a very important part in its successful working. The high-frequency valve is a Cossor 220SG screen-grid type, the detector is a Cossor HL210 and the power valve is a Cossor 220P. The total anode-current consumption was found to be just 12 milliamperes. This is quite reasonable for a three-valve set using a good power valve, but it is advisable to use a double-capacity battery for the high-tension supply.

Before I put this set into operation I examined the controls. These are quite easy to handle. The only part of the operation that is likely to puzzle the beginner is the operation of the two tuning dials. There is some discrepancy between the settings of the aerial tuning and the anode tuning, but once this has been found, by logging one or two of the local stations there is no particular difficulty in bringing in the foreigners.

Between the two tuning dials, which are of the latest slow-motion type, are fixed the subsidiary controls. In the centre of the panel is the on-off switch and on the left of this is the reaction knob. To the left is the knob operating the filament rheostat in the screen-grid valve circuit.

On the left-hand side of the baseboard are the two remaining controls, namely the wave-change switch knob and the knob of the pre-set aerial condenser. There may seem to be rather a lot of controls, but it is difficult to see how the number could be reduced without loss of efficiency.

Personally, I prefer the flexibility of the controls on this set to the greater apparent convenience of some other three-valvers.

On test in the south-west of London, the new Cossor set put up a very satisfying show. The sensitivity shows how good are the new valves.

This is how the home stations came in during a daylight test:—

North Regional at 70 degrees on the left and 75 degrees on the right-hand dial, Midland Regional at 56 and 64 degrees, London Regional at 50 and 56 degrees, and London National at 25 and 30 degrees.

These readings show the discrepancy between the two dials, but of course, this varies with every aerial to which the set is connected.

Many Continental stations were heard after dark. The strength of these stations convinced me that during the winter months the Cossor set will be able to provide a log of at least 30 stations at full loud-speaker strength.

The selectivity of the set depends to some extent on the setting of the pre-set aerial condenser. With this condenser at its half-way position it is possible to cut out Brookmans Park stations within 8 degrees, without losing much in the way of signal strength when listening to foreign stations.

Finally, I must say that this kit is a worthy successor to the long line of Cossor kits that has been produced for the constructor by A. C. Cossor Ltd.

SET TESTER.

"SIMPLE TUNING CIRCUITS"

(Continued from page 828)

an aerial and earth across the coil and condenser is to increase the wavelength, due to the inductance and capacity of the aerial system.

In most of the plug-in coil ranges, the smallest coil is a No. 25 and the largest is a No. 300. The intermediate coils are usually Nos. 35, 40, 50, 60, 75, 100, 125, 150, 200, 250. With a .0005-microfarad condenser this range will cover all wavelengths between 150 and 2,000 metres.

Fig. 1 shows the usual form of a plug-in coil and next to it is shown its circuit symbol. Note that the two coil ends are taken to a plug-and-socket arrangement. Fig. 2 shows a typical condenser of the .0005-microfarad capacity we have mentioned so often in this article. Note its circuit symbol on the right. By the way, for short-wave work, tuning from say 20 to 100 metres, we usually use a much smaller maximum capacity, either .00015 microfarad, or at the most .00025 microfarad.

Fig. 3 shows the simplest possible tuning circuit, comprising a plug-in coil connected across a .0005-microfarad variable condenser. This is not much use in these days of ether congestion, so next week I will show some very effective plug-in coil circuits that will serve as the basis for experiment. There is still a lot to learn about these circuits!

HOTSPOT.

The luxury of Columbia at new 'economy' prices •

Model 352

The **ULTRA MODERN**
4 Valve receiver
23 GNS

With moving coil speaker.



A long distance high power set. One knob tunes 3 ganged condensers. Field-excited moving coil speaker. Mains aerial attachment. Provision for attaching gramophone pick-up and additional speaker. Walnut Cabinet. For A.C. or D.C. Mains.

Britain's answer to foreign competition lies in these two instruments. This 4-valve radio will give a far more satisfactory performance, and the tone is incomparably better. The Radio-Graphophone brings Columbia luxury within reach of all.

You may test either of these models in your home, free and without obligation, by sending a postcard to Columbia, 99, Clerkenwell Road, London, E.C.1.

Model 602

The latest 3 valve circuit (2 screen grid.) Band pass tuning. Illuminated tuning scale marked in wavelengths. Mains excited moving coil Speaker. Electric motor. Auto Stop. Dark Oak Cabinet. For A.C. or D.C. Mains.



32
GNS



Model 602

MAKING THE MOST OF REACTION

By J. H. REYNER, B.Sc., A.M.I.E.E.

SOME people still cling to the idea that reaction is an evil and that radio would be much better without it. Now that we are able to obtain a stage gain of anything from 40 to 80 in quite ordinary practice, the purists suggest that reaction is a retrograde step.

In point of fact, reaction serves as a very useful arrangement for levelling the sensitivity of a receiver. As one goes from the lower to the higher wavelengths it is nearly always found that the sensitivity falls off. This is an inherent defect of the tuning circuit as we use it to-day, for the voltage

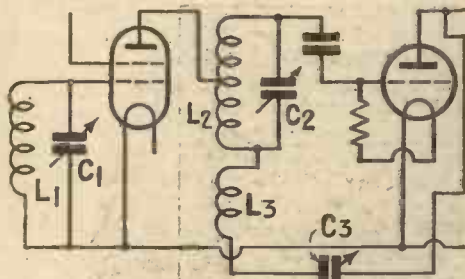

Fig. 1. Coupling between L_1 , C_1 and L_2 , C_2 will cause the screen-grid valve to oscillate before the detector

developed across the circuit depends upon the capacity, and falls off considerably if the capacity is increased. Since our ordinary tuning arrangement consists of a variable condenser connected across a fixed coil, it will be clear that, going from the bottom to the top of the scale, we are using more and more capacity all the time and, therefore, obtaining less and less sensitivity.

In a well-designed receiver this variation in sensitivity need not be unduly great, and, of course, if one goes to sufficient trouble it is quite practicable to use constant-coupled arrangements whereby the effective aerial or anode tap is made to depend upon the position of the tuning condenser, so that more energy is introduced into the circuit at the top of the scale to compensate for the falling off in sensitivity which would otherwise be obtained.

Reaction Control

For all ordinary purposes, however, the provision of one small extra control in the form of a reaction condenser overcomes all the difficulties, provided that the set is soundly designed in the first place. If the high-frequency amplification is a real factor, so that the set is quite lively without any reaction at all, then the reaction control may be used to increase the amplification at the higher wavelengths and maintain the sensitivity of the set at an even level throughout. Such a use as this is quite legitimate and need involve no loss of quality, because it is not necessary to force the reaction in order to hear a station—or, at least, it should not be.

Therefore, most people to-day accept reaction as a useful accessory, and this being the case it behoves us to find how we can make the best use of the effect. Reaction, of course, consists in feeding

back a small amount of energy from the anode circuit of a valve (usually the detector valve) to the grid circuit of the same or preceding valve. If this energy feedback is in the right direction, voltages will be induced in the same direction as the signal at any instant, and the signal strength will, therefore, be increased. If the reaction is too great, the increase in signal is so large that continuous oscillation sets in, and, of course, all reaction must be employed below this oscillating point if satisfactory results are to be obtained.

Despite the apparent simplicity of this process, there is no doubt that in some sets the reaction control is more effective than others. We all know that pleasant feeling where increasing the reaction gradually strengthens the signal without any alteration in the tune, and when the limit is reached the set gradually slides into oscillation. We can, if we like, leave the set trembling on the verge of oscillation. Quality will be badly distorted, but occasionally we are prepared to put up with this for some special purpose, and it is very useful to have a set which will behave in this manner when occasion demands.

Oscillation "Plop"

Compare this with the other type of set, apparently the same in general construction, but quite different in performance. On increasing the reaction control, very little alteration in signal strength appears to take place. In some cases the signal strength goes down until we retune on the main dial, indicating that the reaction and the tuning controls are not independent. Finally, as we continue to increase the reaction, we find that the set bursts into oscillation with a "plop." The increase in signal strength just before the oscillation point was not by any means as great as we should have liked, and in order to stop the oscillation we have to move the reaction control so far back that we are pretty well where we started.

The use of a reaction control like this is a work of art. We have to gauge exactly where the oscillation point is coming, and adjust the receiver just a little below this point, hoping all the time that it will not jump into oscillation. Any real long-distance reception is quite impossible under these conditions.

We should all like the first type of set, but we do not always know how to obtain the particular smooth reaction we wish to acquire. As a matter of fact, there are numerous little effects which all help, and we can only refer to a few of the principal ones in the present article.

The first point is that the reaction control must feed back energy in the right relationship. It is not sufficient that it should be in the correct direction, but the voltage fed back should coincide as nearly as possible with the grid voltage already existing in the set. This is obtained by using a small reaction coil and a relatively large condenser. Generally speaking, the use of

a .0001 reaction condenser is the smallest that should be permitted, and where circumstances will allow the use of a .0002 or .0003 is preferable. An arrangement such as this also overcomes a tendency to interaction between the tuning and reaction circuits already discussed.

Unstable H.F. Stages

A second feature, more often found in connection with high-frequency receivers, is that of instability in the H.F. stage. With no reaction present the receiver may be quite stable, but it must not be forgotten that there is a reaction effect existing around the high-frequency valve, whether this is of the neutralised variety or the more modern screen-grid variety. Any excessive transfer of energy from the anode to the grid circuit of the valve will result in a reaction effect, either positive or negative.

If the former is the case, so that the feed-back round the H.F. valve is in such a direction as to cause oscillation, the receiver has an inherent tendency to instability and the application of reaction causes the high-frequency circuit to become unstable before the detector circuit.

It is easy to see how this happens. We have a certain voltage in the anode circuit of the H.F. valve, and this is forcing back a certain amount of energy, through stray couplings, through the valve or by feed-back through the battery, so that the circuit, although stable, is tending towards oscillation. With the normal conditions no oscillation sets in, but when we commence to apply reaction around the detector valve we automatically increase the voltage in the grid circuit of the detector valve. This, however, is the same as the anode

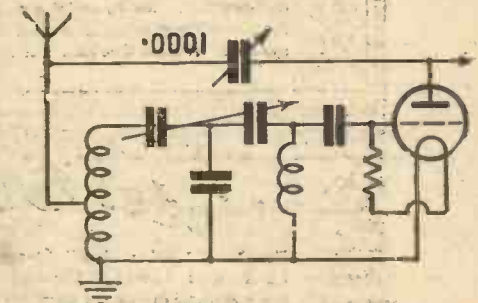

Fig. 2. Simple method of obtaining reaction with a band-pass filter

circuit of the H.F. valve, and therefore we increase the voltage on the anode.

This causes an increased feedback in the H.F. stage, and it is quite possible that this high-frequency circuit will start to oscillate before the full reaction has been applied to the detector. It will be clear that there are two disadvantages in this procedure. In the first place, we cannot obtain the greatest benefit from our reaction control, and, secondly, any self-oscillation of this sort is nearly always "ploppy," the circuit slipping into oscillation suddenly. As often as not there is backlash present, so that in

(Continued on page 849)

again

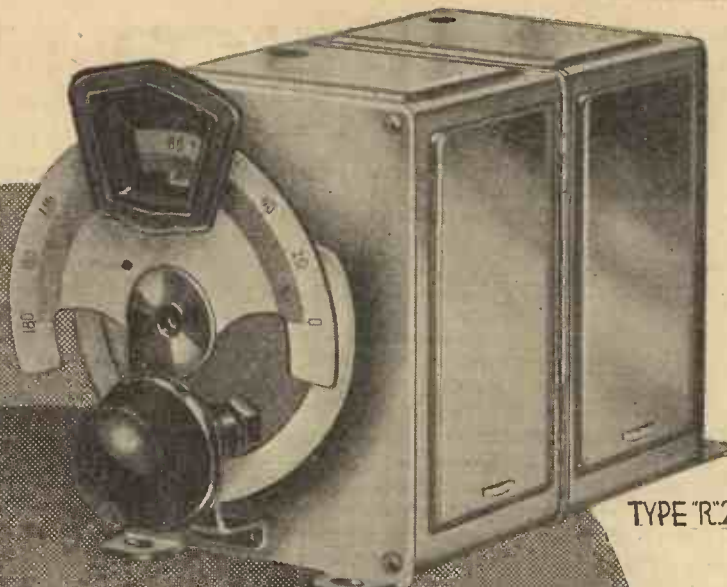

TYPE "R"2.



and again!



TYPE "R"1.

J.B. Precision Instruments, chosen for still another Star Circuit—this time the Amateur Wireless "Britain's Super."

The J.B. "R" type Gang Condensers specified are the very latest in tuning devices, thoroughly shielded and enclosed, with neat clip-on screens to every stage. Very easily fitted, because only *round* holes need be cut in panel.

There are Trimmers (for adjustment once only) in each stage. A Vernier Disc Drive, scaled from 0 to 180 with a neat bakelite panel plate, is supplied as standard.

Start building "Britain's Super" to-day, and build for best results by following the lead of the designers.

Use J.B. Gang Condensers Type "R"1 12/6. Type "R"2 21/-.

USED AND SPECIFIED IN "BRITAIN'S SUPER"

WE TEST FOR YOU

A weekly review of
new components



and tests of
apparatus.

Conducted by J. H. REYNER, B.Sc., A.M.I.E.E.

R.I. Dux Transformer

AN interesting component which we have received for test is the new R.I. Dux transformer. This transformer follows the usual R.I. practice as regards general appearance, being housed in a neat maroon-coloured bakelite casing, on which the connections are clearly indicated. The



R.I. L.F. transformer

overall dimensions are $3\frac{3}{8}$ by 2 by $2\frac{1}{2}$ in.

On test the transformer gave a distinctly good account of itself. When used in conjunction with a valve of the L210 type an amplification of 40 to 50 times can be expected from a single stage.

A measurement of the inductance with D.C. in the primary was made. With no D.C. the inductance was approximately 33 henries, this value falling to about 20 henries with 5 milliamperes.

The transformer is marketed at the very low price of 6s. 9d. and this fact, coupled with the fact of its good performance, should make it a very attractive proposition to all constructors.

The Screw-Grip

A HANDY little gadget which we have received for report this week is the "Screw-Grip." This is a small attachment for fitting to any size screw-driver to facilitate the driving home of screws. Anyone who has done any construction work will realise its value as an aid to placing of the numerous screws required in the construction of a receiver in their correct positions and having placed them, to keep them there until firmly held by the material into which they are being screwed. This little attachment greatly facilitates this operation by firmly gripping the screw as long as required.

The Grip consists of a piece of coil spring about $1\frac{1}{2}$ in. in length which is placed over

the end of the screw-driver. At one end of the spring the last two coils are flattened in order to form a friction grip on the shank of the driver. At the other end, the wire of the spring is bent so as to form a hook, which fits around the screw just under the head.

In order to use the Grip, the screw is placed in the hook and the spring extended slightly so that the blade of the driver can slip into the slot on the head of the screw, the latter being now held quite firmly. Having started the screw in its required position it is a simple matter to release it from the Grip, when it can be screwed right home in the usual way. This little gadget retails at the modest price of 6d. It is marketed by the Screw-Grip Co., 105 Osborne Road, Romford, Essex.

Ripaults' Flex

WE were very interested to receive from Messrs. Ripaults, Ltd., a sample of their red and black flexible wire for test. We have long been of the opinion that quite a large percentage of the flex sold to-day is of a very poor quality. It need hardly be pointed out that, as in many cases these flexibles have to carry quite large voltages, they should be of a high grade. Even a small permanent leak across a high-tension battery will very considerably reduce its life, while in the event of a direct short circuit, the battery will be ruined. In the case of eliminator apparatus, the voltages at the moment of switching on are sometimes very much higher than the steady values, and this may easily cause breakdowns if a poor quality flex is being used. Another position in which flex is almost universally employed is that between the loud-speaker and the receiver. If the speaker is of a high impedance type, quite large voltages are developed across it, and with poor flex appreciable leakage can occur, and even complete breakdown.

Many other cases might be cited, but in every one the use of a poor quality flex is to be very strongly deprecated, the very small saving in money so effected being far more apparent than real. The sample of flex sent by Messrs. Ripaults is of a very high

grade and is suitable for use in all cases. This flex is sold from branded spools, so that all customers can see the make and the price of flexible being purchased.

Readi-Rad Super-het Choke

AN interesting high-frequency choke which we have tested this week is that marketed by Messrs. Ready Radio Ltd.,



The new H.F. choke produced by Readi-Rad for super-hets



intended for use in the long-wave section of the usual type of super-heterodyne receiver.

At the present time the majority of super-heterodyne intermediate-frequency amplifiers work at a frequency of approximately 120 kilocycles, which is well above the working range of the normal H.F. choke, which is designed to be efficient up to approximately 2,000 metres, after which the performance in the majority of cases falls off rapidly. The Ready Radio choke has been designed to work satisfactorily at this lower frequency.

The choke is of usual construction, an ebonite former being used, having twelve slots into which the windings are placed. The former is mounted on a small moulded bakelite base which also carries one terminal, the other being at the top of the former itself. A complete test in accordance with our usual practice was conducted on the choke, and the results obtained indicate that the choke is quite satisfactory up to approximately 2,800 metres, but that the performance begins to fall off somewhat rapidly after 3,000 metres.

The performance factor from 1,500 metres up to 2,200 metres is practically 100 per cent, while at 2,500 metres, i.e., 120 kilocycles, it is 94 per cent. The self inductance is approximately 174,000 microhenries, the self capacity approximately 5 micro-microfarads, and the resistance is 650 ohms. The choke retails at 5s. 6d.

Make the Most of Your Home Radio!

See the special feature in next week's issue. Make sure of your copy now by placing an order with the newsagent. This new feature will create a big demand.



This machine-made dry battery lives longest

You expect an H.T. dry Battery to do its job without supervision. You expect it to give long service. Then buy the battery that cannot go wrong; that is machine-made and machine-tested. This illustration shows the carbons around which has been moulded by machinery a measured quantity of depolarizer. No defective part, no weak cell can ever get into a FULLER 'Super' dry Battery. That is why it gives exactly the power it is labelled to give. That is why it outlasts other batteries and improves your wireless reception the moment it is installed. Fit a FULLER 'Super' and your wireless will take a new lease of life.

F.1.	60 VOLTS	—	7/5
F.2.	66 ..	—	7/11
F.3.	99 ..	—	12/4
F.4.	108 ..	—	13/9
F.5.	120 ..	—	15/3

Full List of other types and sizes with names of Local depots on application.

FULLER
'SUPER' DRY BATTERY
EMISSION UP TO 20 MILLIAMPS

Visit us at The Edinburgh Radio Exhibition and The Motor Show, Stand No. 316, National Hall Gallery.

FULLER ACCUMULATOR CO. (1926) LTD., CHADWELL HEATH, ESSEX
Telephone: Seven Kings 1200. Telegrams: Fuller, Chadwell Heath.
Contractors to British and Overseas Government Departments, Railways, etc.

To Ensure Speedy Delivery, Mention "A.W." to Advertisers

A LITTLE GIFT OF WIRELESS

"**JACK!**" Angela rushed into the sitting-room, treading heavily on my outstretched toes and startling the cat into a momentary display of feline hysterics. A sheet of note-paper waved under my nose.

"It's a letter from Uncle Horace!" Angela announced dramatically.

"Is that sufficient reason for grinding my toes into the carpet and disorganising the nervous system of a dumb animal?" I inquired coldly, nursing my crushed member.

"But, Jack, Uncle's coming, and he's bringing a wireless set 'cause he knows we haven't one," interrupted Angela all in one breath.

"A wireless set?" I repeated, just to make sure.

Angela handed me the letter and there it was in black and white.

"I've always liked your Uncle Horace," I murmured feelingly, then with a surge of energy, "Well, if we're going to have a wireless, I'd better see about the aerial and so on. I'll soon fix it up myself."

It was only after the aerial pole had arrived next day that I had qualms. Our garden is by no means suitable for Swedish drill with a twenty-five-foot mast.

However, I dug a nice deep hole and just as I stood back with my hands on hips and a kink in my back, Angela came out and said she had specially reserved that corner for next year's radishes and we certainly couldn't have the pole there.

I gazed at her.
 "No doubt you mean well, Angela," I remarked cuttingly at last. "But I have spent thirty minutes in digging that hole and, furthermore, a few wireless waves will liven up your radishes. Just think how they'll enjoy hearing the latest hits. Soon someone will write a song called 'Can a Radish Blow It's Nosie?' and that will be—"

"Oh, do stop talking nonsense, and fill up that wretched hole!" snapped Angela. "We'll have the aerial over here."

So, under protest, I dug another hole and lowered the mast into it. At least that was the idea. But a merry tinkle of glass from Jones' hothouse next door warned me that, as Euclid should have said, any twenty-five-foot length has two ends which are not less than twenty-five feet apart, each to each.

At any rate, Jones was annoyed about his hothouse and so was Brown, our other neighbour, when by sheer misadventure, I brought down his aerial wire. But it really was unfortunate that whilst placating Jones, my irresponsible pole should shatter Brown's back-room window, also.

However, in time the mast was erected for better or for worse, and the wire swung gaily in the breeze. 'Twas a brave victory, dearly won. Our garden was, of course,

a shambles and so in a lesser degree were those of Brown and Jones, though the incoherent rage of their respective owners was, I thought, overdone.

Just then Angela reappeared. "Uncle's come," she said slowly. "Ah!" I exclaimed genially. "And the set? Is it a nice one?"

"It's a beauty," returned Angela queerly. "But—but, Jack, it's a portable!"

There was a considerable pause, then I laughed harshly.

"What a pity we shall have to sell it to pay the neighbours' bill of damages!" I remarked with fierce mirth.

ACOUSTIC SHOCKS

ONE of the many troubles experienced by a wireless operator is that of "acoustic shock" caused by the sudden impact of a strong atmospheric on the aerial, usually when he is straining hard to catch a distant signal. This is often quite sufficient to deafen the unfortunate victim for several seconds. An ingenious safeguard is to use a miniature receiver which fits right into the ear passage. The windings are designed to give the same sensitivity for ordinary speech or morse signals as the standard type of earpiece, but the diaphragm is so small that when a heavy atmospheric comes along it is unable to transmit sufficient energy to cause any appreciable shock to the ear.

B. A. R.

When at the Grimsby fishing grounds, a North of Scotland fishing drifter was last week approached by another vessel with the information that an SOS had been broadcast for a deck-hand on the first ship, whose wife had been taken dangerously ill. The drifter immediately made for Scarborough, and the man was landed there, to make a speedy 300-miles train journey to his home in Peterhead. The vessel for which the distress call was intended did not carry wireless.

STATION IDENTIFICATION

AMATEUR WIRELESS has organised a new service of the greatest importance to all listeners. This Station Identification Service is available for identifying stations from information supplied by readers, and will be conducted by J. Godchaux Abrahams in conjunction with "A.W." The fee is 6d. for identifying any one station, but if three identifications are required at a time the fee is only 1s. A stamped addressed envelope must be enclosed.

Address your inquiry to Station Identification Service, "Amateur Wireless," 58-61 Fetter Lane, E.C.4, and give fullest possible details. State type of set used, date and time when station was heard, wavelength, call or interval signal, and details of any programme heard.

PERSONALITIES IN THE WEEK'S PROGRAMMES

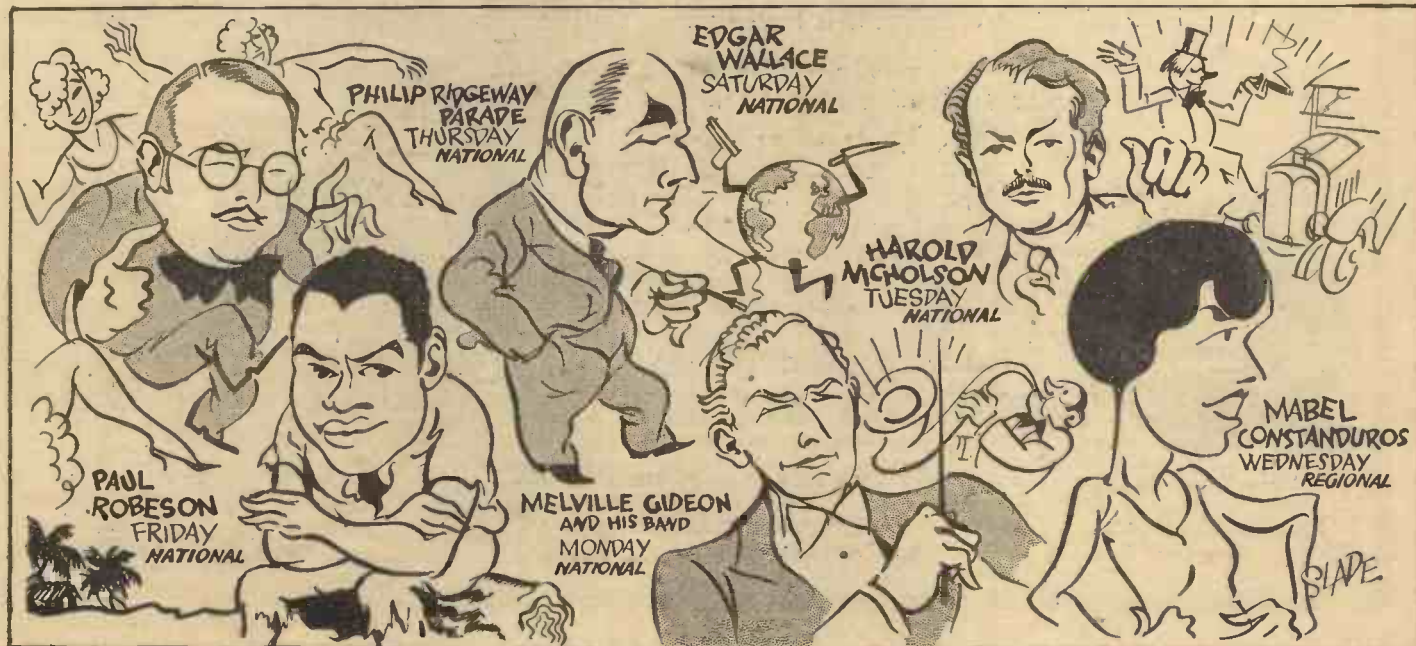

PERMANENT MAGNET EPOCH MOVING-COIL SPEAKERS



EPOCH MODEL A.2 is the climax of years of pioneer experience in scientific acoustics and musical reproduction. This new model carries Epoch's fame for quality reproduction still further. Extremely clear, sharp and brilliant without high-note paper resonance common to moving-coils, making it particularly suitable for the modern Super-Het. Perfect speech correctly pitched. No false tone-colouration. No booming or drumming. See what Mr. J. H. Reyner says in "Amateur Wireless," Oct. 10:—The ideal Speaker for 'Britain's Super.'

THE SPEAKER OF THE SEASON

Cobalt Steel Permanent-Magnet Epoch Moving-Coil Speaker complete with 3-ratio tapped input transformer for Super-Power or Pentode Valves. Fitted with Interchangeable Diaphragm. Ask your Radio Dealer for it. He will gladly demonstrate this or any Epoch Model. If you have any difficulty send for name of nearest dealer or visit our New Demonstration Rooms. Send for our large free art booklet A.S.5.

EPOCH A.2. 63/-
WITH 3-RATIO INPUT TRANSFORMER

EPOCH RADIO MANUFACTURING CO. LTD. EXMOUTH HOUSE, EXMOUTH STREET
At the junction of Farringdon Rd. & Rosebery Av.

DON'T LEAVE IT TO CHANCE.

Protect your S.G. or Pentode Valve with a Belling-Lee Anode Connector. Contacts are safely placed *inside* the insulated cap. Short circuits impossible.

S.G. Safety Anode Connector - - - 6d.
Engraved Wander Plug - - - 2d.
Belling-Lee Battery Cords with engraved Wander Plugs and spring grip Spade Terminals. 5, 6, 7, 8, 9 and 10 way.
54-in. cords 4/- to 6/6. 30-in. cords 2/6 to 5/-.
With fuse, 1/- extra



37 DIFFERENT LETTERINGS.

Belling-Lee Terminal, Type "B," with insulated engraved heads that *can't come off*. 37 different letterings that *don't rub off*. 6d. each.
Type "M" 4½d. (Insulated and non-rotating name.)
Type "R" 3d.

BELLING-LEE TERMINAL MOUNT.
To take two terminals of any type - 8d.



IN "BRITAIN'S SUPER" BELLING-LEE TERMINALS

For perfect design, finish and workmanship Belling-Lee Terminals are unequalled. Chosen by all the leading Wireless Journals and by most manufacturers of sets and battery eliminators. Your choice, too.

BELLING-LEE
FOR EVERY RADIO CONNECTION

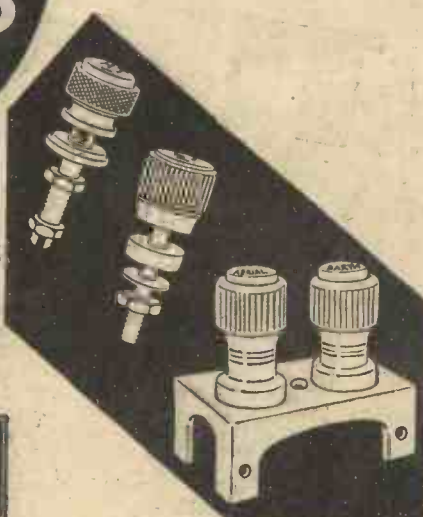

Advt. of Belling & Lee, Ltd., Queensway Works, Ponders End, Middlesex.

To Ensure Speedy Delivery, Mention "A.W." to Advertisers

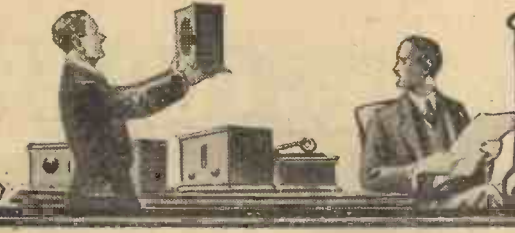

Band-pass Tuning

SIR,—I have constructed a band-pass receiver and have endeavoured to match up the tuning of the band-pass condensers. I get the stations at one definite setting on the condenser at the lower end of the scale, but when I advance the condenser to get stations like North Regional and Brussels No. 1, there appears to be two distinct settings for the condenser knob. These settings are as much as two to five degrees apart. Although I have tried to get them closer I have failed, and now wish to ask your advice in the matter.

W. G. (Maidstone).

It is common to experience a slight double-hump at the top end of the band-pass condenser scale so that what you experience is more or less normal. So long as your condenser readings are definite at one point at the lower settings, you should not worry about them becoming doubled or slightly apart at the upper end of the scale.—Ed.

Aerial Space and Aerials

SIR,—I am afraid I am rather awkwardly situated for erecting a good outdoor aerial. I live in the centre of the town where there is no garden space longer than twelve feet. I use a receiver consisting of a

screen-grid H.F. stage, detector and one L.F., and my results are poor. Is there any way in which I can overcome the poor results due to a poor aerial?

T. W. (London).

Because you have not a large space in which to erect an outdoor aerial, it does not follow that you cannot use an efficient aerial. The horizontal or overhead part of an aerial does not improve the normal reception of stations and, so long as you may erect a good high vertical type aerial, there is nothing to prevent your getting entirely satisfactory reception. See that you use stranded copper wire for your aerial and your earth wires and obtain a low-resistance earth connection and you will not be disappointed. Also, make sure you have plenty of H.T. current available for the working of the valves in your set. Having a high-voltage H.T. battery does not mean there is ample current available. The capacity of the battery governs the amount of current available for working the valves.—Ed.

Adding Pentode to "Century Super"

SIR,—I have constructed the "Century Super" strictly to the blueprint wiring plan and your constructional details and get highly satisfactory results so far as the number of stations are concerned. I would like, however, to use a pentode output

valve to get the more distant stations at a little greater volume. Can you explain how this valve may be connected in circuit?

D. L. (Epsom).

First of all you will need to arrange an output or loud-speaker transformer between the existing output from the receiver and the actual loud-speaker. You should then connect a 10,000-ohm resistance between the positive H.T. terminal on the output transformer and the terminal on the side of the pentode and then join one terminal of a 1-microfarad condenser also to the terminal on the side of the pentode. The other terminal of this condenser should be joined to negative H.T. If you find you get too much high-note reproduction, we suggest you connect a tone-correction circuit across the primary of the loud-speaker transformer.—Ed.

Defective Condensers

SIR,—I have constructed the "Century Super" and fail to obtain reception. I have tested each valve separately in another receiver, and these appear to be working satisfactorily. The coils and frame aerial have been returned to the manufacturers, who report the components in good order. The wiring has been checked and I still do not get even a rushing sound,

(Continued on page 840)



PD220
L 210
P 220
PP 415
PP 430



Here are five new types from the complete new Tungram range: P.D.220—a new and specially designed anti-microphonic detector valve particularly suitable for portables; L210, an entirely new valve, mainly suitable as detector or first L.F. amplifier; P220—a new and extremely efficient low current consumption power valve particularly suitable for portables; PP415—a new multiple grid output valve having the extremely high magnification factor of 60, and can be operated from battery or mains; and PP430—a new and larger multiple grid output valve which gives a much greater power and can be operated with an anode voltage of 300 volts. It is extremely suitable for use on A.C. Mains.

Prices from 5/6 to 19/-. Write to Dept. ST for full particulars of the complete new range.

TUNGSRAM ELECTRIC LAMP WORKS (Gt. Britain) Ltd.
Radio Department, Commerce House, 72 Oxford Street, London, W.1.

Makers of the famous Tungram Electric Lamps
Birmingham, Bristol, Cardiff, Glasgow, Leeds, Manchester, Newcastle, Nottingham, Southampton.
Lamp, Valve, and Glass Factories in Austria, Czechoslovakia, Hungary, Italy, and Poland.
I.F.S. Organisation, Tungram Lamps & Radio, Ltd., 11 Burgh Quay, Dublin.
Tungram Photo Electric Cells: Nava "E" (for scientific measurement), 22 17s. 6d.; Nava "R" red sensitive cell (for colour matching devices), 23 3s. 0d.; Nava "EH" (for talkie work), 23 13s. 6d

REALISM that gives Radio a sparkle of Romance

Once you hear the new MoToR Units or Loudspeakers you will understand why they are acclaimed to be the loudspeaker sensation of the year. Their startling brilliancy of tone, their punch and musical beauty are beyond comparison. Rich rendering of bass notes, bell-like clarity of high notes, give a new interest to listening-in . . . a sparkle of romance to your radio nights entertainments. Three MoToR Units, three corresponding Chassis assemblies and five beautiful Cabinet Speakers are priced to please your purse and to suit the output of your Set.

MoToR SUPER UNIT
TYPE S8 **23/6**
This new MoToR Unit is a revelation in clarity, tone and power. Unapproached for superb workmanship at a more than reasonable price.

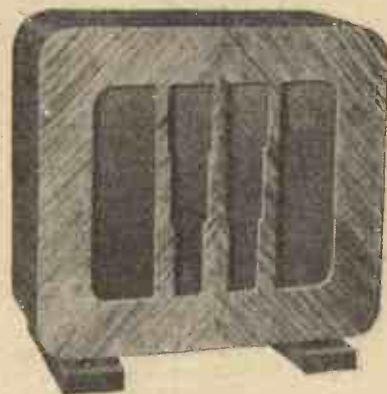

MoToR LOUDSPEAKER "BETA" (Caucasian Walnut) **47/6**

*
"The Speaker is working on a one-valve . . . set and is giving wonderful results. It is flooding the village with music."
J. R. L., Pncraig.
nr. Ross-on-Wye.

TEKADE RADIO & ELECTRIC, LTD.
147, FARRINGDON ROAD, LONDON, E.C.1
Northern Wholesale Distributors: L. REMNER, Ltd., 2, Bradshaw Street, Manchester. Agent for Scotland: R. G. J. NISBET, 132, Renfrew Street, Glasgow, C.2. West of England: BRUNWEC, Ltd., 28, Cumberland Street, St. Paul's, Bristol.



IN RESPONSE TO THOUSANDS OF APPLICATIONS

Now the
Osborn Cabinet for the "V.3 Kit"

(Radio for the Million)



OBTAINABLE FROM ALL DEALERS

Send 3d. in stamps for 56-page illustrated catalogue

CHAS. A. OSBORN DEPT. A. W.

The Regent Works, Arlington St., London, N.1. Telephone: Clerkenwell 5095. And at 21 ESSEX ROAD, ISLINGTON, N.1. (1 min. from the Agricultural Hall). Telephone: Clerkenwell 5634.

PRICE COMPLETE

16/-

This Cabinet is specially constructed for the "V.3 Kit." Polished Black with White, Green and Black futuristic facings. Note how the dials of this particular set fit and harmonise with the coloured facings. Price complete-16/- carriage paid. Make sure it's an Osborn cabinet, with the White, Green and Black facings.

STAND No. 9 BLOCK B
Scottish National Radio Exhibition, Edinburgh, Waverley Market. Nov. 11 - 21

The Outstanding feature of the show



BRITISH GENERAL

BAND PASS 10K.C. TUNING UNIT

At last—a Tuning Unit which gives the separation of 10 Kilocycles as laid down by the International Radio Convention, and yet gives full strength throughout the entire wave-band between 230 and 550 and from 800 to 2,000 metres.

From all dealers of repute or direct from the manufacturers—

BRITISH GENERAL MANUFACTURING CO. Ltd.

Brockley Works, London, S.E.4

PRICE **14/6**
INCLUDING COUPLING CONDENSER

Don't Forget to Say That You Saw it in "A.W."

"READERS' IDEAS AND QUESTIONS"

(Continued from page 838)

which denotes that current is reaching the valves. I am using a wire-wound potentiometer and the spaghetti resistances have been replaced without effect. Can you suggest what might be the cause of non-reception and no sounds of any description?

F. G. (Windsor).

It is more than possible that one of the by-pass condensers between the anode and filament terminals of the second detector valve is faulty and shorting the signals to earth. If you have a milliammeter available you could check the total current consumption of your valves and if this proves to be excessive, you should check for a short circuit of your valves via the anode-circuit components. You should also test your speaker by substitution or, if you are using choke-filter or transformer output to the set, you should test the choke or transformer. A faulty filter circuit condenser could also account for your trouble.—ED.

Moving-coil Speakers

SIR,—Can you explain to me why it is necessary to use an output transformer in conjunction with a moving-coil speaker? I notice that when such a transformer is not actually incorporated in a moving-coil speaker, the manufacturers definitely state that a suitable transformer must be used.

T. F. (Winchester).

First, the large current dissipated by the valve, which has to work a moving-coil speaker, would certainly tend to damage the fine-wire windings of the moving coil. Secondly, the impedance of the valve is usually far greater than the impedance of the speaker

windings and poor volume would be obtained were the speaker not matched up to the output valve. Finally, it is not wise to pass the steady D.C. H.T. current for the valve through the loud-speaker windings as this tends to saturate the speaker windings and gives rise to overloading and distortion.—ED.

Mains Hum

SIR,—I have had an all-mains set for some months and have recently found it necessary to renew my detector. With the new valve the receiver gives rise to considerable mains hum. Replacing the old valve, the set is quiet, but the volume of signals is extremely poor. The new valve is of similar type to the old valve and the makers assure me the valve design has not been altered in any way. Can you suggest what may be accounting for the trouble I am experiencing?

H. S. (Croydon).

We are of the opinion that your new valve has a greater anode-current consumption than your original valve and that the extra current load through the primary of your L.F. transformer is saturating the core of the transformer. We would suggest you get a milliammeter and test the current consumption of your new valve under working conditions. If the current reading exceeds 3 or 4 milliamperes, add a voltage-dropping resistance between the supply and the primary of the transformer. There should also be a 2-microfarad condenser connection between the junction of the resistance and transformer primary and negative H.T.—ED.

Broadcast Criticism

SIR,—As an occasional reader for some years and a regular subscriber since

1930, may I be allowed to congratulate you upon the general excellence of AMATEUR WIRELESS, with special reference to the weekly criticisms by Mr. Whitaker-Wilson, which, in my opinion, is one of "A.W.'s" most interesting features.

It is indeed a pleasure to peruse this page of fearless, yet always fair, criticism of broadcast programmes, with its underlying humour, by an advocate of real music and clean entertainment.

E. K. B. (Worthing).

Syncopation

SIR,—I would like to endorse the remarks of "L. J. L." in a recent issue of "A.W." Mr. Whitaker-Wilson seems to have a marked partiality for Bach, Beethoven, etc., and looks with strong disfavour on syncopation, particularly a syncopated pianist.

Most intelligent people, those with high-brow tendencies, have some small consideration for syncopation generally. Mr. Wilson may be quite a good critic of high-brow stuff, but syncopation is apparently beyond his scope to understand, or at least, try to understand. While I have great admiration for some of the works of the great composers, the cleverness and comparative originality of syncopation is, on many occasions a welcome and delightful change of musical fare.

It is enjoyed by many thousands of people, not always for the melody, but for the novelty of its composition and rendering. Perhaps it may appear nonsensical, but it is always very interesting and novel.

S. C. (Burnham-on-Crouch).

HAVE YOU SEEN THE NEW

HOBBIES

SETS AND CABINETS?



The New Hobbies Three

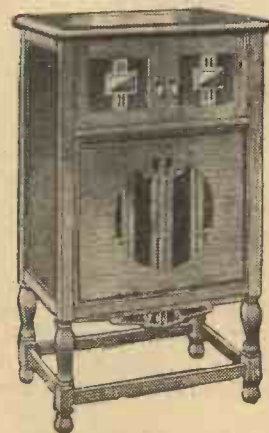

An All-in Cabinet

If you build a set or a cabinet you should know about the accessories that Hobbies supply. Ready-to-make cabinets, a new set, wood for bases, panels, cabinets, etc., hinges, fancy catches, legs, and so on. Every home constructor and woodworker should have the special Radio Catalogue for reference. Free on application as below.

THE HOBBIES THREE

A modern three-valve set specially planned for the beginner. A chart of parts anyone can read; a set of components anyone can afford. You cannot go wrong. A wonderful set for selectivity, volume, and control. Complete chart, prices, and all particulars 6d., post free.

CABINETS & ACCESSORIES

The handsome all-in cabinet can be built in oak by any amateur carpenter. Full-size patterns and working chart, with complete instructions, free with the 1932 Hobbies Catalogue. Also full range of wireless accessories, how to build sets, cabinets, and speakers. Over 300 pages. Of any newsagent, price 9d. Or from Hobbies, as below.

Hobbies own branches in London, Glasgow, Manchester, Birmingham, Sheffield, Leeds, Southampton, Brighton. Or sent by post from Dept. 16, Hobbies, Ltd., Dereham, Norfolk.



Handsome — easily assembled.
JACOBAN OAK CABINET
for
WIRELESS OR RADIO - GRAM

This exceptionally low priced Cabinet is made to suit your special requirements. For Wireless only (Overall size, 32 in. high, 21 in. wide, 14 1/2 in. back to front, panel 20 in. x 8 in.) or for Radio-Gram (Overall size 36 in. high, 21 in. wide, 16 1/2 in. back to front, panel 20 in. x 8 in.) Fret front, constructed from 9 m/m oak faced ply.

Prices	As Wireless Cabinet.	As Radio-gram Cabinet.
R.T.A.	20/-	26/6
Assembled ready for	27/-	34/-
Polishing		
Completely finished	30/-	37/-
and Polished		

Cash with Order. Carriage Paid anywhere in England and Wales

(Dept. A8), A. H. FOSTER & CO.
11 HIGH STREET, ERDINGTON, BIRMINGHAM.

A NEW "AMATEUR WIRELESS" HANDBOOK
The HOW & WHY OF RADIO

By ALAN HUNTER
2/6 NETT.

This book has been expressly written for beginners. It provides a clear conception of the general theory and practice of wireless reception in simple non-technical terms. It has been mainly compiled from the series of articles in "Amateur Wireless"—"The How and Why of Radio"—which proved so popular during the past twelve months.

Of all Newsagents and Booksellers, or 2/9, post free, from "Amateur Wireless," 58/61 Fetter Lane, London, E.C.4

Have you put
your **WIRELESS**
on the **MAINS**
yet?



10/-
DOWN
AND BALANCE
IN EASY
MONTHLY
PAYMENTS

This is
HOW IT IS DONE
Any type of battery set
can be linked up with an
"ATLAS" Unit in a few
moments—then never
again need you use an H.T.
Battery! Attach Unit to
the electric light by plug
provided, fasten leads
from set terminals to the
Unit plugs marked, and
your battery troubles are
over for ever! Each Unit
illustrated also keeps your
L.T. battery charged.

MODEL A.K.22.—1 Tapping 60/80v., 1 Tapping 90/100v., 1 Tapping 120/150v. Output, 12 m/A. Trickle Charger for 2 volt L.T. accumulators : t .3 amps. 77/6; or 10/- down and 9 monthly payments of 8/6 each.



MODEL A.K.260.—1 Tapping 60/80v. (maximum and minimum), 1 Tapping 50/90v. (maximum, medium, and minimum), 1 Tapping 120/150v. Output 20 m/A at 120v. Trickle Charger for 2, 4, and 6-volt L.T. accumulators at .3 amps. 90/-; or 10/- down and 9 monthly payments of 10/- each.

MODEL A.C. 188.—Voted the finest Mains Unit at Olympia, 1930.
2 Variable Tappings 0/100 and 0/120v., 1 Fixed 150v. Output 25 m/A at 150v. Trickle Charger for 2, 4 and 6-volt L.T. accumulators at .5 amps. £6; or 10/- down and 7 monthly payments of 15/6 each and one of 14/6.



All Units Guaranteed for Twelve Months

**"CLARKE'S
ATLAS"
ALL-MAINS UNITS**

Ask your dealer for a demonstration and write for free booklet, "Power from the Mains."

H. CLARKE & CO. (M/CR) LIMITED,
OLD TRAFFORD :: MANCHESTER. Trafford Park 1744.
London Office: Bush House, W.C.2. Temple Bar 7130. ©

When the very best
reproduction is required



Minor D.C. Model
Price £1.11.6.

Minor Permanent
Magnet Model
Price £2.10.0.

1931/2 Senior Per-
manent Magnet
New Reduced
Price £5.12.6.

1931/2 Models.
Senior A.C. Model
New Reduced
Price £7.15.0.

Senior D.C. Model
New Reduced
Price £5.5.0.

... the
expert chooses a **B.T.H.**

First among moving coil
speakers was the R.K. and
still it retains its supremacy.
When really first-class re-
production is required—
the expert chooses an R.K.
When leading radiogram
designers consider the
question of speakers—they
specify an R.K. The very
best of the moving coil
speakers, and at a price
within the reach of all.



**MOVING COIL
REPRODUCER**

(100% BRITISH MADE)

**GREENWICH
TIME FROM THE
MAINS**



Have you seen the Edi-
swan A.C. Mains Elec-
tric Clock? Ask your
radio dealer. Prices
from 45/-

EDISWAN RADIO



THE EDISON SWAN ELECTRIC CO. LTD.
Radio Division: 155 Charing Cross Road, London, W.C.2

W.179



COVENTRY is the fifth town from which a concert will be broadcast in the Midland Towns and Cities series. This broadcast takes place on November 2.

"Songs from the Shows," as a programme title, hints at a lively evening of musical comedy numbers. John Watt is to present such a programme on November 3 for London Regional listeners.

A new programme by the Hulbert Brothers will be heard on the National wavelength on November 9. Jack Hulbert and Cicely Courtneidge will be supported by the Hulbert Chorus, and Jack will act as producer.

Nora Savage, who has appeared in Mr. Charles Brewer's revues, will sing some ballads during a concert given by the Ripley United Band on November 1.

Another symphony concert by the City of Birmingham Orchestra on November 3 brings the first performance in this country of a Fantasia for Pianoforte and Orchestra by Debussy.

On October 31 the Leeds Symphony Concert will be relayed from the Town

Hall, Leeds. The conductor will be Keith Dougläs.

Among the special broadcasts of Cardiff Radio Week is a talk on October 27 by Mr. W. J. Williams, Director of Education for Cardiff, dealing humorously with pitfalls in the pronunciation of Welsh place names.

A Civic Service will be relayed from St. John's Church, Cardiff, on November 1. The bells will be heard for five minutes before the service.

The first concert of "the season of the Cardiff Musical Society will be given in the Park Hall on November 1, relayed from 9.5 to 10 p.m.

On October 26 Mr. L. du Garde Peach will start a short series of talks under the title: "Further Problems of the Amateur Actor."

The City of Birmingham Choir show ambition in tackling for their concert on November 4 Kodaly's "Psalmus Hungaricus," with Frank Titterton as tenor soloist.

On October 27 Mr. Stephen Williams, who is literary editor of the Northern edition of

the Daily Express, will give a talk entitled "The Month in Northern Music." These talks, which will be of monthly occurrence, will review the musical activities in the North.

The Rev. Gwilym Davies will speak during the Welsh Interlude on November 2 on "The World as it Appears from Geneva."

A musical-comedy programme will be given from Cardiff on November 3.

Professor William Rees gives a talk on "Early Coal Mining in Wales" on November 4.

The second orchestral concert in the Dufferin Hall, Bangor, given by the B.B.C. in co-operation with the Bangor Borough Council, will be relayed on November 12.

The cheerful suite, "Children's Games," by Bizet, is to form part of a light orchestral concert by the Belfast Wireless Orchestra on November 10.

The North Staffordshire District Choral Society is giving a concert on October 29.

A new series of regional revues is launched on October 30, when "Regional Revels" will be performed. Last year's revues were very popular and these are claimed to be improvements on their predecessors.

The New London Trio, a combination new to Midland Regional listeners, will broadcast in the Philharmonic Midday Concert from Queen's College, Birmingham.

Professor John Edward Lloyd will give a talk on the Early History of Cardiff on October 26, for West Regional listeners. At 9.50 p.m. on the same day there will be a special concert by well-known Cardiff artistes.

SOVEREIGN OF BRITISH MANUFACTURE
MAKERS OF BETTER RADIO COMPONENTS

ANNOUNCE A NEW CONDENSER FOR MODERN SET BUILDERS



ON SALE AT ALL RADIO DEALERS

Consistent with Sovereign policy of keeping in step with Modern Radio, we have introduced a new type Fixed Condenser specially for the requirements of modern receivers described in this journal: It is housed in compact case of solid moulded bakelite. Prices of this condenser are sensationally low for such a quality component. Obtain this and all other Sovereign lines from your dealer.

Send for our new free catalogue describing the complete range of Sovereign Radio Components. Send direct for name of nearest dealer if you have difficulty in obtaining these.

Tested at 750 V.D.C.		Tested at 1,000 V.D.C.	
.1 mfd.	2/-	.1 mfd.	2/6
.25 mfd.	2/-	.25 mfd.	2/6
.5 mfd.	2/-	.5 mfd.	2/6
1 mfd.	2/3	1 mfd.	3/-
2 mfd.	2/9	2 mfd.	4/6

SOVEREIGN PRODUCTS LTD., 52/54 Rosebery Av., LONDON, E.C.1
 CLERKENWELL 2788.

IT'S **THE LIMIT** YOU ARE WANTING

The PICK-UP with the Adjustable Reed.

Obtainable from Dealers or write direct.

Combination Pick-up and arm, 32/6
 Pick-up only, with side fitting, 21/-

LIMIT RADIO Ltd., 15/29 Windsor St., Essex Road, N.1.

BE SURE OF YOUR **EBONITE**

USE THE FAMOUS **BECOL LOW LOSS FORMER**

TESTED ELECTRICALLY and ensure Satisfaction
 LOOK FOR TRADE-MARK **REDUCED PRICES**

THE BRITISH EBONITE CO., LTD.
 HANWELL, W.

Join the new Radio Cult!



CONVERTS YOUR OLD BATTERY SET INTO AN ALL-MAINS RADIO

COSTS ONLY 1d. A WEEK TO RUN



ANY MODEL DELIVERED TO YOU FOR ONLY 10/6 DOWN Balance in Easy Monthly Payments.

BATTERY ELIMINATORS

"MULTIVO"	"VOLTEX"	"MINIVO"
H.T. OUTPUT: 25 milliamperes. 1 variable tapping - 0/100 volts. 1 tapping .. 50/90 .. 1 tapping .. 150 ..	For indirectly heated valves. H.T. OUTPUT: 25 milliamperes. 1 variable tapping - 0/100 volts. 1 tapping .. 50/90 .. 1 tapping .. 150 ..	H.T. only. OUTPUT: 120 volts at 20 milliamperes. 1 tapping .. 50/90 volt. 1 tapping .. 90/100 .. 1 tapping .. 120/150 ..
Trickle charger for 2-, 4-, and 6-volt accumulator at 5 amps. CASH PRICE £5 5 0	L.T. OUTPUT: 4 volts 4 amps. (Raw A.C.) CASH PRICE £5 5 0	CASH PRICE £3 3 0

ASK YOUR DEALER TO DEMONSTRATE OR WRITE NOW FOR Fully illustrated Catalogue "B" to:

ARTHUR PREEN & CO., LTD.,

GOLDEN SQUARE, PICCADILLY CIRCUS, LONDON, W.1. Crown Works, SOUTHAMPTON
See also page 848.

Tests Everything!
VALVES
FILAMENT
ANODE & GRID
COMPONENTS
AND CIRCUITS
H.T. AND L.T.
MILLIAMPS

AS
INDISPENSABLE
AS A CLOCK

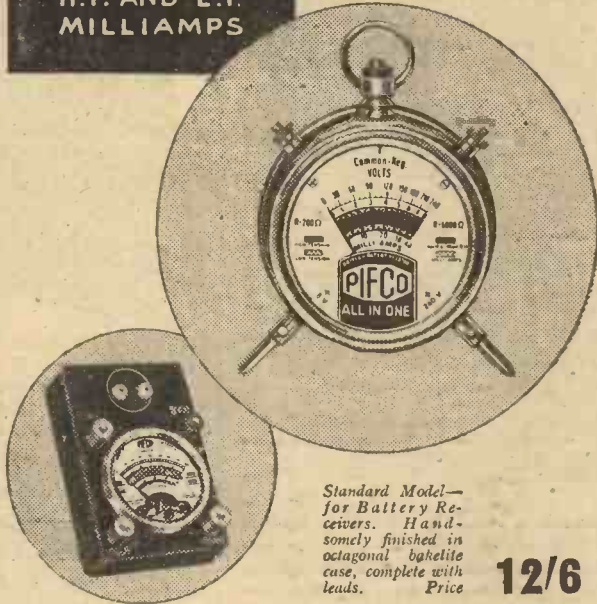

Standard Model—
for Battery Receivers. Hand-
somerly finished in
octagonal bakelite
case, complete with
leads. Price

12/6

De Luxe Model
125,000 ohms Re-
sistance, for Elec-
tric Receivers,
Mains Units, and
Battery-operated
Sets. In maroon,
Bakelite case, com-
plete with cables.
Price

£2:2:0

The innermost problems of your radio can be easily diagnosed—with an "All-in-One" Radiometer. This wonderful little instrument enables you to keep a constant check on the conditions of every part of the set.

Electric Current, Valves, Batteries, Circuits, Components—everything can be kept under perfect supervision, and the slightest variation in performance instantly traced to its source.

The "All-in-One" Radiometer will save its first cost over and over again by safeguarding your set and making you independent of expensive expert assistance.



The Sherlock
Holmes of Radio.

PIFCO
ALL IN ONE
RADIOMETER

Obtainable at all Stores and good class Radio Dealers. Booklet free from Patentees: PIFCO LTD., HIGH STREET, MANCHESTER.

© P.2A

Do you say —

"Watmel" when you buy your components? If you do you are buying All-British components, thoroughly up to date, tested, and guaranteed to do their job perfectly. Take our coils, for instance. These coils have been specially made in view of modern broadcasting conditions. They are designed to such a size as to be most efficient for screening and they are .0005 condenser in width, so as to keep wiring compact and short. All contacts are gold-silver alloy, which does not oxidise. This results in perfect low-resistance contacts and reliable switchings. The screens are aluminium with a spring contact between top and bottom. The windings are arranged for all circuits.

TYPE S.A.1



Screened Aerial Tuner, with aperiodic aerial tapping for high selectivity. The idea of the coil being screened is that no direct pick-up is obtained. This tuner is suitable for straight receivers and is tuned with a .0005 condenser and .0001 for reaction. This tuner can be adapted to any type of receiver.

Price **8/6**

TYPE S.A.2

Similar to the above, but for use when reaction is not to be used.

Price **8/6**

TYPE S.S.3

H.F. Tuner, with reaction winding.

Price **8/6**

TYPE S.S.4

H.F. Tuner, without reaction winding.

Price **8/6**

BAND-PASS AERIAL UNITS

This type of Band-pass Tuner has been designed on new lines. The aerial is aperiodic, coupled to the first tuner by choke feed, and a second band-pass inductively coupled to the first. The two tuners are carefully matched for ganged tuning and mounted on a metal base, with copper earthing strip.

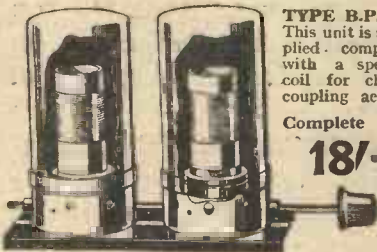

TYPE B.P.A.1
This unit is supplied complete with a special coil for choke coupling aerial.

Complete set,
18/-

TYPE B.P.A.S.2

The same as above, but with extra H.F. Tuner, with reaction winding, suitable for screened-grid H.F. receivers. Complete with choke coupling unit.

Price **28/6**

Write for Component Catalogue.

N.B.—We shall be pleased to supply circuit diagrams free on application.



Watmel

"GETS THE BEST OUT OF ANY SET"

WATMEL WIRELESS CO., LTD.,
Imperial Works, High Street, Edgware.
Telephone: Edgware 0323.
Trade Inquiries Invited.

CABINETS FOR "BRITAIN'S SUPER"

TWO specially attractive cabinets for Mr. James' new set, "Britain's Super," are being manufactured by Messrs. Peto

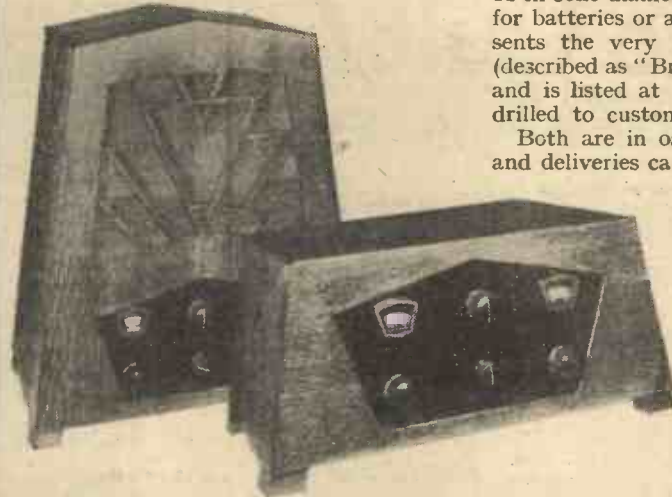

Two Peto-Scott cabinets, referred to in the accompanying text, which have been specially designed for "Britain's Super"

Scott. The first is a table model, described as "Britain's Super" Popular Cabinet, with

a modern vignettted front, ebonised feet and removable back, listed at 19s. 6d.

The other cabinet permits the set, speaker and power pack to be assembled in self-contained style. The speaker compartment will take any speaker up to a 12-in cone diameter and a shelf is provided for batteries or an eliminator. This represents the very latest in cabinet designs (described as "Britain's Super" Console) and is listed at 35s. complete with baffle drilled to customer's requirements.

Both are in oak, hard french polished, and deliveries can be made from stock.

Listeners who may have missed the first of Mr. J. M. Duthie's talks on Scottish Country Dancing will be able to catch up on the second, which will be given on October 28.

From time to time licence offenders are brought before the Scottish courts, but fines still show a remarkable disparity in different localities. The latest conviction at Edinburgh, for example, only brought a penalty of 10s.

THE MICROBOX

THE new pick-up invented by S. G. Brown gives practically the same effect as an electric gramophone amplifier without the use of valves. Its action depends upon the use of a differential microphone operated by the record needle and energised through a centre-tapped transformer from a 10-volt accumulator. The current passed is approximately half an ampere, or a power consumption of 5 watts, which gives ample volume to fill any ordinary room. The relatively high battery voltage is, however, found to be somewhat of a drawback in actual practice.

Two one-act plays, *Sacrifice* and *Coming Events*, will be broadcast from Belfast on October 31.

The Radio Ball organised by the Cardiff wireless traders is being held at the City Hall on October 30. The Ball includes a cabaret which will be broadcast at 10.30 p.m. and dance music by Stanley C. Mills and the New Theatre Embassy Orchestra will also be relayed from 11 to 11.30 p.m.

Work on the new wireless station at Rungally, near Cupar, Fifeshire, is to begin next month. The contractors are to work to a time schedule of 35 weeks, and the cost of the station buildings is estimated at about £10,000.

M. B.

BATTERY SETS MADE

ALL-ELECTRIC

FOR **9/2**

and 11 payments of 8/8 or

CASH PRICE £4:15:0

TYPE G.B.1

H.T. 150 v. at 15m/a. or 120 v. at 20 m/a. Also S.G. and Det. Tappings.

G.B. 3 Tappings up to 12 v. Independent of H.T.

L.T. 2, 4 or 6 v. Trickle Charger.

Similar to above but larger output.

—**TYPE G.B.3**

TANNOY mains units incorporate independent G.B. Pat. No. 353375.

Write for particulars

TANNOY
PRODUCTS

Dalton St. :: West Norwood



Postcard Radio Literature

GET THESE CATALOGUES FREE.

Here "Observer" reviews the latest booklets and folders issued by well-known manufacturers. If you want copies of any or all of them FREE OF CHARGE, just send a postcard giving the index numbers of the catalogues required (shown at the end of each paragraph) to "Postcard Radio Literature," "AMATEUR WIRELESS," 58-61, Fetter Lane, E.C.4. "Observer" will see that you get all the literature you desire.

A Burton "Three"

BURTON have just sent me a blueprint giving full constructional details for making up a good straight three-valver, the total cost of which, with valves, is £4 12s. 6d.

590

New Mains Components

From Tunewell comes a useful booklet of eliminators, mains unit components and wire-wound resistances, including the new wire-wound spaghetthis, which cost from 9d. upwards only.

591

A Ferranti Inductor

A Ferranti inductor speaker chassis for only £3 10s. is too good to be missed, particularly as it is claimed to have a reproduction range of from 50 cycles to 6,000. There is a leaflet, W552, describing this.

592

A Good Unit

I have just been looking at one of the new very low priced speaker units produced by Messrs. J. & H. Walter, Ltd. I advise anyone who is in doubt about the efficiency of an existing speaker to write for literature describing this new unit, which is not only cheap but appears to be a very sound electrical job.

593

A Lissen Bandpass "Three"

I am interested to see that Lissen have gone in for bandpassing and have brought out a highly selective three-valver having bandpass tuning with one-knob control.

594

Igranic Rheostats

Wire-wound rheostats and potentiometers for really heavy work are made by Igranic and are described in the new leaflet 6568. Wire-wound resistances to carry 2.5 amperes are available and the 400-ohm .1 ampere potentiometer should be useful in heavy-duty circuits.

595

Good Connections

Some novel little plugs and sockets with patent spring grips are in the new Gripso range. Gripso also make good indicating switches, earthing clips and other useful small parts. These are all described in the new eight-page booklet.

596

Oldham H.T.'s

From Oldham comes a folder giving voltages, dimensions and prices of standard, double and triple H.T. batteries and grid-bias batteries.

597

OBSERVER.

New Times Sales Co

We can supply any accessory advertised in "Amateur Wireless" on EASY TERMS. Send us your next order. We guarantee you every satisfaction.

ORDER THE NEWEST IN RADIO ON THE EASIEST OF EASY TERMS

MANUFACTURERS' KITS

10/- DOWN AND 11 MONTHLY PAYMENTS OF 10/10
V3 RADIO FOR THE MILLION

Screened-grid, Detector, and Power. With valves, less Cabinet. CASH PRICE **£5.17.6**

COSSOR 234 EMPIRE MELODY MAKER

Screened-grid, Detector, and Power. With valves and cabinet. CASH PRICE **£6 15s. 0d.** 10/-
Balance in 11 monthly payments of 12/6. WITH ORDER

MULLARD 3 1932 TYPE

Screened-grid, Detector, and Pentode. With valves less cabinet. CASH PRICE **£6 10s. 0d.** 11/11
Balance in 11 monthly payments of 11/11. WITH ORDER

OSRAM NEW MUSIC MAGNET 4

Two Screened-grid, Detector, and Power. With valves and cabinet. CASH PRICE **£10 15s. 0d.** 19/8
Balance in 11 monthly payments of 19/8. WITH ORDER

SIX-SIXTY CHASSIKIT BATTERY MODEL

Complete three gang band-pass tuning, S.G., Detector and Pentode. With valves less cabinet. CASH PRICE **£6 17s. 6d.** 12/7
Balance in 11 monthly payments of 12/7. WITH ORDER

SIX-SIXTY CHASSIKIT A.C. MODEL

Complete as above with A.C. Mains Valves. With valves less cabinet. CASH PRICE **£7 6s. 6d.** 13/5
Balance in 11 monthly payments of 13/5. WITH ORDER

ATLAS A.C. ELIMINATOR TYPE A.C.244.

Three tappings, S.G., Detector, and Power. Output, 120 volts at 20 m/a. CASH PRICE **£2 19s. 6d.** 5/6
Balance in 11 monthly payments of 5/6. order

EKCO K.18 COMBINED H.T. ELIMINATOR AND L.T. TRICKLE CHARGER.

Delivers 18 m/a, and suitable for 1- to 5-valve sets. S.G., 50/80 volts, 120/150. Charges at .25 amp. at 2, 4, or 6 volts. A.C. Mains. CASH PRICE **£4 12s. 6d.** 8/6
Balance in 11 monthly payments of 8/6. order

REGENTONE ELIMINATOR, TYPE W.1.F.

Three tappings, S.G., Detector, and Power. Output 120 volts at 12 m/a. A.C. Mains. CASH PRICE **£2 7s. 6d.** 8/4
Balance in 5 monthly payments of 8/4. order

EKCO H.T. UNIT. TYPE A.C.25.

For multi-valve sets requiring up to 25 m/a. 3 tappings. S.G., detector and 120/150 volts. For A.C. Mains. Cash or C.O.D. Price **£3 17s. 6d.** 7/1
Balance in 11 monthly payments of 7/1. order

HEYBERD H.T. UNIT—"D" MINOR

Output 120v. at 12 m/a—Tapped at 80v., 100v., and 120v. Westinghouse rectification. A.C. Mains. CASH PRICE **£2 17s. 6d.** 5/4
Balance in 11 monthly payments of 5/4. order

EXIDE 120-VOLT TYPE W.H., H.T. ACCUMULATOR, in crates.

CASH PRICE **£4 13s. 0d.** 8/6
Balance in 11 monthly payments of 8/6. order

AMPLION MOVING-COIL SPEAKER, TYPE M.C.6. Permanent magnet, with output transformer. Complete. Cash price **£3 7s. 6d.** With 6/2
Balance in 11 monthly payments of 6/2. order

BLUE SPOT PERMANENT MAGNET MOVING-COIL SPEAKER. Complete with input transformer. Cash price **£3 15s. 0d.** With 6/11
Balance in 11 monthly payments of 6/11. order

CELESTION PERMANENT MAGNET MOVING-COIL SPEAKER. Type R.P.M.8, with 8" reinforced diaphragm. Chassis only, without input transformer. Cash Price **£3 10s. 0d.** With 6/5
Balance in 11 monthly payments of 6/5. Order

EPOCH PERMANENT MAGNET MOVING-COIL SPEAKER. Type A.2. Chassis model complete with input transformer. Cash price **£3 3s. 0d.** With 5/9
Balance in 11 monthly payments of 5/9. order

EPOCH J.I. PERMANENT MAGNET MOVING COIL SPEAKER. In Chassis form with multi-ratio input transformer. Cash price **£2 5s. 0d.** With 4/2
Balance in 11 monthly payments of 4/2. order

B.T.H. R.K. MINOR PERMANENT MOVING-COIL SPEAKER. Capable of handling outputs up to 2 watts. Cash price **£2 10s. 0d.** With 6/-
Balance in 8 monthly payments of 6/- order

W.B. PERMANENT MAGNET MOVING-COIL SPEAKER, TYPE P.M.3. With 3 Ratio input transformer. Cash price **£2 12 6** With 5/10
Balance in 9 monthly payments of 5/10. order

W.B. PERMANENT MAGNET MOVING-COIL SPEAKER, TYPE P.M.2. Complete with input transformer. Cash price **£4 5s. 0d.** With 7/10
Balance in 11 monthly payments of 7/10. order

R.&A. "100" PERMANENT MAGNET MOVING COIL REPRODUCER. Complete with tapped Input Transformer. Cash price **£2 17s. 6d.** With 5/4
Balance in 11 monthly payments of 5/4. order

ORMOND PERMANENT MAGNET MOVING-COIL SPEAKER. With input transformer. Cash price **£3 5s. 0d.** With 6/-
Balance in 11 monthly payments of 6/-. order

NEW B.T.H. "SENIOR" PICK-UP AND TONE-ARM. Complete. Cash price **£2 5s. 0d.** With 4/2
Balance in 11 monthly payments of 4/2. order

GARRARD INDUCTION GRAMOPHONE MOTOR MODEL 202. Mounted on 12-inch Nickel Motor Plate with fully automatic electric starting and stopping switch. Cash price **£2 18s. 6d.** With 5/4
Balance in 11 monthly payments of 5/4 only. order

FORMO "MINIVO" MAINS UNIT. For 1-, 2- and 3-valve sets. H.T. Output, 120 Volts at 20 Milliampers. 1 Tapping, 50/90 Volts; 1 Tapping, 90/100 Volts; 1 Tapping, 120/150 Volts. Cash or C.O.D. Price **£3 3s. 0d.** With 5/9
Balance in 11 monthly payments of 5/9. order

ESTABLISHED IN 1924. FIRST WITH EASY TERMS

NEW TIMES SALES CO., 56 LUDGATE HILL, LONDON, E.C.4. Phone: CENTRAL 2716.

(a) Please send me further particulars of.....

(b) I enclose.....s.....d. as first payment for.....

NAME

ADDRESS

A.W. 24/10/31.

CLIX

CONSTRUCTOR'S KIT

A Time and Money Saver for all Set Builders.

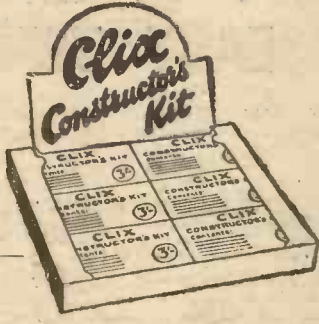

Contents.—2 Spade Terminals engraved L.T.; 2 Plugs and Sockets (A and E); 7 Terminals, H.T., L.T., L.S., 6 Wander Plugs, H.T., and G.B. Value 3/5.

From all dealers or direct.

Price 3/-

Clix Kit for the "OLYMPIAN THREE"

Contains all Clix fittings as specified by "Amateur Wireless."

- 7 Wander Plugs
- 2 Spade Terminals
- 4 Panel Terminals
- 1 S.G. Anode Connector

2/6

All correctly engraved. From all dealers or direct.

What you require for "Britain's Super"

- 2 Panel Terminals
- 2 Spade Terminals
- 8 Wander Plugs

1/10

All engraved to specification.

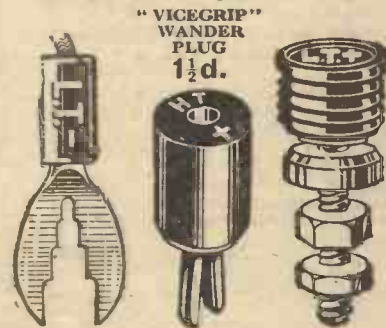

"FR-ALL" SPADE TERMINAL 2d.

"VICEGRIP" WANDER PLUG 1½d.

PANEL TERMINAL 3d.



CLIX VALVEHOLDER.

Type B for baseboard mounting. 2-pin Model with screw terminals 10d. 4-pin Model without screw terminals 8d.

Fully Illustrated Clix Folder "A" Free.

Cheapest PERFECT Contact

Lectro Linx, Limited - 254, Vauxhall Bridge Road, S.W.1

NEW PARTS FOR THE "SUPER"

"BRITAIN'S SUPER" builders will be pleased to know that, simple as is the construction of this new outfit, it is rendered even more straightforward by the introduction, by Wright & Weaire, Ltd., of a special chassis. This consists of a stout ebonite base on which are mounted the necessary valve and coil holders. Part of the wiring is done, too, by means of metal links. Where external leads have to be connected soldering tags are provided.

The set is designed to work on an ordinary aerial, of course, and, as first tests show, a short indoor wire is quite satisfactory. Formo have produced the "7 in 1"



Three parts of interest to "Britain's Super" builders. Wearite chassis, Formo aerial and Read-Rad Instamat transformer

indoor aerial, which is suitable for use with the "Super" and can be obtained in a 15-ft. length for 3s. 9d. or in a 20-ft. length for 4s. 6d. A special insulation is used in this wire so that it can be strung around a room, without causing serious capacity losses.

In order to keep down the overall cost of "Britain's Super" no output device is incorporated. Users of the set who wish to work it from the mains, or who have speakers with no input choke or transformer, will find a great advantage in the Instamat tapped output transformer produced by Ready Radio, Ltd. Two models are available, the Instamat or Instamat Major. The standard model gives 5 ratios and the Major model 6 ratios, 10 to 1, up to 25 to 1, and has a current carrying capacity of up to 150-milliamperes without core saturation. The standard model costs 27s. 6d. and the Major 37s. 6d.

A "BRITAIN'S SUPER" DEMONSTRATION

SPECIAL demonstrations of "Britain's Super" have been arranged in the Radio Department of Messrs. Selfridge & Co., Ltd., of Oxford Street, London, W., starting on Monday, October 26, and continuing for a week.

Intending constructors should take advantage of this wonderful opportunity to examine the set for themselves and see it demonstrated. Between the hours of 12 and 2, Mr. L. Chapman, of the "A.W." Technical Staff will be in attendance to answer all queries relating to the "Super," while from 5 to 7, Mr. G. P. Kendall, the chief engineer of Messrs. Ready Radio, Ltd., will demonstrate.

Get a Thrill!

BREAK AWAY FROM THE TIES OF ORDINARY BROADCAST AND RECEIVE WORLD-WIDE TRANSMISSIONS DIRECT WITH THIS

No Soldering. No Technical knowledge required.

MODERN SHORT-WAVE ASSEMBLY



Blueprint and full details, 1/- post free

Free from hand capacity. Perfectly smooth reaction. Absolute simplicity in erection and control.

Price for complete assembly, with coils for 15.55 metres ... £3 16 0

(Individual parts obtainable) STRATTON & Co., Ltd., WEBB'S RADIO STORES, Bromsgrove Street, 184 Charing Cross Road, W.C.2, Birmingham. Tel.: Temple Bar 2944.

SCIENTIFIC

AN "EDDYSTONE" PRODUCT.

GIVE YOUR OLD BATTERY SET

a New Lease of Life!

By fitting—



The Philipson SAFETY ALL-POWER UNIT

(Patent No. 353,357 Under Licence)

WESTINGHOUSE RECTIFIERS

H.T. — 3 tappings — 60/75v., 0/120v., 130v., at 20 m.a. Price:

L.T. — 2v., 4v. and 6v. £4. 17. 6

G.B. — 1½v., 4½v. and 10v.

The set itself may be quite good, but it can never give first-class results while subject to a voltage that is never constant and is always decreasing! And then look at all the trouble and expense of new batteries every so often!

Write for details

Made by the makers of "The Safety All Electric Band-Pass 3."

PHILIPSON & CO., LTD. Est. over 60 years ASTLEY BRIDGE, BOLTON.

'Phone: 2038

'Grams: Safety, Bolton.

OUR LISTENING POST

By JAY COOTE

WORK is so far forward on the Prague 120-kilowatt erected at Liblice that every effort is to be made to give it an official send-off on October 28 in order to celebrate the Czecho-Slovak national holiday. In the meantime, although the station is not working regularly at night, you may pick up its transmissions between 9 and 11 a.m. As a matter of fact, the carrier wave can be heard from 5 a.m., but little else. During the day at odd times the Liblice station is brought into action for the broadcast of the Prague studio programme. You may find it necessary to alter your condenser settings slightly, for, with a view to diminishing interference with our North Regional, the wavelength has been raised to 488.6 metres. Referring to settings, by the way, prompts me to draw your attention to this week's revised "Broadcast Telephony." You will find that some slight modifications have been made in the wavelengths of a number of foreign stations in order to secure a better frequency separation. In such cases as Heilsberg, Turin, Tallinn, Hilversum, and others an experimental exchange of wavelengths is being carried out.

Have you recently logged Genoa? It has definitely abandoned its attempts to work in the neighbourhood of Sundsvall and is now settling down on 315.8 metres—a position previously occupied by the now silent Marseilles. It may retain this allotment for a short period; in any case until October 28, when the station is to be promoted to the 10-kilowatt class, but later some modification may be found necessary if there is any interference with the Marseilles temporary station.

News reaches me from Paris that the French *Ministere de l'Interieur* (Home Office), under the call letters FPC (France Police Central), has installed a 2-kilowatt telegraphy and telephony station in the capital. It is destined to work both on long and short waves, and the schedule of transmissions is as follows: At 9 a.m. on 1,050 metres and at 11.45 a.m. and at 5.15 p.m. on 1,140 metres. At 10 a.m. and at 4 p.m. it works on 44.75 metres; at 10.15 a.m. and at 4.15 p.m. on 59 metres; at 10.30 a.m. and at 4.30 p.m. on 84 metres. You will not hear very much more than the call and a few announcements for the present, as the station is still in an experimental stage.

The International Concerts

Most of the International European concerts are well worth hearing, as on these occasions the broadcasting studios, for the benefit of their neighbours, give of their best. As a reminder, you might make a note of November 7, when a number of Continental transmitters are to relay the Lehar concert from Vienna between 7.30 and 9 p.m. On November 10 you will be given an opportunity of listening to Helsinki and two days later to a Jugoslavian contribution by the Philharmonic Orchestra of Zagreb.

During the past week or so the Russians have been brought daily to my notice. On many evenings, from both Moscow and Leningrad, you may hear the calls of Kharkov, Kiev, Odessa, and Nijni Novgorod, and from the nature of the broadcasts I gather that a nightly round of the provincial centres is carried out by the capital studio. Relays from these are made regularly, so if you hear a strange call on the Moscow or Leningrad wavelength you will know that you are not receiving the broadcast direct.

(Continued on page 848)



NEW DARIO RADIO VALVES

with

The Very Steep Slope

Made in one of the most modern factories in the world under a special secret process, Dario valves incorporate the new Radio Micro Dull Emitter Filament which ensures great sensitivity, unequalled performance and utmost current economy.

- DARIO UNIVERSAL BIVOLT - 5/6
- DARIO SUPER H.F. BIVOLT - 5/6
- DARIO SUPER POWER BIVOLT 7/6
- etc., etc.

Also 4 volts and A.C. Mains type.

Write for illustrated folder giving full particulars.

TRANSFORMERS

Dario Transformers are made under a special process of wiring and insulating the different circuits. Notwithstanding their very low price they give marvellous results.

- Ratios 1-3 and 1-5.
- Constructor ... 4/6
- Normal ... 5/-
- Super ... 6/-
- Also available extensive range of Mains Transformers and Filter Chokes.

DARIO SILVER OXIDE CHARGER

The best in the world. Enables you to charge your accumulators in your own home. **17/6**

DARIO SETS

The Dario S.G.3 Battery Type Receiver now reduced to **£5 17s. 6d.** complete with Dario Valves, represents amazing value. Highly sensitive, gives wonderful volume. Renowned for its purity of reception.

The Dario Regional Straight 3 Transportable housed in an attractive modern oak cabinet complete with Dario valves and matched speaker. **£4 17s. 6d.**

Inside frame aerial 10/- extra



do you want your set?

- (1) To enable you to receive stations on the ultra short-wave band?
- (2) To receive stations clearly and distinctly with a frame aerial?
- (3) To present a neat appearance in harmony with its surroundings, at a low cost?

(1) The Eelex Short-wave converter enables you to receive stations on the ultra short-wave band with your present set. It is indispensable inasmuch that it gives you a wide range of programmes on the 16-60 metre band. An additional coil for the 140-190 metre band is available at 5/- extra.

PRICE 60/-
ALL MAINS MODEL 65/-

(2) The Eelex Frame Aerial—originally designed for use with Superhet receivers can be used with or without centre tap. With a definite minimum silent point it is the finest value obtainable.

PRICE 20/-

(3) Anyone can now construct a handsome cabinet the "Byldurone" way. All that is required is a saw, screwdriver, "Byldurone" corner pieces and a supply of 5-ply wood. The finished cabinet can be covered in veneer leather or stained to match the surroundings.

Do not accept substitutes. Investigate for yourself the merits of Eelex Products. See two-page report in "Wireless World," Aug. 5th, 1931.

WRITE FOR LIST B.10.

J. J. EASTICK & SON
EELIX HOUSE,
118 Bunhill Row, London, E.C.1
Metropolitan 03145/6.

"OUR LISTENING POST"

(Continued from page 847)

Although, for reasons of economy, I understand that we are not to expect any dips into the American programmes by our home stations, we shall still be able to obtain them through Continental channels. Berlin, as already stated, intends to tap the National Broadcasting Company's programmes freely and an agreement has now been made for an exchange of entertainments with Radio Paris. The first of these transatlantic relays to France is to take place next month.

Radio Toulouse on Sundays, from 10.45 p.m., may puzzle you with its English announcements if you do not recognise the interval bell-signal. For about an hour the station broadcasts a sponsored transmission of gramophone records. Apparently, on these occasions, as an assistant, Monsieur Jean Roye has secured the services of an Englishman.

Reports on Radio Valencia (Spain) on 268.3 metres are reaching me from many quarters. It is a Union Radio station installed at Villa Nueva del Grao at the mouth of the harbour. Its power is 1 1/2 kilowatts, and according to one of my correspondents, the plant is not that formerly used by Radio Catalana at Barcelona. Whether and whither this was transferred I have not yet been able to find out.

On one evening last week I lost Söttens (Radio Suisse Romande) and particularly noticed that my reception of both Katowice and Midland Regional had greatly improved. A search was made and much to my surprise I picked up the French-Swiss high-power transmitter at full power on about 760 metres, or what I judged to be Geneva's wavelength. That position, barring occasional morse and (temporary?) atmospheric, was a good one and I listened to a complete programme without trouble. I cannot say yet whether the station will continue to broadcast on that wavelength, but it is a corner of the waveband which demands nightly investigation.

More Russian Stations

The new Russian high-power transmitter to which I referred a week or so ago is now going at full blast. It is not Leningrad, as on one occasion I found a broadcast of the opera *Aida*, relayed from the Leningrad Opera House on both 1,000 metres and on just about 900 metres. From the new station the broadcast was received at terrific volume. There have been many rumours lately of the launching of two new Soviet transmitters and, no doubt this is one of them. Moscow Popoff on 1,104 metres can also now be heard fairly well and the Trades' Union station is a certainty from dusk onwards.

Possibly owing to the fact that I heard the new Radio Toulouse testing, I now find the old and weaker plant rather anæmic; during the past ten days the broadcasts from this station have been poor. On the other hand, just below this transmitter you cannot fail to tune in Lvov which, at present, very heavily overshadows the Frenchman. As a relay of the Warsaw programmes it is more reliable than either Katowice or Wilno. It is not that the giant Raszyn station taking the capital programmes is not worth receiving, but that, as a rule, its signals are marred by Eiffel Tower.

When the latter has closed down, Warsaw should be receivable on the simplest of portables; its entertainments are always interesting.

Although Reykjavik is now officially on the air with a full schedule of broadcasts, I am afraid that except in Northern England and Scotland, its reception may remain of a casual character. With regard to Istanbul, a search for this transmission towards 6.30 or 7 p.m. may meet with success, providing conditions are favourable. In my log I find two recent entries with reference to Oriental concerts received at clear but medium loud-speaker strength. The signals suffer from periodical fading.



(INDOOR) (LOW-LOSS)

7 in 1 AERIAL

has eliminated un-
sightly, inefficient and
costly outdoor aerials

LABORATORY TESTS
PROVE 25% INCREASE
IN SIGNAL STRENGTH.

Have you ever considered the fact that aerials are the only remaining parts of modern wireless reception that have lagged behind in the swift development of wireless?

Do not waste any more money on repairing your outdoor aerial. Simply place the FORMO Low-loss Aerial around the picture-rail or other convenient place, and enjoy improved and trouble-free reception of stations you may never have heard before.

PRICES:
15 ft. - 3/9
20 ft. - 4/6



SLOW MOTION CONDENSER

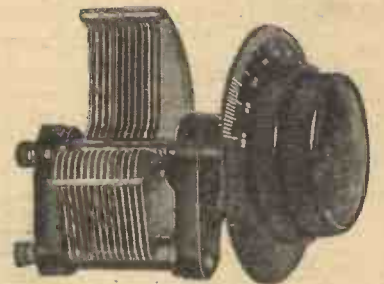

The Formo Company, with their great experience in construction of variable condensers, introduce this new model Fast- and Slow-motion Condenser, confident that this is the highest quality instrument available. The slow-motion drive is silky and permits the tuning of close stations to a degree of accuracy that vastly improves the reception of your set. Other features are the Internal Pigtail, and its small size and light weight. **PRICE 6/-**



Obtainable from all Radio Dealers.

Complete catalogue from:—

ARTHUR PREEN & CO., LTD.

Golden Square, Crown Works,
Piccadilly Circus, London, W.1 Southampton

SEE ALSO PAGE 843

BEWARE THE POWER THIEF

*Is Electrical leakage
robbing you of money
—and the power your
Set needs?*

ELECTRICAL cell to cell leakage has been definitely eliminated. Smooth top H.T. Accumulators with their 10-volt single glass cell provide direct electrical connection between terminals. Thus power leaks away causing serious waste. In the Lively 'O' H.T. Accumulator this cannot happen. Each 2-volt cell is separated from its neighbour by an air-gap. All the power you have paid for is stored up, being released *only* when working your Set—there can be no "falling off" in voltage—your Set gets *all* the power it needs. Write for free booklet—it tells you all about it.

TWO TYPES
Standard 10-volt Unit
(2,750 milliamps)

5/6

Extra large capacity
(5,500 milliamps) per
10-volt Unit

6/9



LIVELY 'O'

H.T. ACCUMULATORS



Advt. of Oldham & Son, Ltd., Denton, Manchester

9254

"MAKING THE MOST OF REACTION"

(Continued from page 832)

order to stop the oscillation we have to reduce the reaction control quite a considerable way, thereby undoing the work we have done.

The remedy for this is to ensure that the high-frequency circuit is absolutely stable first. Make certain that the layout is satisfactory and that there are no stray couplings, that the H.T. supply is well condensed (if necessary, decoupled), and that the wiring is not such as to bring anode and grid leads together. Try the effect of various alterations and you will find, when you have straightened matters up, that the reaction control is now much better. It will cause the signal strength to increase smoothly and progressively, and the whole set will slide gently into oscillation when the critical point is reached.

If the reaction effect on the H.F. valve is negative in tendency, so that it tries to reduce the signal strength instead of increasing it, the reaction effect will still be smooth; but the receiver will not be as lively as it should, and this effect can easily be diagnosed by these symptoms.

Band-pass Reaction

Before leaving the subject, reference may be made to a form of reaction which is very convenient with band-pass filters. It is illustrated in Fig. 2. It is always necessary to couple the feed-back from the anode of the detector to some point in the opposite phase to the grid. If we couple it on to the grid circuit itself the reaction will be reversed, so that it is usual to extend the coil somewhat as shown in Fig. 1, and to couple the reaction circuit on to this extended portion.

In the question of a band-pass filter, however, there is a change in the direction of the voltage at the coupling between the two circuits. Therefore, if we couple our reaction circuit on to the first tuned circuit we have automatically obtained the change of phase we require, and quite smooth reaction is obtainable. It is not usually desirable to couple straight on to the tuned circuit, because this requires a rather small condenser, and we have seen that this is bad. Therefore, couple to a tapping point fairly low down on the coil—the aerial tapping makes a convenient point—and you will find that reaction is much improved.

This form of reaction again can either be smooth or "ploppy." The criterion in this instance, however, is that the two tuned circuits shall both be in tune. Therefore, if the reaction is found to be "ploppy," readjust the trimmers until the circuit is properly tuned up, when it will be found that the reaction will be exceptionally smooth and will cause a gradual slide up to the oscillation point in the best approved manner.

Miss Mary Diana Morgan, the author of *Cindelectra*, has written a fantasy called *The Towers Talk*, which will be broadcast on October 28. It deals with adventures which befall an announcer when he leaves the Cardiff studio after saying, "Good-night, Everybody."



THE PURETONE

An All-British Loud-speaker Unit for

7/6

This is the latest unit and incorporates the most modern and up-to-date improvement.

Every inflexion of tone is brought out to its best in the "Puretone." The light and shades of speech and music are reproduced perfectly. Crackle and distortion are completely absent. True-to-life reproduction is the essence of the "Puretone." It is a loud-speaker unit different both in design and construction to anything else on the market and we guarantee the *Puretone* for one year.

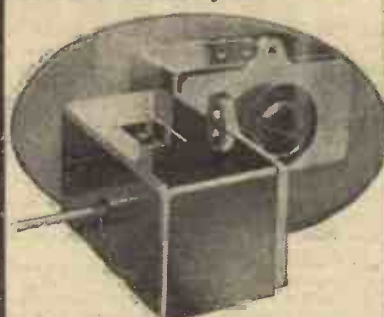

- BRITISH MADE AND GUARANTEED.
- HIGHLY SENSITIVE.
- A VERY TRUE TO LIFE REPRODUCTION.
- VERY ROBUST—NOT A SCREW OR BOLT IN ITS CONSTRUCTION.
- AND ONLY 7/6.

Provisional application patent numbers 18442/31 and 17937/31.

Ask your local dealer to let you hear one. *It's blue!* you can't miss it and "SPEAKS FOR ITSELF."

N.B.—Orders dealt with promptly.

If you have any difficulty in obtaining a unit, write direct to us—giving the name of your local dealer—and we will send you a "Puretone" by return of post.

Trade enquiries invited.

BUY BRITISH COMPONENTS

The **WALTER
PURETONE**
loudspeaker
unit

J. & H. WALTER, LTD.

31a, FARM LANE, FULHAM, S.W.6.

Telephone: Fulham 5645. (M.C.201)

BROADCAST TELEPHONY

Broadcasting Stations classified by country and in order of wavelengths. For the purpose of better comparison, the power indicated is *aerial energy*.

A GOOD JOB!

British Radio Constructors still show their recognition of a good job well done. Since their introduction Benjamin switches and valve-holders have established unrivalled popularity.

They will continue to maintain their sterling quality.

Write for our New 1932 Radio Catalogue—it contains three very interesting and original circuits by a prominent designer.

The Benjamin Electric Ltd.,
Tariff Road, Tottenham, N.17
Tottenham 1600



EASY TERMS

WE SUPPLY ALL GOOD QUALITY RADIO RECEIVERS, COMPONENTS AND ACCESSORIES ON DEFERRED TERMS. WE CARRY ADEQUATE STOCKS AND CAN GIVE PROMPT DELIVERY

NEW HEYBERD A.C. ELIMINATOR KIT C.150.—Complete Kit of Parts for building an H.T. Eliminator, including steel case. Output, 25 m.a., 150 volts, 3 H.T. Tappings, one variable.
Cash Price, £3/15/-

or 7/6 with order and 11 monthly payments of 7/-
12 EXIDE W.H. HIGH-TENSION ACCUMULATORS (120 volts, 5,000 m.a.). Higher voltages if desired.
Cash Price, £3/15/-

or 7/6 with order and 11 monthly payments of 7/-
Carriage charged on all orders from Scotland.

N.K. FARRAND INDUCTOR LOUD-SPEAKER UNIT.—Quality of reproduction almost equal to a moving-coil speaker. Cash Price, £3/10/-

or 5/6 with order and 11 monthly payments of 6/6
SET OF THREE VALVES, S.G., DET. AND POWER, MULLARD OR COSSOR. Cash Price, £1/19/0

or 6/- with order and 7 monthly payments of 5/4
NEW BLUE SPOT 6ER UNIT.—The finest balanced-armature movement on the market. Complete with large Cone and Chassis. Cash Price, £2/10/-

or 5/- with order and 10 monthly payments of 5/-
NEW CELESTION MOVING COIL L.S. UNIT (PERM. MAGNET), with Transformer. Cash Price, £4/5/-

or 13/6 with order and 10 monthly payments of 8/-
Send list of requirements and quotation will be sent by return.

LONDON RADIO SUPPLY CO.
11 Oat Lane, Noble Street, London, E.C.2
Telephone: National 1977

Kilo-Metres	Station and Call Sign	Power (Kw.)	Kilo-Metres	Station and Call Sign	Power (Kw.)	Kilo-Metres	Station and Call Sign	Power (Kw.)
GREAT BRITAIN								
25.53	Chelmsford (G6SW)	16.0	328.2	Grenoble (PTT)	3.0	1,935	Kaunas	7.0
242.3	Belfast	1.2	328.9	Poste Parisien	1.2	NORTH AFRICA		
261.3	London Nat.	68.0	345.2	Strasbourg (PTT)	15.0	364.5	Algiers (PTT)	13.0
288.5	Newcastle	1.2	370.4	Radio LL (Paris)	0.5	416	Radio Maroc (Rabat)	10.0
288.5	Swansea	0.16	447.1	Paris (PTT)	2.0	NORWAY		
288.5	Plymouth	0.16	466	Lyons (PTT)	2.3	235.1	Kristianssand	0.63
288.5	Edinburgh	0.4	1,445.7	Eiffel Tower	15.0	240.2	Stavanger	0.625
288.5	Dundee	0.16	1,724.1	Radio Paris	17.0	364.5	Bergen	1.35
288.5	Bournemouth	1.2	1,724.1	Radio Paris (testing)	85.0	368.9	Frederiksstad	0.8
288.5	Aberdeen	1.2	GERMANY			453.2	Porsgrund	0.8
301.5	North National	70.0	31.38	Zeesen	15.0	495.9	Thronheim	1.35
309.9	Cardiff	1.2	217.1	Königsberg	1.7	560	Hamar	0.8
355.8	London Regional	70.0	218.5	Flensburg	0.6	1,083	Oslo	75.0
376.4	Glasgow	1.2	227.4	Cologne	1.7	POLAND		
398.9	Midland Regional	38.0	227.4	Munster	0.6	214.2	Warsaw (2)	1.9
480	North Regional	70.0	227.4	Aachen	0.3	234	Lodz	2.2
1,564.4	Daventry (Nat.)	35.0	232.2	Kiel	0.31	244.1	Wlino	21.0
AUSTRIA			239.4	Nurnberg	2.3	312.8	Cracow	1.5
218.5	Salzburg	0.6	245.9	Cassel	0.3	334.4	Poznan	1.9
245.9	Linz	0.6	253.4	Gleiwitz	5.6	381	Lvov	21.0
283.5	Innsbruck	0.6	259.3	Leipzig	2.3	408	Katowice	16.0
352.1	Graz	9.5	274.2	Heilsberg	75.0	1,411.8	Warsaw	158.0
453.2	Klagenfurt	0.6	283.6	Magdeburg	0.6	PORTUGAL		
517.2	Vienna	20.0	283.6	Berlin (E)	0.6	290.5	Lisbon (CTIAA)	2.0
also testing on 1,255 m. from 8.0 p.m. (Mon. Wed. Sat.)			283.6	Stettin	0.6	also on 42.9 m.		
BELGIUM			318.8	Dresden	0.3	ROMANIA		
206	Antwerp	0.4	325	Breslau	1.7	304	Bucharest	16.0
216	Bruxelles	0.2	360.6	Mühlacker	75.0	RUSSIA		
Conference			372.3	Hamburg	1.7	427	Kharkov	25.0
223.5	Binche	0.1	390	Frankfurt	1.7	497	Moscow	1.2
244	Schaerbeek	0.2	419	Berlin	1.7	511	Archangel	1.2
337.8	Brussels (No. 2)	20.0	453.2	Danzig	0.6	720	Moscow (PTT)	20.0
509.3	Brussels (No. 1)	20.0	472.4	Langenberg	17.0	815	Kiev	20.0
BULGARIA			532.9	Munich	1.7	840	Nijni Novgorod	1.8
318.8	Sofia (Rodno Radio)	1.0	559.7	Kaiserslautern	1.7	937.5	Kharkov (Rv20)	25.0
CZECHO-SLOVAKIA			566	Hanover	0.3	1,000	Leningrad	100.0
263	Moravska-Ostrava	11.0	569.3	Freiburg	0.3	1,034.5	Tiflis	10.0
279.3	Bratislava	14.0	1,620	Norddeich	10.0	1,073	Rostov Don	4.0
293	Kosice	2.5	1,634.9	Zeesen	75.0	1,103	279.6 Moscow Popoff	75.0
341.7	Brunn (Brno)	34.0	2,525	Königswusterhausen (press)	15.0	1,304	Moscow (Trades Unions)	165.0
488.6	Prague (Praba)	5.5	2,900	Königswusterhausen (press)	15.0	1,481	Moscow (Kom)	40.0
488.6	Lieblitz (test)	60.0	HOLLAND			SPAIN		
DENMARK			31.28	Eindhoven (PCJ)	30.0	252.7	Barcelona (EAJ15)	1.0
281	Copenhagen	1.0	296.1	Hilversum	8.5	289	Valencia (tests)	5.0
1,153	Kalundborg	7.5	298.8	Radio Idzerda (The Hague)	3.0	348.8	Barcelona (EAJ1)	8.0
ESTONIA			285	Kootwijk (testing)	10.0	368.1	Seville (EAJ5)	1.5
298.8	Tallinn	0.7	1,071.4	Scheveningen-Haven	10.0	425.7	Madrid (EAJ7)	2.0
465.8	Tartu	0.5	1,875	Huizen	8.5	450	San Sebastian (EAJ8)	0.6
FINLAND			550	Budapest	23.0	SWEDEN		
291	Tampere	1.0	HUNGARY			230.3	Malmö	0.75
291	Vilpuri	13.2	550	Budapest	23.0	257.3	Horby	15.0
386.1	Helsinki	13.2	ICELAND			307.5	Falun	0.6
1,796	Lahti	54.0	1,200	Reykjavik	16.0	322	Goteborg	15.0
FRANCE			224.4	Cork (6CK)	1.5	436	Stockholm	75.0
220	Fecamp	5.0	413	Dublin (2RN)	1.5	542	Sundsvall	15.0
237.2	Beziers	0.6	IRISH FREE STATE			770	Ostersund	0.7
238.5	Bordeaux	0.6	224.4	Cork (6CK)	1.5	1,229.5	Boden	0.75
FRANCE (continued)			413	Dublin (2RN)	1.5	1,348	Motala	40.0
249.6	Juan-les-Pins	2.0	ITALY			SWITZERLAND		
255	Toulouse (PTI)	1.0	25.4	Rome (3RO)	9.0	244.1	Basle	0.65
265.4	Lille (PTI)	2.0	247.7	Trieste	15.0	246	Berne	0.5
272	Rennes	1.2	276.5	Turin (Torino)	8.5	403	Sittens	25.0
286	Montpellier	2.0	315.8	Genoa (Genova)	10.0	459	Beromuenster	75.0
287	Radio Lyons	30.0	331.5	Naples (Napoli)	1.7	TURKEY		
294.7	Limoges (PTI)	0.5	441	Rome (Roma)	75.0	1,204.8	Istanbul	5.0
304	Bordeaux (PTI)	15.0	453.2	Bolzano (IBZ)	1.5	1,538	Ankara	7.0
312.6	Natan-Vitus (Paris)	0.5	501.7	Milan (Milano)	8.5	YUGOSLAVIA		
316	Marseilles (temporary)	0.3	541.5	Palermo	3.7	307	Zagreb (Agram)	0.7
FRANCE (continued)			LATVIA			430.4	Belgrade	3.0
FRANCE (continued)			525.4	Riga	13.0	574.7	Ljubljana	2.8

YOU CAN BUILD A £40 GRAMOPHONE WITH OUR SCALE DRAWINGS FOR 40/-

Book of instructions 3d. Catalogue of Motors, Tonearms, Soundboxes, latest internal amplifiers, Gramophones and Cabinets Free. Cash or Terms.

W. BURT, 185 High St., Deptford

MAKE OR BUY A GRAMOPHONE AT a quarter shop prices. Or buy Cabinets for Wireless. British double spring motor, 12 in. velvet turntable, swan arm, metal sound-box, amplifier, needle cups, for £1-16-0 p.p., and build your own Cabinet. Portable Gramophones from 15/6, postage 1/6. Motors from 7/6. Lists free. 64 pp. 1931 Catalogue No. 220 with Reduced Prices, Drawing and How to Make Gramos, 3d. Established 27 years.

Regent Fittings Co., A.W., 120 Old St., London, E.C.1

THE "KINVA" SCREENED H.F. CHOKE

The latest addition to screening practice. Designed for effective choking up to 3,000 metres for all "STRAIGHTS" and "SUPERS." Absence of external fields assists circuit stability and compact "LAYOUT." Incorporates multi-slot high-inductance coil. No other choke offers all these points.

Reduced view, Standard Type, Design Regd.

PRICE 2/9

WRITE FOR DESCRIPTIVE LIST.

IF YOUR DEALER IS NOT STOCKING, WRITE DIRECT TO MANUFACTURERS.

POSTLETHWAITE BROS.,
KINVER :: Nr. STOURBRIDGE

SET CRACKLING IS ANNOYING!

IF IT'S YOUR SWITCH

FIT THE "BUSCO" SWITCH

and ensure perfect switch contact! There is no contact point to turn round, and when you "switch on" you have contact like a power switch.

They are as cheap as the inferior type but far superior in operation.

From your local dealer, Halford's Cycle Stores, or

BUSBY & CO., LTD. (Patentees)
Dept. A.W., PRICE ST., BIRMINGHAM

SUPER-HETS AND TELEVISION

SUPER-HETS undoubtedly fill the need of the moment in giving the highest possible factor of selectivity. This is essential in ordinary reception, but there is a possibility that for television work extreme selectivity, as given by a super-het, may be a disadvantage. This question is being dealt with by the Chief Engineer of a leading American television concern.

"In ordinary broadcast work," he says, "a width of 10 kilocycles is considered sufficient, but in television we must face the fact that four times as wide a band is required. Getting even amplification at 10 kilocycles has been a problem in broadcast receiver design. It is easy to imagine the difficulties of designing a television amplifier with even amplification at 80 kilocycles."

If we put a television signal, requiring a width of 80 kilocycles, through a super-het designed to cut off sharply at 10 kilocycles, a lot of detail is lost in the process. This is what may happen when people try to receive television on a broadcast super-het.

The possibility of building a super-het which will pass an 80-kilocycle band is feasible, but if this is used for broadcasting it would be too flatly tuned to be useful. K. U.

THE "MAINS" AERIAL

IN many of the new mains-driven receivers the usual self-contained frame is dispensed with and a special plug is fitted to allow the electric-lightwiring to serve as an aerial. The arrangement is specially suitable for "midget" sets, or where space is a consideration, the signal pick-up from the mains being found to compare very favourably with that from an indoor aerial or from a frame. The idea is by no means new, but it was not so successful when first introduced as it is now, owing to the enormous amplification given by the modern type of A.C. valve. It is, in effect, another step towards simplifying wireless reception. From the garden aerial we have passed first to the self-contained frame, and now to what may be truly called the "all-mains" receiver.

B. A. R.

Eric Coates' amusing fantasy *The Three Bears* is to be one of the items in the weekly concert relayed from the Belfast Museum on October 28.

"Amateur Wireless and Radiovision." Price Threepence. Published on Thursdays and bearing the date of Saturday immediately following. Post free to any part of the world: 3 months, 4s. 6d.; 6 months, 8s. 9d.; 12 months, 17s. 6d. Postal Orders, Post Office Orders, or Cheques should be made payable to "Bernard Jones Publications, Ltd."

General Correspondence is to be brief and written on one side of the paper only. All sketches and drawings to be on separate sheets.

Contributions are always welcome, will be promptly considered, and if used will be paid for.

Communications should be addressed, according to their nature, to The Editor, The Advertisement Manager, or The Publisher, "Amateur Wireless," 58-61 Fetter Lane, London, E.C.4.

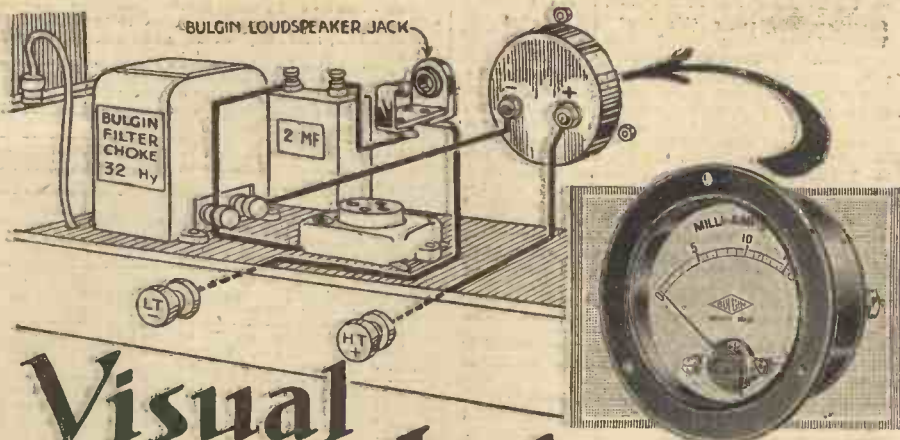

Visual Indication

MOVING COIL MILLIAMMETERS

- RANGE
 0-2 mA
 0-5 " "
 0-10 " "
 0-50 " "
 0-100 " "
 0-200 " "

PRICE 30/- EACH

See that the pointer of the milliammeter keeps steady. If it kicks upwards the valve is over-biased—if downwards, under biased. Bulgin Moving Coil Milliammeters are precision instruments of the highest quality. Every instrument is hand calibrated. The bearings are jewelled and the dead-beat movement so designed that readings are quite independent of position. Diameter 2 3/8 in.

Send 2d. postage for new 75 pp. Illustrated Catalogue and Manual which describes the new Bulgin Technical Service.



EVERY METER GUARANTEED FOR ONE YEAR.

A. F. BULGIN & CO., LTD., Abbey Road, BARKING, ESSEX.
 Telephones: Grangerwood 3266 & 3267.
 London Showrooms: 9, 10, 11, Cursitor St., Chancery Lane, E.C.4. Telephone: Holborn 2072.

Every Heayberd Mains Unit is Guaranteed 3 yrs.



This is the test of quality, service and efficiency that only Heayberd can offer. There is a Kit for every Set. A.C. and D.C.

Model C. 200
 Output 30 ma. at 200 v. or 175 v. Three tappings, one variable. Westinghouse rectification. Mounted in handsome case. Requires wiring up only. Point-to-point Diagram.
 Price 90/-

Send 3d. stamps for full lists showing how to build your own Mains Unit; also details of various Transformers with circuit diagrams.



10, Finsbury Street, London, E.C. 2.

ONE MILLION SOLD ANNUALLY

That fact indicates their quality and extreme reliability. They are World-famous. Write to-day for the new illustrated lists and new low prices.



VALVE HOLDERS AND SWITCHES

Made by the makers of the Famous W.B. Permanent Magnet Moving Coil Speakers

WHITELEY ELECTRICAL RADIO CO., LTD., NOTTINGHAM RD., MANSFIELD, NOTTS.

Irish Free State Distributors: Kelly & Shiel, Ltd., 47, Fleet Street, Dublin.

PREPAID ADVERTISEMENTS

Advertisements under this head are charged THREEPENCE PER WORD, minimum charge THREE SHILLINGS. DEPOSIT SYSTEM

As the Publishers cannot accept responsibility for the bona fides of advertisers in this publication, they have introduced a system of deposit which it is recommended should be adopted by readers when dealing with persons with whom they are unacquainted. It is here explained.

Intending purchasers should forward to the Publishers the amount of the purchase money of the article advertised. This will be acknowledged to both the Depositor and the Vendor, whose names and addresses must necessarily be given. The deposit is retained until advice is received of the completion of the purchase, or of the article having been returned to and accepted by the Vendor. In addition to the amount of the Deposit, a Fee of 6d. for sums of £1 and under, and 1s. for amounts in excess of £1, to cover postage, etc., must be remitted at the same time. In cases of persons not resident within the United Kingdom, double fees are charged.

The amount of the Deposit and Fee must be remitted by Postal Order or Registered Letter (Cheques cannot be accepted), addressed to

"AMATEUR WIRELESS" ADVERTISEMENT DEPARTMENT, 58/61 FETTER LANE, LONDON, E.C.4

VERT WIRING CLIP.—No soldering. Fits any component. Perfect contact. Tested and approved "A.W." Quarter gross, 1/2; half-gross, 2/-; gross, 3/6.—Green & Sons, Redcliffe, Horley, Surrey.

MODERN THREE-VALVE SETS with valves, £3/15/- Century Super kits, £3/15/-. Anything wireless supplied at keeneest prices. Send list of requirements for quotation.—Scrivwell Wireless Supplies, 74 Gough Street, London, E.14.

R.K. SPEAKERS.—Modern Components in part exchange.—Scott, 10 East Parade, Ilkley.

"UNIVERSAL" RADIO BARGAINS of Bankrupt Stock.—Transformers: Triumph, 3/11; Telsen Ace, 4/7; Grand, 7/3; Dynaplus, 3/9; Stal, 3/3. Valves: Triotron, Darlo, 4/3; Power, 5/3; Radvaco, 3/11; Power, 4/11. Spenser Units: Ormond, 6/3 and 9/3; Triotron "W", 8/3; Telsen, 4/6; Zelo, 3/3. Nassak Var. Condensers, 3/3; with vernier, 4/3. Differential, 1/6. Ormond, 3/3. Six-pin B.B.C. Coils, 1/11; Dual, with Switch, 3/11. Compressions, 1/-. Sutra Double-reading Voltmeters, 3/11. N. & K. Speakers, 49/6. Telsen Output Chokes, 6/8. Burndett Pickups, 10/6. Sovereign Volume Controls, 3/6. All goods in original sealed cartons. Thousands of other bargains. Request our price any component.—"Universal," 20 Victoria Road, Peckham, S.E.15.

NEW ELECTRIC GRAMOPHONE MOTORS, 5-guinea models, suit A.C. or D.C., complete with 12-in. turntable, switch, regulator, etc. Blueprint instructions. Money return guarantee. 40/- each.—King, 1 Kingsley Road, Hounslow, Middlesex.

UNUSED BANKRUPT STOCK.—P.M. Loudspeakers Baker, £2 15s.; Epoch, £1 12s. 6d.; Triotron, 15s. units, 7s. 9d.; Siemens, 1500-v. condensers, 2Mfd., 4Mfd., 5s. 3d.; Wavemaster 0.0005SM, 4/6. Quotations. Catalogues Free.—Pepper, Wakegreen Road, Birmingham.

"CRAFTSEAS" CABINETS are supplied "ready to assemble" or "assembled." Write for catalogue.—D. Craftseas Works, Winscombe.

AGENTS, ACTIVE ENTHUSIASTS: sell "Brookman British Ebonite Panels," cabinets, and specialities, suppliers of all makes of radio apparatus. Send for particulars of our system of trading. Brookman Rapid Radio Service, 105 Spencer Street, Birmingham.

ENGINEERS.—Seriously, if you are earning less than £10 per week you cannot afford to carry on without reading "ENGINEERING OPPORTUNITIES." Whether you are an old hand or a budding apprentice, this 200-page volume will point to a worth-while future. Among other things the book explains the methods of our unique Appointments Department, gives details of all leading Eng. Exams. (A.M.I.Mech.E., A.M.I.E.E., B.Sc., G.P.O., etc.) and outlines modern Home Study Courses in Civil, Mech., Elec., Motor, Aero., Radio, "Talkie," and all other branches of Engineering. This book will alter your entire outlook and earning power. It is quite FREE. Send for your copy now. British Institute of Engineering Technology, 109 Shakespeare House, 29-31 Oxford Street, London.

PHOENIX THREE-VALVE KITS, complete with cabinet, £1/7/6. Ditto with valves, £2/15/-. Ditto with H.T. and L.T. batteries and speaker, £4/10/6. Three-valve S.G. kits, 30/- extra. H.P. terms on kit; 10/5 deposit, 2/7 per week.—Phoenix, 314 High Road, Lee, S.E.13.

MOVING-COIL LOUD-SPEAKERS. Marcomphone 6v. units, 10 in. cones, complete 25/-. Unrepeatable bargains. Hillier, 22 Cork Street, W.1.

"STANDUP" Wet Battery replacements. All sizes up to 80,000 milliamps capacity. Lists free.—Scottish Batteries, Braeside, Uphall Station.

MAKE YOUR OWN SPEAKER UNIT.—Efficient chassis-less cone unit easily constructed in an hour for few pence. Superb quality. Incorporates compensated armature movement. Prov. Pat. 455/31. Complete illustrated instructions (submitted to "A.W." for approval). Obtainable through all newsagents, booksellers, etc. Price 1/- or send remittance and stamped addressed envelope direct.—W. S. Osborn, 53 Abbotts Park Road, London, E.10.

OAK CABINETS, hand polished, 12 in. and 14 in. by 7 in. by 10 in., 6/-; 16 in. and 18 in. by 7 in. by 10 in., 6/6; 21 in. by 7 in. by 10 in., 8/-. Baseboards, 6d. extra. C.V.O. Refunded unsatisfied. Carriage 1/6. State nearest station. Send for price of type of cabinet required. Panels supplied, etc.—F. S. Gibson, 99 Burnley Road, Alnsdale, Dept. A.W.

ELIMINATOR COMPONENTS for home constructors. Stamped addressed envelope brings Eliminator Diagrams, with prices of complete range of mains components.—Mains Power Radio, Broadway Works, Eastern Road, Romford, Essex.

CHARGE YOUR H.T. FROM YOUR L.T. AT HOME.—Combination trickle. Charges efficiently, 1 to 12. H.T. 10-volt accumulators, 10/6. Postage 6d. Diagram only 1/6.—R. Fox, 188 Camberwell Grove, S.E.5.

WANTED, PORTABLE CENTURY SUPER, complete or less batteries. Lowest cash.—Write, Portable, 6 Tavistock Road, East Croydon.

ANELOY RADIO, 36 Hindmans Road, East Dulwich, S.E.22. Get our price first for anything radio—specialists in H.T. batteries and accumulators. All goods sent on approval against cash or C.O.D.

EKCO L.T. UNIT, A.C., list £8 15s., £5 new. Amplion Lion Chassis, £3 5s. Quantity components, valves, etc. List free.—Bailey, 66 Queen's Road, Hinxley.

LARGE QUANTITY UNUSED VALVES, transformers, condensers, resistances, etc., less than half price; write for list.—44 Claremont Road, W.13.

BANKRUPT BARGAINS.—List with 3-valve diagram free. Get my price for any kit; I will definitely save you money. Transformers from 2/9; Ace, 4/9; Radiogram, 7/6. Wavemaster, 0005, 2/6. Differentials, 2/- S.M., with dials, 5/- S.M. Dials, 1/6. Dual Coils, 4/-; plug-in from 1/-. Ultra S.W., 1/3. Fixed condensers, to .002, 5d.; 1 mfd., 1/8; 2 mfd., 2/-. Speaker Kits from 10/6. Units from 4/- Triotron, Tungram Valves, 4/6; power, 5/6. Cabinets, oak, from 6/-. Speaker, 5/- Century Super Kits, 70/- Three-valve Kits, with cabinets, 32/6; two-valve, 24/-; £3 Three, 30/-; £3 3/4 Four, 47/6; Comet Three, 43/- Eliminators, A.C., 40/-; D.C., 22/6. Everything wireless supplied.—Butlin, 143b Preston Road, Brighton.

ELECTRADIX

AERIALS.—R.A.F. Steel Tube Masts, 2 ft. 6 in. sections, 1/3; 30 ft., with haliard and pulley, 15/-. Pole Tops, 1/6. Stay Plates, 1/-. Earth Plates, 9d. Earth Spikes, 1/-. 7/22 Copper Aerial Wire, 50 ft., 1/6; 100 ft., 2/8. Webbing Aerials for under the carpet indoors, 1/-. Earth Wire, rubber covered, 1d., 2d., and 3d. yard. Lightning Arrestors, self restoring vacuum type, 1/6; G.P.O. type, 1/-. Earth pipe Clamps for 1 to 2-in pipe, 1/-. Earth Clips, 6d.

BELLS.—G.P.O. type, 3/-. Indoor Bells, 2/6. Small Sheep Cong, 2/6. Large Metal, 5/-. Bell Wire, 3/- per 100 yds. Pushes, 6d. each. Wireless Sundries: Ruby Mica 2-in. squares, 6d. doz. W.E.C.O. Peanut Valves, 4/6, 4-pin or American base, £1.40 Power Valves, 6 volt, 4/6. B.T.H. Valve Holders, 1/6. Ashley, 6d. Electradix, 3/1 and 5/1. Transformers, 3/6. 9-lb. parcel Wireless Experimental Sundries, 6/-, post free.

RECEIVERS.—G.E.C. Victor III, new, metal cabinets, drum dials, 200/2,000 metres, with battery leads, 67/6. Few only left of the fine seven-guinea receivers at 67/6 cash. Fellow's 3-valve, 45/-; ditto, 4-valve, 60/-, all oak. Superhets, 6 valve, £5 15s.; 7 valve, W.E., £7. Full-graph Picture Machines, new, 45/-.

Send addressed envelope for our new Sale Bargain List of everything radio and electrical.

ELECTRADIX RADIOS,

218 Upper Thames Street, London, E.C.4. City: 0191.

EASY PAYMENTS

"There's no placelike Holmes." The first firm to supply wireless parts on easy payments. Seven years since our first advertisement appeared in "Amateur Wireless." Thousands of satisfied customers.

GOSSOR 1932 Kit. Cash £6/15/-, or 10/- with order and 11 monthly payments of 12/6. Also Osram, Mullard Kits, etc.

EXIDE 120-volt H.T. Accumulator. Cash £3, or 6/- with order and 9 monthly payments of 6/8, Also Oldham, etc.

BLUE SPOT 66R Unit, with Cone and Chassis, Cash 42/6, or 5/6 with order and 9 monthly payments of 4/6. Also Wufa, etc.

EKCO Eliminator, A.C.18, 1- to 5-valve sets. Cash £3/7/-, or 7/5 with order and 9 monthly payments of 7/5. Other models and Atlas, Regentone, etc.

New Goods Obtained for Every Order. Send us a list of the parts you require and the payments that will suit your convenience, and we will send you a definite quotation. Anything Wireless.

H. W. HOLMES,

29 Foley Street, 61, Portland St, London, W.1. Museum 1414.



PAULETTE ALL WAVE TUNER

250-2,000 metres. No coils to change. Greatly improved selectivity and range. PRICE, with Switch, 7/- post paid. Send stamp for FREE WIRING DIAGRAMS of PAULETTE 3-VALVE SET. Easy to construct. Parts cost £2.12.6.

PAULLS WIRELESS STORES, 43, Caroline Street, Cardiff.

FULL-SIZE BLUEPRINTS

When ordering, please send Postal Order, NOT STAMPS.

CRYSTAL SET (6d.)

1931 Crystal Set AW308

ONE-VALVE SET (1s.)

Easy to Build One AW304

TWO-VALVE SETS (1s. each)

- Talisman Two (D, Trans) AW194
No-battery Gramo-radio 2 (D, Trans) AW238
1930 Talisman 2 (D, Trans) AW239
Arrow Two (D, Trans) AW249
Forty-five-shilling Two (D, Trans) AW250
Everybody's All-in 2 (D, Trans) AW273
Twenty-shilling Two (D, Trans) AW274
The Room-to-Room 2 (D, Trans) AW298
Big-volume Two (D, Pentode) AW309
Cleaner Two (D, Trans) WM201
Merlin Two (A.C. Set) WM213
Five-point Two (D, Trans) WM220
Brookman's A.C. Two (D, Trans) WM225
Aladdin Two (D, Trans) WM231
Ever Tuned Regional Two (D, Trans) WM241
Station-finder Two (D, Trans) WM253

THREE-VALVE SETS (1s. each)

- 1931 Ether Searcher (SG, D, Trans) AW271
1931 Ether Searcher (A.C. model) AW276
Mains Unit AW277
Ultra-selective Straight Three (SG, D, Trans) AW282
1931 Ether Searcher (D.C. model) AW284
Mains Unit AW285
Square Peak Three (SG, D, Trans) AW293
B.B.C. Selective Three (D, RC, Trans) AW289
Universal Short-wave Three (SG, D, Trans) AW301
Olympian Three (SG, D, Trans) AW306
Brookman's Three (SG, D, Trans) WM161
Five-point Three (SG, D, Trans) WM212
New Brookman's Three (SG, D, Trans) WM218
Five-point Short-wave (D, RC, Trans) WM223
Baffle-board Three (D, RC, Trans) WM226
Plug-in-coil Three (D, 2 Trans) WM232
Regional Three (SG, D, Trans) WM236
Band-pass inceptor-dyne (SG, D, Trans) WM244
Ether Marshal (SG, D, Trans) WM247
Meridian Short-wave (D, RC, Trans) WM256
Five-advantage Three (D, RC, Trans) WM257
Everybody's Radiogram (SG, D, Trans) WM258

FOUR-VALVE SETS (1s. 6d. each)

- The £3 3s. Four (SG, D, RC, Trans) AW303
The £3 3s. Four (Improved Model) AW303A
Everybody's Radio-gramophone AW310
Regional Band-pass Four (SG, D, RC, Trans) WM211
Five-Point Four (SG, D, RC, Trans) WM216
Regional A.C. Four (SG, D, RC, Trans) WM222
Supertone Four (SG, D, Push-pull) WM227
Brookman's Three-plus-one (SG, D, RC, Trans) WM233

FIVE-VALVE SETS (1s. 6d.)

- Britain's Super (Super-het) AW311
Regional D.C. Five (SG, D, RC, Push-pull) WM252

SIX-VALVE SETS (1s. 6d. each)

- Century Super (Super-het) AW287
A.C. "Century Super" (Super-het) AW295
Mains Unit (1/-) AW295A
Super 60 (Super-het) WM229
A.C. Super 60 Radio Gramophone (Super-het) WM239
A.C. Super 60 (Table Model) WM245
Super 60 (with Wearite base) WM249
Super 60 (with Lewcos base) WM251

SEVEN-VALVE SET (1s. 6d. each)

- Super Senior (Super-het) WM256

AMPLIFIERS (1s. each)

- High Quality Amplifier for A.C. Mains AW275
2-Watt Amplifier for A.C. Mains AW283
Add-on H.F. Screened-grid Unit AW296
Universal Push-pull Amplifier AW300
D.C. Fader WM242

PORTABLE SETS

- Portable "Century Super" (Super-het) AW297 1/6
Super 60 Portable (Super-het) WM238 1/6
Home and Garden Three (D, RC, Trans) WM246 1/-

MISCELLANEOUS (1s. each)

- Our H.T. Unit for A.C. Mains AW262
Gramophone Tone Control AW264
Short-wave Super-het Adaptor AW268
H.T. Unit and Trickle Charger for D.C. Mains AW272
Booster Speaker (6d.) AW286
"A.W." Tone changer (6d.) AW288
"A.W." Selectivity Unit (6d.) AW290
A.C. Trickle Charger AW305
Amateur's Lining Speaker AW307
Big H.T. Unit for A.C. Mains WM230
Loud-speaker Tone Control WM234
"W.M." Lining Diaphragm Loud-speaker WM235
Two-Minute Adaptor for Short Wave WM240
Super 60 A.C. Unit WM248
Simple Neon Oscillator WM250

Copies of the "Wireless Magazine" and of "Amateur Wireless" containing descriptions of any of these sets can be obtained at 1s. 3d. and 4d. respectively, post free. Index letters "A.W." refer to "Amateur Wireless" sets and "W.M." to "Wireless Magazine."

Address letters: Amateur Wireless Blueprints Dept., 58-61 Fetter Lane, London, E.C.4.

TAYLEX WET H.T. BATTERIES

New Prices: Jars 1/3. Sacs 1/2. Zincs 1 Od. Sample doz. 18 Volts complete with bands and electrolyte 4/1 post 9d. Sample unit 6d. illus. booklet free. Bargain list free. AMPLIFIERS, 30/-, 3 VALVE ALL-STATION SET £3. A. TAYLOR, 57, Studley Road, Stockwell, LONDON.

SO GENTLE SO POWERFUL

The last whisper of a muted violin, the swelling crescendo of a mighty organ are reproduced with equal exactitude. To achieve such perfection requires tremendous flexibility. BLUE SPOT 66R is flexible to the n'th degree. There is no vibration in the musical range that it cannot handle with ease. Even with sets having an enormous output distortion and rattle are entirely absent. For genuinely magnificent performance and superb reproduction it is impossible to better BLUE SPOT 66R, especially if it is used, as it ought to be, in conjunction with a BLUE SPOT Chassis.

Your dealer will demonstrate BLUE SPOT with pleasure.

BLUE SPOT UNITS: 66K. 25/-; 66P. 27/6; 66R. 35/-;
100U (Inductor type mounted). 39/6.

BLUE SPOT CHASSIS: MAJOR . . 15/-; SPECIAL . . 7/6.

THE BRITISH BLUE SPOT COMPANY LTD

BLUE SPOT HOUSE · 94/96 ROSOMAN STREET · ROSEBERY AVENUE · LONDON · E C 1
Telephones: Clerkenwell 3574, Telegrams: "Bluspot, Isling, London."

Distributors for Northern England, Scotland, and North Wales: H. C. RAWSON (Sheffield and London), Ltd., 100 London Road, Sheffield; 22 St. Mary's Parsonage, Manchester; 183 George Street, Glasgow.

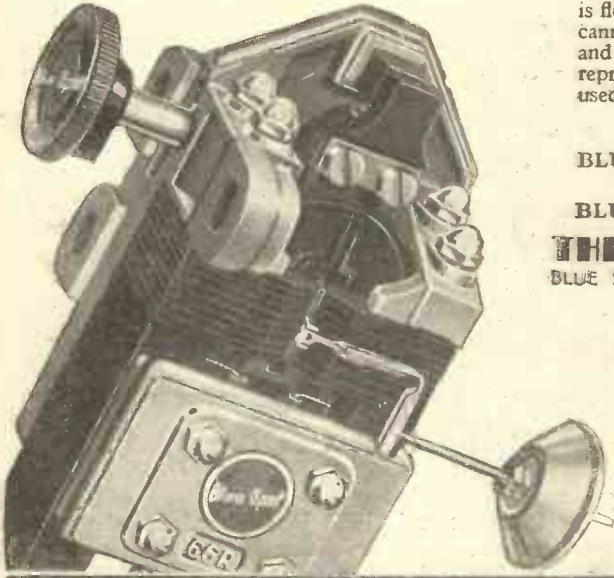

Write for Catalogue A.W.13 which gives full details of Blue Spot Units

Registered Trade Mark

"AMATEUR WIRELESS" HANDBOOKS 2/6 each net

Of all Newsagents and Booksellers, or 2/9 post free from Cassell and Company, Limited, La Belle Sauvage, London, E.C.4.

WIRELESS CONTROLLED MECHANISM

For Amateurs. By Raymond Phillips

This book is an illustrated practical guide to the making and using of short-range wireless control apparatus, and it has been written so simply that it can be understood by any enthusiast possessing an elementary knowledge of wireless.

THE PRACTICAL WIRELESS DATA BOOK

The intelligent novice, and particularly the home constructor and the keen wireless amateur who is always rigging up different circuits and experimenting for progress, will find this Data Book extremely helpful.

THE BOOK OF THE NEUTRODYNE

By J. H. Reyner, B.Sc. (Hons.), A.M.I.E.E.

CONTENTS: Why Neutralising is Necessary; Systems of Neutralising; Difficulties Encountered in Neutralised Circuits; How to Obtain Good Selectivity Without Loss of Quality; Design of High-frequency Transformers; Lay-out in Neutralised Receivers; Some Suitable Circuits.

Price 1/6 net, or post free for 1/9

PLAYER'S

Plain or tipped with cork of pure natural growth



10 for 6^d
20 for 11^d
50 for 2/5 100 for 4/8

"It's the Tobacco that Counts"

NCC 325

Advertisers Appreciate Mention of "A.W." with Your Order

Your batteries yearly cost you pounds



--an EKCO Unit will give you trouble-free radio for 1/- a year and finish with batteries for ever.

Connect an EKCO Unit in place of your usual battery (no alterations to your set or wiring.) Plug in to the electric light or power supply. Then switch on—that's all. You will be more than delighted by the improvement in the performance of your set.

The new EKCO Units surpass all previous achievements, embody many exclusive features and combine highest efficiency with greatest simplicity. Made by the Pioneers and leading Specialists of All-Electric Radio.

H.T. Units (A.C. and D.C.) from 39/6.

Combined H.T. and L.T. Charger Units (A.C.) from £3 19 6.

All-Power Units (H.T., L.T., and G.B.) from £6 0 0.

All obtainable on Easy Payment Terms from as little as 3/8 per month.

POST COUPON NOW FOR FULL DETAILS.



To :
E. K. COLE,
Ltd. Dept. K.14,
EKCO Works,
Southend-on-Sea.

Please send me full details of EKCO Power Units.

Name

Address

SET BUILDING MADE EASY

A STEP-BY-STEP PICTORIAL GUIDE
FOR HOME CONSTRUCTORS



SPECIALLY PREPARED BY THE
"AMATEUR WIRELESS" STAFF

BY way of introduction, we must explain that this supplement has been specially prepared to show constructors how to make the best possible use of the full-size blueprints issued with all AMATEUR WIRELESS set designs. In compiling the instructions in the following pages we put ourselves in the position of the reader who buys a blueprint.

From a preliminary study of this blueprint, we take the constructor through all the stages in the drilling, assembly and wiring of the set, showing how the layout of the set in blueprint form aids the completion of each stage.

We should emphasize the fact that the instructions given in these pages are, in general, applicable to the construction of all our sets. Whether it is a simple two-valver or an ambitious five-valver, the sequence of constructional operations is almost invariably as indicated.

To cover as many of the constructional points as possible, we have taken W. James's "Britain's Super" set to illustrate our explanations. This five-valver is quite easy to build if the instructions are carefully followed. Being a five-valver it involves more component fixing than a small set, although the amount of wiring is probably not appreciably greater.

We are assuming in this article that the intending constructor of "Britain's Super" has already read the technical details given by Mr. James in last week's issue and continued elsewhere in the present issue.

Here, then, we are to confine ourselves to the interesting job of materialising a "Britain's Super" set from a complete kit of the components specified.

This fine-looking set can be built by every amateur who follows the simple instructions given in this supplement. A view of "Britain's Super"



In addition to all the components mentioned in the list accompanying W. James's articles, the constructor will need certain tools. All of them are cheap to buy and easy to manipulate. The most used tools are screwdrivers and pliers. We suggest two screwdrivers, one for reaching the

small grub screws in control knobs and the other, of larger size, for fixing the panel to the baseboard, and the baseboard components.

A thin-nosed pair of pliers will be needed for wiring and a square-nosed pair of pliers for tightening up component-fixing nuts.

Unless the panel is bought already drilled, a fret-saw will be needed to cut out the holes for the condenser escutcheon plates.

Another important tool is a breast-drill for making the remaining holes in the panel. This should be fitted with twist drills, one-eighth, five-sixteenths and three-eighths sizes being the most commonly needed.

A bradawl for marking out holes, a scriber and a pair of compasses complete the kit of tools needed for the construction of Britain's Super. (The scriber is detailed on page 3.)

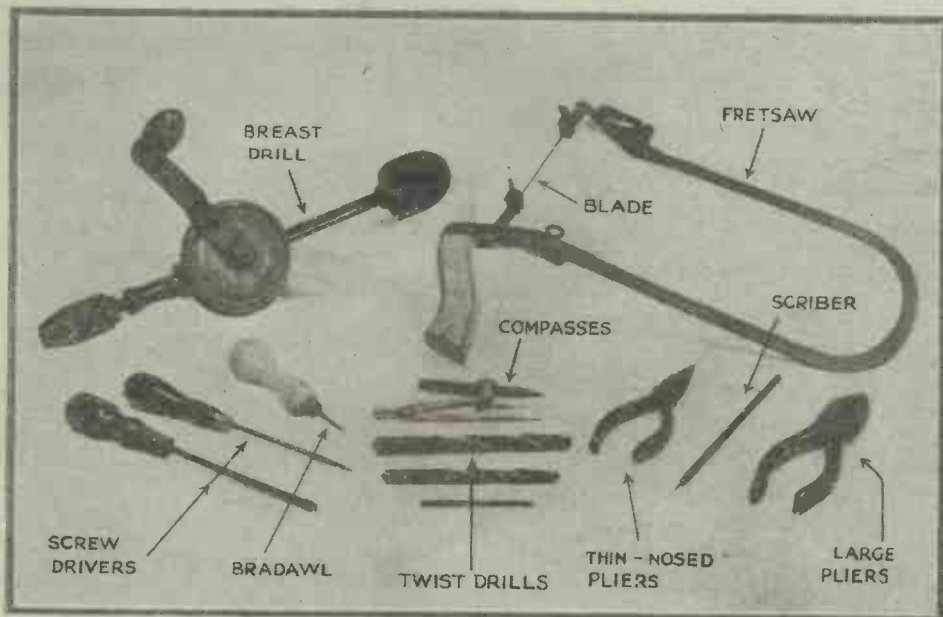

Here are the most commonly used tools for the home construction of wireless sets

Here are the COMPONENTS for "BRITAIN'S SUPER"

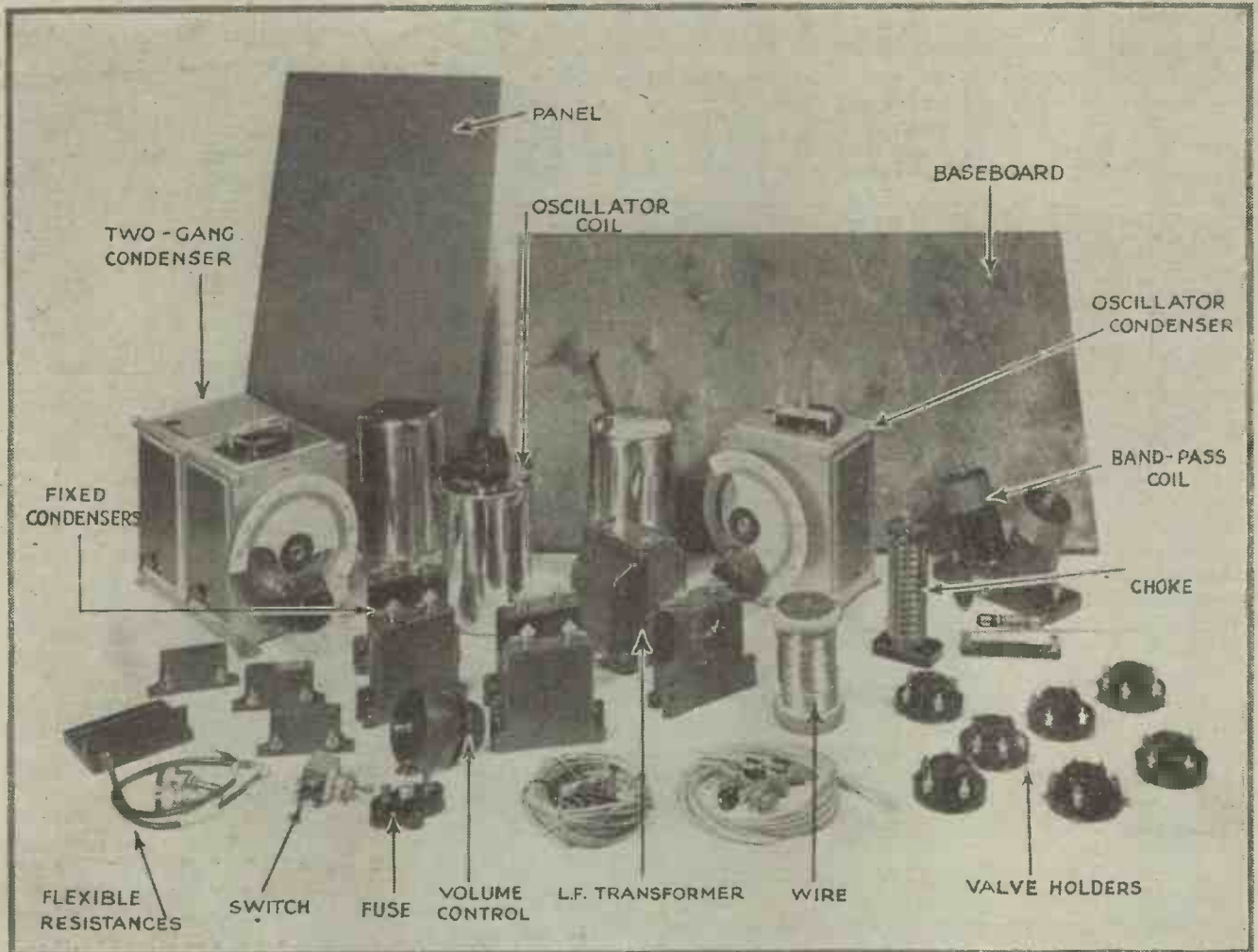

All the components needed for the assembly of "Britain's Super" are clearly shown in this specially enlarged pictorial diagram. Note the wire and sleeving!

ONE of the most important preliminary jobs in the homeconstruction of a wireless set is a careful checking to see that all the necessary component parts have been gathered together.

On this page we reproduce the complete selection of parts needed for the set whose construction we are going to describe, namely "Britain's Super." Note that at the back of the picture is the baseboard.

Other important parts clearly seen in this picture are the oscillator and two-gang tuning condensers, the oscillator and intermediate-frequency screened coils and the band-pass coil.

In addition to the remaining smaller components we show a reel of tinned copper wire and coils of insulating sleeving. From the illustration it is clear that, although "Britain's Super" is a five-valver, the number of parts is quite small.

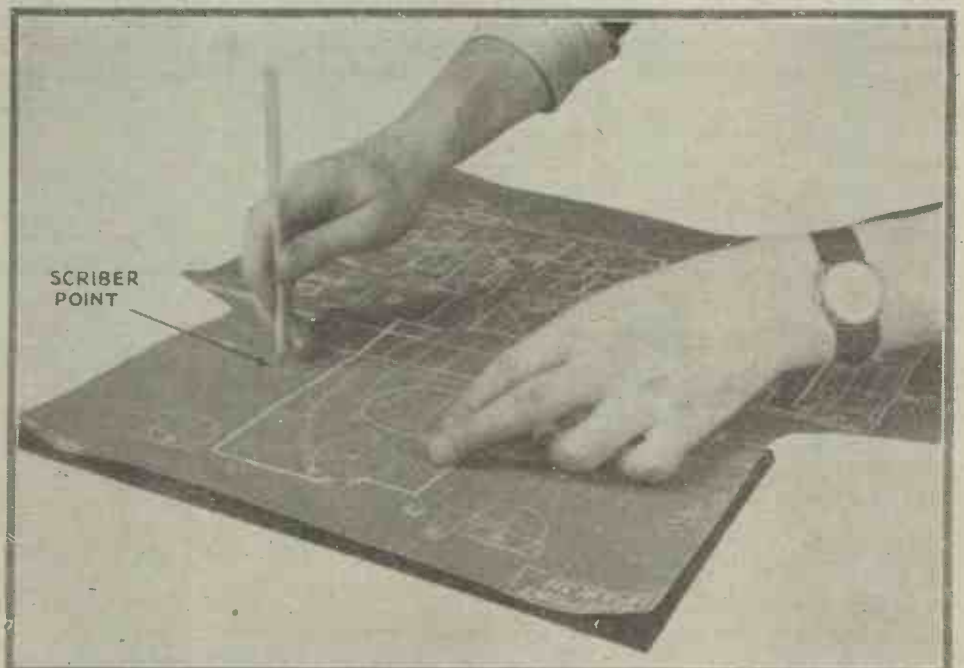

Marking with a scribe the positions of the panel components with the aid of the full-size blueprint

MARKING and Drilling the Panel of "BRITAIN'S SUPER"

WE are now ready to start building "Britain's Super." The first step is to remove the panel from its folder or wrapper and lay it on the table or bench ready for marking. It is a good tip to lay the panel on top of its wrapper, so that the polished surface is not scratched. See that odd washers and screws are cleared away from the space on which the panel is laid.

At this point the full-size blueprint is invaluable. We should point out that for the "Britain's Super" set full-size reproductions of the blueprint were given in last week's issue of AMATEUR WIRELESS, and these can be used instead of the actual blueprint if the constructor so desires.

The blueprint is carefully laid on the back of the panel. We hope we have made it clear that whichever side of the panel is to be the front of the set is now face downwards.

To make quite sure that the blueprint is correctly laid over the panel, we suggest cutting away the edge of the blueprint so that the diagrammatic outline of the panel on the blueprint coincides exactly with the actual corners of the panel.

Here we have to make use of a scribe, in order to carry the blueprint markings on to the panel. A suitable scribe can be improvised by pushing a gramophone needle into the end of a wooden meat skewer. This can be done by first making a small hole in the skewer, gripping the needle-point with a pair of pliers, and then tapping the pliers so that the blunt end of the needle is pushed home.

This scribe, or any convenient sharp point, such as the compasses, is used to prick through every centre of every circle marked on the panel section of the blueprint. Then

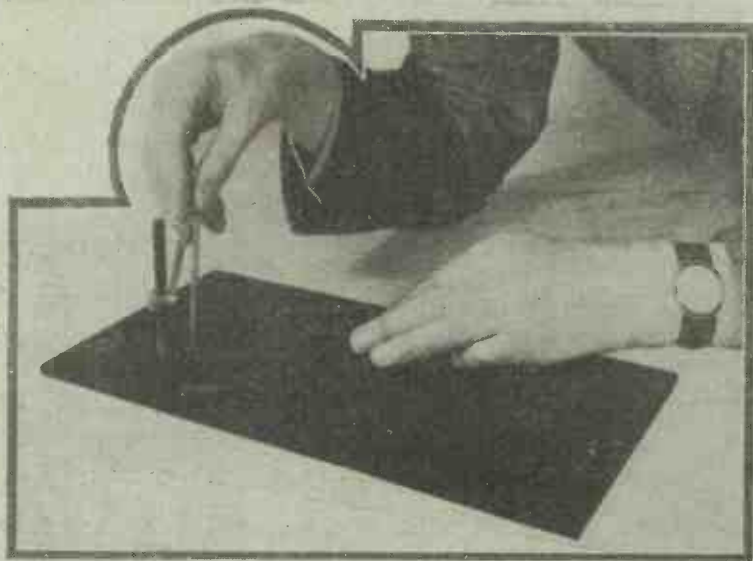

A pair of compasses used to mark the circles for the escutcheon plates as shown by this picture

the blueprint is removed and the holes made by the scribe are enlarged with the aid of the $\frac{1}{8}$ -in. twist drill, which, for this job, can be twisted between the thumb and finger of the right hand. This enlarging of the scribe-made holes ensures the correct centring of the larger drills when the panel holes are actually made.

Do not exert too much force when drilling the panel, otherwise the polished surface may be chipped



Keep the drill vertical. A willing helper holds the panel steady while drilling is in progress

Here is one of the most used of the panel controls—the volume control, which is mounted at the centre

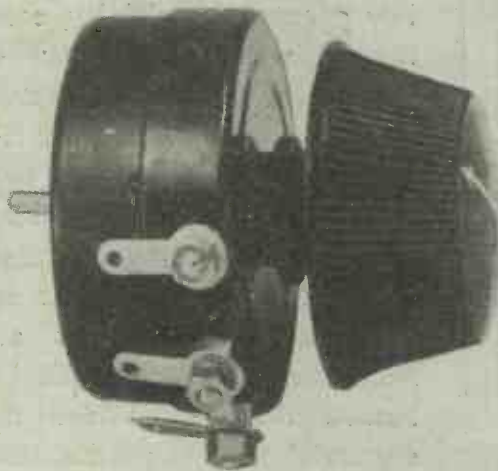

At this point the compasses should be used to describe circles around the two escutcheon plate centres. Later we shall see that somewhere on the inside of the circumference of these circles is the starting point of the fret saw used to cut away the ebonite to accommodate the escutcheon plates.

Now drill the four holes along the bottom of the panel with the $\frac{1}{8}$ -in. drill. Also drill two starting holes on the inside of the circles drawn for the fixing of the escutcheon plates.

Next drill the two condenser spindle holes with the $\frac{5}{16}$ -in. drill. Lastly, drill the $\frac{3}{8}$ -in. holes to take the variable resistance and oscillator coil.

The above is our recommended sequence of drilling the panel. Go very steady when completing all the panel fixing holes, otherwise the ebonite may be chipped. The four holes for fixing panel to baseboard should be counter-sunk with the $\frac{3}{8}$ -in. drill, sufficient to allow the screw heads to be inserted flush with panel. An extra pair of hands to hold the panel steady is not essential, but is very helpful.

Ready Radio's "Britain's Super"



tested in
58 towns
throughout
the country

THE IMPORTANCE OF ACCURATE MATCHING

For greatest sensitivity, combined with simplicity of operation, the tuned circuits must be **ACCURATELY MATCHED**. In order that every constructor of "Britain's Super" may enjoy the best possible results from his set all Ready Radio Kits are **ACCURATELY MATCHED** before dispatch, under the supervision of Mr. G.P. Kendall.

"In view of the importance which I attach to "Britain's Super" I have thought it advisable to carry out really comprehensive tests on the instrument in widely separated localities. Accordingly, a series of tests have been made in positions so chosen as to provide data which can be taken as a guide to its performance in any possible locality in Great Britain. These have ranged from the extreme south-west of England to the North of Scotland, taking in a sufficiency of intermediate and lateral points to explore the whole country.

"In every instant the instrument has given a truly excellent performance and amply confirmed my original belief that it will become the standard high-power receiver for the season.

"Even in localities usually considered extremely difficult, "Britain's Super" proved capable of bringing in its characteristic string of British and foreign programmes at full strength and with ease and certainty.

"It proved pleasingly easy to operate under all conditions, although naturally it will repay a little trouble taken in mastering the method of handling it to the best advantage.

"It is certainly easier to operate than any previous super-het and I am sure no one will experience any difficulty here, especially if the hints given in "10 Hows for Modern Radio Constructors" are employed.

G.P. Kendall

CHIEF ENGINEER,
READY RADIO

"10 HOWS FOR MODERN RADIO CONSTRUCTORS" by G. P. Kendall, B.Sc., contains information of special importance to all users of "Britain's Super," including a chapter entitled "How to operate a Super-heterodyne."

Send four 1½d. stamps for your copy.

Advt. of Ready Radio Ltd.

Ready Radio

Head Office and Works: Eastnor House, Blackheath, S.E.3.

Phones: Lee Green 5678. Grams: Readirad, Sedist.

Showrooms: 159 Borough High St. London Bridge, S.E.1. Phone: Hop. 3000.

Build it with a READY RADIO MATCHED KIT



APPROVED LIST AT A GLANCE

	£	s.	d.
1 Ebonite Panel, 14 in. by 7 in., drilled to specification ...		4	6
1 "WALDOR" Cabinet with baseboard, by Ready Radio	1	5	0
1 J.B. two-gang .0005 variable condenser, type R2 ...	1	1	0
1 J.B. single .0005 variable condenser, type R1 ...	12		6
1 Colvern 50,000-ohm variable resistance (three terminal type) ...		5	6
3 Lewcos super-het coils, one oscillator and two intermediates, types I.F.T.P., I.F.T., Osc.126 ...	1	17	6
1 Lewcos band-pass filter unit with extension rod, type B.P.F.	12		0
*6 Junit 4-pin valve holders ...		4	0
1 Junit 5-pin valve holder ...			10
4 T.C.C. 1 mfd. condensers, type 50 ...	11		4
1 T.C.C. 2-mfd. condenser, type 50 ...	3		10
2 T.C.C. .0002-mfd. fixed condensers, type 34 ...	3		0
1 T.C.C. .0003-mfd. fixed condenser, type 34 ...	1		6
1 Readi Rad 1-meg. grid leak and holder ...	1		4
1 Readi Rad Super-het choke ...	5		6
1 R.I. general purpose L.F. transformer ratio 7-1 ...	10		6
1 Lewcos 15,000-ohm spaghetti resistance ...	1		6
1 Lewcos 20,000-ohm spaghetti resistance ...	1		6
1 Readi Rad H.T. fuse and holder ...	1		3
1 Bulgin toggle switch, type S88 ...	2		9
1 Packet Jiffilix for wiring ...	2		5
1 Sovereign terminal block ...			6
2 Belling-Lee insulated terminals ...			6
8 Belling-Lee wander plugs ...	1		4
5 Valves as specified ...	3	7	6
Screws, flex and two spade terminals, etc. ...			10
TOTAL (including valves and cabinet)	£12	0	0

NOTE:—5-pin holder is provided for the first detector. This is a universal type and allows for either a 4-pin or 5-pin double grid valve.

Any part may be obtained separately if desired.

Kit "A" (Less valves and cabinet) **£7.7.6**

or 12 monthly payments of **13/6**

Kit "B" (With valves less cabinet) **£10.15.0**

or 12 monthly payments of **19/9**

Kit "C" (With valves and cabinet) **£12.0.0**

or 12 monthly payments of **22/-**

IMPORTANT ADDITION—

A .01 Band Pass Condenser is recommended by "Amateur Wireless" for increasing volume. We recommend the use of a T.C.C. Type 40 Condenser, price 1/9.

If required, add 1/9 to the price of the Kit, or 2d. per month to the monthly payments.

TO INLAND CUSTOMERS.—Your goods are dispatched post free or carr. paid.

TO OVERSEAS CUSTOMERS.—Everything Radio can be supplied against cash. In case of doubt regarding the value of your order, a deposit of one-third of the approximate value will be accepted and the balance collected by our Agent upon delivery of the goods. All goods are very carefully packed for export and insured, all charges forward.

EASY PAYMENT ORDER FORM

To: Ready Radio, Ltd., Eastnor House, Blackheath, S.E.3.

Please dispatch at once my Easy Payment Order, for which I enclose first deposit of £.....

NAME.....

ADDRESS.....

Goods Required A.W. 24/10/31

Advt. of Ready Radio, Ltd.

CASH or C.O.D. ORDER FORM

To: Ready Radio Ltd., Eastnor House, Blackheath, S.E.3.

Please dispatch at once my order for which (a) I enclose £.....

(b) I will pay £..... on delivery. (Cross out whichever does not apply)

NAME.....

ADDRESS.....

Goods Required A.W. 24/10/31

PANEL AND BASEBOARD MARKING AND DRILLING

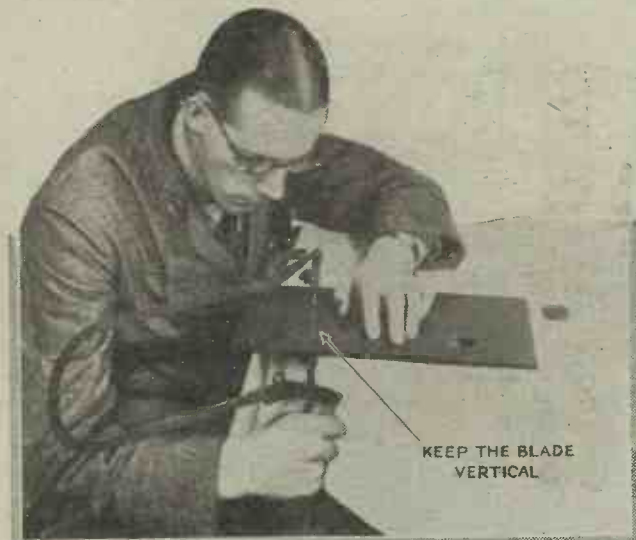

Cutting out the holes for the two escutcheon plates. Note that the panel is held by the left hand

THE cutting of the two circular holes to accommodate the escutcheon plates for the variable condensers mounted on the panel is well worth noting, since the method adopted here is recommended for all such panel-cutting operations.

Two small holes on the inside of the circumference of the two escutcheon-plate circles have already been drilled.

It is important to fit the fretsaw blade so that the teeth slope downwards. The cutting is done on the downward cut of the saw and not on the upstroke.

Fix one end of the blade, which may be of medium size, in the lower jaw of the fret-saw by means of the thumb-screw on the side. Then thread the free end of the blade through the small guiding hole in the panel and secure the blade in the top jaw.

After this, the blade should be tensioned up with whatever tensioning device is provided on the saw.

Cutting the Panel Holes

Now comes the most delicate part of the fret-saw process. It is quite easy to carry through the job with complete success if the panel is held with the left hand spread over it and the fret-saw is worked with the right hand. The blade must be kept vertical, otherwise an irregular circle will be formed. A gentle force can be exerted on the downward stroke, which should be made in a slightly forward direction. No force should be exerted during the upward stroke of the blade.

Follow the compass-made outline of the circle, keeping the saw in the same vertical position and slowly working round the panel until the circle has been completed. The waste ebonite circle will then fall out.

When this happens, the tensioning device on the fret-saw can be released, the blade unthreaded and the hole-cutting process repeated for the other escutcheon plate.

Now we have to fix the panel to the baseboard. In this set we use four three-quarter-inch counter-sunk screws of No. four gauge. Thicker screws should not be used, otherwise the plywood of the baseboard may be cracked.

It is best to lay the baseboard on the table, stand the panel in a vertical position against the edge of the baseboard and then, with the aid of the scribe, prick through the panel holes to the baseboard, thus locating the holes for the baseboard-fixing screws. After enlarging the scribe holes in the edge of the baseboard, the four fixing screws can be inserted.

Baseboard Component Marking

We now have the frame-work upon which the component assembly is arranged, namely an ebonite panel, ready drilled, fitted at right angles to a wooden baseboard.

The next step is to mark out the positions of the components to be mounted on the baseboard. Here, again, the use of the blueprint is strongly recommended.

The edge of the blueprint can be cut away at one corner in order to ensure the baseboard diagram coincides with the corner of the baseboard itself.

Once again the scribe is used to prick through the blueprint in order to mark the positions of the baseboard components. The scribe holes are then enlarged with the bradawl, and the baseboard is then ready for the fixing of its components.

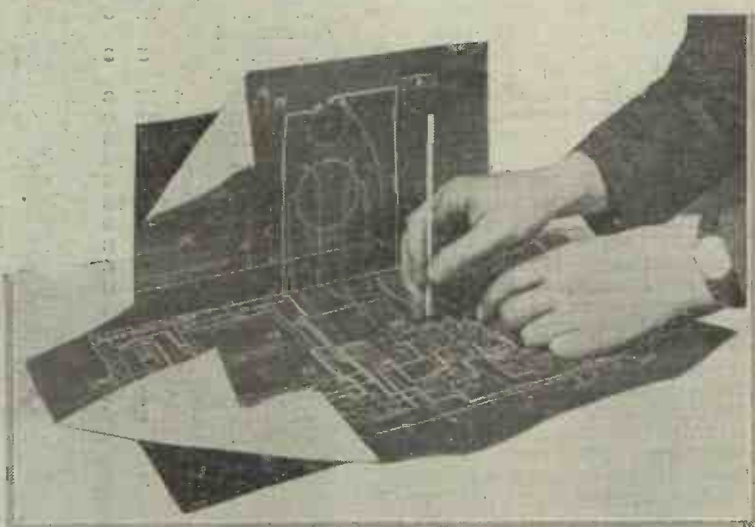

Using the scribe to mark, through the blueprint, the positions of the baseboard components. Note how the left-hand corner of the blueprint is cut away to show the exact position of the baseboard

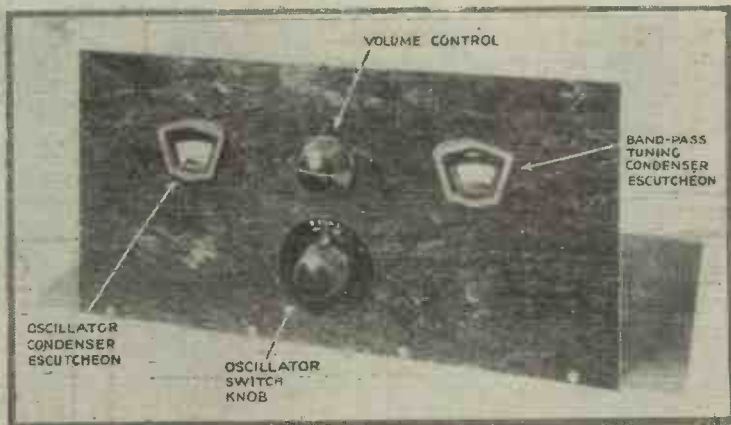

Here are all the panel components mounted in their correct positions. Note the escutcheon plates on each side, the volume control and oscillator switch knob at the centre

HOW TO FIT THE COMPONENTS ON THE PANEL

ON page vi will be seen a picture of the components mounted on the panel, as seen from the front. Our next job is to see how these components are fitted. We should explain that the baseboard marking was done before fitting the panel components, for the simple reason that the panel-mounted components would have been in the way while marking the baseboard.

We recommend the following sequence for the fixing of the panel components. Of course, the constructor can please himself about the order of component fixing, but we give the sequence actually adopted in building the set shown by the photographs.

First of all, mount the two escutcheon plates. Constructors will recall that fretsaw holes have already been made to take these. The J.B. escutcheon in "Britain's Super" is provided with very convenient metal clamp, which is first removed while the escutcheon is fitted into its hole. Then the clamp is screwed to the back of the panel by tightening the nut put on the screw shank protruding from the bakelite part of the escutcheon.

This method of mounting the escutcheon avoids the necessity

— READ —
"AMATEUR WIRELESS"

Every Thursday :: Price 3d.
FULL OF ALL THE LATEST DEVELOPMENTS IN WIRELESS FOR CONSTRUCTORS AND LISTENERS.

for drilling small holes. The same procedure is carried out for the other escutcheon-plate mounting. Before finally tightening the escutcheon clamps, make sure that the escutcheons are correctly aligned on the panel.

Although the oscillator coil has to be sub-



This shows the positions on the panel of the escutcheon plates, volume control, and oscillator coil

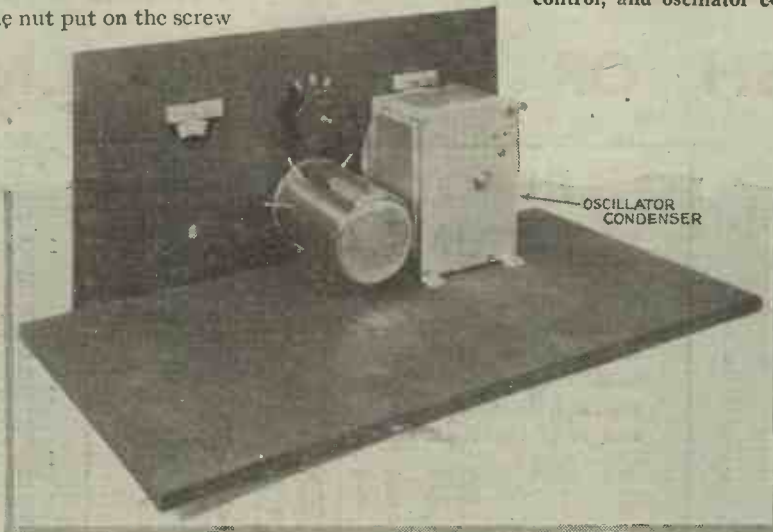

After the panel components have been fitted, the oscillator condenser is screwed to the baseboard, with its spindle projecting through the panel

sequently removed in order to connect flexible leads to it, we are explaining at this point how it is fitted to the panel. Unscrew the knob and the ivory indicating disc and fit the oscillator coil by pushing its spindle through the $\frac{3}{8}$ -inch hole in the panel. Then replace the indicating disc, put on the nut, tighten it, and finally fit the knob.

Make sure that the position of the knob-pointer with respect to the indications on the disc coincides with the coil connections.

The best position for the oscillator coil is with the white tag facing the baseboard. This will facilitate the wiring, as explained later.

Now we fit the volume control. Remove the knob and fixing nut and push the spindle through the top hole in the panel. Put on the nut, tighten it, and finally fit knob, which is tightened by inserting a narrow screw-driver in the hole for the grub screw.

We have now completed the actual panel-mounted component assembly, although the two variable condensers are yet to be fitted. Their fitting is common to panel and baseboard.

First fit the single condenser for oscillator tuning. Remove the knob on the spindle and locate condenser position on baseboard by pushing through spindle and making condenser feet correspond with the holes already marked.

Then with $\frac{3}{8}$ -inch round-head black screws, fix the condenser feet to baseboard. Replace the knob on spindle and tighten. The same procedure is followed for the fitting of the two-gang condenser.

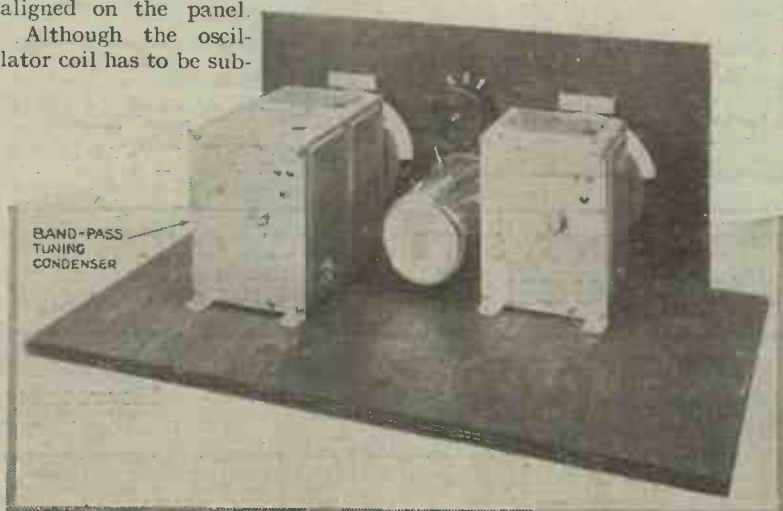

How the baseboard and panel look when both the tuning condensers have been fitted



DON'T TAKE POT-LUCK!

You must have the correct components; it is equally important that you use the correct accessories.

The equipment described below has been actually tested in conjunction with "Britain's Super" by Mr. Kendall before being recommended by Ready Radio.

IMMEDIATE DISPATCH OF EQUIPMENT Recommended for "Britain's Super" CASH OR EASY PAYMENTS

BATTERY EQUIPMENT

	£	s.	d.
consisting of:			
1 Complete kit of components, including valves and cabinet (KIT "C")	12	0	0
1 Pertrix 120-volt Super Capacity H.T. Battery	1	5	6
1 Pertrix 2-volt 30-amp. L.T. Accumulator type PXG.3	11	0	
1 Pertrix 9-volt Grid Bias Battery	1	6	
1 British Blue Spot Cabinet Loud-speaker, type 44R	2	12	6

Total **£16 10 6**

Or 12 monthly payments of **30/3**

The complete kit as above, but with completely assembled receiver (including Royalties). **£19 0 6**

Or 12 monthly payments of **34/10**

READY RADIO MAINS UNIT

Specially designed by Mr. G. P. Kendall, B.Sc., Chief Engineer of Ready Radio, Ltd., for use with the "Britain's Super." Fully decoupled with four separate positive tapings specially adjusted to suit the receiver. Gives ample output and adequate voltage. Price

£5 17 6
Or 12 monthly payments of **10/9**

The beautiful "Waldor" Cabinet, used for "Britain's Super," was designed specially by the Ready Radio artists at the request of "Amateur Wireless."

PRICE ONLY 25/-

A.C. MAINS EQUIPMENT

	£	s.	d.
consisting of:			
1 Complete kit of components, including valves and cabinet (KIT "C")	12	0	0
1 Ready Radio Mains Unit with trickle charger	5	17	6
1 Pertrix 2-volt 30-amp. L.T. Accumulator, type PXG.3	11	0	
1 Pertrix 9-volt Grid Bias Battery	1	6	
1 British Blue Spot Cabinet Moving-coil Permanent Magnet Loud-speaker	5	10	0

Total **£24 0 0**

Or 12 monthly payments of **44/-**

The complete kit as above, but with completely assembled receiver (including Royalties). **£26 10 0**

Or 12 monthly payments of **48/9**

COME AND HEAR "BRITAIN'S SUPER" AT OUR SHOWROOMS: 159 BOROUGH HIGH STREET.

Head Office and Works:
EASTNOR HOUSE,
BLACKHEATH, S.E.3
Phone: Lee Green 5678
Grams: Readirad, Sedist

Advt. of Ready Radio, Ltd.



Showrooms:
159 Borough High Street
London Bridge, S.E.1
Phone: Hop 3000

EVERYTHING RADIO FROM READY RADIO

READY RADIO H.T. ELIMINATORS

(Designed and tested by Mr. G. P. Kendall, B.Sc.)

- R.1.—120 volts at 20 m.a.
3 H.T. Tappings £3 3 0
Or 8 equal monthly payments of ... 8/6
- R.2.—120 volts at 20 m.a.
1st H.T. Tapping variable, 3 H.T. Tappings, £3 10 6.
Or 12 equal monthly payments of ... 6/6
- R.3.—175 volts at 25 m.a.
3 H.T. Tappings, £4 0 0
Or 12 equal monthly payments of ... 7/6
- C.R.2.—120 volts at 20 m.a.
3 H.T. Tappings, 2 variables; also ½ amp. trickle charger, £5 7 6
Or 12 equal monthly payments of ... 10/-
- C.R.1.—120 volts at 20 m.a.
3 H.T. Tappings, also ½ amp. trickle charger, £4 10 0
Or 12 equal monthly payments of ... 8/3
- G.R.1.—120 volts at 20 m.a.
3 H.T. Tappings, also a ½ amp. trickle charger, and grid bias tappings —1½v., —4½v., —12½v. £5 0 0
Or 12 equal monthly payments of ... 9/3
- G.R.3.—175 volts at 25 m.a.
3 H.T. Tappings, also ½ amp. trickle charger, and grid bias tappings —1½v., —4½v., —12½v. £5 17 6
Or 12 equal monthly payments of ... 10/6
- A.R.3.—175 volts at 25 m.a.
3 H.T. Tappings, also 2 windings of 4 volt 3 amp. A.C. Note, these windings can be used in parallel to give 4 volts at 6 amp., £5 0 0
Or 12 equal monthly payments of ... 9/3

B.T.H. R.K. MOVING-COIL LOUD-SPEAKERS

- SENIOR A.C., £7 15 0
Or deposit of 15/9 and 6 equal monthly payments of ... £1-4-10
- SENIOR D.C., £5 5 0
Or deposit of 10/9, and 6 equal monthly payments of ... 17/-
- PERM. MAG., £5 12 6
Or deposit of 11/6, and 6 equal monthly payments of ... 18/2
- MINOR PERM. MAG. with matching transformer, £3 1 6
Or 6 equal monthly payments of ... 11/3

GRAMOPHONE EQUIPMENT PICK-UPS

- A.E.D.—With Tone Arm No. 601
Every note perfect. Negligible record wear. Perfect tracking, £2 2 0
Or 6 equal monthly payments of ... 7/9
- A.E.D. "Beta" type, with tone arm No. 612, £1 10 0
Or 6 equal monthly payments of ... 5/6

We maintain a stock of over £40,000 worth of Radio Apparatus of every make and description. Whatever you want, large or small, you can be sure it is in stock at Ready Radio ready for IMMEDIATE DISPATCH. AND you can buy either for Cash or by Easy Payments. Avoid delay and disappointment by ordering all your radio from Ready Radio.

B.T.H. SENIOR, £2 5 0
Or 6 equal monthly payments of ... 8/3

BLUE SPOT, £3 3 0
Or 8 equal monthly payments of ... 8/6

MOTORS

COLLARO A.C. Induction, £3 0 0
Or 11 equal monthly payments of ... 6/-

COLLARO, Double Spring, B.30, £1 13 0
Or 6 equal monthly payments of ... 6/-

KITS

R for M. V.3., £5 17 6
Or 12 equal monthly payments of ... 10/6

MULLARD 1932, without cabinet, £6 10 0
Or 12 equal monthly payments of ... 12/-

COSSOR 1932, No. 234, with cabinet, £6 15 0
Or 12 equal monthly payments of ... 12/3

COSSOR, A.C. Mains, £9 19 6
Or 12 equal monthly payments of ... 18/3

SIX-SIXTY Chassis Kit, £6 17 6
Or 12 equal monthly payments of ... 12/6

OSRAM New Music Magnet 4, £10 15 0
Or 12 equal monthly payments of ... 19/8

BLUE SPOT LOUD-SPEAKERS

44.R.—Cabinet Speaker in Oak, £2 12 6 (incorporates 66.R. Unit)
Or 7 equal monthly payments of ... 8/-

100.D.—Inductor in Oak Cabinet, £3 3 0 (moving coil quality at cheap cost)
Or 8 equal monthly payments of ... 8/6

GOLIATH 30 P.M. in walnut cabinet, £5 10 0 (moving coil reproduction at its best. Very sensitive)
Or 12 equal monthly payments of ... 10/-

66.R.—Unit and special chassis, £2 2 6
Or 6 equal monthly payments of ... 7/9

100.U.—Inductor Unit Chassis, £1 19 6
Or 6 equal monthly payments of ... 7/3

Permanent Mag. Moving-Coil Speaker Chassis with output matching Transformer, £3 15 0
Or 12 equal monthly payments of ... 6/9

W.B. LOUD-SPEAKERS

PM.1.—With Output Matching Transformer, £6 0 0
Or 12 equal monthly payments of ... 11/-

PM.2.—With Output Matching Transformer, £4 5 0
Or 12 equal monthly payments of ... 7/9

PM.3.—With Output Matching Transformer, £2 12 6
Or 7 equal monthly payments of ... 8/-

H.T. ACCUMULATORS

FULLER, Type DMHG.—120 volt, 6,500 m.a. capacity £4 1 0
Or 12 equal monthly payments of ... 7/6

FULLER.—150 volt, 6,500 m.a. capacity, £5 1 3
Or 12 equal monthly payments of ... 9/3

H.T. BATTERIES

PERTRIX.—150 volt Super Capacity H.T. Battery No. 301, £1 11 0
Or 6 equal monthly payments of ... 5/9

INSTAMAT TRANSFORMERS

For Magnetic type Speakers, £1 7 6
Or deposit 10/- and 4 equal monthly payments of ... 5/-

For Moving Coil Speakers, £1 17 6
Or deposit 10/- and 6 equal monthly payments of ... 5/-

EPOCH LOUD-SPEAKERS

J.1.—P.M. Moving-coil Speaker with Matching Transformer, £2 5 0
Or 6 equal monthly payments of ... 8/-

A.2. P.M. Moving-coil Speaker with Matching Transformer, £3 3 0
Or 8 equal monthly payments of ... 8/6

1011.E.—A.C. Mains Chassis only, without Rectifier, £6 15 0
Or 12 equal monthly payments of ... 12/6

1011.E.—A.C. Mains Chassis with Mains Transformer and Westinghouse 2 amp. Rectifier, £10 0 0
Or 12 equal monthly payments of ... 18/3

EASY PAYMENT ORDER FORM

To: Ready Radio Ltd., Eastnor House, Blackheath, S.E.3

Please dispatch at once my Easy Payment Order, for which I enclose first deposit of ... £.....

NAME

ADDRESS

Goods Required..... A.W. 24/10/31

Advt. of Ready Radio Ltd.

CASH OR C.O.D. ORDER FORM

To: Ready Radio Ltd., Eastnor House, Blackheath, S.E.3

Please dispatch at once my order for which (a) I enclose £.....

(b) I will pay £..... on delivery.
(Cross out whichever does not apply)

NAME

ADDRESS

Goods Required..... A.W. 24/10/31

STEP-BY-STEP BASEBOARD ASSEMBLY



First step in the baseboard assembly—Fitting the valve holders to accommodate the five valves and the two screened intermediate frequency super-het coils

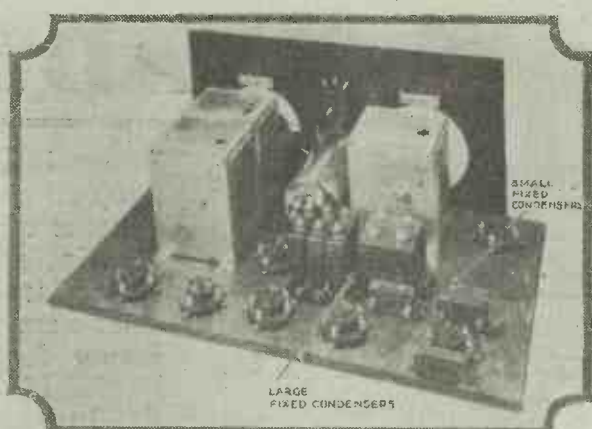

The large and small fixed condensers fitted in position on the baseboard

Special Note: If extra band-pass fixed condenser is used, it is fitted just behind the two-gang condenser on the left

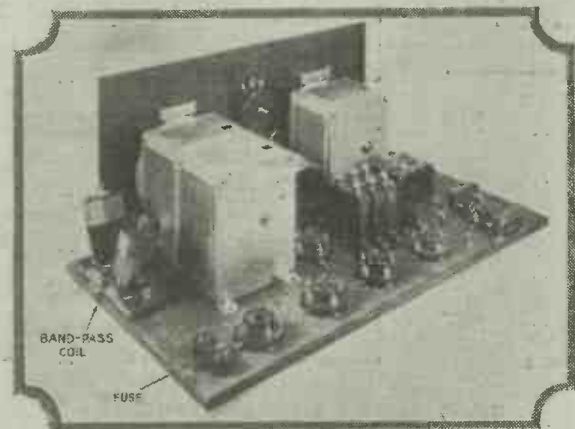

Note the switch of the band-pass coil is pointing outwards



Final baseboard fixing—The transformer, choke, and grid-leak holder

IN our fixing of the panel components we have already made a good start on the baseboard, for by now the two variable condensers are in position and a very good idea of the final set is taking shape.

We recommend that, in the fixing of the baseboard components of Britain's Super, our particular sequence is adopted. In general, it is easier to fit the smaller components first. If they are fitted last some difficulty may be experienced in getting at the fixing holes.

Follow the Blueprint!

The first step of the baseboard assembly is therefore the fitting of the valve-holders for taking the valves and coils. Altogether there are seven of these holders. Follow the blueprint implicitly in fitting them, in order to make quite sure that the grid and anode terminals are the correct way round.

Looking from the back of the panel, the valve holders arranged in a line along the baseboard have their anode terminals on the right-hand side.

The second step in the baseboard component assembly is the fixing of the large fixed condensers. First fit the 2-microfarad condenser and then the four 1-microfarad condensers, all with $\frac{1}{2}$ -inch screws.

Next fit the smaller condensers in an upright position and not by the alternative method of laying them flat on the

baseboard. Again refer to the blueprint to check the exact positions, which are critical so far as the wiring is concerned.

If extra fixed condenser is used on band-pass coil, refer at this stage to supplementary blueprint.

Now we must fit the band-pass tuning coil. This is done with two five-eighths screws. Note that the position of this coil is on the extreme left-hand end of the baseboard, looking from the back. See that the switch on this coil is pointing outwards. The fuse-holder can now be fitted at the extreme left-hand end of the baseboard.

We now arrive at the final component fixing, comprising the low-frequency transformer, the choke and the grid-leak holder. Five-eighths screws are used for the transformer fixing, half-inch for choke and three-eighths screws for the grid-leak holder.

Make quite sure when fitting the baseboard components to see that they are mounted square with the baseboard, otherwise the final appearance will be untidy.

Another valuable hint (which is not intended as a reflection on the component makers!) is to make sure that the terminal shanks are tightly screwed home on each component before components are screwed down. There is nothing more annoying than a loose terminal connection during the wiring process, since this necessitates undoing the component to tighten up the shank from underneath. We have now completed the baseboard assembly.

LET "AMATEUR WIRELESS" SOLVE YOUR RADIO PROBLEMS!

READ THESE HINTS AND TIPS BEFORE WIRING UP!

BEFORE giving detailed instructions about the wiring, some general hints and tips will be useful. We make our connections with round tinned-copper wire of No. 20 gauge. Over this is slipped insulating sleeving of $1\frac{1}{2}$ -millimeter diameter. For the "Britain's Super" set we are describing, 8 ft. of sleeving are needed and a quarter of a pound reel of the tinned copper wire. Not all this wire is required, but it is not usually sold in smaller quantities.

No Soldering!

It is important to note that there is no soldering in this set. All the connections are made by means of pressure contacts formed by clamping the bare looped end of the wire between the terminal washer and nut.

Now for the method of making these pressure-contact connections. First of all, straighten the wire by uncoiling about 18 in. from the reel. The straightening is done by gripping the free end of wire in the jaws of the pliers held in the right hand and holding the reel end of the wire in the left hand, exerting a gentle pull until the wire "gives."

This process enables the wire to be threaded quite easily through the sleeving. After straightening, cut off the wire and sub-divide as required.

Now we will give an example of how a connection is made. Take the wire in the left hand and grip the free end with pliers held in the right hand. Gently turn the wire into a loop just large enough to slip over the terminal shank. Put the looped end of the wire on the terminal shank so that it

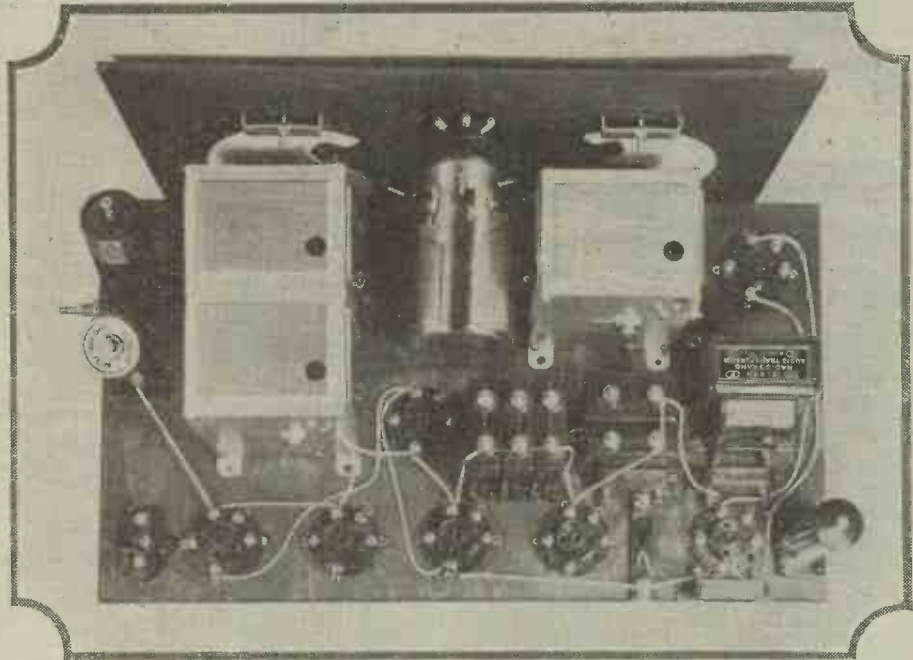

Here is the first part of the wiring—all the connections of the filament circuit have been made at this stage

coils in a clockwise direction.

When the terminal nut is screwed up it will then tend to close the loop instead of uncoiling it—as would happen if the loop were put on the opposite way round.

At this stage the length of bare wire, with one end looped, is fitted to one terminal connection. Next the bare wire is laid along the route indicated as near as possible by the blueprint and the wire is cut off $\frac{1}{2}$ -in. beyond its point of connection.

Next, measure up sufficient sleeving to cover the intervening wire length. Then cut off this piece of sleeving and slip over the wire. We arrive at the final process of making a connection, which is the looping of the free end of the wire over the second terminal shank.

This can be done as already described for the first connection, or the straight end of the wire can

*Full technical details of "Britain's Super" were given in last week's "Amateur Wireless."
See also other pages in this issue.*

be curled round the shank in a clockwise direction.

Those who would prefer to have their connecting wires ready-made should use the Ready Radio packet of Jifflinx—already looped and insulated.

Sometimes two wires have to be clamped under one terminal nut. The best plan is to screw up one connection and later undo the terminal nut to take the second connection. This prevents loss of nuts!

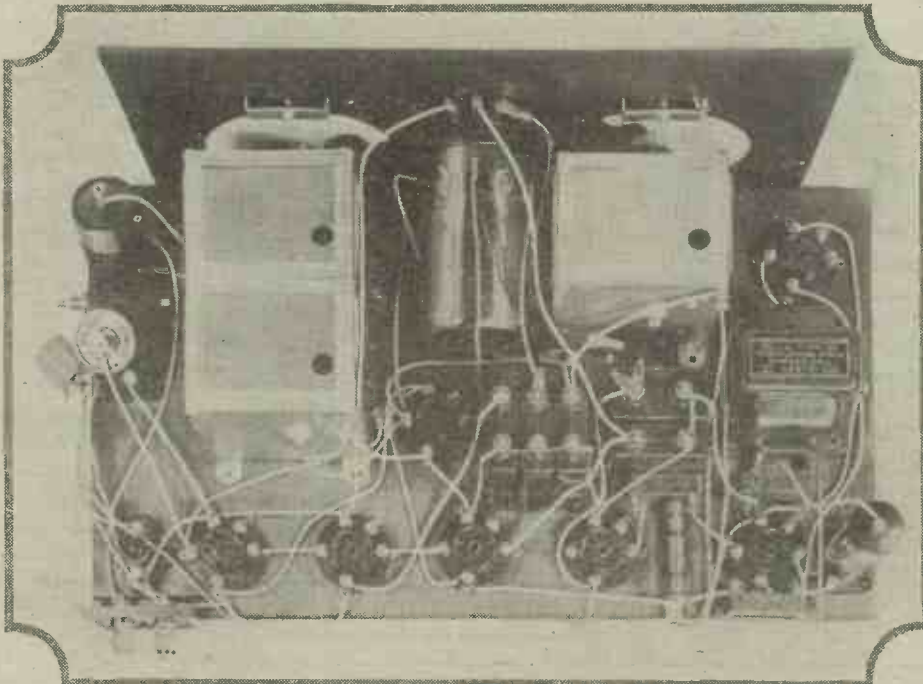

The completed wiring—note the switch on the left, near the band-pass coil

FINAL WIRING AND CHECKING OF "BRITAIN'S SUPER"

In making the lengths of wire for the connections do not slavishly follow the actual outline given on the blueprint. This may sound like heresy, but it will be readily understood that the blueprint is drawn in two dimensions only and cannot, therefore, fully convey the relative planes of the connections with respect to each other.

The blueprint accurately indicates the direction of the connections and also specifies implicitly the point-to-point connections.

To prevent any possibility of mistake, each of the connections shown by the blueprint is numbered. The point to remember is that each wire length has a separate number. Where two lengths of wire have a common terminal connection, the wires follow in numbered sequence.

Carrying out the wire looping instructions already given, the constructor can start with No. 1 wire and continue until wire No. 41 is finished. At this stage the oscillator coil must be removed and 9-in. lengths of bare wire pressed into the clamping tags on the oscillator coil.

This coil is then replaced on the panel with the only unconnected tag, that is the white tag, facing the baseboard. Carry on as before measuring suitable lengths of sleeving to cover the coil connections indicated by the blueprint.

Note that wires No. 46 and No. 47 are flexible resistances. After fixing these the aerial and earth terminal strip is screwed to the left-hand of the

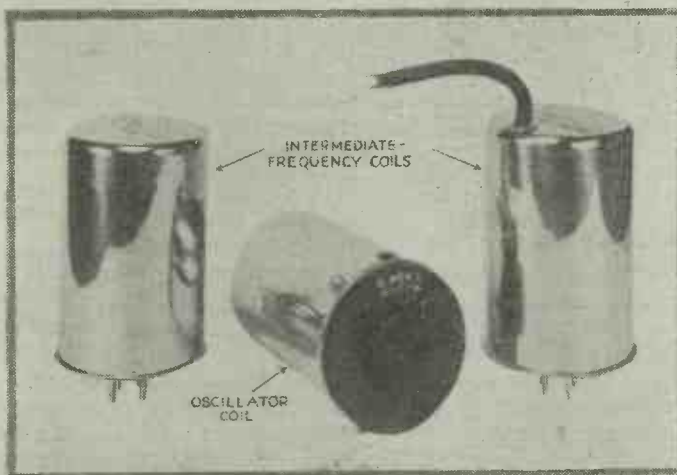

The heart of the set—the super-het coils

baseboard. Then the wiring is continued with wire No. 48.

Wire No. 50 is the last of the stiff connections and No. 51 starts the flex connections to the switch later to be mounted on the side of the cabinet.



If the instructions given in this supplement are closely followed, the construction of "Britain's Super" is very simple!

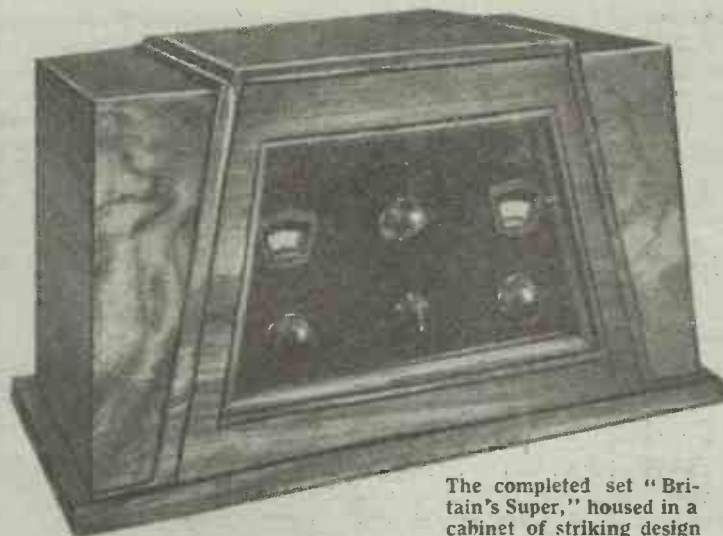

The completed set "Britain's Super," housed in a cabinet of striking design

Wire No. 53 is the start of the flexible connections to the batteries and these are very clearly marked on the blueprint.

Note that there is no loud-speaker terminal strip, as flexible wires are taken to the anode of the power valve and from the wire marked HT + 4 on the blueprint. These leads are numbers 62 and 63.

Wire No. 64 completes the wiring, this being the flexible lead from the connection of the oscillator valve holder to the side terminal on the bi-grid valve.

If fixed condenser for band-pass coil is fitted, note the alterations on the supplementary blueprint.

Now that all the wiring has been completed, the time has arrived for the fitting of the wander plugs and spade terminals on the ends of the battery flexible wires. Bare about 1/2-in. of the flexes and twist the bared end of wire back on to the rubber covering, bending it back as closely as possible to the beginning of the bared portion.

Push the prepared flex end into the coloured moulded top of the plug and screw in the metal plug, thus making a firm connection.

For neatness we suggest that the flexes be twisted together in groups, one group for the high-tension battery, another group for the low-tension battery and the third group for the grid-bias battery.

The set is now completely ready to be inserted in its cabinet, but before doing so make sure that the grid leak and the fuse bulb are inserted in their correct holders.

In fitting the set into the cabinet the constructor must take care to locate the correct positions of the holes on the right-hand side of the cabinet, looking from the front, accommodating the band-pass aerial coil switch and the battery switch.

An extension rod is provided with the band-pass coil and this can be cut off to the required length after the set has been fitted into the cabinet. The battery switch is fixed by means of a nut on the outside of the cabinet.

270

MAKING YOUR SET MORE SELECTIVE

A SPECIAL "HOME RADIO" HOW-TO-DO-IT FEATURE

Amateur Wireless

Every
Thursday 3^d

and
Radiovision

Vol. XIX, No. 490

Saturday, October 31, 1931

HOW TO MAKE YOUR SET MORE SELECTIVE!



ALSO IN THIS ISSUE

A SPECIAL
"HOME-RADIO"
FEATURE

GETTING STATIONS WITH BRITAIN'S SUPER



Another LEWCOS^{Regd.} "All-British" Triumph

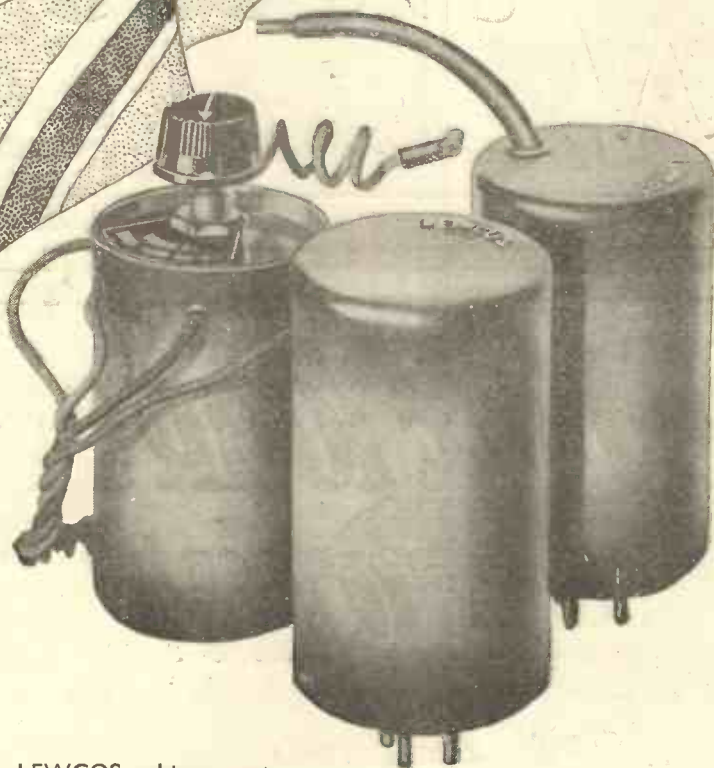

The Super-Het Coil Kit

(Ref. SHK No.3)

PRICE 37/6

Comprising:

- I OSCILLATOR COIL
Ref. O.S.C./126.

- I INTERMEDIATE FREQUENCY
TRANSFORMER (without pigtail)

- I INTERMEDIATE FREQUENCY
TRANSFORMER (with pigtail)

This new LEWCOS achievement—the Super-Het Coil Kit—which has a nine Kilo-Cycle Wave-band separation and consists of one Oscillation Coil, one I.F. Coil with "Pigtail" and one I.F. Coil without, marks a new epoch in Radio reception.

The small space available is completely inadequate to give even a short description of these wonderful new LEWCOS Coils, but you are invited to write for an illustrated explanatory leaflet, Reference R.71.

THE LEWCOS
BAND-PASS
FILTER, Price 12/-
is also specified for
"BRITAIN'S
SUPER"
RECEIVER.



The Lewcos Super-Het Coil Kit is specified for the "Britain's Super" Receiver described in this issue.

*Buy British and
Keep British
Labour Employed.*

LEWCOS RADIO PRODUCTS FOR BETTER RECEPTION

THE LONDON ELECTRIC WIRE COMPANY AND SMITHS LIMITED, CHURCH ROAD, LEYTON, LONDON, E16

Advertisers Appreciate Mention of "A.W." with Your Order

MUTUAL CONDUCTANCE 6.5
 ANODE RESISTANCE 11,500
 AMPLIFICATION FACTOR 75



AC2/HL

METALLISED

IN THE MAZDA RANGE OF MAINS VALVES

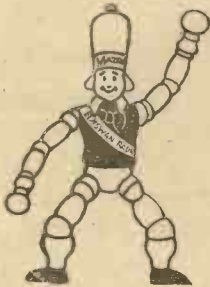

This valve is one of the new metallised types in the Mazda mains range. Its high mutual conductance and low anode resistance make it an ideal power grid detector. Amazingly sensitive to small currents it can also be used with great success as an intermediate L.F. Amplifier. Performances like that given by the AC.2/HL are typical of Mazda mains types. When you purchase a Mazda valve you are getting a product of Mazda resources—Mazda engineering skill—Mazda research.

You can buy these valves at all good radio dealers.

MAZDA MAINS VALVES

TYPE	A.C. MAINS	PRICE
AC/HL ...	Clear ...	15/-
AC.2/HL ...	Metallised ...	15/-
AC/SG ...	Clear or Metallised ...	22/6
AC/S.2 ...	Metallised ...	22/6
AC/P ...	Clear ...	17/6
AC/P.1 ...	Clear ...	20/-
AC/PEN ...	Clear ...	25/-
D.C. MAINS		
DC/SG ...	Clear ...	22/6
DC/HL ...	Clear ...	15/-
DC/P ...	Clear ...	17/6
DC/PEN ...	Clear ...	25/-
DC.3/HL ...	Clear ...	15/-
DC.2/P ...	Clear ...	17/6
DC.2/PEN ...	Clear ...	25/-

THE AMAZING

MAZDA

THE
BRITISH
VALVES

THE EDISON SWAN ELECTRIC CO. LTD.
 RADIO DIVISION:
 155 CHARING CROSS ROAD, LONDON, W.C.2



EDISWAN RADIO

V139

You Will Help Yourself and Help Us by Mentioning "A.W." to Advertisers

Quality Radio for £6.6.0

SEVEN VITAL FEATURES

● Self-Contained Loud Speaker ● Band-Pass Tuning and Pentode Output giving Astonishing Selectivity and Power ● Economical Battery Consumption ● Full Broadcast Range (230-550 & 1,000-2,000 metres) and Easy Operation ● Entirely New and Simple Colour-Coded Assembly without Soldering ● Fixed Pick-up Sockets ● Compact Walnut Cabinet ●

At its amazing low price the Zonophone Kit Set brings Quality Radio within the reach of the most modest purse. The simple and ingenious construction of this set is praised by expert and amateur alike.



GRAMOPHONE ENTHUSIASTS!

The Zonophone Pick-up is the finest value in the world at

15/-

AND OF COURSE ZONOPHONE BATTERIES

Highest Efficiency
Greatest Economy

ZONOPHONE KIT SET

Famed alike for  Radio and Records

Prices shown do not apply in Irish Free State.

as easy as that!



SLOW MOTION CONDENSER

cuts out close stations with amazing accuracy

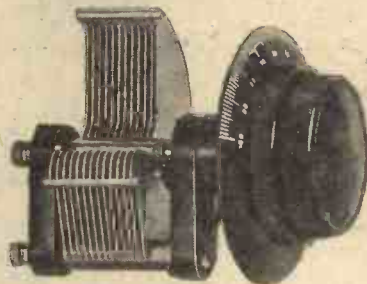

PRICE 6/-

The selective qualities of your set depend upon the efficiency of the condensers. Fit the new Formo slow motion with the silky drive—it makes all the difference.

DUAL AND TRIPLE GANGS



DUAL GANG
The two Condensers are completely insulated one from the other. The position of the stators can easily be seen as there is a hidden pointer behind the celluloid drum which throws a shadow on to the drum. Price 18/6

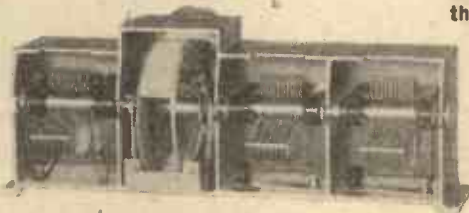

TRIPLE GANG
(completely screened) incorporating the same stator indicator as Dual Gang. Housed in rigid casting. Price 30/-

Obtainable from all Radio Dealers. Ask us to send you Complete Catalogue.

ARTHUR PREEN & CO., LTD.,
GOLDEN SQUARE, PICCADILLY CIRCUS, LONDON, W.1

SEE ALSO PAGE 866.

To Ensure Speedy Delivery, Mention "A.W." to Advertisers



Switches may appear to play a comparatively insignificant part in a wireless receiver. If, however, their functions and positions are considered, it will be seen that sound design and construction are of paramount importance.

Most radio switches are entirely unsuitable for the high-frequency side of a receiver, where losses and bad and noisy contacts cannot be tolerated. With this in mind, J. Sieger, the famous radio engineer, has designed the new LOTUS Universal Switch. This is a unique rotary switch with self-cleaning contacts which is provisionally patented by virtue of its design. The switch can be ganged in different ways, and is especially suitable for wave-change switching in any position.

Type US/3 1/6.

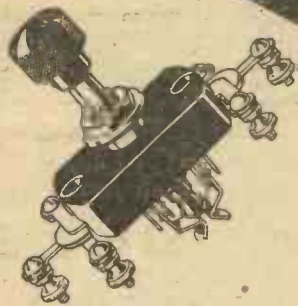

JS/9
The LOTUS Jack Switch. D.P.D.T. 4/-.

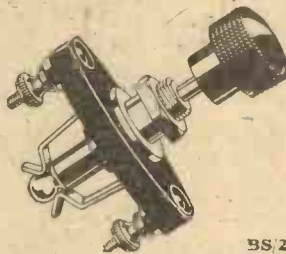

BS/20
The LOTUS Battery Switch, 1/6.

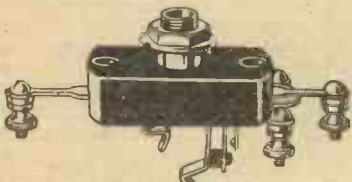

JK/4
The LOTUS Single Filament Control Jack, 2/6.

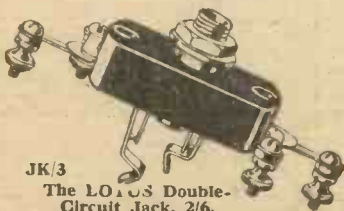

JK/3
The LOTUS Double-Circuit Jack, 2/6.



JP/1
The LOTUS Jack Plug, 2/-.



RADIO JACKS AND SWITCHES

Write for leaflet giving suggestions for use of the switch and a copy of the LOTUS Component Catalogue. Every home constructor should have one.

LOTUS RADIO LTD., MILL LANE, LIVERPOOL

Ⓢ

Advertisers Appreciate Mention of "A.W." with Your Order

EVERYTHING NEW IN RADIO

IMMEDIATE DELIVERY

**C.O.D.
CASH
H.P.
as usual**

WE are the largest and oldest established Radio House in the Country, and in sending your orders to us there is no risk of delay. Orders executed on our famous 3-WAY PLAN—C.O.D., CASH or H.P. Express Service for everything Radio Guaranteed.

New 116-page catalogue 6d., post free.

MANUFACTURERS' KITS

**COSSOR
MELODY MAKER
TYPE 234
10/- DOWN**

Screened grid, detector, and power. Complete with specified valves and cabinet.

Cash Price £6:15:0

Balance in 11 monthly payments of 12/6

**FINISHED INSTRUMENT,
Royalties paid.**

Cash only. **£7:10:0**

EKCO H.T. UNIT, TYPE A.C.25 Send
For multi-valve sets requiring up to 25 m/a. Three tapings—S.G., detector, and 120/150 volts. For A.C. mains. Cash or C.O.D. £317/6. Balance in 11 monthly payments of 7/1

ATLAS A.C. ELIMINATOR, TYPE A.C. 244. Three tapings—S.G., detector, power. Output, 120 volts at 20 m/a. Cash Price or C.O.D., £2:19:6. Balance in 11 monthly payments of 5/6

REGENTONE W.5A COMBINED H.T. ELIMINATOR AND TRICKLE CHARGER. One S.G., 1 variable and 1 fixed tapping for H.T. L.T. for 2, and 8 volts. For A.C. mains. Cash Price £4:12:6. Balance in 11 monthly payments of 8/6

REGENTONE ELIMINATOR, TYPE W.1F. Three tapings, S.G., Detector, and Power. Output 120 volts at 12 m/a. A.C. Mains. Cash Price £2:7:6. Balance in 5 monthly payments of 8/4.

AMPLER MC.5 MOVING-COIL SPEAKER. Permanent magnet. With output transformer. Complete. Cash Price £3:7:6. Balance in 11 monthly payments of 6/2.

CELESTION PERMANENT-MAGNET MOVING-COIL SPEAKER. Type RP18. 8in. reinforced diaphragm. Chassis form without input transformer. Cash Price £3:10:0. Balance in 11 monthly payments of 6/5.

BLUE SPOT PERMANENT MAGNET MOVING-COIL SPEAKER. Complete with input transformer. Cash Price, £3 15 0. Balance in 11 monthly payments of 6/11.

W. B. PERMANENT MAGNET MOVING-COIL SPEAKER P.M.3. Complete with 3-ratio input transformer. Cash Price, £2 12 6. Balance in 11 monthly payments of 4/10.

R. & A. PERMANENT MAGNET MOVING-COIL SPEAKER. Complete with multi-ratio input transformer. Cash Price, £2 17 6. Balance in 11 monthly payments of 5/4.

EPOCH A2 PERMANENT MAGNET MOVING-COIL SPEAKER. Fitted with multi-ratio input transformer. Cash Price, £3 3 0. Balance in 11 monthly payments of 5/9.

NEW B.T.H. "SENIOR" PICK-UP AND TONE-ARM. Complete. Cash price £2 5s. 0d. Balance in 11 monthly payments of 4/2.

SPECIAL FOR "BRITAIN'S SUPER"
Lewcos "B.P.F." Band Pass Filter Unit, 12/-; Lewcos or Wearite Super Het Coils (types 02, 0T2 and 0T1), 37/6; J.B. 2-gang Condenser, 21/-; J.B. Single Condenser, 12/6. Cash or C.O.D., £4 3 0. Complete parcel. Or 12 monthly payments of 7/7.



VOXKIT RADIOGRAM CABINET MODEL 1932. Accommodation for largest of home-built receivers with a full-size speaker and mains or battery equipment. Complete with motor board. Dimensions overall: 39in. high by 22in. wide by 17in. Internal Panel, 18 by 7in., baseboard, 18 by 14in., Speaker chamber, 18 by 14in. by 16in. Panel, 12 1/2 in. between moulding. Oak. Cash Price £4-10-0 Or 12 monthly payments of 8/3.

PILOT PERMANENT MAGNET MOVING-COIL SPEAKER. Matches the requirements of all modern receivers. Includes Unit designed and built specially for Peto-Scott by Epoch. Handles the smallest to the greatest input and brings out most minute details of tonal quality with pure, full volume. A multi-ratio input transformer is fitted and provides for matching to all super-power and pentode valves. The handsome hand-polished solid oak cabinet is built to give added depth of tone, and is fitted with ebonised base and side wings and silk-covered fret. Cash Price £3-15-0 Or 12 monthly payments of 6/11.



VOXKIT 1932 CONSOLE (Radio only). Another attractive addition to the famous Voxkit range. Accommodates the largest home built receiver and bulkiest speaker, mains or battery supply. Almost identical with the 1932 Voxkit Radiogram. Dimensions: 37 in. high by 22 in. wide by 13 1/2 in. Panel, 18 by 7 in. Baseboard, 18 by 12 in. Speaker compartment, 18 in. wide by 14 in. high by 12 in. deep. Front panel, 12 1/2 in. Oak. Cash Price £3-15-0 Or 12 monthly payments of 6/11.

KELSEY SHORT-WAVE ADAPTOR

Add more stations to your set. Plugs direct into your battery or eliminator operated receiver. Complete with instructions. Sent C.O.D. Postage free. Pay the postman. Mahogany or Oak Cabinet ... 7/6. Nothing more to buy—no valves or any extras.

37/6



SPECIALLY RECOMMENDED

EPOCH J.1 PERMANENT MAGNET MOVING-COIL SPEAKER Send
with multi-ratio input transformer. Cash Price, £2 5 0. Balance in 11 monthly payments of 4/2.

BLUESPOT DYNAMIC TYPE SPEAKER UNIT AND CHASSIS TYPE 100 U. Cash Price, £1 19 6. Balance in 7 monthly payments of 5/5.

GARRARD INDUCTION GRAMOPHONE MOTOR. Model 202. For A.C. Mains only. Mounted on 12-in. Nickel Motor Plate with fully automatic electric starting and stopping switch. Cash Price, £2 18 6. Balance in 11 monthly payments of 5/4 only.

ORMOND PERMANENT MAGNET MOVING COIL CHASSIS (No. 464). With tapped input transformer. Cash Price, £3 5 0. Balance in 11 monthly payments of 5/11.

ROLA PERMANENT MAGNET MOVING-COIL SPEAKER. Complete with Input Transformer. Cash Price, £2 17 6. Balance in 8 monthly payments of 7/1.

All orders over 10/- sent carriage paid

PETO-SCOTT

PETO-SCOTT CO. LTD. Head Office: 77 CITY ROAD, LONDON, E.C.1. Clerkenwell 9406. 62 HIGH HOLBORN, LONDON, W.C.1. Chancery 8266. MANCHESTER: 33 WHITELOW ROAD, CHORLTON-CUM-HARDY. Phone: Chorlton-Cum-Hardy 2028. NEWCASTLE, STAFFS: 7 ALBANY ROAD. Phone: 67190.

**V 3 KIT
RADIO FOR THE MILLION
10/- DOWN**

Powerful, selective, and ultra modern. Employs screen grid, detector, and power valves. With valves, less cabinet.

Balance in 11 monthly payments of 10/10

Cash Price. £5:17:6

**FINISHED INSTRUMENT,
with valves and cabinet. Royalties paid.**

Cash only. **£7:8:6**

EXPRESS ORDER FORM

TO PETO-SCOTT CO. LTD.
Please send me C.O.D., CASH/H.P.

.....
.....
.....
.....
for which I enclose
Cash/H.P. Deposit £ s. d.
Name

Address

A.W. 31/10/31.

Near Britain's Super demonstrated at our Showrooms:
77, CITY ROAD,
LONDON, E.C.1.
69, HIGH HOLBORN,
LONDON, W.C.1.

This is the Set the Author Built

the Season's greatest hit



DOMINATING FEATURES OF PILOT AUTHOR'S KITS

Chosen and first specified by the Technical Department of Amateur Wireless, and used by Mr. W. James. Officially approved, therefore, by an established technical authority you can trust implicitly. Backed by Peto-Scott himself, twelve years Radio Experience and a world-wide reputation. Enables the Author's published Set to be duplicated exactly in every respect.

The No Substitute Kit
IMMEDIATE DELIVERY

The No Substitute Kit
BRITAIN'S SUPER
This is the Kit the Author Used

Any reputable dealer will gladly supply you with a PILOT AUTHOR'S KIT for Britain's Super. Do not trust a substitute kit made up of substitutes.

PILOT AUTHOR'S KIT

Check this Pilot Author's Kit of parts for "Britain's Super" with the Author's specification in this week's issue of "A.W." £ s d.

- 1 Ebonite Panel 14" x 7". Drilled to Author's specification ... 4 6
 - 1 Baseboard 17" x 9 1/2" ... 1 6
 - 1 J.B. Type R2 Two-gang .0005-mfd. Variable Condensers ... 1 1 0
 - 1 J.B. Type R1 Single .0005-mfd. Variable Condenser ... 12 6
 - 1 Varley 50,000-ohm Variable Resistance ... 6 6
 - 3 Wearite Super-het Coils (one Oscillator and two Intermediates, Types O2, OT2 and OT1) ... 1 17 6
 - 1 Lewcos "B.P.F." Bandpass Filter Unit, with extension rod ... 12 0
 - 4 T.C.C. 1-mfd. Fixed Condensers ... 11 4
 - 1 T.C.C. 2-mfd. Fixed Condenser ... 3 10
 - 2 Telsens .0002-mfd. and one .0003-mfd. Fixed Condensers ... 1 6
 - 1 Telsens one-megohm Grid Leak ... 9
 - 1 Ready Radio Grid-leak holder ... 6
 - 1 Ready Radio Super-het Choke ... 5 6
 - 1 Telsens Low-frequency Transformer (7-1) ... 12 6
 - 2 Lewcos Spaghetti Resistances, one 15,000-ohm and one 20,000-ohm ... 3 0
 - 1 Bulgin Fuse holder and Fuse ... 1 0
 - 1 Junit Terminal Block ... 8
 - 1 Bulgin Type 588 Double-pole Toggle Switch ... 2 9
 - 4 Lengths of sleeving: connecting wire 20-gauge bare tinned copper, 6 yards of thin flex all screws and nuts ... 3 6
 - 2 Belling-Lee terminals—Aerial and Earth ... 9
 - 8 Belling-Lee marked Wander Plugs ... 1 4
 - 2 Spade Terminals ... 4
 - 1 T.C.C. .01 mfd. Fixed Condenser upright type ... 3 0
- AUTHOR'S KIT "A" Cash or C.O.D. £7 7 9**

Any of the above items supplied separately. If order over 10/- sent carriage paid. C.O.D. we pay post charges.

COMPLETE KIT PRICES
KIT A Author's Kit less Valves and Cabinet

CASH or C.O.D. **£7.7.9**

or 13/7 down and 11 monthly payments of 13/7

KIT B Author's Kit with Valves but less Cabinet. CASH or C.O.D. **£10.15.3**

or 19/9 down and 11 monthly payments of 19/9

KIT C Author's Kit complete with Valves and Cabinet. CASH or C.O.D. **£12.0.3**

or 22/- down and 11 monthly payments of 22/-

FINISHED INSTRUMENT
Ready assembled, Aerial Tested. Royalties Paid. **£14.10.0**
Cash Price or 26/7 down and 11 monthly payments of 26/7.

SPECIAL C.O.D. ITEMS
Pay the Postman We pay all Post charges

- 3 Wearite Super Het Coils (one oscillator and two intermediates) Types O2, OT2, OT1 ... 1 17 6
- 1 Lewcos "B.P.F." Bandpass Filter Unit with Extension Rod ... 12 0
- J.B. Type R2 2 Gang Variable Condenser ... 1 1 0
- J.B. Type R1 Single Variable Condenser ... 12 6
- Cabinet as specified ... 1 5 0
- Peto-Scott popular priced hand french polished Oak Cabinet ... 19 6
- 5 Mullard Valves as specified: P.M.1DG, P.M.2DX, P.M.12, P.M.1HL, P.M.2A. ... 3 7 6

SPECIALLY DESIGNED PETO-SCOTT CABINETS

Britain's Super Popular Cabinet



CASH PRICE **19/6**

Takes 14" x 7" Panel and 17" x 9 1/2" Baseboard. Attractive vignetted front. Removable back. In handsome French Polished Oak with ebonised feet.



Britain's Super Console
Takes 14" x 7" Panel, 17" x 9 1/2" Baseboard and any type of Speaker up to 12" Cone Diameter. Fitted with shelf for batteries or Main equipment. Back fretted to ensure perfect acoustic conditions. Hand French Polished Oak with silk gauze. Ebonised feet. Complete with baffle board cut to requirements. Cash **35/-**

TRADE SUPPLIED. DELIVERY FROM STOCK

C.O.D. | CASH | H.P. | unusual

PETO-SCOTT

PETO-SCOTT CO. LTD. Head Office: 77 CITY ROAD, LONDON, E.C.1. Clerkenwell 9406. 62 HIGH HOLBORN, LONDON, W.C.1. Chancery 8266. MANCHESTER: 33 WHITELOW ROAD, CHORLTON-CUM-HARDY. Phone: Chorlton-cum-Hardy 2028. NEWCASTLE, STAFFS.: 7 ALBANY RD.

EXPRESS ORDER FORM
To PETO-SCOTT CO. LTD.
Please send me C.O.D., CASH/H.P.

.....
.....
.....
for which I enclose
Cash/H.P. Deposit £ s. d.
NAME.....
ADDRESS.....

A.W. 31/10/31

Mention of "Amateur Wireless" to Advertisers will Ensure Prompt Attention

TELSEN VARIABLE CONDENSERS

TELSEN BAKELITE DIELECTRIC CONDENSERS

These Condensers are of a new and improved type and of exceptionally compact dimensions. The moving vanes, which are interleaved with finest quality bakelite, are keyed on to the spindle so that they cannot be pushed out of line, and there is a definite stop at each end of the travel. The connection to rotor is made by means of a phosphor-bronze pigtail so that there is no crackling due to rubbing contacts. The connection to the stator vanes is absolutely positive—a very important point.

All Telsen Bakelite Condensers are supplied complete with knob.

- Differential Condenser—
Capacities of .0003, .00015, .0001 Price 2/-
- Reaction Condenser—
Capacities of .0003, .00015, .0001 Price 2/-
- Capacities of .00075, .0005 Price 2/6
- Tuning Condenser—
Capacities of .0005, .0003 Price 2/-

TELSEN LOGARITHMIC VARIABLE CONDENSERS

The Telsen Logarithmic Variable Condenser is of robust construction and high insulation. The H.F. losses are very low and the frame is braced at three points, so that the possibility of distortion and short circuiting is negligible. Substantial terminals are provided with alternative connections to the stator.

- Telsen Logarithmic Variable Condenser—
Capacities of .0005, .00035, .00025 Price 4/6

TELSEN PRE-SET CONDENSERS

These Condensers have been carefully designed to give proper separation of vanes when the adjustment is unscrewed, which results in a very low minimum capacity, giving a wide range of selectivity adjustment when used in the aerial circuit.

- Telsen Pre-set Condenser—
Made in capacities from .002 to .0001 mfd. Price 1/6

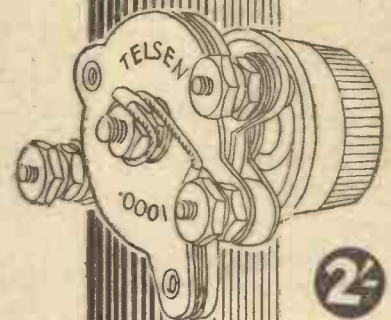

2/-

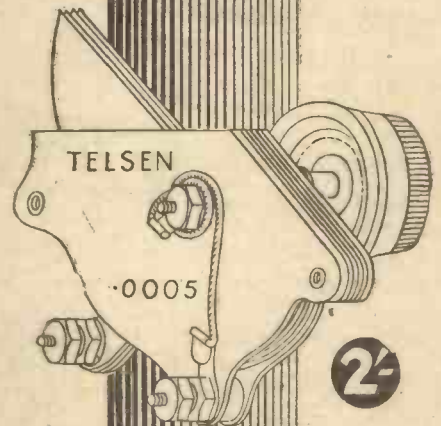

2/-

TELSEN

THE SECRET OF PERFECT RADIO RECEPTION

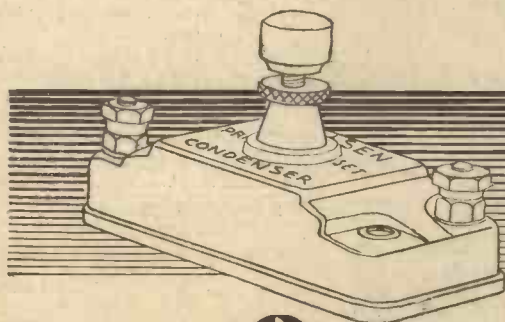

1/6

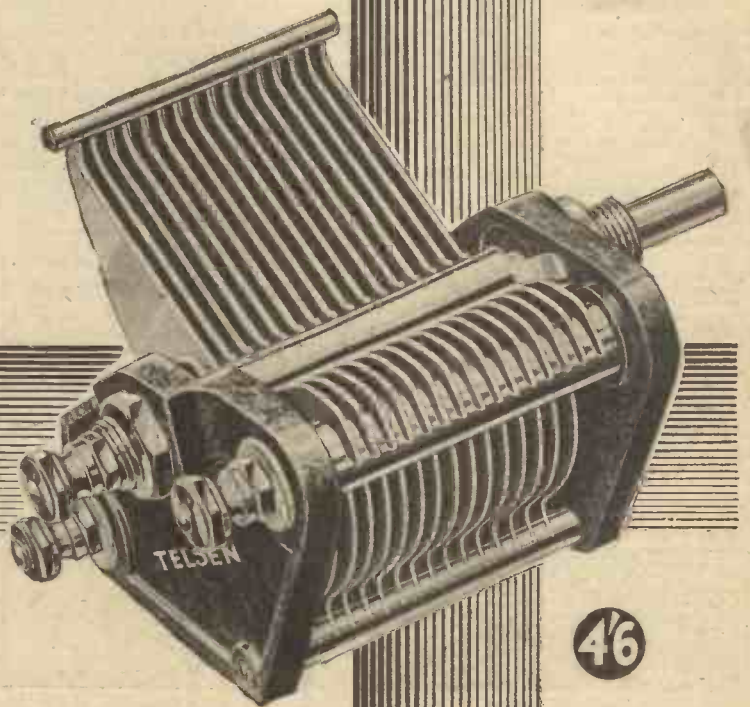

4/6

Send for the "Telsen Radio Catalogue" and book of "All-Telsen Circuits" to The Telsen Electric Co., Ltd., Aston, Birmingham.

To Ensure Speedy Delivery. Mention "A.W." to Advertisers



BRITAIN'S LEADING RADIO WEEKLY
FOR CONSTRUCTOR, LISTENER & EXPERIMENTER

EDITOR:
BERNARD E. JONES.

TECHNICAL EDITOR:
J. H. REYNER, B.Sc. A.M.I.E.E.

RESEARCH CONSULTANT:
W. JAMES

ASSISTANT EDITOR:
H. CORBISHLEY.

NEWS & GOSSIP OF THE WEEK

IN THE HOME

IN this issue you will find a special feature, "Home Radio," which is a how-to-do-it feature certain to make a big appeal to listeners who feel that they are not getting the best out of wireless in the home. Batteries, remote controls, loud-speaker extensions, selectivity units, and other practical gadgets are described. This special feature starts on page 875.

TELEVISION HOPES

WE hear that the chief engineer of the B.B.C., on his return from a recent demonstration at Long Acre of the latest Baird television apparatus, expressed the view that television on an entertainment basis might be brought appreciably nearer by the use of the ultra-short waves.

CHANGE OF FRONT

THERE seems to be a very definite change of front at Savoy Hill in relation to television. Whether the B.B.C.'s experiments on the 7-metre band, referred to in previous issues, will have any bearing on the short-wave television experiments

is not stated. The opinion has been expressed at the B.B.C. that short waves may overcome two of the present obstacles in the path of commercial television.

PRESENT LIMITATIONS

AT present there is, of course, the well-known limitation in image detail imposed by the 9-kilocycle band width of broadcasting stations. Then there is the problem of finding available frequencies for television broadcasting, at a time when ordinary broadcasting cannot be squeezed into the available ether space. This problem would also vanish if the ultra-short waves were utilised for television. Two years' time is given by optimists at Savoy Hill for a regular short-wave television service.

AT ROME

AT the time of writing, the Chief Engineer and the B.B.C. contingent are in the thick of the discussion at Rome, where the International Broadcasting Union is now sitting. The Chief Engineer has denied the statement that the B.B.C. intends to withdraw from the Union unless

the wavelength situation is cleared up. All the same, the B.B.C. delegates are concentrating on getting other European broadcasters to agree to an 11-kilocycles separation between stations, at least between stations above 300 metres.

MÜHLACKER'S SEPARATION

PROBABLY most listeners are unaware of the fact that the high-power German station, Mühlacker, is at present working 11 kilocycles away from London Regional, instead of the scheduled 9 kilocycles. Those who are suffering from Mühlacker's interference when listening to London Regional at the present time must blame their sets and not broadcasting conditions.

BROADCASTING HOUSE

EVERY week there is something to say about the B.B.C.'s new headquarters at Portland Place! At the moment all decorative work in the studios has been held up, because the engineers have discovered a "boom" in all of them. This resonance must be got rid of before decorations can proceed.

THE SCOTTISH SHOW

THE Scottish National Radio Exhibition in the Waverley Market, Edinburgh, opens on November 11. A feature of this is the model studio, from which broadcasting will take place during the afternoon and evening. This model studio is cut off from the public by a sheet of plate glass, through which broadcasters will be seen speaking into the microphone.

SEEING THE ARTISTES

AMONG those who will be visible in this model studio and who will be heard on speakers in the hall are the "Uncles" and "Aunts" from the Children's Hour, Pipe-Major J. A. Gordon, Jack McKendrick, the well-known Scots comedian, and the Studio Orchestra under their new leader, Mr. Guy Daines. It has been arranged also to broadcast the opening speeches at the Exhibition, which will be given by Mr. David Cleghorn Thomson, Scottish Regional Director, and Sir Thomas Whitson, the Lord Provost of Edinburgh, who will occupy the chair.

A TRAVELLING "MIKE"



This is the travelling microphone and modulation amplifier carried by outside broadcast engineers of the WGY, Schenectady, station

See the special announcement of the A.W. "Star" Sets on page 862

NEWS · & · GOSSIP · OF THE · WEEK — Continued

AMERICAN RELAYS

THE National Broadcasting Company of America is experimenting with special sets for the reception of our short-wave station, 5SW. The Columbia organisation has been tapping the resources of Europe by relaying from Paris, Berlin, and London prominent thinkers of the day, through the Rugby transatlantic phone service.

EVENING DRESS

WE hear this is likely to be compulsory for vaudeville artistes taking part in shows staged in the new vaudeville studio at Broadcasting House.

BOULT GOES OVER

DR. ADRIAN BOULT, the B.B.C.'s Music Master, has now installed himself at Broadcasting House, presumably to be nearer the Queen's Hall rehearsals for the Sunday symphony concerts. A natty 'bus now carries the B.B.C. staff from Portland Place to Savoy Hill and vice versa.

FOUR MILLION MARK

SO the B.B.C. has achieved its heart's desire—there are now more than four million licensed listeners in this country! We have to thank the Post Office detection vans for this sudden recent addition to licences. On September 30 we find

that 3,930,577 licences had been issued, but within seven days of the Post Office drive the four million mark had been passed.

MORE FIGURES!

1931 WILL certainly be a record year for licence increase. Within the first nine months of this year over half a million new licences have been taken out. The previous record annual increase was in 1924, when 544,623 licences were taken out, a total already reached this year—and there are three months to go.

THE PRINCE TO BROADCAST

THE PRINCE OF WALES, the Earl of Derby and the Lord Mayor of London are the principal speakers at the Master Mariners' Banquet at the Town Hall, Liverpool, on November 4. The relay of these speeches will last from 9.30 to 10.15 p.m.

A "FOOTER" COMMENTARY

ON October 17 a running commentary will be broadcast at 2.50 p.m. on the Association Football International between Ireland and England. This match is to be played on the ground of the Linfield Club, Windsor Park, Belfast, and the commentary will be broadcast by courtesy of the Irish Football Association. The commentator will be Mr. George F. Allison, and the match will be relayed on the National wavelengths.

MORSE PRACTICE

KEEN amateurs will be interested to know that the Radio Society of Great Britain is starting a regular series of morse practice transmissions, starting on Sunday, November 22. Morse signals will be given at various speeds on three wavelengths for approximately half an hour, the speed increasing from six words a minute to the more expert rate of twelve words a minute. These transmissions, full details of which can be had from the R.S.G.B., will interest enthusiasts who realise what they are missing on the short waves by not knowing morse code.

RE-DIFFUSION

A LARGE scheme for programme re-diffusion is now before the Post Office for sanction. The B.B.C., as most listeners know, is against the general principle of re-diffusion, and this latest proposal raises a point of controversy between the

B.B.C. and the Post Office. There is no undue friendliness just now between the two departments, other bones of contention being the wavelength problem and tele vision.

PROVINCIAL PROGRAMME CUTS

BEGINNING in November, local programmes from regional centres will be affected by the new rule of economy enforced by the B.B.C., following its voluntary loss of revenue. These local programmes will either have to be fewer in

See the special announcement on page 862 of an amazing new development by "A.W." of interest to all set-builders.

number or less expensive. The B.B.C. does not think the listeners will notice any marked deterioration in the quality of their local programmes, as economy is to be effected mainly by greater sharing of programmes between regional stations.

B.B.C. QUINTET

THE B.B.C.'s passion for dividing its Symphony Orchestra has been extended now to its Theatre Orchestra. Four of the strings of this orchestra, namely two violins, one viola and one 'cello, can now be extracted and, with an extra pianist, form the new B.B.C. Quintet. We take it that small outside orchestral combinations, such as the Gershom Parkington Quintet, will be less heard in the future.

INTERNATIONAL RELAY

ONE of the series of European concerts arranged internationally will be relayed to National listeners from Vienna, with the co-operation of the Austrian Broadcasting Company, on November 7. It will consist of extracts from the works of Franz Lehar, who will conduct the Vienna Philharmonic Orchestra, and the soloists will be of the Vienna Opera.

TREATMENT BY WIRELESS!

AN Argentinian, under treatment for an eye trouble, was on a visit to Berlin, says a Philips correspondent. During his stay his eye suddenly became worse. The doctor was on the other side of the Atlantic and the man was afraid to trust himself to a new doctor. A photograph was taken of his eye, sent by Atlantic picture telegraph service to Buenos Ayres in eight minutes, where it was reproduced very clearly, examined by the doctor, and treatment was wireless back!

WHO FOUND IT?

THEY are very fond of sending round omnibus chits for the attention of the staff at Savoy Hill. We hear that recently one of these chits, circulating from the Director-General down to the genial Director of Ceremonies at "North Entrance," contain the pathetic news that the productions department had lost a Swanee whistle!

MAKING A TALKIE

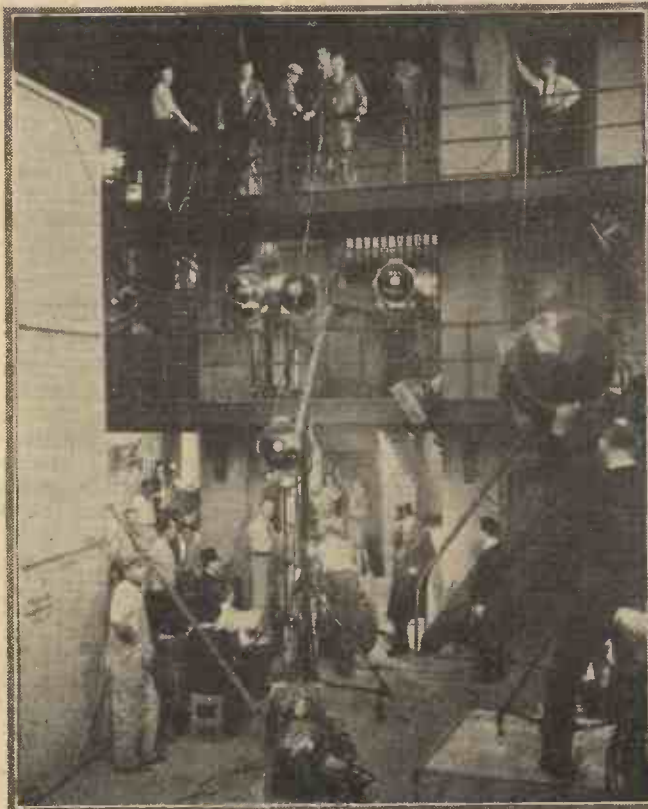

Behind the scenes in the talkie-film studio. Microphones and spotlights are being arranged for a scene in the new film "The Mad Genius." The camera and one of the microphones are moved on a trolley made of old car parts.

AN EASILY-MADE H.T. UNIT FOR D.C. MAINS



All set users who have direct-current mains available will be interested in this simple mains unit which abolishes battery bothers

NO listener who has direct-current electric-light mains available need go to the expense and bother of buying dry high-tension batteries. A mains unit which can be made up at a trifling cost, comprising only a choke and a few condensers and resistances, will take the place of the battery and give an ever-ready source of steady high tension.

The little mains unit illustrated by the accompanying photographs is just the job you want. It is so simple that anyone can make it up; all that has to be done is to screw the condensers and choke to a piece of plywood and mount a few terminals and the controlling resistance on an ebonite strip.

The principle of all these direct-current mains units is that the mains supply is smoothed by a choke (in this case a 50-henry component) and a reservoir condenser, and is cut down for the various tappings by means of resistances.

Outputs

In this unit spaghetti resistances are used for three tappings and a variable wire-wound potentiometer is provided for the screening grids. The spaghetti resistances have 2-microfarad condensers connected to the negative terminal for additional smoothing and by-passing.

The values of spaghetti resistances have been chosen so that on a 220-volt supply, which may be taken as the average typical D.C. mains supply, the following outputs are obtained: Tapping 4 (power), 160 volts at 30 milliamperes to 180 volts at 20 milliamperes; tapping 3 (for L.F. valve), 140 volt at 4 milliamperes; tapping 2 (detector), 140 volts at 2 milliamperes; and tapping 1 (variable for screen grid), 0-70 volts.

If a 200-volt supply is available, then the maximum voltages in each case will be very slightly reduced, but this will not matter.

It will be seen that the 2,000-ohm super-type spaghetti resistance, used in series with the No. 4 tapping, gives 160 volts at 30 milliamperes, rising to 180 volts at 20 milliamperes. In sets where a small power valve is used, not capable of standing

up the unit. The terminal strip carries the high-tension output and earth terminals, and also the potentiometer controlling the screening grid voltage. This ebonite strip can easily be drilled and screwed to one end of the plywood board on which the condensers and choke are mounted.

To make the connections and mounting details quite clear, you should have the full-size blueprint, to be obtained—price 1s., post free—from The Blueprint Department, AMATEUR WIRELESS, 58-61 Fetter Lane, London, E.C.4.

Wiring should be done with insulated wire. There are few leads, for the spaghetti resistances eliminate many connections. You will see that there is a 2-microfarad fixed condenser across each resistance tapping and a 1-microfarad condenser across the variable screen-grid tapping.

In addition, there is a 2-microfarad condenser connected to the earth terminal. This point needs watching when connecting up the unit to the set. The set will work only when the mains plug is inserted the right way round, of course.

Connect up the set in just the same way as you would to a high-tension unit, taking the power terminal to tapping 4, the L.F. valve, if there is one in the set, to tapping 3, the detector to tapping 2, and the screen-grid screening grid (not anode) terminal to tapping 1. In a three-valve set with no intermediate L.F. valve the screening grid anode may be taken to tapping 3.

(Continued in 3rd column of next page)

COMPONENTS NEEDED FOR THE "A.W." D.C. MAINS UNIT

- Baseboard, 9 in. by 5 in. (Peto-Scott, Readi-Rad, Camco).
- Terminal strip, 5 in. by 2 in. (Peto-Scott, Readi-Rad, Becol).
- Six 2-mfd. fixed condensers and one 1-mfd. (Lissen, Telsen, Dubilier, T.C.C., Formo).
- Smoothing choke (Heayberd type E.50, Telsen, Lissen, Ferranti, Varley, Wearite, Lewcos, R.L.).
- Four spaghetti resistances, 2-40,000, 59,000, 20,000 (Graham-Farish, Readi-Rad, Telsen, Lissen, Lewcos, Sovereign, Bulgín).
- 2,000-ohm super-type spaghetti resistance (Bulgín).
- Fuse and holder (Bulgín, Telsen, Readi-Rad).
- Six terminals marked: H.T.—, H.T. +1, H.T. +2, H.T. +3, H.T. +4, Earth (Belling-Lee type R, Ealex, Burton).
- 50,000-ohm wire wound resistance, variable (Sovereign type W, Colvern, Regentstat, Watmel Wearite).
- Twin connecting flex (Lewcos).
- Connecting wire (Lewcos).
- Sleeving (Lewcos).
- Mains adaptor (Bulgín).

up to 160 or 180 volts, then two power-type 2,000-ohm spaghetti resistances may be used in series, or where the current drain is considerably less than 20 milliamperes, then a standard spaghetti resistance of any suitable value to produce the required voltage may be used.

There is nothing difficult about making

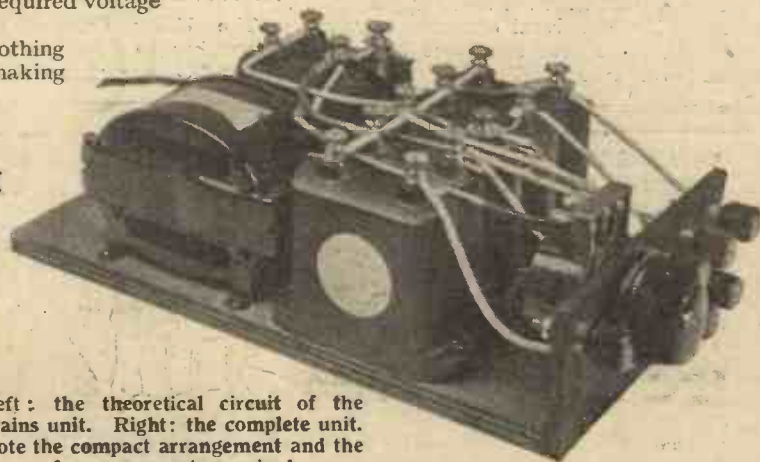

Left: the theoretical circuit of the mains unit. Right: the complete unit. Note the compact arrangement and the few components required

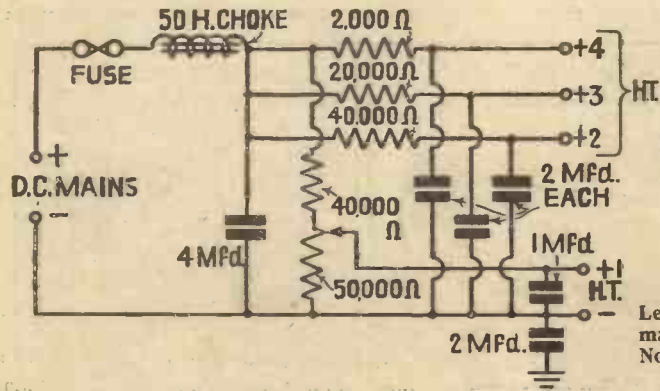

INTRODUCING THE "A.W." "STAR" SET SERIES

NEXT week AMATEUR WIRELESS does it again!—by which we mean that yet another triumph in set design is to be presented, providing constructors with still further proof of our determination to keep not merely up-to-date, but right ahead of the times.

Striking out along structural lines hitherto restricted almost entirely to the radio set factory, the designers of the new AMATEUR WIRELESS Star sets—Alan Hunter and Rutherford Wilkins—have evolved a type of set that will create a new fashion in amateur design.

Metal Chassis

The new sets, built around robust chassis, are sound engineering jobs—and they are sure to inspire confidence as soon as they are seen, a confidence that will not be misplaced!

The AMATEUR WIRELESS Star sets have been built according to a pre-determined and carefully-laid plan—a plan to give home constructors the benefit of all the latest radio developments in sets. In the first place, the sets had to be **easy and cheap to build** and secondly they had to meet the stringent needs of to-day, not only in **selectivity and ease of control**, but in **quality of reproduction**—from either broadcast programmes or gramophone records.

Metal is widely used in the modern factory-built set, as every observant visitor to the radio shows must have appreciated. Metal for the chassis, metal to screen the coils, metal around the tuning condensers, even metal on the bulbs of the valves—truly a **complete metallisation of radio!**

This great use of metal in the modern set is obviously more applicable to the factory-built set than to the amateur-built set. The designers of the new AMATEUR WIRELESS Star series have seen so many advantages to the constructor in the technique adopted in the factory that they have applied it to the problem of producing a "blueprint" product—that is a set capable of being simply drawn in blueprint form for publication in AMATEUR WIRELESS.

So completely has this all-metal plan succeeded that, with the much-appreciated co-operation of several component manufacturers, these Star sets have been produced with a simplicity that will evoke

unstinted praise from the expert and unrestricted delight from the novice.

Simple Ganging

Ganging—that is a word to inspire certain fears in the mind of the amateur constructor. But in the new AMATEUR WIRELESS Star sets the principle of ganging has been applied with scientific precision, so that the screened tuning coils and variable condensers work together for perfect tuning.

Quite apart from ganged tuning, which means the simultaneous operation of three separate tuning circuits by the rotation of one knob, the volume control has a dual action—a ganged volume control, in fact!

Gramo-Radio

Gramophone reproduction—how much a part of wireless reception this has become. Appreciating amateur needs, the designers of the AMATEUR WIRELESS Star sets have provided full facilities for gramophone reproduction, with pick-up volume control, connection and switching rarely found in the normal run of sets.

If the Star sets strike a new note in home construction they will have achieved a good deal in these days of stereotyped design. But the designers claim still more for these sets—**perfection of performance hand in hand with originality of design.**

Look out for the details in next week's issue of AMATEUR WIRELESS, when the first of the AMATEUR WIRELESS Star sets makes its bow—the forerunner of a series destined to create tremendous interest for many months to come!

Among the Scottish cities, Glasgow is regarded as the worst so far as "pirates" are concerned. Aberdeen is in the most creditable position.

Sir Henry Wood will conduct the Liverpool Philharmonic Society's concert, which will be relayed to North Regional listeners on November 3.

A programme of part songs by Macfarren has been arranged by the studio chorus for Midland Regional listeners on November 9.

The Unity Quartet plays again on November 10 from the Royal Society of Artists' Gallery, Birmingham.

"AN EASILY-MADE H.T. UNIT FOR D.C. MAINS"

(Continued from preceding page)

Disconnect the earth lead from the set and connect it to the earth terminal on the unit. This is the only alteration in wiring that has to be made.

There is no switch on the unit, and the mains plug should be pulled out or the switch in the room turned off when the set is not being used. This prevents the mains current running through the potentiometer winding when the set is not working, but the current passed is negligible. There is no danger in the working of the unit. The little fuse will blow if a mistake has been made in the wiring.

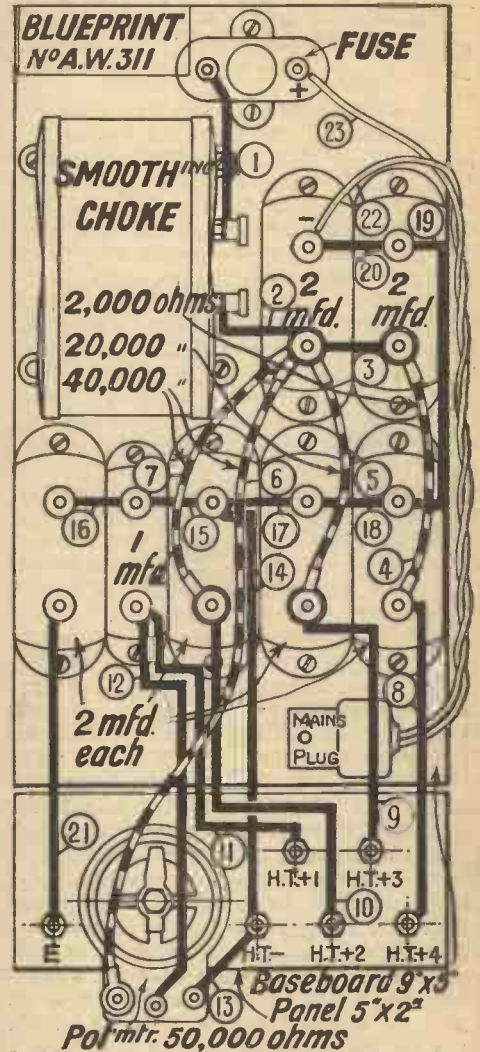

A full-size blueprint is available, price 1/-



AT THE B·B·C.

IN BROADCASTING HOUSE CONTROL ROOM

An advance visit to the huge new control room at Broadcasting House is here described by
KENNETH ULLYETT



LAST week I paid an advance visit to the huge new control room at Broadcasting House. This is not yet complete and behind locked doors the engineers were busy at work on the grey metal racks carrying the line-termination equipment, microphone and line amplifiers, checking receivers and switching apparatus.

As a result of tests carried out at the Manchester control room and as a result of the steady progress in design of speech-input equipment, there are several important new ideas in the London control room and as some of these are of a "hush-hush" description for the time being, until they have been given a further testing, I cannot describe all the studio control apparatus.

At the Top

The control room is up on the eighth floor running along the east side of the building and has a huge sloping glass roof,

facing which are the big racks. The whole place reminds one very much of the London Trunk telephone exchange! There are roughly half the number of control positions (where the control engineer sits) as there are studios in Broadcasting House and this is based on the assumption that for the next year or so all the studios at the London building will not be required to work simultaneously. The main feature of the design is that the vertical racks shall contain all the apparatus which is remote controlled from the little control desks facing them.

Thus, if the vaudeville studio is to be brought into play while the concert hall and one of the talks studios are being used, a control engineer at a control desk will operate a switch to connect the microphone in the required studios to amplifiers on the rack and thence to the line feeding Brookman's Park or a rehearsal loud-speaker as may be required.

Meters on his desk show the volume which he can control by means of a potentiometer knob in front of him.

What is known as a "trap valve" is used on each panel so that the control man can listen in to what is going on down in the studio. The trap valve is a single L.F. stage connected up to the R.C. coupled intermediate amplifier on the rack.

Listening on Phones

It would not do, you see, to plug a pair of phones directly into the output of the main microphone amplifier, because the impedance of the output load might be varied, which would affect the tone and the switch clicks might be heard. The trap valve stage connected to one of the "mike" amplifier stages prevents any chance of the control engineer's phone reception upsetting the lines.

A number of studios can be switched through to a D.C.P. room, that is, a separate room where the producer of a radio play sits and turns knobs which bring in the "effects," switch on the echo room and bring the composite studios in, in turn. It

is not yet settled how many echo rooms there will be, but there will probably be several in the basement.

Post Office Plant

At Savoy Hill at present there are five desks for the nine studios in the building, and the switching is done with Post Office type plugs and jacks, which is not ideal. In Broadcasting House, the amplifiers on the racks are all screened in metal boxes so that there will be no interference between one studio and another. There are milliammeters in all important circuits on the front of the panels and from these the control men can see that the amplifiers are not overloaded, and can quickly trace faults.

All the relay switching and magnet bobbins for the lines are enclosed in metal cans, too, and this will help to overcome the trouble experienced at Savoy Hill in the early days, namely cross-talk, between one line and another, and troubles due to dust.

In the Broadcasting House control-room are the terminating points for the lines going out to Brookmans Park and other station centres. There are four lines to Brookmans Park, only two of which are normally in use, and on a separate bay are line correctors or equalisers for ensuring that the frequency response curves of the lines is made as linear as possible to avoid distortion.

VARIABLE-MU VALVES

IN the new variable-mu valves the "pitch" of the spiral grid, instead of being uniform, is made to increase gradually along the length of the cathode. This has the effect of straightening out the characteristic curve and of preventing cross-modulation, even when a wide range of volume-control bias is applied to the grid. In the ordinary type of valve when the grid bias is increased beyond a certain limit the valve works "over the bend," and so causes distortion. In the variable-mu valve this defect is obviated.

M. A. L.

It is stated that the power of the Huizen (Holland) transmitter will shortly be increased to 20 kilowatts (aerial) and that in May, 1932, a new 60-kilowatt station will be installed at Hilversum.



The back of a control room panel. The amplifiers are in the shielded boxes on the left and at the end of the passage, and the batteries are controlled by the switchboard on the right. This is the gear installed for test at Manchester before fitting the new control panels in Broadcasting House.



IN MY WIRELESS DEN

Weekly Hints — THEORETICAL
CONSTRUCTIONAL & BY
W. JAMES

These New Electrolytics

ELECTROLYTIC condensers are being used this season by several prominent manufacturers.

You will have noticed that one terminal of the condenser is marked positive and the other negative. Ordinary paper condensers are not marked in this way.

The electrolytic condenser is, in a sense, a rectifier. If you take a unit consisting of an aluminium electrode in a suitable electrolyte, a current will flow through the unit when the electrolyte is positive with respect to the aluminium electrode. No current flows when the aluminium is positive.

Actually, a very thin film forms on the surface of the aluminium and unless the voltage is above a certain value, there will be no flow of current from the aluminium to the electrolyte. The film may be considered as a dielectric between the aluminium and electrolyte when the aluminium is positive, and as the film is very thin, the effective capacity obtained from a small area of anode is considerable. In fact, one of the features of the electrolytic condenser is the large capacity available for the small size.

Power Valves in Parallel

Valves are sometimes connected in parallel in the last stage in order that more volume than can be obtained from one of the valves working alone shall be provided.

The input voltage needed to load the valves in parallel is just the same as that which can be dealt with by a single valve. It is the anode current that is increased by connecting valves in parallel and, of course, the impedance of the stage is reduced.

The impedance is halved, for example, by connecting two equal valves in parallel and is one-third that of a single valve when three valves are joined in parallel.

As a rule, it is better to arrange for the valves to be independently biased, in order that the anode current of each valve may be made equal in amount. The increase in volume expected will not be obtained unless a satisfactory output circuit is used, such as a transformer having a ratio suited to the impedance of the loud-speaker and the combined impedance of the valves.

L.F. Couplings

An advantage of the parallel-feed system of transformer coupling is that the direct current is kept out of the primary winding.

As I mentioned in an earlier note, breakdowns usually occur through corrosion and not through overloading and burning out.

In the parallel-feed system the direct current flowing in the anode circuit of the valve is prevented from passing through the primary coil of the transformer by a stopping condenser. Therefore the chances of a breakdown occurring are remote.

Experience has shown that practically no breakdowns occur when the direct current is kept out of the primary, and so here is an advantage of the parallel feed system. The resistance normally used in the anode circuit ought not to be a source of trouble when a good make is used.

Power-grid Detection

Many amateurs using dry batteries for high tension attempt to obtain power-grid detection by using suitable values of grid condenser and leak and then wonder

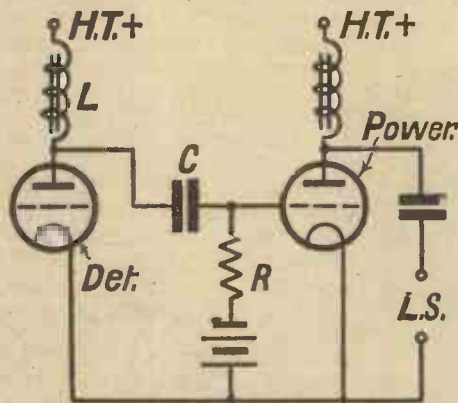

The various points of this power-grid detector circuit are described in the accompanying paragraph by W. James

why the results are not noticeably better than before the change was made.

Generally, the truth is that the power valve is overloaded long before signals of sufficient strength for good results can be applied to the detector. In power-grid

detection we need, besides a grid condenser of .0001 microfarad and a leak of .25 megohm, a valve of moderate impedance and plenty of high tension.

This detector will deal with fairly strong signals and so the power valve which is normally coupled through a transformer is easily overloaded. In the interests of quality of reproduction, therefore, a circuit that does not magnify very much is helpful and the diagram of a choke-coupled stage on this page shows a circuit well worth trying.

The choke in the anode circuit should have as high an inductance as possible, say 50 henries or more, and the condenser *c* may be of .1 microfarad and the resistance *r* of .25 megohm.

If a valve that will take as large a grid swing as possible is used in the power stage, the quality ought to be very good. The mistake usually made is of providing too much low-frequency magnification, with the result that the power valve overloads when the detector is dealing with signals that are relatively too weak for good results.

Accumulator Noises!

I was listening to a set the other day when I noticed that the reception was spoiled by noises.

The noises turned out to be due to the filament accumulator, which was freshly charged. I was told that the noises had been noticed on other occasions.

Apparently the noises lasted for a few hours after the battery was first connected when it was brought in from charging. This is not a normal happening. The battery was rather old and out of condition. It no longer held a full charge.

Possibly there are other instances where the accumulator is responsible for noises and has not been suspected.

The Welsh interlude on November 9 will be taken by Mr. E. T. Griffiths.

When the Prague 100-kilowatt transmitter takes over the Czechoslovak wireless entertainments the old 5.5-kilowatt station will act as relay for the capital. Its wavelength will be reduced to 249.6 metres.

It is now officially reported that the Juglinster-Luxembourg (Grand Duchy) broadcasting station will be a replica of the new Radio Paris transmitter with the extra advantage that, if necessary, its power can be considerably increased. Every effort is to be made to complete its installation by April, 1932, and to bring it into operation in the following July.

THINGS HEARD FROM KOENIGSBERG

- "Cockney" German.
- "Cockney" English.
- A member of the orchestra playing a bar ahead of the others.
- Much talking.
- A good news service.
- Many girls and women.
- A mouth-organ trio.
- A violin and mouth-organ duet (?).
- A graphic description of an English football match.
- A sports bulletin.

TELSEN TRANSFORMERS & CHOKES

TELSEN L.F. & OUTPUT TRANSFORMERS

Telsen transformers have achieved fame in the radio world on account of the high standard of their quality and performance. Designed and built on the soundest engineering principles, these robust, full-size transformers will give not only efficient but enduring service.

TELSEN L.F. TRANSFORMERS

- Telsen "Ace" Transformer, Ratios 3-1, 5-1 ... Price 5/6
- Telsen "Radiogrand" Transformer, Ratios 3-1, 5-1 ... Price 8/6
- Telsen "Radiogrand" 7-1 Super Ratio Transformer ... Price 12/6
- Telsen Intervalve Transformer, Ratio 1.75-1 ... Price 12/6

TELSEN OUTPUT TRANSFORMERS

Telsen Multi-Ratio Output Transformer, giving three Ratios of 9-1, 15-1, 22.5-1 ... Price 12/6

Telsen Output Transformer, Ratio 1-1 ... Price 12/6

Telsen Pentode Output Transformer ... Price 12/6

TELSEN L.F. CHOKES

Telsen L.F. Intervalve Coupling Choke, 40 and 100 henrys

Telsen Heavy Duty Power Grid L.F. Choke, 40 henrys

TELSEN OUTPUT CHOKES

Telsen Output Choke (Plain), 20 henrys ... Price 8/-

Telsen Output Choke (Tapped), 20 henrys ... Price 8/6

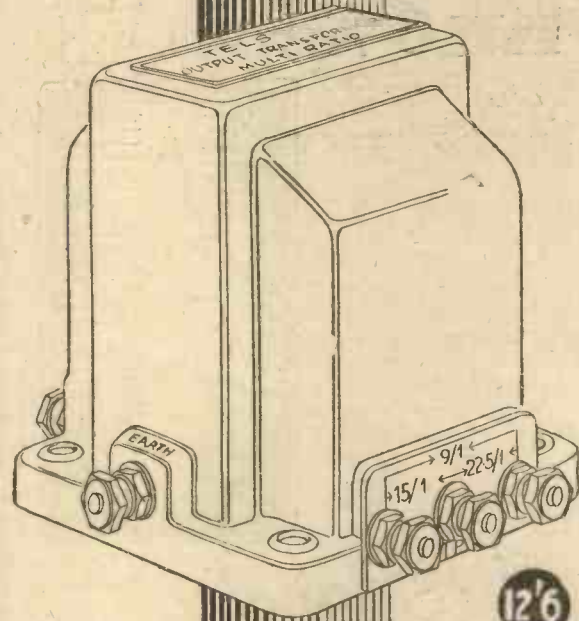

12/6

TELSEN

ALL-BRITISH
RADIO COMPONENTS

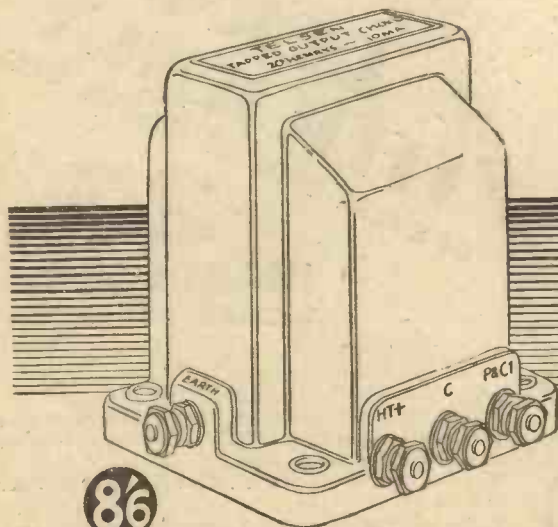

86

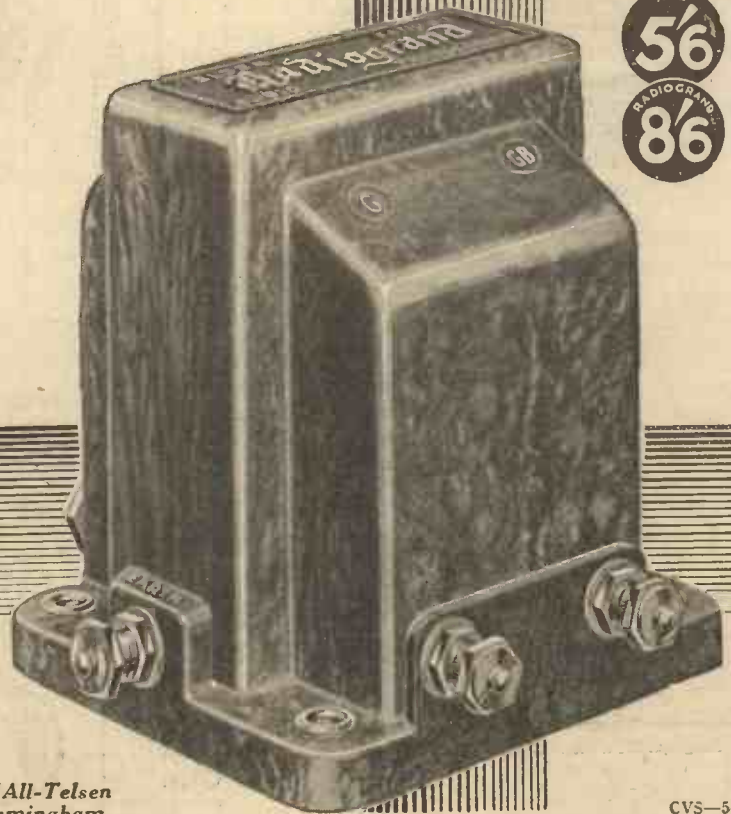

ACE
5/6
RADIOGRAND
8/6

Send for the "Telsen Radio Catalogue" and book of "All-Telsen Circuits" to—The Telsen Electric Co., Ltd., Aston, Birmingham.

**Do
You
Know?**

Historical Signs—No. 2



*The Sign of
the Sugar Loaf*

IN olden times sugar was sold to the grocer in conical loaf form. To indicate his trade, the grocer hung out the sign of the sugar loaf. Inns of to-day bearing the sign of "The Swan and Sugar-Loaf" indicate that in earlier days the landlord combined the sale of wine with that of other commodities.

Now no sign is needed to tell a man's calling, but T.C.C. has given you a means of recognising—at a glance—a condenser that is backed by the unique experience of 25 years' specialised research—they have put all their condensers in a green case—a sign that such a condenser has proved itself to be of downright reliability and absolute accuracy. Be sure of your next condenser—be sure it is a "condenser in the green case."

Look for the initials
T.C.C.
on the condenser
in the green case

T.C.C.
CONDENSERS

The Telegraph Condenser Co. Ltd., Wales Farm Road, N. Acton, W.3.

♥ 9241

MOTOR SUPER LOUD-SPEAKER UNIT

Its pure, rich tone wins instant admiration

TYPE S8

Every loud-speaker value is outclassed by this new wonder MoToR balanced armature unit. Clarity—tone—purity—power—by every standard of comparison it is a revelation, not only in performance, but also in its superb workmanship and more than reasonable price.



Your radio dealer will get you the new complete catalogue of MoToR Loud-speakers, Units and Chassis. In case of difficulty only, write to:—

TEKADE Radio & Electric LTD.
147 FARRINGTON ROAD,
LONDON, E.C.1

Northern Distributors: **L. KREMNER, Ltd.**, 2 Bradshaw Street, Manchester.
Agent for Scotland: **R. G. J. NISBET**, 132 Rensfrew Street, Glasgow, C.2

Type S8 UNIT **23/6**

C88 Chassis, complete with Unit and Cone **43/6**
(as illustrated)



7 IN 1

AERIAL
reveals amazing

"DORMANT" EFFICIENCY
OF EVERY TYPE OF RADIO SET

PRICES
15 ft. - 3/9
20 ft. - 4/6

25%

INCREASE IN SIGNAL STRENGTH



Our laboratory has proved this remarkable increase in efficiency, but—disregard it! Just place the aerial round your picture rail, join the aerial terminal and experience, to your satisfaction and amazement, the extraordinary difference in volume, clarity and increased range. Stations you have never heard really strong, come in with startling clarity.

YOU WILL BE ASTONISHED AT YOUR SET'S PERFORMANCE
Ask your local dealer—he recommends it.

Catalogue of all Formo Products obtainable on request from:—

ARTHUR PREEN & CO., LTD., Golden Square, Piccadilly
Circus, London, W.1.

You Will Help Yourself and Help Us by Mentioning "A.W." to Advertisers

PERFECT PAIR WAY
TO PERFECT RADIO



Wander plugs in the PERTRIX H.T.? PERTRIX L.T. connected up all right? Then switch on. You never realised radio could be so good, did you? That's the best of getting the Perfect Pair—they work in perfect harmony with each other and with your set, giving you just Perfect Radio. And they last longer, too . . . infinitely longer.

Made by BRITANNIA BATTERIES, Limited at Redditch who also make:

Batteries for Central Stations • Batteries for Country House Lighting • Emergency and Stand-by Lighting Batteries for Theatres, Cinemas, Hospitals, etc. • Batteries for the Starting and Lighting, and Lighting and Ignition of Motor Cars, Motor Cycles, Buses and Coaches • Batteries for Electric Vehicles, Trucks, Locomotives, Ships and Yachts • The only Nickel-Iron Alkaline Battery on sale in Britain that is entirely made in this country.

PERTRIX
SUPER LIFE
DRY BATTERIES
&
ACCUMULATORS

THE PERFECT PAIR FOR PERFECT RADIO

Advert: of BRITANNIA BATTERIES LTD., 233, Shaftesbury Avenue, London, W. C. 2.
Telephone: Temple Bar 7971 (5 lines) Works: Redditch

Please mention "A.W." when Corresponding with Advertisers

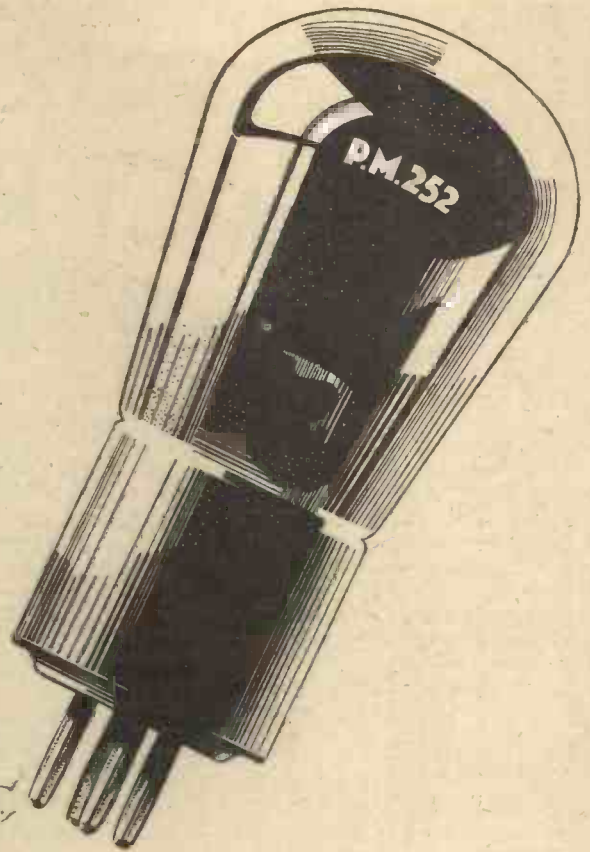

It is not enough that Mullard 2-volt valves are providing faultless reproduction for millions of satisfied listeners. The work of research and improvement continually goes on. It has produced a re-designed P.M.252, with greatly improved characteristics. This is the 2-volt super-power valve. It is designed as an output valve for battery operated receivers, where it is desired to operate powerful speakers at full volume. Buy one to-day from your dealer.

PRICE 13/6

Mullard

THE MASTER VALVE

Advt. The Mullard Wireless Service Co., Ltd., Mullard House, Charing Cross Road, London, W.C.2

Arts

On Your Wavelength!

"TUNING-UP" THE LOUD-SPEAKER

IT is surprising how much can be done to improve the performance of a moving-coil speaker by a little skilful handling. Mind you, I don't recommend fiddling about with a good instrument when it is giving satisfaction—much better leave it alone. But when there is ground for disappointment there is equally room for improvement. For instance, one often finds a clue to the trouble in the moving coil, which may be badly centred, or clogged with filings or other foreign matter, so that it cannot swing freely on the low notes. Again the material used for connecting the edges of the diaphragm to the case may be too stiff. If so, it should be replaced by very thin rubber or leather, so that the diaphragm will respond to the slightest breath. A friend of mine who found his speaker too harsh tried the experiment of cutting a few radial slits about an inch long in the diaphragm, and was delighted with the resulting gain in mellowness.

A QUESTION OF RESONANCE

IT is equally surprising what a difference a change of position will sometimes make. The same friend, who makes a hobby of this subject, assures me that he once tuned-up a speaker so that it was as near perfection as possible. Then he took it into the next room where it immediately went off, simply because of the different resonating properties of the new room. The same effect can often be observed even in the same room, the response being noticeably better when the speaker is pointed in one direction than in another. One gets the same thing on a smaller—though more pronounced—scale in self-contained sets, where box-resonance is apt to produce what are called "barrel tones" or alternate peaks and valleys of sound. Box resonance is, in fact, one of the most troublesome problems the modern designer has to face.

A FAMOUS INVENTOR

THE world has lost a great figure in Thomas Alva Edison. Among his most notable inventions were the carbon microphone, the phonograph, the cinematograph, and the talking motion picture. The microphone has, of course, a direct connection with broadcasting, whilst both the gramophone and the kinema are closely linked to it through the thermionic valve.

It is a matter for dispute as to how much Edison owed to other workers in the field covered by his inventions. It is true that in some cases he merely put existing theory into practice, though this is not always so simple as it may appear. On other occasions there was so close a race that it is difficult to know who really "got home" first. Edison undoubtedly had a rare genius for invention, combined with a very sound commercial judgment.

THE "EDISON EFFECT"

HOWEVER, there were occasions on which he "missed the boat." For instance, he was experimenting with wireless waves twelve years before Hertz, though he didn't fully appreciate the fact. He also discovered the "Edison effect" when working on some electric lamps, but left it to Fleming—some twenty years later—to construct the first thermionic valve. I am surprised, and rather relieved to read that he was no mathematician. It is said that he pooh-poohed anything outside simple arithmetic. He was once asked to define genius and replied that it was "one per cent. inspiration and ninety-nine per cent. perspiration."

A MAINS TROUBLE

WHILE testing out a D.C. mains receiver of screen-grid, detector, L.F. type, which had just been completed, a combination of troubles occurred which took an annoying amount of time to locate, simple though they were. The receiver in question employed a band-pass filter of the mixed type in the aerial circuit with a single circuit inter-valve coupling, all circuits being ganged on one control.

On first connecting to the supply mains the receiver refused to function. However, the connection to the D.C. mains was reversed, and the receiver again switched on with the full expectation of hearing something. There was nothing but a faint hum from the energised moving-coil loud-speaker. As the wiring had already been checked, the next thing was to prove the presence and test the values of the various voltages. This investigation revealed nothing, everything apparently being quite as it should be.

WATCH THE TRIMMER

IN an endeavour to localise the trouble the aerial was next connected through a small series condenser direct on to the grid of the detector valve. Matters were now very slightly improved, both Brookmans Park stations being heard very faintly, but quite equally over the whole dial of the gang condenser. This was distinctly suspicious, and attention was directed towards the inter-valve tuned circuit. As the wiring had already been proved, the only thing left was a minute inspection of the separate pieces of apparatus themselves.

This revealed nothing until the main tuning condenser was inspected; it was found that a dead short existed across the plates. This completely baffled me for a moment as the main vanes were obviously not shorting together; suddenly an idea came; what about the trimmer? The type of trimmer in use is that so popular nowadays, being constructed from a small sheet of mica placed between two metal plates. On opening up the trimmer to its minimum capacity, the cause of the trouble was immediately apparent. A substantial part of the mica plate was missing and the

plates had been in contact, thus shorting out the whole condenser.

SIMPLE!

HAVING removed the trouble and replaced the apparatus, the receiver was again connected to the mains and the switch operated, but still nothing could be heard, except the irritating little hum from the loud-speaker. The receiver was quite dead, there was not even the faint whisper from Brookmans Park which had previously been heard. Another investigation was begun, but from loud-speaker to aerial nothing was apparently wrong, and in desperation the only remaining thing, namely the mains connecting lead, was inspected. Then the bright idea came, and, with bowed head, the mains plug was reversed!

BY INSTALMENTS

THERE has been a great deal of talk lately about wireless licences by instalments. Undoubtedly the 10s. is a good deal to find all at one time for many of those who can only just manage to afford to have the simplest form of wireless equipment. I don't think, though, that any system of quarterly instalments would work, and here is one very strong reason against its adoption. There is no question that winter is the season in which by far the greatest amount of listening is done. Hundreds of folk who lead a more or less out-of-door life during their spare time in summer make very little use of their wireless sets between May and September. If quarterly licences were issued I have not the least doubt that there would be a large drop in the summer figures and that many people would take out only two or perhaps three quarterly licences during the twelve months. If a considerable proportion of listeners paid only 5s. or 7s. 6d. for their annual entertainment there would be a huge drop in the B.B.C.'s income and the programmes would suffer greatly in consequence. That seems to me to be the real snag.

HERE IS MY SUGGESTION

BUT I can see a way in which it might be made possible to purchase licences by the easiest of easy payments. Why not issue to anyone who asked for it a card marked off into forty-eight squares, each big enough to take a postage stamp? The recipient would purchase each week a 2½d. stamp and stick it into one of the squares. He could, of course, buy his stamps in blocks once a month or once a quarter if he likes. In any case, the expense would work out at 2½d. a week for forty-eight weeks in the year. When the date for renewing the licence came round he would simply hand in his completed card. The stamps would then be cancelled and he would receive his wireless licence without further fuss. Very little trouble or expense would be involved to the Post Office if this system were adopted and there would be a distinct gain financially, since a large proportion of

:: :: **On Your Wavelength! (continued)** :: ::

the licence fees would be paid in advance.

THE PIRATES

THERE is unquestionably a large amount of piracy at present which is most regrettable. I think, myself, that a small number of the pirates are people who simply cannot find the money for a new licence. They decide, when the time for renewal comes round, to put the set out of commission; but the temptation to use it proves too strong, and they cannot resist tuning in broadcast programmes every now and then. The card system would, I am sure, do a very great deal towards reducing the amount of piracy in the country, and for that reason, if for no other, I would like to see it adopted. There is no question, though, that many of the pirates are people who deliberately steal their entertainment by not taking out the receiving licence which they can perfectly well afford. The man who does this sort of thing is a pretty despicable creature, and no one has any sympathy for him when he is tracked down and smartly fined.

GETTING THE WIND UP

THE psychological effect of the Post Office van is so great that whenever one appears in a district there is a rush of pirates to put themselves on the right side of the law by taking out receiving licences *instantly*. A rather funny thing happened at a seaside town that I was visiting in the summer of 1930. A broadcasting van belonging to a certain newspaper turned up in the town for the purpose of providing entertainment for visitors. Somebody who had not seen it started the rumour that it was a G.P.O. sleuth van, and there was a perfect stampede to the local Post Office on the part of the unlicensed!

A PITY

TO return, though, to the genuine pirate tracker, the authorities have themselves to blame for having allowed such wild rumours about its powers to be put into circulation. To claim that any kind of device can track down a wireless set, even when it is not working, is the sort of statement that requires a good deal more than the proverbial grain of salt to make it swallowable. How could this uncanny apparatus distinguish between a wireless set and other kinds of homely electrical appliances, such as the door-bell, the vacuum cleaner, the fan, or the telephone? The rather tall accounts of its performances might, I think, have been taken a good deal further. Why not an imaginary description of the instrument and a special reference to a large dial around which moved a delicate pointer? One-half of the dial would be white, the other coloured red. When the van was opposite an innocent house the pointer would remain in the white half, showing that the set was duly licensed. But when it arrived opposite a pirate's lair, the pointer would immediately swing into the red half, where it would indicate infallibly whether the set was valve or crystal, portable, or otherwise!

STRAIGHTENING THEM OUT

AS I write, the special technical commission of the International Broadcasting Conference is in session at Rome. The problem before it is to find some way of putting an end to the mutual interference which still unhappily exists, particularly upon the medium waveband. It was rumoured not long ago that the B.B.C.'s delegates would attend the meeting breathing fire and slaughter. Ultimatums were to be issued, gauntlets were to be thrown down, and goodness knows what else was to happen. It was said that unless a satisfactory agreement could be reached without delay, the B.B.C. would withdraw from the Union. So far, there have been no signs of anything of the kind, and I fervently hope that there will not be. Were the B.B.C. to withdraw, half Europe would immediately follow suit, and we should then shortly find ourselves back in the chaos that prevailed before the original Geneva plan came into being, and we should be far worse off nowadays than we were then, owing to the greatly increased number of European stations and the higher power in general use. The only hope for European broadcasting lies in the strengthening of the Union, which must include not most of the countries of Europe, but every country without question.

THE WAY OUT

THE position in Europe at the present time is extraordinarily difficult. Every country, naturally, wants to give its own listeners a first-rate service. Its authorities, therefore, say: "We must have more stations and increase the power of those that we already have." The number of wavelengths available is limited, and there simply isn't room for newcomers. When, therefore, new stations come into operation they have to elbow their way into the already overcrowded wavebands, where they are absolutely bound to cause interference. This interference forces other stations to move from their allotted wavelengths in the hope of finding peace. Their moves upset others, and so wholesale wavelength wandering and widespread jamming result.

SUPERFLUOUS WAVELENGTHS

THE truth is that there are already too many stations in Europe and that a perfectly good service could be provided with far fewer. Countries such as France and Sweden have many more wavelengths than they really need. They and everybody else would be far better off if they would consent to give up a few. The B.B.C. could give a very useful lead in this way. If it would not abandon one or more wavelengths altogether, it might at least undertake to use one only from each twin station when in the ordinary way both would be taking the same programme. What, for instance, is the sense in sending out the same programme from the London Regional on 356.3 metres and the London National on 261.3 metres? There is not a soul within the service area of the London

National transmitter who cannot receive the Regional transmissions. I have always said that we could abandon most, if not all, of the medium-wave national wavelengths if we put the power of 5XX up to 100 kilowatts or perhaps a bit more.

5XX'S RANGE

I HAVE been surprised when travelling about the country to notice how enormous is the service area of the Midland National transmitter, or 5XX, as many of us still call him. Though his present power is not more than 35 kilowatts, he seems to be receivable in almost every part of the country with a small set. Of course, you cannot get him on a crystal at very long range; but how many crystal sets are there in use nowadays? There was not one on view at the exhibition—at any rate, I didn't see one. Valve sets are nowadays so cheap to buy or to build that the crystal set is rapidly becoming a museum piece. If the power of 5XX were put up to 100 kilowatts, single-valve reception should be possible over the whole country and one national wavelength would suffice.

THE LOUDEST SHOUT

SOMETHING like a wireless war is being waged in Eastern Europe. Some time ago the Russians erected several high-powered stations near the Polish frontier. So great was their signal strength that the small Polish stations then existing were swamped and listeners could not obtain a proper service. Poland retaliated by erecting a high-powered station at Lemburg (or Lwow, if you prefer it that way) and by putting the power of Warsaw No. 1 up to the terrific figure of 158 kilowatts. Russia now threatens an increase in the power of her stations, and Poland will have to go one better. Poland, though, is not the only country affected. Czecho-Slovakia has also suffered from the swamping, and a big new transmitter is already operating experimentally at Prague. This is causing misgivings to both Poles and Austrians. It seems likely that as a counterblast to the new Prague, a fresh Vienna station will be required. And so the insane shouting-down competition goes on. When will Europe as a whole become sensible and limit the power of stations, as everyone knows it ought to be limited?

MY MILLIAMMETER

I READ with great interest the letter in AMATEUR WIRELESS No. 488 from Messrs. Electradix Radio about the milliammeter I repaired. I know, of course, that if one of the springs is unduly shortened, the instrument is thrown slightly out of balance and the calibration is affected. Still, an instrument that is not quite accurate is a good deal better than one which won't work at all. Actually, after the repair which I described I tested the mended milliammeter out against a standard instrument and found that the error introduced was trifling. Luckily, the break took place at the very end of the spring, so that when repaired it was shortened by only a very small amount.

THERMION.

HOW TO MAKE YOUR SET MORE SELECTIVE

A helpful article by ALAN HUNTER

WHENEVER amateurs begin to talk about selectivity the question of aerials inevitably crops up. This is because in the last year or so every article written about selectivity has included some reference to the need for shortening the total length of aerial to something like 60 feet.

It is a little unfortunate that so much importance has been attached to shortening the aerial, because many amateurs have carried out this advice while neglecting to look into the tuning circuits of the set.

A re-design of the set's tuning arrangements will probably yield much more satisfactory selectivity than any tinkering with the aerial. Probably the simplest way of getting more selectivity without altering the

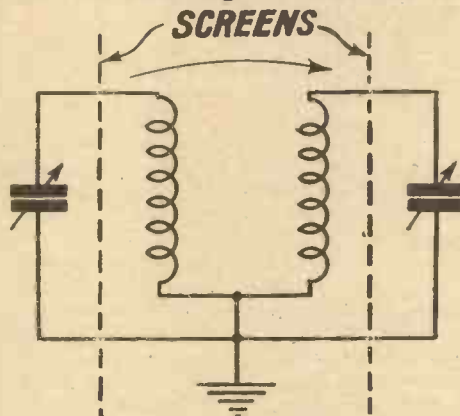

Fig. 1. Two plug-in coils in a loose-coupled circuit

can use plug-in coils in band-passing. This can be done provided that due care is taken in the screening arrangements.

Fig. 1 shows two separate tuning circuits coupled together by the mutual inductance of the two coils. This circuit forms what is generally known as a loose-coupled tuner, but it is also quite right to describe it as a band-pass circuit with mutual inductance coupling—provided that the two variable condensers are screened from each other and from the two tuning coils.

Fig. 2 shows how two plug-in coils, with two separate .0005-microfarad variable condensers, could be arranged to give band-pass tuning. Note that the two coils are fixed so that they are almost at right angles to one another. These two coils are separated by a screening partition, which extends between the two condensers as shown. Unless this screening is carried out

the coupling between the two tuning circuits will be too great to give band-pass tuning. Then the result would be two coupled tuned circuits, with all the attendant disadvantages.

Fig. 3 shows a further elaboration of the Fig. 1 circuit. It will be seen that a .01-microfarad fixed condenser is inserted between the earth point and the earth end of the two coils. Preferably, this fixed condenser should be of the non-inductive type.

The purpose of this condenser is to even up the band-pass action over the tuning range of the coils. It may result in some slight loss of signal strength, but as a rule its inclusion is an advantage.

For this Fig. 3 circuit I recommend a

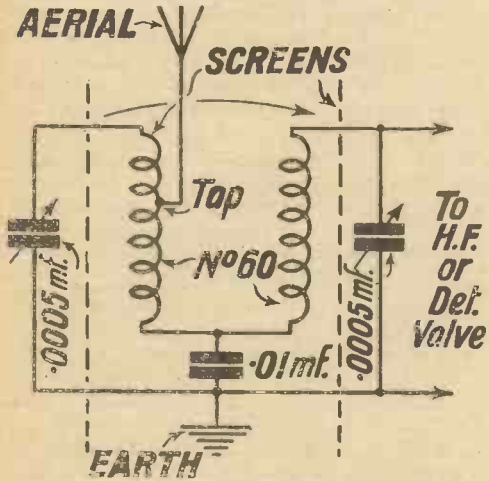

Fig. 3. A recommended band-pass circuit for plug-in coils

aerial is to include a pre-set type of condenser in the aerial lead.

If such a condenser is fitted to a set using plug-in coils it is likely that a size larger tuning coil will be needed to cover the medium wavelengths. In general, a No. 60 coil will cover the medium broadcasting wavelengths when a pre-set aerial condenser is used.

Without doubt the most effective way of improving aerial selectivity is to fit one of the new band-pass coils. Several are available, such as the Lewcos and Varley. Unfortunately, in these hard times many constructors have to make do with existing apparatus, which nearly always includes a set of plug-in coils.

The question then arises as to whether we

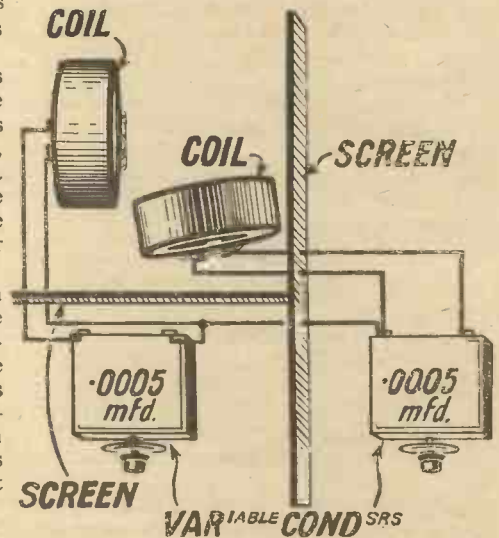
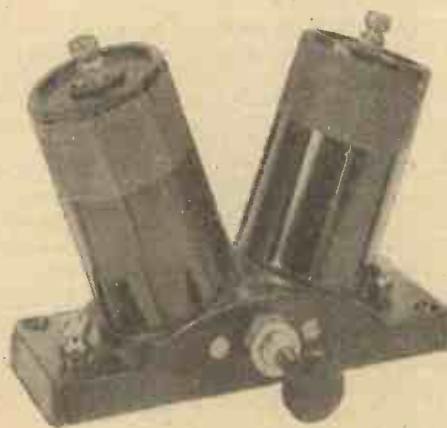

Fig. 2. Suggested layout for plug-in band-pass coils

No. 60 tapped plug-in coil for the aerial section and a No. 60-untapped coil for the grid section.

The best results are obtained with a two-gang totally screened variable condenser, but there is, of course, no objection to the use of two separate .0005-microfarad variable condensers, provided screening partitions are fitted.



A modern band-pass coil—the Lewcos

The Swansea Orpheus Choral Society gives a popular concert in the Central Hall, Swansea, on November 13, which will be relayed from 8 to 9 p.m.



THE PICK OF THE MONTH'S RECORDS

A GUIDE TO THE BEST OF THE LATEST RELEASES.

The records reviewed below are a careful selection of the best of the recent issues. It will be noted that criticism is chiefly devoted to the treatment of the music and quality of recording rather than the actual composition.

ORCHESTRAL RECORDS

- Martha Overture, 2s.** BRDCST 5244
A very well played (and well recorded) performance by the Berlin S.O. The heavy passages are most impressive.
- Cupid's Army and Almond Blossom, 2s. 6d.** H.M.V. B3916
An exceedingly attractive rendering of each. There will (appropriately) be many versions of the first delightful composition, and this record must take a high place.
- Tancredi Overture, 1s. 1d.** PIC 818
The Athanaeum S.O. play this well, but Rossini does not appear at quite his tuneful best.
- Spring Song and Anitra's Dance, 1s. 6d.** STERNO 758
A fair performance. The players are a little heavy-handed in places.
- You and You, 2s.** BRDCST 5249
The best-known air in Strauss's "Die Fledermaus." Very well played by the Berlin S.O. Recording first rate.
- Hungarian Dances 5 and 6 (Brahms), 2s.** BRDCST 5246
The Viennese Light Orchestra do these splendidly. No. 5 on this record will win anybody's admiration.
- Erstes Waltzer, 2s. 6d.** H.M.V. B3790
With so many excellent full versions of the works of the Lehar-Strauss-Waldtenfel school, there seems no real excuse for recording this *potpourri*. But De Groot and orchestra make good going.
- Handel in the Strand and Mock Morris, 2s.** BRDCST 5250
These two well-known Grainger pieces are well played by a string orchestra (with piano). These lively airs have a real appeal.
- Cavalina (Raff) and Liebesträume, 1s. 6d.** BRDCST 3087
The combination of string orchestra and cinema organ makes quite a pleasing presentation of these old favourites.
- Autumn Leaves and Liebesfreud, 1s. 1d.** PIC 819
Both delicately played by the Viennese Café Orchestra. A very pleasing record.
- Gipsy Love Selection, 2s. 6d.** H.M.V. B3889
Another De Groot record. His orchestra is quite at home with this.
- Komm Tzigany and O Cara Mia, 1s. 6d.** DEC F2445
In the Czech and Argentine tradition. Well done, with the authentic touch.
- Sally in our Alley and Cherry Ripe, 1s. 6d.** DEC F2388
Played in very grandiose fashion by the London Chamber Orchestra. This good record suggests a *symphony* orchestra playing an elaborately scored rhapsody.
- Francesca da Rimini, 12s.** H.M.V. D1929-30
None can doubt that Tchaikovsky uses the *Inferno* setting as a background to his musical picture. The first side is a prelude of sheer horror and works through the story to a climax which unfortunately leaves the story unfinished. But this performance of the L.S.O. is extraordinarily interesting—to those whose tastes run that way.
- From the New World Symphony, 30s.** H.M.V. D1893-7
There is such a wealth of great music in this amazing work as to satisfy anybody but the most egregious lowbrow. I cordially commend these five records to those who want to commence to hear good music. Stokowski conducts the Philadelphia Orchestra through Dvorak's masterpiece, and the oftener you hear it the better you will like it.
- Destiny Waltz and The Choristers' Waltz, 2s. 6d.** PARLO R1007
These two ancients are modernised by Edith Lovand and her Orchestra.

- Eine Kleine Nachtmusik (Mozart), 12s.** COL LX144-5.
A haunting delicate piece beautifully played by the British Symphony Orchestra, conducted by Bruno Walter. Another of the many compositions which so easily lead to the understanding of good music. If you are a stranger to it, hear No. 2 first.
- Prélude à L'Après-Midi d'un Faune (Debussy), 4s.** COL DX279
Wide familiarity with this piece makes it unnecessary to say more than that this performance of the Straram Orchestra of Paris is an artistic gem.
- The Mastersingers Overture, 4s.** H.M.V. C2188
The Berlin State Opera Orchestra do this. Their interpretation strikes me as sound without being inspired.
- Waltzes from Vienna and Smiling Lieutenant Selection, s.1 6d.** WIN 5360
A full-blooded performance by the Scala Salon Orchestra.

BAND RECORDS

- Bandmaster and Bosnia Marches, 1s. 1d.** PIC 821
By the Brooklyn Military Band. Obviously an American performance in the Sousa tradition. The tunes are of no great merit, but the playing goes with fine "snap."
- Cupid's Army and Serenade (Heykens), 1s.** BRDCST 744
The Welsh Guards make a very attractive record. The vocal part of the first is very well done, and as the words are good, two fine tunes make a record of real merit.
- Parade of the Elephants and The Old Frog Pond, 2s. 6d.** COL DB597
Characteristic pieces—very. By the Grenadier Guards, who do this sort of thing so well.
- Stealing Through the Classics—The Oratorios, 4s.** COL DX283
The strictest propriety is observed in this very interesting and competent performance of Debroy Somers' Band. I could wish for a little less brass at times, otherwise it is enormously diverting.

DANCE RECORDS

- Trees and The Match Parade, 2s. 6d.** H.M.V. B6048
A very effective pair by Jack Hylton's Band.
- Les Million (f.) and We're All Alone (w.), 1s. 6d.** STERNO 757
Two popular tunes very well played by André Astan and Orchestra. Well recorded, too.
- Pagan Serenade and Belle of Barcelona, 2s. 6d.** H.M.V. B6055
By the New Mayfair Dance Orchestra. Modern dancers are certain to "fall" for this waltz and one-step. They seem to be replete with most of the tricks.
- Around the Volga, 1s. 1d.** PIC 820
Jack Leon and Band play a "waltz medley" that will doubtless find favour.
- Sorrows (w.) and Madonna of the Bullfighters, 2s. 6d.** BRUNS 1178
With all the pep that an Argentinian band can put into it. A novelty.
- Twilight Waltz and Blaze Away, 1s. 6d.** ZONO 5952
The Orpheus Dance Band in their usual excellent form.
- If You're Really and Truly in Love and I'm a Hundred Per Cent in Love, 1s. 6d.** ZONO 5955
A safe "buy." The Rhythmic Eight are splendid.
- By the River Sainte Marie and When the Moon Comes Over the Mountain, 1s. 6d.** ZONO 5953
A very good version of each by the Arcadians Dance Orchestra.

(Continued on page 898)

TELSEN DUAL-RANGE COILS

TELSEN DUAL-RANGE AERIAL COIL

The Telsen Aerial Coil is the very latest development in dual-range aerial coil design. It incorporates a variable series condenser which can be set to give any desired degree of selectivity, making the coil suitable for all districts whatever reception conditions may be. It has been tested in various parts of the country, and down to distances of five miles from Regional stations, a single tuned circuit will definitely separate the Regional programmes. This adjustment also acts as an excellent volume control and is equally effective on long and short waves. The waveband change is effected by means of a three-point switch. A reaction winding is provided and the primary and secondary windings are separated so that the aerial circuit can be isolated in mains driven or screen-grid receivers.

Telsen Aerial Coil with Variable series Condenser incorporated ... Price **7/6**

TELSEN H.F. TRANSFORMER AND AERIAL COIL

This Coil is primarily designed for H.F. amplification in conjunction with screen-grid valves. It is arranged so that it can be connected as a tuned-grid or tuned-anode coil, or alternatively as an H.F. Transformer.

It also makes a highly efficient aerial coil where the adjustable selectivity feature is not required. A reaction winding is incorporated. When used as an H.F. Transformer the wave-change is effected by means of a two-pole (four-point) switch. When connected otherwise a three-point switch should be used.

Telsen H.F. Transformer and Aerial Coil ... Price **5/6**

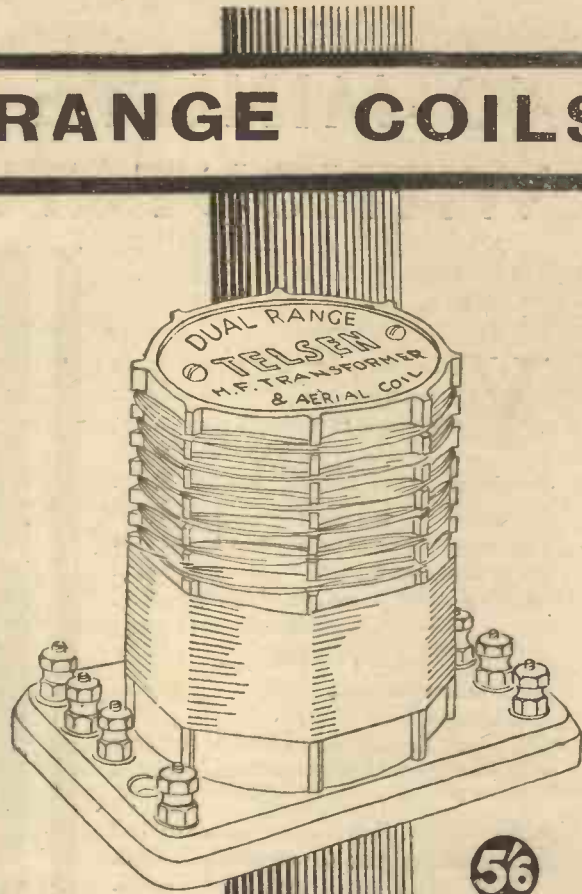

5/6

TELSEN

THE SECRET OF PERFECT RADIO RECEPTION

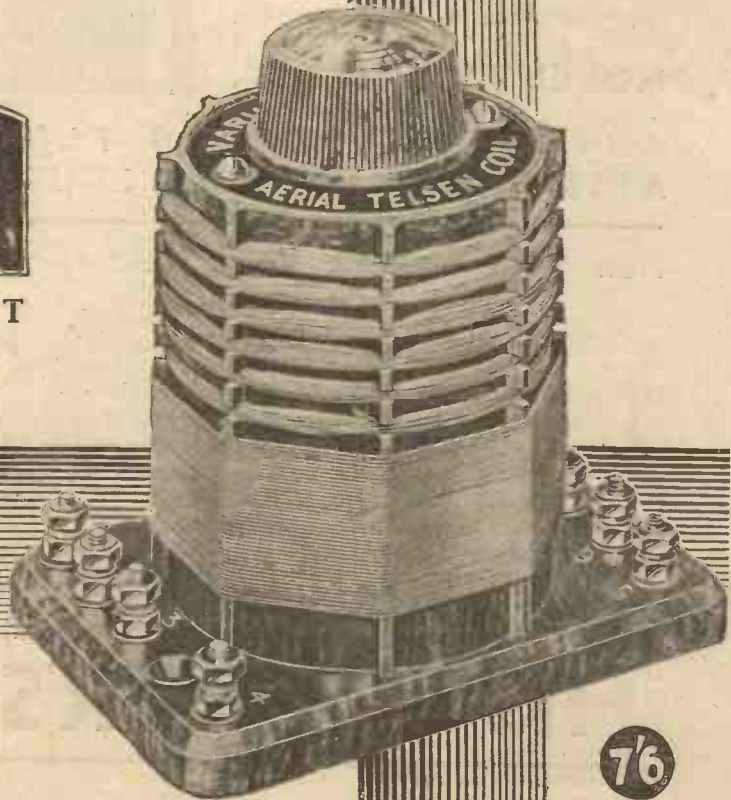

7/6

Send for the "Telsen Radio Catalogue" and book of "All-Telsen Circuits" to The Telsen Electric Co., Ltd., Aston, Birmingham

CVS-56

Advertisers Appreciate Mention of "A.W." with Your Order

40-MINUTE PROGRAMME— WITHOUT TUNING-IN

YOU just place eight records on the arms of the automatic changer—turn the index switch, and after pressing the button on the front of the instrument, retire to a comfortable armchair to enjoy a programme of your own choice. A programme of music which can range from the latest dance music of England and America to performances of your favourite operas rendered by the world's most famous artists.

Until you have installed one of the new "His Master's Voice" automatic record changing units in your own home, you will not have realised the pleasure and entertainment that can be enjoyed from the electrical reproduction of gramophone records. The production of a simple and inexpensive automatic record changer is one of the greatest achievements of the firm which introduced the gramophone to Europe in 1897.

MODEL 117 - 18 gns.



**AUTOMATIC RECORD PLAYER (A.C. or D.C.) FOR
ATTACHMENT TO ANY LOUDSPEAKER RADIO-RECEIVER**

New "His Master's Voice" Accessories for the Radio Experimenter
(As fitted to the "His Master's Voice" Models)

A NEW PICK - UP

THIS pick-up is similar to the one fitted to all our new instruments. It can be attached easily to any type of tone-arm and is supplied complete with a logarithmic volume control and connecting leads. The weight of the pick-up is $5\frac{1}{2}$ ozs.; it has an input of over 1 volt R.M.S., and a D.C. Resistance of 6,000 ohms.

MODEL 11 - - Price Complete 2 gns.

MOVING - COIL LOUDSPEAKER

A PERMANENT magnet moving-coil loudspeaker in an arched walnut cabinet of attractive design. It is extremely sensitive and will handle up to 3 watts without difficulty. A universal input transformer incorporated in the instrument enables it to be matched to receivers with triode, pentode or push pull output.

MODEL LS.7 - - - Price 5 gns.

Your local "His Master's Voice" dealer will be pleased to give you full particulars of this and the other thirteen new models.

"HIS MASTER'S VOICE"



The Gramophone Co. Ltd., London, W.1

Don't Forget to Say That You Saw it in "A.W."



Photo: H.M.V.

HOME RADIO

A "HOW-TO-DO-IT" FEATURE FOR THE PRACTICAL MAN

Here are a number of suggestions for the keen amateur together with brief instructions for carrying them out

WHY NOT GRAMO-RADIO?

MANY listeners with good sets, sometimes battery and quite often mains-operated, toy with the idea of converting the existing apparatus to record reproduction—but owing to uncertainties about the correct method of fixing up the extras they never get any further.

Now, there is so much fun to be obtained from the electrical reproduction of gramophone records that every owner of a good broadcast set should make an effort to include this facility as an alternative to broadcast programmes.

Given a set with gramophone pick-up terminals already fitted, the extra equipment can be fitted up in a few minutes. What extras are needed? Firstly, a pick-up—and, if possible, one fitted to a well-designed arm. Secondly, a turntable, preferably electrically driven; or else the clock-work motor of an existing mechanical machine can be utilised. If the mains are available, get hold of an electric motor—and so abolish the tedium of winding up every two or three records. If the mains are A.C., an induction motor will be the thing—there are many inexpensive models on

the market. If the mains are D.C., a universal motor will have to be used.

The only other extra is a volume control, to be fitted between the pick-up and the pick-up terminals. This will have to be a high-resistance potentiometer, say 250,000 ohms.

It is a good plan to build up a motor board for the gramophone part of the set's function. Mount the turntable on the top, fit the pick-up in a convenient position nearby, taking care the makers' tracking instructions are followed. Then mount at some convenient position on the side the volume control, arranging the two pick-up leads so that they make convenient connection to the set. The diagram shows how this system makes a neat and efficient grammo-radio outfit.

By the way, for those really keen on a first-rate gramophone attachment to the set, there is the new H.M.V. playing desk, price 10 guineas, or with automatic record-changing device, 18 guineas. This comprises an induction motor, pick-up, and volume control, with a lid that shuts out all the pick-up noises during reproduction.

Some sets are not provided

with terminals for the connection of a pick-up, but it is very easy to convert the detector valve of, say, a three-valver into a gramophone amplifier, as shown by the diagram. Here is shown a three-point switch, with

the detector grid taken to the centre point; the slider of the potentiometer control on the pick-up forms the "gramo" point of the switch and the grid condenser and leak form the "radio" point.

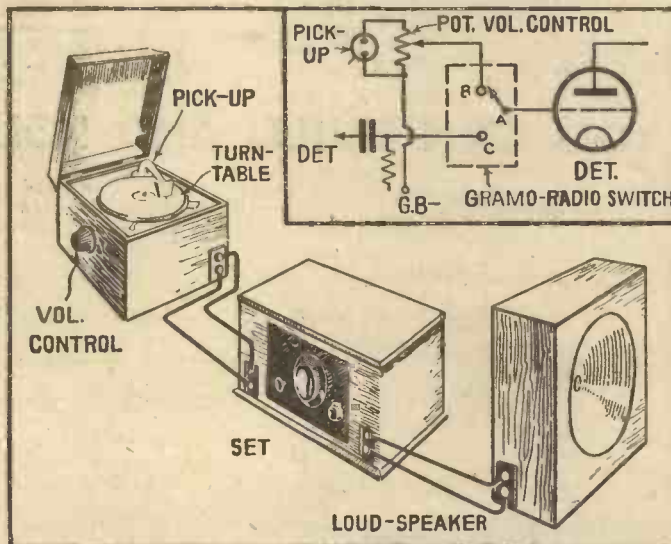

The circuit arrangements for using an ordinary set for grammo-radio and the scheme of connections

CHARGING ACCUMULATORS AT HOME

WHERE the mains are available, then every listener will find it worth while rigging up a charger. With D.C. mains the easiest plan is to put the battery in series with a reading lamp, so that the small current passed by the bulb, usually a quarter of an ampere, with the average metal-filament bulb used, will act as a trickle

charger. This is easily arranged.

Simply cut one of the wires of the flex going to the reading lamp, bare the ends, and (not holding them with the fingers) dip them in water with the current switched on. Bubbles will rise owing to electrolysis and the lead giving the most bubbles should be connected to the negative terminal of the accumulator.

Fit clearly marked spade tags so that other members of the family can disconnect the battery and put it on charge. There is no danger, providing one attends to the terminal connections before the current is switched on.

For A.C. mains there are several inexpensive chargers on the market, such as the Ferranti,

Ekco, Regentone, and Tannoy. The basic principle is a metal rectifier, converting low-voltage A.C. into direct current suitable for charging the accumulator at .5 ampere or 1 ampere.

These rectifiers are connected between the mains supply and the accumulator, but as only a low voltage is needed to overcome the accumulator voltage,

we insert a transformer with a step-down winding between the mains and the rectifier.

The complete sequence of a simple charger for A.C. mains is

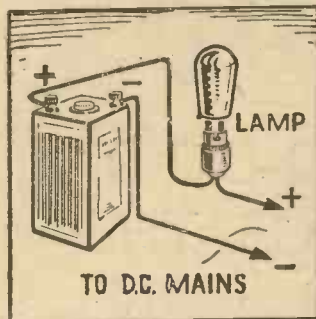

A simple method of charging an accumulator from D.C. mains

therefore transformer, rectifier, and accumulator. Usually the transformer is tapped so that 2-, 4-, or 6-volt accumulators can be charged as desired.

Some listeners imagine there is a lot of complications about installing a charger of this kind. Actually, nothing could be simpler. The diagram shows the usual arrangement. The accumulator is connected in the usual way to the set and need not be disconnected when the charger is switched on. This is a point often misunderstood. Of course when the set is in action it is desirable not to have the charger on, as the mains will then cause a hum background to reception.

So foolproof are these metal rectifier chargers in action that

they can safely be left switched on during the night. This is a great convenience, for the current taken out of the accumulator during the evening's reception can be replenished by the charger during the night.

The .5-ampere chargers are very convenient, because the average set takes just about .5 ampere from the accumulator. The charging may therefore be taken as the number of hours equivalent to the use of the set. As the set will be used only three or four hours per night, as a rule, it is a good plan to leave the charger on every other night.

The essence of the type of charger under discussion is that it enables the accumulator to be kept up to its maximum state of charge. With such a charger

there is no excuse for a run-down accumulator.

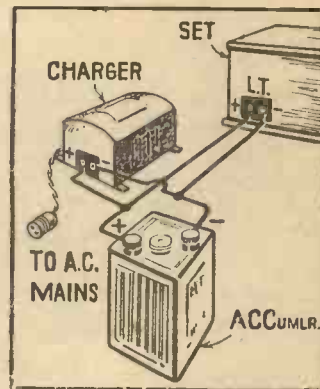

Scheme for charging when A.C. mains are available

HEADPHONES AND LOUD-SPEAKER

OFTEN the listener to a loud-speaker in one room wants to arrange for headphone reception in another room. How can this be done, so that the strength in the headphones is not overpowering? There are several possible ways, but the way suggested by the diagram is probably the most satisfactory.

This consists of an output transformer between the loud-speaker terminals and the extension lines. The ratio will depend upon the matching requirements of the power valve and loud-speaker, but assuming

these are already well matched, a 1-to-1 ratio transformer will be satisfactory. The loud-speaker is connected directly to the

secondary winding and the parallel extension leads taken to the distant phones.

Between the end of the exten-

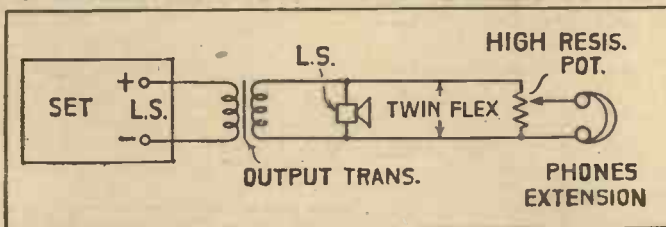

This diagram shows how phones and loud-speaker can be used on the same receiver

sion and the phones is inserted a potentiometer, the winding going across the extension and the phones being tapped across by taking one phone lead to the slider and the other to one end of the winding—it is immaterial which.

As the slider approaches the end of the winding connected to one of the phone leads, the strength of signals in the phones will decrease. In this way a variation in phone strength can easily be found, while the maximum output is being delivered by the loud-speaker.

YOU CAN BUILD AND POLISH YOUR OWN CABINET

IT is quite an easy job to make your own cabinet at home and to get a professional finish on it, too.

Kits of parts are available



An Osborn cabinet of which the parts can be obtained ready to assemble

for all types in which the wood is ready cut to size and the joints made ready for fitting, the only tools required being a hammer, chisel and screwdriver. The illustration of an Osborn cabinet below which has been assembled from such a kit shows that the finished article leaves nothing to be desired, and of course a considerable saving is effected.

The best method of finishing is, undoubtedly, french polishing and it is hoped that the following hints will enable those who would like to try their hand at this method of polishing to do so with a fair amount of success.

The most suitable woods for polishing are the hard varieties such as mahogany, whitewood, walnut, beech, sycamore, etc., and if the amateur woodworker in making his cabinet does not mind the little extra inconvenience occasioned by the use of a hard wood; he will be well advised to select one from the kinds mentioned above.

After planing, the wood should be sandpapered with No. 2 sandpaper, and finished off with No. 1. It must be sandpapered in one direction only—viz., parallel to the grain. When this has been done thoroughly, the wood should be given a

smear of raw linseed oil, the purpose of which is to prevent the grain of the wood from rising unduly.

The surplus oil is wiped off, and then the wood should be given a coat of french polish with a camel-hair brush, obtainable at any oil shop.

The best materials for making french polish are 1 oz. of orange shellac and a ½-pint of methylated spirits. (Shake well at intervals until dissolved.)

Put the job on one side for twelve hours or so, when it will be noticed that the wood has now taken on a rougher surface, which is due to a portion of the grain rising. This must be rubbed down with No. 0 sandpaper until all trace of the rough grain has disappeared.

After dusting, the job should be given another coat of french polish with the camel hair brush. After a further interval of twelve hours it should be given a smooth-off with sandpaper (No. 0). Each time the sandpaper is used all trace of dust must be removed before applying polish again.

If you want a mahogany finish, get a small quantity—say ¼-oz.—of Bismark Brown soluble in alcohol (get the

chemist to guarantee that it is so). Put some of this in a small calico bag and immerse it in a small quantity of polish. Stir and pound this alternatively with a piece of wood—a firewood chip will do admirably—until the desired colour is attained. Of course, if the colour is not deep enough, simply add more of the brown and repeat the process.

The colour is applied to the wood with the camel-hair brush. Two coats will probably suffice,



The partly assembled cabinet; the french polish is applied with a brush at first

but if desired the process can be repeated until a satisfactory colour results.

Walnut finishes are obtained by adding an equal proportion of aniline black to the bismark brown.

Now comes the actual job of polishing. Some of the polish (the clear polish, of course) is poured on to a wad of cotton wool, and this is wrapped in a piece of clean calico. The most delicate part of the whole job now comes along. The pad or rubber, as it is called, formed by the cotton wool, should be neither too dry nor too wet—just damp, and it should be kept damp throughout the process.

The job should now be smeared in different places with raw linseed oil and the rubber taken over the surface of the wood with a circular movement, care being taken to keep it moving steadily the whole time. Go over the job once in this manner and then wait a minute or so before repeating the operation. Great care must be taken not to

disturb the soft surface of the polish which is on the wood, as this surface, though dry, is now very soft and will easily be disturbed and made rough.

In using the rubber, the best advice is to take your time, and in no circumstances allow the

rubber to stop on the surface. If this occurs, the surface will become rough.

After approximately an hour's polishing, in the case of fairly small articles, the polisher will notice that under the surface of the oil, the wood is becoming

clear and smooth in appearance, as the polish is now getting well into the grain. When it appears that the wood is assuming a nice finish (still under the oil) the oil must be removed by means of a further rubber moistened with methylated spirits only, and used with the circular motion described above. When the oil has been practically absorbed, however, the rubber can be allowed to dry while in use.

As soon as the rubbing can be done without leaving any smear of oil behind it, the job can be regarded as finished and laid aside for twenty-four hours, by which time the surface will have hardened.

It must not, of course, be expected that at the first attempt one can get the results attained by a professional polisher, but after a few attempts on small articles, if these instructions are carefully observed, very satisfactory results will ensue; and remember that in this, as in many other things, practice makes perfect.



After treatment with linseed oil the wood is carefully sand-papered. Polishing is done with a rubber held in the manner shown below



REMOTE-CONTROLLING YOUR SET

TO make the most of radio at home you must have provision for working a speaker in more than one room. The set should be fitted in the room most generally occupied, so that long extension leads are not necessary, but often the necessity for a short aerial lead compels one to fit the set in a spare room near the lead-in and to have long leads to the loud-speaker.

there is no need to have two wires.

It is common knowledge that an output choke or transformer is needed to insulate the speaker itself from D.C. current. A tapped choke or transformer is advisable and the choke should be capable of carrying at least 10 milliamperes without saturation.

The connections for choke and transformer systems are shown. The dotted line represents the one wire which alone is needed for the loud-speaker extension. The other terminal of the speaker is connected to any convenient earthed point. The return circuit is made via the earth side to negative low-tension.

This scheme will not work if a mains unit, having a condenser in the earth lead, is used so that the set is not connected to earth in a D.C. sense.

Take care with low-tension extensions. It is a great convenience to switch a set off at a distance, but if the extension leads are very long, you must have one of the several relays on the market, for otherwise the voltage drop across the long L.T. leads will affect the set's performance. For a short L.T. extension, a simple remote control switch can be rigged up as shown in an accompanying sketch, where a jack switch is used so that as the speaker contacts are opened by the insertion of the loud-speaker plug, the L.T. circuit is closed. The Lotus re-

mote control is a suitable device.

The same idea can be applied to mains switching in an all-mains set, but it is not always easy to get good enough insulation between the mains side of the jack and the speaker contacts, which latter, with an output choke, are at earth potential.

Remote control of volume is a more difficult matter than L.T. switching, because most effective volume controls need at

the capacity set up causes some of the high tones to be cut off.

A variable resistance across the speaker forms a handy volume control, but there is generally an alteration in tone if too much resistance is brought into circuit. It is better than no control at all, and is often more effective than extending the three potentiometer wires of the set's volume control.

Tone control of a speaker

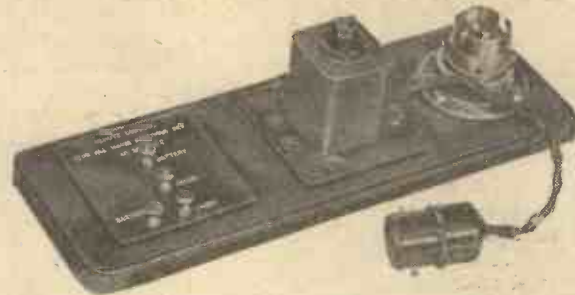

The Lotus system of remote control for mains receivers

least one lead going to the grid of a valve and if this is very long (on the low-frequency side), then

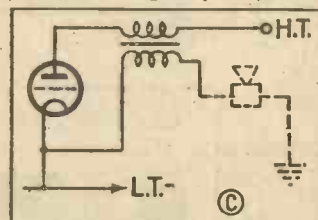

Transformer output for loud-speaker extensions

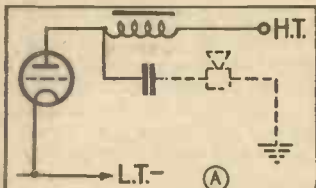

Choke output system for loud-speaker extension

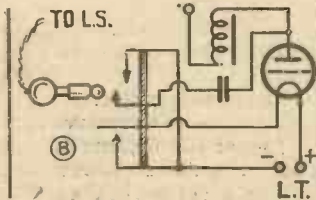

With this arrangement the filament current is automatically switched on when the speaker plug is inserted

In any case, where a loud-speaker extension is needed,

which is at a distance from the set is best done by having two or three fixed condensers which, by means of a rotary switch, can be brought in turn directly across the speaker windings without having to go back to the set to make the adjustment. As the capacity is increased so the higher notes will be by-passed and the tone of the speaker will appear to deepen.

MODERN AERIAL EQUIPMENT

WHICH shall we use—outdoor aerial, indoor aerial, frame aerial, or the mains aerial? The answer depends a good deal on the type of set

and on the reception requirements. For the simple two- or three-valver, not too close to a powerful station, there is still everything in favour of the

outdoor aerial, erected on the lines shown at A in the diagram.

For such an aerial, the 7/22 gauge copper wire, either bare or enamelled, is by far the most

satisfactory, and will beat all the stunt aerials ever invented. Do not use the full 100 ft. of wire. About 70 ft. is quite
(Continued on page 888.)

THREE CURIOUS FAULTS

—AND THEIR SOLUTION. By J. H. REYNER, B.Sc., A.M.I.E.E.

I HAD a set the other day in which there were no fewer than three rather nasty faults which took some little time to discover. As fault tracking is always a subject of interest to the constructor, I propose to discuss these faults here, and show how they were overcome.

The set was an A.C. one, but two of the faults were not peculiar to A.C. working. The third one was, and, as it happened, this fault had to be located and cured first, because when the set was switched on it gave immediate indication that something was wrong in the low-frequency stage.

Easy Overloading

The quality was horribly thin, and the reproduction would blast on the slightest provocation. This, of course, pointed to low-frequency difficulties, and in order to confirm this a gramophone pick-up was connected to the grid of the detector valve. The particular receiver had no provision for doing this. I, therefore, disconnected the tuning coil on the detector circuit and removed the grid leak. The gramophone pick-up was then connected across the grid and cathode in series with a $1\frac{1}{2}$ volts grid-bias battery. On endeavouring to reproduce a record, the same miserable quality was observed, proving that the trouble was in or after the detector valve.

The first component inspected was the L.F. transformer, and I got out an ohmmeter and measured the resistance of the primary and secondary windings, switching the set off during this test, so that there would be no stray voltages in the set which would pass through the ohmmeter and possibly damage it or give misleading readings. The transformer, however, was apparently quite in order.

I then jumped to the loud-speaker, because I have sometimes very carefully tested a set and found that the set itself was quite all right, but that the loud-speaker or the connections thereto were not in order. The loud-speaker, however, was O.K., and so also was the output transformer which was supplying it.

Voltage Checking

The next stage was to test the valves for emission and also to check up the voltages in various parts of the circuit. For the latter purposes a high-resistance voltmeter was used, so that the current taken by the voltmeter was small in comparison with that normally flowing in the circuit, and the reading was thus a substantially correct one. If the meter takes an appreciable current, then the voltage drops in the different parts of the circuit become different, and the readings may be quite misleading.

However, everything was apparently O.K., although the grid-bias reading did not seem to be particularly happy. Sometimes it seemed all right, but at other times I could obtain no reading. Yet the G.B. resistance appeared quite O.K. I therefore switched on the set and started the gramophone pick-up playing straight away.

As the valves warmed up the reproduction came through quite loud and clear. This, however, only lasted for about a minute, after which the horribly distorted quality made its appearance.

This provided the clue to the trouble. The set was allowed to run in this condition for another minute, after which I switched off and quickly measured the value of the grid-bias resistance. This proved to be infinity, indicating a broken wire. Further examination showed that the former on which the resistance was wound expanded with the heat, and as the wire had been wound on somewhat tightly this had resulted in a break. When the former cooled down the two ends of the winding came together and gave an apparently continuous reading, but as soon as the set had warmed up, the ends were forced apart again, giving no grid bias on the last valve, and hence bad quality.

This fault was soon rectified, and attention was then turned to the remainder of the set. When an aerial and earth was connected up it was found that London could be received at weak strength all round the dial. No variation in the position of the tuning condenser seemed to make any difference at all. I immediately suspected faulty coils, and again tested with an ohmmeter to find out what the difficulty was.

All the coil tests proved O.K., however. There was a resistance of 3 ohms on the short-wave band, and 30 ohms on the long-wave band, and both coils gave substantially the same resistances. This not only showed that the coils were 'through,' but that the switches were working correctly, which seemed to rule out the coils altogether.

The next step was to remove the aerial from its normal terminal, and connect it on to the grid circuit of the detector valve, thereby cutting out the H.F. stage and making the set a plain detector and L.F. This, of course, is a very old trick which is often helpful in locating troubles. However, it failed in this instance, and the difficulty still remained, indicating either that there was some very silly fault or that the trouble itself was in the detector tuning circuit.

After a time I came to the conclusion that the defective part was the tuning condensers

themselves. These were of the modern type having a screening cover over them. I therefore removed the said cover and immediately spotted the difficulty. The spindle of the condenser had become jammed and the dial was slipping on the spindle, so that the rotation of the dial was not really moving the condenser at all. After a little adjustment, the condenser shaft was freed, and the dial tightened up, when it was found that the circuit tuned in a perfectly normal manner.

Everything now appeared to be satisfactory, until I tried to check up the ganging—the set was a simple three-valve set having a two-gang condenser for tuning. It then transpired that the ganging had to be altered considerably in changing from the long to short waves, so that if it was correctly adjusted on one waveband it was hopelessly out for the other.

Coil Connections

Now, the coils happened to be home-made coils of a very simple type. There were two sections on the windings, one short wave and one long wave, the latter being short-circuited for reception on the short waves. As I knew that the resistances of the coils were correct, it did not seem that there could be very much wrong. On the long waves the resistance of both coils was 30 ohms and on the short waves it was 3 ohms. If there had been anything seriously wrong with the winding of the coils, there would have been a difference between the resistances, and that might have accounted for the lack of ganging. As it happened, there was no difference and, moreover, an examination of the coils did not indicate any obvious reason for the discrepancy.

The two condensers were unganged and the actual tuning points noted. There was no doubt about it; the coils were reasonably matched on the short waves, and hopelessly out on the long. Examination of the condensers and switches showed no explanation of this. Indeed, if the condensers had been at fault the ganging would have been out on both wavebands, and not only on one; and I was forced to conclude, therefore, that the inductance of the two coils on the long waves was considerably different despite their equal resistances.

The coils, therefore, were removed again and examined more closely, and this time the fault became apparent. Inadvertently the long-wave section of one of the coils had been connected up in the reverse direction. It was intended in the long-wave position that the coil should be one continuous coil, starting at the top of the short-wave coil and running right through to the bottom of the long-wave coil. As it happened, however, the bottom of the long-wave coil had been connected to the bottom of the short-wave coil, and this was placing the two sections of the coil in opposition. When this connection was made good the coil behaved in a satisfactory manner and when placed in the set it worked in a perfectly normal manner.

CONNECTING S.G. VALVES

Make the leads to the anodes of your screen-grid valves as short as possible so that if one pulls loose there will be less chances of a short circuit. In a well-designed set such as the "Century Super," the leads from the coil to the valves are already very short, as shown here.





OUR BROADCAST CRITIC

TALKS ABOUT—

REVUE

AFTER my recent experiences of these shows, I switched into *Peep-Bo-Hemia* with some amount of misgiving.

It was even worse than I expected, which is saying something. The whole production lacked what so many of these productions have recently lacked—originality.

There is nothing new or original in mere noise. In this instance it chiefly consisted of what seemed to me to be a frantic desire on everybody's part to "make it go." They gave me the impression of flogging it; there was a forced sense of gaiety about it which was very disappointing.

Just a few lines, usually of no value, to introduce a song or a duet, the songs being chosen to fit the lines, or vice versa.

The only feature that attracted me in the least was the chorus, which sounded quite effective, especially with the echo behind the singers. Otherwise, it was very poor fare, and must be written down as another failure.

When are these things going to improve? Is there no one who can write a good show of this description?

With the exception of well-known comedians, the B.B.C. provides us with very little that is entertaining on the light side.

Very soon we shall be including excerpts from the Bach cantatas into the vaudeville shows just to liven them up. I can see it coming.

Quite a good concert came through from the North Regional in which the North Regional Orchestra took part. I thought the orchestra played splendidly.

I quite enjoyed Winifred Small and Maurice Cole playing the F major piano-and-violin sonata of Beethoven. With the exception of the *Kreutzer*, this is my favourite fiddle sonata by that composer.

I thought the slow movement, according to them, lacked the tenderness I have always thought it contained, but I appreciated their rendering of the Rondo. I amused myself by playing it with them; my piano happens to be exactly the same pitch as the one in the studio.

As a matter of fact, I am inclined to point out to students that to play a work with a pianist on the wireless, provided one's set is powerful enough, is not at all bad fun.

Mr. Mais, on "Foreign Travel at Home," was most artistic, I thought. It seems to me that, just as the quality of broadcast humour goes down, so that of the more

serious side of broadcasting rises. Strange, but 'tis so.

I was not impressed with Jenny Howard's impersonations of various actresses. To be successful at that sort of thing, one must change one's voice more than Miss Howard did.

As a comedienne I enjoyed her; as a mimic she left me thoroughly sorry for those she mimicked.

There is nothing in the way of a musical instrument that I dislike more than a banjo—unless it be a mandoline or a guitar. I hate all plucked instruments with the exception of the harp.

All the same, I must be honest and confess that I was slightly attracted to Mario de Pietro, who played on this kind of instrument in a vaudeville programme.

He seemed artistic; if he could be artistic on such instruments he must, in my view, indeed be an artiste.

Did you hear Bert Coote in *The Duke of Chicago*? I thought it rather far-fetched.

I see it was written by Dion Titheradge and Harold Simpson. Honestly, I should have credited them with something smarter altogether.

I listened very intently to Nikolai Orloff's pianoforte recital, more especially because he played three Chopin studies which I am particularly fond of playing myself.

His tone delighted me until he began the

Revolutionary Study. Granted that Chopin wrote it in indignation, I think the good Nikolai spoilt it by his heavy touch.

A word to Harold Nicholson. Please, sir, will you speak a little faster and with more variation in your voice?

A word to G. D. Cunningham, also. If you have made the mistake (that so many organists make) of imagining you must detach your chords for wireless transmission please take the hint from me that it is not necessary.

I listened to some of the Foundations as usual. I doubt if the type of Spanish music that was broadcast can honestly be placed in the category of Foundations. Far too flimsy for such a dignity. However, it was a change.

I went to the first Symphony Concert. Beethoven's Fourth Symphony was spoilt by the Scherzo being taken too slowly. Dr. Boult has upset me that way before. Please, Mr. Director, keep to the *only* pace for these things! It is too late now to try experiments with the speed of a Beethoven symphony; we all know what the correct pace is.

Backhaus was superb. The daily papers said his Schumann was not Schumann. *Nonsense!*

Austral must have thrilled many listeners. I only wish it had been possible for them to watch her after her last vocal phrase.

I cannot refrain from remarking that her splendid dignity, as she stood there for at least four minutes during the orchestral postlude to her aria, was something to admire. Thank you, madam, for your artistry!

Did you hear *Chopin*? It interested me vastly. All the same, I think it must have missed many who were not familiar with the story of his life. I thought the play strongly atmospheric, but I found myself thinking of George Sand and his later life.

Also, I thought there was a little too much of his "Funeral March," especially as the incident referred to an early period in his life.

However, there was not much amiss with it, taken as a whole. Plays based on lives of great men are very acceptable to those who, like myself, read and study biography. More, please! WHITAKER-WILSON.



An Impression of Joan Fred-Emney

AN ordinary outdoor or indoor aerial may be used with "Britain's Super." There is no need to choose the aerial carefully as the selectivity of the set itself is enough.

This is helped by the band-pass aerial tuner, which filters the signals collected by the aerial and greatly reduces interference. It is necessary that the two circuits of which the filter is composed be accurately in tune or the strength of the signals will suffer as well as the sharpness of the tuning.

As readers of this paper well know, the advantage of a good band-pass circuit, such as the one used, is that the tuning is really sharp and yet the signals are not distorted as in ordinary sharp tuning single circuits.

Really Selective

In this set we therefore start off with a good selective circuit. Then we follow this by the two beat-frequency filters. These have two tuned circuits each, and being accurately tuned by the makers and sealed in copper boxes, are no trouble to use in spite of their selective properties.

You may rely upon the accuracy of the tuning of the two beat-frequency filters as the makers take great care in the matching. All coils are adjusted to a standard so that any two or three taken at random and used in a set will be found to tune properly.

The only matching that the builder of this set must do is of the two tuned circuits forming the input filter.

GETTING STARTED WITH BRITAIN'S SUPER

By W. JAMES

DETAILING BATTERY VALUES, ADJUSTMENTS, VALVES AND GENERAL OPERATING INSTRUCTIONS

connecting the aerial and earth is very small. It is enough to affect the results, however, and must be considered.

Then there is the inductance of the aerial, but this is usually so small that it is neglected altogether.

Across the second coil and condenser is the capacity, composed of the grid circuit of the valve and its holder. This is too large not to be considered. And so we have to balance the effect of added capacities to the aerial and grid circuits.

This is why trimming condensers are used. They are small condensers connected one to each main condenser of the two-gang unit and can be adjusted by turning the knobs provided.

The method of ganging the two circuits in order that the maximum selectivity and signal strength shall be obtained was described last week. Incidentally, there is a tuning condenser on the single condenser used to tune the oscillator, but it is not needed. The knob may be unscrewed, making the capacity added to the circuit by the trimmer the minimum.

Ganging

You will not be able to obtain the most accurate ganging when tuning to the local station if this is very strong, and it is better therefore, to make a rough adjustment when tuned to the local station and then to tune in a distant station. The oscillator



"Britain's Super" is particularly easy to build

There are two coils in this filter. Both are of equal inductances, having been adjusted by the makers. The two parts of the two-gang tuning condenser used have equal capacities and so all that we are left with is the stray circuit capacities and that of the aerial.

Now, the aerial is connected to one of the coils through a very small condenser, which is fitted by the makers in the base of the coil unit. Therefore, the effective capacity added to the tuned circuit as the result of

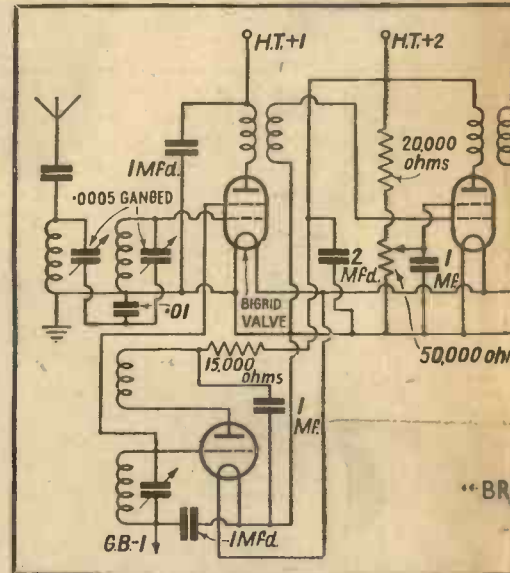

COMPONENTS REQUIRED FOR

- Ebonite panel, 14 in. by 7 in. (Permacol, Peto-Scott, Danipad, Becol, Readi-Rad, Goltone).
- Cabinet, with baseboard, 17 in. by 9 1/2 in. (Readi-Rad "Waldor," Peto-Scott, Camco).
- Two-gang .0005-mfd. variable condenser (J.B. type R2, Lotus, Utility, Polar).
- Single .0005-mfd. variable condenser (J.B. type R1, Lotus, Utility, Polar).
- 50,000-ohm variable resistance (Varley, Bulgin, Sovereign, Colvern, Lissen, Regentstat, Igranic, Watmel).
- Three super-het coils, one oscillator and two intermediates (Wearite, types O2, OT2, and OT1, or Lewcos).

- Band-pass filter unit, with extension rod (Lewcos "BPF").
- Seven valve holders (W.B., Lotus, Lissen, Goltone, Telsen, Benjamin, Graham-Farish, Wearite, Junit).
- Four 1-mfd. fixed condensers (T.C.C., Dubilier, Telsen, Lissen, Formo).
- 2-mfd. fixed condenser (T.C.C., Formo, Dubilier, Telsen, Lissen).
- .01 fixed condenser (only required for modified construction) (T.C.C., Sovereign, Dubilier).
- Two .0002-mfd., and one .0003-mfd. fixed condensers (Telsen, Dubilier, Graham-Farish, Goltone, T.C.C., Ormcnd, Formo, Lissen).

- One-megohm grid leak holder (Goltone, Lissen, Readi-Rad, Bulgin).
- Grid-leak holder (Lissen, Goltone, Dubilier).
- Super-het choke (Readi-Rad, Lissen, Goltone, Dubilier).
- Low-frequency transformer (Lewcos, Lotus, Lissen, Bulgin, Igranic, Graham-Farish, Wearite, Junit).
- Two spaghetti resistors and one 20,000-ohm resistor (Lewcos, Lotus, Lissen, Bulgin, Igranic, Graham-Farish, Wearite, Junit).

ATIONS WITH TAIN'S "SUPER"

T, SUITABLE
RUCTIONS



circuit will be found to be the more sharply tuned and the left-hand tuning condenser must be turned very slowly or stations will be passed over.

A station may be heard with two settings of the oscillator. This is normal and is due to the fact that a station can be converted to the frequency of the beat frequency amplifier by mixing with the signals oscillations having the frequency of 126 kilocycles, more or less.

Thus, if the frequency of the station being received is 1,000 kilocycles (300 metres) the oscillator may be tuned to 1,126 or 874 kilo-

cycles. The difference between the two frequencies in both instances is 126 kilocycles.

Selectivity is, of course, helped by the super-heterodyne action. In this set we use a four-electrode valve as the mixer and apply the incoming signal to one grid and the oscillations from the oscillator to the second grid. Both sets of oscillations combine to produce a signal of 126 kilocycles in the anode circuit of the four-electrode valve, and it is this new signal which is magnified by the screen-grid stage associated with the two special filter coils.

This four-electrode valve is easily adjusted, all that is necessary being to vary the high tension applied to plug H.T.+1, whilst listening to a weak signal. As a matter of fact, the voltage may be adjusted over comparatively wide limits without greatly affecting the strength of the signals.

H.T. Supply

High tension for the oscillator and the screen-grid valve is obtained through H.T.+2 and may be about 120 volts. In fact, the voltage may be the same as that applied to the power valve through plug H.T.+4 when the maximum available is about 120.

You will find that the best results are obtained when the voltage applied to the detector is 90 or more, this being applied

through H.T.+3. Do not use a greater voltage here than necessary, though, as there is no sense in increasing the high-tension current above that needed for the best results.

The volume control is connected to the screen of the screen-grid valve and enables the magnification to be varied over a wide range. There is no reaction control in the set.

How to Tune

When searching for stations the volume control is usually placed three-quarters of full on, and the two tuning controls, that of the aerial circuit and of the oscillator, are slowly moved in step. After a little practice it will be easy to have the two controls

VALVES TO USE

Make	Bi-grid	Oscillator	H.F.	2nd Det.	Power
Mullard	PM1DG	PM2DX	PM12	PM1HL	PM2A
Cossor	—	210LF	215SG	210HF	220P
Mazda	—	L210	SG215	HL2	P220
Marconi	—	L210	S22	HL2	LP2
Osram	—	L210	S22	HL2	LP2
Eta	—	BY2010	BY6	BY1814	BW1304
Fotos	—	BC18	BC150	BC18	BD5
Lissen	—	L210	SG215	HL210	P220
Tungram	—	LG210	S210	H210	P215
Six-Sixty	—	210D	215SG	210HL	22PA

together keeping them in step, but the chief point is that they must be moved very slowly.

The chances are that stations will, at first, be missed, because the tuning is so sharp. There is a slight noise when the circuits are properly in step and the volume control can be turned to make the sounds as strong as possible.

Having heard a signal and brought it up to the maximum strength by adjusting the

**A CONSTRUCTOR'S
PICTURE GUIDE
APPEARS ON THE NEXT PAGE**

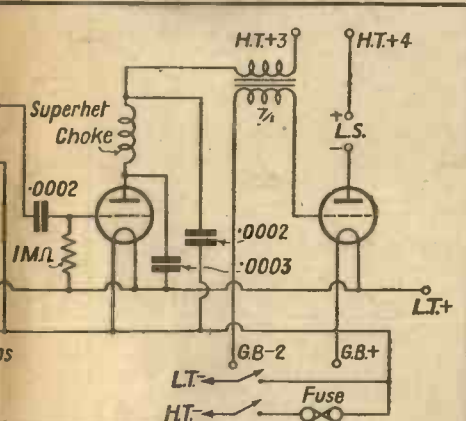

TAIN'S SUPER" CIRCUIT

THE "BRITAIN'S SUPER"

ak (Telsen, Dubilier, Rad, Graham-Farish,

Fuse holder and fuse (Bulgin, Telsen, Readi-Rad, Belling-Lee).

Two spade terminals marked: L.T.+, L.T.— (Belling-Lee, Clix, Eelex).

Readi-Rad, Bulgin, er, Graham-Farish).

Terminal block (Unit, Sovereign, Belling-Lee).

ACCESSORIES

li-Rad).

Two terminals marked Aerial and Earth (Belling-Lee, Bulgin, Clix, Eelex).

Loud-speaker (Amplion, H.M.V., Blue Spot, W.B., Celestion, B.T.H.):

ormer (Telsen, R.I., Varley, Ferranti, h-Farish, Burton).

Double-pole toggle switch (Bulgin, type S.88).

H.T. battery (Drydex, Ever-Ready, Lissen, Fuller, Palaba, Pertrix).

nces, one 15,000-ohm wcos, Telsen, Bulgin, Rad, Lissen, Sovereign,

Connecting wire (Jiffilix).

G.B. battery (Drydex, Ever-Ready, Fuller, Lissen, Palaba, Pertrix).

Six yards of thin flex (Lewcoflex).

L.T. accumulator (C.A.V., Ever-Ready, Exide, Fuller, Pertrix).

filter circuit and oscillator tuning condensers, there is only the volume control to be varied. Tuning is, therefore, very easy. There are no tricky adjustments to be made as with some sets having reaction, the stations being heard as soon as the two adjustable condensers are set to the tuning point.

A power valve that is larger than the PM2A recommended may, of course, be used if the high tension is available and more volume will be obtained and better quality. The volume of the standard arrangement will be enough for most amateurs, who normally use batteries, however, and the valves have been chosen to provide the results expected with the least possible high tension.

If the voltage of the supply to the power valve can be increased to 150 so much the better, and the grid bias must be increased in proportion.

"BRITAIN'S SUPER"

Designed by W. JAMES

CONSTRUCTOR'S PICTORIAL GUIDE

Reference figures and letters correspond with those on the blueprint

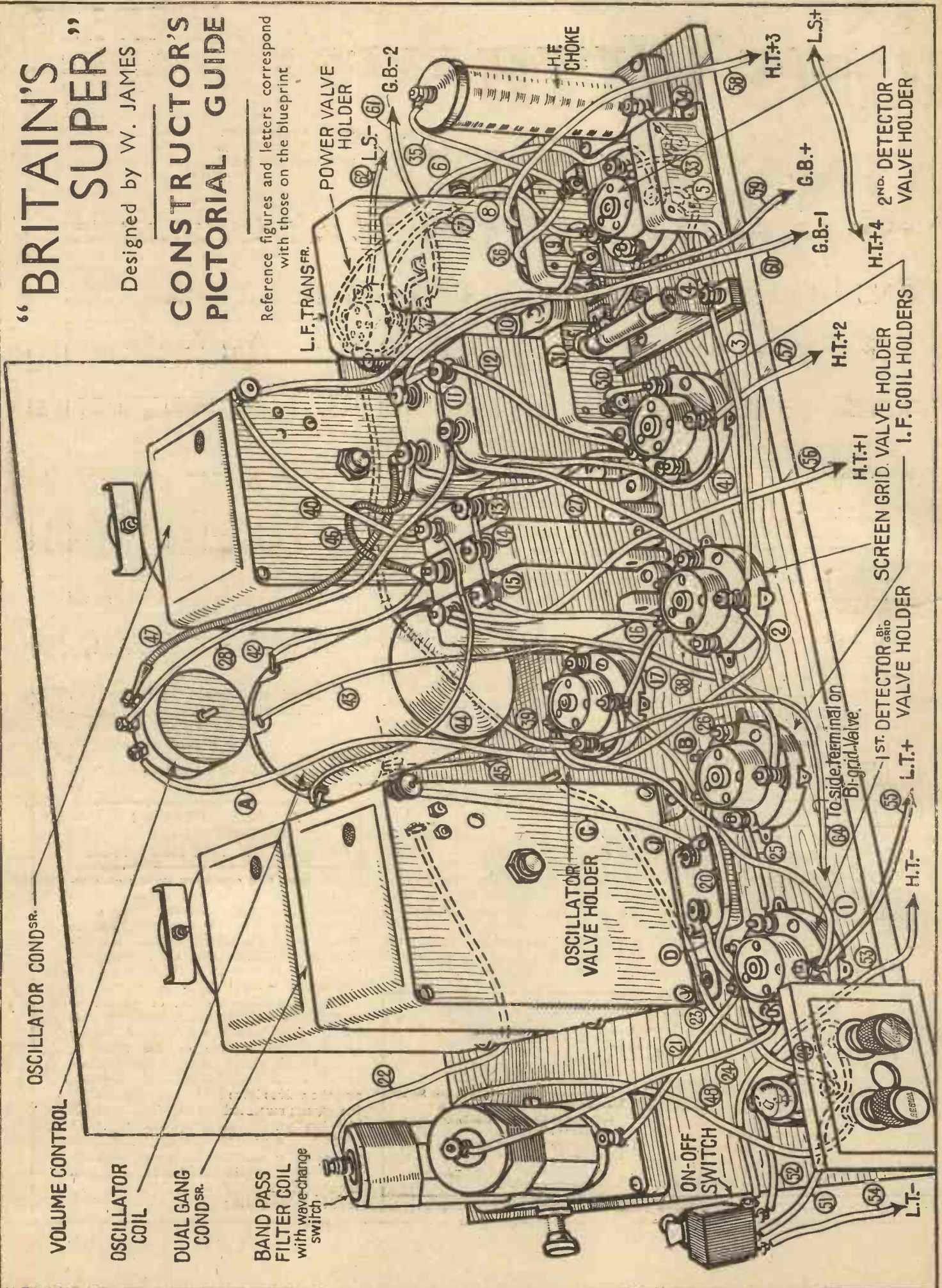

OSCILLATOR COND^{SR}.

VOLUME CONTROL

OSCILLATOR COIL

DUAL GANG COND^{SR}.

BAND PASS FILTER COIL with wave-change switch

OSCILLATOR VALVE HOLDER

L.F. TRANSFR.

POWER VALVE HOLDER

H.F. CHOKE

ON-OFF SWITCH

SCREEN GRID VALVE HOLDER

1ST DETECTOR VALVE HOLDER

L.T.+

H.T.-

H.T.+1

H.T.+2

G.B.-1

G.B.+

H.T.+3

L.S.+

2ND DETECTOR VALVE HOLDER

I.F. COIL HOLDERS

to side terminal on Bi-grid-Valve.

L.S.-

G.B.-2

H.T.+4

L.T.-

H.T.+1

H.T.+2

H.T.+3

H.T.+4

H.T.+5

H.T.+6

H.T.+7

H.T.+8

H.T.+9

H.T.+10

H.T.+11

H.T.+12

H.T.+13

H.T.+14

H.T.+15

H.T.+16

H.T.+17

H.T.+18

H.T.+19

H.T.+20

H.T.+21

H.T.+22

H.T.+23

H.T.+24

H.T.+25

H.T.+26

H.T.+27

H.T.+28

H.T.+29

H.T.+30

H.T.+31

H.T.+32

H.T.+33

H.T.+34

H.T.+35

H.T.+36

H.T.+37

H.T.+38

H.T.+39

H.T.+40

H.T.+41

H.T.+42

H.T.+43

H.T.+44

H.T.+45

H.T.+46

H.T.+47

H.T.+48

H.T.+49

H.T.+50

H.T.+51

H.T.+52

H.T.+53

H.T.+54

H.T.+55

H.T.+56

H.T.+57

H.T.+58

H.T.+59

H.T.+60

H.T.+61

H.T.+62

H.T.+63

H.T.+64

H.T.+65

H.T.+66

H.T.+67

H.T.+68

H.T.+69

H.T.+70

H.T.+71

H.T.+72

H.T.+73

H.T.+74

H.T.+75

H.T.+76

H.T.+77

H.T.+78

H.T.+79

H.T.+80

H.T.+81

H.T.+82

H.T.+83

H.T.+84

H.T.+85

H.T.+86

H.T.+87

H.T.+88

H.T.+89

H.T.+90

H.T.+91

H.T.+92

H.T.+93

H.T.+94

H.T.+95

H.T.+96

H.T.+97

H.T.+98

H.T.+99

H.T.+100

FREE WITH EVERY FREE READY RADIO

BRITAIN'S SUPER MATCHED KIT

Full-Size Wiring Diagram and Plan.

19 pages with complete Instructions
and over 30 interesting Illustrations

APPROVED LIST AT A GLANCE

	£	s.	d.
1 Ebonite panel, 14 in. by 7 in., drilled to specification	4	6	
1 "WALDOR" cabinet, with baseboard, by Ready Radio	1	5	0
1 J.B. two-gang .0005 variable condenser, type R2	1	1	0
1 J.B. single .0005 variable condenser, type R1	12	6	
1 Colvern 50,000-ohm variable resistance (three terminal type)	5	6	
3 Lewcos super-het coils, one oscillator and two intermediates, types 1.F.T.P., 1.F.T., Osc. 126	1	17	6
1 Lewcos band-pass filter unit with extension rod, type B.P.F.	12	0	
*6 Junit 4-pin valve holders	4	0	
1 Junit 5-pin valve holder	10		
4 T.C.C. 1-mfd. condensers, type 50	11	4	
1 T.C.C. 2-mfd. condenser, type 50	3	10	
2 T.C.C. .0002-mfd. fixed condensers, type 34	3	0	
1 T.C.C. .0003-mfd. fixed condenser, type 34	1	6	
1 Readl Rad 1-meg. grid leak and holder	1	4	
1 Readl Rad Super-het choke	5	6	
1 R.I. general purpose L.F. transformer, ratio 7-1	10	6	
1 Lewcos 15,000-ohm spaghetti resistance	1	6	
1 Lewcos 20,000-ohm spaghetti resistance	1	6	
1 Readl Rad H.T. fuse and holder	1	3	
1 Bulgin toggle switch, type S88	2	9	
1 Packet Jiffilax for wiring	2	6	
1 Sovereign terminal block	6		
2 Belling-Lee insulated terminals	6		
8 Belling-Lee wander-plugs	1	4	
5 Valves as specified	3	7	6
Screws, flex, and two spade terminals, etc.	10		
TOTAL (including valves and cabinet)	£12	0	0

NOTE.—5-pin holder is provided for the first detector. This is a universal type and allows for either 4-pin or 5-pin double grid valve.

Any part may be obtained separately if desired.

THE IMPORTANCE OF ACCURATE MATCHING

In order that every purchaser of a Ready Radio "Britain's Super" may obtain the greatest sensitivity, combined with simplicity of operation, all Ready Radio Kits are accurately matched before dispatch under the supervision of Mr. G. P. Kendall, B.Sc.

IMPORTANT

A .01 Band-pass Condenser is recommended by "Amateur Wireless" for increasing volume. We recommend the use of a T.C.C. Type 40 Condenser, price 1/9.

If required, add 1/9 to the price of the kit, or 2d. per month to the monthly payments.

Kit 'A' (Less valves and cabinet) **£7.7.6**

OR BY EASY PAYMENTS

12 monthly payments of **13/6**

Kit 'B' (With valves less cabinet) **£10.15.0**

OR BY EASY PAYMENTS

12 monthly payments of **19/9**

Kit 'C' (With valves and cabinet) **£12.0.0**

OR BY EASY PAYMENTS

12 monthly payments of **22/-**

SEE ALSO PAGES 885 and 889

★ HEAR "BRITAIN'S SUPER" at our SHOWROOMS
159 Borough High Street, (2 minutes from London Bridge Stations) ★

Showrooms :

159 Borough High Street
London Bridge, S.E.1

Phone : Hop 3000



To Ensure Speedy Delivery, Mention "A.W." to Advertisers

Head Office and Works :
EASTNOR HOUSE,
BLACKHEATH, S.E.3

Phone : Lee Green 5678
Grams : Readirad, Blackvil

THE HOW AND WHY OF TUNING—VIII

MAKING SIMPLE TUNING CIRCUITS SELECTIVE

Another of a short series of articles on tuning, specially written for newcomers to wireless.

AS I said last week, the simple tuning circuit comprising a coil and a parallel variable condenser is not good enough for modern requirements. If we connect an aerial and earth to the coil and condenser, as shown by Fig. 1, it is doubtful whether even the local station or stations

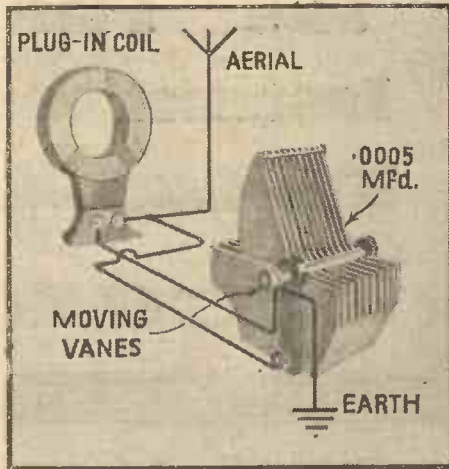

Fig. 1. Selectivity is not obtainable with a circuit of this type

could be received without interference from other signals.

One or two points should be noted about this Fig. 1 circuit. For example, the connection of the aerial to one side of the tuning coil and the earth to the remaining coil connection results in an increase in the maximum wavelength range. This is because the aerial and earth system have a natural wavelength, which is added to that of the coil and condenser circuit.

If we consider the aerial as one plate of a condenser, the earth is the other plate, and the capacity between the aerial and earth will be in parallel with the tuning

circuit. The minimum capacity of the Fig. 1 circuit will therefore depend on the capacity of the aerial to earth and not only on the minimum capacity of the tuning condenser.

Whatever this aerial to earth capacity may be, it is clear that the variation of capacity when the aerial is connected is reduced. Consequently the variation in the wavelength range of the coil may be reduced even though the maximum wavelength may be increased.

Now take a look at Fig. 2, where the simple coil and condenser circuit has been modified by the inclusion of a small fixed condenser in series between the aerial lead and the coil to which the aerial would normally be connected. Bearing in mind the dotted line capacity of Fig. 2, it is easy to see that the inclusion of the small fixed condenser is really its connection in series with the aerial capacity. In other words, the new fixed capacity and the aerial capacity are in series with each other and at the same time the series arrangement is in parallel with the coil.

end of the coil remote from the earth we connect it to a tapping on the coil. The nearer this tapping is to the earth end of the coil, the smaller is the damping effect of the aerial on the whole coil.

The auto-transformer coil connections shown by Fig. 3 are now adopted as stan-

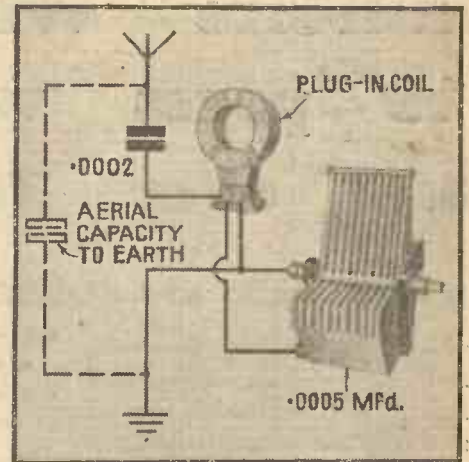

Fig. 2. The effect of the fixed condenser is to reduce aerial capacity

Effect of Series Condensers

Now when condensers are connected in series the resultant capacity is always less than the capacity of any one of the condensers. So the effect of the small fixed condenser is to reduce the capacity of the aerial across the tuning coil. Suppose the aerial capacity were .0002 microfarad and the small fixed condenser also has a capacity of .0002 microfarad; then the total capacity across the coil is only .0001 microfarad.

The tuning range of the coil is therefore increased, although the inclusion of the fixed condenser, by reducing the parallel aerial capacity, also reduces the maximum wavelength of the coil and variable condenser. For this reason, it will be found that when using the Fig. 2 circuit a larger coil will be needed to tune to any given wavelength than with the Fig. 1 circuit. A No. 40 coil would do for most of the medium wavelengths with the Fig. 1 circuit, but a No. 60 coil would be needed for the Fig. 2 circuit.

dard, and usually the coil has several tapping points, so that various degrees of coupling and therefore of selectivity can be obtained.

With the aerial connected to tap No. 2 in the Fig. 4 circuit, a good compromise between selectivity and volume would probably be obtained. Tap No. 1 would give greater selectivity, but only with some loss of volume. Tap No. 3 would give less selective tuning, but the volume would be greater.

In such simple tuning circuits, it is always necessary to compromise between the need for selectivity and the need for

(Continued at foot of page 886)

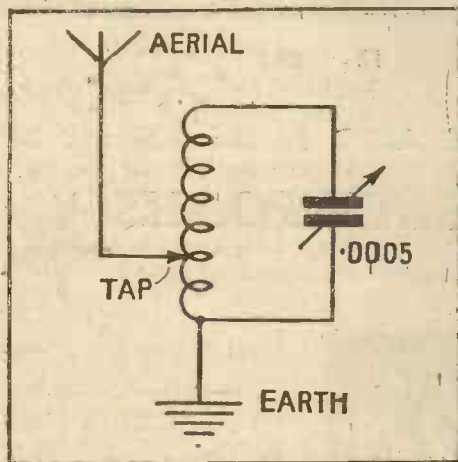

Fig. 3. An effective way of reducing aerial damping

Aerial Damping

Quite apart from the question of wavelength ranges, we must not overlook the fact that the Fig. 2 circuit is much more selective than the Fig. 1 circuit, due to the fact that the damping of the aerial resistance is decreased by the series condenser between the aerial lead and the coil.

Another simple and effective way of reducing the high-resistance damping effect of the aerial on the aerial tuning circuit is shown by Fig. 3. Here we have a tapped coil, the whole of which is tuned by the .0005-microfarad variable condenser. Instead of connecting the aerial lead to the

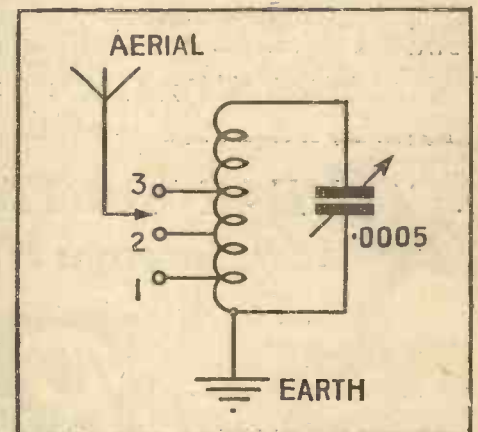

Fig. 4. An arrangement that will provide a compromise between selectivity and volume

Ready Radio

Specially Recommended

for

Britain's Super



BATTERY EQUIPMENT

	£	s.	d.
consisting of:			
1 Complete kit of components, including valves and cabinet (KIT "C")	12	0	0
1 Pertrix 120-volt Super Capacity H.T. Battery	1	5	6
1 Pertrix 2-volt 30-amp. L.T. Accumulator type PXG.3	11	0	
1 Pertrix 9-volt Grid Bias Battery	1	6	
1 British Blue Spot Cabinet Loud-speaker, type 44R	2	12	6

Total **£16 10 6**

Or 12 monthly payments of **30/3**

The complete kit as above, but with completely assembled receiver (including Royalties). **£19 0 6**

Or 12 monthly payments of **34/10**

The beautiful "Waldor" Cabinet, used for "Britain's Super," was designed specially by Ready Radio artists at the request of "Amateur Wireless."
PRICE ONLY ... 25/-

INSTAMATIC OUTPUT

The Instamat Output Transformer, recommended by "Amateur Wireless," combines all the advantages of an Output Transformer of the most perfect design, with the unique advantages of *instant matching* of output valve and speaker. Price **27/6**

For all speakers except low-resistance moving coils.

INSTAMAT MAJOR (for low resistance moving coils). Price **37/6**

READY RADIO MAINS UNIT

Specially designed by Mr. G. P. Kendall, B.Sc., Chief Engineer of Ready Radio, Ltd., for use with the "Britain's Super." Fully decoupled with four separate positive tapings specially adjusted to suit the receiver. Gives ample output and adequate voltage.

Price **£5 17 6** Or 12 monthly payments of **10/9**

A.C. MAINS EQUIPMENT

	£	s.	d.
consisting of:			
1 Complete kit of components, including valves and cabinet (KIT "C")	12	0	0
1 Ready Radio Mains Unit with trickle charger	5	17	6
1 Pertrix 2-volt 30-amp. L.T. Accumulator, type PXG.3	11	0	
1 Pertrix 9-volt Grid Bias Battery	1	6	
1 British Blue Spot Cabinet Moving-coil Permanent Magnet Loud-speaker	5	10	0

Total **£24 0 0**

Or 12 monthly payments of **44/-**

The complete kit as above, but with completely assembled receiver (including Royalties). **£26 10 0**

Or 12 monthly payments of **48/9**

READIRAD SUPER-HET CHOKE
Designed by G. P. Kendall, and chosen by W. James for "Britain's Super." Price **5/6**

FREE WIRING DIAGRAMS AND FULL CONSTRUCTION DETAILS—See page 883

CASH or C.O.D. ORDER FORM

To: Ready Radio, Ltd.,
Eastnor House,
Blackheath, S.E.3.

Please dispatch to me at once the following goods

for which (a) I enclose (b) I will pay on delivery } (Cross out line not applicable) £.....

NAME

ADDRESS

A.W. 31/10/31

EASY PAYMENT ORDER FORM

To: Ready Radio, Ltd.,
Eastnor House,
Blackheath, S.E.3.

Please dispatch to me the following goods

for which I enclose first deposit of £.....

NAME

ADDRESS

A.W. 31/10/31

TO OVERSEAS CUSTOMERS.—Everything Radio can be supplied against cash. In case of doubt regarding the value of your order, a deposit of one-third of the approximate value will be accepted and the balance collected by our Agent upon delivery of the goods. All goods are very carefully packed for export and insured, all charges forward.
Advt. of Ready Radio, Ltd.

TO INLAND CUSTOMERS.—Your goods are dispatched post free or carriage paid.

To Ensure Speedy Delivery, Mention "A.W." to Advertisers

"BRITAIN'S SUPER" AS A RADIOGRAM

Working "Britain's Super" as an electric gramophone amplifier, in conjunction with an automatic record-changing turntable

ALTHOUGH "Britain's Super" is not fitted as standard with provision for working from a gramophone pick-up, it is, nevertheless, easy to fit a pick-up and so convert the set into a very effective electric gramophone. I have obtained a great deal of pleasure in working the "Super" with the new H.M.V. record-changing turntable, model 117.

Before adding a pick-up of any kind to the "Super," a slight alteration of the grid-circuit wiring of the second detector is

needed and a two-way switch or a short length of flex which can be plugged into one or other of two sockets must be fitted. The necessary alterations are easily carried out. The two-way switch places the grid of the second detector either on the .0002-microfarad grid condenser or to the volume control of the pick-up drive. In the case of the H.M.V. turntable, it is a matter of only a few minutes to connect up the

pick-up to the set. The two blue plugs on the back of the turntable cabinet are connected to one side of the radio-gramophone switch to be fitted on the set and to negative $1\frac{1}{2}$ volts grid bias. The black plug on the cabinet is connected to earth. The turntable works on D.C. supplies from 50 to 250 volts and on A.C. from 100-130 and 200-260 volts. A sliding resistance is provided to cut down the voltage of a D.C. supply and, as this is clearly marked, there is no fear of overloading the turntable motor.

Two copper links have to be put in place on a small terminal strip for A.C. working, and the turntable can then be connected to

maximum of eight records, either 10 in. or 12 in., and a knob and slider adjusts the automatic record-changing mechanism for records of either size. A single record can be repeated any number of times, up to eight, by adjusting a knob on the turntable which controls the record changing, and this ability to repeat a record over and over again is a big advantage when testing a set and one is using, say, a constant frequency record.

If one does not want to play the full number of records, then the knob is set so that if, say, only three records are required the pointer stands at "five" on the scale. A button on the front rejects any record, and even while a record is playing another can be put on the turntable merely by pushing the button. After playing the last record the mechanism automatically returns the selector knob to the off position and switches off the main supply to the motor.

Automatic Working

A big advantage I found in the automatic changing mechanism was that it is necessary only to pick out eight records which you want to hear, put them in the magazine, switch on, shut the lid of the cabinet, and leave the turntable mechanism and "Britain's Super" to do the rest.

Volume is controllable by means of a knob on the outside of the cabinet, and very smooth control is obtained. The best position is near the minimum end, for the voltage output of the H.M.V. pick-up is considerable. The pick-up works only with loud-tone Tungstyle needles, and as these play forty to fifty double-sided records, needle changing is by no means a bother.

At the back of the volume control is a clip carrying resistances which prevent the first valve being overloaded. A 25,000-ohms resistance is supplied as standard and is satisfactory for the "Super." A change of tone is obtainable by using resistances of different values.



"Britain's Super" connected up to the H.M.V. automatic record-changer

needed and a two-way switch or a short length of flex which can be plugged into one or other of two sockets must be fitted.

The necessary alterations are easily carried out. The two-way switch places the grid of the second detector either on the .0002-microfarad grid condenser or to the volume control of the pick-up drive. In the case of the H.M.V. turntable, it is a matter of only a few minutes to connect up the

an A.C. supply. A special condenser has to be fitted for 130-160-volt supplies, and for supplies of 75-100 cycles a special A.C. motor is available. The standard motor works on 40-60 cycle supplies.

It is advisable to change over the leads to the two blue plugs to get the most satisfactory position. Once this adjustment has been made, the whole outfit is ready for work. The H.M.V. turntable plays a

"MAKING SIMPLE TUNING CIRCUITS SELECTIVE"

(Continued from page 884)

adequate volume. Even if there is plenty of amplification after the tuning circuit, it is unwise to carry the sharpening of the tuning of a single circuit too far, otherwise, as mentioned in previous articles, the quality of reproduction will be impaired by the cutting of the higher audible frequencies.

For broadcast reception on the medium waves, using the Fig. 4 arrangement, a No. 50 and a No. 60 tapped coil will usually be suitable. For the long waves, a No. 250 tapped coil should work well.

A very useful tuning circuit is shown by Fig. 5, combining the advantages of the Fig. 2 and Fig. 3 circuits. The small series condenser is variable, and should be a .0003-microfarad pre-set type, as shown by Fig. 6. The coil can be a No. 60 centre-tapped plug-in type, and this, with a

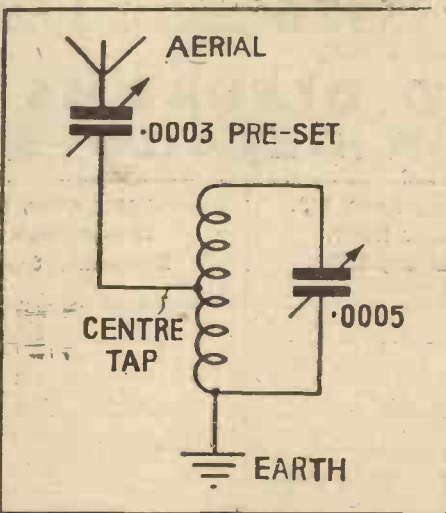

Fig. 5. A useful tuning circuit of a simple type

.0005-microfarad tuning condenser in parallel, should cover all the medium wavelengths.

A great deal of interesting work can be done with solenoid coils wound at home for a few pence. Next week I will give suitable winding details for home-made solenoids, as well as some excellent selective circuits for crystal and valve sets.

HOTSPOT.

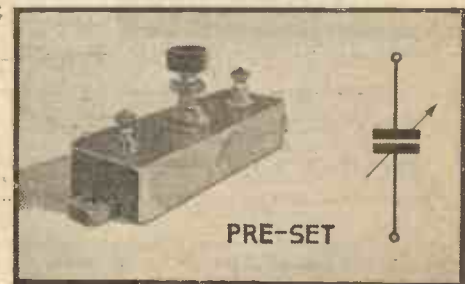

Fig. 6. A pre-set condenser and its symbol

TYPICAL OF TELSEN VALUE

TELSER VALVE HOLDERS (Prov. Pat. No. 20286/30)

The Telsen four and five-pin valve holders embody patent metal spring contacts which are designed to provide the most efficient contacts with split and non-split valve legs, and are extended in one piece to form soldering tags. Low capacity and self-locating.

- Telsen 4-pin Valve Holder Price 6d.
- Telsen 5-pin Valve Holder Price 8d.

TELSER FIXED MICA CONDENSERS (Prov. Pat. No. 20287/30)

Telsen Fixed Mica Condensers are made in capacities from .0001 microfarad to .002 microfarad. They can be mounted upright or flat and the .0003-microfarad Telsen fixed mica condenser is supplied complete with patent grid-leak clips to facilitate series or parallel connections.

- Telsen Fixed Mica Condensers Price 6d.

TELSER GRID-LEAK HOLDER

The Telsen Grid-Leak Holder will hold firmly any standard size or type of grid leak. Ample clearance is provided between the terminal screw leads and the baseboard (underneath), preventing any surface leakage upsetting the value of the grid-leak. The terminals and fixing holes are accessible without removing the grid-leak.

- Telsen Grid-Leak Holder Price 6d.

TELSER SPAGHETTI FLEXIBLE RESISTANCES

These are made in a range of values from 300—200,000 ohms with a maximum current varying from 42 m/a to 1 1/2 m/a. The terminal tags are firmly fixed to the wire and clearly marked with their respective resistance values; they are impregnated with special insulating compound which renders them proof against corrosion.

- Telsen Spaghetti Flexible Resistances from 6d.

TELSER FUSE HOLDER

This is a neat and inexpensive device which should be incorporated in every set as a precaution against burnt-out valves. The Telsen Fuse Holder firmly grips the standard radio fuse, giving a perfect contact.

- Telsen Radio Fuse Holder Price 6d.

TELSER GRID-LEAKS

Telsen Grid-Leaks are absolutely silent and non-microphonic, and practically unbreakable. They cannot be burnt out, and are unaffected by atmospheric changes. Telsen Grid-Leaks are not wire wound, and therefore there are no capacity effects. Their value is not affected by variation in the applied voltage. Made in values from 1/4—5 megohms.

- Telsen Grid-Leak Price 9d.

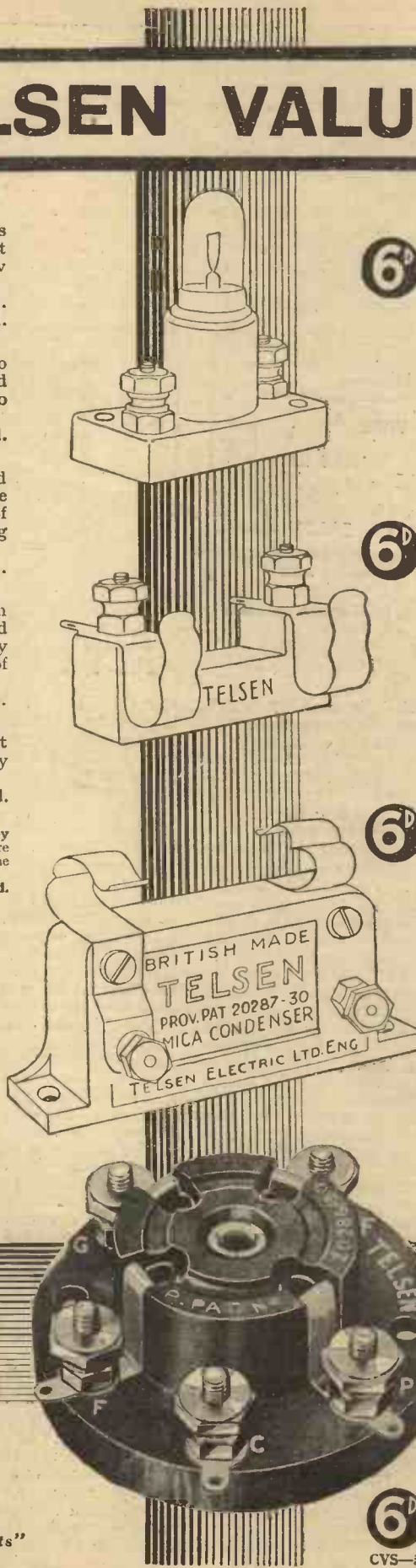

TELSER

ALL-BRITISH RADIO COMPONENTS



9d

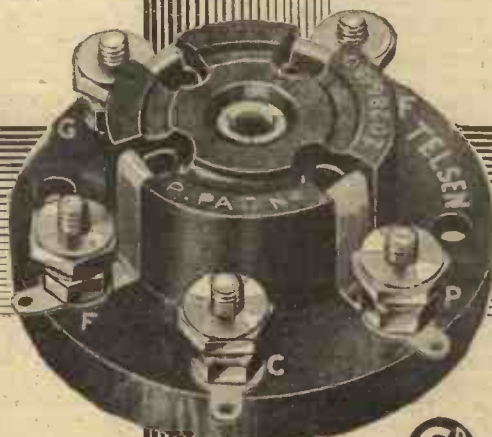

6d

Send for the "Telsen Radio Catalogue" and book of "All-Telsen Circuits" to The Telsen Electric-Co., Ltd., Aston, Birmingham.

CVS-56

To Ensure Speedy Delivery, Mention "A.W." to Advertisers

"HOME RADIO"

(Continued from page 877)

long enough, and this must include the down lead—the section coming from the insulator at the house end.

There is no need to break the wire at the point where the down lead starts.

Keep the down lead well away from the wall. The minimum distance of this wire from the wall should be 1 ft. and preferably more.

Earths are very important,

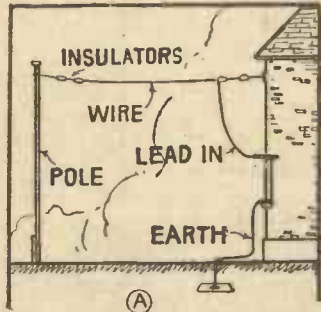

The usual type of outdoor aerial

specially in mains sets, where the use of a poor earth is sure to cause hum. The buried plate or spike driven in moist ground makes the best type of earth, but a clean connection to a main water pipe is very satisfactory.

In these days of powerful stations many listeners are finding that an indoor aerial, consisting of, say, 50 ft. of cotton-covered wire of 20 gauge, makes quite a satisfactory aerial—and has the advantage of imparting

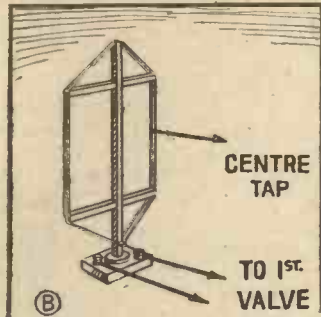

Connections for frame aerial

to the aerial tuning a good degree of selectivity.

The most selective aerial device known is the frame aerial, as used in such sets as the "Century Super," described recently by W. James. A powerful set is needed with a frame aerial, which, owing to its action is the least efficient collector of wireless waves. The modern frame aerial is centre-tapped, the tap going to the earthed point, or rather low potential point of the set, as at B.

Many inexpensive frame aeriels have been developed for AMATEUR WIRELESS sets of the super-het type. The directional

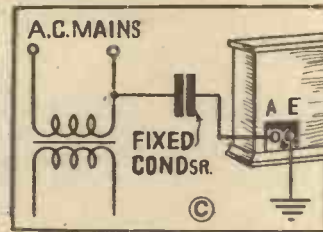

The lighting mains can be used as an aerial in this manner

advantage of frame aeriels should not be forgotten. This peculiar advantage of the frame enables two stations whose waves are coming from different directions to be entirely separated even on sets that are not particularly selective.

This season the mains-operated sets have nearly all been fitted with a mains-aerial attachment, the circuit outline of which is shown at c in the diagram. The mains-aerial enables the mains conduit to be utilised as a pick-up for wireless waves, though not, of course, of a very efficient type. Nevertheless, on a powerful four-valver, for example, the mains aerial will enable several foreign stations to be reproduced at full loud-speaker strength.

Even on less powerful sets the mains aerial gets the locals quite satisfactorily. There is no appreciable mains hum introduced.

In order of merit, one ought to place aeriels as follows: outdoor, indoor, mains, and frame.

FITTING ADAPTORS

THERE is nothing which upsets family reception quite so much as the desire by *pater familias* to tinker about with the set for long-distance or short-wave work.

An obvious way to overcome this is to have two sets, but where the strictest economy must be observed it is possible to work an ordinary broadcast reception set on the short waves or as an ultra long-distance set, merely by convertors or adaptors which can be switched in when required. There are two ways of working a broadcast band set on the short waves.

A little detector stage with short-wave coils, high-resistance leak, a .0001-microfarad condenser, and valve holder, can be mounted up on a piece of board with flex leads taken to a plug fitting in the detector stage of the broadcast set. The valve is removed and put in the short-wave adaptor. Battery connections are automatically made via the filament and anode sockets.

This conversion can be made in a couple of minutes without

disturbing even the tuning setting of the broadcast-band set. It is generally a more efficient way. Fitting short-wave coils in broadcast-band coil sockets generally results in a fair amount of loss owing to the high capacity and there need be no capacity losses with an adaptor.

A super-het adaptor can be used, too, and is a great advantage if the broadcast set has one or more H.F. stages, preferably S.G.'s. The super-het adaptor connects across the "front" of the set, aerial and earth that is, and acts as the oscillator and first detector of the super-het.

The S.G. stage of the broadcast set is tuned to act as the intermediate amplifier and the broadcast-band detector valve acts as the second detector of the super-het sequence. This can only be done with a set having at least one H.F. stage, unless one is prepared to incorporate the intermediate stage (S.G. valve) in the adaptor unit.

No matter whether an auxiliary detector or a super-het adaptor is used, the broadcast set can easily be made to work

on the short waves, without altering the wiring. A good set for broadcast reception is usually a good distance getter and so not much conversion is needed for the man who occasionally wants to get away from the locals and, when the family is in bed, do a bit of DX listening.

A set specially designed for

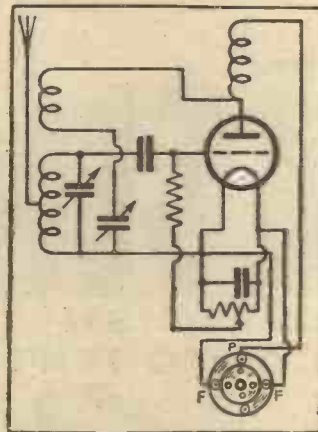

Circuit for adapting a broadcast receiver to short-wave reception

long-distance reception, though, differs in certain respects from an ideal B.B.C.-reception set. The detector stage may have different values for condenser and leak. The valve itself may be of a trifle higher impedance. This will mean a different coupling to the L.F. stage.

Volume controls, tone correctors, and pick-up fittings, necessary in a broadcast set, may mean loss of signal strength, which will be a serious worry to the long-distance enthusiast. Here again, the best solution is an adaptor detector stage.

A separate holder can be provided carrying a valve with an impedance of about 20,000 ohms, grid condenser and leak of .0002- and 3-megohms respectively and a fairly high-ratio transformer, preferably resistance-capacity fed, so that there is a high step-up, without loss of quality.

This adaptor can be brought into use when the owner wants to make the most of the distance-getting properties of the set and does not mind slight loss of quality.

MAINS OPERATION

MAINS units designed for use with a particular receiver are often required for use with a totally different design of receiver. Provided the total output current and voltage available from the mains unit is sufficient, it is quite a simple matter to determine suitable voltage-dropping resistances. Knowing the current required by a particular valve at a given anode voltage, we subtract this voltage from the maximum output voltage of

the mains unit and divide the figure that is left by the current requirements of the valve. As the current consumed by the valve is usually in the order of milliamperes, the result from the above simple sum should be multiplied by 1,000. The answer is the resistance required to give the necessary voltage drop. As an example, suppose the voltage of the mains unit is 200, and the current required for a particular valve is 2 milli-

amperes at 120 volts, the excess voltage of 80 divided by 2 and multiplied by 1,000 equals 40,000 ohms anode-dropping resistance.

The method of determining suitable values of resistances for automatic grid biasing is easy. The current consumption of the valve at a certain grid bias and anode voltage should be determined from the valve makers curve. The figure representing the grid-bias voltage should then be divided by the figure repre-

senting the current consumption of the valve. As the current consumption of the valve is in milliamperes, the result of the above simple sum should be multiplied by 1,000. Assuming that the current consumption is 10 milliamperes at 120 volts and 10 volts grid bias, divide the bias voltage of 10 by the milliampere consumption of 10 and multiply by 1,000, and the result—1,000 ohms—is the value of a suitable biasing resistance.

KENDALL REPLIES

to typical queries concerning

BRITAIN'S SUPER

As I have electricity in the house, I would like to build the "Britain's Super" for mains operation. Can it be converted easily and what are the alterations?

I should not advise you to attempt to modify the set for the use of mains valves, but rather to use a good mains unit incorporating a trickle charger to keep your L.T. battery up to scratch the whole time. In this way you can dispense with the H.T. battery and get almost the full convenience of all mains working.

Can I use a pick-up with "Britain's Super"? If so, will you please tell me how to connect it. Will it affect the performance of the set in any way?

The easiest way to use a pick-up with this set is to employ one of those special adapters which can be inserted between the detector valve and its socket, and take a flex lead from this to your pick-up. In this way you will not affect in any way the performance of the receiver.

"Britain's Super" is obviously a distance-getter, but how about local-station reception? Is quality good and can the volume be reduced sufficiently?

The volume control provided in the design has quite a wide range of action, and you will find that it is possible to cut down the strength even on a powerful local until perfectly good quality is obtainable. Actually, the quality of reproduction given by "Britain's Super" is definitely good.

The panel included in Ready Radio kits is already cut and drilled to specification. A screwdriver is the only tool you need when building your set with a Ready Radio kit.

The circuit diagram shows the loud-speaker terminals connected directly between the output valve and H.T.+ . Why is this? I thought an output circuit was always advisable, especially with a powerful receiver.

Although an output circuit is not essential, naturally if some form of output circuit is employed by which proper matching is achieved between loud-speaker and output transformer, the best possible quality is assured. A good multi-radio transformer such as the Instamat is suggested for this purpose.

The blueprint of the "Britain's Super" shows all the wiring arranged in straight lines with sharp angles, but the photographs show the components connected just anyhow. Which do you recommend for best results?

Actually, this receiver is not a very critical one as to wiring, so long as reasonable discretion is used in spacing out the more important wires, such as those to the plates and grids of the valves. Much the easiest way to wire up your set is by using Jiffilinx, with which you can make a very neat job, and your work will be quicker and easier because the links have the necessary connectors already fastened on their ends and are supplied in various lengths from which you can choose.

Always use Jiffilinx for wiring. They save you time and trouble, eliminate soldering, and give perfect contact.

These extracts of typical letters from Mr. Kendall's postbag are printed, with Mr. Kendall's replies, as we believe they will answer many of the questions which may arise in the minds of intending constructors of "Britain's Super."



G. P. Kendall, B.Sc., Chief Engineer, Ready Radio (for many years Chief of Research of Popular Wireless and Modern Wireless).

Why is a super-het choke specially recommended? I have a — (which I believe is a good make of H.F. choke), and I would naturally like to use it.

The point here is that a choke for this purpose must have a very high value of inductance and a high natural wavelength in order to function efficiently on the comparatively long wavelength of the "intermediate amplifier" of a super-heterodyne. The particular choke you mention definitely fails to conform to these requirements, and you are advised to stick to the original specification here.

I see that a slight alteration is now recommended in order to give band-pass tuning, but this is stated to decrease selectivity, although it increases the volume. For all-round performance, do you consider "Britain's Super" is best with or without this addition?

The decrease in selectivity which results from the insertion of the band-pass coupling condenser is extremely slight. For general results, I certainly advise the use of this condenser, since I have found on test that it makes a marked difference to the volume of the long-wave stations and also has a definite, though less marked, effect on the strength of those on the medium wave band.

I have not heard a super-het for many years, but I remember that the old types did not give very good quality. What sort of quality does "Britain's Super" give?

"Britain's Super" definitely gives reproduction of excellent quality, and you need have no fear that it will be in the least like the muffled and deep tone of the older instruments which you mention.

Every builder of "Britain's Super" should read Kendall's book entitled "Ten Hows for Modern Radio Constructors." Send four 1½d. stamps for your copy.

In order to get the very best from "Britain's Super," would there be any advantage in using two separate tuning controls, or the addition of a trimmer condenser to one of the ganged condensers?

This is certainly not advised. Separate tuning controls are extraordinarily difficult to handle on a band-pass circuit, and, as far as the trimmer condenser is concerned, this should be quite unnecessary with a properly matched kit as supplied by Ready Radio.

I should very much like to build "Britain's Super," but have never tackled anything larger than a two-valve set and have very little technical knowledge. Am I likely to experience any difficulty if I attempt "Britain's Super"?

You need have no fear whatever on this score, because it is very doubtful whether you will find "Britain's Super" any more difficult to make than the two-valver which you originally attempted. It is a particularly easy set to build, partly as the result of the use of complete units for the various sections and partly as the result of skilful design. You will find Jiffilinx a great help, especially as they eliminate soldering.

Hear "Britain's Super" demonstrated at the Ready Radio showrooms, 139 Borough High Street (two minutes from London Bridge Station).



SEE SPECIAL FREE OFFER Page 883





A weekly review of new components and tests of apparatus conducted by J. H. Reyner, B.Sc., A.M.I.E.E.

Varley H.F. Coil

READERS will recall that we recently reviewed in these columns the now well-known Varley Square-Peak aerial coil, a band-pass filter of a "mixed" variety. Designed especially for use with the Square-Peak coil, the Varley High-frequency Intervalve coil has now been placed on the market. This coil is housed in a pressed aluminium can provided with lugs at the bottom to facilitate baseboard mounting. Connections to the coil are made by means of lugs which protrude from the top of the screening can and which carry terminals. The screening can is not in electrical connection with the windings and will, therefore, require to be earthed separately. The wavechange switch is also mounted near the top of the can to enable it to be ganged with the switch of the Square-Peak aerial coil and the windings are arranged so that either a tuned-grid or a



Varley H.F. Coil

tuned-anode scheme may be used. The short-wave winding is tapped approximately one-third down from the grid end. A reaction winding is provided which is permanently connected to the earth end of the grid coil, it will thus be necessary to use a reaction condenser which is insulated from any metal screening.

On test the coil was quite satisfactory, good ganging being obtained with the Square-Peak aerial coil over the whole tuning range. The coil retails at 8s. 6d., complete with instructions for fitting and operating.

Atlas H.F. Choke

THE Atlas high-frequency choke which we have tested this week is a good example of modern design. The binocular form of construction has been adopted, the winding being on two ebonite formers which are placed side by side on a small ebonite

base. Each former has seven slots and a terminal at the top for the external con-

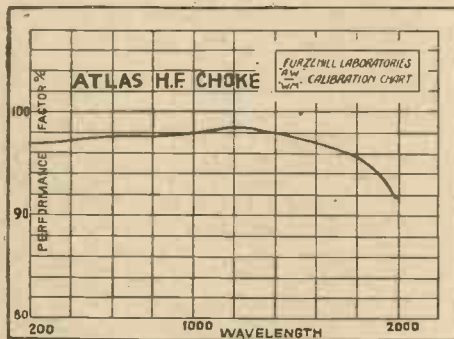

Characteristic curve of the Atlas binocular H.F. choke

nection. The whole job is neat, small and sturdy.

A performance test in accordance with our usual practice was conducted on the choke. From the data obtained, a performance factor is evolved, which gives an indication of the effectiveness of the choke by comparison with a .0001-microfarad condenser.

The results of the test are shown on the curve herewith, which indicates that the choke is quite satisfactory. It will be seen that from 200 metres to 1,700 metres approximately, the choke has a performance factor averaging about 98 per cent., indicating that 98 per cent. of the high-frequency current would be by-passed through the .0001-microfarad condenser, while only 2 per cent. passes through the choke itself; at 2,000 metres the factor is still 91 per cent. The inductance of the choke is approximately 186,000 microhenries, the resistance



A new H.F. choke by Atlas

approximately 330 ohms, and the self-capacity of the order of 2 micro-microfarads. This component can be recommended.

Formo Gang Condenser

WE are reviewing this week the new Formo triple-gang condenser. This condenser, which is interesting in several respects, is intended primarily for use in three-valve circuits of the type employing an aerial band-pass filter with a single coil intervalve coupling.

Two condenser units on the left of the control panel are intended to tune the filter circuit, and are provided with the usual type of trimmer, consisting of two metal plates separated by a mica sheet, thus enabling the filter circuit to be properly balanced up. In order to ensure ganging between the aerial circuit and the intervalve circuit, the stators of the two aerial condensers can, by means of a second control, be shifted in position relative to that of the third condenser, so that good ganging can be ensured even if the inter-valve coil is of considerably different type from that used in the aerial circuit.

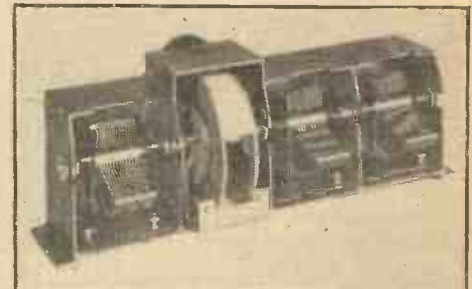

Formo triple-gang condenser

The drum-dial employed is of the usual Formo slow-motion type, in which is incorporated a small lamp to illuminate it from the rear. This lamp also causes a shadow from a hidden pointer to fall on the scale to indicate the position of the stators of the aerial condensers. A high-frequency test was conducted on the condenser with the object of determining the equivalent series resistance which would be introduced into a tuned circuit by the use of this condenser. The results obtained gave a resistance of 0.75 ohm at 400 metres, this value rising to 3.2 ohms at 250 metres. These figures are normal values and the condenser will give good service in all circuits.

The capacity of each condenser unit is just over .0005 microfarad, the minimum capacity being approximately .00007 microfarad, and the two condensers for tuning the band-pass circuit appeared to be very well matched over the whole scale. This condenser retails at 30s. complete, or at 31s. 6d. if required with rotor of the right-hand condenser insulated from those on the left hand.

Greater effective amplification ensures LONGER RANGE



COSSOR 215 S.G.

Cossor 215 S.G. 2 volts, .15 amp. Impedance 300,000. Amplification Factor 330. Mutual Conductance 1.1 m.a./v. Normal Working Anode Volts 120. Positive Voltage on Screen, 60-80.

Price 20/-

COSSOR 220 S.G.

Cossor 220 S.G. 2 volts, .2 amp. Impedance 200,000. Amplification Factor 320. Mutual Conductance 1.6 m.a./v. Normal Working Anode Volts 120. Positive Voltage on Screen, 60-80.

Price 20/-

The above valves are available with plain or metallised bulbs.

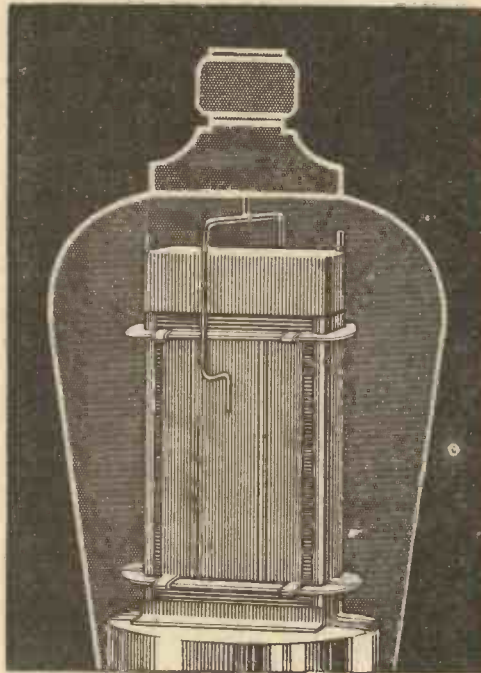

DUE to their abnormally low inter-electrode capacity, which has been reduced to the order of '001 micro-microfarads — lower than that of any other S.G. Valve on the market — Cossor

Screened Valves permit exceptionally high effective amplification. As a result they effect a marked increase in the range of any Screened Grid Receiver in which they are used. Other important constructional features in

these remarkably efficient valves ensure a considerable improvement in selectivity. By equipping your S.G. Receiver with Cossor Screened Grid Valves, you can, at small cost, materi-

ally enhance its performance — hear more stations and sharpen up its tuning. Cossor Screened Grid Valves are obtainable from your Radio Retailer in types to suit all Battery operated and A.C. Mains Receivers.

COSSOR SCREENED GRID VALVES BRITISH MADE

9223

To A. C. COSSOR LTD., Melody Dept., Highbury Grove, London, N.5
Please send me free of charge a copy of your 72-page "Cossor Valve and Wireless Book" B.11.
Name
Address

A.W. 9/10/31

Mention of "Amateur Wireless" to Advertisers will Ensure Prompt Attention

SETS OF DISTINCTION

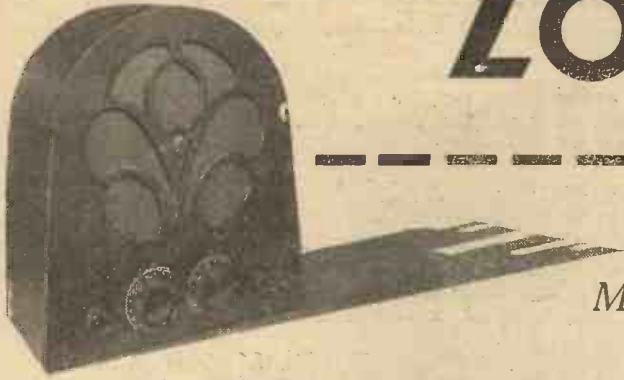

ZONOPHONE KIT SET

Makers: *British Zonophone Company, Ltd.*

Price: 6 guineas

THE Zonophone kit of parts for a three-valver with self-contained loud-speaker is quite unlike any other kit on the market. The biggest difference is noticed during the assembly, which is on the approved mass-production lines. That is to say, the constructor takes a stamped piece of insulating material and after bolting to it a number of clips this is fixed on the underside of a stout aluminium chassis, the wiring proceeding according to a colour code.

When I first started to make up this chassis from the parts supplied, I must confess it all seemed rather strange and I began to entertain a sneaking respect for the mass-production worker! But after five minutes, I am glad to say, the unusual nature of the job of assembly gave place to complete understanding of the instructions, which, if followed implicitly, and by the help of a little common sense, quickly enable the whole three-valver to be assembled and wired.

A good plan is adopted in the assembly. The constructor is told to undo each packet as its contents are required. This saves much confusion. The wiring is not a separate stage, but is done for each constructional stage. Thus, the fixing of the resistance clips and the fixed condensers on the insulated valve deck is immediately followed by the wiring together of the various parts so mounted. Wiring is done with coloured flexes, and I found the code quite easy to follow.

The wired and assembled valve deck is then mounted on the underside of the

aluminium chassis, to which are also fitted the three variable condensers, two for tuning and one for reaction. At this point, also, the wavechange switch, with its connections already soldered, is fitted.

Stage 3 sees the fixing in position of the connecting cable, the several branches of which go off to the condensers and switch. The next stage is the fitting of the long band-pass coil, and the wiring up of its connections.

Finally, the loud-speaker unit and cone are fitted to the cabinet and connected up to the chassis, which is inserted in the cabinet and held firmly in position with bolts from the under side.

Thus, in a series of simple stages, a complete three-valve set, chassis-built on factory lines, is fitted in a good-looking walnut cabinet, containing, in addition, the loud-speaker.

The makers give seven "vital points" about the Zonophone kit, and these are worth noting. (1) Self-contained loud-speaker. The advantage of this is that correct matching with the pentode is obtained. (2) Colour-coded assembly, without soldering. This, as my own experience shows, works out admirably in practice. (3) Economical battery consumption. The total anode current is fairly well within the capabilities of the standard-capacity battery. (4) Full broadcast range and easy operation. Although there are two tuning knobs, the operation is certainly quite easy.

(5) Band-pass tuning and pentode output for selectivity and power. Both these claims are justified by the tests I have made of my completed Zonophone kit.

(6) Pick-up sockets. These are conveniently arranged at the back of the chassis, and when tested with the new Zonophone pick-up the reproduction, considering the limited power supply, was good. (7) Compact walnut cabinet. This is one of the most attractive features of the Zonophone kit.

Well, I certainly think the makers have managed to combine a number of excellent

features in their first kit. I admire their originality and I emphasise to readers the simplicity of the assembly and wiring. The kit literally "falls together" after the first two stages! And so firmly is everything assembled that there is not the slightest chance of the kit coming adrift afterwards.

The Zonophone Kit differs in its circuit from almost all the other kits on the market. The chief difference is in the valve sequence,

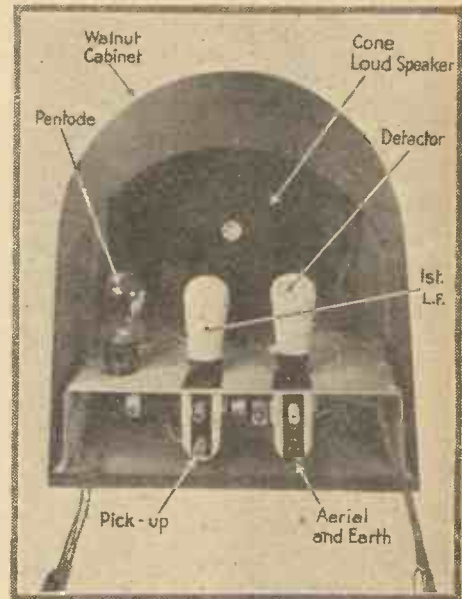

A rear view of the Zonophone Kit Set: note the extreme simplicity

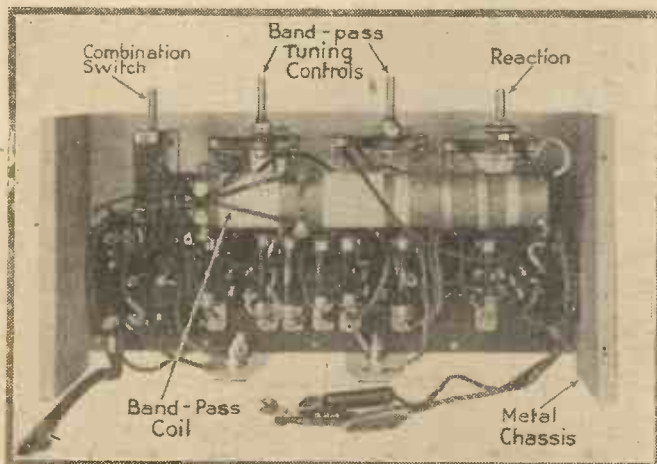

View of underside of chassis showing position of band-pass coil

which consists of a detector and two resistance-capacity-coupled low-frequency amplifiers. The detector works on the leaky-grid system and is preceded by an efficient band-pass tuning arrangement, comprising two separate tuning circuits, with reaction applied to the second.

For cheapness and simplicity, presumably, the two sections of the band-pass are tuned by separate variable condensers, which are of the bakelite dielectric type.

Tests show that the two condensers keep in step over most of the tuning range, so there is nothing difficult in the handling of the two band-pass condensers.

The detector is provided with suitable decoupling arrangements, and the pick-up is inserted in the grid circuit of the first low-frequency-amplifying valve. Two fixed condensers in the aerial lead provide the

(Continued at foot of page 894)

WORTHY COMPANIONS FOR THE "SQUARE PEAK" COIL

(REG. TRADE MARK)

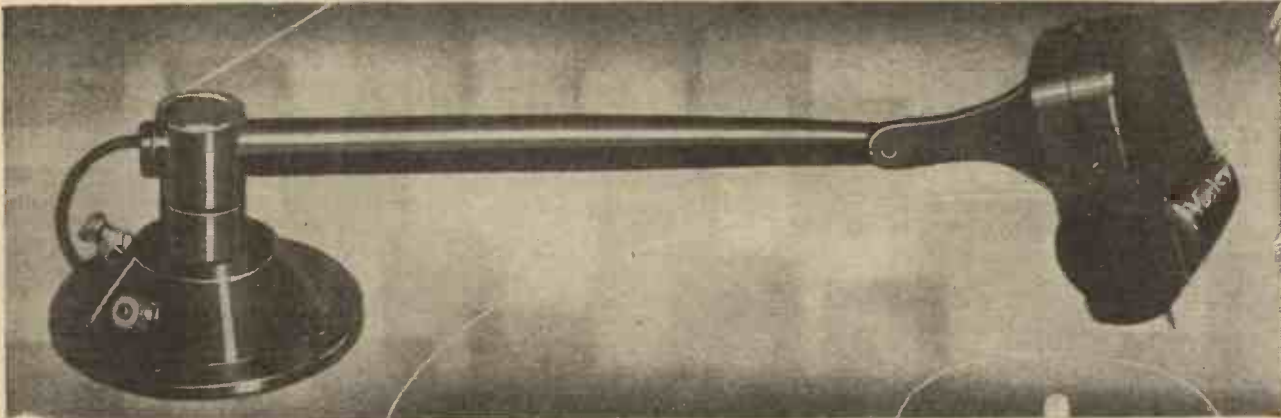

THE ONLY VOLUME CONTROL



ADAPTABLE FOR GANGING

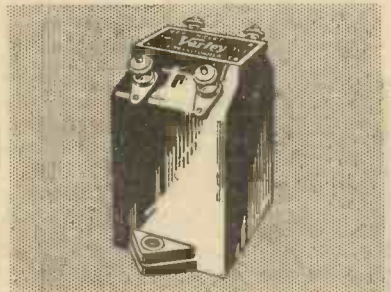

"NICLET" L.F. Transformer

NEW PICK-UP AND TONE-ARM

After all, good radio is the cheapest form of entertainment, so have it *as good as you can get it*. Build Varley Components into your set or radiogram and you will build in Quality. Quality of workmanship, of materials and of performance.

For full particulars of the components shown on this page write for sections B, C and D of the new Varley Catalogue.

VARLEY COMBINED PICK-UP AND TONE ARM.—Pick-up enclosed in black bakelite case. Compensated bass output, giving gradually increasing response as the frequency decreases below 250 cycles. Needle scratch and subsidiary record noises practically eliminated. Self-adjusting needle clutch—no screws to tighten. You merely press the needle in. Ball-bearing, frictionless Tone-Arm, suitable for turntables from 10 in. to 12 in. Almost perfect tracking and minimum record wear. Plays records of all sizes, from small nursery ones to the large 12 in. type. List No. CPI38. 42/-.

VOLUME CONTROL.—Exceedingly compact. Two or more easily ganged by means of the ganging equipment which is listed separately. Smooth action—all strain removed from spindles when ganged. 25,000, 50,000, or 250,000 ohms. 6/6 each.

GANGING EQUIPMENT.—1 coupling link and 1 mounting bracket, to gang 2 Volume Controls. 1/- per set. (For each additional Volume Control a set of Ganging Equipment is needed.)

NICLET L.F. TRANSFORMER.—Primary inductance 45 henries with no D.C. Ratio $3\frac{1}{2}$ to 1. The primary will carry a steady D.C. current up to 3 m.a. When resistance fed, ratios of 2.5, 3.5, and 4.5 to 1 are obtainable. List No. DP21. Price 7/6.



SPECIFIED IN "BRITAIN'S SUPER"
 1 Varley Volume Control (as illustrated above) 50,000 ohms. 6s. 6d.

For the Newcomer to Wireless: USING A HYDROMETER

I HAVE often seen the use of a hydrometer recommended for testing the condition of accumulators. What exactly does it do?

It measures the specific gravity of the acid solution in the cells.

Specific gravity?

To avoid technicalities we may say that the hydrometer gives you the weight of the solution as compared with that of pure water, which is used as a standard.

How exactly?

If I drop this key into a glass of water it promptly sinks, whereas this piece of cork floats. The reason is that, bulk for bulk, the key is heavier than water, whilst the cork is lighter. The chemist would say that the key had a greater specific gravity than the cork.

And what about the electrolyte?

This consists, as you know, of a mixture of sulphuric acid and water. Sulphuric acid is heavier than water and the stronger we make the solution, the heavier it will become in comparison with water or the higher will be its specific gravity. To put it in another

way, the specific gravity is a sound test of the strength of the acid solution.

But how does it show whether an accumulator is fully charged or not?

During the process of discharge the sulphur and the oxygen which go to make up sulphuric acid are given up by the electrolyte and combine with the lead of the plates. The solution thus becomes weaker and the specific gravity grows less.

And the hydrometer?

You know that when you are swimming you float higher in sea water than in fresh?

Yes, I have noticed that.

That is because sea water contains dissolved salts and has, therefore, a higher specific gravity than fresh water. In other words, your body weighs less in the sea than it does in an inland swimming bath.

That's quite clear.

The hydrometer is simply a weighted glass float. It floats upright in the solution. The upper end is in the form of a thin tube, on which graduations are marked. The deeper the float sinks the

lower the specific gravity and vice versa. A good float for accumulator testing purposes is marked off from say, 1.100 to 1.400, which means that it will measure the gravity of solutions from 1.1 times to 1.4 times as heavy as water bulk for bulk.

How do you take a reading with a hydrometer?

For accumulator testing purposes a convenient form of hydrometer is a large glass syringe containing a float. You draw up the solution from the cell that is being tested, then hold the instrument vertical and observe what line of the hydrometer's graduation is level with the surface. This gives you the specific gravity direct.

That seems simple enough. Can you tell me what the reading should be for a fully-charged accumulator?

It varies a little with different makes, but as a general rule a wireless accumulator should show a reading of 1.250, or 1.250, as it is generally known, when fully charged. At 1.220 it is nearing half discharge and at 1.180 it should be sent for a "refill."

OUR LISTENING POST

By JAY COOTE

IN my daily post-bag I receive so many queries regarding morse stations working on and around 1,000 metres that I believe a short list of the fog beacons and direction finders off our coasts may prove useful to listeners. The following are the transmitters mostly heard on the long waves: GCM (Bar Light Vessel, Mersey), MMM (May Island, near Firth of Forth), MMC (Cromer), GDM (Dun-geness), MMK (Kinnaird Head, Scotland), GFP (Ordfordness, East Coast), GGG (Round Island, Scilly), G GK (Skerries, Anglesey), GGB (South Bishop, Wales), MMH (Spurn Head Light Vessel), GSM (Start Point, South Devon), MMF (Butt of Lewis, Hebrides). The above list is by no means complete, as on and around 1,000 metres there are many French, German, and Dutch stations.

Although officially stated to be transmitting on 219 metres, Radio Normandie (Fécamp) has now been broadcasting for some time on 223 metres. Moreover, the power of this station has been increased, as you may judge for yourselves when you tune in towards the later hours of the evening. On Sundays from about 10.15 p.m. G.M.T. you will find the wavelength altered to 245.9 metres. On that day special broadcasts are made of concerts destined to the British Isles, and this special wavelength

has been chosen as being more favourable for reception over here than the lower one. The transmissions are sponsored by a London commercial company and all announcements are put out in both French and English, similarly to those from Radio Toulouse in the same circumstances. On a recent Sunday, as a test, the broadcast was carried on until 2 a.m.

It had been hoped to launch the new Radio Paris 85-kilowatt on the ether on October 21, and to this effect preparations had been made for a gala concert befitting the occasion. But it was not to be; not withstanding its many tests, the transmitter was not ready in time. Provisionally, although no new date has been definitely fixed for the official ceremony, unforeseen circumstances excepted, it should take place on or about November 11. If at all possible, every effort will be made to inaugurate it on Armistice Day.

From the same source news reaches me that the Poste Parisien 60-kilowatt station will be brought into action for the Christmas Holidays; no definite promise has yet been made concerning Radio Toulouse, but the new studio is ready and will be in use within the next few days.

In these notes recently I mentioned that I

had heard the Sottens broadcast on the Geneva wavelength. In view of the latter's low power, it did not seem possible that I had received it direct, and consequently I presumed that an effort was being made to find a better position for the Swiss National transmitter. Anyhow, Sottens is again back on its original wavelength of 403 metres. Both the Swiss high-power stations come in nightly at extraordinary strength; in fact, Beromuenster seems to provide a louder signal, barring the local, than any of our home stations.

As you will have seen from "Broadcast Telephony" in last week's issue, some slight modifications have been made in the wavelengths of a number of European stations with a view to obtaining greater frequency separation in the more troublesome cases. In some instances an exchange of positions has been attempted as an experiment. You may find some improvement all round, but the measures adopted have not been sufficiently drastic.

However, there exist but few nights on which it is not possible to pull some twenty stations or more out of the mush; even a dozen or so, at loud-speaker strength, added to the home programmes will always supply a sufficiency of varied entertainments likely to suit everybody's taste.

From my mail bag I find that the Portuguese experimental station Radio Lisboa, on 290.5 metres, is being logged by a number of readers. The best time for a search is between 10 p.m. and midnight on Mondays, Wednesdays, and Saturdays, but broadcasts are often carried out until 1 a.m., and even later.

"ZONOPHONE KIT SET"

(Continued from page 892)

variation of selectivity needed to cope with the different aerials in use.

The front of the set presents a clean and simple appearance. The two 0-180 degree tuning dials occupy the central positions. On the left is the combined wavechange switch and on-off switch. On the right is the knob controlling the reaction.

The loud-speaker is fitted with an adjusting screw on the fret, and this is useful when installing the set, as it enables the right unit setting to be obtained for any given volume requirement.

The high-tension, low-tension, and grid-bias batteries are easily connected up by means of the battery cord coming from the back of the chassis.

I obtained very pleasing reception of the

London stations, and I was impressed with the fact that these powerful stations occupied only a few degrees on each of the tuning dials. The two low-frequency stages and the pentode output valve combine to invest the set with quite unexpectedly good distance-getting capabilities. I got twelve foreigners on the medium waves—all at pleasant loud-speaker strength.

SET TESTER.

HAVE YOU SEEN THIS GUARANTEE ?



LONGER LIFE FOR LESS MONEY -guaranteed

LONGER lasting power has been put into the Improved Lissen H.T. Battery—and a **LIFE GUARANTEE** is printed on the side of every Improved Lissen Battery you buy.

Prices, too, have been greatly reduced so that to-day when you buy a Lissen H.T. Battery you get much longer lasting battery for much less money than before.

Look for the Lissen Longer Life Guarantee—buy only at the reduced prices. Ask for "the Improved Lissen H.T. Battery"—stocked by all good radio dealers.

LISSEN LTD., WORPLE RD., ISLEWORTH, MIDDLESEX.

The
**IMPROVED
LISSEN
HIGH TENSION
BATTERY**

60 VOLT
WAS ~~7/11~~
NOW **5'6**

100 VOLT
WAS ~~12/11~~
NOW **9'3**

To Ensure Speedy Delivery, Mention "A.W." to Advertisers

READERS IDEAS

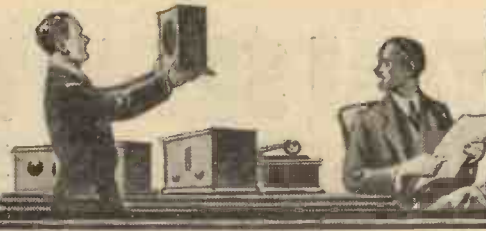

AND QUESTIONS

Over Eighty Stations

SIR,—No doubt you will be interested to read of any opinions given on the new "Britain's Super." I write entirely as an amateur, and no doubt my many hundreds and thousands of co-amateurs must have found the result of broadcasting during the past year or two practically an impossibility owing to the interruptions from many Continental high-power stations.

Having built the "Century Super," this seemed to me to be the answer to selectivity in radio requirements, but now, having built and worked the "Britain's Super," which, to my mind, is a vast improvement, both in quality and selectivity, I must offer you my heartiest congratulations on producing a circuit which really does give as many as eighty to ninety alternative stations at loud-speaker strength, with ideal selectivity. I cannot too strongly recommend amateurs to build this set, which seems to me the essence of simplicity owing to the easy ways you have taken of explaining the building details.

I was interested in your paragraph in this week's AMATEUR WIRELESS, written by a user in South London, who logged a matter of forty-five stations on a 50-ft. aerial, but I can assure you that over eighty stations were received in Sutton, Surrey, last evening.

Might I make one suggestion to prospective builders: buy two copies of AMATEUR WIRELESS and paste the blueprint of one copy on the baseboard and then mount the components on top in their respective positions, this method being much easier

than working out the positions of the components by measurement. You can then wire up from the second blueprint.

I think that this circuit and its British components are a credit to the British wireless trade.

"Saxtone" (London, S.W.9).

Repairing Components

SIR,—I feel it my duty to thank two of your advertisers. Recently I was unfortunate enough to have some trouble with a 66K Blue Spot unit, followed by some more trouble with an A.C. eliminator by Messrs. Clarke & Co., Ltd., of Manchester. Both were sent up and repaired free of charge by these firms and returned in good order.

It speaks volumes for these concerns and the public may rest assured that these quality experts will always stand by their goods to be the best.

P. L. (Cambridge).

A Problem for "Thermion"

SIR,—I have been very interested by "Thermion's" note in a recent issue regarding the insertion of a milliammeter in the detector feed and noting the deflection at resonance. I have used this method frequently in calibrating my "Century Super" and have found it very helpful, but my original idea in noting the behaviour of the needle was to try to find out why on certain stations volume cannot be satisfactorily increased beyond a certain point.

I have discovered that a station giving

a large deflection, i.e., a strong transmission, cannot be brought up to an acceptable level of sound, whilst a weaker one can be readily made to overload the push-pull P240's although only giving, say, 1/2 milliampere reduction in detector current. I am certain the fault lies in the detector but I cannot discover what it is. The standing current is 4 milliamps. Four or five of the B.B.C. stations will give a change exceeding 2 milliamps; output then much below average strength. It occurred to me that drop in volume might be due to the fall in anode current itself, so standing current was raised to 6 milliamps, with which I could get a maximum deflection of nearly 4 milliamps, but still no improvement in volume.

I believe it must be bound up in some way with the percentage modulation at the transmitter, as I understand the greater the modulation the less the change in anode current. This hardly explains, however, why my "local" stations (northern), which give a large field strength in Liverpool, produce considerably less power than practically any of the Continentals, and any movement of the volume control past a quarter turn causes progressive diminution of output. Several valves have been tried and various leak and condenser combinations; "power grid" values with 100 volts at the anode give best quality. The same effect was present in my previous set ("All Britain 3"), so it has nothing to do with the super-het. circuit.

Can "Thermion" spot the trouble?

W. H. D. (Liverpool).

PERSONALITIES IN THE WEEK'S PROGRAMMES

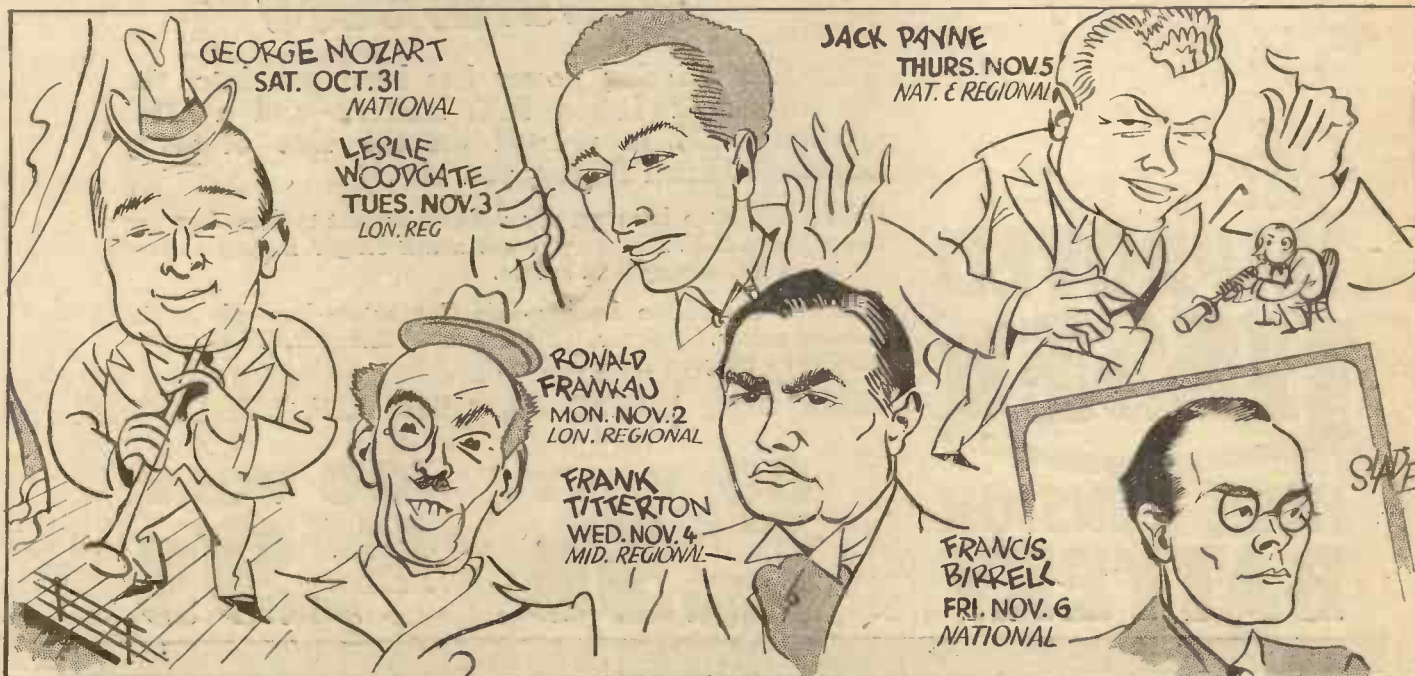

The Two Principles of Amplification!

The Parallel Feed System With **PARAFEED**

The exponents of the system of Parallel Feed Amplification declare that it yields the positively best reception in suitable circuits.

R.I. by a masterly piece of brilliant research, have produced the "Parafeed," now universally acknowledged to be the Best Transformer for this form of coupling—the five N.P.L. Curves definitely prove this by High and Uniform Amplification of **25 to 8,000 Cycles**

as also does its amazing inductance of **100 henries**



8'6

The "PARAFEED" operates with a condenser and resistance, and gives reception of unsurpassed brilliance over all frequencies.
List No. DY28. Pat. No. 316449. Size: 2½ × 2½ × 1½ ins. Weight: 3½ ozs.



And for the standard principle

DUX

The Reliable Low Priced Transformer for Standard Coupling

A Transformer with an inductance of **30 HENRIES**

and a performance, to quote the Technical Press, equal to many transformers at four times the price.

You know before you buy "DUX" that the performance will be right by the published technical facts given in the "DUX" leaflet, which also contains suitable diagrams, and is obtainable free from your dealer, or us, at request.

Ratio: 1-3½ (standard) or 1-4½ (auto-connection).
Weight: 11½ ozs. Size: 3½ × 2 × 2½ ins. high. List No. DY29.

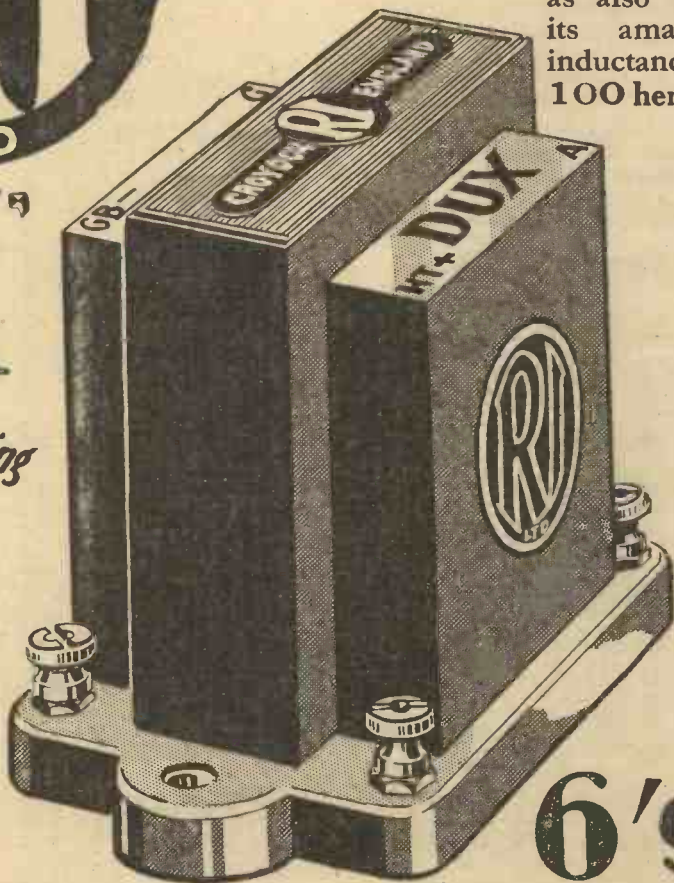

6'9

The lowest price you can pay for reliability

ASK YOUR DEALER OR US FOR BOOKLET "THE PARAFEED WAY TO BETTER AMPLIFICATION" AND ALSO FOR DUX LEAFLET

THE PICK OF THE MONTH'S RECORDS

(Continued from page 872)

Heartaches and Roll On, Mississippi, 1s. 6d. WIN 5358
Sid Phillips and His Melodians (a really good band) do these in fine style.

INSTRUMENTAL RECORDS

Old Favourites, 2s. BRDCST 5245
The Gershom Parkington Quintet in excellent form. Collectors of medleys will enjoy it immensely.

Sonata in D Minor (Beethoven), 8s. COL DX277-8
One of the simpler sonatas played beautifully by Gieseking. The recording is a masterpiece of pianoforte reproduction.

Melodic and Humorouske, 6s. COL LX146
Cello solos by Gaspar Cassado. The excellent performance of Dvorak's piece should sell this record.

Gavotte and Barcarolle, 2s. 6d. COL DB599
A splendid record by the Lever String Quartet. This is an outstanding bargain—for everybody.

Tambourin Chinois and Souvenir (Drdla), 1s. 6d. ZONO 5931
Two violin solos very well played by Norbert Wethmar. A very good record.

VOCAL RECORDS

Oh, Sailor, Behave and The Bargain Hunter, 2s. 6d. H.M.V. B3912
Gracie Field's latest contributions.

Mrs. Carter and 'E Dunno Where 'E Are ; The Golden Dustman and If It Wasn't for the 'Ouses in Between, 1s. 6d. each. STERNO 783-9
Lovers of the Cockney band of humour will revel in these. Gus Elen has staged a great "come-back."

Kingfisher Blue and Jhelum Boat Song, 4s. H.M.V. C2177
Peter Dawson sings these well. The first is the better song. Lovers of Amy Woodforde Finden will like them.

My Message and Little Grey Home in the West, 1s. 6d. DEC F2381
Desirée Ellinger's voice is always pleasing. In these two old songs there is a world of appeal.

The Two Gendarmes and The Two Beggars, 1s. 6d. DEC F2377
Duets by Frank Titterton and Richard Watson. Quite well done. The first is, of course, much the better number.

Bedouin Love Song and The Carnival, 4s. COL DX289
If you like these old songs the superb voice of Dennis Nobel and his perfect enunciation will give the best record of them ever made.

A Bold Young Farmer and My Johnny was a Shoemaker ; As I was Going to Banbury, 2s. 6d. COL DB607
Collectors of folk songs will surely like these. Annette Blackwell's voice suits them, although too powerful here and there. The somewhat monotonous structure of the airs demands flexibility.

Herr Kavalier and Das Schone Fest, Johannstag, 6s. H.M.V. DB1543
Kipnis' magnificent bass is heard at its best in these Strauss and Wagner excerpts.

Good Night and Pardon, Madame, 4s. PARLO ODEON R020156
Tauber's version (to which I referred several months ago) is now here. It is good—very good—but would be better still if his powerful voice were subdued in certain passages.

Little Sweetheart of the Prairie and Springtime Reminds Me of You, 1s. RAD 1537
A very effective performance by Sam Browne, who croons most pleasantly.

MISCELLANEOUS RECORDS

Waltzes from Vienna, 1s. 6d. BRDCST 3082
"Vocal gems" by various principals of the Alhambra Company. A good record for collectors of souvenirs of the production.

Musical Hall Memories, 1s. 3d. IMP 2516
The title is enough. Another average excursion into the young days of this century.

Drinking Songs, 1s. 3d. IMP 2529
A very jolly affair by Jay Wilbur's Orchestra. The singing is quite well done.

The Same Again and Then We Won't Go Home, 1s. 6d. ZONO 5936
A most entertaining pair by Clarkson Rose and Olive Fox.

Radi) Tit-bits, 1s. 6d. WIN 5351
Jenny Howard's best yet. Her versatility foreshadows a rapid advance to the front rank of worth-while artistes.

RECORDER.



FERRANTI CONDENSERS AND RESISTANCES

FOR POWER SUPPLY UNITS

Most constructors will agree that to provide a Receiver with H.T. power from a dry battery or accumulator, if A.C. Mains are available, is like lighting the house with candles. It's out of date.

If your Set depends on batteries for its power—power that should be ample, constant and silent—and from batteries it seldom is—you will derive lasting satisfaction from a High-Tension Power Supply Unit.

In the construction of such a Unit it is of great importance to use components that can be depended upon to stand up to the severe conditions imposed.

As is to be expected, inferior components give inferior service, and are liable to break down under the electrical stresses set up, with possibly serious results to the Receiver and the components of which it is constructed.

Therefore, do not take unnecessary risks. Employ components designed with knowledge of the conditions they have to deal with, and built by Engineers with nearly 50 years' electrical experience behind them.

FIXED CONDENSERS for smoothing.
RESISTANCES for voltage dropping.
CHOKES and MAINS TRANSFORMERS.

FERRANTI issue free CHARTS for the construction of H.T. Power Supply Units to meet all conditions. A copy will be forwarded on request accompanied by 1½d. stamp.

WHATEVER YOU DO, put in reliable components. It pays, on the Mains.

FERRANTI

FERRANTI LTD. Head Office & Works: Hollinwood, Lancs. London: Bush House, Aldwych, W.C.2



" 'Mr. Sparks,' that's what they call me, sir, and I may say I'm proud of it! People don't give you a name like that unless they have a bit of respect for you; do they, now? And a bit of a warm spot for you, too, 'specially the ladies!

" Ladies? Why, yes, sir; hundreds of 'em come in here. Y'see, in a general way, they're a bit cautious—don't want to be talked into buying a thing they don't understand, in a manner of speaking; so they makes quite sure who they're dealing with. Yes, sir, I reckon I've more lady customers than any dealer for miles around!

GRAHAM FARISH 50,000 ohm VARIABLE RESISTANCE



" Same with the gents. They come in more of an evening, of course; sometimes for a bit of advice or a few things for their set; but pretty near everyone asks my advice, and what's more, takes it, too!

" What it comes to is this. I never, to my knowledge, let a customer down. I take care to have nothing here that isn't first class—it don't pay—not when you've a reputation to consider. Once or twice I've been caught. You've got to only handle goods what have a good name behind them, and what'll be a credit to you.

" Now you're going to make up the 'Britain's Super,' are you? Oh, well, you can be sure any circuit in AMATEUR WIRELESS is alright—if you put good stuff in it, that is! And by good stuff I mean Graham Farish—wonderful how good it really is. Now let's go through the list with one of their catalogues.

" Now, first of all, you want a 50,000-ohm variable resistance. Well, Graham Farish have got

just the thing you want. Here it is, sir, price 3s. 6d. potentiometer type for pick-up or any grid circuit control. Maximum value, approximately 500,000 ohms.



GRAHAM FARISH VALVE HOLDER

" Next, you'll want seven valve holders. Now there's a Graham Farish 4-pin rigid holder for 6d., or a 5-pin rigid for 8d., or the anti-microphonic holder for 9d.

" Then you'll want two .0002-mfd. and one .0003-mfd. Graham Farish fixed condensers. There is a complete range of capacities with upright or flat mounting, and prices range from 6d. to 1s. 6d.

" Now we come to the grid leaks and holders—Graham Farish make two types—the 'Kone Kap,' at 9d., and the 'Standard,' fitted with terminal ends, at 10d. The holders for these are made for either upright or horizontal mounting, and both cost 6d.

" Their new 'Snap' L.F. transformer you will find wonderful value for money, at 5s. 6d.

GRAHAM FARISH FIXED MICA CONDENSER

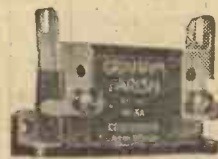

" Now spaghetti resistances—you'll see Graham Farish make these flexible resistance links in all sizes from 1,000 ohms to 20,000 ohms at 1s., and 25,000 to 100,000 ohms at 1s. 6d.

"Then, of course, there's a few other odds and ends to complete your set, and I think that's all—barring, of course, your loud-speaker! You know, as well as I do, sir, that it's no good putting even the best components in your set unless you use the best speaker. Here you are—the Graham Farish 'Amazing' speaker, finished in oak, mahogany, or walnut, for £2 2s.



(Upper) GRAHAM FARISH

'KONE KAP' Grid Leak

(Lower) GRAHAM FARISH

'STANDARD' Grid Leak

" But, you may say, this costs less than the recommended price! Well, that's where you score using Graham Farish components; cheaper and absolutely reliable; and don't thank me—my reputation depends on fair dealing; but, mind you, I hope you won't forget to tell your friends that it was Mr. Sparks that put you on to Graham Farish, Limited."

GRAHAM FARISH UPRIGHT HOLDER



GRAHAM FARISH VERTICAL HOLDER



Mr. Sparks will be happy to enlarge in these columns on topics of mutual interest to readers of "Amateur Wireless," and Graham Farish, Ltd. A postcard to him, c/o Graham Farish, Ltd., will receive his careful consideration. The directors of Graham Farish, Ltd., beg to state that the above article is intended to advertise their goods and they hope that Mr. Sparks will prove a popular and entertaining personality and that their endeavour to combine business with pleasure will be appreciated.



GRAHAM FARISH 'AMAZING' SPEAKER

You will Help Yourself and Help Us By Mentioning "A.W." to Advertisers



AS a tribute to the late Thomas Alva Edison, Marconi telegraphs: "Edison, above all, has done incalculable service to the advancement of human progress. His influence has gone beyond his immediate discoveries which he made and has permeated the whole realm of science. I feel deeply this great loss and I can even call it a personal loss, as he furnished me with most of my inspiration to achieve my results in scientific research. The world has wonderfully gained through his life and his genius. His death is a blow to all mankind."

Municipal election results are to be broadcast on the National and Regional wavelengths on November 2, as received from 11.15 p.m. onwards.

Mr. Compton Mackenzie's success with *The Lost Cause* will be followed by another characteristic Scottish play on November 14. This is *The Druries of Durrisdeer*, and the adaptor is Mr. J. C. S. Macgregor, a member of the staff of the B.B.C.

Mr. Guy Pocock continues his new series on "More Sailors of the West" on November 13.

Michael Mullinar continues to give his recitals of little-known music, which have become immensely popular. On November 8 a recital of "Modern Spanish Music" will be heard.

The Manchester pianist, Edward Isaacs, will be the only soloist at the Philharmonic midday concert, to be relayed from Queen's College, Birmingham, on November 12. Mr. Isaacs is almost completely blind.

The Birmingham Festival Choral Society gives a concert on November 12 in conjunction with the City of Birmingham Orchestra.

One of the best known of Charlotte Brontë's novels, *Jane Eyre*, has been adapted for the microphone by Barbara Couper and Howard Rose and will be broadcast on the National wavelength on November 13.

Tom Clare is soon to give a new type of programme. He calls it "Reminiscences of Piano Humour."

Ronald Frankau returns to vaudeville on November 2, with Greta Keller, who also

has not been heard lately. This programme is on the London Regional.

The host of listeners who wrote appreciative letters to the B.B.C. after Hayden Coffin's programme of musical comedy memories on September 22 will be glad to learn that he is to give a repeat performance on the Regional on November 13.

A medley of old war tunes lends a sentimental interest to Charles Brewer's little show, *Ricochets*, which will be heard from the Midland Regional station on November 13.

For the first time in its history Whitehaven will provide a service in the North Regional programme on November 1. The relay comes from St. Nicholas' Church.

Listeners should note that the weekly relay from the Majestic Hotel, St. Annes-on-Sea, will be transferred from Wednesday to Monday. An exception will be made on November 9.

A newcomer to the microphone is Mr. H. J. Ditton, who will talk on "Association Football in South Wales" on November 14.

Frederick Steger will be the vocalist at a concert from the studio given by the Western Studio Orchestra on November 11.

A drama of the Bristol riots has been prepared by Mr. Froom Tyler, entitled, *The Mob is Mad*; it will be produced by Cyril Wood on November 12.

A chorus from the Newport Musical Society will take part in an orchestral and choral concert given by the Western Studio Orchestra for West Regional listeners on November 8.

PERFECTION —
Given an undistorted input the R. & A. '100' reproduces speech and music with a fidelity more nearly approaching the ideal than has yet been attained by any type of speaker. The sensitivity is such that perfect results are obtained with two-valve receivers, and also with large power amplifiers. Compare the R. & A. '100' with any speaker you may choose, and you will agree it is unequalled for sheer beauty of tone and brilliant response throughout the whole audible range. The R. & A. Multi-ratio Output Transformer to suit all power valves including Pentodes is modestly priced at 12/6.

Your Dealer can supply . . . Write us for full particulars
REPRODUCERS & AMPLIFIERS LTD.
Frederick Street
Wolverhampton.

The R. & A. "100" PERMANENT MAGNET MOVING COIL REPRODUCER

ASK YOUR NEWSAGENT

FOR

Wireless Magazine

16 PAGE SUPPLEMENT

2 NEW SETS

148 PAGE ISSUE

NOVEMBER ISSUE NOW ON SALE

PRICE 1/-



NEW PERMANENT MAGNET MOVING COIL SPEAKER AT 45/-

Three-ratio output
transformer extra 7/6

Handsome grained oak cabinet illustrated 30/-

This is the speaker that the Editor of "Radio for the Million" has so strongly recommended for use with the V.3. Its Sheffield-made cobalt steel magnet weighs 5 lbs. Gives true and brilliant moving-coil reproduction from any 2 or 3-valve receiver. A great success on sheer merit. Made by the PIONEERS in PERMANENT MAGNET Moving Coil Speakers. Write to-day for FREE art booklet, "Speaking of Speakers."

Permanent Magnet Moving-coil Speakers having a low resistance winding require a multi-ratio step-down transformer between set and speaker. We supply our three-ratio transformer—at prices stated—with each speaker.

Made by the makers of the famous W.B. Valveholders and Switches,

Whiteley Electrical Radio Co., Ltd., Radio Works, Nottingham Road, Mansfield, Notts.

Irish Free State Distributors: Kelly & Shiel, Ltd., 47, Fleet Street, Dublin.

The PM3 for the V3

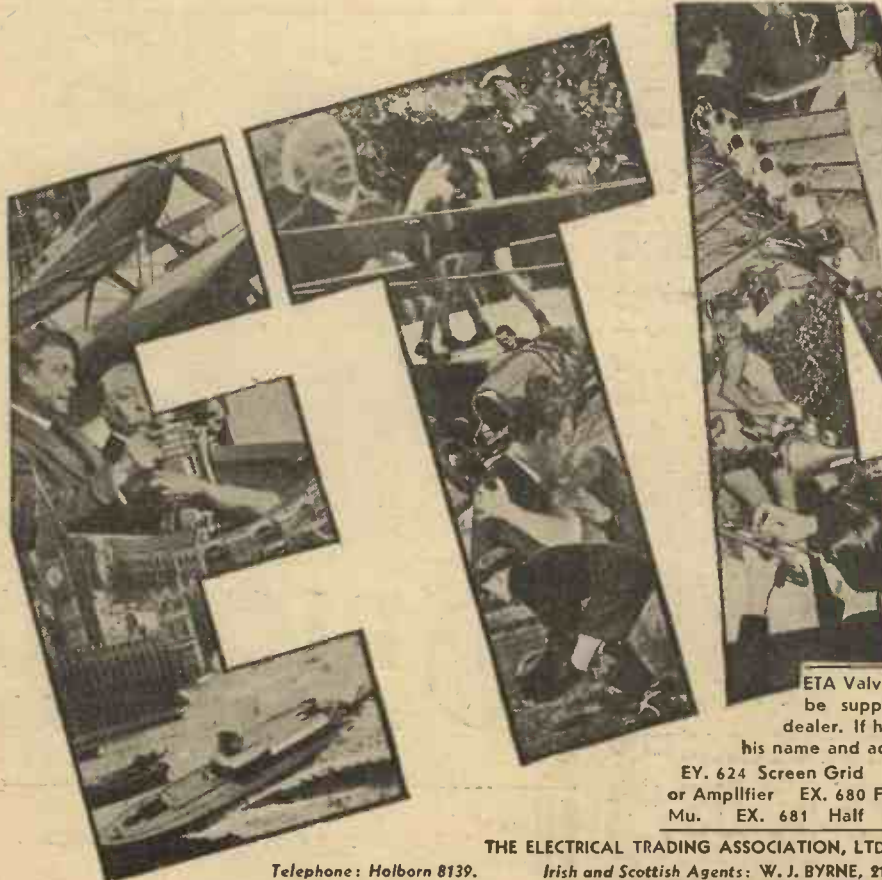

**Radio
through
ETA Valves
means
clearer
Reception
better
Selectivity**

ETA Valves suitable for American type sets can be supplied from stock through your usual dealer. If he is unable to supply, write us, giving his name and address.

- EY. 624 Screen Grid
- EX. 650 Amplifier
- EY. 627 Defector or Amplifier
- EX. 680 Full Wave Rectifier
- Mu. EX. 681 Half Wave Rectifier.
- EY. 635 Variable
- EX. 645 Power.

THE ELECTRICAL TRADING ASSOCIATION, LTD., Aldwych House, London, W.C.2.

Telephone: Holborn 8139.
Telegrams: Eltradax, Estrand, London.

Irish and Scottish Agents: W. J. BYRNE, 21, TEMPLE LANE, DUBLIN.
R. G. JACKSON NISBET, 132, RENFREW STREET, GLASGOW.

Mention of "Amateur Wireless" to Advertisers will Ensure Prompt Attention

When Heston Talks about the Weather!

"HALLO, Hallo! Hallo, Hallo! This is the Automobile Association calling from Heston Airport! Here is the Air Ministry weather forecast for the period until dusk. It is in four areas. Area one . . ."

That is the kind of announcement that can be heard when, in the course of tuning over the lower portion of the long wave-band, one encounters the stentorian voice of the wireless operator at Heston aerodrome, broadcasting on a wavelength of a little over 830 metres.

The Heston Airport radio station has recently inaugurated a regular service of weather reports and forecasts, supplied by the Air Ministry and issued by the Automobile Association, for the benefit of owners of light aeroplanes, etc. The messages are broadcast in radio-telephony (i.e., ordinary speech, not morse) at frequent intervals during the day.

Transmission Times

The actual times of transmission are as follows: Morning, 8.45, 9.30, 10.30, and 11.30. Afternoon, 12.30, 2.45, 3.30, and 4.30. The reports contained in the messages are representative of the whole country, and cover places such as Newcastle, Harrogate, Chester, Birmingham, Cranwell, Felixstowe, Ross-on-Wye, Winchester, Croydon, Lympne, Plymouth, Southampton, Liverpool, and, of course, Heston itself.

Some idea of the information given in the

reports may be gathered from the following typical example: "Croydon, thirteen-thirty G.M.T." (1.30 p.m.) "Partly cloudy; visibility five miles; two-tenths low cloud, three thousand to five thousand feet; wind north by west, twelve to eighteen miles per hour."

A weather forecast for the following day is given in the final transmission at 4.30 p.m. All the forecasts give detailed information about weather, wind (at the surface and at various heights), visibility, and so on, anticipated for the different areas covered.

Weather Messages

At the end of each transmission (which usually lasts, say, six to ten minutes), the operator announces the time by a clock at the airport, and also states the time at which the next transmission will take place, thus:—

"That concludes the Air Ministry weather reports. Heston is now closing down until 8.45 a.m. to-morrow morning. Good-night, everybody. Heston switching off!"

Each sentence in the messages is repeated twice in succession, with a pause between the repetitions, so there is time to write down the information quite comfortably, even in longhand. These weather messages should be of interest and use to ordinary listeners (especially motorists) as well as to aeroplane owners. The time announcements, too, are useful for putting one's

watch or clocks right at times of the day when no B.B.C. time signals are available.

The signals from the Heston station come in at excellent strength in the London area. On the writer's receiver, situated some nine or ten miles from Heston, they are full loud-speaker strength on three valves—quite equal to the Daventry National's signals. The speech quality is not quite up to ordinary broadcast standard, perhaps, but is, nevertheless quite clearly intelligible.

W. O.

Captain H. B. T. Wakelam will give a running commentary on the match on October 31.

The Egyptian Government has decided to install a powerful station in Upper Egypt in order to facilitate air navigation. Luxor is mentioned as probable installation points.

The additional necessary building for housing the League of Nations wireless station has been completed. The station is expected to be ready for operation at the beginning of next month.

The experimental television station, W2XCD, is back again and will broadcast on Tuesday, Thursday, and Saturday afternoons from 2 to 3 p.m. New York time. A new direct camera equipment and transmission circuits will be tested from time to time during this experimental period.

Building a Radiogram?

— select your Pick-up from this Range

If you want brilliant reproduction—sparkling treble, ample bass, crystal clear middle register—you must have a B.T.H. Pick-up. Whichever model you select—the "Minor" at 27/6 or the "Senior" at 45/-—you are getting a product of the engineering skill which has made the B.T.H. Pick-up the recognised choice of radiogram experts. Ask to hear one at your dealer's.



Minor Pick-up



Senior Pick-up



"Minor" B.T.H. Pick-up and Tone Arm. Price complete 27/6

"Senior" B.T.H. Pick-up and Tone Arm. Price 45/-

"Senior" B.T.H. Pick-up only with adaptors. Price 27/6

EDISWAN RADIO



PICK-UP
and **TONE ARM**



THE EDISON SWAN ELECTRIC CO. LTD.
Radio Division:
155 Charing Cross Road, London, W.C.2
Showrooms in all the Principal Towns

W.167

ANOTHER NEW



SOVEREIGN

COMPONENT SPECIFIED IN D.C. H.T. UNIT

Described in this week's issue.

SOVEREIGN'S NEW WIRE-WOUND VARIABLE RESISTANCE (50,000 ohms) specified for this splendid new H.T. Unit. Extremely important, it is essential that this component be satisfactory in every detail, performance, quality, reliability, so Sovereign was chosen. Obtain from your dealer or send direct. Complete with domed pointer knob ...

4/6

Send for Catalogue of full range of SOVEREIGN Components. Use them to improve any radio apparatus. This journal specifies SOVEREIGN.

SOVEREIGN PRODUCTS Ltd.
52-54 Rosebery Avenue,
LONDON, E.C.1

LARGER AND BETTER THAN EVER!

THE NEW "LANGMORE" RADIO-GRAMOPHONE CABINETS (No. G1)

These cabinets are very strongly constructed of selected Oak. Size overall, 3 ft. 6 in. high by 21 in. wide by 15 in. deep.

THE TOP SECTION. Size, 4½ in. high by 18 in. wide by 14 in. deep, gives ample accommodation for gramophone or pick-up.

THE CENTRE SECTION. Size, 10 in. high by 18 in. wide by 14 in. deep, is for the Wireless Set, to take a panel either 18 in. by 7 in. or 18 in. by 8 in.

THE BOTTOM SECTION. Size, 16 in. high by 18 in. wide by 13½ in. deep, gives accommodation for Loudspeaker and Batteries.

Wooden Panels to fit, with oval aperture, 12 in. by 5½ in. 2/- extra.

The whole of the back is enclosed by double doors, so that all parts are easily accessible. ALL are fitted with hinged top, heavy platform to take a 12-in. turntable for the Gramophone, and a substantial baseboard for the Wireless Set.

THE MISCELLANEOUS TRADING Co. Ltd.
13 & 17, NEW OXFORD STREET, LONDON, W.C.1

Phone: Holborn 4894.



Price **49/6** each

Packed FREE and sent Carriage Paid to any address in Gt. Britain.

Trade Inquiries Invited.

BEAUTIFULLY FINISHED
:: JACOBAN OAK ::

ALL EQUALLY GOOD!

Utility ganged condensers are already famous for quality and performance, but equally good is the complete range of utility condensers. Here are a few of them:—

* AIR DIELECTRIC

		Capacity	Price
STANDARD	.. A low loss condenser.	.0005	8/6
		.0003	7/6
		.0002	6/6
UNIVERSAL	.. For panel or base-board mounting, suitable for ganging.	Knob 1/- extra. Vernier 6/6 extra.	8/-
		.0005	8/-
MITE	.. One of the smallest condensers available, but in performance, as good as the larger models.	.0005	6/6
		.0003	6/-
		.0002	5/-
DIFFERENTIAL	.. Air-gapped, therefore far superior to the ordinary model.	Knob 1/- extra. Special Vernier 3/6 extra	9/6
		.0003	7/-
		.00015	7/-
		.0001	6/6
		Including Knob.	

* BAKELITE DIELECTRIC

REACTION CONDENSERS	Use them and save your valves. Also suitable for tuned circuits.	.00075	2/6
		.0005	2/-
		.0003	2/-
		.0002	2/-
		.0001	1/6
		Including Knob.	
DIFFERENTIAL	All accurately rated.	.0003	2/6
		.0002	2/6
		.0001	2/6
		Including Knob.	

Ask your dealer to show you these condensers, and while you are there have a look at our micro-dials, the best job of work you have ever seen. Two models are available, both at 7/6 each, and both eminently suitable for short wave, superhet and any other work demanding hairsplitting tuning. Write for our new catalogue and read more about our components.

WILKINS & WRIGHT Ltd.

Utility Works, Holyhead Road, Birmingham

AGENTS—London: E. R. Morton, Ltd., 22, Bartlett's Buildings, Holborn Circus, E.C.1. Scottish: E. B. Hammond, 113, Vincent Street, Glasgow. Lancashire and Cheshire: J. R. Lister, 83, Old Road, Blackley, Manchester. Westmorland, Cumberland, Durham, Northumberland, Yorkshire and Derbyshire: E. G. Rawson, Ltd., 300, London Road, Sheffield. Lawrence Fraser, Chelsea House, Lansdown Road, Bath.

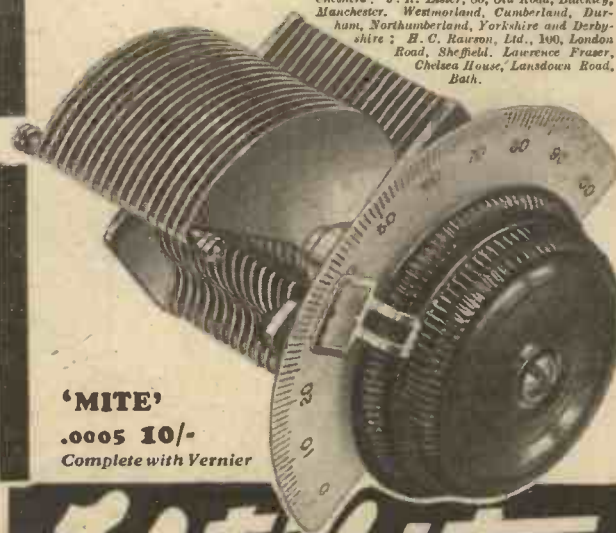

'MITE'
.0005 10/-
Complete with Vernier

Utility

BELMONT

Advertisers Appreciate Mention of "A.W." with Your Order

A "BRITAIN'S SUPER" KIT ON TEST

WE have received for test a "Britain's Super" made up from a kit of parts supplied by Ready Radio, Ltd., of Eastnor House, Blackheath, London, S.E. The set was supplied in the special "Waldor" cabinet designed for it by Ready Radio, and the general finish of the whole job is very pleasing.

An examination of the set unit showed that the workmanship, too, is good and that, apart from minor deviation in the specification, the receiver is exactly the same as that described by us.



The "Super" made up from a Ready-Rad kit, and in the special "Waldor" Cabinet

A brief daylight test gave convincing proof of the smooth control and reaching-out powers of this outfit, and it was every bit as good as the standard "Britain's Super" in the "A.W." Construction De-

partment at Fetter Lane. This is a bad centre for reception, owing to adjacent metal work, and this made the Ready Radio set's performance all the more creditable.

The completely assembled receiver, including valves and cabinet, costs £14 10s., and kits of parts are available from £7 7s. 6d. upwards. Hire-purchase facilities are available. The complete sets are aerial tested by Mr. G. P. Kendall, Messrs. Ready Radio's chief engineer.

DO YOU KNOW

THAT when adding an extra circuit in order to get bandpass tuning for your set it may be necessary for you to use a very small-capacity coupling condenser, and even a .0001 pre-set condenser may have too large a minimum value? A neutralising type of condenser should be used.

THAT in an H.F. set having grid tuning in the detector stage, you can sometimes get better selectivity by taking the tapping to the grid a little way down the coil and not directly from the top end?

THAT tone-control can be carried out by connecting a condenser across the speaker terminals? This results in an apparently lowered tone because it cuts off the higher frequencies. The greater the value of condenser, the more are the high notes cut off.

THAT it is a mistake to have too high a detector voltage in some sets. With the tapping taken to about 60-volts, reaction is much smoother and the tone better than when the detector is given a full 100 volts.

BAND-PASSING

WHAT a difference band-pass tuning has made to our wireless reception. It provides just the right degree of selectivity if the components are well designed and solves some of the most important problems of the would-be foreign listener who found himself a year or so ago in an almost hopeless position owing to the blotting out effects of the high-power twin stations. It does not enable him to cut out his local station at short range by turning the tuning condenser through one division or so, but it does confine this station's spread to reasonable limits. The ideal band-pass tuner would, of course, have an absolutely clean cut-off at 4,500 cycles above and below the carrier frequency of the incoming station. This, however, cannot be done (yet at any rate) if the station is a powerful one and not very far away. It is wonderful, though, what a degree of selectivity can be achieved by means of several tuned circuits of this type. One would never have thought a year ago that anything of the kind could be done with straight sets. B.

It is expected that the 60-kilowatt transmitter now under construction at Milan will start testing towards the beginning of November. When the Bari station is completed it will be linked up with Naples to take the latter studio's programme, but later, three times weekly, all Italian stations will take their entertainments from the capital.

THE MAKING OF A FINE RADIO-GRAM

The Pick-Up is the heart of a Radio-Gram, and must be scientifically designed and constructed of first grade materials to achieve the best results obtainable. In this respect there is none so good as the British Ideal "DAPTACON" Pick-Up.

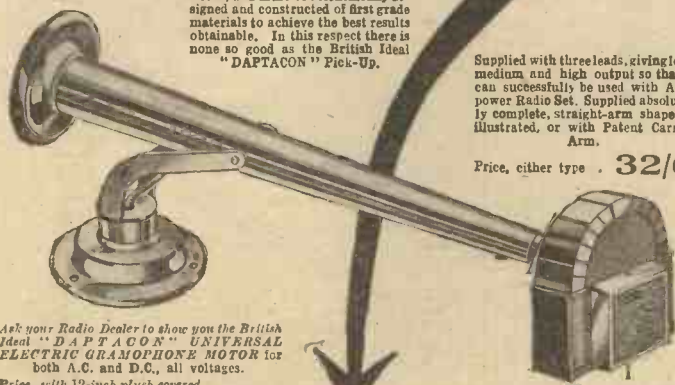

Supplied with three leads, giving low, medium and high output so that it can successfully be used with ANY power Radio Set. Supplied absolutely complete, straight-arm shape as illustrated, or with Patent Carrier Arm.

Price, either type . 32/6

Ask your Radio Dealer to show you the British Ideal "DAPTACON" UNIVERSAL ELECTRIC GRAMOPHONE MOTOR for both A.C. and D.C., all voltages. Price, with 12-inch plush covered Turntable and geared Speed Indicator . 55/-

"DAPTACON" PRODUCTS

ON SALE AT LEADING DEALERS EVERYWHERE

Trade enquiries to: BRITISH IDEAL PATENTS, Ltd., Green Street, Brimsdown, Middlesex Phone: Enfield 1741-1808. Or to the usual Factors.

A NEW "AMATEUR WIRELESS" HANDBOOK The HOW & WHY OF RADIO

By ALAN HUNTER 2/6 NETT.

This book has been expressly written for beginners. It provides a clear conception of the general theory and practice of wireless reception in simple non-technical terms. It has been mainly compiled from the series of articles in "Amateur Wireless"—"The How and Why of Radio"—which proved so popular during the past twelve months.

Of all Newsagents and Booksellers, or 2/9, post free, from "Amateur Wireless," 58/61, Fetter Lane, London, E.C.4

THE CABINET THAT MAKES A GOOD SPEAKER BETTER!



That's the Camco "Melodee" Speaker Cabinet, which improves the performance of YOUR Speaker. Gives volume without distortion. Suitable for ALL well-known makes of Speakers and made in Oak, Mahogany and Walnut, in two sizes from 22". Write for FREE copy of the new 1938 24-page Radio Cabinet Catalogue.

CARRINGTON MFG. CO., LTD. Showrooms—24 HATTON GARDEN, LONDON, E.C.1 Phone: HOL 8202 Works: S. Croydon

NAME _____ ADDRESS _____ A.W.18

Every CAMCO Cabinet bears the CAMCO Seal

"BRITAIN'S SUPER"

WITH
WEARITE COMPONENTS
MAKES A
SUPER RECEIVER

VALVE HOLDERS
Fitted with sprung sockets.

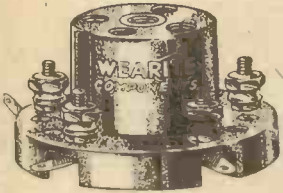

6 4-pin,
1 5-pin.
8/9
per set.

PAXOLIN PANEL 14" x 7"
In black, walnut or mahogany finish. Drilled to specification. 6/-

Insulated Sleeving up to 2 m/m internal dia., will take 16 gauge bare wire. Per dozen yards, 2/-

SUPER-HET COILS

BRITISH MANUFACTURE

Made in London
under British
Patent No. 349403

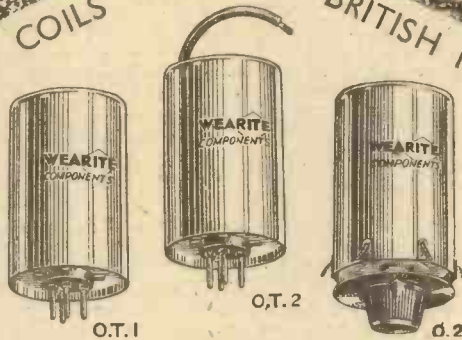

PRICE, PER SET
OF THREE COILS,
37/6

SPECIFIED BY Mr. W. JAMES
FOR
"BRITAIN'S SUPER"



SUPER-FRAME AERIAL
Dual range, centre tapped, in oak or mahogany. Price 42/-

NOTE

Special coil and valve chassis complete with grid leak clips and all essential wiring for Britain's Super. Price 8/-

"WEARITE" SUPER-HET H.F. CHOKE

This choke has been recommended for all "Amateur Wireless" Super-Het Circuits. It has a range from 15-2,500 metres and a D.C. resistance of 310 ohms. Inductance 400,000 M.H. List No. HFS.

Price 6/6

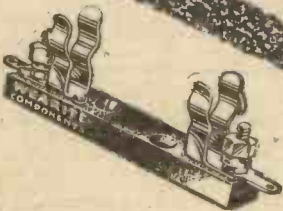

GRID LEAK HOLDER
Price 6d,



Your Earth must be perfect for "Britain's Super." The Wearite earth tube deserves your attention. Price 3/6

WEARITE COMPONENTS

Write for free lists **WRIGHT & WEAIRE, LTD., 740 High Rd., Tottenham, N.17. TOTTENHAM**

Phone: **3847-8-9**

Mention of "Amateur Wireless" to Advertisers will Ensure Prompt Attention

Selected by "A.W."
for the
H.T. Unit for D.C. Mains

Where perfect smoothing is essential the Heyberd Choke must be incorporated in the circuit. Specified by "Amateur Wireless," the new Heyberd 751 Choke is designed as follows:

No. 751		
Inductance	Resistance	Price
50 henrys	850 ohms	12/6

POST THIS TO-DAY
I enclose 3d. stamps for full Lists giving circuit diagrams of Kits of Components for A.C. & D.C. Mains Units, and details of new Transformers.

M.....
Address.....



10 FINSBURY STREET, LONDON, E.C. 2



ENSURE THE BEST RECEPTION

FRAME AERIAL

A first-class frame aerial which can be used with any circuit, with or without centre tap, for only 20/- . The milliwatt output is higher than any other aerial, definite minimum silent point,

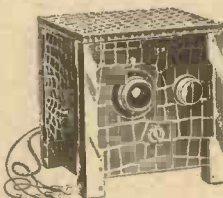

SHORTWAVE CONVERTER

If you fit the new Elex Converter your present set can be used for reception on the ultra short waves. It is an indispensable addition, it will add 50 stations to your log,

BYLDURONE CABINET

The ideal system for the home cabinet maker. You can safely use "Byldurone" because no experience is needed to build a cabinet the "Byldurone" way. Ask your dealer about "Byldurone."

WRITE FOR LIST B11.

J. J. EASTICK & SONS
ELEX HOUSE, 118, BUNHILL ROW,
LONDON, E.C. 1.

Phone: Metropolitan 0314/5/6.

BROADCAST TELEPHONY

Broadcasting Stations classified by country and in order of wavelengths. For the purpose of better comparison, the power indicated is aerial energy.

Metres	Kilo-cycles	Station and Call Sign	Power (Kw.)	Metres	Kilo-cycles	Station and Call Sign	Power (Kw.)	Metres	Kilo-cycles	Station and Call Sign	Power (Kw.)	
GREAT BRITAIN												
25.53	11,751	Chelmsford	16.0									
(G5SW)												
242.3	1,238	Belfast	1.3									
261.3	1,148	London Nat.	68.0									
288.5	1,040	Newcastle	1.2									
288.5	1,040	Swansea	0.16									
288.5	1,040	Plymouth	0.16									
288.5	1,040	Edinburgh	0.4									
288.5	1,040	Dundee	0.16									
288.5	1,040	Bournemouth	1.2									
288.5	1,040	Aberdeen	1.2									
301.5	995	North National	70.0									
309.9	968	Cardiff	1.2									
355.8	843	London Regional	70.0									
376.4	797	Glasgow	1.2									
398.9	752	Midland Regional	38.0									
480	625	North Regional	70.0									
1,554.4	193	Daventry (Nat.)	35.0									
AUSTRIA												
218.5	1,373	Salzburg	0.6									
245.9	1,220	Linz	0.6									
283.5	1,058	Innsbruck	0.6									
352.1	852	Graz	9.5									
453.2	666	Klagenfurt	0.6									
517.2	580	Vienna	20.0									
also testing on 1,255 m. from 8.0 p.m. (Mon. Wed. Sat.)												
BELGIUM												
206	1,456	Antwerp	0.4									
216	1,389	Bruxelles										
Conference												
223.5	1,340	Binche	0.1									
244	1,229	Schaerbeek	0.2									
337.8	888	Brussels (No. 2)	20.0									
509.3	589	Brussels (No. 1)	20.0									
BULGARIA												
318.8	941	Sofia (Rodno Radio)	1.0									
CZECHO-SLOVAKIA												
263	1,139	Moravska-Ostrava	11.0									
279.3	1,074	Bratislava	14.0									
293	1,022	Kosice	2.5									
341.7	878	Brno (Brno)	34.0									
488.6	614	Prague (Praha)	5.5									
488.6	614	Lieblitz (test)	60.0									
DENMARK												
281	1,067	Copenhagen	1.0									
1,153	260	kalundborg	7.5									
ESTONIA												
298.8	1,004	Tallinn	0.7									
465.8	644	Tartu	0.5									
FINLAND												
291	1,037	Tampere	1.0									
291	1,037	Viiuri	13.2									
368.1	813.8	Helsinki	13.2									
1,796	167	Lahti	54.0									
FRANCE												
223	1,345.2	Fecamp	5.0									
237.2	1,260	Beziers	0.6									
238.5	1,258	Bordeaux										
Sud-Ouest												
249.6	1,202	Juan-les-Pins	0.5									
255	1,175	Toulouse (PTT)	1.0									
265.4	1,130	Lille (PTT)	2.0									
272	1,103	Rennes	1.2									
286	1,049	Montpellier	2.0									
287.4	1,043.7	Radio Lyons	30.0									
294.6	1,018	Limoges (PTT)	0.5									
304	936	Bordeaux (PTT)	15.0									
312.6	960	Natan-Vitus (Paris)	0.5									
316	950	Marseilles (temporary)	0.3									
328.2	914	Grenoble (PTT)	3.0									
328.9	912	Poste Parisien	1.2									
345.2	869	Strasbourg (PTT)	15.0									
385	779	Radio Toulouse	8.0									
447.1	671	Paris (PTT)	2.0									
466	644	Lyons (PTT)	2.3									
1,445.7	207.5	Eiffel Tower	15.0									
1,724.1	174	Radio Paris	85.0									
GERMANY												
31.38	9,560	Zeesen	15.0									
217.1	1,382	Königsberg	1.7									
218.5	1,373	Flensburg	0.6									
227.4	1,319	Cologne	1.7									
227.4	1,319	Munster	0.6									
227.4	1,319	Aachen	0.3									
232.2	1,292	Kiel	0.31									
239.4	1,253	Nurnberg	2.3									
245.9	1,220	Cassel	0.3									
253.4	1,184	Gleitwitz	5.6									
259.3	1,157	Leipzig	2.3									
269.8	1,112	Bremen	0.2									
274.2	1,094	Heilsberg	75.0									
283.6	1,058	Magdeburg	0.6									
283.6	1,058	Berlin (E)	0.6									
283.6	1,058	Stettin	0.6									
318.8	941	Dresden	0.3									
325	923	Breslau	1.7									
360.6	832	Mühlacker	75.0									
372.3	805	Hamburg	1.7									
390	770	Frankfurt	1.7									
419	716	Berlin	1.7									
453.2	662	Danzig	0.6									
472.4	635	Langenberg	17.0									
532.9	563	Munich	1.7									
559.7	536	Kaiserslautern	1.7									
559.7	536	Augsburg	0.3									
558	530	Hanover	0.3									
569.3	527	Freiburg	0.3									
1,620	185	Norddeich	10.0									
1,634.9	183.5	Zeesen	75.0									
2,525	119.3	Konigswusterhausen (press)	15.0									
2,900	103.5	Konigswusterhausen (press)	15.0									
HOLLAND												
31.28	9,599	Eindhoven (PCJ)	30.0									
296.1	1,013	Hilversum	8.5									
298.8	1,004	Radio Idzerda (The Hague)	3.0									
285	1,053	Kootwijk (testing)	10.0									
1,071.4	280	Scheveningen-Haven	10.0									
1,875	160	Huizen	8.5									
HUNGARY												
550	545	Budapest	23.0									
ICELAND												
1,200	250	Reykjavik	16.0									
IRISH FREE STATE												
224.4	1,337	Cork (6CK)	1.5									
413	725	Dublin (2RN)	1.5									
ITALY												
25.4		Rome (3RO)	9.0									
247.7	1,211	Trieste	15.0									
278.5	1,085	Turin (Torino)	8.5									
315.5	951	Genoa (Genova)	10.0									
331.5	905	Naples (Napoli)	1.7									
441	680	Rome (Roma)	75.0									
453.2	662	Bolzano (IBZ)	1.5									
501.7	598	Milan (Milano)	8.5									
541.5	554	Palermo	3.7									
LATVIA												
525.4	572	Riga	13.0									
LITHUANIA												
1,935	155	Kaunas	7.0									
NORTH AFRICA												
364.5	823	Algiers (PTT)	13.0									
416	721	Radio Maroc (Rabat)	10.0									
1,350	222.2	Tunis	0.5									
NORWAY												
235.1	1,276	Kristiansand	0.63									
240.2	1,249	Stavanger	0.825									
364.5	823	Bergen	1.35									
368.9	814	Frederiksstad	0.8									
453.2	662	Porsgrund	0.8									
495.9	605	Trondheim	1.35									
586.7	511.3	Hamar	0.8									
1,071.4	280	Oslo	75.0									
POLAND												
214.2	1,400	Warsaw (2)	1.9									
234	1,283	Lodz	2.2									
244.1	1,229	Wilno	21.0									
312.8	959	Cracow	1.5									
334.4	897	Poznan	1.9									
381	788	Lvov	21.0									
408	734	Katowice	16.0									
1,411.8	212.5	Warsaw	158.0									
PORTUGAL												
290.5	1,033	Lisbon (CTIAA)	2.0									
also on 42.9 m.												
ROMANIA												
394	761	Bucharest	16.0									
RUSSIA												
427	702.5	Kharkov	25.0									
497	603.5	Moscow	1.2									
511	585	Archangel	1.2									
720	416.6	Moscow (PTT)	20.0									
800	375	Kiev	20.0									
840	357	Nijni Novgorod	1.8									
937.5	300	Kharkov (Rv20)	25.0									
1,000	320	Leningrad	100.0									
1,034.5	290	Tiflis	10.0									
1,073	279.6	Rostov Don	4.0									
1,103	273	Moscow Popoff	75.0									
1,304	230	Moscow (Trades Unions)	165.0									
1,481	202.5	Moscow (Kom)	40.0									
SPAIN												
252.7	1,187	Barcelona (EAJ15)	1.0									
269	1,115	Valencia (tests)	5.0									
348.8	860	Barcelona (EAJ1)	8.0									
368.1	815	Seville (EAJ5)	1.5									
425.7	704.7	Madrid (EAJ7)	2.0									
453	662.2	San Sebastian (EAJ8)	0.6									
SWEDEN												
230	1,304	Malmö	0.75									
257.3	1,166	Hö:by	15.0									
307.5	975.5	Falun	0.6									
322	932	Göteborg	15.0									
436	689	Stockholm	75.0									
542	551	Sundsvall	15.0									
770	389	Ostersund	0.7									
1,229.5	244	Boden	0.75									
1,348	222.5	Motala	40.0									
SWITZERLAND												
244.1	1,229	Basle	0.65									
246	1,220	Berne	0.5									
403	743	Sötens	25.0									
459	653	Birmuenster	75.0									
TURKEY												
1,204.8	249	Istanbul	5.0									
1,520	197.3	Ankara	7.0									
YUGOSLAVIA												
307	977	Zagreb (Agram)	0.7									
430.4	697	Belgrade	3.0									
574.7	522	Ljubljana	2.8									

WHEN SUBMITTING QUERIES

Please write concisely, giving essential particulars. A Fee of One Shilling (postal order), a stamped addressed envelope, and the coupon on the last page must accompany all letters. The following points should be noted.

Not more than two questions should be sent with any one letter.

The designing of apparatus or receivers cannot be undertaken.

Modifications of a straightforward nature can be made to blueprints, but we reserve to ourselves the right to determine the extent of an alteration to come within the scope of a query. Modifications

to proprietary receivers and designs published by contemporary journals cannot be undertaken.

Postcard Radio Literature

GET THESE CATALOGUES FREE

Here "Observer" reviews the latest booklets and folders issued by well-known manufacturers. If you want copies of any or all of them **FREE OF CHARGE**, just send a postcard giving the index numbers of the catalogues required (shown at the end of each paragraph) to "Postcard Radio Literature," "AMATEUR WIRELESS," 58/61, Fetter Lane, E.C.4. "Observer" will see that you get all the literature you desire. Please write your name and address in block letters.

"Power from the Mains"

HERE is a neat little book from Atlas bearing the above title and showing how easy it is to use mains units for H.T. supply and for trickle-charging accumulators. The book gives, too, details of the new Atlas A.C. and D.C. 16 and 18 eliminators. **598**

Fotos Valves

I have just been glancing through a neatly arranged folder which gives details of Fotos valves. A copy of this should be in the possession of every valve user, as it is a handy index of types for each stage. **599**

On the Stage

It is one of the new Camco cabinets which houses the wireless-set which many readers may have seen in the London play *Late Night Final*. This is one of the cabinets illustrated in the new booklet of Camco productions, a copy of which has just been sent to me. **600**

A Good Home Recorder

The Kingston-Wearite Home Recorder is making a good name for itself. Many friends of mine are enthusiasts about this method of making one's own gramophone records at home. There are several novel points about this system, and you should get a free folder which gives full technical details. **601**

Dagenite Accumulators

There is a good tell-tale indicator, showing the state of charge incorporated in several types of Dagenite glass and celluloid contained accumulators. Wire carrying handles are included, too, in most models. Battery users would find it worth while to write in for the new folder. **602**

New Clix Leaflets

I have just received from Lectro Linx, Ltd., a handy little folder carrying a number of leaflets describing the latest Clix plugs, sockets, and connectors. You can get copies of this free. **603**

Columbia Sets

If you have not seen the new Columbia mains sets, then why not write for an illustrated folder? Copies will be sent free. **OBSERVER. 604**

LANGMORE RADIO GRAMOPHONE CABINETS

IT should be noted that in the Miscellaneous Trading Co., Ltd., announcement on page 782 of AMATEUR WIRELESS for October 17, the cabinet illustrated was wrongly described. The type shown was the Langmore style 8 cabinet, which sells



The Langmore radio gramophone cabinet, type G.1, which houses set and speaker

at 30s., and has no provision for a turntable unit.

The type G.1 cabinet, which was described in the announcement, is shown here. This is a really good quality radio gramophone cabinet, with provision for set, speaker, and gramophone turntable. It costs only 49s. 6d. Full particulars can be obtained from the Miscellaneous Trading Co., Ltd., 13 New Oxford Street, W.C.1.

FOR THE WOODWORKER

THE 1932 manual and catalogue produced by Hobbies, Ltd., Dereham, Norfolk, contains a wealth of designs for the fretworker and woodworker.

Special articles in the radio section deal with a radio-gramophone cabinet and cabinets for loud-speakers. The catalogue section of this 304-page manual includes full details of every woodworking tool, accessory, and material likely to be needed. Copies of the book may be obtained, price 9d., from Hobbies, Ltd.

STATION IDENTIFICATION

AMATEUR WIRELESS has organised a new service of the greatest importance to all listeners. This Station Identification Service is available for identifying stations from information supplied by readers, and will be conducted by J. Godchaux Abrahams in conjunction with "A.W." The fee is 6d. for identifying any one station, but if three identifications are required at a time the fee is only 1s. A stamped addressed envelope must be enclosed.

Address your inquiry to Station Identification Service, "Amateur Wireless," 58-61 Fetter Lane, E.C.4, and give fullest possible details. State type of set used, date and time when station was heard, wavelength, call or interval signal, and details of any programme heard.

Easy Terms FIRST IN 1924 FIRST IN 1931

COSSOR 234 EMPIRE MELODY With **10/-**
MAKER. Screened-Grid, Detector and Power. With valves and Cabinet. order

Cash Price £6 15s. 0d.
Balance in 11 monthly payments of 12/6.

V.3 RADIO FOR THE MILLION. With **10/9**
Screened-grid detector and power. With valves, less cabinet. order

Cash price £5 17s. 6d.
Balance in 11 monthly payments of 10/9.

AMPLION MOVING COIL SPEAKER, With **6/2**
TYPE MC6. Permanent magnet, with output transformer. Complete. Cash price £3 7s. 6d. order

Balance in 11 monthly payments of 6/2.
ATLAS A.C. ELIMINATOR, TYPE A.C. With **5/6**
244. 3 Tappings, S.G., detector and power. Out-put, 120-v. at 20m/a. order

Cash price or C.O.D. £2 19s. 6d.
Balance in 11 monthly payments of 5/6.

W.B. PERMANENT MAGNET MOVING-COIL SPEAKER, TYPE P.M. 3. Complete with **4/10**
3-ratio input transformer. order

Cash Price £2 12s. 6d.
Balance in 11 monthly payments of 4/10.

ORMOND PERMANENT-MAGNET With **5/11**
MOVING-COIL SPEAKER. Chassis Model, complete with input transformer. order

Cash Price £3 5s. 0d.
Balance in 11 monthly payments of 5/11.

We can supply any accessory advertised in "Amateur Wireless" on **EASY TERMS.** Send 6d. in stamps for **NEW Catalogue.**

See our advertisement in last week's issue, page 845

New Times Sales Co

56 LUDGATE HILL, LONDON, E.C.4
(Established 1921) Telephone: CENTRAL 2710

SEND FOR FREE CATALOGUE

GODWINEX

H.T. ELIMINATORS
Here's the greatest Eliminator value ever offered—
S.G.A./12. (For screened grid valves).
Output 12 m.a. 3 positive tappings
—60, 80, and 100 m.a.—
POWER 50/-
S.G.A.T./12 as above, with
L.T. Trickle
70/-
Charger
Models for every type of
set. For A.C. or D.C. sup-
plies. Detented Terminals.
J. DYSON & CO.,
Ltd. (Dept. A.11)
5 & 7 Godwin St
BRADFORD.

S.G.A./12

GRIPSO

"SUPER PUSH-PULL
INDICATING SWITCH
WITH FOOLPROOF CONTACTS"

NICKEL PLATED OR BRONZE ESCUTCHEONS

2PT. 19 3PT. 2/- 2MB. 2/-

MADE IN ENGLAND
LUTON, ENGLAND
THE GRIPSO COY.
32, VICTORIA STREET, LONDON, W.1

**YOU CAN BUILD A
£40 GRAMO-
PHONE WITH
OUR SCALE
DRAWINGS FOR 40/-**

Book of instructions 3d. Catalogue of Motors, Tonearms, Soundboxes, latest internal amplifiers, Gramophones and Cabinets Free. Cash or Terms.

W. BURT, 185 High St., Deptford

TAYLEX WET H.T. BATTERIES
New Prices: Jars 1/3, Sacs 1/2, Zincs 10d. Sample doz. 18 Vols complete with bands and electrolyte 4/1 post 9d.
Sample unit 6d. illus. booklet free. Bargain list free.
AMPLIFIERS, 30/- 3 VALVE ALL-STATION SET £1.
A. TAYLOR, 57, Studley Road, Stockwell, LONDON.

PREPAID ADVERTISEMENTS

Advertisements under this head are charged THREEPENCE PER WORD, minimum charge THREE SHILLINGS. DEPOSIT SYSTEM
As the Publishers cannot accept responsibility for the bona fides of advertisers in this publication, they have introduced a system of deposit which it is recommended should be adopted by readers when dealing with persons with whom they are unacquainted. It is here explained.
Intending purchasers should forward to the Publishers the amount of the purchase money of the article advertised. This will be acknowledged to both the Depositor and the Vendor, whose names and addresses must necessarily be given. The deposit is retained until advice is received of the completion of the purchase, or of the article having been returned to and accepted by the Vendor. In addition to the amount of the Deposit, a Fee of 6d. for sums of £1 and under, and 1s. for amounts in excess of £1, to cover postage, etc., must be remitted at the same time. In cases of persons not resident within the United Kingdom, double fees are charged.

The amount of the Deposit and Fee must be remitted by Postal Order or Registered Letter (Cheques cannot be accepted), addressed to
"AMATEUR WIRELESS" ADVERTISEMENT DEPARTMENT, 58/61 FETTER LANE, LONDON, E.C.4

PHOENIX THREE-VALVE KITS, complete with cabinet, £1/17/6. Ditto with valves, £2/15/-. Ditto with H.T. and L.T. batteries and speaker, £4/10/6. Three-valve S.G. kits, 30/- extra. H.P. terms on kit; 10/5 deposit, 2/7 per week.—Phoenix, 314 High Road, Lee, S.E.13.

VERT WIRING CLIP.—No soldering. Fits any component. Perfect contact. Tested and approved "A.W." Quarter gross, 1/2; half-gross, 2/-; gross, 3/0.—Green & Sons, Reddelyfe, Horley, Surrey.

MODERN THREE-VALVE SETS with valves, £3/15/-. Century Super kits, £3/15/-. Anything wireless supplied at keenest prices. Send list of requirements for quotation.—Servwell Wireless Supplies, 74 Gough Street, London, E.14.

CHARGE YOUR H.T. FROM YOUR L.T. AT HOME.—Combination trickle. Charges efficiently, 1 to 12. H.T. 10-volt accumulators, 10/6. Postage 6d. Diagram only 1/6.—R. Fox, 188 Camberwell Grove, S.E.5.

ELIMINATOR COMPONENTS for home constructors. Stamped addressed envelope brings Eliminator Diagrams, with prices of complete range of mains components.—Mains Power Radio, Broadway Works, Eastern Road, Romford, Essex.

EXCEPTIONAL BARGAINS.—Very latest All-mains Receivers, in beautiful cabinets, 5, 6, and 8 valves, self-contained, with moving-coil speakers. Fully guaranteed. Must clear, from £5 cash. Call and inspect.—Morgan Hastings, Ltd., 212 New Kings Road, Fulham, S.W.6 (opposite Putney Bridge Station).

R.K. SPEAKERS.—Modern Components in part exchange.—Scott, 10 East Parade, Ilkley.

"UNIVERSAL" RADIO BARGAINS of Bankrupt Stock.—Transformers: Triumph, 3/11; Telsen Ace, 4/7; Grand, 7/3; Dynaplast, 3/9; Stal, 3/3. Valves: Triotron, Dario, 4/3; Power, 5/3; Radvaco, 3/11; Power, 4/11. Speaker Units: Ormond, 6/3 and 9/3; Triotron "W", 3/3; Telsen, 4/6; Zelco, 3/3. Nassak Var. Condensers, 3/3; with vernier, 4/3. Differentials, 1/6. Ormond, 3/3. Six-pin B.B.C. Coils, 1/11. Dual, with Switch, 3/11. Compressions, 1/-. Sutra Double-reading Voltmeters, 3/11. N. & K. Speakers, 49/6. Telsen Output Chokes, 6/8. Burnside Pickups, 10/6. Sovereign Volume Controls, 3/6. All goods in original sealed cartons. Thousands of other bargains. Request our price any component.—"Universal", 20 Victoria Road, Peckham, S.E.15.

NEW ELECTRIC GRAMOPHONE MOTORS, 5-guinea models, suit A.C. or D.C., complete with 12-in. turntable, switch, regulator, etc. Blueprint instructions. Money return guarantee. 40/- each.—King, 1 Kingsley Road, Hounslow, Middlesex.

AGENTS, ACTIVE ENTHUSIASTS sell "Brookman British Ebonite Panels," cabinets, and specialties, suppliers of all makes of radio apparatus. Send for particulars of our system of trading.—Brookman Rapid Radio Service, 105 Spencer Street, Birmingham.

ENGINEERS.—Seriously, if you are earning less than £10 per week you cannot afford to carry on without reading "ENGINEERING OPPORTUNITIES." Whether you are an old hand or a budding apprentice, this 200-page volume will point to a worth-while future. Among other things the book explains the methods of our unique Appointments Department, gives details of all leading Eng. Exams. (A.M.I.Mech.E., A.M.I.E.E., B.Sc., G.P.O., etc.) and outlines modern Home Study Courses in Civil, Mech., Elec., Motor, Aero, Radio, "Talkie," and all other branches of Engineering. This book will alter your entire outlook and earning power. It is quite FREE. Send for your copy now. British Institute of Engineering Technology, 109 Shakespeare House, 29-31 Oxford Street, London.

"STANDUP" Wet Battery replacements. All sizes up to 30,000 milliamps capacity. Lists free.—Scottish Batteries, Braeside, Uphall Station.

LARGE QUANTITY UNUSED VALVES, transformers, condensers, resistances, etc. less than half price; write for list.—44 Claremont Road, W.13.

1932 OSRAM FOUR MUSIC MAGNET KIT, unopened. Cash wanted.—Write, 120 Matlock Road, E.10.

CABINETS.—Best and cheapest. New Illustrated List. Special discounts.—Imperial Cabinets, 18 Summerhill Street, Birmingham.

ANELOY RADIO, 36 Hindmans Road, East Dulwich, S.E.22. Get our price first for anything radio—specialists in H.T. batteries and accumulators. All goods sent on approval against cash or C.O.D.

COMPONENTS.—We save you pounds if you are a home constructor. Send for amazing offers.—Imperial Radio, 18 Summerhill Street, Birmingham.

MOVING-COIL SPEAKERS, various makes, from 10/-, with output transformer. All voltages; brand new. Write requirements to Plater, 92 Umfreville Road, Harringay, N.4.

BANKRUPT BARGAINS.—List free, with 3-valve diagram. Transformers from 2/9; Ace, 4/9; Radiogrand, 7/6. Dual Coils, 4/-. Telsen, 4/9 and 6/6. Wavemaster, .0005, 2/6. Wavemaster Diffs., 2/- Telsen, 1/9. Zelco S.M. with dials, 4/-. Wavemaster, 5/-. Fixed, 5d. Valve Holders, 5d. Leaks, 7d. Panels from 2/6. Oak Cabinets from 6/-. Speaker Kits, from 10/6. S.M. Dials, 1/3. H.F. Chokes, 1/3. Switches, 6d. All Telsen Kits supplied with panel, connecting wire, etc., free. Three-valve kits, with cabinet, 32/6. Two-valve, 24/-. Century Super Kits, 76/- Conet 3 Kit, 43/-. £3/3/- Four Kit, 47/6. Speaker Units, Zelco, 4/-; Telsen, 4/9; Triotron, 9/6. Eliminators, Bullphone, D.C., 22/6; A.C., with Westinghouse, 40/-. Positively no junk. The right stuff at low prices. Thousands of satisfied customers. Get my price first. Special: Britain's Super Kit, J.B., Lewcos, etc., 105/-; with Tungrams, £7.—Butlin, 143b Preston Road, Brighton.

CENTURY SUPER, with Frame and Cabinet, £4/10/-—Paine, 38 Alpha Street, Slough.

"MAKE YOUR OWN SPEAKER UNIT."—Simple, easily constructed Cone Unit. Converted standard parts obtainable any wireless shop. Cost few pence (this is not a "catch" to sell special components). Improved armature mounting achieves wonderful fidelity and volume. Requires no chassis. Complete illustrated instructions (submitted "A.W." for approval). 1/- and stamped envelope.—Osborn, 53 Abbots Park Road, London, E.10.

VARIOUS KIT SETS AND COMPONENTS, ETC., for sale, cheap; taken for debt; all new and guaranteed. Please state requirements.—123 Choumert Road, Peckham, S.E.15.

THE "TONIC" SELF-GENERATING TRICKLE-CHARGER KIT will help you to economise by keeping your 2-v. L.T. accumulators fully charged at home. A boon to town or country dwellers. 7/- each, postage 9d.—Williams, Netherend, Cradley, Birmingham.

BETTER ACCUMULATOR CHARGING.—Complete H.T. and L.T. Hire Services. Collection and Delivery.—Aneloy Radio, 36 Hindmans Road, East Dulwich. Official Oldham Service Station (Trade supplied), and Charging Contractors to Camberwell Borough Council.

"Amateur Wireless and Radiovision." Price Threepence. Published on Thursdays and bearing the date of Saturday immediately following. Post free to any part of the world: 3 months, 4s. 6d.; 6 months, 8s. 9d.; 12 months, 17s. 6d. Postal Orders, Post Office Orders, or Cheques should be made payable to "Bernard Jones Publications, Ltd."
General Correspondence is to be brief and written on one side of the paper only. All sketches and drawings to be on separate sheets.
Contributions are always welcome, will be promptly considered, and if used will be paid for.
Communications should be addressed, according to their nature, to The Editor, The Advertisement Manager, or The Publisher, "Amateur Wireless," 58-61 Fetter Lane, London, E.C.4.

NEW "PURATONE" PROCESS
2 VOLT DARK EMITTER
H.F., L.F., VALVES 3/9
DET., R.C.
POWER - 5/3
Super-Power 6/3 Screen-Grid 7/6
BRITISH MADE. FULLY GUARANTEED
Actual Makers: RUBON LTD.
189 New King's Rd., London, S.W.6

RADIO FURNITURE DE LUXE
PICKETTS
Usual Price Makers Price
£2-15-0 £4-18-0 Save
£7-7-0 £5-10-0 You
£2-3-0 £2-7-0 Money.
Famous experts, B.B.C., 3,000 clientele.
Sent ON APPROVAL FREE!—return at OUR expense if not delighted. Deferred Terms 10/- or £1 monthly.
Photographs and List FREE!
PICKETT'S Radio-Furniture (A.M.)
Albion Road, Bexleyheath

FULL-SIZE BLUEPRINTS

- When ordering, please send Postal Order, NOT STAMPS.
CRYSTAL SET (6d.)
1931 Crystal Set ... AW303
ONE-VALVE SET (1s.)
Easy to Build One ... AW304
TWO-VALVE SETS (1s. each)
Talisman Two (D, Trans) ... AW194
No-battery Gramo-radio 2 (D, Trans) ... AW238
Forty-five-shilling Two (D, Trans) ... AW250
Twenty-shilling Two (D, Trans) ... AW274
The Room-to-Room 2 (D, Trans) ... AW298
Big-volume Two (D, Pentode) ... AW309
Gleaner Two (D, Trans) ... WM201
Merlin Two (A.C. Set) ... WM213
Five-point Two (D, Trans) ... WM220
Brookman's A.C. Two (D, Trans) ... WM225
Aladdin Two (D, Trans) ... WM231
Ever Tuned Regional Two (D, Trans) ... WM241
Station-finder Two (D, Trans) ... WM253
Music Lover's Two (D, Trans) ... WM260

- THREE-VALVE SETS (1s. each)
1931 Ether Searcher (SG, D, Trans) ... AW271
1931 Ether Searcher (A.C. model) ... AW276
Mains Unit ... AW277
1931 Ether Searcher (D.C. model) ... AW284
Mains Unit ... AW285
Square Peak Three (SG, D, Trans) ... AW293
B.B.C. Selective Three (D, RC, Trans) ... AW289
Universal Short-wave Three (SG, D, Trans) ... AW301
Olympian Three (SG, D, Trans) ... AW306
Brookman's Three (SG, D, Trans) ... WM161
Five-point Three (SG, D, Trans) ... WM212
New Brookman's Three (SG, D, Trans) ... WM218
Five-point Short-waver (D, RC, Trans) ... WM223
Plug-in-coil Three (D, 2 Trans) ... WM232
Regional Three (SG, D, Trans) ... WM236
Band-pass Inceptor-dyne (SG, D, Trans) ... WM244
Ether Marshal (SG, D, Trans) ... WM247
Meridian Short-waver (D, RC, Trans) ... WM256
Five-advantage Three (D, RC, Trans) ... WM257
Everybody's Radiogram (SG, D, Trans) ... WM258
Double Band-pass Three (SG, D, Trans) ... WM259
Everybody's Radiogram (with Automatic Grid-bias) ... WM262

- FOUR-VALVE SETS (1s. 6d. each)
The £3 3s. Four (SG, D, RC, Trans) ... AW303
The £3 3s. Four (Improved Model) ... AW303A
Everybody's Radio-gramophone ... AW310
Regional Band-pass Four (SG, D, RC, Trans) ... WM211
Five-Point Four (SG, D, RC, Trans) ... WM216
Regional A.C. Four (SG, D, RC, Trans) ... WM222
Brookman's Three-plus-one (SG, D, RC, Trans) ... WM233

- FIVE-VALVE SETS (1s. 6d.)
Britain's Super (Super-het) ... AW311
Regional D.C. Five (SG, D, RC, Push-pull) ... WM252

- SIX-VALVE SETS (1s. 6d. each)
Century Super (Super-het) ... AW287
A.C. "Century Super" (Super-het) ... AW295
Mains Unit (1/-) ... AW295A
Super 60 (Super-het) ... WM229
A.C. Super 60 Radio Gramophone (Super-het) ... WM239
A.C. Super 60 (Table Model) ... WM245
Super 60 (with Wearite base) ... WM249
Super 60 (with Lewcos base) ... WM251

- SEVEN-VALVE SET (1s. 6d. each)
Super Senior (Super-het) ... WM256
Super Senior (with Wearite base and Lewcos coils) ... WM261

- MISCELLANEOUS (1s. each)
Our H.T. Unit for A.C. Mains ... AW262
Gramophone Tone Control ... AW264
Short-wave Super-het Adaptor ... AW268
H.T. Unit and Trickle Charger for D.C. Mains ... AW272
Booster Speaker (6d.) ... AW286
"A.W." Tone changer (6d.) ... AW288
"A.W." Selectivity Unit (6d.) ... AW290
A.C. Trickle Charger ... AW305
Amateur's Linen Speaker ... AW307
D.C. H.T. Unit ... AW311
Big H.T. Unit for A.C. Mains ... WM230
Loud-speaker Tone Control ... WM234
"W.M." Linen Diaphragm Loud-speaker ... WM235
Two-Minute Adaptor for Short Waves ... WM240
Super 60 A.C. Unit ... WM248
Simple Neon Oscillator ... WM250

Copies of the "Wireless Magazine" and of "Amateur Wireless" containing descriptions of any of these sets can be obtained at 1s. 3d. and 1s. respectively, post free. Index letters "A.W." refer to "Amateur Wireless" sets and "W.M." to "Wireless Magazine." Address letters:

Amateur Wireless Blueprints Dept., 58-61 Fetter Lane, London, E.C.4.

MAKE OR BUY A GRAMOPHONE AT A QUARTER SHOP PRICES. Or buy Cabinets for Wireless. British double spring motor, 12 in. velvet turntable, swan arm, metal sound-box, amplifier, needle cups, for £1-16-0 p.p., and build your own Cabinet. Portable Gramophones from 15/6, postage 1/6. Motors from 7/6. Lists free. 64 pp. 1931 Catalogue No. 220 with Reduced Prices, Drawing and How to Make Gramos, 3d. Established 27 years.
Regent Fittings Co., A.W., 120 Old St., London, E.C.1

Amateur Wireless
FEE 1/-
INFORMATION BUREAU
COUPON
Available until Saturday
NOVEMBER 7, 1931



"We're Fluxite and Solder, The reliable pair. Famous for Soldering—Known everywhere! We've soldered all connections, And here's the reward—Good Programmes come clearly, From Home and Abroad!"

See that Fluxite and Solder are always by you—in the house, garage, workshop—anywhere where simple, speedy, soldering is needed. They cost so little, but will make scores of everyday articles last years longer! For Pots, Pans, Silver, and Brassware; RADIO; odd jobs in the garage—there's always something useful for Fluxite and Solder to do.

All Hardware and Ironmongery Stores sell Fluxite in tins, 8d., 1/4 and 2/8.

NEW "JUNIOR" SIZE, 4d. per tin

FLUXITE SOLDERING SET
Simple to use and lasts for years in constant use. Contains special "small-space" soldering iron with non-heating metal handle; pocket blow-lamp; Fluxite, Solder, etc.; and full instructions

COMPLETE, 7/6, or LAMP only, 2/6.

FLUXITE, LTD.
(Dept. 325)
ROTHERHAM, S.E.16

ANOTHER USE FOR FLUXITE
Hardening Tools and Case Hardening.
Ask for Leaflet on improved method.

ALL MECHANICS WILL HAVE

FLUXITE

IT SIMPLIFIES ALL SOLDERING

MOVING COIL L.S. BARGAIN MAGNAVOX TYPE 130

Aluminium Chassis, Input Transformer. New, in maker's carton.

39/6

FULTOGRAPHS for B.B.C. WIRELESS PICTURE TRANSMISSIONS

Complete new £22 kits with double spring grammo. motor worth 50/-. Relay clutch and tracking gear worth £4. Moving coil 0.5 milliammeter transformer, six pin plugs and sockets, panels and connections, etc., with diagram.

27/6

WECO VALVES

The famous Western Electric Midget Peanuts. Work on one volt at 1/2 amp. An 8/6 valve for 4/-. The supply at this price is limited, so order early. **POWER AMPLIFIER VALVES**, same make for big volume and 200 milliwatts output 6 volts .13 amp. Cut to 4/6

HEADPHONES

SULLIVAN'S Double Headphones, 2 receivers with metal headbands, 120 ohms, 3/- pair; ditto, 8,000 ohms, 4/- pair; field service headphones, leather headbands, L.R., English make, 2/6 pair; clean, and boxed in makers' cartons; single earpieces, L.R., 1/6; all as new and guaranteed 2 years; microphone insets, 2/-.

ELECTRADIX RADIOS,
218, UPPER THAMES STREET, E.C.4

NOW . . . DUBILIER CONDENSERS

at a price to
suit everybody



This entirely new range of Types 665 and 670 Condensers has been introduced in addition to our well-known 610 and 620 Mica Condensers and are sold at prices within the reach of all. These new models are specially designed for use where high efficiency, compactness and light weight are essential and are built up to a standard—not down to a price.

PRICES:

TYPE 665.
.0001, .0002, .0003 mfd. - - 6d. each
.0005 mfd. - - - - - 9d. each

TYPE 670.
.0001, .0002, .0003 mfd. - - 1/- each
.0005, .001, .002 mfd. - - - 1/3 each
.005 and .006 mfd. - - - 1/6 each
Types 610 and 620, prices from 1/8 to 3/- each.

DUBILIER CONDENSER CO.
(1925) LTD.

Ducon Works, Victoria Rd., N. Acton,
LONDON, W.3.

A pleasure to look at ...
A joy to listen to !

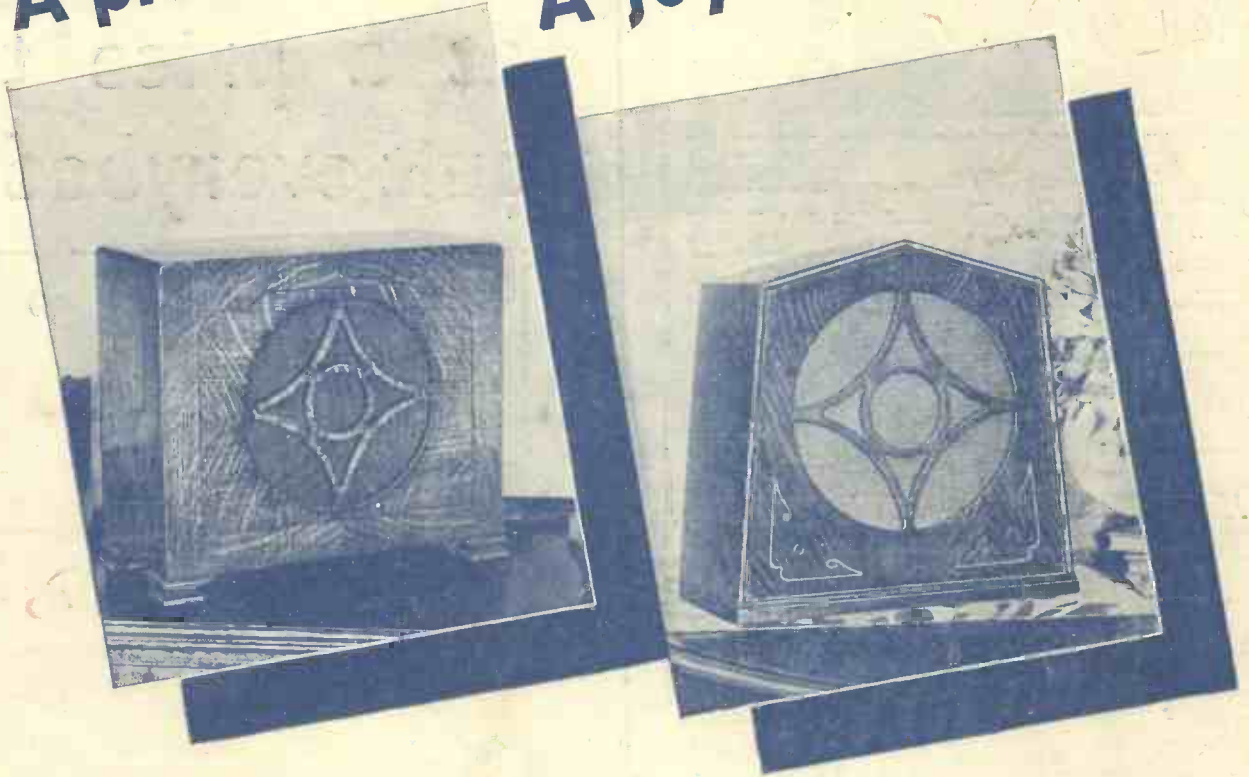

(BRITISH MADE THROUGHOUT)

Illustrated above on the left is the
INDUCTOR TYPE BLUE SPOT
SPEAKER 100D in Oak.

Price complete 63/-

Illustrated above on the right is the
BLUE SPOT SPEAKER 44R, also
in Oak.

Price complete 52/6

*Write for catalogue A.W.14 showing complete
range of speakers.*



TRADE MARK

Regd. Nos. 515639 & 516180.

AREN'T they beautiful—these new **BLUE SPOT** Loud Speakers with their graceful lines, delightful proportions and lovely graining of fine quality woods. They will enhance any room, harmonise with any furniture,

And the beauty of their appearance is reflected in the beauty of their tone, the faultlessness of their reproduction. Harshness is a word meaningless in their presence, distortion and blurring are unknown to them. Their reproduction is life-like, unbelievably, astonishingly life-like. They make listening-in a pleasure—even the most exacting critic will admit their perfection.

Your dealer is proud to sell these speakers. He will demonstrate them with pleasure. Ask him to do so to-day.

Ask to hear the New **BLUE SPOT RECEIVERS**
—a triumph of modern technical skill. Ask for descriptive leaflet.

THE BRITISH BLUE SPOT COMPANY LTD.

BLUE SPOT HOUSE, 94/96 ROSOMAN ST. ROSEBERY AV., LONDON, E.C.

Telephone: Clerkenwell 3570. Telegrams: "Bluospot, Isling, London."
Distributors for Northern England, Scotland and North Wales:—H. C. RAWSON (Sheffield and London) Ltd., 100, London Road, Sheffield: 22, St. Mary's Parsonage, Manchester: 183, George Street, Glasgow.

Hutcheonad