

HINTS AND TIPS ON GETTING PURE TONE

"CENTURY SUPER"—ANOTHER MODEL

Amateur Wireless

Every Thursday 3^d

and Radiovision

Vol. XVIII. No. 470

Saturday, June 13, 1931

The A.C. "CENTURY SUPER"

FULL DETAILS

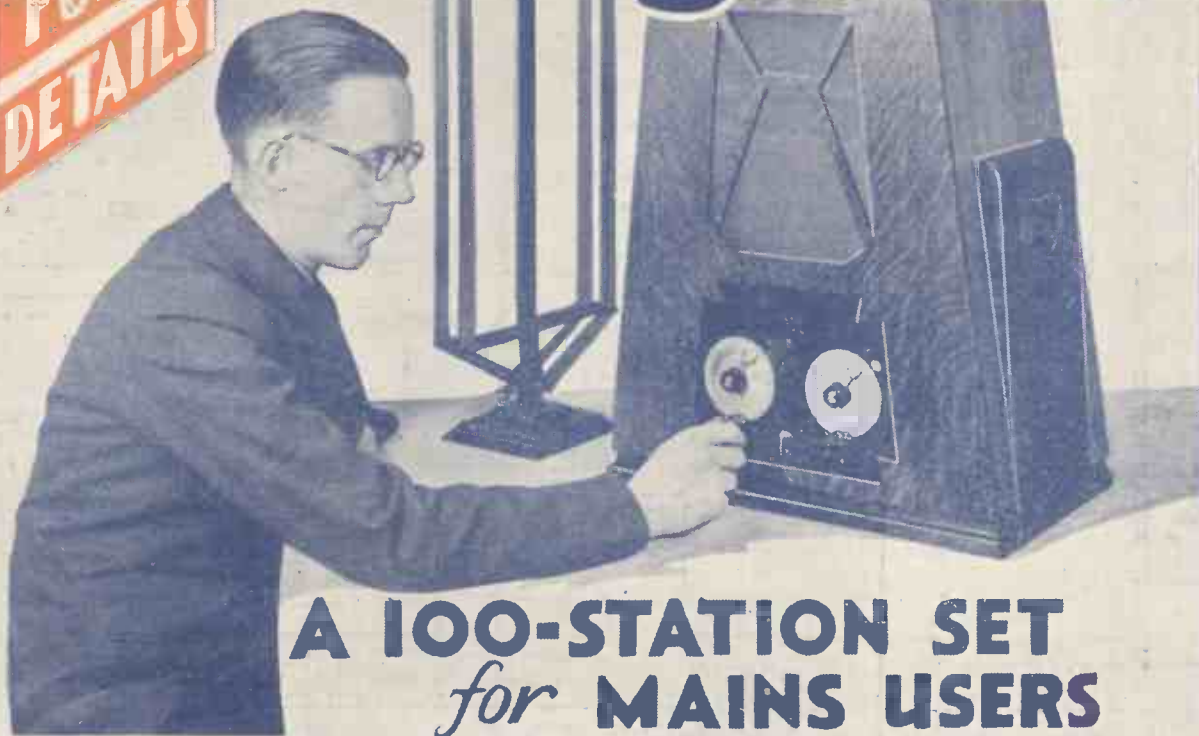

A 100-STATION SET
for MAINS USERS

Registered at the G.P.O. as a Newspaper

RANGE THE WORLD

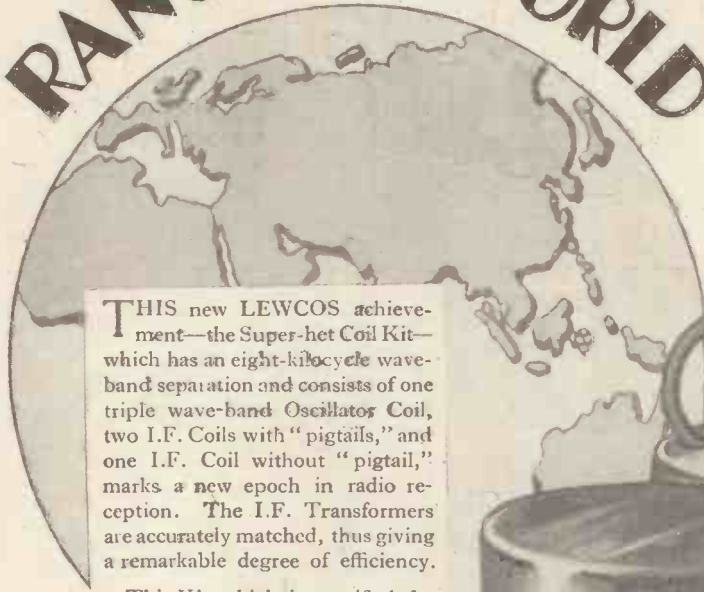

with The

LEWCOS

(Regd)

THIS new LEWCOS achievement—the Super-het Coil Kit—which has an eight-kilocycle wave-band separation and consists of one triple wave-band Oscillator Coil, two I.F. Coils with “pigtails,” and one I.F. Coil without “pigtail,” marks a new epoch in radio reception. The I.F. Transformers are accurately matched, thus giving a remarkable degree of efficiency.

This Kit, which is specified for the A.C. “Century Super,” can also be fitted with extraordinary ease in any set of similar design and the results will be truly astounding!

The small space available is completely inadequate to give even a short description of these wonderful new LEWCOS Coils, and you are invited to write for an illustrated explanatory leaflet.



SUPER-HET COIL KIT

(Provisional Patents Pending)

(Designed and manufactured at our Leyton Works),

which is specified for the

A.C. “CENTURY SUPER”

receiver described in this issue of “A.W.”

Price 50/-

Ref. S.H.K. No. 1.

BRITISH THROUGHOUT

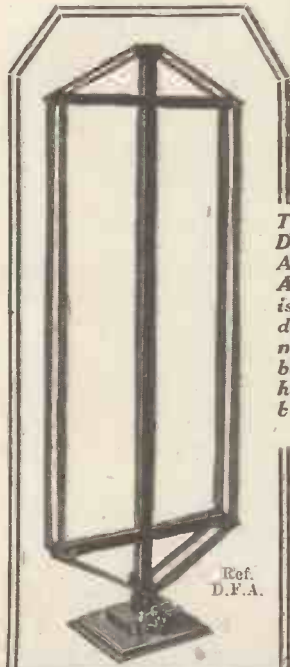

This is a photograph of the LEWCOS Dual Range Centre-Tapped Frame Aerial which is specified for the A.C. “Century Super.” The Frame is wound with silk-covered Litzendraht wire and the switch and terminals are mounted on the moulded base, thus presenting a neat and handsome appearance. The wave-band change is effected by the turn of a knob.

Size: 30" high x 10" wide.

PRICE 32/6

Ref. D.F.A.



A TRIPLE COIL BASE FOR I.F. COILS (Ref. I.F.B.3)
Price 2/6
IS NOW AVAILABLE.

LEWCOS “Spaghetti Resistances” of 15,000 and 20,000 ohms each
PRICE 1/6 each
are specified for the A.C. “Century Super”

LEWCOS RADIO PRODUCTS FOR BETTER RECEPTION

THE LONDON ELECTRIC WIRE COMPANY AND SMITHS LIMITED, CHURCH ROAD, LEYTON, LONDON, E.10

Advertisers Appreciate Mention of “A.W.” with Your Order

TELSEN'S

LEAD

TO THE

RADIO

WORLD



ONLY TELSEN

All the established Telsen components are now reduced to price figures which enable modest purses to purchase real luxury radio A further range of Telsen components will be introduced at staggering prices, and the high standard of quality and performance for which Telsen is famous is rigidly maintained. Only colossal production could make these two events possible—*only Telsen could do this.*

Specify Telsen when buying components.

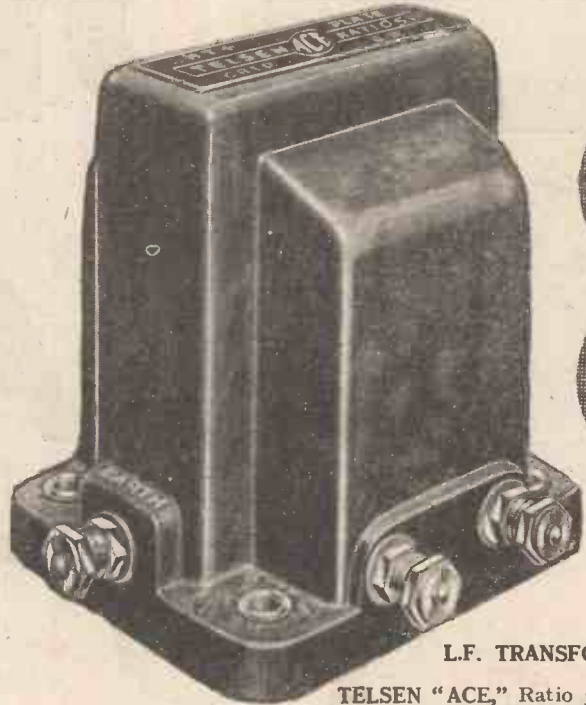

L.F. TRANSFORMERS

	Price
TELSEN "ACE," Ratio 3-1,	each 5/6
Ratio 5-1,	each 5/6
TELSEN "Radiogrand," Ratio 3-1, each	8/6
Ratio 5-1, each	8/6
TELSEN "Radiogrand" Super, Ratio 7-1, each	12/6

WATCH FOR THE NEW COMPONENTS NEXT WEEK

TELSEN GRID LEAKS.
Absolutely silent and non-microphonic, practically unbreakable, cannot be burnt out and are unaffected by atmospheric changes. Telsen Grid Leaks are not wire wound, therefore there are no capacity effects. Made in capacities of $\frac{1}{4}$, $\frac{1}{2}$, 1, 2, 3, 4 and 5 megohms. Price, 9d. each.



TELSEN

RADIO COMPONENTS
ARE ALL BRITISH

THE LARGEST RADIO COMPONENT MANUFACTURERS IN THE WORLD

You will Help Yourself and Help Us by Mentioning "A.W." to Advertisers

COULD DO THIS:-

COLOSSAL PRICE REDUCTIONS WITHOUT SACRIFICE OF QUALITY



6^d

TELSEN VALVE HOLDERS.—PROV. PAT. No. 20286/30. An improved design in Valve Holders embodying patented spring contacts for split or solid valve legs, low capacity and self locating. Prices: 4 pin, 6d. each; 5 pin, 8d. each.



6^d

TELSEN FIXED MICA CONDENSERS.—PROV. PAT. No. 20287/30. Made in capacities up to .002 mfd. .0003 supplied complete with patent Grid Leak Clips to facilitate series or parallel connections, can be mounted upright or flat, tested at 500 volts. Price, 6d. each.



2^s

TELSEN STANDARD H.F. CHOKE.—Designed to cover the whole wave-band range from 18 to 4,000 metres, exceptionally low self capacity, inductance 150,000 microhenries, resistance 400 ohms. Price, 2s. each.

CVS-19



Send for the Telsen Component Catalogue —use the coupon below, and it will be sent post free.

To: THE TELSEN ELECTRIC CO., LTD.,
ASTON, BIRMINGHAM.

Please send, post free, the new Telsen Component Catalogue.

NAME

ADDRESS

A. 13-6

Mention of "Amateur Wireless" to Advertisers will Ensure Prompt Attention

MAZDA ACHIEVEMENTS



Where Mazda Valves are made.

IN all those epoch-making developments which have attended the evolution of the modern radio valve, Mazda has lead the way. From the time when the first indirectly heated valves made the commercial all-mains receiver a practical possibility, Mazda engineers have been in the van of achievement.

MAZDA RESULTS

The reason for the amazing success of Mazda valves need not be sought. They are used by the leading set manufacturers and are generally acknowledged by public, trade and press to be the finest range of valves the radio world has known.

Remember that when you equip *your* set with Mazda valves you get Mazda experience—Mazda quality—Mazda performance

MAZDA THE BRITISH VALVES

All-mains, battery and rectifier types from all good radio dealers.



Mazda engineers introduce the first indirectly heated valve—1926. Made the all-mains set a commercial possibility.



Mazda engineers invent method of applying insulating coating direct to heater. Now universally adopted by valve manufacturers



Mazda engineers introduce first indirectly heated S.G. valve—1928. And the first indirectly heated pentode—1930.



Mazda announce the new Unitary Structure principle and so insure absolute uniformity of characteristics.



Mazda introduce anti-microphonic filament supporting hooks and produce the first really non-microphonic battery valve



Mazda markets the first D.C. mains valve already standardised by leading set makers.



THE EDISON SWAN ELECTRIC CO., LTD.
Incorporating the Wiring Supplies, Lighting Engineering
and Radio Business of the British Thomson-Houston Co., Ltd.
Radio Division
135 Charing Cross Road, London, W.C.2
Showrooms in all the Principal Towns.

EDISWAN

Please mention "A.W." when Corresponding with Advertisers

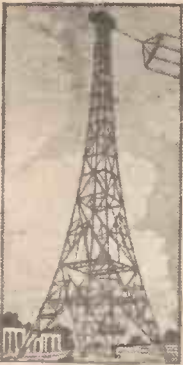

Amateur Wireless

and
Radiovision



EDITOR:
BERNARD E. JONES.

RESEARCH CONSULTANT:
W. JAMES.

TECHNICAL EDITOR:
J. H. REYNER, B.Sc., A.M.I.E.E.

ASSISTANT EDITOR:
H. CORBISHLEY.

THE LEADING RADIO WEEKLY FOR THE
CONSTRUCTOR, LISTENER & EXPERIMENTER.

NEWS · & · GOSSIP · OF THE · WEEK

THE "A.C. CENTURY SUPER"

IN this issue, on pages 920-922 and 924, you will find full constructional details of the A.C. edition of AMATEUR WIRELESS' star set, the "Century Super." If you have mains available, then this is certainly the most up-to-date and highest-performance set you could wish to build. For the battery model we claim 100 stations and excellent purity of tone. This has been proved by the hundreds of letters we have received from enthusiastic "Century" builders. *And now here is the all-mains version.*

SIR JOHN COMES BACK

SIR JOHN REITH returns from his American trip on June 20, and two days later Admiral Carpendale, who has, of course, been in charge during the Director-General's absence, leaves for the Lausanne conference.

AT LAUSANNE

AT Lausanne it seems probable that all manner of questions affecting broadcast listeners will be discussed. The power of broadcasting stations, wavelength separation, and the question of propagandist stations will be dealt with. You must bear in mind that the International Radiotelegraphic Convention is due to be held at Madrid in 1932 (it is a quinquennial convention and the last one was held at Washington). Then all these matters—affecting all wavelengths and not only those used for broadcasting—will be discussed again.

THESE BIG STATIONS

THERE is a feeling in certain quarters that broadcasting authorities will not get complete satisfaction at Madrid, and at present there is rather a tendency to "jump" wavelengths. To take one

PRINCIPAL CONTENTS

News and Gossip	905
Solving Radio's Problems	907
The "Square Peak 3"	908
Hints and Tips on Getting Pure Tone	909
In My Wireless Den	910
On Your Wavelength	915
Do We Want Re-diffusion?	917
The Goodness Factor of a Valve	918
Without Fear or Favour	919
The A.C. "Century Super"	920
Broadcasting on a Modern Liner	926
How to Make a Scratch Filter	928
Edison Bell Picnic Portable	932
We Test for You	934
Broadcast Telephony	938

TELEVISION AT THE DERBY!



Here is the Baird Television van which was drawn up by the railings of one of the enclosures and which was used for the daylight television broadcast. Exceptionally good results were obtained

example, the new Luxemburg station is causing a deal of anxiety, as it is difficult to see how this can be fitted in the existing waveband without causing interference.

RECORDING O.B.'s

"WHEN I was at Savoy Hill the other day," says our B.B.C. correspondent, "I went into a special room which had been reserved for the Blattnerphone—the new tape-recording machine which has already been described in AMATEUR WIRELESS. This is being used extensively by 'Talks,' and 'Radio Plays,' and it is also coming in handy for recording outside broadcasts, such as the Derby relay and the ship-to-shore talk from the *Empress of Britain*."

NEW LIGHT ORCHESTRA

WHEN the new vaudeville orchestra of twenty players is formed in the near future by the B.B.C., Leslie Woodgate is expected to become the conductor. This talented young composer has for some time assisted Stanford Robinson, the B.B.C.'s Chorus Master.

IN BROADCASTING HOUSE

OUR B.B.C. Correspondent says that the gallery of the concert hall—Studio No. 1—which occupies three storeys

NEXT WEEK: Don't miss the further article on the A.C. "Century Super"

NEWS · & · GOSSIP · OF THE · WEEK — Continued

of the central tower, has been reduced in size in order that the acoustics of the hall, from a broadcasting point of view, may benefit. The seating capacity has suffered and it is now calculated that there will be seating for an audience of 750.

FROM THE OUTSIDE

THE outside of the place looks nearly finished. The B.B.C.'s coat of arms has been carved over the motto: "Nation shall speak Peace unto Nation," on the main façade at fourth-floor level. In the stonework of the second floor is a running ornamentation of waves. In the niche over the main entrance is to be placed a piece of sculpture by Mr. Eric Gill, showing Prospero presenting Ariel to the world. Gill is also the sculptor for a figure of "The Sower," which will be placed directly opposite the doorway in the main entrance hall.

SOME FIGURES!

SAYS an architect engaged on the work: "There have been 2,630,000 bricks used in the construction of Broadcasting House. Its weight is approximately 24,000 tons, and it has a capacity of 2,260,161 cubic feet. Forty-three thousand tons of material were excavated from the site, for the accommodation of the three floors below street level."

MORE INTERFERENCE

BUT not for us. This time it is on the other side of the Atlantic. As no agreement exists between the United States and Mexico on wavelengths, some of the new Mexican stations are causing serious interference with U.S. stations. Station XEW especially, with studios in Mexico City and the transmitter eight miles away, is causing serious concern. It is suggested that XEW be made the centre

of a chain system of radio stations to extend right across Mexico somewhat on the American plan. When these plans mature it is certain that more interference than ever will occur!

BELOW 10 METRES

TO gain a satisfactory solution of the problem of broadcasting on the ultra-short waves Philips, at PCJ, have been making experimental transmissions on a wavelength of 7.58 metres. These transmissions—music—commenced last February and are still continuing. A very important factor which has been discovered is that the range of the transmissions is confined to a very short distance and does not cause interference outside a radius of a few miles.

TRY FOR THIS!

WE hear that the French Academy is offering a prize of 4,000 francs for the best essay on the importance and influence of broadcasting on civilisation. That is about £35. Those who have brushed up their French by listening to Radio Paris, might try a hand at this!

NEW AMATEURS TO HEAR

THE number of amateur transmitters is growing. DX enthusiasts might note that the Polish and Austrian authorities have authorised the issue of transmitting licences to more amateurs. So far upwards of 27 have been issued in Poland, and 15 in Austria. Call signs are prefixed by SPI and UOI, UO2 or UO3 respectively. Make a note of this in your log.

FREE FROM RULES

AS the Vatican station enjoys a certain amount of immunity from the international rules which usually govern broad-

cast station operation, it is to be used extensively for experimental purposes. For instance, Marconi will use the station for research work in connection with the "echo" effect of waves.



Our artist's impression of "G.B.S." who broadcast a talk on Saint Joan of Arc recently—but not in this costume!

NEW USE FOR SPEAKERS

IN Berlin recently," says a correspondent, "was seen an omnibus fitted with speakers controlled by a microphone placed near the driver who announced stopping places to his passengers." Similar systems are in use in New York, where some Underground trains are fitted with a microphone and speakers enabling the guard to announce stations and to give warning when the doors are to close.

TWO MASTS FOR FALKIRK

THE London high-power station at Brookmans Park has four masts to support the two aerials, two masts for each aerial. When erecting the northern high-power station the B.B.C. economised by cutting the number of masts down to three. One aerial at Moorside Edge hangs between mast No. 1 and mast No. 2, and the second aerial between mast No. 2 and mast No. 3. It is probable that a further economy will be made at Falkirk, for the Scottish high-power station. The probability is that only two masts will be used here. This is the result of a successful experiment at Daventry.

Since the change of Midland Regional's wavelength from 479 metres to 398 metres both the Daventry National and the Midland Regional aerials have been suspended from the two original 5XX masts. The Daventry National aerial runs from the top of one mast to the top of the other. The Midland Regional aerial consists of two wires, one from the top of one mast to the ground, at an angle to the ground, and the other similarly from the top of the second mast to the ground.

AT THE OTHER END



In the Baird Studios in Long Acre, London, a number of standard television receivers were fitted up for receiving the Derby sound- and -sight broadcast. Mr. Baird (right) is seen "looking in" to the race

Solving Radio's Problems

An account of the experimental work at the Radio Research Station, Slough. From a Correspondent



SOME of the most remarkable radio research work of recent years is centred at the Radio Research Station of the Department of Scientific and Industrial Research which I had the opportunity of visiting recently. The station is actually situated in the lush Thames meadows, surrounding the historic moated mansion of Ditton Park, far away from the noise of traffic and disturbances due to electric trams and machinery.

The first thing that struck me on arrival at the station was the scattered and isolated character of the huts composing it. This, I at once realised was necessary in order that a number of experiments could be conducted simultaneously without the risk of mutual interference.

The work of the station deals mainly with the scientific aspects of the fundamental problems of the propagation of waves, direction-finding, and atmospherics.

The starting point of much of the present work of the station may be regarded as the

direct experimental proof of the existence of the Heaviside layer, which was obtained in 1925 by Professor E. V. Appleton, F.R.S., working in conjunction with the Board. By a very elegant method it was shown that the energy from a transmitting station reached a given receiving aerial by two routes, part—the atmospheric ray—being propagated upwards and deviated down again by the Heaviside layer, while another part was propagated along the ground. The Heaviside layer, or layers—for Professor Appleton's work has definitely shown there are at least two—consist of huge clouds of minute electrically-charged particles (electrons), one situated at about 60 miles, the other at about 120 miles up in the atmosphere. I was told at the station that practically all the successes and failures of radio communications could be traced to the effects of these layers. The only place where they do not enter as a serious factor is in the direct service area of a local station.

An important effect of the layers—known to all listeners to distant broadcasts—is the production of fading. This phenomenon is due to the waves, arriving at the receiving aerial by the two different routes, falling in and out of step; the result is that the two streams at one moment strengthen, and at another moment oppose each other's effect in the receiver. Fading is one of the problems which is being closely studied at Ditton Park. Several important experiments are continuously in progress in connection with measurements (by Professor Appleton's method) of the height and electron density of the layers, while simultaneous observations are also made of the fading of the signals from distant stations.

The mere aural strength of reception being not sufficient criterion of the degree of fading, recorders are used to give continuous traces of the rise and fall of the carrier wave.

Fig. 1 shows such a recorder giving a rectified output which is proportional to the carrier of the station being received. A notable feature is the extent of the variations recorded, showing the extraordinary tolerance of the ear in the matter of its response to different sound intensities. These records provide data as to the mean level of signal strength to be

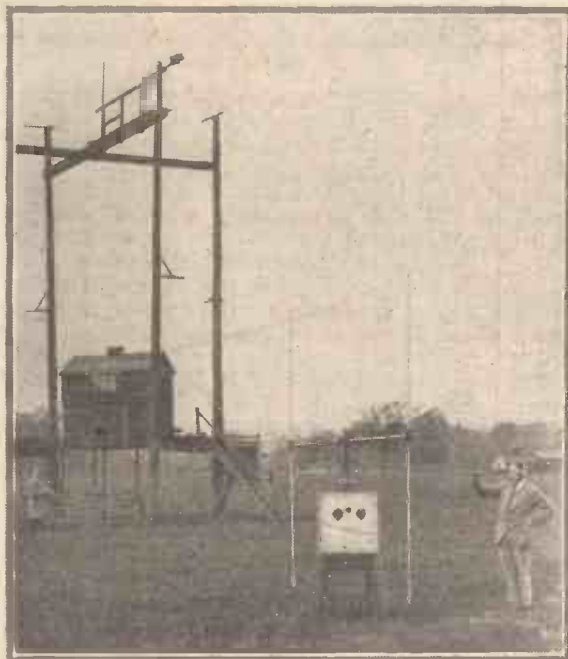

Fig. 2. An arrangement to prevent horizontal pick-up



Fig. 1. Recording the strength of received transmissions

expected from various distant stations. They may also indicate the possible effect on fading of the design and construction of different types of transmitting aerial.

Although possibly of less direct interest to broadcast listeners, another important effect of the Heaviside layer is in connection with direction-finding. It has long been known that a wireless direction-finder employing any form of closed loop frequently ceases to tell the truth at night. Earlier work at the station showed that this "night error" effect is due to the downcoming waves reflected from the Heaviside layer. As readers are doubtless aware, when a direction-finding coil is set with its plane at right angles to the direction of the transmitter, no signal should be audible, the voltage produced in the frame then being zero. In the conditions prevalent at night-time for waves usually employed for direction-finding—and at any time for short waves—the forces in the waves bent down from the layer can be so twisted as to set up voltages in the horizontal limbs of

(Continued on next page)

the coil. The effect may be completely to spoil the zero, or, what is worse, to give a completely wrong indication. So pronounced can this effect become that on one

Mahomet's coffin—in mid-air, supported on the poles shown in Fig. 2, with vertical aerials at each pole. Each vertical was divided into two parts and the mid-point

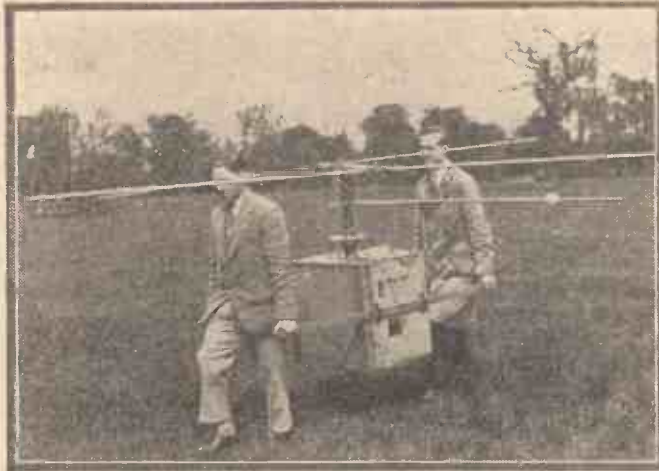

Fig. 3. The short-wave direction-finding apparatus about to undergo tests

occasion of continuous observation at Ditton Park, the Bournemouth station appeared to leave its position on the south coast and to drift gradually round the whole compass about Slough. A similar effect is produced by the downcoming wireless signals from aircraft.

Once the cause of these errors had been discovered, their elimination lay in the development of a receiving aerial system which would be free from horizontal pick-up.

The first development in this direction meant the suspension of a hut—like

similar to those that are experienced when the waves are being returned from the Heaviside layer.

In the study of propagational problems it is frequently necessary to work at various distances from transmitting stations. To facilitate this work, the station is equipped with a travelling laboratory (shown in the heading). The apparatus there being used is for the study of ultra-short waves. One of the main objects of the investigation is to find under what conditions, if any, the electron density in the layers is sufficient to return such waves to the ground.

horizontal leads to the hut were arranged to neutralise each other and give no horizontal pick-up. With short waves, using smaller aerials, only one pair, capable of rotation, is necessary. A modern short-wave direction-finder using this system is shown in Fig. 3, where the aerials are turned into the horizontal position for convenience of carrying.

A small transmitter is located near the top of one of the scaffold poles, and this can be twisted so as to give artificial conditions of downcoming rays

Another important part of the station's work is the investigation of atmospherics. Recent developments have made it possible to photograph wave-forms and directional indications as received on a cathode-ray oscillograph. Directional observations by this method are being made synchronously at Ditton Park and Leuchars, Fifeshire. Our last photograph (Fig. 4) shows the method of analysing the records made on an

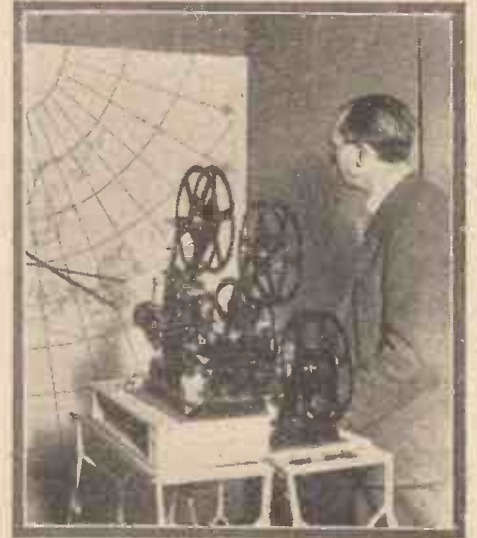

Fig. 4. A cinema apparatus is used to analyse the directional indications recorded by a cathode-ray oscillograph

ordinary cinema film, the directional traces being projected to give intersections which show the origin of the individual atmospheric.

The "Square Peak" and North Regional

By J. H. REYNER, B.Sc., A.M.I.E.E.

"I LIVE five miles from Moorside Edge," writes a North Country reader. "I have a good full-length aerial on which I used to be able to tune in foreigners galore. Now, of course, I cannot do this. Will the 'Square Peak 3' help me out of my difficulty, and can I still use the full aerial?"

Yes, undoubtedly. The cut-off at each side of the tuning point is so sharp that even with a full-size aerial foreign stations can be tuned in quite easily. In fact, I do not recommend the use of too short an aerial with this set. It tends to make tuning rather too difficult owing to the exceptional sharpness. When the regional station first started the general recommendation to anyone who was in trouble was to shorten the aerial. While this did cut down the dial spread of the local transmission, it rendered the reception of distant stations more difficult. This new form of tuning provides a complete solution to the problem and enables one to go back to the old size 100-ft. aerial with all its extra signal strength, and yet does not give the hopelessly unselective results which would be obtained if an ordinary tuning coil were obtained.

Trimming

One reader is a little troubled as to whether he will be able to tune the set in, in view of my remarks regarding the trimming. I went into the subject of tuning rather carefully last week, so that the information would be available for those readers who wanted to get the last ounce out of their set. In any set there are ways and means of obtaining slightly better results, and I outlined a few of these accordingly. It is

not necessary, however, to have everything "just so" before results can be obtained. Indeed, the fact that plug-in coils are used for the H.F. stage proves that the set is by no means critical in operation.

If the two trimmers are set approximately in the middle of their travel there will be no difficulty in tuning in quite a number of stations without any further readjustment. When one is used to the feel of the receiver, however, the

When building any set follow the blueprint and "A.W.'s" instructions as closely as possible, particularly with regard to the order of fixing the parts.



effect of altering the trimmers should be tried, tuning the set to some distant station and then adjusting the trimming condensers until the signal strength is a maximum. You will be surprised at how great the difference can be, due to the steep sides of the resonance curve on the Square-peak coil. When they have been readjusted in this manner the dial will be found to contain quite a number of stations which were not there before.

I see that I have not mentioned the anode-current consumption in the previous articles. This is quite normal, being about 15 milliamps with the average power valve. This, of course, really needs the use of double-capacity batteries, but no three-valve set to-day should ever be used with a single-capacity battery. A double-capacity battery lasts more than twice as long because it is working nearer to its proper rated discharge current, and the internal wastage is nothing like as bad. Even if it only lasted twice as long, however, its cost is by no means twice as great. Therefore, the outlay in the first place is amply justified.

Using a Mains Unit

A mains unit may be used quite easily with this set. Although I tested it out on high-tension accumulators, I took the precaution of making a special test with a resistance of 500 ohms in series with the high-tension lead. This produced the effect of a run-down battery or mains unit, and there was no sign of instability or L.F. howling. To make doubly sure, the set was used on an A.C. mains unit delivering 150 volts at 15 milliamperes, and excellent results were obtainable.

HINTS and TIPS ON GETTING PURE TONE

One of the most usual set faults is overloading in the last stage, so that no matter how good the speaker arrangements may be, the tone is distorted. Here is some useful advice by KENNETH ULLYETT

I WONDER how many set users there are who can honestly say that the tone is never distorted because of overloading the last stage? It is my experience that this is an all too-common trouble, particularly as an increasing number of listeners

valves and an increase in high tension will not cure this last-stage overloading without going to great expense, and there are three ways of enabling the power stage to deal with more volume.

If one valve is not capable of handling the full volume passed on by the detector then one way of curing the overloading is to put two valves in parallel.

If you want to use this method—and it is quite a workable way with some valves—then it is worth while doing the job thoroughly. In Fig. 1 I show how two valves can be used in parallel, using two separate small L.F. transformers.

There are two advantages. For one thing the two small transformers required need not be expensive; for another thing, by using two transformers you can apply

separate grid bias, and this is essential because few power valves (unless specially matched for push-pull working) have exactly similar characteristics.

The small 1,000-ohm resistances shown are placed in the grid leads and are needed to prevent self-oscillation.

I have shown a choke output circuit because some form of filter output will be needed. A transformer output could, of

course, be used if you have an output unit on hand.

The push-pull method uses two power valves to handle a power input which would overload one valve alone. There are methods of using a push-pull stage with ordinary transformers, but it is generally much better to have special input push-pull and output transformers.

It is possible to get input transformers having split secondary windings so that you can put a separate grid bias supply on each valve and, as with the parallel valve system I have just referred to, this is a great advantage in getting the valves matched up. The 1,000-ohm stopper resistances are again included in Fig. 2.

In both these circuits it is worth while using a milliammeter in each anode lead in turn when making the grid bias adjustment. In either case the milliammeter should not be put in the main H.T. lead, but should be connected directly in circuit with the wire going to the anode terminal of each valve holder. Each anode circuit must be tested in turn, of course, and the grid bias to each valve should be varied (taking care to switch off the H.T. before the grid bias plug is removed each time) in accordance with the manufacturers' curve.

If the present small power valve in your set is often overloaded by the local stations, and if you do not want to go to the trouble of making a parallel valve or push-pull stage, then why not try using a power pentode? It is never advisable to use a pentode following a number of L.F. valves, and the use of a pentode should be restricted

(Continued in third column of next page)

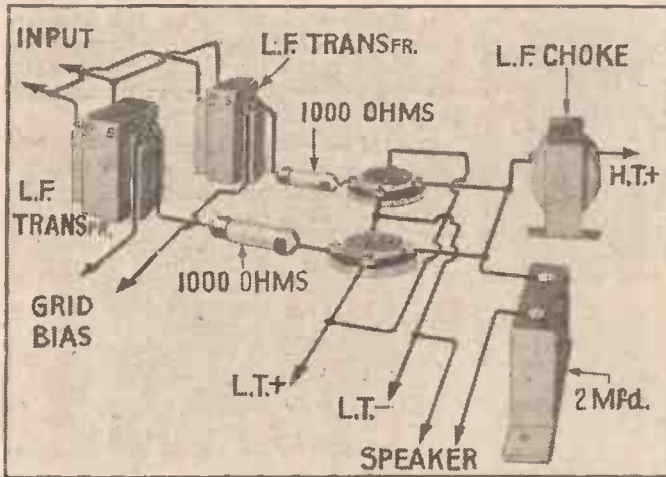

Fig. 1. This is a good way of using two small power valves in parallel. Two transformers are used

have come within the full service areas of B.B.C. stations.

So many people can now get full speaker reception of at least two or three stations and there is so much power to spare that one stage in the set, most frequently the power stage, is overloaded.

The reason why most people are not anxious to cure this trouble, even when they know that it exists, is that a certain amount of cash outlay is needed to improve matters. Perhaps more H.T. is needed, or a larger power valve.

There are even cases where bigger power

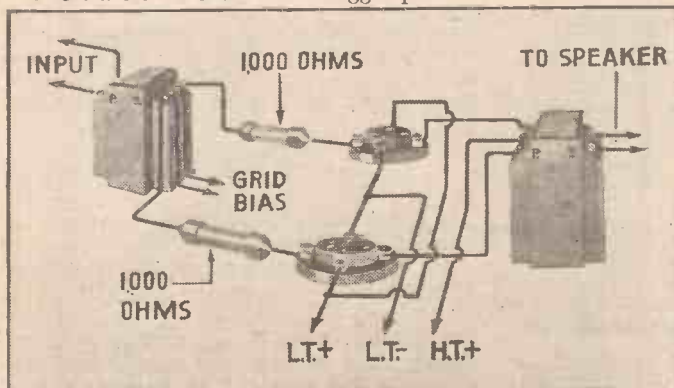

Fig. 2. These are good connections for valves used in push-pull. Note the stopper resistances

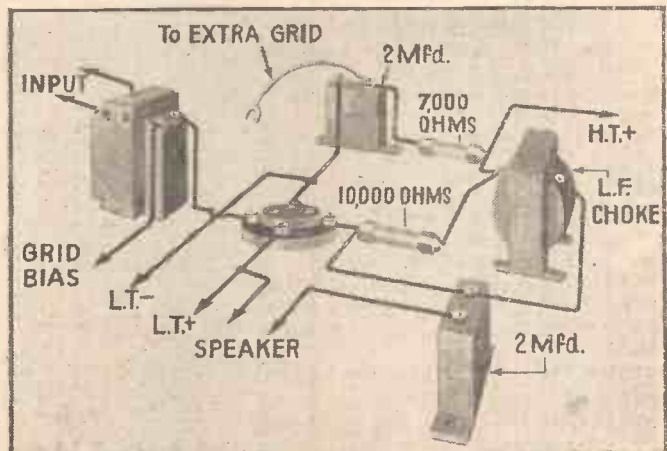

Fig. 3. A power pentode can be used in preference to a small power valve, and these are the connections

IN MY WIRELESS DEN

WEEKLY TIPS—
CONSTRUCTIONAL AND THEORETICAL

By W. JAMES.



Bias and Mains Valves

GRID bias must be used with mains valves in amplifying positions. I mention this because in one or two instances poor results have been complained of and the trouble has been traced to lack of bias on the screen-grid valve.

Grid current in mains valves usually starts at about -1 volt. Therefore, if the bias is less than this amount, grid current is flowing. Tuning is broad when grid current flows, and the magnification is less than it should be.

The correct amount of bias to use depends upon the type of valve and the anode and screen-grid voltages. Usually a bias of -1.5 volts is enough, but -3 volts may be needed. As you increase the bias the effectiveness of the valve as regards its impedance and magnification factor falls off. This cannot be avoided, excepting, sometimes, by adding to the screen-grid voltage.

A point worth noting is that increasing the bias may stabilise a stage, owing to the effectiveness of the valve being reduced. In some sets the volume control consists of a potentiometer connected in the grid bias circuit and a smooth variation is usually to be obtained.

Distortion and other troubles may well be experienced, however, if the bias is increased beyond a certain point, and for this reason the bias form of volume control must be used with care. Incidentally, increasing the bias reduces the anode current.

These Ganged Condensers

Gang-tuning condensers that are not properly made are apt to be troublesome in use owing to changes in the capacity of one or more of the sections.

A good gang condenser ought to have a stout frame. When a rather thin framework construction is used, twisting may take place and after a time the tuning may alter.

I have met with several instances where the tuning has gradually gone flat owing to this. Resetting of the trimming condensers has put matters right, but in a manufactured set this would be rather awkward. When the separate circuits in a gang-tuned set are fairly sharply tuned, it is necessary for the ganging to be very accurate or the advantage of the good circuits is lost.

The tuning, instead of being sharp, will be either broad or a station will tune at two or three points close together. Too good circuits are to be avoided unless they can be carefully set up and the tuning condenser is a precision job.

There are some gang condensers about that are very good. Others are satisfactory enough, but hardly suitable for use in very good circuits. Flimsy constructions ought to be avoided, but on the other hand, mere weight and bulk mean not a great deal by themselves.

Testing for Distortion

A milliammeter is very useful when setting up a set, as it is possible to note very quickly whether all valves are passing their normal currents and responding to grid bias and screen voltage.

When fitted in the anode circuit of the last valve, distortion through overloading or through wrong bias is easily noted. The instrument is connected as indicated in the accompanying diagram, that is, between the high-tension supply and the anode circuit of the valve.

As a rule, the needle of the instrument will kick when signals are being received.

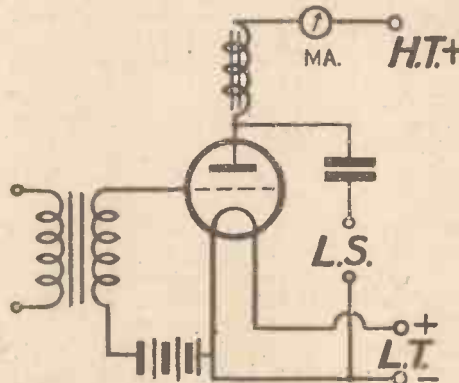

A good method of connecting a meter to show distortion

You may be able to make adjustments which have the effect of causing the needle to remain steady, but often the output is then too low.

If the needle moves farther across the scale when the signals are tuned in, there is probably too much grid bias. If now you reduce the bias the needle may remain fairly steady, but when the valve is being overloaded the needle usually vibrates on the stronger passages.

When the needle moves towards the zero end of the scale there is usually not enough grid bias. It is easy enough to set the last stage in this way, using the milliammeter as an indicator and the bias may be accurately set for the best results.

Use a Good Meter

A good meter is very useful for testing purposes, in fact I do not know how people

discover faults without the assistance of an instrument. A good position to connect one in a circuit until it is behaving properly is the detector.

In this position it will show, roughly, the strength of the signals. When the detector is of the grid-leak type, the reading of the meter will decrease when a signal is brought in. Many adjustments to the high-frequency part of the receiver can be made and the effect noted by watching the meter when no audible difference in the sound output is produced.

Such adjustments as altering the screening and grid-bias voltages will make a difference to the anode current of the detector. When ganging a set a meter is practically essential. At all events it is much easier to gang a circuit when a meter is used, for slight changes in the tuning will usually produce noticeable differences in the reading of the meter.

A useful range is 0.5 milliamperes, but a lower range is better when dealing with a battery set. If possible the instrument should have several ranges, so that the current taken by all valves may be measured.

"HINTS AND TIPS ON GETTING PURE TONE"

(Continued from preceding page)

to sets with, at the most, only one stage of low-frequency amplification.

A good circuit for a power pentode is shown in Fig. 3, and the values are given. To get the best results use as much screen-grid voltage as possible. The circuit I show here incorporates an output arrangement, which is, of course, necessary with a pentode.

For fairly small sets a power pentode arrangement such as this will give full speaker volume, without any trace of distortion, on an output which might overload certain types of small power valve.

The actual amplification given by the pentode is, of course, also appreciably greater.

A. J. Alan is to retell one of his favourite old stories, "An Adventure in Norfolk," on June 16 (National wavelength) and June 20 (Regional).

G. K. Chesterton's novel, *The Napoleon of Notting Hill*, in a radio version by John Watt, will be broadcast to National listeners on July 9. Some other plays to be heard that month are adaptations of Sapper's *Jim Mailland*, R. L. Stevenson's *The Wrecker*, and Housman's *The House Fairy*.

how many COMPONENTS has your wireless set

Perhaps you have never counted them. But consider, for a moment, what an amazing number of small super-sensitive instruments there are—all delicately adjusted to harmonise with one another—all relying on the H.T. Battery for their power and efficiency! Each component depends on a constant, unwavering flow of adequate voltage before it can play its part in giving you the perfect reception you expect.

That is why it is so important to make sure, before anything else, that you are using a good, reliable battery. And you can make sure by giving your set an EVER READY. This sound British made battery is guaranteed by a Company which has been making batteries for over 28 years. The exclusive process of manufacture ensures an unusually even output of power. No falling off, no fading, no premature breakdown. Ask your dealer for the right size to suit your set.

EVER READY
BRITISH MADE
HIGH TENSION BATTERIES

The Batteries that give unwavering power

An EVER READY 120 volt, double-capacity battery and an EVER READY 9 volt grid bias battery are specified by W. James for the battery version of the Century Super, the sensational receiving set described in this issue.

THE EVER READY CO. LTD., HERCULES PLACE, HOLLOWAY, N.7

To Ensure Speedy Delivery, Mention "A.W." to Advertisers



If you could see inside a T.C.C. Condenser!

EVERY T.C.C. Condenser is hermetically sealed against the action of the atmosphere. If you could open up its case you would see a coil of paper and foil. The purpose of the paper is to insulate the two long strips of foil—which form the actual condenser—from each other.

If you were a paper expert you would be impressed by the fact that the paper used is a pure linen fissure—a very expensive paper. T.C.C. use this paper because, from the electrical standpoint, it is the best and because it ensures a life-long dependability.

All the materials in T.C.C. Condensers are of the finest quality—this is one of the reasons why T.C.C. Condensers have such a remarkable reputation for long service.

You are safe when you choose

T.C.C.

"Green for Safety"

Advertisement of Telegraph Condenser Co. Ltd., N. Acton, W.3.

Edison Bell PICK-UPS

GREAT PRICE REDUCTIONS

- Cat. No. 407—New Price, 27/6 (Old Price, 37/6)
- Cat. No. 407A—New Price, 21/- (Old Price, 30/-)
- Cat. No. 448—New Price, 35/- (Old Price, 45/-)
- Cat. No. 455—Cinema Model, Price, 30/-

ONE GOOD THING FOLLOWS ANOTHER.



Cat. No. 407.

Revised Price, £1 : 7s. : 6d.

The Pick of Gramophone Pick-Ups bears the World's Best Known Trade Name.

Write for further particulars—It will pay you.

EDISON BELL LIMITED, LONDON, S.E.15

EDISON BELL CONDENSERS—BEST FOR ALL PURPOSES.

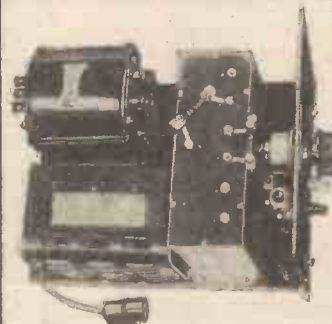

"Never a Second's Trouble in 3 Years"

Just another of the many unsolicited testimonials that daily reach the Heayberd Service Dept. **Guaranteed Two Years**, there is never a fear of breakdown with Heayberd Mains Units.

Model C150
150 v. at 25 ma. Westinghouse rectification. Three tappings, 60/80, 120 and 150 volts. Assembled in case. Requires wiring up only. Non-technical point-to-point diagram.
Price - 76/-



Enclose 3d. stamps for List 947 showing how to build the Mains Unit best suited to my particular Receiver.

NAME
ADDRESS

10, Finsbury St., LONDON, E.C.2

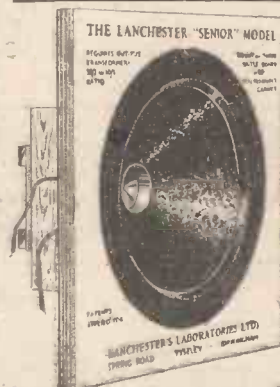

The Lanchester

PERMANENT MAGNET MOVING-COIL SPEAKERS of Perfect Reproduction and Full Volume

Sold direct to the public only, on 7 DAYS' FREE TRIAL against cash with order or C.O.D.

Write for particulars

SENIOR and JUNIOR MODELS Complete in Cabinet—

£4.4.0 & £2.8.0

CHASSIS ONLY, £2.78.0 and £1.8.0

Output Transformers extra. Prices on application.

LANCHESTER'S LABORATORIES
TYSELEY LIMITED BIRMINGHAM

Your Name and Address.....

CENTURY SUPER SUPER SIXTY

Chosen by
Mr. W. James

CENTURY SUPER
Wright & Weaire Ltd. sole
concessionaires in the Brit-
ish Empire for these coils.
(British Patent No. 349403)

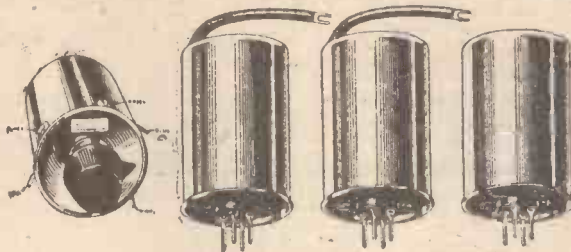

SUPER SIXTY
Price of complete
set of coils ... **50/-**
Illustrated descriptive leaflets ex-
plaining the unique constructions
of the coils will be sent on request.



TRIPLE COIL BASE

Base for above coils, complete with terminals
and tags. Coil sockets are sprung similar to
valve holders. **PRICE, 2/9**

Combined 3-coil strip and 5-valve strip with
all essential wiring complete as one
chassis, for "Century Super"
and "Super Sixty."

7/-



**MAINS
TRANSFORMER**

Standard input at 50
cycles; output 4 volts
at 6 amp. Centre tap-
ped. 135 volts at
60 m/a.
Price **32/6** (made for
25 cycles if specially
ordered).



**5-PIN A.C.
VALVE
SOCKET**

Price **1/3** each

**ULTRA SHORT-WAVE
MINIATURE FRAME AERIAL**

We have just designed a short-wave coil (or frame)
suitable for receiving short-wave stations. It will replace
existing frame aerial, and is centre-tapped for receiving the
ultra-short-wave stations. The winding is Litzendraht wire.
Price **5/9** supplied complete with base. The above short-
wave coil (or frame) is standard for either "Super 60,"
"Century Super" or the "All-Mains" sets.

DUAL-RANGE FRAME AERIAL

Entirely new in design
and embodying exclu-
sive features which
give extremely high
efficiency. The wind-
ings are of Litzend-
draht wire, carefully
wound at even tension
throughout, in order
to maintain the accu-
racy of spacing. The
winding is centre-
tapped and provided
with the necessary
three terminals for
connection to set. The
change from short to
long waves is effected



by means of a switch
at the base: no other
alterations to con-
nections are necessary.
The frame aerial
swings through 180
degrees and is mount-
ed on a polished
mahogany base. It is
of particularly hand-
some appearance.

Price **42/-**

Price per complete
set of parts, less
wire, **30/-**



**WEARITE THREE-
POINT SHORTING
SWITCH**

Push-pull action. Sound
self-cleaning contact.
With insulated spindle. **PRICE 1/6**

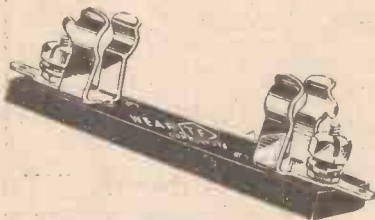

**WEARITE GRID-
LEAK HOLDER**

Has new type contact
spring clips. Fits any
size grid leak. **PRICE 6d.**

Send for Free Illustrated Lists and Leaflets

**MAHOGANY
PANELS**

Black or natural finish. **5/9**
12 in. by 8 in. by 3/8 in.
(Drilled to specification)

WEARITE COMPONENTS

**WRIGHT AND
WEAIRE, LTD.**
740 High Road,
Tottenham, N.17

Telephone : Tottenham 3847-8-9

THE OLDEST ESTABLISHED COMPONENT MANUFACTURERS

You will Help Yourself and Help Us by Mentioning "A.W." to Advertisers

Chief of Pilot Kit Organisation new cabinet design accepted by Britain's leading Radio Weekly ... for this week's set—

A.C. CENTURY SUPER

Build your A.C. Century Super with an
approved and fully-tested PILOT RADIO KIT



The Peto-Scott
Dorchester Cabinet

PETO-SCOTT for FRAME AERIALS

**PETO-SCOTT CENTURY
FRAME AERIAL.** As
specified for the original
Century Super Het. Three-
way lead and six spacers.
Each strand of wire is
enamelled and covered over-
all, which ensures maximum
results. Correct centre-
tapped. The only Frame
Aerial complete with wave-
change switch and base at
20/-. Sent C.O.D. Pay the
Postman 20/-.

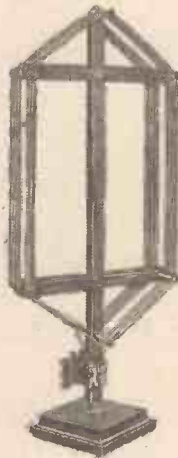

TRADE SUPPLIED.
Terms upon application

**PETO-SCOTT DUO-RANGE
FRAME AERIAL.** As
specified for the "Super 60"
described in *Wireless Maga-
zine*. A compact and highly
efficient unit. Long and
short waves. Mahogany.
Sent C.O.D. Pay the postman
27/6.

LEWCOS FRAME AERIAL.
Sent C.O.D. Pay the Postman
32/6.

Wearite FRAME AERIAL.
Sent C.O.D. Pay the postman
42/-.

KIT "A" (less valves, cabinet frame,
speaker and mains equip-
ment. CASH or C.O.D.) **£8.19.6**

or 12 monthly payments of 18/6
As above but including **PETO-SCOTT CENTURY
FRAME AERIAL,** Cash or C.O.D. **£9.19.6**
or 12 monthly payments of 18/5

Detailed list of specified parts for KIT "A"

	£	s.	d.
1 Ebonite Panel, 12x8, drilled to specification	4	8	
Peto-Scott			1 6
1 Baseboard, 17x10, Peto-Scott	17	6	
2 0.0005-mfd. variable condensers, Cydon "Juni- log"	10	0	
2 Slow-motion dials, Astra, type 2	4	6	
1 50,000-ohm variable wire wound resistance, Sovereign	2	10	0
1 Complete set of super-het. coils, Wearite or Lewcos	2	9	
1 Triple Coil base, Peto-Scott	18	9	
5 2-mfd. fixed condensers, Ferranti, type C2	9	0	
2 2-mfd. fixed condensers, tapped at 1 mfd., Ferranti, type C2C	1	0	
2 Grid-leak holders, Bulgia	1	6	
3 Fixed condensers, .0002, .002, .001 mfd., Telsen	1	5	0
1 Low-frequency transformer, Ferranti, type AF3	1	0	0
1 Low-frequency choke, Varley, 20 henries, 140 M/a, type DPI0	1	0	0
6 Spaghetti resistances: (2) 50,000, (2) 30,000, (1) 20,000, and (1) 5,000 ohms, Lewcos	9	6	
1 1-meg. grid leak, Telsen	1	0	
1 100,000-ohms grid leak, Telsen	2	0	
Konneckerkit, comprising wire and sleeving, screws and nuts	6		
1 Terminal strip and frame-aerial connection with terminals, Peto-Scott	6		
	£8	19	6

A.C. CENTURY SUPER—MAINS PORTION (as specified)

	£	s.	d.
1 Baseboard, 16x7 1/2 in., Peto-Scott	4	0	
1 Mains transformer with 135 volt 30 m/a and 4 volt 6 amp. windings, Junit	1	10	0
1 Smoothing choke, Regentone, type GR	1	1	0
1 Metal rectifier, Westinghouse, H.T.7	1	1	0
4 4-mfd. fixed condensers, 800 volt test, Dubilier, type LFD	1	4	0
Baseboard mounting twin fuscholder and fuses, Bulgia	2	6	
	£5	9	6

NOTE: Alternatively, the REGENTONE A.C. ELIMINATOR, Type 820,
may be substituted for the above equipment, £4 10 0.
KIT "A" as above, with Century Frame Aerial and
Regentone type 820 eliminator, cash or C.O.D. 14 9 6
or 12 monthly payments of 20/8

KIT "C" complete as above, with valves, cabinet, and
Century Frame Aerial, cash with order... 22 9 0
or 12 monthly payments of 41/8

FINISHED INSTRUMENT, ready assembled aerial tested.
Complete with Epoch Speaker, and royalties paid, cash
with order... 31 10 0
Deposit £6 10s. and 11 monthly payments of £2 10s.

RECOMMENDED ACCESSORIES

1 DORCHESTER A.C. SUPER CENTURY CABINET, Specially designed by Peto-Scott	1	15	0
1 Dorchester baffle board speaker chassis complete with brackets and screws	3	6	
1 Permanent-magnet moving-coil speaker, Epoch A1/D96 (new type)	3	7	6
6 Mullard valves; (3) 354V, (E) A.C.0041, (2) 84V	6	1	0



ACCESSORIES

ATLAS A.C. ELIMINATOR TYPE A.C.244, 3 tappings—8 G., detector, Power Output 120 volts at 20 m.a. Cash Price or C.O.D. £2 19 6 Balance in 11 monthly payments of 5/6	Send only
REGENTONE MODEL W.I.F. FOR A.C. MAINS. Three fixed tappings, S.G. Det. and Power Output 110-120 v. at 12/15 m.a. Cash Price or C.O.D. £2 7 6 Balance in 11 monthly payments of 4/4	Send only
LAMPLUGH OR FARRAND INDUC- TOR SPEAKER for perfect reproduction. Unit and Chassis complete, ready mounted. Cash price £3 10 0	Send Only
Balance in 11 monthly payments of 6/5	
BLUE SPOT SPEAKER UNIT TYPE 66R, 4 pole balanced armature with Major Chassis and Cone (37 cm) Cash Price or C.O.D. £2 10 0 Balance in 5 monthly payments of 8/10	Send only
EXIDE 120-VOLT WH. TYPE ACCUMULATOR, in crates Cash Price or C.O.D. £4 13 0 Balance in 11 monthly payments of 8/6	Send only

CENTURY SUPER

Battery Model

KIT "A" Less Valves, Cabinet, and Frame Aerial	£5.0.0
or 12 monthly payments of 9/2	
With Frame Aerial	£6.0.0
or 11 monthly payments of 11/-	
KIT "B"	£8.16.0
As above with valves but less Cabinet and Frame Aerial	
or 12 monthly payments of 16/2	
With Frame Aerial	£9.16.0
or 12 monthly payments of 18/-	
KIT "C"	£10.11.0
Complete with Valves, Cabinet and Baseboard, Panel and Frame Aerial. or 12 monthly payments of 19/5	
FINISHED INSTRUMENT Complete as Kit "C" and Royalties paid. Batteries excluded.	£13.17.6
or deposit £3.17.6 and 11 monthly payments of £1	

Special CENTURY Items sent C.O.D.

Wearite or Lewcos Super-Het Coils:
Set of 4 coils. As used by the designers **£2.10.**
and included in Pilot Radio Kits
Shortwave Kit for Century Super.
Complete Kit—Coil, Holder, Neutralising
Condenser, Flex, Spare Tags, etc. **7 6**

TRADE NOTE

Peto-Scott Frame Aerials and other
Super-Het Equipment are available
to the trade. Terms upon application.

EXPRESS ORDER FORM

To PETO-SCOTT CO. LTD.
Please send me C.O.D./CASH/H.P.

For which I enclose Cash/H.P. Deposit
£ s. d.

Name

Address

A.W. 13/6/31

C.O.D.

PAY THE POSTMAN — it costs no
more—WE PAY ALL CHARGES

CASH

Cash with order—Carriage Paid

H.P.

Strict Privacy Guaranteed
on all Easy Payment Orders

PETO-SCOTT CO. LTD.

77 CITY ROAD, LONDON, E.C.1: Clerkenwell 9406. 62 HIGH HOLBORN, LONDON, W.C.1
Chancery 8266. MANCHESTER: 33 WHITELOW ROAD, CHORLTON-CUM-HARDY. Phone:
Chorlton-cum-Hardy 2028. NEWCASTLE, STAFFS: 7 ALBANY ROAD. Phone: 67190.

On Your Wavelength!

QUEER PRANKS

LITTLE oddities in wireless reception are always cropping up. No one can really explain them, and it is the occurrence of this kind of thing that makes long-distance work so fascinating. Here is an example within my own ken. Though it is 403 feet or so above sea-level, my house is near the bottom of a valley running roughly east and west. A friend lives a quarter of a mile from me on the south-facing side of the valley. His house is perhaps 100 feet higher than mine, but it is more than that below the top of the ridge which forms the southern rim of the valley. Both of us use indoor aeri-als.

In my house, Brussels No. 1 is so powerfully received that full loud-speaker strength is obtainable at any time, whether in daylight or in darkness, that he is working. He is at all times a good deal stronger with me than is his twin brother, Brussels No. 2. The friend has precisely the opposite experience. Brussels No. 1 is very rarely a daytime station for him, though Brussels No. 2 not infrequently is. At no time does he receive No. 1 with anything like the strength of No. 2. This, I must say, absolutely baffles me. If they were transmissions coming from different quarters one could see a possible explanation. But when both come from the same place I really cannot see how it happens that at receiving posts so close together their performances should be precisely reversed.

ANOTHER QUEER ONE

HERE is another very queer point in reception. A few weeks ago a friend rang me up very late at night to ask if I was trying for America, as U.S.A. stations were coming in well. My super-het, which usually gets anything that is going, would have nothing to do with them on its own small frame, though it brought in over a dozen with terrific volume as soon as I connected up a comic auxiliary aerial in the form of a few feet of wire running up to a curtain rod. The strength of stations was so wonderfully good that the idea came to me to try what a portable could do. My portable (it calls itself a portable, though really it is a self-contained "stationary") is a very good four-valver with one S.G.H.F., a grid-leak detector, and two L.F.'s, I brought it into the same room, stood it on the table, turned it westwards, switched on, and began to tune in. Station after station was picked up without any difficulty.

WHAT IS THE REASON?

BUT here is the curious point. The portable was doing it on its own tiny frame alone. And its frame is not a particularly good one, for it consists of a rather close winding of No. 30 d.c.c. copper wire put on round the wooden chassis of the loud-speaker. The sides of this little frame measure 12 inches. For the super-het I use a larger frame very carefully wound and nicely spaced. Now, why in the same room should one set with a far

smaller amount of H.F. amplification have worked well from a small frame, whilst the other would not? It is all the more curious since, as a general rule, the portable, even with an auxiliary aerial of fair size in use, will not bring in a whisper from stations that the super-het causes to roar in with the aid of its own frame and nothing else. Again, I confess myself completely beaten.

LONG-DISTANCE CONDITIONS

THOUGH the big foreign stations are continuing to give us good service, despite the present long hours of daylight, the smaller fry have practically disappeared, unless you have oodles of amplification at your command; and this means very often that you amplify small atmospherics into ear-splitting crashes. But, despite the disappearance of many of the 1- or 2-kilo-watters—or, rather, I should say because of it—the number of stations from abroad that can now be received perfectly clear of interference is larger than it has been for some time.

THE SILVER LINING

BUT let me explain this dark saying. In winter time minute stations at enormous distances can cause heterodynes. I have known a good many cases of loud whistles produced by 250- or 300-watt relays hundreds of miles away from stations with which they were interfering. As we change from winter to summer conditions the ranges of stations become smaller and the interference that they cause grows, therefore, less and less. As things are at present, almost all of the very few heterodynes left are due to stations of considerable power which are not adhering quite strictly to their wavelengths. If you are inclined to feel sad about not being able to hear this and that moderate-powered station you can rejoice at the silver lining of the cloud, reflecting that you are now getting stations that are really worth while without any unwanted accompaniment.

NOTE THESE

POSSIBLY you are one of those who have the idea that summer long-distance work is hardly worth while, for which reason you confine yourself during the lighter months mainly to the local programmes and don't bother about radio trips abroad. Well, this summer is not like those that have gone before. I am not referring to the weather; I mean from the wireless man's point of view. There are heaps of big stations now at work, and if you have not tried round you may be surprised to find how many of them are waiting for you. Let us think about the medium waveband. You probably won't hear much of Budapest, Vienna, and other stations up at the very top; but, unless you are very unlucky, you will find pretty useful reception from Brussels No. 1. Langenberg, too, is in excellent form, and, not far away from him, Rome, Stockholm, and Bero-muenster are all offering entertainment.

PLENTY TO CHOOSE FROM

THE other big Swiss station, Sötzens, is coming through with plenty of vim, and there is hardly ever an evening when you cannot obtain full loud-speaker reception from Toulouse and Hamburg. Frankfurt is almost as good. Just below the London Regional you have three very fine stations in Strasbourg, Brussels No. 2, and Breslau. Further down, Hilversum, Heilsberg, and Turin will all repay attention. There are others, Götterburg, for example, is usually good and the same may be said of Bordeaux. Of course, you won't expect to receive each and every one of these whenever you run round the dials, but if your H.F. amplification is up to the mark you ought to be able to get a very fair proportion of them on any evening when conditions are not hopelessly bad.

A HUNDRED YEARS ON

HAVE you ever speculated about what our great grand-children will think of our wireless a hundred years from now? I can foresee my successor, the "Thermion" of 2031, writing one of his paragraphs somewhat on these lines: "I have spent an interesting afternoon amongst the old bound volumes of wireless papers in the local library. One can hardly believe nowadays that in the whole of Great Britain there were not more than four million wireless sets in use. And what queer things they were! In those days they used queer contrivances known as valves, and one finds writers gloating over an actual amplification of from 50 to 100 per stage. These valves (here follows an amusing technical description) required to have either their filaments or their cathodes heated, whilst 100 volts of what they were pleased to call high-tension current was regarded as quite a high figure. I came across a paragraph by the 'Thermion' of 1931 to the effect that his 'up-to-date' seven-valve set required no more heating than the single-valve that he had in use in 1919. If only that 'Thermion' were alive to-day would he not be surprised at our modern apparatus? Every station in the world is, of course, at the beck and call of any receiving set.

"We all to-day find it hard to realise how troubled our ancestors were over the problem of selectivity. Can readers believe that in 1931 only about 200 transmitting stations were at work on the band between 200 and 550 metres and that they caused considerable interference with one another? The broadcast band nowadays, of course, covers only 50 metres and contains more than 10,000 stations, none of which interferes with any other."

A FURTHER PEEP

THEN I can imagine super-Thermion waxing quite humorous on the subject of the loud-speakers of the early "Nineteen hundreds." He may even reproduce some response curves to serve as comic illustrations for his remarks, "And would you

On Your Wavelength! (continued)

believe," he will say, "that in order to fill one of their quaint little living-rooms they had to feed into these weird loud-speaker contrivances current that ran into quite a number of milliamperes? Anyone who cares to visit the Science Museum at South Kensington can see for himself the demonstration set installed by the B.B.C. which was then held to be absolutely the last word as regards purity of reproduction. Readers, however, may not know that the attendant will on request turn on this extraordinary apparatus which has been adapted to receive the No. 105 London station. They can then judge for themselves the kind of reproduction that our queer old ancestors indulged in. Don't fail, if you go to South Kensington, to examine the actual receiving set. Note the knobs which were used for tuning and, if possible, have a look inside the apparatus. You will be struck, I am sure, by the huge variable condensers, the queer coils and the utterly amazing transformers."

FUNNY—ISN'T IT?

ONE generation can very rarely understand why the previous one, or the one before that, just couldn't get hold of what seemed to be a perfectly obvious way of doing things. To us it seems rather remarkable that the steam engine took so long to become a locomotive, that the motor cars of 1900 could rarely travel ten miles without a break-down, and that for years men rode penny-farthing bicycles without ever thinking of equalising the wheels and using a geared-up drive. It will be exactly the same when posterity looks back on the young days of wireless. They will admire our keenness and the whole-hearted way in which we settled down to tackle the problems that beset us, but they will be astonished how the perfectly simple solutions of most of our difficulties managed to elude for so long the greatest scientific brains.

THE NEW KONIGSWUSTERHAUSEN

WITH the increase in power of the Königswusterhausen transmitter to 75 kilowatts in the aerial, many of the German programmes are brought right to our door. As the authorities were anxious to bring the station into operation as quickly as possible, the re-invigorated plant was launched on Sunday, May 31, but to complete the alterations the station will be compelled to close down some time during August for three days when the broadcasts will be made with the old 8-kilowatt transmitter. It was unfortunate that on its first evening Königswusterhausen should have been obliged to suspend operations for an hour or so, but the thunderstorms raging over Northern and Central Europe were such that in any case the broadcasts would not have been clearly heard; even with their high power they were swamped by electrical disturbances.

A USEFUL CHANNEL

KONIGSWUSTERHAUSEN is on the air daily at 5.45 a.m. B.S.T. with a weather forecast and a gramophone recital

from Hamburg; later, apart from its own educational broadcasts it takes wireless entertainments from Berlin, Königsberg, Leipzig, Cologne and whenever anything special is offered from other German provincial centres. At mid-day you may turn to it daily for a luncheon-hour concert. Königswusterhausen will be a useful addition to the daily log for on many evenings during the summer it may prove the only channel through which we may hear broadcasts from German stations less likely to be tuned in.

PROGRAMME INTERCHANGE

I UNDERSTAND that similar to the arrangement made between the German and Italian organisations and the National Broadcasting Company of New York, Radió Paris also contemplates an interchange of programmes with our American friends. Although France is anxious to relay to the United States a radio-picture of the July 14 celebrations with a speech by the new President of the French Republic, I am informed that there is little likelihood of this taking place and that nothing serious will be contemplated before October next.

WHAT'S YOUR RESISTANCE?

THE human body is not at all a bad conductor of electric currents, a fact which we sometimes lose sight of when we are making tests with measuring instruments. The other day, for instance, I suspected an insulation leakage in a multiple plug. To ascertain whether there was or not I made use of a nine-volt grid battery and a very sensitive 0.2 voltmeter. In a thoughtless moment I held one lead on to a plug point with my right hand and the other on to battery negative with my left. Immediately the voltmeter needle gave a little kick and I got a reading of half a volt. "There's a short right enough," thinks I, and then I realised that I had been idiot enough to fall into a very old trap. The short was simply through my body from right hand to left hand. This was verified by wetting the fingers, when the voltmeter reading leapt up to rather more than double what it had been. Always remember this point when you are making tests of any kind for it may have an important bearing on the results.

MAKING HOME-TALKIES

HAVE you tried making home-talkies yet? Now that home recording is a practicable proposition it becomes quite an easy matter for those of us who have ciné-cameras to make quite amusing talking films. The amusement comes very largely in actual production of the films, because there are all sorts of minor difficulties to be got over, which occupy one's attention very closely. I spent a very interesting afternoon quite recently fitting up a microphone to do a little recording, while at the same time, the scene was shot with a ciné-camera. The recording apparatus was some distance away from the camera and numerous little difficulties cropped up.

MANY DIFFICULTIES

FIRST of all, having got everything right on a test inside, we found that out of doors the strength was nothing like sufficient. This was because there were no walls to catch and enclose the sound, and the difference was very much greater than I had any anticipation of. I had to add another stage of amplification in front of the main amplifier before it was possible to get a good recording when speaking in a quiet tone of voice about six feet away from the microphone.

Another difficulty arose owing to the length of lead between the microphone and the amplifier. The quality was not good, although with shorter lengths of lead it was quite satisfactory. This difficulty was found to be owing to loss due to capacity of the leads.

It was eventually overcome by breaking open the microphone, which was of the self-contained type having a built-in transformer, and mounting the transformer close to the amplifier. The long lengths of lead were then included on the primary side, which is of low resistance.

GREAT SENSITIVITY

OWING to the extra resistance of the lead it was necessary to increase the battery power from 2 to 4 volts in order to pass the same current through the microphone. With this arrangement the quality was perfectly satisfactory and an excellent record was produced. Incidentally, one must not increase the voltage on a microphone too much or hissing occurs, and the most sensitive position is just below this limit. In the end the microphone was made so sensitive that birds singing and dogs barking, and all sorts of things like that could be heard quite audibly on the record, and we had to cut down the sensitivity a little and speak just a little louder in order that this interference should not reach too high a level.

A "RATTLING" RECTIFIER

THE other day I was called in by a friend to pass judgment on a Tungar rectifier that had developed rather peculiar symptoms. As soon as the current was switched on it started to "hum"—not offensively at first. To a limited extent this is to be expected, but as the rectifier warmed up, the hum grew louder and louder until it could be plainly heard two rooms away. In fact, it was so bad that battery-charging was, for the time being, strictly "verboten" by the lady of the house, until the cause of the trouble could be located and removed. It wasn't really difficult. A close inspection showed that one of the holding-down bolts of the transformer had worked loose. This allowed the A.C. surges from the mains to take charge, and they simply "bumped" the heavy core up and down against the base-plate with great vigour. A few turns with a spanner, and all was peace and quietness.

THERMION.

Do we Want Re-diffusion?

Asks ALAN HUNTER, who, in this topical article, reviews some of the more important aspects of the relaying by landline networks of B.B.C. and other broadcast programmes.



WHENEVER a wireless theory is translated into practice we have to ask ourselves whether another milestone has been passed or whether we are merely contemplating a side track that leads nowhere. So it is with the system now known as re-diffusion.

Does the scheme of relaying broadcast programmes by landline or power cable, from a central receiving point to hundreds of listeners' homes, offer a service that is, or can be made, incomparably better than the service obtained by the installation of sets in every home?

That seems to me to be the crucial question. If re-diffusion, landline relaying or whatever you may call it, is merely an alternative method of hearing broadcast programmes, not materially cheaper or technically better, there is nothing in it.

What Re-diffusion Is

Re-diffusion, briefly, implies that programmes would be on tap just as conveniently as the electric light, gas or water. The idea put forward by Captain Eckersley is to utilise the existing networks of the electricity supply corporations, to superimpose programme currents and to sift them at the electric-light socket in each house on the corporation's supply. In other words, every one on a re-diffusion electric-light supply would, presumably for a certain annual fee, be able to receive programmes without the need for ordinary receiving apparatus. Exactly how pirating could be prevented is not disclosed by the promoters.

This re-diffusion scheme differs from the many landline organisations springing up all over the country. Instead of a complicated system of extension wires radiating from the central receiving point, Captain Eckersley would make use of the existing power cable network.

There is quite a general idea that all one would need at each receiving point would be a suitable condenser attachment and a

loud-speaker. Actually, I imagine something rather more complicated would be needed. This we should know soon, because I understand the experiment of superimposing programmes on the supply network is expected to begin quite soon at Farnham, in Surrey.

An expert in these matters with whom I have been talking suggests that it may be very difficult to get good quality over power lines. Whether this is because the tone filter needed to cut out the mains hum will also cut out the low frequencies of broadcast speech and music is not stated. This expert seemed inclined to think that quite an elaborate set would be needed.

If that is so, there is not much hope for re-diffusion. For the orthodox radio set, in spite of all the limitations imposed upon it

by the congestion of the ether, is now a cheap, fairly fool-proof instrument capable, at least in the better models, of supplying good quality from a large number of stations.

In any case, the percentage of the total number of listeners who are on any electric supply is still small. This objection does not rule out the landline relay systems, which are not only practicable, but are growing very rapidly. Then there is the scheme of Mr. Holmes of St. Annes, for sending out three or four different programmes over the ordinary telephone wires to all listeners lucky enough to be connected up to a Post Office exchange.

P.O. Regulations

The present relay organisations work under a Post Office licence, the terms of which have been framed to prevent abuse of existing services and, at the same time, to permit reasonable development. I have, through the courtesy of the Post Office, been supplied with an outline of this licence.

The first condition imposed upon those seeking to establish a landline relay system is that the P.M.G. shall have the right of purchasing the complete equip-

ment on "tramway terms," and this with only three months' notice. Thus the Post Office could, within a very short time, close down every relay organisation in the country. There is no question, therefore, of such organisations getting out of hand.

Secondly, the equipment must be maintained in a satisfactory working condition. The P.M.G. reserves the right to inspect the gear at any time. British-made apparatus must be used.

Thirdly, only programmes from public broadcasting stations may be relayed. The Post Office expressly forbids the relay people to *originate* items.

Fourthly, the P.M.G. has the right to prohibit the relaying of any specific programme or item.



Mr. Sam Youles, who is responsible for the running of the Brighton relay service

Fifthly, the relays can be suspended or taken over by the Post Office in a national emergency.

Sixthly, it is laid down that each subscriber must take out a 10s. receiving licence and so must the relay station. In this way the B.B.C. benefits from listener increases due to the relay organisation development. Probably for that reason the B.B.C. takes a fairly benevolent interest in this scheme of distribution.

Before a licence is granted, the relay organisation has to conform with certain technical conditions imposed by the Post

(Continued at foot of next page)

THE HOW AND WHY OF RADIO—XL

THE GOODNESS FACTOR OF A VALVE

Written specially for beginners who want simple and practical explanations of the underlying principles of radio

CONTINUING our series of articles on valves, we now come to one of the most important facts that can be obtained from the slip enclosed with the valve carton, namely, the mutual conductance. This factor has been called, appropriately enough, the goodness factor of the valve.

At first sight, the true index of a valve's goodness would appear to be its amplification factor. Unfortunately, the value of a high amplification factor is largely offset by the inevitable high impedance of the valve that follows from a high-magnification construction. We have a practical example of this in screen-grid valves, whose enormous high amplification factors mean very little because with such factors goes high impedance.

To obtain effective amplification from a valve we need a low impedance; then the amplification factor will provide a substantial voltage gain, while the low impedance will permit a substantial power output.

Mutual conductance takes into account both these needs, for it combines the valve's amplification factor and its impedance. In fact, mutual conductance can be found by dividing the amplification factor by the valve impedance.

It is easy to see from this simple formula that for a given amplification factor an increase in mutual conductance will be obtained from a decrease in the valve's impedance; and that as the valve's impe-

dance is increased, so the mutual conductance is decreased. A valve that obtains its high amplification factor only with a high impedance is no advantage, since there is no increase in mutual conductance.

The great value of the factor of mutual conductance is that it indicates the way the anode current is controlled by the grid voltage. The greater the mutual conduc-

tance the greater is the change in anode current for a given change in grid volts.

We can, as a matter of fact, indicate mutual conductance by noting how many grid volts are required to bring about a given anode current change. The mutual conductance of a valve can be found quite easily by dividing any given change in anode current by the change in grid volts needed to produce this anode-current change. The curve of the P2 valve shown by the diagram clearly illustrates this point.

From this curve, which is for an anode voltage of 150 volts, we see that when the negative grid voltage is 8, the anode current is 24. And when the negative grid voltage is 6, the anode current is 32 milliamperes. In other words a change of 2 grid volts, from 8 to 6, causes an 8-milliamperere anode-current change, from 24 to 32 milliamperes.

Thus, the mutual conductance is 8 divided by 2, that is 4. Actually, this is not the most accurate way to determine mutual conductance, but it serves as an illustration. We can check up our answer by dividing the amplification of a valve by its impedance. In this example the amplification factor is given as 7.5 and the impedance as 2,150 ohms. Division shows that the figure for mutual conductance is then 3.5, which is not far from the rough and ready figure just found from the graph.

HOTSPOT.

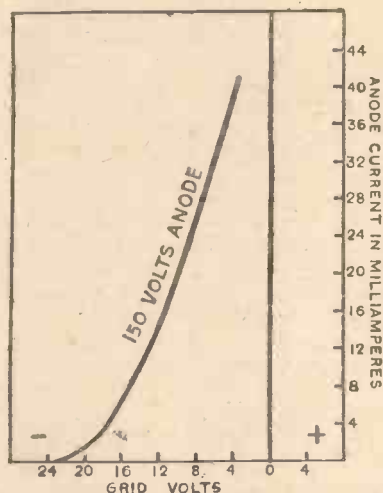

Characteristic curve of P2 valve, showing relative values of grid volts and anode current

DO WE WANT RE-DIFFUSION?

(Continued from preceding page)

Office. For example, a step-down transformer must be used between the output valve of the central receiver or sub-amplifier and the distributing network.

The use of earth as a return is prohibited, so that at least two wires must be used. In erecting the wires, care must be taken to place them as remote as possible from existing Post Office lines or at right angles to them.

The Post Office cannot grant "wayleaves" to the relay people, nor can it allow the use of Post Office poles. But the P.M.G. will provide, on a rental basis, lines between a main receiving station and a sub-amplifying station.

It is interesting to note that up to the present nearly 100 licences on the above terms have been issued and 26,000 subscribers are now involved. The growth in three months is stated to be 4,500, comparing with the total licence growth of 236,000 over the same period.

The question naturally arises as to what the B.B.C. thinks about this landline relay development. I was recently given an answer to that question in the course of an interview with a B.B.C. official. In brief, the B.B.C. now looks upon such systems

with benevolent misgiving.

When the idea first started, the B.B.C. was inclined to favour it, taking the line that any stimulus to an increase in licence revenue was to be encouraged. Even then, the B.B.C. hardly smiled upon anything in the nature of an intermediary between the source of transmission and the point of reception.

The rapid growth of the landline relay business, taken in conjunction with the proposals for re-diffusion by power cables, has to some extent modified opinion at Savoy Hill. The B.B.C. and the Post Office are closely watching developments.

So far as I can see, the Post Office really has the whip hand. Apart from the limitations it imposes in its licence, the Post Office has the monopoly right of all forms of communication in this country. Those who argue that re-diffusion or relaying might, with the aid of records, entirely dispense with B.B.C. programmes and so free itself from all obligation, must not overlook the Post Office's monopoly—

strong enough to shut up the scheme at a moment's notice if there were sufficient evidence of abuse.

Just what is meant by abuse? Well, as already indicated, Post Office sanction is granted only for the relay of programmes from public broadcasting stations, either from the B.B.C. or from the Continent. It would be an abuse of privilege if other sources of entertainment were utilised. That there are other sources is now becoming evident. From America comes the "bottled" concert, in the form of talking film reels, which, when played through an amplifier, reproduce speech and orchestral music with a realism indistinguishable from a studio performance.

As all these considerations show, it is clear that relaying and re-diffusion are rapidly gaining ground. Whether existing regulations will be transgressed and ultimately modified remains to be seen. At present the re-distribution of broadcast programmes affects only a very small percentage of licensed listeners. But if supply corporations and telephone exchanges are to be induced to lend their networks for programme re-diffusion the percentage may well grow to proportions that will need careful handling by the Post Office and the B.B.C.

THE SET YOU HAVE BEEN WAITING FOR—THE ALL-ELECTRIC "CENTURY SUPER"

A Weekly Programme Criticism—By SYDNEY A. MOSELEY.

Without Fear or Favour



"G.B.S."

PLAY TECHNIQUE

I BET our beloved G.B.S. didn't feel quite comfortable with his informal chat on Saint Joan of Arc! This experienced speaker must have discovered that a visual audience of excited admirers who interrupt with loud cheers—thus giving pause for more thought!—is quite useful, if not necessary, for *impromptu* addresses.

Result: G.B.S. kept the B.B.C. and a few million listeners waiting for ten minutes while he fumbled for an appropriate peroration! Personally, I would listen to him with pleasure for a hundred minutes—or *min-yoots*, as he calls 'em. Come oftener to the mike, George! And larn us!

Lance Sieveking's latest essay, *Assault on Professor Wellmann* promised well. He had carried out my suggestion and, instead of writing a play of his own, took one already in being, had it translated from the German, and adapted it for the microphone.

It failed for these reasons: His characters, although the play was in English, spoke a broken tongue; and the climax, if you please, was given in German! Too much morse, which few understand. The name of the professor was pronounced in German fashion. I know a bit of German, but I didn't always recognise it. The opening character was indistinct. Sieveking, somehow, has a knack of not only writing involved plays, but he further complicates matters by employing artistes with "affected" elocution.

Other "experiments" by "Productions" have not come off. *The Jockey*, I hope, will never mount Savoy Hill again. *The Stage Revolves* I didn't hear, but I am told that it was only moderately successful.

Meanwhile, the Productions Director and "two colleagues," "Bim" Hodder and Holt Marvel, tried to get me down to Toynbee Hall, London, where Val Gielgud was speaking on radio plays. This University settlement in East London is worth supporting; so I sent a message which was read out and, according to Hodder, "evoked shrieks of merriment." Here is an extract from my message:—

"... I have not heard what Gielgud has to say about the future of radio drama, but whatever he has to say, I profoundly disa-

gree with it! He has, no doubt, suggested that radio drama must have a technique of its own, although he will not tell you why such a sound principle is not followed with regard to the activities of the B.B.C. . . . The most successful productions so far are those which have been adapted from well-known plays. The fault, therefore, seems to lie not so much in technique, but in the rather poor efforts submitted by people with strange names, which are very likely *nom de plumes* of cousins and aunts of one or other of the commissionaires of Savoy Hill . . ."

I wonder whether the Prince of Wales knew that the microphone was sensitive when he sharply called on the movie-camera man to shut down. Rather a pity, I thought.

Henry Ainley was good in his appeal for aid on behalf of the Naval and Training Ships Leave Camp. I see that the sums received through such microphone appeals vary greatly. Extraordinary the number of charities in the world! I see, by the way, that on the same night that Henry Ainley appealed through the London Regional



Stanford Robinson, who conducts the B.B.C. choral division

"EXPERIMENTS"

FOREIGN "STARS"

and London National, the National transmitter gave us an organ voluntary instead.

The xylophone comes over well, even when Teddy Brown is not the soloist. The tone is more mellow and not so thin, for instance, as the harp or the flute, and although Miss Goossens plays well—furthermore, plays the stuff I prefer—I still have to award the palm to that lower brow, the xylophone.

Cicely Courtneidge would make quite a good broadcast comedienne if she didn't speak so quickly! The legitimate stage is the last place in the world to learn or practice elocution. That is why so many stars fail before the "mike."

Her little sketch was quite well put over, although not in the best Mabel Constanduros vein. I liked her little song, too, "I pluck my Gaitar." She certainly has the making of a big broadcasting star.

I hope the B.B.C. will not fall for press-agent publicity value of foreign stars. They made a fuss of a certain lady who was no better and no worse than a hundred British second-rate stars.

By the way, the tendency to prolong applause is becoming worse again. There are new personalities directing the studios. These new announcers and new managers should be told that the applause should be merely polite if there is to be any applause at all.

Greta Keller sang the usual sad, slobbering slush, but Ivy St. Helier was better. I do not care very much for Peter Haddon's type of humour.

Walter G. Alcock in his organ recital from All Saints, Margaret Street, played the right sort of music on the right sort of organ. He even played a Bach fugue, which I thoroughly approved, disliking, as I do, ragtime tunes on this instrument.

I came in the other day to hear a speaker say "and this kind of food interferes with the digestion. Mastication—proteid—does us good. . . ." Naturally, I thought this was talk about food values, but it turned out to be about "cows."



The A.C. CENTURY

**MAINS MODEL OF
A STATION FOR EACH
CHEAP TO BUILD A**

Specially Designed for

THE A.C. "Century Super" about to be described represents the very simplest method of arranging the battery "Century Super" for running from alternating-current supplies.

Special A.C. valves are used, of course, and the high-tension supply and that for the heaters of the valves is obtained from the mains. Dry-battery grid bias is used for cheapness and simplicity. An attempt has been made to arrange the whole receiver in attractive fashion, the set, mains unit and loud-speaker being fitted in a case combining economy with good appearance and convenience.

The frame aerial may stand by the side of the cabinet.

In looking at the circuit of this new A.C.

set and comparing it with that of the battery model, it will be noticed that the chief changes are in the filter circuits.

Thus a potentiometer and a 2-microfarad condenser are connected in the supply circuit to the first valve, the anode-bend detector. This valve therefore has a fraction of the full high-tension voltage applied to it, as the drop in the resistances are in proportion to their values.

Besides de-coupling the circuit the supply is further smoothed by the combination of resistance and capacity. The return side of the condenser goes, of course, to the cathode of the valve.

All cathodes are connected and go to high-tension negative and to the centre point of the heater transformer.

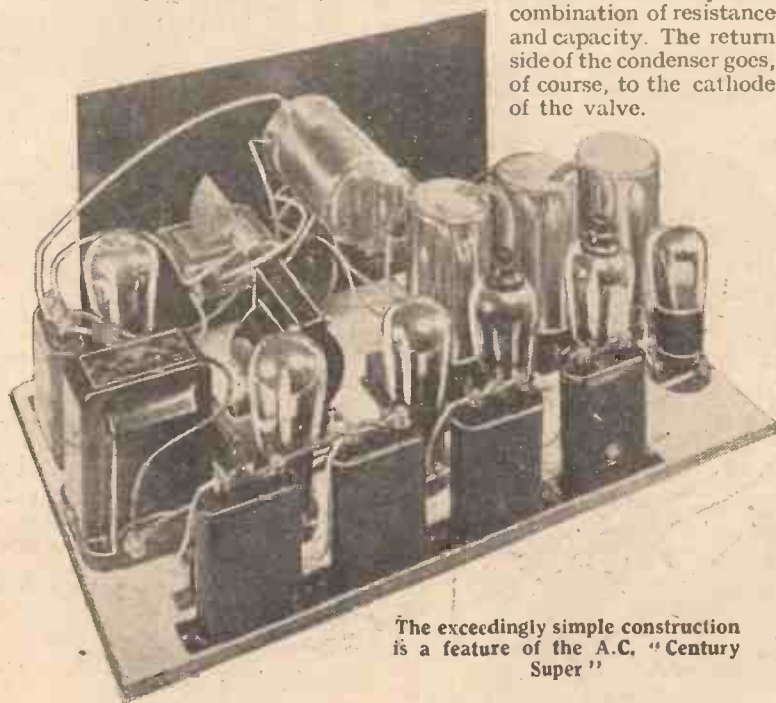
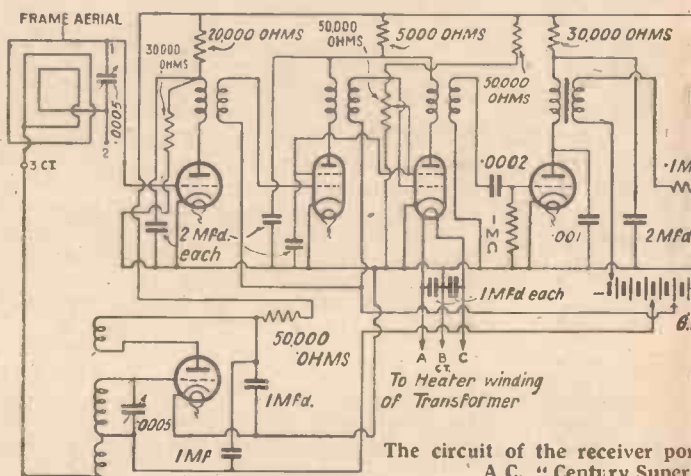

The exceedingly simple construction is a feature of the A.C. "Century Super"

COMPLETE LIST OF COMPONENTS

- Special cabinet (Peto-Scott "Dorchester," Readi-Rad, Camco).
- Frame aerial (Lewcos, Readi-Rad, Peto-Scott, Wearite, Ward and Goldstone, H. & B.).
- Ebonite Panel, 12 in. by 8 in. (Becol, Peto-Scott, Potter, Trelleborg).
- Baseboard, 17 in. by 10 in. (Clarion, Camco, Peto-Scott, Pickett).
- Permanent-magnet moving-coil loud-speaker (Epoch A1 type D98).
- Two .0005-mfd. variable condensers (Cydon, "Junilog," J.B., Readi-Rad, Ormond, Polar, Voltron, Lotus, Lissen).
- 50,000-ohm variable resistance (Sovereign, Colvern, Lissen, Rotorohm, Regentstat).
- Complete set of super-het. coils (Wearite or Lewcos).
- Triple coil base (Peto-Scott, Wearite, Readi-Rad, Lewcos).
- Six 5-pin valve holders (Telsen, Lotus, W.B., Junit, Benjamin, Wearite, Lissen).
- Five 2-mfd. fixed condensers (Ferranti, type C2, T.C.C., Dubilier, formo).
- Two 2-mfd. fixed condensers, tapped at 1-mfd., (Ferranti, type C2C).
- Two grid-leak holders (Readi-Rad, Lissen, Dubilier, Wearite).
- Three fixed condensers, following capacities; .0002, .002, .001 mfd. (Telsen, T.C.C., Lissen, Dubilier, Readi-Rad, Sovereign, Watmel).
- Low-frequency transformer (Ferranti type AF3, Telsen, R.I., Lissen, Varley, Voltron).

RY SUPER

AN AMAZING SET DEGREE ON THE DIAL AND CHEAP TO RUN

"A.W." by W. JAMES

In the anode circuits of the next two valves, which are of the screen-grid type working as high-frequency amplifiers, the usual by-pass condenser is included and there is also a 5,000-ohm resistance through which the supply to the two valves passes.

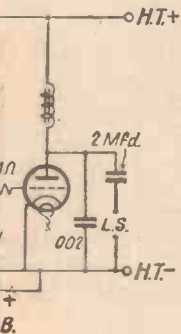

Volume Control

For the screen circuits there is a further 2-microfarad condenser and the supply is obtained from a potentiometer which is connected in series with a fixed resistance. These two parts have values of 50,000 ohms each and so, when the contact of the potentiometer is at the full on position, the

from reacting

A choke-condenser output circuit is used, the loud-speaker being of the high-resistance type. If a low resistance pattern were used a transformer of the correct ratio would be needed here. The oscillator is fed through a resistance, this resistance tending to level out the current taken by it over the tuning range.

voltage of the screens is approximately half that of the full high tension. Owing to screen current, the voltage cannot be quite as much as half.

This potentiometer, being fitted on the front panel, is used as a volume control. By adjusting the voltage of the screens in this way the effective magnification is varied and quite a nice control of the volume is obtained.

In the next circuit, which is the detector, we use a 30,000-ohm anode-feed resistance and a 2-microfarad by-pass condenser for the two purposes of de-coupling the detector and of giving it a suitable working voltage. There is a high-frequency by-pass condenser and included in the grid lead to the power valve is a grid-leak filter to stop high-frequency currents on the grid of the valve.

Across the heater circuit is a condenser unit having two 1-microfarad condensers, the centre connection going to the cathode. This condenser is for the purpose of helping to stabilise the set.

From the description you will see that the parts needed over and above those for the amplifying circuits themselves are few in number, with the result that the total cost is reasonable and what is more, the set is easily built.

Current Supply

A good mains unit is needed and you can either make your own or purchase a complete power unit. The circuit shows the connections of the unit. It has a Westinghouse metal rectifier rated at 200 volts, 30 milliamperes approximately. Actually, if the current is exceeded the voltage falls a little or if the current is reduced, the voltage increases.

A good input transformer is needed to supply the heaters of the valves and the rectifier. We have six valves and need 6 amperes at 4 volts. The heater winding must be centre tapped, although a low-resistance potentiometer could be used across the heater circuit and the cathodes be taken to the contact. I rather prefer

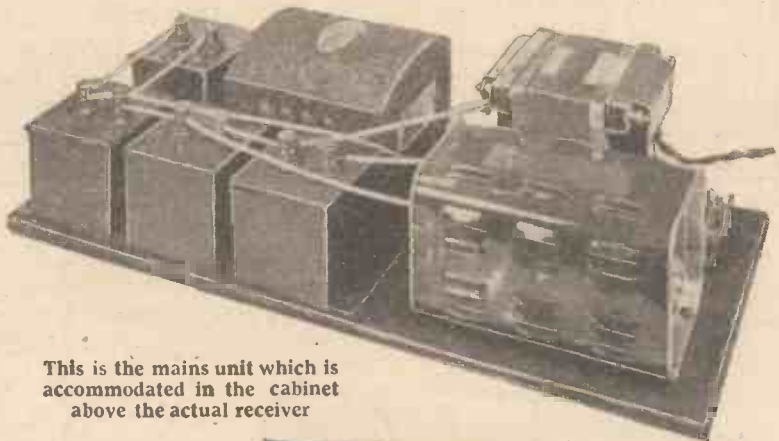

This is the mains unit which is accommodated in the cabinet above the actual receiver

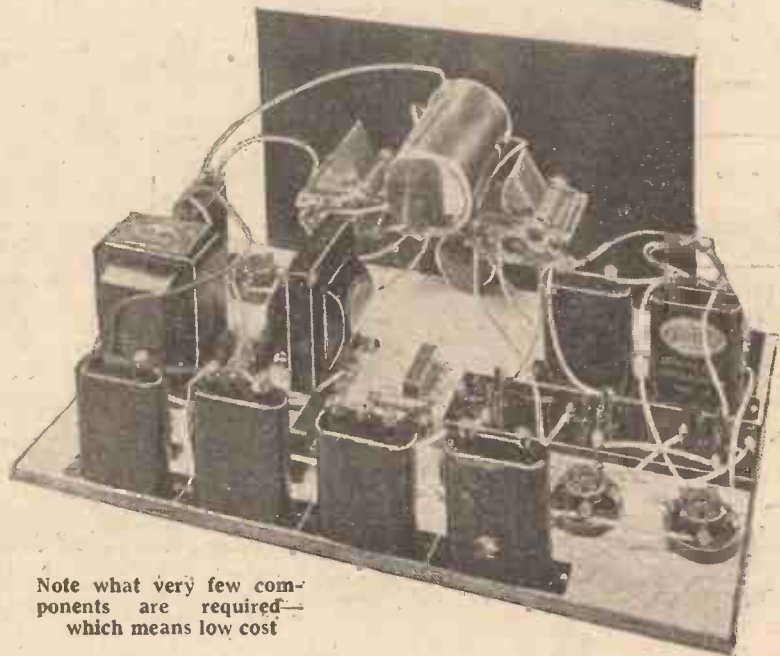

Note what very few components are required which means low cost

FOR THE A.C. "CENTURY SUPER"

- Low-frequency choke (Varley, 20-henries 140 m/a, Regentone, R.I.).
- Five spaghetti resistances, following values: 50,000 (2), 30,000 (2), 20,000 and 5,000 ohms. (Readi-Rad, Lewcos, Tunewell, Lissen, Bulgin, Sovereign, Magnum).
- 1-meg. grid leak (Lissen, Dubilier, Telsen, Sovereign).
- 100,000-ohm grid leak (Lissen, Telsen, Dubilier).
- Connecting wire and sleeving (Lewcos).
- Two slow-motion dials (Astra type 2, Ormond, Lotus, Brownie, J.B., Lissen, Formo).
- Terminal strip for frame aerial connection (Peto-Scott, Readi-Rad, H. & B.).

A.C. MAINS PORTION

- Baseboard, 16 in. by 7 1/2 in. (Clarion, Camco, Peto-Scott, Pickett).
- Mains transformer with 135-volt 30 m/a, and 4-volt 6-amp. windings (Junit, Wearite, Regentone, R.I., Atlas).
- Smoothing choke (Regentone type GR, Varley, Lewcos, Bulgin, R.I., Parmeko, Lissen).
- Metal rectifier (Westinghouse HT7).
- Four 4-mfd. fixed condensers (800 volt test) (Dubilier type LSB, T.C.C., Formo, Ferrantl).
- Baseboard-mounting twin fuseholder and fuses (Bulglin).
- Connecting wire and sleeving (Lewcos).

OR—

SPECIAL MAINS UNIT (REGENTONE TYPE S60 OR MARCONI-PHONE TYPE AM7).

“THE A.C. ‘CENTURY SUPER’” (Continued from preceding page)

the centre-tapped transformer winding, however, as it saves the cost of the potentiometer.

The Rectifier

The Westinghouse rectifier is used in a voltage-doubler circuit involving a pair of 4-microfarad condensers as well as the choke and output-condensers. With a good

smoothing choke coil and 8 microfarads of capacity across the output, the high-tension current is free from ripple and so the set works without hum or noise. The mains part is arranged upon a separate baseboard in order that it may be placed in the top part of the cabinet with the loudspeaker. It has a pair of fuses and a flex lead, but no mains switch is included and I

imagine that anyone desiring to include a mains switch in the set will be able to fit one to the side of the cabinet.

Three 9-volt grid batteries or a 16½- and a 9-volt will be required, and these may be fitted inside the cabinet, using suitable clips. Some people, I know, don't like the idea of using grid batteries in a mains set, (Continued on page 924)

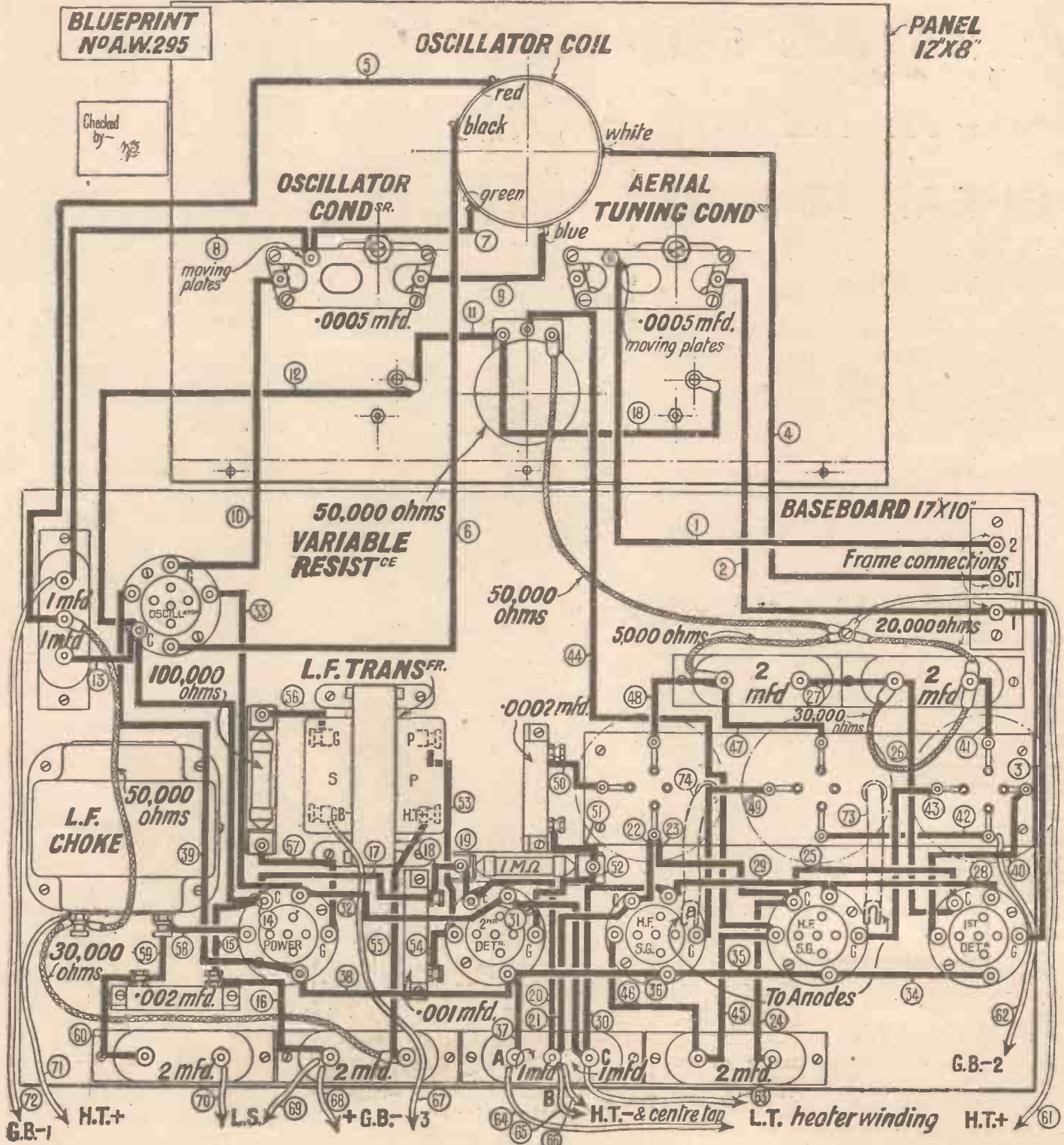

The layout and wiring diagram of the receiver. A full-size blueprint is available price 1s. 6d. The layout of the mains unit will be published in next week's issue

EIGHT DEFINITE POINTS OF SUPERIORITY

Price £1:0:0

1

PRICE!

Accurately Spaced Windings

5

2

Stranded Aerial Wire

Rigid Ebonite Spacers

6

3

Special Wave-change Switch

Easy Rotation

7

4

Solid Base

PRICE!

8

Price £1:0:0

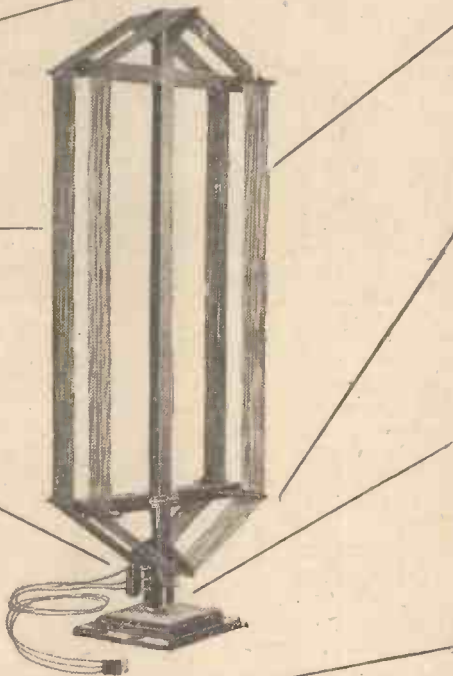

The Ready Radio Frame Aerial is made strictly to "Amateur Wireless" specification and is actually specified by the designer for use with the "Century Super" and "A.C. Century Super"—absolute proof of its superiority.

Two separate centre-tapped windings of stranded wire, accurately spaced, covering medium and long waves. Windings can be used separately or can be connected in parallel by means of the special wave-change switch incorporated.

Get best results from your "Century Super" by using the specified Ready Radio Frame Aerial!

Can be obtained from your local dealer

Now turn to page 925

Ready Radio
 159, BOROUGH HIGH STREET,
 LONDON BRIDGE, S.E.1.
 Telephone: Hop 5555 (Private Exchange) Telegrams: READIRAD, SEDIST.

You Will Help Yourself and Help Us by Mentioning "A.W." to Advertisers

"THE A.C. 'CENTURY SUPER'"

(Continued from page 922)

but the majority of readers will prefer them to a number of resistances and condensers which might be added to the circuit for grid bias, the valves being adjusted according to the valves used.

There are no other special features in the circuit. A good low-frequency transformer is used and a good output choke, in fact, all parts are of first-class quality, so that the set should last well and give no trouble.

Looking at the ebonite front panel of the set you will note that the parts are arranged well together and yet there is ample room for them. There are the two tuning condensers, for the frame aerial and the oscillator, the volume control and the wavelength range switch of the oscillator. The oscillator coil with switch is above the volume control, so that the tuning controls are nicely arranged and allow the front of the cabinet to be attractively shaped. Geared dials are used and they have proved satisfactory, with compact type tuning condensers.

The illustrations show that there is ample room for the parts. Upright type condensers are used. There are two 1+1 microfarad condensers and five 2-microfarad. At the back of the set will be seen several condensers in line and there is one close to the oscillator. There are also various flexible resistances to be seen in the illustrations, these being the voltage dropping resistances described above.

For the three super-heterodyne long-wavelength coils a special base is used for convenience, instead of separate valve holders. This is mounted well to the end of the baseboard with the result that the end coil stands a little over the edge. There is room for this in the cabinet, owing

to the fitting of corner pieces along the base of the cabinet, but if a different case is used it would have to be allowed for.

On the extreme left-hand side and near the panel edge is the frame-aerial connecting strip. It is quite near the tuning

There are two 2-microfarad condensers just near the frame-aerial tuning condenser. Next comes the coil holder strip, which must be accurately placed and then a row of valve holders.

The oscillator is by itself to one side of



This picture shows a mains unit—the Regentone—fitted into the cabinet. Another suitable unit is the Marconi-telephone AM7 shown above

the baseboard and quite near the oscillator tuning condenser with a 1+1 microfarad fixed condenser. There is adequate room for the parts, but they should be placed as indicated in order to avoid hum.

If you have fixed condensers of other makes they may be used provided they are arranged in the best positions. Two separate 1-microfarad condensers could, for instance, be fitted in place of the small unit.

Larger tuning condensers could not be fitted, however, unless the spacing is altered and then there might not be room for the oscillator. The cabinet, too, would have to be altered if the spacing of the condensers was increased. Next week the wiring and other details will be described, and a list of recommended valves will be given.

condenser and is wired to the valve holder opposite it, which is for the first detector. This works as an anode-bend detector.

Before fitting any of the parts it is as well to go over them and to tighten all connections as I usually find a few loose screws which would further loosen when fitted.

Carefully drill the front panel and fit the parts, seeing that the condensers clear the oscillator coil. Then screw the panel to the baseboard. Lay the various parts on the baseboard and work from the panel edge.

THE "Century Super" with its ultra-sensitive combination of valves, has produced a new demand for frame aeri-als, and there are now on the market many frames from which a Century user may choose and, in addition, he can, of course, make up his own frame according to the description published on page 842 of "A.W." No. 468. New commercially-made frames have just been produced, in addition, which deserve special mention.

The first of these is the Goltone dual-

MORE FRAMES FOR THE "CENTURY"

range frame. This is very compact, the overall height being only 24 in. and the width of the frame 11 1/2 in. It is, of course, of the dual-range type, the two sections being supported on ebonite spacers and wound with the special Goltone stranded

wire. The frame itself does not rotate, but, being mounted on a solid circular base, it can easily be turned in any direction. Connections are brought out to three terminals conveniently placed on the base of the frame.

Another frame which will make a particular appeal to the man who wants the very best from a technical point of view is the new Wearite. This is a frame which has been brought out specially for the "Century Super" and incorporates several novel features. The medium- and long-wave turns are on entirely separate formers and the winding is carried out with stranded wire. The leads are brought out to a double-throw low-loss type of switch in the centre. The workmanship of this Wearite frame is thoroughly sound and at a price of £2 2s. it represents thoroughly good value. A smaller cheaper model of the same make is also available.

It is of interest here to mention also the Read-Rad frame which has been used with great success in our tests of the original battery model of the "Century" and which is equally suitable for the A.C. version. This frame, which costs only £1 complete, is a very well-made job, the turns being spaced and the connections neatly and conveniently brought out. It is selective and gives very sharp tuning on the frame condenser of the set—an advantage. It is well up to the standard in sensitivity, and may be thoroughly recommended.



Three frames for the "Century"—left to right, the Read-Rad, Wearite and Goltone

HERE IS THE A.C. CENTURY SUPER

THE A.C. CENTURY SUPER

	£	s.	d.		£	s.	d.
1 Ebonite panel, 16 in. by 8 in. by 3/16th in. drilled to specification	6	0		2 Readl-Rad 50,000-ohm link resistances	3	6	
1 Readl-Rad cabinet to specified design	1	15	0	2 Readl-Rad 30,000-ohm link resistances	3	0	
1 Readl-Rad centre tapped frame aerial	1	0	0	1 Readl-Rad 20,000-ohm link resistance	1	3	
2 Readl-Rad .0005-mfd. variable condensers	9	0		1 Readl-Rad 5,000-ohm link resistance	1	0	
1 Sovereign 50,000-ohm potentiometer	4	6		1 Readl-Rad 1-meg. grid leak	10		
1 Set Lewcos super-het. coils	2	10	0	1 Ediswan 100,000-ohm grid leak	1	6	
1 Readl-Rad triple coil base	2	9		2 Brownie slow-motion dials	5	0	
6 Telsen 5-pin valve holders	4	0		1 Readl-Rad 3-point frame connector	6		
5 T.C.C. 2-mfd. fixed condensers	19	2		1 Packet Readl-Rad "Jillinx" for wiring	2	6	
2 Ferranti C2C fixed condensers	9	0		6 Valves as specified: 2, 84V, 2 AC/HL, 1 41M/RC, 1 AC064	5	11	0
2 Readl-Rad grid-leak holders	1	0		Screws, flex, etc.	6		
3 Telsen fixed condensers .0003 mfd., .001 mfd., and .002 mfd.	1	6					
1 Telsen "Radiogrand" L.F. transformer	8	6		TOTAL (including valves and cabinet)			£16.2.0
1 Atlas 20-henry L.F. choke	1	1	0				

THE BATTERY OPERATED "CENTURY SUPER"

KIT A £6 : 18 : 6

(Less Valves and Cabinet but including Wound Frame aerial.)
or 12 equal monthly instalments of **12/8**

KIT B £10 : 14 : 6

(Including Valves, Wound Frame Aerial, but less Cabinet)
or 12 equal monthly instalments of **19/8**

KIT C £11 : 9 : 6

(Including Valves, Cabinet and Wound Frame Aerial)
or 12 equal monthly instalments of **21/0**

The CENTURY SUPER

Completely assembled with valves, cabinet and wound frame aerial, ready for use and aerial tested.
Or 12 monthly payments of **£14.10.0** **26/6**

KIT "A" Less valves and cabinet **£8.16.0**

Or twelve equal monthly instalments of 16/-

KIT "B" With valves, less cabinet **£14.7.0**

Or twelve equal monthly instalments of £1.6.2

KIT "C" With valves and cabinet **£16.2.0**

Or twelve equal monthly instalments of £1.9.4

Buy all
your radio from
Ready Radio

159, BOROUGH HIGH STREET,
LONDON BRIDGE, S.E.1.

Telephone Wop 5555 (Private Exchange)

Telegrams READIRAD. SEDIST

Cash or Easy Payments

A.C. MAINS UNIT

	£	s.	d.
1 Baseboard, 16 in. by 7 in.	1	6	
1 Junit mains transformer	1	10	0
1 Atlas L.F. choke	1	1	0
1 Westinghouse H.T.7 metal rectifier	1	1	0
4 Dubilier 4-mfd. fixed condensers, type LSB	1	14	0
1 Bulgin F11 fuse holder with fuse	2	6	
Wire, flex, plug adaptor, etc.	2	8	

£5 : 12 : 6

Or twelve equal monthly instalments of **10/4**

OR

1 Regentone model 500-unit **£4:10:0**

Or twelve equal monthly instalments of **8/3**

TO OVERSEAS CUSTOMERS

All your goods are very carefully packed for export, and insured, all charges forward.

TO INLAND CUSTOMERS

Your goods are despatched Post Free or Carriage Paid.

IMMEDIATE DESPATCH ORDER FORM

To: **READY RADIO (R.R.) LTD., 159 Borough High Street, London Bridge, S.E.1**

CASH ORDER. Please despatch to me at once the goods specified for which I enclose payment in full of £.....

C.O.D ORDER. Please despatch to me at once the goods specified for which I will pay in full the sum of £.....

EASY PAYMENT ORDER. Please despatch my Easy Payment order for the goods specified for which I enclose first deposit of £.....

Cross out whichever does not apply

Name..... **Kit required**.....

Address.....

BROADCASTING ON A MODERN LINER

Few listeners know what kind of radio gear is carried by a modern liner, and here is an interesting account by an

UNDoubtedly the best radio gear I have ever seen on board ship is that carried by the new liner *Empress of Britain*. Most listeners imagine that "sparks" on board ship still uses apparatus savouring of the coherer days; I think they would have a surprise if they could see the bank of transmitters, receivers and auxiliary gear on a modern liner.

The *Empress of Britain's* radio plant includes telegraph transmitters and receivers for long and short wavelengths, short-wave duplex apparatus with a world-wide radius; lifeboat wireless sets; a direction finder and, although not strictly speaking wireless equipment, a band repeater which provides entertainment throughout the ship.

A two-kilowatt Marconi transmitter for long-wave telegraph transmission is augmented by a two-kilowatt short-wave installation, and selective receivers are installed to ensure good reception over the complete band of wavelengths used by the ship.

A Marconi direction finder facilitates the work of the navigators, and the latest type with the fixed-frame aerial system has been installed. Bearings with this instrument can be either true or relative to the ship's head, and a gyro-repeater, fitted with the direction finder, adds to the simplicity of taking true bearings by giving a direct reading from the compass dial.

The outstanding section of the equipment is, of course, the short-wave radio telephone installation. By means of this, anyone on land can speak to any passenger on the

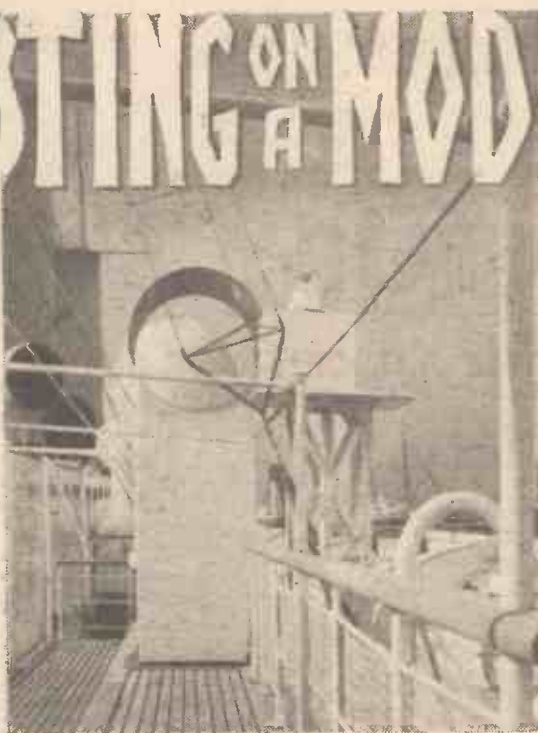

"Amateur Wireless" Special Correspondent of the transmitters and receivers on board the new "Empress of Britain."

telephone service for Canada, the United States, Mexico and Cuba.

The band repeater is a fine idea, of course, for it broadcasts music all over the ship. In order to present a variety of programmes, three alternatives are provided. Microphones can be plugged in in various places to relay the ship's orchestra, concerts, and other events of interest. A special type of receiver provides broadcast programmes as they become available; and gramophone records will relieve the orchestra when necessary and supply the latest dance tunes.

ship. A refinement in the *Empress of Britain's* equipment is the ability to speak from the ordinary cabin 'phones which are connected to the wireless telephone through the ship's manual switchboard, so that the telephone service on the ship is equally as convenient as that on shore. The apparatus itself is designed for quick adjustment to the wavelength best suited to the atmospheric conditions of the moment, and is capable of communicating directly with any country offering suitable terminal facilities, and of making use of the land line or wireless 'phone connections from such countries. In this way, London is the connecting link between ship and practically every telephone subscriber in Europe, and similarly New York provides a

The main amplifier, wireless receiver, gramophone with a double-turntable and a motor-generator, are accommodated in the band repeater room, and microphone points are installed in the ballroom, lounge, and first-class dining saloon. Announcements can also be made through a microphone in the band repeater room.

Gone is the day when "sparks" occupied one small cabin on the upper deck! Four large cabins are devoted exclusively to the wireless equipment. The long and short-wave outfits and a broadcast receiver are contained in a large cabin just aft of the bridge. Two other cabins on the top deck are devoted to the radio 'phone apparatus. The receiving cabin is between the first and second funnels, and the transmitting cabin between the second and third funnels.

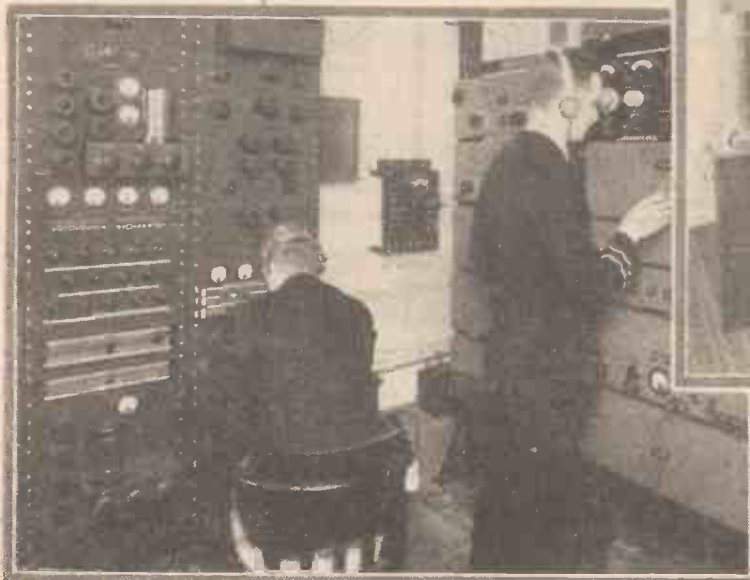

(Left) Inside the receiving room. In front of the operator's chair is the monitoring switchboard, connected to the ship's telephone so that passengers can be connected up to the receivers.

(Above) This shows part of the transmitting gear covering all wavelengths from the ultra-short 15 metres to the long commercial wavelength of 20,000 metres. Without moving from his seat, the operator can vary any of the transmitter controls and see all the meter dials.

SUPER NICKEL CORE
SCREENED INTERIOR
WEIGHT 3½ OZS
Patent No-316-449



8'6

PARAFEEED

A MIRACLE in TRANSFORMER AMPLIFICATION

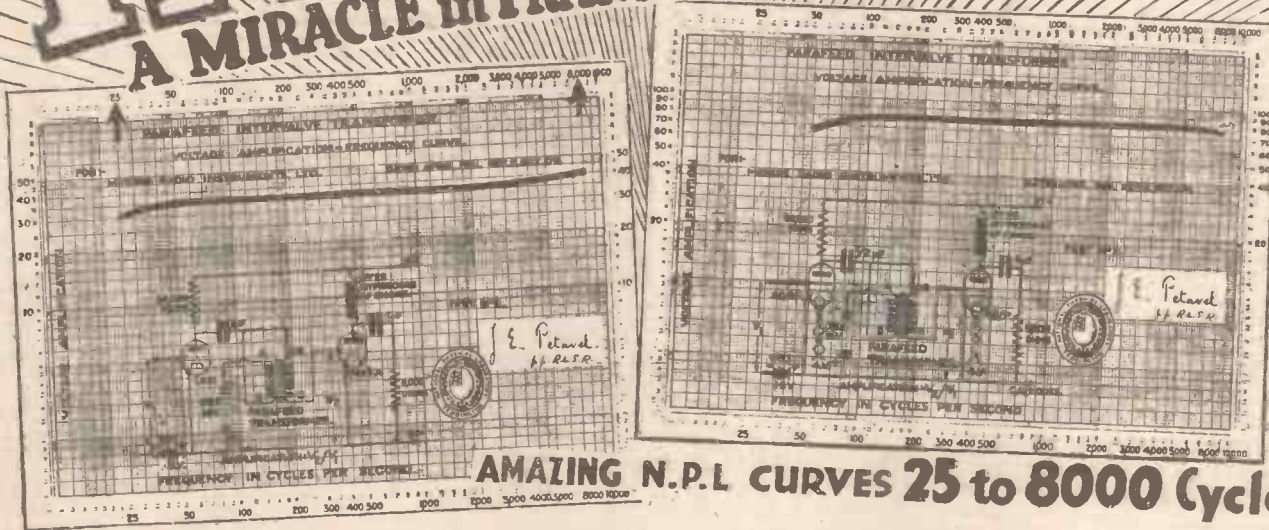

AMAZING N.P.L. CURVES 25 to 8000 Cycles

Always ahead in transformer design, R.I. have produced a masterpiece in modern amplification, the "Parafeed," which achieves two remarkable successes—One: Amazing and unequalled performance, proved by N.P.L. curves (see above) 25 to 8,000 cycles, with a rising characteristic. Two: Lowest price of any transformer of the SUPER-NICKEL alloy core series.

The "Parafeed" differs from other intervalve transformers inasmuch as it is designed for use with the Parallel Feed System. Any existing Resistance of 30,000 or 50,000 ohms and paper Condenser of ½ or 1 mfd. may be used with the "Parafeed" to divert the anode current. Resistances and Condensers made by the Dubilier Company have been specially approved as suitable.

NOTE THESE IMPORTANT "PARAFEEED" ADVANTAGES:

INCREASED BASS AND HIGH NOTE RESPONSE

ABSOLUTE FREEDOM FROM ELECTROLYSIS AND BREAKDOWN

BETTER L.F. STABILITY

Much lower values of speech current flowing through H.T. source render the "Parafeed" less liable to motor-boating than other transformers.



THREE VARIATIONS OF RATIO by Auto Connection: 2:1; 3:1; 4:1.

IMPROVED VOLUME CONTROL by use of variable anode feed resistance instead fixed.

ASK FOR THE "PARAFEEED" BOOK Ask your dealer for a free copy of the "Parafeed" Way to Better Amplification. It explains the evolution and principles of L.F. Transformer Amplification in a lucid manner most useful to every constructor.

A GREAT TRIUMPH OF R.I. RESEARCH AND PRODUCTION

Advertisement of R.I. Ltd., Madrigal Works, Purley Way, Croydon, Phone: Thornton Heath, 3211.
You Will Help Yourself and Help Us by Mentioning "A.W." to Advertisers

HOW TO MAKE A SCRATCH FILTER

By J. H. REYNER, B.Sc., A.M.I.E.E.

"I WISH I could cut out some of my pick-up scratch," said a friend the other day. "I always thought that electrical reproduction was supposed to do away with scratch, but it is certainly not the case with my set."

I explained to him that the theory so often put forward that electrical reproduction is scratchless was quite fallacious. In fact it is more than likely that electrical reproduction will show a greater proportion of scratch if one is using a really high-quality amplifier. The theory arose

noise which occurs above this frequency. We are thus left with a little scratch and reasonably good brilliance, so getting the best compromise under the difficult circumstances.

In passing it is as well to mention that gramophone scratch is not the only form of mush with which we have to contend. In the reception of foreign stations mush is very troublesome, particularly with a high-power receiver. A scratch filter may be employed with great success in such cases. It cleans up the mush to a remarkable extent and enables us to receive the foreign stations much freer from atmospheric disturbances. Hence the remarks made in this article will be of interest alike to the gramophone enthusiast and the radio user.

that the voltage applied to the valve falls off quite smartly. This, therefore, is approaching the type of arrangement we want.

The system shown by Fig. 1, however, is not a true low-pass filter, a simple version of which is shown by Fig. 2. This will be seen to be similar to Fig. 1, but to possess two chokes, one on each side of the condenser. The effect of this second choke is quite appreciable, as can be seen by reference to Fig. 3. Curve A in this figure shows the cut-off obtained with the Fig. 1 circuit,

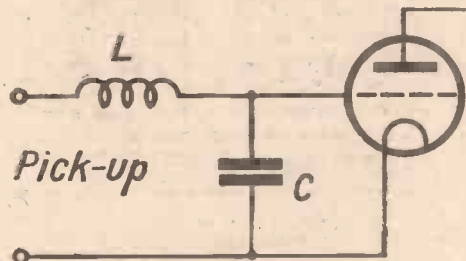

Fig. 1. A simple filter circuit

because many of the early pick-ups were not capable of giving a good response at the high frequencies and, moreover, they were probably used with amplifiers which also cut off at an early stage, so that a mellow and scratch-free reproduction was obtained which was satisfying for a time. Now we know more about things the position is quite different.

The Cause of Scratch

Scratch is due to slight unevennesses in the bottom of the record groove. These irregularities produce the rustling noise which we have come to term needle scratch and which is due to a number of frequencies, all fairly high, commencing in the

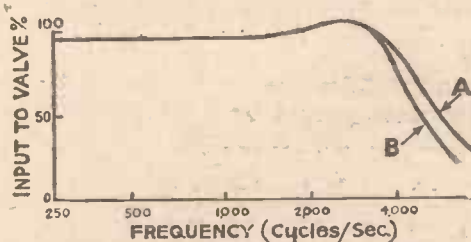

Fig. 3. Curves showing effect of second choke

4,000-cycle region. If we have a reproducer which does not give adequate reproduction at or above this frequency a good deal of the scratch will be suppressed. At the same time so will the upper harmonics of the music, which will accordingly lack brilliance.

It will be seen that the problem of eliminating scratch is not an easy one. Scratch occurs within a frequency band on which we desire full magnification, so that the problem would seem to be insolvable. We can adopt a compromise in which we cut off very sharply above a certain frequency, usually about 4,000 cycles. This has the effect of preserving sufficient of the high notes to give good brilliance and cutting off all that proportion of the scratch

Obtaining Sharp Cut-off

How are we to obtain this very sharp cut off? It is done by what is known as a low-pass filter. This is an arrangement of inductance and capacity which has practically no effect upon currents below a certain frequency but cuts off to an increasing extent above this critical value. A simple circuit of this type is shown by Fig. 1. It consists of an inductance and a capacity in series. The voltage applied to the grid of the valve is that across the condenser.

Now the inductance and the capacity form a resonant circuit and they must tune at some frequency. Suppose we arrange this frequency to occur about 4,000 cycles and see what happens. At low and medium frequencies the inductance of the choke has no appreciable effect, so that the voltage applied to the valve is practically the same as that from the pick-up. Towards 4,000 cycles we begin to obtain a resonance between the inductance and the capacity. This has a very useful effect, because it causes the voltage of the condenser to rise above that supplied by the pick-up itself.

Filter Action

There is not space in this article to explain exactly why this should be, although it is a simple application of the ordinary laws of resonance. The action will be understood if I point out that in an ordinary tuning circuit the voltage developed across the condenser is much greater than the voltage received on the aerial, due to the resonance, this being the property we utilise for tuning. A similar effect is taking place here, due to the resonance between the inductance and the capacity, and the voltage on the capacity rises above that supplied by the pick-up itself.

Therefore, we get a slight increase in the reproduction at these frequencies. The rise is not very marked with a simple circuit of this character unless the D.C. resistance of the choke L is made small, which is usually not the case. Immediately beyond this point the condenser begins to shunt the current to a very large extent, while the choke in series with the pick-up lead presents an increasing impedance, so

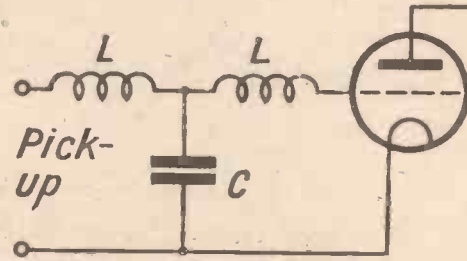

Fig. 2. A simple low-pass filter circuit

while curve B shows the cut-off with the true low-pass filter shown by Fig. 2. The two curves will be seen to be identical up to the 4,000 mark, but the cut-off with the true filter is much more severe. Incidentally, the slight resonance just before the cut-off point can easily be seen.

Those who want to do the job really properly should use a two-section filter, as shown in Fig. 4. Not only is the rise in frequency just before the cut-off point more defined, reaching a value of nearly 20 per cent. in excess of the normal, but the cut-off is particularly sharp, and this

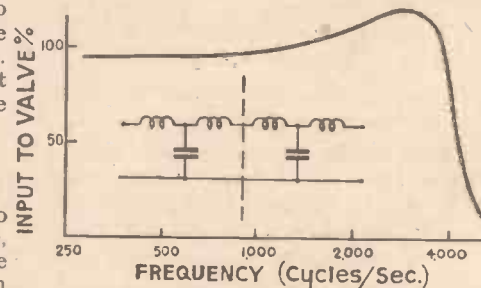

Fig. 4. Circuit of two-section filter

is a form of filter which can be used with great advantage.

Having discussed the circuit, we now have to find the values of components in order to obtain a cut-off at a given frequency. I have found that it is better to work from the point of view of the resonance rather than to apply the formulae for low-pass filters because the latter only apply when the resistance is comparatively small. The chokes used for ordinary scratch-filter work are not of low resistance and, therefore, the formula gives results which are rather too high. Working from the resonance value, on the other hand, we obtain results which are reasonably in accordance with actual practice, but the cut off occurs just after the resonance.

(Continued on page 930)

SPECIFIED AND SPECIALLY CONSTRUCTED

FOR THE A.C. CENTURY SUPER

DESCRIBED IN THIS ISSUE

A mains unit specially constructed by Regentone for "Amateur Wireless A.C. Century Super"—exactly to specification—Regentone Model S.60. Price £4 10 0. Like every other unit in the extensive Regentone range, it has the quality and efficiency and refinement which only seven years' exclusive specialisation in mains radio can give and it is backed by the comprehensive Regentone guarantee.

Write for FREE Art Booklet "The Simple Way to All-Electric Radio" giving full details of the Regentone range.



MODEL S.60 £4. 10.

Size, 7 in. by 7 in. by 3 in. Output H.T. 200 v. at 28 m.a. L.T. 4 v. at 6 amps with centre Tap. Tappings, One fixed, Case totally enclosed, well-ventilated, pressed steel.

REGENTONE LIMITED, Regentone House, 21 Bartlett's Buildings, E.C.4. Tel: Central 8745 (5 lines).

Irish Free State Distributors: Kelly & Shiel, Ltd., 47 Fleet Street, Dublin

DON'T BE CONTENT...

No longer need you be content with a speaker having a tone claimed to be as good as a Moving Coil.

Gone for ever are the two main objections held by thousands of listeners to the purchase of a Moving Coil Speaker, namely HIGH COST AND DIFFICULTY OF OPERATION. . . .

Amplion by the introduction of their M.C.6. unit (a permanent magnet), have at last brought Moving Coil reproduction within the means of everyone.

It requires no external excitation and it is remarkably sensitive, working splendidly from the output of most standard sets.

A FEW POINTS TO NOTE ABOUT AMPLION MOVING COILS.

1. In addition to the M.C.6. unit, a larger model is also available, the M.C.9. This also is a permanent magnet but much more powerful.
2. The diaphragms of both these units are unaffected by any change in climatic conditions.
3. The M.C.6. and M.C.9. can be supplied in really beautiful cabinets—Oak and Walnut.
4. Except in the case of the M.C.9. when bought as a unit—a suitable transformer is fitted and is included in the list price.
5. This transformer provides three alternative ratios, enabling the speaker to be correctly matched to the output.
6. The M.C.9. unit and all Moving Coil Cabinet Models may be purchased on deferred terms.



Diameter of Cone, 6 1/2 ins.
Overall length, 6 1/2 ins.

M.C.6. UNIT

67/6

DO NOT FAIL TO ASK FOR A DEMONSTRATION OF THE NEW AMPLION MOVING COIL MODELS.

COMPLETE WITH TRANSFORMER & READY FOR MOUNTING

Ask your dealer for full details and prices of **AMPLION MOVING COILS** or write for folder **W.L.58 to Graham Amplion, Ltd., 26, Savile Row, W.1.**

AMPLION

royds

Advertisers Appreciate Mention of "A.W." with Your Order

"HOW TO MAKE A SCRATCH FILTER"

(Continued from page 928)

Therefore, as an approximation, we may take the cut-off frequency as in between the two, the formula being :

$$f = \frac{200}{\sqrt{LC}} \text{ cycles/sec.}$$

where L = inductance in henries,
C = capacity in microfarads.

I have found in practice that a very convenient choke to use is the Wright & Weaire iron-cored H.F. choke. This has an inductance of 0.3 henries, and this, with a capacity of .01, will give a cut-off at 3,600 cycles. The figures accompanying this article were actually obtained with a choke of this variety. One of these chokes must be used every time an inductance is shown in the diagram, so that there are three available circuits to choose from. The first of these is the simple Fig. 1 circuit, requiring one H.F. choke and one .01 condenser. The second is the true low-pass filter circuit in

which two chokes are required. These may be mounted side by side at a distance of 1 to 2 in. without any difficulty. The third arrangement is the double-section filter shown by Fig. 4, in which four chokes and two .01 condensers are required.

As an alternative, use may be made of the fact that the Wearite choke is centre-tapped, each half having an inductance of 0.1 henry. Thus the two halves, with a condenser of .03, could be used in the Fig. 2 circuit, but this is not so good owing to the mutual inductance between the two halves, and the use of two chokes is preferable.

Increasing the size of the capacity reduces the cut-off, while decreasing the capacity increases the cut-off. Therefore by trial and error the filter may easily be adjusted to give best results for one's own particular conditions. If necessary two values of condenser may be used, one cutting off at about 6,000 cycles for radio work and the other at 3,500 or 4,000 for gramophone work.

A "FRICTION" AMPLIFIER

ONE of the earliest types of speech amplifiers was the electromotograph invented by Edison. It consists of a mica diaphragm impulsed by a metal disc which rests in frictional contact with a chalk cylinder. The surface of the cylinder is kept moistened with caustic potash and the speech currents to be amplified are passed across the moistened contact. By a curious electro-chemical effect the frictional drag between the disc and cylinder is found to vary in strict proportion to the amount of current which passes. The disc is rotated at a constant speed by a motor which applies amplified impulses to the diaphragm. The same "chemical friction" effect has been utilized in the Johnsen-Rabek loud-speaker. M. A. L.

The Flint Concertina Quartet, once well known at the old Nottingham B.B.C. station, is to appear at the Birmingham studio on June 24 in an instrumental interlude.

A.C. CENTURY SUPER

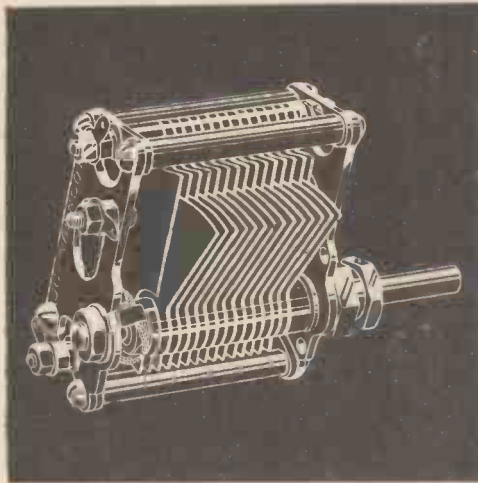

CYLDON FOR NEW SUPER-HÉT.

TWO CYLDON "Junilog" Mid-Line Condensers are specified for the A.C. Century Super. CYLDON—because only the finest materials are used. CYLDON—because mathematical precision used in construction and assembly ensures best results. CYLDON—because every condenser is tested throughout each stage of its manufacture. CYLDON—because its accuracy and reliability lasts.

BUILD WITH CYLDON, never known to wear out.

In case of difficulty send direct to the makers:
SYDNEY S. BIRD & SONS LTD.
CYLDON WORKS,
SARNESFIELD ROAD, ENFIELD,
MIDDLESEX
Telephone: Enfield 2071/2
Telegrams: Capacity, Enfield.

cyldon

FIVE YEARS GUARANTEE

JUNIOLOG
CONDENSERS
Type J5
.0005 mfd. as specified

8/9

EACH S.F.B.

Ask for

BURTON

THE BASIS OF BEST RECEPTION

C.F. & H. BURTON · PROGRESS WORKS · WALSALL · ENGLAND

RADIO RECEIVERS & COMPONENTS

FERRANTI CONDENSERS



SUPER QUALITY
HIGHEST SAFETY FACTORS
LOWEST PRICES

No better condensers are available

INSIST ON FERRANTI CONDENSERS AS
YOU WOULD ON FERRANTI TRANSFORMERS

FERRANTI LTD. Head Office & Works : HOLLINWOOD, LANCASHIRE. London : Bush House, Aldwych, W.C.2

CHOSEN by W. JAMES for the A.C. CENTURY SUPER

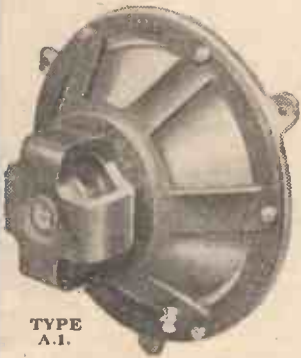

MR. JAMES, the designer of the famous 'Century Super' has chosen the equally famous Epoch permanent magnet moving-coil speaker for use with the A.C. model of the 'Century Super,' described in this issue. The combination will give you radio at its very best. Refuse all substitutes—ask for the Epoch model type A.1., price £3 : 3 : 0; of all radio dealers.

EPOCH MOVING COIL LOUD-SPEAKER

Booklet AS4a and supplements.
:: FREE ON APPLICATION ::

EPOCH RADIO MANUFACTURING CO., LTD.,
FARRINGDON AVENUE, E.C.4

Cheaper than H.T. Batteries and last for ever—

Banish the doubt and expense from your Radio. Get the new "ATLAS" H.T. Unit Model A.C. 244—the finest A.C. Mains Unit ever produced at the price.

This Model is suitable for all the popular 2, 3 or 4 Valve Sets and can be adapted to the Set in just as simple a manner as an H.T. Battery. It incorporates the Westinghouse Metal Rectifier, provides 3 Tappings 60/80 V, 90/100 V, and 120/150 V, and gives output of 120 V at 20 m/A or 150 at 15 m/A. It is fully guaranteed for 12 months and safe and silent in operation. Ask your dealer for demonstration or write direct for Leaflet No. 56 to

H. CLARKE & CO. (M/CR) LTD.
Atlas Works,
Old Trafford,
MANCHESTER.

LONDON OFFICE :
60 Chandos Street,
Strand, W.C.2.

GLASGOW OFFICE :
24 Oswald Street.

CLARKE'S "ATLAS" H.T. MAINS UNIT



MODEL
A.C. 244

Don't Forget to Say That You Saw it in "A.W."

SETS OF DISTINCTION



EDISON BELL

PICNIC PORTABLE

Makers: EDISON BELL, LTD.

Price: £14 : 10s. (De luxe model)

THERE is more scope for the portable type of set during the long summer evenings than in the winter and the name of the portable set under review conjures up delights of radio picnics and other excursions.

There are many excellent models on the market and prices this year are very reasonable. The Edison Bell picnic portable is a typical example of a compact self-contained five-valver. It is not at all difficult to transport, as the inclusive weight is only 26 pounds. Moreover, the shape of the suitcase container, which is rather squat, is to a large extent rendered convenient by the thoughtful placing of the strap handle nearer to one side of the case than the other.

Good Selectivity

This portable is supplied with the usual batteries to run the five valves. There is a 99-volt standard-capacity high-tension battery, a 9-volt grid-bias battery and a 2-volt non-spillable accumulator with jelly-acid electrolyte. I found the total anode current consumption was 10 milliamperes. The standard battery is, therefore, somewhat over-run, but this is inevitable. The battery should last about two or three months with average use.

The combination of valves is straightforward. There are two high-frequency-amplifying valves, both aperiodically coupled, followed by a leaky-grid detector valve and two stages of low-frequency amplification. Mullard valves are used throughout, the output valve being a Mullard PM2. The tuning of the set depends entirely upon the frame aerial circuit across the first high-frequency valve.

The selectivity of the Edison Bell Picnic portable is above the average—for the type of circuit used. Thus, the London National station, maximum at 34 degrees, was inaudible at 39 and 30 degrees, a total spread of only 9 degrees. London Regional, maximum at 72 degrees, had disappeared at 68 and 74 degrees, a spread of only 6 degrees.

In a run round the tuning dial, during the early evening, I was able to get Midland Regional very strongly at 78 degrees and North Regional was a good signal at 90 degrees. Brussels No. 1 at 96 degrees was logged at full loud-speaker strength. Rome at 76 degrees was also strong. On the long waves Daventry was very good at 82 degrees, but interfered somewhat with Radio Paris at 88 degrees.

The control of the Edison Bell Picnic Portable is extremely simple. To the left

of the main compartment are fitted two slow-motion dials. There is a plainly-marked tuning dial at the top and the reaction dial is below it. Both dials are engraved from 0 to 100 degrees. There is a large switch lever in the bottom right-hand corner of the lid. At its centre position the set is switched off. When the lever is pushed up, the long waves are received and when pushed down, medium waves.

Undoubtedly, this is an easy set to operate. The reaction control is notably smooth and was found to build up the strength of all stations very satisfactorily.

The case and fittings of the de luxe model tested strike an attractive note. The de luxe model is obtainable in crocodile finish or antique red, green or blue. A special waterproof cover can be obtained for an extra 10s. 6d. The standard model is listed at £13 10s.—very good value for money.

An unusual provision is a switch to extend the wavelength range from the normal medium band of 240 to 500 metres. By pulling out this switch, medium waves are available from 190 to 350 metres. The complete wavelength range covered is therefore 190 to 2,000 metres.

SET TESTER.

ELECTRO-STATIC SPEAKERS

IN the electro-static type of loud-speaker, the driving force is applied equally over the whole surface of the moving diaphragm, which, in effect, forms one plate of a condenser. This is a distinctly better arrangement than is found in the magnetic type of speaker, where the impulses are confined to a small area at or around the apex of the diaphragm. On the other hand the electro-static speaker requires a constant polarizing potential, of the order of 100 to 200 volts, applied to the diaphragm. Efforts are at present being made to find a convenient way of doing this without using either the mains or batteries. Electrically charged bodies, or "electrets," have been produced which are the electro-static equivalent of a permanent magnet, and can be similarly used to provide a steady polarizing force in the case of static loud-speakers. M.B.

LET "A.W." SOLVE YOUR WIRELESS PROBLEMS.

A VALVE TIP

Be careful when removing a valve from its holder. Take hold of the base of the valve, and not the bulb, for if a valve is continually handled by its



bulb the special cement fixing this to the base may be broken. Also there is the risk, if the bulb is held, that the glass may be cracked.

THE P.M.G. LICENCE

ONE receiving licence covers the use of any number of sets in the same household. It does not, however, cover the use of a set installed in a sub-let part of the same house. For instance, if a lodger puts a set in his own room he must take out a separate licence. Where the owner of one set feeds a loud-speaker installed in a neighbour's house or in a sublet room, a separate licence must be taken out by the second party. A householder's licence covers the use of a portable set as well as a permanently installed set, though if the portable is taken away from home the owner should carry his licence with him, as he is liable to be called upon to produce it by any authorized official of the Post Office.

B. A. R.

AN EVEN BETTER "CENTURY SUPER"—WORKS ALL FROM THE MAINS

TENFOLD INCREASE IN SELECTIVITY!

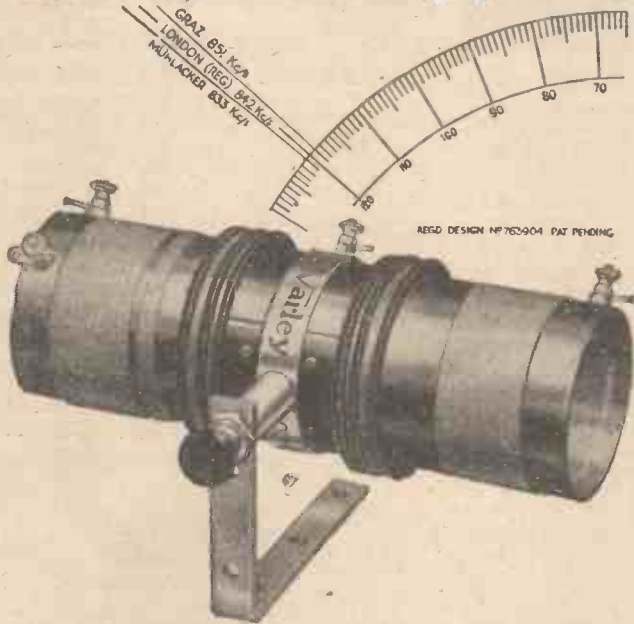

CONSTANT SQUARE PEAK COIL
15/-

The Varley Constant Square Peak Band-Pass Coil—the ideal pre-selective device for any set; S.G., Reacting Detector or Super-het.

Confines local station to 3-4 degrees on the simplest set. Enables programmes—now swamped by powerful transmissions—to be heard and enjoyed. Actually improves quality of reproduction. Abolishes all interference by medium waves on long waves. Supersedes wave-traps. Easily replaces existing aerial coils. Needs no screening.

This new Coil Combines *negative* inductance and capacity coupling, so giving a constant square-topped peak and separation of substantially 9 kilocycles over the whole of both wavebands.

Supplied complete with extension rod for switch and universal mounting bracket.

Ask your dealer for the Free Colour Folder, or write direct.

It is desirable to use a non-inductive coupling condenser (.04 mfd.). THE DUBILIER CONDENSER CO. (1925) LTD., are manufacturing a special condenser, Type 9200, for use with this coil.

SPECIFIED IN THE SQUARE PEAK THREE

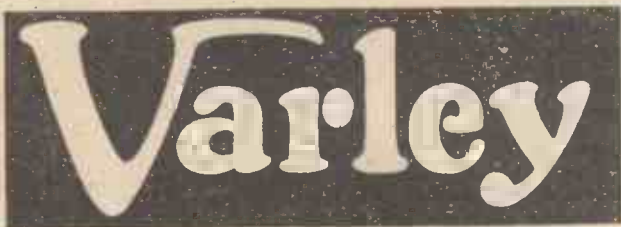

Advertisement of Oliver Pelt Control Ltd., Kingsway House, 103, Kingsway, London, W.C.2. Telephone: Baborn 5303.

Varley RECOMMEND



The J.B. Gang Condenser, Type U.20, has been specially designed in collaboration with Varley for use with the CONSTANT SQUARE PEAK COIL.

Supplied complete with Illuminated Disc Drive and Dial calibrated in wavelengths.

J.B. GANG CONDENSER TYPE U.20 - - 24/-

Advertisement of Jackson Brothers, 72 St. Thomas' Street, London, S.E.1 Telephone: Hop 1837

The POLAR "TUB TWO" GANGED CONDENSER

Recommended by "Varley" for use with their "Square Peak Coil."



With accurately matched ganging condensers, no trimming is required.

Polar "Tub Two" 21/- (less drive)
Polar Drum Drive 8/6

Advertisement of Wingrove & Rogers Ltd. 188/9 Strand, London, W.C.2. Polar Works, Old Swan, Liverpool.



Don't Forget to Say That You Saw it in "A.W."

WE TEST FOR YOU

A weekly review of
new components



and tests of
apparatus.

Conducted by J. H. REYNER, B.Sc., A.M.I.E.E.

Tunewell Mains Transformer

TUNEWELL coils have long been known to readers. It is of interest, therefore, to learn that this firm is now marketing a range of mains apparatus. We are reporting this week on a small transformer intended for simple receivers and, as will be seen from the photograph, the general assembly of this component is neat and compact.

A generous iron circuit is provided, the whole assembly being held together with aluminium frames, the terminals being carried on strips mounted along the top. The overall dimensions are $3\frac{1}{4}$ in. by 3 in. by $3\frac{3}{4}$ in. high, so that the component occupies very little space.

The particular model submitted is intended for use with the Philips type 1801 or Six-Sixty S.S.W.432 valves, giving 30 milliamps smoothed D.C. These valves are single-wave rectifiers, and the H.T. winding is thus a plain untapped winding, while the only other winding required is a 4-volt centre-tapped winding to carry 0.6 ampere.

The high-tension winding gave 200 volts A.C. on no load, and appeared to have a good regulation, for it delivered 75 milliamps before the voltage fell to 170. The instrument is, therefore, well up to its job. The filament winding gave just under



One of the new Tunewell mains transformers

4 volts at the full load current. The no-load watts were 2.1, indicating satisfactory design and freedom from waveform distortion.

The application of the particular instrument is limited, of course, to H.T. eliminators, but it is nevertheless a worthy production, and we shall look forward to examining further samples of Tunewell mains apparatus.

Thimbel Valve Screen

ONE of the most interesting valve screens we have seen is the Thimbel component illustrated herewith. This screen is designed for fitting to the valve itself and not on the baseboard, as is usual. First of all there is a rubber ring, which is pushed over the cap at the base of the valve. A short screen, 3 in. long, is then placed over the valve and the bottom end fits on to this rubber ring. By this means the outside of the valve is completely shielded, while the valve can be removed at any time as a complete unit if desired.

For making connection to the screen a small strip of copper foil is inserted between the rubber ring and the metal cover. We would suggest that this would be better if it were terminated in the form of a small clip, which could be inserted over one of the



The handy Thimbel valve screen

filament pins. This would retain the self-contained feature which has obviously been in the minds of the producers.

True, it is now possible to obtain metal-sprayed valves for which screens are unnecessary, but for the many readers who still possess the old type, this screen is worthy of consideration. It sells at 2s. 6d.

Star L.F. Transformer

MESSRS. STAR ENGINEERING have been making moving-coil loud-speakers of various types for some time now and there are many satisfied users of their products in various parts of the country. Recently this concern brought out a book entitled, "Moving-coil Loud-speakers Simply Explained," in which are shown a number of circuits.

We understand that the firm are now marketing a number of components suitable for use in these circuits, more particularly, of course, with their own loud-speakers.

The first of these which we have received for test is an all-purpose L.F. choke. This component is rated at 20 henries 75 milliamps, so that it is quite capable of being used without saturation in output circuits delivering 5 watts or so, where the anode current is 50 to 70 milliamps in the ordinary course of events. A value of 20 henries is quite sufficient for such circuits.

The component is only small in size, measuring $2\frac{1}{2}$ in. by 2 in. by 3 in. high, and is assembled with neat aluminium cast



A neat L.F. transformer—the Star

frames carrying a terminal strip at the top. Insulated terminals are provided, which is a useful feature, and the appearance of the component in general is very neat.

On test we found that the inductance is up to standard and is not seriously affected by the D.C. current. The D.C. resistance of the choke is 330 ohms, so that little voltage drop will be caused on this account. It thus has equal application, either as a smoothing or as an output choke.

A Blue-Spot Receiver.—Considerable interest is aroused by the announcement that the British Blue Spot Co. is to enter the set market. We understand that an all-mains receiver—probably a four-valver—is to be the first production, and this has, during the past few months, been subjected to rigorous tests in various centres in England to ensure that it is thoroughly suitable for the most difficult reception conditions. Blue Spot speakers have achieved a wonderful reputation, and the progress of this new development of the British Blue Spot Co. will be watched with great interest.

Two songs by Sibelius, "The Tryst" and "Black Roses," and a group of Cyril Scott's delightful lyrics, will be a feature of Dorothy Showell's programme during the Sunday afternoon concert from the Birmingham studio on June 21.



A WEST Somerset dialect one-act play, entitled *Thic Thare Dawg*, by Miss Phoebe M. Rees, will be the central feature of a West Country programme which will be relayed from the Bristol Musical Club, Bristol, on June 18. The Lockier String Orchestra, conducted by Harold Bernard, will play.

A new play by Joe Corrie will be broadcast on June 16. This is entitled *The Darkness*, and tells the story of a miner who loses his sight in a pit explosion. This has been adapted for the microphone by Mr. T. P. Maley.

An effort is to be made to teach the fundamentals of Scottish country dancing by wireless.

The French Posts and Telegraphs have now completed the laying of the first specially pupinised cable destined to link up Paris and Marseilles in the broadcasting system. Later it will be extended to Nice. In the course of a month or so it is hoped that good land-line relays will also be possible from Bordeaux and Toulouse. To complete the net a cable is to be laid between Paris and Brussels, and between the French capital and London.

A scheme has been placed before the Storting for a complete reorganisation of the broadcasting system in Norway. It is proposed to hand over the control of all the stations to a new corporation, in which the main newspapers are interested and which would provide the necessary capital. A second body under Government control would be responsible for the construction and operation of some forty transmitters. The broadcasting authorities consider that this large number of stations is necessary if 90 per cent. of the existing population is to be given the opportunity of hearing the radio programmes on simple crystal receivers.

The new Beromuenster (Switzerland) high-power transmitter will be officially opened on June 11. Special programmes will be broadcast by the Berne, Basle, Zurich group on this occasion.

June 15 is the provisional date fixed for the first of the International programmes to be exchanged between the United States of America and Germany. This series will include relays from Germany of talks by Einstein, Echener Von Mueller and other celebrities, and from the American side interviews with President Hoover, Edison and Ford as well as visits to Hollywood and other interesting centres.

The new Waldorf hotel now under construction in New York will be equipped with an extensive combination of radio and public-address systems. In all of its 2,000 rooms patrons will have a choice of six programmes.

A Welsh programme will be given to West Regional listeners on June 16, when the Rhondda Ladies' Choral Society, conducted by James Davies, will sing both Welsh and English items.

The new Palermo (Italy) broadcasting station was officially opened on June 7; it works on 453.2 metres.

During June the German stations will broadcast late night concerts on the following dates: Breslau (Thursday, 11); Langenberg (Monday, 15); Frankfurt-am-Main (Friday, 19); Munich (Tuesday, 23); Stuttgart via Mühlacker (Thursday, 25); and Königsberg, Heilsberg (on Monday, June 29). The concerts are timed to start at 12.30 a.m. B.S.T. on the dates indicated.

In Inverness, the capital of the Scottish Highlands, it is impossible to achieve adequate reception of any Scottish broadcast programme, and this is given as a glaring instance of the "starvation tactics" of the B.B.C. so far as the northern part of Scotland is concerned.

The west of Scotland is interested in the news that a high-power station is to be established near Belfast. While this is intended primarily, of course, for northern Ireland, it should also provide another alternative programme at good strength for Scottish listeners in the west.

BROADCASTING THE T.T.

THE final hour of the senior T.T. motor-cycle race in the Isle of Man will again be broadcast by the B.B.C. in the National programme this year on June 19. The broadcast is timed to take place from 12.45 to 1.45 p.m.

The running commentary last year was so successful that the B.B.C. has decided to elaborate its arrangements this year. Last year the race was described by commentators stationed at two points on the course—the grandstand at Douglas, and Craig-ny-Baa. This year a third point will be used—the famous hairpin bend at Ramsey.

Thus, while the world's crack motor-cyclists are racing round the famous Manx circuit, wireless listeners will receive a sound-picture of the race from three points on the course.

Major Vernon Brook, Mr. B. H. Davies ("Ixion," the motor-cycle journalist), and Mr. Victor Smythe (a Manchester official of the B.B.C.) will be the three commentators. Their microphones will be linked by telephone wires to a central switching point at Douglas where the switching over from one commentator to another will be performed. From this point the voices of the commentators will be carried along a submarine cable on the bed of the Irish Sea to Blackpool and thence by landline to the B.B.C. transmitters.

The Matched Pair



Why is it that the Junit Mains Transformer is specified in the A.C. Century Super-Het set?

It is because it is a known fact that Junit components are most accurate and most reliable.

They are made not only to do their job efficiently and well, but behind every one of them is an ample safety factor.

Every Junit Mains Transformer and Choke is tested between windings and between windings and core at no less than 5 times the working voltage.

If you want the finest results buy the Junit Mains Transformer together with the Junit Choke—the matched pair.

JUNIT MAINS TRANSFORMER.
135 volts 30 m/a with 4 volts 6 amps. Centre tapped winding. Weight 4 lbs. 6 1/2 ozs. PRICE 30/-

JUNIT CHOKE.
D.C. Resistance of 330 ohms, maximum current 30 m/a. PRICE 21/-



JUNIT MANUFACTURING CO., LTD.
2, Ravenscourt Square, London, W.6



The "Century" on an Outdoor Aerial
SIR,—I seem to have heard that a "Century Super" builder worked his set on an outdoor aerial and obtained very good results. If this is so, why is a frame aerial recommended? Should I get better results if I used an outdoor aerial?

W. N. (Birmingham).

On no account must the "Century Super" be used on an outdoor aerial during normal broadcasting hours. A super-heterodyne is a receiver of the oscillating type and, quite apart from the fact that it is contrary to Post Office regulations to work an oscillating receiver on an open aerial, very serious interference would be caused. A frame aerial is "closed" and, therefore, may under the existing regulations, be used. The sensitivity of the "Century" is so great that you need have no fear that you are losing stations by using a frame aerial.—Ed.

A Frame for the "Century"

SIR,—As I want to make sure of getting the very best results with the frame aerial which I am building for my "Century Super" (according to the description published on page 842 of AMATEUR WIRELESS, No. 468), I should be glad if you would let me have one or two further measurements so that I can be sure of making up the frame exactly as described. What is the exact overall size of each frame and is there any spacing between the turns? How far apart should each section of the frame be spaced?

B. L. (Middlesex).

The long-wave frame measures 16 in. long by 10 in. wide. The medium-wave frame measures 18 in. by 10 in. The long-wave winding is formed with the turns close together, but approximately 1/10th-in. space is left between each turn of the medium-wave winding. There is about 3/4-in. space between each section of the medium-wave frame, and 1 1/2 between the long-wave frame sections.—Ed.

A Good Crystal Set

SIR,—I have just built up the "Tapped-Coil" Crystal Set for an old lady, and fixed up but a short outside aerial, the best that can be arranged. North Regional on 479.2 metres comes in very strong even with three pairs of phones. There is very

little difference in signal strength whatever crystal tap is employed.

Tuning is very sharp indeed on 1, 2, 3, and 4 tapings, whilst with the crystal tapped to the 46th turn, the station does not spread beyond five degrees on either side of the peak!

I have heard the North National testing, and presumably because this tunes in at the lower end of the scale the tuning is a little broader, but with the crystal tapped to the 46th turn the spread is only 10 degrees on either side of the peak. Thus my friend will have excellent strength from each station without any interference.

She is very pleased indeed with the set, and so am I.

F. M. (Bradford).

Grid-leak Connections

SIR,—In some circuits the grid leak is joined across the grid condenser, while in others it is between the grid of the detector valve and one side of the filament. What determines which way the grid leak should be connected?

P. G. (Brighton).

In both cases the grid leak is really between the grid and filament. When the side of the grid condenser farther from the grid of the valve is connected to the filament circuit through either a tuning coil or the secondary of an H.F. transformer, placing the grid leak across the condenser virtually connects it between grid and filament. When, however, the detector valve follows a stage of tuned-anode coupling, the grid leak must not be connected across the grid condenser as this would result in it being connected, through the tuned-anode coil, between the detector grid and H.T. positive.—Ed.

Gramo Radio

SIR,—I am using a pick-up with my receiver, the amplifier portion of which consists of one R.C. stage and one push-pull stage. Ordinarily my wireless reception on a moving-coil loud-speaker is all that one could desire, but as soon as I put on the pick-up, especially with some records, reproduction seems distorted. The pick-up is of good make. Can you suggest anything?

I. F. M. (Felixstowe).

You are overloading the valves in your amplifier. The pick-up may be rather too efficient for your particular amplifier and the first valve is being badly overloaded. We suggest that you fit a volume-control across your pick-up and in this way regulate the amount of energy applied to the grid of the first amplifying valve. The use of a controlling device will be quite satisfactory.—Ed.

Using a Pentode

SIR,—I have constructed one of your three-valvers, and it has certainly exceeded all expectations in regard to reception of different stations and the power with which they are received. In fact, on some stations, the volume is so great as to cause distortion, and it is for this reason that I write. I am using a PM2 power valve with adequate H.T. supply and I have proved that I am overloading the grid of this valve. In view of this, should I use a pentode valve, or should I get a larger power valve?

R. N. (London, E.10).

If you want purity and you are already overloading the grid of a PM2 valve, then a pentode type of valve is not to be recommended. Granted that it has a larger grid swing than a PM2 valve, there is still the possibility that even the grid of this valve will be overloaded. We suggest that you use a super-power valve of the ordinary type.—Ed.

Screened Wavetraps

SIR,—I have been in the habit of using a wavetraps to cut out interfering signals, but having read of a screened wavetraps, I am wondering whether this would be an improvement.

R. Y. (Yorks).

There is little point in using a screened wavetraps unless it is needed to obviate interference due to "shock-effect" reception from some powerful near-by station. When shock-effect reception is experienced, it is usually necessary to screen the whole receiver, so that a screened wavetraps holds no advantages over the ordinary unshielded type, unless the receiver itself is also screened. If you reside within a mile or so of your local station and you wish to get other stations farther afield, then, provided your receiving set is screened, a screen wavetraps will be useful.—Ed.





B.I. HELSEBY CONDENSERS

Helsby fixed capacity condensers for Wireless Receivers, Battery Eliminators, Smoothing circuits, etc., are made in several different types to suit the various uses for which Condensers are required in connection with Wireless Circuits. These condensers are the result of 30 years' experience in the manufacture of all kinds of condensers from the smallest sizes up to condensers weighing more than two tons. All Helsby Wireless Condensers are made with pure metal foil plates. Helsby Condensers are an insurance against breakdown.

- Type 209T.** Working voltage 250 D.C.
1 mfd. - - 2/7 2 mfd. - - 3/6
- Type 212.** Working voltage 400 D.C.
1 mfd. - - 3/7 2 mfd. - - 4/9

Manufactured by :-

**BRITISH INSULATED CABLES
LIMITED**

PRESCOT, LANCS.

Makers of B.I. Cables

Telephone No.: PRESCOT 171

London Office: Surrey House, Embankment, W.C.2

Telephone No. Temple Bar 4793, 4, 5 & 6.

EVEN

BETTER RESULTS
obtained with the

"CENTURY SUPER"

using the new

**GOLSTONE SUPER
DUAL RANGE
FRAME AERIAL**

wound with special GOLSTONE PRICE
Multi-strand enamelled and
silk-covered wire. Fitted with
wave-change switch on Base. **21/-**

Your Dealer can supply.

REFUSE SUBSTITUTES—
if any difficulty write
direct:—

WARD & GOLDSTONE Ltd.
PENDLETON, MANCHESTER.

**GOLSTONE
Daily
Dispatch
SELECTOR UNIT.**
Not just a WAVE-
TRAP, but a com-
plete Extra Tuning
Stage.
Cuts out Powerful Regional
Transmitters, and enables
reception of far-distant
stations hitherto unobtain-
able. Price 6/6. Full par-
ticulars, with large RADIO
CATALOGUE, on request.

VOLUME CONTROL SPECIFIED

for the
**A.C. CENTURY
SUPER**

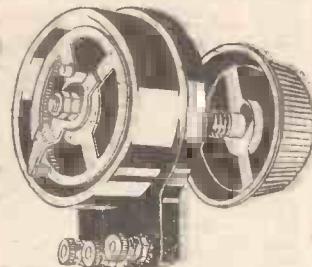

THE famous SOVEREIGN VOLUME CON-
TROL (50,000 ohms) is specified in most
famous of sets; the A.C. CENTURY SUPER.
Complete with Bakelite knob, 3 terminals,
totally enclosed movement, its smooth,
silky action controls volume to a fine
degree. Absolutely noiseless. Use **4/6**
this and other Sovereign com-
ponents in this super set - - - EACH

Other values: 100,000; 500,000 ohms
and 1 and 2 megohms

Sovereign Com-
pression Type
Condensers, the
specified com-
ponent for selec-
tivity. Equally
well made, equally
popular. All
values (except
"H" type) 1/6 ea.

If your dealer cannot
supply, send for de-
tails of full range and
terms to:—



**SOVEREIGN PRO-
DUCTS. LTD.**

52/54 Rosebery Avenue
London, E.C.1

You will Help Yourself and Help Us by Mentioning "A.W." to Advertisers

Easy Terms

FIRST IN 1924 FIRST IN 1931

ATLAS A.C. ELIMINATOR, TYPE A.C. 244. 3 Tappings, S.G., detector and power. Output, 120-v. at 20 m/a. Cash price £2 19s. 6d. Balance in 11 monthly payments of 5/6.

EXIDE 120-VOLT, TYPE W.H., H.T. ACCUMULATOR, in crates. Cash price £4 13s. 0d. Balance in 11 monthly payments of 8/6.

BLUE SPOT SPEAKER UNIT, Type 66R. Send 4-pole balanced armature with major chassis and cone (37 cm.). Cash price £2 10s. 0d. Balance in 5 monthly payments of 8/10.

LAMPLUGH OR FARRAND INDUCTOR SPEAKER for perfect reproduction. Unit and chassis complete, ready mounted. Cash price £3 10s. 0d. Balance in 11 monthly payments of 6/5.

ULTRA MAJOR MOVING COIL A.C. CHASSIS (200-250 volts). Complete with input transformer, as above, mains transformer, metal rectifier, and smoothing condenser. Cash price £4 17s. 8d. Balance in 11 monthly payments of 9/-.

EPOCH PERMANENT MAGNET SPEAKER, with type B4 unit only. Cash price £4 4s. 0d. Balance in 11 monthly payments of 7/9.

W.B. PERMANENT MAGNET MOVING-COIL SPEAKER (transformer not included). Cash price £4 10s. 0d. Balance in 11 monthly payments of 8/4.

EPOCH PERMANENT MAGNET MOVING-COIL SPEAKER, Type A.1. Cash price £3 7s. 6d. Balance in 11 monthly payments of 6/4.

WUFA 60-POLE UNIT, WITH CHASSIS. Cash or C.O.D. price £2 0s. 0d. Balance in 5 monthly payments of 7/1.

Every make of Radio Set or Accessory can be supplied on Easy Terms. Send for our free 96-page Illustrated Catalogue, and let us know your Radio requirements.

New Times Sales Co

56 LUDGATE HILL, LONDON, E.C.4
(Established 1924) Telephone: CENTRAL 2716

Buy the **RIGHT Eliminator Now**—for years of trouble-free radio

"GODWINEX" ELIMINATORS

are Engineer-built and guaranteed to give satisfactory service. Large variety of models to suit every type of set—for A.C. and D.C. supplies. Any model obtainable on easy deferred terms. Illustrated is model S.G.A. (for screened grid valve sets).



£3

Total output 20 m.a. 3 tappings—60, S.G. and 120 volts. S.G.A.T. with Trickle Charger for L.T. Accumulators, 20/- extra. With 1, 4 1/2 x 9 volts G.B. tappings, 10/- extra.

Send for Catalogue, mentioning your dealer's name and address.

J. DYSON & CO., LTD. (Dept. A1),
5 & 7, Godwin Street, BRADFORD.

DX THE STANDARD PLUG-IN COIL

Sold everywhere from 1/-

DX COILS Ltd, London, E.8

MAGNUM

ALL THAT IS BEST IN RADIO COMPONENTS SETS ETC.

BURNE-JONES & CO. LTD.
29, BORO' HIGH, LONDON, S. 1.

Let "AMATEUR WIRELESS" solve your wireless problems

BROADCAST TELEPHONY

Broadcasting Stations classified by country and in order of wavelengths. For the purpose of better comparison, the power indicated is *aerial energy*.

Kilo-Metres	Station and Call Sign	Power (Kw.)	Kilo-Metres	Station and Call Sign	Power (Kw.)	Kilo-Metres	Station and Call Sign	Power (Kw.)
GREAT BRITAIN								
25.53	11,751 Chelmsford (G5SW)	16.0	317.3	945.4 Marseilles (PTT)	1.5	416	721 Radio Maroc (Rabat)	10.0
242	1,238 Belfast	1.2	328.2	914 Grenoble (PTT)	3.0	1,250	240 Tunis Kasbah	0.0
261.3	1,148 London Nat.	68.0	329.3	911 Poste Parisien	1.2	NORWAY		
288.5	1,040 Newcastle	1.2	345.2	869 Strasbourg (PTT)	15.0	235.5	1,274 Kristianssand	0.025
288.5	1,040 Swansea	0.16	370	810.5 Radio LL (Paris)	0.5	240.0	1,247 Stavanger	0.025
288.5	1,040 Plymouth	0.16	385	779 Radio Toulouse	8.0	384	824 Trondelag	1.35
288.5	1,040 Edinburgh	0.4	447	671 Paris (PTT)	2.0	386.2	819.2 Frederiksstad	0.7
288.5	1,040 Dundee	0.16	466	644 Lyons (PTT)	2.3	453.2	662 Forsgrund	0.8
288.5	1,040 Bourne-mouth	1.2	1,445.7	207.5 Eiffel Tower	15.0	493.4	608 Bergen	1.35
288.5	1,040 Aberdeen	1.2	1,725	174 Radio Paris	17.0	587.1	571 Hamar	0.8
301.5	995 North Regional (tests)		1,725	174 " (testing shortly)	85.0	1,071	280 Oslo	75.0
309.9	968 Cardiff	1.2	GERMANY					
356.3	842 London Reg.	70.0	31.38	9,560 Zezen	15.0	214.2	1,400 Warsaw (2)	1.9
376.4	797 Glasgow	1.2	217	1,388 Königsberg	1.7	234	1,283 Lodz	2.2
398.9	752 Midland Reg.	38.0	219	1,369.7 Flensburg	0.6	244	1,229 Wilno	22.0
479.2	626 North Regional	70.0	227	1,310 Cologne	1.7	314.2	954.8 Cracow	1.5
1,554.4	193 Daventry (Nat.)	35.0	227	1,310 Münster	0.6	335	896 Poznan	1.9
AUSTRIA								
218	1,373 Salzburg	0.6	232.2	1,292 Kiel	0.31	381	788 Lvov	21.0
246	1,220 Linz	0.6	239	1,256 Nürnberg	2.3	408	734 Katowice	16.0
283	1,058 Innsbruck	0.6	246.4	1,217.2 Cassel	0.3	1,411.8	212.5 Warsaw	158.0
352	831 Graz	9.5	253.8	1,182 Gleiwitz	5.6	PORTUGAL		
453	666 Klagenfurt	0.6	259.3	1,157 Leipzig	2.3	290.5	1,033 Lisbon (CTIAA)	2.0
517	581 Vienna	20.0	269.8	1,112 Bremen	0.3	ROMANIA		
also testing on 1,249 m. from 8.0 p.m. (Mon. Wed. Sat.)								
BELGIUM								
206	1,456 Antwerp	0.4	318.8	941 Dresden	0.3	427	702.5 Kharkov	4.0
215.6	1,391 Radio Conférence Brussels	0.25	325	923 Breslau	1.7	720	416.6 Moscow (PTT)	20.0
244.9	1,224.8 Schaerbeek	0.5	300	833 Mühlacker	75.0	800	375 Kiev	20.0
338.2	887 Brussels (No. 2)	20.0	372	806 Hamburg	1.7	824	364 Sverdlovsk	25.0
509	590 Brussels (No. 1)	20.0	390	770 Frankfurt	1.7	837.5	320 Kharkov (RV20)	25.0
BULGARIA								
318.8	941 Soña (Rodno Radio)	1.0	418	716 Berlin	1.7	1,000	300 Leningrad	100.0
CZECHOSLOVAKIA								
263	1,139 Moravska-Ostrava	11.0	452.1	662 Danzig	0.2	1,050	283 Tiflis	15.0
279	1,076 Bratislava	14.0	473	635 Langenberg	17.0	1,103	272 Moscow Popoff	40.0
293	1,022 Kosice	2.5	533	563 Munich	1.7	1,200	250 Kharkov (RV4)	25.0
341.7	878 Brunn (Brno)	34.0	559.7	536 Kaiserslautern	1.0	1,304	230 Moscow (Trades Unions)	165.6
487	617 Prague (Praha)	5.5	566	530 Hanover	0.3	1,380	217.5 Bakou	10.0
487	617 Cesky Brod	75.0	570	527 Freiburg	0.35	1,481	202.5 Moscow (Kom)	20.0
(testing shortly)								
DENMARK								
281	1,067 Copenhagen	1.0	1,635	283.5 Zezen	75.0	250	1,153 Barcelona	1.0
1,153	263 Kalundborg	10.0	1,635	283.5 Norddeich	10.0	SPAIN		
ESTONIA								
296.1	1,013 Tallinn	0.7	31.28	9,599 Eindhoven (PCJ)	30.0	266.5	1,125.6 Valencia	8.0
405.8	644 Tartu	0.5	299	1,004 Hilversum	8.5	349	860 Barcelona (EAJ1)	8.0
FINLAND								
220.8	1,358.3 Helsinki	15.0	299	1,004 Radio Idzerda (The Hague)	3.0	386.9	817.7 Seville (EAJ5)	1.5
291	1,031 Tampere	1.0	1,060	283 Scheveningen-Haven	5.0	424	707 Madrid (EAJ7)	2.0
291	1,031 Vupuri	15.0	1,875	160 Huizen	8.5	453	662.2 San Sebastian	0.6
1,796	167 Lahti	54.0	HUNGARY					
FRANCE								
219.0	1,364 Fecamp	1.0	550	545 Budapest	23.0	SWEDEN		
220	1,363 Beziers	0.6	ICELAND					
235.1	1,275 Nimes	1.0	1,200	250 Reykjavik	21.0	230.3	1,364 Malmö	0.75
238.5	1,258 Bordeaux	2.0	IRISH FREE STATE					
FRANCE (continued)								
249.9	1,200 Juan-les-Pins	0.5	224.4	1,337 Cork (6CK)	1.5	257	1,166 Hörby	15.0
256	1,172 Toulouse (PTT)	1.0	413	725 Dublin (2RN)	1.5	306.9	977.2 Falun	0.65
265	1,130 Lille (PTT)	15.0	ITALY					
272	1,103 Rennes	1.2	25.4 and 80	Rome (3RO)	9.0	322	932 Göteborg	15.0
283.4	1,051 Montpeller	2.0	247.7	1,211 Trieste	15.0	436	689 Stockholm	75.0
287.1	1,045.1 Radio Lyons	0.5	296.1	1,013 Turin (Torino)	8.5	542	554 Sundsvall	15.0
294.1	1,020 Limoges (PTT)	0.5	312.8	959 Genoa (Genova)*	1.5	770	389 Ostersund	0.75
304	936 Bordeaux (PTT)	20.0	332	905 Naples (Napoli)	1.7	1,229.5	244 Boden	0.75
314.1	955 Natan-Vitus (Paris)	0.5	441	680 Rome (Roma)	75.0	1,352	221.9 Motala	40.0
FRANCE (continued)								
256	1,172 Toulouse (PTT)	1.0	453.2	662 Palermo	8.5	SWITZERLAND		
265	1,130 Lille (PTT)	15.0	456.6	657 Bolzano (IBZ)	0.2	244.1	1,229 Basle	0.65
272	1,103 Rennes	1.2	501	599 Milan (Milano)	8.5	245.9	1,220 Berne	0.5
283.4	1,051 Montpeller	2.0	* testing on 525 m.					
287.1	1,045.1 Radio Lyons	0.5	LATVIA					
294.1	1,020 Limoges (PTT)	0.5	525	572 Riga	13.0	LITHUANIA		
304	936 Bordeaux (PTT)	20.0	1,935 155 Kaunas					
314.1	955 Natan-Vitus (Paris)	0.5	NORTH AFRICA					
303.4 825.3 Algiers (PTT) ... 13.0								

WHEN SUBMITTING QUERIES . . .

Please write concisely, giving essential particulars. A Fee of **One Shilling** (postal order), a stamped addressed envelope, and the coupon on the last page must accompany all letters. The following points should be noted.

Not more than two questions should be sent with any one letter.

The designing of apparatus or receivers cannot be undertaken.

Modifications of a straightforward nature can be made to blueprints, but we reserve to ourselves the right to determine the extent of an alteration to come within the scope of a query. Modifications

to proprietary receivers and designs published by contemporary journals cannot be undertaken.

Readers' sets and components cannot be tested at this office. Readers desiring specific information upon any problem should not ask for it to be published in a forthcoming issue, as only queries of general interest are published and these only at our discretion. Queries cannot be answered by telephone or personally.

Readers ordering blueprints and requiring technical information in addition, should address a separate letter to the Query Department and conform with the rules.

STUDIO DISTORTION

IT is found that reflection from the walls of a broadcast studio is liable to produce a peculiar type of distortion, which is not noticeable in the studio itself owing to the binaural effect of the ears, but which comes into evidence when the sounds are fed through a "single ear" channel, such as

the microphone used in transmission. One method of overcoming this difficulty is to break up the walls of the studio into a number of separate small reflecting-surfaces, which serve to "scatter" the reflected sounds before they reach the microphone, and so give a more normal reproduction at the receiving end.

B. A. R.

ASSEMBLE YOUR OWN WEEDON'S A.W. JAMES SUPER 60 and CENTURY SUPER CENTRE TAPPED FRAME AERIAL



Build this Super frame aerial at home from our kit of parts. Kit comprises, specially selected wood machined and cut to size. Ebonite end pieces to carry windings. Screws, wave-change switch. Brass bush to carry rotating spindles. Two reels litz wire, 27/40 and 9/40. This frame is of scientific design, giving wonderful selectivity and maximum volume output. Range covered approx. 200 to 650 metres and 1,000 to 2,000 metres.

18" x 18" over frame.

DETAILED DRAWING AND FULL INSTRUCTIONS
 Price **13/9** POST FREE
FREE
 WEEDON & CO., 26a Lisle Street, LONDON, W.C.2.

"RADIO & POWER SWITCHES"

LYONS "B.A.T." "Q.M.B." SWITCHES ARE THOROUGHLY RELIABLE

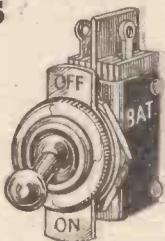

Latest model illustrated. Easily breaks 3 amps. at 250 volts. Q.M.B. action. Indicating. Live parts are insulated from lever. One hole fixing. Nickel finish. Small. Neat.

Guaranteed fully.

- No. 728 with Soldering Tags... 2/- each
- No. 730 with Screw Terminals 2/3 each
- No. 729, 2-way Type... 2/6 each
- No. R.671, S.P. 4-way... 3/9 each
- No. 156, D.P. Model, 5 Amp... 3/6 each
- No. D.56, D.P.D.T. Model... 5/3 each

MANY OTHER TYPES

Send for Free Booklet "Switches for Radio and Power," with 20 new circuits.

CLAUDE LYONS LTD.
 76, OLDHALL ST., LIVERPOOL
 40, BUCKINGHAM GATE, S.W.1

R.A.F. ECONOMY SALE

There has just been a final A.M. clear-up sale of Surplus Radio and Electrical Apparatus which we were able to secure. Please send us your enquiries as the range is enormous. This is the last of the Air Force Surplus and cannot be repeated. Bargain hunters should therefore send addressed envelope at once for new White List just printed. It is impossible to repeat these goods at sale prices.

ELECTRADIX RADIOS,
 218 UPPER THAMES STREET, E.C.4
 Phone: City 0191.



YOU CAN BUILD A £40 GRAMOPHONE WITH OUR SCALE DRAWINGS FOR 40/-

Book of instructions 3di. Catalogue of Motors, Tonearms, Soundboxes, latest internal amplifiers, Gramophones and Cabinets Free. Cash or Terms.

W. BERT, 185 High St., Deptford

TAYLX WET H.T. BATTERIES
 New Pairs: Jars 1/3. Sacs 1/2. Zincs 1 Od. Sample doz. 18 Volts complete with bands and electrolyte 4/1 post 9d. Sample unit Gdl. illus. booklet free. Bargain list free.
AMPLIFIERS, 30/- 3 VALVE ALL-STATION SET 55.
 A. TAYLOR, 57, Studley Road, Stockwell, LONDON.

Postcard Radio Literature

GET THESE CATALOGUES FREE

Here "Observer" reviews the latest booklets and folders issued by well-known manufacturers. If you want copies of any or all of them **FREE OF CHARGE**, just send a postcard giving the index numbers of the catalogues required (shown at the end of each paragraph) to "Postcard Radio Literature," "AMATEUR WIRELESS," 58/61, Fester Lane, E.C.4. "Observer" will see that you get all the literature you desire. Please write your name and address in block letters.

Amazing Price "Cuts"

NEWs has just reached me of amazing price reductions to be made on Telsen components. Transformers, valve holders, H.F. chokes and fixed condensers are all subject to this reduction, and as an example of the value now obtaining I would instance the small fixed condensers which cost only 6d., complete with grid-leak clips. Make a point of dropping a line, through my free catalogue service, for literature describing these economical parts. **273**

The "Square-peak" Idea

Following the first description in **AMATEUR WIRELESS** of the new "Square-peak 3," which is a straight receiver of a wonderfully selective type; great interest has been aroused in the new band-pass type of coil which forms the basis of the circuit. To hand from Varley, Ltd., is a useful folder giving technical details of the coil. You should have a copy of this. **274**

Cutting Out Interference

I see that the technical experts on the staff of Philips Lamps, Ltd., have produced a good handbook called "How to Eliminate Radio Interference." Copies of this can be obtained, price 1s. post free, and I certainly think that any listeners who are having trouble with interference and "man-made" static should get a copy. **275**

A Saxon List

Here is another fine illustrated catalogue from Messrs. Saxon Radio, of Blackpool. All kinds of interesting parts for set builders are described in this. You can get a free copy through my catalogue service. **276**

Grawor Speakers

To hand is a useful illustrated sheet from Messrs. Henry Joseph who market Grawor speakers. This illustrates the whole range of complete speakers, chassis and Grawor gramophone pick-ups. You should have this. **277**

Becol Panels

An ebonite panel is still a necessity in many sets, and for that reason I think all set builders should write for free copies of leaflets giving details of the new high-grade Becol panels. Formers suitable for tuning coils and chokes are also described and are bound to be of use to the home constructor. **OBSERVER. 278**

Especially designed for
PORTABLES
 the only
MAINS UNITS

incorporating independent Grid Bias.
 Type: G.B.I. Prov. Patent No. 1642/31

- H.T.** 150v. at 15 m/a. or 120v. at 20 m/a. Also S.G. and Det. Tappings.
- G.B.** 3 Tappings up to 12 v. Independent of H.T.
- L.T.** 2, 4 or 6v. Trickle Charger.

(full-wave Westinghouse Rectifiers)

£4-15-0

(Deferred Terms on all products)

TANNOY PRODUCTS

Dalton Street, West Norwood, S.E.27

EASY TERMS

We supply all good quality Radio Receivers, Components and Accessories on deferred terms. We carry adequate stocks and can give prompt delivery.

NEW HEAYBERD A.G. ELIMINATOR KIT C.150.—Complete Kit of Parts for building an H.T. Eliminator, including steel case. Output, 25 ma., 150 volts. 3 B.A. Tappings, one variable.

Cash Price, £3/16/-
 or 7/6 with order and 11 monthly payments of 7/12
EXIDE W.H. HIGH-TENSION ACCUMULATORS (120 volts, 5,000 m.a.). Higher voltages if desired.

Cash Price, £3/15/-
 or 6/6 with order and 11 monthly payments of 7/-
Carrriage charged on all orders from Scotland.

N.K. FARRAND INDUCTOR LOUD-SPEAKER UNIT.—Quality of reproduction almost equal to a moving-coil speaker.

Cash Price, £3/10/-
 or 5/6 with order and 11 monthly payments of 6/6
B.T.H. PICK-UP AND TONE ARM.—One of the best pick-ups available.

Cash Price, 45/-
 or 5/- with order and 9 monthly payments of 5/-
NEW BLUE SPOT 66R UNIT.—The finest balanced armature movement on the market. Complete with large Cone and Chassis.

Cash Price, £2/10/-
 or 5/- with order and 10 monthly payments of 5/-
 Send list of requirements and quotation will be sent by return.

LONDON RADIO SUPPLY CO.
 11 OAT LANE, NOBLE STREET
 LONDON, E.C.2
 Telephone: National 1977

ELEX

Price **5/6**
FOR BETTER RECEPTION
ELEX MOISTURE RETAINING EARTH BOWL



Supplied with 9-ft. rubber-covered lead connector, price 5/6 each.
 Write for List P87
J. J. EASTICK & SONS, Elex House, 118
 Bunhill Row, E.C.1

NEW! Improved Elex Testing Prods



Invaluable for testing a wireless receiver and circumventing all possibilities of shock, burnt-out valves or damage to other components. In red and black, 3/6 per pair.
 Phone Hvt. 0314/5

"A.W." Solves your Wireless Problems

PREPAID ADVERTISEMENTS

Advertisements under this head are charged THREEPENCE PER WORD, minimum charge THREE SHILLINGS. DEPOSIT SYSTEM

AGENTS WANTED to sell well-known H.T. Units, etc., for cash or easy terms. Prices are very competitive and good commission is offered.

CHARGE YOUR H.T. FROM YOUR L.T. AT HOME. Reliable, convenient, effective, trickle charge, set on or off. Equipment and diagram complete.

THOUSANDS OF RADIO BARGAINS (Bankrupt Stock). Telsen Ace, 5/11; Grand, 7/11; Triotron Valves, 3/11; Power, 4/11; differentials, 1/9; variable condensers, .0003 or .0005, 2/-; Ormond units, 8/11; sprung valveholders, 6d. each; H.F. chokes, 1/-.

WANTED.—Ferranti Transformers, Chokes, etc.; also R.I. Varley. Cash or offer per return.—Johnsons, 86 Gt. Portland Street, W.1. Mus. 7852.

FIRST-CLASS PORTABLE CASES, suitcase and oak and mahogany types, all made for "Classic" Radio (in liquidation). Hide, 15/-, 15 by 12 by 8 deep. Blue fabricoid and fancy design, 7/6 to 15/-, latter fitted fret and drilled chassis.—G. A. Knyall, 192 Kennington Road, London.

CENTURY SUPER KITS, £4/10/6; Pop-vox kits, £4/10/-. Comet Three kits, £2/9/-. Kits include cabinets. All wireless goods supplied at lowest prices.

ENGINEERS, we offer you the finest and most complete book on Engineering Careers ever compiled, absolutely free of charge. This book contains 180 pages of invaluable information and advice. It also contains details of B.Sc., A.M.I.C.E., A.M.I.Mech.E., A.M.I.E.E., A.M.I.A.E., A.M.I.Struct.E., M.R.San.I., L.I.O.B., F.S.I., G.P.O., C. & G., etc. Exams, outlines home-study courses in all branches of Civil, Mechanical, Electrical, Motor, Wireless, Aeronautical, and Talkie Engineering, and explains the unique advantages of our special Appointments Department.

"ELDORADIO" AUTOMATIC LIGHTNING PROTECTOR, for use with outdoor aerials. A long overdue invention. Price 2/6 post free, or send for free illustrated folder. Money returned if dissatisfied. Obtainable only from Eldorado Mfg. Co., 93 Vancouver Road, Edgware.

FREDERICK PATERSON, late Burndept Service Engineer; radio sets, apparatus, made, modernised, repaired. Full guarantees. Any set, kit, component, sent C.W.O. or C.O.D. 7 Lisle Street, W.C.2.

PHOENIX THREE-VALVE kit complete with cabinet, £1/17/6. Ditto with valves, £2/15/-. Ditto with H.T. and L.T. batteries and speaker, £4/19/6. H.P. terms on kit: 10/5 deposit, 2/7 per week. Phoenix, 314 High Road, Lee, S.E.13.

BARGAINS.—Shop-soiled and partly used components, sets, speakers, etc., all guaranteed perfect electrical condition. Supplied on 7 days approval against cash. Send list your requirements. Bostock & Stonnill, 1 Westbourne Terrace, S.E.23.

EXPERIMENTER must clear set; super-het. coils, 39/-; 2 J.B. condensers, 13/6; mains transformer, 15/6; 30-henry chokes (5); 6/6 each; 4-gang Tub 0005, 22/6; 3-gang ditto, £1; A.F.3, 15/-; Telsen Radiogrand, 5/-; 7-1 transformer, 5/6, etc. Unused, unboxed. Also J.B. Chassmount, £1; set Ether Searcher Colvern coils, 15/6; valves, transformers, pick-ups, etc., C.O.D. or deposit. Ransome, 6 Cyprus Avenue, N.3.

PAILLARD INDUCTION MOTORS (4), suitable 100-250 volts 50 cycles. Brand new. Complete with Autostop and 12-in. turntable, 36/-; B.T.H. pickup and arm (4), 32/-; Resa, 2a New Road, Brentwood.

BANKRUPT BARGAINS.—List free with 3-valve diagram. Century Super Kit, 84/-. 3-valve Kit with Cabinet, 35/-; 2-valve, 24/-. Speaker Kits, Eliminators, Valves, etc. .0005 Variable, 2/8; Differentials, 2/6. Dual Coils, 5/-; S.M. Dials, 1/6. Transformers, 2/9; Telsen A.C.E., 6/6; Radiogrand, 9/6. 3-valve Sets complete, 37/6, or with valves and batteries, 62/6. Speaker Units: Bullphone, 9/6; Triotron, 9/6; Millgate, 6/6.—Butlin, 143b Preston Road, Brighton.

BRUCE'S mains transformers specially designed and suitable for the "W. James Super 60," price 25/6. Fully guaranteed. Write for our lists. Bryce's Transformer Dept., Dawson Street, Bury, Lancs.

ANOTHER REVIVAL

THE super-het. promises to be first favourite with the up-to-date listener during the coming season, chiefly on account of its clear-cut selectivity. Another old favourite which may also stage a "come-back" in the near future is the super-regenerator. This circuit is particularly suited for the reception of very short waves, and there are already indications of interesting developments taking place in this direction.

THE IDEAL SUMMER SET—100 STATIONS AND BATTERY BOTHERS ABOLISHED—BUILD THE ALL-MAINS "CENTURY"

The vaudeville programme on June 16 (Regional) and 19 (National) includes Jack and Claude Hulbert in another of their clever fraternal turns.

For the first time Cornelia Otis Skinner, the American diseuse, will appear before the B.B.C. microphone on June 15, when National listeners are to hear her in a vaudeville programme.

Portland Cement, a Concrete Case for Broadcasting, is the title of a Charles Brewer revue which listeners to the Regional and National transmitters are to hear respectively on June 18 and 20. The background of Portland Cement is the nearly completed headquarters of the B.B.C. in Portland Place. Clapham and Dwyer will take part in the broadcast.

"Amateur Wireless and Radiovision." Price Three-pence. Published on Thursdays and bearing the date of Saturday immediately following. Post free to any part of the world: 3 months, 4s. 6d.; 6 months, 8s. 9d.; 12 months, 17s. 6d. Postal Orders, Post Office Orders, or Cheques should be made payable to "Bernard Jones Publications, Ltd."

General Correspondence is to be brief and written on one side of the paper only. All sketches and drawings to be on separate sheets.

Contributions are always welcome, will be promptly considered, and if used will be paid for.

Communications should be addressed, according to their nature, to The Editor, The Advertisement Manager, or The Publisher, "Amateur Wireless," 58-61 Fetter Lane, London, E.C.4.

KONDUCTITE

(Proc. Patent 481731) METALLIC PAPER

Konductite consists of a thin sheet of aluminium mounted on a comparatively stiff backing paper and has all the advantages of sheet metal. It is very easy to work with and infinitely superior to tin or copper foil. It is now specified in all leading circuits.

For Covering Baseboards: Back of Panels: Linings of Cabinets and all Screening purposes

In sheets measuring 30" x 20" 2/-. Postage and packing 6d. extra Free sample on receipt of stamped addressed envelope GRAMO-RADIO APPLIERS LTD., 1a NEW LONDON ST., E.C.3 'Phone: Royal 4300

FULL-SIZE BLUEPRINTS

When ordering, please send Postal Order, NOT STAMPS.

CRYSTAL SET (6d.) B.B.C. Crystal Set ... AW236

ONE-VALVE SETS (1s. each) Regional Ultra-selective One ... AW278 B.B.C. One ... AW280 Hartley One ... WM198

TWO-VALVE SETS (1s. each) Talisman Two (D, Trans) ... AW194 No-battery A.C. Mains Two (D, Trans) ... AW238 No-battery Gramo-radio 2 (D, Trans) ... AW239 Arrow Two (D, Trans) ... AW249

THREE-VALVE SETS (1s. each) 1930 Clarion Three (SG, D, Trans) ... AW223 Beginner's Regional Three (D, 2LF) ... AW233 The "A.W." Exhibition 3 ... AW247

FOUR-VALVE SETS (1s. 6d. each) Regional Band-pass Four (SG, D, RC, Trans) ... WM216 Five-Point Four (SG, D, RC, Trans) ... WM222

FIVE-VALVE SETS (1s. 6d. each) James Quality Five (2SG, D, RC, Trans) ... AW227 Companion Portable (2HF, D, RC, Trans) ... AW279

SIX-VALVE SETS (1s. 6d. each) Century Super (Super-het) ... AW287 A.C. "Century Super" (Super-het) ... AW295

AMPLIFIERS (1s. each) "A.W." Gramophone Amplifier ... AW205 Two-valve Amplifier ... AW216

PORTABLE SETS Continental Portable (SG, D, Trans) ... AW241 1/- Companion Portable (2HF, D, RC, Trans) ... AW279 1/6

MISCELLANEOUS (1s. each) Handy L.T. and G.B. Unit for A.C. Mains ... AW254 Our H.T. Unit for A.C. Mains ... AW262

Copies of the "Wireless Magazine" and of "Amateur Wireless" containing descriptions of any of these sets can be obtained at 1s. 3d. and 4s. respectively, post free. Index letters "A.W." refer to "Amateur Wireless" sets and "W.M." to "Wireless Magazine."

Amateur Wireless Blueprints Dept., 58-61 Fetter Lane, London, E.C.4.

Amateur Wireless COUPON Available until Saturday JUNE 20, 1931

hear the difference



TYPE S4.
Isophon-MOTOR
Super Power UNIT
A 4-pole balanced armature Super Power Unit, sensitive to the slightest impulse, yet capable of handling an amazing top load power.
27/6

Something more than vivid realism makes itself felt when you hear a MoToR Speaker. Startling clarity, pure and undistorted volume, a generous richness of tone—these things you get in MoToR Speakers to a high pitch of perfection that you cannot realise until you hear it. Then you will be satisfied with nothing less.

Type S5. Isophon-MOTOR Super UNIT
22/6 Compact in size but generously large in power.
MOTOR CHASSIS
with S4 Super Power Unit
C44.12" Cone 42/6
C46.15" Cone 47/6

Northern Distributors
L. KREMNER, Ltd.,
49a Shudehill, Manchester.
HARDMAN & Co. Ltd., The Baum, Yorkshire St., Rochdale; 61 Bridge St., Manchester; 12 Back Lord Street, St. Annes-on-Sea; 25 Trinity Street, Leeds.
Agent for Scotland: —
R. G. J. Nisbet, 133, Rinfrew Street, Glasgow, G.2.

MOTOR

UNITS • CHASSIS • SPEAKERS

TEKADE Radio & Electric LTD.
29, Farringdon Street, London, E.C.4.
Telephone: Central 2482.

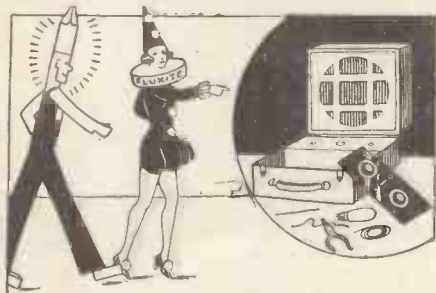

"We're Fluxite and Solder—
The reliable pair,
Famous for Soldering,
Known Everywhere!
If your Set is in trouble,
There's no need to moan,
Let US come and help you
restore it to 'tone'!"

See that Fluxite and Solder are always by you—in the house, garage, workshop—anywhere where simple, speedy, soldering is needed. They cost so little, but will make scores of everyday articles last years longer! For Pots, Pans, Silver, and Brassware; RADIO; odd jobs in the garage—there's always something useful for Fluxite and Solder to do.

All Hardware and Ironmongery Stores sell Fluxite in tins, 8d., 1/4 and 2/8.
ANOTHER USE FOR FLUXITE
Hardening Tools and Case Hardening.
Ask for Leaflet on improved method.

NEW "JUNIOR" SIZE, 4d per tin
FLUXITE SOLDERING SET
Simple to use and lasts for years in constant use. Contains special "small-space" soldering iron with non-heating metal handle; pocket blow-lamp, Fluxite, Solder, etc.; and full instructions.
COMPLETE, 7/6, or LAMP only, 2/3.
FLUXITE, LTD.
(Dept. 323)
ROTHERHITHE, S.E.16

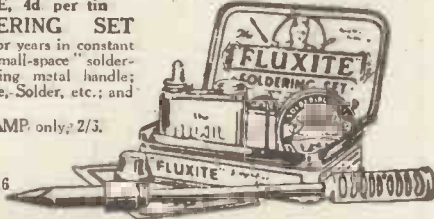

ALL MECHANICS WILL HAVE
FLUXITE
IT SIMPLIFIES ALL SOLDERING

Don't Forget to Say That You Saw it in "A.W."



USE THESE HIGH VOLTAGE CONDENSERS IN YOUR A.C. CENTURY SUPER

Another tribute from the experts this time from the designers of the A.C. CENTURY SUPER. They know that a breakdown of a high voltage condenser may have serious consequences. That's why they specify Dubilier, the condensers whose infallible reliability is proved in service. Be sure you use Dubilier Type LSB 4 mfd. Condensers in your A.C. Century Super. These Condensers are tested at 800 volts D.C. Price, each **8/6**

DUBILIER
CONDENSER CO. (1925) Ltd.
DUGON WORKS, VICTORIA RD., NORTH ACTON, LONDON, W.3

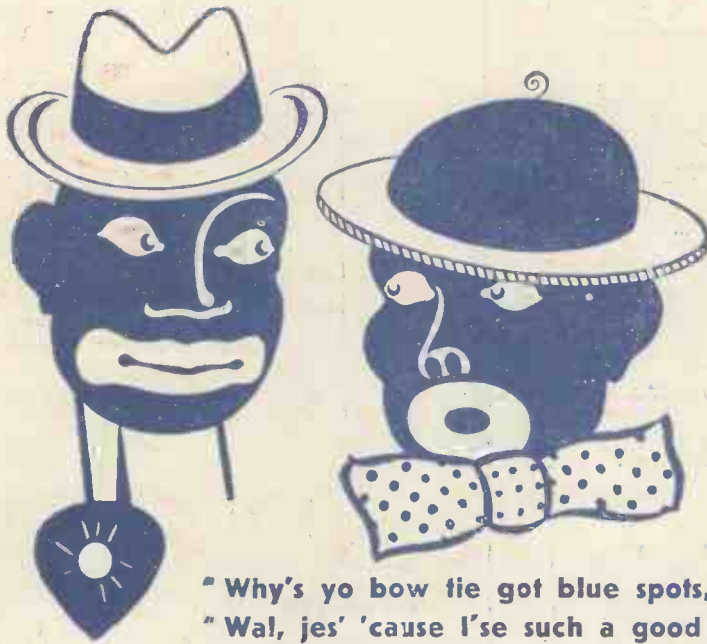

"Why's yo bow tie got blue spots, unconscious!"
 "Wal, jes' 'cause I'se such a good speaker, yo black pudden!"

If you like VAUDEVILLE and want to enjoy it thoroughly you must have a good speaker. There's nothing more annoying than losing the point of a good joke or a new "wise-crack" because your speaker chooses that precise moment to blare or blur, to splutter or squeak.

That's the beauty of a BLUE SPOT Speaker. It never lets you down; you can listen for a whole evening with complete enjoyment. Every spoken word, every song, every note of music is reproduced exactly as spoken, sung or played at the studio. A BLUE SPOT Speaker is as near perfection as mortal skill can make it.

Go round and see your dealer—ask him for a demonstration. When you've listened long enough to convince yourself that BLUE SPOT is the best speaker you've ever heard, ask your dealer for his honest opinion. If he can produce a better speaker at anywhere near the same price, you ought to buy it. BLUE SPOT Speakers are available at prices to suit all pockets.

41K . . . 50/₶ 51R . . . 84/₶
 71R . . . 95/₶ 29R . . 116/₶

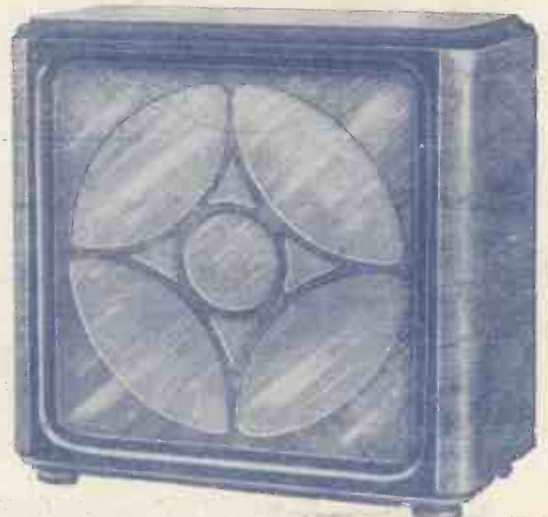

THE BRITISH BLUE SPOT COMPANY LTD.

BLUE SPOT HOUSE :: 94/96 ROSOMAN STREET :: ROSEBERY AVENUE :: LONDON, E.C.1

Phone: Clerkenwell 3570

Grams: "Bluspot, Isling, London."

Distributors for Northern England, Scotland and North Wales:—H. C. RAWSON (Sheffield and London), LTD., 100 London Road, Sheffield; 22 St. Mary's Parsonage, Manchester; 183, George Street, Glasgow.

