

“STOPPING JAMMING” – By the B.B.C. Chief Engineer

“1931 ETHER SEARCHER” FOR MAINS WORKING

Amateur Wireless

Every Thursday 3^d

and
Radiovision

Vol. XVIII. No. 455

Saturday, February 26, 1931

The **“ALL-ELECTRIC
ETHER
SEARCHER”**

**THE SET OF THE SEASON
ADAPTED FOR
MAINS WORKING**

**FULL
DETAILS**

Registered at the G.P.O. as a Newspaper.

INTRODUCING



SPAGHETTI FLEXIBLE RESISTANCES

Like all other "LEWCOS" products, the Spaghetti Resistances maintain a high standard of quality—the result of over fifty years experience in Wire Manufacture.
The terminals of this new product are specially constructed to prevent loose connections and accuracy is guaranteed within five per cent.
The following Lewcos resistances, which are suitable for use in all circuits, are available:—

Resistance Ohms	Capacity M.amps	Resistance Ohms	Capacity M.amps
300	30	10,000	10
400	30	15,000	7.5
500	30	20,000	7.5
750	30	25,000	6
1,000	30	30,000	6
2,000	15	40,000	5
3,000	15	50,000	5
4,000	15	75,000	5
5,000	10	100,000	5
7,500	10		

The value of the resistance is shown on the sleeve)
"If it's 'LEWCOS' it must be good"

Six Lewcos Spaghetti Resistances are specified for the "1931 All-Electric Ether Searcher" Receiver described in this issue.



THE LONDON ELECTRIC WIRE COMPANY AND SMITHS LIMITED
Church Road, Leyton, London, E.10

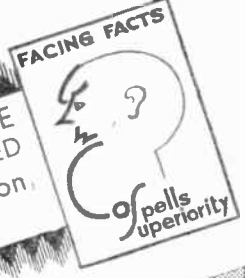

Don't Forget to Say That You Saw it in "A.W."

Your ambition is to get the best out of your set

It is our function to help you to realise your ambition. This we do by bringing to your notice **TELSEN Components**, and by proving their superiority.

All **TELSEN Components** are scientifically designed and built by expert radio engineers—they incorporate many patented features—they anticipate radio requirements—have exceptionally long life—they not only ensure true reproduction, but give tremendous power—they are consistently incorporated by expert set designers throughout the country.

Your ambition will be more than realised if, when buying components you insist on **TELSEN**.

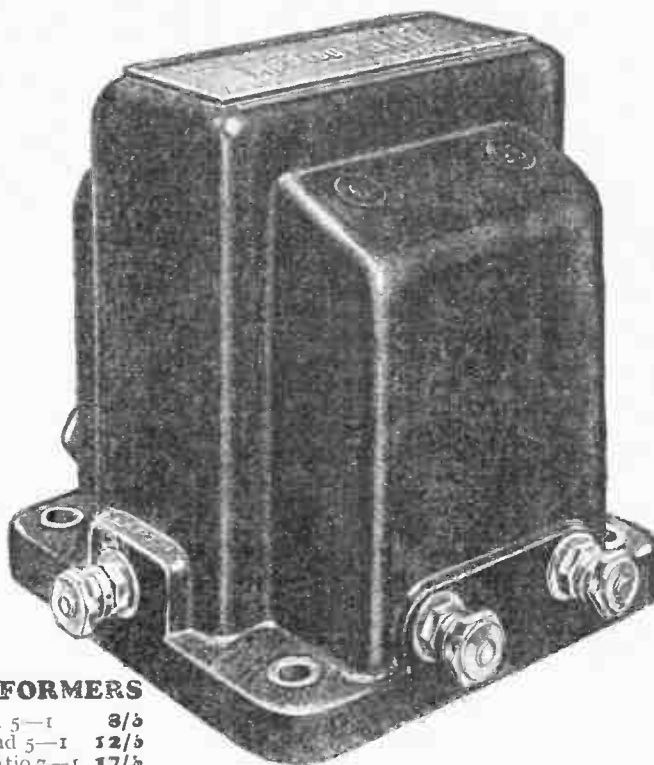

Telsen Four-pin Valve Holders. Price 1/- each.

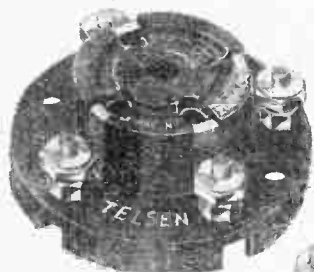

TELSEN L.F. TRANSFORMERS

- "ACE" Ratios 3-1 and 5-1 3/6
- "RADIOGRAND" 3-1 and 5-1 12/6
- "RADIOGRAND" Super Ratio 7-1 17/6

Telsen Five-pin Valve Holders. Price 1/3 each.



Telsen Valve Holders. Pro. Pat. No. 20286/30. An entirely new design in Valve Holders, embodying patent spring metal contacts, which are designed to provide the most efficient contact with the valve legs, whether split or non-split. Low capacity, self locating, supplied with patent soldering tags and hexagon terminal nuts.

Telsen Fixed (Mica) Condensers. Shrouded in genuine bakelite, made in capacities up to .002 mfd. Pro. Pat. No. 20287/30. .0003 supplied complete with patent grid-leak clips, to facilitate series or parallel connection. Can be mounted upright or flat. Tested on 500 volts. Price 1/- each.

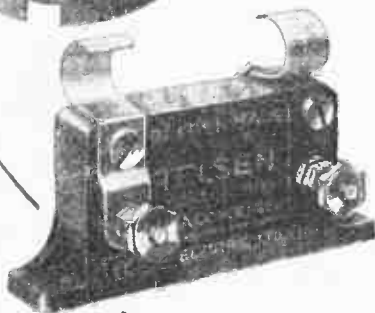

Telsen H.F. Chokes. Designed to cover the whole waveband range from 18 to 4,000 metres, extremely low self capacity, shrouded in genuine bakelite. Inductance. 150,000 microhenries; resistance. 400 ohms. Price 2/6 each.



Telsen Grid Leaks. Absolutely silent and non-microphonic, practically unbreakable, cannot be burnt out, and are unaffected by atmospheric changes. Not being wire wound, there are no capacity effects. Made in capacities. 1, 2, 3, 4, and 5 megohms. Price 1/- each.

TELSEN COMPONENTS

Advt. of Telsen Electric Co., Ltd., Birmingham

Please Mention "A.W." When Corresponding with Advertisers

Better and more beautiful

This new Undy model is not only a masterpiece in modern artistic furniture but in loudspeaker design and loudspeaker performance. The more critical the examination the more definitely convinced you will be that there is no speaker equal either in finish or results to this new Undy product. Indeed no other speaker can claim such true tone reproduction. Gives satisfactory results with any set large or small.

Only the Undy—the 8 pole speaker gives a definite reproduction of all frequencies found in music or speech.

The New Speaker

WITH THE

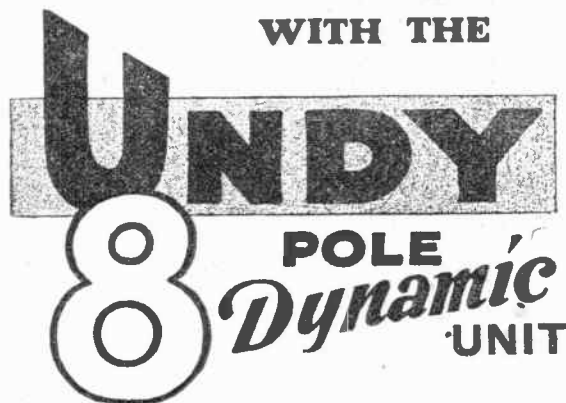

Ask for demonstration at any wireless stores.

British Patent No. 386,930

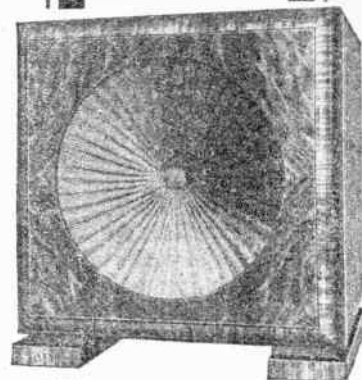

70/-

W. JAMES' LATEST—THE "SUPER 60"

Full constructional details of the "Super 60," the finest set ever described in WIRELESS MAGAZINE, are contained in the March issue now on sale. It is a revolutionary 6-valve super-het that gives over 60 stations at full loud-speaker strength, without any interference.

Simple to construct, amazingly selective, it has only TWO tuning dials, takes no more current than the average 3- or 4-valve set, and is astonishingly inexpensive to build—£12 includes valves, frame, aerial and cabinet.

A SUPER set in every sense of the word!

WORLD'S BROADCAST GUIDE

SIXTEEN-PAGE SUPPLEMENT containing complete list of European and short-wave stations with spaces for recording dial readings; three pages of maps; special medium- and long-wave

tuning charts—an indispensable directory for every listener.

More than sixty interesting and instructive articles are also included in the March issue of

WIRELESS MAGAZINE

GET YOUR COPY OF THE MARCH ISSUE NOW ON SALE - - - - - PRICE 1/-

You will Help Yourself and Help Us by Mentioning "A.W." to Advertisers

H & B

ALL-ELECTRIC 1931 ETHER SEARCHER GUARANTEED KITS THE SECRET

58, 61 Fetter Lane,
London, E.C.4.
February 2nd, 1931.
Messrs. H. & B. Radio Co.,
34, 36, 38 Beak Street,
Regent Street, W.1.

Dear Sirs,

We have tested a model of the "1931 Ether Searcher" constructed by you to our specification and drawings and have pleasure in saying that it is well and accurately made.

In testing it we referred to the scale given in our January 31st issue, and found that the stations came in at the identical readings there shown.

We note that the coil screens are sturdier than formerly and are to be commended.

Yours faithfully,
BERNARD JONES,
Editor.

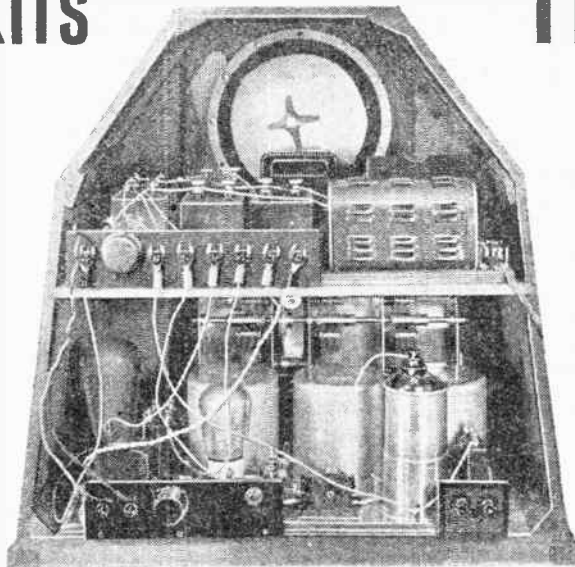

of the Ether Searcher is the Screening. . .
Mr. SIEGER uses H. & B. SCREENS Exclusively

A.C. 1931 ETHER SEARCHER

	£	s.	d.
Baseboard, 16 in. by 10 in. (H. & B.)	1	0	
Panel, 8 in. by 6 in. (Trellborg)	2	0	
Three-gang, 0.005-mfd. Variable Condenser, with drum dial (J.B. Chassinont)	1	15	0
.0003-mfd. Variable Series Aerial Condenser (Polar)	3	0	
.0001-mfd. Variable Reaction Condenser (Polar)	3	0	
Set of three Matched Coils, with gauging switch (two colvern type TGSC and one type TGSB)	1	10	0
Low-frequency Transformer (Telsen "Ace," ratio 5 to 1)	8	6	
.01-mfd. Fixed Condenser (T.C.C. flat type)	2	6	
.002-mfd. Fixed Condenser with grid-leak clips (T.C.C.)	2	3	
.0002-mfd. Fixed Condenser (Telsen)	1	0	
.0003-mfd. Fixed Condenser (Telsen)	1	0	
Three 1-mfd. Fixed Condensers (Dubilier)	7	6	
2-mfd. Fixed Condenser (Dubilier)	3	6	
Three Five-pin Valve Holders (Telsen)	3	9	
High-frequency Choke (Telsen)	2	6	
Two 2-megohm Grid Leaks (Telsen)	2	0	
Grid-leak Holder (Lissen)	6		
Three Coil Screens and S.G. Valve Screen (H. and B.) (SPECIFIED)	7	0	
Aluminium Foil Sheet, 15 1/2 in. by 9 1/2 in. (H. & B.)	3		
Terminal Block (Junit)	8		
Ebonite Strip, 7 in. by 2 in. (Trellborg)	1	0	
Four Terminals, marked: A, L, L.S. (2) (Belling-Lee)	1	6	
Pick-up Jack (Lotus type 3JK)	2	3	
15-ohm Potentiometer for panel mounting	2	6	
600-ohm, 1,000-ohm, and 100,000-ohm Spaghetti Resistances (H. & B.)	4	3	
1,000-ohm Wire-wound Resistance (Claude Lyons)	1	3	
Low-frequency Choke, 20 henries (Lissen)	12	6	
Two yards of thin Flex (Lewcoflex)	3		
Seven Spade Terminals, marked: H.T., H.T.-1, H.T.-2, H.T.-3, H.T.-4, L.T. (2) (Glix)	1	2	
Connecting Wire and Sleeving (H. & B.)	1	3	
CASH PRICE	£7.4.10		

ORDER TO-DAY
NO DELAY THE
H. & B. WAY.

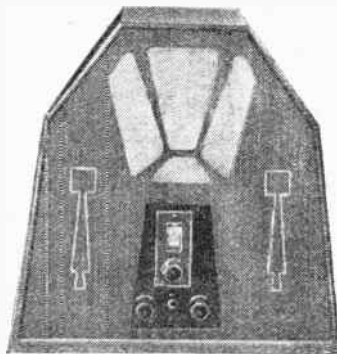

H. & B. CABINET
£1. 16. 6

Built to Specification.

Supplied by return

TRADE SUPPLIED

A.C. UNIT FOR 1931 ETHER SEARCHER

	£	s.	d.
Baseboard, 16 in. by 17 1/2 in. (H. & B.)	1	6	
Mains Transformer, with secondary windings for 4-volt filament and H.T.7 Westinghouse rectifier (Regentone, type WR.7)	1	8	0
Westinghouse Metal Rectifier, type H.T.7	1	1	0
20-hour Smoothing Choke (Varley)	1	1	0
Three 1-mfd. Fixed Condensers (400-volt working) (Dubilier)	18	9	
Three 2-mfd. Fixed Condensers (Dubilier)	7	6	
120,000-ohm Variable Wire-wound Resistance (Regentone)	9	6	
20,000-ohm Spaghetti Resistance (H. & B.)	1	3	
30,000-ohm Spaghetti Resistance (H. & B.)	1	6	
Ebonite Strip, 9 in. by 2 in.	1	0	
Seven Terminals, marked: H.T.-1, H.T.-2, H.T.-3, H.T.-4, L.T. (2) (Belling-Lee)	3	0	
Three yards of Mains Flex (Lewco)	2	0	
Thin Connecting Wire and Sleeving (H. & B.)	1	0	
Hex Switch (Belgion)	2	0	
Double Fuse Holder	2	6	
CASH PRICE	£6.1.6		

BATTERY MODEL

ANY PART SUPPLIED SEPARATELY. EVERY KIT ORDER DISPATCHED THE SAME DAY. TRADE SUPPLIED. Terms:—Carriage paid on all retail orders. C.O.D. charges paid on all orders over £1

H & B GUARANTEED KIT, Cash Price £5. 13. 7
3 Mullard Valves £1 : 19 : 0 extra ; Oak Cabinet £1 : 1 : 0 extra.

H & B RADIO CO.

34, 36, 38, BEAK ST., REGENT ST., LONDON, W.1.

Telephone: GERRARD 2834

210 H.L.



Designed for more efficient H.F. Amplification

The New Cossor 210 H.L. affords to all users of non-screened grid Receivers an opportunity of materially improving the performance of their Sets. Its favourable grid current characteristics enable it to give an unusual degree of H.F. amplification without the use of grid bias. Its advanced constructional features (described in detail below) result in great mechanical strength, which ensures exceptionally long life. And, by employing the famous seven point system of filament suspension the New Cossor 210 H.L. is rendered definitely non-microphonic. The use of this valve will considerably increase the efficiency of any non-screened grid Receiver.

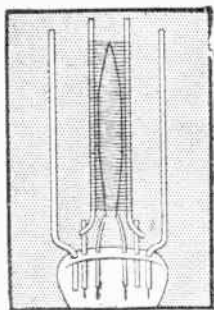

SEVEN POINT SUSPENSION

Practical experience has shown that the Cossor 7 point suspension system definitely eliminates microphonic noises. This system is employed in the support of the exceptionally long filament of the Cossor 210 H.L.

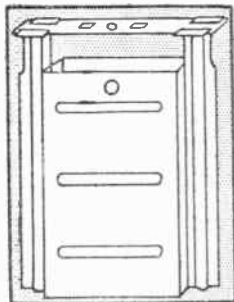

MICA BRIDGE MOUNTING

Permanent alignment of the electrode system is ensured by a stout mica bridge which forms an integral part of the anode assembly. When finally secured in position the whole structure becomes one interlocked unit.

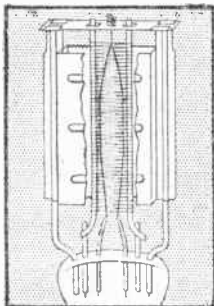

UNIFORM PERFORMANCE

The Cossor mica bridge construction permits no variation of characteristics due to differences in inter-electrode spacing. Complete uniformity of performance is therefore ensured between all valves of the same type.

The new Cossor 210 H.L. 2 volts, 1 amp. Impedance 22,000. Amplification Factor 24, Mutual Conductance, 1.1 m.a.v. Anode voltage 8/6 75-150. Price

THE NEW COSSOR 210 H.L.

Be sure to get one of our novel, circular Station Charts, which give identification details of nearly 50 stations with space for entering your own dial readings. Ask your dealer for a copy, price 2d. or send 2d. stamp to us and head your letter "Station Chart, A.W."

A. C. Cossor Ltd., Highbury Grove, London, N.5

7719

Advertisers Appreciate Mention of "A.W." with Your Order



Amateur Wireless

and
Radiovision

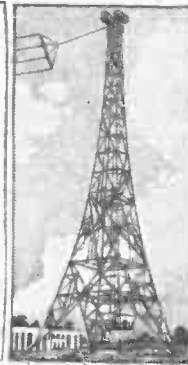

EDITOR:
BERNARD E. JONES.

TECHNICAL EDITOR:
J. H. REYNER, B.Sc., A.M.I.E.E.

RESEARCH CONSULTANT:
W. JAMES.

ASSISTANT EDITOR:
H. CORBISHLEY.

THE LEADING RADIO WEEKLY FOR THE
CONSTRUCTOR, LISTENER & EXPERIMENTER.

NEWS · & · GOSSIP · OF THE · WEEK

OUR GREAT COMPETITION

WHAT about your entry for the "Ether Searcher" Competition? Already many entries have been received, and the Technical Staff is starting on the difficult job of selection. Every "Ether Searcher" builder *must* make a point of taking part in this simple competition, which is open to every amateur constructor. We are offering fifteen cash prizes, totalling £50, and, in addition, there will be a number of small commendation prizes for the owners of sets the performance of which is not quite up to winning standard. Turn to page 361 for full particulars of the competition, and get busy on your set now.

B.B.C. FINANCE

WHEN the question of subsidising opera by money taken from the B.B.C.'s licence revenue was discussed in Parlia-

ment some time ago, the Postmaster General stated that the B.B.C.'s licence was up for revision. Although the B.B.C. will undoubtedly need more money for the development of its Regional Scheme and for the improvement in National and Regional programmes, nothing definite has yet been settled by the Treasury officials. The sum of £200,000 has been mentioned as a figure likely to indicate the amount of increased revenue coming to the B.B.C., but this is, so far as we are able to learn, pure speculation.

PROGRAMME COSTS

IN view of the fact that the B.B.C.'s policy of centralisation has advanced appreciably during the past year, the question has been asked as to whether the B.B.C. is thereby saving money on programmes. On the contrary, Savoy Hill tells us that

PRINCIPAL CONTENTS

	Page
News and Gossip	345
What we Talked About at Sem- mering	347
Voltage Regulators	348
Watching Your Loud-Speaker Work	349
A Talkie and O.B. Comparison ...	350
On Your Wavelength	353
Wanted—New Curves for Power Valves	355
For the Newcomer	356
In my Wireless Den	359
At Radio Velthem	360
Faults in Transmission	362
Without Fear or Favour	363
The "All-Electric 1931 Ether Searcher"	364
Receiving in Berlin	370
Grid Stoppers in L.F. Amplifiers	372
The Electroset Two-Valver	374
We Test for You	376

ENGLAND'S RECORD-BREAKER BROADCASTS



During his speed-making trip in America, Malcolm Campbell had frequently to face the microphone and talkie camera—and when he returned he was rushed off to the B.B.C. microphone! Here he is making a talkie, standing by "Bluebird"

programmes cost more now than when all the relays were working and sending out programmes of local interest. The reason for this increased expenditure is due to the general improvement in the standard of the programmes. And one must not overlook the fact that the B.B.C. Symphony Orchestra costs over £100,000 per annum.

NO SOUND YET

REPORTS that the North Regional station has been heard testing are incorrect, because up to the time of going to press the only signal that has been sent out from the Moorside Edge site has been from a little experimental transmitter of less than 100 watts power. This has sent out a carrier wave to provide the B.B.C. engineers with general radiation data. The usual rumours prior to the opening of a new B.B.C. station are now coming thick and fast from the north. Possibly by the time this is read preliminary tests of the actual North Regional gear will be taking place. But they will be on low power and not intended for public participation. We may expect an announcement regarding the public test times during the second or third week of March.

NEWS · & · GOSSIP · OF THE · WEEK —Continued

STILL THEY GROW

WHETHER the B.B.C.'s Regional Scheme is liked or not seems to be indicated by the fact that records for January, 1931, show the largest increase for several years, namely 108,627 licences. The total now stands at 3,501,077 for paid licences and there are 19,942 licences issued free to the blind. It is interesting to compare the present total with that of the same period last year. During January, 1931, licences passed the three-and-a-half-million mark, whereas in January, 1930, they passed the three-million mark. This increase is all the more remarkable in view of the general state of depression.

ELECTRICAL INTERFERENCE

FOLLOWING the article in last week's issue, some further facts are now available regarding electrical interference. Over three thousand complaints were received during 1930, of which a considerable proportion were sent to the Post Office for investigation. For ordinary electrical interference large fixed condensers are still the most effective cure. It is interesting to learn that, since the inception of Brookmans Park, fewer complaints of electrical interference have been received from North London. No doubt the increased ratio of signal strength to interference accounts for this improvement.

FORTHCOMING O.B.'s

A LARGE number of sporting events are entered in the Outside Broadcast list for running commentary arrangements in the coming months. On February 28 National listeners will hear Captain Wakeham describe the Wales v. France Rugby International and Regional listeners will have Mr. Allison's story of a match in the sixth round of the F.A. Cup. The Oxford and Cambridge Boat Race on March 21 will be described in a running commentary by Mr. John Snagge, while the scenes on the course during the race will be described by Mr. Holt Marvell. The latter, it will be remembered, did the commentary of Amy Johnson's arrival at Croydon from Australia. Both he and Mr. Snagge are members of the B.B.C. staff. Other future arrangements include commentaries on the Grand National, the semi-final and the final of the F.A. cup, the Derby, and the race for the Schneider Trophy.

RELEASED FOR RADIO

TOM WALLS has written to Denis O'Neil, releasing him from his part in *Marry the Girl* on the nights of March 5 (Regional) and March 7 (National) to enable him to take part in the radio play *Rich Girl, Poor Girl*. This is the first occasion in the history of the B.B.C. that an artiste has been released from his theatre contract to enable him to broadcast. Denis O'Neil will take the character of "Tom" in this radio musical comedy. A few years ago Denis O'Neil's name was frequently in the broadcasting programmes.

A NEW TELEVISION SYSTEM?

RECENTLY a demonstration was given in Paris by M. Barthelemy, of a television device which works successfully on an ordinary set. A report stated that figures were produced in clear relief and in colours, that the image was not blurred, and facial features were sufficiently distinct to permit easy recognition of individuals. It is understood that M. Barthelemy claims his apparatus attains a perfection thus far not reached in other countries, and he says he can televise a complete scene. But—so far, details are not available.

HYJ—THE VATICAN STATION

HYJ the new Vatican transmitter, which was opened by the Pope, and was so much "splashed" by the daily Press, was built at Chelmsford. It works on either 19.84 or 50.26 metres. The first of the four transmitter panels is the main amplifier unit for both waves. The second contains the intermediate amplifiers and the new Marconi-Franklin valve master drive unit for the shorter wavelength. The third panel comprises the intermediate units and master drive unit for the longer wavelength, while the fourth panel is a modulator and keying unit. The transmitter is rated to deliver from 8 to 10 kilowatts to the aerial feeder system, the output depending slightly on the wavelength used.

TWO AERIALS

TWO aerials are provided, one aerial for each wavelength. This type of aerial has been developed by the Marconi Co., and is an improved type of vertical short-wave aerial. Both aerials are suspended between two self-supporting lattice steel towers 200 feet in height and 296 feet apart. The power from the transmitter is conveyed to the two aerials by two separate concentric copper tube feeders similar to those used at the Beam stations. The transmitting building itself is situated near the railway terminus in a part of the grounds in the Vatican which is surrounded by a Roman wall 45 ft. high, and the masts are placed outside this wall. In order not to destroy the amenities of the Vatican gardens a tunnel 141 ft. long passing under the Roman wall has been constructed to accommodate the aerial feeders.

BISHOP'S MITRE MASTS!

EVERY effort has been made to harmonise, so far as possible, the transmitting buildings and aerial towers with the surroundings of the Vatican city. The tops of the masts are finished off to give a Bishop's mitre effect. A special receiver maintains good communication between the Vatican city and practically any part of the world. This receiver is situated in one of the rooms of the transmitting station and uses a vertical aerial placed at a distance of only a few yards from the transmitting aerial. Its length is adjustable from the receiving room. During tests which have taken place during the last week the Vatican station has carried out communication with Australia, India, South Africa, Argentina, Canada, and the United States outside Europe, and with London, Paris, Berlin, and Madrid.

THE NEW STATION

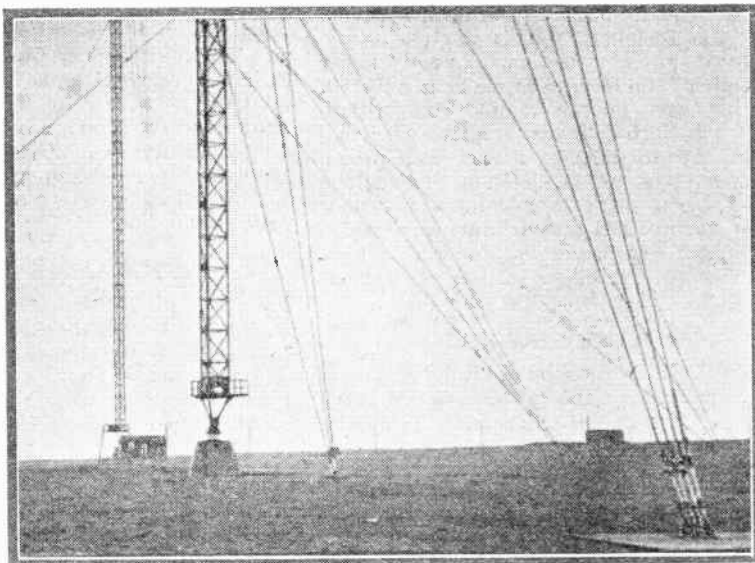

The bases of the huge masts at Slathwaite, from which test broadcasts will be heard in the near future. A small 100-watt experimental transmitter is at present testing on the site

SHORT-WAVE TELEVISION

SOME interesting experiments have just been made by engineers of the National Broadcasting Company in the transmission and reception of television on short waves. These tests were conducted in the heart of New York City and it was found that the waves acted very much like light waves—being easily absorbed, reflected and refracted. They literally bounced around among the steel buildings. Reflected waves caused the television receivers to show two or even more images! With these short wavelengths many "dead spots" were found where little or no signals could be received, these areas of poor reception being due evidently to absorption by steel buildings.

The Radio Maroc programmes are daily relayed to the Rabat short-wave transmitter during the day on 23.8 metres and from 8 p.m. G.M.T. on 32.26 metres.

EXCLUSIVE TO
"AMATEUR WIRELESS"

WHAT WE TALKED ABOUT AT SEMMERING



Tackling the high-power jamming problem, as explained by Mr. NOEL ASHBRIDGE, Chief Engineer of the B.B.C., in an interview with the "AMATEUR WIRELESS" Special Commissioner.

MY first question to the Chief Engineer was why the European broadcasting organisation had recently met at Semmering. I was told that this meeting had not been specially convened through any specific trouble but was one of the usual meetings of the Union Internationale de Radiodiffusion.

The Technical Committee that met at Semmering had to consider proposals concerning broadcasting matters for the C.C.I.R., which takes place at Copenhagen in the summer of this year. There was also a special committee to frame proposals for the International Telegraph Convention, which will take place at Madrid probably in the latter part of 1932.

"Apart from these discussions," stated the Chief Engineer, "we had long talks concerning the growing interference between high-power European broadcasting stations."

Extension of Wavelengths

I gathered that the preparations for the Madrid Conference included proposals for an extension of the present wavelengths allocated to broadcasting. An attempt will be made to obtain longer wavelengths, which are, of course, more capable of giving a service over a wide area than the short wavelengths, particularly in mountainous districts.

"The difficulty at the moment," explained Mr. Ashbridge, "is that several countries in Europe find it impossible to give a truly national programme owing to the attenuation of the short wavelengths allocated to their broadcasting stations."

Readers will recall that, at the Washington Conference in 1927, when the world-wide distribution of wavelengths was last reviewed, broadcasting was a comparative newcomer. It was not nearly so much an essential part of everyday domestic life as now. In view of the world-wide interest taken in broadcasting there is reason to hope that, in spite of contending claims, broadcasters will perhaps gain some concessions in connection with wavelengths above the normal medium band between 200 and 600 metres.

"With regard to the question of interference between high-power stations, particularly those on adjacent wavelengths, discussion at Semmering naturally centred round the interference that has been experienced between the London Regional station and the new high-power Mühlacker station.

"During the week preceding the meeting at Semmering some tests were carried out at Tatsfield by the B.B.C. in conjunction with German engineers. The object of these tests was to find out why the Mühlacker station was causing such bad interference in the London district. Several receivers of different types were used during these tests. It was apparent that the interference could be cut out by highly selective sets. To obtain complete elimination of interference it was necessary to cut off frequencies above 4,000 cycles.

"This naturally affects quality very seriously and is therefore not an acceptable permanent solution of the difficulty. And even under these conditions some side-band interference may be audible at times, although such interference is only slight owing to the comparative weakness of side bands above about 5,000 cycles.

Modulation and Interference

"It also appeared that the amount of interference experienced was roughly in proportion to the depth of modulation of the distant station. Moreover, slight over-modulation did not enormously increase the amount of interference. On the other hand any appreciable amount of over-modulation not only causes an increase of interference, but spoils reception in the service area of the station itself.

"It may be said that the reason Mühlacker disturbs the London station is that the strength of the reflected wave in the London area is unusually great. In fact, the field strength rises at times to four or five millivolts per metre.

"The German engineers are trying to see whether this effect has anything to do with the arrangement of the aerial at Mühlacker. You can say that the Germans are doing everything possible to improve

conditions for us. There is the possibility also that we may be experiencing this trouble through a peculiar condition of the Heaviside layer.

"Similar difficulties are being experienced in America, where, you will remember, most stations have a 10-kilocycle separation. It appears that under certain conditions even 10 kilocycles is not enough separation for high-power stations."

An Experiment

It is realised by the European broadcasting organisations that the interference problem is serious and that the difficulty between Mühlacker and the London Regional is likely to be repeated elsewhere. But they have to bear in mind that some high-power stations in Europe working on adjacent wavelengths do not interfere with each other. A good example is the case with which Rome and Stockholm work side by side in the medium wavelength band in spite of the fact that both stations have power ratings of 75 kilowatts.

"The Conference at Semmering decided to carry out very extensive tests whereby the strength of a large number of European broadcasting stations will be measured in as many countries as possible, probably about fifteen. Working according to a programme already arranged, our object will be to find out whereabouts in Europe the down-coming or reflected wave of any particular station may be expected to be strongest. It is obvious that data of this kind will be a great help should it become necessary to rearrange the wavelengths of European broadcasting stations."

The tests referred to by the Chief Engineer will take two or three months, as a very careful analysis of the measurements will be necessary. Before I left, the Chief Engineer sounded a note of hope to broadcast listeners.

"The difficulties of high-power broadcasting are now fully realised by the broadcasters of Europe. It will not be necessary to wait until every station is interfering with every other station before any attempt is made to remedy troubles due to interference."

THE HOW AND WHY OF RADIO

**XXV—MAINS WORKING—
VOLTAGE REGULATORS**

If you are a beginner in wireless, now is your chance to gain a clear conception of its theory and practice. In this series of articles, specially prepared for the beginner, no previous knowledge of wireless is assumed. It is intended to deal with every aspect of the subject and the whole series will endow the beginner with sufficient knowledge to enable him to derive the greatest possible interest from the fascinating hobby of wireless

NOW for voltage regulators; in the normal set only the last valve needs the maximum voltage of the mains unit, the preceding stages of high-frequency and low-frequency amplification working with much lower anode voltages. The most straightforward way of dropping the maximum voltage to a lower voltage is shown by Fig. 1. Here is a resistance in series between the positive side of the maximum output and a terminal marked "+ Sub."

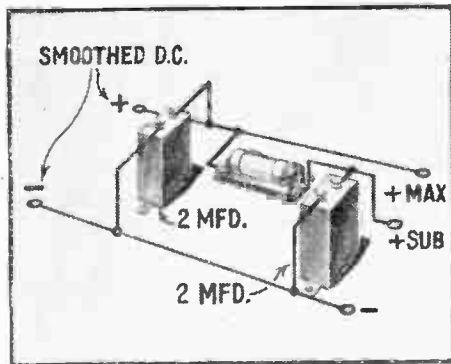

Fig. 1. The series-resistance method of dropping voltage

This subsidiary terminal will provide a certain voltage with respect to the negative output, this voltage depending upon the value of the resistance and the current flowing through the resistance. Now, the current flowing through the resistance will be the anode current of the valve whose anode goes to "+ Sub." Suppose the

maximum voltage is 200 volts, the subsidiary voltage wanted is 120 volts, and the anode current is 3 milliamperes. Knowing these facts, we can easily ensure the required drop of 80 volts by applying our old friend Ohm's Law to the simple problem of fixing the value of the series resistance.

Voltage Drop

By Ohm's Law we know that resistance in ohms equals potential drop in volts divided by the current in amperes flowing through the resistance. So in our example,

$$R = \frac{E}{I} = \frac{80}{\frac{3}{1,000}} = 1,000 =$$

27,000 ohms approximately.

To feed the anode of a valve with less voltage than the maximum therefore involves a very simple sum to find the right voltage drop in the resistance. Once again, resistance in ohms equals volts to be dropped divided by current in amperes. As the anode current is always in milliamperes (thousandths of an ampere), we have to multiply the answer by 1,000.

Another Method

Another method of voltage dropping is shown at Fig. 2. This is called the potential-dividing method, sometimes used when the series-resistance method would be inconvenient, but rather prone to cause unstable results unless precautions are taken in the set. The two ends of the winding of the potentiometer are connected across the output, the slider and the negative end

forming the subsidiary output. The current flowing through the potentiometer winding is kept down to a low value by making the resistance high.

Note that the value of the resistance in this circuit has little to do with the value of the subsidiary voltage, which depends on the position of the slider along the potentiometer winding. From the positive to negative ends of output there is a progressive fall of potential; thus at the mid

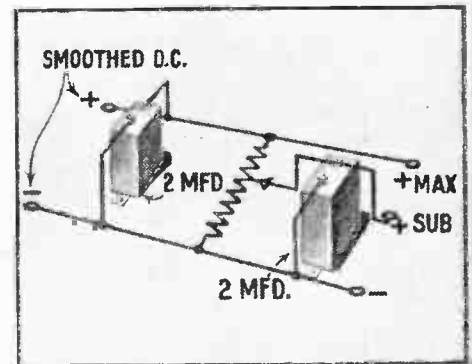

Fig. 2. An alternative method of dropping voltage making use of a potentiometer

point the subsidiary output would be half the maximum; two-thirds of the way towards negative the subsidiary output would be one-third of the maximum, and so on. Note that, in the Fig. 1 and Fig. 2 circuits, condensers are shunted across the subsidiary and negative terminals.

HOTSPOT.

A FEW days ago a friend, who has just taken up short-wave work, asked me if it was really necessary to use any particular type of aerial for short-wave reception and, if so, what was the best type to use? Some people tell you that they get excellent results with just any kind of aerial, and others state that some particular type is necessary for use on the short waves. An instance of this is shown in the peculiar construction of the aerials used for beam reception. Anybody might state perfectly truthfully that they can receive the beam signals on their own receivers at a shattering strength merely by attaching a few yards of wire to the aerial terminal, and yet at the beam receiving stations complicated aerial systems are used, which to the ordinary listener may appear to be quite unnecessary.

**AROUND THE
SHORT-WAVE DIAL**

The truth is that, as far as the ordinary amateur is concerned, he cannot do better than follow the conventional rules and erect as efficient an aerial as he possibly can. The amateur experimenter generally demands that his short-wave receiver be capable of reception on, or over the whole of the short-wave band from, say, 15 to 100 metres, and the usual type of aerial, provided that its efficiency is the maximum possible under normal usual conditions, will give the best possible results for this type of receiver. At the same time, it must not be forgotten that it is certainly possible to design an aerial of some par-

ticular type which will give results better than the usual type, but this type of aerial can only be used over a limited waveband. Thus, a number of aerials, each designed to work efficiently on a certain limited range of wavelengths, would be necessary. So it will easily be seen that for ordinary amateur use the usual single aerial of multi-stranded wire, will provide the most satisfactory results.

It is gratifying to the amateur to notice that manufacturers are at last paying some attention to the needs of the short-wave enthusiast. In the United States, manufacturers have been very quick in responding to the demand for short-wave receivers and apparatus. Many are now making short-wave super-heterodyne adaptors, intended for use with their own particular type of broadcast receiver. M.B.

WATCHING YOUR LOUD-SPEAKER WORK

A novel experiment that will enable you to observe the complex vibrations of your loud-speaker diaphragm

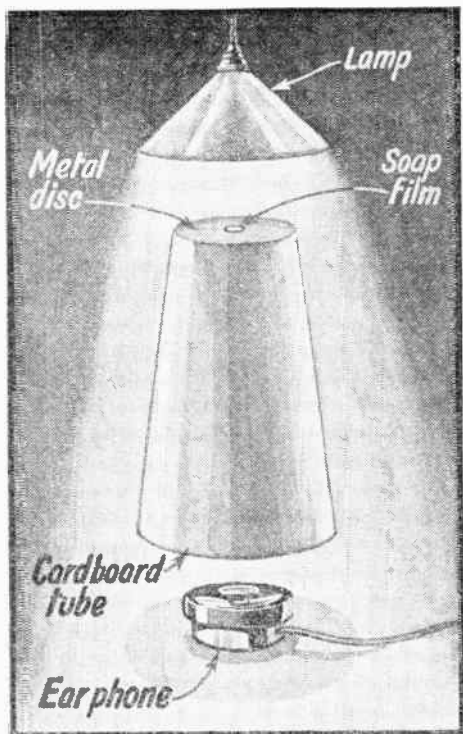

IS there any way by which the ordinary listener, without laboratory facilities, can form some mental picture of the types of vibration taking place in the diaphragm of a loud-speaker? It is comparatively easy to picture the rapid vibration of a taut string or the legs of a tuning-fork when pure or fundamental notes are being sounded, but it is quite beyond the powers of most of us to imagine what complicated vibrations (say those produced when the Gershom Parkinson quintet are playing) look like.

Simple Stylus Vibrations

It is sometimes stated that the indentations on the grooves of gramophone records, if presented in graphic form will show us the type of such vibrations, but this is not strictly true. What we see in the record graph is the necessary variation in the impulse that must be given to the stylus or needle to set the whole body of the soundbox diaphragm into the remarkable gymnastics necessary for the production of complex sound waves in the air. First of all we must grasp the fact that the vibrations of a diaphragm-actuating stylus are altogether different from those of the diaphragm itself. It is just as different as are the movements of the fingers of a pianist compared to those of the strings of the piano itself. The movement of the stylus is the sum total of movement in two directions only—from side to side—as graphically shown in Fig. 1. On the other hand, it is quite impossible to form a simple single-line representation of the movements of a diaphragm for the simple reason that it does not move as a whole, but as an almost infinitely variable number of separate sections.

The effect of the impulses given to the diaphragm by the movements of the stylus is to cause separate sections of the diaphragm to go into particular rates of vibration so that we get an heterogeneous group of air-waves produced simultaneously. We must, therefore, clearly distinguish

the graphic wave-form represented in the groove of the gramophone record as quite distinct and different from that of the vibrating diaphragm. We must realise that sound waves are not comparable with a train of dissimilar coaches all connected together and travelling continuously in one straight line, but are more comparable to hundreds of different trains of various characters and lengths, all travelling on parallel lines. At one instant there may be one hundred or more of these trains travelling in association and all arriving together on the ear-drum of the listeners, while at the next instant but three or four trains travelling and arriving in association.

Making Sound Vibrations Visible

If this is a little difficult to comprehend mentally, there is a way of making complex sound vibrations easily visible by means of a simple piece of apparatus shown above.

This merely consists of a soap-bubble film stretched across a circular aperture in a metal plate which is attached to a

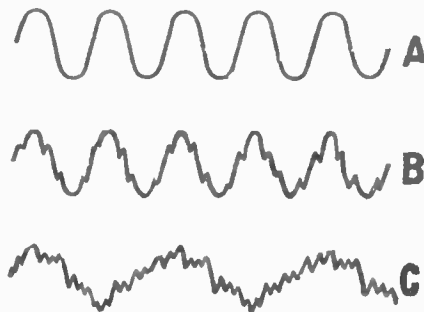

Fig. 1. Diagrams showing the movement of the gramophone stylus

short sound-collecting tube. It may be made as follows. Obtain a circular sheet of aluminium plate about 1/32 in. in thickness and 3 in. in diameter, and at the centre of this disc punch, or cleanly cut out, a hole from 1 in. to 1 1/2 in. in diameter. From thin cardboard make a funnel-shaped tube, open at both ends, about 9 in. long, with the smaller end slightly less than 3 in. diameter. The other end of the tube should be somewhat larger. Place the metal disc on the top of the smaller end and secure the disc in this position by means of adhesive paper applied to the upper surface of the disc and the sides of the tube. The central hole in the disc must, of course, be left entirely uncovered.

Now make up a strong soap solution, preferably in rain or distilled water to which may be added about 5 per cent. of glycerine—or one of the "soap bubble" solutions may be purchased and used instead. Dip a finger into the soap solution, place the full length of the finger on the

upper surface of the disc and sweep it evenly over the central hole. This will result in the production of an intact soap-bubble film over the hole in the disc; a good quality film will be found to last for from five to ten minutes during the subsequent experiments. The film is easily renewed in the same manner.

How the Experiment is Made

If the open end of the device is now held a short distance from the mouth of a loud-speaker, or a telephone ear-piece is placed in the open end of the tube, the complex group of air-waves which are produced by the diaphragm of the electrical reproducer in action will cause the delicate membrane-diaphragm of the phonoscope to vibrate in similar complex unison. To anyone who has not seen this experiment before, the result is apt, at first sight, to be a little disappointing, but with careful attention and some idea what to expect, a remarkably interesting and instructive time can be spent watching the elaborate movements of the film. These movements are most easily observed if an electric lamp is arranged in such a way that it is a little above and to one side so that its rays fall on the soap-film at an angle of about 45 degrees, while the observer watches the film from about the same angle on the opposite side of the instrument. During pauses in the programme transmission the film will be seen in faint tremor, but immediately a voice or music sounds a shimmering rapidly changing pattern of reflected light will appear on the surface of the film. These intricate light patterns are pulsating

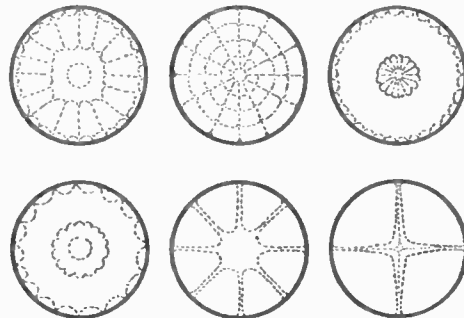

Fig. 2. A few examples of the light figures on the soap-bubble film in the experiment

sections of the soap membrane, each revealing the groups of air-waves which are impinging on the membrane; dancing, in fact, in absolute step with the pulsating figures set up in the ear-phon or loud-speaker diaphragm, and producing an exactly comparable total picture.

Notice the slower and much more extensive pulsations, on the whole, which occur when bass instruments or low-toned male voices sound; the dance of the light
(Continued at foot of next page.)



Making a talkie of Jack Hylton's band while recording for the gramophone

THE other day I was at the First National Pathé studio when a "talkie short" was being made of Jack Hylton's band; and I was forcibly impressed by the extremely complicated process involved in the making of even a short sound film of this description in what one may consider ideal conditions. One cannot help making comparisons with the conditions obtaining in an outside broadcast. The idea was to film Jack's band in the act of making a gramophone record, and a certain amount of by-play was introduced to give the effect of the record-making process. What a fine outside broadcast it would have made!

The Pathé studio is draped, and is about the same size as the studio No. 7 at Savoy Hill. The same elaborate precautions to keep out extraneous noises are provided, the doors to the studio being about 12 in. in thickness. At one end is the "set"—a stretch of parquet flooring with a heavy curtain at the back forming an effective setting for the film. At the other end, in a sound-proof cabinet with a glass window, is a camera.

When I arrived, the lighting engineers were busy fixing up the huge "saus"—arcs and mercury lamps, which flood the place with artificial daylight. The heat and electrical interference caused by these

is amazing and this, of course, is a difficulty with which the B.B.C. never has to contend. There are travelling light battens too, which are carried on a sort of conveyor crane affair hanging on steel girders from the roof. Up in the gallery is another sound-proof hut where the recording engineers can work entirely insulated from the noise going on below.

The immediate space reserved for the film set was faultless, but every other inch of space not within range of the camera was covered with film apparatus, light battens and coils and coils of trailing cable. To add to the general confusion the camera man realised that he could not get a proper "shot" from inside the sound-proof cabinet, and so the camera was stood in a precarious position on the top of the box, the engineers having to clamber up and down on ladders.

Studio Chaos

Ten minutes before Jack was due to begin it seemed impossible that order could ever be resolved from this chaos. The B.B.C. does not cut its limits so fine in this respect; but in due time everything was ready. The camera-man signalled that he was in focus, the light man touched a switch and released a flood of dazzling

A "TALKIE" AND "O.B." COMPARISON

The similarity in the apparatus used by talkie-film engineers and that handled by the B.B.C. "O.B." department is commented upon in this account of a visit to a London film studio

white light, the producer blew his whistle and then all waited for the sound engineer who, up in his little hut in the gallery, had the final word. There were ten seconds of silence while the sound-record film was started running, and then the red light flashed.

Just before Jack raised his baton an engineer dashed forward into full focus and banged together two large pieces of wood. The orchestra had not expected this and there was so much general confusion that a new start had to be made!

"It's all right," said the producer, "we do that just to create a synchronising mark both in the camera and on the sound recording machine." So, reassured, Jack played on! For the purpose of giving the impression that the recording was being done in a gramophone studio an old-pattern Western Electric microphone was put in full view, but the real microphone for the film recording was hung up above the orchestra and was, of course, out of range of the camera.

While the band was playing I clambered up to the sound engineers' hut and heard what was going on below through his pilot loud-speaker.

I repeat; it would make a fine outside broadcast. K.U.

"Watching your Loud-Speaker Work"

(Continued from preceding page)

spots from the centre of the film radially to its edge at the termination of a sentence by the announcer; the comparative simplicity of the light pattern when a single note is sounded; and the astonishingly intricate response when an orchestra is playing. In Fig. 3 a few of the simpler light patterns are indicated.

A Visual Image

For a clear conception of a visual image of the character of sound waves the important thing is to remember always that the diaphragm is not simply sending out a complicated train of air-waves, but that the whole diaphragm has the peculiar faculty of breaking up into variously pulsating sections.

PROSPECTING BY RADIO

WHEN ores are suspected beneath a piece of land, the usual procedure is to instal expensive drilling apparatus, sink shafts, obtain specimens taken at different levels and await the geologists' reports.

Nowadays, mining engineers use radio to assist in the search for the lodes. When a transmitter or oscillator is operated on the ground any lodes beneath the surface will have current induced in them. This will create a magnetic field which can be detected by special receiving apparatus.

In this way all ore deposits occupying an area of at least 50 superficial yards and at a depth of not more than 200 feet, can be accurately located. Zinc ore, however, owing to its not containing sufficient

sulphide to render it conductive to high-frequency currents, cannot be located by this means. It is only ore which will not react to induced currents.

A transmitter with a directional aerial and using a wavelength of 10,000 metres is mounted on a car. The receiver is placed above the suspected ore and the transmitter placed fifty yards away.

The operator then listens in for induced currents in the immediate vicinity. In Canada the system has been in use for a considerable time and during its use over a period of eighteen months, only one error was made.

If there are any power lines or even telephone wires near the area under survey, it is a somewhat difficult matter to use the radio system satisfactorily, and it is in the open spaces miles from habitation that its utility is most pronounced.

"A.W." Solves your Wireless Problems

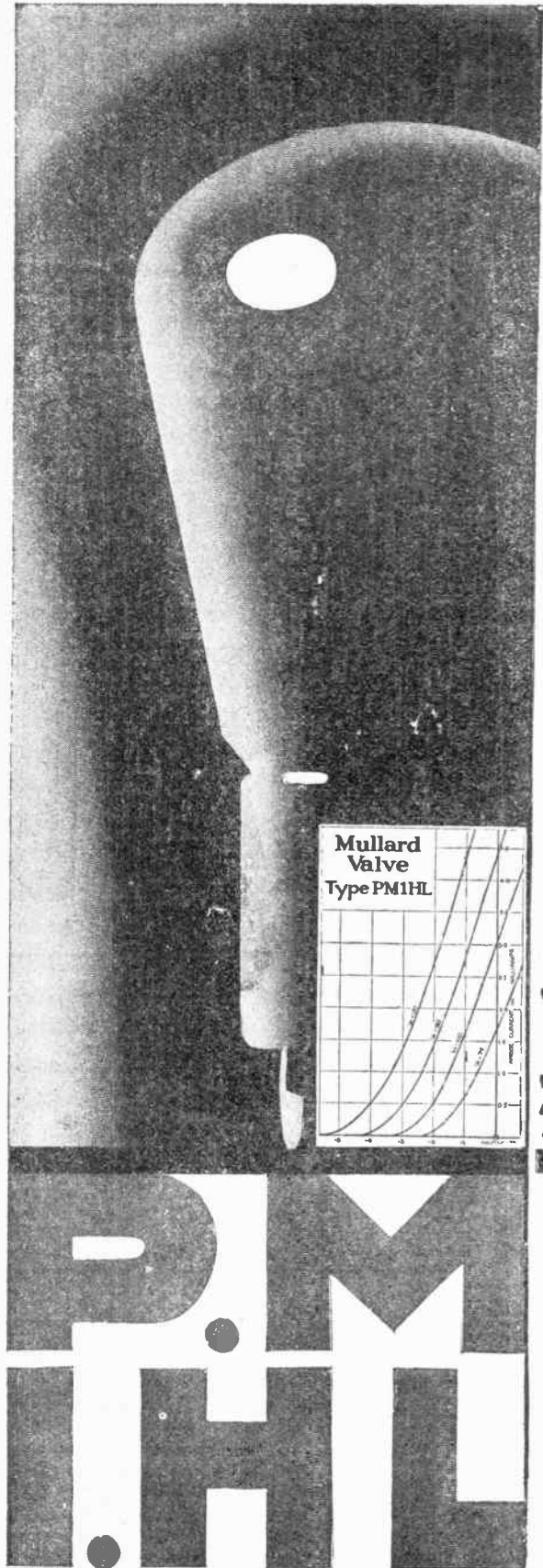

A NEW MULLARD 2-VOLT VALVE FOR MODERN RECEIVERS

Type P.M. 1HL has been particularly designed for use in aperiodic choke-coupled high frequency stages such as are incorporated in many modern portable receivers, but it is equally efficient as a high frequency amplifier in stages employing tuned coupling circuits, or as a detector when followed either by a high impedance low frequency transformer or by a resistance-capacity coupling incorporating an anode resistance of approximately 100,000 ohms.

CHARACTERISTICS.

Maximum Filament Voltage	- - -	2.0 volts
Filament Current	- - -	0.1 amp
Maximum Anode Voltage	- - -	150 volts
*Anode Impedance	- - -	18,500 ohms
*Amplification Factor	- - -	28
*Mutual Conductance	- - -	1.5 mA/volt

*At anode volts 100: grid volts zero.

PRICE 8/6

Mullard

THE MASTER VALVE

**P.M.
1HL**

Advt. The Mullard Wireless Service Co., Ltd., Mullard House, Charing Cross Road, London, W.C.2

Ark:

To Ensure Speedy Delivery, Mention "A.W." to Advertisers

1931 ALL-ELECTRIC ETHER SEARCHER

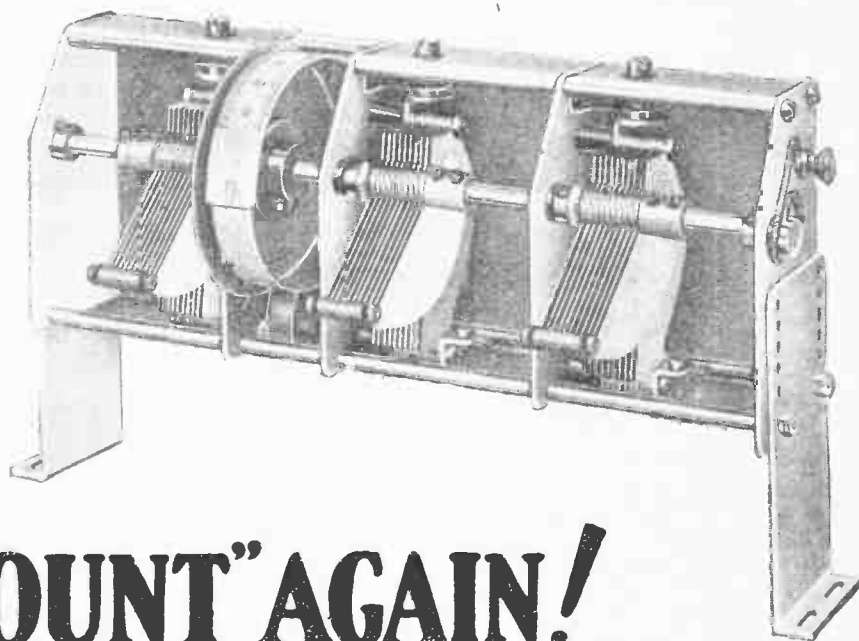

"CHASSIMOUNT" AGAIN!

The new J.B. "Chassimount" is the basis of the season's Star Circuits—the Mullard Orgolas, the Challenge series, the amazing 1931 Ether Searcher. J.B. precision has made possible the accurate control of several tuned circuits with a single dial. Two, three, even six tuned circuits—one knob keeps them perfectly in tune, brings in station after station.

The J.B. "Chassimount" is built and designed as a unit. Each stage is adequately screened, and has a .0001 "trimmer" to balance out stray capacities. This trimmer is adjusted *once* only—no alterations during tuning.

For the 1931 All-Electric Ether Searcher you need the J.B. "Chassimount" type D.3. Your dealer can supply immediately.

J.B. "CHASSIMOUNT" GANG CONDENSERS (with drum drive)

Type D2	2 stage	.0005	26/6
" D3	3 "	"	35/-
(Illustrated above). As required for the "1931 All-Electric Ether Searcher."			
Type D4	4 stage	.0005	42/6
" D5	5 "	"	50/-
" D6	6 "	"	57/6

THE SENSATION OF THE SEASON!



Advertisement of Jackson Brothers, 72, St. Thomas' Street, London, S.E. 1

Telephone: Hup 1837

PRECISION INSTRUMENTS

You will Help Yourself and Help Us by Mentioning "A.W." to Advertisers

On Your Wavelength!

THE WIRELESS CONFERENCE

IT is hoped that tangible—or, at any rate, audible—results will follow the meeting of the International Broadcasting Union, which has just finished its conference at Semmering, in Austria. The meeting was an interim one, the real jamboree coming off next year at Madrid. Delegates who attended it were not armed with plenipotentiary powers; so that all they could do was to discuss matters and to make recommendations. It is cheering to hear that fifteen European countries have decided to co-operate in the carrying out of tests with a view to eliminating mutual interference. Such tests actually have been taking place for some time now, and I am glad to hear that the idea is to be extended, for it is still not too late to set European broadcasting on a sound basis and to avoid the chaos which must ensue if present programmes of development are carried out in full.

THREE POINTS

THE three most important matters, to my mind, are these. Every station should be compelled to install crystal or tuning-fork control of frequency and to stick to its allotted channel strictly. There should be a limitation of output power to a reasonable figure. And, lastly, the degree of modulation should be limited. As regards this last point, several stations are now causing twice as much interference as they need, because their modulation is so terrific that it actually varies the carrier frequency.

WHAT'S YOUR VIEW?

LIVING, as I do, just fifteen miles, as the wave waggles, from Brookmans Park, I have always found it a rather difficult business to obtain decent quality from "Noisy Nat," and the same complaint has been made by friends, no matter what kind of set they were using. Just now he is worse than he has ever been, and I have had to own myself defeated. At such short range the best of receiving sets gives much the same impression as regards its reproduction as with an ancient two-valver tuned to the silent point between squeals. Both speech and music are rough and ragged to an almost incredible degree. The reason appears to be that "Noisy Nat" has proved a great disappointment as regards the size of his service area. With a view to increasing this, his power has been pushed up to 68 kilowatts (as against 45 for "Raucous Reg") and modulation is made as deep as it possibly can be. Perhaps those living fifty miles or more away from the station benefit by this, but we who are closer find reception absolutely ruined.

POOR QUALITY AREAS

IF you stick the point of a pair of compasses into Brookmans Park on the map and describe a circle with a range of fifteen

miles you will find that a pretty thickly populated part of the service area is included. Actually, the poor quality is observed at longer ranges than this. It seems, then, that for the sake of enabling crystal reception to take place on the fringes of its service area the station is being worked in such a way that valve-set reception cannot take place—at any rate, with any pleasure to the listener—in a very large part of this area. A queer business, and not very satisfactory.

THE DEEP END AGAIN

LIFE is, luckily, full of little humorous incidents which help to dispel the prevailing gloom. To the wireless man these are not infrequently provided by the lay journalist who comes out with bright suggestions on radio matters. There was rather a gorgeous one the other day in one of the morning papers. The writer was worried over the fact that broadcasting provides a hitherto undreamt-of means of propaganda either in peace time or in war. His bright suggestion was that we should install a kind of blanketing station working on the beam system which would be able to blot out any transmission that the authorities might consider undesirable. He was referring not to the short waves, but to the medium and long-wave broadcast band.

WHAT WOULD HAPPEN

YOU can, of course, "beam" short-wave transmissions without much trouble, but you might have a bit of a job if you were called on to design a beam aerial for broadcast wavelengths. And even suppose you could, think what the result would be. The gifted writer appeared to imagine that if you shot your beam at the undesirable station you would blot it out, just as the schoolboy dazzles his long-suffering usher with a piece of looking-glass on a sunny day. I am afraid, though, that you wouldn't and that no kind of beam extinguisher would be very effective. I should mention, by the way, that the advocate of the system wants his beam station to be able to transmit simultaneously on *all* wavelengths if necessary. Some transmitter!

PRACTICAL BLOTTING

ON the other hand, spoiling a transmission on the short waves is a practical possibility, and that the thing can be done was shown the other day during the Pope's broadcast. There seems to be no doubt that the interference was quite deliberate, and it was just the kind of foolish act which defeats the purpose of its perpetrator, for, whatever his religious opinions may be, everyone immediately sympathizes with the sufferer from ill-mannered behaviour of this kind. Those who engineered the interference might well have considered, had they had the brains to consider anything, that they were

offending not only the Pope himself, but also millions of Roman Catholics in all parts of the world. It was a silly, stupid business. I must say that I am rather surprised that the B.B.C. did not foresee something of the kind and make arrangements for relaying with the help of the land line rather than the direct short-wave link. Let us hope, though, that another time forewarned will be forearmed.

TOLD OFF—

ONCE again I have been properly told off by a correspondent who is quite sure that he knows all about battery charging, and that I don't. He recommends me to purchase a textbook on accumulators, and he may be glad to know that I accepted this advice—a good many years ago. I am afraid that his letter proves him to be just one of the people that I am shooting at when I write, as I do from time to time, about the desirability of keeping an eye on charging stations. "It may interest 'Thermion' to know," he writes, "that a specific gravity of over 1,200 would in many cases spell death to celluloid (? celluloid-cased) cells, but that in the case of ebonite cases the gravity may be as high as 1,475!!!—The exclamation marks are his, but I would quite willingly add another half-dozen of my own.

SPOILING THE BATTERY

I DID not rush into print about specific gravity figures without previously consulting a good many accumulator manufacturers of repute, and you can take it from me that 1,240 is not far out as the proper specific gravity for a fully charged wireless accumulator, whatever its case may be. The gravity differs a little with different makes and types, but in no case is the optimum value very much under this figure. I can assure my correspondent that adjusting the electrolyte so that when the battery is fully charged it is under 1,200 will spell very rapid ruination to any kind of accumulator, as well as a short service life at each charge. Now, with regard to his other figure of 1,475 for ebonite cased batteries. The highest figure recommended by any maker that I have approached is 1,300 for the particularly stout batteries specially designed for motor-car starting and lighting work.

—AND AGAIN

BUT he has not finished with me yet. The same correspondent (who, by the way, suggests that I am not open to argument and won't give publicity to his letter) goes for me again on the subject of hydrometers. "Has 'Thermion'," he asks, "ever troubled to test half a dozen of the same make of hydrometer?—if he has, he must have been struck by the large difference of opinion of each hydrometer over any given gravity of acid." Well, I certainly have tested a great many hydro-

:: :: **On Your Wavelength!** (continued) :: ::

meters, and I can reply at once that if you buy a twopenny-halfpenny instrument you cannot expect it to be reliable, whilst if you purchase something of decent quality it is as accurate in its line of business as is a good quality milliammeter or voltmeter; that is to say, the percentage of error is minute. The market at the present time is flooded with cheap hydrometers of Continental or American origin which are not particularly reliable. You can, though, purchase quite cheaply a good English instrument and you can rely upon its performances. I am open to any amount of argument, and my correspondent will see that his letter has had full publicity.

TRACK 'EM DOWN

MR. HAY HALKETT flung bouquets (and there weren't any horseshoes in them, either) at wireless the other day in the Marylebone Police Court when he was trying a case in which two men were charged with the theft of a basket of clothing. The basket was stolen from a music-hall whose manager saw the men rush it into a waiting car. He immediately telephoned to Scotland Yard, who forthwith wirelessed the information to police motor patrols. The message was picked up by Detective-inspector Gooch and Sergeants Greene and Smith as they were travelling through Somers Town in a police tender. As luck would have it, they were already going in the same direction as the men charged when the message was picked up. The driver of the tender immediately stepped on the gas, and a "fair cop" was effected in a matter of minutes. Mr. Hay Halkett marked the charge sheet: "A very clever capture by the police car, thanks to Detective-inspector Gooch and the wireless outfit in the car."

BREAKERS AHEAD!

ONE must naturally feel somewhat concerned as to what is going to happen to the ordinary listener if the present competition in high-powered transmission continues. It looks as if before long we shall have so many interfering programmes that only the most selective sets will stand any chance of making good. The worst of it is that the fashion was set by our own B.B.C. in an attempt to give "crystal" service to as wide a circle of listeners as possible. This was all very well so long as we were the only ones in the field, but now that other countries are following suit, the prospect does not seem so bright. A far-sighted correspondent writes to say that the whole position is degenerating into one of "shouting louder than your neighbour." He goes on to suggest that one possible remedy would be to drop the present high-power craze in favour of a system of low-powered central transmitters, working on wavelengths below one hundred metres, and each feeding by radio link a number of subsidiary crystal-controlled relay stations. In this way the whole country could be adequately served with programmes free from the defects due to over-modulation.

THE CRYSTAL SET

IN catering so largely for the crystal "merchant" the B.B.C. undoubtedly, at the time did its best for a class of listener who certainly deserved every consideration. But circumstances alter very quickly in these days of modern progress, and the relative proportion of those who use crystal and valve reception has changed. The fall in the price of valves and the all-round reduction in the cost of loud-speaker sets is steadily weighting the scales against the crystal user, so that it may become necessary to reconsider the whole policy of high-powered radiation.

A RE-DIFFUSION SCHEME

MY correspondent has to some extent already been forestalled by Manfred von Ardenne, a well-known German inventor, who has recently put forward a scheme for ensuring reception, free from interference, particularly in large towns where listeners have special difficulties to contend with. In the first place, they are usually under the shadow of the local transmitter. In the second place, weak signals coming in from distant transmitters have to pass through a relatively heavy background of "artificial" interference. Von Ardenne proposes to erect a local relay station some little distance away from the town, and outside the range of "man-made" static. Here the distant signals will be received under the most favourable conditions and amplified. They will then be re-radiated so as to reach the local listeners at a strength at least fifty times greater than they could normally be received. In order to handle a number of foreign programmes simultaneously, so that the listener can pick and choose, the relay transmitter operates on an ultra-short wavelength, and the various programmes are all superposed on this common carrier-wave.

DOUBLE DETECTION

THIS sounds rather more complicated than it really is. All that is required to adapt the local set for reception is to use a short-wave aerial to pick up the carrier wave and to provide a preliminary stage of rectification. After this a standard type of receiver can be used to select any desired programme from all those that pass through the first rectifier. An ordinary tuned input may be sufficient or, better still, one or more stages of tuned H.F. amplification. The signals so selected are then passed through a second detector valve to separate out the audible signals. The operation is, in fact, very similar to using a super-het circuit, except that there is no local oscillator. The whole scheme is highly ingenious, and if it turns out successful in practice should put city listeners on even a better footing than those in the country so far as Continental programmes are concerned.

A CURIOUS VALVE TROUBLE

ICAME across a rather interesting snag the other day on an H.F. set employing

a screen-grid valve. I was not able to obtain results from it, although it was quite a simple set, and I therefore resorted to the usual step-by-step methods of testing. When I did this I found there was no current in the anode circuit of the screen-grid stage, and I therefore began checking over all the parts of the circuit in turn. Working from the batteries back, however, I found that the voltage appeared at each part of the circuit and that there appeared to be no faulty component anywhere. In fact, the voltage arrived at the anode of the valve quite successfully, but still there was no current.

I then examined the filament circuit of the valve because I thought that perhaps either the valve was burnt out or that the filament circuit was broken in some way. I found, however, that the filament circuit was intact, for putting another valve in cured the difficulty. I was therefore faced with the fact that the valve I had just taken out was in some manner dud, and I proceeded to check the filament for continuity. To my surprise, this proved O.K., and I looked at the valve with some perturbation to see if I could see anything wrong. In the process of doing so, the top cap came off quite neatly in my hand, exposing the bald head of the valve, with the anode wire sticking through the glass like a solitary hair. I soldered this up again to the cap and stuck it on with Secotone, whereat the valve functioned quite satisfactorily without further ado.

ADVANTAGES OF THE FRAME

THE frame aerial is becoming increasingly popular, partly owing to its compactness and convenience, partly because it increases selectivity owing to its directional properties, and partly because the screen-grid valve has made good high-frequency amplification so easy to obtain. In ordinary circumstances the frame, when used with a suitable set, will do all that is necessary; but I have found, as a result of experiments, that its response to weak and distant signals, such as those from American stations, may be very poor, despite the fact that it will enable the set to bring in a vast number of transmissions from the Continent. If your set is normally a good distance-getter and you find that you cannot hear American stations, though your friends are doing so, the frame may be the cause of the trouble.

A FRAME TIP

HERE is a way of improving its performances during transatlantic reception. Earth the terminal of the frame, which is connected either to low-tension negative or to the grid battery of the first valve in the set. Stretch a short piece of, say, No. 22 double-cotton-covered wire across the room about a foot below the ceiling and attach the end of this to the frame terminal, which is connected to the grid of the first valve. You will probably be surprised to find the increase in signal strength from far-away stations that results.

THERMION.

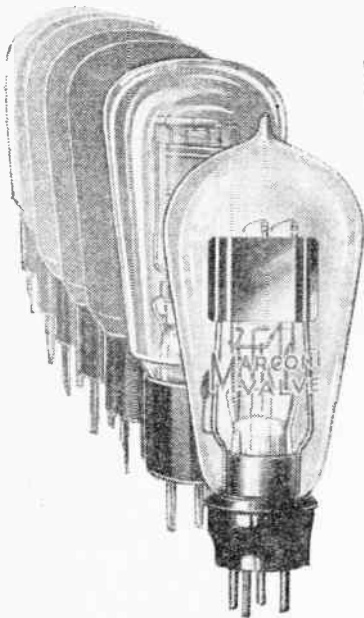

WANTED — MORE FACTS ABOUT POWER VALVES

In this article ALAN HUNTER suggests that valve-makers could enlarge the scope of the data now given with the characteristic curves of power valves

WHETHER the average amateur makes any use of the curves supplied with valves is an open question. Personally, I doubt very much whether the little slips of paper so carefully prepared by the valve-makers greatly interest the non-technical valve-user. But, if the actual curves are ignored, some attention is generally given to the operating details underneath. This article is a plea for the issue of more facts about power valves.

For the power valve has so greatly improved that our criterion of judgment

watts dissipation of a power valve has its uses; but as an index to the capabilities of the valve it is useless. One might as well try to indicate how many miles an hour a car would go by stating how much petrol the tank would hold! The most important thing to know about a power valve is not its anode dissipation, or its amplification factor, but the *maximum undistorted power in A.C. watts* passed on to the loud-speaker, *assuming this is of the correct impedance*. This undistorted A.C. power is only a fraction of the power indicated by the anode dissipation. For example, the PX₄ is a 10-watt valve, but its undistorted A.C. output is only 1 watt.

Useless Curves?

Readers must be tired of hearing that the function of a power valve is to interpret input voltages as current variations; what is wanted now is some simple way of appraising how well or how badly this function is performed.

I suggest that the curves and data now supplied with power valves do not help the valve user to do this. Take, for example, the ordinary static curves, which must be familiar to all, since every valve carton contains one; here we find several curves corresponding to different values of anode voltage, drawn to show the values of anode current resulting from different values of negative grid volts. Fig. 1 shows a typical example of a grid-volts'anode current curve, drawn for a PX₁ super-power valve.

Laboratory Curves

It has been suggested by a learned contemporary that these static curves could be usefully augmented by another set of curves, showing the relationship between anode volts and anode current. To the engineer such curves are, of course, essential, but since one can interpret them accurately only by graphical methods, their use to the average amateur is even less obvious than the use of the Fig. 1 curves.

After all, the Fig. 1 curves showing the connection between grid volts and anode current involve values that the user has under observation; he can readily adjust grid bias and just as readily measure the

steady anode current resulting from a given grid bias and anode voltage. But the Fig. 2 curves deal with the alternating voltage applied to the grid of the power valve and with the alternating anode current and voltage so developed. The amateur can neither see nor readily measure these things.

Two Essential Facts

Fig. 2 shows the extra curves of the PX₄ valve, giving the relationship between the anode volts and the anode current for varying grid voltages.

From the Fig. 2 curves it is possible to find out two essentially useful power-valve facts; (1) the most suitable loud-speaker impedance, and (2) the maximum undistorted A.C. output. One firm of valve makers, which recently started to issue these curves with power valves, states that the publication of the A.C. power output is not practicable because opinions vary as to the amount of permissible output distortion.

(Continued at foot of next page)

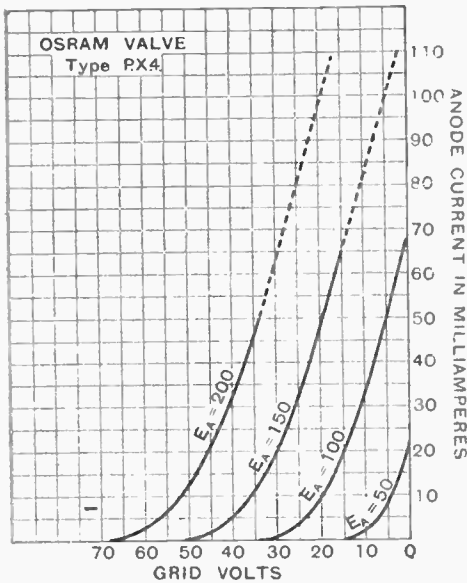

Fig. 1. Showing the grid-volts'anode current curves of the PX₄ power valve

needs some modification if we are truly to assess the merit of any particular specimen. One hears of a 10-watt power valve; as the unit of power is the watt one might jump to the conclusion that such a valve would provide 10 watts to the loud-speaker; this would be quite wrong, for that 10 watts is merely the electrical equivalent of the heat dissipated or wasted at the anode when the valve is working.

As a means of classification, the anode

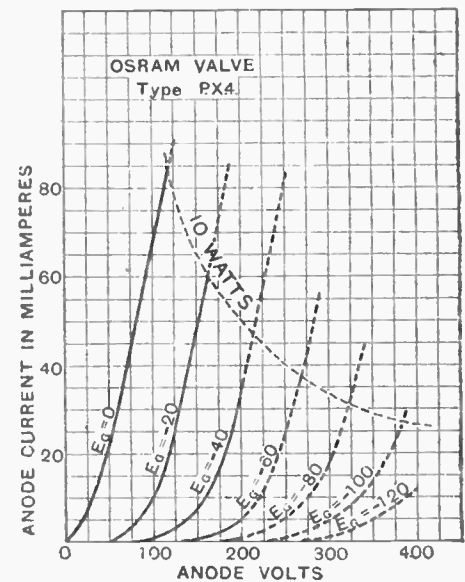

Fig. 2. The anode volts'anode current curves of the PX₄ valve

For the Newcomer to Wireless : NIGHT AND DAY RECEPTION

WHY is it that I can tune in stations like Nuremberg and Stockholm at tremendous strength after dark, though usually I can't hear a sound of them in daylight?

It is all due to the existence of what is known as the Heaviside layer.

What is that?

Air at ground level is an excellent insulator—in the wireless set, for example, we have air spacing between the vanes of our variable condensers. If you could go up to an enormous height in a balloon you would find that air remained an insulator for thousands upon thousands of feet, though the barometer continued to indicate a lower and lower pressure. At a certain point, though, a change would be observed; you would suddenly find that the surrounding air had become a good conductor. You would have reached, in a word, the Heaviside layer.

I seem to remember that wireless waves travel easily through insulators and are stopped by conductors. Is that right?

Yes, absolutely. The conducting layer of air that forms a kind of envelope round the world won't allow wireless

waves to pass. Its effect upon them is much the same as that of a mirror upon light waves.

You mean that it reflects them?

That's it exactly. Now, at nighttime the Heaviside layer is comparatively near the surface of the earth, its height being from fifty to seventy-five miles. Also it presents a nice smooth lower surface which reflects the wireless waves back to earth without loss.

What happens during the daytime?

The Heaviside layer is much higher and its earthward surface is very irregular. During the day that portion of a transmitting station's radiation which is thrown upwards and outwards fritters away most of its energy in the upper layers of the atmosphere. At night it is reflected back with hardly any loss of strength.

Then how do we hear a near-by station during the day?

There is a second portion of the radiation from a broadcasting aerial. This is known as the ground wave. Instead of going up until it meets the Heaviside layer it follows pretty closely the contours of the ground. It is this that we rely upon for daylight reception in the

service area of a broadcasting station. Since the waves lose energy in passing over the surface of the land, their range is necessarily somewhat limited. You will see, then, that Nuremberg and Stockholm can't reach you by day, but their signals are reflected to you by night.

But I don't find the same thing with, say, Radio-Paris and Hilversum.

No, that is rather different. These are long-wave transmissions, whilst the others are medium-wave signals. The former are not nearly so much affected by the daylight state of the Heaviside layer, for they have not the same tendency to waste energy in the upper air. We may say, in fact, that the longer the wave, up to a reasonable point, the more constant will be its strength throughout the twenty-four hours. There is one drawback, though, to long-wave transmissions.

What's that?

They need a good deal more power behind them to ensure that they will be received at long range at all hours. Then, of course, you have got to remember that atmospheric interference is usually much worse on the long waves than on the medium and short.

"WANTED—MORE FACTS ABOUT POWER VALVES"

(Continued from preceding page)

I contend that, since the issue of anode volt-anode current curves can interest only experts, the average valve user would be better served with some actual figures. It should be quite practicable to say of a power valve that it will provide one watt undistorted output within the accepted permissible limit, provided that the loud-speaker impedance were of a stated value.

In brief, the valve makers could, with all power valves, give us two figures; the first one would indicate the maximum A.C. output available for working the loud-speaker and the second would indicate the value of anode impedance needed to produce this result.

Knowledge of the actual A.C. power output of the valve is not very helpful unless one knows the A.C. power requirements for different volumes of sound. Here the loud-speaker makers can be excused, for it is obviously difficult to grade the volumes of undistorted sound delivered by the various reproducers in use; but since most listeners have a very good idea of the relative volume capabilities of moving-coils and large and small cones, it is possible to work backwards from any known volume requirement to the A.C. power output needed of the power valve.

To fill a public hall as much as 5,000 milliwatts output would be needed, whereas ample volume would be delivered for home use by the average moving-coil fed with 1,000 milliwatts. Still less power would be needed for the smaller cones, between 200 and 500 milliwatts corres-

ponds to medium volume as delivered by a portable set or small table cabinet set.

We should very soon grow accustomed to speaking of a 500-milliwatt valve instead of a small power valve, or of a 1,000-milliwatt valve for moving coils.

The usual loud-speaker impedance value for optimum power output results is given as twice the resistance of the valve, but since the makers can readily determine with accuracy this value by means of a graphical interpretation of the several curves shown by Fig. 2, may we not hope that this extremely useful piece of data will be included in future lists?

In the meantime, I suggest that those interested in finding out the undistorted A.C. power output of their existing power valves (in order to compare them with any new power valve) should turn to page 240 in the February 7 issue of AMATEUR WIRELESS, where J. H. Reyner, in his

article on power valve comparisons, shows how this factor can be roughly determined without reference to the Fig. 2 curves.

It was shown that the power output in watts, when r equals valve-resistance, m equals amplification factor, and E_g equals grid bias, is given by the expression:—

$$\frac{m^2 E_g^2 n}{2r (n+1)}$$

The necessary data for substituting actual values in the above expression is all given in the usual curves supplied by the valve makers, with the exception of n . This denotes the ratio of loud-speaker impedance to valve resistance. The optimum value of this impedance can be determined by reference to the "load line" of the Fig. 2 curves, but as already stated, for all ordinary power valves the output impedance should be twice the valve resistance.

If we say $n=2$, the expression $\frac{n}{n+1}$

boils down to .22. Let us take the power valve I specified in the A.C. amplifier last week, the Osram PX4. Its amplification factor is given as 3.5, its resistance as 1,350 ohms, and the maximum grid bias is 33 volts.

Substituting these values in the above expression we get $\frac{(3.5)^2 \times (33)^2 \times .22}{2 \times 1350}$

all of which comes down to $\frac{2035}{2700}$ watts,

or just over 1 watt, that is, 1,000 milliwatts. By graphical means the maximum A.C. power output of the PX4 works out to 1,020 milliwatts, so the expression is quite workable for this type of power valve.

DO YOU KNOW THAT

a new interval signal consisting of a musical A is now emitted by Brunn?

if the set overloads and gives a "reedy" tone, then it is quite probable that a larger power valve is called for? The existing valve may have an impedance of 9,000 ohms and be capable of standing up to only a relatively small grid swing. A larger valve with a lower impedance should be fitted.

over a thousand ships are now fitted with special "calling apparatus" designed to sound an automatic alarm should the wireless operator be off duty when the S.O.S. signal is sent out from a ship in distress?

Why MAZDA VALVES *give the best results!*

Mazda engineers have the longest experience of any in the design and manufacture of A.C. Mains Valves. Sound manufacturing methods ensure robust construction, long life and consistent quality. Their amazingly high efficiency has won for them a reputation as the "World's finest valves." They are standardised in all the leading commercial receivers.

With the amazing Mazda valves in your set its efficient and trouble-free performance is assured.

From all good radio dealers.

The amazing

MAZDA

RADIO VALVES

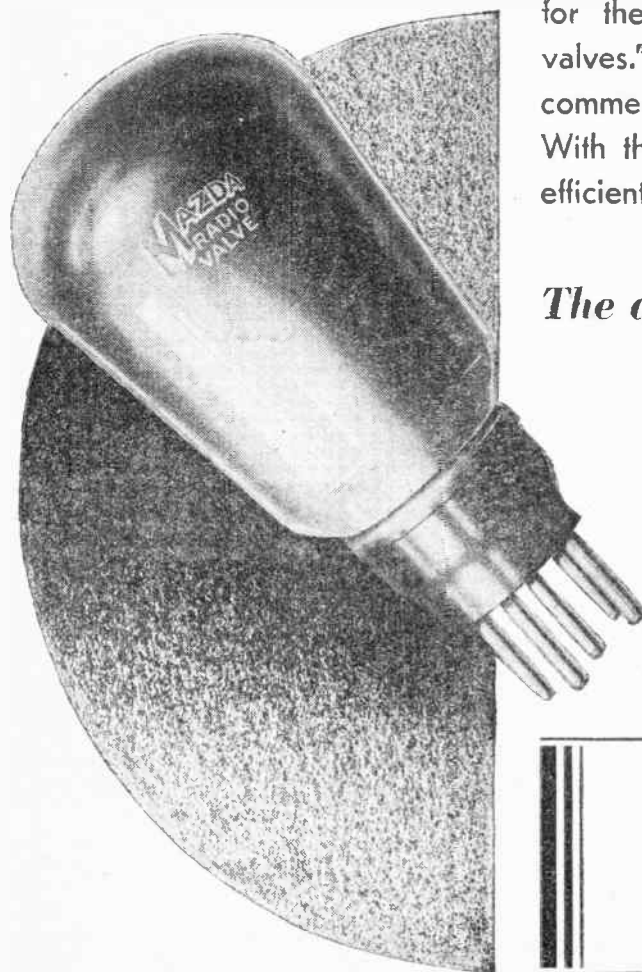

THE EDISON SWAN ELECTRIC CO. LTD.
*Incorporating the Wiring Supplier, Lighting Engineering and
Radio Business of the British Thomson-Houston Co. Ltd.*

Radio Division Showrooms:
155 Charing Cross Road, London, W.C.2
Showrooms in all the Principal Towns

EDISWAN

T.98

Please Mention "A.W." When Corresponding with Advertisers

Drydex is in the shops!



Dx2

The supreme new dry battery by the makers of the world famous Exide

RED TRIANGLE

60 volts 7/- • 66 volts 7/6
99 volts 11/6 • 120 volts 14/-

GREEN TRIANGLE

60 volts 9/6 • 66 volts 10/6
99 volts 15/6 • 120 volts 18/6

ORANGE TRIANGLE

Triple Capacity • 60 volts 14/-
105 volts 24/6 • 120 volts 27/-

BLUE TRIANGLE

For portable sets • 63 volts 9/-
99 volts - 14/- • 108 volts 15/6

For Grid Bias: Red Triangle. 9 volts—1/4. 16.5 volts—2/3. Green Triangle. 9 volts—1/9. 16.5 volts—2/9.
Unit Cells for Torches: Green Triangle. 1.5 volts—4d. Batteries for Pocket Lamps: Red Triangle 4.5 volts 6d.

Obtainable everywhere from all good dealers.

Exide Batteries, Clifton Junction, near Manchester. Branches at London, Manchester, Birmingham, Bristol and Glasgow.

Mention of "Amateur Wireless" to Advertisers will Ensure Prompt Attention



IN MY WIRELESS DEN

WEEKLY TIPS—
CONSTRUCTIONAL AND THEORETICAL

By W. JAMES.

Gramo-radio Needles

A PICK-UP is usually designed to work with a needle of a definite type and a needle having very different characteristics ought not to be used if the results intended by the makers are to be obtained.

But there are certain records which seem to need rather special attention, a finer quality being secured by using a special needle.

There are so many makes and sorts of needles that you can hardly try them all, but it is well worth having a selection of them. Many interesting tests can be carried out. The relative strength of the high and low notes depends to an extent upon the type of needle and it is surprising what wide differences in tonal qualities can be detected by trying various needles.

With the finer needles a grip ought to be used. If the pick-up arm has a device for adjusting the effective weight of the pick-up upon the record, then this ought to be regulated according to the type of needle. With some types the effective weight can be very little.

These Cheap Fixed Condensers

Now that inexpensive fixed condensers of the small mica type are available it is necessary for us to look out for inaccurate values. Personally, I hesitate before using a .0001 microfarad condenser unless I can first measure it.

In some circuits a condenser seriously out would cause trouble, and I know that some .0001-microfarad sizes are as low as .00006 microfarad.

If you connected one of these in the aerial circuit, for example, the signal strength would in all probability be much less than it would be were a condenser having an actual value of .0001 microfarad used.

The effect of using one in a detector circuit might also be serious. In many instances a pre-set condenser is likely to be a good investment as the value may be adjusted by trial. When a by pass is needed in the detector circuit, for example, a pre-set type is valuable.

Ways to Selectivity

A point which sometimes crops up is whether it is better, in the interests of selectivity and signal strength, to include a condenser of little capacity in the aerial circuit or to tap the coil itself for the aerial.

Tests show that with fairly good coils the tap method is the better. The effect of the aerial is reduced as the connection is made nearer the earth end of the coil, with the result that the selectivity is

improved. Also the tuning range is usually increased and, up to a point, the signal strength

It is not always convenient to tap a bought coil, but when this can be effected without hurting the coil in any way the aerial tap ought to be tried. You might be able to lift a turn of the wire with the point of a penknife and to slip under a piece of insulating material. A short wire to form a convenient tap may then be soldered on.

Loose-coupled Tuning

The keen amateur can obtain an amount of fun from a detector and two low-frequency set having a loosely-coupled aerial circuit.

Quite surprising results are, as a matter of fact, to be obtained. But the circuit

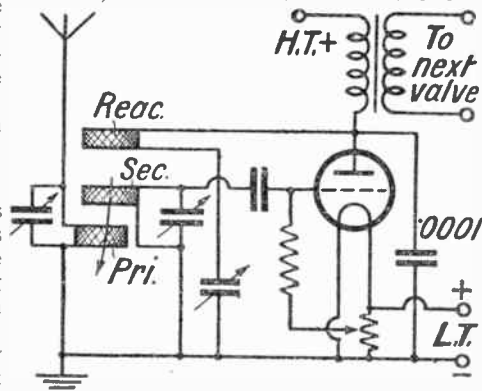

This is a good arrangement, using plug-in coils, which results in a loose-coupled circuit giving good selectivity. For details, see the accompanying paragraph

needs tuning. With skill, stations can easily be separated, but the person without experience might well be disappointed.

You see there are two circuits to tune and two to adjust. The aerial and secondary circuits must be tuned to the station and the coupling adjusted to give just the right degree of selectivity. Then the reaction must be regulated to provide just the right amount.

When the circuit is carefully designed it will be possible to adjust things finely and then interesting results are obtained.

The accompanying circuit shows an arrangement easily put together. Plug-in coils are indicated with slow-motion tuning condensers. There is a potentiometer for the grid leak. Various grid leaks could be tried; a high-resistance one of say, 3 or 4 megohms might well be found more suitable than one of say, 1 or 2 megohms. The coils should be as low loss as possible.

How Do You Charge?

Do you trickle charge your low-tension accumulator? If so, you ought to note the voltage of the battery on occasions as it may well be much in excess of the two volts per cell which we expect.

The voltage may, as a matter of fact, be say, 2.5 when the set is first switched on, falling to 2.2 at the end of the evening. If, now, the battery is put on charge once more, this relatively high voltage will always be applied to the filaments of the valves. Actually, the valves may not be harmed, but it is not wise to supply their filaments with much more than the rated voltage for lengthy periods.

NOT TO BE MISSED!

TWO special features make the March issue of *Wireless Magazine* more than usually interesting.

In the first place there is a sixteen-page *World's Broadcasting Guide*, printed on tinted paper, which is definitely of the greatest utility to every set-owner.

It contains identification details of the fifty best stations; three pages of maps; an international survey of broadcasting; three pages of photographs; lists of European and short-wave stations in order of wavelength, with spaces for recording dial settings; and special medium- and long-wave tuning charts.

This is just the sort of thing that will enable you to get more enjoyment out of your radio activities.

Then there are details of a sixty-station set, specially designed by W. James, that is certain to have a pronounced effect on radio practice of the future. Although this set—it is called the "Super 60"—has six valves the cost of parts is only £12, and the anode-current consumption is not more than 12 to 15 milliamperes!

"The 'Super 60' is the best set I have ever handled," says Mr. James.

Even if six valves do not attract you at once, you will become enthusiastic when you see the eleven pages of illustrations and descriptions devoted to this super set.

And if these two features are not enough to convince you that you must read the *March Wireless Magazine*—although it is certain that they will be—note that for your shilling you will be getting 132 pages of vital radio literature, containing more than sixty articles and nearly 150 illustrations.

In fact, this issue is not to be missed!

ANNOUNCERS TELL THEIR STORIES



The Velthem station orchestra is composed of some forty members

'MESDAMES et messieurs—puis-je me presenter?' May I introduce myself? I am the announcer at the station of Velthem-Louvain. Velthem? A little township some twenty miles from Brussels—a village the population of which would be lost in comparison with the hundreds of thousands of listeners to Radio Velthem all over Belgium, and in many other parts of Europe, too.

My right to the position of announcer? Goodness only knows! I'm sure there isn't one of any importance, but the fact is that I have presided before the microphone for a twelve-month, and no listener has yet said that he is "fed-up" with hearing me on his loud-speaker!

Trying to Please

I doubt if there is a more interesting profession in the whole world than that of trying to please the many listeners, and of arranging, or trying to arrange, programmes so that each succeeding day is better than the last. But it has its little trials, as when the engineers switch on two minutes before the programme is timed to begin, or when they switch off just before the end of the last item; or—worse—when, after you have given a talk on religion, they switch on from the control room a jazz record to fill in a programme gap!

Then there are the little bothers caused by having to show famous politicians and learned professors how to address the microphone and where to stand; one has to be so tactful!

One is always in touch with listeners. Often I try to get some humorous twist into an announcement, only to be rung up on the 'phone by some friend or other who says, "Look here, old man, you can do better than that, you know!"

Then, again, nothing needs more tact than when a woman listener rings up to ask (as one did recently) at what time the eight o'clock concert would be broadcast—as though she imagined there was, for some mysterious reason, a delay between the time when the programme was performed and when it was broadcast! I longed to say that the programme, after having been put through the "mill," amplified, and filtered, may be broadcast at 10 p.m. if all goes well! And the chances are that that broadcast may actually go through the "mill" of poor

modulation, heterodyning and atmospherics so that to distant listeners it is unrecognisable!

To some announcers, no doubt, the silence and privacy of the studio is a boon—especially to those who have "rows" at home! One of my colleagues says he is glad to escape from the torrent of words of his nagging better-half, where at home he can't get a word in edgewise, to the studio; and there, in the quiet, he can tell his troubles to the "mike"—but not literally, of course! It wouldn't do to end up the programme with "*Bonsoir mesdames; bonsoir messieurs*—to all except my quarrelsome wife!"

Children make an announcer's job a pleasing one—sometimes! It's all right when it comes to broadcasting those cheerful birthday messages about finding presents and sweets in hidden places; but it's very humiliating when, the following morning, paterfamilias turns up at the station to ask why you didn't get the pronunciation of his kiddie's name correctly!

The happy side of an announcer's job is when listeners give praise and advice by 'phone calls and by correspondence, when they beg autographs, and when charming families beg the honour of one's company at dinner. The unhappy side—such as it is—is caused by the necessity of being a most extraordinary kind of man—one who is always in a good temper, who likes Beethoven as much as jazz, who likes broadcast religious addresses as well as cabaret shows, who has the cool nerves of a newspaper reporter, and who is as laconic; and, finally, who has always the same pronunciation and intonation, clear and sympathetic, firm and cheerful.

As a matter of fact, the first time I broadcast I was not by any means cheerful. My first experiences of broadcasting were distinctly unnerving and unpleasant. If you have never broadcast I can assure you that you won't get much pleasure out of the

AT RADIO VELTHEM

By the Announcer of K.V.R.O.
Radio Velthem

first occasion. The microphone isn't at all reassuring!

Funny things happen sometimes in the studio. I remember on one occasion I had to give a talk having advertising as its basis—a "sponsored" item, I believe you call it. Anyway, I had to talk about biscuits. A little girl who—her father told me afterwards—was listening in and waiting for her birthday radio message, jumped up at the mention of biscuits and called out to her mother: "Fetch a box quickly. They're going to broadcast the biscuits!"

M. JEAN BOON the
announcer at Radio
Velthem



"LISTENING" TO BEARINGS

THERE are many quaint uses for valves and microphones, but a well-known engineering firm manufacturing ball bearings has thought of a new adaptation for microphone and L.F. amplifiers.

When bearings are being tested a microphone is stood a few inches away so that any undue noises set up by the balls in their races is picked up and amplified. The output of the amplifier is connected to a milliammeter which varies in its reading as any noise is picked up by the microphone. In this way each set of bearings has to pass a silence test which is also a test of mechanical accuracy.—A.

A GREAT COMPETITION FOR AMATEUR CONSTRUCTORS £50 IN CASH PRIZES EVERY "1931 ETHER SEARCHER" BUILDER MUST COMPETE

WE offer Fifty Pounds in cash prizes, as well as a number of consolation awards, in a competition for amateur builders of the "1931 Ether Searcher." The competition is open to every reader who either has built this remarkable three-valver or will be doing so during the next two or three weeks.

We ask all "1931 Ether Searcher" builders to send us an account of how they built the set, how they used it, and how they found its performance. Just a short account—not exceeding 300 words, please.

WHAT THE READER IS TO DO

Readers can comment, for example, on the ease or the difficulty with which they built the set; on the time taken to build the set; on their experiences after they had built it; the number of stations actually logged and any particular successes obtained, especially in relation to the conditions of reception in their own district. They should state where they bought the components.

As a guarantee of good faith, we should like every reader to get a friend or neighbour to add a few words to the account, saying that he has seen the "1931 Ether Searcher" built by Mr. —, and has every reason to believe that the account is true. Get the friend or neighbour to sign his statement and give his address.

If you can manage to send us a good photograph of yourself with your set, so much the better. A "good" photograph, you will understand, is not a tiny under-

exposed "snap" which could not be satisfactorily reproduced.

We reserve the right to publish all, or any, of the entries, wholly or in part.

COMPETITION CLOSES MONDAY, MARCH 9

All entries must reach us not later than Monday, March 9. After considering them in detail, we shall choose from among

and award points for workmanship and general appearance, and will then test each set and award points for performance. The Editor will act as Chairman of the Judges, and his decision will be final.

CELEBRATING SUCCESS

We have arranged this competition, firstly, to prove our own great faith in the "1931 Ether Searcher" and to celebrate the tremendous success that it has won, and, secondly, to give the amateur constructor the pleasure of competing with his fellows for a number of cash prizes each thoroughly worth having.

We want an entry from every reader who has made the "1931 Ether Searcher" or who intends to make it during the next fortnight or so. All you need do is to send us the short account asked for. We repeat, all accounts must reach us by Monday, March 9.

Any set sent us, except at our own special invitation, will not be considered. Competitors must wait to hear from us before sending their sets. Their job is to post us their 300-word account in good time.

The next step is ours.

In making our selection of readers whose sets are to be sent us for examination and test, we shall be guided by our special experience and by ordinary common sense, and readers must rely on our good faith in this and in all other matters relating to the competition.

We pledge ourselves to award the full prize money.

THE EDITOR.

FIFTEEN CASH PRIZES TOTTALING £50 WILL BE AWARDED

- 1st Prize—
Cheque for Twenty Pounds
- 2nd Prize—
Cheque for Ten Pounds
- 3rd Prize—
Cheque for Five Pounds
- 4th Prize—
Cheque for Three Pounds
- 5th Prize—
Cheque for Two Pounds

There will be Ten other Prizes, each of a cheque for One Pound.

In addition we shall award a number of small "commendation" prizes.

the competitors some such number as twenty or thirty who will be specially invited to submit their actual sets for a brief period. We shall send each of the selected competitors special packing instructions and addressed labels, and we shall pay for both packing and carriage.

Further, we shall give each of these selected competitors an undertaking not to retain his set for more than six days. The Editor, with his Technical and Constructional Staff, will examine each set

ARE B.B.C. announcers human? Have they the same hopes, fears, and aspirations as we lesser mortals? Have they families to whose bosoms they return after putting on the ether that classic saying, "Good-night, everybody; good-night."

I think there is a good deal of mystery about the B.B.C. announcer, don't you?

No one has ever clutched me by the arm in the street and said, in an awed whisper: "There goes a wireless announcer." And, solemn thought, though I have been introduced to a prize-fighter, a politician, a jockey, a lady novelist, and a man who writes articles for the funny papers, I have never yet met socially a B.B.C. announcer.

I've often wondered what B.B.C. announcers are like to look at. Are they all of a pattern; tall, slim young gods with crinkly hair and tiny ears and Grecian noses? Or are they diversified in appearance? I can't imagine a fat, paunchy, wireless announcer, can you?

Do wireless announcers take an interest

THE MYSTERY OF THE B.B.C. ANNOUNCER

in their job, I wonder? It is so difficult to distinguish any trace of feeling in their cool, steady voices. They give no hint of depression when announcing depressions over Iceland, nor by an excusable lapse do they hint that they have won a packet on the 3.30 when they give out the racing results.

I shouldn't think that wireless announcers ever get irritable, or morose, or fed up. Just the same equable temperament, from 10.30 in the morning until last thing at night.

You can never tell what a wireless announcer is thinking about, can you?

When he has issued to a hushed, expectant world that Professor Bolweevil will deliver a talk on the amorous instincts of the lesser-spotted spider he gives no indication that the announcement affords him pleasure or otherwise. He announces

the peppy dance bands in just the same tone of voice. The wireless announcer never discriminates. The professor, the dance band conductor and the comedian are all one to him.

I wonder what the B.B.C. announcer does when he's not announcing. What does he do with those odd quarters and three quarters of hours when someone else is monopolising the microphone?

Is he compelled to listen-in at the wings, as it were, and take the part of prompter? Or is there a room in the B.B.C. buildings where jaded announcers can go to rest their shattered nerves, or polish up their already over-bright elocution?

I really think we ought to know a bit more about the B.B.C. announcer, don't you? I mean to say, we help to support them, don't we? One of these days a talk in the My Job series will be given by a wireless announcer, and then the whole mystery will be cleared up.

And then the romantic, glamorous air of the wireless announcer will be dissipated.

By LESLIE T. BARNARD.

FAULTS IN TRANSMISSION AND HOW THEY AFFECT THE RECEIVER

By MORTON BARR

THE standard of transmission maintained in this country by the B.B.C. is as a general rule beyond reproach. The same does not, however, apply to certain Continental stations, where the poor quality of the received programmes is frequently due either to over-modulation, or carrier wave "wobble," rather than to any defect in the listener's set—or in the much maligned loud-speaker.

Modulation and Range

In modulation, the signal currents from the microphone are superposed on the carrier wave and produce both upper and lower side bands. Actually the total radiation consists partly of signal energy (in the form of side bands) and partly of an unmodulated wave (the residue of the carrier) which contains no signal components.

The relative proportion of side band to carrier energy is determined by the strength of the applied microphone current, *i.e.*, the percentage of modulation. If the carrier is only lightly modulated, the possible range of reception is limited because, after a certain distance, the weak side bands become so attenuated that they cannot influence the detector. The residual carrier wave may, of course, travel further afield, but it will not reproduce the original signals in the receiver.

Heavy Modulation

On the other hand when the first consideration is to cover as wide an area as possible, then heavy modulation—up to 100 per cent—is resorted to. This applies, for instance, to the Toulouse station, which radiates advertising matter and therefore aims at reaching a large circle of listeners—even though it means sacrificing the quality of transmission.

The accompanying diagram shows the result of modulating a carrier wave with a single low-frequency note. The effect of superposing, say, orchestral music, is too

complex to be illustrated, but the principle is the same in both cases.

The left-hand portion from A to B shows the form of the carrier before it is modulated whilst the series of "humps" to the right illustrates the combination of the carrier with a low-frequency note of constant pitch. It will be seen that the amplitude of the humps rises and falls above the level BC of the original carrier by an amount *h*.

The ratio of the height *h* to the normal amplitude of the unmodulated carrier indicates the percentage of modulation and determines the strength of the radiated side bands. For full or 100 per cent. modulation the amplitude of the hump varies from zero to twice that of the original carrier.

In partial modulation, as previously stated, there is a residual unmodulated carrier wave which can be received at greater distances than speech or music and is usually heard as a continuous hissing note.

At first sight, indications would seem to be in favour of using full modulation, but the apparent advantages of this method are offset by certain distortion effects, as will be explained. The best results are obtained in practice by using a two-thirds or 66 per cent. modulation as in the B.B.C. transmissions.

Exceeding the Limit

When this is exceeded, two things may happen. First the voltage applied by the modulating valve may drive the carrier-wave generator off the straight-line part of its characteristic curve, so that the peaks of the modulated curve are flattened out. This gives rise to an artificial hollow effect, or "drumminess," in reception which is quickly resented by the trained ear.

In the second place, the rectifier valve at the receiving end can only function by working "around the corner" of the straight line part of its curve. In doing this it produces a double-frequency note, the strength of which depends upon the degree of modulation.

Such a note, if present in any strength, is bound to affect the quality of the original signals. It is found in practice that so long as the modulation does not exceed 60 or 70 per cent., the effect is hardly perceptible, but for heavier modulation it becomes objectionable.

Carrier-wave "wobble" occurs when the frequency of the transmitter is not anchored down to a constant value, either by means

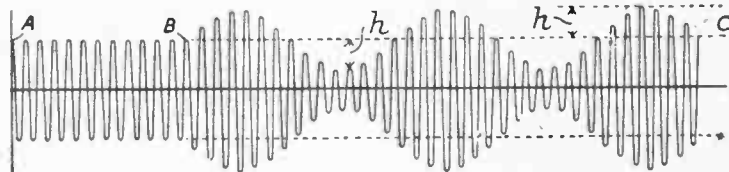

Example of carrier modulated by single low-frequency note

of a piezo-crystal oscillator or similar form of master control. This is a fault too frequently in evidence in many Continental stations.

Fading

When a selective set is tuned in to such a station, the programme "wanders" in and out of audibility with the fluctuations in the carrier wave, leaving the exasperated listener suspended, so to speak, in an empty ether. The blame for this kind of "fading" must be placed on the transmitter and not on the Heaviside layer.

Carrier-wave "wobble" is in fact one of the most serious faults in modern broadcast transmission. The ether is already overcrowded, and any station which deviates from its allotted wavelength is bound to cause heterodyne interference to listeners over a very wide area.

EGBERT HEARS IT!

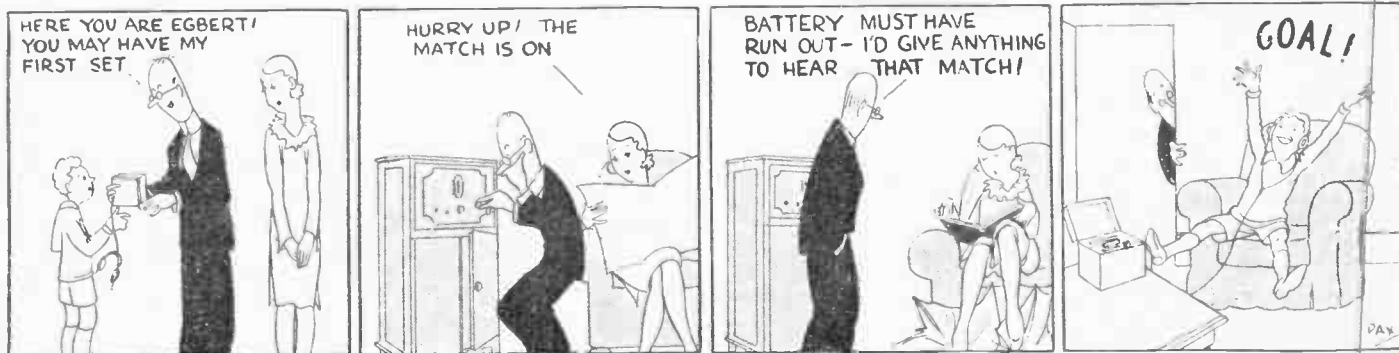

A Weekly Programme Criticism—By SYDNEY A. MOSELEY.

Without Fear or Favour



THE CRITICS' CIRCLE

"ALEXANDER AND MOSE"



"BY KIND PERMISSION"

MORE
OPERATIC TRANSMISSIONS

I WAS about to engineer one more new movement—that is, the Wireless Critics' Circle—when I opened my AMATEUR WIRELESS and found that the Editor has got in first with the news that the Critics' Circle proposes to include wireless critics!

It is not altogether a question of great minds thinking alike, because I still wonder whether it would not be better for me to start a wireless critics' circle. Still, my confrères on the Critics' Circle, many thanks for the compliment.

"Alexander and Mose" got away with it, as I reported in this column, but in their last appearance they seemed to be rather conscious of their audience, or of their success. They were not quite so spontaneous. It seems to me, too, that there has been rather a repetition of their funny little sayings. So I hope they won't appear too often, unless their material is changed a lot.

Bachhaus had a marvellous reception in the last Symphony Concert, and he certainly seemed to be very much at home. I remember hearing him at the Queen's Hall long before the war. Small wonder he has learnt his party pieces by now. Talk about the unemotional English!—they don't applaud in this frenzied fashion in Germany or France.

Readers should not be impatient regarding my campaign for an extended Sunday programme. I am by no means despairing, and hope to report good news before very long.

Harold Nicholson, talking about unemployment in his weak but not altogether unattractive voice, said the unemployment problem would last for another fifty years. He, in common with a good many other public speakers, imagines that the unemployment problem is a post-war problem. It is not. It was always grave and prominent, ever since I can remember.

Really, I am tired of the descriptions of "Mr. So-and-so or Miss So-and-so appearing by kind permission of this manager and

that," and after all this you hear a very ordinary turn. What I object to is the blatant advertising. The B.B.C. should keep out of all this.

The other day a television artiste who had appeared several times notified the Baird Co. that before her renewed engagement she would have to get permission from Mr. So-and-so, whose company she had now joined. Mr. So-and-so obviously wanted the announcement to be made, either in the press or over the microphone. I refused, and told the lady she need not appear.

Ernest Thesiger was deplorably tame in a recent vaudeville programme. He was down for three separate items, but the one on the Debating Society was quite enough for me. Mr. Thesiger should stick to his Cockney stuff.

The 6.40 concert from the London Regional, in which May Blithe and Roy Henderson sang with Alec Fenerman's Quintet, was the kind that must always get over. When you have, say, a selection of Edward Gernian's songs, Schubert's "Sere-

nade," Macdowell's "Sea Pieces," and songs by Easthope Martin, Fletcher, and Strauss—well, I call this a good programme, don't you?

The truth about the abandoned discussion between Lord Edward Percy and Sir Oswald Moseley was that these two young sparks found that they both had much in common, and each would have slashed the Government. The B.B.C. was scared, and when the B.B.C. is scared it does what the doubtful sub-editor does—cuts it out.

"The Planets," Gustav Holst's big work, is certainly a great achievement, but I do think that having to bring in the Wireless Chorus for just a few bars at the end is rather an extravagance, although admittedly, the effect of voices dying away was striking.

Florence Marks and Wilfred Shine scored emphatically with the little Irish episode, "On the Bench." Delightful brogue and bright dialogue make it a little masterpiece in its way.

Pursuit of Pleasure, another effort by Lance Sieveking, was spoilt by a cast which irritated in attempting to achieve the peculiar language of young moderns and foppish Victorians. The idea was good—we always alike looking backwards—but again, in attempting to strive for effect, Mr. Sieveking overdid it. Simplicity and Sieveking are, alas, not synonymous, and what we really require over the wireless is more simplicity and less juggling with new technique—which should be left to laboratory experiments.

It is good to see that we are having more operatic transmissions. Why should we have to go abroad for these? The Covent Garden Opera Company, therefore, is doing good work in its arrangements with the B.B.C. for the broadcasting of its first-rate touring company. Rigoletto is not one of my favourite operas, nor Il Trovatore, but both transmissions were first-rate. Now, what about Tosca and Boheme, and something in the Wagnerian line?



A Lissenden idea of VICTOR GL. F

Here are constructional details of an all-electric version of this famous set. This mains-driven set embodies the same basic circuit as that which has proved so successful in the case of the battery model and which is one of the reasons for its having proved the most popular three-valve that AMATEUR WIRELESS has introduced.

MANY readers have asked us for an all-electric version of the "1931 Ether Searcher." This is a request that was anticipated when the battery model of this famous set was first designed, but it was realised that as so many listeners have not mains equipment available, and as, in any case, it is possible to work a battery set with a mains eliminator, it was decided that a straightforward battery edition would be the best model to present first.

The All-electric Model

However, with a little modification the basic circuit of the "Ether Searcher" lends itself very well to all-electric work-

COMPONENTS REQUIRED FOR THE A.C. RECEIVER

- Baseboard, 16 in. by 10 in. (Camco, Pickett, Clarion, Peto-Scott).
- Panel, 8 in. by 6 in. (Trelleborg, Becol, Peto-Scott).
- Three-gang .0005-mfd. variable condenser with drum dial (J.B. Chassimount, Polar, Lotus, Formo).
- .0003-mfd. variable series aerial condenser (Readi-Rad, Polar, Lotus).
- .0001-mfd variable reaction condenser (Readi-Rad, Lissen, Bulgin, Polar, Peto-Scott, Lotus, Burton).
- Set of three matched coils with ganging switch (two Colvern type TGSC and one TGSR).
- Low-frequency transformer (Telsen Ace, ratio 5-1, Lissen, Varley, Lotus, R.I., Voltron, Ferranti).
- .01-mfd. fixed condenser (T.C.C. flat type, Lissen, Dubilier, Telsen).
- .0002-mfd. fixed condenser with grid leak clips (T.C.C., Dubilier, Lissen, Telsen, Watmel).
- .0002-mfd. and .0003-mfd. fixed condenser (Lissen, T.C.C., Dubilier, Telsen).
- Three 1-mfd. fixed condensers (Lissen, T.C.C., Dubilier, Filta).
- 2-mfd. fixed condenser (T.C.C., Dubilier, Lissen, Filta).
- Three 5-pin valve holders (Telsen, Junit, Lotus, W.B., Benjamin).
- High-frequency choke (Telsen, Lewcos, Readi-Rad, Bulgin, Tunewell, Peto-Scott, R.I.).
- Two 2-megohm grid leaks (Dubilier, Lissen, Watmel, Graham-Farish).
- Grid-leak holder (Bulgin, Wearite, Graham-Farish).
- Three coil screens (H. & B., Readi-Rad, Colvern, Peto-Scott).
- S.G. valve screen (H. & B., Colvern).
- Aluminium foil sheet, 15½ in. by 9½ in. (Readi-Rad, H. & B., Peto-Scott).
- Terminal block (Junit).
- Ebonite strip, 7 in. by 2 in. (Becol, Trelleborg, Peto-Scott).
- Four terminals, marked: A, E, L.S.(2) (Belling-Lee, Clix, Burton).
- Pick-up jack (Lotus J.K.3).
- 15-ohm notenometer for panel mounting (Wearite, Clarostat).
- One 600-ohm, one 1,900-ohm, and one

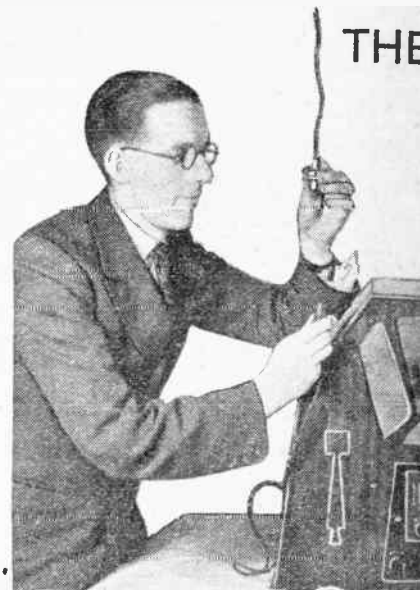

The ALL-ELECTRIC 1931

THE SET OF THE SEASON ADAPTED FOR MAINS V
DESIGNED B

ing. Very many of the requests we have received have been from owners of mains apparatus who have already made up the battery model of the "Searcher" and who naturally do not want to carry out unnecessary alterations in order to make it work entirely from the mains.

With this idea in view we produced an all-electric version of the set which differs only where absolutely necessary from the battery model. For the benefit of readers who have not previously considered building the battery model

of the "Ether Searcher" it should be pointed out that full constructional details were given in AMATEUR WIRELESS Nos. 449, 450 and 451.

Full-size layouts, wiring plans and constructional guides were given and these are a help in the construction of the all-electric model. Comparison of these full-size plans with the layout of the mains-driven set given here shows the small amount of alteration that it has been necessary to effect.

It should be explained that the battery model does not itself incorporate mains

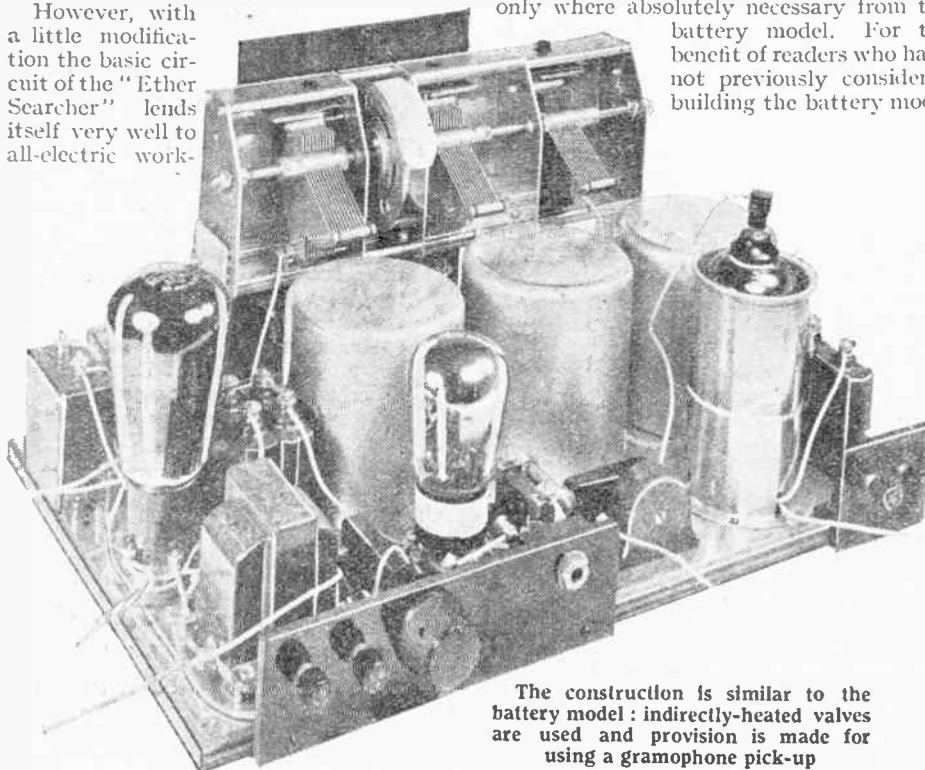

The construction is similar to the battery model: indirectly-heated valves are used and provision is made for using a gramophone pick-up

THE UP-TO-DATE CIRCUIT OF THE "ALL-ELECTRIC 1931 ETHER SEARCHER"

The circuit of the receiver is shown here with the theoretical connections of the "Ether Searcher" mains unit above. The set has bandpass tuning, and the method in which it takes its H.T., L.T. and G.B. from the mains can be seen. Bias is obtained by the dropping resistances in series with the cathodes of the S.G. and detector valves. Note the "stopper" circuit in the grid lead of the power valve. The connections of the double-wave H.T. rectifier can be seen, together with the 4-volt L.T. transformer winding

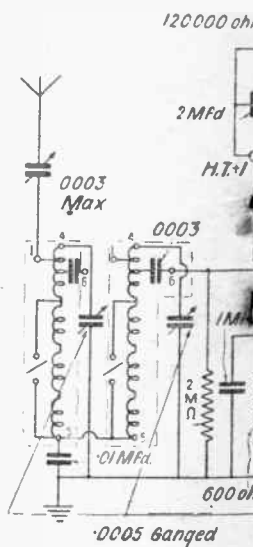

THE MOST UP-TO-DATE
"THREE"



ALL-ELECTRIC SEARCHER

WORKING - 50 STATIONS ON THE LOUD-SPEAKER

BY J. SIEGER

eliminator apparatus—the idea is that the set, with A.C. valves, can be used with an ordinary mains high-tension eliminator and with a 4-volt mains filament transformer. An accompanying photograph shows the set in use with a Philips high-tension eliminator and a Regentone filament transformer.

The Mains Apparatus

For those who wish to make up their own mains apparatus the construction will be described of a suitable high- and low-tension eliminator which connects straight

COMPONENTS REQUIRED FOR THE A.C. RECEIVER (Continued)
 100,000-ohm spaghetti resistance (Lewcos, Bulgin, Readi-Rad, Peto-Scott).
 1,000-ohm wire-wound resistance (Watmel, Claude Lyons).
 Low-frequency choke, 20-henries (R.L. Lissen, Varley).
 Two yards of thin flex (Lewcoflex, Peto-Scott).
 Seven spade terminals, marked: H.T.—, H.T.+1, H.T.+2, H.T.+3, H.T.+4, L.T. (2) (Clix, Belling-Lee).
 Connecting wire and sleeving (Lewcos)

COMPONENTS for A.C. UNIT for 1931 Ether Searcher
 Baseboard, 16 in. by 17½ in. (Camco, Clarion, Peto-Scott).
 Mains transformer, with secondary windings for 4-volt filament (Regentone, type WR7).
 Westinghouse metal rectifier, type H.T.7.
 20-henry smoothing choke (Varley, Lissen, R.L., Wearite).
 Three 4 mfd. fixed condensers (430 volt working) (T.C.C., Dabilier, Lissen, Filta, Formo).
 Three 2-mfd. fixed condensers (T.C.C., Dabilier, Lissen, Filta, Formo).
 120,000-ohm variable wire-wound resistance (Regentstat).
 20,000-ohm spaghetti resistance (Lewcos, Bulgin, Peadi-Rad, Peto-Scott).
 30,000-ohm spaghetti resistance (Lewcos, Bulgin, Readi-Rad, Peto-Scott).
 Ebonite strip, 9 in. by 2 in. (Becol, Trelleborg, Peto-Scott).
 Seven terminals, marked: H.T.—, H.T.+1, H.T.+2, H.T.+3, H.T.+4, L.T. (2) (Belling-Lee, Clix, Burton).
 Length of mains flex (Lewcos).
 Thin connecting wire and sleeving (Lewcos).
 Flex type mains switch (Bulgin).
 Baseboard-mounting twin fuse (Bulgin).
 OR—
 Philips high-tension unit, type 3009 and 4-volt 3-amp. mains transformer (Regentone type ACV). OR—
 Mains unit with 4-volt 3-amp. output (Regentone WIA, Junit, Clarke's "Atlas" AC220, Tannoy).

up to the set and provides all the current requirements. The set works entirely from the mains and not even an additional grid bias battery is needed.

The Circuit

The circuit shown here explains the way in which grid bias is obtained for all three valves. It will be seen that so far as the main tuning and coupling are concerned, the circuit of

the other grid dropping resistance, is shunted by a fixed condenser having a value of 1 microfarad.

The detector, as in the battery model, is of the leaky-grid type and normally no negative bias is required.

You will see that in this new (Continued on pages 366 and 368)

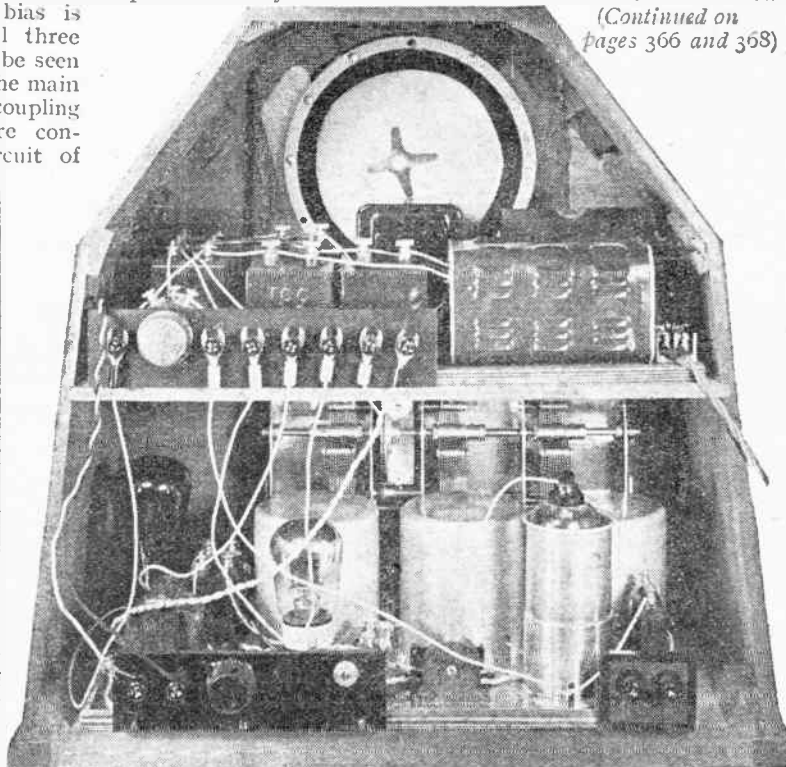
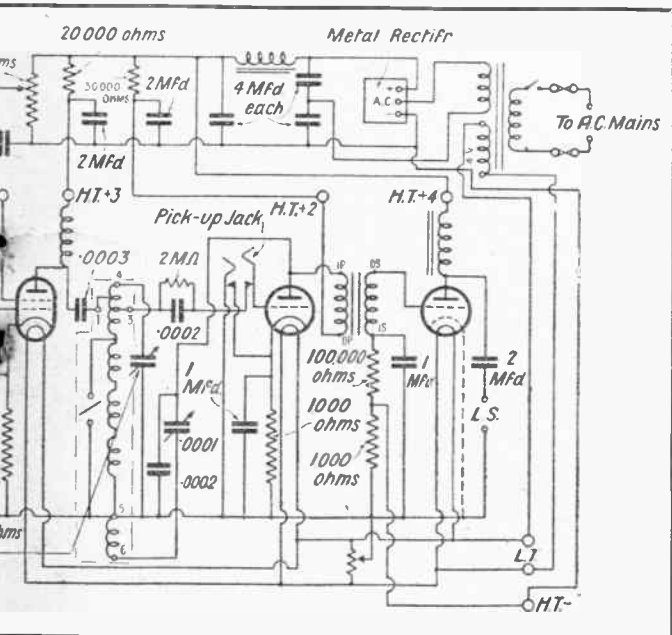

A rear view of the "All-Electric 1931 Ether Searcher"; the mains apparatus is in the upper compartment

“THE ALL-ELECTRIC 1931 ETHER SEARCHER” (Continued on page 368)

BLUEPRINT N°A.W. 276

This up-to-date receiver takes all its current from the mains and as will be seen from the layout is as simple to build as the battery model

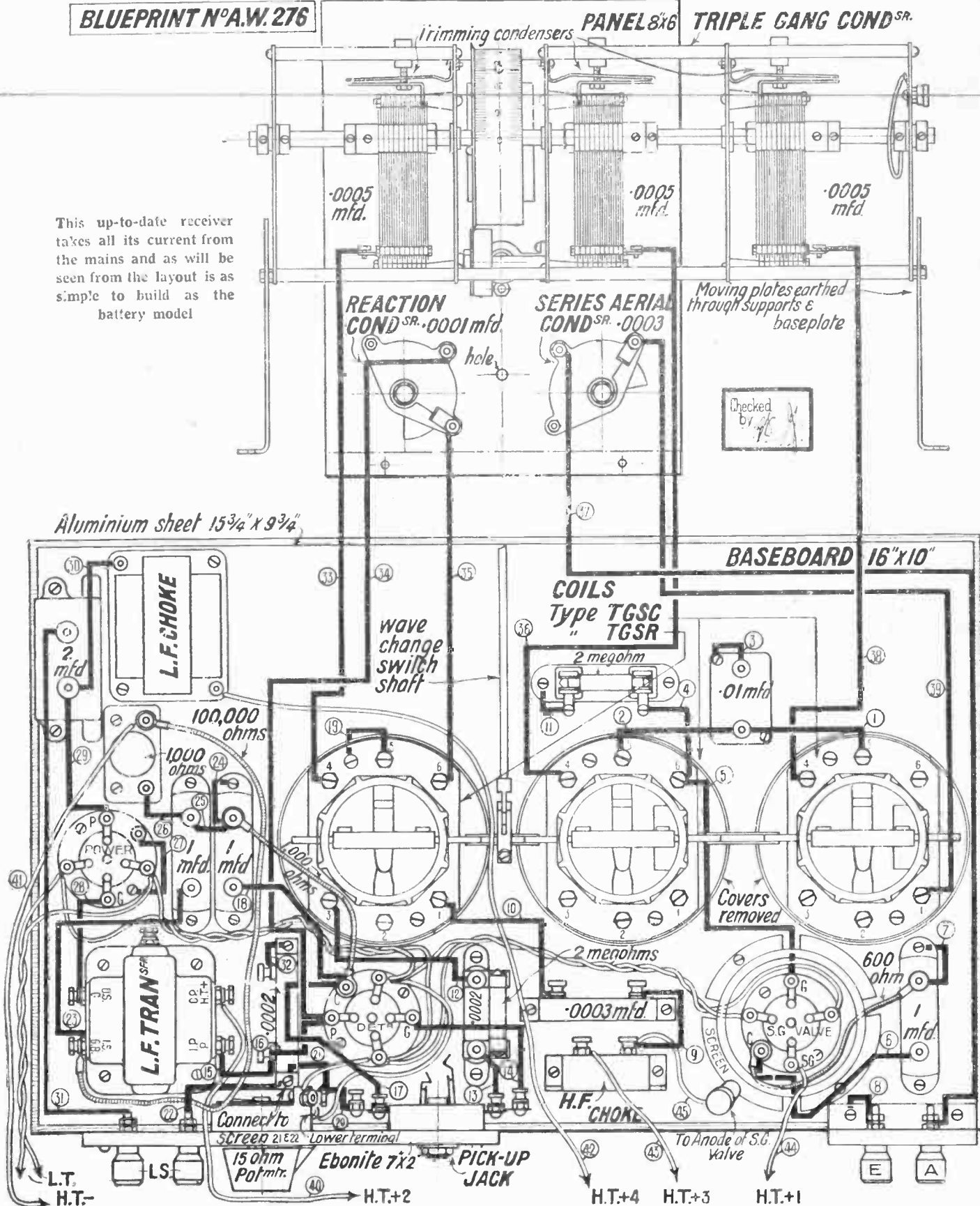

The layout and wiring diagram of the "All-electric 1931 Ether Searcher." The mains unit will be described in next week's issue. Full-size blueprints of both are available, price 1 - each.

CONVERT YOUR 1931 ETHER SEARCHER TO AN ALL-ELECTRIC RECEIVER

Components you will want to convert your 1931 Ether Searcher to an All-Electric Receiver

(including Special Mains Valves)

	£	s.	d.
2 T.C.C. 1 mfd fixed condensers ...	5	8	
1 T.C.C. 2 mfd fixed condenser ...	3	10	
3 Telsen 5-pin valve holders ...	3	9	
1 Terminal Strip 7 in. x 2 in. x 3/8 in.	2	6	
1 Lotus JK 3 Jack ...	2	6	
1 Wearite 15ohm P.M. Potentiometer Q11 ...	2	0	
3 ReadRad Link resistances (resistances 600, 1,000, 100,000) ...	4	3	
1 Colverstat 1,000 ohm W.W. resistance	2	6	
1 Atlas 20 Henry LF Choke ...	1	1	0
2 Yards thin Flex, Screws, etc. ...			10
7 Clix spade Terminals HF-, +1, +2, +3, +4, Lt. (2) ...	1	2	
1 Baseboard 16 x 17 1/4 ins. ...	1	0	
1 Regentone Main. Transformer WR7 with additional 4-volt secondary winding ...	1	8	0
1 Westinghouse Metal Rectifier HT. 7	1	1	0
1 Atlas 20 Henry Smoothing Choke ...	1	1	0
3 T.C.C. 4 mfd fixed condensers. (Tested 800 volts) ...	1	5	6
3 T.C.C. 2 mfd fixed condensers ...	11	6	
1 Regentstat resistance, 120,000 ohms type "A" ...	9	6	
2 ReadRad Link resistances, 20,000 and 30,000 ohms ...	2	9	
1 Ebonite strip, 9 in. x 2 in. x 3/8 in.			9
7 Belling-Lee "R" type terminals H.T., 1, 2, 3, 4, and 2 L.T. ...	1	9	
3 Yards Twin mains flex and mains adaptor ...	1	3	
1 Packet Jiffilux for wiring ...	2	6	
1 Bulgin flex mains switch S.18 ...	2	0	
1 Bulgin F.11 Twin Mains fuse ...	2	6	
Valves Mazda AC/SG, AC, HL, AC, PI	2	17	6
Total, including special Mains Valves	£11	16	6

or 12 equal monthly payments of 21.8

Every Ready Radio Ether Searcher Kit is guaranteed ACCURATELY MATCHED.

Components you will want to build the All-Electric 1931 Ether Searcher Complete

	£	s.	d.
1 Ebonite Panel (8 ins. x 6 ins. x 3/8 ins.) drilled to specification			2 6
1 J.B. 3 gang .0005 mfd. condenser D.3	1	15	0
1 ReadRad .0003 mfd. "Brookmans" type aerial condenser			3 6
1 ReadRad .0001 mfd. "Brookmans" reaction condenser			2 6
1 Set Colvern Matched coils with gauging switch	1	10	0
1 Telsen "Ace" LF Transformer 5-1			8 6
1 T.C.C. .01 mfd Flat type fixed condenser			2 6
1 ReadRad .0003 fixed condenser			10
1 ReadRad .0002 fixed condenser			10
1 T.C.C. .0002 fixed condenser with clips			1 6
3 T.C.C. 1 mfd. fixed condensers			8 6
1 T.C.C. 2 mfd. fixed condenser			3 10
3 Telsen Five Pin valve holders			3 9
1 Telsen H.F. Choke			2 6
2 ReadRad 2 megohm grid leaks			1 8
1 ReadRad Grid leak holder			6
1 Set ReadRad Coil and valve screens			7 6
1 Aluminium foil base 15 3/4 in. x 9 3/4 in.			1 6
1 Terminal Block 2 in. x 2 in.			3
1 Terminal Strip 7 in. x 2 in.			6
4 Belling Lee "R" type terminals A.E. & 2 L.S.	1	0	
1 Lotus Jack No. JK3			2 0
1 Wearite 15 ohm P.M. potentiometer Q11			2 0
3 ReadRad 600 ohms, 1,000 ohms, and 100,000 ohms link resistances			4 3
1 Colverstat 1,000 ohms wire wound resistance			2 6
1 Atlas 20 henry L.F. choke	1	1	0
2 Yards thin flex screws etc.			11
7 Clix spade terminals H.T., 1, 2, 3, 4, and 2 L.F.	1	2	
1 Packet Jiffilux for wiring			2 6
1 Baseboard 16 in. x 17 1/4 in.			1 0
1 Regentone Mains Transformer W.R.7, with additional 4-volt secondary winding	1	8	0
1 Westinghouse Metal rectifier HT.7.			1 0
1 Atlas 20 henry smoothing choke			1 0
3 T.C.C. 4 mfd fixed condensers (Tested 800 volts)	1	5	6
3 T.C.C. 2 mfd fixed condensers	11	6	
1 Regentstat resistance 120,000 ohms type "A"	9	6	
2 ReadRad Link Resistances 20,000 and 30,000 ohms	2	9	
1 Ebonite strip 9 in. x 2 in. x 3/8 in.			9
7 Belling Lee "R" type terminals (H.T., 1, 2, 3, 4, 2 L.T.)	1	9	
3 Yards Twin mains flex, and mains adaptor	1	3	
1 Packet Jiffilux for wiring	2	6	
1 Bulgin Flex mains switch S.18	2	0	
1 Bulgin F11 Twin Mains fuse	2	6	
Total	£14	7	0
3 Valves (Mazda) AC/SG, AC/HL, AC/PI			2 17 6
1 Cabinet in Oak			1 15 0

KIT A £14:7:0

or 12 monthly payments of 26/3. Complete All-Electric Kit less valves and cabinet

KIT B £17:4:6

or 12 monthly payments of 31/6. Complete All-Electric Kit with valves less cabinet

KIT C £18:19:6

or 12 monthly payments of 34/9. Complete All-Electric Kit with valves and cabinet

Ready Radio

159, BOROUGH HIGH STREET, LONDON BRIDGE, S.E.1.

Telephone: Hop 5555 (Private Exchange) Telegrams: READIRAD, SEDIST.

IMMEDIATE DISPATCH. All goods post free or carriage paid in the British Isles.

ORDER FORM

To Ready Radio Ltd., 159 Borough High Street, London Bridge, S.E.1

Please send me..... at £.....

FREE to every purchaser of a Ready Radio 1931 Ether Searcher Kit: A Booklet containing constructional details, full-size wiring diagram, notes on operation, tuning guide and other useful information—and One Atalanta Radio Screwdriver.

- 1 Ether Searcher Kit at £11:16:6, or 12 monthly payments of 31/5.
- 1 All-Electric Ether Searcher Kit A at £14:7:0, or 12 monthly payments of 26/3. (Cross out items not required)
- 1 All-Electric Ether Searcher Kit B at £17:4:6, or 12 monthly payments of 31/6.
- 1 All-Electric Ether Searcher Kit C at £18:19:6, or 12 monthly payments of 34/9.

Name.....

Address.....

CASH ORDER FORM

Please dispatch to me at once the goods specified for which I enclose payment in full of

£.....

C.O.D. ORDER FORM

Please dispatch to me at once the goods specified for which I will pay in full on delivery the sum of

£.....

HIRE PURCHASE ORDER FORM

Please dispatch my Hire Purchase order for the goods specified for which I enclose first deposit of

£.....

Please Mention "A.W." When Corresponding with Advertisers

"THE ALL-ELECTRIC 1931 ETHER-SEARCHER" (Continued from page 366)

"Ether Searcher" provision is made for the addition of a gramophone pick-up and, naturally, when the pick-up is in use, the valve following it requires a small amount of negative bias in order that it shall not be overloaded by the pick-up peak voltages.

This bias is obtained in the same way as that for the screen-grid valve and a 1,000-ohm dropping resistance is connected in series with the valve cathode. This resistance is also shunted by a 1-microfarad condenser.

The power valve calls for a larger amount of grid bias, and this is provided by means of a resistance in series with the high-tension supply. This is an entirely satisfactory arrangement, but to clear up the tone and to prevent any circuit interaction a grid filter circuit is provided. This, you will see, consists of a 100,000-ohm resistance and a 1-microfarad bypass condenser. The 1,000-ohm resistance provides the necessary amount of automatic bias.

There are several other interesting technical points about the circuit, but these will be raised as the constructional work proceeds and, of course, when the operating notes are given.

Simple Construction

Constructional work of the set is just as easy as that of the battery model. A list of the parts needed is given in an accompanying panel and readers who have already made up the first set and merely wish to convert it will see the extra parts required.

The general appearance of the set is very much the same as that of the battery model and externally the only difference noticeable is that no filament switch is provided. You are advised to get the full-size blueprint which can be obtained, price 1s. post free from the Blueprint Department of AMATEUR WIRELESS, 58 Fetter Lane, E.C.4. Clearly mark your request *Mains-driven 1931 Ether Searcher* to prevent confusion with the issue of prints for the battery model.

There is very little panel drilling to be done, but the hole for the condenser drum must be cut. The components can be mounted, including the drum-dial escutcheon plate. The panel can then be screwed to the baseboard.

Place the aluminium foil on the baseboard and, using the full-size blueprint as a template, the components can be screwed in position. This will be sufficient to hold the foil in place and keep it flat.

Fixing the Coils

As was the case with the first model of the "Searcher," fixing of the coils requires special mention. One of the three coils is different from the others in that it has four sections of windings on the long-wave section instead of three, this extra winding being for reaction. So be careful when placing the coils. Note that a .0003 condenser is included in one of the coils.

Working from the back of the set, join

all three coils together by means of the links, taking care that the coil with the reaction winding is on the extreme left. An important point to remember here is to see that all switches are "open," that is, with the ebonite switch bars flat and the contacts apart. Make sure that the coils fit centrally in the screening box lids.

When the coils have been mounted, the wavelength switch rod can be fixed. With the switches turned so that all contacts are open, fix the small lever so that it slopes towards the panel. The screw on this can then be tightened. It is only necessary now to pass the rod through the hole in the panel and screw it into the lever. The filament wiring must be put in first of all.

There remain now the gang condenser and screen-grid valve screen to fix into place. The condenser is an easy component to fix.

Take care to place it on the baseboard so that the small spindle slides easily into the hole on the panel. The condenser can then be screwed down with four screws and the knob fixed to the spindle.

In a subsequent issue constructional details will be given of the high- and low-tension unit to attach to the set, and detailed operating notes will be given regarding various methods of working the set with existing mains units.

For the benefit of amateurs who wish to purchase all the necessary parts, together with the valves, at this stage, it should be explained that although it is possible in the power stage to use certain types of 4-volt battery valve, this is not recommended. Mains valves should be used throughout.

In the screen-grid stage we have,

**Next Week:
A FULL DESCRIPTION
OF THE
MAINS UNIT**

during preliminary tests of the new "Ether Searcher," obtained entirely satisfactory results with a Mazda AC/SG valve. Other valves which may be used are the Mullard S₄V and the Marconi or Osram MS₄.

For the detector valve we have used a Mazda AC/HL, while valves having similar characteristics are the Mullard 354V or Marconi MHL₄.

A great deal of the success obtained with the set depends upon the correct choice of a power valve. During initial tests we used the Mazda AC/P₁ which, of course, is a valve of the indirectly-heated type.

It should be noted, though, that the valve-holder connections are so arranged that a directly-heated valve such as the Mullard AC 06₄ may be used. We have also tried the Marconi and Osram type ML₄ with great success.

In next week's issue final details will be disclosed and constructional particulars will be given of the mains unit.

See the original mains-driven "Searcher" in the Radio Department windows of Messrs. Selfridge & Co., of Oxford Street, London, W.1.

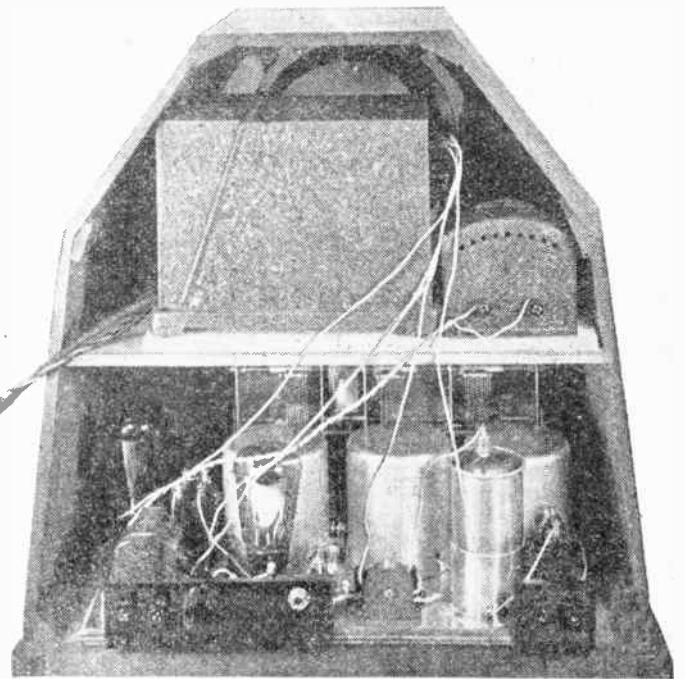

Here is the "Ether-Searcher" with the Philips type 3009 H.T. unit and the Regentone ACV filament transformer

KITS FOR THE "ETHER SEARCHER"

CERTAINLY the cheapest and best way to buy your parts for the "1931 Ether Searcher," either the original battery-operated model or the new mains-driven set described in this issue, is by means of a complete kit made up by a dependable firm. This saves you the trouble of having to purchase the parts separately, and there is the further advantage that with a complete kit all the little incidentals, such as short lengths of wire, screws and so on, are included, and you do not have any last-moment worries before actually beginning to build the set, as to whether all the necessary parts are at hand. We have already tested a set home-built from a kit of parts supplied by Ready Radio and, needless to say, the results are really first class. In the making of the set the least possible time was taken because of the advantage of having everything at hand.

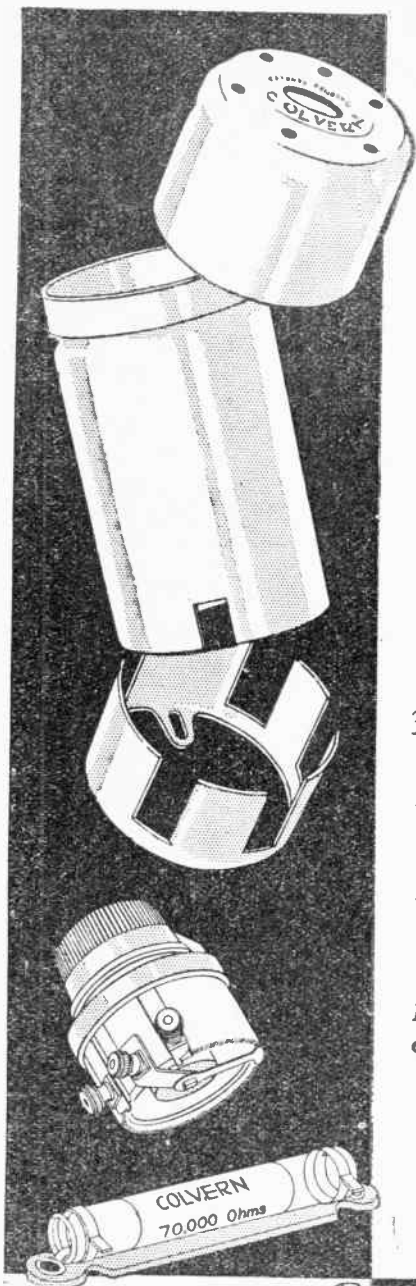

COLVERN COMPONENTS

for the

"1931 Ether Searcher" —A.C. and Battery Models

- 1 Set of Matched Coils, type E.S.1 **28/6 set**
- 3 Screens, type C.C.S. **3/6 each**
- 1 Valve Screen, type V.S. **2/9**
- 1 Switch, type S.I. **1/3**

For particulars of the full range of components send for the Colvern Booklet.

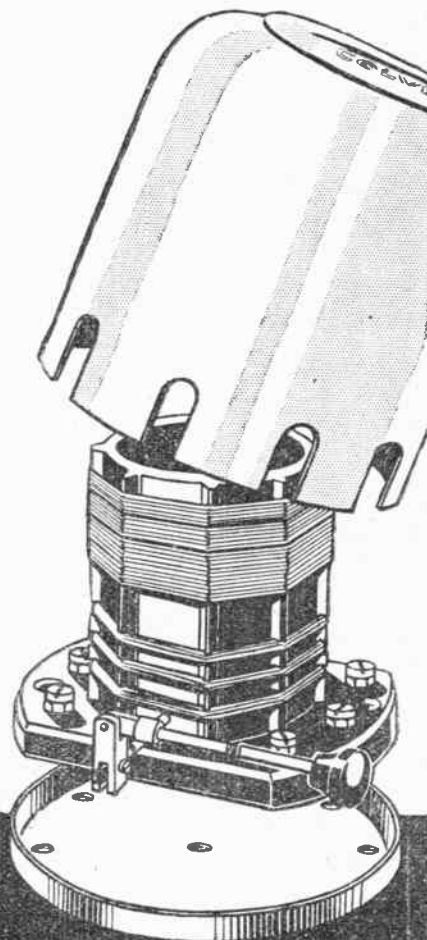

COLVERN RADIO

Advt. of COLVERN LTD., MAWNEY'S ROAD, ROMFORD.

Don't Forget to Say That You Saw it in "A.W."



Owing to the large number of broadcasting stations in Germany, and the high power of many of them, portable-set reception is easy. Here a portable set is being worked by some enthusiasts in "Sans-souci"—a well-known Berlin pleasure garden

I DID not take a portable set with me when I was called away on business to Berlin because I had heard that the Customs officials on the German side are rather too attentive to such things.

However, on what was really my first night in the German capital—a Saturday—I had first-hand experience of reception conditions. The friend with whom I was staying is himself an enthusiastic owner of a *fernempfänger* (portable set), and late in the evening when my luggage had been unpacked, he suggested that we could go along to a local wireless store, where his set was being fitted out with a new high-tension battery, and should then go back to the flat and try to pick up some B.B.C. stations.

Portable Radio!

The portable set weighed about the same as the average British example—it weighed some twenty-four pounds at a rough guess—and we took a taxi. So I had at the same time my first experience of Berlin traffic and Berlin wireless; we worked—or tried to work—the set while the taxi was going.

Neither experience was very pleasant! Traffic arrangements in Berlin are chaotic in comparison with those in London, but despite the hooting of other taxis (it was about theatre time) and fierce application of the brakes, we tried to pick up Witzleben.

All we could hear was the crackle of the taxi's magneto. We were held up in the traffic block for quite five minutes by a *Schupo* (the equivalent of a point-duty policeman) who was interested to see what we were doing with that mysterious-looking box on the back seat of the taxi!

But when we did get back to the flat my German friend gave me an opportunity of seeing what sort of alternatives are to be had by the average set-user in Berlin.

We specialised in Mühlacker, Witzleben, and Königswusterhausen. Of course, it was impossible to hear the London Regional as a programme for Mühlacker drowned it completely. The heterodyne could be

way, was of a well-known German make, and one or two of the components which were embodied I recognised as having seen in London radio-shop windows. It was a four-valver with two high-frequency stages and a pentode, but the performance certainly was not up to what the average British amateur would expect from a set of this description, made up with British parts. Although it was not light in weight it was exceptionally compact and there was plenty of metal screening. The endeavour towards compactness had been carried to extremes and the coils did not impress one as being very efficient.

Later on in the week my friend had again occasion to call at a wireless shop and while waiting I heard one or two other German commercial table-type sets working. It is extremely difficult to judge quality on a foreign transmission in a



German portable sets are generally very compact, with ample metal screening. Here is a commercial portable in use.

RECEIVING IN BERLIN

Amateurs who complain of interference from Stuttgart and the other big German stations must remember these provide a fine service for German listeners. Here is a first-hand account of a British amateur's radio reception in Berlin

heard. The two French stations, one of which we did not stop to identify, and another which by its wavelength was obviously Radio Paris, came in well, as did the London National and Midland Regional.

When we had made out this rough reception log I was asked to try the dials and examine the set. The set, by the

foreign language, but the general impression I had was that the general standard of tone is perhaps not *quite* so good as that appreciated by British listeners. Certainly there is no attempt to produce a "boomy" bass. Two speakers which I heard working on ordinary three-valve mains-driven sets were rather "reedy" in tone.

Mains-driven Sets

I should say that the average set in Berlin is mains-driven, and all the mains sets I saw had valve rectifiers. There was one mains-driven two-valve set which, complete with its valve rectifier, was contained in a box measuring only 13 in. by 5 in. by 5 in.

On the morning after my arrival I was able to hear a typical continental Sunday programme at first hand. I saw, on reference to the programme in a newspaper, that Witzleben had broadcast gymnastics at 6 o'clock in the morning and that weather forecasts and the agriculture bulletins had been broadcast before breakfast. At odd intervals during the day I listened to an outside broadcast of the unveiling of a memorial to Schöneberg inhabitants who fell in the Great War, a programme of light music from Königsberg, a variety programme, and an orchestral concert.

It seemed that the whole day was adequately provided for by broadcasts of one kind and another, but then one must remember that the continental conception of Sunday is very different from that held by, say, the B.B.C.

NOISY VALVES

MANY valves, whilst functioning perfectly well as amplifiers or detectors, are apt to give trouble on account of the microphone noises which arise owing to vibration. This noise is not always due to the set being touched, but may arise from other sound waves impinging upon the glass walls of the valve or owing to vibration. The trouble might be overcome in many ways which can be improvised. For instance, a strong spring faced with electrician's rubber tape may be clipped upon the valve, the two ends of the spring gripping one each side; or another dodge is to place the set upon four pieces of sponge rubber. Very often a valve becomes unduly microphonic when the filament is overloaded, and this may be overcome by reducing the brightness to the lowest point at which good operation is obtainable. Also reducing the high-tension voltage is some times helpful.

TECHNICALLY PERFECT —AND PERFECT IN PRACTICE TOO!

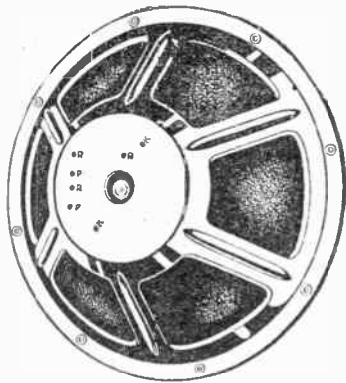
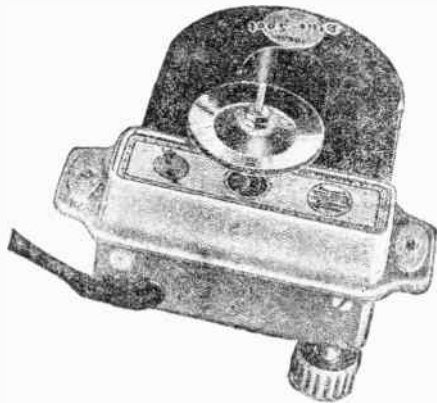

BLUE SPOT Units and Blue Spot Chassis are complementary to each other. Used in conjunction they form the essentials of a loud-speaker which will stand up to the most exacting technical and practical tests with ease and never fail to give the utmost satisfaction in ordinary everyday use.

BLUE SPOT UNIT 66K illustrated here has already won for itself a very high reputation. It reproduces the whole range of notes with fidelity. It allows both voices and music to retain their full warmth and colour—every instrument is made crystal clear, every voice pregnant with life and personality.

In achieving such genuinely wonderful results the BLUE SPOT SPECIAL CHASSIS plays a very important part. It is specially built by our own engineers to respond sympathetically to the vibrations of the stylus of the unit. To obtain so complete a harmony in practice is by no means easy and entailed the most careful calculations and painstaking research in order to ensure scientifically correct measurements from apex to base, and diameters of apex and base. The perfection of the finished product is the measure of the care expended in producing it.

In selecting a Blue Spot Unit, therefore, the Home Constructor is making a wise choice, and he will be still further satisfied if he is careful, for the reasons given above, to insist upon using a BLUE SPOT CHASSIS—AND NO OTHER.

BLUE SPOT UNITS

Type 66K (25 m/a) 25/-
As illustrated

Type 66P (30 m/a) 27/6

Type 66R (50 m/a) 35/-

BLUE SPOT CHASSIS

SPECIAL 31 cm 10/6

MAJOR 37 cm 15/-

Suitable for all types of Blue Spot Units

THE BRITISH BLUE SPOT COMPANY LTD

BLUE SPOT HOUSE • 94/96 ROSOMAN STREET • ROSEBERY AVENUE • LONDON • E C1.

'Phone: CLERKENWELL 3570

'Grams: "BLUESPOT, SMITH, LONDON."

Distributors for Northern England, Scotland and North Wales: H. C. RAWSON (Sheffield and London), LTD 100 London Road, Sheffield; 22 St. Mary's Parsonage, Manchester; 183 George Street, Glasgow.



You will Help Yourself and Help Us by Mentioning "A.W." to Advertisers

GRID STOPPERS IN L.F. AMPLIFIERS

By J. H. REYNER, B.Sc., A.M.I.E.E.

ONE often sees stopping resistances placed in the lead to the grid of an L.F. valve. These resistances are familiarly known as grid stoppers, and it is generally realised that their purpose is to prevent high-frequency oscillation from being set up in the L.F. stages. Some readers may have tried this device, however, and been disappointed with the results. The truth is that, like most other things in wireless design, the device must be used with a

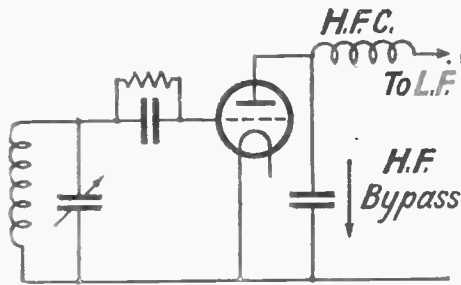

Fig. 1. H.F. choke in anode lead

knowledge of what is happening in order to obtain the correct effect.

Let us consider for a moment the methods we adopt to isolate the high-frequency from the low-frequency, immediately after the detector. We place a high-frequency choke in the anode lead as shown in Fig. 1, choosing the value of the inductance so that it does not affect the upper audio frequencies to an appreciable extent, but does present a high impedance to radio frequencies. In a practical circuit we cannot completely achieve this result because a choke of a 100,000 microhenries inductance offers an impedance to frequencies of 5,000 cycles of a little over 30,000 ohms, and several of the chokes now in use have inductances considerably greater than this, so that we are cutting off an appreciable proportion of our high notes in our attempt to choke back the high-frequency oscillations.

An Alternative Path

This in itself is not sufficient, however, and it is essential for the correct action that a low-impedance path be provided for the high-frequency current as an alternative route. This we do by connecting a by-pass condenser between the anode and L.F., of a value usually about .0001 microfarad. As I have shown in various articles dealing with H.F. chokes, a good component of this class will present such an impedance to radio frequency that 95 per cent. of the current will pass through the .0001 condenser, leaving only some 5 per cent. to find its way into the low-frequency stages.

It would seem that this small residue of H.F. current would be incapable of causing trouble, but with an efficient modern amplifier this is not always the case. There is, too, a second source of difficulty—that of continuous oscillation at a radio frequency. The leakage inductances and self-capacities in the circuit often will combine to form a tuned radio-frequency

system in which continuous oscillations are sustained by the valve.

The undesirability of such a state of affairs is obvious and in some cases there is a risk of serious damage. For example, the anode current of the valve may rise to several times the normal value with the result that the filament will lose its emission very rapidly.

Hence it is necessary to adopt some form of protection against H.F. oscillation in the amplifier itself. This usually takes the form of a grid stopper which is a resistance inserted in the grid lead as shown in Fig. 2. As in the previous instance the action is based upon the difference in the impedance of the circuit at high and low frequencies. Fig. 3 shows the circuit re-drawn in its essential parts. We have a supply of voltage coming from the secondary of the transformer which has been represented by a small generator. The current supplied by this passes through a stopper resistance, and then home again through the capacity between the grid and filament of the valve. The value of this capacity depends upon the conditions it is something of the order of 50 microfarads.

Let us assume that the stopper resistance is 100,000 ohms. At 400 metres the

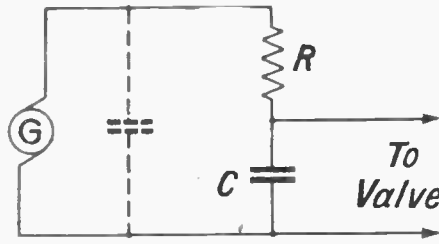

Fig. 3. The essential features of a stopper arrangement

valve capacity of 50 micro-microfarads will have an effective impedance of 4,000 ohms. Therefore, nearly all the voltage will be developed across the stopper resistance and only 4 per cent. will be applied across the grid and filament of the valve. Thus the valve is a very inefficient amplifier of any high-frequency currents, and for the same reason will not sustain oscillations of a high frequency, even if the circumstances are otherwise favourable. At low frequencies,

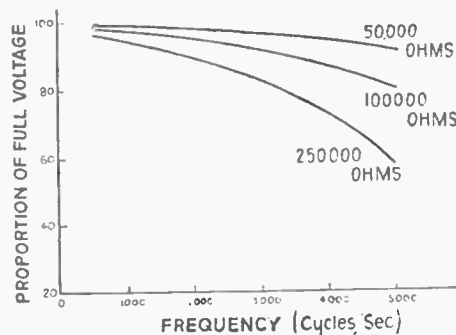

Fig. 4. Curve showing effect of stopper resistance on upper frequencies

on the other hand, of, say 800 cycles, the reactance of the capacity is something like 4 megohms, so that the effect of the 100,000 ohms in series is quite small, causing a drop of about 2.5 per cent. only.

If necessary, an H.F. choke can be used in place of the stopper resistance. A choke of 100,000 microhenries inductance will only have a reactance of 500 ohms at 800 cycles, and the low-frequency would be practically unaffected. The reactance

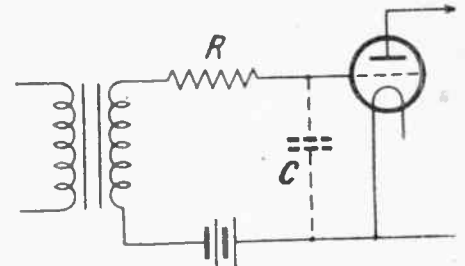

Fig. 2. Stopper resistance in grid lead

to radio frequency, however, would probably be very much greater than 100,000 ohms (this depending upon the effectiveness of the choke), so that the arrangement is excellent for our purpose, but, of course, this method is more expensive since a good high-frequency choke costs four or five shillings, whereas a stopper resistance costs a shilling or less. As the difference between the two methods is quite small, we prefer to use the more economical one.

Now, in this particular instance there is no need to provide a by-pass. In the detector stage we are dealing with the anode circuit in which current is flowing, and if we do not provide a by-pass for the high-frequency currents they will force their way into places where we do not want them. Incidentally, the detector will not function at its proper efficiency, so that neither the H.F. current nor the L.F. modulations will be as strong as they should be. Here, however, we are dealing with voltages, and the circuit comprising the stopper resistance and the grid capacity simply acts as a potentiometer across the transformer. The current taken by this potentiometer is very small owing to the high impedance of the arrangement and it is the voltages with which we are concerned. As we have seen, the greater part of this voltage is absorbed by the stopper resistance at the radio frequencies, while at the audio frequencies nearly the whole voltage is developed across the valve where we need it.

So far, however, we have not considered the self-capacity of the transformer itself. If we take this into account we find that the effectiveness of the stopper resistance is even more increased. This self-capacity is shown dotted in Fig. 3, and would probably be of the order of 20 micro-microfarads. Now, at a wavelength of 400 metres, this would have an impedance of 10,000 ohms. The parallel circuit, consisting of the stopper resistance and the

(Continued on next page)

grid capacity has an impedance of something over 100,000 ohms, so that the high-frequency voltages have an easy path to earth, and only a small proportion would flow round the circuit etc. Consequently, the self-capacity of the transformer tends to assist the elimination of radio frequencies and, indeed, in certain cases it is desirable to connect a small condenser across the secondary where the high-frequency response is sufficiently good to stand being cut down by a small amount. This, in conjunction with a stopper resistance, renders the elimination of high-frequency currents almost complete.

We have assumed a value of 100,000 ohms for the stopper resistance, and it will be clear from what has already been said that this value is quite large enough for all practical purposes. There is no point in increasing it beyond this figure, and, indeed, in many cases a value of 50,000 ohms is quite sufficient. This is even more the case when one considers the shunting action of the self-capacity as just explained, and, of course, to disturb the upper audio frequencies as little as possible the value of this stopper resistance should be kept low. Fig. 4 shows the cut-off produced by various values of stopper resistance at different frequencies on the assumption of a 50 micro-microfarad valve capacity, and it is clear from these curves that unless one deliberately wishes to sacrifice some of the other registers it is not desirable to exceed a value of 100,000 ohms.

SHORT-WAVE RECORDS

THE remarkable range of communication that may be attained with short-wavers on board ship was recently proved during the voyage of the R.M.M.V. *Winchester Castle*, of the Union Castle Line.

This liner has a Radio Communication short-wave transmitter, and the excellent results obtained were shown by the operator's report that night communication was easily maintained at all times, on a wavelength of 36.5 metres, with England, South Africa, and North America. While the ship was off the South African coast communication was also established with Sydney, New South Wales. Daylight communication with England on 17.8 metres was maintained up to 2,540 miles, and with Walvis Bay up to 3,574 miles. This set works over a wave range of 16 to 40 metres, and any wavelength within these limits can be obtained with very fine tuning. It has its own rectifier, generator, starter, and regulators.

Similar tests are always being made, and there is a splendid opportunity for amateurs to pick up these short-wave signals. B.

Sir William Bragg, one of the greatest chemists of the day will broadcast a National Lecture on March 4. His subject will be the life and work of Michael Faraday.

A premium of £600 was paid to insurance brokers when a one hour's "stunt" advertising programme was broadcast in the States. The consideration was, that £200 should be paid for every minute that the programme had to be held up to prevent interference with morse S.O.S. signals.

DOUBLE YOUR PRIZE

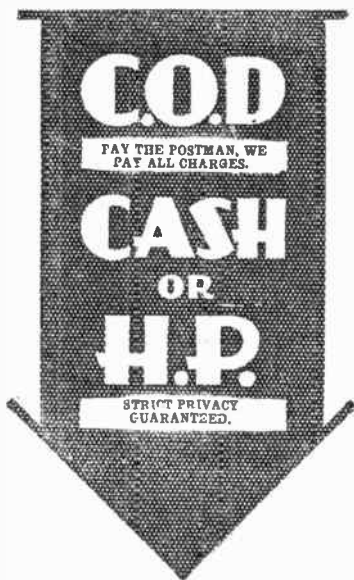

BUILD YOUR 1931 ETHER SEARCHER with a PILOT RADIO KIT

● Enter your 1931 Ether Searcher into the "Amateur Wireless" Competition. If you are awarded a prize and your set is built with a Pilot Radio Kit, Peto-Scott Co., Ltd., guarantee to *Double Your Prize* by presenting selected Radio Equipment equal in value to the prize awarded.

OFFICIALLY APPROVED

Messrs. Peto-Scott Co., Ltd.,
77 City Road, London, E.C.

January 8th, 1931

Dear Sirs—You have submitted a model of the "1931 Ether Searcher" according to our instructions and specifications. We have examined and tested it, and find that it comes up to the standard of our own receivers. We, therefore, have pleasure in approving the kit. We are glad to note that the dial readings agree with the average of those given by our own receivers.

Yours faithfully,
(Signed) Bernard E. Jones,
Editor, "Amateur Wireless."

● Any Parts supplied separately. See official lists published in "A.W.," Jan. 17, 24 and 31. If over 10/- in value sent C.O.D. You pay the postman, we pay all charges.

KIT "A" Pay the Postman £5.14.6 Or 12 monthly payments of 10/6 (Less Valves and Cabinet)
KIT "B" Pay the Postman £7.13.6 Or 12 monthly payments of 14/- (With Valves less Cabinet)
KIT "C" Pay the Postman £8.14.6 Or 12 monthly payments of 16/- (With Valves and Cabinet)
THE A.C. 1931 ETHER SEARCHER (Described in this issue.)
KIT "A" (Less Valves and Cabinet) Cash or C.O.D. You pay the Postman. £13.9.3 Or 12 monthly payments of 24/8
KIT "B" (With Valves Less Cabinet) Cash or C.O.D. £16.6.9 Or 12 monthly payments of 30/-
FREE Every Pilot Radio Kit for the Ether Searcher includes a Set of "BETTA" No-Soldering Links.

PETO-SCOTT CO. LTD.

77 CITY ROAD, LONDON, E.C.1 Clerkenwell 9406
62 HIGH HOLBORN, LONDON, W.C.1 Chancery 8266

BRANCHES:

MANCHESTER: 33 Whitelaw Road,
Chorlton-cum-Hardy. Phone:
Chorlton-cum-Hardy 2028.
NEWCASTLE, STAFFS: 7 Albany
Road. Phone: 67190

POST THIS COUPON NOW.
Please send me your Pilot Radio Chart with full details of the 1931 Ether Searcher, with particulars of the VOXKIT RADIOGRAM CABINET.

Name.....
Address.....
A.W. 28 2/31

Pilot Kits Guarantee perfect Radio

SETS OF DISTINCTION

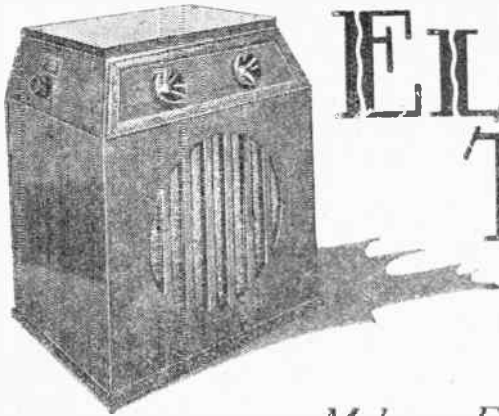
ELECTROSET
TWO-VALVE
A.C. SET

Makers: Electroset Radio Co. Price: £15

HERE is a self-contained two-valver working entirely from A.C. mains. This efficient set costs only a penny for 6 hours running. A single knob changes from one wavelength to another. One dial tunes the different stations within range and a similar dial controls reaction. Provision is made for the use of a gramophone pick-up. A Westinghouse metal rectifier is used to convert the A.C. to D.C. The self-contained loud-speaker is a Blue Spot chassis. The only externals needed are a good aerial and earth.

Good Value

I have given these brief details to indicate that the Electroset two-valver is good value for money. I must confess I was agreeably surprised at the excellent results obtained during tests. The good efficiency is in some measure due to the inclusion of a Binowave coil. It will be remembered that the Binowave coil was designed by Mr. James, our Technical Consultant.

Two aerial connections are provided, one going direct to the coil and the other through a series fixed condenser. The provision of these two aerial terminals proved useful in the separation of the two local stations. I found it was practicable to use a 50-foot aerial, since this gave enough volume on the locals and enabled them to be separated using the direct coil connection for the aerial wire. The London National, maximum at 48, spread down to 30 and up to 58 on the tuning dial, a total swamping effect of 28 degrees.

The London Regional, curiously enough, had a smaller spreading effect. Maximum at 50, it had disappeared at 100 and at

78 degrees on the dial, a total spread of 22 degrees. On the long wavelength range, Daventry was well received on the loud-speaker. Maximum at 110, it spread

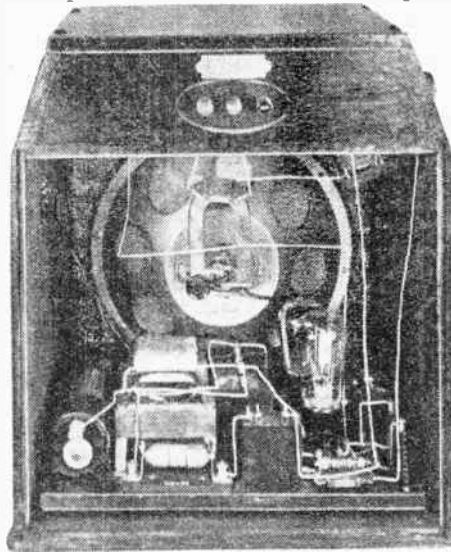

This back view of the Electroset shows how well advantage has been taken of the available space

down to 100 and up to 130. Possibly the question of the spreading effect of Daventry is not important, since one can hardly expect to receive any other station at good loud-speaker strength.

Excellent Range

On looking through my log, I find Radio Paris was a fair loud-speaker signal at 135 and that Eiffel Tower at 98 was also

heard. Hilversum was logged at 150 at weak loud-speaker strength. On the medium waves I logged the Midland Regional at good loud-speaker strength at 135. Brussels 145 was a fair loud-speaker signal, as was Stockholm 120, Rome 122, and Toulouse 104.

These good results are rather surprising for a two-valver. But one must remember that the two valves used in this set are exceptionally sensitive. The detector valve is an Osram MH4, having the high amplification factor of 35, in spite of its low impedance, namely, 16,000 ohms. The output valve is an Osram PT425, a 4-volt pentode with an amplification factor of 100 for an impedance of 50,000 ohms.

The overall amplification given by these two valves is therefore considerable. Add to this the excellent Binowave coil and you have sufficient reasons for the efficient results obtained on the Electroset. The detector valve is indirectly heated at 4 volts, but the pentode is directly heated from the same 4-volt secondary winding on the power transformer.

The quality of reproduction satisfied me. The pentode valve works well with the Blue Spot chassis. Ample volume was handled without distortion.

This set should appeal to listeners desiring a self-contained local station set for A.C.-mains operation. The two circular slow-motion dials mounted at the top of the cabinet, left for tuning and right for reaction, are very easy to manipulate. The only other controls for the receiver are the waveband switch and the mains on/off switch.

SET TESTER.

HOW MANY SETS?

AN authoritative analysis places the total number of wireless sets now in use at the astonishing figure of 24,000,000, and their value at £200,000,000. Broadcasting estimates both in this country and in the United States agree that a conservative figure would be three listeners to every set in use, so that on this basis the number of listeners may be taken as 72,000,000. It would be interesting to count up the number of transmitting stations—amateur and professional—in the world!

DO YOU KNOW THAT—

there is no real advantage in using power valves in parallel unless only small valves are available?

you can work a portable set with an earth connection? Simply connect low-tension negative to a water pipe or to an earth tube. Often this improves the range and working of a transportable, even without the addition of an aerial.

if your short-wave receiver suffers from bad body-capacity effects, even though it may be completely shielded, you may use an H.F. choke and a 2-microfarad condenser in each of the H.T. leads?

THE SCOTTISH REGIONAL

WHEN the new Scottish Regional station is operating at Westerglen, near Falkirk, the Aberdeen station will carry on as before, although the Glasgow, Edinburgh and Dundee transmitters will be closed down. It has been found that Aberdeen will probably be outside the range of the new Regional transmission. The nature of the country round Aberdeen makes it impossible for listeners there to hear effectively from a point suitable to other stations, and special precautions will, obviously, have to be taken.

E.

RI
Transformers and Chokes

Specified
 for Best
 Results
 in the
 A.C. 1931
 ETHER
 SEARCHER

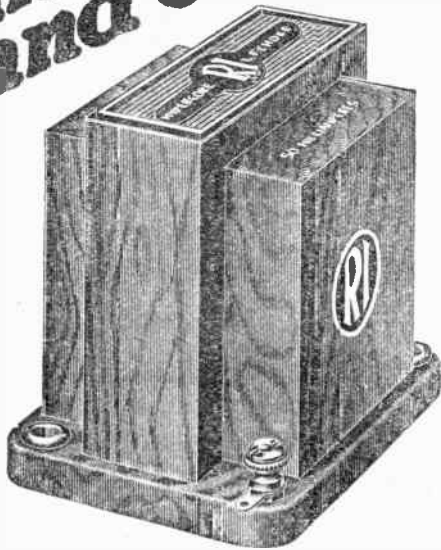

**HYPERCORE
 NIKALLOY CORE CHOKE**

Gives unequalled brilliance of musical tone and finesse of sound detail to reproduction. The first NIKALLOY Choke for output filtering or smoothing. **17/6**

Inductance, 30 henries. Maximum D.C., 80 milliamps. Weight, 18 oz. Walnut-finished bakelite case.

NEW G.P. CHOKE

For output filter smoothing or I.F. coupling (maximum D.C., 60 m.a.). A small general-purpose Choke for portables or receivers where space is limited. **12/6**

D.C. resistance, 400 ohms. Inductance, 25 henries. Maximum D.C., 30-60 milliamps. Size, 2 in. by 2 1/2 in. high. Bright green bakelite case.

HYPERMITE

The marvellous midget transformer with the NIKALLOY CORE.

Gives the generous tone of deep bass and shrillest treble to reproduction. A marvel for its weight and size. Indispensable for efficiency in compact set assembly. **12/6**

Primary inductance, OVER 50 HENRIES. Ratio, 3 1/2-1. Weight, 7 oz. Walnut-finished bakelite case.

HYPERMU

Incontestably the best Transformer, with a guaranteed performance proved by N.P.L. curves and showing the most amazing handling of all frequencies between 25 to 7,000 cycles. Incorporates the famous NIKALLOY CORE. **21/-**

Primary inductance, 85 henries. Ratio, 4-1. Weight, 13 oz. Black bakelite case.

IMPROVED G.P.

An improved model of the famous original G.P. Transformer, redesigned for use where space in set building need not be considered. **10/6**

Ratio, 3 1/2-1. Primary inductance, 35-40 henries; D.C. resistance; primary, 1,050 ohms; secondary, 6,600 ohms. Weight, 1 lb. 2 oz.

Buy **RI** they're **BEST** and cost no more

R.I. LTD., MADRIGAL WORKS, PURLEY WAY, CROYDON.
 Phone: Thornton Heath 3212

YOU CAN SIMPLY SWITCH ON!

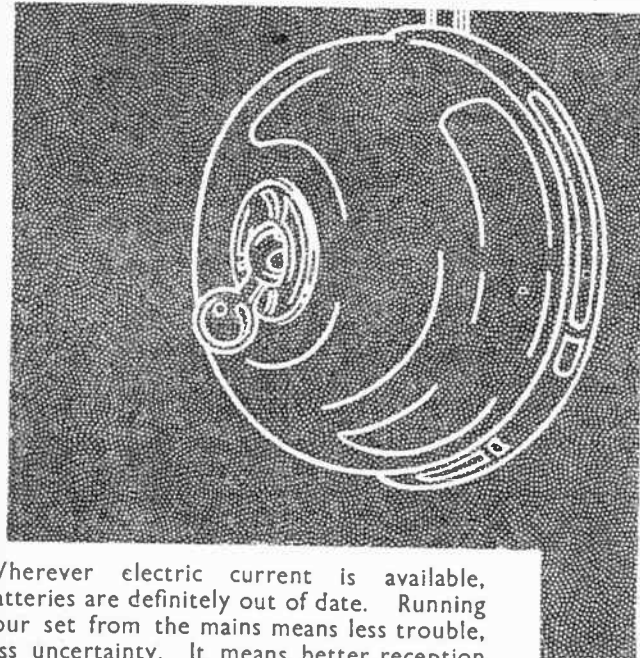

Wherever electric current is available, batteries are definitely out of date. Running your set from the mains means less trouble, less uncertainty. It means better reception and greater economy.

Most mains provide alternating current, which is, of course, unsuitable for radio purposes and has to be converted to direct current by means of a rectifier.

The Westinghouse Rectifier is quite different from all others. It is all-metal and contains nothing to burn or wear out. It converts—in conjunction with other components—existing battery-run sets to mains sets; it is ideal for use in constructors' kits; and it is incorporated in most good makes of mains-receivers—if you are purchasing, make sure that it is in yours.

There is not sufficient room to give details here, but a great deal of interesting technical information and complete descriptions are given in our forty-page booklet, "The All-Metal Way, 1931," which will be sent to you on receipt of the coupon (please enclose 3d. for your copy).



METAL RECTIFIERS

THE WESTINGHOUSE BRAKE AND SAXBY SIGNAL CO., LTD.,

82 York Road, King's Cross, London, N.1.

Telephone: North 2415

COUPON

Please send your forty-page booklet, "The All-Metal Way, 1931," for which I enclose 3d. in stamps.

NAME.....

ADDRESS.....

(Please write in Block Letters)

A.W. 28.2.31

Advertisers Appreciate Mention of "A.W." with Your Order

WE TEST FOR YOU

A weekly review of new components



and tests of apparatus.

Conducted by our Technical Editor: J. H. REYNER, B.Sc., A.M.I.E.E.

New Regentone D.C. Unit

UNIFORM with the A.C. eliminator which we tested recently is the Regentone D.C. combined model which provides H.T. when the set is in operation and trickle-charges the accumulator when the set is switched off. As in the previous cases which we have reviewed recently, the instrument is produced in a handsome brown crystallite finish, the size being such that it will replace the customary H.T. battery in the average portable set.

There is a commendable absence of knobs, the only control being a switch having two positions. In one, the apparatus supplies high-tension voltages, and in the reverse position the H.T. is switched off and a trickle-charge current is passed through the accumulator. The high-tension voltages are brought out to sockets on a small moulded strip at the end of the unit, three tapplings being provided, viz. 80 volts for the screen grid, 60 to 70 volts for the de-

rector, and 120 volt for the power tapping. The method of breaking down the voltage for trickle charging is ingenious.

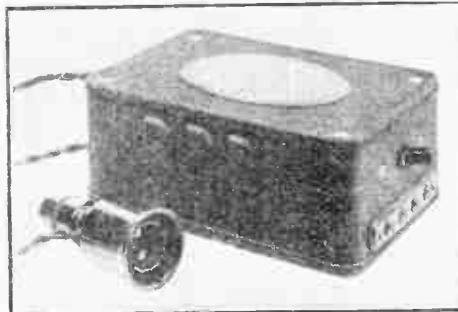

This is the new D.C. combined-model 2 Regentone mains unit. It incorporates an accumulator trickle-charger

A special adaptor is provided which plugs into any lamp socket. At the other end of this adaptor is a socket into which is

inserted the lamp which was formerly in the lamp socket. This lamp forms the breaking-down resistance necessary and the charging rate varies from .1 ampere for a 30-watt lamp, up to .5 ampere for 100-watt lamp. By using the lamp in this manner the inevitable heat generated is kept away from the set itself, and this is highly desirable.

We checked up the performance and found not only that the voltages were as rated, but that the regulation was good. The instrument is constructed in a workmanlike manner usually associated with Regentone products, and once again it is sent out with an instruction book which should render failure to obtain satisfactory results quite impossible.

An A.E.D. Pick-up

THE A.E.D. gramophone motor is made by Auto Electric Devices, Ltd., of Diamond Works, Brighton, and we are (Continued on page 378)

RECOMMENDED FOR THE ALL-ELECTRIC '1931 ETHER SEARCHER'

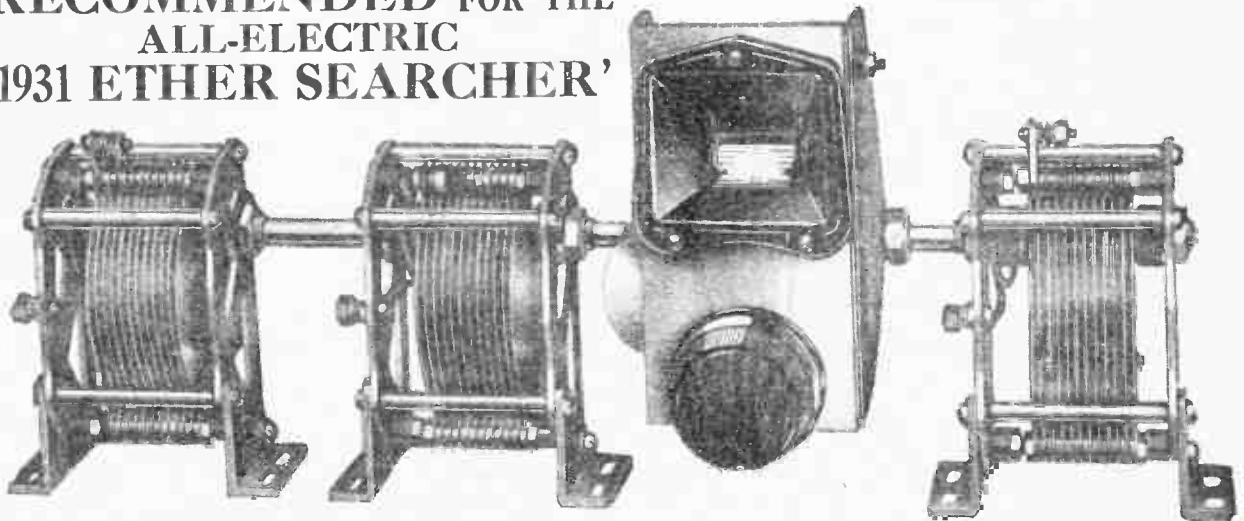

In design, construction and finish, this Component, recommended by the designer of the "All-Electric 1931 Ether Searcher," reflects the care and accuracy in manufacture which characterise all Lotus Components.

The separate spindle with which it is fitted enables any number of condensers to be ganged together, and it can be supplied complete with either two or three condensers.

An angle Knob Control and Bracket, with a socket for pilot light to illuminate the scale, are included, and it is available with artistic brown or black escutcheon plate, as desired.

PRICES:

Drum Dial, complete with two .0005 Condensers	22/-
Drum Dial, complete with three .0005 Condensers	28/6
Drum Dial only	8/6
.0005 Condenser only	6/9

Obtainable from any Wireless Dealer

LOTUS DRUM DIAL for GANGED CONDENSERS

Garnett, Whiteley & Co. Ltd., Lotus Works, Mill Lane, Liverpool

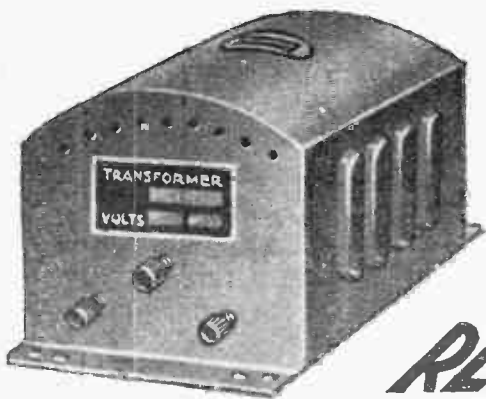

SPECIFIED FOR THE 'ALL-ELECTRIC ETHER SEARCHER' RECOMMENDED BY WESTINGHOUSE FOR

Regentone Power Transformer with windings for A.C. valve heaters giving 4 volts up to 4 amps. Type WR.7. Price 28/-.

USE WITH THEIR CIRCUITS

Also specified in the 1931 Ether Searcher are a "Regentstat" totally wire-wound variable resistance of 120,000 ohms, Type A, Price 9/6, and a Regentone Transformer for A.C. valve heaters, Type A.C.V., supplying 4 volts up to 4 amps, and costing 15/-.

The Regentone Power Transformer (Model WR.7, with raw A.C. windings) has been chosen by Mr. Sieger for the 1931 All-Electric Ether Searcher. The whole Regentone range of Power Transformers is recommended by Westinghouse in every circuit of their "All-Metal Way 1931." Remember that Regentone have behind them the specialised knowledge of six years' experience in mains radio. That is your guarantee. Write for FREE Art Booklet "The Simple Way to All-Electric Radio" giving full particulars of the Regentone range—or your dealer will give you a copy.

REGENTONE LIMITED, Regentone House, 21 Bartlett's Buildings, E.C.4.
Irish Free State Distributors: Kelly & Shiel, Ltd., 47 Fleet Street, Dublin



Telephone: Central 8745 (5 lines).

BUILD IT WITH BURTON COMPONENTS

Don't experiment with Radio parts, it is a costly business. The manufacturers of BURTON Radio Components have done all the experimenting and research for you, and offer the perfected product in their latest range of parts—exactly the same parts which have made BURTON RECEIVERS such an outstanding success during the present season.

Ask your dealer for BURTON Condensers, Transformers, Valve Holders, Chokes, Changeover Switches, etc., or send for latest lists and name and address of nearest agent.

The independent test report of the BURTON Screen-grid Three which appeared in the Feb. 7th issue of this paper is your best guide to the efficiency of BURTON Components.



THE BURTON AUDIO TRANSFORMER

A neat and compact instrument of the highest efficiency, being carefully wound to give correct ratios. Enclosed in neat moulded case.
TYPE B, 3, ratio 3-1 10.6 each
TYPE B, 5, ratio 5-1 10.6 each

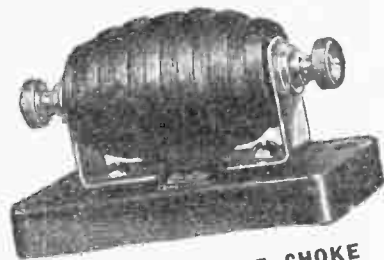

THE BURTON H.F. CHOKE

A highly efficient Choke covering a waveband of 20-2,000 metres. The self-capacity is extremely low, which, coupled with high inductance, makes it ideal for any set. Price 3/9 each

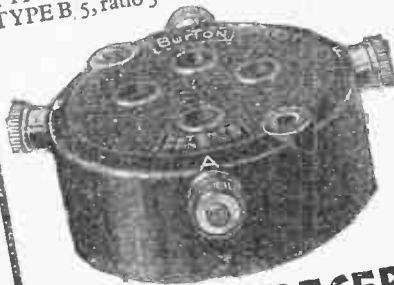

THE BURTON MIDGET VALVE HOLDER

Reg. design Pat No 216758
This self-locating Valve Holder means prolonged life to your valves. Dia. 1 1/8 in. Height 1/2 in. Complete with fixing screws - 1/- each
Also special 5-pin type suitable for A.C. Valves 1.3 each

THE BASIS OF BEST RECEPTION

C. F. & H. BURTON, PROGRESS WORKS, WALSALL, ENG.

You Will Help Yourself and Help Us by Mentioning "A.W." to Advertisers

C.O.D. Pay the Postman
We pay all charges
CASH or H.P.

Everything
best in Radio



MANUFACTURERS' KITS

- COSSOR EMPIRE MELODY MAKER KIT**, 1931 model, S.G., detector and power. Cash Price £8 17 6 **Send 10/-**
Balance in 11 monthly payments of 12/9 Only
 - MULLARD 1931 ORGOLA THREE-VALVE KIT**, S.G., detector and power. Cash Price £8 0 0 **Send 14/8**
Balance in 11 monthly payments of 14/8 Only
 - 1931 OSRAM MUSIC MAGNET KIT**, 2 S.G., Detector and Power. Cash Price £11 15s. 0d. **Send 23/6**
Balance in 12 monthly payments of 18/6 Only
 - DYNAPLUS SCREENED THREE KIT**, S.G., detector, and power. Cash Price £5 14 6 **Send 10/6**
Balance in 11 monthly payments of 10/8 Only
- All above Kit Prices include valves and cabinet.

ACCESSORIES

- REGENTONE W.6 COMBINED H.T. ELIMINATOR AND TRICKLE CHARGER**, One S.G., 1 variable, and 1 fixed tapping for H.T., L.T. charging for 2, 4, and 6 volts. For A.C. mains. Cash Price £5 17 6 **Send 10/9**
Balance in 11 monthly payments of 10/9 Only
- EXIDE 120-VOLT WH. TYPE ACCUMULATOR**, in crates. Cash Price £4 13 0 **Send 8/6**
Balance in 11 monthly payments of 8/6 Only
- STANDARD WET H.T. BATTERIES**, 144 volts, 20,000 m/A. Cash Price £4 2 0 **Send 7/6**
Balance in 11 monthly payments of 7/6 Only
- Other voltages and capacities available, detailed prices on application.
- LAMPLUGH or FARRAND INDUCTOR SPEAKER**, for perfect reproduction. Unit and chassis complete, ready mounted. Cash Price £3 10 0 **Send 6/5**
Balance in 11 monthly payments of 6/5 Only

We are the largest suppliers of Radio in the country. If your requirements are not listed, send P.C. for detailed quotation.

PETO-SCOTT CO. LTD.

- 77 City Road, London, E.C.1
- Phone: Clerkenwell 9406-7-8.
- 62 High Holborn, London, W.C.1
- Phone: Chancery 8-66.
- 33 Whitelaw Rd., Chorlton-cum-Hardy, Manchester.
- Phone: Chorlton-cum-Hardy 20-25.
- 7 Albany Road, Newcastle, Staffs. Phone: 61790.

POST COUPON NOW

Please send me FREE your Easy Way Catalogue with full details how I can buy Easy Way Radio on Easy Way Terms with strict privacy.

NAME.....
ADDRESS.....

A.W. 28-2-31

"WE TEST FOR YOU"

(Continued from page 376)

informed that this concern is shortly marketing a range of components of various kinds. One of the first of these is the A.E.D.

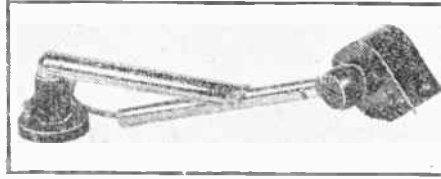

A new A.E.D. product, a fine pick-up and carrier arm

pick-up and tone-arm which is a worthy forerunner of the series. The pick-up itself is housed in a bakelite moulding, while the tone-arm of slightly unconventional design, is heavily nickel plated. The attachment of the pick-up to the end of the tone arm is set at an angle, so obtaining the effect of a cranked tone-arm, while the pick-up is capable of being rotated through 180 degrees so as to bring the bottom uppermost for changing the needle. We tested the tracking and found that there was a maximum error of plus or minus 3 degrees.

The movement of the tone-arm is very free, and this combined with a very lightly damped armature should make for small record wear. Packing washers are provided for fitting underneath the base, in order to adjust the height to suit the varying turntables.

We tested the instrument for its response and the curve is reproduced herewith. It will be observed that the response is above the average and is well maintained at the lower frequencies. There is a resonance

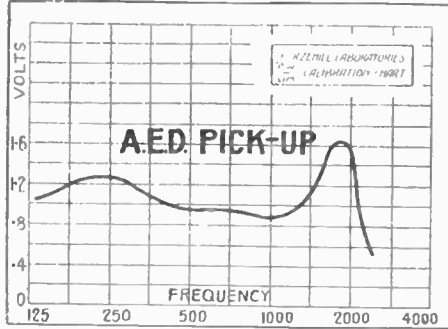

The characteristic curve of the new A.E.D. pick-up

around 2,000 cycles, followed by a somewhat sharp cut-off. This cut-off appears rather early as practically no response could be obtained from the pick-up at 3,000 cycles. However, if the instrument is used with an amplifier having a good upper register we find the response is quite pleasing.

The internal resistance of this pick-up is higher than usual, being 5,000 ohms. The component is very neatly finished, and sells at a price of £2 2s.

Drydex H.T. Battery

IT is good news to hear that the manufacturers of the well-known Exide accumulator, which gives such good service in many radio homes, are now marketing a series of high-tension batteries. Naturally,

before a firm of this standing embarked on such a course they took particular care to see that their products were at least up to the best prevailing standards.

There are four types of this new Drydex battery, as it is called; the Red Triangle, Green Triangle, and Orange Triangle are standard, double, and triple capacity batteries, while the Blue Triangle model is designed for portable sets, having a capacity, as far as we can gather, approximately equivalent to that of the double-capacity type, but presumably being lighter in weight.

We tested a 66-volt Red Triangle model according to our usual practice of dis-



A newcomer to the ranks of high-tension batteries—the Drydex, made by Exide

charging it through a constant resistance. The current was 7 milliamps to commence, and the discharge was continued until the current had fallen to 3½ milliamps. The battery lasted under these conditions for 230 hours, corresponding to an effective capacity of 1,250 milliampere hours. This is 25 per cent. longer than our normal rating for a standard-capacity battery.

Our good opinion of the battery was further confirmed by a measurement made of the internal resistance taken at various intervals during the discharge, from which we found that the resistance was maintained at a relatively low value throughout the discharge, so that the battery will not only give a long life, but will give satisfaction throughout that life.

AT THE QUEEN'S HALL

BRAMMS' First Concerto was played at the B.B.C. concert on February 18 by Dohnanyi and the B.B.C. Orchestra. Dohnanyi is himself a composer of the period immediately succeeding Brahms; he therefore understands the Romantic Movement, of which this is a typical concerto. It was written when Schumann had become insane, and Brahms was a young man, deeply affected by the tragedy.

This programme was romantic in the mystic sense in which we understand the term when applied to the love of natural forces; it began with Beethoven, perhaps the first musical romanticist, and ended with Elgar, perhaps the last.—L. R. J.

It is a well-known axiom that a radio set cannot give satisfaction unless it is properly laid out. Our tame cynic complains that no advice is given as to whether a hatchet or a coal hammer is more suitable for the purpose.



HAIRBREADTH ADJUSTMENT

that links two Continents

Wonderful selectivity and fractional movement -



The wonderfully smooth action and fractional accuracy of the Formo Vernier Dial used in conjunction with Formo variable condensers makes tuning of close stations a simple operation with the certainty of clear-cut reception.

The scientific thoroughness of Formo condenser construction is your assurance of the best possible results from any set. High performance is further assisted by the enclosed and protected pigtail within the shaft and minimum eddy current losses.

MID LOG VARIABLE CONDENSER.

In 4 capacities. Price 4/6. Weight 4 1/2 oz. Size 3 1/2" x 2 1/2". Small mass of metal, approx. air suspension. Low loss. The finest condenser made.

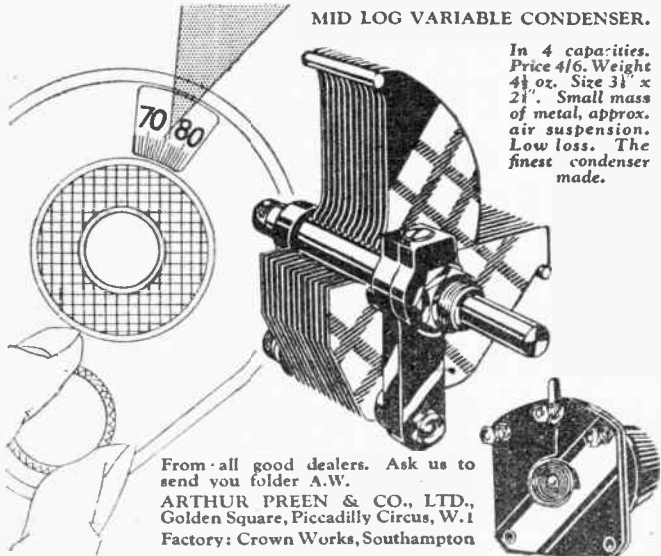

From all good dealers. Ask us to send you folder A.W.
ARTHUR PREEN & CO., LTD.,
Golden Square, Piccadilly Circus, W.1
Factory: Crown Works, Southampton



DIFFERENTIAL CONDENSER.
.00015 Cap. Price 3/9. Compact, perfect, integral pointer.

CONDENSERS

BUY YOUR RADIO WHERE YOU

SEE THESE FORMO Displays



The Sign of the Best Dealers Everywhere

A GREAT BRITISH BATTERY

-AT A LOWER PRICE THAN YOU PAID BEFORE

NO sacrifice of quality is made in "CARLTON" Batteries—the low price is possible only because of super efficient production methods and low overheads. For 6/- you buy 66 volts of long life, splendid recuperation and smooth power. It will pay you to try a "CARLTON."

60 volts (reads 66) 6/-
100 " (" 108) 10/-
120 volts 11/9

If any difficulty in obtaining, write the Manufacturers for name of nearest dealer:
VINCE'S DRY BATTERIES LTD.,
LION WORKS, GARFORD STREET, LONDON, E.14

CARLTON

LONG LIFE • LOW PRICE RADIO BATTERIES

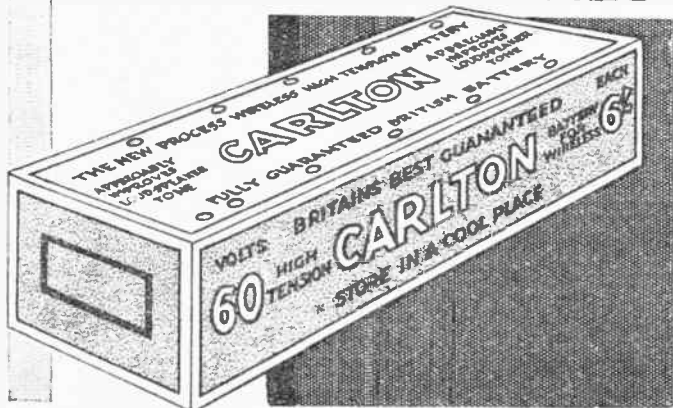

Please Mention "A.W." When Corresponding with Advertisers

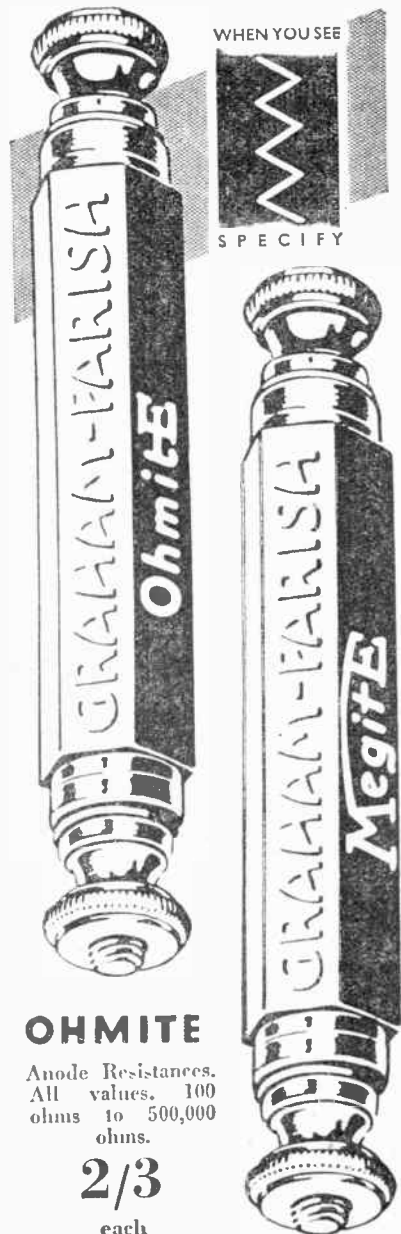

OHMITE

Anode Resistances. All values. 100 ohms to 500,000 ohms.

2/3
each

MEGITE

Grid Leak. All values, 1 megohm to 5 megohms.

2/-
each

Ohmite and Megite Resistances are constant in value, of negligible self capacity and non-inductive. Dead silent and always reliable, they provide the most effective resistance on the market, giving the full range of values required. Supplied with vertical or upright holders of superior brown bakelite construction 6d. extra. Graham Farish components carry a written guarantee of accuracy.

Ask your dealer to obtain, or write to

GRAHAM FARISH LIMITED. . . . BROMLEY, KENT



THE Maharajah of Alwar in London recently ordered eighteen sets, including a four-valve receiver and moving-coil speaker, for his personal use. The Maharajah of Kashmir, well known as the wealthiest of the Indian ruling princes, also ordered two Philips radio-gramophones. The two Maharajahs were prominent at the recent India Round-table Conference.

In view of the revival of interest in radio clubs, London readers may care to know that the Wanstead and District Radio Society is still going strong, after ten years, and the membership is increasing. The head-quarters of the club are the Overton House, 20 High Street, Wanstead, E.11. Local amateurs should get in touch with the Hon. Sec.

It is a pity that "Modern Heroes" has had to be postponed until Wednesday, March 25, to make additional rehearsals possible. This should make a broadcast of rather an unusual nature. The National Chorus is taking part, Basil Maine is the Orator in this unusual piece, and it will be conducted by the composer.

Perth, Western Australia, has now equipped its police flying squads with radio equipment. In the wireless-room at the police barracks is a receiver which picks up signals transmitted from the cars. The actual transmitter has a nominal rating of 2 kilowatts, giving an efficient range of several miles.

One of the Czech transmitters, Kosico, has recently inaugurated a new type of children's hour. Instead of adults appearing before the microphone for this hour, children of six years and upwards take charge. Now the Kosico children's hour is looked forward to not only by the kiddies, but by the grown-ups as well.

A "request" hour is given every Tuesday between 11 and 12 a.m. by Bordeaux. During the week requests are received from listeners and advantage is taken of this once-weekly hourly broadcast to give popular items.

To add to the already long list of German broadcasting stations, the Berlin officials are contemplating the construction of a new transmitter which will be in the neighbourhood of the Kaiserdamm.

Provision has been made on Sir Douglas Mawson's exploration ship, the *Discovery*, which is now en route for the South-polar regions, to broadcast programmes direct from the ship. The equipment includes the latest type of short-wave apparatus.

Some 52 per cent. of the 800,000 families constituting the population of Denmark are possessors of wireless receivers. Based

on the number of licences issued to the end of December, 1930, the figures show that over 12 per cent. of the total number of inhabitants listen to the broadcast programmes.

Considerable developments are expected shortly in the Yugoslavian broadcasting system. It is stated that the Belgrade station is to be reconstructed with a view to an increase in power, and relays are to be erected at Subotica, on the borders of Hungary, and at Skolpje, in South Serbia.

During 1932 the Budapest broadcasting station is to be replaced by a new transmitter capable of radiating a minimum of 100 kilowatts in the aerial. To ensure adequate service throughout the country, Hungary also proposes to install two further 10-kilowatt stations as relays of the capital programme.

Although the site has not yet been definitely fixed, Austria's new relay transmitter will most probably be erected at Leoben in Styria, which, although at no great distance from Graz, is separated from that city by a range of high mountains. The new station will work on a common wavelength with Salzburg.

In Spanish wireless circles it is now definitely stated that the entire system of broadcasting in that country is to be revolutionised in the near future. A ten-year concession has been granted by the Spanish Government and the Ministry of Posts and Telegraphs will take over the technical construction, operation, and supervision of the new transmitters. In order to provide alternative radio programmes the Capital will be endowed with a 60-kilowatt and a 30-kilowatt station and five further regional transmitters will be installed in Catalonia, Andalusia, Valencia, Galicia, and Vascongadas. Work on the reorganisation of the system is to proceed forthwith.

There are sixty-seven licences already issued per 1,000 of the population of Liverpool.

The new Poste Parisien (France) broadcasting station which is under construction at Limours, some twenty-four miles from the French capital will be capable of radiating sixty kilowatts in the aerial in order that its transmissions may be well heard in Eastern Europe and Northern Africa.

Private tests for the tuning of the aerial were recently carried out by the new Sottens (Switzerland) high-power transmitter and for experimental purposes, within the next few weeks, relays will be carried out of the Zurich or Berne programmes.

Mr. SIEGER'S CHOICE-

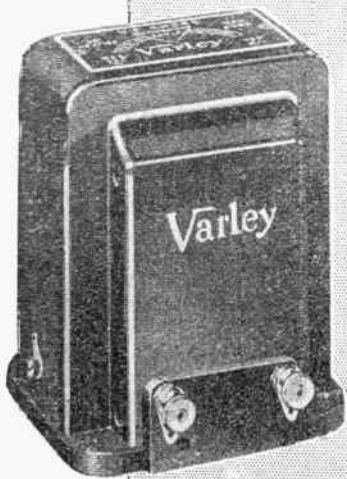

The wonderful qualities of the 1931 Ether Searcher are still more marked in the new all-electric model for which Varley is specified. In a powerful circuit of this kind, where all-out efficiency is required, each component must be the very best in its class—must be capable of continuous and consistent working under exacting conditions. This is why Mr. J. Sieger has chosen the Varley 20 Henry L.F. Choke for his latest achievement.

High inductance under heavy load, low D.C. resistance and a great current-carrying capacity are outstanding features of the Varley Standard L.F. Choke (20 Henries). It is the ideal smoothing Choke for H.T. Eliminators and mains-operated sets; the ideal output filter choke for use after a super-power valve.

Write for section D of the Varley Catalogue for full particulars.

Varley Standard L.F. Choke, Price £1.0.0

Inductance	20 Henries
D.C. Resistance	250 ohms
Maximum Current	140 m/a
Weight	2 lbs. 10 ozs.

Varley

For the All-Electric Ether Searcher

Varley (Proprietors: Oliver Pell Control Limited), 103, Kingsway, London, W.C.2

P.W.G.

FOR...
ELECTRIC REPRODUCTION
USE A LIMIT

Adjustable
Length Tracking
Angle
Spring Tension



PICK-UP ARM 15/6

Obtainable through all factors and dealers or write

EACH

LIMIT RADIO LIMITED, ALBION ST., LONDON, N.1

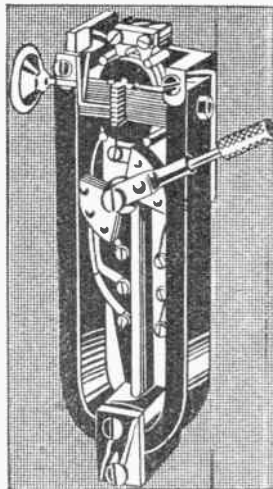

WUFA

Search where you like, there's no finer speaker for your "Ether Searcher."

Superlatives are frequently used to purchasers by Salesmen—the WUFA reverses this custom.

Read these few, from many letters of praise:

"Congratulations! Just listening to Albert Sandler on one of your 'Wufa' Units and Chassis, it could not have sounded better, even at the Park Lane Hotel."

"I have tried most leading makes but 'Wufa' is the 'Ace.'"

"My 'Wufa' gives splendid reproduction and volume."

"WUFA" 40/-
Complete with Chassis
60 Pole Unit only 27/6

If your dealer has not yet received supplies, send order direct to us, giving dealer's name and address
WRITE DEPT. A.

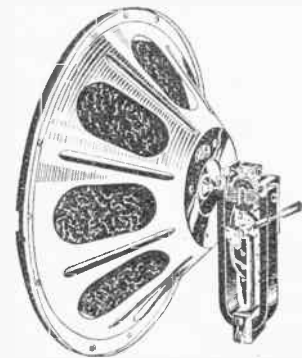

M. LICHTENBERG,
4, Gt. Queen Street, Kingsway, W.C.2

NOTICE

BECOL LOW LOSS EBONITE FORMERS

ARE

RELIABLE

Tested before despatch

PANELS, RODS, TUBES



12 SIZES

LOOK FOR TRADE-MARK BRITISH MADE

Sole Makers—
THE BRITISH EBONITE CO., LTD.
HANWELL, LONDON, W.7

Mention of "Amateur Wireless" to Advertisers will Ensure Prompt Attention

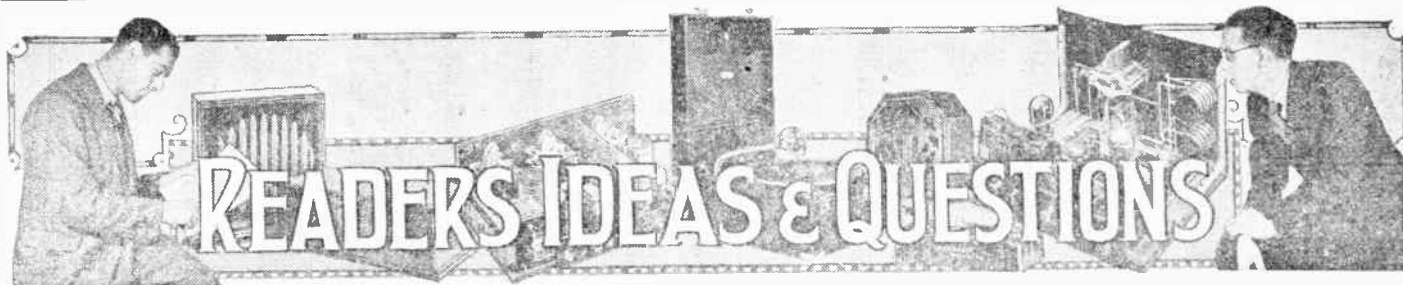

Trouble with a Set

SIR,—I have built up the "Challenge Four" receiver and find reception very poor. In testing through the receiver by stages I have found that by cutting out the two S.G. valves I get best results. This seemed to point to insufficient H.T. current, but as I am using large-capacity H.T. accumulators which are fully charged, this possibility is ruled out. On test, the coils prove good for continuity and there are no faults in the wiring of the H.F. side of the set. The valves have also been tested in another set. Can you explain this apparent phenomena? G. H. (Chertsey).

We are of the opinion that you are using a type of Challenge coil which has a single sheet of ebonite at the base. The terminal heads are probably not sufficiently countersunk and are, therefore, shorting on to the metal foil on the baseboard. Slacken off the screws holding the coils to the baseboard and insert pieces of mica or cardboard beneath the under parts of the terminals. This will prevent shorting of the tuning circuits.—Ed.

The "Challenge Four"

SIR,—Just a word of appreciation of the "Challenge A.C. Four" designed by

Mr. W. James. I can thoroughly recommend it to anyone who requires a modern set. The distant stations, both home and abroad, come in with rare volume and clarity. On Sunday evening last, from 6.30 p.m. to 7 p.m., I logged thirty-six foreign stations at full L.S. strength.

W. G. (Leeds).

Religious Broadcasts

SIR,—I am surprised to read the comments on Cardinal MacRory's criticism of the B.B.C.'s "religious" series (AMATEUR WIRELESS, No. 451). You are certainly not taking the view of many of your readers, who view the policy of the B.B.C. (in allowing all sorts of doctrine to be broadcast) with alarm. How could such opposite views as given in the "Science and Religion" series be of help? If you had six broadcasters on arithmetic with very opposite views on the correct and best way to work out a problem, would it not mystify rather than help? H. A. (Chorley).

The Super-het Adaptor

SIR,—I have constructed the "Super-het Adaptor" described in a recent issue, and here are some of the results obtained. The following stations were heard at good speaker strength: Rabat (23.28 m.), Pittsburgh W8XK (25.25 m.), Rome 3RO (25.4 m.), Berlin (31.38 m.), Schenectady W2XAF (31.48 m.). Rabat

(Continued on page 384)

"Amateur Wireless and Radiovision." Price Threepence. Published on Thursdays and bearing the date of Saturday immediately following. Post free to any part of the world: 3 months, 4s. 6d.; 6 months, 8s. 9d.; 12 months, 17s. 6d. Postal Orders, Post Office Orders, or Cheques should be made payable to "Bernard Jones Publications, Ltd."

General Correspondence is to be brief and written on one side of the paper only. All sketches and drawings to be on separate sheets.

Contributions are always welcome, will be promptly considered, and if used will be paid for.

Communications should be addressed, according to their nature, to The Editor, The Advertisement Manager, or The Publisher, "Amateur Wireless," 58-61 Fetter Lane, London, E.C.4.



**A
good item
on any
programme**

*Player's
please*

*It's the
Tobacco that Counts*

N.C.C.899

**"AMATEUR WIRELESS"
HANDBOOKS 2/6 each
net**

Of all Newsagents and Booksellers, or 2/9 post free from Cassell and Company, Limited, La Belle Sauvage, London, E.C.4.

WIRELESS CONTROLLED MECHANISM

For Amateurs. By Raymond Phillips

This book is an illustrated practical guide to the making and using of short-range wireless control apparatus, and it has been written so simply that it can be understood by any enthusiast possessing an elementary knowledge of wireless.

THE PRACTICAL "SUPER-HET" BOOK

Explains what the super-het is, what it does, how it works, and how to build up a number of super-het sets made of tested, British-made components.

THE SHORT-WAVE HANDBOOK

By Ernest H. Robinson (5YM)

Describes in very simple language the wireless apparatus used in short-wave work, shows how to make it and how to use it, and explains the technical principles with which the beginner will need to become acquainted.

THE PRACTICAL WIRELESS DATA BOOK

The intelligent novice, and particularly the home constructor and the keen wireless amateur who is always rigging up different circuits and experimenting for progress, will find this Data Book extremely helpful.

THE BOOK OF THE NEUTRODYNE

By J. H. Reyner, B.Sc. (Hons.), A.M.I.E.E.

CONTENTS: Why Neutralising is Necessary; Systems of Neutralising; Difficulties Encountered in Neutralised Circuits; How to Obtain Good Selectivity Without Loss of Quality; Design of High-frequency Transformers; Lay-out in Neutralised Receivers; Some Suitable Circuits.

Price 1/6 net, or post free for 1/9

LITTLE STORIES OF GREAT MOMENTS



**"Listen—
The machine
is speaking!"**

Hearing the inventor's own voice from the weird machine before him, the startled company little realised they were witnessing a revolution in the pleasures of mankind. They could not see in Edison's phonograph the gramophone or the talking film which have come from it. Yet if its inventor had not dreamed of things greater than selling newspapers and had not devoted his life to doing one thing and doing it well, these things would not have been given to the World.

It is this same spirit of "doing one thing and doing it well" which has, for years, been behind all T.C.C. endeavour. That is why T.C.C. have never made anything but Condensers, and why T.C.C. Condensers are unmatched — for accuracy and dependability.

One of the many types is shown here. It is the T.C.C. 2 mfd. type (for maximum working voltage of 800 D.C. peak value.) Price 10.-

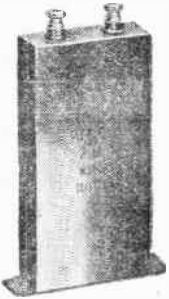

TELEGRAPH CONDENSER CO., LTD., N. ACTON, W.3.

7518



MIDNIGHT REVIEW

"I wonder if it's the battery?" said father after puzzling over the set till midnight: and when he tried an Ever Ready instead, the reception was perfect. That's what the Ever Ready was designed for—to give perfect reception as well as to last a long time. All through its long life it stays up to pitch. You get no fading. You have no distortion. The Ever Ready is made by an exclusive process—an exceptionally thorough and careful process. It stays alive for months, and while it's alive it's awake! Every Ever Ready battery is guaranteed to give satisfactory service by a company which has been making reliable batteries for 28 years.

Ever Ready batteries are made for all wireless sets. If you own a portable you can obtain an Ever Ready of the right size and shape to fit it. Write for free list,

which gives full particulars, including exact dimensions in inches.



**BRITISH MADE
HIGH TENSION
BATTERIES**

The batteries that give unwavering power

The Ever Ready Co. (U. Britain) Ltd., Hercules Place, H. Roway, London, N.7

Don't Forget to Say That You Saw it in "A.W."

FIFTY EXPERTS AGREE!

Eighteen speakers tried out—six of them moving coils, of which two were energised. Yet this W.B. Permanent Magnet Speaker was unanimously placed first! This was at a meeting of the Edinburgh Radio Society, 50-60 members being present. This W.B. Speaker is free from resonances and remarkably sensitive. Its massive Sheffield Cobalt steel Magnet weighs 10½ lbs. and is guaranteed for 5 years. Ask your dealer to demonstrate.

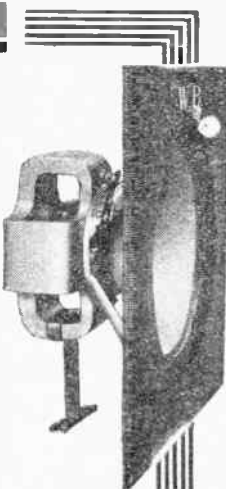

Available in chassis form with 14 in. baff. £5:6:0
Oak Cabinet Model. £8:8:0
Mahogany. £8:18:6
Walnut. £9:9:0

Made by the Makers of the famous W.B. Cone Speakers, Switches and Valve-Holders.

Whitely Electrical Radio Co., Ltd.,
Radio Works, Nottingham Road, Mansfield, Notts.
Irish Free State Distributors:
Kelly & Steel, Ltd., 47 Fleet Street, Dublin.

MOUNT YOUR TERMINALS ANYWHERE!

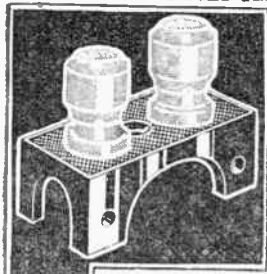

P. Pending

Use the new Belling-Lee Terminal Mount for your aerial lead-in, for loud-speaker extensions, for battery leads. It takes two terminals of any type and mounts them anywhere, vertically or horizontally—on your baseboard, window-ledge, wall, or skirting. Write for FREE Belling-Lee Handbook, "Radio Connections" (2nd Edition), which illustrates some of its many uses.

14 Belling-Lee Terminal.
Type "B," 6d. each.
Type "M," 13d. each.
Type "R," 3d. each.

BELLING-LEE
FOR EVERY RADIO CONNECTION

Advertisement of Belling & Lee, Ltd., Ltd., Queenway Works, Ponders End, Middlesex.

"READERS' IDEAS AND QUESTIONS"

(Continued from page 382)

(32.26 m.), Pittsburgh WSXK (48.80 m.), Boundbrook W3XAL (49.18 m.), Lisbon CTIAA (42.9 m.), and others which were not definitely identified.

"1168" (Bridlington, Yorks)

Trolley-bus Interference

SIR.—As a regular reader of your valuable weekly, there is one matter which no one seems to bring forcibly to the front and which within my district has brought such a calamity in its trail, that I am taking the matter up with you in the hope that some action will be taken.

Our Council has installed electric buses, and one might as well be again in the front-

line trenches and listen to the roar of numerous machine-guns firing away.

This is what we are getting here; I have made complaints to both the Council and the B.B.C.

The Council considers that it rests with the B.B.C. to remedy this interference for their listeners. The B.B.C. has said that the trouble can be remedied to some extent.

This is as far as we have now got; the area affected is three miles, where some hundreds of sets are now out of commission.

L. F. (Pontypridd)

A Home-recorder Hint

SIR.—Here is a useful tip for users of Kingston home recorders. Before cutting a new record, rub a candle over the surface. This is a good lubricant and I am now getting marvellous results.

J. W. S. (N.W.10)

What are the Sound Waves Saying?

THEY have said a good deal about Mozart recently, and I have often wondered whether people realise what he went through in the writing of his charming works. Mozart seems always so affectionate in his writing; he is ever trying to charm the listener. Yet there was little in his life that would have charmed anybody. It all began before he had been a thousand days on earth; he used to toddle into the room where his elder sister was having lessons and after she had finished he would clamber on to the stool and begin to perform himself. Most of us, I imagine, have done much the same sort of thing, but it is doubtful whether we picked out the thirds and sixths in preference to the fourths and fifths when we did it. At five Mozart was playing in public; before he was turned eight he had undertaken a triumphant tour of nearly half Europe.

One Sunday morning his father returned from church to find little "Wolferl," as they called him, sitting on the floor busy writing music. His father inquired what the "work" was. He was told that it was a "concerto for clavier." Mozart senior laughed and asked to see the manuscript. The crotchets were pools of ink and the minims had the appearance of saucepans on a shelf, but the understanding was there, a fact that caused Mozart's father considerable emotion.

In their travels Mozart and his sister, accompanied by their father, visited the English Court where Christian Bach, John Sebastian's youngest son, was court musician. Bach and Mozart soon became fast friends. Mozart's simple, childish ways fascinated Bach, who used to take the little prodigy upon his knee and give him fugue subjects to work out extemporaneously at the keyboard.

Naturally Mozart was made a great fuss of and it is a wonder that he was not turned into an objectionable little prig there and then. He seems, however, to

have charmed everyone. Marie Antoinette was never tired of telling how she picked little Mozart up when he slipped on a polished floor; he bowed to her most politely and said: "Thank you; you are very kind. When I grow up I will marry you."

Mozart's brief career is full of incident and, it may be added, of disappointment. It was a bad day for him when he entered the service of the Archbishop of Salzburg, a distinctly unpleasant man named Hieronymus. His treatment of Mozart was such that the latter was not sure whether he was court musician or menial.

Mozart had some success—*Figaro* was one of the greatest. Unfortunately, such things as substantial royalties were unknown in those days and he received a mere pittance for the work. The well-known story of his writing what he considered to be his own requiem may be worth repeating. A stranger, dressed in deep mourning, accosted Mozart and asked him to write a requiem. Mozart promised to do so, but had to be reminded by the stranger. The real point is that Mozart became intuitive regarding his own death and that the requiem was never finished by him, but by Süssmayer, his favourite pupil, to whom he entrusted the work.

WHITAKER-WILSON.

Harry Tate has chosen his famous sketch, "Fishing," for his vaudeville broadcast on February 28. The sketch has been specially adapted for the microphone. Other artistes in the programme on this date are Gwen Alban and the Tea Time Four.

Joseph Conrad's novel, *The Rescue*, has been adapted for the microphone by Cecil Lewis, who will produce the radio version on March 13, on the National wavelengths.

DRY BATTERIES are the CURSE OF RADIO !

Solve the bugbear of costly dry battery replacements with a Standard Leclanche Type Battery. It supplies abundant H.T. for 12 months or more and can then be refilled simply, easily and at less cost at home ready for another long term of trouble-free service. The Standard Leclanche Type Wet H.T. Battery charges itself overnight and is as fresh as the dawn every morning. No background or crackling—great improvement in reception and an enormous saving in cost.

Do not waste any more money on the costly replacement of dry batteries, 5 - DOWN and five monthly payments of 12/6 secures this fine 72 No. 3 cell, 108 volt Standard Wet H.T. Battery complete with chemical, all fitted in 3 Unibloc Tra. s. List price, £3 4s. 0d.

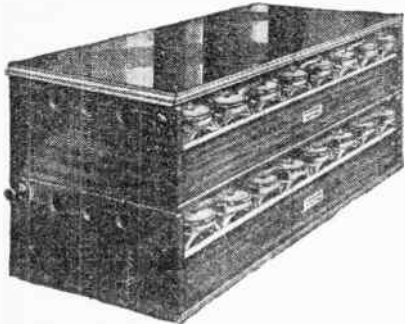

WATES STANDARD WET H.T. BATTERY

Send particulars of number and type of valves and we will recommend perfect battery to suit, without obligation to purchase. Obtainable at Halfords, Currys and Radio Dealers everywhere.

THE STANDARD BATTERY CO.
Dept. A.W.
184-188 Shaftesbury Avenue, London, W.C.2

A Magnificent Cabinet for the MUSIC MAGNET 4

The 'Kabiloc' Magnafour Cabinet makes this well-known receiver a delight to the eye as well as to the ear. The special extension rods supplied with the Cabinet provide easier external tune control, the set being housed in the upper portion, while ample space is allowed below for loud-speaker, batteries or eliminators, etc.

CABINET THAT DOES JUSTICE TO YOUR SET
'Kabiloc' Cabinets are unrivalled for the elegance of their design and the perfection of their workmanship.

£4-7-6
OAK
£4-17-6
MAHOGANY

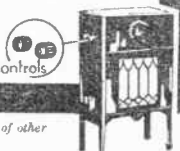

Write for free list of other cabinets to
W. & T. LOCK, LTD., 6 St. Peters Works, Bath.
London Showrooms - 11 Red Lion Sq., High Holborn, W.C.1

Postcard Radiō Literature

GET THESE CATALOGUES FREE

Here "Observer" reviews the latest booklets and folders issued by well-known manufacturers. If you want copies of any or all of them FREE OF CHARGE, just send a postcard giving the index numbers of the catalogues required (shown at the end of each paragraph) to "Postcard Radio Literature," "AMATEUR WIRELESS," 58/61, Fetter Lane, E.C.4. "Observer" will see that you get all the literature you desire. Please write your name and address in block letters.

A New Speaker Chassis

EVERYBODY knows the Wates speaker chassis, of course, for owing to the low price combined with excellent reproduction, it has earned a good name for itself. There is a new type, model 31, just put on the market. Three models are made with diameters of 12 in., 14 in., and 20 in. This is a double diaphragm chassis of an entirely new type, and all who are interested in the home construction of speakers are advised to drop a line, through my free Catalogue Service, for full particulars. **189**

A Free Print

Ferranti, Ltd., have sent me a chart which has just been issued, giving full constructional details of a screened-grid four-valve set. If you are thinking of making up a four-valver, then you should certainly have this, for it gives the fullest particulars for making up the set. **190**

Cossor Sets

Are you interested in complete sets, such as the Cossor? I have just had a letter from A. C. Cossor, Ltd., intimating that they will send to all readers who care to drop me a line a 16-page catalogue of sets. **191**

Radio Gramophones

It is quite a false idea that radio-gramophones are necessarily very expensive. I see that Dubilier have just produced a two-valve radio-gramophone in a fine cabinet which sells at only 30 guineas. You can get particulars of this in a free folder available. **192**

A New Radio-gram Cabinet

No doubt you have heard of the well-known Waverley Radio-gram cabinet made by the Carrington Manufacturing Co., Ltd. A new radio-gram cabinet, the Waverley Senior, has just been produced. The price of this, in oak, is only £6. Full particulars are given in an illustrated booklet. **193**

A Cheap Speaker

I do not know how Goodman's manage to produce a cabinet type cone speaker at the ridiculously low price of 19s. 6d. But let it suffice that they do. It is housed in a well-made oak cabinet and has cobalt steel magnets, in a unit of a balanced differential type. Full details are given in an illustrated leaflet. **OBSERVER 194**

The only MAINS UNIT for portables incorporating independent Grid Bias.

Type G.B.I. Prov. Patent No. 1642/31

H.T...... 150v. at 15 m.a.
or
120v. at 20 m.a.
Also
S.G. and Det.
Tappings

G.B...... 3 Tappings up to 14v. independent of H.T.

L.T...... Trickle Charger

(full-wave Westinghouse Rectifiers)

£4 · 15 · 0

TANNOY
PRODUCTS

Dalton St., West Norwood, S.E.27



WEAR AND CARE

In the base of the Vibroder we insert a stout transparent insulating disc. This prevents the accumulation of dust between the valve pins and also prevents the valve being forced down, straining the sockets or touching the baseboard.

The terminal strips are sunk 3/16" in the bakelite so they can't touch the baseboard either.

It pays you to buy a good job.
Write for Catalogue 1142.
The BENJAMIN ELECTRIC LTD.
Tarrif Road, Tottenham, N.17.
Luttenham 1520

16

BENJAMIN

OUR BLUEPRINT SERVICE

Constructors of receivers described in this Journal should make full use of our Blueprint Service and avoid all risk of failure.

Let "Amateur Wireless" solve your problems

A NEW

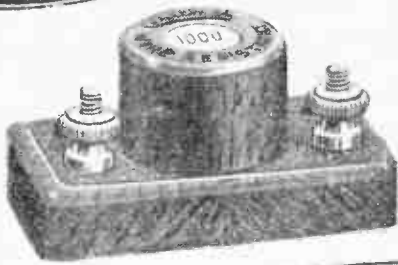

WIRE WOUND RESISTANCE

This new wire-wound Resistance has been specially designed for circuits requiring non-inductive wire-wound resistances, such as in potential dividing, series resistance, free grid biasing, voltage regulation, etc.

The wire is wound on sectionalised spaced bakelite bobbins, mounted in such a way as to enable free air cooling, although the size of the wire used for the rating of the resistance is sufficiently large that if the current is not exceeded the temperature rise is less than 10 per cent.

The values and the current-carrying capacity are clearly marked on the top, and the whole mounted in attractive mottled bakelite case, with suitable connecting terminals and screwing-down holes. The illustration is approximately full size, so that very little space is required to accommodate. We can always supply quickly in sizes or values additional to those listed below, and in some cases, if necessary, higher current rating, at a slightly increased charge.

Resistance Value.	Carrying Capacity.	Price.
100 to 600 ohms ...	50 m/A	1/6
1,000 to 2,000 ohms...	30 m/A	2/-
3,000 to 5,000 ohms...	20 m/A	2/6
6,000 to 10,000 ohms	16 m/A	3/-
15,000 to 20,000 ohms	11 m/A	3/6
25,000 ohms ...	11 m/A	4/-
50,000 ohms ...	8 m/A	5/6
100,000 ohms...	6 m/A	7/6

Write for the Blueprint of the T.31 S.G. Imperial Three Receiver. A new highly selective wide-range set. Simple to construct and easy to operate. Free to constructors.

WatMel

WATMEL WIRELESS CO. LTD.,
Imperial Works, High St., Edgware.

Telephone: EDGWARE 0323

(M.P. 21)

BROADCAST TELEPHONY

Broadcasting stations classified by country and in order of wavelengths. For the purpose of better comparison, the power indicated is *aerial energy*.

Kilo-Metres	Station and Call Sign	Power (Kw.)	Kilo-Metres	Station and Call Sign	Power (Kw.)	Kilo-Metres	Station and Call Sign	Power (Kw.)			
GREAT BRITAIN											
25.53	11,751 Chelmsford	15.0	294.6	1,014 Limoges (PTT)...	0.5	363.4	825.3 Algiers (PTT) ...	13.0			
200	1,500 Leeds.....	0.16	304	953 Bordeaux (PTT) 35.0		416	721 Radio Marco (Rabat)	10.0			
242	1,238 Belfast.....	1.2	315	952.5 Natan-Vitus(Paris)0.5		1,250	240 Tunis Kasbah ...	0.6			
261.3	1,148 London Nat. ...	68.0	317.8	945.4 Marseilles (PTT) 1.5		NORWAY					
288.5	1,040 Newcastle.....	1.2	328.2	914 Grenoble (PTT) 3.0		235.5	1,275 Kristianssand ...	0.5			
288.5	1,040 Swansea.....	0.16	345.2	860 Strasbourg (PTT) 12.0		241	1,244 Stavanger.....	0.5			
288.5	1,040 Stoke-on-Trent.....	0.16	370	810.5 Radio LL (Paris) 0.5		361	824 Bergen.....	1.0			
288.5	1,040 Sheffield.....	0.16	447	671 Paris (PTT).....	2.0	395.1	817.7 Frederikstad ...	0.7			
288.5	1,040 Plymouth.....	0.16	466	644 Lyons (PTT).....	2.3	453.2	663 Forsgrund.....	1.5			
288.5	1,040 Liverpool.....	0.16	1,445.7	207.5 Diffal Tower.....	15.0	494.2	607 Nidaros.....	1.2			
288.5	1,040 Hull.....	0.16	1,725	174 Radio Paris.....	17.0	584.7	513.2 Hamur.....	0.8			
288.5	1,040 Edinburgh.....	0.4	GERMANY			1,071	230 Oslo.....	75.0			
288.5	1,040 Dundee.....	0.16	31.38	0,560 Zeesen.....	15.0	POLAND					
288.5	1,040 Bournemouth ...	1.2	216.3	1,387 Königsberg.....	1.7	214.2	1,400 Warsiw (2).....	1.0			
288.5	1,040 Bradford.....	0.16	219	1,399.7 I lensburg.....	0.6	234	1,283 Lodz.....	2.2			
301	905 Aberdeen.....	1.2	227	1,319 Cologne.....	1.7	244	1,229 Cracow.....	1.5			
301.9	668 Cardiff.....	1.2	227	1,319 Münster.....	0.6	312.8	959 Wilno.....	4.0			
356.3	842 London Reg. ...	45.0	227	1,319 Aachen.....	0.3	388.1	887.1 Poznan.....	1.9			
376.4	707 Manchester.....	1.2	227	1,319 Kiel.....	0.31	381	824 Lvov.....	16.0			
398.9	752 Glasgow.....	1.2	232.2	1,292 Nurnberg.....	2.3	403	731 Katowice.....	16.0			
479.2	626 Midland Reg. ...	38.0	239	1,256 Cassel.....	0.3	1,411	212.5 Warsaw.....	14.0			
1,554.1	193 Daventry (Nat.)	55.0	246.4	1,217.2 Gleiwitz.....	5.6	PORTUGAL					
AUSTRIA											
218.5	1,372 Salzburg.....	0.6	253.4	1,184 Leipzig.....	2.3	240	1,250 Oporto				
246	1,220 Linz.....	0.6	259.3	1,157 Bremen.....	0.3	ROMANIA					
281.7	1,053.5 Innsbruck.....	0.6	269.8	1,123 Heilsberg.....	75.0	281.7	1,053.6 Lisbon (CTIAA) ...	0.25			
351.7	857 Graz.....	9.5	283.6	1,058 Magdeburg.....	0.6	RUSSIA					
453	666 Klagenfurt.....	0.6	283.6	1,058 Berlin (E).....	0.6	391	761 Bucharest.....	16.0			
517	581 Vienna.....	20.0	283.6	1,058 Stettin.....	0.6	426.3	701.7 Kharkov.....	4.0			
BELGIUM											
206	1,456 Verviers.....	0.3	318.8	941 Dresden.....	0.3	720	416.6 Moscow (PTT)...	20.0			
206	1,456 Antwerp.....	0.4	360	833 Muhlacker.....	75.0	800	375 Kiev.....	20.0			
216	1,391 Chatelaineau.....	0.25	372	806 Hamburg.....	1.7	824	304 Sverdlovsk.....	25.0			
216	1,391 Radic Conference		390	770 Frankfurt.....	1.7	937.5	320 Kharkov (RV20)	25.0			
			418	716 Berlin.....	1.7	1,000	300 Leningrad.....	40.0			
			452.1	662 Danzig.....	0.2	1,065	281.7 Tiflis.....	15.0			
244.7	1,226 Ghent.....	0.25	473	635 Langenberg.....	17.0	1,103	272 Moscow Popoff.....	40.0			
249.6	1,202 Schaerboek.....	0.5	533	563 Munich.....	1.7	1,200	250 Kharkov (RV4)	25.0			
338.2	857 Velthem		559.7	536 Kaiserslautern...	1.0	1,304	230 Moscow (Trades Unions)	195.0			
			559.7	536 Augsburg.....	0.3	1,850	217.5 Bakou.....	10.0			
609	590 Brussels (No. 1)	15.0	566	530 Hanover.....	0.3	1,481	202.5 Moscow (Kom)	20.0			
BULGARIA											
319	941 Sofia (Rodno Radie)	1.0	570	527 Freiburg.....	0.35	SPAIN					
CZECHO-SLOVAKIA											
263.8	1,113 Moravska		1,035	183.5 Zeesen.....	10.0	251	1,193 Barcelona (EAJ15)	1.0			
			1,035	183.5 Norddeich.....	10.0	268	1,121 Barcelona (EAJ13)	10.0			
			31.28	9,599 Eindhoven (PCJ) 30.0		340	860 Barcelona (EAJ1)	8.0			
278.8	1,075 Bratislava.....	14.0	299	1,002 Huizen.....	8.5	368	815 Seville (EAJ5)...	1.5			
293.6	1,022 Kosice.....	2.5	299	1,002 Radio IJzerda (The Hague) 0.6		424	707 Madrid (EAJ7)...	2.0			
342	873 Bruun (Brno).....	2.0	1,071	280 Schevevingen-Haven 5.0		453	662.2 San Sebastian (EAJ8)	0.5			
487	617 Prague (Praha)...	5.5	1,875	155 Hilversum.....	8.5	SWEDEN					
DENMARK											
281	1,067 Copenhagen.....	1.0	550	545 Budapest.....	23.0	220.3	1,304 Malmo.....	0.75			
1,158	260 Kalundborg.....	10.0	ICELAND			257	1,166 Horby.....	15.0			
ESTONIA											
296.1	1,011 (Tallin).....	0.7	IRISH FREE STATE			302.8	990.8 Falun.....	0.65			
403	648 Tartu.....	0.5	224.5	1,327 Cork (IFS).....	1.5	322	932 Göteborg.....	15.0			
FINLAND											
221	1,355 Helsinki.....	15.0	413	745 Dublin (2RN) ...	1.5	426	680 Stockholm.....	75.0			
291.5	1,130 Tampere.....	13.0	ITALY			542	554 Sundsvall.....	15.0			
1,796	167 Iakti.....	64.0	25.4 and 80	Rome (3RO).....	0.0	770	389 Ostersund.....	0.75			
FRANCE											
172.5	1,270 St. Quentin.....	0.3	295.9	1,012.6 Turin (Torino)...	8.5	1,237	242.5 Boden.....	0.75			
222.0	1,246 Yccamp.....	1.0	313.2	958 Genoa (Genova)...	1.5	1,348	222.4 Motala.....	40.0			
225	1,537 Strasbourg SGI	0.3	330.5	907.8 Naples (Napoli)...	1.7	SWITZERLAND					
235.1	1,275 Nimes.....	1.0	441	650 Rome (Roma)...	75.0	244	1,229 Basle.....	0.5			
237.2	1,263 Bordeaux		450	602 Bolzano (IBZ) ...	0.2	403	743 Berne.....	1.1			
			441	650 Rome (Roma)...	75.0	459	653 Zurich.....	0.75			
			450	602 Bolzano (IBZ) ...	0.2	680	442 Lausanne.....	0.6			
240.0	1,247 Póitiers.....	0.6	601	599 Milan (Milano)...	8.5	700	395 Geneva.....	1.5			
249	1,205 Juan-les-Pins.....	0.5	625	572 Riga.....	12.0	TURKEY					
256	1,171 Teulouse (PTT)...	1.0	LITHUANIA			1,242	241.5 Istanbul.....	5.0			
265	1,130 Lille (PTT).....	15.0	1,985	155 Kaunas.....	7.0	1,597.3	187.5 Ankara.....	7.0			
273	1,103 Rennes.....	1.2	MICROPHONIC AMPLIFIERS								
285.7	1,086 Radio Lyons.....	0.5	When Submitting Queries								
285.4	1,051 Montpellier.....	2.0	Please write concisely, giving essential particulars. A Fee of One Shilling (postal order), a stamped addressed envelope, and the coupon on the last page must accompany all letters. The following points should be noted.								

MICROPHONIC AMPLIFIERS

A FEW years ago, when valves were more expensive to buy and to run than now, many listeners succeeded in operating a loud-speaker from a crystal set by means of a microphonic amplifier of the Skinderviken-button type. Mr. S. G. Brown has recently demonstrated the possibilities of reproducing at high volume from a gramophone pick-up in much the same way, i.e., without using a valve amplifier mounted. The pick-up needle drives a diaphragm between two layers of carbon so as to form a "differential" microphone, from which the amplified currents are drawn through a 6-volt accumulator.

B. A. R.

When Submitting Queries

Please write concisely, giving essential particulars. A Fee of One Shilling (postal order), a stamped addressed envelope, and the coupon on the last page must accompany all letters. The following points should be noted.

The designing of apparatus or receivers cannot be undertaken.

Modifications of a straightforward nature can be made to blueprints, but we reserve to ourselves the right to determine the extent of an alteration to come within the scope of a query.

Queries cannot be answered personally or by telephone.

OUR LISTENING POST

By JAY COOTE

THE Warsaw Giant is on the air; I picked up its transmissions on several occasions and in particular on a recent Sunday night, when it relayed dance music from the Hotel Bristol in the Polish capital. It may not be testing at full power—they seldom do at the start—but I can assure you that notwithstanding its distance of roughly 900 miles from my receiver its signals were, in volume, at least equal to those of our big Daventry. What they will be like when it reaches its full energy of 16 kilowatts in the aerial can be left to your imagination. The quality of the broadcast was excellent and may be favourably compared to that of Rome. Possibly you may find some difficulty in keeping out Eiffel Tower, which is dangerously close in the wave-band, but fortunately for us, on most evenings the French station closes down early.

L.vov

Lvov, on 381 metres, is also working on some evenings with its new 16-kilowatt plant, and so the strength of these transmissions is now well explained. Wilno, on 20 kilowatts and 312 metres, will be formally opened in March and you will do well to tap this wavelength now and again during the later evening hours if you wish to pick up the preliminary tests. Within the next month or so the best Polish entertainments should be as easy to receive as those of our local station.

On the longer band, also, you may also shortly hear the Vienna programmes. For experimental purposes the broadcasts are to be tried out through the Rosenhügel station on various wavelengths above 1,000 metres. You may, therefore, chance to pick up the familiar "Hallo! Radio Wien" call in an unaccustomed position on your condenser dials.

Can anybody kindly explain this peculiarity? I have always been given to understand that (a) Russia works to Eastern European Time, and (b) that Eastern European time is two hours in advance of G.M.T. Twice, when listening to the Trades' Unions announcements in English and French I have been informed that "our next broadcast will take place on — at midnight; Moscow time, or 9 p.m. G.M.T. Is it that Moscow is one hour ahead of Leningrad or is the announcer responsible for a slip?

If you have not yet heard those peculiar wailings given out by Arab musicians and singers, now is your chance, for during the Feast of Ramadan, the great Mohammedan festival, Radio Algiers will devote two hours on every Tuesday and Saturday to these special oriental concerts. For your guidance they start at 9 p.m. G.M.T., and Algiers is an easy station to log.

Interval Signals

The search for original interval signals goes on merrily; Radio Berlin (France) has adopted the crowing of a rooster to identify itself to its listeners. Curiously enough, recently, between two news items broadcast through Koenigs-wusterhausen, I picked up this very sound and quite naturally jumped to the conclusion that Berlin had also roped in some kind of fowl, or what the German styles a *Pausenzeichen*. I was wrong; in this instance the farmyard call was unwanted. It would appear that the new Berlin Broadcasting House reeks of fresh paint and is also centrally heated to the extent of most continental premises; if the announcers are to enjoy good health it is found necessary to open the windows to let in fresh air. The site of the studio is outside city limits in the vicinity of allotments, market gardens, and a farmyard or so. Steps have now been taken to prevent the feathered artistes from butting in during the more serious portions of the programme.

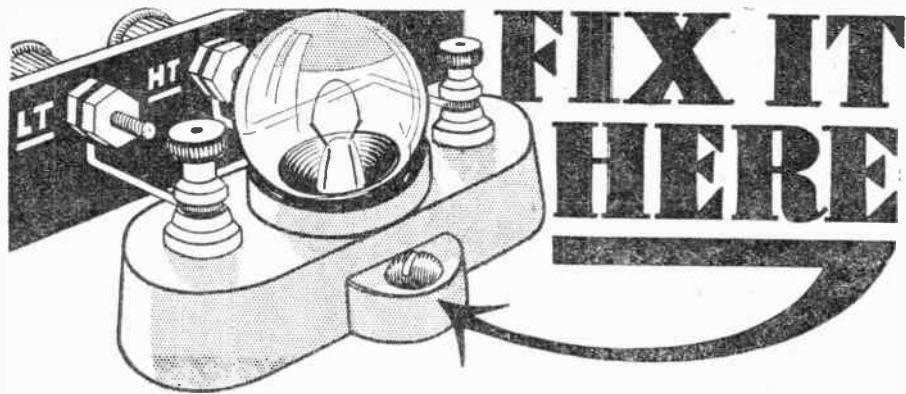

SINGLE TYPE FUSEHOLDER

Regd. Design No. 744264

All Bakelite insulated, fitted with spring contact and terminal connections. The original British Made Fuseholder.

See 1 for our 60 page catalogue. Enclose 2d. postage

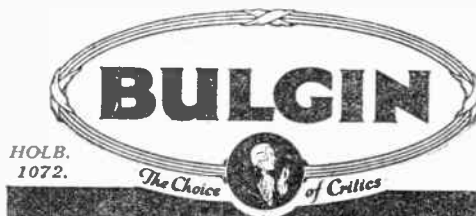

HOLB. 1072.

and rest assured that your valves are safe in the event of an accidental short circuit. Can be fitted in ten minutes to any receiver. Simply cut the connecting wire between H.T.— and L.T.— and fix as shown above.

9^D EACH
fuse 6^d extra

A.P. BULGIN & CO., LTD.
9, 10, 11 CURSITOR STREET,
CHANCERY LANE, LONDON, E.C.4

KAY'S CABINETS

"THE INVICTA"
RADIO GRAMPHONE CABINET

For Panels 18" x 7". Removable Motor Board for 12" Turntable with 31" clearance for Pick-up, and 4 1/2" clearance for Motor. Speaker Chamber 18" square with artistic Grille front, and independent 7-ply inner Baffle; hole cut to requirements. The whole of back of Cabinet is removable. Height 39", width 21", depth 16". Soundly constructed of Oak, and polished Jacobean shade. A wonderful example of value 45/- Returnable crate 3/-. Price 45/-

Illustrated Lists of 60 Cabinets FREE.

H. KAY, Cabinet Manufacturer, Mount Pleasant Road, LONDON, N.17. 'Phone: Walthamstow 1626

DOES YOUR SWITCH SPINDLE TURN ROUND ?

IF SO, YOUR SET "CRACKLES!"

BY FITTING A "BUSCO" SWITCH your trouble is ended because there is no contact point to turn round, and when you "switch on" you have contact like a power switch.

WHY NOT FIT ONE? They are as cheap as the inferior type but far superior in operation. From your local dealer, or

BUSBY & CO., LTD. (Patentees)
Dept. A.W., PRICE ST., BIRMINGHAM

LET "A.W." SOLVE YOUR WIRELESS PROBLEMS.

HAVE YOU HAD OUR NEW GREEN LIST ?

Saves you Pounds!

Crammed with illustrations and details of all sorts of fascinating and useful gear, at very reasonable prices.

RADIO ELECTRICAL SCIENTIFIC INSTRUMENTS MOTORS GENERATORS

Just send a stamped envelope

50 RANGES for 50/- with the MULTI-RANGE DIX-ONEMETER 6 TERMINALS

Latest Model. To 1st Grade Brit. Eng. Standard. Mirror Double Scale. Moulded Base. The Finest Precision Multi-measuring instrument obtainable.

Test Booklet Free.

ELECTRADIX RADIOS, 218, Upper Thames Street, E.C.4 Telephone. City 0191.



MICRO AMPS to 20 AMPS
MILLIVOLTS to 2,000 VOLTS
50 OHMS to 50 MEGOHMS
WITH ONE METER

You MUST have the "WIRELESS MAGAZINE" Every Month Price 1/-

FULL-SIZE BLUEPRINTS

When ordering, please send Postal Order, NOT STAMPS.

Table listing various radio sets and their prices, including Crystal Set, One-Valve Sets, and Two-Valve Sets.

Table listing Three-Valve Sets and Four-Valve Sets with their respective prices and descriptions.

Table listing Five-Valve Sets and Six-Valve Sets with their respective prices and descriptions.

Table listing Miscellaneous sets and their prices.

Table listing Amplifiers and their prices.

Table listing Miscellaneous sets and their prices.

Table listing Miscellaneous sets and their prices.

Copies of the "Wireless Magazine" and of "Amateur Wireless" containing descriptions of any of these sets can be obtained at 1s. 3d. and 4d. respectively, post free.

Address letters: Amateur Wireless Blueprints Dept., 58-61 Fetter Lane, London, E.C.4.

TAYLOR WET H.T. BATTERIES - New Prices: Jars 1/3, Sacs 1/2, Zincs 1/0d. Sample doz. 18 Volts complete with bands and electrolyte 4/1 post 9d.

AMPLIFY! Let your Own or Hire Speaker give that Moving-coil Quality in simple, detourless volume without extra valves by adding the "Magne" Amplifier (Pat. App.).

DX THE STANDARD PLUG-IN COIL Sold everywhere from 1/- DX COILS Ltd, London, E.8

RELIABILITY WIRELESS GUIDE No. 256C Review No. 165. "Amateur Wireless," Jan. 24. "You should get a copy of this Guide before buying any apparatus for that new set."

REPAIRS to any make of L.F. Transformer, Headphones or Loudspeaker (except Bu. Soud) dispatched in 48 Hours - TWELVE MONTHS' GUARANTEE

MAGNUM THAT IS BEST IN RADIO COMPONENTS SETS ETC. BURNE-JONES & CO. LTD.

YOU CAN BUILD A £40 GRAMO-PHONE WITH OUR SCALE DRAWINGS FOR 40/-

TEST YOUR SET WITH SAFETY AND SAVE YOUR VALVES EELEX TESTING PRODS

"THE INSULATED INSULATORS" for perfect aerial resistance (Reviewed "Amateur Wireless," 15.11.30).

BANKRUPT BARGAINS - List free with cheap 3-volt circuit. Transformers, 2/9; Telsen A.C.E., 6/6; Radiocord, 9/6; 0005 Variable, 2/6; Differential, 2/9.

WE WILL ACCEPT YOUR SURPLUS APPARATUS (making you a high allowance) in part payment for any new apparatus; your inquiry will be dealt with promptly.

CHARGE YOUR H.T. FROM YOUR L.T. AT HOME. Reliable, convenient, effective, economy 75% good reception.

PREPAID ADVERTISEMENTS Advertisements under this head are charged THREEPENCE PER WORD, minimum charge THREE SHILLINGS. DEPOSIT SYSTEM

AGENTS, DEALERS, SET-MAKERS! - Write now for particulars of our unique system of trading. Deliveries on time guaranteed.

WIRELESS BARGAINS - Three-valve brand new portable sets, best makes, from £5 19s. cash or 11/6 with order.

VERT WIRING CLIP - No soldering. Tested and approved "Amateur Wireless." Samples 3d. and stamped envelope.

ENGINEERS - IMPORTANT NOTICE - After months of intensive effort and research work we are pleased to announce that our new handbook is now out of the publishers hands, and ready for distribution.

TRICKLE CHARGERS, A.C. mains, for 2- and 4-volt accumulators, 0.5 amp.; no upkeep, 18/6, carriage paid.

BARGAINS FOR CONSTRUCTORS. - L.F. Transformers, ratios 3 to 1 and 5 to 1, 8/6 each.

FOR SALE. - Philips all-mains £22 set. Best offer near £10. - Brown, 37 Cavendish Square, W.1.

BRUCE'S RENOWNED MAINS TRANSFORMERS. To suit all "Amateur Wireless" circuits. Fully guaranteed for efficiency and regulation.

SOLID OAK WIRELESS CABINETS, for 18 in. by 7 in. panel, 10 in. deep, hinged lid, well polished, 6/6 each.

ALL MAINS ETHER SEARCHER. - Lotus Mains Units give H.T., L.T., G.B. for A.C. valves, £1. Listed £7 7s.

DININ ACCUMULATORS, H.T. - Sole concessionaries, The Turpin Engineering Co., Ltd., 177 The Vale, Acton, W.3

THE AMAZING PANTHEON (Regd. Design). A Magnificent Three-valve Receiver built to the limits by experienced craftsmen.

Amateur Wireless COUPON Available until Saturday MARCH 7, 1931

SOVEREIGN AGAIN!

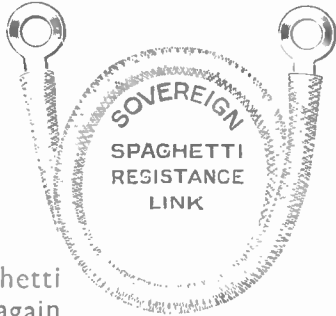

EVERYBODY wants Spaghetti Resistances and once again Sovereign are foremost in meeting this sudden demand. As usual, you can rely on Sovereign, and this range of Spaghetti Resistances is no exception to the rule that Sovereign Components are best. They improve any circuit.

Values and Prices of Spaghetti Resistances.

600 ohms, 1,000 ohms	- 6d.
2, 3, 4, 5, and 10,000 ohms	- 1/-
15,000 and 20,000 ohms	- 1/3
25,000 ohms	- 1/6
50,000 "	- 1/9
60,000 "	- 2/-
80,000 "	- 2/6
100,000 "	- 2/9

KEEP THIS LIST BY YOU.—Sovereign Fixed Condensers, Grid Leaks, Volume Controls, Dual Range Coils, Wire-wound Resistances, Rheostats, Wave Traps, Screen-grid Coils, H.F. Chokes, etc. Components upon which experts rely.



If it is difficult to obtain these and other sovereign components, write direct (also a full list) to

SOVEREIGN PRODUCTS LTD.
52-54, Rosebery Avenue, LONDON, E.C.1

YOU NEED LESS SCREENING...

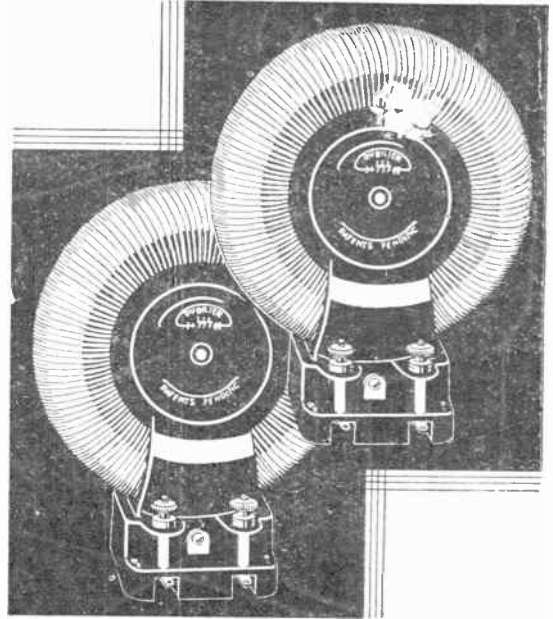

IF YOU USE

It is far less trouble to build a really efficient screened grid set if you use Dubilier Toroids because they have no external field and because of their high efficiency and adaptability. Very simple screening is sufficient if you use Toroids, thus reducing eddy currents which are often of sufficient magnitude seriously to impair the performance of your set. If you already have a set it is a simple matter to change to Toroids. If you contemplate building one, Toroids will ensure success.

RETAIL PRICES:

10/6 to 15/-

according to wave-length range
(Prices include holder)

DUBILIER TOROIDS

DUBILIER CONDENSER CO. (1925) LTD.,
Ducon Works, Victoria Road, N. Acton, London, W.3.

OVERHAUL YOUR GRAMOPHONE AND FIT

THE NEW "DIEHL" ARISTOCRAT ELECTRIC MOTOR

The Price?—Remarkably Low—Only 84/- Complete!

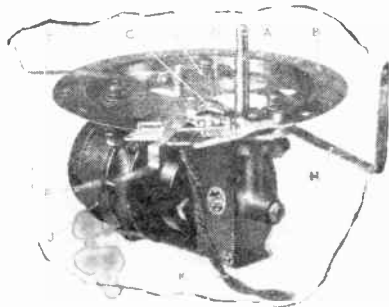

AT LAST!—A NEW, BRILLIANTLY "ORIGINAL" ELECTRIC GRAMOPHONE MOTOR THAT IS DISTINCTLY "BETTER." Produced by the DIEHL MFG. CO., Electrical Division of the World-Famous SINGER SEWING MACHINE CO., and distributed exclusively by "LYONS."

That we are behind this new motor is sufficient warranty that it marks a step

forward in correct design; it is really superfluous to add that Singers' 46 years' experience in the World's largest Small Motor Plant is also backing and positively guaranteeing this proposition.

NEW FEATURES INCLUDE; Bakelite Non-Rusting and Non-Warping Turntable; Spring Suspension; One-Hole Fixing; Induction Motor; Guaranteed Humless; Non-Interfering; No Brushes; Worm-Driven with Single-Plate Cork Clutch; Speed Indicator; Automatic Stop and A.C. Snap Switch.—IN FACT, DEFINITELY THE BEST MOTOR NOW AVAILABLE. AND WHAT A SURPRISINGLY LOW AND ATTRACTIVE PRICE... ONLY 84/- COMPLETE! THE DEMAND IS ENORMOUS.

Special Folder Free on Request by Return. Large Stocks.

EXCLUSIVE DISTRIBUTORS IN GREAT BRITAIN:

CLAUDE LYONS LTD.,

76 Oldhall St., LIVERPOOL. LONDON, 40 Buckingham Gate, S.W.1.

You will Help Yourself and Help Us by Mentioning "A.W." to Advertisers



...CHECKMATE

the source
of

TROUBLE

Fit Fotos valves in your receiver and eliminate a possible source of trouble, for Fotos are the valves with a pedigree. Tested to the utmost under strenuous conditions before leaving the factory, Fotos are made to give you faithful, lasting service.

Enquire for particulars of the new range of 25 Fotos valves. A valve to suit every requirement, every receiver.

PRICES FROM 5'6

Inform us if your local dealer does not stock them.



fotos
CONCERT VALVES
Trade Mark
THE HEART OF EVERY SET



CONCERTON RADIO & ELECTRICAL CO., LTD., 256/7 Bank Chambers, 329 High Holborn, W.C.1 Phone: Holborn 5667

Printed in England. Published by Bernard Jones Publications, Ltd., 58/61 Fetter Lane, London, E.C.4.
Sole Agents for South Africa: CENTRAL NEWS AGENCY, LIMITED. Sole Agents for Australasia: GORDON & GORCH, LIMITED. Saturday, February 23, 1931.