

£50 in PRIZES for CONSTRUCTORS

Full-size
Print of the
"20/- TWO"

Amateur Wireless

and
Radiovision

Every
Thursday
3^d

Vol. XVIII. No. 453

Saturday, February 14, 1931

The 20/- TWO



SELECTIVE COIL
HOME-MADE in 10 MINUTES

Cash Prizes for "Ether Searcher" Builders

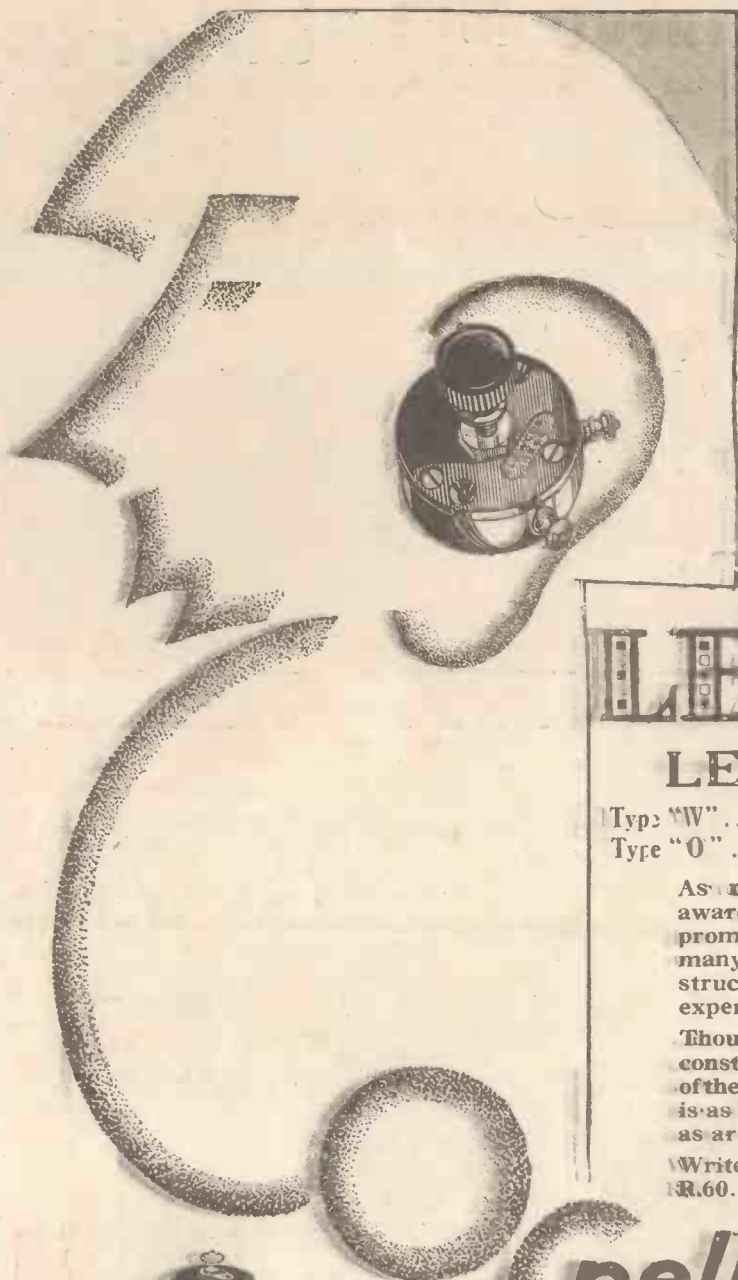

The
Ear of
Many
Successful
Receivers—

THE
LEWCOS^{Regd.}
LEWCODENSER

Type "W" . . Capacity .00002-.0002 mfd. . . Price 2/6 each
Type "O" . . Capacity .00015-.001 mfd. . . Price 2/6 each

As many wireless experimenters are aware, the Lewcodenser has figured prominently in the specification lists of many of the most successful sets, constructed, tested and described by the experts of this Journal.

Thousands of discriminating amateur constructors who have taken the advice of the experts, know that the Lewcodenser is as vital a necessity to their receivers as are the ears to the human being.

Write for fully descriptive leaflet Ref. R.60.

*Spells
Superiority*

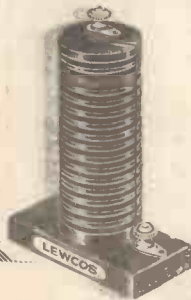

The Lewcos H.F. Choke is specially constructed to eliminate self-oscillation. Price 7/9.
Write for fully descriptive leaflet Ref. R.33.

A Lewcodenser, as illustrated above, is specified for the "Twenty-shilling Two" Receiver described in this issue.

Write for fully descriptive leaflet Ref. R.63.



LEWCOS RADIO PRODUCTS FOR BETTER RECEPTION

THE LONDON ELECTRIC WIRE COMPANY AND SMITHS LIMITED, CHURCH ROAD, LEYTON, LONDON. E.10

Don't Forget to Say That You Saw it in "A.W."

Unmatched Efficiency

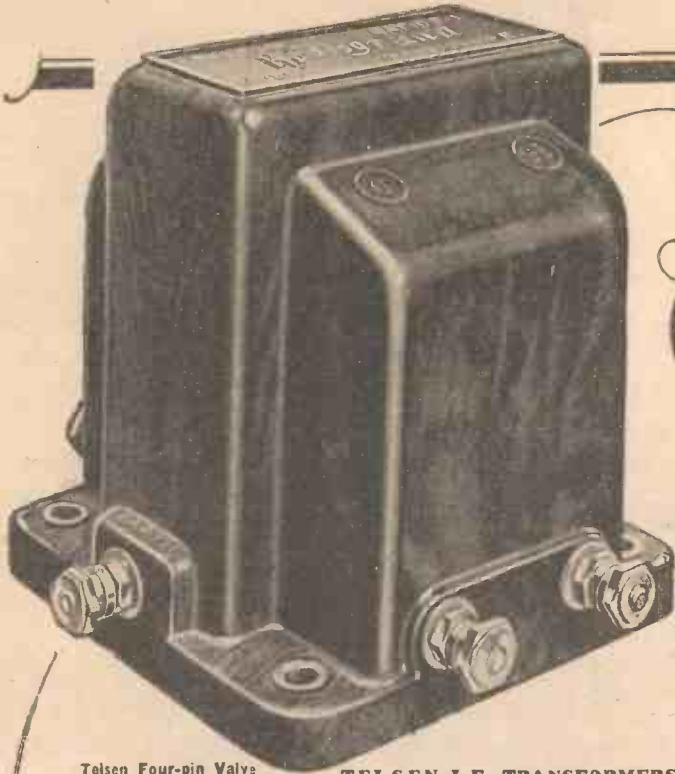

Only

features proved by time & experience

are embodied in Components made by **TELSEN**. These features, many of which are patented, are responsible for the extraordinary efficiency . . . the exceptional tonal quality, and the remarkable volume of receivers fitted with **TELSEN** Components.

Your present set will be re-vitalised if you change to **TELSEN**, or . . . if you are building a new set, take no chances, follow the experts' lead . . . and choose

Telsen Four-pin Valve Holders. Price 1/- each.



TELSEN L.F. TRANSFORMERS
 "ACE" - ratios 5-1 and 3-1 8/6
 "RADIOGRAND" - 5-1 and 3-1 12/6
 "RADIOGRAND" super ratio 7-1 17/6

Telsen Five-pin Valve Holders. Price 1/3 each.



Telsen Valve Holders. Pro. Pat. No. 20286/30. An entirely new design in Valve Holders, embodying patent metal spring contacts, which are designed to provide the most efficient contact with the valve legs, whether split or non-split. Low capacity, self locating. Supplied with patent soldering tags and hexagon terminal nuts.

TELSEN COMPONENTS



Telsen Grid Leaks. Absolutely silent and non-microphonic, practically unbreakable, cannot be burnt out, and are unaffected by atmospheric changes. Not being wire wound, there are no capacity effects. Made in capacities: 1/2, 1, 2, 3, 4, and 5 megohms. Price 1/- each.



Telsen Fixed (Mica) Condensers. Shrouded in genuine bakelite. Made in capacities up to .002 mfd. Pro. Pat. No. 20287/30. .0003 supplied complete with patent grid-leak clips to facilitate series or parallel connection. Can be mounted upright or flat. Tested on 500 volts. Price 1/- each.



Telsen H.F. Chokes. Designed to cover the whole waveband range from 18 to 4,000 metres, extremely low self capacity, shrouded in genuine bakelite. Inductance, 150,000 microhenries; resistance, 400 ohms. Price 2/6 each.

Advt. of Telsen Electric Co., Ltd., Birmingham

YOU CAN SIMPLY SWITCH ON!

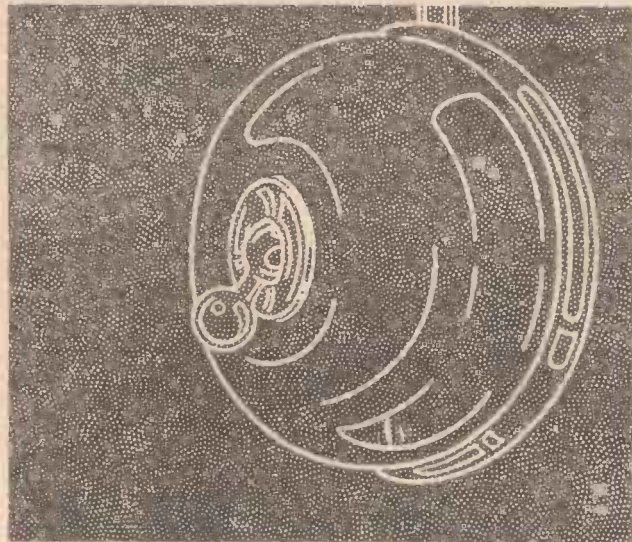

Wherever electric current is available, batteries are definitely out of date. Running your set from the mains means less trouble, less uncertainty. It means better reception and greater economy.

Most mains provide alternating current, which is, of course, unsuitable for radio purposes and has to be converted to direct current by means of a rectifier.

The Westinghouse Rectifier is quite different from all others. It is all-metal and contains nothing to burn or wear out. It converts—in conjunction with other components—existing battery-run sets to mains sets; it is ideal for use in constructors' kits; and it is incorporated in most good makes of mains-receivers—if you are purchasing, make sure that it is in yours.

There is not sufficient room to give details here, but a great deal of interesting technical information and complete descriptions are given in our forty-page booklet, "The All-Metal Way, 1931," which will be sent to you on receipt of the coupon (please enclose 3d. for your copy).

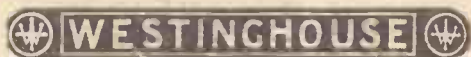

METAL RECTIFIERS

THE WESTINGHOUSE BRAKE AND SAXBY SIGNAL CO., LTD.,

82 York Road, King's Cross, London, N.1.

Telephone: North 2415

COUPON

Please send your forty-page booklet, "The All-Metal Way, 1931," for which I enclose 3d. in stamps.

NAME.....

ADDRESS.....

(Please write in Block Letters)

AN H.F. CHOKE



FOR EVERY PURPOSE

IMPROPERLY designed H.F. Chokes may have a bad effect on the circuit and may, indeed, be the cause of many obscure troubles. A Choke may be suitable for the Anode circuit of, say, a detector valve, and quite unsuitable for use in H.F. stages. And vice versa. Any ordinary Choke must necessarily be a compromise. The only really safe way to choose a Choke is to select one from the Dubilier range, a Choke specially designed for the job it will have to perform. You'll have no Choke troubles if you use Dubilier.

FOUR TYPES AVAILABLE

PRICE **4/6** ALL TYPES

DUBILIER COMPONENTS

DUBILIER CONDENSER CO. (1925) LTD.,

Ducon Works, Victoria Road, N. Acton, London, W.3.

Don't Forget to Say That You Saw it in "A.W."

H & B

GUARANTEED KIT

1931

WILL YOU WIN FIRST PRIZE?

EVERY KIT CONTAINS exactly the same components as used in the constructed set referred to in THE EDITOR'S REPORT.

Read the Editor's Report.

Published by
BERNARD JONES PUBLICATIONS LTD.
Published every Thursday

Amateur Wireless
and
Radio

Telephone: CITY 52
Telephone: BELLY 176
Telephone: BELL 1000

3361, FETTER LANE
LONDON, E.C. 4

February 2nd, 1931.

Messrs. H. & B. Radio Co.,
34/36/38, Beak Street,
Regent Street, W.1.

Dear Sirs,

We have tested a model of the "1931 Ether Searcher" constructed by you to our specification and drawings and have pleasure in saying that it is well and accurately made.

In testing it we referred to the scale given in our January 31st issue, and found that the stations came in at the identical readings there shown.

We note that the coil screens are sturdier than formerly and are to be commended.

Yours faithfully,
Bernard Jones
Editor

ETHER SEARCHER

THE SECRET of the Ether Searcher is the Screening. Mr. SIEGER uses H & B SCREENS EXCLUSIVELY.

WE WILL PRESENT TO THE WINNER OF THE FIRST PRIZE, A CELESTION SPEAKER VALUE £5.12.0 IF SET WAS CONSTRUCTED WITH THE H & B KIT.

COMPLETE SET 7/-

	£	s.	d.
1 Ebonite panel, 8 by 6 in. (Trelléborg) ...	2	0	0
1 3-gang .0005-mfd. variable condenser, with drum dial (J.B., Chassimount) ...	1	15	0
1 .0003-mfd. variable series aerial condenser (Polar) ...	3	0	0
1 .0001-mfd. variable reaction condenser (Polar) ...	3	0	0
1 Set of 3 matched coils, with ganging switch (Colvera type, TGSC2 and TCSR1) ...	1	10	0
1 On-off switch (Pioneer) ...	1	3	0
1 Low-frequency transformer (Telsen Ace, 5-1) ...	8	6	0
3 Valve holders (Telsen) ...	3	0	0
1 .0002-mfd. fixed condenser (Telsen) ...	1	0	0
1 .0003-mfd. fixed condenser (Telsen) ...	1	0	0
1 High-frequency choke (Telsen) ...	2	6	0
1 .01 fixed condenser, flat type (T.C.C.) ...	2	3	0
1 .0002-mfd. fixed condenser, S.P. type (T.C.C.) ...	2	3	0
1 1-mfd. fixed condenser (Lissen) ...	2	6	0
2 2-meg. grid leaks (Lissen) ...	2	0	0
1 Grid leak holder (Lissen) ...	0	0	6
1 SET OF H. & B. SPECIFIED SHIELDS (3 coil shields, 1 S.G. valve shield, ready slotted) ...	7	0	0
Aluminium foil sheet, 16 by 10 in. (H. & B.) ...	3	0	0
2 Terminal blocks (H. & B.) ...	8	0	0
4 Terminals, marked; L.S.+ , L.S.- , A, E (Belling-Lee) ...	1	6	0
7 Wander plugs; H.T.+1, H.T.+2, H.T.+3, H.T.-, G.B.+ , G.B.-1, G.B.-2 (Belling-Lee) ...	1	9	0
2 Spade ends, L.T.+ , L.T.- (Belling-Lee) ...	1	8	0
Insulated sleeving (H. & B.) ...	1	0	0
12 ft. wire and 6 ft. rubber flex (Lewcos) ...	1	0	0

CASH PRICE £5 13 7

3 Mullard Valves - £1 : 19 : 0 extra
Oak Cabinet - £1 : 1 : 0 ,,

Trade Supplied

TERMS: Carriage Paid on all retail orders. C.O.D. charges paid on all orders over £1.

H & B RADIO CO. 34, 36, 38, BEAK ST., REGENT ST., LONDON, W.1

Telephone: GERRARD 2834

210 H.L.

A new Valve with the famous Cossor 7 point suspension

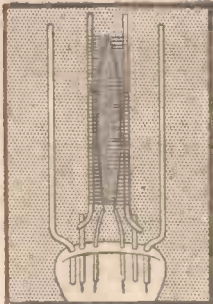

SEVEN POINT SUSPENSION

Practical experience has shown that the Cossor 7 point suspension system definitely eliminates microphonic noises. This system is employed in the support of the exceptionally long filament of the Cossor 210 H.L.

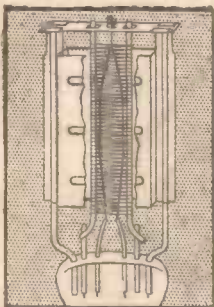

UNIFORM PERFORMANCE

The Cossor mica bridge construction permits no variation of characteristics due to differences in inter-electrode spacing. Complete uniformity of performance is therefore ensured between all valves of the same type.

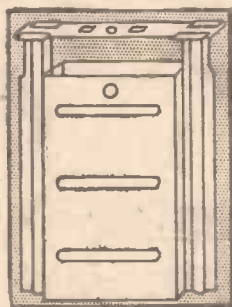

MICA BRIDGE MOUNTING

Permanent alignment of the electrode system is ensured by a stout mica bridge which forms an integral part of the anode assembly. When finally secured in position the whole structure becomes one interlocked unit.

To all users of non-screened grid Receivers this new Cossor valve is of special interest. Designed specifically for more efficient H.F. Amplification it incorporates all the most advanced constructional features. The famous Cossor System of 7 point suspension ensures complete freedom from microphonic noises. Its favourable grid current characteristics permit a remarkable degree of distortionless H.F. amplification without the use of grid bias. The new Mica Bridge Mounting method of assembly ensures greatly increased accuracy in the inter-electrode spacing and an unusually high standard of uniformity. The use of the new Cossor 210 H.L. will result in a considerable increase of efficiency in any non-screened grid Receiver.

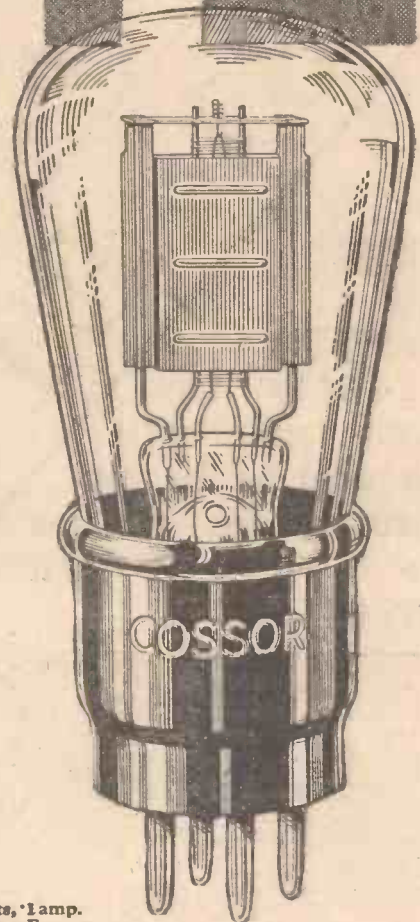

The new Cossor 210 H.L. 2 volts, 1 amp. Impedance 22,000. Amplification Factor 24, Mutual Conductance, 1.1 m.a.v. Anode voltage 75-150. Price 8/6

THE NEW COSSOR 210 H.L.

Be sure to get one of our novel, circular Station Charts, which give identification details of nearly 50 stations with space for entering your own dial readings. Ask your dealer for a copy, price 2d. or send 2d. stamp to us and head your letter 'Station Chart A.W.'

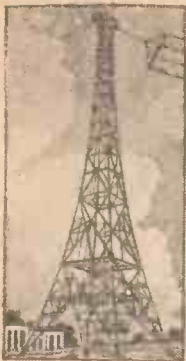

Amateur Wireless

and
Radiovision



EDITOR:
BERNARD E. JONES.

TECHNICAL EDITOR:
J.H. REYNER, B.Sc., A.M.I.E.E.

RESEARCH CONSULTANT:
W. JAMES.

ASSISTANT EDITOR:
H. CORBISHLEY.

THE LEADING RADIO WEEKLY FOR THE
CONSTRUCTOR, LISTENER & EXPERIMENTER.

NEWS · & · GOSSIP · OF THE · WEEK

£50 IN PRIZES

"ETHER SEARCHER" builders—turn to page 260 for full details of a wonderful competition in connection with your set. Big cash prizes are to be given. There is no time to lose. Read the particulars *now*.

FOR CONSTRUCTORS

YOU will see that in this issue we give another free full-size constructional guide and wiring plan. This time it is of a novel little receiver, "The 20s. Two"—a set which really can be built for the figure named, and which incorporates a feature not to be found in many receivers of triple the price, namely, automatic tuning.

The set is so arranged that there is no tuning control on the panel, but at the touch of a switch the local Regional or the National programme can be brought in at will. This is just the set for beginners and for the non-technical members of the family, and the cost is bound to suit every pocket! With the full-size wiring plan and constructional guide you simply can't go wrong.

NORTH REGIONAL TESTS

IN their latest traders' bulletin, B.B.C. engineers warn traders and other listeners not to take too much notice of the first open-aerial tests of the North Regional station. The point is made that power and modulation under service conditions will both be quite different from the quantities involved in the preliminary tests. Once again it is emphasised that no hitch has occurred in the Regional plans and that apart from weather conditions there has been little unforeseen delay in the completion of the Moorside Edge installation.

ALL-NIGHT TESTS

LAST week we mentioned how the German and British broadcasting authorities were co-operating in the problem of the mutual interference between London Regional and Mühlacker. On January 27 and January 29, Noel Ashbridge and B.B.C. engineers were down at the Tatsfield listening post with Herr Schaeffer, chief engineer of the Reich Rundfunk, and Dr. Weith, of the same organisation. They were listening to all-night transmissions

PRINCIPAL CONTENTS

	Page
News and Gossip of the Week	257
More about the "Everybody's All-in Two"	259
A Great Competition for Amateur Constructors	260
More Hints and Tips for "Ether Searcher" Builders	261
Philip Ridgeway Discusses his Microphone Girl	262
On Your Wavelength	265
An Ether Policeman	267
The How and Why of Radio	268
How a Super-het Works	271
New Talkie Horn	272
Without Fear or Favour	273
Announcers Tell Their Stories	275
The "20s. Two"	276
In My Wireless Den	280
"Regentone All-electric Four"	282
Readers' Ideas	284
"A.W." Tests of Apparatus	292

from Mühlacker and London Regional. Standard commercial 2- and 3-valve receiving sets were used. A direct telephone line linked Tatsfield with Mühlacker. This high-power German station varied its wavelength and modulation according to instructions sent over the line by the German engineers at Tatsfield. Some very useful data was gathered from these tests. No more striking proof of the German Broadcasting Company's desire to co-operate is needed. We sincerely hope that the strenuous efforts of the engineers concerned will be appreciated by both German and English listeners.

B.B.C.'S STUDIO LICENCE

SOME concern has been expressed regarding the B.B.C.'s intention in taking out a licence for music and dancing for the new giant studio in Broadcasting House. The B.B.C. denies that it has any thought of running the studio in competition with legitimate entertainment houses. The Civil Engineer had the bright idea that such a licence would prove useful in the future. Possibly he had in mind the use of the studio for staff dances, although many interested parties will not accept this rather ingenuous reason without further statements from the B.B.C. Meanwhile, it is

BROADCASTING HOUSE DESIGNER



Discussion about Broadcasting House is now fierce, many critics maintaining that the design should have been on larger lines to allow of development. Here is Lieut.-Col. G. Val Myer, the architect, at work on Broadcasting House plans

NEXT WEEK: A SUPER-QUALITY ALL-ELECTRIC AMPLIFIER

NEWS & GOSSIP OF THE WEEK —Continued

profitable to remember that the B.B.C. has for years given public entertainments. What of the Queen's Hall?

THE CRITICS' CIRCLE

ALTHOUGH there are relatively few wireless programme critics, we have long felt that worthy pioneers like our own critic, Mr. Sydney Moseley, deserve some recognition for their work of enlightenment. We are now pleased to record that wireless critics are to be admitted to the famous Critics' Circle. This will undoubtedly raise the status of wireless programme criticism. The day may not be remote when a radio critic achieves the eminence of President of the Critics' Circle.

NEWCASTLE'S FUTURE

WE can still only speculate on what is to happen to the Newcastle broadcasting station. When it went on to the 288.5-metre common wavelength, the B.B.C. made it clear that this was only a temporary measure, pending the development of the Regional scheme. It is recognised that Tyneside listeners have an individuality that distinguishes them from Midland and Northern Regional listeners. At the moment the question is whether Newcastle shall continue as a National relay or whether it shall attempt to go on the Northern Regional's wavelength and so take the Northern programmes. There is another possibility that must not be overlooked. We refer to the 'release of the

A BOOTLEG STATION



Radio is still being used by American rum-runners. Here is a "bootleg" station which has just been tracked down by Federal agents at Newark

Leeds wavelength of 200 metres. When Leeds closes down Newcastle might take on its wavelength and so please itself as to what programme source it should radiate.

NORTHERN WIRELESS ORCHESTRA

IN spite of all the protests that have been recorded in the provincial press and elsewhere, the Northern Wireless Orchestra is to be disbanded at the end of March. Only nine players will be left, to form a combination for light orchestral broadcasting, as is done at Birmingham. We wonder whether Northern listeners really have a grouse about this decision. After all, the small orchestral combination cannot do such justice to symphony music as, for example, the Hallé Orchestra. The need during the daytime is for light music, and this can be well executed by the combination of nine. For the important symphony broadcasts in the evening the Hallé Orchestra or the City of Birmingham Orchestra obviously provide listeners with a more complete entertainment. Our sympathies are with the disbanded players; but we do not think listeners themselves will have any cause for complaint.

POPE TO BROADCAST?

THIS question has been asked so many times that we shall be quite surprised to hear that the Pope is actually to broadcast. We believe it is the B.B.C.'s intention to relay the Papal utterances if the Italian Broadcasting Company is able to arrange the broadcast. The question has been asked as to whether the Pope would speak in English or Latin. Whichever language he chooses, we feel the B.B.C. would attempt the relay.

WIRELESS FOR THE BLIND

THE total sum of money received by the British "Wireless for the Blind" Fund amounted to exactly £30,000 at the end of January. About £5,000 of this sum had been sent in response to Mr. Winston Churchill's appeal broadcast on Christmas Day. More than 7,500 wireless sets, most of them crystal sets, have already been delivered to blind listeners in various parts of the country, and during the present week distribution of 5,000 single-valve sets will be begun for use in districts removed from a broadcasting station. To serve areas still further

remote, an order has just been placed for 1,000 two-valve sets.

MAKING IT POPULAR!

ALTHOUGH the B.B.C. comes in for a lot of criticism, especially as regards "low-brow" and "high-brow" music, one must admit that the broadcasts of classical music are certainly improving the musical tastes of the man in the street. A window cleaner was recently heard whistling a selection from one of Verdi's works as he went about his job. A railway porter trundled milk-cans at Vauxhall to a tune

FULL-SIZE WIRING PLANS

As announced on the front cover, we are including in this issue a full-size wiring plan of the "20-Two"—an entirely a val two-valver which really can be built at a cost of £1. This plan is similar to those given for the "1931 Ether Searcher," and makes the job of construction as simple as child's play. Turn to pages 276 and 277 where you will find the constructional guide.

from *Madame Butterfly*, while a guard on the underground softly whistled some bars from the "Unfinished Symphony." Possibly the whistlers did not know what they were whistling, but nevertheless the music must have made an impression; otherwise it would not have been remembered. Ten years ago, tunes such as "Yes, we have no bananas" would have been the rage, and not excerpts from the classics!

RIDGEWAY AGAIN

THE Ridgeway Parade" comes back to the microphone on March 2 (National) and March 3 (Regional), with several new artistes and many new ideas. Mr. Philip Ridgeway's chief difficulty has been the finding of a girl with a "personality" voice, which will appeal to listeners for its freshness, charm and freedom from accent—Cockney, "refaned," or any other kind. "I can only describe what I want as a pure, young English voice," he says. He has given auditions to more than a hundred girls, and on page 262 will be found an interesting account of an interview with Ridgeway by an "A.W." representative, where he describes his latest "star."

RADIO BENEFACTORS!

AN American contemporary suggests that a great new field for philanthropy has opened up, and that rich people who formerly made bequests to hospitals and institutions should now try leaving money to endowed radio stations. As America is (supposedly) a land of many rich people, any such suggestion is bound to carry weight; and according to all accounts, American radio is in need of some other support than that provided by advertisers!

A PRINCE LISTENS

BROADCASTING in Japan is making strides and the Japanese Royal family is keenly interested in listening. Prince Takamatsu regularly listens to the local station at Tokio, and also to numerous foreign stations. As a matter of fact, the Prince has a modern mains-driven set working off the private mains supply to the Palace

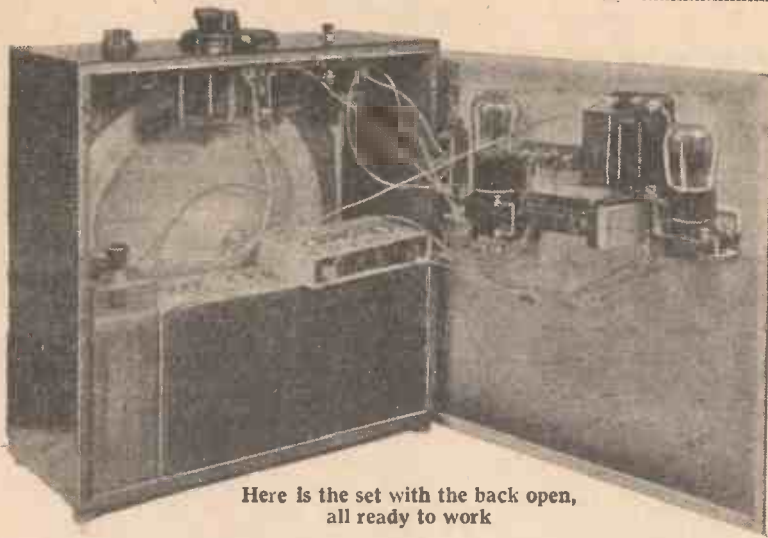

Here is the set with the back open, all ready to work

WORKING "EVERYBODY'S ALL-IN TWO"

TESTING THE SET VALVES AND BATTERIES TUNING FOR BEST RESULTS

WHEN the parts for the "Everybody's All-in Two" have been mounted, then the next job is to connect them up and to fit suitable valves and batteries.

The wiring up of the separate two sets of parts on the backboard of the cabinet and on the inside of the top has already been described. This part of the wiring is carried out with stiff insulated wire and for convenience it is best to make soldered connections. Flex leads, of course, have to be used for the various connections between the sections of the set, that is, the parts on the underside of the cabinet, on the backboard, the speaker and the battery compartment.

You must take care with these flexes, because although the battery leads terminate in wander plugs and spade tags, the other leads need have no marking, provided they are connected correctly in the first place. The blueprint, and the small reproduction of it, given last week shows exactly how these sections are wired.

Battery Leads

The battery leads are shown short for convenience in drawing, but actually they are of any convenient length needed to connect up with the H.T., L.T. and G.B. batteries.

Checking is quite simple if you take each lead in turn and compare it with its counter-part on the blue print. You can do this with the small reproduction given last week, or you can work with the full-size blueprint which can be obtained, price 1/-, post free, from the Blueprint Department, AMATEUR WIRELESS, 58-61 Fetter Lane, E.C.4.

The flex leads between the components, beneath the cabinet top and those on the backboard, are the only wires which are apt to be confusing, but as each lead is numbered you can check them one by one and make sure that they are correctly wired.

There are only five connections on the coil and there is no difficulty at all about getting these right. Make sure that the speaker unit is connected the right way round, that is, positive terminal connected to the H.T. + 2 wander plug and with the negative terminal connected to the anode terminal of the power valve socket.

If the unit is wired the other way round its polarity will be weakened in time.

There is, as you see from the photograph above, ample space in which to mount a 100-volt H.T. battery, a two-volt accumulator and a nine-volt grid-bias battery. If the grid-bias battery is placed on its side on top of the H.T. battery, then it will not foul the parts on the top of the cabinet. The H.T. and G.B. battery wander plugs should make very good connection and a firm contact in their sockets, for otherwise you will always be bothered with crackling noises due to poor contact.

The "Everybody's All-in Two" works quite well with a mains eliminator. The best type to employ for this set is a portable unit, preferably incorporating a trickle charger so that the accumulator can be always kept up to tip-top condition.

As the speaker unit is well removed from the eliminator, there should be no tendency to hum due to induction from the mains transformer or choke in the eliminator, but with some eliminators you may find it advisable to try various positions, for in one position induction may make itself obvious while in another the relation of magnetic fields will not be so strong.

Some eliminators are provided with an earthing terminal for the case and you might try connecting this to the earth terminal on the back of the cabinet.

So far as valves are concerned, the detector valve should be chosen from the following two-volters. Four- or six-volt equivalents may be used, but, generally speaking, owing to the space available for

the accumulator, two-volt valves are best to use. Mullard PM2DX, Cossor 210 Det, Marconi L210, Mazda L210, Osram L210.

Some good two-volt small power valves are the following: Cossor 215P, Marconi LP2, Osram LP2, Mullard PM2A, Mazda P220.

Aerial and Earth

Other valves may, of course, be used, if greater power is required and (most important) if sufficient H.T. is available to work them.

Nothing very elaborate is required in the way of an aerial or earth. Get as good an earth connection as you can, to a near-by water pipe or earth tube. In most districts a small indoor aerial will be found

COMPONENTS FOR THE "ALL-IN TWO"

Cabinet (Cameo Triumph).	Two valve holders (Junit, W.B., Parex, H. & B.).
Talisman dual-range aerial coil (Wearite).	On-off switch (Bulgin, Readi-Rad, Wearite, Junit, Burton, Benjamin, Lotus, Lissen).
.0005-mfd. variable condenser (Lotus, J.B., Polar, Lissen, Formo, Ormond, Burton, Utility).	Loud-speaker unit (Ormond, Blue Spot, Hegra, Tunewell, Trilotron, K.D., Sheffield Magnet).
.00034-mfd. reaction condenser (Lotus, Readi-Rad.)	Loud-speaker cone with frame (Kone-Dope).
.001-mfd. fixed condenser (Dubilier, Readi-Rad, Lissen, Telsen, Watmel, T.C.C., Graham-Farish).	Vernier dial (Brownle, Lissen, Ormond, Formo, Astra).
.0001 - mid. max. pre-set condenser (Sovereign, Polar, Formo, Leweos).	Two terminals, marked: A., E. (Belling-Lee, Clix, Burton, Eelex).
.0003 - mid. max. pre-set condenser (Sovereign, Polar, Leweos, Formo).	Five wander plugs, marked: H.T. + 2, H.T. + 1, H.T. —, G.B. +, G.B. — (Belling-Lee, Clix, Eelex, Burton).
Low-frequency transformer (Ferranti type A.F.S, Telsen, Lissen, Burton, R.I., Voltron, Varley, Leweos).	Two spade terminals, marked: L.T. +, L.T. — (Belling-Lee, Clix, Eelex).
.0003-mfd. fixed condenser with grid-leak clips (Dubilier, Lissen, T.C.C., Readi-Rad, Telsen, Graham-Farish, Watmel).	Rubber-covered flex for battery leads (Leweo-flex).
2-megohm grid-leak (Lissen, Telsen, Graham-Farish, Ferranti, Dubilier, Sovereign).	Glazite for wiring.
High-frequency choke (Leweos, Telsen, Lissen, Varley, Readi-Rad, Bulgin, Sovereign, Voltron, Burton, Tunewell, R.I.).	2-volt accumulator (C.A.V., 2AN7).
	High-tension battery, 100 volts (Fuller)
	Grid-bias battery, 9 volts (Fuller).

quite satisfactory and there is no reason why you should not run separate aeri-als round the picture rails of two or three rooms in the house, so that the set can be carried from room to room.

London amateurs will be interested to know that the "Everybody's All-in Two" can be seen in the Radio Department windows of Messrs. Selfridge & Co., Ltd., Oxford Street, London, W.1.

A GREAT COMPETITION FOR AMATEUR CONSTRUCTORS £50 IN CASH PRIZES

EVERY "1931 ETHER SEARCHER" BUILDER MUST COMPETE

WE offer Fifty Pounds in cash prizes, as well as a number of consolation awards, in a competition for amateur builders of the "1931 Ether Searcher." The competition is open to every reader who either has built this remarkable three-valver, or will be doing so during the next two or three weeks.

We ask all "1931 Ether Searcher" builders to send us an account of how they built the set, how they used it, and how they found its performance. Just a short account—not exceeding 300 words, please.

WHAT THE READER IS TO DO

Readers can comment, for example, on the ease, or the difficulty, with which they built the set; on the time taken to build the set; on their experiences after they had built it; the number of stations actually logged and any particular successes obtained, especially in relation to the conditions of reception in their own district. They should state when they bought the components.

petitors some such number as twenty or thirty who will be specially invited to submit their actual sets for a brief period. We shall send each of the selected competitors special packing instructions and addressed labels, and we shall pay for both packing and carriage.

Further, we shall give each of these selected competitors an undertaking not to retain his set for more than six days. The Editor, with his Technical and Constructional Staff, will examine each set and award points for workmanship and general appearance, and will then test each set and award points for performance. The Editor will act as Chairman of the Judges, and his decision will be final.

CELEBRATING SUCCESS

We have arranged this competition, firstly to prove our own great faith in the "1931 Ether Searcher," and to celebrate the tremendous success that it has won and, secondly, to give the amateur constructor the pleasure of competing with his fellows for a number

FIFTEEN CASH PRIZES, TOTTALLING £50, WILL BE AWARDED

1st Prize, Cheque for Twenty Pounds
2nd Prize, Cheque for Ten Pounds
3rd Prize, Cheque for Five Pounds
4th Prize, Cheque for Three Pounds
5th Prize, Cheque for Two Pounds

There will be Ten other Prizes, each of a Cheque for One Pound. In addition, we shall award a number of small "commendation" prizes.

As a guarantee of good faith, we should like every reader to get a friend or neighbour to add a few words to the account, saying that he has seen the "1931 Ether Searcher" built by Mr. ———, and has every reason to believe that the account is true. Get the friend or neighbour to sign his statement and give his address.

If you can manage to send us a good photograph of yourself with your set, so much the better. A "good" photograph, you will understand, is not a tiny under-exposed "snap" which could not be satisfactorily reproduced.

We reserve the right to publish all, or any, of the entries, wholly or in part.

COMPETITION CLOSES MONDAY, MARCH 9

All entries must reach us not later than Monday, March 9. After considering them in detail, we shall choose from among the com-

of cash prizes each thoroughly worth having.

We want an entry from every reader who has made the "1931 Ether Searcher," or who intends to make it during the next fortnight or so. All you need do is to send us the short account asked for. We repeat, all accounts must reach us by Monday, March 9.

Any set sent us, except at our own special invitation, will not be considered. Competitors must wait to hear from us before sending their sets. Their job is to post us their 300-word account in good time. The next step is ours.

In making our selection of readers whose sets are to be sent us for examination and test, we shall be guided by our special experience and by ordinary common sense, and readers must rely on our good faith in this and in all other matters relating to the competition.

We pledge ourselves to award the full prize money.
THE EDITOR.

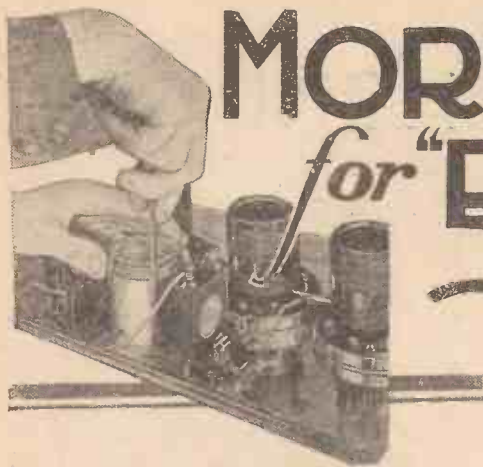

MORE HINTS & TIPS for "ETHER SEARCHER" BUILDERS

Helpful and practical hints for constructors and users of the new "1931 Ether Searcher"

Ganging is Important

YOU will not get good results from the "Ether Searcher" unless you first set the ganging correctly. This is not at all difficult, but it is necessary to take a little care in making sure that the matching of the tuning circuits is accurate. The first step is to pick out a local station which is well received, and tune this in with the main condenser according to the Station log. Then adjust the small trimming knobs in turn, with a screwdriver. First deal with the trimming condenser screw at the top of the dial, looking from the front. Tune to the silent point of the carrier wave (the set should be just oscillating) and then decrease reaction. Do not choose for these adjustments, a station which swamps the tuning. Now adjust in the same way the trimming condenser screw on the left of the dial.

Those Trimming Condensers

When adjusting the ganging of a set which is to be used within the swamp area of a main station, then the trimming condenser of the main aerial tuning condenser (on the left looking from the front) should be screwed in so that it will be necessary to have the aerial condenser on the panel at its minimum setting. You can find the best adjustment here by trial.

Good Detectors

In getting the best out of the "Searcher," a great deal depends on having a suitable detector valve. Do not use a detector having too high an impedance or the quality will not be good, the best being missed. Valves such as the Osram or Marconi L210, Cossor 210Det., Mullard PM2DX, or Mazda L210, should be used.

The Grid Condenser

Make sure to get the grid condenser the right way round. You will see that a small "condenser" is marked in red on the top of the component between the two terminals which actually are connected to the vanes. The other outside terminal is merely connected to one holder of the grid leak. It is important to connect these three terminals exactly as shown on the print.

Using the Tuning Scale

Once the "Ether Searcher" has its

circuits correctly ganged, you should have no trouble in logging most of the stations shown on the automatic tuning scale given with AMATEUR WIRELESS, No. 451. You will find that this scale is approximately accurate for most receivers made up exactly as described. However, a small alteration in either direction may be needed to make the scale true. This is quite easily done. Simply cut out the centre portion of the scale and then tune in a large station, such as one of the Regionals, and note its reading on the tuning dial. Slide the centre portion of the scale up or down so that the

the screen grid valve. There is, with most valves, no need to have a greater value than this. With some old types of screen-grid valve, this bias may not be needed and the G.B.—1 wander plug should then be removed and the lead connected to the G.B. positive flex lead.

H.T. for the "Ether Searcher"

It should be noted that the C.P.2 Tannoy high-tension eliminator referred to last week is entirely suitable for the "Searcher," and gives an output of approximately

COMPONENTS REQUIRED FOR THE "1931 ETHER SEARCHER"

Ebonite panel, 8 in. by 6 in. (Becol, Trelleborg).
3-gang 0005-mfd. variable condenser with drum dial (J.B. Chassimount, Lotus, Polar).
.0003-mfd. variable series aerial condenser (Readi-Rad, Brookmans type, Lotus).
.0001-mfd. variable reaction condenser (Readi-Rad, Brookmans type, Bulgin, Lissen, Lotus, Burton).
Set of three matched coils with ganging switch (two Colvern type TGSC, and one type TQSR).
Low-frequency transformer (Telsen, 5-1 Ace, Lissen, Varley, Ferranti, R.L., Burton, Voltron).
On-off filament switch (Bulgin Junior, Junit, Lissen, H. & B., Benjamin, Readi-Rad).
.01-mfd. fixed condenser (T.C.C. flat type, Lissen, Dubilier, Watmel).
.0002-mfd. fixed condenser (T.C.C. SP type, Lissen, Dubilier, Watmel).
Three valve holders (Telsen, Junit, Lotus, Benjamin, W.B., Clix).
.0002-mfd. fixed condenser (Lissen, T.C.C., Dubilier, Watmel).
.0003-mfd. fixed condenser (Lissen, T.C.C., Dubilier, Watmel).
1-mfd. fixed condenser (Lissen, T.C.C., Dubilier, Filta).
Two 2-megohm grid leaks (Lissen, Dubilier, Watmel, Ferranti).
Grid-leak clips (Bulgin, Wearite, Ferranti).
Three coil screens (H. & B., Readi-Rad, Colvern).
S.G. valve screen (H. & B.).
High-frequency choke (Telsen, Varley, Readi-Rad, Lissen, Bulgin, Sovereign, Tunewell, Lewcos, Burton).
Aluminium foil sheet, 15½ in. by 9½ in. (Readi-Rad, H. & B., Farex).
Two terminal blocks (Junit).
Four terminals, marked: L.S.—, L.S.—, A., E. (Belling-Lee Junior, Clix, Ealex, Burton).
Seven wander plugs, marked: H.T.—3, H.T.—2, H.T.—1, H.T.—, G.B.—, G.B.—1, G.B.—2 (Belling-Lee, Ealex, Clix).
Two spade terminals marked: L.T.—, L.T.— (Belling-Lee, Ealex, Clix).
Insulated sleeving (Lewcos, H. & B.).
Cabinet (Clarion Camco, H. & B., Readi-Rad).
2-volt accumulator (C.A.V. 2AG11).
10-volt high-tension battery (Fuller, Sparta) and 16-volt grid-bias battery (Fuller, Sparta).
Loud-speaker unit (Ormond, Blue Spot, Lissen, Hegra).

dial reading on the set is alongside the wavelength of the station received as shown by its scale. You may find it necessary to adjust both the medium- and long-wave scales and both, of course, will need separate tuning tests and adjustments. When you have these readings quite accurate, then the three scales may, in their correct positions, be pasted on a card and you will then find that the scales will read approximately correct for all other stations.

Grid Bias

With most valves, the best bias values are 1½ volts negative for the G.B.—1 tapping, and 4½ for the G.B.—2 tapping. With large power valves such as the Mullard PM252, Marconi or Osram P2 and so on, a greater amount of bias will be needed, and the exact value should be ascertained from the manufacturer's leaflet accompanying the power valve. The G.B.—1 tapping supplied 1½-volts negative to the grid of

20 milliamps, and not 10 milliamps as stated last week. It will therefore be seen that this Tannoy model, which is very low-priced, can be used with quite large-power valves, and that the volume output of the set is considerable. On test we found this unit entirely satisfactory and free from hum.

Good Control

Make use of the pre-set aerial condenser on the panel when tuning in distant stations. In all probability you will find that a slight readjustment of this turns a faint signal into one at speaker strength. This is particularly the case at the extreme ends of the tuning scale, where ganging may not be quite correct. Alteration of the pre-set condenser brings the circuits back into the proper tune. This adjustment is not at all critical but must be done slowly so that the correct point of tune is found. Remember that the set should always be tuned slowly or stations will be missed.



Babs Farren, the "microphone girl" discovered by Philip Ridgeway

PHILIP RIDGEWAY, when he started his famous Parades, brought a refreshing personality to the microphone. He applied twenty-five years' experience in theatre producing to the infinitely more difficult technique of broadcast entertaining; and he undoubtedly got away with it. His "pep" was infused into the artistes, who were dressed for their parts in

PHILIP RIDGEWAY DISCUSSES

HIS MICROPHONE GIRL

In an exclusive interview with ALAN HUNTER

a strenuous effort to break down the phlegm of the ether; to put across that intangible but essential quantity we call atmosphere.

Ridgeway does not believe in letting his medium cramp his style. Because listeners cannot see the broadcast artistes one might imagine that the voice alone mattered in choosing artistes for a radio show. But, since the sound of a voice must inevitably conjure up a vision, is it not desirable that the vision shall be entrancing?

"I asked myself why I could not have a beautiful girl for my next Parade," said Philip Ridgeway. "Someone to correspond to the soubrette in a pierrot show; not necessarily a girl with a marvellous voice or endowed with exceptional acting ability; just a charming personality."

Well, Ridgeway had literally thousands of applications in response to his request for "a girl with the voice of spring."

"I heard the first hundred or so," Ridgeway told me. "How did I hear them? In a way that did not permit their appearance to prejudice me, one way or the other. Before I saw each girl I heard her through the microphone and a pair of telephones."

"How did I test each girl's suitability? By extracting from her the whole gamut of human emotions. She had to be able to

laugh easily; and to cry naturally. As you know, my opinion of producing is that it is the art of drawing out of each artiste just the emotions the part demands. I produce people, not plays."

During the lengthy auditions that followed, a piece from the musical show *Darling, I Love You* happened to be played. Came the turn of Babs Farren. Ridgeway had an inspiration. "Let me hear how you would say 'Darling, I love you,'" commanded the producer, listening intently to his earphones. And the way this girl said this expressive sentence so impressed Ridgeway that he decided she was the girl for his show.

"I wanted to hear through the microphone youth, sincerity and unaffected beauty. Babs Farren's voice conveyed just these qualities."

So this young artiste, who is only twenty years of age, will appear in the new Ridgeway Parade on March 2. "It is not a revue; nor a vaudeville show; call it a song and dance show," explained Ridgeway. "My new show will appeal to the unsophisticated listener; to the family at home. I shall not treat my listeners as children, nor shall I try to educate them. My job will be to entertain; to cheer and to interest, with as much sincerity as possible."

AND still they come! Possibly in the last few days you may have heard tests with gramophone records; on most occasions without any announcement, in the region of Milan and Vienna. Well, the new Velthem-Louvain 20-kilowatt transmitter is now in daily operation, and although from the beginning of the month it has been run by the Institut National Belge de Radiodiffusion it is still our old friend Radio-Belgique. On some nights you will pick up the familiar call in French; on others you may hear "Ici Radio Catholique Belge." The latter is only given out when the programmes are contributed by one of the subsidiary associations. Brussels No 2, on 338.5 metres, is also working on higher power, and from this station with Flemish announcements we get the calls "Katholieke Radio Omroep" or "Hier Sarov," as the case may be. It depends also on which organisation is in temporary possession of the studio. For the present, I find that Radio Belgique suffers from fading and its modulation has been far from perfect. Both stations are now on the air daily and "Velthem"—the name more conveniently used to designate the station on 338.5 metres—is carrying out relays from Antwerp and from other Belgian cities.

Roykjavik is still merrily testing its new station, and recently I have picked up announcements in Danish, French, German, and English. I do not know whether a lady has been permanently engaged for these duties, but on three separate occasions a woman has acted as announcer in

OUR LISTENING POST

By JAY COOTE

the short programmes broadcast.

A persistent morse-like signal, which you may have logged on a wavelength slightly above Kalundborg, and which now and again, on Mondays, Wednesdays, and Fridays, interferes with the Danish

programmes, emanates from the Belin Laboratories at Reuil-Malmaison, Paris. It is a picture transmission by that well-known French process, and if you are lucky towards 10.15 p.m., when the station closes down, you may catch the verbal call!

Every fortnight on Wednesdays at 9.50 p.m. the Breslau studio takes its listeners to the principal picture palace in that city for the relay of all sounds emanating from a weekly review of the International talkie news bulletins. In this way I heard the boatswain's pipe and drums and fifes whilst a hornpipe was being danced by a number of boys on a British training ship. In the course of the same broadcast I heard also the cheers of the spectators on the banks of the Serpentine as the intrepid all-the-year-round veterans took their daily dip, and there were sundry other excerpts of well-known gazettes, which I had seen actually barely a month ago at the local cinema.

Have you noticed that the transmissions of the Moscow Trades' Unions "giant" are being jammed on some evenings. I am informed that this interference is wilfully provided by Poland when the Russian outpourings are directed towards that country. The "jam" is supplied by Warsaw and consists of the letters R.P. (in morse) broadcast *ad nauseam*.

Finally, as a reminder, it may interest short-wave experimenters to know that the Vatican (Rome) station is now regularly testing on 19.84 metres. Try for it between 2 and 3 p.m. G.M.T. The call is regularly given out in Italian, French, Spanish, and English.



An impression of PHILIP RIDGEWAY

UNBIASSED EXPERT EVIDENCE FULLER DRY BATTERIES

SPECIFIED BY
"AMATEUR WIRELESS"
FOR THE "1931 ETHER
SEARCHER"

Fuller Dry Batteries are power units on which you can absolutely rely. The current emission is always, under all conditions, steady and unvarying. That is why Fuller Batteries improve the performance of any set. That is why they are specified for the "1931 Ether Searcher."

Obtainable through Fuller Service Agents or any reputable dealer. Full list of sizes and types post free.



Fuller dry H.T. battery for portables
W.O.P.100 (reads 108)
10" x 5" x 3" 15/-.
16 volt Grid Bias
Price 2s. 10d.

FULLER DRY H.T. BATTERIES

L.T. BATTERIES

Mammoth plates to give the power modern valves demand; micro-porous paste; patent double grease-cup terminals; patent non-slip metal carrying handle; L.D.G. 2v. 60 a.h. 9s. 6d. And other sizes and prices, including Non-Spill for Portables.

CAR BATTERIES

Patent Rubber U Plate Protectors to prevent plates touching under any shock. Patent double grease-cup terminals to eliminate risk of escaping acid and subsequent corrosion.

FULLER ACCUMULATOR CO. (1926) LTD., CHADWELL HEATH, ESSEX

To Ensure Speedy Delivery, Mention "A.W." to Advertisers

CHEAPER ELECTRIC RADIO by



Cheaper electric radio by Regentone—specialists in all-electric radio. Three new Mains Units added to the Regentone range. Three new Mains Units which fit inside any portable. Prices lower than ever before for such high quality in electric radio. Now it costs only £2:12:6 to electrify your portable for D.C. Mains (Model II). £4:15:0 for A.C. Mains (Model W.5.A.), or Model W.1.D., (H.T. only—3 fixed tapings) price £3:7:6.

These additions to the famous Regentone range, known wherever radio is known, give you electric radio at its cheapest and best. Write for FREE Art Booklet, with colour supplement "Cheaper Electric Radio by Regentone"—or get it from your dealer.

REGENTONE LIMITED, Regentone House, 21 Bartlett's Buildings, London, E.C.4.

Telephone : Central 8745 (5 lines).

Irish Free State Distributors : Kelly & Shiel Ltd., 47 Fleet Street, Dublin.

E.V.G.

RADIO'S NEWEST TUNING DEVICE

The New J.B. "CHASSIMOUNT"

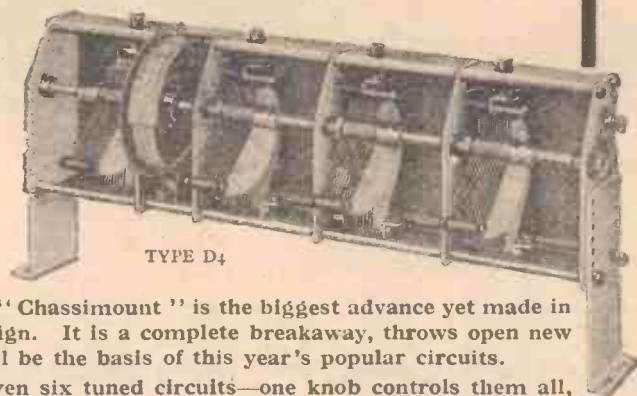

TYPE D4

J.B. 'CHASSIMOUNT'
TYPE D.3

SPECIFIED

for

**Mr. J. SIEGER'S
1931 ETHER
SEARCHER**

Your dealer can supply
immediately.

The new J.B. "Chassimount" is the biggest advance yet made in condenser design. It is a complete breakaway, throws open new fields, and will be the basis of this year's popular circuits.

Two, three, even six tuned circuits—one knob controls them all, keeps them perfectly in tune, and brings in station after station.

Once again J.B. lead the way. J.B. precision has made the "Chassimount" possible and ensured the various condenser units matching over the whole range.

The J.B. "Chassimount" is built and designed as a unit. Each stage is adequately screened and has a special device which balances out all stray capacities. AND IT COSTS LESS THAN SEPARATE CONDENSERS.

J.B. "CHASSIMOUNT" GANG CONDENSERS

(With drum drive)

Type D2	2 stage	.0005	26/6
" D3	3 "	"	35/-
" D4	4 "	"	42/6
" D5	5 "	"	50/-
" D6	6 "	"	57/6



PRECISION INSTRUMENTS

Advertisement of Jackson Brothers, 72, St. Thomas' Street, London, S.E.1. Telephone : Hop 1837.

You Will Help Yourself and Help Us by Mentioning "A.W." to Advertisers

On Your Wavelength!

A FRAME TROUBLE

I CAME across a curious effect in a neighbouring listener's frame-aerial set the other day. It happens that quite close to his house is an overhead extension line which supplies electric light to a garage. As there happened to be a number of trees along the route, he simply flung a piece of workshop flex between the branches of the trees, where it was quite out of sight, and it saved him the trouble of using a proper buried cable for the purpose.

Now it happened that he had gone in the other day from the garage on a pouring wet night and had, unfortunately, left the light on. He only noticed this when he returned to the house, and, being an essentially lazy person, he said to himself, "I'm not going out in the rain again. I'll switch off the light from the house," which he was able to do by means of a second switch.

On doing this he was greeted with a howl of execration from his wife, who was sitting quietly listening to the broadcast. Apparently the simple action of switching off the light had caused the broadcast to fade away completely. Now, his particular set is a mains-driven self-contained set, having a frame aerial; and, of course, I naturally assumed that some funny effect had happened on the mains. Yet, when I came to inspect the set, there was the customary faint hum, and everything appeared to be in order. I therefore twiddled the dial, and—lo and behold!—in came the programme once again about 10 degrees different from its usual position!

TRACKING IT DOWN

INVESTIGATION of the matter showed that the variation was due to a capacity effect to earth; due to the cable, coupled with the fact that the set itself had no earth other than that obtained through the mains. An artificial earth is used on the set, obtained by the well-known dodge of connecting two 1-microfarad condensers in series across the mains and using the middle point as the earth. While this is quite satisfactory in the normal course of events, it is apparently liable to give differences in the tuning if there are any overhead conductors round about.

It does not matter whether these conductors are connected to the mains or not. I have often noticed, for example, that when switching the telephone from this house on to a short overhead extension out to a cubby hatch I obtain the same effect, i.e., a distinct change in the strength of the signal being received. A little investigation showed that in this case again the signal could be brought back to its normal value by retuning. The difference here, however, is not very marked, and I have never before experienced a case where the signal completely vanished as it did when I simply switched off the light in the garage the other night.

Possibly some other readers may have puzzling troubles when they are working on

mains sets, and I recommend this to their notice as a possible solution.

FROM OUTER SPACE

OF all the waves that jostle their way through the ether, the famous "cosmic rays" of Professor Millikan are perhaps the most mysterious. As regards frequency, they are as far removed from visible light as the latter is remote from the welter of the broadcast band. Yet, in a sense, like broadcast waves, they are "news carriers," since they bring us knowledge of the far-off regions of the universe. According to Professor Millikan, they come, not from the sun or the distant stars, but from the intensely cold regions in the depths of interstellar space. Hydrogen is the lightest and most widely distributed of all the known elements. Somewhere in the outer spaces, away from the heat of the sun or stars, it is continually being built up into other more complex or heavier elements, such as oxygen and nitrogen, and the production of cosmic rays seems to be a by-product of Nature's far-off factory. If this is all true, it is as fascinating a story as any yet carried "via the ether."

WAR ON SPEAKERS!

I SEE that the Paris authorities have scheduled the loud-speaker as one of the nuisances to be firmly dealt with in the new campaign to be launched against unnecessary "noise." I agree that Paris is one of the noisiest cities in Europe, but I cannot say I was ever troubled there by a blatant loud-speaker. Taxi-cabs and other motors are responsible for most of the nerve-shattering din. In future, however, mechanical music is only to be tolerated so long as it cannot be heard outside the house in which it is played, and a wireless-receiver is included in this category. As usual, the French know how to be drastic in their reforms, once they get going. In this country some local authorities have already taken measures to restrict the excessive use of loud-speakers by wireless dealers, but the private owner is generally left alone, unless he creates a common-law nuisance.

THE OTHER SIDE

BUT "sauce for the goose is sauce for the gander," and all this fuss about speaker noise makes me wonder why the powers that be can't take steps to ensure more peace and quietness in the ether. I am not referring here to the increasing overlap between broadcast stations. That I'm afraid is going to get much worse before it gets better. Nor do I mean "static," which, like the poor, will always be with us—unless some genius can find an effective way to eradicate it. No, my point is that we are suffering from an increasing amount of "noise" due to tramways, electric trains, all sorts of motors, and electric labour-saving devices generally, which "spark" and radiate trouble to every listener in the vicinity. This kind of thing really ought to

be prevented. If it was made an illegal offence to create such "interference" a remedy would soon be found.

TELEVISION IN FRANCE

BAIRD TELEVISION, LTD., is now associated with the French company which recently acquired the well-known Radio-Vitus station, and television broadcasts will shortly be commenced from that station, at first on 12 kilowatts, though it is hoped to increase the power at first to 30 and finally to 70 kilowatts. Even at the present rating it should be possible to receive the transmissions in this country. In America the Bell Telephone Laboratories have succeeded in perfecting a combined telephony and television installation by means of which two people can both speak to and see each other simultaneously at a distance. It is significant, however, that in a recent address on future developments Dr. E. H. Colpitts, the well-known radio expert, omitted all reference to the subject of television. It rather looks as if he thought the prospects were none too rosy—at least, in America—and he ought to know.

AS YOU LIKE IT

YOU would have been very interested if you could have spent the other evening with me whilst I was adjusting the tone response of my set in order to obtain exactly the correct balance between all musical frequencies. The particular set was a Stenode, and in the laboratory model that I have you can get at the corrector circuit easily and do all kinds of funny things with it. The purpose of the corrector circuit, as you know, is to restore the balance between bass and a treble which is upset by the very selective circuits used on its H.F. and I.F. side. Dispense with the corrector altogether, and you have nothing but a great wooming and booming volume of bass. Applying the fullest possible amount of correction, on the other hand, pretty well strains out all the bass and leaves you with nothing but a thin and squeaky treble. The corrector circuit, by the way, is not in the least complicated, consisting, as it does, of two fixed condensers and two fixed resistances. These are of the clip-in popular type; so that you can change the values with great ease.

"HOW WILL THAT DO?"

TO assist me in my labours I pressed into service a very musical friend whom I placed in a comfortable armchair by the fire. Then, choosing a suitable transmission of music, I switched on with the corrector as adjusted by me during the afternoon. "How's that?" I asked. I explained that he could have more treble or more bass, just as he required. He didn't believe me at first, and said, jokingly: "Well, bring the bass right out." I changed one resistance, and instantly we were overwhelmed by double basses, bombardons, drums, and things. He agreed

:: :: *On Your Wavelength!* (continued) :: ::

that, though it sounded awfully jolly, there was really too much in the way of bass; so we went back to a more normal state of affairs. For the next hour or so he kept on saying: "Now let's see what a little more bass would sound like," or, "Let me hear what it sounds like if you make it just a trifle more brilliant." Eventually we got it exactly right. At least, we thought so at the time; and I have since had the diagnosis confirmed by trying it on another musician.

WHY NOT TRY?

OF course, the ordinary set which has no corrector cannot be adjusted quite so finely as this as regards the tone of its reproduction; still, a good deal can be done, and you may find it very interesting to experiment along these lines with your own apparatus. First of all, the output valve can make a heap of difference. The lower the impedance of the output valve, generally speaking, the greater will be the amount of bass that comes your way. If normally you get too much bass, you can raise the tone to a surprising extent by employing a pentode (with, of course, the correct filter circuit or output transformer) in the last holder. Personally, I much prefer an output transformer to a filter circuit for any kind of output valve, and I like a tapped one. You will find that large variations in tone can be made by employing different tappings. And there is another interesting experiment that you may try if you have a balanced-armature loud-speaker with both high and low resistance connections. Just see what a difference you obtain if you change over from one to the other. Some loud-speakers have a medium tapping as well, and this increases the field for experiment. There still remains something else that we can play about with. This is the loud-speaker itself, if it is of the balanced-armature type. These vary very greatly in their tone, according to the type. One kind of unit may give you, on a particular set, reproduction that is too high pitched, another may be too low pitched, whilst a third may be just right. You can do wonderful things if you acquire a pair of balanced-armature units, choosing one for its brilliance and the other for its bass. Run the two in series and shunt the bass fellow with a series combination of a 10,000-ohm variable resistance and a .001-microfarad compression type adjustable condenser.

A GOOD STATION

THERE is one station, by the way, that is particularly useful when you are trying out or adjusting the pitch of any set's reproduction. This is Strasbourg on 345 metres, which is, fortunately, very powerfully received in most parts of this country. From 8.35 p.m., on a good many evenings in the week, Strasbourg relays music by the orchestras of the Café de la Paix and the Café de l'Odéon. One of these—I forget which at the moment, but you will soon find out when you tune him in—has a double-bass amongst the instruments, and both put in some pretty work on the violin

E string. You have, therefore, an ample musical range in the transmissions to help you in your experiments. Naturally, if any of the home stations is doing an orchestral concert, an organ recital, or a brass band programme, you have pretty well everything you want there. But dance music and variety programmes are not, as a rule, helpful; so that you have to make a trip abroad. Radio-Paris and Kalundborg, on the long waves, and Rome, Turin, and Heilsberg, on the medium, are all useful stations at times. Unless, though, your set has a very generous reserve of H.F. amplification, you will be well advised to make your quality adjustments on something that comes from nearer home.

BATTERY RUNNING

I AM always meeting people who tell me that they cannot manage to have anything bigger than a three-valver in the house because they haven't got lighting mains, "and, you know, costs are so huge with batteries." Well, I haven't got electric light in my house; so I have to run off batteries. I do use big sets, and I don't find the expense crushing. My Stenode requires about 30 milliamperes at 150 volts, but it is outdone by a smaller set in another room, which is designed for obtaining the best possible quality from the local stations. This has only three valves, but it eats over 40 milliamperes when it is in action. So far as I can see, the tendency in the near future will be for the number of valves to increase, owing to the greater and greater need for selectivity. It will be many years before everyone has electric light in his house, and the battery-operated set must, therefore, be widely used for a long while. I feel that people who have the idea that only small sets can be run economically from batteries are founding their opinions on a wrong basis, and at present I am very carefully investigating the question. It will be some little time before I can furnish the experiments necessary to show just what the costs are, but I will let you have the results as soon as I do.

RESULTS UP TO DATE

I HAVE used both wet and dry H.T. batteries for heavy loads, and I can give you some of my results with them in the past. Of one thing I am absolutely and completely convinced after long experience, including laboratory tests on something like a thousand high-tension batteries. This is that the standard-capacity battery, even of the best make, is not an economical proposition if the H.T. current is much over 7 milliamperes. The great majority of dry-battery users who complain about expense are people who will try to run sets requiring anything from 10 to 25 milliamperes off these tiny batteries. By far the most economical dry H.T.B., if you have a load of this order, is the size known as the super or quadruple capacity. This has cells 1 1/4 in. in diameter by 3 1/2 in. in height, and the batteries are usually made up in 45-volt units, which weigh about 14 lb. apiece. I have seen the term "super capacity"

applied by makers to batteries of small-cell size, but weight will guide you if you remember that the real super has a voltage of a little over 3 for each pound of its weight. Batteries of this size will operate a big set for twelve months and a smaller one for much longer. I have had units in use for a couple of years on end, and I always discard them when their voltage has dropped from 45 to 30. With these big batteries I have found running costs for H.T. about a shilling a week or, say, twopence a night.

ACCUMULATOR H.T. BATTERIES

ABOUT three years ago I installed a new accumulator H.T. battery. I meant to have one of the 5.5-ampere-hour capacity, but by mistake one of 2.75 ampere hours was sent down, and since it was there I couldn't be bothered returning it. Now, this battery has been thoroughly bullied in the course of its existence. Its proper load is probably not much more than 10 milliamperes, but it has been called on to deliver from 30 to 40 at most times. And it is still doing it remarkably well. Even now it gives me about fifty working hours under this load at one charge, and, out of the fifteen 10-volt units which originally composed it, only one has been ruined. It is an Oldham's battery, and its record just shows what can be expected from this or other good makes. During the whole of its career it has given me a complete freedom from noisiness, even in sets employing enormous amounts of amplification.

SOMETHING BIGGER

I AM on the verge of putting in a 5.5-ampere-hour accumulator H.T.B., and I am going to run tests on this to discover just what running costs are for the very biggest sets operated by batteries. It will be run for three hours a day under a load of 40 milliamperes, which is as much as any domestic receiving set is likely to require, and a good deal more than the vast majority draw. After a thorough test under these conditions, I will let you know the figures, and I think that you will be surprised to learn how small is the cost of running a large set from batteries when compared with the wonderful entertainment that it provides.

HEAR AMERICA

I MENTIONED recently that American stations were coming in well just now, and (touching wood!) they continue to do so. I used to listen to them pretty regularly during the good period six or seven years ago, and I have had some pretty wonderful reception. Never, though, have I had anything like the reception that I obtained the other night from WJZ. For a whole hour on end I held this station, listening entranced to his programme. There was no sign of fading, no interference, no distortion whatever. He came through, in fact, with the strength of one of the bigger European stations and with perfect quality. A little later I turned to WTIC, which was coming in with even greater punch.

THERMION.

AN "ETHER POLICEMAN"

All big broadcasting organisations have receiving stations at which reception experiments and wavelength checking are carried out. A British amateur now in Germany here describes the testing station of the Reichsrundfunk Gesellschaft, the equivalent of the B.B.C.'s Tatsfield.



The Zehlendorf testing apparatus is at a private house in a Berlin suburb (above). The low-frequency testing apparatus is seen at the right



WHEN in Berlin, recently, I was invited by an engineer connected with the Reichsrundfunk Gesellschaft to see the receiving station at Zehlendorf. This, he told me, is used for the same purpose as our own receiving station at Tatsfield (formerly Keston), and as this engineer had, when in England some two years back, seen the apparatus used at Keston he was able to explain the working of Zehlendorf to me in relation to our own Tatsfield.

Zehlendorf, I should explain, is a small suburb of Berlin corresponding somewhat to the Hampstead Garden Suburb; in fact, its appearance is very similar. The receiving apparatus is situated mostly in the base-

ments and also for unofficially checking up weather reports.

The head of the Zehlendorf laboratory is Dr. Reisser, who is one of the chief engineers of the Reichsrundfunk Gesellschaft and who is particularly interested in scientific research as a sideline of broadcasting.

At the receiving station are several sets which are used for checking up the transmissions of the R.R.G. and all European stations in general. That is the "Ether Policeman."

There is a high-quality receiver made by Telefunken which is used chiefly as a side-tone quality test of the local transmissions.

In the "Lab."

In the receiving laboratory at Zehlendorf there is a private switch-board connected up by several lines with the control room, and the officials can keep in touch with the control-room engineers regarding wavelength constancy, depth of modulation, and the several other matters which need constant watching when a transmitter is in operation.

There is also a microphone (Reisz) connected by a special line with the transmitter so that announcements can be made from Zehlendorf and broadcast when necessary. Such occasions may arise when relays are made of other stations' transmissions.

Generally speaking, the B.B.C. uses the radio link only for relaying American

stations, but with the German stations and with many other European stations it is quite a common practice to pick up other transmissions and to relay them if there is sufficient programme interest.

There is an eleven-valve super-het. receiver, having each stage separately screened. I am told that it is this receiver which is generally used for relaying purposes and for short-wave reception.

The Zehlendorf staff is at present carrying out some experimental work in connection with loud-speakers, amplifiers, and gramophone recording systems. Some of these things may appear to be rather remote from the essential job of broadcasting, but the R.R.G. Engineering Department likes to be self-contained and to have its own experience of these things which are occasionally brought into use in connection with broadcasting.

Use is made of two Parlographs which are connected up to L.F. amplifiers, and on which electrical recordings can be made on tubular records. Parlographs somewhat resemble the ordinary office dictating machine.

There are several new loud-speaker arrangements which are being tested in special baffles and the response of each of these is checked up by making records on the Parlograph.

The engineers are experimenting with many angles of low-frequency amplification which are bound to be of value not only in transmitting, but in the manufacture of radio sets. But, owing to the extraordinary position of the industry in Germany, no doubt this knowledge will be very helpful.

As I left I noticed two completely screened receivers which were being used for some short-wave tests on a new frame aerial reception arrangement



Testing the various units of the eleven-valve super-het used for re-broadcasting at Zehlendorf

ment of a private house in one of the main streets of Zehlendorf which has been acquired by the Reichsrundfunk Gesellschaft.

There are several receivers, as I will explain later, a large amount of testing apparatus, and in the garden of the house is a collection of meteorological apparatus which is used by the officials for scientific

THE HOW AND WHY OF RADIO

XXIII—MAINS WORKING—THE RECTIFIER

If you are a beginner in wireless, now is your chance to gain a clear conception of its theory and practice. In this series of articles, specially prepared for the beginner, no previous knowledge of wireless is assumed. It is intended to deal with every aspect of the subject and the whole series will endow the beginner with sufficient knowledge to enable him to derive the greatest possible interest from the fascinating hobby of wireless

WE have already learned, from last week's article, that A.C. mains cannot be used for supplying high-tension current to a wireless set until the two-way nature of the A.C. has been changed to one-way current, or D.C. The piece of apparatus that changes A.C. to D.C. is called the rectifier. Several types are in use, but to avoid confusion I will deal only with those that are really popular.

First, we have the half-wave rectifier, illustrated in a typical circuit at Fig. 1. The A.C. is applied to the primary of the transformer, which steps up or down the input voltage; the A.C. in the secondary winding, caused by the flow of A.C. in the primary, is then applied to the rectifier. In the average A.C. supply the current reverses its direction 50 times per second; the rectifier allows current to flow in one direction only, so, obviously the application of a constantly-reversing current will produce a series of one-way pulses of current after the rectifier, corresponding to every alternate flow of the applied A.C.

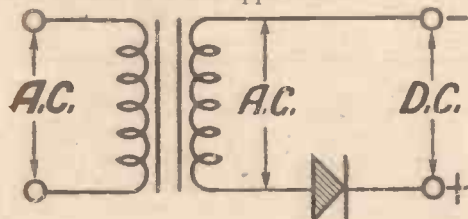

Fig. 1. The circuit of a typical half-wave rectifier

From this it should be clear that, although the rectifier of Fig. 1 has the effect of converting applied A.C. into D.C., that D.C. will be very irregular, since the surges of current flowing after the rectifier will be interrupted every time the A.C. changes direction. And the time of the interruption will be as long as the time of the D.C. surge itself.

In practice this means that the D.C. output from a half-wave rectifier is a little difficult to smooth. That word "smooth" is very descriptive of what a filter actually does—it smooths out the irregularities in the pulses of D.C., in a way I shall explain next week. We use these half-wave rectifiers in the form of valves for small units, where only a small maximum current is wanted, say, 15 to 20 milliamperes at 120 volts. And there is a half-wave metal rectifier available, giving 45 volts output for grid bias.

Here a distinction must be made between valve and metal rectifiers. In Fig. 1 a half-wave valve rectifier would consist of only two elements, a filament and an anode. The stream of electrons from filament to anode forms the one-way path

for A.C. In a metal rectifier for the half-wave system, a bank of copper plates are interleaved with a bank of copper-oxide plates, and the interaction between these metallic surfaces allows current to flow more readily in one direction than in the opposite direction. Valve rectifiers are now

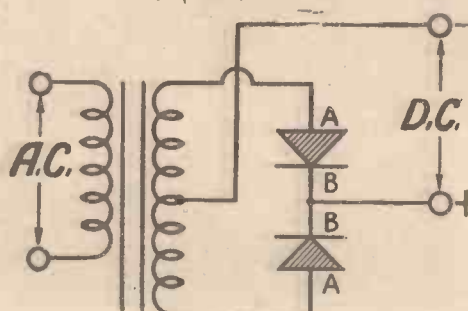

Fig. 2. How full-wave rectification is obtained

quite inexpensive, but their life is definitely limited, whereas the more expensive metal rectifiers are for practical purposes everlasting.

Fig. 2 shows the skeleton arrangement of two half-wave rectifiers so joined that full-wave rectification is obtained. That is to say, when the A.C. reverses its direction, there is no stoppage in the flow of D.C. output, for one rectifier passes the current flowing in one direction and the second rectifier passes the current flowing in the opposite direction. To achieve this action a centre-tapped secondary winding is needed on the transformer.

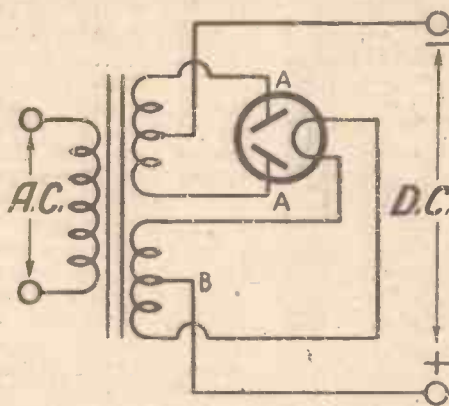

Fig. 3. Connections for a full-wave valve rectifier

Now this centre tap forms the negative side of the D.C. output. The junction between the two half-way rectifiers forms the positive side of the D.C. output. If we want 200 volts output, each end of the transformer must be at least 200 volts positive with respect to the centre tap,

which is at zero potential. So the voltage across the two ends of the transformer will be 400 volts, or twice the required unsmoothed D.C. output voltage.

In practice, we use only valves for this sort of full-wave rectification. Readers will note that, at Fig. 2, what I call the A elements of each of the half-wave rectifiers are connected to the two ends of the transformer, the B elements being a common connection for the positive output. I mention this point to simplify the explanation of Fig. 3, which shows all the connections for a full-wave valve rectifier. Note that only one valve is needed; this is because two rectifying elements can be readily combined in one bulb, for, as we saw at Fig. 2, apart from the separate connections of the A elements, the B elements of the two rectifiers are common.

This means that a valve with one filament (acting as the B elements) and two separate anodes (acting as the A elements) is in

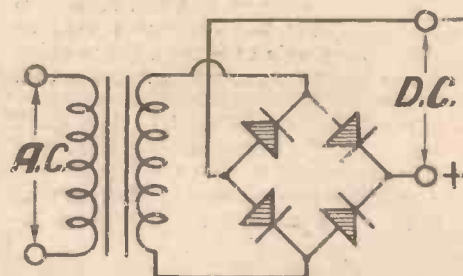

Fig. 4. Metal rectifier in a full-wave circuit

effect two half-wave rectifiers, conveniently mounted and connected inside a single bulb. The filament has to be heated before it will emit electrons, to form the two one-way paths of current to the two adjacent anodes. This heating can be done with the A.C. supply, stepped down to 4 or 6 volts through an additional secondary winding on the mains transformer. As seen at Fig. 2, the positive D.C. output terminal is the junction between the two B elements; but as these are the filaments of the rectifying valve, and as that filament is connected to an alternating supply, we must get this positive output connection from the centre tap of the filament winding.

Briefly the Fig. 3 circuit works like this; the mains A.C. flowing in the primary of the transformer appears in both centre-tapped secondaries; the large winding applies a high voltage to the anodes of the rectifier and the small winding heats the filament, which emits electrons to both anodes thus offering two paths to the A.C.; one electron path is a one-way outlet for

(Continued on page 272)

Why MAZDA VALVES give the best results!

Mazda engineers have the longest experience of any in the design and manufacture of A.C. Mains Valves. Sound manufacturing methods ensure robust construction, long life and consistent quality. Their amazingly high efficiency has won for them a reputation as the "World's finest valves." They are standardised in all the leading commercial receivers.

With the amazing Mazda valves in your set its efficient and trouble-free performance is assured.

From all good radio dealers.

The amazing

MAZDA

RADIO VALVES



THE EDISON SWAN ELECTRIC CO. LTD.
*Incorporating the Wiring Supplies, Lighting Engineering and
Radio Business of the British Thomson-Houston Co. Ltd.*
Radio Division Showrooms:
455 Charing Cross Road, London, W.C.2
Showrooms in all the Principal Towns

EDISWAN

V.98

You will Help Yourself and Help Us by Mentioning "A.W." to Advertisers

Medium Magnification Valves which satisfy the most exacting requirements

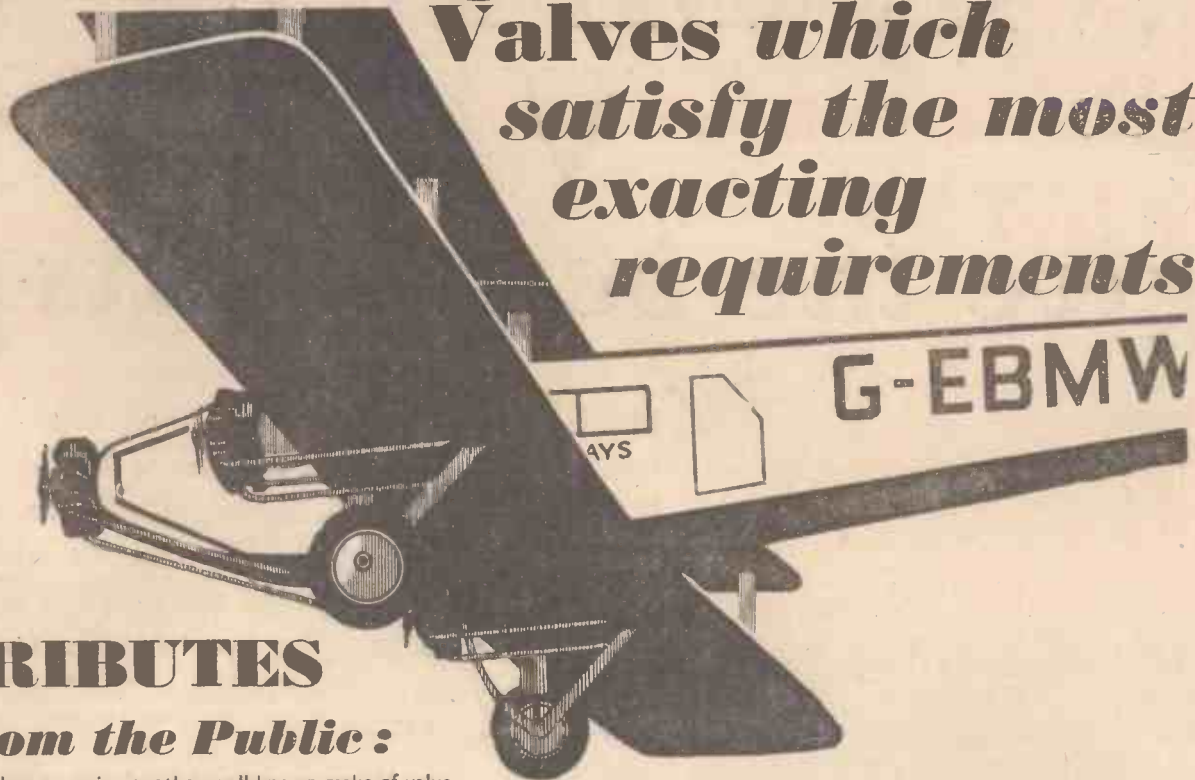

TRIBUTES

From the Public :

"I had been running another well-known make of valve, but I can honestly say that it has not got the same in it as your HL210.

"I have tried several different makes but have found nothing better for all-round results than yours. They seem to have just that final touch and punch in them that others lack in bringing out distant stations."—E. R., Leicester.

From the Experts :

Marconi Valves, the products of unequalled research and manufacturing resources, are designed with one object in view—the evolution of a complete series which will enable the greatest practical benefit to be derived from the highest theoretical efficiency. To this end it is imperative to combine every useful feature in a perfectly balanced design—no single factor being emphasized to the detriment of practical performance.

All Marconi Valves are practical interpretations of this ideal ; each contains just those features, which, properly united, ensure the best all-round results and highest effective efficiency. The soundness of this principle is conclusively established by the fact that Marconi Valves are used by the B.B.C., Imperial Airways, Trinity House Beacon Stations and Lightships, Metropolitan Police, Empire Wireless Communications, Large Passenger Liners, etc.—a unique tribute to their unequalled performance and dependability.

"HL" The symbol of an unobtrusive, often overlooked, but nevertheless important member of the modern set—the medium magnification valve. Many people take immense pains over the selection of high frequency and output valves, but forget that the efficiency of the set is equally dependent on the intermediate stages.

Marconi medium magnification valves combine high mutual conductance and small current consumption with consistent performance through a long useful life. Suitable for the detector or initial L.F. position in almost all sets they are worthy team-mates of the famous Marconi Screen Grid and Output Types.

Recommend Marconi Valves—HL210 (2-volt), HL410 (4-volt) and HL610 (6-volt) for accumulators—price 8/6, or MH4 and MHL4 for A.C. mains—price 15/-.

Marconi

The Valves
the
Experts Use!

Valves

Don't Forget to Say That You Saw it in "A.W."

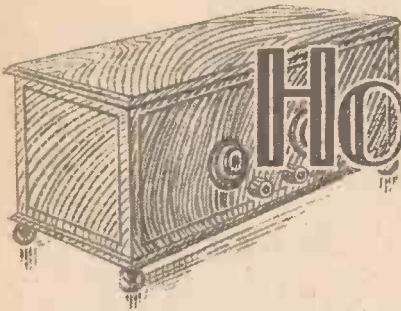

HOW A SUPER-HET WORKS

In this article the Technical Editor explains why a second detector is needed in the super-heterodyne system of amplification

MOST people have a general idea as to the functioning of a superheterodyne receiver. The essential principle is that the main portion of the amplification, and the selection of the required station, is carried out at a fixed wavelength, which is quite different from the wavelength on which one is receiving. By an apparently mysterious process the incoming signals are converted into this other wavelength as and when required. The advantage of the system is, of course, that one can make the intermediate amplifier selective and highly powerful by incorporating several stages without the extra number of tuning controls which this would normally involve, since the intermediate stages are of fixed tune.

In an article in last week's issue, entitled "Back to the Super-het," a brief exposition of the frequency conversion was given, and I want to explain this part a little further. The simplest way to do this is to work back from ordinary well-known facts. For example, if one's receiver is allowed to oscillate when it is tuned approximately to any given station, a whistle will be heard, due to "heterodyning" or beating between the local oscillation and the carrier wave of the particular transmission being received. The pitch of this whistle can be varied as one alters the tune of one's receiver.

Beat Frequencies

This whistle arises because we have two oscillations. One is received from the distant transmission, and the other is generated locally in the receiver. The two oscillations are not exactly of the same frequency, and therefore they interfere with one another, and produce beats which in the present instance are of an audible frequency. The actual frequency of the beat is equal to the difference between the frequency of the two oscillations, so that as we bring the receiver more and more into tune with the distant transmission, the pitch of the beat note gradually falls, until it becomes inaudible.

An oscillation is a current which flows first in one direction and then in the other. If we have two such currents, both of which start off together, clearly they will add together, and we will have a current of twice the amplitude, flowing first in one direction and then in the other as before.

If one of the currents, however, is oscillating at a slightly different frequency, it will gradually fall out of step. In certain parts of the cycle, one current will subtract from the other instead of adding to it, this reaching its climax at the point where the two currents are exactly out of step. At such a point, one current will be at a maximum in one direction, while the

other current will be a maximum in the opposite direction, and the total effect will be zero. Our resultant current, therefore, varies from twice the normal value to zero and back again.

It will also be quite clear that the rapidity of this variation depends entirely upon the difference in frequency between the currents. If there is no difference at all, then the currents will never fall out of step. If the difference is only small it will take a relatively long time before the currents become completely out of step, and in fact the actual time period variation from a maximum to zero and back to a maximum again, is equal to the difference between the frequencies.

Now comes a most important point. We have just seen that this beating or heterodyning arises from a variation in the

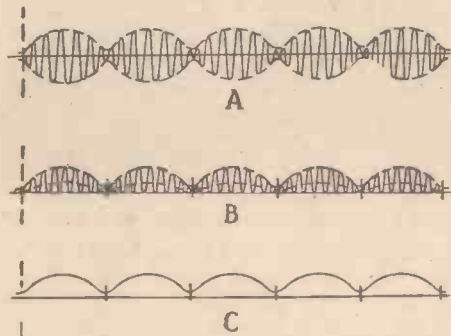

These three curves A, B and C, show the super-het process diagrammatically.

amplitude of the current, and is not an entirely separate oscillation. But we cannot hear the original high-frequency oscillation, which is far beyond the limit of audibility, and therefore neither can we hear the resultant current produced by the mixing of the high frequencies. The effect is exactly the same as the modulation in a telephone transmission. If one places a set of telephones in the aerial lead of a set no signals can be heard, even though the station is quite close by.

We overcome this defect in an ordinary telephone transmission by rectifying. That is to say, we remove the negative portion of the current by inserting some form of conductor which only allows the current to flow in one direction. Then the state of affairs is quite altered because although the impulses still follow one another at an exceedingly rapid rate, they are now all in the same direction, giving a definite mean or average value. What is more, this value will vary if the strength of the oscillation is changed. In the case of a telephony transmission the strength of the oscillation is continually altering in accordance with the speech or music impressed

at the transmitter, we are thus able to hear speech currents in a telephone receiver. In the same way if we have two oscillations heterodyning one another and producing beats as we have just discussed, we can only detect these beats as long as we rectify the resultant current, so that the mean value is capable of varying. This point may be made clear by reference to the diagram of Fig. 1, which shows the process diagrammatically.

Having appreciated this important point, namely, that the beat frequency produced by mixing two high-frequency oscillations can only be heard after the resultant current has been rectified, we can now proceed one stage farther, and consider the case of the super-heterodyne. By arranging that the local oscillation is considerably different from the incoming oscillation, say perhaps, 50 kilocycles different, we can obtain a beat frequency of 50 kilocycles.

Intermediate Frequency

This is quite above the audible limit, actually corresponding to a wavelength of 6,000 metres. Thus, if we rectify the resultant oscillation we shall obtain our original high-frequency oscillation, modulated at a frequency of 50 kilocycles. We have now finished with the original high-frequency oscillation and, therefore, we by-pass it to earth in some suitable manner, leaving ourselves with the 50 kilocycle variations, which are passed through a suitable intermediate amplifier, where they are modified and interfering signals are rejected. At the end of this we have a relatively large 50 kilocycle carrier, which, however, is again modulated by the low frequencies ranging from 50 to 5,000 cycles, corresponding to the speech or music. The beat frequency produced by the first detector does not affect the relatively slow variation in amplitude produced by the transmitter, and therefore, these speech modulations are carried right through to the end of the intermediate frequency amplifier.

This possibility will be made clear if one considers the relative frequencies. Our beat frequency is 50,000 cycles. The speech frequency, however, even at the upper frequencies, takes place about five thousand times a second and, therefore, during one complete five-thousand-cycle note we have one hundred variations of the 50 kilocycle carrier wave. It will be quite clear that the low-frequency variation is so slow, relatively speaking, that the simple arguments which have been developed are not affected at all, and we can consider the process taking place just as has already been described, except for the fact that the amplitude of the whole complex oscillation

(Continued in third column of next page)

A NEW TALKIE HORN

Details of a shallow horn developed by the Bell Laboratories for use in theatres showing talking films.

UP to the present time, theatres wired with the Western Electric sound-picture system have employed what is known as the type 15a horn loud-speaker. The field of sound covered by this horn is satisfactory for approximately 15 degrees on each side of the axis of the loud-speaker. A single loud-speaker would therefore serve only a narrow auditorium. For wider auditoriums two or more horns have to be used and, as these have to be flared, that is, pointed towards the sides of the auditorium, the depth of the horn is considerable. Quite a number of theatres have only a limited space behind the projection screen, insufficient to accommodate the standard horn, which has a depth of 52 inches.

Such a theatre is the Roxy, a famous talkie house on Broadway, in New York. The need has arisen for a horn that is not only shallow, but that has a relatively wide angle of sound distribution, in order that it can be used flat against the screen.

An essential requirement of a horn capable of handling the frequencies of talking films is a fixed rate of taper from the small end to the mouth. Moreover, the mouth must have a certain minimum area; and any bends in the horn must have a radius of curvature large compared with the width of the sound passage along the radius of curvature.

The new horn, shown by the photograph, has a depth of only 26 inches. The mouth area is oblong and the air column is divided into two equal branches a short distance behind the mouth. As a result, the divided air columns are much narrower and may thus be curved around shorter radii.

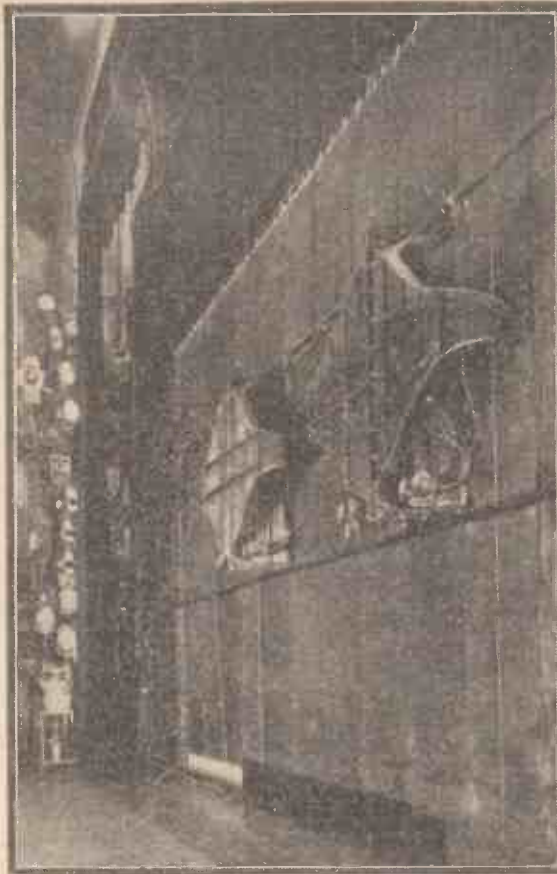

How the shallow horns are fitted at the back of the screen

The two halves of the horns are curved in opposite directions around a 90-degree bend, starting 14 inches back from the mouth and then, after running straight for a short distance, making a 180-degree bend at right angles. The rate of taper for each half of the new horn remains the same as

for the air column of the standard horn, but the cross-sectional areas at equal distances from the mouth are only half as large.

It is interesting to note that experimental models of this new horn have been made of wood, fabric, and metal and each has been found to have practically the same performance characteristics. In the final model thin sheet steel is used, all the seams being welded to prevent rattling.

The difference in loud-speaker technique for large audiences as compared with loud-speakers for domestic use is illustrated by the behaviour of this new horn as regards directional properties. At low frequencies, where the wavelength of sound is of the same order in dimension as the mouth of the loud-speaker, radiation is more or less non-directional. But with the higher frequencies, where the wavelengths are relatively short, radiation takes more the form of a beam. For this reason the high-frequency radiation covers a smaller area than the low-frequency. The quality of reproduction to those within the beam of radiation tends to be high pitched.

With the new type of horn, this high-pitched effect is largely overcome. The divided opening projects a double beam of high-frequency radiation, which more completely covers the field of low-frequency radiation. In effect, the divided mouth section acts as a single radiator for low frequencies, and as two radiators for high frequencies. The new horn has a sound field of approximately 45 degrees on each side of the centre axis. Thus, the new horn can be used singly where two or even three of the older type would be required. A.S.H.

"MAINS WORKING—THE RECTIFIER"

(Continued from page 268)

current flowing in one direction and the other electron path is a one-way outlet for current flowing in the opposite direction.

The D.C. output is then a series of one-way current surges, which follow one another just as rapidly as the A.C. supply changes direction. Full-wave valve rectifiers are still widely used, but the new metal rectifiers offer certain advantages that will undoubtedly tend to oust the valve in due course.

Look at Fig. 4, where I show the simple connections for full-wave rectification with a metal rectifier, consisting of four rectifying units. A great advantage of this system is that the voltage of the A.C. applied to the rectifier is approximately the same as the voltage of the D.C. output. This bridge method of connection avoids the centre tap and so cuts out the need for a secondary having a voltage twice as great

as the unsmoothed D.C. output. The transformer winding is thus very greatly simplified, since instead of two centre-tapped secondaries only one untapped secondary is needed. The dotted lines around Fig. 4 indicate the internal connections of the full-wave metal rectifier and help to show how simple is the whole scheme; just two terminals for the A.C. input and two more for the D.C. output.

HOTSPOT.

Next week: Mains Working—Filters and Voltage Regulators.

There are still large tracks of territory in Australia which are not linked by telegraph or telephone. When important events take place several newspaper men now use portable radio transmitters to send news to their paper. In this way results of an important regatta recently were published in the Press two days earlier than they might have been.

"HOW A SUPER-HET WORKS"

(Continued from preceding page)

is gradually varying in intensity in accordance with the speech frequencies.

Thus, we are left at the end of the intermediate-frequency amplifier with a strong 50-kilocycle carrier, modulated by speech frequencies just like an ordinary carrier wave. Now 50 kilocycles is still an inaudible frequency, and therefore, we are unable to detect the low-frequency modulation unless we rectify once again. Therefore, it is necessary to have a second rectifier at the end of the intermediate amplifier, as a result of which the mean current in the anode circuit varies in accordance with the speech frequencies, as is the case of an ordinary radio receiver. At this point, therefore, we by-pass the 50-kilocycle oscillation to earth, since we have now finished with it, and we are left with pure low-frequency which may be magnified in the ordinary manner and applied to the loud-speaker.

A Weekly Programme Criticism—By SYDNEY A. MOSELEY.

Without Fear or Favour



STRAVINSKY

VAL GIELGUD PLAYS

AMERICAN DANCE RECORDS

PLENTY OF BACH



INTRODUCING Mr. Stravinsky! A gentleman to be seen as well as heard. Therefore, I went to Number 10 Studio, and saw a little energetic and excitable man divest himself of his coat, collar and tie, and conduct in a pullover. Many members of the orchestra evidently enjoyed it also. The famous composer was given a tremendous reception—when the red light was switched off—not only by the audience, but by the hard-working members of the orchestra. A great evening.

Incidentally, I felt rather sorry for Hibberd, the chief announcer of the golden voice, who had to read out the long description in full view of the audience. Accustomed as he is to the silence of the Talks studio, it must have been an ordeal. But all he would vouchsafe, however, was that he felt the nervous tension. I sympathised.

About these Sunday programmes—oh, well, never mind!

I am glad to see that Mr. Appleton proceeds with his "Joan and Betty" Bible stories as dramatised by him. If these items were in a more mixed type of programme they would receive greater attention and encouragement.

I listened at 2.30 in the afternoon to the Children's Hour relayed from Birmingham. It was an excellent way of combining entertainment with instruction, and Mr. Leslie Heward and the City of Birmingham Orchestra must be congratulated on their patience and helpfulness, and I think a good many adults would be interested in transmissions of this character. One point, however. Dr. D. Wauchope Stewart pronounced "scherzo" as "skirt-so," whereas, the *pukka* B.B.C. announcer pronounces it "scare-zo." Since I like to air my musical knowledge, I wonder which is right?

As is the case with most outside broadcasts, *Little Tommy Tucker* was spoilt with too much echo, far too much laughter and noise, and too little point or reason for the laughter. These outside broadcasts, in my view, are definitely not worth while.

Dreaming by the fireside, listening to the quiet, soothing strains of a quintet

playing some good-light music, I wondered whether, after all, the very expensive orchestras of the B.B.C. were really necessary—I mean, for broadcasting purposes.

The St. Celia Singing Festival by 500 members of London Girls' Clubs, relayed from the Queen's Hall, was something new, and therefore worth while.

When I saw the announcement of a special transmission of American dance records I thought: "Good heavens, don't we get enough in the ordinary programmes!" As it turned out, however, some of these were unusually hot, and the title ought to have been altered so as to include the adjective.

Of course, a good many of us have got into the habit of offering gentle raillery on the Sunday programmes, but actually part of it is excellent. For instance, "Comfortable Words," which was a selection from the oratorio, was well chosen, and with Kate Winter as soprano the vocal success was assured. Of course, our kick is that we don't get a Sunday programme. We only get a part.

Julian Rose, when you get him into his stride, is certainly funny. But he rattles

off his jokes at such a rate that many of them are missed. It is about the only genuine and spontaneous outburst of laughter by the studio claque.

In Olive Groves the B.B.C. has a singer of consistent ability. Her singing of "Black-eyed Susan" stuff is always good and she blends well with George Baker. Remarkable how some of the good old English songs remain as fresh as ever. For instance, "A Summer Night," by Goring Thomas, and "What is in the Air To-day?" are two bright little things one never tires of hearing. "Passing By," by Purcell, is yet another.

The light opera and musical comedy programme conducted by Joseph Lewis was well arranged. That is a pretty song, "Little Princess, Look Up" from *Amasis*, while a selection from *Katherine*, by Moussourgsky, is chock-full of bright, tuneful compositions.

I always look out for plays produced by Val Gielgud, the B.B.C. productions director. I think Mr. Gielgud rather inclines to my view, and until the technicality of putting over plays has been advanced it would be for better to stick to well-known plays rather than to experiment with new plays as well as new technique. You should look out for Mr. Gielgud's next production, a Shakespearean play which will be given on a Sunday!

We had plenty of Bach last week. Besides the Sunday dish, Bach was included in the "Foundations of Music." I wonder if anybody at Savoy Hill has a grudge against the master, for they are doing their best to make him unpopular by giving us overdoses of him.

I have remarked before, that some people are not too happy about their pronunciation. I have just heard a glaring case. The announcer was giving out a piece of news regarding Romford, in Essex. He started off by calling it "Rum'ord," didn't seem sure, and the next time compromised and said "Rerford." The third time he sounded thoroughly peeved, and boldly said "Romford."



An impression of Maurice Toubas

Blank

ANNOUNCERS TELL THEIR STORIES

AT RADIO ROMA

by the woman announcer of the E.I.A.R.
controlling the famous Italian station



The announcer at the microphone of Radio Roma

the microphone. But it will do all right. You may commence to-morrow."

And that's how the "mike" and I first became friends! I'm sorry if it isn't romantic enough. It's just fact.

My apprenticeship cost me many tiring days and sleepless nights. Everything was so strange—the routine, the silence, the indicator lights, and the signal and control switches.

At first I had many of those dreadful moments when I couldn't think of a word to say in front of the microphone—and

Several days were spent in doing nothing more than announcing the titles of American dance records, just for practice.

"In a very clear voice, please," said the Studio Director; but it was not always easy to do! "A little more natural, please—that's better, but not too confidential—a little more persuasive in tone—a little higher—a little lower." That's the kind of thing you get from the Studio Director.

There was trouble, too, with the manuscripts. The slightest rustle of the leaves was sufficient to be picked up by the microphone, which is exceptionally sensitive to that kind of thing.

A Bad Habit!

There was one amusing bother. I had got into a habit, while announcing, of holding a pencil in my hand, and instinctively I tapped with this, at the end of each sentence, quite lightly on the table.

But unfortunately this slight tapping was picked up by the microphone and, when broadcast sounded like the rapping of a station pushing out morse! It puzzled the engineers!

But don't talk to me of mistakes! An announcer should never forget, nor make mistakes. No matter how hurriedly the news manuscript is brought up to the studio, and although one may not have had time to read it through before the broadcast starts, there is no room for mistakes.

But when a mistake is made, or a wrong word spoken, it is done and finished with. You can't call it back!

THE "Mike?" One's thoughts naturally turn back to one's early days of broadcasting, and in my case it makes me think of the moment when the microphone and I first met.

When I was first shown into the silent studio, hung with dark velvet, I clearly remember that my first impression was one of anxiety—one of wondering what elves and gnomes I should have imagined had I been a child! A silly thought, but then the microphone does upset your balance!

But the dream didn't last long. I was asked to sit at the table with the white-enamelled "mike"—though why it was white-enamelled I never did find out!

Microphone Fright!

I suddenly felt frightened, and not a little unhappy. There was a "catch" in my throat which prevented me from speaking; and when at long last I did manage to say a few words, encouraged by the Studio Director, my voice quivered with emotion. My hands were trembling, and—far worse—I forgot the chosen bit which I had to say! "Madame," said the Studio Director, "you may begin, if you like. My assistant and I will go into the next room and listen to you."

The little "mike" on the table seemed to say: "Take care! I hear every breath and sigh—and every mistake you make. Don't take any notice of me. Take courage. Carry on—carry on."

I carried on.

A First Test

All of a sudden a hand touched my shoulder and I looked up in surprise. I hadn't heard the door open, and the Studio Director enter. I had read all my piece.

"It's quite all right," he said. "There are only a few little faults, which will be quite easy to correct, and we shall have to vary your position in front of

there is nothing worse than a silent announcer!

I had the horrible sensation of realising that I was being listened to by millions and millions of radio enthusiasts, and I developed "microphone fright."

Fixing the Tone

One of the first difficulties of an announcer is to fix a proper tone for the voice. Sometimes, unless one is careful, it seems too high, and at other times it seems too low. A roughness is sometimes noticeable, and is sometimes difficult to suppress. Try speaking yourself for a moment, and see how easy it is for a little hoarseness to crop up.



The control desk of Radio Roma

A NEW USE FOR HIGH-FREQUENCY CURRENTS

FEW amateurs are aware of the extent to which wireless apparatus and methods have helped other industries. The enormous value of the valve in making it possible to amplify and use practically currents of previously useless strength has given a fresh impetus to all classes of physical measurement. A fresh instance occurred the other day, when a discovery of the use of high-frequency currents was made at the famous Conservatoire des Arts et Métiers in Paris. The use of nitrogen for hardening steel has now been in use for a year or two, and has proved of immense value, but the nitriding of the metal only penetrates to a depth of about one-hundredth of a millimetre. By passing high-frequency oscillations through the furnace during treatment with nitrogen, it has been found that the effect penetrates to a depth of .35 millimetre, or thirty-five times deeper. H.

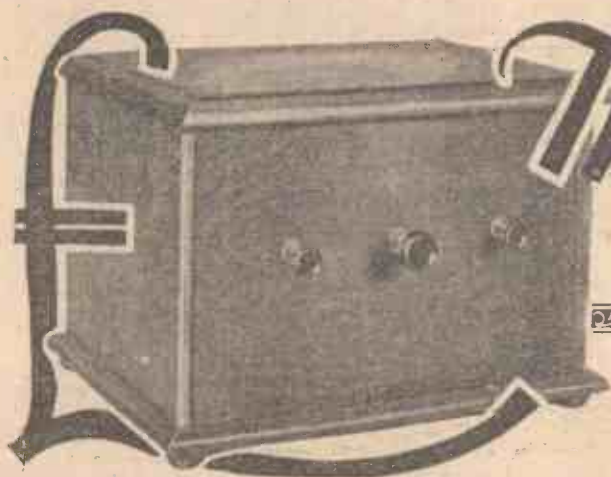

The 20/- Two

FULL CONSTRUCTIONAL DETAILS OF A SET WHICH CAN BE BUILT AT A COST OF APPROXIMATELY £1. EMBODIES A NOVEL FORM

THIS latest product of the AMATEUR WIRELESS Technical Staff has a special purpose. First, it is probably the cheapest two-valver which has ever been produced. We claim that provided it is built up exactly as shown with the components specified the cost is approximately £1.

It may seem hardly possible that anything satisfactory can be built for so little, despite the fact that radio prices are to-day reaching a very low level.

However, with this price limit in mind, an attempt has been made to design a simple two-valver which will be an even more useful type than a straight two-valver with ordinary tuning.

Special Tuning

In brief, the idea is that a form of pre-set tuning is adopted so that at the touch of a switch, either the National or Regional programme can be brought in. This

makes the set as suitable for the absolute novice who is concerned only with getting the twin programmes cheaply, as it is for the man who wants a two-valver giving good quality on broadcast programmes and yet which is economical in making up and in running costs.

The low cost of the "Twenty Shilling Two" has been achieved not by skimping of parts, but by careful design and the elimination of unnecessary components. Also the cost is reduced by the fact that a home-made coil is incorporated. This coil is of a special type to suit the pre-set tuning adopted in the set, and it is so simple that anybody can make it up.

From the photographs you will see that apart from the terminal strips, panel and baseboard there are only ten components in the set. Further, to lower cost, a plywood panel is used, this being almost as good as ebonite, for a set of this description. It has the further advantage that it is easier to drill.

How it Works

The circuit shown on page 278 explains how the pre-set tuning operates. There are two pre-set condensers across the tuning coil. One of these is connected always in circuit, while the other is put in parallel when desired by means of a switch. The aerial is connected to an intermediate point on the coil so resulting in a good degree of selectivity. A reaction winding and a .0002 mfd. reaction condenser are provided to boost up the signal strength.

Briefly, the idea of the preset tuner is that a preliminary adjustment of tuning is made and the lower wave station of the local twin transmitter is tuned in with the condenser directly connected across the coil, the other condenser being switched out of circuit.

When this tuning adjustment has been made, the tuning switch is pulled out and the second condenser is adjusted until the other programme is received. Then it is necessary only to push or pull the tuning switch, to receive one programme or the other.

The rest of the set is arranged on quite straightforward lines, the detector being of the ordinary leaky-grid variety followed by a transformer-coupled power valve.

Our Full-size Chart

To make matters as easy as possible for novices at radio constructional work, a full-size constructional chart and wiring plan is given. This you will find on pages W1 and W2 of this issue, where the panel and baseboard layouts are shown full-size. To make use of this plan, it is necessary only to detach the sheets from the centre of the issue and there you have a full-size plan, from which you can get the drilling centres for all the parts, and which also shows the wiring.

This novel idea of presenting a free, full-size wiring plan with every issue proved so successful recently, in the case of the "1931 Ether Searcher," that it was decided to make a similar gift of a full-size plan for this novel "20/- Two."

From an accompanying panel you will

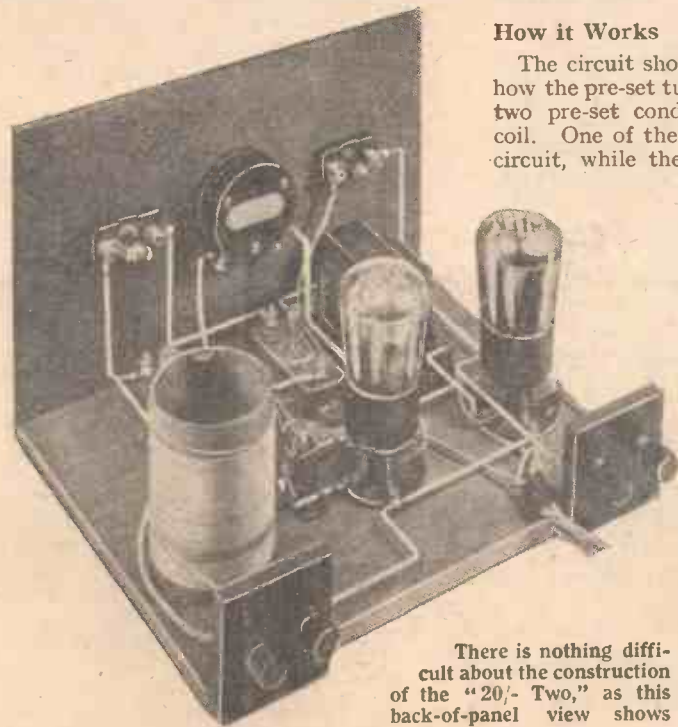

There is nothing difficult about the construction of the "20/- Two," as this back-of-panel view shows

COMPONENTS NEEDED

Low-frequency transformer (Lissen "Torex," Telsen, Varley, Ferranti, R.I.).

Two valve holders (Clix, Telsen, Lotus, Junit, Benjamin).

One .0002-mfd. pre-set condenser (Lewcos, Formo, Polar, Sovereign).

.0002-mfd. fixed condenser (Telsen, Lissen, T.C.C., Dubilier).

2-megohm grid-leak (Telsen, Lissen, Dubilier).

Two pre-set condensers (Sovereign, Lewcos, Formo, Polar).

Two on-off switches (Readi-Rad, Bulgin, Lissen, Junit, Benjamin).

WO

PLE TWO-VALVER WHICH MATELY £1, AND WHICH OF TUNING

see the parts needed. The cost is, of course, based on the first-mentioned parts specified. In every case alternatives are given which can be used.

Before mounting any of the parts, you will need to wind the coil. The former for this consists of a length of impregnated cardboard or paxolin, 2 in. in diameter and 3 in. long. The winding consists of No. 22 double silk-covered wire and approximately 1 ounce will be required. Make two small holes at about $\frac{1}{8}$ in. from one end of the former and twist the end of the wire through these to secure it.

Winding the Coil

Then wind on 15 turns of wire. Secure the end of the winding the same way, by drilling two small holes and twist the wire through. Make a small loop in the wire and then $\frac{1}{4}$ in. up make two more small holes in the former and secure the wire again. Wind on 15 more turns in the same direction, make a twisted loop in the wire and, without leaving a space, wind on another 35 turns also in the same direction. This should bring the winding to about $\frac{1}{4}$ -in. or $\frac{1}{2}$ -in. from the end of the former, and the end of the winding may again be secured by twisting through two holes.

The coil is mounted at right angles to the baseboard by a small strip of plywood

which should be cut to be a tight push fit inside the former and if placed at the lower end of the former (that is where the separate 15-turn winding is) two small nails may be inserted from the sides to hold the coil in position.

To get the drilling and mounting centres for the other parts, place the free wiring plan on the panel and baseboard. The baseboard should be of seven-ply wood while the panel may be of somewhat thinner stuff; three-ply wood is quite suitable. Prick through the mounting holes and screw holes for the various parts. The condenser and the two switches on the panel have one-hole fixings. The various parts on the baseboard are simply attached with wood screws. When these holes have been marked, the panel may be placed at right angles to the baseboard and three wood screws will secure it in position.

You must have the free full-size wiring plan and constructional guide when it comes to mounting the parts, for it makes it simply child's play to mount each part in its correct position. The print you will see on pages W1 and W2 of this issue, and it is necessary to lift this whole sheet complete.

For the panel and baseboard work the print is simply placed on top of the wood and the mounting holes pricked through. As both panel and baseboard are of wood the job of panel drilling—which many amateurs are tempted to shirk when ebonite is the material used—should not take more than three or four minutes for the three components which are to be fixed.

The Layout

There are no special points to notice about the layout, for full details are given on the full-size constructional guide. By making comparison with the plan view of the "20/- Two," shown at the top of this page, readers should have no difficulty at all in getting the layout correct.

As has already been explained, the cost of £1 is based on the components specified first in the panel of components required. If you use other parts, then it is quite possible that the cost may exceed the stated figure, but then you may be using parts which you already have on hand.

It is interesting to note that the actual cost of the parts which must be bought (as specified) is slightly under £1, and allows

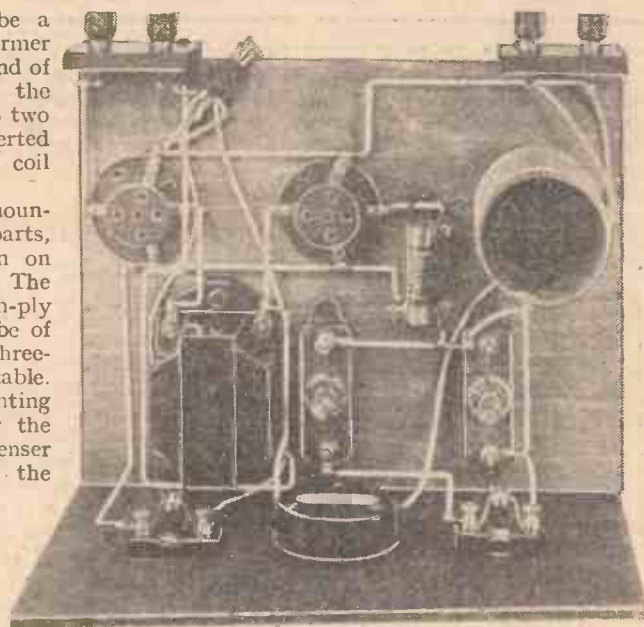

Compare this plan view of the set with the full-size wiring plan and constructional chart given on pages W1 and W2

of a margin of a few pence for the plywood for panel and baseboard, and for the few materials needed for the construction of the simple home-made coil.

Battery Leads

A great saving is effected by the use of flex leads for the battery connections. This also simplifies the construction, for terminals are used only for the aerial and earth and speaker output. These terminals are on two separate strips at the back of the baseboard.

If any deviation is made from the list of components specified then, obviously,

FOR THE "20/- TWO"

Four terminals, marked: A, E, L.S.—, L.S.+ (Belling-Lee).

Four wander plugs, marked: H.T.—, H.T.—, G.B.—, G.B.— (Belling-Lee Midget).

Two spade terminals, marked: L.T.—, L.T.— (Clix).

Two ebonite terminal strips, 2 in. by 2 in. (Becol, Trelleborg).

Paxolin former, 2 in. diameter by 3 in. (Wearite).

One ounce of 22 d.s.c. (Lewcos).

Baseboard, 9 in. by 7 in. (Camco, Pickett, Clarion, Eelex).

Wooden panel, 9 in. by 6 in.

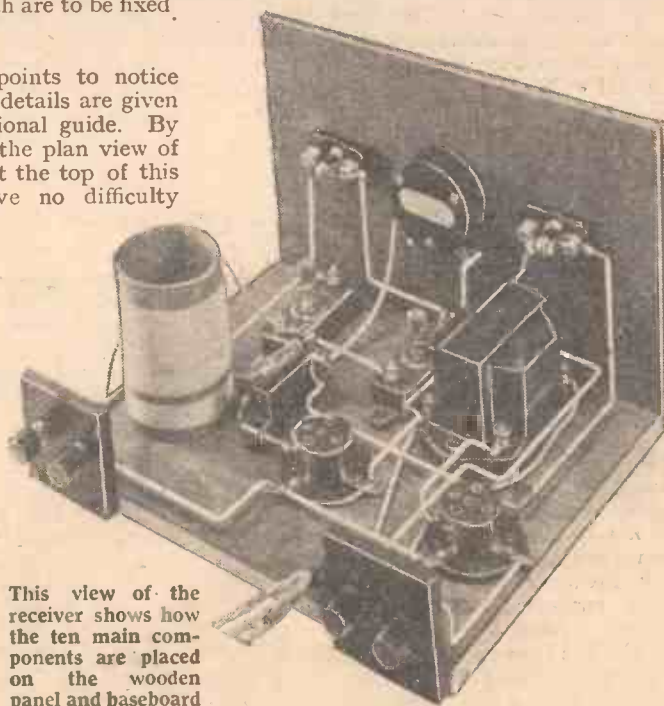

This view of the receiver shows how the ten main components are placed on the wooden panel and baseboard

THE "20/- TWO" (Continued from preceding page)

you must take care in rearranging the layout accordingly. A transformer of a different type from that shown, for example, may need a slight rearrangement so far as its mounting centre is concerned in order to get it in a convenient position. Take care to get the terminals the right

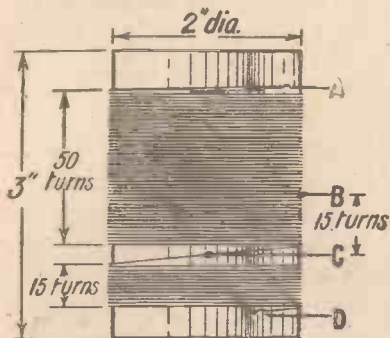

No. 22 d.s.c. wire
This sketch gives details of the winding of the simple solenoid coil which is used. Particulars are given in the accompanying article of the way in which the turns are put on the former

The tuning coil, too, must be mounted so that theappings are on the proper side—two going to the aerial and earth terminals at the back of the baseboard, and the others going to the tuning and reaction condenser on the panel side.

Coil Tappings

The tapping wires may consist of short lengths of flex which are soldered to the ends and tapping loops of the finer wire of which the coil is wound. This is better than taking the ends of the windings to the various terminal points, but, of course, if the constructor is anxious to avoid any unnecessary soldering work, then the wire may be enclosed in lengths of insulated sleeving.

Wiring

Wiring is the next job, and full details will be given in next week's issue when also

operating instructions will be given for the "Twenty Shilling Two." Do not forget that this set can be seen in the Radio Department of Messrs. Selfridge & Co., Ltd., Oxford Street, London, W.1.

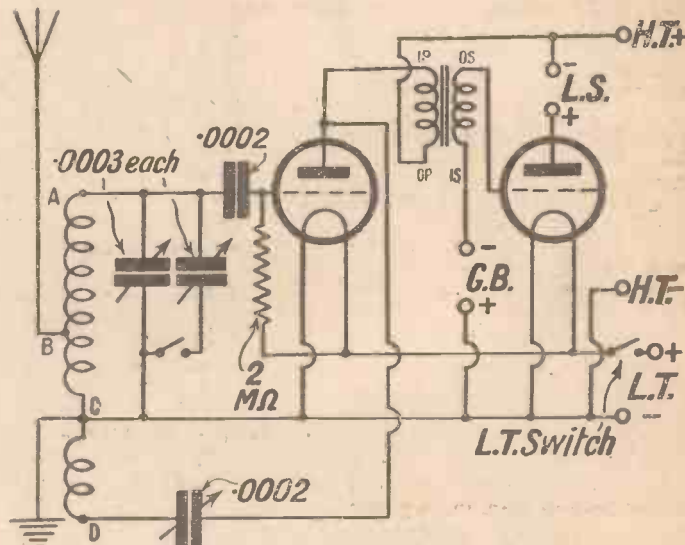

THE CIRCUIT OF THE "20/- TWO"

This shows how the two preset condensers are used for tuning, and how the tuning switch is connected which brings either one condenser or the other into circuit

way round, for the wiring will be made much more difficult if the primary and secondary wire cross over instead of being neatly placed as shown.

WHAT ARE THE SOUND WAVES SAYING?

HANDEL had a rough time of it as a child. His father was a "barbersurgeon." George Frederick was forbidden by his father to hear any music, save that of the church alone.

When Handel went to Hamburg as a young man he became interested in opera and made friends with Matheson, a successful writer in that city. They did everything together. They even applied for the same post—that of an organistship at S. Mary's, Lübeck. The retiring organist, the famous Buxtehude, had the appointment of a successor in his hands. He was willing to offer it to either Handel or Matheson provided one of them would marry his somewhat elderly daughter. On the way home Handel told Matheson he did not like the look of the lady; Matheson said he liked neither the lady nor the organ; as the stipend was not worth their while they thought better of it and returned home unattached.

An Odd Friendship

It was an odd friendship, but it suited them very well. One incident strained it, though not to breaking point. Matheson wrote an opera called *Cleopatra* and decided to play Anthony himself. He asked Handel to conduct the first act while he himself was engaged in the part, and duly returned in time to conduct the second act. Handel by that time had become so interested in the opera that he flatly refused to let Matheson conduct. After the

performance they met outside the theatre and Matheson flew at Handel like a panther. Rapiers were drawn and before anyone was aware of what had happened, the composers were fighting in real earnest.

After one weapon had been shattered someone approached and suggested that the claims of honour had been satisfied. The next evening Matheson sent a note to Handel asking him to dinner. He accepted

and the two became firmer friends than ever.

Handel prospered in England as a writer of Italian opera. When people became tired of the same old thing he could not be persuaded to abandon opera. Consequently he began to lose what he had gained.

The worthy composer could be very insulting if anyone came in late. It appears that he had had an altercation with one of the theatre attendants for admitting someone after the curtain had gone up, and the attendant had sworn revenge. Knowing that Handel could never endure to hear a fiddle being tuned, and that the instruments had to be tuned before he entered the orchestra, the attendant wound down most of the strings in the band and awaited the result. Handel arrived and, after the usual ovation raised his baton to begin. The first chord was enough. He strode out of the orchestra in a rage, kicking a hole in the double-bass as he went. With his enormous strength he picked up a kettle-drum and hurled it at the leader's head. Despite his appalling temper Handel was very popular. His friendship was always worth having. Towards the end of his career he came to see that Italian opera was not wanted in London and used much of his material for the formation of what he called oratorio. From this came the *Messiah*, first performed in Dublin in 1742. The scene at the conclusion defies description.



An impression of Dr. Boult, Musical Director of the B.B.C.

WHITAKER-WILSON.

Blank

"THE 20-TWO"

FOR CONSTRUCTIONAL DETAILS
SEE PAGES 276 AND 277

PANEL 9x6
(WOOD)

FULL-SIZE LAYOUT
AND
WIRING PLAN

REACTION COND^{SR.} .0002 mfd. max.

L.T. SWITCH

STATION SWITCH

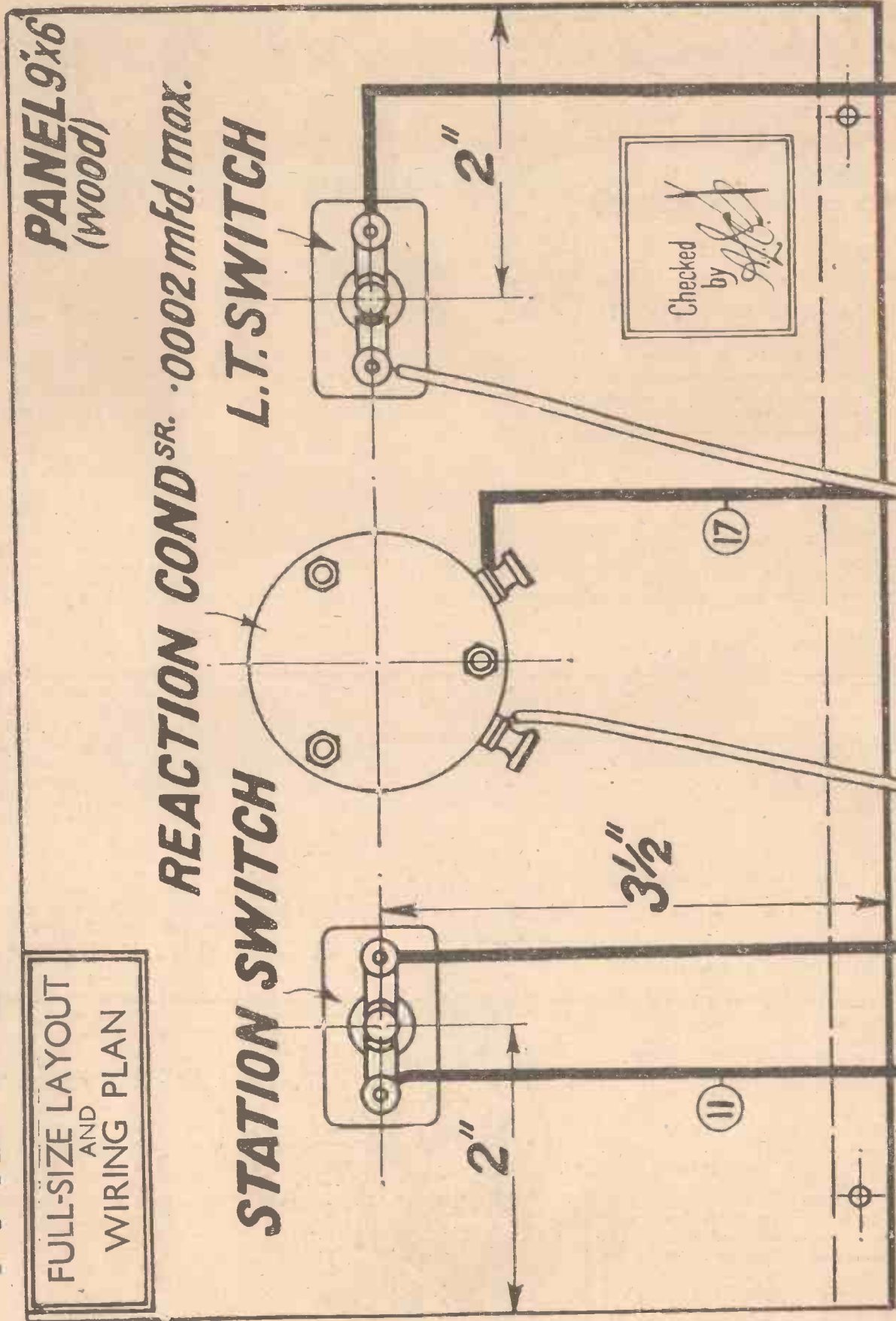



IN MY WIRELESS DEN

WEEKLY TIPS—
CONSTRUCTIONAL AND THEORETICAL

By W. JAMES.

Bad Valve Contacts

VALVES with solid pins, instead of the split or banana type are being issued in ever-increasing numbers. When the valve holders are of sound design good contacts, and lasting ones, too, are readily obtained.

But some holders are not satisfactory. A flexible part must be provided in the socket itself or a firm contact will not be obtained to begin with.

No matter how accurately the valve bases are made, good contact will not be made with a socket that has solid sockets with a plain hole in them for if the contact is made firm it becomes difficult to remove and fit valves.

The solid pins are easier to deal with in manufacturing than the split type. Any slight out-of-truth is bound to be more serious than in the case of split pins, however, so that suitable holders must be used. Some holders are definitely not suitable, but there are plenty of types that seem satisfactory.

A point to note is that with a valve having solid pins slight bending is the only trick to be tried to overcome a poor fit. Bending is not generally recommended, however, but may be tried in bad cases. It must be remembered that the pins, though called solid, are really tubes, the contact wires from the bulb passing through them and being soldered to the tips.

Metal Baseboards

The fashion of using metal bases for sets, upon which to mount the various parts, is not without its dangers.

I have referred already to the necessity of care with valve holders. Some are so constructed that when the valves are pushed home the pins touch the metal and so prevent reception.

Other parts must also be watched. Take the case of certain tuning-coil units. They have terminals in their bases with all too little clearance with the result that contacts with the metal base may occur. A piece of insulating material may be used to safeguard the coil, but this does not look a good job.

The contacts themselves ought to be properly counter-sunk in the base to form a satisfactory component. There are other parts, such as chokes and transformers, which ought to be examined before fitting them to the base. A single contact may possibly ruin all the valves.

A fuse ought, therefore, to be fitted as a precaution. The ordinary flash-lamp type is usually satisfactory. Sometimes a

bulb of too large a current rating is used and then is not a protection at all.

Better Detection

Without entering into a discussion regarding power detection, I think many amateurs would notice better results were some of the features of this method of detection applied to their own sets.

Take the value of grid leak used. Many people stick to the two megohms used for so many years. Try a lower value, down to .5 megohms, and note the difference in the results. You may well be surprised at the improvement.

At the same time you may find the reaction circuit no longer behaves nicely. The circuit may be "floppy," for example. This defect will be removed in most instances by fitting a potentiometer and taking the bottom end of the grid leak to

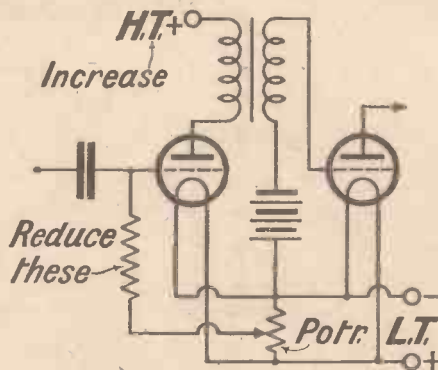

The detector circuit may easily be modified to give better results, and here is the arrangement referred to in the accompanying paragraph

the sliding contact instead of to the positive side of the low tension.

This is shown in the accompanying circuit. A further point concerns the value of high tension. So many people use a valve of fairly high impedance for detection that a full 120 volts is essential for good results. Of course, the anode current increases when the high tension is raised and this may cause a little anxiety. The thing to do is to spend a little time on the detection circuit and make sure that the most is being got out of it with the minimum of current.

Whistling Pick-ups

When trying a gramophone pick-up you may have noted a tendency for a high-pitched whistle to occur when the pick-up is touched.

This is easily to be avoided in many instances by earthing the metal part of the pick-up itself or of the carrying arm. Sometimes a short wire may be taken from the terminal of the pick-up which goes to grid bias, to the case.

In one instrument that I have an earthing terminal is provided. This is connected by the makers to the arm and is certainly a convenience. A pick-up having a winding of many turns of fine wire, being sensitive, is liable to produce the whistle referred to and I always feel that even though the actual whistle is not heard there is the chance of distortion occurring.

When we earth the case of the pick-up or the metal arm, we do definitely remove a possible source of trouble. Long leads between a pick-up and the amplifier are to be avoided. Sometimes a hum is introduced in the input circuit and distortion may certainly occur when the leads are long and not screened.

S.G. and G.B.

The matter of grid current in amplifying valves is an important one. So many screen-grid high-frequency stages are used without grid bias that it is necessary when possible to avoid valves which pass a fair grid current when the grid bias is zero.

Some valves pass much more than others at this point and you would therefore expect the performance to suffer with a valve passing current as compared with another passing a lesser current.

There are considerable differences between the grid current characteristics of valves and these are reflected to an extent in the other characteristics. If you just plug in one valve, note the results, and then try another valve and obtain different results, grid current may be playing a part. I have noted that a valve having a heavy grid current at zero bias tends to broaden the tuning and to "deaden" the circuit.

When grid bias is used, such as negative .9 volt the results are not likely to be so different. In fact, provided there is no grid current at this bias, the valve having most at zero bias will probably provide the strongest signals. This is a point that I have noted many times.

Complaints are still being made regarding the misuse of loud-speakers by wireless dealers who seem to imagine that if a speaker is kept in operation outside their premises for a long enough period it will attract the buying public.

**WE GIVE
NO PRIZES
BUT —**



A "1931 Ether Searcher" built with a Ready Radio MATCHED KIT was submitted to lengthy tests by Mr. J. Sieger, the designer, and officially approved by "Amateur Wireless."

**WE DO GIVE YOU
THE BEST POSSIBLE
RESULTS FROM YOUR
"ETHER SEARCHER"**

The "1931 Ether Searcher" is such a remarkably efficient set that hundreds have already been built solely for the pleasure of enjoying the excellent reception which it gives.

All the hundreds of "A.W." readers who have purchased Ready Radio Kits know that every claim made for the "Ether Searcher" is justified because Ready Radio MATCHED KITS give the best possible results obtainable from the circuit.

That is why a Ready Radio MATCHED KIT is better than any prize—and every reader of "A.W." can obtain one *immediately* by posting the order form on page 283.

If you want a set you will prize—order a Ready Radio Kit now. If, in addition, you want to win an "Amateur Wireless" prize—make sure of it by using a Ready Radio MATCHED KIT.

We feel perfectly safe in prophesying that every prize winner will have used a Ready Radio Kit.

Ready Radio

159, BOROUGH HIGH STREET,
LONDON BRIDGE, S.E.1.

Telephone: Hop 5555 (Private Exchange) Telegrams: READIRAD, SEDIST.

Mention of "Amateur Wireless" to Advertisers will Ensure Prompt Attention

SETS OF DISTINCTION



REGENTONE.....

ALL-ELECTRIC

FOUR.....

Makers: Regentone Ltd.

Price: 30 Guineas

I HAVE recently completed tests of a very well designed four-valver for A.C.-mains operation. This is the Regentone All-electric Four suitable for mains supplies of 200 to 250 volts. The standard model is for 50-cycle supplies, but special models are obtainable if the periodicity is 25 cycles.

The model supplied to me for test had a plug already wired for supplies of 230 to 250 volts. A very simple alteration to this plug made the set suitable for my supply of 200 volts. For such a powerful four-valver the Regentone All-electric Four is very economical to run. The total power consumption from the mains is only 35 watts, or rather less than that of an electric-light bulb.

This set is ideal for family operation. The absence of controls on the front of the set imparts an air of simplicity that is not belied by actual operation. The only fixture on the front of the cabinet is the tuning dial, illuminated when the set is switched on and operated by a smooth working knob fitted at the left-hand end of the cabinet. This dial is divided into 100-degree divisions, but is not calibrated in wavelengths.

Only Three Controls

The only other knob at the left-hand end of the cabinet is the wave-change switch, giving medium or long wavelengths as desired. At the right-hand end of the cabinet is a knob controlling volume. Altogether there are only three controls on this set. There is no master switch, so the mains must be switched off by withdrawing the plug socket at the end of the connecting flex.

My first test was on an aerial of only 15 feet, actually a piece of 22-gauge cotton-covered wire slung across the picture rail. I used this modest form of aerial because I had been warned by the makers that a long aerial would result in overpowering signals, due to the great amplifying properties of the four valves.

I must confess I was amazed at the strength of the distant stations brought in on this small aerial when connected to the Regentone set. The makers claim that there is a considerable choice of stations on a short indoor aerial. My tests proved that this is not an exaggerated claim. In fact I think the makers have been too modest.

The National station came in rather low on the tuning scale, being logged at 7 degrees. The London Regional was logged at 32 degrees and the Midland Regional at 64 degrees. Above the last-

named station I obtained very fine results, Budapest at 85, Munich at 81, Vienna at 74, and Milan at 70 being logged at real entertainment strength and quality.

Many Excellent Programmes

Other excellent programmes were enjoyed from Langenberg, 61; Lyons, 59; Rome, 53; and Stockholm, 50. I found that when using the standard test aerial, which is about 50 feet long, these stations came in at the same setting as when using the short aerial. One of the good points about this set is that the length of aerial does not affect the range of reception. I obtained ample volume from the stations mentioned using the 15-foot aerial.

On the long-wavelength range I found the 50-foot aerial gave more satisfactory results, enabling me to log Hilversum, 86; Paris, 74; Daventry, 62; and Eiffel Tower, 50.

These stations came in with an entire absence of background mush. They could honestly be called entertainment alternatives to the local station. Judging by my tests, I should say that the Regentone A.C. Four would bring in at least a dozen stations anywhere in the British Isles, even under poor reception conditions.

As regards selectivity, this property has obviously received the careful attention of the designer. Knife-edge tuning has not been the aim, for each station can be heard over one or two degrees of its maximum tuning point. There is no side-band cutting, a fact that contributes appreciably to the good quality of the reproduction. As a guide to the behaviour of the set under Regional reception conditions, by which I mean the installation of the set within twenty miles of Brookmans Park or Daventry, I give the following figures obtained with the short aerial:—London Regional, maximum at 32, had entirely disappeared at 21 and 38, a spread of 17 degrees. London National, maximum at 7, could still be heard at the bottom end of the scale but had disappeared at 16 degrees, a spread of 16 degrees. On the long waves Daventry at 62 could be heard down to 50

and up to 70, a spread of 20 degrees.

The makers recommend a high-resistance loud-speaker for use with the Regentone set. I obtained first-rate reproduction with an inductor-dynamic model. The Ferranti permanent-magnet moving-coil loud-speaker gave even better results when I connected it to the set through the Ferranti OPM₃ output transformer. The very good quality of the reproduction makes this set suitable for the reproduction of gramophone records. Provision is made for the connection of a gramophone pick-up, but it is then necessary to disconnect the aerial from the set and to turn the volume control to zero.

This Regentone four-valver recommends itself on account of its ease of control, great range of reception and excellent quality of

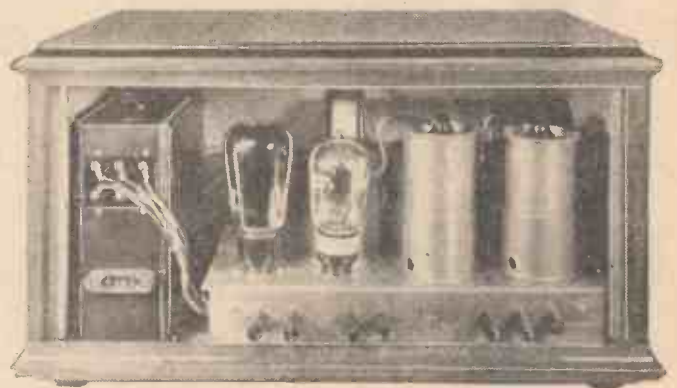

A rear view of the set: the compact layout is obvious

reproduction. Judged by present standards, this set is very good value for money
SET TESTER.

THALOFIDE CELLS

THESE are light-sensitive devices somewhat similar to a selenium cell, but specially suitable for secret signalling by means of infra-red rays. Thalofide is an oxidised thallium-sulphide compound which is particularly sensitive to rays lying outside the visible spectrum. For secret signalling, a "dark" ray is projected from a searchlight screened with an infra-red filter, and is received by the sensitive cell which is mounted at the focus of a parabolic mirror. The thalofide cell is coupled to a thermionic valve which renders the received signals audible in a pair of headphones.

M. A. L.

50 STATIONS WITH THE 1931 ETHER SEARCHER

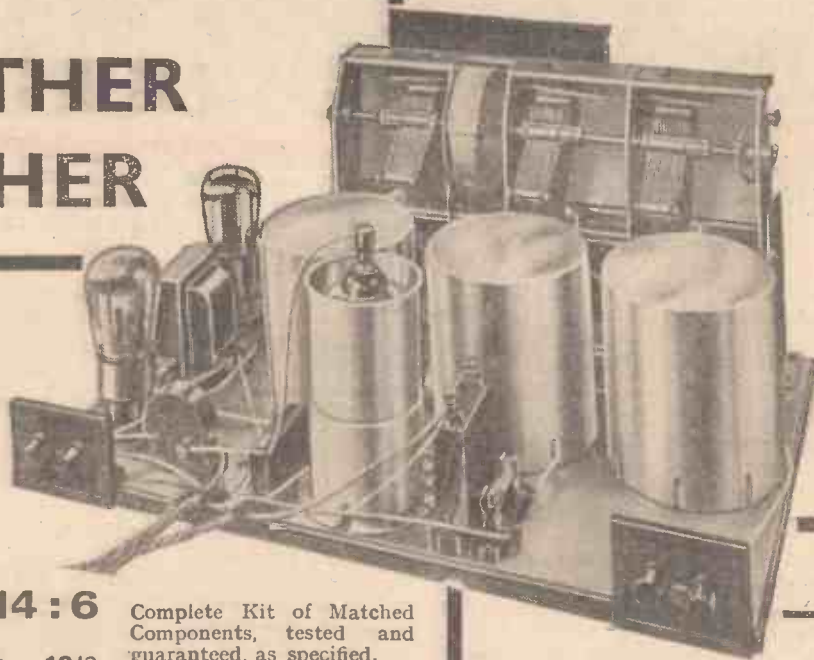

KIT A £5:14:6

or 12 monthly payments of ; ; ; 10/6

KIT B £7:13:4

or 12 monthly payments of ; ; ; 14/-

KIT C £8:14:6

or 12 monthly payments of ; ; ; 16/-

Complete Kit of Matched Components, tested and guaranteed, as specified.

Complete Kit of Matched Components as above with 3 Mullard Valves to specification.

Complete Kit of Matched Components as above with 3 Mullard Valves to specification and special Cabinet (hand made, weathered oak finish).

**BUT
YOU MUST USE A
Ready Radio
MATCHED KIT**

BATTERY-OPERATED EQUIPMENT

Consisting of:—

Complete Kit of Parts with 3 Mullard Valves and Cabinet to specification	£	s.	d.
1 Fuller 120-volt H.T. Battery	8	14	6
1 Fuller 2-volt 30 amp. L.T. accumulator (type SW X7)	11	0	
1 Farrand Inductor-type Loud-speaker Unit	3	10	0
1 Fuller 9-volt Grid Bias Battery	1	6	
	£13	12	10

Or 12 equal monthly instalments of 26/-

READY RADIO MAINS-DRIVE EQUIPMENT

Consisting of:—

Complete Kit of Parts with 3 Mullard Valves, Cabinet to specification	£	s.	d.
1 Atlas Mains Unit with Trickle Charger (A.C.188)	8	14	6
1 Fuller 2-volt 30 amp. L.T. accumulator (type SW X7)	6	0	0
1 Fuller 9-volt Grid Bias Battery	1	6	
	£15	7	0

Or 12 equal monthly payments of 28/3

READY RADIO COMPLETE RECEIVER

£9:17:6 or 12 monthly payments of 18/- (Royalties included)

Completely assembled and ready for use, aerial tested. (With Mullard Valves and Cabinet as specified.)

The 1931 Ether Searcher contains three tuned circuits all operated by one control. It is obvious, therefore, that each circuit must be accurately matched in order that you may enjoy the wonderful sensitivity and selectivity of which the receiver is capable.

Ready Radio Limited—famous for their service to customers—have consequently installed a special department where all kits are ACCURATELY MATCHED and Guaranteed by experts before dispatch. You will consequently be sure of getting the highest efficiency by ordering your kit of parts from READY RADIO. Tested and officially approved by "Amateur Wireless."

ORDER FORM

To Ready Radio Ltd., 159 Borough High Street, London Bridge, S.E.1

Please send.....

FREE to every purchaser of a Ready Radio 1931 Ether Searcher Kit: A Booklet containing constructional details, full-size wiring diagram, notes on operation, tuning guide and other useful information—and One Atalanta Radio Screwdriver.

Name.....

Address.....

All goods post free or carriage paid in British Isles.

CASH ORDER FORM

Please dispatch to me at once the goods specified for which I enclose payment in full of

£.....

C.O.D. ORDER FORM

Please dispatch to me at once the goods specified for which I will pay in full on delivery the sum of

£.....

HIRE PURCHASE ORDER FORM

Please dispatch my Hire Purchase order for the goods specified for which I enclose first deposit of

£.....

Advertisers Appreciate Mention of "A.W." with Your Order



In Praise of the "Searcher"

SIR,—As a staunch reader of "A.W." I was attracted by the "1931 Ether Searcher" and built the set. Living near Brookmans Park I am full of gratitude and I cannot express my thanks fully.

At any rate, please congratulate the designer on his wonderful achievement.

E. W. (East Barnet).

On the Short Waves

SIR,—With reference to the letter from "D. R." (Norwood) in a recent issue, I fully concur with your editorial remarks regarding the reception of American short-wave stations.

I am certain that "D. R." would never regret building a receiver for short waves, as this band is crowded with transmissions at practically all hours; and if he has a knowledge of the morse code, then he will have many more interesting things to log. American short-wave stations, particularly, are received well. My own particular "friend" is W₃XAL, situated at Bound-

brook (N.J.), which works on a frequency of 6,105 kilocycles. The logging of this station is practically a certainty at the hours you mention.

E. T. B. (Southampton).

Slaithwaite

SIR,—I note that the new station at Moorside Edge will shortly be ready for broadcasting and that it will be followed in due course by the Scottish stations at Falkirk. It appears to be that in the future we are to have a number of high-power stations all broadcasting the National programme and all on different wavelengths. As it is at present, the ether is "polluted" with the National programme. I can receive it from Leeds, Belfast, Relays, Aberdeen, and Glasgow. In fact, one gets it all round the dial. I cannot understand why the twin transmitters will not send out the National programme on a common wavelength and thus set the others free for something else.

I see also discussion about the inter-

ference of Mühlacker with London Regional. Now, recently I listened-in to the whole performance of the *Magic Flute*, transmitted by Mühlacker, with practically no interference. London Regional did push himself in for a few minutes upon one occasion, but that was all. If I can separate them in Glasgow, why can readers not do so in London?

"SEPARATOR" (Glasgow)

High-power Stations

SIR,—It is good to find "Thermion" championing the cause of the listener, especially the small man, in a recent paragraph. I note that the B.B.C. chief engineer, in his reply, agrees with "Thermion" that "the question of interference between two high-power stations is likely to present a serious problem in the future." "Thermion" says "the scheme in its present form will be quite unworkable."

Prospective set buyers, please note! To be worth having, wireless must be trouble free, even with the simplest circuits.

D. R. P. (Richmond).

POWER - running to waste!

Sensational disclosure for 1931
research engineer's discovery

Low insulation of Condensers is source of power running to waste

It has been the aim of condenser engineers for years past to produce a condenser having a high test and working voltage, a high insulation value, and long life, at a low cost.

The new Formo condensers have a high insulation value which makes leakage infinitesimal and are tested by the sudden application of the test voltage, and not, as is usual, through a non-inductive series resistance.

The new Formo range is obtainable from all radio dealers—fit one and get clearer, better reception.

Sets a standard of performance never before achieved.

FORMO
ARTHUR PREEN & CO. LTD.

NEW - VAC PROCESS

MAINS CONDENSERS

Arthur Preen & Co. Ltd.
Dept. A.W.
Golden Square, Piccadilly
Circus, Lcn cn, W.1.
Factory: Crown Works, Southampton.

PRICES:				
Cap.	Height	Width	Length	Price
1.0	2½"	1"	1"	2/6
2.0	2½"	1½"	1½"	3/3
4.0	2½"	1½"	3"	5/6

Full range of capacities.
BRITISH INDUSTRIES FAIR
STAND No. D 8

EVERYTHING **The G.E.C.** ELECTRICAL
your guarantee
GECOPHONE

REGD TRADE MARK

THE FAMOUS 20 GUINEA PORTABLE
 NOW **£15.15.0**

4 VALVE SCREEN GRID PORTABLE



MADE IN ENGLAND

Sold by all Wireless Dealers.

FINISHES

Waterproof Leather Finish in Maroon or Brown.
 Table Model in Solid Polished Mahogany.

A SPECIAL NEW YEAR OFFER

THAT SETS AN ENTIRELY NEW STANDARD IN PORTABLE SET VALUES

Exactly the same set with exactly the same wonderful performance

But costing 5 gns. less

THE POINTS THAT COUNT—

- 1** Screen grid circuit gives great sensitivity which allows many Home and Foreign stations to be received.
- 2** Selectivity is such that separation of powerful stations is complete.
- 3** The GECOPHONE "Stork" Loud Speaker fitted into the lid is capable of handling immense power. Thus you are certain of pure reproduction at any volume.
- 4** Equipment includes the latest OSRAM VALVES (with the OSRAM P.2 Output Valve) MAGNET Batteries and MAGNET unspillable Accumulator. A turntable for directional tuning is provided.
- 5** Low current consumption of 11 milliamps.
- 6** The case is waterproof leather finish, very distinctive and very robust. Choice of brown or maroon colours. Also table model of solid polished mahogany.
- 7** Simplicity of operation.

HIRE PURCHASE

You can either buy the GECOPHONE Portable for Cash (£15.15.0) or Hire Purchase—deposit £1.11.0, 12 monthly payments of £1.4.10 Complete with OSRAM Valves, Batteries, Unspillable Accumulator and Turntable, and including Royalty.

This is an event of the greatest importance to the radio world. The price of the famous 20-guinea GECOPHONE Portable has been reduced to 15 guineas. This set is not to be measured by ordinary portable standards. It is a classic . . . having won national fame by its superb performance, reliability and high-class appearance

You can compare the price, but you cannot compare the value for money. Nowhere is it possible to get such a superb receiver for 15 guineas.

Fill in the coupon below for leaflet which reproduces the models in actual colours.

This will be sent POST FREE.

Your local dealer will demonstrate the set in your own home without placing you under any obligation.

We have arranged this with the trade.

COUPON
 Please send me particulars of GECOPHONE Portable
 Name _____ Address _____
 The General Electric Co. Ltd.
 Magnet House,
 Kingsway,
 London,
 W.C.2

Cut out coupon and paste on postcard, or enclose in unsealed envelope. Halfpenny postage in either case. A.W.

Advt. of The General Electric Co., Ltd., Magnet House, Kingsway, London, W.C. 2

Advertisers Appreciate Mention of "A.W." with Your Order



SIR JAMES CRICHTON-BROWN, the famous doctor, will broadcast some reminiscences on February 21.

A running commentary on the semi-final of the F.A. Cup will be broadcast on March 14 from the National transmitters.

Some of Chekov's best work went into short plays and short stories of which the essence is purely humorous. *A Happy Man*, which has been adapted from one of his short stories by Edward Lewis, will be broadcast on February 16 on the National wavelength, and on February 17 on the Regional wavelength.

The Prime Minister's speech at the annual banquet of the Birmingham Chamber of Commerce will be relayed to Midland Regional listeners from the Grand Hotel, Birmingham, on February 23.

Germany has in recent times entered the lists of those nations who pay special attention to light entertainment. An example of the changed outlook will be presented to British listeners in the new musical comedy *Rich Girl, Poor Girl*, early in March.

A boy soprano will be heard from Midland Regional on February 27, when Albert Tansley sings songs by Handel and Schubert.

On February 15 the Northern Wireless Orchestra, Elsie Suddaby, and Edward Isaacs will give a concert of light classical music for Manchester and Leeds listeners.

A playlet entitled *The Philosopher in the Apple Orchard*, based on a story by Antony Hope and adapted by Harcourt Williams, will be broadcast from Birmingham for Midland listeners on February 28.

The National Orchestra of Wales Light Orchestra will give a musical comedy programme on February 27. Glyn Eastman will be the vocalist and the Cardiff University Madrigal Society will sing choruses.

On March 2 the Abbey Players from Dublin will again visit the Belfast studio and present *The Far Off Hills*, a comedy in three acts by Lennox Robinson.

The Scottish schools section of the B.B.C. is running a series of broadcasts entitled "Music and Poetry," in which an endeavour has been made to collect the finest poems

which have been set to music by the finest composers.

Arrangements are being made to broadcast complete scenes from the pantomime *Goldilocks and the Three Bears*, which is at present running at the Theatre Royal, Glasgow.

Shunting is carried out scientifically in a railway yard on the Continent, and the new system has resulted in a great saving of time. Hitherto, when a number of wagons was ready for shunting, hand signals were sent to the shunting engine. Now all signals are sent to a central office, whence they are immediately transmitted by wireless to the engines which are equipped with receivers.

When a man was at a New York studio recently, he decided to make a speech which would end only when he could speak no longer. In this way he hoped to become holder of a record as the world's champion talker! When the studio officials found what he was doing he was asked to stop, but refused. In the end the police were called in to eject him!

The U.S. army are conducting experiments with a view to superseding bands. Instead of a brass band preceding a regiment a loud-speaker equipped car leads the way. So far the British War Office have not tried the experiment!

The Charcoal Burner's Son, by L. du Garde Peach, is a fantasy with Music and a Dragon, to be broadcast on the National on February 20, with Gordon McConnel as the producer.

Do you want a better condenser?

—fit

POLAR IDEAL

You need better condensers to get better results.



POLAR "IDEAL"

with knob-dial, .0005, 12/6; .0003, 12/-

POLAR "IDEAL"

Drum Control, right or left hand:—
.0005, 15/- - - - .0003, 14/6

WINGROVE & ROGERS LTD.
188-9 STRAND, LONDON, W.C.2
Polar Works: OLD SWAN, LIVERPOOL

Modernise your set, get greater efficiency through replacing your old condensers with these Polar Fast and Slow Motion Drive condensers which are recognised as the standard of high-class design and construction.

Take advantage of our special offer which saves you 2/- on the cost of every Polar "Ideal" Drum Condenser you now buy.

Take advantage of this offer now. Next week may be too late.

SPECIAL EXCHANGE OFFER

Every Dealer is authorised to allow you 2/- on every old variable condenser that you hand him when buying a Polar "Ideal" to replace it.

We list the types and capacities under the illustration. They meet every modern requirement.



Five Fine Sets

Charts now available



These Sets are the finest ever put out in charted form for the home constructor.

The full-scale drawings are clear and easy to follow, so that anyone who can drill a hole and drive a screw can build receivers and secure results not equalled by any other home constructor's Sets.

They have been designed to combine the three essentials of good radio: 1st—True reproduction; 2nd—Great range and power; 3rd—Adequate selectivity. Each component employed is the best of its class and has been chosen with one object in view—the ultimate performance of the set. Provision for Gramophone Pick-up. NO SOLDERING.

1931 Editions:

TWO-VALVE

Battery operated

TWO-VALVE

A.C. Mains operated

SCREENED GRID 3

Battery operated

SCREENED GRID 3

A.C. Mains operated

SCREENED GRID 4

Battery operated

Write for the Chart which best meets your requirements.
Free on request.

FERRANTI

Ask your Dealer for a Chart or write to

FERRANTI LTD. Charts Department., HOLLINWOOD, LANCASHIRE

DESERT DIFFICULTIES WITH RADIO

COMMUNICATION in Arabia is being speeded up by the provision of a broadcasting station in Mecca. This will be used chiefly by King Ibn Saud for inter-town communication and not for programmes.

Similar stations are to be erected at Riyadh, the capital of Nejd, about 400 miles from Mecca, so that the King, who has palaces in both towns, will be able to talk from one to the other by means of special microphones.

The stations in the smaller towns will have a power of 500 watts. These also will be capable of working by phone, if required, though only telegraph services are to be used at first.

They will be worked by Arab operators and, in order to facilitate working between the different stations, the controls are adjusted to fixed wavelengths and interlocked, so that once the stations are erected further adjustments for wavelength will be unnecessary. By merely moving a handle into the position of "transmit" or "receive" the operator will automatically switch on the set at the correct wavelength for the service required. This type of set was originally developed for use by unskilled operators on whalers operating in the Antarctic.

A British engineer will supervise the installation of the Arabian stations outside Mecca; and, to provide for the maintenance of the stations after they have been

erected, King Ibn Saud is having four of his subjects trained in radio.

Arabia is one of the few remaining countries of the world which still retains many of the manners and customs of Biblical times, and King Ibn Saud's introduction of wireless as a means of internal communication involves many striking contrasts between ancient and modern methods.

All the apparatus for the stations will be transported by car or camel caravan over the desert tracks which have been in existence from time immemorial, for roads are few and the only railway in the country, that running from Transjordan to Medina, was destroyed during the war.

WIRELESS WIT!

A writer says in a newspaper article that merely tinkering with his radio gives him a feeling of elation. And os-elation!

Desiring to broadcast, a piano-repairer wrote to the officials, adding that he did jobs over a large area. No doubt he had a "wide tuning range"!

It is reported from Prague that a wireless enthusiast who was interrupted by a tax-collector, went down and nearly strangled him. Trying a new "choke."

President Hoover, despite his numerous engagements, finds time to listen in to important items. Putting in "Hoover"-time!

ELECTRIC POWER

THE theoretical unit of electric power is the watt, which is the rate at which work is being done when a current of one ampere flows under a pressure of one volt. In general the product of volts by amps. measures power. The practical unit is 1,000 watts or one kilowatt. By comparison the mechanical unit of one horsepower is equal to 760 watts, so that a kilowatt is roughly one and a third horsepower. In charging consumers for power taken from the electric mains, the commercial standard is the Board of Trade unit, or kilowatt-hour, which represents, say, a current of 5 amps. supplied at a pressure of 200 volts over a period of one hour.

M. B.

"LAZY" SINGERS

SPEAKING of gramophone recording, Mr. Compton Mackenzie says: "The microphone has made singers lazy, because it has made it so much easier for a moderate voice to sound like a good voice. The remedy for this is not to obtain recordings from a performance in front of an audience. My experience of radio listening leads me to suppose that little is gained by this, indeed that, if anything, more is likely to be lost. One gets the impression that one is overhearing rather than listening to music. I have never heard any speaker who was not speaking directly to a radio audience succeed in getting across the microphone."

"A.W." Solves your Wireless Problems



IDEAL FOR RADIOGRAMS
NO INTERFERENCE
if you fit a
PAILLARD
ELECTRIC INDUCTION MOTOR

No brushes or commutator to cause interference. No belt. The motor runs smoothly and silently, without variation in the revolution speed even with largely fluctuating mains current. 12" velvet-covered turntable, automatic brake and cut-out. For 100-130 and 200-250 v. A.C. 7 1/2" x 5 1/2" x 5 1/2"

£4/17/6 (without Unit Plate, £4/10/0).

PAILLARD JUNIOR INDUCTION MOTOR 45/-
 MOTOR with 13" TURNTABLE and SWITCH BRAKE

Super Pick-up and Arm. £2/2/6. Portable Gramophone Cabinet fitted with Paillard Motor, Super Pick-up and volume control, £8/15/0 complete.

APOLLO GRAMOPHONE CO., LTD.
 4-5 Bunhill Row, London, E.C.1

"THE ONE POUND TWO"

A SOVEREIGN SUCCESS

IN this remarkable circuit designed for high performance as well as strict economy TWO Sovereign .001-.0002 Compression Type Condensers are specified. What greater proof is wanted that SOVEREIGN Components are supreme for quality and price? Fit Sovereign guaranteed components wherever you can, they improve any circuit.

SOVEREIGN
 COMPRESSION
 TYPE CONDENSERS

1/6

EACH
 ALL VALUES

KEEP THIS LIST FOR FUTURE REFERENCE. Sovereign Fixed Condensers, Grid Leaks, Spaghetti Resistances (full range), Dual Range

Coils, Wire-wound Resistances, Volume Controls, Potentiometers, Rheostats, Wave Traps, Screen-grid Coils, H.F. Chokes, etc.,



If it is difficult to obtain these and other Sovereign components write direct (and also for full lists) to the makers.

SOVEREIGN PRODUCTS, [LIMITED],
 52-54 Rosebery Avenue, LONDON, E.C.1

You will Help Yourself and Help Us by Mentioning "A.W." to Advertisers

FOR TEN YEARS PILOT RADIO KITS

DOUBLE YOUR PRIZE

EVERYTHING RADIO CASH OR EASY TERMS

In connection with the Competition published in this issue, Peto-Scott Co., Ltd., have pleasure in announcing that to any Prize Winner whose set was built with a PILOT RADIO KIT, they will also present selected Radio Equipment equal in value to the amount of the Prize awarded by the Editor.

1931 ETHER SEARCHER

PILOT RADIO KITS FOR THIS WONDERFUL SET are fully approved

See what the Editor of "Amateur Wireless" says in his letter published in our announcements in "Amateur Wireless" dated January 17th and 24th.

KIT "A" C.O.D. £5.14.6

Less Valves and Cabinet.

Pay the Postman.

H.P. TERMS 10/6 Balance in 11 monthly payments of 10/6

Any parts supplied separately. If over 10/- sent C.O.D.

KIT "B" £7.13.6 **KIT "C" £8.14.6**

With Valves but less Cabinet 14/1 deposit and 11 monthly payments of 14/1.

With Valves and Cabinet 16/- deposit and 11 monthly payments of 16/-.

FINISHED INSTRUMENT. READY BUILT EXACTLY as SPECIFIED. French-polished Oak Cabinet; Aerial Tested and fitted with Mullard Valves. Royalties Paid. **£9-9-0** or **18/-** deposit and 11 monthly payments of **18/-**.

74/- CONVERTS 1931 ETHER SEARCHER INTO A RADIO-GRAMOPHONE VOXKIT RADIOGRAM CABINET

Model "A" costs you only **74/-** extra after deducting 21/- for the table cabinet **SPECIFICATION :-**

Model "A" Handsome Figured Oak, Hand Polished Cabinet, Overall sizes, 22 in. wide, 17 in. deep, 40 in. high. Wates Star Pick-up and Tonearm, Swiss Single Spring Motor, 10 in. Turntable and Volume Control, Silk Gauzed Fret.

Cash Price - £4:15:0

Model "B" As above but fitted with Garrard Double Spring Motor, 12 in. Turntable, B.T.H. Pick-up and Tonearm and Volume Control. As illustrated (regd., design). **Cash Price - £6:15:0**

The Voxkit Radiogram Cabinet is suitable for most "Amateur Wireless" Sets. It adds the finishing touch!



The Voxkit Radiogram Cabinet is an attractive instrument fitted with the 1931 Ether Searcher.



Manufacturers' Kits, Accessories, Etc., Etc.

- Send **10/-** **COSSOR EMPIRE MELODY MAKER KIT**, 1931 model, S.G., detector and power. Cash Price **£6 17 6**
Only Balance in 11 monthly payments of 12/9
 - Send **23/6** **1931 OSRAM MUSIC MAGNET KIT**, two S.G., detector, and power. Cash Price **£11 15 0**
Only Balance in 12 monthly payments of 18/6
 - Send **10/6** **DYNAPLUS SCREENED THREE KIT**, S.G., detector, and power. Cash Price **£5 14 6**
Only Balance in 11 monthly payments of 10/6
 - All above Kit Prices include valves and cabinet.
 - Send **10/9** **REGENTONE W.5 COMBINED H.T. ELIMINATOR AND TRICKLE CHARGER**, One S.G., 1 variable, and 1 fixed tapping for H.T. L.T. charging for 2, 4, and 6 volts. For A.C. mains. Cash Price **£5 17 6**
Only Balance in 11 monthly payments of 10/9
 - Send **8/6** **EXIDE 120-VOLT WH. TYPE ACCUMULATOR**, in crates. Cash Price **£4 13 0**
Only Balance in 11 monthly payments of 8/6
 - Send **6/5** **LAMPLUGH or FARRAND INDUCTOR SPEAKER**, for perfect reproduction. Unit and chassis complete, ready mounted. Cash Price **£3 10 0**
Only Balance in 11 monthly payments of 6/5
 - Send **7/9** **BLUE SPOT MODEL 51R CABINET SPEAKER**. Cash Price **£4 4 0**
Only Balance in 11 monthly payments of 7/9
 - Send **7/9** **EPOCH PERMANENT MAGNET SPEAKER** with type B4 unit only. Cash Price **£4 4 0**
Only Balance in 11 monthly payments of 7/9
- If your requirements are not listed here, send a Pos. card. Detailed Quotation by return of post.*

C.O.D. ITEMS

(Pay the Postman. We pay all post charges) **For the 1931 ETHER SEARCHER**

One set of Colvern Matched Coils **£1 : 8 : 6**
(With Switch 1/6 extra)

One set of Valve Screens **7 : 6**

J.B. Chassimount, 3-Gang Condenser (.0005 mfd.) **£1:15:0**

TWENTY-SHILLING TWO

As described in this issue. Complete Kit of Parts as specified, ready for assembling.

KIT "A" Less valves and cabinet **£1 : 0 : 0**

KIT "B" With valves but less cabinet **£1:13:0**

KIT "C" With valves and cabinet **£2 : 2 : 6**

POST THIS COUPON NOW.

Please send me full details of Radio-Gramophone, for Ether Searcher, the 1931 Ether Searcher. Also your Easy Way Catalogue and other "Amateur Wireless" Sets.

Name _____

Address _____

A.W. 14/2/31

PETO-SCOTT CO. LTD.

77 CITY ROAD, LONDON, E.C.1

Clerkenwell 9406

62 HIGH HOLBORN, LONDON, W.C.1

Chancery 8266

MANCHESTER: 33 Whitelaw Road, Chorlton-cum-Hardy.
NEWCASTLE, STAFFS: 7 Albany Road.

Phone: Chorlton-cum-Hardy 67190

HAVE ECLIPSED ALL OTHERS

You will Help Yourself and Help Us by Mentioning "A.W." to Advertisers

Postcard Radio Literature

GET THESE CATALOGUES FREE

Here "Observer" reviews the latest booklets and folders issued by well-known manufacturers. If you want copies of any or all of them **FREE OF CHARGE**, just send a postcard giving the index numbers of the catalogues required (shown at the end of each paragraph) to "Postcard Radio Literature," "AMATEUR WIRELESS," 58/61, Fetter Lane, E.C.4. "Observer" will see that you get all the literature you desire. Please write your name and address in block letters.

"Radio"

THE February issue of *Radio* has just come to hand and I see that this interesting little publication, obtainable through Marconiphone radio dealers, has been increased in size and now includes more reading matter and an article by radio personalities such as Leonard Henry.

178

Panadyne Speakers

Before you get your new speaker you should see the leaflet obtainable from E. V. Mackintosh & Co., describing the new Panadyne speakers. These can be obtained in chassis form or complete in very attractive walnut-faced cabinets.

179

"Light on the H.T. Battery"

Ripaults, Ltd., know mostly all there is to know about high-tension battery technique, and they give away a lot of valuable information in a handy booklet under the attractive title of "Light on the H.T. Battery." This is well worth having.

180

Loewe Parts

If you are in need of vacuum resistances, paper dielectric fixed condensers, speakers, volume controls or valve rectifiers, then get a copy of the latest Loewe catalogue.

181

Cabinets for Blue Spot Speakers

I have just been reminded by the Carrington Manufacturing Co., Ltd., that the well-known Camco Melodee cabinet No. 1 size is suitable for the new Blue Spot special chassis. These cabinets are specially designed for such a chassis, the front of the cabinet acting as a baffle. Literature describing these Melodee cabinets can be had from Camco.

182

A Short-waver

Two good short-wave sets, one a two-valver and the other a three-valver, are made by the Electroset Radio Co. They can also be adapted to work on broadcast band wavelengths. Full particulars are given in a leaflet just issued.

183

A Ferranti S.G. Three

Ferranti, Ltd., have just produced a new constructional chart for a very good three-valver with one S.G. stage. These charts are full-size and give all the information required to build the set. Copies can be obtained through my catalogue service.

184

OBSERVER.

A TALKING LIGHTHOUSE

LOCAL announcements made by the "talking beacon" at Cumbrae, are reproduced from H.M.V. records, designed specially for the work.

The success of this development in the war against fog, depends upon the fact that exact synchronism must exist between all parts of the apparatus. Very exact recording and record pressing work is essential. For many years sound by bell or hooter has been, in the majority of cases, the only warning possible to ships approaching dangerous areas in fog. Unfortunately the atmospheric conditions, when fog prevails, in many cases make a correct estimation of direction and distance from which a fog warning is being heard a very difficult matter.

The "talking beacon," which is being tried out by the Clyde lighthouses trust, is an attempt to overcome this.

Simultaneously with the usual fog hooter a small radio transmitter sends out a series of signals, preceded by the name of the lighthouse, reproduced from one of the special H.M.V. records.

There is, owing to sound lag, a perceptible time interval between receiving the radio signals and hearing the hooter, and this has made it possible to calculate by this time interval the distance from the lighthouse. The mariner, therefore, has only to wait until he hears the actual sound of the hooter, and note the distance called out by the radio transmitter, which actually coincides with the sound of the hooter, to ascertain his exact distance in miles from the lighthouse.



Everybody's calling for

Player's Please



This is the cabinet for the **ETHER SEARCHER**. Specially designed by us at the request of Mr. Sigr. Ingleston Clarion. The name "Clarion" is on the back of every genuine cabinet.





Wax polished Oak with black cellulose base.

CLARION
Radio Furniture,
23-28 Mansford St., London, E.2

21/-
Carriage paid or C.O.D.

NEW W.B. 3-POINT SWITCH

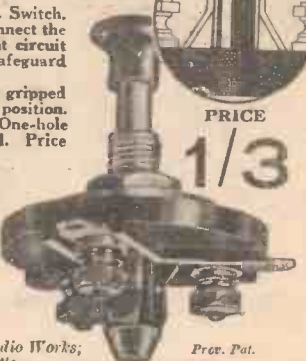
Protect your valves with this new W.B. Switch. The extra contact can be used to disconnect the H.T. battery entirely from your filament circuit as you switch out the filaments—a big safeguard where adjustments are being made. Three powerful spring contacts, firmly gripped between double cones when in the "on" position. Self-cleaning nickel-silver contacts. One-hole fixing. Completely insulated from panel. Price 1/3. 2-point model, price 1/-. **PRICE 1/3**

Made by the Makers of the famous W.B. Permanent Magnet Moving-coil Loud-speakers, Cone-speakers and Valveholders.

W B

Whiteley Electrical Radio Co., Ltd., Radio Works, Nottingham Road, Mansfield, Notts.
Irish Free State Distributors: Kelly & Skied, Ltd., 47 Fleet Street, Dublin.

SETTING THE PACE

In long range and selectivity the DYNAPLUS Kit has set the pace from the day of its introduction. To-day it is still without an equal. A satisfied user tells us that at Southgate, only four miles from Brookmans Park, he can eliminate both the London stations and bring in Continental stations at will. No wavetraps are used. This gentleman has very kindly offered to demonstrate this set to anyone interested. We shall be pleased to supply his name on request.

DYNAPLUS SCREENED 3

The Complete Kit of Parts costs £3 12s. 9d. The complete Kit, with Valves and Collapsible Cabinet, costs £5 19s. 6d. The Loud-speaker Cabinet, fitted with four-pole balanced armature Cone Speaker, designed to take the kit, £2 10s. Every item British made and fully guaranteed.

Get your copy of Captain Eckersley's Book

Do you know who invented grid bias? Do you know how broadcasting started?

Get Captain Eckersley's absorbingly interesting book. It tells you all about it. You will also get free blueprints and constructional details of the DYNAPLUS Set. Send id. in stamps for the book.



VOLTRON

DYNAPLUS COIL

In response to repeated requests for these coils by amateurs who wish to bring the performance of their sets up to the standard of the Dynaplus Screened 3, we have at last released them for general sale apart from complete kits. Fit a pair to-day. The difference will be a revelation.

6/9



14/- per pair

DYNAPLUS L.F. TRANSFORMER

Years of experience in the manufacture of transformers for set makers whose names are world famous have gone into the design of this transformer. The Vacuum treated coil is your guarantee against breakdown. The recent test report by "Amateur Wireless" shows it to be outstanding in performance. Entirely British made.



VOLTRON ELECTRIC LTD.
Queensway, Ponders End, Middlesex

There is an "EKCO" Unit for every make of BATTERY-OPERATED SET

There is an "EKCO" Unit for every type of PORTABLE RECEIVER

There is an "EKCO" Unit for every design of CONSTRUCTOR KIT

Scrap batteries and accumulators for ever by running your radio from your electric supply with an "EKCO" POWER SUPPLY UNIT

All you have to do is done simply and quickly—3 minutes only. Fit the suitable "EKCO" Unit in place of your battery or accumulator or both. Then plug the "EKCO" Adaptor into any light or power socket, and SWITCH ON—THAT'S ALL. "EKCO" Units last a lifetime but cost on an average only 2/6 per 1,000 hours of use. No alterations to valves or wiring necessary.

Model 3F.20 A.C.H.T. Unit. 3 voltage tapplings: — 60-80 for S.G. valve; 90-120/150. For 1 to 5 valve sets. Price £3 19s. 6d. D.C. Model 37.8.

OBTAINABLE BY EASY PAYMENTS FROM ANY RADIO DEALER.

Send for illustrated literature and for details of "EKCO" All-Electric Sets, to:— E. K. COLE, LTD Dept. K.1. "EKCO" Works, Southend-on-Sea.



EKCO
RADIO POWER SUPPLY UNITS

11/001111

Don't Forget to Say That You Saw it in "A.W."

WE TEST FOR YOU

A weekly review of
new components



and tests of
apparatus.

Conducted by our Technical Editor: J. H. REYNER, B.Sc., A.M.I.E.E.

A Novel Gramophone Motor

WE are getting very critical these days as regards gramophone motors. The early electric motors were not up to the standard of the spring-driven motors which had been in use for so many years.

One of the best checks on steadiness is by the well-known stroboscopic disc, which is placed on the turntable and viewed by light from an electric lamp. The Diehl Aristocrat motor which was tested this week is a good example of modern practice. This is an induction motor running very silently and absolutely steadily. The stroboscopic disc was watched for half a minute, during which time no variation was detected. The workmanship is delightful and a self-contained switch and trip mechanism which works well is included. A further innovation is a bakelite turntable which is driven from the motor by a cork clutch. The turntable is not a driving fit on the spindle as usually, but is relatively free, relying on the friction between the cork surfaces for its drive. Altogether this motor is an attractive proposition.

A Panadyne Speaker

WE have changed considerably since the days when a speaker had a large trumpet and looked rather an ugly affair. The modern speaker is usually contained in a handsome cabinet, and is quite an



The new Panadyne speaker

addition to the furniture of the room. The Panadyne speaker which we have tested this week is a case in point. The instrument is of the cone type, and is housed in a handsome walnut cabinet, finished off with the slightly sloping lines that are so popular to-day. The cabinet itself measures about a foot and a half square by eight inches deep, and as will be gathered from these dimensions, it houses a large-

diameter cone which is driven by a Panadyne unit.

The reproduction, which was inclined to be boomy, showed a marked resonance in the bass. There are, of course, occasions when an accentuation of the bass is useful. The sensitivity is up to standard, and at a price of £4 10s. it will appeal to many readers.

Sovereign Fixed Condenser

A RECENT tendency which will be welcomed by many constructors is the reduction in size of fixed condensers. A condenser which occupies little space often greatly facilitates the construction of a receiver, and assists in preserving a simple layout.

We have just received a Sovereign fixed condenser, which illustrates this point admirably, for it only measures $2\frac{1}{4}$ in. by $\frac{1}{2}$ in., the height being also $\frac{1}{2}$ in. The condenser itself is of the rolled

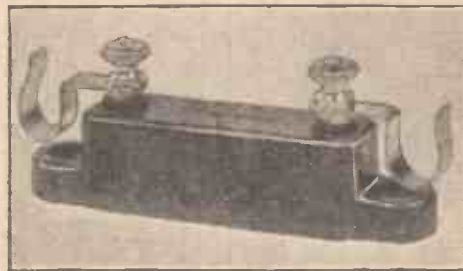

A useful Sovereign condenser with grid-leak clips

construction, often employed in manufactured sets, and this contributes largely to the small size.

Two terminals are mounted on the top which are the standard $1\frac{1}{4}$ in. apart to take a grid leak, and two clips for this purpose are provided. The condenser was rated at .0001 microfarad and was found to have a capacity of .000104 microfarad. This is eminently satisfactory, and the component should find a ready market.

New Regentone A.C. Unit

A SHORT time ago we reviewed one of the new Regentone mains units. We have received this week for test a modified version of one of these units known as the W.5a. This is an H.T. unit and L.T. charger combined. The H.T. portion is somewhat similar to the W1D which was previously reviewed.

Let "Amateur Wireless"
solve your problems

A metal rectifier is used with a voltage-doubling circuit and three H.T. tappings are provided, the largest giving 120 volts at 18 milliamps, with two tappings, one for the screen grid and the other for the detector.

This model also contains three leads for charging the L.T. accumulator when the set is not in use. One of these is a common negative, and the other two are for 2- and 6-volt accumulators respectively. The charging is adequate, being .25 ampere in each case and the simple act of switching off



The new Regentone A.C. portable unit

the mains unit switches on the trickle charger.

We tested the instrument, and as in the previous instance found it well up to its job of delivering the rated voltages at the rated current. A very full set of instructions is provided which should avoid the possibility of any mistakes.

There is a statement in these instructions which perhaps may be misleading, it being suggested that any receiver containing only one H.T. positive tapping is inefficient and old-fashioned. This is hardly true, for although old-fashioned receivers without any de-coupling arrangements were usually only provided with one H.T. tapping, it does not follow that a set with only one H.T. tapping is old-fashioned.

The modern tendency is towards the use of only one H.T. tap, the feed to the various valves being provided inside the set through suitable de-coupling arrangements.

A man who steals wireless sets in the outer London suburbs is being searched for by Scotland Yard. His method of procedure is to take a note of houses fitted with wireless. When the man of the house has left for business, he calls with the explanation that he had been ordered to see the set. If he gains admittance he takes away the set "for repairs."

BRING THESE FAVOURITES FROM THE STUDIO TO YOUR FIRESIDE!



JACK PAYNE



STAINLESS STEPHEN



TOMMY HANDLEY

THE remarkable response and sensitivity of the R. & A. "Type 40" Reproducer will amaze you. It is astonishingly realistic, has extraordinarily good bass response and is capable of handling tremendous volume without chatter or distortion.

The experience gained in producing over 200,000 loud-speakers of different types is embodied in the R. & A. unit fitted to this loud-speaker, thousands of which have been supplied, during the past year, to the most fastidious of set manufacturers.

There is a reason for this deserved success—the R. & A. Unit is made as no other unit CAN be made.

SPECIFICATION:

Fully-floating 12-inch diameter cone. Patented four-pole construction. Gaps milled to .001 inch limit. Differential armature. Milled to .001 inch limit. Adjustable for varying D.C. Currents. Maximum permissible D.C. Current, 30 m.a. Twin magnets of 35% Cobalt steel. Enamelled cast silicon-aluminium chassis.

REPRODUCERS & AMPLIFIERS, LTD.
Frederic Street, Wolverhampton

Phone: Wolverhampton 2722

16/6

"Type 40" Post Free



EBONITE LOW LOSS FORMERS

PANELS, TUBES BRITISH MADE

NOTE—Formers tested before despatch

RIGID—RELIABLE LOOK FOR TRADE-MARK

Sole Makers—**THE BRITISH EBONITE CO., LTD.**
HANWELL, LONDON, W.7

SAFETY FUSE

Protect Your Set against Damage by Lightning—

The **SPA SAFETY AERIAL FUSE**

PRICE **5/-**
Post Free.

Scrap that old Clumsy, Dusty, hand-operated Earthing Switch. This wonder fuse is entirely automatic in action. If the aerial is struck, the fuse blows and by means of a spring-operated contact chunts the lightning direct to earth. It needs no attention. No switching on or off every night. Very neat in appearance. *Easy to Fit. Full instructions with every fuse.*

F. E. HAMMER & CO. LTD.
Dept. B, KNOWSLEY HOUSE, BOLTON



Amateur Wireless HANDBOOKS

each **2/6** net.

- Loud-speaker Crystal Sets.
- Wireless-Controlled Mechanism for Amateurs.
- The Short-wave Handbook.

- The Wireless Man's Workshop.
- The Practical "Super het" Book.
- The Practical Wireless Data Book.

THE BOOK OF THE NEUTRODYNE, by J. H. Reyner, B.Sc. (Hons.), A.M.I.E.E. Price 1/6 net, or post free for 1/9



Of all Newsagents and Booksellers or by post, 3d. extra, from Cassell & Co., 1, a Belle Sauvage, E.C.4.



FOR ELECTRIC REPRODUCTION

USE A **LIMIT**

Adjustable Length Tracking Angle Spring Tension



PICK-UP ARM 15/6

Obtainable through all factors and dealers or write

EACH

LIMIT RADIO LIMITED, ALBION ST., LONDON, N.1

Don't Forget to Say That You Saw it in "A.W."

AT THE QUEEN'S HALL

SZIGETI played Mendelssohn's violin concerto with extreme sweetness at the B.B.C. concert on February 4. He is one of the greatest violinists alive to-day. The orchestra is consistently even. They can accompany a soloist and they can take the initiative themselves. The overture to *Oberon* was interpreted by Dr. Boult with extreme feeling. Arnold Bax appeared after the performance of *November Woods*, and finally there was a romantic symphony, Schumann's Fourth, in D minor. One of the best evenings I have spent for a long time.

L. R. J

Roughly 53 per cent of the 800,000 families constituting the population of Denmark are now possessors of wireless receiving sets. Taking into consideration the number of licences issued to end December, 1930, over 12 per cent. of the total number of inhabitants listen to the broadcast programmes.

The Grenoble PTT (France) broadcasting station has increased its power to 3 kilowatts and its signals are now well heard over a greater part of the United Kingdom.

Experiments have been conducted with ultra-short waves of from 1 to 6 metres, and it is believed that these very short wavelengths will play an important part in services such as directional beacons and messages to and from trains.

Each of the three hundred houses in the new suburb of Malpas, near Newport, Mon., has been provided with a mast and wireless aerial.

A NEW PORTABLE TYPE ELIMINATOR

TRANSPORTABLE set owners will be very interested to know that there is now on the market a portable eliminator which not only gives an adequate high-tension supply and allows the accumulator to be trickle charged, but which also gives free grid bias in an entirely satisfactory way. There was formerly no



This is the new Tannoy portable-type unit which gives grid bias as well as an H.T. and trickle-charging supply

type of portable set unit on the market which gives H.T., L.T., and grid bias supplies, and considerable interest, therefore, attaches to this new eliminator which is being manufactured by Messrs. Tannoy Products, 1-7 Dalton Street, W. Norwood, S.E.27. In any mains unit which gives grid bias, it has been usual either to incorporate a separate rectifier and smoothing circuit for the grid bias (which, of course, increases cost) or the bias has been obtained by means of a dropping

resistance on the negative side. This has the disadvantage of causing the bias value to vary with the anode current. A new idea has been developed and patented by Messrs. Tannoy Products, in which use is made of the trickle charging circuit for providing the grid bias. This new unit has three grid bias tappings, three fixed H.T. tappings and, of course, provision for trickle charging. The price is £4 15s.

HVJ1, Radio Citta del Vaticano is the official call sign of the new Vatican short-wave station recently erected at Rome. It is now testing daily on 19.84 metres and 50.26 metres with a power of 15 kilowatts in the aerial.

When Submitting Queries

Please write concisely, giving essential particulars. A Fee of One Shilling (postal order), a stamped addressed envelope, and the coupon on the last page must accompany all letters. The following points should be noted.

The designing of apparatus or receivers cannot be undertaken.

Modifications of a straightforward nature can be made to blueprints, but we reserve to ourselves the right to determine the extent of an alteration to come within the scope of a query.

Queries cannot be answered personally or by telephone.



GET YOUR COPY NOW!

12 TESTED SETS FOR YOU TO BUILD

Wiring guides and complete specifications of 12 sets and Mains Units, that cover every listening and gramo-radio need, are described in a 16-page Supplement included in the "WIRELESS MAGAZINE," now on sale, 1/-.

Some of the Other Features:

- Should the B.B.C. Jam Moscow?
- Five full-page Test Reports for Set Buyers
- W. James on "Power" Grid Detection
- A Radio Fan's Causerie
- Why not use a Tone Control? By J. H. Reyner.
- Making Records without an Amplifier
- A New System of Projected Television

- Is Television at a Standstill?
- Recognising German Broadcasts
- Full Instructions for Making:—
- An A.C. 2
- A Gramo-Radio 4
- A novel 3
- And a Short-wave Adaptor

WIRELESS MAGAZINE

Get your Copy of the February Issue
NOW ON SALE PRICE - 1/-

RI
Transformers and Chokes



THE HYPERMITE

NIKALLOY CORE TRANSFORMER

Gives the generous tone of deep bass and shrillest treble to reproduction. A marvel for its weight and size. Indispensable for efficiency in compact set assembly.

Primary inductance, OVER 50 HENRIES. Ratio, 3½-1. Weight, 7 oz. Walnut-finished bakelite case.

12/6

HYPERMU

Incontestably the best Transformer, with a guaranteed performance proved by N.P.L. curves and showing the most amazing handling of all frequencies between 25 to 7,000 cycles. Incorporates the famous NIKALLOY CORE.

21/-

Primary inductance, 85 henries. Ratio, 4-1. Weight, 13 oz. Black bakelite case.

IMPROVED G.P.

An improved model of the famous original G.P. Transformer, redesigned for use where space in set building need not be considered.

10/6

Ratio, 3½-1. Primary inductance, 35-40 henries; D.C. resistance; primary, 1,050 ohms; secondary, 6,600 ohms. Weight, 1 lb. 2 oz.

HYPERCORE

Gives unequalled brilliance of musical tone and finesse of sound detail to reproduction. The first NIKALLOY Choke for output filtering or smoothing.

17/6

Inductance, 30 henries. Maximum D.C., 80 milliamps. Weight, 18 oz. Walnut-finished bakelite case.

NEW G.P. CHOKE

For output filter smoothing or L.F. coupling (maximum D.C., 60 m.a.). A small general-purpose Choke for portables or receivers where space is limited.

12/6

D.C. resistance, 400 ohms. Inductance, 25 henries. Maximum D.C., 30-60 milliamps. Size, 2 in. by 2½ in. by 2½ in. high. Bright green bakelite case.

Buy **RI** they're **BEST** and cost no more

R.I. LTD., MADRIGAL WORKS, PURLEY WAY, CROYDON. Phone: Thornton Heath 321x

Mention of "Amateur Wireless" to Advertisers will Ensure Prompt Attention

Build an ALL-ELECTRIC

You can build an All-Electric Ether Searcher without altering a single connection on the Blueprint. The Six-Sixty A.C. All-Mains Conversion Equipment makes this possible. It supplies H.T. (200 volts), L.T. and Grid Bias from the Mains, and includes a set of the wonderful Six-Sixty A.C. Valves with their added range and power.

ETHER SEARCHER



You will soon save the small extra cost, because there are no batteries to renew or recharge, and all the time you will have the added efficiency and convenience of all-electric radio.

Write for FREE BOOK-LET giving full particulars of the Six-Sixty All-Mains Conversion Equipment and range of famous valves. A post-card brings it by return.

- COMPLETE KIT OF PARTS** as advertised elsewhere in this issue (Peto-Scott, Ready Radio, etc.) - £5 . 14 . 6
- Six-Sixty A.C. All-Mains Conversion Equipment (H.T., L.T. and G.B.) including 3 Six-Sixty Mains Valves - £9 . 3 . 6
- £14 . 18 . 0
- 3 Six-Sixty Valve Adaptors for A.C. Valves, if required - 6 . 0

SAY

SIX-SIXTY

(B.V.A. RADIO VALVES AND EQUIPMENT)

Six-Sixty Radio Co. Ltd., Six-Sixty House, 17-18, Rathbone Place, Oxford Street, London, W.1 Telephone: Museum 0118-7



Better than wire wound

OHMITE

Anode Resistance. All values, 100 ohms to 500,000 ohms.

2/3 each

MEGITE

Grid Leak. All values, 1 megohm to 5 megohms.

2/- each

Ohmite and Megite Resistances are constant in value, of negligible self capacity and non-inductive. Dead silent and always reliable they provide the most effective resistance on the market, giving the full range of values required. Supplied with vertical or upright holders of superior brown bakelite construction 6d. extra.

Graham Farish components carry a written guarantee of accuracy.

Ask your dealer to obtain or write direct to

GRAHAM FARISH

LIMITED, BROMLEY, KENT

BROADCAST TELEPHONY

Broadcasting stations classified by country and in order of wavelengths. For the purpose of better comparison, the power indicated is *aerial* energy.

Kilo-Metres	Station and Call Sign	Power (Kw.)	Kilo-Metres	Station and Call Sign	Power (Kw.)	Kilo-Metres	Station and Call Sign	Power (Kw.)
GREAT BRITAIN			NORTH AFRICA			NORTH AFRICA		
25.53	11,751 Chelmsford (G5SW)	15.0	294.6	1,018 Limoges (PTT)	0.5	302.4	825.3 Algiers (PTT)	13.0
200	1,500 Leeds	0.16	304	938 Bordeaux (PTT)	85.0	416	721 Radio Marco (Kabab)	10.0
242	1,238 Belfast	1.2	314.9	952.7 Natan-Vitus (Paris)	0.5	1,250	240 Tunis Kasbah	0.6
261.3	1,143 London Nat.	68.0	317.9	945.4 Marseilles (PTT)	1.5	NORWAY		
288.5	1,040 Newcastle	1.2	328.2	914 Grenoble (PTT)	3.0	235.5	1,275 Kristianssand	0.5
288.5	1,040 Swansea	0.16	329.5	910.3 Poste Parisien	1.2	241	1,244.5 Stavanger	0.5
288.5	1,040 Stoke-on-Trent	0.16	345.2	869 Strasbourg (PTT)	12.0	364	824 Bergen	1.0
288.5	1,040 Sheffield	0.16	370	810.5 Radio LL (Paris)	0.5	367.1	817.1 Frederiksstad	0.7
288.5	1,040 Plymouth	0.16	385	779 Radio Toulouse	15.0	453.2	662 Porsgrund	1.5
288.5	1,040 Liverpool	0.16	447	671 Paris (PTT)	2.0	494.2	607 Nidaros	1.2
288.5	1,040 Hull	0.16	466	644 Lyons (PTT)	2.3	544.7	513.2 Hamar	0.8
288.5	1,040 Edinburgh	0.4	1,445.7	207.5 Eiffel Tower	15.0	1,077	273.5 Oslo	75.0
288.5	1,040 Dundee	0.16	1,725	174 Radio Paris	17.0	POLAND		
288.5	1,040 Bournemouth	1.2	GERMANY			234	1,283 Lodz	2.2
288.5	1,040 Bradford	0.16	31.38	9,560 Zeesen	15.0	244	1,229 Cracow	1.5
301	995 Aberdeen	1.2	216.3	1,337 Königsberg	1.7	312.8	959 Wilno	0.5
309.9	968 Cardiff	1.2	219	1,369.7 Flensburg	0.6	338.1	887.1 Poznan	1.9
356.3	842 London Reg.	45.0	227	1,319 Cologne	1.7	381	788 Lvov	2.2
376.4	797 Manchester	1.2	227	1,319 Münster	0.6	400.8	732 Katowice	18.0
398.9	752 Glasgow	1.2	227	1,319 Aachen	0.3	1,411	212.5 Warsaw	14.0
479.2	626 Midland Reg.	38.0	232.2	1,292 Kiel	0.31	PORTUGAL		
1,554.4	193 Daventry (Nat.)	35.0	239	1,256 Nürnberg	2.3	240	1,250 Oporto (Teatro Apollo)	0.25
AUSTRIA			246.4	1,217.2 Cassel	0.3	320	937.6 Lisbon (CTIAA)	0.25
218.5	1,372 Salzburg	0.6	253.4	1,184 Gleiwitz	5.6	ROMANIA		
246	1,220 Linz	0.6	259.3	1,157 Leipzig	2.3	391	761 Bucharest	16.0
284.7	1,053.6 Innsbruck	0.6	269.8	1,112 Bremen	0.3	RUSSIA		
351.7	853 Graz	9.5	276.5	1,083 Heilsberg	75.0	426.3	703.7 Kharkov	4.0
453	666 Klagenfurt	0.6	283.0	1,058 Magdeburg	0.6	720	416.6 Moscow (PTT)	20.0
517	581 Vienna	20.0	283.0	1,058 Berlin (E)	0.6	800	375 Kiev	20.0
BELGIUM			283.0	1,058 Stettin	0.6	824	364 Sverdlovsk	25.0
206	1,456 Verviers	0.3	329.3	941 Dresden	0.3	937.5	320 Kharkov (RV20)	25.0
206	1,456 Antwerp	0.4	329.3	941 Breslau	1.7	1,000	300 Leningrad	40.0
216	1,391 Chatelineau	0.25	372	833 Mühlacker	75.0	1,065	281.7 Tiflis	15.0
243	1,235 Courtrai	0.1	372	806 Frankfurt	1.7	1,103	272 Moscow Popoff	40.0
244.7	1,226 Ghent	0.25	418	776 Berlin	1.7	1,200	250 Kharkov (RV4)	25.0
249.6	1,202 Schaerbeck	0.5	452.1	662 Danzig	0.2	1,304	230 Moscow (Trades Unions)	165.0
338.2	887 Velthem (Louvain)	15.0	473	635 Langenberg	17.0	1,380	217.5 Bakou	10.0
509	590 Brussels (No. 1)	15.0	533	563 Munich	1.7	1,481	202.5 Moscow (Kom)	20.0
BULGARIA			559.7	536 Kaiserslautern	1.0	SPAIN		
319	941 Sofia (Rodno Radio)	1.0	569.7	536 Augsburg	0.3	251	1,193 Barcelona (EAJ15)	1.0
CZECHO-SLOVAKIA			566	539 Hanover	0.3	268.7	1,116 Barcelona (EAJ13)	10.0
263	1,139 Moravska-Ostrava	11.0	570	527 Freiburg	0.35	349	860 Barcelona (EAJ1)	8.0
279	1,076 Bratislava	14.0	583.8	527 Zeesen	35.0	348	815 Seville (EAJ5)	1.5
293.6	1,022 Kosice	2.5	1,635	183.5 Norddeich	10.0	425.7	704.7 Madrid (EAJ7)	2.0
342	878 Brunn (Brno)	3.0	HOLLAND			453	662.2 San Sebastian (EAJ8)	0.5
487	617 Prague (Praba)	5.5	31.28	9,599 Eindhoven (PCJ)	30.0	SWEDEN		
DENMARK			299	1,004 Huizen	8.5	230.6	1,307 Malmö	0.75
281	1,067 Copenhagen	1.0	290	1,004 Radio Idzerda (The Hague)	0.6	257	1,166 Hörby	15.0
1,153	260 Kalundborg	10.0	1,071	280 Scheveningen-Haven	5.0	302.8	990.8 Falun	0.63
ESTONIA			1,875	160 Hilversum	8.5	322	932 Göteborg	15.0
401	748 Reval (Tallinn)	0.7	HUNGARY			436	689 Stockholm	75.0
462.1	649 Tartu	0.5	550	545 Budapest	23.0	542	554 Sundsvall	15.0
FINLAND			ICELAND			770	389 Östersund	0.75
221	1,355 Helsinki	15.0	1,200	250 Reykjavik	16.0	1,212	241.5 Boden	0.75
291	1,031 Viicuri	15.0	IRISH FREE STATE			1,348	222.5 Motala	40.0
1,706	167 Lahti	54.0	224.5	1,337 Cork (IFS)	1.5	SWITZERLAND		
FRANCE			413	725 Dublin (2RN)	1.5	244	1,229 Basle	0.5
172.5	1,730 St. Quentin	0.3	ITALY			403	743 Berne	1.1
222.0	1,346 Fécamp	1.0	25.4	and 80 Rome (3RO)	9.0	459	653 Zurich	0.74
225	1,337 Strasbourg 8GF	0.3	296.1	1,013 Turin (Torino)	8.5	678.7	454.6 Lausanne	0.6
235.1	1,275 Nimes	1.0	313.2	958 Genoa (Genova)	1.5	760	395 Geneva	1.5
237.2	1,263 Bordeaux-Sud-Ouest	2.0	332	905 Naples (Napoli)	1.7	TURKEY		
240.6	1,247 Béziers	0.6	441	680 Rome (Roma)	75.0	1,223	244.3 Istanbul	5.0
240	1,205 Juan-les-Pins	0.5	453	662 Bolzano (IBZ)	0.2	1,442	191.5 Ankara	7.0
256	1,171 Toulouse (PTT)	1.0	501	599 Milan (Milano)	8.5	YUGOSLAVIA		
265	1,130 Lille (PTT)	15.0	LATVIA			306	930.4 Zagreb (Agram)	0.7
272	1,103 Rennes	1.3	525	572 Riga	12.0	430.5	696.8 Belgrade	3.0
281.3	1,051.4 Radio Lyons	0.5	LITHUANIA			574.7	522 Ljubljana	2.8
286	1,049 Montpellier	2.0	1,935	155 Kaunas	7.0			

"The Practical Electrician's Handbook."—The 1931 edition of this handy pocket-book has just been published. Its 600 pages contain many practical articles and useful reference facts which any radio enthusiast who comes in contact with mains working in the installation of sets is bound to find helpful. Details are given of the current supply figures for every town of importance in the United Kingdom, and this section has been revised for the 1931 edition. An idea of the large number of facts contained in this pocket-book can be gained from the 20 pages which are devoted only to a detailed subject index, arranged in alphabetical order. It can be obtained, price 2s. 6d., post free, from the publishers of *Electrical Trading and Electricity*.

MAZDA VALVES FOR THE "1931 ETHER SEARCHER"

IT should be noted that, whereas on page 192 of AMATEUR WIRELESS No. 451, Ediswan valves are specified among those suitable for the "1931 Ether Searcher," the same types of Mazda valve should be used. The production of Ediswan valves has been discontinued for some time and Mazda valves represent the combined manufacturing and technical resources of the Edison Swan Electric Co., Ltd., the British Thomson Houston Co., Ltd., and Metropolitan Vickers Electrical Co., Ltd. For the "Ether Searcher" we recommend a Mazda 215SG valve for the screen-grid stage, an L210 for the detector, and a P220 for the power stage.



TRUE

NEEDLE TRACK

THE Watmel Pick-up carrier by its rigidity and accuracy of alignment ensures the electrical pick-up obtaining perfect amplification of the music *only*.

Reproduction is free from mush and needle scratch.

By use of the tracking template supplied, the Watmel Pick-up Carrier can be set affixed with great accuracy and the wear on the records is largely reduced.

PRICE 7s. 6d.

If you cannot get these Watmel products at your dealers, send remittance and order direct to us and the article will be dispatched by return.

THE WATMEL UNIVERSAL STANDARD ALUMINIUM SCREENING BOX

as specified for many of the popular receivers—

Size 6½" x 6½" x 6" with wooden box.

Price complete with screws etc. 4/6

Special type with valve screening, 5/-



Write for the Blueprints of the T.31 S.G. Imperial Three Receiver. A new highly selective wide-range set. Simple to construct and easy to operate.

FREE TO CONSTRUCTORS.



WATMEL WIRELESS CO., LTD., Imperial Works, High Street, Edgware

Telephone: EDGWARE 0323.

M.C.19

Drawn through a Diamond



ELECTRICALLY SPOT-WELDED HERE

NO stone, not even a diamond, is left unturned to ensure quality and efficiency in Bulgin wire-wound resistance links. Bulgin superiority is evinced in the following features :

- (1) ELECTRICALLY SPOT-WELDED to a copper connection as shown, ensuring a perfect permanent connection and correct resistance value.
- (2) FINEST NICKEL CHROME RESISTANCE WIRE of unusually heavy gauge, electrically and mechanically stronger.
- (3) Evenly Wound on Asbestos foundation with an overall of insulated varnished cambric, forming a perfectly flexible connection between components.
- (4) CONSERVATIVELY RATED. Will actually carry higher current than rated, with almost imperceptible temperature rise.
- (5) Sizes from 600 ohms 12 m/a at 9d. each to 100,000 ohms 2 m/a at 2/9 each.

A. F. BULGIN & CO., LTD.
9, 10, 11, CURSITOR STREET, CHANCERY LANE, LONDON, E.C.4



Phones :
HOLBORN
3072, 2072



Write for 60 page ILLUSTRATED CATALOGUE.

The Choice of Critics

RELIABLE RESISTANCE LINKS

Conservatively rated — cannot be overrated

CLIX

Specified for the

"20/- TWO"

CLIX VALVEHOLDER

Built for Efficiency

Not for appearance.

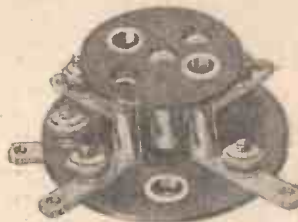

No. 27. Pro. Pat. Reg. Design.

CLIX VALVEHOLDER

Type B for baseboard mounting.

- 4-pin Model with screw terminals 10d.
- 4-pin Model without screw terminals 8d.
- 5-pin Model with screw terminals 1/-
- 5-pin Model without screw terminals 9d.



"FIT-ALL" SPADE TERMINAL

No. 3. Pat.

Fits all sizes of screw terminals. Lead-coated for L.T., Nickel-plated for general use. Insulators, red or black; Engraved or plain. Price, 2s.

Incorporates Clix Resilient Sockets which are the only means of obtaining perfect contact with SOLID or any other type of valve pin. Easy insertion and withdrawal of valve. Sockets air-dielectrically insulated and self-aligning.

An International Radio Gold Medalist says:—"The losses in your Valve-holder, owing to its air spacing, are even smaller than the average Valve Base; also the capacity is greatly reduced."

Fully descriptive Clix leaflet on request.



RING TERMINAL

No. 5. Pat.

The perfect fitment for permanent contact. Lead-coated for L.T.; Nickel-plated for general use. Insulators, red or black; engraved or plain. Price, 2d.

LECTRO LINX Ltd.

254, Vauxhall Bridge Road, S.W.1

Please Mention "A.W." When Corresponding with Advertisers

BUYING A PICKUP

Yours
for
16/-



The moulded case now available in a range of attractive colours with grained finish.

Everybody appreciates the vast improvement in gramophone music when an electrical pick-up is used. Let us assist you to decide on the most satisfactory one for the job. First choose a well-balanced unit, one with the correct weight of 5½ ozs. Then be sure its reproduction curve gives even response on all frequencies. Maximum volume consistent with tonal value is the quality that only a demonstration can give. Such features as these cover the requirements of the ideal pick-up, and when the price is as moderate as 16/- your choice is made up. When making your selection see that you are given a demonstration of the *Wates Star Pick-up*—its perfect tonal quality is a delight to hear.

WATES GRAMOPHONE PICK-UP

Sold by all Radio dealers in the new range of attractive colours complete with simple fixing instructions. *Wates Pick-Up Arm 5/- extra.*

Leaflets from:

THE STANDARD BATTERY CO.
Dept. A.W.
184/188 Shaftesbury Avenue, London, W.C.2

REPAIRS ANY MAKE

of L.F. Transformer, Loudspeaker (except Blue Spot) or Headphones repaired and despatched within 48 HOURS. **TWELVE MONTHS' GUARANTEE** with each repair. 4/- Post Free. *Cash with Order.*

Terms to Trade.

TRANSFORMER REPAIR CO.

Dept. S.953,
GARRATT LANE,
LONDON, S.W.17.

LET "A.W." SOLVE
YOUR WIRELESS
PROBLEMS

TELEVISION IN THE STATES

ALTHOUGH there have been no important announcements concerning American television for some time there is no doubt but that engineers associated with the major broadcasting companies are spending considerable time and money on the problem. It is quite probable that several of the companies are more advanced in their television experiments than they care to say, reserving announcements until some definite concert results have been obtained.

The National Broadcasting Company has licences for experimental work on television and a licence for experimental work has been requested of the Federal Radio Commission by the Columbia Broadcasting System. The N.B.C. for some time past has had an experimental television station in operation in the heart of New York City.

Television in the home has been stated by various American engineers to be from three to five or more years away. Such estimates are, of course, based on the idea that development work will progress along certain definite lines.

There are, of course, a number of stations broadcasting experimental television programmes; regular programmes are transmitted by the Jenkins Television Corp. in New Jersey and from W9XAP, the television station of WMAQ, Inc., operated by the *Chicago Daily News*. The president of WMAQ says that with the large photo-cells they intend to use it will be possible to transmit full length views of actors, instead of just a head and shoulders.

All television licences issued by the Radio Commission are granted on a temporary experimental basis. The Commission is believed to be interested in television development, but also believes that sufficient public interest has not been created to grant permanent licences on the basis of "public interest, convenience and necessity."

Television experimental work in the large laboratories evidently has two aims in view. One is to develop television as a means of home entertainment, using simple but effective apparatus. The other aim is to develop television for the theatre, so that television images may be presented on the stage. **B.**

On January 1 last the number of German licences reached the high figure of 3,509,509, or an increase of 442,827 during a period of twelve months.

"Amateur Wireless and Radiovision." Price Threepence. Published on Thursdays and bearing the date of Saturday immediately following. Post free to any part of the world: 3 months, 4s. 6d.; 6 months, 8s. 9d.; 12 months, 17s. 6d. Postal Orders, Post Office Orders, or Cheques should be made payable to "Bernard Jones Publications, Ltd."

General Correspondence is to be brief and written on one side of the paper only. All sketches and drawings to be on separate sheets.

Contributions are always welcome, will be promptly considered, and if used will be paid for.

Communications should be addressed, according to their nature, to The Editor, The Advertisement Manager, or The Publisher, "Amateur Wireless," 58-61 Fetter Lane, London, E.C.4.

GAS-OHMS Are Better

Why use wire-wound or spaghetti resistances? Use the new Gas-ohms, they carry 2½ times the load of ordinary resistances, guaranteed to be accurate within 5%, non-hygroscopic, and are recommended for heavy duty work. The leading set manufacturers are already changing over to Gas-ohms—so should you.



½ watt 1/8 all values from 1,000 ohms to 10 megohms.
1½ watt 2/- " " " 1,000 ohms to 1 m. gohm.
4 watt 4/- " " " 1,000 ohms to 100,000 ohms.

Sold by all reputable dealers.

Write for details of current carrying capacities.

ROTOR ELECTRIC

LIMITED,
2-3 Upper R. thbone Place,
London, W.1.

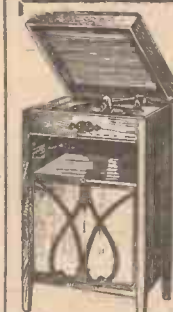

KAY'S CABINETS "THE INVICTA" RADIO GRAMOPHONE CABINET

For Panels 18" x 7". Removable Motor Board for 12" Turntable with 3½" clearance for Pick-up, and 4½" clearance for Motor. Speaker Chamber 18" square with artistic Grille front, and independent 7-ply inner Baffle; hole cut to requirements. The whole of back of Cabinet is removable. Height 39", width 21", depth 16". Specially constructed of Oak, and polished Jacobean shade. A wonderful example of value 45/- Returnable crate 6/- Price 45/-

Illustrated Lists of 60 Cabinets FREE.

H. KAY, Cabinet Manufacturer, Mount Pleasant Road, LONDON, N.17. Phone: Walthamstow 1626

SAVE! 50%

Buy your Radio Cabinets direct from the makers and save 50%. All our cabinets are made by skilled British labour in our own workshops and guaranteed to give satisfaction or cash returned.

- 14 in. x 7 in. x 8 in. 9/6
- 14 in. x 8 in. x 8 in. 9/6
- 16 in. x 8 in. x 8 in. 10/6
- 16 in. x 8 in. x 9 in. 10/6
- 18 in. x 7 in. x 10 in. 11/5
- 21 in. x 7 in. x 10 in. 12/6

HOLID OAK Hand French Polished. Tongued and Grooved lid. American open top type. All 1½ in. opening at back. Complete with baseboard Carriage and packing 1/6 extra. Prompt delivery. Other sizes and designs made to order. Also specialists for combined radio and loud-speaker cabinets. Prices on application. Handcrafts Agent.

REDRUP & SONS, Cabinet Works,
199-203 Fawcett Road, Southsea, Portsmouth

DOES YOUR SWITCH SPINDLE TURN ROUND?



IF SO, YOUR SET
"CRACKLES!"

By FITTING A

"BUSCO" SWITCH

your trouble is ended because there is no contact point to turn round, and when you "switch on" you have contact like a power switch.

WHY NOT FIT ONE?

They are as cheap as the inferior type but far superior in operation. From your local dealer, or

1/3
each

Patents
Pending



BUSBY & CO., LTD. (Patentees)
Dept. A.W., PRICE ST., BIRMINGHAM

COLUMBIA

RADIO BATTERIES

NOW COST LESS

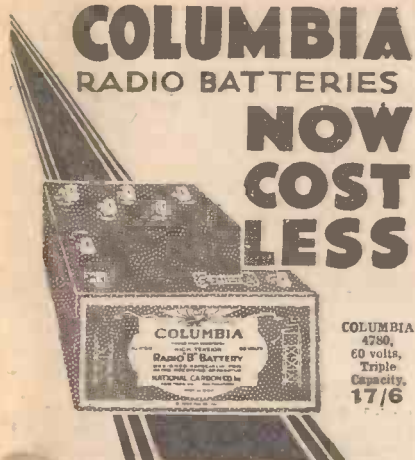

COLUMBIA 4780
60 volts, Triple Capacity, 17/6

Columbia radio batteries are still more economical now. The Columbia 4780 (60 volts Triple Capacity) costs only 17/6, though it outlives three ordinary batteries. More power for every penny; pure trouble-free reception night after night, without a suggestion of background. Say to your dealer—COLUMBIA 4780.

If your dealer has not Columbia, in stock, send to us, giving his name:

Columbia

RADIO BATTERIES

J. R. MORRIS, Imperial House,
15 Kingsway, London, W.C.2.

Scotland: J. T. Cartwright, 3 Cadogan St., Glasgow.



WHEEZY!

Asthmatic reproduction occurs when your valves lose their emission. Preserve your filaments from disintegration by mounting them in Benjamin sprung valve-holders. BENJAMIN remember!

Write for Catalogue 1149.

The BENJAMIN ELECTRIC LTD.
Tarriff Road, Tottenham, N.17.
Tottenham 1500



TAYLEX WET H.T. BATTERIES
New Prices: Jars 1/3. Sees 1/2. Zincs 1 Od. Sample doz. 18 Volts complete with bands and electrolyte 4/1 post 9d. Sample unit 6d. Illus. booklet free. Bargain list free.
AMPLIFIERS, 3/1/- 3 VALVE ALL-STATION SET 5/-
A. TAYLOR, 57, Studley Road, Stockwell, LONDON.

FULL-SIZE BLUEPRINTS

When ordering, please send Postal Order, NOT STAMPS.

CRYSTAL SET (6d. each)

Regional Crystal Set	WM176
ONE-VALVE SETS (1s. each)	
Monodyne	AW258
One Control One	AW267
Hartley Single-valver	WM198
TWO-VALVE SETS (1s. each)	
Talisman Two (D, Trans)	AW194
No-battery A.C. Mains Two (D, Trans)	AW230
No-battery Gramo-radio 2 (D, Trans)	AW238
1930 Talisman 2 (D, Trans)	AW239
Searcher Two (D, Trans)	AW245
Arrow Two (D, Trans)	AW249
Forty-five-shilling Two (D, Trans)	AW250
Searcher Short-wave 2 (D, Trans)	AW259
Challenge Two (D, Trans)	AW261
Loftin-White Two (A.C. Mains)	AW263
Everybody's All-in 2 (D, Trans)	AW273
Twenty-Shilling Two (D, Trans)	AW274
Brookman's Two (D, Trans)	WM168
Cleaner Two (D, Trans)	WM201
Music Monitor (D, Trans)	WM208
Merlin Two (A.C. Set)	WM213
Five-Point Two (D, Trans)	WM220
Brookman's A.C. Two (D, Trans)	WM225

THREE-VALVE SETS (1s. each)

Best-by-Ballot Three (SG, D, Trans) Price 4d. free with copy of "A.W."	AW217
1930 Clarion Three (SG, D, Trans)	AW223
Beginner's Regional Three (D, 2LF)	AW233
Britain's Favourite Three 1930 (D, 2 Trans)	AW243
The "A.W." Exhibition 3	AW247
Push-Pull "Two" (D, Push-Pull)	AW270
1931 Ether Searcher (SG, D, Trans)	AW271
Brookman's Three (SG, D, Trans)	WM161
Brookman's Push-Pull Three (SG, D, Trans) 1/6	WM170
Inceptordyne (SG, D, Pentode)	WM179
Brookman's A.C. Three (SG, D, Trans) 1/6	WM184
Music Marshal (D, 2 Trans)	WM190
Concert Three (D, 2 Trans)	WM199
De-Luxe Three (D, RC, Trans)	WM209
Five-Point Three (SG, D, Trans)	WM217
Falcon Three (A.C. Set)	WM217
New Brookman's Three (SG, D, Trans)	WM218
Five-point Short-waver (D, RC, Trans)	WM223
Baffle Board Three (D, RC, Trans)	WM226

FOUR-VALVE SETS (1s. 6d. each)

Horizon Four (SG, D, 2 Trans)	AW237
Challenge Four (2SG, D, Trans) with copy of "A.W." 4d. post free	AW251
Challenge Four (2SG, D, Trans, mains operated) with copy of "A.W." 4d. post free	AW252
Challenge Radio Gramophone (SG, D, RC, Trans)	AW265
Brookman's Four (2SG, D, Trans)	WM174
Lodestone Four (HF, D, RC, Trans)	WM193
Searcher's Four (SG, D, RC, Trans)	WM194
Regional Band-pass Four (SG, D, RC, Trans)	WM121
Five-Point Four (SG, D, RC, Trans)	WM216
Regional A.C. Four (SG, D, RC, Trans)	WM222
Supertone Four (SG, D, Push-pull)	WM227

FIVE-VALVE SETS (1s. 6d. each)

James Quality Five (2SG, D, RC, Trans)	AW227
All-wave Lodestone Five (HF, D, RC, Push-pull)	WM146
1930 Five (2HF, D, RC, Trans)	WM171
Dual-screen Five (2SG, D, RC, Trans)	WM185
Radio-Record Five (SG, D, Trans-parallel)	WM188
Overseas Five (3SG, D, Trans)	WM191
Regional A.C. Five (3SG, D, Trans)	WM224

SIX-VALVE SET (1s. 6d.)

Hyperdyne Receiver (Super-het)	WM221
--------------------------------	-------

PORTABLE SETS

Continental Portable (SG, D, Trans)	AW241	1/-
Pedlar Portable Two (D, Trans)	WM195	1/-
Pedlar Portable Three (D, 2 Trans)	WM197	1/-
James Portable SG3 (SG, D, Trans)	WM203	1/-

AMPLIFIERS (1s. each)

"A.W." Gramophone Amplifier	AW205
Two-valve Amplifier	AW216
"Mag" Gramo Unit	AW224
Simple Gramophone Amplifier	AW257
Radio-Record Amplifier (DC Mains)	WM183
Selecto Amplifier (HF, Unit)	WM210

MISCELLANEOUS (1s. each)

Simplest H.T. Unit	AW197
By-pass Unit (Wavetrap) with copy "A.W." 4d.	AW218
"Twin" Brookman's By-pass (6d.)	AW222
James H.T. and L.T. Charging Unit	AW232
Simplest H.T. Eliminator for D.C. Mains	AW234
Choke Output Unit	AW240
Simple Tester Unit (6d.)	AW246
"A.W." Improved Linen-diaphragm Speaker	AW248
Handy L.T. and G.B. Unit for A.C. Mains	AW254
Ohmic-coupled DX Unit	AW255
Novel Linen-Diaphragm Speaker	AW260
Our H.T. Unit for A.C. Mains	AW262
Gramophone Tone Control	AW264
Challenge Radiogram, Turntable Layout	AW266
Short-wave Super-het Adaptor	AW268
H.T. Unit and Trickle Charger for D.C. Mains	AW272
Universal Push-pull Amplifier	WM204
"W.M." Standard A.C. Unit	WM214
"W.M." Standard D.C. Unit	WM215
Falcon A.C. Unit	WM219
Hyperdyne Short-wave Adaptor	WM228

Copies of the "Wireless Magazine" and of "Amateur Wireless" containing descriptions of any of these sets can be obtained at 1s. 3d. and 4d. respectively, post free. Index letters "A.W." refer to "Amateur Wireless" sets and "W.M." to "Wireless Magazine".

Amateur Wireless Blueprints Dept., 50-51 Fetter Lane, London, E.C.4.

HERE IT IS

a NEW Mains Unit

(Prov. Patented)

For A.C. MAINS

HIGH TENSION

150v. at 15 m. a. ALSO S.G. and DET. TAPPINGS.
or
120v. at 20 m. a.

GRID BIAS

3 Tappings up to 14v Independent of H.T.

LOW TENSION

2, 4 or fv. Trickle Charger

(full-wave Westinghouse Rectifier)

£4.15.0

The ONLY mains unit for portables incorporating independent Grid Bias.

TANNOY

PRODUCTS

Dalton St., West Norwood

FOR EVERY SOCKET AND EVERY POCKET



Patent

Belling-Lee "Midget" Wander Plug 2d.

Standard Wander Plug 3d.

2 only

The new Belling-Lee "Midget" Wander Plug. Smaller than the standard model and a penny cheaper. Fits in the most confined spaces. Its powerful 3-prong spring contact adapts itself to any battery socket and grips it firmly.

Side entry: the whole flex gripped, wire, rubber and fray. Head clearly engraved in 12 different letterings.

Write for FREE Belling-Lee Handbook "Radio Connections" (2nd Edition).

BELLING-LEE FOR EVERY RADIO CONNECTION

Advertisement of Belling & Lee, Ltd., Queensway Works, Ponders End, Middlesex.

E.V.9.

You will Help Yourself and Help Us by Mentioning "A.W." to Advertisers

NEW SETS FOR OLD!!

YOUR PRESENT SET TAKEN IN PART EXCHANGE. SEND FOR FULL DETAILS 1931 CATALOGUE FREE TO CALLERS :: ::

WILL DAY LTD.
19 LISLE STREET, W.C.2
REGENT 0921-22

MAKE OR BUY A GRAMOPHONE AT



a quarter shop prices. Or buy Cabinets for Wireless. British double spring motor, 12in. velvet turntable, swan arm, metal sound-box, amplifier, needle cups, for £1-16-0 p.p., and build your own Cabinet. Portable Gramophones from 15/6; postage 1/6. Motors from 7/6. Lists free. 64 pp. 1931 Catalogue No. 220 with Reduced Prices, Drawing and How to Make Gramos, 3d. Established 27 years.

Regent Fittings Co., A.W. 120 Old St., London, E.C.1

High-Grade SET & SPEAKER CABINET
Constructed of finely figured Oak on carved ball and claw legs, hand french polished.
THE ACME OF CRAFTSMANSHIP
£8 8 0, carriage paid.
RADIO-GRAMOPHONE CABINET
£10 10 0, carriage paid.
Cabinets made to order a speciality. Thirty-page illustrated catalogue, post free.
GILBERT, Cabinet Maker.
Established 1898. SWINDON.



MAGNUM
ALL THAT IS BEST IN RADIO COMPONENTS SETS ETC.
BURNE-JONES & CO. LTD.
29, BORO' HIGH ST., LONDON, E.C.1



YOU CAN BUILD A £40 GRAMOPHONE WITH OUR SCALE DRAWINGS FOR 40/-
Book of Instructions 3d. Catalogue of Motors, Tonearms, Soundboxes, latest internal amplifiers Gramophones and Cabinets Free. Cash or Terms.
W. BURT, 185 High St., Deptford.

DX THE STANDARD PLUG-IN COIL
Sold everywhere from 1/-
DX COILS Ltd, London, E.8

RELIABILITY WIRELESS GUIDE N° 295X
Review No. 185. "Amateur Wireless," Jan. 24. "You should get a copy of this Guide before buying any apparatus for that new set." Write NOW to:
J.H. TAYLOR & CO
3, Radio House, MACAULAY STREET
HUDDERSFIELD, Phone 341.

TEST YOUR SET WITH SAFETY AND SAVE YOUR VALVES
EELIX
TESTING PRODS 3/6 per pair.
List J.8.
J. J. EASTICK & SONS,
118 Bunhill Row, London, W.C.1

ELECTRADIX BARGAINS MICROPHONES For Home Recording



Sensitive Solo Pendants in cast metal case with cord 4/6. Pulpit Pedestal 12/6. Ring Pedestal Broadcaster 18/6. Hand W/T Mikes, 15/-. Powerful Public Address Mikes, 5/6 and 65/-. Western Electric £28. Transformers, Microphones, Couplers, Valve Amplifiers for Band Repeats or Field P.A. work.

Switchgear. Our enlarged Switchboard department can now build anything to specification up to 100 ft. long. Send us your enquiries for METERS, Portable, Laboratory or Switchboard, A.C. and D.C. RELAYS for all purposes, battery cut-outs for automatic safety. **Dynamos; 4 volts to 4,000 volts D.C. Alternators; 10 volts to 10,000 volts A.C. Motor Generators, and Converters of all sizes.**

DIX-ONEMETERS are now 50/- only, a remarkably small price for a meter worth £10 in comparison with others.

Latest Model. Mirror Double Scale, Moulded Base. The finest Precision Multi-Measuring instrument is the DIX-ONEMETER, the acknowledged Radio Standard beloved by Expert and Amateur.

Test Booklet "A" Free.

ELECTRADIX RADIOS
218 Upper Thames Street, E.C.4.
Telephone: City 0191.

EVERYMAN'S WIRELESS

By Ernest H. Robinson (5 Y.M.)

A handy book telling in plain, non-technical language all that the average man needs to know about Wireless.

CASSELL'S 3/6 net

THE AMAZING PANTHEON (Regd. Design). A Magnificent Three-valve Receiver built to fine limits by experienced craftsmen. Incorporates screened detector circuit, two famous Ferranti transformers, Ormond geared log condensers, and the coil of coils. Variable selectivity control. Distinctive and sensible oak cabinet. Price, ready for use, £3 10s., carriage paid. Every instrument thoroughly tested on aerial. Written 12 months' guarantee. Better than most sets costing twice as much. Exceptional value for money. Obtainable only from the designer and manufacturer: **H. Panagakis, A.M.I.R.E., Manufacturing Radio Engineer.** Works and Research Dept., 91 Dale Street, Liverpool.

WE WILL ACCEPT YOUR SURPLUS APPARATUS (making you a high allowance) in part payment for any new apparatus; your inquiry will be dealt with promptly—**Bostock & Stonnill, 1 Westbourne Terrace, S.E.23.**

NEW "DETEX" GOODS.—Radiograms, £16 16s. Fireside Five Portables, £8 8s. (from stock). Electrostatic Pick-up and Tonearm, 15/6. Magna-Static Speaker Units, 7/6. Used goods: 1930 Demonstration Corsor All-electric (230 volt, 50 cycle), £10 10s. Two "Servis" Threes, complete, £4 17s. 6d. each. Siemens' Phones, 3/6 pair.—Harris, "Detex" Stockist, Trowbridge.

IGRANIC SEVEN-VALVE SUPERSONIC, perfect order. Frame Aerial, Eliminator, etc. Cost £65; sell £22.—1 Cranhurst Road, N.W.2.

LET "A.W." SOLVE YOUR WIRELESS PROBLEMS.

PREPAID ADVERTISEMENTS

Advertisements under this head are charged **THREEPENCE PER WORD**, minimum charge **THREE SHILLINGS. DEPOSIT SYSTEM**

As the Publishers cannot accept responsibility for the bona fides of advertisers in this publication, they have introduced a system of deposit which it is recommended should be adopted by readers when dealing with persons with whom they are unacquainted. It is here explained. Intending purchasers should forward to the Publishers (the amount of the purchase money of the article advertised. This will be acknowledged to both the Depositor and the Vendor, whose names and addresses must necessarily be given. The deposit is retained until advice is received of the completion of the purchase, or of the article having been returned to and accepted by the Vendor. In addition to the amount of the Deposit, a Fee of 6d. for sums of £1 and under, and 1s. for amounts in excess of £1, to cover postage, etc., must be remitted at the same time. In cases of persons not resident within the United Kingdom double fees are charged.

The amount of the Deposit and Fee must be remitted by Postal Order or Registered Letter (Cheques cannot be accepted), addressed to

"AMATEUR WIRELESS" ADVERTISEMENT DEPARTMENT
8/61 FETTER LANE, LONDON, E.C.4

AGENTS, DEALERS, SET-MAKERS—Write now for particulars of our unique system of trading. Deliveries on time guaranteed. Thousands of lines catalogued.—**Brookman Rapid Radio Service, 105 Spencer Street, Birmingham.**

WIRELESS BARGAINS.—Three-valve brand new Portable Sets, best makes, from £5 19s. cash or 14/6 with order. Three-valve Sets, complete, 63/- or 7/3 with order.—Below Send to Fosters for latest Bargain List of Wireless Sets, etc.—Fosters (Highbury), Ltd., 74 Highbury Park, Highbury Barn, London, N.5. Phone: North 4430.

ENGINEERS.—IMPORTANT NOTICE.—After months of intensive effort and research work we are pleased to announce that our new handbook is now out of the publishers hands, and ready for distribution. Three times larger than any previous edition, this book is beyond argument the finest and most complete handbook on Engineering Careers ever compiled. It is a book that will soon be on the bookshelf of every ambitious engineer, whatever his age, position or experience. The book contains, amongst other intensely interesting matter, details of B.Sc., A.M.I.C.E., A.M.I.Mech.E., A.M.I.E.E., A.M.I.A.E., A.M.I.Struct.E., M.B.San.I., L.L.O.B., F.S.I., G.P.O. C. & G., and every other important Engineering Examination, outlines Courses in all branches of Civil, Mechanical, Electrical, Motor, Wireless, Aeronautical, and Talkie Engineering, and explains the unique methods of our Appointments Department. We alone guarantee "NO PASS—NO FEE." The New "ENGINEERING OPPORTUNITIES" is bound to create a mild furor in Engineering circles. See that you get your copy by writing to-day—FREE and POST FREE. (State subject of Exam. of interest.)—**BRITISH INSTITUTE OF ENGINEERING TECHNOLOGY, 109 Shakespeare House, 29/31 Oxford Street, W.1.**

BRYCE'S RENOWNED MAINS TRANSFORMERS. To suit all "Amateur Wireless" circuits. Fully guaranteed for efficiency and regulation. Included in All-mains sets and H.T. eliminators of repute. Type AB.64: Output, 250-0-250 v. 60 m.a., 2-0-2 v. 1 A., 2-0-2 v. 3 A., 3-0-3 v. 1 A. Price 25/6, post free. Write now for illustrated lists.—Bryce's, Trans. Dept., Dawson Street, Bury, Lancs.

WIRELESS.—Laquer Speaker Cabinets, 5/-; postage, 6d.—M. S., 145 High Holborn, London, W.C.2.

"INTRODUCTION TO WIRELESS TELEGRAPHY AND TELEPHONY," by Sir Ambrose Fleming. Is a clear and reliable guide to general principles for every reader; illustrated, 3/6 net, from a bookseller, or Pitman's, Parker Street, Kingsway, W.C.2.

UNWANTED RADIO PARTS, in good order, taken in part payment for brand new. State lowest price acceptable for your goods and exactly what new goods are required. Parts bought for cash, if lowest price stated.—**Ryalls Radio Office, 182 Kennington Road, London, S.E.11.**

VERT WIRING CLIP. No soldering. Tested and approved "Amateur Wireless." Samples 3d. and stamped envelope. Half gross, 2/- (sufficient for three-valve set).—**Green & Sons, Reddlyffe, Horley, Surrey.**

PERSONS REQUIRED IMMEDIATELY to make Leather Matting. Regular work supplied. Cash paid weekly. Send P.C. for particulars to E., 87, "Everlast" Leather Matting Co., Wellingborough.

CHARGE YOUR H.T. FROM YOUR L.T. AT HOME. Reliable, convenient, effective, economy, 75% good reception. Equipment, hydrometer and diagram complete. 60 volts 7/6. 120 volts 10/6. Diagram with Hydrometer 2/6.—**B. Fox, 188 Camberwell Grove, S.E.5.**

BIRMINGHAM'S WIRELESS DOCTOR, R. E. Summerfield, member R.S.G.B., will call and cure your set; sets overhauled; any component supplied; 20 miles radius.—1 Newhall Street, Birmingham.

WIRELESS PARTS AND SETS exchanged for new, up to 50% or more allowed for modern parts if in good condition. Apparatus can be sent for valuation. **W. Burns, Wireless Factor, 4 Loanda Street, Haggerston, E.8.**

TRICKLE CHARGERS, A.C. mains, for 2- and 4-volt accumulators, 0.5 amp.; no upkeep, 18/6, carriage paid.—**A. Benoit, 4 Manor Gardens, Gunnersbury Avenue, London, W.3.**

Amateur Wireless COUPON Available until Saturday FEBRUARY 21, 1931

PURITY

POWER

PUNCH

**FROM YOUR LOUD-SPEAKER
IF YOU USE**

CARLTON

**LONG LIFE · LOW PRICE
RADIO BATTERIES**

Absolute efficiency in working is the secret of the Carlton popularity—each battery carefully manufactured of the finest materials and thoroughly tested.

You get remarkable value in Carlton; give it a trial and get radio satisfaction.

- 60 Volts (reads 66) 6/-
- 100 Volts (reads 108) 10/-
- 120 Volts - - 11/9

If any difficulty in obtaining write the Manufacturers for name of nearest dealer.

VINCE'S DRY BATTERIES LTD.
LION WORKS, GARFORD STREET,
LONDON, E.14



**TRY A
CARLTON
NEXT TIME**

**TELLING THE
TRUTH ON A
CONDENSER**



**Test Voltages or
Working Voltages?**

SOME condensers are marked in a misleading manner. They indicate test voltages, which are obviously so much higher than actual working voltages, you may believe you are buying more efficient and better insulated condensers. This is not necessarily the case. The old idea that the continuous working voltage of a condenser was half its stated test voltage cannot now be relied upon, for Condensers of similar capacity and size have been sold stamped with varying test voltages, but with no indication of the working voltage. Do not take risks, therefore. See that the condensers you buy are definitely marked with their maximum working voltage. You will always find this on

**TCC
CONDENSERS**

TELEGRAPH CONDENSER CO. LTD. N. ACTON. W.3

7618

Please Mention "A.W." When Corresponding with Advertisers



...CHECKMATE

the source of

TROUBLE

Fit Fotos valves in your receiver and eliminate a possible source of trouble, for Fotos are the valves with a pedigree. Tested to the utmost under strenuous conditions before leaving the factory, Fotos are made to give you faithful, lasting service.

Enquire for particulars of the new range of 25 Fotos valves. A valve to suit every requirement, every receiver.

PRICES
FROM
5'6

Inform us if your local dealer does not stock them.

fotos
CONCERT VALVES
Trade Mark
THE HEART OF EVERY SET



CONCERTON RADIO & ELECTRICAL CO., LTD., 256/7 Bank Chambers, 329 High Holborn, W.C.1 Phone: Holborn 8667

Printed in England. Published by Bernard Jones Publications, Ltd., 58/61 Fetter Lane, London, E.C.4.
Sole Agents for South Africa: CENTRAL NEWS AGENCY, LIMITED. Sole Agents for Australasia: GORDON & GOTCH, LIMITED. Saturday, February 14, 1931.