

LOUD-SPEAKER ADJUSTMENTS THAT ARE WORTH WHILE

# Amateur Wireless

Every Thursday 3<sup>d</sup>  
and  
Radiovision

Vol. XVII. No. 423

Saturday, July 19, 1930



A "TWO" for  
RANGE  
&  
POWER

FULL  
WORKING  
DETAILS

The 1930 TALISMAN 2

# THE WIZARD OF WIRELESS



## The LEWCOS SUPER COIL

Superior to any other make the Super Coil is one of the greatest of "LEWCOS" achievements and constitutes a natural and inevitable bridge between transmissions and efficient reception.

A descriptive leaflet, Ref. R.34, giving details of its advantages over other makes will be sent on request.

The fine materials and high-class workmanship used in the manufacture of the Lewcos H.F. Choke make it supreme. The terminals are placed one at the top and the other at the base of the coil to eliminate the risk of additional self-capacity in the wiring of the receiver.

"Its design places it in the front rank of high-class components," writes Industrial Progress (International) Ltd., of Bristol.

A fully descriptive leaflet, Ref. R.33, giving tested values will be sent on request.



The LEWCOS H.F. CHOKE



GLAZITE is 6d. Per 10 ft. Coil and is Not Genuine Unless Made by LEWCOS.

THE LONDON ELECTRIC WIRE COMPANY AND SMITHS LIMITED  
CHURCH ROAD, LEYTON, LONDON, E.10



# LEWCOS



## RADIO PRODUCTS

- Stocks held at the following Branches—
- BELFAST
  - BIRMINGHAM
  - CARDIFF
  - DUBLIN
  - GLASGOW
  - LEEDS
  - LIVERPOOL
  - LONDON
  - MANCHESTER
  - NEWCASTLE
  - NOTTINGHAM

# Amateur Wireless and Radiovision

The Leading Radio Weekly for the Constructor, Listener and Experimenter

Editor:  
BERNARD E. JONES

Technical Editor:  
J. H. REYNER, B.Sc., A.M.I.E.E.

Research Consultant:  
W. JAMES

Assistant Editor:  
H. CORBISHLEY

## Do Land-lines Distort?—The B.B.C.'s Reply—N.B.C. Takes 5SW—More "Mike" Plays—A Revue Encore—A Radio Romance—1930 "Proms"

**Do Land-lines Distort?**—According to an AMATEUR WIRELESS correspondent they do; he says: "The quality of the average land-line transmission not merely disappoints the ordinary music-lover, but positively sets his teeth on edge!" He refers to the Birmingham studio relays by the regional transmitter at Brookman's

weeks the complaints relating to land-lines were considerably less than one per cent. of all technical correspondence from listeners." We ourselves are inclined to suggest that the distortion sometimes very evident to London listeners taking Birmingham relays is probably due to the poor studio balance of the provincial centre. Sometimes, too, the control man up there seems to be guilty of "blasting," especially during vaudeville relays.

**N.B.C. Takes 5SW**—Following a very successful relay by the National Broadcasting Company of America of the Prince of Wales's speech at the dinner of the National Union of Students, we understand the Americans propose to try again on July 18, for a symphony concert, and on July 22 for the Inverness Gaelic choir from Aberdeen. Our 5SW comes in very well in New York, where the interest in relaying British programmes is considerably greater than most of us imagine.

**More "Mike" Plays**—From the Geneva office of the International Broadcasting Union we hear that during the months of February, March and April of this year, over 240 plays were broadcast by the European broadcasting stations. Of these, it is interesting to note that ninety plays were specially written for broadcasting, the remainder being adaptations.

**A Revue Encore**—So great was the success of Philip Ridgeway's "1930 Revue" that a repeat performance is now being rehearsed for August 22. The author's ability to look into the future evidently created a big impression, for the day after the broadcast he was approached by the secretary of the "To-morrow Club"!

### PRINCIPAL CONTENTS

	Page
Current Topics	49
Does Your Loud-speaker "Zizz"?	50
Points About Power Valves...	51
Around the Short-wave Dial	52
Without Fear or Favour	53
More About the Loftin-White Circuit	54
On Your Wavelength	55
Your Valves—How to Choose and Use Them	57
My Wireless Den	59
Building the "1930 Talisman 2"	60
Continental Nights	62
"A.W." Tests of Apparatus	64
The Modern Transformer	66
For the Newcomer	67
What Are the Sound Waves Saying?	68

Baird television reception on a "screen" 12,100 small lamps were used to produce the picture, these being switched on in succession by the huge commutator seen at the rear



Park. The best way to see whether the land-line in between these points is causing distortion is to tune in the London and Midland regionals in quick succession. This is easy, because they are nearly always doing a common programme!

**The B.B.C.'s Reply**—"In the past four

**A Radio Romance**—John Morel, who

will be singing in the July 20 programme from the National transmitter, literally made his name by radio, in a promenade concert broadcast last October. Almost unknown at that time, his success was so great that the next night he was booked to sing the leading rôle in *The Damascus Rose*.

**1930 "Proms"**—The B.B.C.'s 1930 "proms" season will be based on lines very similar to previous years. Mondays will be devoted to Wagner; Wednesdays to Brahms and Bach; and Fridays to Beethoven. Tuesdays will provide mixed fare; on Thursdays the British composers will hold sway, and for Saturdays the usual "popular" programmes have been arranged.

**A Long-wave Portable**—To take advantage of the great range of Daventry 5XX, we have designed a special long-wave portable, particulars to be given next week. This new "three" has a constant-tuned stage of screen-grid high-frequency amplification, so that although sensitivity is good, tuning is very simple. A choke-output helps to dispel the idea that portables cannot give good quality. Altogether, a noteworthy AMATEUR WIRELESS design!

**NEXT WEEK: A PORTABLE SPECIALLY DESIGNED FOR THE LONG WAVES**



# Does Your Loud-speaker "Zizz"?

This article, by R. W. Hallows, has special reference to loud-speakers driven by balanced-armature units. Even the best of them may develop that distressing disease, "zizzing," through causes which are not due to any actual defect in design or make-up

SOME of the inferior units chatter simply because they become overloaded when the input to them exceeds something quite small. In such cases the armature touches the magnet poles as it swings, with results too appalling to be described. Absolutely the only cure in such cases is to reduce the input to the loud-speaker until a point is reached at which it ceases to "zizz."

## Always a Remedy

When a good unit misbehaves itself one may feel sure at once that a remedy can be found. Make quite sure first of all that the armature is truly centred between the magnet poles. In some units the clearance is quite small on either side, so that if the armature lies askew when at rest, it is found to touch the nearer pole when it begins to vibrate at all strongly. It is worth while sometimes to taper off the point of a match with a sharp penknife and to adjust the armature until this little wooden wedge can be inserted—take care that you don't force it in—exactly as far on each side of it. The match is a great help where the clearance is small, for the human eye is not always an infallible guide.

Should zizzing still persist, satisfy yourself that the connecting rod is securely fixed to the armature. Until recently I had never suspected that connecting rods could work loose, but the other day I traced down zizzing in a particularly good unit of mine to this cause and since then I have come across two other cases.

What happens is this. The connecting rod is often soldered to the armature, and in time the solder round the joint crystallises and becomes detached from its moorings. Though the solder looks perfectly sound a trial may show that the rod can be wobbled slightly in its seating. Zizzing then occurs, since the rod vibrates independently of the armature in the loose seating. Unless you are a pretty good hand at delicate soldering, it is better to return the unit to the makers for repair in such circumstances.

## Details that Matter

Another often unsuspected cause of chatter is to be found in the anchorage of the connecting rod to the cone. Little cups

are issued with one or two types of unit. One of these is placed outside the cone and another inside it, felt washers lying between the metal and the fabric of the cone. The rod is then fixed by means of two nuts, one outside and one inside the apex of the cone.

All is well, so long as the metal discs and the felt washers are exactly centered, but it is not at all an easy job to do this. If either or both cups are a little off centre, chattering is very likely to occur.

Here is a method which I find better than the use of metal cups. From a piece of fairly thick celluloid, such as is used for the side-screens of touring cars (any garage will supply this), make two miniature cones, sealing the seams with a drop of amyl acetate. These cones should have a diameter of about one inch and they should fit the main cone closely. You can find the exact shape required by experimenting a little first of all with cones made from stiff paper. In place of the felt washers use rubber washers cut from an old inner tube. Make these about  $1\frac{1}{2}$  inches in diameter and fix them to the inside and outside of the apex of the main cone with rubber solution.

## An Important Point

Chattering may also occur when the loud-speaker cone is provided with a nipple and set-screw fixing for the connecting rod. So long as the rod is something like a push fit for the hole in the nipple trouble is unlikely. But often the diameter of the hole is much larger than that of the rod. In such cases it is best to cut off a strip of copper foil about half an inch wide and to wind it tightly round the rod before inserting it into the nipple. This will prevent the rod from being pressed right over to one side of the wall in the nipple by the set-screw.

With both disc and nipple fixings it is most important that the connecting rod should not be allowed to protrude into the interior of the cone. Not infrequently one sees an inch or more of the connecting rod showing inside the cone and this is a very fruitful source of zizzing. Once you have fixed the rod to the cone to your liking cut off the former quite short.

## Cone Faults

The mounting of the cone itself may give rise to chattering, especially if the driving unit is so sensitive that big movements are produced in the armature when the loud-speaker is working. Where the cone is rigid with its edge fixed to a metal frame, the struts of this frame may vibrate violently and may communicate their vibrations to the support to which the unit is attached or even to the baffleboard. In my humble opinion no balanced-armature unit is at its best unless it is driving a small light cone freely suspended. Shock absorbers may be improvised from ordinary pencil eraser indiarubber between the unit and its support and the cone may be suspended by a ring of very thin rubber. If these precautions are taken chattering is rare.

It is expected that the American Congress will accept the Washington Bureau's budget of £3,700 for a central police broadcasting station. President Hoover has indorsed the project.

More than twice as many receivers were imported by Czechoslovakia in 1929 than in the preceding year. Imports last year were £317,814.

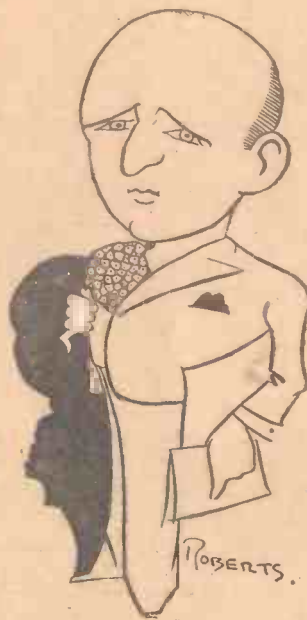

Arthur Mackness in cartoon

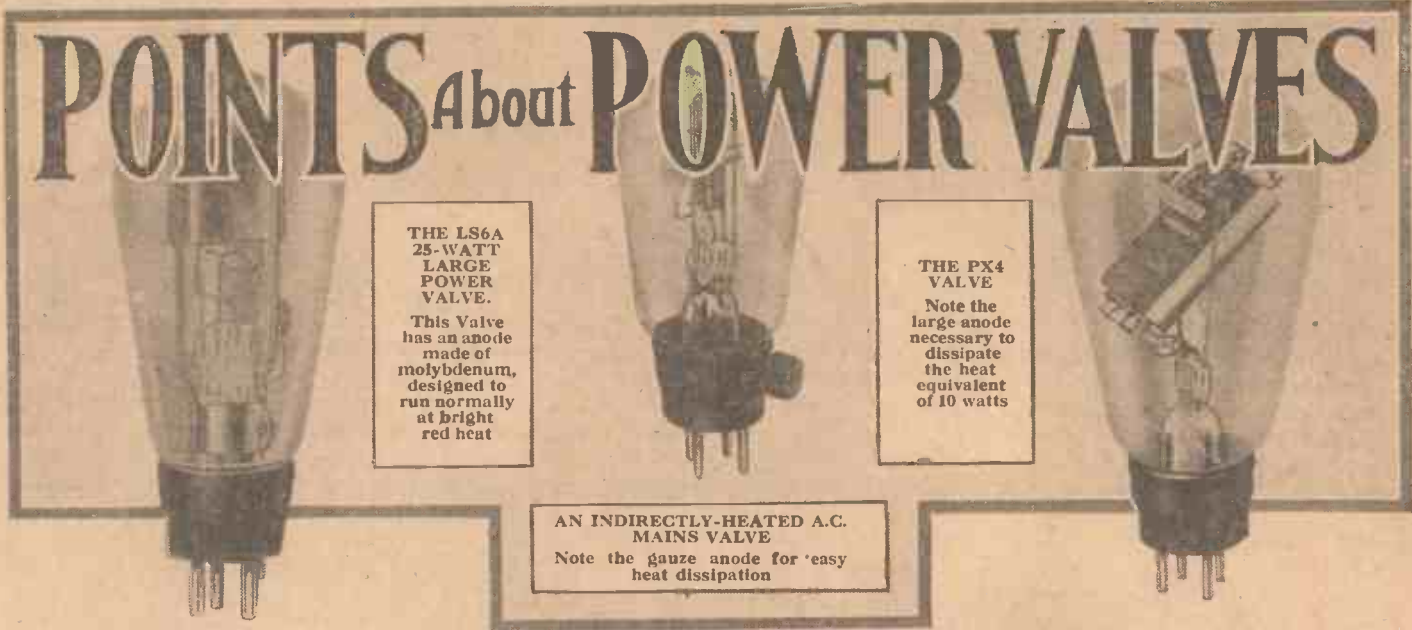

*The Significance of Anode Dissipation—and Some Other Matters.* By F. E. Henderson

IT is now becoming a common thing for the makers of power valves to specify amongst the other published characteristics what is known as the "anode dissipation" in watts. Users who have been applying the characteristics of valves in an intelligent way will by now have become quite familiar with the usual valve characteristics which are shown on the leaflets of the valve makers. For instance, most amateur con-

structors and valve set owners have probably by now become quite familiar with the terms "amplification factor" and "impedance" and will be able to gauge the probable performance of any valve in any circuit from a glance at the figures for these two terms.

When, however, we come to the last stage in the set, in which the function of the valve is to energise the windings of a loud-speaker, the question of power becomes of supreme importance. This is why such valves for use in the last stage are now commonly known as "power valves" or "super-power valves."

metal anode. This phenomenon has probably been noticed by all users of power valves, as it is quite a common occurrence for the glass bulb of such a valve to become quite warm by radiated heat after a short period of use.

In certain types of valves which are designed with a higher "watts dissipation"

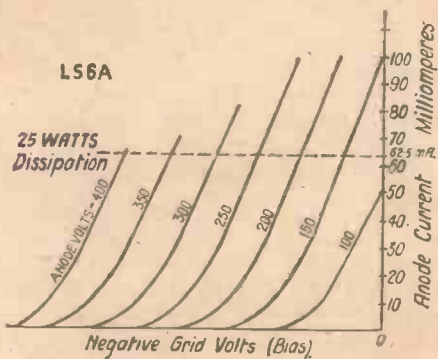

The anode current—grid volts curves for an LS6A power valve, showing how the anode current should be limited by adjustment of grid bias

**Choice of a Power Valve**

When we come to consider the choice of a valve for this stage in the set there is another characteristic of the valve which must be carefully thought of as well as those of amplification factor and impedance, although these in themselves are still of importance. The main function of the power valve is as its name implies to provide power for driving the loud-speaker. Unfortunately, no power valve is 100 per cent. efficient, or anywhere near it. This means that quite apart from the useful power employed in the loud-speaker windings quite a lot of power must be lost in the valve itself. This loss, or waste power, appears at the anode of the power valve in the form of heat and is usually defined as the "watts dissipation" at the anode. The appearance of heat at the anode is caused in exactly the same way as when an electric current passes through a fine wire, as in an electric radiator, iron, or any electrical appliance. It is caused in the case of the power valve by a heavy bombardment of the anode by innumerable numbers of electrons travelling at very high velocity. These hit the metal of the anode so hard that they cause the molecules in it to be jostled amongst themselves and the power expended by this jostling of the molecules appears as radiated heat waves from the

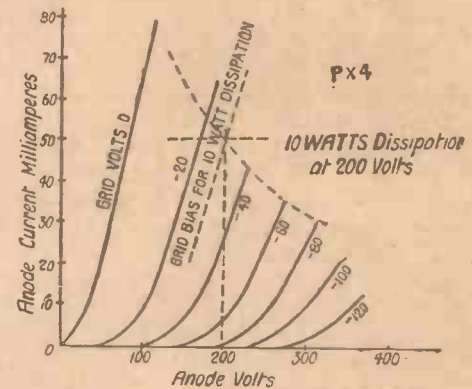

The anode current—anode volts type of curve for a PX4 power valve, showing how an increase in negative grid bias limits the anode current

rating than others, the anode can actually be seen glowing red hot when working.

**An Essential Characteristic**

It is now well known that, for a triode or three-electrode valve, the essential characteristic is that of low internal impedance, this being necessary in order to allow a large anode current to pass which can be converted by the valve into useful power for the loud-speaker. For a given anode or H.T. voltage the lower the impedance the larger will be the anode current under normal operating conditions, and the greater will be the amount of power obtainable from the valve. All this anode current is represented by vast numbers of

(Continued at foot of next page)

**A Good Guide**

With a valve used in the early stages of a wireless receiver, such as in the high-frequency, detector, or early low-frequency amplifying stages, these figures give a very good guide as to the probable performance of the valve to be chosen. This is because all these valves are designed purely for the purpose of amplifying voltages which are

Some Notes on Present-

day Short-wave Conditions

# Around the Short-wave Dial



By M.  
BARNETT

ONE very attractive feature of the transmissions on the short waveband is that one is always liable to stumble across some important transmission without any warning, thus providing plenty of thrills for those who are fed up with conditions on the broadcast band! Many outstanding broadcasts of world-wide importance have been undertaken by various stations in America, Canada, and Australia.

One such transmission was recently broadcast by the General Electric station W2XAD, at Schenectady, N.Y. This was a relay of the proceedings of the National Electric Light Convention, held in San Francisco. The convention was connected, apparently by radio link, with speakers in New York, London, and Berlin. The American announcer was heard calling each of these towns in turn, and they were also heard to reply. Near the end of the broadcast Thomas Edison himself spoke,

his voice coming over remarkably clearly. Apparently some person in each of the above-mentioned towns spoke to the convention via short waves and the whole of the proceedings was broadcast by W2XAD.

At the present moment there is a great improvement in the signal strength of W8XXK, at Pittsburg, on its 25.25-metre transmissions. W2XAD, on the whole, is very much better and more reliable than it has been for some time past, although it appears as though it does not use such a high percentage of modulation as formerly.

Two stations which one hears very little about now are W2XO and W2XK, both at Schenectady. It will be remembered that in the autumn of last year these two stations co-operated with W2XAD, each station broadcasting the same programme and all three working somewhere within

the band of 17 to 23 metres. Some interesting experiments in fading were carried out at this time.

PCJ still continues to shake the ether, and is a great signal in most parts of the British Isles during daylight; it fades rather badly during the darker hours.

Mention might be made of NRH, a small station in Costa Rica, which works on about 30.5 metres. This station formerly only had a power of  $7\frac{1}{2}$  watts, not *kilo-watts*! Even with this ridiculously small power it has been heard in the British Isles, the United States, and many other countries at distances of several thousand miles. Now NRH has installed a 150-watt transmitter, and should stand a still better chance of being heard over here. It works every night from about 3 a.m. onwards. This, of course, is no advantage, but perhaps some very enthusiastic listener will be persuaded to stay up for it!

## "POINTS ABOUT POWER VALVES"

(Continued from preceding page)

minute electrons which, as we saw above, are continually bombarding the anode. Thus, the larger the anode current, the hotter will become the anode, and this is a very important point which is taken care of by the designers of power valves. The anodes of such valves must be so made that they can stand getting very hot without damage and in certain large power valves, such as the LS6A, are made of molybdenum instead of nickel which is commonly employed for the smaller valves, as molybdenum has a much higher melting point and, for another thing, will give up its gas particles easier during manufacture.

### Heat Losses

One of the most important points to be borne in mind in making a large power valve is that of obtaining and maintaining the very finest degree of vacuum possible so that no gas can be given off to damage the filament coating even though the anode may run very hot. The heat lost or dissipated at the anode can be reckoned as the equivalent of electrical power which is the product of the anode volts and the anode current.

To take a concrete example: The new PX<sub>4</sub> power valve is rated at Anode Volts—200 max. Anode Dissipation—10 watts max. This means that when we are running this valve at 200 volts on the anode the

maximum heat dissipation permissible is equivalent to 10 watts and, therefore, 10 divided by 200 = 50 milliamperes.

Of this 10 watts loss at the anode, only about one-fifth is available as useful A.C. power to drive the loud-speaker. It is very difficult to calculate or estimate the exact amount of useful power for any given condition, but this usually bears the same proportion to the anode dissipation in watts. For this reason, such a figure for anode dissipation is of the greatest use in estimating the usefulness of the power output valve.

It is unfortunate, but true, that the larger the valve gets electrically, the more difficult it becomes for the valve maker to ensure exact consistency between valve and valve.

### Importance of Grid Bias

We have seen above that there is a definite limit to the permissible watts dissipation and this, for a given anode volts, represents a definite limit to the anode current. When using large power and super-power valves, therefore, the negative grid bias applied should always be adjusted for each valve individually so as to provide the necessary anode current and no more. It is obvious that when such valves are being used the negative grid-bias plug should only be removed from the grid-bias battery for the purpose of adjustment, etc., while the H.T. voltage is switched off, otherwise the anode current may rise very considerably, the watts dissipation greatly exceed

the maximum permissible figure, and the valve under such treatment will in all probability very soon become filled with gas liberated from the overheated anode and be spoiled.

### Secret of Good Quality

The whole secret of good quality reproduction lies in the choice and use of good power valves and it is a good rule always to use a valve of the lowest impedance and highest watts rating which is allowed by the source of H.T. supply at one's disposal. Obviously, great volume without distortion, or high quality reproduction cannot be realised where only small dry batteries are available for H.T., but if the H.T. can be obtained through a battery eliminator either from the A.C. or D.C. electric-light mains, ample power is therefore available and a really good power valve can be chosen for the last stage.

The penalty for sending a false SOS in America is £1,000 fine, five years' imprisonment, or both.

The Eiffel Tower short-wave station is to be used as the centre of an extensive police radio service. Receiving stations will be established throughout the country.

The National Broadcasting Company's network in America totals seventy-three stations, not including short-wave auxiliaries. Columbia's chain includes seventy-one stations.

**SYDNEY MOSELEY'S WEEKLY PROGRAMME CRITICISM**

The Most Popular Item  
 Two Good Plays  
 Serial Stories

The B.B.C. Dance Band



I SUPPOSE, if it were possible to have a referendum (fashionable word!) of the items that appeal most to listeners, the quintets and sextets—and even the quartets—would top the bill. I thought for a time that the Gershom Parkington Quintet was falling off. It is looking up again.

I cannot help thinking that the pleasure one derives from these performances is lessened considerably by reason of the indifferent vocal numbers which go to make up the programme. In most cases the vocalists themselves are splendid—there is the recent instance of the fine singing of Herbert Cave—but the songs chosen are sometimes too dirge-like and make one impatient for the orchestra to start up again.

I find two distinct views regarding Nellie Wallace's debut the other night. I have shown again and again in the course of these critical notes that stage artistes with reputations do not necessarily make for equal success in broadcasting. Nellie's success on the stage is partly due to her make-up, and this asset, of course, is lacking in broadcasting. The tens of thousands who have seen her could naturally picture her, but as for the new audience of listeners—well, I am afraid she must pray for television. Incidentally, I should like to mention that one of the letters which reached me complains that Nellie paused to give the studio *claque* a chance to demonstrate. But, it goes on, "I would point out to Miss Wallace that her job is to please those that cannot see her." Exactly! This is the point I have been trying to hammer home again and again.

Sometimes criticism of B.B.C. programmes is due to misunderstanding. I have a telephone message from somebody who complains that there was no means of identifying those who took part in revues and such shows. My complainant refers to *Bored and Lodging*. As a matter of fact, the names of those who took part were published.

Stainless Stephen, I think, was as bright as usual, and I wondered why the *claque* did not give him at least as much applause as some of the others.

The two one-act plays, *In the Ravine* and

*The Proposal*, were both first-class efforts, but I preferred *The Proposal*, which was amusing and scintillating.

The acting was absolutely top-notch, and I desire to pay a tribute to Barbara Cooper, Hector Abbas, and Abraham Sofaer. I should very much like to hear this play again.

*In the Ravine* was good, but I could not quite get the climax. Nevertheless, plays of this sort are much preferable to others written by well-intentioned amateurs.

I liked the "Swedish National Programme" better than any produced by Lance Sieveking. It was colourful and tuneful. But I did not quite understand where the balloon came in. After all, people who go to Sweden very rarely see it from a balloon. Incidentally, an excellent advertisement for Sweden. May I suggest that the enterprising producer take us for some trips nearer home. Let him discover Britain for us.

Serial stories at the best of times are uninteresting, even if they are carried on daily. A weekly serial story, in my view, will have attracted very few. One of those

bizarre ideas which *sound* good, but rarely work out well.

I was greatly impressed by a series of variations on "The Wearing of the Green," played by the Birmingham Military Band one evening recently. It was a clever piece of work and played well.

"Harold" writes: "Have just heard Jack Payne's Band for the first time for some weeks. In passing, what's the use of having a B.B.C. band if it spends its time touring the music-halls while we have to put up with any scratch band that happens to be handy? But, to resume, it struck me as being greatly improved."

Another correspondent comments on Tommy Handley being "off colour." "His decline as a humorist," he says, "has been noticeable, and last week he committed hari-kari (temporary, I hope) by wasting his and our time with a string of babble entitled "My Ideal B.B.C. Programme for Saturday 1930."

In a recent programme, sandwiched between Norman Long and Tommy Handley, was a so-called sketch entitled *The Everlasting Club*. This "sketch" was reminiscent of a Greek play brought up to date. It bubbled over with death, lunacy, violent expressions, and suicide. It was well acted and gained the desired effect—but not quite the material for a variety hour.

Norah Howard and Bernard Clifton are pleasant to listen to in that they keep away from the hackneyed tunes and bring forth ditties which, if not remarkable for either words or melody, are at least entertaining and new. I am not so enthusiastic about the patter of these artistes. One would imagine from the cross-talk between songs that they are in the studio for the express purpose of entertaining each other.

Now that the "high-brow" variety hours are with us, I would suggest that musicians like David Wise should be kept to this type of programme and not allowed to appear in the rarely heard "old-style" vaudeville. I have a hearty respect for the musicianship of Mr. Wise, and in the right type of programme he is ideal; in the more robust vaudeville hours, however, he is out of place.



A. Scott-Gatty, as our artist sees him

# MORE ABOUT THE LOFTIN-WHITE CIRCUIT

By J. H. REYNER, B.Sc., A.M.I.E.E

THE essential principles of this circuit were discussed in last week's article. It remains now to show how this system has been developed for practical operation. The basic form of its circuit is reproduced in Fig. 1, and it will be clear that one of the first points to be obviated in any practical form of the device is the batteries coupling the first valve to the second, and so on. This can be done in a fairly convenient manner as follows.

### Using Indirectly-heated Valves

It is clearly unimportant whether the battery is placed in the arm between the anode of  $V_1$ , and the resistance, or in some other part of the circuit. We cannot place it directly in the filament circuit because of the filament current which has to flow, but the introduction of the indirectly heated valve has overcome this defect and, therefore, for A.C. operation a very much simpler system is practicable. The circuit is re-drawn as shown by Fig. 2, the valves being assumed to have indirectly-heated cathodes, the heaters of which are not actually shown in the diagram. Then in the lead between the cathodes there is clearly no actual filament current flowing, and we can if necessary arrange to insert there various batteries, or other sources of voltage, to obtain the potentials we require on the valve.

In the example shown, the battery  $B$ , which was formerly between the anode and the grid of the first and second valve, is now placed between the cathode of the first valve and the bottom end of the resistance  $R$ . The action of the circuit is now the same as before. If the valve  $V_1$  becomes conducting this voltage from the battery passes through the valve, and through the resistance  $R$ , developing a voltage across the second valve, while if the first valve is non-conducting no such voltage is set up.

Fig. 3 shows the circuit as applied to A.C. operation. All batteries have been dispensed with, and in place we have a relatively low resistance potentiometer connected across a suitable source of D.C. supply. This may be obtained in practice by rectifying the A.C. in the customary manner. The tappings between the cathodes of the valves are so chosen that the voltage developed across the tapped portion is just what is required to replace the battery shown in Fig. 2. Thus we are able to obtain a simple circuit,

which will be seen at first sight to bear a distinct resemblance to the "A.W." "Simpler Wireless" system, although on a closer examination it clearly operates on a different principle.

Drift correction is provided as was explained in the last article. The two stages are direct coupled to the output stage which is provided with a choke output filter in the ordinary manner. The drift or bias correction on the first valve is important in the system for the reasons which were

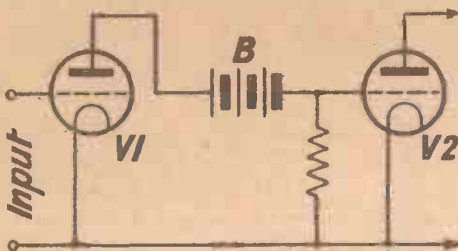

Fig. 1. The basic principle of Loftin-White circuit

detailed in the previous article. A strong carrier will cause such a change in grid voltage on the last valve as to saturate this valve entirely, while again there is a slight tendency for the characteristics to wander, and as this effect is cumulative,

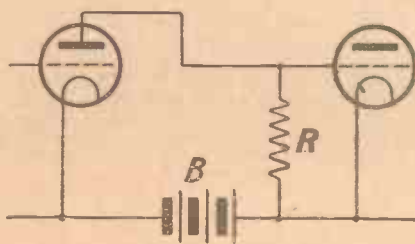

Fig. 2. Loftin-White circuit for use with indirectly-heated valves

the whole amplifier may build up into a choked condition.

The grid bias on the first valve is, therefore, obtained by tapping across a small

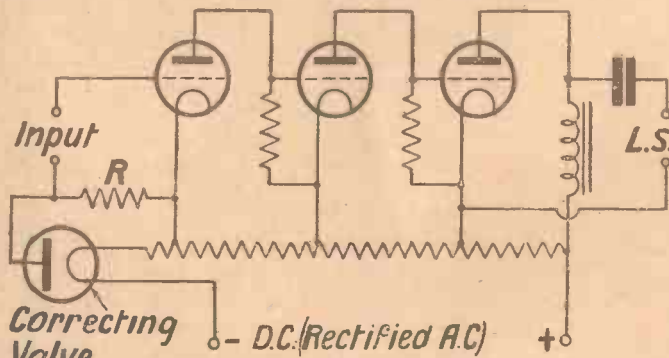

Fig. 3. Loftin-White circuit for A.C. operation

portion of the potentiometer, but in series with this is the correcting valve shown. The filament of this valve is in series with the potentiometer across the supply, and is so adjusted as to be just on the point of being conducting. The voltage developed across the resistance  $R$  is therefore only a fraction of the full voltage across the tapping, depending upon the relative conductivity of the correcting valve. If the current in the last valve increases, this current flows through the potentiometer and through the filament of the correcting valve which warms up a little, with consequent increase in emission and decrease in the resistance. As a result of this the voltage developed across the correcting resistance  $R$  increases, so applying more bias to the first valve. This in turn corrects right through the system and decreases the current of the last valve.

### Other Schemes

There are other ways of obtaining this necessary bias correction some of which do not involve the use of special correcting valves, a bridge arrangement being adopted instead. A further point about the system is that it automatically tends to eliminate hum. This can be explained somewhat simply without going into great detail in the following manner.

Let us suppose that we apply pure A.C. to the anode of a valve. Then if we apply an alternating voltage in the opposite direction to the grid of the valve and adjust this voltage so that it is a suitable fraction of the anode voltage (depending upon the effective amplification of the valve) we could theoretically obtain a complete cancellation of the hum. Reference to the figures already given will show that we are taking voltages from the potentiometer in such a direction that if any ripple is passing through the potentiometer the voltage applied to the grid is in the opposite direction to that applied to the anode at any instant.

Therefore, some measure of hum correction is inherent in the system, due to this fact. The Loftin-White system, indeed, is claimed to be capable of giving large amplification with a distinct economy, in the smoothing arrangement necessary, coupled with excellent performance from the frequency characteristic point of view. This is understandable since there are no devices used in the construction of the amplifier which vary their characteristics appreciably with the frequency.



# On Your Wavelength!

## Needles and the Pick-up

GRAMOPHONE needles are labelled loud, medium, and soft tone according to their physical dimensions. This designation is confusing, however, when applied to needles used in an electrical pick-up, for one generally has sufficient reserve volume to load an amplifier fully even when a soft-tone needle is in use. That needles have some effect on the quality of reproduction is obvious to those who have tried various types with one particular pick-up. Since the needle forms part of the armature system, it follows that it must affect the constants of the armature according to its weight and rigidity. Generally speaking, the lighter the armature, the greater is the effect caused by the needle until one comes to the pick-up which uses a needle as the entire armature, in which case the voltage output and resonances are completely governed by the type of needle.

## The Importance of the Right Type

My own gramophone pick-up has quite a light and flexible armature, but if I use a short, stubby loud-toned needle it invariably refuses to hold the groove of constant frequency records below 100 cycles, and the reproduction on heavy bass passages of orchestral and organ records suffers consequently. If, on the other hand, I insert a very fine soft-toned needle it cuts down the strength of the bass too much. "Ah, 'Thermion' has fallen in the same old trap," some of you clever ones will say; "he is using a volume control across the pick-up with loud-toned needles, and therefore cuts off his treble; then, with soft-toned needles the volume control is not required, and consequently the high notes reappear with comparatively less bass." No; I have considered and made allowance for these matters, and have come to the conclusion that great care must be taken in choosing suitable needles for a given pick-up. I have gone so far as to prove this point by taking various characteristics of a particular pick-up with different types of needle; and, believe me, the difference in the characteristics, especially at the extreme ends of the audible scale, is most noticeable, apart from a difference in voltage output.

## Distorted Records

Due to my own carelessness, the recent heat affected some of my records, for a wax disc, on being subjected for several hours to the rays of a hot sun, assumes a form of sine wave of very low frequency, possibly five a second, an amplitude some-

times very considerable. It is a blessing that pick-ups do not reproduce at this frequency, otherwise I have no doubt the records would be unplayable. As it is, my spring-loaded pick-up merely travels as if on a merry-go-round without having the slightest effect on quality of reproduction. One might imagine that going up hill and then having to come down again would cause a variation in pitch; but, somehow or other, it does not. One of the records most distorted in shape is an instrumental trio by Schubert, in which there are long-sustained fiddle notes, any variation of which would be only too obvious and painful. Incidentally, this record, in spite of its contours, must have been played over fifty times with various types of pick-up, and yet does not seem to have suffered from wear.

## Phew!

With clear, cloudless skies, blazing sunshine during the day and sweltering nights, one would have expected, under such conditions, two things. First of all, a plentiful crop of atmospherics and, secondly, poor all-round strength from foreign stations. There were a few atmospherics on certain nights, though they were seldom of the violent and annoying kind. Curiouser and curiouser, the bright, hot weather brought an increase in signal strength and the number of stations received, instead of just the reverse. Breslau, for example, is much stronger than he has been for some time. Frankfurt showed an improvement and Milan came in distinctly better. The only station that appeared to be feeling the heat was Hamburg, which for some queer reason simply disappeared.

## Good on the Long Waves

On the long waves signal strength was extraordinarily good all round. Atmospherics were, of course, rather worse than on the medium band, as is usually the case, but they were seldom bad enough to worry about very much. Hilversum, Kalundborg, Radio-Paris, and Huizen are all good stations at any time, and you will find the Eiffel Tower and Zeesen worth going for if you tune in at times when other transmissions are not interfering with them or blotting them out. Motala is not up to the same strength, as a rule, but sometimes he comes through well.

## Effects of Locality

When they are going away for their holiday, readers will find it very interesting to compare reception conditions in whatever place they choose for their stay with those that obtain in their own homes.

Some foreign stations seem to come in almost equally well in every part of this country. Amongst these are Rome, Nürnberg, Radio-Paris, and Hilversum. Others, though, are not nearly so consistent. As might be expected, the Scandinavian stations are much better received in the North of England than in the Midlands or the South; in fact, the further south you go, the more does their strength fall off. The north German stations are generally much better in the north than in the south, whilst just the reverse is true of the Spaniards and most of the Italians. The former are usually quite a "valve better" on the south coast than they are even in the Midlands—in summer time, at any rate.

## Inconsistencies

The explanation here is, I suppose, that after travelling over the sea, radiations from them suffer big losses when they have to pass over land. The long-wave stations are not so much affected by one's position as are those on the medium band, but Lahti is usually very much better heard in the north than in the south, and to some extent this applies also to Motala. If you come across any particularly striking differences in reception whilst you are away your "Thermion" would much appreciate a note on the subject. Wireless is full of queer things, and you may strike a spot in Cornwall, or somewhere like that, where the Swedish low-powered stations come roaring in.

## A Valve Question

One or two of us were talking valves the other day, and there seemed to be quite an idea that the present position is not all that it should be. A year or two ago, when prices were much higher than they are now, the examination of valves before they were passed as fit for sale was very strict, and the smallest faults led to immediate rejection. Now there are signs that the factory tests are becoming much less stringent, for one does find much too great a diversity between valves of the same make and class. I happen to possess a rather neat little gadget which enables the mutual conductance of any valve to be found in a trice. Every one that I receive goes into the holder of this, so that I can see at once whether it is up to snuff or not. I must say that I have been very surprised lately by the number of valves whose mutual conductance is widely different from that of the makers' figures. This means, of course, that the whole of the characteristics differ from the standard, and that if such a valve is used to replace

::                      ::                      **On Your Wavelength!**                      (continued)                      ::                      ::

a normal one there may be quite a change in the performances of the set.

### The S.G.

My impression is that screen-grid valves, for all their price, are amongst the least satisfactory at the moment. The other day, when trying out a new set with two screen-grid stages, I placed in the S.G. holders a pair of brand new valves just received from the makers. For once I did not take the M/C figures before trying them. Now, the set gave most disappointing results, though batteries and everything else were right up to the mark. Suspecting the S.G.s, I tested them out, and found that neither had the proper mutual conductance, whilst one of them was very far indeed below the expected figure. Replacing this valve with another, known to be in good order, made an astonishing difference to signal strength, and a further improvement occurred when the second valve also was changed.

### A Suggestion

Since valve makers are banded together in the V.M.A., they can very easily come to an agreement as regards factory tests and the amount of tolerance that should be allowed. As it is, some firms seem to be much stricter than others. I am quite sure that this is a bad thing and that it will do harm to the trade as a whole unless steps are taken to set the matter right. We pay quite enough for our valves, and we should be able to have absolute confidence in those that we buy in sealed boxes. Manufacturing processes are now so exact and tests can be applied so simply, that there is no excuse whatever for allowing valves a long way below par to find their way on to the market.

### A Point to Note

If, by the way, you have two high-frequency stages, whether S.G. or triode, there is one rather interesting point that not everyone appreciates. This is that, supposing that one of your two H.F. valves gives rather more amplification than the other, it should always be placed in the first holder. We will see why in a moment. It is worth while when fitting new H.F. valves, or even when dealing with old ones, to make sure that the best magnifier is next door to the aerial. You can very easily do this by marking your valves A and B, and tuning in some rather faint station with the pair in alphabetical order to begin with. Now leave the tuning where it is and try the effect of changing over so that the order is B, A. In several sensitive sets a slight readjustment of the tuning may be needed, since the inter-electrode capacity of the valves may differ by a fraction. Whichever order gives you the better signal strength is the

one to stick to. Valves that have seen a certain amount of service should be tried out occasionally with their order reversed in the same way, for characteristics may change as time goes on.

### The Reason

If you think for a moment you will see why the most sensitive valve should come first. Signals brought in by the aerial from a weak station may have an almost incredibly small amplitude. If the first valve is not sensitive it may fail to have anything to do with them. When, however, there is a good valve in the first holder the very weakest of signals are dealt with; and once they have been amplified by the first stage, the second stage, though it may not be quite up to the mark, will still be able to boost them up and send them along to the detector.

### G.B. and S.G.

In many sets that I see the screen-grid valves are not grid biased. There is no actual need to give their grids any negative potential, for they will work perfectly well if the grid return is taken to low-tension negative. But rather better working is ensured—an important point to those who want to get the last ounce out of their H.F. amplifiers—by the provision of suitable grid bias. Now, the trouble is that we do our grid-biasing in most cases by means of Leclanché dry cells, whose E.M.F. is in the neighbourhood of 1.5 volts. One and a half volts is rather more than the average screen-grid valve wants to be at its best, but what is to be done about it? There are two ways out of the difficulty. Messrs. Siemens have a cell whose E.M.F. is somewhere about .8 volt, and this will do splendidly for the great majority of screen-grid valves.

### Using a Potentiometer

Another method is to make use of that good old friend the potentiometer. Don't wire it across the biasing cells, or they will very quickly run down, for 1½ volts drive 5 milliamperes through 300 ohms, which is the resistance of the average potentiometer. The proper method is this. Put the potentiometer straight across the low-tension busbars and connect its slider to the positive of the biasing cell. With the

potentiometer at the negative end of its travel the bias supplied is 1½ volts, and when it is moved a quarter the way over towards the positive it is zero. Don't go beyond this point or you will be applying a positive bias to the valve. But by moving very slowly over the first quarter of the slider's travel you will soon be able to find the exact amount of bias that makes for the best results. Besides the small saving in H.T. current, a negative bias has the effect of making a slight increase in the magnification factor of the valve. There is also a very distinct gain in efficiency, since it completely prevents the introduction of damping by any flow of grid current. Bias your S.G.s, therefore, if you are out for real efficiency.

### The Balanced Armature Gets Home

Will you allow your "Thermion" to indulge for once in uttering that tempting saying, "I told you so"? I can claim to have been one of the first strong advocates of the balanced-armature loud-speaker unit. I remember claiming quite a while ago that one of these, which I had very carefully adjusted, really was bringing out the bass and that it was giving something like perfect reproduction without any trace of the boominess that was unfortunately associated with many of the earlier types of moving-coil speaker. Expert friends when they heard these claims either smiled in a superior way and shrugged their shoulders or gave vent right out to hoots of ribald laughter. Despite their (shall we call it?) scepticism, I persevered with my B.A.s and continued to prophesy a great future for them as soon as makers woke up to the fact that really scientific design could produce a very close approach to perfection in reproduction. Since then the balanced armature has been going ahead by leaps and bounds, and it is now possible with its help to make a loud-speaker which gives practically a level response to all audio frequencies between, say, 50 and 6,000. Actual tests have shown that some units give a magnificent response to the lower pitches, whilst others are as brilliant as could be desired right up to the harmonics of treble notes.

### • An Old Tip

The tip that I gave many a year ago about using two loud-speakers in series, one to deal with the treble and the other to tackle the bass, is a really good one. Select two B.A. units with care, provide them with suitable freely suspended cones; match your output valve to them, and you can make a pair of reproducing units that even your musical friends cannot criticise adversely. And the best of the balanced-armature unit is that it does not require a huge output to work it and that it goes on with its job without eating up filament current. THERMION.

### SPARKS

*A newspaper article says that women dislike wearing head-phones, because their nicely waved hair gets caught up. A "wave" trap!*

*In a court case, a West Ham man was charged with throwing a large book at his neighbour's wireless set. Adding "volume" to the loud-speaker!*

*A Southend man stated in Court that he "coiled himself round" a burglar who entered his premises.*

*A "resistance coil."*

# YOUR *How to Choose* and *Use Them* VALVES

## INCLUDING A REVIEW OF THE MOST POPULAR TYPES

FROM a selection of over one hundred and fifty well-known types of valves, the choice of any particular valve for a set obviously calls for careful consideration. The main valve types are fairly well known: high-frequency amplifiers, detectors, low-frequency amplifiers, and power output valves. But in each of these categories are variations.

Take H.F. valves: one can use either a screen-grid valve or a three-electrode valve. The choice is not arbitrary, since the set in which the high-frequency valve is embodied has to be specially designed for each type.

The screen-grid valve is now generally used for high-frequency work, since it imparts great amplification without complication. Three-electrode valves still have a useful function as high-frequency amplifiers, especially in portables, where two stages of untuned high-frequency amplification are often utilised.

The greatly increased efficiency in all British valves has been realised by many portable-set designers, who have found the inherent amplification of two three-electrode valves quite considerable.

Detector valves are the least developed as a special type. The choice of a detector depends on the type of coupling it precedes. When transformer coupling is used the detector should not have too high an impedance, otherwise bass notes will not be well re-

produced. An impedance of 20,000 ohms can be considered average for a detector combining good quality with amplification.

Should the transformer following the detector have a high-permeability core, with a limited primary current, it may be worth while to use a higher impedance valve, such as 50,000 ohms, the idea being to limit the detector anode current, which decreases as the valve impedance increases.

If resistance-capacity coupling follows the detector, the aim should be to select a valve with as high an amplification factor as possible. In this form of coupling, the maximum note magnification is always slightly less than the magnification factor of the valve.

A 50,000-ohm valve, with an amplification in the region of 30, is usually recommended, but is not always the most suitable. Such a valve will have a limited grid swing which will cause distortion if there is much amplification preceding the detector stage.

Where one or two high-frequency stages are employed, the detector will handle the signals more efficiently if it has a lower impedance, even if the coupling after the detector is resistance capacity. In this circuit a better plan would be anode-bend rectification, using a 12,000-ohm valve and plenty of negative grid bias.

In most three-valvers, with a high-frequency, detector, and low-frequency sequence, the low-frequency

(Continued on next page)

### COSSOR

AS one of the pioneers of valve making, A. C. Cossor, Ltd., are now in the position to supply two-, four-, or six-volt valves for every possible requirement. The New Process Cossor valves can be divided into six distinct groups.

- (1) Valves for two-volt accumulators, including H.F., L.F., R.C., Det., P., X.P., S.G., and P.T. types.
- (2) Valves for four-volt accumulators in corresponding types.
- (3) Valves for six-volt accumulators.
- (4) Special power valves for use in public-address systems and other large amplifiers.
- (5) Four-volt mains valves in H.F., L.F., R.C., P., and X.P. types.
- (6) Rectifying valves for full-wave or half-wave circuits designed to supply high-tension current from A.C. mains,

From these groups it will be seen that Cossor valves can find a place in every position of practically every type of radio set. In general, the design of the filament in the new-process Cossor valves is reflected in the excellence of the charac-

The screen-grid valve also is interesting as it is made for two different filament consumptions. The .15 ampere type 215SG has an impedance of 300,000 ohms for an amplification factor of 330. The 220SG screen-grid valve takes .2 ampere filament current to achieve an amplification factor of 200 with an impedance of 200,000 ohms.

Among the super-power valves, the 620T valve is useful for large amplifiers, having an amplification factor of 3.2 for an impedance of 1,400 ohms. The maximum anode voltage of this valve is 400 and the filament current is 1.6 ampere.

The four-volt indirectly-heated mains valves in the Cossor range are all rated at 200 volts maximum high tension. The increased

teristics in all types. Taking an example, the 210HF type, we find the impedance is 20,000 ohms for an amplification factor of 22. The small power valve, type 215P, is very good, having an amplification factor of 9 for an impedance of only 4,000 ohms.

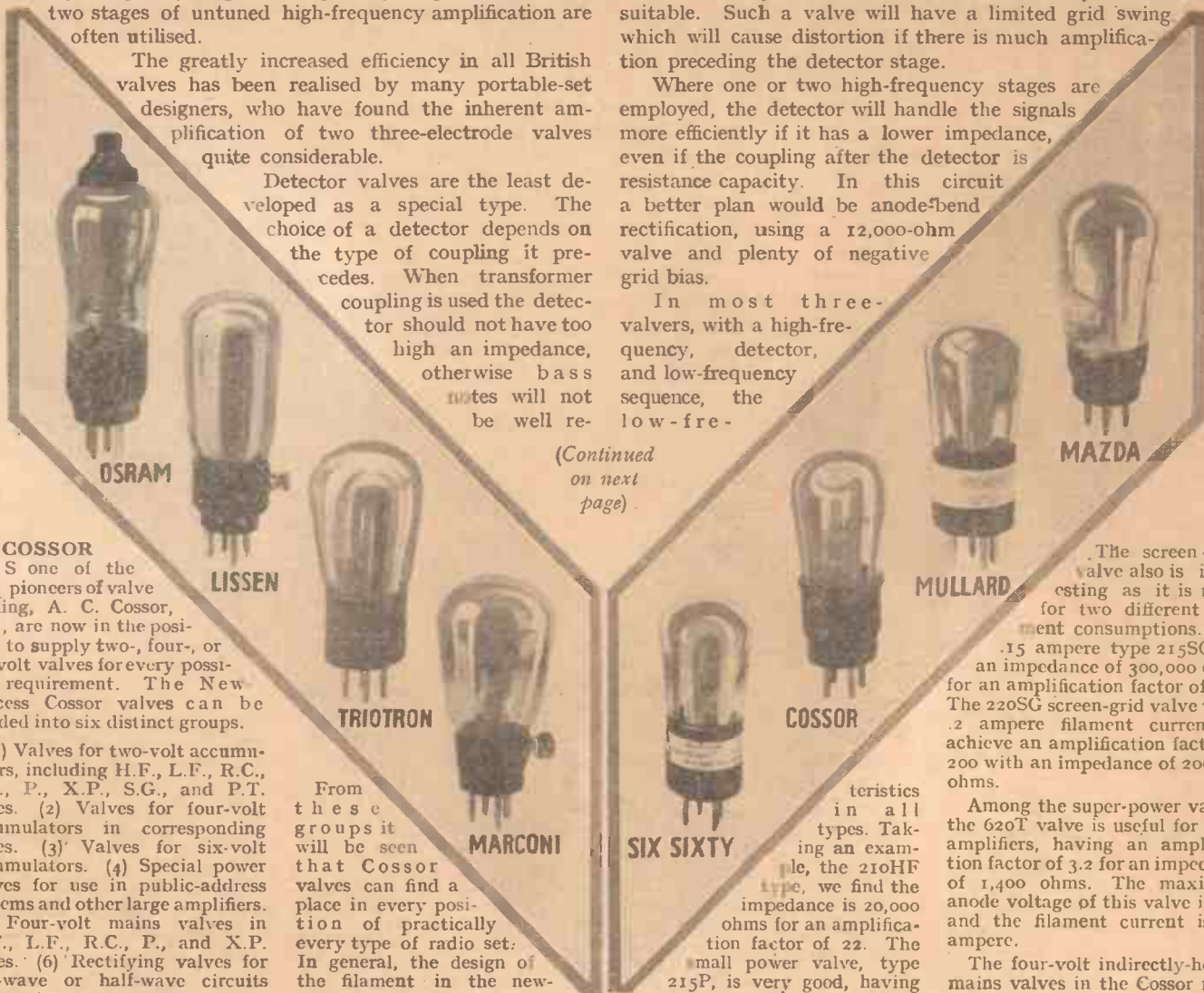

## "YOUR VALVES: HOW TO CHOOSE AND USE THEM" (Continued)

quency valve is also the power output valve. The choice is between amplification and power. A 5,000-ohm valve has a reasonably high amplification factor, but a fairly limited power output. A 2,500-ohm power valve has a lower magnification, but greater power output, with a correspondingly higher anode current consumption.

The power valve determines the amount of possible undistorted volume, but the preceding amplifying stages in the set determine to what extent this limit is approached. For normal domestic use a 5,000-ohm power valve is recommended. It takes only a moderate current from the high-tension supply, gives sufficient output to drive the average cone loud-speaker, and has a useful amount of amplification to augment the preceding stages. Such a valve is ideal for portable sets.

As soon as the impedance is lowered much below 5,000 ohms the anode current consumption increases; 2,000-ohm power valves, capable of great undistorted volume, can only be considered if a large high-tension supply is available.

### Pentodes

Pentodes are an interesting variation in power valves. The chief attraction of the British pentode is that a greater power amplification is derived for a given voltage input than is possible with the normal three-electrode power valve. The pentode is

efficiency of each type, due to the mains filament, is evident from the maker's figures. These valves, in conjunction with one of the wide range of Cossor rectifying valves, form an excellent nucleus for an all-electric set.

### DARIO

MADE by Impex Electrical, Ltd., is a range of Dario valves for two- and four-volt accumulators and for mains operation. The two-volt range are rated at 1.8 volt for the filament, while in the four-volt range the valves are rated at 3.5 volts. Some idea of the efficiency of these valves can be gathered from the following figures. It should be noted that Dario valves sell at much lower retail prices than many others.

The Dario Universal Bivolt, for general purposes, or more especially for detection, has an impedance of 10,000 ohms and an amplification factor of 9. The makers state that the anode voltage can be from 40 to 200 volts. For resistance-capacity coupling, the Resistron has an impedance of 50,000 ohms and an amplification factor of 30. The Dario super H.F. is quite a useful valve, with an impedance of 21,000 ohms and an amplification factor of 25.

The super-power Bivolt has better characteristics than most of the others, since for an impedance of 4,500, its amplification factor is rated at 9. Included in the range is a screen-grid valve and a pentode. The pentode takes .3 ampere filament current. Corresponding four-volt types are available for H.F., detection, L.F., and power positions in the set.

Dario mains valves are of the directly-heated type and four types are included for general purpose, resistance-capacity and super-power. The filament voltage of these mains valves is .6, while the filament current is 1

ampere for the general-purpose valves and 1.5 ampere for the power valves.

### LISSEN

ALTHOUGH comparative newcomers to the valve market, Messrs. Lissen, Ltd., have now produced a comprehensive



range suitable for most sets. Lissen new-process valves are made in an extensive two-volt range; more recently correspondingly four-volters have been made as well as a six-volter suitable for large power outputs.

The Lissen H210, with an impedance of 58,000 ohms and an amplification factor of 35, is suitable for resistance-capacity coupling and in some aperiodic H.F. amplifying stages.

The HL210 has an impedance of 21,000 ohms and is a good detector. The L210 is also useful as a detector; with its impedance of 10,000 ohms, it makes a good first low-frequency valve.

For general loud-speaker requirements, the P220 is an economical power valve with the useful amplification factor of 7.

Among more specialised types, the SG215 is a two-volt screen-

very useful in reducing the number of stages of amplification. A single stage of low-frequency amplification, with a pentode as the output, gives ample volume in a three-valve set where one valve is for high-frequency amplification.

No remarks on valves are complete without some reference as to the relative merits of two-, four- and six-volt filaments. For general convenience, the two-volt valve has deservedly been utilised more than four- or six-volt valves. For portable sets the two-volt valve is obviously the only practicable type. But in normal sets also, the fact that extremely good results in all stages can be obtained with two-volt valves has led to their very widespread adoption.

Only in super-power valves does the difference between a two- and six-volt filament really matter. With very high anode voltages, over 150 volts, the filament must be made robust and must emit a very copious stream of electrons. This can only be done in practice by increasing the length of filament. For high-power amplification, six-volt filaments seem likely to reign supreme for a long time, but even now there is no necessity to utilise more than a two-volt filament for any of the other stages in a normal set.

In order to provide a useful guide we give details of some of the more interesting valves produced by the leading makers.

grid valve with an impedance of 200,000 ohms and a slope of .9. The PX240 is a super-power two-volt output valve, with an impedance of 2,000 ohms and a slope of 2. The filament current is .4 ampere.

The Lissen two-volt power pentode PT225 is designed for economy of working; even so, it gives greater amplification than an ordinary power valve. The slope is 1.4. The anode current is as low as 6 milliamperes, which is rather remarkable. The PT240 super-power pentode is designed for use with moving-coil loud-speakers and for general use where considerable power as well as great amplification is essential.

The new Lissen PX61 is a really big power valve with an impedance of 2,000 ohms, a slope of 2.4 and a maximum anode voltage of 500.

### MAZDA

ONE of the most efficient series of valves obtainable in this country is the Mazda, dis-



P.R.

tributed by the Edison Swan Electric Co., Ltd. In addition to two-, four- and six-volt ranges of battery-operated valves, there is

an improved range of indirectly-heated mains valves.

The two-volt range is especially interesting, as the sensitivity of each type is considerable. The usual S.G., H, HL, L, P, and Pen. types are available. The type 215SG is a good example of Mazda efficiency. The amplification factor is 300 and the impedance 270,000 ohms. The mutual conductance is, therefore, 1.1, which indicates great sensitivity.

In addition to the small power type P220, there is P240 for extra good quality. This valve has the extraordinary slope of 3.7, an amplification factor of 7 for an impedance of under 2,000 ohms. Type 230Pen. is a two-volt pentode giving considerable amplification and power output.

In the six-volt range, the Mazda super-power valves are specially interesting. The P625A is designed for high-power outputs where a moderate filament consumption is required. Its impedance is only 1,600 ohms for an amplification factor of 4. The maximum anode voltage is 200. The P650 has been specially designed for moving-coil loud-speakers. It will deliver one watt undistorted output with only 200 volts on the anode. For a heavy-duty power valve, the .5 ampere filament current is not excessive.

Among mains valves, the Mazda AC/SG has become deservedly popular with set-makers. The amplification factor is really extraordinary, being over 1,000 for an impedance of 800,000 ohms. The AC/HL, with its high amplification and moderate impedance, is suitable for detection or as a first low-frequency amplifier in mains set. The AC/P is designed for the output stage, having a four-volt one-ampere filament. It is a very sensitive valve and requires only a small input to give considerable volume. A wide range (Continued at foot of next page)

In our next issue the MARCONI, ULLARD, OSRAM, PHILIPS, P.R., SIX-SIXTY, IR'OTRON and VATEA ranges of valves will be reviewed

# MY WIRELESS

Weekly Tips,  
Constructional  
and  
Theoretical—



# DEN By W. JAMES

For the  
Wireless  
Amateur

## "Pet" Troubles

[ SUPPOSE we all have our pet troubles. Mine is valve holders, for it nearly always happens that if I forget to tighten all screws before fixing them down one of the contacts is found to be loose when the set is finished. Then the wiring must be moved before the holder can be adjusted.

## "Neuts" and Earths

I wonder how many neutralised sets work satisfactorily when the earth is in good condition, but which oscillate as soon as the earth deteriorates?

A good set ought not to behave in this way, but when stability depends to a large extent upon the damping effect of the aerial, then variable results are to be expected.

The loading effect of an aerial is a quite variable amount. In wet weather the earth is probably good and it is possible that slight leakages may exist in the aerial circuit. Therefore, the damping effect of the aerial upon the tuned circuit to which it is connected is the maximum.

When the earth is dry, however, and the actual earth connection is poor, the damping effect is lowered and instability may result. A long earth lead or lengthy loud-speaker wires may affect stability and should be looked to if poor results are obtained.

## Chokes and Stray Currents

High-frequency choking coils, being associated with H.F. currents, must be looked upon as being capable of having quite large stray fields. In any scheme of shield-

ing, it is of importance that the shield be included.

Failure to remember this may lead to instability. A choke ought to be included within the shield used for its circuit, or if it is fitted in the detector circuit, it ought to be so placed that no coupling with other parts in the high-frequency circuit is possible.

## Matching Valves

A stage of push-pull is often used in these days to provide ample output with

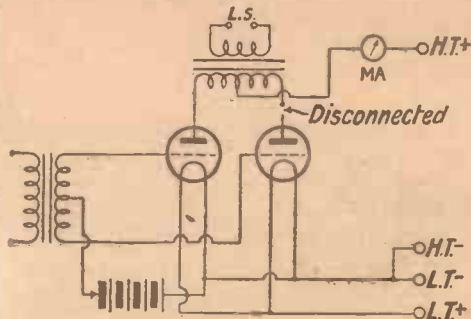

By this experiment it is easy to determine whether push-pull valves are matched

fairly low high tension. Good results are usually obtained, as the stage is easily wired and tends to stabilise the set.

If the output valves differ greatly in their characteristics however, or if the push-pull transformers are not correct, distortion may occur. With a milliammeter it is easy to check the anode currents of the output valves.

This, by itself, provides no indication of matched valves, but a very good idea of whether they are matched or not is to be

obtained by the following experiment: Connect one of the push-pull valves as in the figure and note the current.

Then alter the grid bias by, say, three volts and once again note the anode current. Do this with both valves, and if the values of current are equal, the valves may be said to be matched. As a further test, the change in anode current for different anode voltages can be measured.

Tests of this description are so easily and quickly carried out that it is worth while making them when new valves are fitted. A point is that the actual grid and anode voltages need not be measured, but only the anode current.

## Those Howls

I wonder how often a howl is thought to be due to a bad detector valve, whilst it is really the result of an unstable circuit?

Very often the howl goes when a fresh detector is fitted. But this is no proof that the old valve was faulty. Having a number of valves and various sets, I have noted that howling is likely to commence with certain combinations, although when used in a different set the results appear satisfactory.

The truth is, I think, that some low-frequency circuits are on the point of oscillating. If a frequency curve were drawn, it would show a peak at one part of the range. This may be due to a combination of high-resistance power supply and badly-designed low-frequency circuit. Therefore, next time you have a set which howls, try fitting a motor-boat stopper, of 20,000 ohms and 2 microfarads, to the detector.

## "YOUR VALVES: HOW TO CHOOSE THEM" (Continued from preceding page)

of rectifying valves usefully augment these Mazda mains valves.

### TUNGSRAM

MADE by the Tungram Electric Lamp Works is a range of low-priced Tungram valves for battery and A.C. mains working. The battery range is useful for average sets, the characteristics being commendably good, considering the price.

This range, which is for two-, four- and six-volt accumulators,

includes the following two-volts. The R208, a 50,000-ohms valve for resistance-capacity coupling, this has the useful amplification factor of 35.

The high-frequency valve, H210, has equally useful figures. The impedance is 25,000 ohms for an amplification factor of 25. As a detector the H210 should be useful.

The LG210, with an impedance of 10,000 ohms and an amplification factor of 10, would also be suitable as a detector followed by

a low-impedance coupling, but its chief function is as first low-frequency amplifier, for which position it is admirable.

There are two power valves in the Tungram range, the P215, with an impedance of 3,300 ohms, and the SP230, with an impedance of 2,500 ohms.

Some inexpensive mains valves are included. Four of these are one-volts; type R150 is suitable for resistance-capacity coupling or for normal high-frequency amplification. Its impedance is 18,000

ohms and its amplification factor 25.

The G150 is another one-volt A.C. valve for general purposes. The range is completed by the L190, a 4,200 ohms valve for low-frequency amplification and the P190 for the output stage.

For the detector stage, Tungram four-volt indirectly-heated valves can be used. There are two types, the AR4100 with an impedance of 17,000 ohms and the AG4100 with a lower impedance of 8,000 ohms.

FEW AMATEUR WIRELESS sets have been published which are simpler to construct than this 1930 edition of one of the most popular sets, the "Talisman 2." The original "Talisman 2" was easy to build, and, as we explained last week, the "A.W." post-bag is sufficient proof of the good results which listeners all over the country have obtained with this simple receiver.

**Simple and Efficient**

The 1930 edition is even more efficient and, if anything, even simpler to construct. The simplicity of construction will be immediately obvious to those who are setting about the work at once, and with the aid of the full-size blueprint the whole work should occupy only an hour or so, with only simple tools, such as a screw-driver, a pair of pliers, and a small selection of drills.

Soldering is advised because this makes a permanent job of the wiring. There is no difficulty about this, and there are many kits on the market which make the job of soldering a few connections so

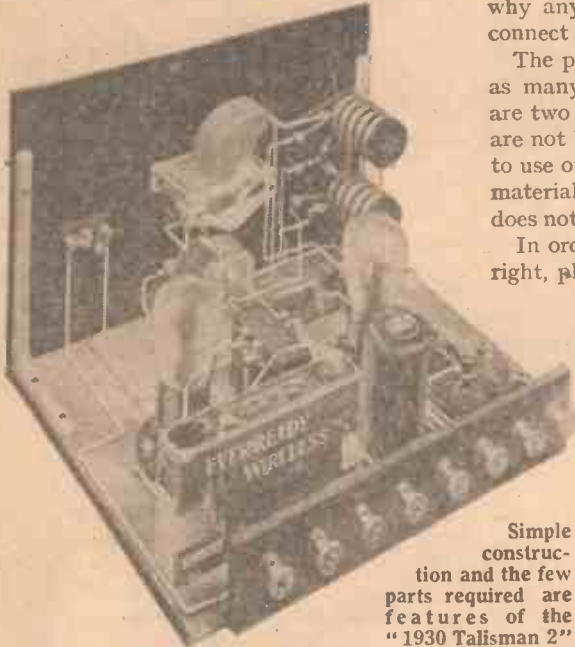

Simple construction and the few parts required are features of the "1930 Talisman 2"

simple that it is to be wondered at that anyone should shirk the work and still use screw-down connections.

**Drilling the Panel**

The blueprint, which can be obtained, price is., post free, from the Blueprint Department of AMATEUR WIRELESS, 58-61 Fetter Lane, London, E.C.4, is an invaluable aid in construction. The panel may be drilled, using it as a template, the parts may be correctly mounted on the base-board; the print is full size and no scale measuring is, therefore, needed; also all the wiring is shown, and there is no reason



**:: A Remarkable Two-valver That Will Give P**

why anybody should leave out a wire or connect a lead incorrectly.

The panel drilling is not half so difficult as many people suppose it to be. There are two secrets. One is to use drills which are not blunted by misuse and the other is to use only good quality ebonite. The best material is quite soft in drilling and it does not easily crack or chip at the surface.

In order to get the drilling centres quite right, place the blueprint on the panel and

difficulty should be found in mounting. When drilling, do not overlook the holes along the edge of the panel for the wood screws which attach the panel to the base-board; nor should the panel bracket bolt holes be overlooked.

Do not mount any of the parts before the panel is fixed to the edge of the base-board. The proper way of attaching the panel is to place it at right angles against the edge of the board, using the panel brackets to ensure that the angle of inclination is correct, and then first temporarily insert the wood screws. Next, the panel brackets can be screwed to the base-board, and the two small bolts passed through the panel and the vertical arms of the brackets. When this has been done the two variable condensers, the coil, and

**RANGE**

attach it at the corners temporarily with four spots of adhesive. With a punch lightly tap the drilling centres so

that a small mark is made in the ebonite where the drilling is to be started. Do not risk drilling without first marking the centres, for it is difficult to get the point of the drill rotating at exactly the point required; there is always a tendency for it to rotate and slip sideways.

**Mounting the Components**

When the centres have been lightly marked, the print may be removed and the holes drilled. All the components used are of the one-hole fixing type, and no

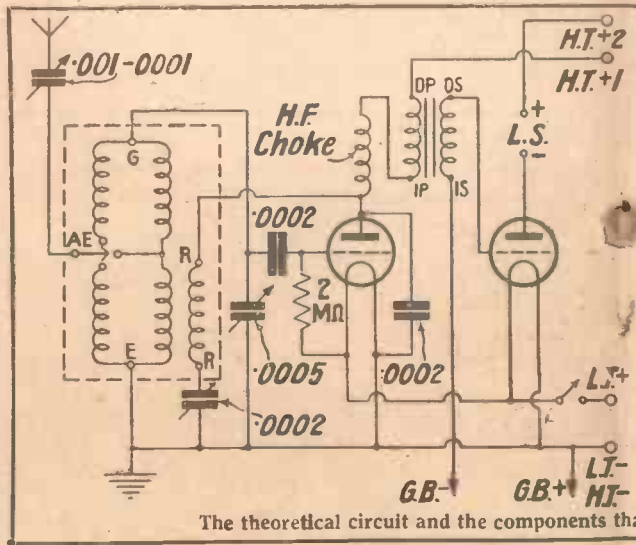

The theoretical circuit and the components th

# TALISMAN 2

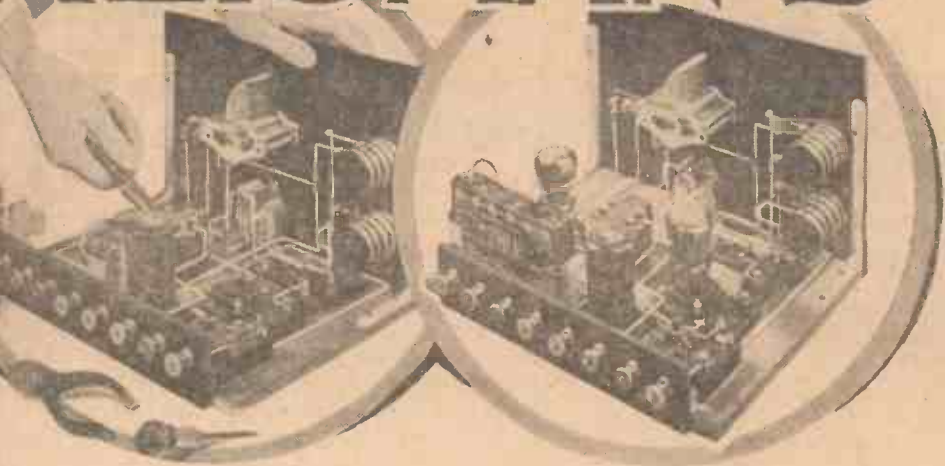

## plenty of Volume and Has a Wonderful Range ::

the L.T. switch can be mounted. The coil should be mounted with the terminals inwards towards the centre of the panel, for otherwise the connecting wires are unduly long.

### Wiring

With the exception of two short leads, all the wiring is carried out with rigid insulated wire, which is quite easy to work and which effectively prevents the possibility of short-circuiting. Two short lengths of rubber-covered wire are used for the connections to the grid-bias battery supporting the clips at the back of the baseboard. Here it should be noted that the terminal strip can generally be purchased ready drilled; or the small work of drilling the eight holes in the strip of ebonite can

be easily done by the constructor.

Five connections have to be made to the coil, and it is important that the wiring in this part should not be confused. If the leads are not fairly well spaced, capacity effects will be set up, which will seriously interfere with results. Do not forget to make a check of the wiring, using the blueprint as a guide, because this may prevent the possibility of burnt-out valves.

So far as valves are concerned, two-

## POWER

four-, or six-volters may be used. The following two-volt valves can be used in the detector socket, and these will serve

as a guide to those who wish instead to use the four- or six-volt equivalents:

Cossor 210HF, Dario Univ., Marconi HL210, Osram HL210, Six-Sixty 210HF, Mullard PM1HF, Mazda HL210, Lissen HL210, Fotos BA9, P.R., PR3LF, Triotron HD2.

The following two-volt power valves are advised, or their four- or six-volt equivalents: Cossor P2, Dario SP, Marconi P2, Osram P2, Six-Sixty 220P, Mullard PM252, Mazda P220, Lissen P220, Fotos BD9, Tungram P215, P.R. PR120.

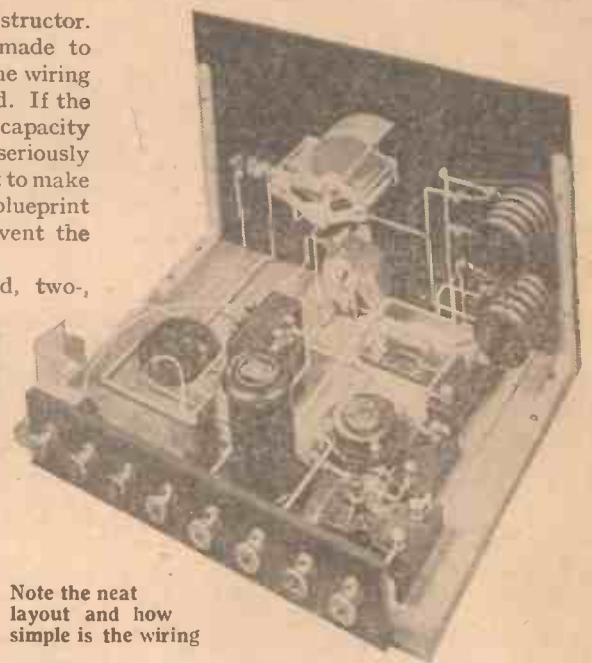

Note the neat layout and how simple is the wiring

### Batteries

As has been said, a medium-capacity dry H.T. battery can be used, but from the point of view of economy a battery of the power type is to be preferred. At least 120 volts should be used, and this may be increased to 150 or 180 where greater volume is required.

In most cases a full grid bias of 9 volts will be needed. Make sure that you get the plugs the right way round. When you are satisfied that all the wiring is correct the batteries may be connected and the valves inserted.

### Getting the Best Results

For a first test screw the knob of the small pre-set condenser right in, and pull out the knob of the "Talisman" coil, thus switching the set on to the medium wave-band. Adjust the loud-speaker and put the full H.T. voltage on the H.T. + 2 tapping and about 60 or 80 volts on the H.T. + 1 tapping. Set the reaction condenser at zero (that is, with the vanes apart) and slightly rotate the aerial condenser until one or other of the local

stations is heard. More critical adjustment of the reaction will improve strength, but too much reaction should not be used on the local stations.

A little experience in handling the set will show to what extent the pre-set condenser knob may be slackened off in an anti-clockwise direction to improve the sharpness of tuning.

The "1930 Talisman 2" will be on view all this week in the windows of the Radio Department of Messrs. Selfridge & Co., Ltd., of Oxford St., London. The Radio Department is in Somerset Street, which is at the back of Oxford Street and parallel to it.

Ebonite panel, 12 in. by 8 in. (Lissen, Becol, Trolitax, Radion).  
Baseboard 12 in. by 9 in. (Pickett, Camco, H. & B., P.B.).  
.0005-mfd. variable condenser (Burton, Lissen, J.B., Igranic, Lotus, Formo, Ready-Radio).  
.0002-mfd. reaction condenser (Dubilier, J.B., Lotus, Bulgin, Formo).  
Talisman dual-wave aerial coil (Wearite).  
Push-pull on-off switch (Trix, Lissen, Bulgin, Junit, Lotus, Benjamin, Wearite).  
Two anti-microphonic valve-holders (Lotus, Benjamin, Formo, Burton, Wearite, Trix, W.B., Lissen).  
Two .0002-mfd. fixed condensers (Lissen, Dubilier, T.C.C., Graham-Farish, Igranic, Watmel, Atlas).  
Pre-set condenser .0001-.001-mfd. (Lissen, Formo, Igranic, Sovereign, Polar).  
2-megohm grid-leak (Lissen, Dubilier, Graham-Farish, Watmel, Ediswan).

Grid-leak holder (Lissen, Bulgin, Watmel).  
High-frequency choke (R.I., Lissen, Lewcos, Tunewell, Bulgin, Sovereign, Watmel, Igranic, Varley).  
Low-frequency transformer 3-1 ratio (Igranic type J., Lissen, Telsen, Lotus, Varley, R.I., Burton).  
Ebonite strip 10 in. by 2 in. (Lissen, Becol, H. & B., P.B., Radion).  
Eight terminals marked: Aerial, Earth, L.T. positive, L.T. negative, H.T. positive 1, H.T. positive 2, L.S. negative, L.S. positive (Ealex, Belling-Lee, Clix, Burton).  
Grid-bias battery clips (Bulgin).  
Pair panel brackets (Bulgin, Ready-Radio, H. & B.).  
Two wander plugs marked G.B. positive, G.B. negative (Belling-Lee, Ealex, Clix, Igranic).  
Slow-motion dial (Brownie, Ormond, Formo).  
Connecting wire (Glazite).

are required for building the "1930 Talisman 2"



## The Toy MUSICAL BOX

# Continental Nights

By J. GODCHAUX ABRAHAMS

ON some evening, if you have not already done so, you will pick up a series of nine bell-like notes, crystal pure, which will carry you back to your childhood days. In a moment you will visualise the toy musical box which churned out, *ad nauseam*, "The Blue Bells of Scotland" or "The Carnival of Venice." Listen carefully, G A, B A B G, and again. It is Budapest calling you!

### The Budapest Studios

As is now customary, the transmitter is not installed in the capital, but at some ten miles distance; it is, as a matter of fact, at Lakihegy, on the small island of Csepel in mid-Danube. Although radio *qua* radio may have been new to the Hungarians, actual broadcasting was not, for



Eduard von Scherz, whose experience of announcing dates from 1907

the *Telefon Hirmondo*, which is still the controlling power in the present organisation, some thirty years ago started a service of news bulletins, stock exchange quotations for subscribers, and, similar to the Electrophone in London, also switched listeners over to opera house, music-hall, or church, as desired.

Budapest, as a newcomer, has benefited by the experience of other capitals and has launched its broadcasting system on a grand scale. It has not worried with temporary headquarters, but possesses perhaps the finest studio on the Continent

—a hall some 65 ft. long, 35 ft. wide, and almost 25 ft. high. The conductor of the orchestra, although visible to his musicians, is actually enclosed in a glass case. As it is sound-proof, he is able to direct the band and listens to the performance by headphone or loud-speaker. In this manner he can judge how the outside world is receiving the programme, and controls his instrumentalists in accordance with his personal observations. The idea is not only novel, but highly practical and, so far as I know, has only been copied by Stuttgart.

As Magyar is a language seldom learnt by foreigners, Budapest makes a point of giving out alternate announcements in French and German, and on some occasions translations of the items broadcast are put out in English. Its speciality is gipsy music. Of these Czigay bands there is a vast choice, and on different evenings you will hear Imre Magyari from the Hotel Hungaria, the Banda Marci from the Café Baross, the Bura Czigany from the Hotel Royal, the Toll from the Café Ostende, the Imri Farkas from the Spolarits Restaurant, and for the present, as dance band, the Jazz Orchestra Pataki from the Margaret Island.

### A Typical Scene

Try to visualise the café or open-air restaurant which the Magyar visits almost nightly to drink his lager beer or light wines. Imagine a brilliantly lighted hall somewhat garishly decorated containing countless marble-topped tables, each accommodating from four to six people. There is noise everywhere; not just the hum of subdued conversation, but the sounds of laughter, of high-pitched voices, the chinking of glasses, the popping of corks, and the monotonous drone of the white-aproned waiters who, passing from table to table, repeat the orders given by their customers. At one end of the hall—in some instances, on both sides—you will see a raised platform for the orchestra of eight, sometimes ten, men of all ages, dark skinned, waxed moustaches, close-cropped heads, their bright-coloured uniforms recalling musical comedy soldiers.

The instruments mostly favoured are the cembalo (a large zither-like instrument

on legs, played with two sticks), violin, 'cello, double bass, and two or three woodwinds, such as clarinet, flute, or piccolo. Suddenly the *primas* or leader strikes up a peculiarly dreamy melody to the accompaniment of his colleagues. No printed music is necessary—they require no band parts. The leader, still playing, steps off the platform and slowly walks amid the visitors, now staying for a few minutes at one table, now passing on to another, and choosing, as a rule, those at which the most beautiful women are sitting. In these extemporizations he goes from grave to gay, from mournful funereal-like wailings to the lighter lilt of musical comedy or operetta; he knits into these themes excerpts from grand opera or the latest jazz hits, and his solo turn may last some ten or fifteen minutes. And during this time the musicians on the platform follow his lead closely and extemporise their own accompaniments. Again, without warning, several loud chords crash out, and the entire band bursts into the mad *tempo* of the *czardas*. Faster and faster they play, carrying with them their entire audience, who enthusiastically tap with their feet or nod their heads in time to the music. A wild and noisy *finale*, the audience bursts into applause, the marble tables are slapped, spoons tinkle against glass or cup, and the *primas*, now on the platform, bows energetically, his face glistening with beads of perspiration and beaming with pride.

### The Oldest Announcer

Budapest can boast of possessing the oldest announcer in the world in the person of Eduard von Scherz; not the oldest in years, but in experience, for as an official of the *Telefon Hirmondo* he first appeared before the microphone in 1907! It is his voice you hear on most nights from the studio. He took up his duties on the opening day and has been responsible for the organisation of the programmes until a recent date.

During the opera season relays are made of complete performances, and in many instances you will agree that both orchestra and voices are in every way equal to those heard from Rome, Milan, or Naples.



As simple  
as

**A  
B  
C**

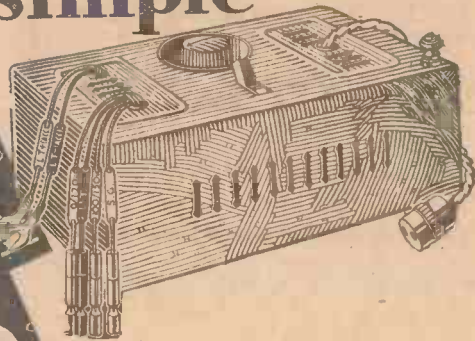

..... and you  
save 50% of the  
running costs  
of your Portable

**Fit an 'Ekco' Portable Unit now!**

Fit the very latest development in All-British All-Electric Radio—THE "EKCO" ALL-POWER UNIT, specially designed to fit snugly in all Portables but also designed for use with any type of set from one to five valves consuming up to 20 m/a.

All you have to do is slip this amazingly efficient Unit into the space previously occupied by your battery—connect your battery and accumulator leads to the "EKCO" Unit terminals—plug the "EKCO" Adaptor into the nearest electric light or power socket, and then, switch-on—that's all. Fitted in less than three minutes.

MODEL C.P.1. for A.C. Mains combines Trickle Charger and H.T. Unit, eliminating batteries and keeping any 2, 4 or 6 volt accumulator fully charged. Tappings: S.G. (60-80 volts); 0-120; 120/150 (100 volts only, if required) **£6. 0. 0.**

MODEL 1V.20 for A.C. Mains, eliminating H.T. batteries only. Tappings: S.G. (60-80 volts); 0-120; 120/150 (100 volts only if required) **£4. 12. 6.**

MODEL 1V.20 for D.C. Mains, eliminating H.T. Battery only. Tappings: S.G. (60-80 volts); 0-120; 120/150 volts **£2. 10. 0.**

Westinghouse Metal Rectifier—flexible output leads and variable tapping in A.C. Models.

Write for details of the "Ekco-lectric" Receivers, radio's supreme two and three valve sets.

**Plug - in—that's all!**



**POWER SUPPLY UNITS  
for ALL PORTABLES**

Obtainable on Easy Payments. Write for NEW illustrated literature! E. K. Cole Ltd., Dept. K "Ekco" Works, Leigh-on-Sea.

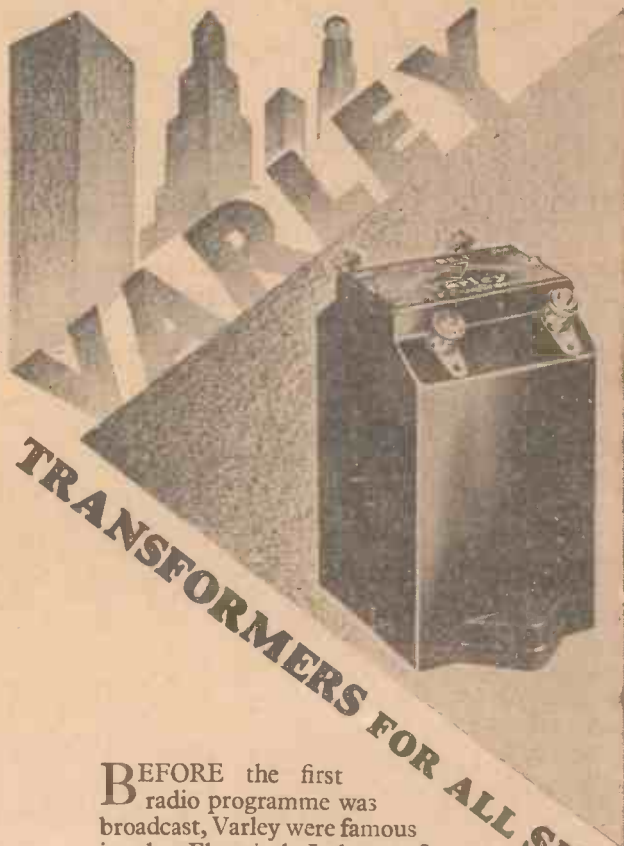

**TRANSFORMERS FOR ALL SETS**

BEFORE the first radio programme was broadcast, Varley were famous in the Electrical Industry for Transformer Coils. And when Varley Engineers designed Transformers for radio, their research was founded on long experience.

Now in this up-to-date range of Varley Transformers you have the benefit of this experience. Transformers are the most efficient and reliable you can buy. Use them in your radio set. Particulars on application.

Nicore I L.F. Intervalve Transformer .....	£1: 0: 0	POWER TRANSFORMERS (For Westinghouse Metal Rectifiers)
Nicore II L.F. Intervalve Transformer .....	£0: 15: 0	Transformer for H.T.1 Rectifiers .....
Heavy Duty L.F. Intervalve Transformer .....	£1: 3: 6	Transformer for H.T.3 and H.T.4 Rectifiers .....
Output Transformer (Double Ratio) .....	£1: 1: 0	Transformer for L.T. Rectifiers .....
Pentode Output Transformer (Dble. Ratio) .....	£1: 0: 0	
Heavy Duty Push-pull Input Transformer .....	£1: 3: 6	POWER TRANSFORMER (For A.C. Valves)
Standard Telephones & Cables, Ltd., Royalty extra, 1/8.		£1: 5: 0
Push-pull Output Transformer (D.R.) .....	£1: 2: 6	MULTI-VOLT PWR. TRANSFORMERS
Standard Telephones & Cables, Ltd., Royalty extra, 1/8.		E.P. 6 for Westinghouse Metal Rects. (60 w.) .....
POWER TRANSFORMERS (For Ictronic-Elkon Metal Rectifiers)		E.P. 7 for Valve Rectifiers (53 w.) .....
Transformer for H.T. Ictronic-Elkon Rect. .....	£1: 5: 0	E.P. 8 for Valve Rectifiers (120 w.) .....
Transformer for L.T. Ictronic-Elkon Rect. .....	£1: 5: 0	£2: 5: 0
		£2: 10: 0
		£3: 10: 0



Advertisement of Oliver Pell Control, Ltd., Kingsway House, 103 Kingsway, London, W.C.2. Telephone: Holborn 5303

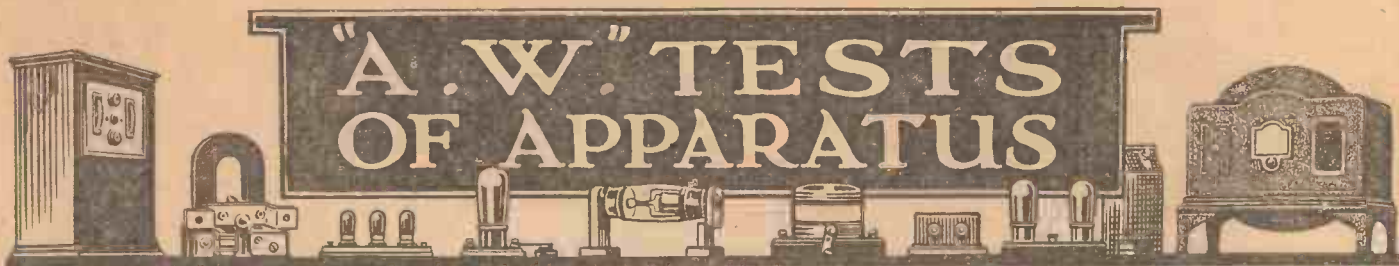

Conducted by our Technical Editor: J. H. REYNER, B.Sc. (Hons.), A.M.I.E.E.

**The New Six-Sixty A.C. S.G. Valve**

THE advantage of having no definite limit to filament consumption is shown by the phenomenal characteristics possessed by some of the new A.C. valves. This statement is particularly true when applied to the new Six-Sixty A.C. screen-grid valve, type 4X S.G. A.C., a sample of which has been sent to these laboratories for test.

An inspection of the internal electrodes of this valve reveals the ingenuity and mechanical robustness of the design. The screen is in the form of a close-mesh grid entirely surrounding the heater and normal grid. Two metal plates, mounted externally and on opposite sides of the screen, form the anode electrode, whilst the heater,

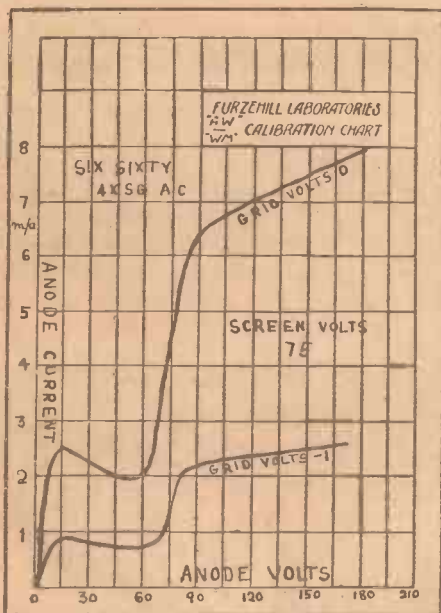

Characteristic curves of the New Six-Sixty A.C. S.G. Valve

which consumes 4 volts at 1 ampere, is placed, as usual, within the cathode. Connections are taken out to a standard five-pin base.

The valve was tested on the laboratory bridge and curves drawn showing the relation between anode current and anode volts for two different values of grid potential; these are shown in the diagram on this page. The value of the impedance was found to be 400,000 ohms, with a high mutual conductance of 4.7 milliamps per volt, giving an amplification factor of 1,900.

A few months ago these figures would have seemed incredible. In the maker's specification the impedance is given as 485,000 ohms and the amplification factor 1,600.

Due to the design and disposition of the electrodes, the self-capacity between grid and anode has been reduced to an abnormally low figure, thus allowing a very high amplification to be obtained under practical conditions.

**Voltron Dynaplug Transformer**

IT is no longer possible to judge an inter-valve transformer by its physical qualities, such as size and weight, while even the price is deceptive. In these laboratories we have tested all types and sizes of transformers and can vouch for the fact that inductance figures taken under operating conditions give the only valuable classification.

The Dynaplug transformer which has been submitted for test by Messrs. Voltron of Queensway, Ponders End, Middlesex, falls into the medium category, both as regards physical dimensions and primary inductance. The price, however, is only 6s. 9d., a figure well below the average for a transformer in this class.

The windings and iron core are completely enclosed in a black insulated moulded case with the primary and secondary terminals on either side. The overall dimensions, including terminals, are 3 1/4 in. by 2 1/2 in. by 2 in. high.

The transformer was subjected to the usual laboratory tests, including inductance measurements of the primary winding. This test was taken under practical operating conditions with a D.C. polarising current and, in addition, a small A.C. current flowing in the primary winding. With 2 milliamps D.C. polarising current, a normal value for low-frequency transformers following a detector valve, the primary inductance was 18 henries; with 5 milliamps, 14 henries, and with 10 milliamps, 10 henries. These values are unusually high for an inexpensive transformer of this type, and if preceded by a valve with an impedance of less than 20,000 ohms good amplification should be obtained of the lower audible frequencies.

**Franklin Fixed Condensers**

THOSE who have built up eliminators for mains work will probably have realised the excessive burden which the

condensers and the eliminator are called upon to bear. This is especially so in the case of A.C. eliminators, where voltage surges can readily exceed three times the normal working voltage, and it is consequently advisable, but not absolutely necessary, to use condensers whose tested voltage is three times the normal operating voltage.

Now that the popularity of eliminators is steadily increasing, condenser manufacturers are making extensive studies of manufacturing processes, and are producing components capable of withstanding high voltages, more compact in size, and inexpensive in price. This week the Franklin Electric Co., of Ilford, Essex, have submitted several high-voltage condensers for test. One of these, a 1-microfarad condenser, is rated at 650 volts and has overall dimensions of 1 3/4 in. by 1 in. by 2 1/2 in. high, excluding two small fixing lugs attached to the base of the condenser. The electrodes are taken out to soldering



One of the range of Franklin fixed condensers

tags, fixed to the insulated compound at the top of the component.

A second sample, also mounted in a metal case, measured 1 3/4 in. by 1 3/8 in. by 2 1/4 in. high and had a rated capacity of 2 microfarads and a test voltage of 700.

A completely adequate test of such components would include a life test over several months of continuous use. Since this is impracticable, the condensers were connected as reservoirs in an eliminator supplying 450 volts. In practice it is not likely they will be asked to stand up to such a stringent test, and as no trouble was experienced, we may state that they are suitable for use with high-voltage eliminators.

**MAKE YOUR SET-  
ANY SET,  
EVEN A  
PORTABLE**



**ALL-ELECTRIC**

WITH  
**REGENTONE**

*-the surest way*

**MAKE SURE  
YOU GET  
THIS BOOKLET**

**— it's FREE**

—from your Dealer—or in case of difficulty, write direct to the Manufacturers



**REGENT RADIO SUPPLY CO.,  
21 Bartlett's Buildings, Holborn Circus,  
LONDON, E.C.4**

Telephone: Central 8745 (3 lines)

*The* **BENJAMIN**  
Turntable  
with folding legs  
is *unique*

**FOR** Outdoor or Indoor use, the new Benjamin ball-bearing turntable is invaluable to the Portable Set user. Used outdoors, the legs are opened out, the capacity of the set to earth being thus considerably reduced. For indoor use the legs are folded, and being fitted underneath with rubber buffers, all damage to furniture is prevented. The smooth running ball-bearings make "direction finding" easy.

Price **7/6** Complete.



Write for illustrated leaflets on all Benjamin radio products.

Buy  
**BENJAMIN**  
*and buy the Best!*

**THE BENJAMIN ELECTRIC LTD.**  
BRANTWOOD WORKS, TOTTENHAM, N.17

**GET THOSE  
FOREIGN PROGRAMMES  
NOW**

USE YOUR EXISTING VALVES, BATTERIES & LOUDSPEAKER TO BEST ADVANTAGE!



Why wait? Why dream of long-distance radio? To-day it is a fact. You can have this new thrill now.

The Dynaplug Screened 3 is different from any other Screened Grid 3. It embodies new principles in coil design. New values in capacities. New screening methods keep the set dead stable so that every ounce of amplification in the Screened-grid Valve is available.

You can build the Dynaplug Screened 3 in full confidence that it will bring you in more stations, louder, clearer than you have ever heard, than you have ever thought possible. Ask your dealer about it to-day.

**DYNAPLUG 3  
SCREENED**  
COMPLETE KIT OF PARTS  
**£3-12-9**

**VOLTRON**  
*years ahead in design*  
COMPONENTS

**ASK YOUR DEALER  
FOR THE FREE  
BLUEPRINTS**

In case of difficulty, write direct to the manufacturers, giving your dealer's name and address.  
**VOLTRON ELECTRIC LTD.**  
Queensway, Ponders End, Middlesex.

Mention of "Amateur Wireless" to Advertisers will Ensure Prompt Attention

# THE MODERN TRANSFORMER

Everybody uses transformers nowadays, because they offer the best all-round means of coupling together valves for low-frequency amplification. Just why they have come into favour is explained in this article

NOT everybody realises just why transformers have so completely come into their own. The makers have, of course, put more wire on the primary winding, reduced the self-capacity of both primary and secondary, and developed cores of high permeability. The combined effect of these improvements has been to straighten out the response curves of transformers, so that both high and low notes are reproduced, in contrast to the thin reedy tone that characterised all but one or two expensive types of five years ago. Now, it is true to say that nearly every transformer can be made to give good quality.

Even a transformer with a small primary winding can give good bass notes if a low-impedance valve precedes it. That brings us to the most potent factor of all in present-day transformer technique. For, while it is true that a low-impedance valve could have been used in the old days, it was only at a great loss of volume. With improved valves, where for a given impedance the amplification is as much as double what it used to be, transformer characteristics can be modified with ease.

So good are modern valves that one stage of low-frequency amplification is usually sufficient to give full loud-speaker signals. The coupling between the detector, which

in the leaky-grid system is also a low-frequency amplifier, and the power valve can be a high-ratio or low-ratio transformer.

### Ratios

Before deciding which to use, find out whether the ratio is varied by the amount of wire on the primary or secondary. In good makes there is enough wire on the primary, irrespective of ratio, to enable at least a medium-impedance valve of, say, 20,000 ohms to be used. But in cheaper makes, an increased ratio denotes a decreased primary winding, the secondary being kept constant.

Usually, a 3 to 1 ratio is a good average for use with an HL type of valve.

With a higher ratio, assuming a lowering of primary impedance, an L type of valve with an impedance of 12,000 ohms is preferable. This plan helps to keep the transformer frequency response level; moreover, the overall amplification resulting from a high-ratio transformer and low-impedance valve is likely to give the following power valve all the signals it can safely handle without overloading. This is a point often overlooked.

As in most radio problems, one must work backwards; if we start with the assumption that a P215 type of small power valve is to be used, the preceding low-frequency

amplification must be arranged with an eye, not only for quality, but quantity. With such an output valve, it is doubtful whether a high-ratio transformer, however good, with a valve such as an HL, is at all desirable.

Among developments that have helped to establish the transformer as the most popular low-frequency coupling, we must not forget the various decoupling circuits, giving stability of operation and greater purity of reproduction. The simple connections of a transformer primary are seldom used to-day; instead of taking one end to H.T.+, a resistance is inserted; and at the junction of resistance and winding, one side of a 2-microfarad condenser is connected, the other side going to earth.

In addition to its use as a coupling between low-frequency amplifiers, the transformer has come into great use as a coupling between the power valve and the loud-speaker. With greater anode currents, the need for an isolation of the loud-speaker winding has become imperative. But in addition to protecting the loud-speaker from direct current, the output transformer helps to maintain purity of reproduction in a well-designed set. Its primary matches the impedance of the output valve, and its

(Continued at foot of page 69)

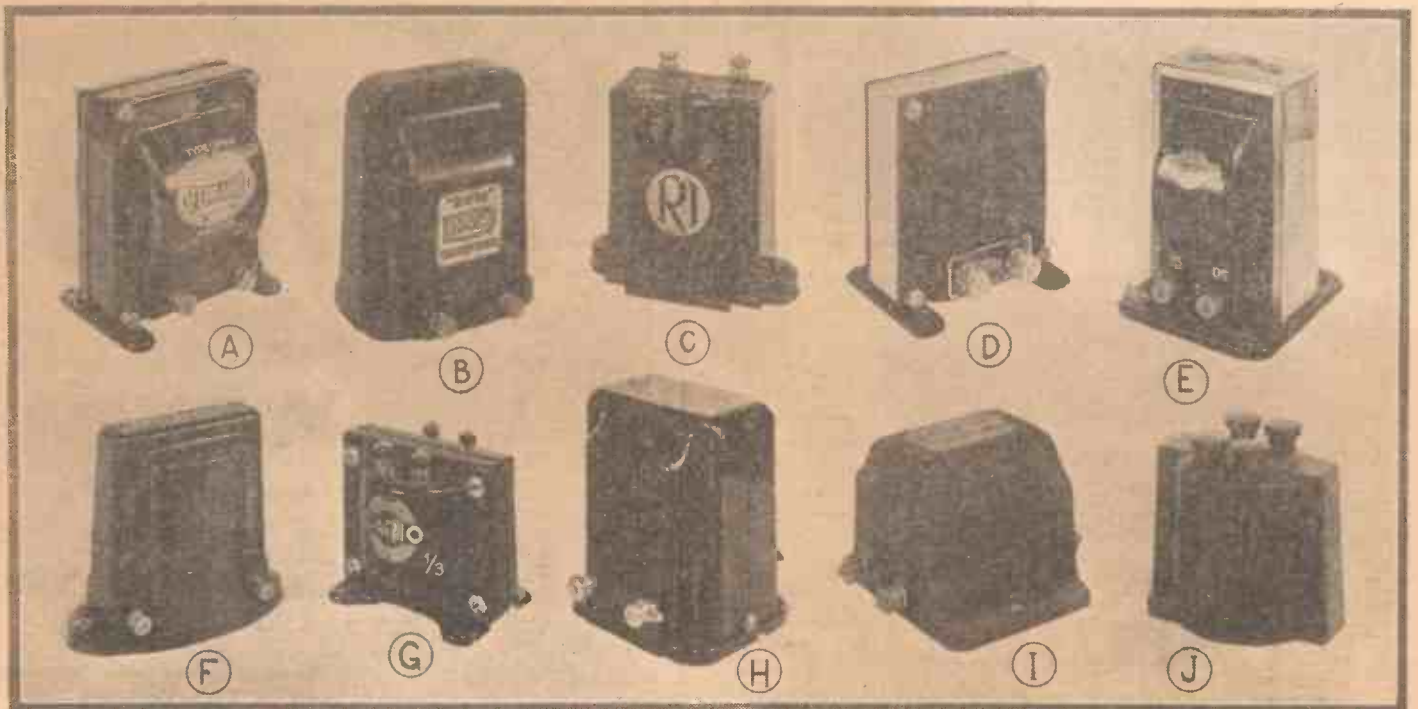

Due to the use of improved materials, size is no longer any criterion of the quality of a transformer. In this picture are shown (A) Ferranti, (B) Lissen, (C) R.I., (D) Telsen, (E) Igranica, (F) British General, (G) Darlo, (H) Varley, (I) Cossor, (J) Brownie

# For the Newcomer to Wireless : WAVEMETERS

I'VE just acquired a buzzer wavemeter and I'd like to know something of the way in which it works.

It's a very simple business really. Let us see if we can make it clear. Do you know the circuit of a meter of this kind?

I'm not quite sure that I do.

Well, in its simplest form it consists of an ordinary tuned circuit, that is, a coil with a condenser in parallel, and the coil is so arranged that when the buzzer is in action, current from the operating battery passes through it. Draw the symbol for a coil. Now from its "top" end show a lead to a buzzer. Continue from the buzzer to one terminal of a cell and from the other terminal of the cell back to the "bottom" of the coil. Now just draw in a condenser in parallel with the coil and there is the simple circuit.

I follow that.

You ought to show a switch, too, in series for throwing the buzzer into or out of action. Now at the moment of switching on, contact is made through the buzzer and current flows through the coil. Next instant the armature of the buzzer moves, breaking the contact and stopping the flow of current.

I see. What happens then?

During the instant whilst the circuit is made the condenser across the coil is charged up. In the very brief period whilst the circuit is broken by the movement of the armature the condenser discharges through the coil.

Then at each movement of the armature the condenser alternately charges up and discharges?

Exactly, and since the discharge of a condenser is oscillatory, the circuit formed by the coil and condenser is set oscillating at the frequency to which it is tuned. Usually the coil is fixed and the condenser variable.

And, of course, by adjusting the condenser the wavelength of the circuit can be changed?

That's it. Calibrate the condenser dial in wavelengths or frequencies, or, if you like, make a calibration chart for the instrument and the wavelength or frequency to which the meter is tuned can be read off at once.

But how exactly do the oscillations of the wavemeter circuit affect my receiving set?

The buzzer wavemeter is, in effect, a small transmitter, for every transmitter can be boiled down to a tuned circuit

with something to set it oscillating. As the wavemeter has no aerial, its radiation is small, but it is quite enough to provoke a response from your receiving set if you bring the buzzer coil anywhere near the aerial coil of the set.

Then the "buzz" is picked up, amplified, and rectified by my set just like any other signal?

That's so, and if the wavemeter is carefully designed so as to avoid damping the tuning will be pretty sharp. Hence you will hear much the loudest response from your telephones or loud-speaker when the buzzer circuit and your own set are tuned to resonance.

So that when the buzz is most loudly heard one can read off on the meter the wavelength to which the set is tuned, I suppose?

Precisely. Here is one tip for you. When using a buzzer wavemeter, always couple it so loosely to the receiving set that even when resonance is achieved the buzz is only just comfortably audible. You will then hear nothing of it until you are quite close to the resonance point and you will have no difficulty in determining the exact tuning that gives the loudest response.

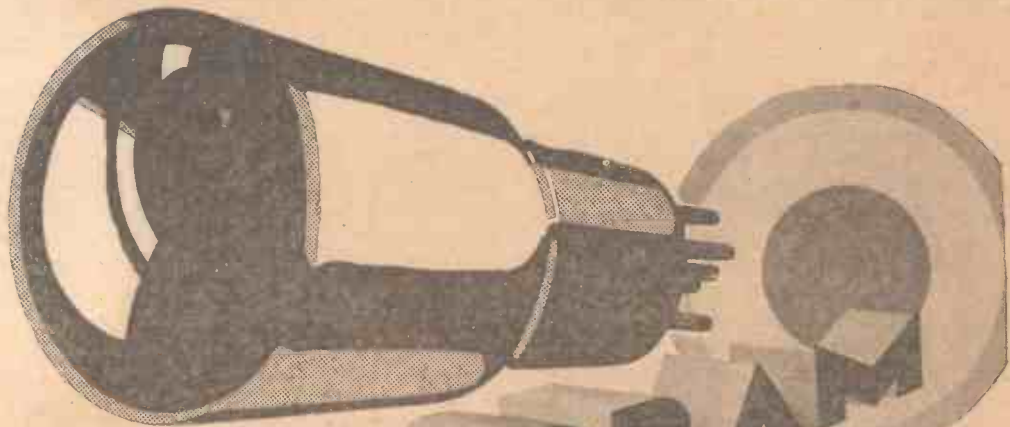

Tungram A.C. Valves for mains operated sets. They are the best A.C. Valves you can buy. Their first cost is less. They cost less to run, and they have a long life. And their performance: long range, selectivity, volume, and perfect tone. For better, more economical radio use Tungram A.C. Valves.

## A.C. VALVES

INDIRECTLY HEATED VALVES, 9/6. - 4 v. A.C. POWER VALVES, 8/-.

Tungram Photo Electric Cells (3 types) Standard, £2 10 0. Nava E and Nava R, £2 17 6.

TUNGSRAM ELECTRIC LAMP WORKS (Great Britain) Ltd., Radio Dept., Commerce House, 72 OXFORD ST., W.1  
 FACTORIES IN AUSTRIA, CZECHO-SLOVAKIA, ITALY, HUNGARY, POLAND. BRANCHES IN BELFAST, BIRMINGHAM, BRISTOL, CARDIFF, GLASGOW, LEEDS, MANCHESTER, NEWCASTLE, NOTTINGHAM, SOUTHAMPTON.





THE ceremony known as *Chairing the Bard* will take place at the National Eisteddfod at Llanelly on August 7. This curious custom, as well as a speech by Mr. Lloyd George, will be relayed in the National programme on that date.

The number of licensed listeners in Finland now totals 90,232, of which 12,984 are of Swedish nationality.

The Fourth International Conference on Wireless Regulations is to be held at Liège from September 22 to 26 next.

In view of the fact that the Brixton Astoria has adopted complete talking film programmes, after July 22 relays of orchestral and organ music from this cinema will no longer take place.

Work on the new 15-kilowatt transmitter destined to feed the Lille (France) district has been started. The site is at Camphin-en-Carembault at about eight miles from the city. Every effort is to be made to complete the station by the end of the autumn.

## What are the Sound Waves Saying?

THE sound waves said a good deal the other night, for they brought me a Beethoven symphony. I found myself thinking of Beethoven. What a fascinating character he was. He had a bad time as a youngster, though, for his father was a hard drinker and not a hard worker; but the day came when he had either saved enough or had borrowed enough money to take him to Vienna, the city of music, where the musical *élite* always drifted at some stage in their career. Mozart was there, and who had not heard of his wondrous doings in those days.

Beethoven sallied forth with a grim determination about him. He had the cheek of his years, and made no bones about it; he just called on the great Mozart. I cannot think that Mozart was glad to see him. Beethoven was a wild-looking youth, with a jaw set like a bulldog's and a quantity of hair on his face as well as his head. He introduced himself in his characteristic blunt fashion; you must also remember that he spoke with a decided provincial accent. Mozart, perfectly garbed and bewigged, received him a trifle coldly. Beethoven's idea was not so much to play as a *pianist*, but to show off his powers as a *composer*. So he improvised. Mozart mistook the improvisation for a rendering of something Beethoven had previously written down and memorised. "Yes," he said, "you have a good memory." That upset Beethoven. He protested that he was improvising, whereat Mozart bowed and begged his pardon.

Beethoven determined not to leave Mozart without having improvised upon a

theme set *especially* for him. He said as much. Mozart thought a moment. Then he played a theme which he knew would take some handling. Beethoven did not think a moment; he simply poured out his music. He twisted that theme into every artistic shape imaginable and in a manner that astonished Mozart to such a degree, that he quietly left the room and went into an adjoining one, where some friends were seated. "Listen to him," said Mozart. "He will make a big noise in the world some day."

Poor Beethoven! For the last twenty years of his life he hardly heard a sound, except the music in his brain. When he first realised that he was becoming deaf, he could not bear to tell his friends; he shunned their society rather than have to ask them what it was they said. He did unburden himself to Wiegler in a letter. "I shall," he wrote, "as far as possible, defy my fate, though there will be moments when I shall be the most miserable of God's creatures. But I shall grapple with Fate—*she shall never drag me down.*"

When the end came, he fought it with a will. He died shaking his fist at a thunderstorm that was raging at the time.

But he was a lovable old thing. He snapped at his friends; he quarrelled outright with some of them, but they always came to him again, so strong was his personality. His pupils worshipped him. Some of them were duchesses, and an occasional princess figured amongst them. But they had their lessons at their palaces or sent their carriages to his shabby dwelling, *as he chose to direct.*

WHITAKER-WILSON.

On Sunday afternoon, August 3, the B.B.C. will relay "The Old Contemptibles" service to be given at St. Martin's-in-the-Fields.

"Sob Stuff" is the title of the latest of Gordon McConnell's light entertainments; it will be broadcast through London National on July 28 and through the Regional stations on the following evening.

The B.B.C. has now concluded all arrangements for the carrying out of three relays of performances broadcast during the Salzburg (Austria) Music Festival. Mozart's *Serenade* will be transmitted on August 7, the first act of *Iphigenie* on August 20, and an orchestral concert on August 30.

New plans have now been formulated for the reorganisation of the Spanish broadcasting system. The latest scheme provides for a 30-kilowatt transmitter at some spot approximately in the middle of that country, four 15-kilowatt stations at Madrid, Barcelona, Valencia, and Vigo, and a high-power short-wave transmitter to relay the capital programmes.

Nidaros (Norway), formerly known as Trondhjem, is now in possession of a 1.2 kilowatt relay station working on 453.1 metres; it takes all its wireless programmes from Oslo.

Amongst the various cruises over Europe projected by the German airship *Graf Zeppelin* during the months of July and August is one over the British Isles on July 29. In connection with this event it may be interesting to recall that wireless telegraphy and telephony messages from this airship have been picked up on 1,032 metres and on 53, 35.4, and 26 metres.

The Telefunken Co. of Berlin has secured the order for the erection of a powerful broadcasting station in Nanking; it will be erected near the Yangtze River.

Mr. E. P. H. James, sales promotion manager of the American National Broadcasting Company, at a luncheon given by the Aldwych Club in London stated that "one hour's broadcasting time on stations which covered the whole of the United States cost 10,000 dollars, and advertisers would in addition spend amounts up to 7,000 dollars on a programme to fill that time."

The Federal Radio Corporation has allocated wavelengths to the American Radio News Corporation, a company formed for the operation of automatic printers by radio. At a cost of about £10,000 each four transmitting stations are to be built at New Rochelle, N.Y., San Francisco, Chicago, and Atlanta. Receiving machines will be leased to news agencies.

An international institute of television has been established in Brussels to deal with collecting and propagating the results of researches made in connection with picture broadcasting.

# BROADCAST TELEPHONY

Broadcasting stations classified by country and in order of wavelengths. For the purpose of better comparison, the power indicated is *aerial energy*.

Metres	Kilo-cycles	Station and Call Sign	Power (Kw.)	Metres	Kilo-cycles	Station and Call Sign	Power (Kw.)	Metres	Kilo-cycles	Station and Call Sign	Power (Kw.)
<b>GREAT BRITAIN</b>											
25.53	11,751	Chelmsford (5SW)	15.0	306	980	Bordeaux (PTT)	1.0	365	821	Algiers (PTT)	10.0
1200	1,500	Leeds	0.13	309	970	Radio Vitus	1.0	416	720	Radio Maroc (Rabat)	10.0
*242	1,238	Belfast	1.0	316	950	Marseilles (PTT)	0.5	1,250	240	Tunis Kasbah	0.6
*261	1,148	London Nat.	45.0	326	914	Grenoble (PTT)	0.5	<b>NORWAY</b>			
*288.5	1,040	Newcastle	1.0	329	914	Poste Parisien	0.5	364	824	Bergen	1.0
288.5	1,040	Swansea	0.13	345.2	869	Strasbourg (testing shortly)	12.0	368	815	Frederiksstad	0.7
288.5	1,040	Stoke-on-Trent	0.13	370.4	870	Radio LL (Paris)	0.5	445	674	Rjukan	0.18
288.5	1,040	Sheffield	0.13	385	779	Radio Toulouse	8.0	453	663	Nidaros	1.2
288.5	1,040	Plymouth	0.13	447	677	Paris (Etat)	0.8	453	663	Tromsø	0.1
288.5	1,040	Liverpool	0.13	466	644	Lyons (PTT)	5.0	455	659.3	Porsgrund	0.7
288.5	1,040	Hull	0.13	1,446	207	Biffel Tower	12.0	*493	608	Oslo	00.0
288.5	1,040	Edinburgh	0.35	*1,725	174	Radio Paris	10.0	<b>POLAND</b>			
288.5	1,040	Dundee	0.13	<b>GERMANY</b>							
288.5	1,040	Bournemouth	1.0	*218	1,373	Flensburg	0.5	214	1,400	Warsaw (2)	2.0
288.5	1,040	Bradford	0.13	*227	1,373	Cologne	4.0	234	1,283	Lodz	1.5
*301	995	Aberdeen	1.0	*227	1,319	Münster	3.0	*313	959	Cracow	0.5
*310	968	Cardiff	1.0	*227	1,319	Aachen	0.35	*335	896	Poznan	1.2
*355	842	London Reg.	30.0	232.2	1,310	Kiel	0.35	384	780	Wilno	0.5
*377	797	Manchester	1.0	*230	1,256	Nürnberg	2.0	381	788	Lvov	2.0
*390	753	Glasgow	1.0	244	1,227	Cassel	0.25	*408	734	Katowice	10.0
*470	626	Midland Reg.	25.0	*253	1,184	Gleiwitz	2.0	1,411	212.5	Warsaw	8.0
1,551	193	Daventry (Nat.)	25.0	*259	1,157	Leipzig	2.5	<b>PORTUGAL</b>			
<b>AUSTRIA</b>											
*246	1,220	Linz	0.5	*270	1,112	Kaiserslautern	0.25	320	937.6	Lisbon (CTIAA)	0.25
*283	1,058	Innsbruck	0.5	*275.8	1,087	Königsberg	2.5	<b>ROUMANIA</b>			
*352	851	Graz	9.0	*283	1,058	Magdeburg	0.5	*304	761	Bucharest	12.0
*453	666	Klagenfurt	0.5	*283	1,058	Berlin (E)	0.5	<b>RUSSIA</b>			
*518.6	578.5	Vienna	20.0	*283	1,058	Stettin	0.5	720	416.6	Moscow (PTT)	20.0
<b>BELGIUM</b>											
206	1,460	Antwerp	0.4	*316.8	947	Bremen	0.35	800	375	Kiev	20.0
207	1,450	Brussels	0.25	*320	937.6	Dresden	0.25	824	364	Sverdlovsk	25.0
216	1,391	Chatelineau	0.25	*325	923	Breslau	1.5	934	320	Moscow-Stehelkovo (C.C.S.P.)	100.0
230	1,256	Binche	0.3	*360	833	Stuttgart	1.5	1,000	300	Leningrad	20.0
216	1,218	Schaerbeek	0.5	*372	806	Hamburg	1.5	1,060	283	Tiflis	10.0
244.7	1,226	Ghent	0.25	*390	770	Frankfurt	1.5	1,073	279	Rostov (Don)	10.0
338	887	Forest	3.0	*418	716	Berlin	1.5	1,103	272	Moscow Popoff	40.0
*500	590	Brussels	1.0	*453	662	Danzig	0.25	*1,304	230	Kharkov	25.0
<b>CZECHO-SLOVAKIA</b>											
*263	1,139	Moravska-Ostrava	10.0	*473	635	Langenberg	15.0	1,380	277.5	Bakou	10.0
*270	1,076	Bratislava	12.5	*533	593	Munich	1.5	1,500	200	Moscow (Kom)	40.0
294.6	1,018	Kosice	2.0	560	536	Augsburg	0.25	<b>SPAIN</b>			
*342	878	Brunn (Brno)	12.0	*566	529	Hanover	0.35	251	1,193	Barcelona (EAJ15)	0.5
*487	617	Prague (Prahá)	5.0	569	527	Freiburg	0.35	266.7	1,124	Barcelona (EAJ13)	5.0
<b>DENMARK</b>											
*281	1,067	Copenhagen	0.75	*1,635	183.5	Zeelen	20.0	368	815	Seville (EAJ1)	8.0
1,153	260	Kalundborg	7.5	1,635	183.5	Norddeich	10.0	424	707	Madrid (EAJ7)	2.0
<b>ESTONIA</b>											
401	748	Reval (Tallinn)	1.5	<b>HOLLAND</b>							
<b>FINLAND</b>											
*221	1,355	Helsinki	10.0	31.28	9,599	Eindhoven (PCJ)	30.0	462	649	San Sebastian (EAJ8)	0.5
*1,796	167	Lahti	40.0	*299	1,004	Huizen (between 11.40 a.m. and 5.40 p.m. B.S.T.)	0.5	135	2,222	Motala	00.0
<b>FRANCE</b>											
20.7	10,180	Radio Experimental (Paris)	1.4	*1,071	280	Huizen	0.5	231	1,301	Malmö	0.6
175	1,774	St. Quentin	0.1	*1,071	280	Scheveningen-Haven	5.0	*257	1,160	Hörby	10.0
219.0	1,364	Beziens	0.3	*1,875	160	Hilversum	0.5	272.1	1,103	Falun	0.5
219.0	1,364	Fécamp	0.7	<b>HUNGARY</b>							
237	1,265	Bordeaux (Radio Sud-Ouest)	1.0	210	1,430	Budapest (Csepel)	1.0	*322	932	Göteborg	10.5
259	1,255	Nimes	0.25	550	545	Budapest	20.0	*436	689	Stockholm (tests)	00.0
249	1,205	Juan-les-Pins	0.5	<b>ICELAND</b>							
256	1,171	Toulouse (PTT)	1.5	*1,200	250	Reykjavik (shortly testing)	16.0	*542	554	Sundsvall	1.0
265	1,130	Lille (PTT)	0.7	<b>IRISH FREE STATE</b>							
268	1,121	Strasbourg	0.7	*225	1,337	Cork (IFS)	1.0	*403	743	Berne	1.0
*272	1,102	Rennes (PTT)	0.5	*413	725	Dublin (2RN)	1.0	*459	653	Zurich	0.83
286	1,046	Montpellier	0.3	<b>ITALY</b>							
*287	1,044	Radio Lyons	0.5	25.4	17,870	Rome (3RO)	9.0	673.7	442	Lausanne	0.6
295.2	1,026	Limoges (PTT)	0.5	201	1,030	Turin (Torino)	7.0	760	395	Geneva	0.25
<b>NORTH AFRICA</b>											
<b>NORWAY</b>											
<b>POLAND</b>											
<b>PORTUGAL</b>											
<b>ROUMANIA</b>											
<b>RUSSIA</b>											
<b>SPAIN</b>											
<b>SWEDEN</b>											
<b>SWITZERLAND</b>											
<b>TURKEY</b>											
<b>YUGOSLAVIA</b>											

All wavelengths marked with an asterisk have been allotted according to the Plan de Prague.

## "THE MODERN TRANSFORMER"

(Continued from page 66)

secondary matches the loud-speaker impedance. Thus, differences in loud-speaker and output valve impedances can be reconciled with an output transformer.

While using an output transformer in conjunction with an inter-valve transformer, the system of push-pull is worth considering. The secondary of the inter-valve transformer is centre-tapped, the two ends going to the two grids of identical output valves. The centre tap goes to a common grid bias. The output transformer has a tapped primary, the two ends going to the anodes of the output valves, the centre tap providing the common H.T. +

potential. Some of the latest types have two separate secondaries on the inter-valve push-pull, so that separate grid bias can be applied to the push-pull valves. The



The Lotus transformer—

made by

Garnett, Whiteley & Co.

advantage is that the push-pull valves need not be identical, their working characteristics being made equal by adjusting the bias so that each passes the same anode current.

## IN THE HIGHEST CLASS



### TUNEWELL TRANSFORMERS

#### NEW POPULAR MODEL

Ratios 3-1 and 5-1

Price 8/9

#### SUPER TRANSFORMER

Ratios 3-1 and 5-1

Price 12/6

Write for List of Speakers

### TURNER & CO.

54 Station Road, New Southgate, N.11

# SIX-SIXTY

this tester proves your valves & set

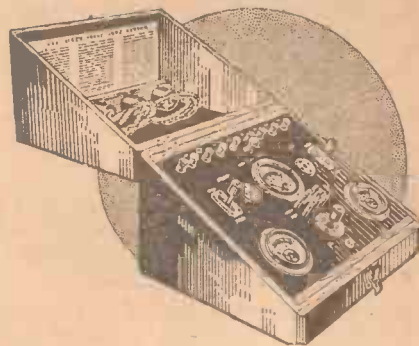

When you want to prove the performance of your set; when it has faults which you cannot locate; when you want to test it stage by stage—A.C. or D.C. Valves, Batteries, or H.T. Eliminators—for output, voltage, current and performance—use the SIX-SIXTY Valve and Set Tester.

The SIX-SIXTY Valve and Set Tester saves time and money—you can get the highest pitch of performance without any costly experiments. Price, £8 : 16 : 3.

## SIX-SIXTY VALVE & SET TESTER

Made by the makers of the famous Six-Sixty Valves  
Six-Sixty Radio Co. Ltd., Six-Sixty House, 17/18  
Rathbone Place, Oxford Street, W.1  
Telephone: Museum 6126/7

# THE WATCH DOG FOR YOUR SET

Let the famous Wates three-in-one Meter be your set's watch dog. Let it keep guard over the batteries. It will prevent many an evening being spoilt through their being run down. Let it find instantly those obscure faults which happen. Let it give you inside information about your set that will enable you to run it like an expert.

Obtain one now. Insist on the genuine Wates Meter. DO NOT BE PUT OFF WITH IMITATIONS. Patent No. 322558.



Popular Model. Crystallized Black Finish. 8/6  
Res. 5,000 ohms  
Milliammeters 0-25 or 0-50 m.a. with 9/6  
Jewel Bearings  
Panel Model "3 in 1" Meter. Rearrange plugs for readings 13/9

READINGS  
0-150 Volts 0-8 Volts  
0-30 Milliamps  
Resistance 5,000 ohms.  
Patent No. 322558.



Meter Case for standard model. Satisfactory lined substantial fittings well made 1/9

Obtainable from all dealers

## WATES "three in one" VOLT-AMP RADIO TEST METER

THE STANDARD BATTERY CO. (Dept. A.W.)  
184/188, Shaftesbury Avenue, London, W.C.2

### EASY TERMS

We SPECIALISE in the supply of all Good Quality Radio Sets, Components and accessories on Easy Terms. We will give you efficient service. Send us your list of requirements and a quotation will be sent by return.

LONDON RADIO SUPPLY COMPANY  
11 Oat Lane, Noble St., London, E.C.2

NATIONAL 1977

Let "Amateur Wireless" solve your problems

## LETTERS TO THE EDITOR

The Editor does not necessarily agree with the views expressed by correspondents

### Faulty Components

SIR,—Have we not yet reached the days when the makers of components should turn their articles out in a condition ready to use? I have just finished building the second "Best-by-Ballot," using all parts as recommended by AMATEUR WIRELESS. Having fixed and screwed everything in position, it is most annoying to find a locknut on the variable condenser terminals not tightened, a wire connected to the coil not properly locked. In all, I had to take down five components to remedy defects of this description. When one is buying the best British components, instead of dumped Continental goods, it is only to be expected that every detail has been examined. Have any other of your readers noticed these annoying faults?

A. H. (Thornton Heath).

### Sunday Programmes

SIR,—I am in complete and cordial agreement with the recent article on the Sunday programme scandal. I visit a large number of Northern set owners every week, and can positively assure you that even this article only very mildly describes the state of mind and feelings of very many working-class licence payers, like myself, who are absolutely fed up with the class of programmes provided for us, not only on Sundays, but practically every evening of the week. But what can we do to alter this state of affairs?

If you can suggest any scheme which is likely to succeed in bringing about a more satisfactory kind of programme (for Northern listeners, at all events), then now is the time to place it before us, and thus earn our sincere gratitude and thanks.

A. B. (Bolton).

### Neon Lamps for Television

SIR,—It may be of interest to television experimenters to know how to obtain the greatest brilliancy from neon lamps. Should the bulb be frosted, as is sometimes the case, glycerine or medical paraffin will render it transparent. The lamp should be enclosed in an ellipsoidal reflector made up from a motor head-lamp reflector and a concave mirror with centre hole, this hole being covered by a bull's eye lense to diffuse the effect of the opaque electrodes. A narrow parallel beam is thus obtained which uses the whole available light.

C. M. (Leeds.)

### Jamming the Foreign Stations

SIR,—I am afraid your contributor "Thermion" is wasting space and time in discussing the question of B.B.C. policy regarding programmes, Sunday or week-day.

(Continued on next page).

## FULL-SIZE BLUEPRINTS

When ordering, please send Postal Order, NOT STAMPS

CRYSTAL SETS (6d. each)	
B.B.C. Brookman's Park Set	AW205
Regional Crystal Set	WM176
ONE-VALVE SETS (1s. each)	
B.C. Official One	AW208
Hartley Single-valver	WM198
TWO-VALVE SETS (1s. each)	
Loud-speaker America Two	AW100
Talisman Two (D, Trans)	AW194
British Broadcast Two (D, Trans)	AW215
Easy-tune Two (D, Trans)	AW226
Wavelets Two (D, Trans)	AW229
No-battery A.C. Mains Two (D, Trans)	AW230
No-battery Gramo-radio 2 (D, Trans)	AW238
1930 Talisman 2 (D, Trans)	AW239
Brookman's Two (D, Trans)	WM168
Programme Two (D, Trans)	WM177
New Crusader (D, Trans)	WM182
Radio-Record Two (SG, D)	WM187
Cleaner Two (D, Trans)	WM200
THREE-VALVE SETS (1s. each)	
All-wave High-mag. Three (D, 2 Trans)	AW199
Knife-edge Three (D, RC, Trans)	AW201
Talisman Two-three (D, RC, Trans)	AW203A
Wide World short-wave Three (HF, D, Trans)	AW207
Everybody's Three (SG, D, Trans)	AW209
1930 Ether Searcher (SG, D, Trans)	AW211
New All-Britain Three (HF, D, Trans)	AW214
Best-by-Ballot Three (SG, D, Trans) Price 4d. free with copy of "AW"	AW217
Brookman's By-pass Three (D, 2 Trans)	AW220
Everybody's all-electric Three (SG, D, Trans)	AW221
1930 Clarion Three (SG, D, Trans)	AW223
Beginner's Regional Three (D, 2LF)	AW233
Standard Coil Three (HF, D, Trans)	WM117
Janfar (D, 2 Trans)	WM157
Brookman's Three (SG, D, Trans)	WM161
Community Three (D, RC, Trans)	WM164
New Q3 (SG, D, Pentode)	WM167
Brookman's Push-Pull Three (SG, D, Trans) 1/6	WM170
Celerity Three (SG, D, Trans)	WM173
All-nations Three (D, 2 Trans)	WM178
Inceptordyne (SG, D, Pentode)	WM179
Brookman's A.C. Three (SG, D, Trans) 1/6	WM184
Music Marshal (D, 2 Trans)	WM190
Gramo-Radio D.C. Three (SG, D, Trans)	WM196
Concert Three (D, 2 Trans)	WM199
FOUR-VALVE SETS (1s. 6d. each)	
Clarion All-electric Three (SG, D, Trans)—A.C. Rectifier	AW200
Music-Lover's Gramo-radio (SG, D, RC, Trans)—1s. 6d.	AW202A
Music-Lover's Gramo-radio (Loud-speaker)—1s.	AW202B
Horizon Four (SG, D, 2 Trans)	AW237
Standard-coil Four (HF, D, 2 RC)	WM122
Dominions Four (SG, D, Trans)	WM134
Arrow (SG, HF, D, Trans)	WM154
1930 Monodial (2SG, D, Trans)	WM158
Electric Four (All A.C.—SG, D, RC, Trans)	WM182
Brookman's Four (2SG, D, Trans)	WM174
Transportable Four (SG, D, 2 RC)	WM180
Super Q (SG, D, 2 Trans)	WM189
Lodestone Four (HF, D, RC, Trans)	WM193
Searcher's Four (SG, D, RC, Trans)	WM194
Invitation Four (SG, D, RC, Trans)	WM201
FIVE-VALVE SETS (1s. 6d. each)	
James Quality Five (2SG, D, RC, Trans)	AW227
All-wave Lodestone Five (HF, D, RC, Push-pull)	WM146
1930 Five (2HF, D, RC, Trans)	WM171
Dual-screen Five (2SG, D, RC, Trans)	WM185
Radio-Record Five (SG, D, Trans-parallel)	WM188
Overseas Five (1SG, D, Trans)	WM191
AMPLIFIERS (1s. each)	
A.W. Gramophone Amplifier	AW205
Brookman's Separator (HF Unit)	AW212
Two-valve Amplifier	AW216
"Mag" Gramo Unit	AW224
Concentrator H.F. Unit	WM160
Radio-Record Amplifier (DC Mains)	WM183
MISCELLANEOUS (1s. each)	
Short-wave Adaptor (1 v.)	AW183
Simplest H.T. Unit	AW107
By-pass Unit (Wavetrap) with copy "AW"—4d.	AW218
"Twin" Brookman's By-pass (6d.)	AW222
"A.W." Paper Loud-speaker	AW231
James H.T. and L.T. Charging Unit	AW232
Simplest H.T. Eliminator for D.C. Mains	AW233
Simplest H.T. Eliminator for A.C. Mains	AW236
Choke Output Unit	AW240
A.C. Mains Amplifier	WM149
H.T. Unit for A.C. Mains	WM159
"W.M." Linen-diaphragm	WM172
Brookman's "Wipe-outs"	WM186
Short-wave adaptor for Overseas Five	WM192
Staminator Unit for A.C. Mains	WM202
PORTABLE SETS	
Holiday Portable Three (D, RC, Trans)	AW138 1/-
Music Leader (SG, D, RC, Trans) with copy "AW"	AW203 1/4
Merry-maker Portable (D, 2 Trans)	AW228 1/-
Sunshine Three (SG, HF, SG, D, Trans)	AW235 1/-
Wav'arer Portable (Super Hct)	WM139 1/6
Pedlar Portable Two (D, Trans)	WM195 1/-
Pedlar Portable Three (D, 2 Trans)	WM197 1/-
James Portable SG3 (SG, D, Trans)	WM203 1/-
Copies of the "Wireless Magazine" and/or "Amateur Wireless" containing descriptions of any of these sets can be obtained at 1s. 3d. and 4d. respectively, post free. Index letters "A.W." refer to "Amateur Wireless" sets and "W.M." to "Wireless Magazine" sets.	

AMATEUR WIRELESS 58-61 FETTER LANE LONDON, E.C.4



**READ THIS:—**

"There is everything in favour of buying a complete kit of parts and nothing against it. You get all the little items, such as screws, etc., and your panel is neatly drilled for you. Moreover, you are certain that every component is suitable for the set—that is if you purchase an approved kit such as is sold by Ready Radio."  
*vide "Popular Wireless."*

**KITS OF PARTS**

HORIZON FOUR  
MAXIMUM FOUR  
1930 TALISMAN TWO  
GRAMO-RADIO TWO  
ETC., ETC.

Cash or Easy Terms. Lists on Application

**Ready Radio**

159 BOROUGH HIGH STREET,  
LONDON BRIDGE, LONDON, S.E.1  
Phone: HOP 5555 (Private Exchange)

**FRANKLIN**

FULLY GUARANTEED CONDENSERS



1 MFD. 500v. D.C. test - 24-  
1 MFD. 500v. A.C. test - 2-8  
1 MFD. 1000v. D.C. test - 3/4  
Use them for a full 6 months and we will replace any which prove defective. Remember the name. At your dealers or direct from—

FRANKLIN ELECTRIC CO.  
187-189 Ilford Lane Ilford, Essex  
Phone: Ilford 0251

**P.B.**

RADIO CO.

Write NOW for full details sent free on request.

35 OXFORD STREET  
LONDON, W.1

Phone: Gerrard 3546.  
Telegrams: Equipregin, London.

**KIT OF PARTS for**  
"TALISMAN 2"  
"HORIZON 4"  
"SUNSHINE 3"  
and all "A.W." Sets.  
Parts as specified.  
Everything radio supplied without delay.  
Satisfaction Guaranteed.  
Carriage paid on all orders.

**OUR BLUEPRINT SERVICE**  
Constructors of receivers described in this journal should make full use of our Blueprint Service and avoid all risk of failure.

(Continued from preceding page)

As he very rightly says, it is scandalous that the Corporation should seek and obtain permission to work a twin-wave regional scheme on what turns out to be simply a pretext of supplying alternative programmes. In my opinion it has never had the least intention of giving contrasted programmes; and what is more, does not care a hang what listeners think about it.

"Thermion" perhaps forgets that the B.B.C. is in an unassailable position. Why should it trouble about the likes and dislikes of listeners? The number of licences is constantly increasing, and will I suppose continue to do so for some time yet; is it likely that, having spent anything from say £5 to £50 on a set the owner is not going to renew his licence in due course? We all do so automatically, whether programmes suit us or not, simply because we should be ordered by the G.P.O. to dismantle our gear if we didn't.

The B.B.C. seems bent upon using the 261-metre wavelength not so much for alternative programmes purposes, as for what amounts to almost deliberate jamming of the foreign transmissions, for it is quite unnecessary to send out the same stuff on both 356 and 261 metres.

C. G. (Lewisham).

Wireless licences issued at the close of 1929 in Prague numbered 71,992, and at the end of March last 72,607.

Messrs. Radio Instruments, Ltd., have appointed Messrs. J. D. Morrison & Co., of 10 Whitworth Street West, Manchester, as representatives for all R.I. products throughout the whole of the north of England.

**New Amplion Speaker.** In the test report of the new Amplion cabinet cone speaker, which appeared in our issue dated July 12, it was stated that the unit used was the B.A.2, which is obtainable as a unit alone. Messrs. Graham Amplion inform us, however, that the unit employed is one that has been specially designed for this speaker and which is not sold separately.

*When Asking Technical Queries*

*PLEASE write briefly*

A Fee of One Shilling (postal order or postage stamps) must accompany each question and also a stamped addressed envelope and the coupon which will be found on the last page. Rough sketches and circuit diagrams can be provided for the usual query fee. Any drawings submitted should be sent on a separate sheet of paper. Wiring plans and layouts cannot be supplied.

Queries cannot be answered personally or by telephone.

**Fit the Lotus L.F. Transformer**



**and note the improvement in your set.**

Whether you are building a new set or merely overhauling your old one, the installation of a Lotus L.F. Inter-valve Transformer will double its efficiency.

Housed in a black bakelite moulded case, the Lotus Transformer is both compact and efficient. It embodies all the accuracy and careful finish which are expected from Lotus Components.

Available in ratios of 3-1 and 5-1.

PRICE 12/6

Full particulars on request.

**LOTUS**  
L.F. TRANSFORMER

Garnett, Whiteley & Co. Ltd.  
Lotus Works, Mill Lane.  
Liverpool.

**MORE RADIOGRAMS**

ONE of America's most prominent radio inventors is developing what he calls an anti-ad. machine, which shuts a set off when the advertising talk is started by the announcer.

Scottish chamber-music groups are being made quite a feature of the B.B.C. musical entertainment in that part of its domain. Each combination, besides being Scottish in personnel, is expected to give the work of Scottish composers and song writers a leading place in its programme.

In many European States listening licences have been issued free to the blind. In Denmark steps have been taken to carry the idea one step further and to distribute wireless receivers to poor, aged, or permanently disabled persons. In order to raise sufficient capital to defray the necessary expenses a committee has been formed at Copenhagen, and by arrangement with the Post Office authorities a special stamp has been issued for sale to the general public. Its cost is roughly 3½d. and all listeners have been requested to purchase one and to affix it to their annual licence.

"Hier Leuwen Proeffunk" and "Ici Louvain, station expérimentale" are the calls put out by a small broadcasting station recently opened at Louvain, Belgium.

**THE TRANSATLANTIC FLIGHT**

Wing-Commander Kingsford Smith's operator, Mr. Stannage, found that the only satisfactory connection to a screen-grid valve was the Belling-Lee Anode Connector.

This was fitted to prevent risk of loose connections and blowing of valves during the famous Transatlantic Flight.



Patent PRICE 6d.

**BELLING-LEE**  
FOR EVERY RADIO CONNECTION

Advertisement of Belling & Lee, Ltd., Queensway Wks., Ponders End, Mdx.

**TANNOY MAINS UNITS**

NEED NO ATTENTION  
MORE VOLUME  
GREATER SELECTIVITY  
CHEAPER THAN DRY BATTERIES  
H.T. from £2 17 6  
L.T. " £1 19 6  
TANNOY PRODUCTS  
1-7 DALTON ST.  
S.E.27

Transmissions are carried out every Sunday morning between 10 a.m. and midday on 246 metres.

UOR2, the Vienna short-wave transmitter which up to the present has relayed several times weekly the studio programmes on 25 and 49 metres, has suspended its broadcasts until further notice.

Although some wireless journals continue to include Radio Luxembourg in their list of working radio transmitters, it should be understood that the Grand Duchy, having withdrawn its permission, no broadcast is being made by that station for the present.

Radio Stamboul (Istanbul-Turkey) is on the air roughly five hours daily; apart from native music, some two hours of the broadcast are devoted to the relay of foreign stations.

A move is on foot in Glasgow to get wireless entertainment into the public-houses. Publicans are being blamed for the "drab condition" of their premises contrasted with the conditions existing in England. It is very questionable if the local authorities will look with favour on the introduction of broadcasting to the public-house. Tea rooms, ice cream shops, and cafés are regarded, however, in a different light.

Radio and speedy radio-equipped police cars were responsible for 157 arrests of dangerous criminals by the Detroit, Mich., police during January.

At Hloubetin, a small town some three miles east of Prague in the direction of Brno, the Czechoslovak Ministry of Posts and Telegraphs has installed an experimental short-wave station. Broadcasts of gramophone records and of information of interest to amateur wireless transmitters are made every Tuesday and Friday between 8.30 and 10.30 p.m. B.S.T. on 58 metres. All announcements are given out in the Czech, German, French and English languages. The official call-sign is OK 1 MPT, but during broadcasts at intervals the name of the station is mentioned; it is Radio Elektra Mars.

"Amateur Wireless and Radiovision." Price Threepence. Published on Thursdays and bearing the date of Saturday immediately following. Post free to any part of the world: 3 months, 4s. 6d.; 6 months, 8s. 9d.; 12 months, 17s. 6d. Postal Orders, Post Office Orders, or Cheques should be made payable to "Bernard Jones Publications, Ltd."

General Correspondence is to be brief and written on one side of the paper only. All sketches and drawings to be on separate sheets. Contributions are always welcome, will be promptly considered, and if used will be paid for. Queries should be addressed to the Editor, and the conditions printed at the head of "Our Information Bureau" should be closely observed. Communications should be addressed, according to their nature, to The Editor, The Advertisement Manager, or The Publisher, "Amateur Wireless," 58-61 Fetter Lane, London, E.C.4.

**PREPAID ADVERTISEMENTS**

Advertisements under this head are charged **THREEPENCE PER WORD**, minimum charge **THREE SHILLINGS**.

**DEPOSIT SYSTEM**

As the Publishers cannot accept responsibility for the bona fides of advertisers in this publication, they have introduced a system of deposit which it is recommended should be adopted by readers when dealing with persons with whom they are unacquainted. It is here explained.

Intending purchasers should forward to the Publishers the amount of the purchase money of the article advertised. This will be acknowledged to both the Depositor and the Vendor, whose names and addresses must necessarily be given. The deposit is retained until advice is received of the completion of the purchase, or of the article having been returned to and accepted by the Vendor. In addition to the amount of the Deposit, a Fee of 6d. for sums of £1 and under, and 1s. for amounts in excess of £1, to cover postage, etc., must be remitted at the same time. In cases of persons not resident within the United Kingdom, double fees are charged.

The amount of the Deposit and Fee must be remitted by Postal Order or Registered Letter (Cheques cannot be accepted), addressed to

"AMATEUR WIRELESS,"  
ADVERTISEMENT DEPARTMENT,  
58/61 FETTER LANE, LONDON, E.C.4

**PATENTS.**—Trade Marks. Advice Handbook free.—B. T. King, Regd. Patent Agent, 148a Queen Victoria Street, London.

**SUPERDYNE BOOSTER**, transforms your obsolete 2- or 3-valve into a powerful portable without extra valves.—Particulars, Ledsham, 297 King St., Hammersmith.

**ENGINEERS**—novice or expert—£300, £400, £500 per year or more is within your grasp. In our Handbook "ENGINEERING OPPORTUNITIES," Prof. A. M. Low explains where the good posts abound. This handbook has shown the way to better things to over 20,000 of your fellows. It contains details of A.M.I.Mech.E., A.M.I.E.E., A.M.I.C.E., A.M.I.A.E., A.M.I.Struct.E., Matric. C. and G., G.P.O., etc. Examinations, outlines home study courses in all branches of Electrical, Mechanical, Motor and Wireless Engineering and shows the unique advantages of our Appointments Department. Why stay in the "Hammer and File Branch?" Send for our free Handbook at once, stating Branch, Post or Exam. which interests you.—British Institute of Engineering Technology, 109 Shakespeare House, 29-31 Oxford Street, London, W.1.

**WE WILL ACCEPT YOUR SURPLUS APPARATUS** (making you a high allowance) in part payment for any new apparatus; your enquiry will be dealt with promptly.—Bostock and Stannill, 1 Westbourne Terrace, S.E.23.

**BANKRUPT BARGAINS.**—Component list free. Easily cheapest. Bull'n. 143b Preston Road, Brighton.

**TABLE WET H.T. BATTERIES**  
New Prices: Jars 1/3. Sacs 1/2. Zincs 10d. Sample doz. 18 Volts complete with bands and electrolyte 4/1 post 9d. Sample unit 6d. Illus. booklet free. Bargain list free.  
AMPLIFIERS 30/- 3 VALVE ALL-STATION SET £3  
A TAVOR 57 Studley Road, Stockwell LONDON

**C.F. Radio Controller**  
finds faults in your set

Write for Illustrated Leaflet to  
**FONTEYN & CO. LTD.**  
2 to 6, Blandford Mews, Baker St., W.1

**DX THE STANDARD PLUG-IN COIL**

Sold everywhere from 1/-

**DX COILS Ltd, London, E.8**

**REPAIRS**

Any make of L.F. Transformer, Loud-speaker or headphones repaired and dispatched within **48 HOURS—TWELVE MONTHS' GUARANTEE** with each repair. 4/- Post Free.

Terms to Trade

**TRANSFORMER REPAIR CO.**

"Service" Dept.

214 High Street, Colliers Wood, London, S.W.19

**EVERYMAN'S WIRELESS**

By **ERNEST H. ROBINSON (5 Y.M.)**

A handy book telling in plain, non-technical language all that the average man needs to know about Wireless.

**CASSELL'S 3/6 net.**

**Amateur Wireless** **COUPON**  
Available until Saturday  
**JULY 26, 1930**

## BRITISH GENERAL TRIUMPH L.F. TRANSFORMER

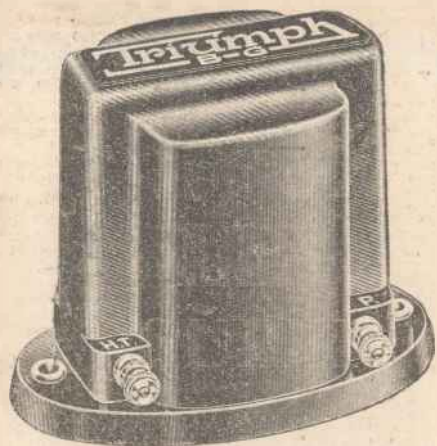

This triumph of design, engineering, and performance has only been made possible by using the very latest method and material. It has a high inductance and is suitable for either first or second stage of L.F. amplification owing to the fact that its ratio is 3.5-1, a ratio which has been well tried and found to be the best under all circumstances. Enclosed in handsome Bakelite case.

RETAIL PRICE

**6/6**

# BRITISH GENERAL

MANUFACTURING COMPANY LTD.,  
BROCKLEY WORKS - LONDON, S.E.4.

## DARIO VALVES

*Best way to all Stations!*

**DARIO PRICES**  
Bivolt or Forvolt

Universal Resistor	5/6	Super Power	- 7/6
Super H.F.		Hyper Power	- 9/6
Super Detector	6/6	Super Power	- 18/6
		Pentodion	- 18/6

Dario Transformer—Ratios 3-1 or 5-1 - 5-

## SCREENODION 15/6

Write for Free Folder to:

**IMPEX ELECTRICAL LTD.**  
Dept. J  
538 High Road, Leytonstone, London, E.11

181

You MUST have the  
"Wireless Magazine"

Every Month Price 1/-

## FOR ... ELECTRIC REPRODUCTION

### USE A LIMIT

*Adjustable Length Tracking Angle Spring Tension*

*Continental and Bayonet Fittings.*

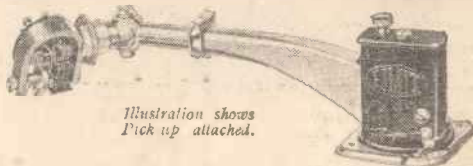

*Illustration shows Pick up attached.*

## PICK-UP ARM 15/6

Obtainable through all factors and dealers, or write

**EACH**

LIMIT RADIO LIMITED ALBION ST. LONDON N.1

# WESTINGHOUSE RECTIFIERS

"The All Metal Way, 1930"

32 pages of valuable eliminator information with circuits, etc. All users of A.C. Supplies should have a copy of this book.

Send your name and address and a 2d. stamp.



The Westinghouse Brake & Saxby Signal Co., Ltd.,  
82 York Road, London, N.1.

Advertisers Appreciate Mention of "A.W." with Your Order



## METAL RECTIFIERS

are unquestionably the most convenient and reliable means of rectification yet devised. The circuits are simple, and the rectifiers have nothing to wear out and do not require periodical replacement. That is why they are now being used in such large numbers by the leading manufacturers.

# WHEN BUYING VALVES REMEMBER!



When the RI00  
was lost in fog  
MARCONI VALVES  
gave her position  
through Wireless  
Direction  
Finders

Marconi Valves are used by Imperial Airways—  
The B.B.C.—Metropolitan Police—Trinity House  
Lightships and Beacon Stations—Croydon Control  
Tower, etc., etc. They are chosen for unflinching  
dependability.

Perfect quality demands the best L.F. Valves, and remember—the first L.F. stage is as important as the output stage. Marconi Valves possess all the qualities needed for first L.F. stage efficiency—good magnification factor—low impedance—large grid base capable of handling a generous grid swing, so giving a magnificent undistorted output to the last valve. These are the famous Marconi Valves which will improve first L.F. stage performance—L.210 (2 Volt); L.410 (4 Volt); L.610 (6 Volt); M.L.4, A.C. mains (indirectly heated).

# MARCONI VALVES



# TESTS OF TIME

## Built by..

... Sir Christopher Wren in 1671—259 years ago, the Monument certainly has stood the test of time. T.C.C. "the condenser in the green case," too, has stood the test of time—and come through with flying colours.

The Telegraph Condenser Co. have been making condensers for a quarter of a century—so, remember, run no risks when choosing the condensers for your Set, follow the experts' lead: choose T.C.C. the guaranteed condenser and know that you are getting dependability.

Every good Wireless Dealer sells them!

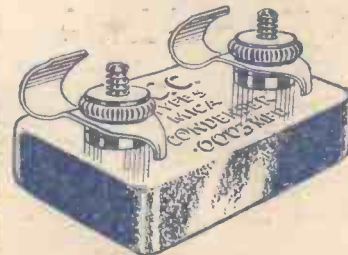

The condenser illustrated is the .0003 mfd. T.C.C. flat mica type . . . . . 1/3d.

# THE MONUMENT

ADVERT. OF THE TELEGRAPH  
CONDENSER CO. LTD., N. ACTON, W.3.

5222