

MODERNISING YOUR SET

Amateur Wireless

And Electrics

Every
Thursday 3^d

Vol. XII. No. 291

Saturday, Jan. 7, 1928

IN THIS ISSUE—TWO SPECIAL SETS



**THE
SHORT-
WAVE
“SUPER
SIX”**

**—AND THE
“ECONOMICAL
TWO”**



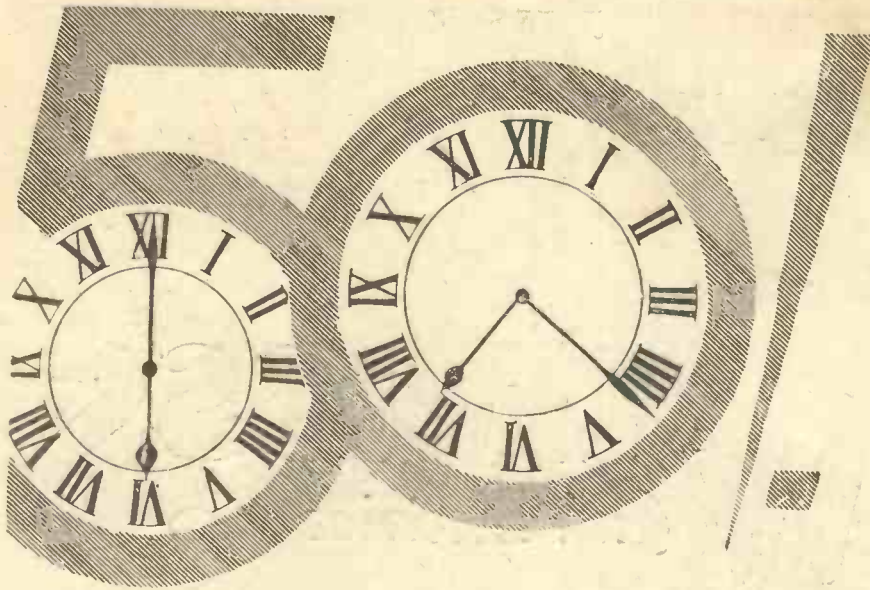

**YOU MAKE THE
NEW R.C.
THREESOME
IN 1½ HOURS**
*- the parts cost
only fifty
shillings*

**ONLY 5
CONNECTIONS**

No soldering—nothing you cannot understand—nothing to go wrong. You need know nothing about radio mechanics to make up this set. Just an hour with nimble fingers and a screwdriver—and you can be sure of wireless reception of amazing purity.

The new R.C. Threesome brings in many additional stations with all the quality of the original receiver.

The valves essential for the very best results are H.F.210, R.C.2 and P.V.2—three valves from the Ediswan range.

Send coupon at once for Free Instruction Book and easy-to-follow full size Blue Print.

Bring in those other stations by using the new Ediswan Local Station Eliminator. Ask your dealer for particulars. Price 25/-.

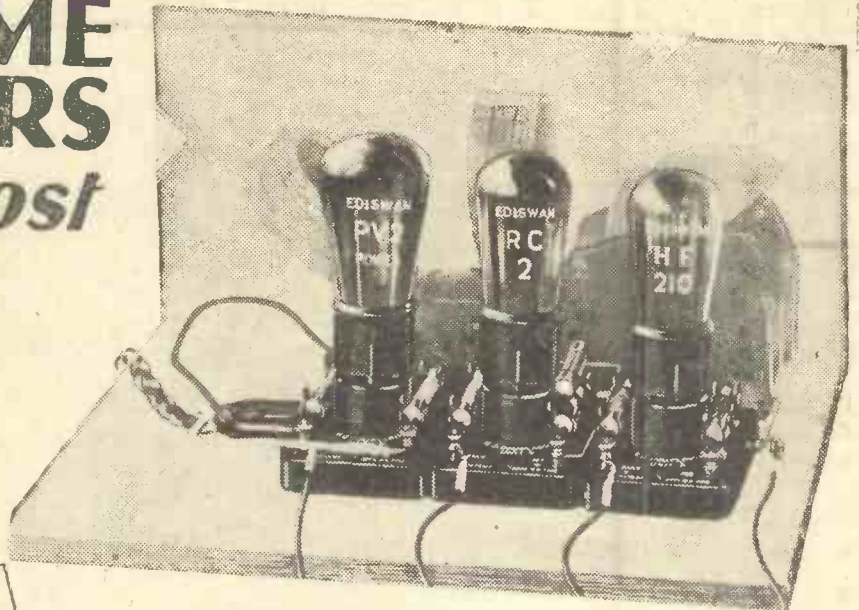

SEND THIS COUPON NOW A.W., 7.1.28.

To THE EDISON SWAN ELECTRIC CO., LTD.
(Publicity), 12315, Queen Victoria St., London, E.C.4.

Please send, post free, presentation
copies of the New R.C. Threesome
Instruction Book and Blue Print.

NAME

ADDRESS

V.7!

**EDISWAN
VALVES**

**CLEAREST-STRONGEST
LAST THE LONGEST**

A type for every purpose



The Heart of a Super Het

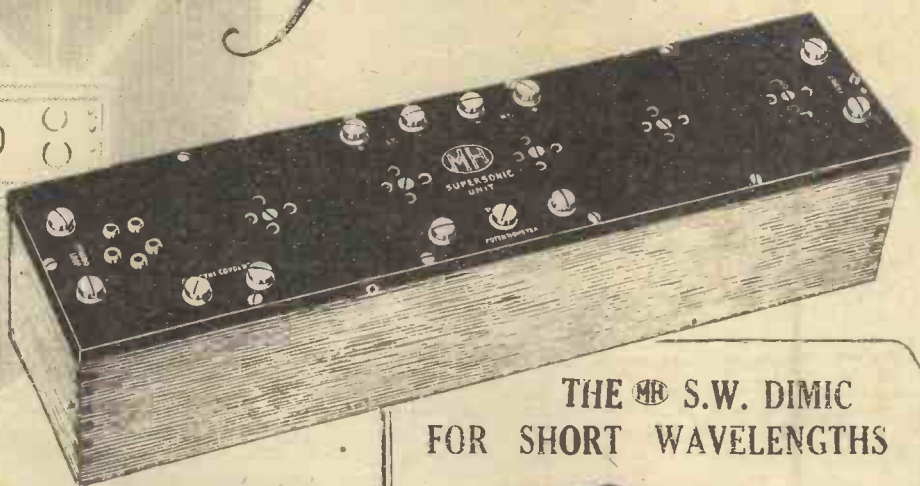

MH SUPERSONIC UNITS Provide the Best means of Supersonic Reception

Where the extreme limit of range is required without complication, the supersonic system offers marked and unique advantages. The **MH** series of units comprise Supersonic Transformers, Auto Oscillators, complete Kits, Block Units, and high-grade Supersonic Receivers of seven and eight valves. Space precludes a detailed description of the various applications—suffice it to say that the units illustrated on this page are of the **MH** standard of workmanship and performance affording results second to none.

THE **MH SUPERSONIC BLOCK UNIT FOR RECEPTION ON SHORT WAVES.** Short-wave enthusiasts will be well advised to give this serious consideration. Here are a few points of advantage:

1. Simple Control.
2. High Amplification.
3. Adaptable to any waves between 10 metres and 2,000 metres.

To purchasers of the **MH** Supersonic Block Unit two Blueprints are given, one showing the method of connecting up, and the other the adaptation to Short Waves. This unit forms the nucleus of the 6-Valve Receiver used by Mr. Allen, A.M.I.P.E., for the direct reception of the Empire Broadcast Programmes transmitted by 2FC Sydney, Australia, a distance of 13,000 miles. Reports of this success appeared in the "Daily Mail," September 5th, 1927.

Price: **MH** Block Unit (including 5 Point Oscillator) 300-600 Metres .. £6 : 6 : 0
Short-wave Adaptor, additional to above, 12/6

Telephone : Slough 441-442
L. M. MICHAEL LTD
Manufacturers of Wireless and Scientific Apparatus
WEXHAM ROAD, SLOUGH, BUCKS.
London Office and Wholesale Showrooms : 179 STRAND, W.C.2. Telephone : CENTRAL 6938
IRISH AGENTS: B. N. B. WIRELESS, LTD., DUBLIN & BELFAST.

THE **MH** S.W. DIMIC FOR SHORT WAVELENGTHS

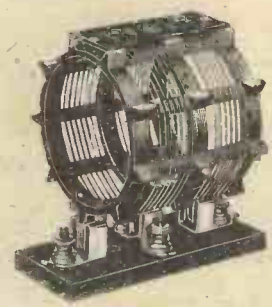

- COILS AS UNDER:
- S.W. 1.
 - S.W. 2.
 - S.W. 3.
 - S.W. 4.

PRICE, ALL NUMBERS, 9/- each. BASE 2/- EXTRA.

THE **MH** SHORT WAVE UNIMIC

Similar to that illustrated, but having 5 turns only.



PRICE 5/- each.
BASE & STILT 2/6 EXTRA.

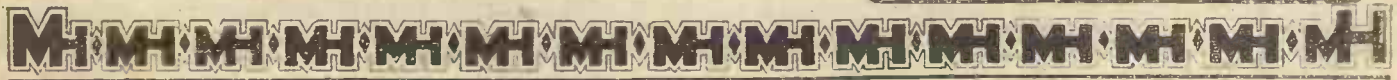

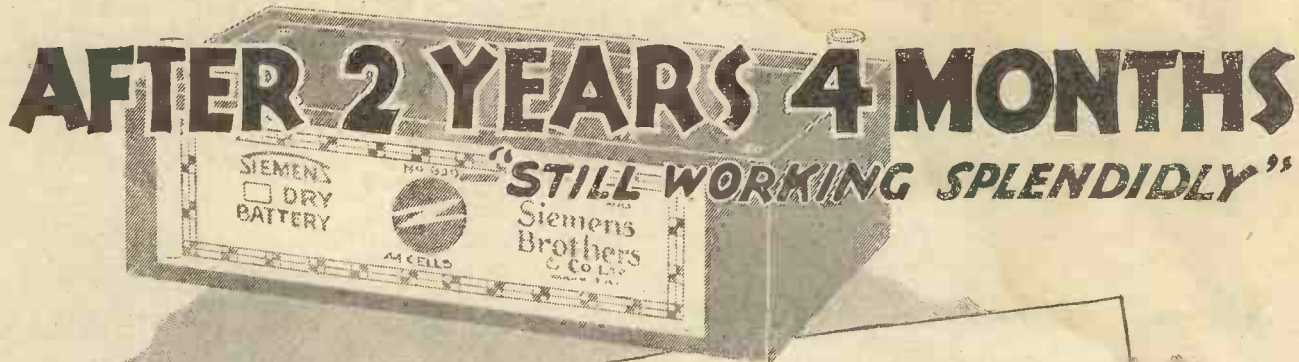

Oakbank,
Morley Road,
Little Eaton,
Derby.

November 19th, 1927.

Messrs. Siemens Brothers & Co. Ltd.

Gentlemen,

I am writing thinking perhaps you would be interested to hear of the longevity of your High-Tension Batteries. I am a regular user of my wireless set, sometimes using one or two valves (D.E.2 volts) as the case may be. I use your 60 volt H.T. Batteries and have only found it necessary to purchase two since July 1925. No. 1. was in use from July 9th 1925 until April 6th 1926.

From April 7th 1926 to Sept. 30th 1926, I was not using my wireless set owing to change of residence. I commenced using Set again on October 1st 1926 and, thinking my H.T. Battery would be useless, I purchased No. 2 which was in use regularly from October 1st 1926 until about middle of May 1927, when one day I thought I would just see if there was any life left in No. 1; the date would be about May 20th, 1927, when I found it worked splendidly. I am still using same and can get many Foreign Stations with it, although it has been in my possession no less than 2 years and 4 months. No. 2 is also working well yet.

I remain,
Yours truly,
(Sgd.) H. Spence.

SIEMENS

Amateur Wireless

and Electricians

The Leading Radio Weekly for the Constructor, Listener and Experimenter

Vol. XII. No. 291

Edited by BERNARD E. JONES
 Technical Editor: J. H. REYNER, B.Sc.(Hons.), A.M.I.E.E.

JANUARY 7, 1928

Australia on the L.S.!—A Mystery Station—Local Station Orchestras— The Zeesen Station—American Broadcasting—A White Elephant

Australia on the L.S.!

THE "Short-wave 'Super Six,'" the receiver of which full constructional details are given on page 20 of this number, sets a new standard for short-wave reception. "Australia at full loud-speaker strength!" is the claim made by its designer, Mr. J. Sieger. And it is a claim which the receiver will fully substantiate on any evening! Although a super-het. in dimensions, the "Short-wave 'Super Six'" is not an ordinary super-het. It is, on the other hand, really inexpensive and easy to build, while operation is remarkably simple—tuning is done by a single condenser, the only other variables being a potentiometer and a reaction condenser. The "Short-wave 'Super Six'" is a "super" set which does not require a superman to own it!



Zeesen, the German super-station, came into operation on Tuesday, December 20. With its reserve power of 120 kilowatts it is the most powerful station in the world, although, at the present, it is only putting 18 kilowatts into the aerial. Its wavelength is 1,250 metres—the same as was used by Königswusterhausen, which has now closed down—and although it is actually situated at Zeesen, its call-sign is "Königswusterhausen, Deutschlandsender." The ticking of a metronome has been adopted as an interval signal. The purpose of the station, it is said, is to transmit German propaganda to the world. As our photograph shows, the building itself is on decidedly German lines!

White Elephant?

ALTHOUGH there are about forty transatlantic calls made every week, the P.M.G. recently stated that the revenue obtained from the wireless telephone at present barely covers working costs.

A Mystery Station

THE Danish authorities are carrying out a wide-spread search for a mystery station which is transmitting Bolshevik propaganda in the Danish language. It seems first to have been discovered by a Professor Rung, who came across the station when tuning in Copenhagen. He listened for some time, and, deciding that the broadcast was of a character not allowed in Denmark, he communicated with the authorities. It is believed to be situated somewhere along the Baltic coast. Has it been heard in England yet?

5GB Again!

THE B.B.C. has issued a report on its trials and troubles with 5GB. It seems that when the long-awaited 300-ft. masts were tested it was found that the shielding in the Birmingham direction by the masts of 5XX was accentuated. The new masts have now to be re-arranged in the hope of overcoming the trouble. The aerial, the report adds, is otherwise better than the twin aerial now in use, but the experiments will ultimately be of value.

"Bonnie Harry" on American Broadcasting

"I do not like the American system of broadcasting. I say this simply from my experience of what I have heard. I have listened to wireless programmes on many occasions in America, and often I have heard a dozen people singing and jazzing at the same time. In other words, it was a muddle, and I don't like muddles," said Sir Harry Lauder when asked whether he would broadcast in America during his forthcoming tour. He said he would not.

Local Station Orchestras

COMPLAINTS are being made in Scotland that the orchestras at the local stations lack several of the instruments demanded by classical works. "It is perhaps just as well," declares a critic, "that Schubert did not add anything more to the Unfinished Symphony; 5SC does not play all the notes he did write!"

Of Interest to You

IN our next issue a rather unique receiver will be fully described. The "Duopath Dynaflex" has been designed and built by Mr. C. C. Prior for economy and simplicity of operation together with inexpensive construction. Ordinary condensers are used and the coils can be made by any home constructor. The circuit is based on the well-known Rice neutrodyne circuit. This is an interesting receiver. The other constructional article in the number will give details of a two-valve amplifier consisting of R.C. and transformer-coupled stages. This method ensures good volume with purity. We recommend the unit to all those of our readers whose desire is greater volume.

PRINCIPAL CONTENTS

Current Topics	3	"A.W." Tests of Apparatus	18
Only a Dream!	4	Practical Odds and Ends	19
How I Modernised his Set Without Fear or Favour	5	The Short-Wave "Super Six"	20
The Broadcast Weather Reports	8	Our Information Bureau	24
On Your Wavelength	13	Mains Working	26
The "Economical Two"	15	"Remedies" that were not Cures	30
How Good are your Valves?	17		

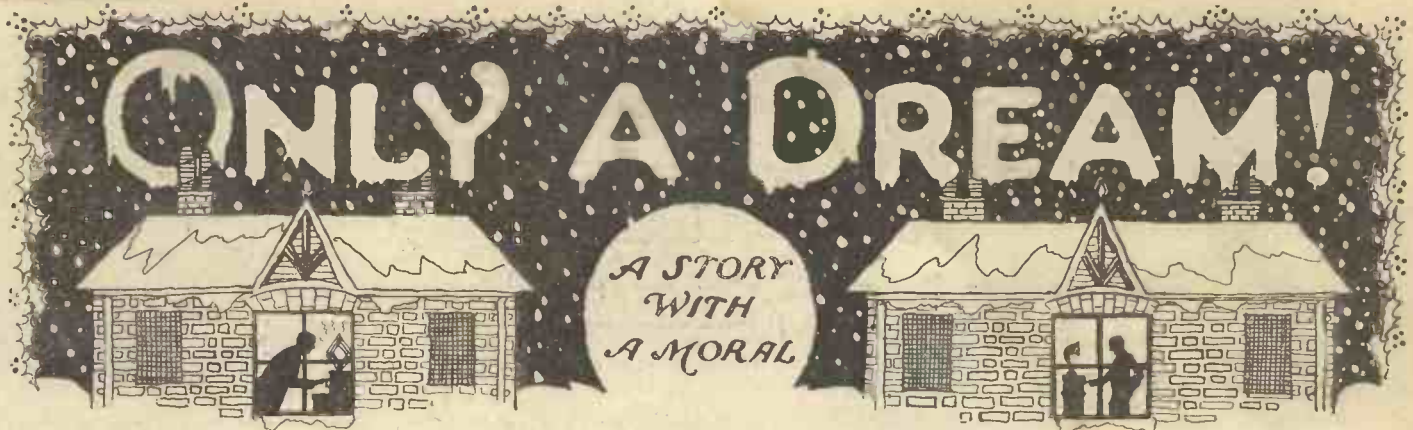

By C. A. OLDROYD

I HAVE a radio neighbour—and I know it! Judging by the squeals and whistles he produces, he must be qualified for membership in the S.R.O. (Society of Radio

cheerful chirps. The only remedy is to wait until *he* has finished with that particular waveband. I sat down, lit my pipe, and waited.

was installed. I swept my condensers over the whole broadcast range, and found only music and talks; no howls whatever.

"He must be sick," suggested The

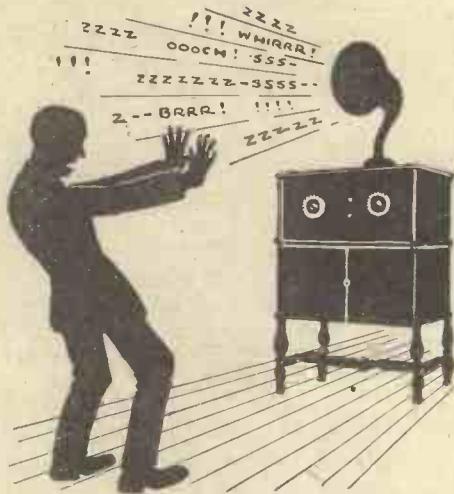

I have a neighbour—and I know it!

Organists). This lucky individual has built himself what he calls the world's best set—a giant eight-tuber to his own design.

Since the Monster made her appearance amongst her lesser—but far more quiet—sisters, we no longer enjoy undisturbed reception. At regular intervals, shrieks, groans, and all sorts of uncanny noises interrupt the programme. But the Monster is at her best in the early hours of the morning, when her proud owner makes desperate attempts to bring in distant continental and American stations. I don't think he has ever heard KDKA's cheerful announcer or, for that matter, any other American station, for if he had brought in only the faintest whisper it would have been all over the town.

Last night—or, rather, this morning—I was fishing for American stations. Atmospherics were coughing and gargling in the phones, as usual, but things were not too bad. A faint murmur, "Can this be WGY?" when—"swish, swish, tack, tack, shriek, ?? XXX ??"—came the Monsterdyne, as I affectionately call her.

I am at a slight disadvantage; my set is properly neutralised, and no amount of juggling with the dials will return the

Suddenly I became aware of another person in the room; my old pal The Tinker, a wonderful hand at inventing new circuits and stunts.

"Look here, Charlie, my boy," he said, "I know what's on your mind. The—the—what do you call it?"

"Monsterdyne," I suggested.

"Yes, that's it," replied The Tinker. "Take a tip from me; you cannot get over this little bit of trouble without some effort. I have got an idea that may help us; as a matter of fact, I made all the special gear needed. A slight addition to your circuit, a few changes in the set, and your receiver becomes a short-range transmitter!"

Inquiringly, I looked at The Tinker.

"Well, don't you see, my boy, our problem is solved. When the Monsterdyne howls, switch on the transmitter gear, grasp the mike, and tell your pal a few home truths. Thanks to the new selector coil, *only the oscillator will hear what you say!*"

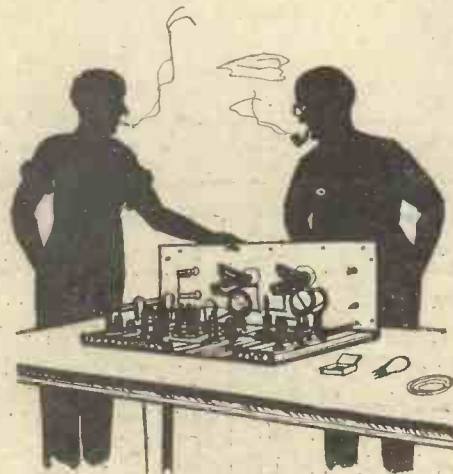

For an hour we toiled over my trusty old five-valver

"Hurrah!" I shouted. "Let's!"

For an hour we toiled over my trusty old five-valver, and at last the new device

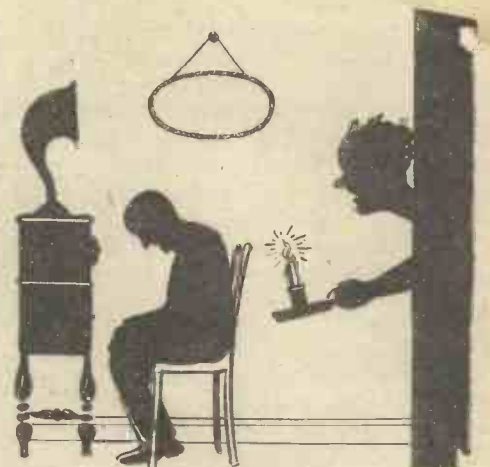

Are you never coming to bed? It's two a.m.!

Tinker, when all at once a mighty roar assured us that the owner of the Monsterdyne was still hale and hearty.

"Click!" went the switch of the transmitter attachment. I grasped the microphone and bellowed into it:—

"Stop that howling instantly, you silly fool; you spoil everybody else's pleasure! Get a crystal set and dump the Wonder Set in the dust-bin!"

Wailing, the whistle grew fainter and fainter; then darkness again and a silence, as the poet puts it. Peace at last!

"Tinker, old man, we have done it! More push behind that contraction of yours than I thought. *We've done it!*"

Just then another voice broke in, "Are you never coming to bed? It's two a.m.! What are you shouting about? *Who is we?*"

"Never mind, my dear," I assured my wife (another radio widow). "I must have dozed off and talked in my sleep. *I had a lovely dream!* Well, let's turn off the set and turn in."

My finger was almost touching the switch when a terrific roar echoed through the house—the Monsterdyne calling to its Mate!

How I Modernised His Set

A PRACTICAL ARTICLE

By G. C. P. BRAUN

THE rebuilding of obsolete receivers is, of course, largely a question of finance. If funds allow, you will doubtless scrap your "hay-wired" old monstrosity and begin again with new components and a modern AMATEUR WIRELESS blueprint.

There are, however, many cases where an expenditure of about £1 is all that can be contemplated. To those who for the moment are in this category the writer would say, "Rebuild nevertheless, and do it now."

It is no exaggeration to say that an

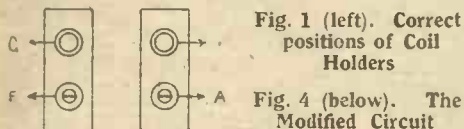

Fig. 1 (left). Correct positions of Coil Holders

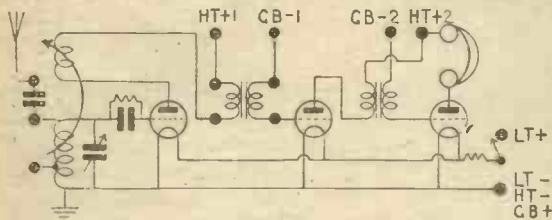

Fig. 4 (below). The Modified Circuit

improvement of from thirty to fifty per cent. in both range and quality may be achieved by modern wiring and layout alone.

I recently "helped" a friend in the reconstruction of the old receiver illustrated, the £1 limit being rigidly enforced. As the photograph shows, the underside of the panel was enough to appal the stoutest heart. My friend assured me the thing worked. It certainly emitted horrible sounds from the loud-speaker from the local station. Daventry was only just audible on the phones by means of ruthless oscillation.

The first step was to remove the old wire from the panel. There were 7½ yards of this, or 2½ yards per valve! The components extracted from under this entanglement were as follows.

Three valve-holders (old pattern with legs embedded in composition); one coil-holder, two-way (antique, but serviceable); one variable condenser .001 and separate vernier (too

large and worn out); one R.I. transformer, in good condition; one unknown transformer, looked good, but must be suspected; four rheostats (dreadful); two fixed condensers .0003 microfarad and .0005 microfarad; one grid-leak (had been soldered on to wire and inside coming out in consequence).

It was obvious from the start that a new variable condenser was essential, and my friend insisted on a vernier dial. An Ormond S.L.F. .0005 condenser and slow-motion dial were therefore bought at once, together with a Benjamin switch. The latter would serve for filament lighting, using one of the old rheostats as a fixed resistance.

All the old components were then tested carefully with phones and battery for insulation leakage and found O.K. as were also the transformer windings.

A wooden panel 14 in. by 8 in. was cut out. Wood is quite permissible in a straight o-V-2 receiver as the spindle of the condenser is at earth potential.

The Trix switch is in the positive filament lead and the worst it could do would be to short circuit the accumulator through about 20-megohm, even using wet wood.

As the old valve-holders had to be used for baseboard-mounting and the unknown transformer might have to be used as an L.F. choke, it was found that the American system of sub-panel wiring was most convenient. A horizontal panel of thin

wood, 14 in. by 8½ in. was therefore cut.

The valve-holders and the doubtful transformer were mounted on pieces of ebonite as shown, and screwed down over apertures in the horizontal panel. Sufficient ebonite was cut from the old panel for this job-as well as for the terminal strip at the back.

The first real snag was the coil-holder. This had a fault common at the time it was made, the plugs and sockets being arranged in the wrong order.

The proper arrangement of plugs in a coil-holder is shown in Fig. 1. Plug must

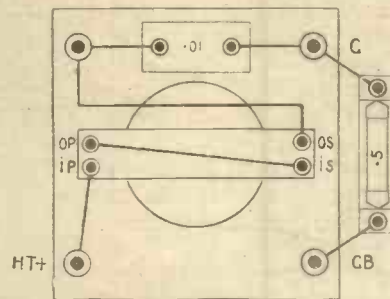

Fig. 2. Rearrangement of Transformer for Choke Coupling

be opposite plug and socket opposite socket. The leads to grid, filament, phones, or transformer and anode should be arranged in the order given. If a plug had been opposite a socket and the leads kept in the same correct order, reaction effects might still be obtained, but signal strength would be poor, the direction of winding of the coils being reversed.

The plugs were therefore arranged in the proper way and an extension piece of 2B.A. rod fitted which passed through a screwed bush in the panel. This bush was taken from the old variable condenser.

The unknown transformer was next mounted on its square of ebonite with terminals as shown in Fig. 2. Fortunately it was found to give good results as a transformer, that is with O.P. connected to A., I.P. to H.T.+, O.S. to G., and I.S. to G.B.—.

The diagram shows the line of retreat to choke coupling supposing this course had been found necessary for quality.

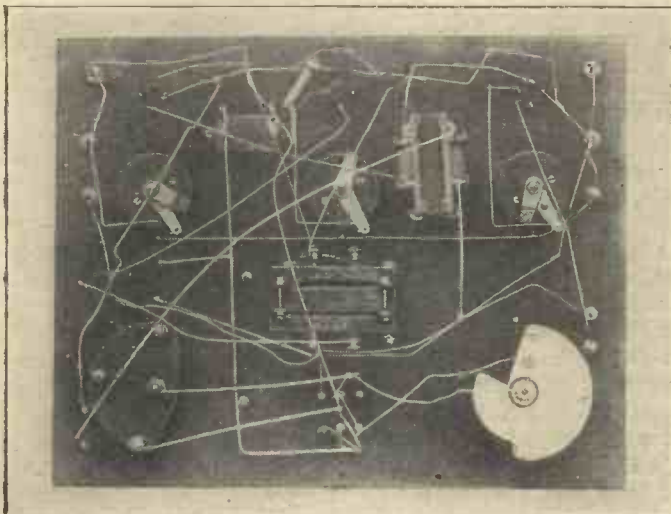

This Picture gives some idea of the Original Construction

The by-pass condenser of .0005 microfarad was permanently fixed between A. and H.T.+, this condenser being necessary for either system of coupling immediately following the detector.

on the loud-speaker without any difficulty. The quality had improved beyond all recognition and the work proved to have been more than justified. The actual outlay was as follows :

	£	s.	d.
One slow-motion dial (Ormond)	5	0	
One switch (Benjamin)	1	3	
One grid-leak (Lissen)	1	0	

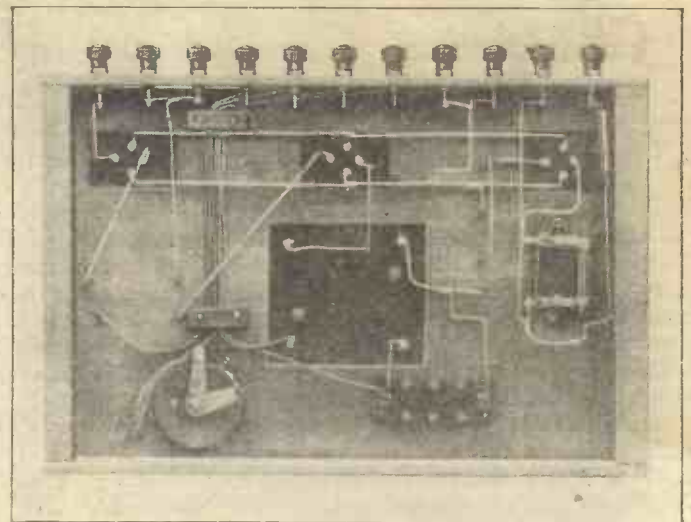
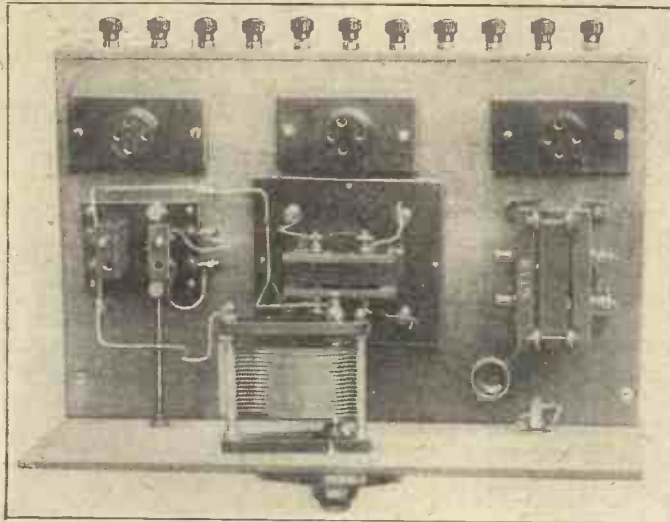

The improvement effected will be apparent upon comparison of these photographs of the upper and under sides of the baseboard and the preceding photograph

Fig. 3 shows the sub-panel wiring diagram. Wires passing through holes in the panel must, of course, be insulated. Quite a number of wires may be "bunched" and kept in position by two wooden cleats seen on the left of the diagram. Capacity between these does not matter, and more room is left for the others.

Fig. 4, the theoretical diagram, shows a small fixed condenser in the aerial circuit. Here the old variable condenser might have been used, and the nucleus of a wave-trap already formed. The best results were obtained with a Lissen "X" coil, the aerial being taken direct to the coil.

The improvement in the reconstructed set was truly astonishing. Selectivity was, of course, not very good but some half-dozen foreigners were tuned-in after broadcast hours

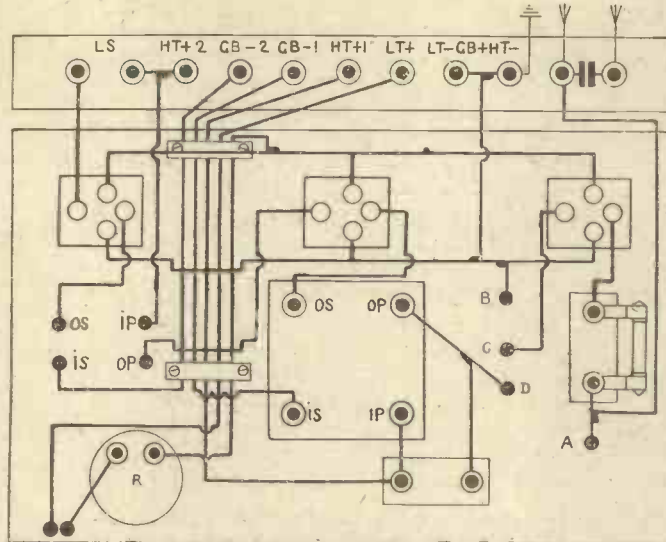

Fig. 3.—The Modified Wiring Diagram

	£	s.	d.
One Ormond .0005 S.L.F. condenser	6	6	

One fixed condenser .0001 microfarad (Lissen)	1	0
Eleven terminals	2	3½
Wood	3	0
	£1	0 0½

It is hardly necessary to add that a power-valve is essential in the last socket of a set of this description. As the valve-holders are not "anti-pong" it is best to use 2-volt valves.

Speaking generally, the lower the ratio of volts to amperes in a valve, the less seems the tendency to "pong". Even if a transformer is "burnt out" as to its primary, the secondary winding frequently makes a good L.F. choke.

H.F. stages in old sets are almost always useless and it is best to cut them out altogether.

AN UNUSUAL FAULT

I HAVE just assisted in tracing a very unusual cause of reception trouble. A neighbour returned from his holidays, retrieved his accumulators from the charging station, connected up and switched on.

Results were a little weaker than usual; but he put that down to the transmitter, as he has a milliammeter in his H.T. circuit and that was showing the normal reading. Later in the evening rain started, signal strength gradually decreased until the local station had almost entirely disappeared. It was just audible, and that was all. He sent to know if I could come

and help him investigate, and when I arrived he was feverishly going over the aerial connections.

By that time it was getting dark and was raining really hard; but I could see nothing wrong in the set, and so we hauled the aerial down and examined the far end insulators with the aid of a flash lamp. There were four small ones in series, and it did not seem possible that they could be wrong. They were, though. Somehow or other, a piece of string about eighteen inches long had wrapped itself round them and the aerial and hauling wire. This did not much matter so long as the string was

dry, but directly it got thoroughly wet it provided an almost complete short to earth. We removed the string, and all was well.

Then we speculated as to how the string had got up there, as the aerial had not been touched for four or five months. We decided that a bird must have dropped it on the insulators some time before and that the wind and rain had well and truly wrapped it round where it could do most harm. The experience did illustrate the wisdom of having measuring instruments in the battery circuits. We did know that the set was all right. THERMION

WITHOUT FEAR OR FAVOUR



A Weekly Programme Criticism by Sydney A. Moseley

THE New Year rings changes on the programmes! For instance, John Henry's appearance the other night was heralded as his last—for the time being, at any rate. I had hoped for the impossible in this farewell call—that J.H. would have put over such a turn as would have sent all of us bombarding Savoy Hill on his behalf.

Alas, we were given a reading of a light and slight monologue! That John Henry was one of the early wireless turns is a memory of which he may deservedly feel proud. To lay down a principle, however, that a record number of appearances entitled one to go on appearing for ever is, of course, absurd. The best of us pall after a time. One hopes that his absence from the microphone will enable him to refresh his ideas and his style.

What other changes? One should look with hesitancy at the publicity stunts which promise all kinds of innovations. I doubt whether Mr. André Charlot's trumpeting is the right sort of thing for wireless. They are more used to this kind of thing in the theatres. When Mr. Charlot delivers the goods we'll let him know what we think of them. Till then, I should say, the best policy is "Mum's the word."

Why this repetition of Verdi's *Rigolletto*? The programme people seem to be more enamoured of this admittedly tuneful opera than many better operas. The music is good enough, but the story is horrible—full of seduction and murder. When I was a pupil at the London School of Opera they put the part of *Rigolletto* on to me. The lady who took the part of Gilda has since sung at Covent Garden, and we heard her in that jolly "babes-in-the-wood" opera, *Hansel and Gretel*. As charming as she was, I felt I could not go on with it; it nauseated me.

That is the worst of these foreign operas—the theme is always the same; more like our modern trashy plays. *The Bohemian Girl* story, *Maritana*, all Gilbert and Sullivan's, German's *Merric England*, and a score of other British productions—each of these tells a good clean story which loses nothing in the manner of its musical telling. If they must give us foreign opera, what is wrong with the *Tales of Hoffmann*, *Tann-*

hauser, and many others which I cannot catalogue here?

I wonder whether the Nativity plays appeal to listeners. Outsiders, in the lonely spots in Cornwall, where the last one was produced, may be thrilled, but I doubt whether the average listener is. To the world at large they must sound amateurish and, despite their admitted simplicity, suggest the Sunday school rather than a sacred production of a high order.

Julian Rose is a typical musical-hall turn, and must be accepted as such. I like him personally because he spins off jokes (and alleged jokes) in almost every line. There is no padding, as in other comedians who keep you waiting on tenterhooks for something funny to turn up. Many of Rose's jokes may not get across, however, for he rushes them off at a music-hall pace. Others are too local to be appreciated. But, on the whole, he amuses.

St. John Ervine has established a reputation as a dramatic critic, and bearing this in mind, as well as the fact that he has been teaching us over the ether how to write plays, I listened with peculiar interest to his three-act production *The Ship*. Well, friend St. John, here are a few well-meant—and I hope well-chosen—comments:

The theme admittedly is not original; see "Rutherford & Son," etc. Nor is the claim that it is handled differently sustained. There were few lines which could be called either epigrammatic or witty. The talk about tea was unreal and unnecessary—the sort of obvious padding used by amateurs. Nor do ladies of eighty-three talk like old Mrs. Thurlow in real life—Nancy Price or no Nancy Price. Indeed, there was much of a muchness in the talk of all the characters. The play, in fact, wanted pruning badly. I prefer Mr. Ervine as a critic rather than a playwright.

A five-o'clock-in-the-afternoon ballad concert had three top-notchers in Melsa (the violinist), Angelica Messarosh (the 'cellist), and Aubrey Millward (the baritone), who gave half an hour or so of first-rate music.

I suppose my calling as a journalist renders me somewhat sensitive to the way they handle the news; but the latest stunt of tabulating the news under "Parliament," "Questions in the House," and so on, is sadly lacking in news value. Why, they did that in newspapers a hundred years ago! The boys at Savoy Hill are great fellows, young, fresh, and handsome. But as an old-stager, I shall certainly have to go down there and show them how to do it.

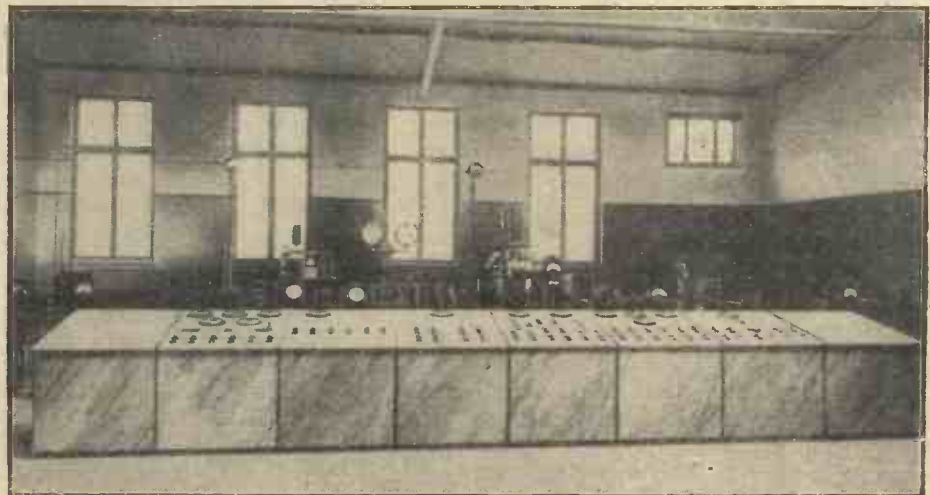

GERMANY'S NEW SUPER-POWER STATION

This photograph of the tone control table of the new Zeesen station shows that the plant is laid out on original lines. At present some 45 kilowatts are being modulated, although the power supplied to the aerial is only 18 kilowatts.

THE BROADCAST WEATHER REPORTS

How the Information is Gathered

By DONALD W. HÖRNER, F.R.A.S., F.R. Met. Soc.

WHEN we listen-in to the weather report and general inference as broadcast by the B.B.C. we are hearing the result of the work of many observers scattered over thousands of miles of sea and land.

In these days of radio-telegraphy it is possible by means of relay work, as well as by direct transmission, to obtain simultaneous (technically known as "synchronous") reports, not only from land stations throughout western and north-western Europe, but from ships in various positions out on the Atlantic Ocean.

Directly a "depression" (area of low barometer) or an "anti-cyclone" (area of high barometer) makes its appearance in the North Atlantic, some conveniently placed liner reports its exact position and intensity in a specially prepared code prefixed by the word "Meteorology," and such messages are transmitted with the utmost expedition, either directly to a shore station or, if the distance be too great for this, from ship to ship until the message reaches a shore terminal.

A simple code was devised by Sir Napier Shaw, F.R.S., whereby the weather messages are sent in four groups of five figures each, referring to the position of the ship making the observation; the hour at which the observation was taken; the state of the weather; the height of the barometer; and direction and force of the wind at the time.

For this purpose a North Atlantic chart is divided into rectangles of ten degrees side, and these again are subdivided into squares of one degree side, and all these little squares are numbered, so that, when the wireless message is sent, all that has to be done is to put the number of the square

in which the ship transmitting the weather message is situated at the time, and its position is at once known.

These observations thus sent, on reaching the Meteorological Office in London, are decoded and transcribed into plain language, together with the reports received from land observing stations over the land line,

on many other vessels of varying sizes and tonnage.

In the days when this map was made, barometer observations were transmitted in "inches of mercury," with which we are all more or less familiar from our acquaintance with the "weather glass." Of recent years, however, to obviate making various corrections and reductions for sea-level, temperature, etc., which it would serve no useful purpose to go into here, the coded readings of the barometer (one of the most important factors in weather chart forecasting) are transmitted in what are known as millibars, and in the charts published in the press the equivalent values in inches and millibars are given at each end of the *isobars*, or lines of equal barometric height or pressure, which we see running across these maps. These lines run through places where the barometer, or "weather glass," stands at the same height in the mercury tube.

From the aspect of these synoptic charts or weather maps, the "General Inference" is deduced which is broadcast each evening

for our information.

It will be seen from this brief exposition of the procedure followed, therefore, that the information which we hear every day is the result of the continuous labours of many individuals working (many of them voluntary) for the welfare of the community at large, and with no other thought than to make the observations as accurate as possible so that the deductions from them may lead to correct forecasts for use both on sea and land.

* The chart is reproduced by permission of Messrs. Brown, Son and Ferguson, Ltd., of Glasgow, from "Weather Signs and How to Read Them; for Use at Sea," extracts from which have also been made.

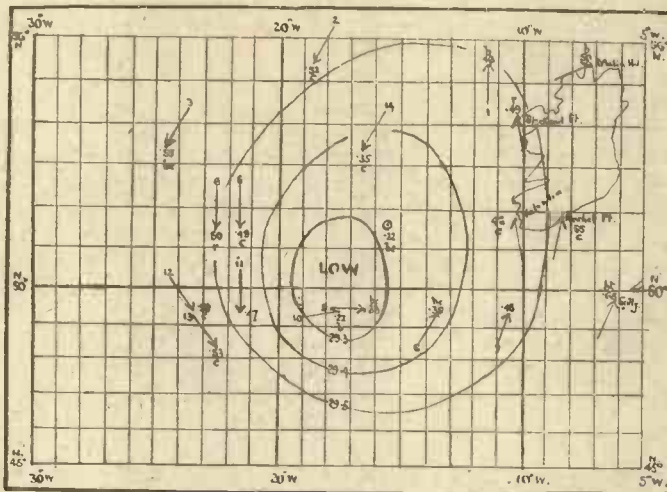

WIRELESS TELEGRAM SYNCHRONOUS CHART.
7 A.M. G.M.T. 25th APRIL 1909

Isobars: drawn for each tenth of an inch. Arrows fly with the wind. force: 1-47 -> Calm

Example of Synchronous Weather Chart *

and are plotted on charts similar to that shown on this page, of which more later.

It is from information thus gathered that the weather reports and forecasts are prepared which are broadcast daily by the B.B.C. and which also appear in the daily press.

The chart given here is a wireless telegram synchronous chart, actually made on the s.s. *Inquirer*, on April 23, 1909, at 7 a.m. Greenwich Mean Time. The map is interesting as being one constructed at a time when radio work was in its "infancy," so to speak. Nowadays, of course, such wireless weather charts are quite common, being made on all Atlantic liners, and also

ALKALINE CELLS

THE plates of the Nife or iron-nickel type of accumulator consist of a mixture of iron and nickel oxide. The positive plates comprise alternate layers of nickel hydroxide and the pure metal, whilst the negative plates are formed of iron oxide containing a certain percentage of mercury to improve conductivity. The electrolyte is a twenty per cent. solution of potassium hydrate, and serves merely as a conducting medium between the active materials.

The chief advantage of such accumulators is that, unlike the lead type, they can be

left idle, whether charged or uncharged, for an indefinite period without suffering any deterioration. The electrolyte takes no active part in the chemical action producing the current, and therefore cannot give rise to damage similar to sulphating. It should, however, be completely renewed after being in use for a year or eighteen months.

B. A. R.

TO THE RESCUE AGAIN!

AN extraordinary incident, in which wireless played a leading part, took place at Christmas time. Whilst the pilot of one of the London-Paris aeroplanes was

crossing the Channel he observed, far below him, a small steamer on fire. He immediately called Croydon by means of his transmitter, reporting the position of the ship. Croydon telephoned the message on to GNF, which promptly broadcast it to all ships and coastal stations. It was picked up by FFB, and a tug put out without delay from Boulogne. Thanks to her timely arrival, the fire was put out and the vessel towed into Boulogne with her crew of fifteen all safe and sound. This must be the first time—at any rate, since the war—that an aeroplane has sent out a shipping S.O.S. It gives yet another proof of the wonderful value of wireless.

*These numbers
save you money—*



**Valves with the wonderful
MULLARD P.M. FILAMENT**

Pay less for great power, long length of life and beautiful purity from your valves—use the new Valves with the wonderful Mullard P.M. Filament consuming only '075 ampere filament current.

These are the valves that have revolutionised maintenance costs and performance, making 1/10th ampere consumption extravagant.

There are many unique advantages in Mullard Valves with the wonderful Mullard P.M. Filament. Use them and enjoy the improved performance and economy they bring to any radio receiver.

Mullard
THE · MASTER · VALVE

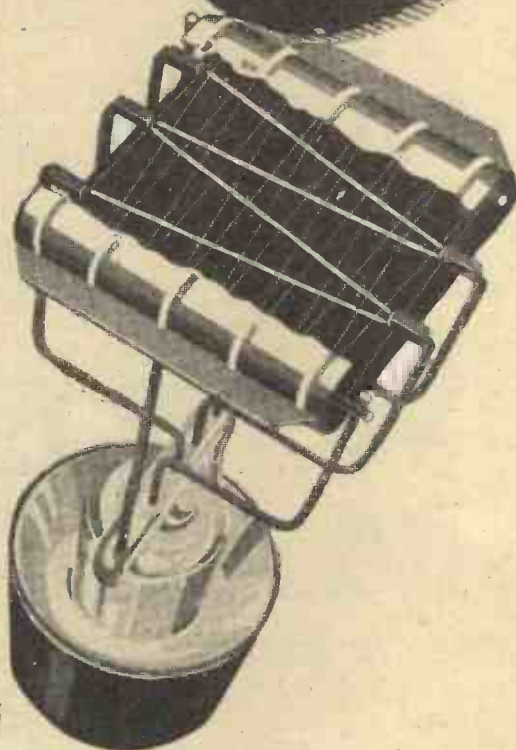

Advert. MULLARD WIRELESS SERVICE CO., LTD., MULLARD HOUSE, DENMARK STREET, LONDON, W.C.2

Mention of "Amateur Wireless" to Advertisers will Ensure Prompt Attention

*The Set you have
waited for*

1928



FIVE

The famous "1927 Five" Receiver has been revised and brought right up-to-date. Every owner of this set, and all who want to know about its wonderful successor, should read the comprehensive details given in the "Wireless Magazine" for January - Now on sale

**WIRELESS
MAGAZINE**

for January - - - - - 1/-

Get your Copy To-day

A Home-made Met-Vick Four

For working off the Electric Light Mains

The "Met-Vick" 4-Valve A.N.P. Set, shown on this page, can also be constructed for working direct from the electric light mains. This involves the use of "Cosmos" A.C. Valves and Battery Eliminators, and is fully described in the booklet 7117/4, obtainable from your wireless dealer complete with drilling template and wiring diagram. The performance of the set is astonishingly good, giving great selectivity with a wide range high quality of reproduction and simplicity of operation.

The cost of the necessary parts is low. Ask your dealer for the booklet or write to the makers.

METRO-VICK SUPPLIES LTD.

(Proprietors: Metropolitan-Vickers Elec. Co., Ltd.)

155 Charing Cross Road,
LONDON, W.C.2



Booklet 7117/5 describes fully the same set for use with battery valves.

R
P102

You will Help Yourself and Help Us by Mentioning "A.W." to Advertisers

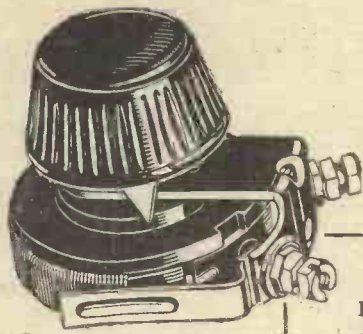

Actual Size

PRICE

2/-

The Latest and best Rheostat

A really high-grade rheostat possessing every known refinement necessary for perfect filament control at the exceptionally low price of two shillings.

The Igranic C.H. Filament Rheostat is the greatest value in rheostats ever offered. It is not cheap and nasty, but the very best filament rheostat yet designed, backed by Igranic's unrivalled experience in the manufacture of rheostats.

The Igranic C.H. Filament Rheostat

embodies every feature which experience has shown desirable for perfect filament control. The body is of Bakelite, providing perfect insulation. The contact finger is of a well-tried type which provides a smooth-running contact free from chattering and noises. Terminals are conveniently placed and easily accessible from the top of the set.

A particularly attractive feature is its compactness. It is only 1 1/8 in. in diameter and projects only 1/2 in. behind the panel. One-hole fixing, for panels 1/2 in. to 3/4 in. thick, makes it easy to mount. Supplied in three resistance values, viz., 6, 15 and 30 ohms. Price 2/-.

Your dealer has them or can get them for you immediately.

Write to Dept. D75.

Igranic components are always stocked by reputable dealers. All reports received by us of difficulty in obtaining them receive immediate attention.



149 QUEEN VICTORIA STREET,
LONDON, E.C.4
Works: Bedford.

BRANCHES:

Birmingham, Bristol, Cardiff, Glasgow, Leeds, Manchester, Newcastle.

MAKE YOUR OWN CONE SPEAKER

TWO WONDERFUL UNITS AT ONLY 15/- EACH
YOU'LL BE SURPRISED!

The New Wonder "Nightingale" CONE UNIT

GRAMOPHONE ATTACHMENT



AS FITTED TO OUR CABINET CONE

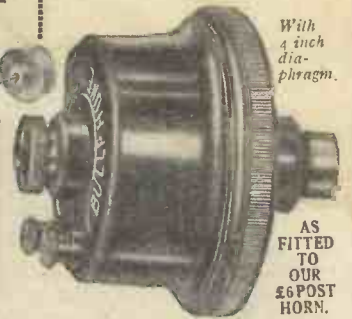

With a 1 inch diaphragm.

AS FITTED TO OUR £6 POST HORN.

From a 3 ply board, 3/16" square cut out a 1 1/2" circle then cut a strip of wood



1 1/2" dia. in centre, this will carry the unit. Fix strip to board as shown.

BULLPHONE DOUBLE PAPER CONE

2/-

Postage 3d. extra

Exactly as fitted to our own Speaker.

Reduced from 32/6 to 15/- solely as an advertisement for the famous Bullphone Nightingale Speakers, Gebalt magnet guaranteed for all time.

ASTONISHING RESULTS, equal to the most expensive Loud Speakers yet made, are guaranteed with either of these Units

BUY ON 10/- DEPOSIT EASY TERMS 5/- DEPOSIT

10/- SECURES THIS SPEAKER

5/- SECURES THIS SPEAKER

SEND DEPOSIT NOW.



CABINET CONE

Size 17 ins. high by 15 ins. in Mahogany, Walnut or Rosewood finish.

77/6 CASH, OR EASY TERMS. 10/- deposit, and 12 monthly payments of 6/-.



DE LUXE

21 ins. high with 14-inch Bell Mahogany finished, with plated arm and stand.

57/6 CASH, OR 5/- DEPOSIT and 12 monthly payments of 5/-.

SATISFACTION GUARANTEED OR MONEY REFUNDED

Obtainable from your Local Dealer or direct from :-



38, HOLYWELL LANE, LONDON, E.C.2

On Your Wavelength!

What's Ahead?

FOR quite a number of years now I have taken it upon myself to prophesy all kinds of things in the early days of January for the coming New Year. Sometimes I have been right, and duly patted myself upon the back; sometimes, again, I have been wrong, in which case I have said nothing about it. However, looking back, I find that I seem to have hit the mark fairly often; so here goes for another fit of rashness. Let us take first of all the bits and pieces wherefrom the wireless set is made. Old 1927 gave us the screened-grid valve (did I not say, twelve months ago, that there would be some important valve progress?), which, to quote a hackneyed phrase, is still in its infancy.

Screened Valves

I expect that, before it has run its course, 1928 will provide us with some pretty big developments in the matter of screened valves. So far, they are applied generally to only one purpose—that of high-frequency amplification. They do this jolly well, one must admit, but I feel that there is a wider future in store for them. We don't yet understand the full usefulness of those funny knobby bits of their curves, and we still have not been able to apply them successfully to low-frequency amplification. Possibly, in 1928—but certainly not very much later—there will be big advances in the valve, both as a rectifier and as a low-frequency amplifier. I should not be at all surprised to see the advent of the single-valve set capable of giving good loud-speaker reproduction at considerable distances from a broadcasting station.

More Valve Possibilities

The power valve, too, will, I believe, come in for its share of attention. The trouble at present is that, in order to get a long, straight working portion of characteristic, a great deal of high-tension current must be used. Looked at in one way, this current is mainly wasted; for what the loud-speaker wants to give power to its elbow is not D.C., but A.C. At present, we cannot really bring out the very low notes without using in the last stage a super-power valve, which may well require 15 or so milliamperes of current.

Valve Theories

Now, 15 milliamperes, though it will not seem much to a member of the Electricity Board, is a very great deal to the wireless man-in-the-street. Little batteries simply will not supply it; in fact, to deliver it properly, something really fat and heavy is required. Big batteries cost money and take up a great deal of room. Quite a number of theories about valves have been

shaken by the screened-grid arrangement. It used to be held, for example, that any increase in the magnification factor must mean a decrease in the mutual conductance, and *vice-versa*. This idea has had to go by the board, for in the screened-grid valve just the reverse happens. It is therefore quite within the bounds of possibility that the design of the power valve may be completely revolutionised before so very long, and that we may have something which will give us big and undistorted volume without being a glutton for H.T. current.

Microphonic Noises

The next thing that occurs to me is the rectifier. Nearly everyone knows by bitter experience that the majority of valves in this position are strongly microphonic. If you do any short-wave work you will have realised just what the term microphonic can mean! Microphonic noises are produced by the vibration of the electrodes, and the electrode that vibrates to beat the band, if it gets even .0000001 of half a chance, is the filament. In order that it may pass a small amount of current the dull emitter must, as things are at present, have a thin filament; the thinner the filament, the more apt it is to be microphonic—and there you are.

Personally, I would not mind a little more filament current and a thicker filament, if only I could get freedom from those ponging noises in sensitive circuits. I have an idea that the question of the rectifier will be taken up scientifically before 1928 is out and that something really non-microphonic will become available. There is one non-microphonic rectifier on the United States market now, but it consumes a whole ampere of current, having a fat tungsten filament. Much as I dislike those ringing noises, I don't think that I could run to an ampere to put an end to them; and I feel pretty sure that I shan't have to do so before you and I are many months older.

Other Parts

In variable condensers we are not likely to see any great advance, for the good and sufficient reason that those that we already have are so extraordinarily efficient. Semi-variable condensers, however, are likely to show improvement, and I foresee an increasing use of these in sets used almost entirely for the reception of the local station. Slow-motion dials again are so good that no big step forward can be looked for. I do hope, though, with a certain amount of confidence, that we shall see the elimination of some of the baser kinds with their jumps, jerks, and free-wheelings.

Short-wave Condensers

What I do want and expect to see before the next exhibition comes round is a variable condenser specially designed for short-wave work. This will have as its main drive a slow-motion dial with a ratio of 8 or 10 to 1. In addition, there will be a "low gear" with a ratio of 200 to 1 or so. A component such as this would be invaluable when one is searching for those elusive weak transmissions on the wavelets.

Transformer Improvements

I should not be at all surprised to see the low-frequency transformer come into its own within the next twelve months. Great strides have been made in 1927, and the old idea that a transformer must distort is no longer so strongly held as it once was. Another thing that I expect to see is a marked rise in the sales of bigger capacity high-tension batteries. People are beginning to realise that, though its initial cost is less than that of any other, the small light H.T. battery is not nearly so economical, except where the plate current is tiny, as its bigger brother.

Valve-holders

We shall probably wake up to the fact that the main duty of a valve-holder in a sensitive circuit is not to be springy, but to introduce the smallest possible losses. Only those who have measured them can have any idea of the losses due to badly designed valve-holders. Now that we have plenty of H.F. amplification available without undue use of reaction, increasing use is likely to be made of the frame aerial, or some other form of indoor collector, and the outdoor wire will be less and less seen in 1928 and in years to come.

Broadcasting

One thing that I expect to see in 1928 is a complete revision of the regional scheme as originally outlined by the B.B.C. authorities. As matters stand at present, the proposal is that this country shall erect five stations of gigantic power to broadcast on five individual wavelengths. When the scheme was first mooted it was pointed out that only in this way could interference be drowned and a reliable service given to all parts of the land. Since then several things of importance have occurred. Other countries have put up high-powered stations; and we realise that to shout the other fellow down is not the proper policy. A short time ago, as I mentioned in these columns, Berlin Witzleben was actually "coming through" 5GB. Imagine the state of affairs if not only England, but also France, Belgium, Holland, Germany, Sweden, Denmark, and Norway, to speak

:: :: **On Your Wavelength! (continued)** :: ::

only of our nearest neighbours, adopted similar schemes.

Giant Stations

Go a step further and imagine that, whilst Britain is content with 25-kilowatt stations, other countries erect transmitters rated at 50, 100, or even 1,000 kilowatts. The users of valve sets know how extensive is the wipe-out of 5XX, 5GB, Langenberg, and other main stations at times. Try to fit a couple of hundred super-power stations into the band between 200 and 550 metres, and what will the result be? America has been faced with much the same problem, and the only solution that she can find is to limit not only the number of stations licensed to broadcast, but also their power. To my mind, it is only by some similar co-operative action on this side of the Atlantic that broadcasting salvation is to be found.

Harmonic Troubles

Another matter not to be forgotten is the appalling harmonics generated at quite long range by super-power stations. So strong with me, for example, is 5GB's second harmonic that I frequently use it for loud-speaker reception. Every super-power station with a wavelength between 550 and 400 metres will produce powerful second harmonics between 275 and 200 metres; which, to say the least of it, will not lessen the complication. I believe that the best way of providing alternative programmes is to "scrap" the crystal standard and to educate the broadcast public up to the use of valves.

An Adventure!

Have you ever blown up a high-tension battery? It is not the kind of thing that I make a hobby of, but I was unfortunate enough to do it the other day. Here is how it happened. A new type of screened-grid valve came along for trial. To all appearances, the thing was in working order and a flash-lamp test showed that the filament was intact. The valve was put into the receiving set. When it was pressed into its holder there was not so much a spark as a flame! As luck would have it, it slipped easily into the holder, but could not be got out again for a few moments. Queer sighing noises came from one part of the high-tension battery, and when the valve had been extracted it was found that all that portion of it which lay between the 80-volt and 150-voltappings had practically exploded! The cells had bulged and burst, and the sealing at the top had cracked in all directions.

The Reason

Investigation showed a rather curious state of affairs. The valve had apparently received rough treatment during its journey

through the post, with the result that the outer grid was touching the plate, though this could not be seen owing to the gettingting. When, therefore, the valve was stuck into its holder there was a direct short-circuit across 70 volts of H.T. Since the battery was (I say "was" advisedly!) a big one, the current passing for a few moments must have run into a good many amperes. Naturally, large quantities of gas were generated within the cells and the pressure became so great that they blew up.

A New Cologne Station

During the last week or so you will have picked up transmissions on the Dortmund wavelength at a vastly increased strength; they emanate from the new 4-kilowatt Cologne relay station, which unofficially went on the air on December 15, in company with the 1½-kilowatt transmitter at Aachen. Dortmund has now been withdrawn from active service. In the Rhineland, Cologne, possessing the principal studio, becomes the main station for that district, the high-power Langenberg transmitter acting as its relay, and also as a link for the radio-diffusion of entertainments from Munster, Dortmund, Dusseldorf, Essen, Elberfeld, Muenchen-Gladbach, and other centres.

Zeesen Tests

The two new stations will remain in the probation stage until towards the end of January, 1928, when, with due ceremony, they are to be added to the German broadcasting net. The delay, I believe, was an intentional one, as it was hoped on the same occasion to launch the super-power transmitter, of which the equipment has just been completed at Zeesen, in the neighbourhood of Berlin. For its preliminary tests Zeesen is relaying lectures from the *Deutsche Welle*, usually broadcast by Königswusterhausen; it is utilising the same wavelength. If, therefore, during the day or early evening you pick up these transmissions easily, you may feel sure that you are hearing Zeesen, which ultimately may blossom out as a 40- to 50-kilowatt broadcaster.

German Progress

Radio in Germany is making considerable strides, and so far as I can see, the number of stations in that country will soon beat the Swedish record. As I mentioned recently in these notes, many complaints have been lodged with the authorities in reference to the power of the new Polish Kattowitz transmitter; in Silesia, in view of this interference with the Gleiwitz and Breslau concerts, a falling-off is noted in the number of broadcast licences renewed. To counteract this effect, will Germany increase the power of its local stations?

Long Ago

I was turning out some old catalogues the other day, and amongst them I came across a few curiosities. In one of them, which was published only seven years ago, there is no mention of valves at all, and the cheapest crystal set is marked at £4 15s. It is stated to have a range of 800 miles. Probably it had for strong spark signals. Nowadays you cannot imagine anyone buying or making a set specially for the reception of sparks; but they were all that the crystal man had to listen to then. Another catalogue, of about a year later, shows a foreign-made bright-emitter valve at the then remarkably low price of 14s. 6d.

What would interest you most probably is the section dealing with variable condensers. Most of us made our own in those days, because the finished articles were beyond the reach of all except the idle rich. Both fixed and moving vanes were 3s. 6d. a dozen, whilst the spindle complete with knob could be purchased for as little as 4s. 6d. You had to cut out, drill and bush your own ebonite end-pieces, and to make, from a length of 2 B.A. studding, the supporting pillars for the fixed vanes. The cost of making up a .0005-microfarad condenser did not leave very much change out of a one-pound note!

The Milan Programmes

Milan recently, on 317 metres, seems to have buried itself in mush and morse; at least, this has been my experience of its transmissions. Fortunately, however, the same programme can be captured on 549 metres, with some 7 kilowatts to send it on its way. Nightly, now, the new transmitter erected at Vigentino, a suburb of Milan, broadcasts these entertainments; very shortly it will definitely replace its weaker brother, which is to be transferred to another Italian city.

Jungle Transmissions

Wireless amateurs who nightly search the ether for distant signals on short waves may possibly pick up, early in January and onwards, messages transmitted by a small party of Americans who have set out on an expedition to find Colonel H. P. Fawcett, an English explorer lost in the jungles south of the Amazon. Commander Dynott, who is leading the rescue party, is taking with him two efficient short-wave transmitters with a view to maintaining communication with civilisation during the whole trip.

The advance party will be equipped with a 15-kilowatt field wireless telephony outfit, and a 200-watt semi-portable transmitter to be held at the base. It is expected that with such an equipment the party will be able to keep the United States informed of its progress through the jungles. All transmissions are to be effected on a wavelength of 36 metres. THERMION.

THE "ECONOMICAL" TWO

*Low Cost :
Simple Construction*

*Pure Tone :
Good Appearance*

By DUDLEY HISCOX

THE details in this article of a complete two-valve outfit makes it possible to construct an excellent loud-speaker set for a very moderate outlay. The amount spent upon the cabinet is, of course, a matter of personal choice. With an ordinary aerial its range for loud-speaking is 15 miles from main stations and 60 to 70 miles from the Daventry high-power station; also satis-

Other photographs show the set removed from its cabinet, and give a clear idea of the method of construction. The baseboard fitting, which also forms a "foundation" for the panel and the terminal strip, is a little unusual, and forms the subject of the sketch Fig. 2. This special base was made for the writer by a local joiner for a very moderate charge. A particular point to notice about this is that the baseboard proper does not extend so far as the arms that hold the terminal strip. This detail greatly facilitates the work of soldering to the terminal shanks.

Components

A complete list of the set of parts is given below:—

Ebonite panel, 12 in. by 8 in. by 1/4 in., polished (Becol, Ebonart, Raymond).

.0005 variable condenser (Ormond, Cyldon, Jackson, Formo).

.0003 variable condenser (Ormond, Cyldon, Jackson, Formo).

Resistance coupling unit, first stage (Polar, Lissen, Dubilier, R.I. & Varley).

Two valve-holders (Lotus, Lissen)

Coil-holder for baseboard mounting (Edison Bell, Lissen).

.0003 fixed condenser and 2-meg. leak (Edison Bell, Dubilier, Lissen, C.D.M.).

.001 fixed condenser (Dubilier, Edison Bell, Lissen, C.D.M.).

Eleven terminals (Belling-Lee, Eastick).

Break switch.

Wire, screws, etc.

Baseboard.

Lissen "X" coil, 75 (or 250 for 5 XX).

Cabinet (Camco, London Radio Supply Co.).

The panel as shown was purchased to the size of 12 in. by 8 in., whereas the actual panel of the set is 12 in. by 6 1/2 in. The panel as bought should be sent to be engraved, and after this has been done the 1 1/2 in. terminal strip can be cut off.

The components should be assembled as shown in the photographs and in Fig. 3, which is the practical wiring plan, except that the tuning condenser should be omitted. Wiring up can then commence. The first connections it is desirable to make are earth terminal shank to L.T. plus terminal to valve-holders filament tags. Connect valve-holders opposite tags. Connect

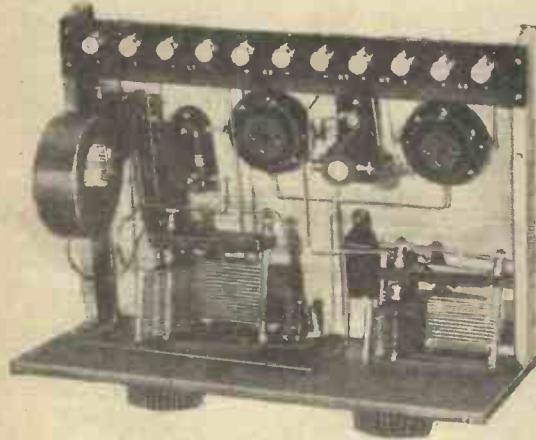

A Plan View of the Set

factory distant reception can be obtained on the headphones. Not only does the design make economical construction possible, but it provides for loud-speaker results of distinct quality.

The circuit used is shown by Fig. 1, and is that of the Reinartz type; that is, with reaction controlled by a variable capacity. It will be observed by those who know the circuit that the customary high-frequency choke has been omitted from the plate or anode circuit of the detector valve. This omission is rendered possible as the windings of the resistance in the coupling unit act effectively as a choke.

The complete outfit, as shown by the photograph of the complete set, is a handsome piece of apparatus. The polished ebonite panel is set at a slant in a french-polished white-wood cabinet. This cabinet also accommodates the high-tension, low-tension, and the grid-bias batteries. No terminals are exposed, and the only visible connections are the aerial and earth leads, and the speaker cord. These emerge from three holes in the back of the cabinet.

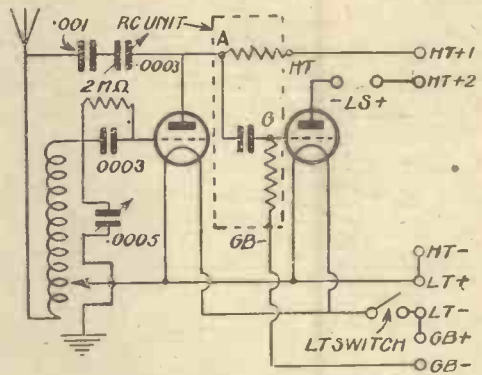
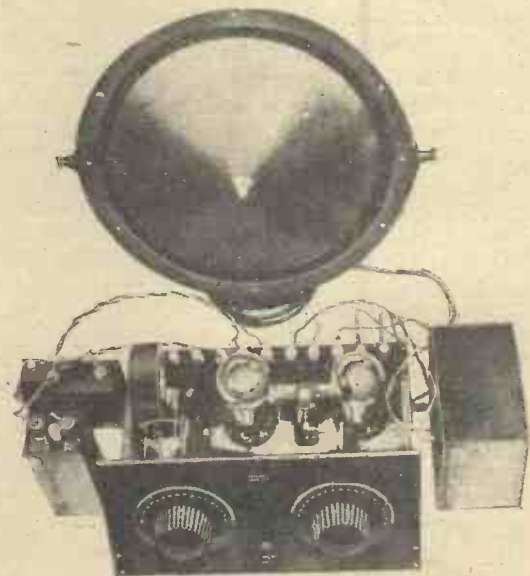

Fig. 1. The Circuit Diagram

from this bar to break switch. Strap L.T. minus and G.B. plus terminals. Connect from the other side of the break switch to this strap.

After the last connection has been made,



The "Economic Two" on Test

the tuning condenser should be mounted. Now connect tuning condenser fixed vanes to coil-holder socket. Make branch to grid condenser. Connect grid condenser to first valve-holder grid tag. Connect tuning condenser moving vanes to the wire between earth and L.T. plus terminals. Now wire from aerial terminal to coil-holder plug, and to "safety" condenser. Next from the

the wire connecting the first valve-holder plate and resistance unit A terminal.

Resistance unit H.T. terminal should be connected to the H.T. plus terminal on the strip and resistance unit G.B. terminal to G.B. minus terminal on the strip. The second valve-holder A tag (plate) is connected to L.S. minus terminal and L.S. plus terminal is strapped to the adjoining

accumulator, or other makes of a similar type will be quite suitable.

The tuning of the set is quite simple. The reaction condenser is set at a low value and the local station searched for by slowly revolving the tuning condenser. When it has been found, the reaction condenser is "increased," which brings up the volume. Care should be taken not to

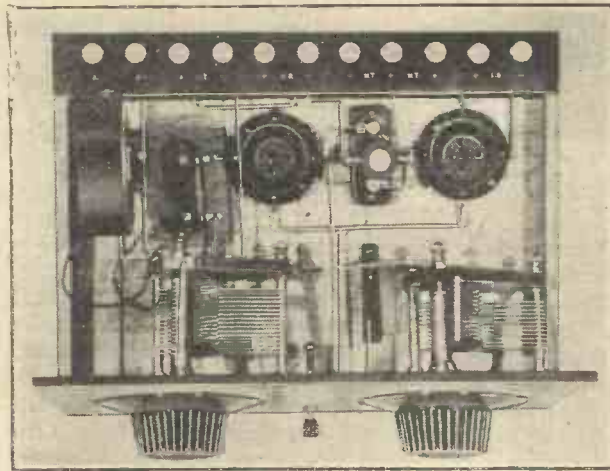

The "Economical Two." The photograph on the left clearly shows the layout and the diagram, Fig. 3, the wiring. (Blueprint available, price 1/-).

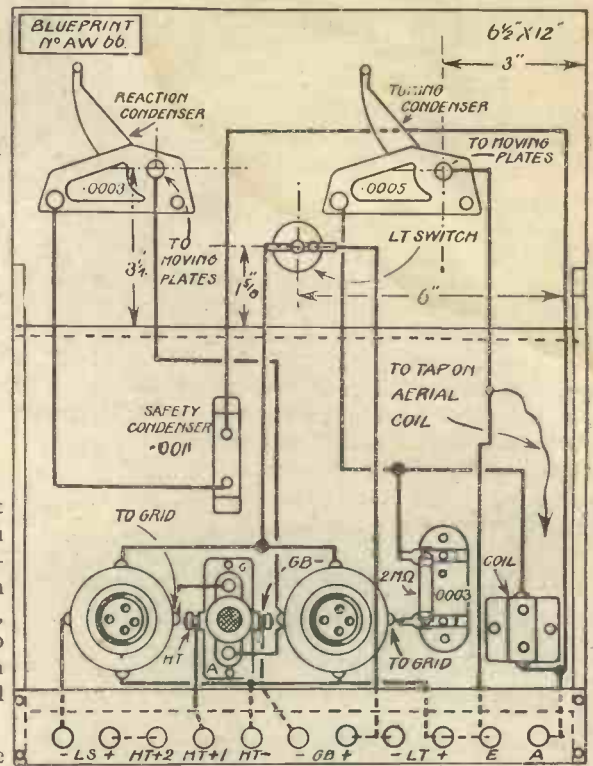

other side of the "safety" condenser to reaction variable condenser fixed vanes.

Follow these connections by putting in that from the first valve-holder plate tag to the resistance-coupling unit A terminal,

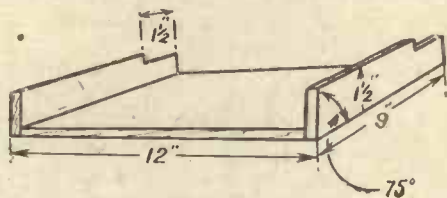

Fig. 2.—Details of Baseboard

and the second valve-holder grid tag to resistance unit G terminal. Next connect the reaction condenser moving vanes to

H.T. plus terminal. Connect H.T. minus terminal to the earth bar. The only remaining connection is a piece of flex from tuning condenser moving vanes, which is used to connect up to the tap of the Lissner "X" coil when this is inserted in the coil-holder.

As previously mentioned, the use of an R.C. valve is essential. This should be inserted in the first valve-holder, of course. A suitable valve to follow is the B.T.H. B6, which is a power valve, or a B.T.H. B5 valve can be used to work off a 2-volt

apply too much reaction, otherwise the set will oscillate and annoy others. When the volume has been increased in this manner the tuning condenser can be readjusted.

Before the Microphone

The Jekylls and Hydes of Broadcasting

THE first time I broadcast, I was conscious that I was posing. My voice was not exactly my own, but my own with a microphone plus: my accent was not the usual one used by me, it was that of the B.B.C. announcers as near as I could get it; my pronunciation was my usual one and yet there was a difference which I could not exactly explain. The fact was that although I was broadcasting it was not myself in my natural state. I did not speak into the microphone as I would speak to a friend in a drawing-room or to an audience or congregation.

The many times that I have broadcast since that time have only strengthened the conclusion that I am not natural when I broadcast. I am not my pulpit self, nor my platform self, nor yet my ordinary self. This is not my difficulty only. This week I have been discussing the problem

with a few of my broadcasting friends, and when all the cards were put on the table there was a general confession that somehow it is difficult to be oneself before the "mike."

A college professor finds that although he lectures for at least two hours daily without any trouble, he is embarrassed with his accent when he faces the invisible audience. This is not nerves merely; it is not a question of temperament. Speakers know that a certain standard of speech has been set by the B.B.C. and in trying to attain to that standard they find themselves speaking in a strange tongue.

Sir Walford Davies is not quite natural before the "mike," for all the homely way he talks. He is entirely free from nerves; he uses his own pronunciation; he uses his own emphasis. But then when his wireless voice is compared with his ordinary voice

it is found to be much lower and more racy.

One of our great linguists—an English purist too—puts on tremendously in his radio talks. Indeed, the first time I heard him I questioned greatly whether it was he. The announcer had announced him it is true, but even with that his natural self was hardly recognisable.

One wonders whether radio will develop a voice as well as an accent and a pronunciation of its own. The pulpit, the stage, and the platform have already made Jekylls and Hydes. Will the broadcasting studio follow? —E. B. RARD.

The Copenhagen broadcasting authorities, after carrying out all-night tests on three recent occasions, have now officially opened the new 2-kilowatt transmitter. The station is situated at Axelborg, in the vicinity of the Danish capital.

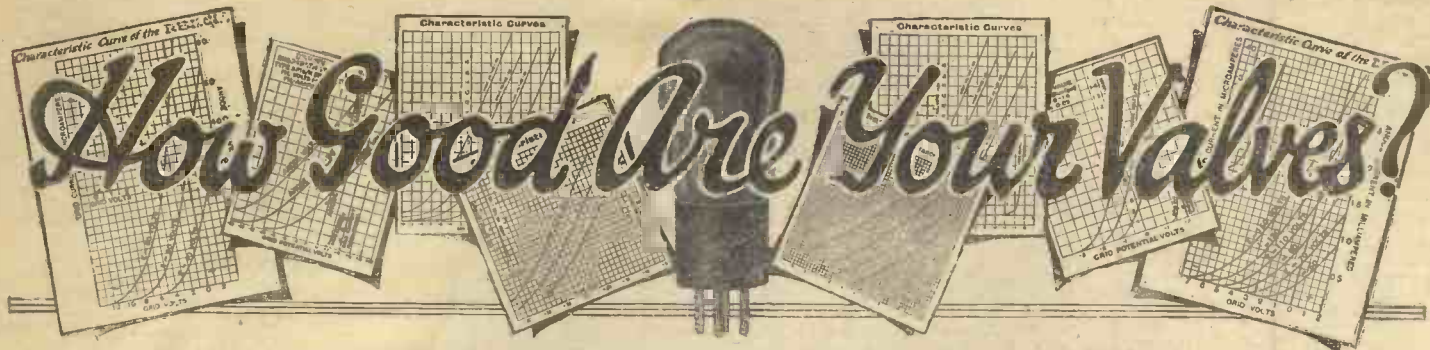

This is the first of a short series of articles by our Technical Editor, discussing the subject of valves in different positions in the receiver, and how the relative merits of different types may be gauged for these various purposes

THE choice of a valve to fulfil any particular requirement is to-day a matter requiring some thought on the part of the expert and professional user. To the average amateur, whose experience is necessarily less wide, the problem is considerably greater, whilst to the novice, who is just entering the field of wireless,



Fig. 1.—Simple Valve Circuit

the multiplicity of valves of all types is little short of bewildering.

Relative Merits

The principal test of the relative merits of any particular valve is in its actual operation under practical conditions. If one valve gives better signal strength than another, with identical results in other directions, then it is a better valve. To take another instance, we may find that one particular valve gives better selectivity in a circuit with the same value of signal strength and here again, we should say that it was the better valve. There is also the vexed question of whether two-, four- or six-volt types should be employed. Is there any way in which we can gauge the relative performance of different types of valve?

Data Specified

In classifying valves to-day it is customary to specify two principal properties, namely the A.C. anode resistance of the valve, often referred to as the internal impedance, and the amplification factor. A third property which is inter-linked with the other two is the mutual conductance, a factor which really tells us a great deal about the particular valve. As this can readily be determined from the other two however, it is not absolutely necessary to specify this explicitly and to avoid having another quantity to be remembered it is customary to refer only to the two factors previously mentioned. The question is just

how far these various factors assist us in determining the utility of a particular valve in an actual circuit.

I propose in this article to illustrate the application of these factors by tracing the action of a valve in its various functions. Some of the more interesting points about the factors themselves will then be dealt with in further articles so that the reader will be in a position to size up for himself the relative merits of the various types of valve.

A Simple Circuit

Let us consider a simple valve circuit as shown in Fig. 1. We apply our voltage across the grid and filament of the valve, and as a result of this we obtain corresponding variations in the anode current. In the anode circuit of the valve we place some suitable device such as a transformer, tuned circuit or resistance across which voltages are developed by the fluctuating anode currents. These voltages are considerably greater than those originally applied across the grid and filament. In order to estimate the amount of amplification which will be obtained from the valve, it is usual to ascertain the behaviour of the particular valve under certain conditions as a result of which curves can be drawn illustrating its performance.

Characteristics

These curves are known as characteristic curves and it is from these that the quantities usually specified (namely A.C. resistance and amplification factor) are determined. The curves usually plotted are those showing the variation of the anode current of the valve when the grid voltage is varied. In order to obtain this characteristic, a given value of high-tension voltage is applied to the anode of the valve, a milliammeter being inserted in the high-tension circuit to measure the anode current. Various values of voltage are then applied across the grid and filament, these values usually ranging from a small positive potential to a fairly large negative potential, the actual figure depending upon the particular type of valve. Several such curves are taken for different values of anode voltage, these values being chosen, as a rule, to be around the mean voltage at

which the valve is intended to be operated. Such a characteristic is shown in Fig. 2.

Two Properties

Now there are two principal properties of the valve as determined from this characteristic. Let us assume, for example, that we are working with 90 volts high tension with a steady grid bias of -6, we apply a signal voltage across the grid and filament which is alternating in character. That is to say, it will cause alternate increases and decreases in the actual voltage between the grid and filament. Suppose we assume that the signal varies between plus and minus one volt. As we have a

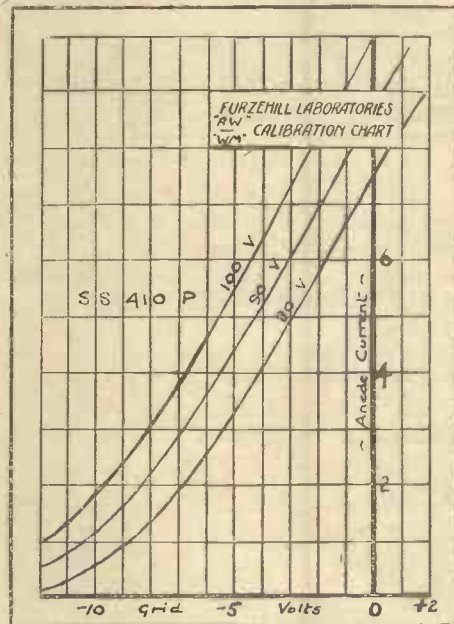

Fig. 2.—Characteristic Curves of Valve

steady value of -6 volts permanently applied, this means that the grid voltage will vary between -5 and -7 volts.

Mutual Conductance

From the characteristic it will be seen that this will cause the anode current to vary between 2.9 and 4.4 milliamps. Now it will be clear that the variation in the anode current depends upon the slope of

(Continued on page 28)

"A.W." TESTS OF APPARATUS

Conducted by our Technical Editor, J. H. REYNER, B.Sc. (Hons.), A.M.I.E.E.

R.I. & Varley Variable Resistance

THE wire-wound resistances made by R.I. & Varley, Ltd., of Kingsway House, 103 Kingsway, W.C.2, are well known for their efficiency and reliability in use. Owing to the special methods of winding, the resistances are strictly non-inductive and in consequence have no undesirable choking action.

Wire-wound resistances are eminently suitable for use in the anode circuit of a resistance-coupled amplifier. The best value, however, depends on the type of valve in use. In order to assist the user in obtaining the best results from his valves, an R.I. & Varley variable resistance has been designed. This takes the form of a barrel, which will fit the standard holder. It is tapped at six points, giving resistances varying from 120,000 to 240,000 ohms. A



R.I. and Varley Variable Resistance

metal ring with suitable projection can be rotated so that it makes contact with any one of the various tapping points. It is thus quite simple to change from one resistance to another without removing the component from the holder.

Laboratory tests revealed that the resistance values as listed on the component were remarkably accurate. This is a most useful article and should commend itself to readers.

Marconi Power-drive Resistance Unit

THOSE readers who have D.C. mains available can easily make use of this source of supply in order to provide H.T., L.T., and grid bias for their receivers. With modern low-consumption valves, requiring only .1 ampere for the filament, it is quite a simple matter to wire the filament circuits in series and to reduce the voltage of the mains to the required value, by a fairly heavy series resistance. The voltage drop on this breaking-down resistance can be used for high-tension purposes.

The actual resistance usually requires working out somewhat carefully, and the constructor will be assisted in this by the Marconiphone power-drive resistance unit being produced by the Marconiphone Co., Ltd., of 210-212 Tottenham Court Road,

W.1. This is made up of enamel-covered resistance wire wound on a large former. The resistance is in two sections. The first section is such that a current of .1 ampere flowing through it will develop 120 volts across it, while a centre tapping enables 60 volts to be obtained for the detector



Marconiphone Power-drive Resistance Unit

valve. The second section is for use where the voltage of the mains exceeds 120, five tapplings being provided so that any voltage up to 260 may be used.

The two sections are intended to be connected together through a 200-ohm potentiometer used as a rheostat, so that the current can be adjusted accurately to .1 in conjunction with the correct tapping.

The component is well made and was found to handle the required current without undue temperature rise. It can be recommended to readers.

Andia "Magic" Loud-speaker

THE time has come when an ugly form of loud-speaker is no longer tolerated. In its place we have many artistic designs which tend to harmonise to a greater extent with the furniture of a room.

We recently tested the Andia "Magic" loud-speaker, made by Artandia, Ltd., of 38 Bedford Street, Strand, W.C.2, which has an original and striking appearance.



Andia "Magic" Loud-speaker

The actual speaker consists of an electromagnetic unit attached to a small tapering tube, which projects on to the wall of a comparatively large chamber: the sound is deflected towards the base of the instrument and ultimately escapes after reflection from the article on which the speaker is mounted.

The outer appearance of the instrument does not suggest that of a loud-speaker, as it simply takes the form of an ornamental design. Various designs are possible, the sample submitted being a model of three well-known children's pets. The figures are faithful and recognisable representations, and will therefore appeal particularly to the children, while the colouring is good. An amusing effect is obtained when speech or music emanates from the group. The sound is reproduced quite well, with reasonable sensitivity, although a slightly muffled effect is obtained on speech.

Ediswan R.C. Units

THE simplicity and efficiency of resistance-capacity coupling have popularised this system; in consequence, various valve manufacturers have designed special valves to give the high efficiency in a resistance amplifier. The Edison Swan Co.,



Ediswan R.C. Unit

Ltd., of 123-125 Queen Victoria Street, E.C.4, market a range of special valves and also a number of R.C.C. units designed to suit these valves.

Three of these units were submitted for test in our laboratory. Owing to the provision of three plugs and sockets in each unit, it is possible to couple any desired number together by pushing the pins of one into the sockets of the other. Two units are made. The type A consists of a valve-holder, a grid condenser of .00032 microfarad capacity, a grid leak of 2 megohms, and a series aerial condenser of .0002 microfarad capacity, and serves as the detector unit. Type B consists of a valve-holder, an anode resistance having a tested value of 110,000 ohms, a grid leak of 5 megohms resistance, and a coupling condenser, the value of which was .008 in one sample and .01 in the other.

A special plug is provided for connecting to the filament pins, while the remaining pin forms the loud-speaker connection from the anode of the last valve. In addition, terminals are provided at suitable points whereby the H.T. and G.B. batteries and the detector tuning circuit may be connected to the assembly.

This system of units is thus easy to build up and good results are ensured.



PRACTICAL ODDS & ENDS



Phone Distributor

A PHONE distributor board can be made in a few moments in the following way.

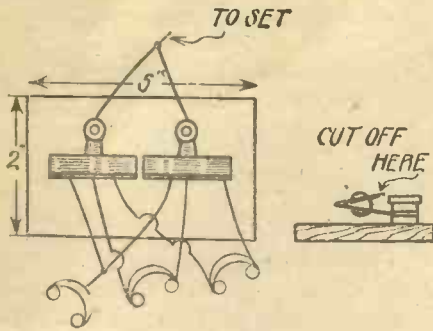

A Phone Distributor

Two terminals are mounted on a suitable baseboard. Two clips, such as can be obtained at any photographer's, are then obtained. One arm of each is then secured under one of the terminals. If the other arms foul the terminals they can be cut down. The phone leads are simply inserted in the clips.
E. J. B.

A Combined H.T. and L.T. Switch

THE drawing given below shows fully how a knife switch—or any switch having three poles—can be used as a combined high- and low-tension switch.

This type of switch can be used for panel mounting very neatly.

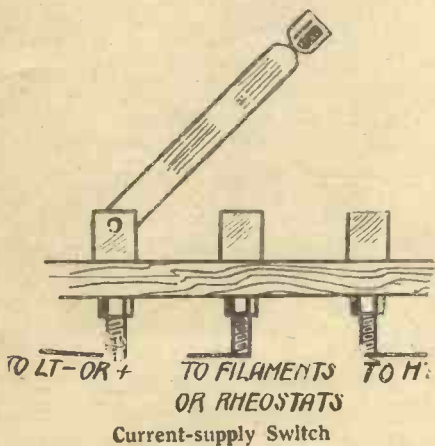

Although, of course, it is not essential to switch off the H.T. current, there are, many reasons why it is advisable that the batteries should be entirely disconnected from the set when it is out of use.

H. A. G.

Making Fixed Resistances

THE sketch shows a simple and convenient method of making fixed resistances for experimental purposes and emergencies. A piece of blotting-paper, cut to the dimensions shown at A, is well soaked in Indian ink, allowed to dry, and then tightly rolled in the manner indicated at B. Such an element will generally have a resistance value of from 50,000 to 60,000 ohms; but, of course, the value may be made smaller or larger by modifying the size of the blotting-paper. A simple method of mounting these makeshift resistances is shown at C, where fairly stout brass clips are clamped longitudinally over the ends. An alternative method is shown at D, where the resistance is arranged on the interchangeable principle,

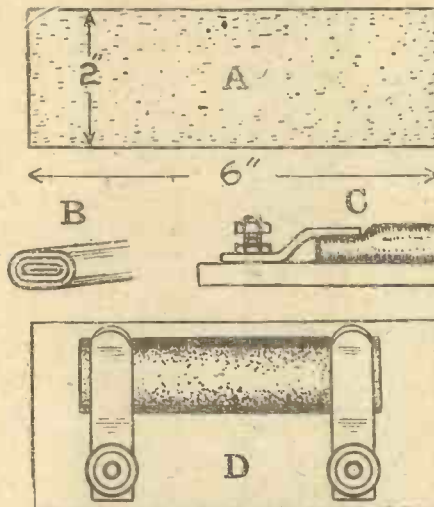

Making a Fixed Resistor

two springy brass clips, two terminals, and a small piece of ebonite forming the mount.
O. J. R.

"Stunt" Broadcast Announcements

WITH the general adoption of the electrical gramophone pick-up, "stunt" broadcasts in the home have become quite a practical proposition.

Much interest can be added, however, by

Have You any "Odds and Ends" in use? Why not let other constructors have the benefit of them? We pay for those published. We cannot return suggestions unless they are accompanied by a stamped addressed envelope.

the introduction of vocal announcements between the playing of records. To do this properly a microphone designed for the purpose is, of course, necessary; but quite good results can be obtained by using a

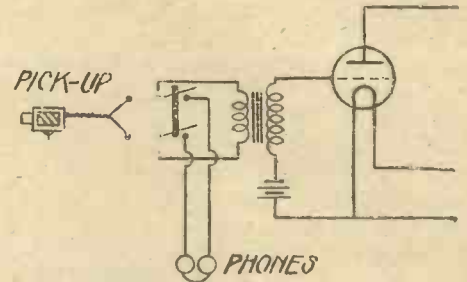

Connections for "Stunt" Announcements

pair of ordinary 4,000-ohm headphones. These should be connected in the manner illustrated to a double-pole double-throw switch, so that either the pick-up or headphones can be brought into circuit.

By speaking into the earpieces it will be found that sufficient current is generated in the windings of the magnet coils by the vibration of the diaphragms to give quite good results.
W. M. Y.

An Aerial Tip

THERE is nothing more annoying than to have the aerial put out of action for two or three days, owing to the parting of the aerial hoist rope. This is due more to the tension on the rope than its exposure to the weather.

The idea shown in the drawing relieves the rope by hitching the aerial to a hook

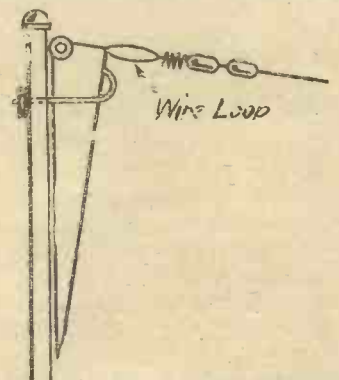

An Idea to prevent broken Aerial Hoists

mounted on the mast. The aerial is hoisted in the usual way and the strong wire loop which is between the hoist and the aerial insulators is pulled down over the hook by means of the second rope.—J. K. K.

WHENEVER reliable short-wave reception is essential, as in the case of the B.B.C. short-wave relays and amateur two-way transatlantic working, some form of super-heterodyne receiver is invariably used.

The reason is not far to seek. For on wavelengths below 150 metres or thereabouts it is almost impossible with straight-forward apparatus to amplify signals before rectification. The only type of "straight" receiver which gives reasonably good results is the popular "detector with reaction and 2 L.F." arrangement. Although some extraordinary results can be obtained with this system, when conditions are favourable, there is no getting away from its inherent disadvantage—instability. The H.F. amplification is all done with the reaction detector valve, and it is an extremely difficult business to "hold" even a strong signal with perfect steadiness.

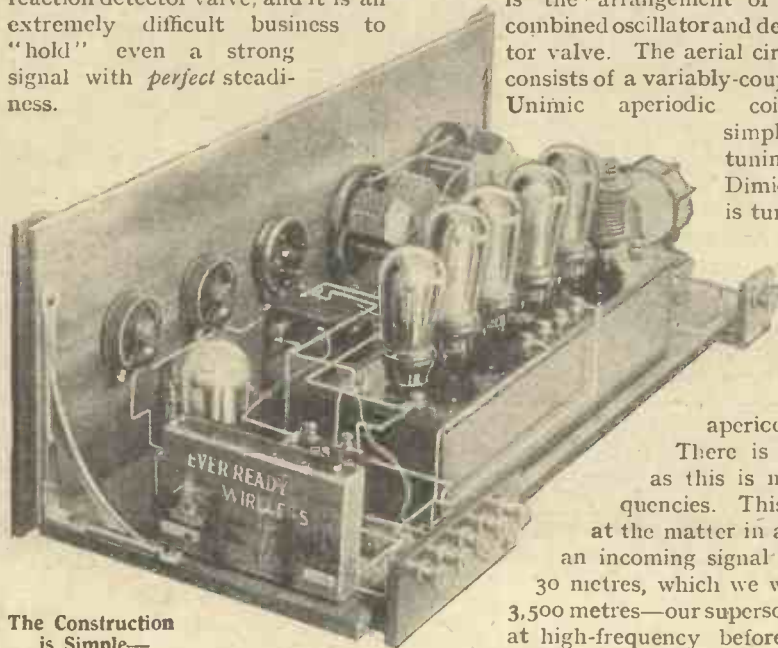

The Construction is Simple—

Because we feel that there is a sufficiently large number of enthusiasts who would go to the extra expense and trouble of building a special "super-het" receiver for exclusive use on short waves, Mr. J. Sieger has designed the Short-wave "Super Six."

An Empire Receiver

In particular it is felt that readers in the Dominions will find in this receiver a ready solution of the problem of receiving Empire broadcasting from the mother country. We have received Australia on the loud-speaker with this set with the greatest ease and we see no reason why Australian listeners should not receive 5SW Chelmsford, Essex, equally well.

The problem was simplified by the use of a McMichael supersonic unit, which together with a few accessories can be built up into a really fine reliable short-waver. The control is as simple as with a

local-station receiver and the reception as steady at 12,000 miles as it is at 30!

The Circuit

The reader's attention is directed to the theoretical circuit diagram and reduced reproduction of the full-scale blueprint (obtainable, price 1s. 6d., at this office), as an examination of these drawings will facilitate the explanation. The blueprint reproduction shows the actual wiring, while the theoretical diagram includes the internal wiring of the supersonic unit.

The first noticeable point is the arrangement of the combined oscillator and detector valve. The aerial circuit consists of a variably-coupled Unimic aperiodic coil—a

simple solenoid of 5 turns of wire. The tuning and reaction coils are halves of a Dimic plug-in coil. One half of this coil is tuned with a .00035-microfarad variable condenser, and the other half, in conjunction with a .00035-microfarad variable reaction condenser, gives a smooth Hartley reaction system. The two "inners" of the halves of the Dimic coil are joined and earthed with one side of the aperiodic coil.

There is no separate oscillator in the circuit as this is not necessary on the very high frequencies. This may surprise some readers, but look at the matter in a simple mathematical way. We have an incoming signal with a wavelength of, shall we say, 30 metres, which we want to change to a wavelength of 3,500 metres—our supersonic wavelength—in order to amplify at high-frequency before passing it on to the rectifier proper. A wavelength of 30 metres corresponds to a frequency of 10,000,000 cycles. Similarly a wavelength of 3,500 metres corresponds to a frequency of 85,710 cycles. Thus, to convert the 10,000,000 cycle signal to a frequency of 85,710 cycles we must, in the ordinary super-het way of things, generate a local oscillation with a frequency of either $10,000,000 \pm$ or $- 9,914,290$ cycles. If we consider the difference in wavelengths between the incoming signal, and the oscillation required still creates an intermediate frequency of 85,710 cycles we shall realize that this will be approximately 2 metres. This small change can be obtained

SHORT WAVE

A SET FOR WORLD - WIDE LOUD-SPEAKER RECEPTION



COMPONENTS

- Cabinet 24 in. by 8 in. (Radio Supply Co.).
- Baseboard and panel, 24 in. by 8 in. (Radio Supply Co.).
- Two .00035-microfarad (Remler, Jackson, Ormond).
- Five-valve supersonic unit adaptor (McMichael).
- Dimic coil base (McMichael).
- Unimic coil base (McMichael).
- Low-frequency transformer (R.I. & Varley).
- 400-ohm potentiometer (Lissen).
- Two 6-ohm rheostats (Lissen).
- Filament, loud-speaker jack (Bowler-Lowe, Formo).
- Anti-microphonic valve (Lissen).
- Two 2-microfarad fixed condensers (Lissen).
- Two terminal strips, 2 in. (Ebonart or Becol, R.I. & Varley).
- Seven terminals marked H.T. + 1, H.T. + 2, H.T. - 1, H.T. - 2, H.T. - 3, H.T. - 4, H.T. - 5.
- Glazite for wiring.
- Loud-speaker plug (Lissen).

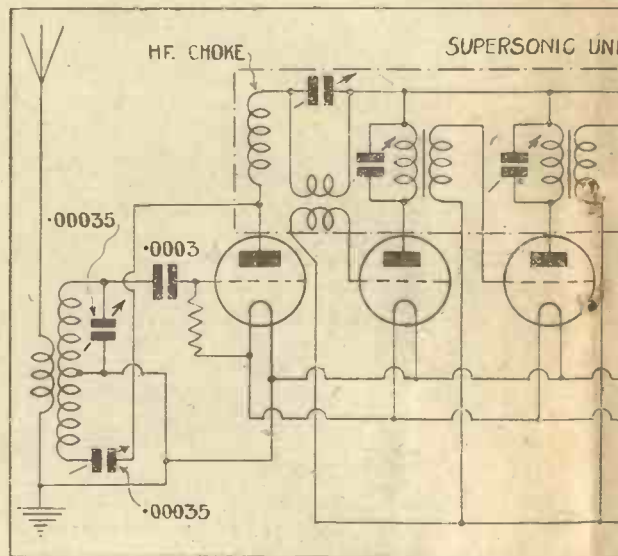

The Circuit Diagram of the



"SUPER SIX"

DESIGNED AND BUILT AND TESTED BY J. SIEGER

slightly detuning the oscillating detector circuit here is no loss of signal strength and this very small frequency difference between the incoming signal and the tuned detector circuit produces the required beat frequency of 3,500 metres. This process is only possible on the short-waves where the frequency is so high. But its advantage is obvious—the usual oscillator control is eliminated, leaving one tuning condenser, a reaction condenser and a potentiometer for the complete control of the receiver. In brief we tune one oscillating pick-up valve to a wavelength just above or just below the wavelength of the incoming signal,

proved to be almost essential to success. 3. Besides the two variable condensers there are three other controls on the panel, a potentiometer and two rheostats. The potentiometer should be a good one, as it is used as a reaction control. Its purpose is to stabilise the long-wave H.F. amplifying valves by applying a slightly positive bias to the grids and so causing grid current to flow and damp the circuits as much as is necessary. The ends of the potentiometer connected across the accumulator and the slider joined to the common grid returns of the intermediate valves. One rheostat controls the current of the first five valves and a separate control is provided for the power valve. One H.T. + tapping is used for the first five valves and a separate H.T. + for the last. The loud-speaker jack in the anode circuit of the last valve, when the L.S. plug is inserted, connects the loud-speaker up and automatically completes the six filament circuits.

Negative grid-bias is,

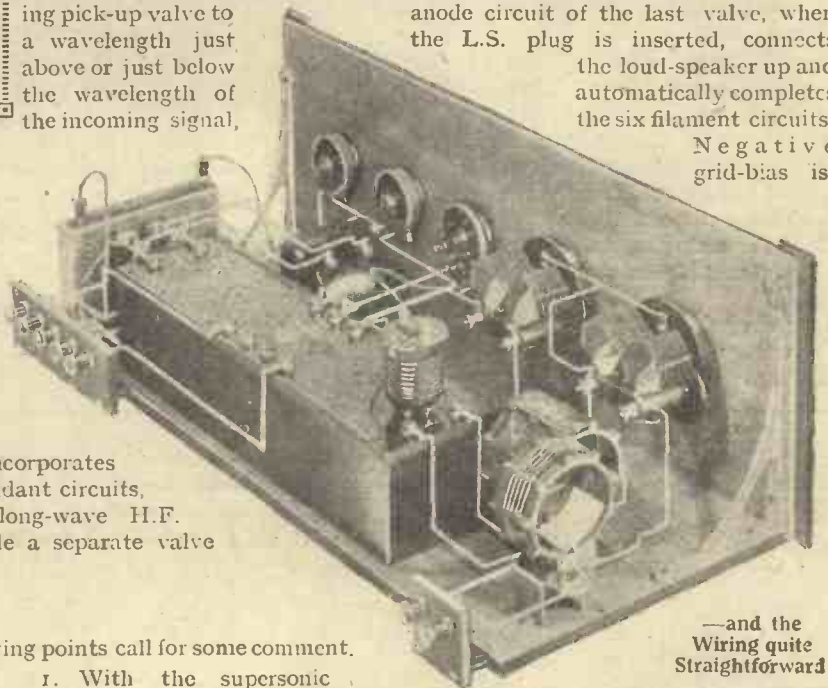

—and the Wiring quite Straightforward

REQUIRED

Carrington or London
 in. by 8 in. (Carrington Co.).
 variable condensers (Cydon).
 unit with short-wave
 (mael).
 (mael).
 mer (Ferranti, A.F.3,
 (Yaxley, Igranic, or
 Igranic, Yaxley, Lissen).
 ack (Igranic No. 65 or
 e-holder (Benjamin,
 condensers (Dubilier,
 in. by 2 in., 6 in. by
 Raymond, Radion).
 A, E, L.T.+, L.T.—,
 (Eclax or Belling-Lee).
 Igranic, Bowyer-Lowe,

by using an ordinary reaction system incorporated in the circuit of the first detector valve. Good amplification is obtained in this way.

This amplifier consists of three stages of tuned-transformer H.F. amplification. These stages are matched by the makers and need no adjustment—in fact they are sealed in the cabinet of the unit. Following this amplifier is a second detector valve, transformer-coupled to a power L.F. stage. The unit incorporates the first five valve-holders and attendant circuits, i.e., the first detector, 3-valve long-wave H.F. amplifier and second detector, while a separate valve holder is used for the L.F. valve.

Practical Considerations

Turning to practicalities, the following points call for some comment.

1. With the supersonic unit must be obtained a 5-pin short-wave adaptor, which, when plugged into the left-hand end of the unit, converts the internal connections to conform with our theoretical diagram and provides a winding for the H.F. choke shown in the anode circuit of the first detector valve, necessary for the Hartley reaction effect.

2. The specified variable condensers were chosen because of their smooth working without "crackling" noises and if alternatives are used, pay particular attention to the bearings and connections. An earthed set of moving plates or a dial with a shield has been

of course, provided for the power valve.

It will assist constructors if they pay due regard to the dotted lines in the theoretical diagram, which enclose the supersonic unit connections.

Intending constructors should consult the list of components required and when these are available construction can be started.

Construction

Although a "super-set" in its proportions as well as in performance, the "Short-wave Super Six" is not difficult to assemble. The specially polished wood panel supplied by Messrs. Carrington accommodates the two variable condensers, potentiometer, two rheostats and loud-speaker jack.

The baseboard layout, which is clearly shown by the full-size blueprint, and to a lesser degree by the reduced reproduction

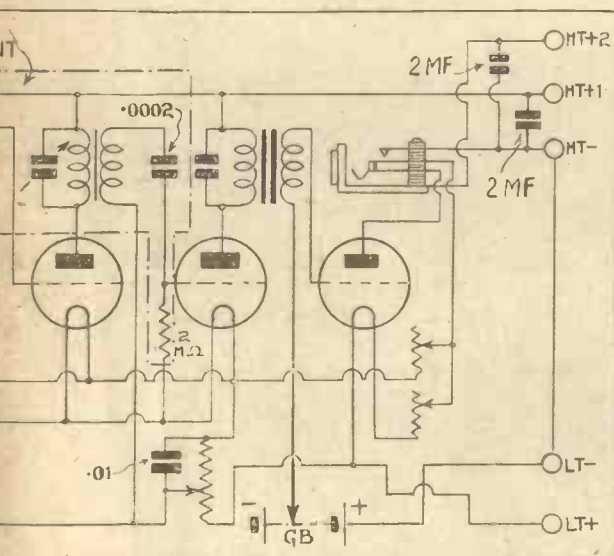

"Short-wave Super Six"

"Short-Wave 'Super Six'"

(Continued from preceding page)

shown in these pages, is extremely straightforward and well planned. The chief baseboard component is, of course, the McMichael supersonic block unit. Round this unit are grouped the remaining components, in positions calculated to give the most efficient results and to provide the simplest wiring connections.

Looking from the back of the panel, as in the blueprint drawing, the aperiodic aerial coil mount and the Dimic coil-base are screwed on the baseboard at the extreme right. The aerial-earth terminal strip is mounted at the right-hand end of the panel so that short direct connections can be made to the Dimic coil-base.

It will be noted that $\frac{1}{2}$ -in. long ebonite pieces separate the terminal strips from the baseboard. This procedure is not a "low-loss" stunt, it is merely a convenient way of adjusting the distance of the terminal strip from the back of the cabinet. In cases where the terminal strip projects too far through the cabinet these distance pieces can be shortened or omitted. The five battery terminals are mounted in the order shown at the other end of the baseboard.

There are no grid-bias terminals, as the grid-bias battery is incorporated in the receiver. Two spring-clips screwed near

With the exception of the L.F. valve, the valves are plugged into the unit. The L.F. valve holder, the only valve holder used, is mounted quite conveniently near

eliminated by connecting the "dial" terminals to earth. The three-terminal provision is made, of course, to allow the dial to be earthed when neither sets of plates

A plan view of the "Short-wave Super Six"

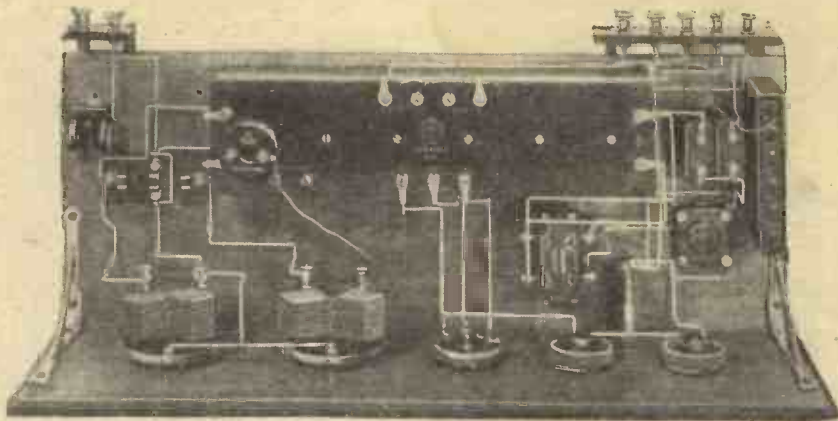

the G.B. battery. The only other component is the L.F. transformer, and this is screwed on the board, between the panel and the unit as shown.

When drilling the panel it is advisable to use the blueprint as a drilling template, or to make a template by transferring the dimensions given by the drilling diagram to a sheet of cartridge paper. The Remler variable condensers require four holes each

are earthed, as in some H.F. circuits. The potentiometer and two rheostats and L.S. jack are all one-hole fixed.

Baseboard Assembly

As far as the baseboard assembly is concerned this is all plain sailing if due regard is paid to the photographic views and blueprint. The supersonic unit is secured to the baseboard by means of three wood screws countersunk from underneath the baseboard and screwed into the underside of the wooden cabinet of the unit.

The wiring of the "Short-wave Super Six" should be carefully duplicated as far as possible, by studying the photographs and blueprint.

The two terminals marked "tuned-loop" on the unit are taken to the Dimic tuning coil as shown.

The three terminals marked "potentiometer" on the unit are connected to the nearby potentiometer connections on the panel-mounted potentiometer.

The "phones" terminals of the unit are joined to the primary of the L.F. transformer. Opposite the three terminals marked "potentiometer" on the unit are four terminals marked L.T.+, L.T.-, H.T.+, H.T.-. The H.T.+ and L.T.+ unit terminals are connected to corresponding H.T.+ and L.T.+ terminals on the terminal strip. The H.T.- and L.T.- unit terminals are not connected in any way, because the connections made to the potentiometer render this unnecessary. The unit terminals marked "autodyne condenser" are also left free in this particular arrangement. The rest of the wiring is straightforward. Flex leads for grid-bias are taken from the terminal on the Ferranti L.F. transformer marked "grid bias" and the L.T.- terminal on the strip. A flex lead is also provided from one side of the reaction

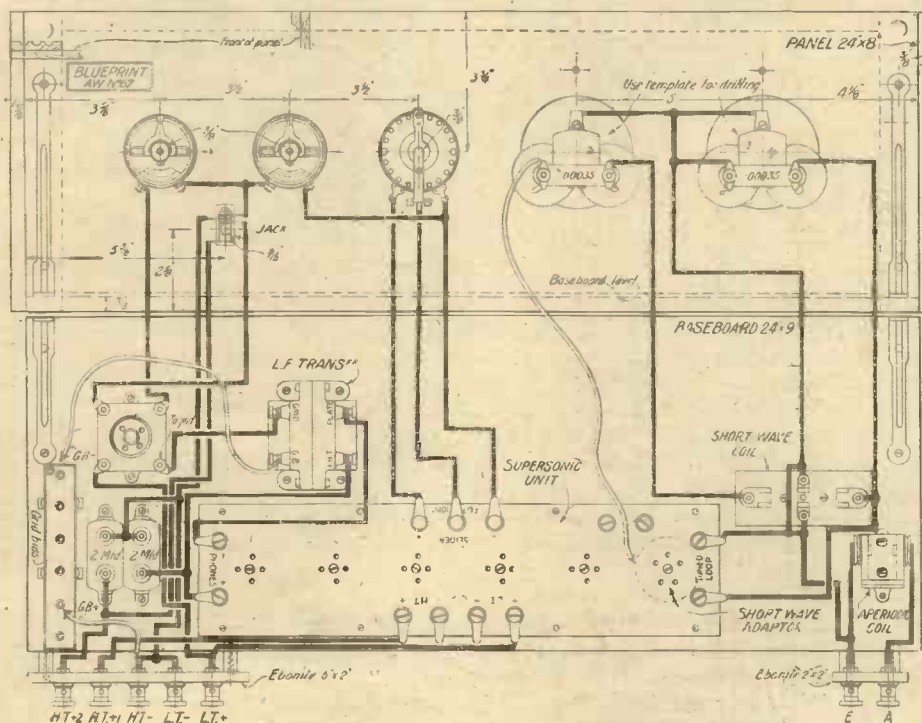

The Wiring Diagram. Blueprint available, price 1/6.

the left-hand edge of the baseboard firmly secure a 9-volt G.B. battery in position.

Between the grid-bias battery and the "phones" end of the supersonic unit are mounted the two 2-microfarad by-pass condensers.

for fixing, but as the makers supply a template this is quite a simple process.

Another interesting point about these condensers is the provision of three terminals one for each set of plates and one for the dial. Hand-capacity effects are entirely

(Continued on page 29)



CAN BE BUILT WITH LISSEN PARTS

Congratulations to Messrs. Cossor on an excellent set

IT has been definitely proved that LISSEN parts can be used for this Set with eminently satisfactory results, as well as for every other type of Circuit which may be popular at a given time, and which requires Standard parts of recognised quality.

LISSEN parts are guaranteed to give satisfaction every time they are used. Test the LISSEN TRANSFORMER against any other, and if you are then willing to part with your LISSEN, and return it within seven days of purchase, your money will be willingly refunded.

Use the other LISSEN parts as well, resistances, condensers, rheostats, valve-holders, batteries, etc.

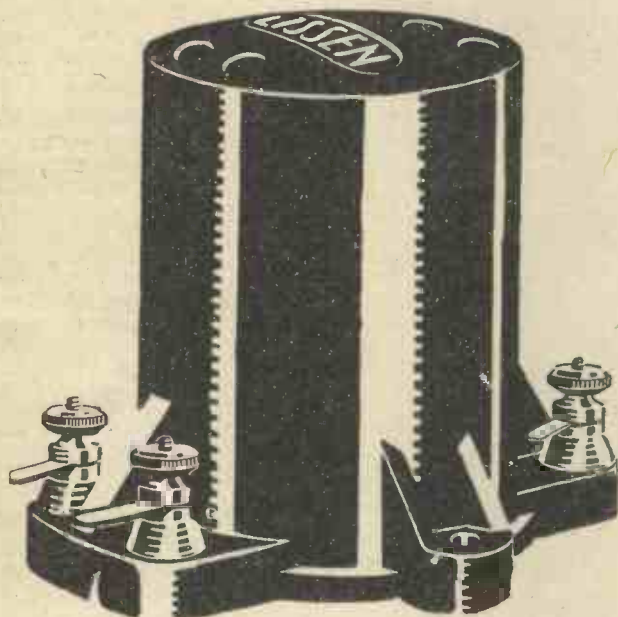

Lissen parts for the Cossor Melody Maker

- 1 Lissen L.F. Transformer (price 8/6).
- 1 Lissen .001 Fixed Condenser (to be put across the primary of the L.F. Transformer) (price 1/-).
- 1 Lissen Baseboard Rheostat, 7 ohms (price 1/6).
- 2 Lissen Key Switches or Lissen 2-way Switches (price 1/6 each).
- 2 .0003 Lissen Mica Fixed Condensers (Grid Leak Clips are included) (price 1/- each).
- 1 Lissen .0001 Mica Fixed Condenser (price 1/-).
- 1 Lissen .001 Mica Fixed Condenser (price 1/-).
- 1 Lissen .002 Mica Fixed Condenser (price 1/6).
- 1 Lissen Mansbridge Type Condenser .2 mfd. (price 3/6).
- 1 Lissen Grid Leak, 3 megs. (price 1/-) and 1 Lissen Combinator (price 6d.).
- 1 Lissen Grid Leak, .25 megs. (price 1/-).
- 1 Lissen Grid Leak, 4 megs. (price 1/-) and 1 Lissen Combinator (price 6d.).
- 3 Lissen Valve Holders (price 1/- each).
- 1 Lissen 9-volt Grid Bias Battery (price 1/6).

Also use the Lissen H.T. Battery

All these Lissen parts for the Cossor "Melody Maker" are obtainable from 10,000 radio dealers throughout the country. Ask for Lissen parts in a way that shows you will take no other, and be sure of perfect results.



LISSEN

LISSEN LIMITED

16-20 Friars Lane, Richmond, Surrey

MANAGING DIRECTOR: THOMAS N. COLE

Mention of "Amateur Wireless" to Advertisers will Ensure Prompt Attention



RULES.—Please write distinctly and keep to the point. We reply promptly by post. Please give all necessary details. Ask one question at a time to ensure a prompt reply, and please put sketches, layouts, diagrams, etc., on separate sheets containing your name and address. See announcement below

Thickness of Condenser Vanes.

Q.—Does the thickness of the condenser vanes in a variable condenser in any way affect the tuning? Is there any special advantage in having thick or thin vanes?—R. T. (Belfast).

A.—From the point of view of tuning the thickness of condenser vanes is of no appreciable importance. Actually the thicker the vanes the higher will be the minimum capacity of the condenser and therefore the smaller its tuning range in conjunction with any given coil. From this it will be seen that unduly thick vanes are not desirable, but, on the other hand, very thin vanes would easily become bent so that a compromise must be made between vanes which are thick enough to be substantial mechanically and thin enough to reduce the minimum capacity of the condenser to a reasonably small amount.—N. F.

Rectification.

Q.—Is there really any great difference in results between grid-condenser and anode-bend rectification?—F. L. J. (Stockport).

A.—Generally speaking, there is not a great deal of difference in the results given by the two methods of rectification you mention. The grid-condenser method is undoubtedly a certain degree more sensitive, while the anode-bend method is somewhat better from the purity point of view. These differences would, however, only be noticed appreciably if one were striving to obtain either the greatest positive sensitivity or the best possible quality of reproduction.—R. D.

Laminated Transformer Cores.

Q.—What is the disadvantage of solid iron cores for transformers? I notice that these cores are always built up from a number of thin strips.—G. B. H. (Stoke).

A.—The use of a laminated core (as the built-up core is called) greatly increases the efficiency of the transformer for the following reason. The iron core is a mass of conducting material situated in a varying magnetic field—that set up by the varying currents flowing in the windings. Under these conditions varying currents will be set up by induction in the core. These currents in the core (which are termed "eddy currents") will cause a heating effect and represent so much energy wasted. The idea of using the laminations is to restrict the paths of these eddy currents as much as possible; the laminations are insulated one from another.—N. F.

Potentiometer and Variable Resistance.

Q.—What, exactly, is the difference between a potentiometer and a variable resistance?—T. L. P. (Buxton).

A.—Both a potentiometer and a variable resistance (or rheostat) consist of a resistance with a means of making contact at different points. But in the case of a rheostat current only flows through the portion of the resistance between one end and the point at which contact is made, whereas in the potentiometer current always flows through the whole of the resistance. The rheostat has only two connections, while the potentiometer has three. A variable resistance is used when it is desired to vary the amount of current flowing, while the

potentiometer is employed to control the voltage applied across two points.—N. F.

Aerial Length.

Q.—When an unrestricted space is available for the erection of an aerial, which is the best type to use and what is the ideal length for ordinary broadcast reception?—E. P. S. (Blackpool).

A.—A single-wire, inverted L-type aerial, with a combined height and length of about 80 ft. will generally be found best. Greatest range and signal strength will be obtained as

When Asking Technical Queries

PLEASE write briefly and to the point

A fee of One Shilling (postal order or postage stamps) must accompany each question and also a stamped, addressed envelope and the coupon which will be found on the last page.

Rough sketches and circuit diagrams can be provided, but it will be necessary to charge a special fee (which will be quoted upon request) for detail layouts and designs.

the average height of the aerial is increased, but atmospheric interference is generally less when a comparatively low aerial is employed.—P. C.

Two-valve Neutralised Circuit.

Q.—Can you give me a theoretical circuit diagram of a two-valve set, H.F. and detector, the first valve to be neutralised by using a centre-

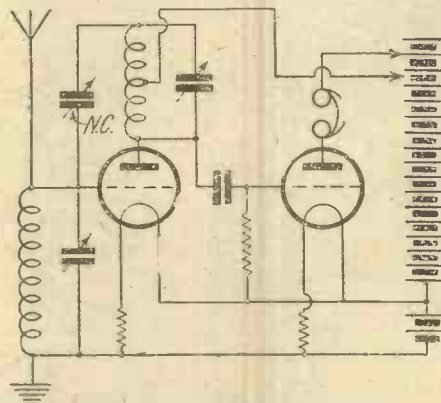

Two-valve Neutralised Circuit

tapped anode coil? I do not wish to employ direct reaction, as I understand that a reaction effect can be obtained by reducing the capacity of the neutralising condenser below that required for perfect neutralisation.—P. M. (Suffolk).

A.—The circuit required is given on this page. The aerial condenser may have a value of .005 microfarad and the anode condenser of .003 microfarad. The values of the grid condenser and leak should be the usual .003 microfarad and 2 megohms respectively.

The coil sizes, of course, will depend upon the wavelengths to which it is desired to tune. For ordinary broadcasting the aerial coil may be a 35, 40, or 50, and the anode coil a 60 or 75, while for the reception of 5XX a 150 or 200 coil in the aerial circuit and a 200 or 250 coil in the anode circuit will be satisfactory. As you suggest, reaction may be controlled by means of the neutralising condenser.—N. F.

Non-inductive Resistance.

Q.—How can I wind a non-inductive resistance?—F. L. D. (Perth).

A.—To do this you must make the field of one half the winding neutralise the field of the other half. A simple way of accomplishing the desired object is to proceed as follows: First of all ascertain the amount of wire required to give the desired resistance and then divide it into two equal portions. Now join one end of one portion to one end of the other portion and commence to wind the double wire on the former as though it were but a single strand. When all the wire has been put on the former, the two remaining free ends will form the connections to the external circuit.—R. D.

Accumulator Discharge Rate.

Q.—How can one tell if an accumulator is suitable for the work in hand? For instance, if it is desired to use a certain number of valves, how can one tell the right size of accumulator to use?—R. D. S. (Birmingham).

A.—The discharge rate of an ordinary lead-plate accumulator should never be allowed to exceed one-eighth of its actual ampere-hour capacity. That means to say that a 40 actual ampere-hour accumulator should never be discharged at more than 5 amps. To find the type of accumulator required for a wireless set, add the filament consumptions of all the valves together, multiply the result by eight, and that will give you the minimum actual ampere-hour capacity of the battery required. A larger battery, of course, would be an advantage, but it would not be wise to use so large a battery that it would not need recharging for many months.—N. F.

The Grid Leak.

Q.—I notice that in some circuits the grid leak is joined directly across the grid condenser, while in others it is joined between the grid of the detector valve and one side of the filament. What determines which way the grid leak should be connected in any particular case?—S. A. C. (Ramsgate).

A.—This depends upon the circuit. In every case the grid leak is really connected between the grid and filament of the detector valve. When the side of the grid condenser farther from the grid of the detector valve is connected to the filament circuit through either a tuning coil or the secondary of an H.F. transformer, placing the grid leak across the condenser virtually connects it between grid and filament. When, however, the detector valve follows a stage of tuned-anode coupling, the grid leak must not be connected across the grid condenser as this would result in it being connected, through the tuned-anode coil, between the detector grid and H.T. positive.—G. N.

TRY RAYMOND'S FOR The "Mullard Master Three"

NO SOLDER — Only 20 wires to connect
COMPLETE SET OF COMPONENTS

The components specified by Mullard's are:

- | | | |
|------------------------------------------------------|-----------------------------------------------------------------------|-------------------------------------------------------------|
| 1 Terminal strip, 2½ in. x 2 in. x ½ in. | Master Three coil (Colvern). | 4 Terminals—A., E., L.S.—, I.S.—(Bellinglee). |
| 1 Coil base (Lewcos). | 1 Long wave Master Three coil (Colvern). | 1 Set of ABC connecting links (Junit). |
| 1 S.L.F. variable condenser, .0005 mfd. (J.B.) | 1 On and off switch (Bulgin). | 2 Spade terminals—1 red, 1 black (Ealex). |
| 1 S.L.F. variable condenser, .00035 mfd. (J.B.) | 1 R.C.C. unit, type A, (R.I. Varley). | 8 Wander plugs—4 red, 4 black (Ealex). |
| 1 H.F. choke (Climax). | 1 L.F. transformer, G.P. (R.I. Varley). | Suitable length of red and black flex. |
| 3 Anti-vibratory valve holders with terminals (Pye). | 1 Combined grid leak, 2 megohms, and condenser, .0003 mfd. (Mullard). | 1 Ebonite bush, ¾ in. diameter, ¾ in. hole, 3/16 in. thick. |
| 1 Pair panel brackets (Magnum). | | |
| 1 Broadcast wave, | | |

Together with 3 Mullard PM valves

£6 · 17 · 6

Aluminium Panel, Highest Quality, drilled, Grid Battery, and 120 volts H.T.

GIVEN FREE with above components
JUST SEE WHAT YOU SAVE!

IMPORTANT

IT IS IMPOSSIBLE TO ADVERTISE ALL THE WIRELESS PARTS NOW ON SALE BUT IF YOU WANT THEM TRY RAYMOND'S FIRST! BE SURE YOU VISIT THE Bargain Window.



We Stock, Igranic, Climax, Ever-Ready, Mellesden, Siemens, Formo, Ferranti, Wearite, Ormond, I.B., Benjamin, Lotus, Mullard, Dublin, Lissen, Lewcos, Utility, Magnum, Peto-Scott, Peerless, Burndept, Pye, Marconi, McMichael, Cosmos, Carborundum, R. I. Varley, Gambrell, Brown's, Sterling, Amplicon, in fact, everything it is possible to stock.

SET OF THE SEASON COSSOR MELODY MAKER COMPONENTS FOR SAME

2 Ormond .0005 S.L.P., 2 Do. Slow-Motion Dials, T.C.C. Condensers, .0001, .001, .0003, .002, 2 mfd. 2 Grid Leak Clips, B.B., Dublier, 3, 4, and .25 meg. 3 W.B. V.H., 1 Farranti A.F.3, 2 Bulgin P.S., Wound coil, ready to use, Terminals, Glazite, Systoflex, Variable Resistance, B.B., 9-v. Grid Bias. Handsome American Type Cabinets, baseboard, hinged lid, solid oak, for 21 x 7 panel, 25/-; Ebonart, Resiston, Parfait Panels, Mahogany, or black Polished, Grade A, from 5/-.

KIT £4: 10: 0 (as specified)

High-grade polished panel 21 x 7 and Radion strip.

FREE with above Kit.

Also cabinet for 18/11 instead of 25/- if purchased same time.

CABINETS

Large stocks of really useful cabinets kept or made to order. Solid oak glass finish. American type, hinged lid, baseboard.

10 x 8 x 8	... 8/11
12 x 8 x 0	... 11/6
14 x 7 x 0	... 13/11
16 x 9 x 0	... 16/11
18 x 8 x 0	... 19/11
20 x 8 x 0	... 22/6
21 x 7 x 9	... 25/-
24 x 7 x 9	... 27/6
Post	2,6 each.

PERSONAL SHOPPERS

USUAL HOURS
TWO SHOPS

if one is closed the other is open.

ALL DAY SATURDAY
ALL DAY THURSDAY
ALL DAY EVERY DAY

9 a.m. to 8 p.m.
Sat. 9 a.m. to 9 p.m.
Sunday morning 11-1

almost alive!

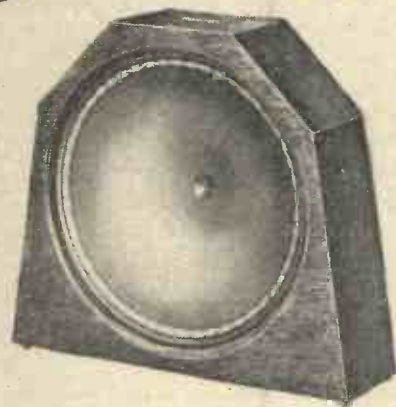

If, to-night, at a friend's house, you were to hear the **BROWN Mascot Loud Speaker** without knowing you were listening to a loud speaker, you would be almost sure to ask who was his singing friend. Then when he replied that it was a loud speaker you heard, you would laugh and offer him the other leg. At that his eyes would sparkle, as he disillusioned you, and you would be quite astonished that a mere instrument could be so human. After that you would want a **BROWN Mascot Loud Speaker** for yourself, and when you had bought one you would say that in all the world there was no better place than your own fireside, in your old chair, with this almost-living loud speaker to thrill the evening hours.

The Wireless shop round the corner has the **BROWN Mascot Loud Speaker** Only 90/- is its price.



S. G. BROWN, LTD.,
Western Avenue, North Acton,
London, W. 3.

No. 1392

K. RAYMOND
27 & 28a, LISLE St.,
LONDON, W.C.2.
Phone: Gerrard 4637.

COME TO
LEICESTER SQ. TUBE
(Important)

Ask for back of Daly's Theatre
This address is opposite.

MAINS WORKING

The Eighth and Concluding Article on Coupling the Receiver to the Mains

By H. J. BARTON CHAPPLE, Wh.Sc., B.Sc. (Hons.), A.M.I.E.E.

WHEN using .06 valves under the scheme of series connection it is not advisable generally to exceed three valves; a five-valve circuit would be almost impossible to handle efficiently and the connections would be better as a parallel filament working, giving a maximum

25 c.p. carbon filament lamps can be used in series and H.T. tappings taken at the lamp junctions; the variable resistance should then be about 600 ohms. The resistance values just mentioned are for .06-type valves but with other valves the resistance is calculated quite easily by the

any difficulty, it being assumed for the purposes of calculation that the current taken from the mains is equal to the valve-filament current—the actual value can be measured at the mains input terminals. With 240 volts and .06 valves the power consumed is 14.4 watts which at 4d. a

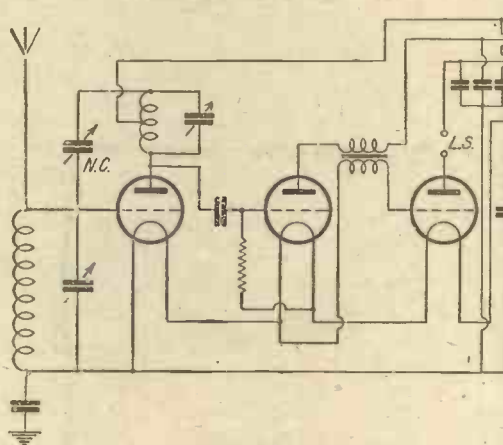

Fig. 23. (Left) Suggested 3-valve Mains Circuit

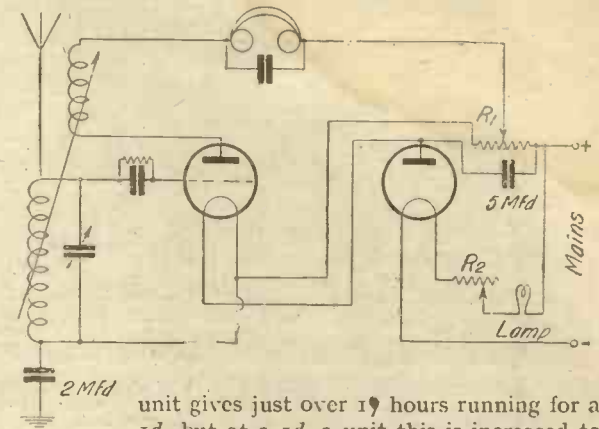

Fig. 24. (Right) A Modified Arrangement

current drawn from the mains as .3 ampere. With quarter-ampere valves the problem is not quite so acute, but the same reasoning must be applied. Typical examples will not be given, however, as enough has been said to point out the little pitfalls which the experimenter is apt to overlook unless great care is paid to details.

Returning now to general details, the actual value of the resistance required will of course depend upon the voltage of the mains and the type of valve employed on the receiver. With quarter-ampere valves and 240-volt mains, the resistance would be 960 ohms, but with the .06 type this value is increased to 4,000 ohms. This resistance will not be wholly located in one part of the unit, for account must be taken of the filament resistances, regulating variable resistance, intermediary resistances between the filaments if desired for grid bias and the resistances of the chokes. The smoothing must now take place before the resistance is reached and not after the potentiometer or lamps as was suggested in Fig. 12. At least two large chokes (30 henries being the minimum) and a pair of condensers are required and this must be duplicated or the inductance values increased if the ripples are very pronounced.

Fig. 23 gives a suggested arrangement for a three-valve circuit similar to that shown in Fig. 19 but minor details must be settled from the point of view of the receiver circuit which it is desired to use. The variable resistance should be of the order of 400 ohms and condensers of 1 to 2 microfarads capacity should be shunted across each H.T. tapping and L.T. In lieu of an ordinary wire-wound resistance, four

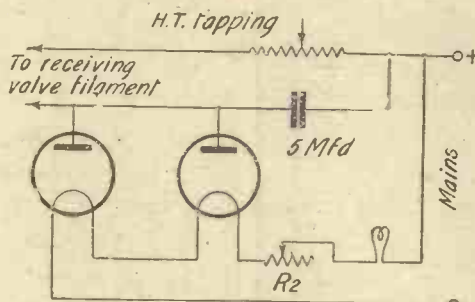

Fig. 25. Filaments in Series

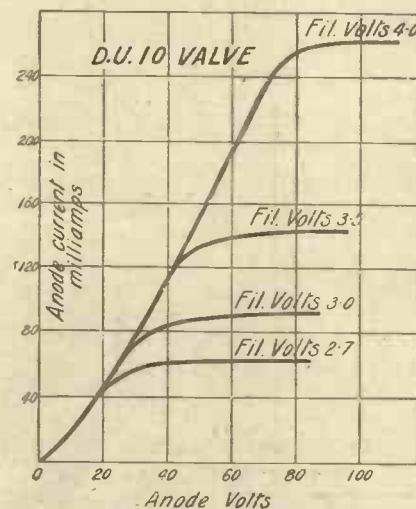

Fig. 26. Curves of Valve with Different Filament Voltages

use of Ohm's law. It will be noticed that no ammeter has been included since its exact location must be settled from the considerations previously enunciated.

Questions of running costs do not present

unit gives just over 19 hours running for a 1d., but at a 1d. a unit this is increased to nearly 70 hours for 1d. or roughly a fortnight's working of 5 hours a day—a remarkably low figure.

Using quarter ampere valves the price, of course, is higher, the payments now working out at just over 4 hours for a 1d. at 4d. a unit, or between 16 and 17 hours at the penny rate for electricity.

In a similar manner to that shown for the system just discussed the method of smoothing suggested by Dr. James Robinson can be adapted quite readily to supply both the low-tension and high-tension circuits. Figs. 16 and 17 gave the simple H.T. arrangement and it only remains to break the R1 circuit and place it in series with the valve filaments. Fig. 24 shows the slight modification introduced into the single-valve circuit of Fig. 17, a filament rheostat (not shown) being introduced, if desired, to give fine regulation of the current. Since the magnitude of the filament current of the receiving valve is controlled by the emission of the smoothing valve it will be apparent that this filament current should be kept as low as possible, the .06 type valve preferably being employed. The emission required would then be of the order of 65 milliamps such as would be provided by a DE5 valve with 6 volts across its filament or a DE5 c valve with the same filament potential, the grid and plate being joined together in each case.

A bright-emitter valve such as the LS5 would also be effective but the arrangement is more costly since the filament current of this valve is .75 ampere. The special rectifying valve of Mullards, the DU10, would also serve excellently with a filament

(Concluded on page 28)

Getting better results from 2 volts



B 210 H
R.C. and H.F.
 Fil. Volts 2
 Fil. Amps. . . . 0.10
 Max H.T. Volts 150
10s. 6d.

B 210 L
General Purpose.
 Fil. Volts 2
 Fil. Amps. . . . 0.10
 Max H.T. Volts 120
10s. 6d.

B 215 P
Power Amplifying.
 Fil. Volts 2
 Fil. Amps. . . . 0.15
 Max H.T. Volts 120
12s. 6d.

The above prices are applicable in Gt. Britain and N. Ireland only.

WHEN we say that the B.T.H. Nickel Filament Valves are superior to all other 2-volt valves, we are not referring merely to subtle improvements in construction or characteristics. We mean that the new valves give results which, to the average listener as well as to the critical expert, are quite obviously better in volume, tone and length of service than those given by any other 2-volt valves.

To get the very best from your 2-volt accumulator you must use Nickel Filament Valves. But don't take our word for it. Try them in your set. You will be delighted and astonished at the wonderful improvement in reception—a result that will more than justify the cost of the change.

Your dealer holds adequate stocks of these valves.



VALVES

NICKEL FILAMENT

Made at Rugby in the Mazda Lamp Works.

The British Thomson-Houston Co., Ltd.

2871

Advertisers Appreciate Mention of "A.W." with Your Order

"HOW GOOD ARE YOUR VALVES?" (Continued from page 17)

the characteristic. If the characteristic were horizontal, then there would be no change in the anode current as the grid voltage was altered. As the slope of the characteristic increases, so the change in anode current for a given change in grid voltage, increases. This, therefore, is one fundamental property of the valve, namely the slope of the characteristic.

The property is known as the mutual conductance. It is a measure of the relative conductivity of the valve between the anode and filament as controlled by the grid circuit and since this depends upon the mutual interaction between the grid and anode circuits, it is termed the *mutual conductance*. The property will be further described in a future article.

A.C. Anode Resistance

There is a second important property which can be deduced from these curves. It is not only the grid voltage which affects the anode current, but the anode voltage itself also has some reaction. This is clear from the fact that the three curves taken at different anode voltages occupy different positions on the chart. With any value of grid voltage, say -6 volts, the anode current is different for these three particular values of anode voltage. In this case, we are dealing with a straightforward circuit. We have a voltage applied by the high-tension battery across the anode and filament of the valve, as a result of which a certain current flows. We can therefore assume that the valve has a certain resistance which we can determine by dividing the voltage by the current in accordance with the well-known Ohm's law.

In valve circuits, however, we are dealing with varying currents the whole time, and consequently we do not wish to know the actual value of the resistance at any instant, but rather the effective resistance

of the valve to alternating currents. Thus at 90 volts H.T. and -6 volts grid bias, the actual anode current is 3.6 milliamps, which would give us an absolute resistance of

$$\frac{90}{.0036} = 25,000 \text{ ohms}$$

Practical Conditions

We are concerned, however, with what happens if the anode voltage varies. Thus at 80 volts and -6 volts on the grid the anode current is 2.5, while at 100 volts it is 4.7 milliamps. Thus an increase of 20 volts on the anode has caused an increase in the current of 2.2 milliamps giving us an effective resistance of 9,100 ohms, only about $\frac{1}{3}$ of the previous figure. This is the resistance which the valve will appear to offer to alternating currents and we therefore refer to this as the A.C. anode resistance. As has been remarked, this is often referred to as the internal impedance of the valve, although the impedance really should take account of the small capacity effect between anode and filament.

This A.C. anode resistance is a useful factor as such. A valve definitely acts as a resistance shunted across whatever circuits happen to be placed in the anode circuit, and the effect on the circuit can be calculated on this assumption. For this reason, this property of the valve is one of the two factors generally quoted as determining the performance of a valve in practice. More will be said about this aspect of the question in due course.

The third factor with which we are concerned is the amplification factor of the valve. The primary object of the valve is to amplify the signals and therefore some indication of its amplifying properties is an essential constant. The amplification factor cannot be deduced directly from the

characteristic just given, but is easily obtained from the two factors already discussed, namely the mutual conductance and the A.C. anode resistance.

Amplification Factor

We have seen that a change in grid voltage will produce a certain change in the anode current. In a similar manner, a change in anode voltage will also produce a change in anode current. The change required in the anode voltage is much larger, however, owing to the fact that the grid is closer to the filament, this being the fundamental phenomenon which gives the valve its amplifying power. From this aspect of the question, the amplification factor of the valve will readily be appreciated. It is simply the change in anode volts divided by the change in grid volts required to produce the same change in anode current.

Now we have already seen that

$$\text{Mutual conductance} = \frac{\text{Change in anode current}}{\text{Change in grid volts}}$$

Also we have seen that

$$\text{A.C. anode resistance} = \frac{\text{Change in anode volts}}{\text{Change in anode current}}$$

If we multiply these two factors together we get

$$\text{Amplification factor} = \frac{\text{Change in anode volts}}{\text{Change in grid volts}}$$

This is exactly what we require to define our amplification so that we have the three properties all linked up together by the relationship:—

$$\text{Mutual conductance} \times \text{A.C. anode resistance} = \text{Amplification factor.}$$

How these factors affect the valve in practice will be discussed in the next article from which we shall see that they completely define the performance of the valve and enable us to size up its practical utility at a glance.

"MAINS WORKING" (Continued from page 26)

voltage as low as 2.7, the filament current being of the same order as an LS5. To furnish this current, two 25 c.p. carbon-filament lamps would be used in parallel and the combination placed in series with the resistance R_2 .

If attention is turned to the case of receiving valves with filament currents exceeding .06 ampere then difficulties arise owing to the emission current of the smoothing valve. Of course valves can be used in parallel but we immediately come face to face with the problems dealt with in an earlier paragraph, namely, the current differences with the valve filaments run in series owing to the anode currents, which in this case must of necessity be heavy. To be on the safe side I would recommend

that no more than two smoothing valves be used in parallel, the filaments being joined in series as indicated in Fig. 25, the valves being, say, two DE5B's. The problem would appear to be more easily solved by utilising the DU10 valve previously mentioned.

A glance at the curves of Fig. 26 will show the characteristics of the valve at different filament voltages. At 3.5 volts the saturation current is about 140 milliamps while at 4 volts this plate current has risen to just over 250 milliamps. Thus this valve will satisfy the cases of 100 milliamps and quarter-ampere receiving valves when properly adjusted.

With multi-valve receivers and using this smoothing arrangement, meticulous

care must be paid to the series filaments of the set and it is advisable not to exceed three valves unless the parallel feeding of the filaments is resorted to. The running costs are calculated in an identical manner to the previous case, the figures being the same for the quarter-ampere valve such as the DE5B which was suggested as being suitable. The LS5 would be three times as dear and the DU10 between three and four times. When considering these figures for the running costs in terms of hard cash we are prone to overlook the other advantages which are not measured in this manner—convenience, continuity of service, cleanliness, and so on, but in weighing up the whole problem all points must be given their true perspective.

"SHORT-WAVE 'SUPER-SIX'"

(Continued from page 22)

condenser to a spade tag clamped under the "A" terminal of the McMichael short-wave plug-in adaptor.

When completely wired with Glazite or Junit connecting wire, the "Short-Wave Super Six" should be very methodically checked over, care being taken to tighten up every wire. A single loose connection in a "super" such as this can easily cause untold trouble in the way of "cracklings" and "rustlings" which, by the way, are noticeably absent in the model described.

Operation

With the valves or alternatives specified inserted in the valve-holders, and adequate H.T., L.T., and G.B. supplies connected up, the receiver can be brought into operation. First insert the L.S. plug in the jack, then switch on the rheostats and turn the potentiometer to the positive side of the accumulator bias and finally rotate the reaction condenser until the first detector is oscillating. Tuning is then carried on in the normal way, the sensitivity being brought up to a maximum by turning the potentiometer until the long-wave amplifier is just below the oscillation point.

To receive C.W. signals the long-wave amplifier should be allowed to oscillate, but when receiving telephony, work the potentiometer round to the positive bias to prevent long-wave oscillation. Further operating notes and a full test report will be given next week.

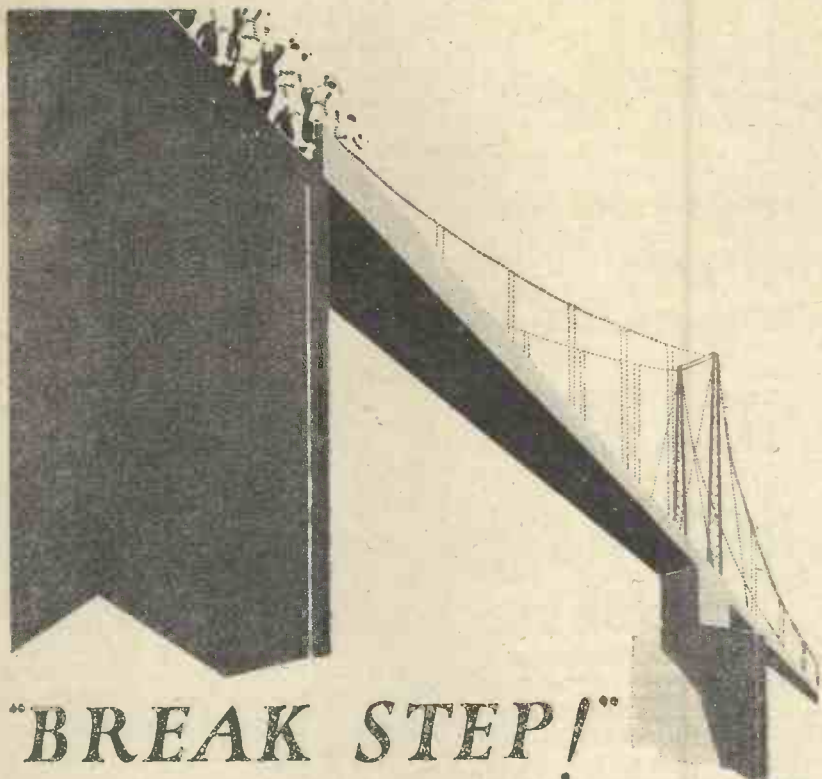

"BREAK STEP!"
~ else the bridge might be wrecked



IT JUST shows you how serious vibration can be. Soldiers marching across a bridge are given the order to break step. If they kept in step their marching would create a regular vibration that might wreck the bridge!

Yet there are still thousands of radio men who mount their valves in old-fashioned or inefficiently sprung valve-holders, so that the rhythmical street vibration reaches the delicate filaments. And then they wonder that their valves have short lives!

Only BENJAMIN anti-microphonic Valve-holders will effectively prevent every quiver of vibration, every shock from reaching the vital filament. Bring your set up-to-date, make your reception purer and treble the life of your valves by fitting BENJAMIN anti-microphonic Valve-holders in every stage.

These five features are exclusive to BENJAMIN Valve Holder:

- 1 Valve sockets and springs are made in one piece with no joints or rivets to work loose and cause faulty connections.
- 2 Valves are free to float in every direction.
- 3 Valves can be inserted and removed easily and safely.
- 4 Valve legs cannot possibly foul the baseboard.
- 5 Both terminals and soldering tags are provided.

BENJAMIN BATTERY SWITCH

For sheer simplicity, usefulness and reliability the BENJAMIN Battery Switch has not yet been equalled. Nothing to get out of order. Nothing to break. Measures only 1 1/8" top to bottom. The metal parts are nickel-plated, of course, and soldering tags are built in. It's off when it's in.

Price 1/-

BENJAMIN

Anti-Microphonic
VALVE HOLDERS

2/-
 each

THE BENJAMIN ELECTRIC LTD.
 Brantwood Works, Tariff Road, Tottenham, N.17.

THE "A.W."

STATION-IDENTIFICATION SERVICE

In order to assist readers who find difficulty in identifying foreign transmissions, we have engaged the services of a well-known expert, who will advise on all matters relating to foreign reception.

A FEE OF ONE SHILLING (postal order or postage stamps) must accompany each inquiry, which should give as many particulars as possible relating to the date, time, wavelength, language and any distinctive call sign or interval signal.

"Amateur Wireless and Electrics." Price Threepence. Published on Thursdays and bearing the date of Saturday immediately following. Post free to any part of the world: 3 months, 4s. 6d.; 6 months, 8s. 9d.; 12 months, 17s. 6d. Postal Orders, Post Office Orders, or Cheques should be made payable to "Bernard Jones Publications, Ltd."

General Correspondence is to be brief and written on one side of the paper only. All sketches and drawings to be on separate sheets.

Contributions are always welcome, will be promptly considered, and if used will be paid for.

Queries should be addressed to the Editor, and the conditions printed at the head of "Our Information Bureau" should be closely observed.

Communications should be addressed, according to their nature, to The Editor, The Advertisement Manager, or The Publisher, "Amateur Wireless," 58/61, Fetter Lane, London, E.C.4.



*Why's your face
as smooth as
mine dad?*

*That's an easy one
Sonny! I shave with*

ECLIPSE
SAFETY RAZOR
BLADES

THE "ECLIPSE" GUARANTEE.

Buy a packet of 5 "Eclipse" blades from your usual supplier (or if unable to obtain, send 1/8 to makers). If, after using 2, you are not entirely satisfied, return the 5 blades direct to us and your 1/8 will be refunded.

5 for 1/8 Obtainable from 10 for 3/4
usual suppliers

Made by
JAMES NEILL & CO. (Sheffield) LTD.
Steel Manufacturers
(Dept. R.8) Napier Street, SHEFFIELD

The "Lindley" 5
FIVE-VALVE PORTABLE

Range—400 miles on Daventry 5 XX.
300 " " " 5 GB.
100 " " Local Stations

Also receives several Continental Stations.

Purity of reception is most marked.

Volume is excellent and splendidly reproduced on the self-contained speaker.

All components are British and the set is easily tuned for desired stations.

ALL-IN PRICE £30 ROYALTIES PAID.

Canvas slip-over cover supplied free.

FROM ALL DEALERS OR

LINDLEY & CO. Telephone: Holborn 3052

14 Great Queen Street, Kingsway, LONDON, W.C.2

REPAIRS—THREE MONTHS' GUARANTEE accompanies all our repairs. Any make of L.F. Transformer, Headphone, or Loud-speaker. Repaired to maximum efficiency. 4/- Post Free. Terms to Trade.
SERVICE 214 HIGH ST., COLLIER'S WOOD, LONDON, S.W. 19. (New Address.)

"REMEDIES" THAT WERE NOT CURES

By R. W. HALLOWS

(Continued from last week's issue)

"I WONDER," I said, "if you realize what an exceedingly complicated matter the design of suitable resistance-coupling units is? Many people imagine that the anode resistance must be high in order to get a respectable degree of amplification, but don't realize that if it is too high, bad reception often results. They believe, too, that the only other essentials for the R.C. unit are a pretty big coupling condenser and a rather low value of grid leak. Actually you cannot make the coupling condenser too large or unpleasant results are liable to follow. A big condenser takes an appreciable time to charge up and to discharge through the grid leak. If the values of the condenser and of the grid leak are wrong, secondary rectification may easily take place, in which case the distortion produced may be exceedingly painful. Now just what values are you using in the anode circuit of your third valve?"

"Well," said Bradlow, "I have got a half-megohm resistance for R₇, C₇ is a .0005 condenser and R₈ is 2-megohms."

I took a bit of paper and a pencil, and figured things out. The formula used is, perhaps, rather too complicated for the ordinary wireless fan, but the calculation showed that with the particular valve which Bradlow was employing as V₃ a condenser of about .002-microfarad and a grid leak of 2-megohms would have given far better results. The moral is that unless you really understand what you are doing, it is far better to use coupling units made by a firm of standing and specially designed to follow valves of given impedance than to make up your own in the home workshop. If you are a mathematician—or just lucky—you may happen to strike just the right combination of resistance, condenser and grid leak; but if you are unlucky, you won't. In his case what was actually happening was that the bass notes were insufficiently amplified in this stage of the receiver. I told him so and he was immediately up in arms.

"But," he cried, "half the trouble is that I am getting too much bass and too little treble."

"That fact," I said, "is largely due to the condensers shunting the anode resistances of the detector and first L.F. valves. In resistance amplifiers the shunting condensers have much greater effect than is the case with transformers or choke couplings. You're not getting real bass; you hear a great deal of the deep notes simply because you're smothering the treble. You would have found it far better to use

much smaller condensers and to wire them straight across from the plates of the second and third valves to L.T.—"

"You seem," said Bradlow, rather bitterly, "to have pulled almost the whole of my circuit to pieces. Probably you will say next that the distortion is partly due to the use of an anode-bend rectifier."

"I'm sorry," I said with a smile, "to destroy any illusions that you may have left, but the anode-bend rectifier gives perfect purity only if the valve is exactly suitable for the job and if its plate circuit impedance is what it should be. A badly designed—I am not saying that yours is bad, but it may be—anode-bend rectifier can distort as painfully as the very worst of grid leak and condenser detector valves."

I did not see Bradlow for some days. When we met again he was all smiles, and asked me to come and hear what his receiving set could do. The paper circuit differed hardly at all from that seen in the diagram except that an output transformer was shown. Actually, however, many more alterations had taken place. Properly designed coupling units were employed and the valves had been re-arranged, the high impedance valve had become V₂ and V₃ was a low-impedance "1st L.F." valve. The result was a little short of miraculous. Reproduction was now almost, if not quite, perfect.

Don't imagine that any especially lauded circuit is a complete cure for all evils, however it may be made up. Every circuit demands design and the right components.

THE "SIMPLER WIRELESS" A.C. RECTIFYING UNIT

READERS who are building the "Simpler Wireless" Rectifying Unit, described in AMATEUR WIRELESS No. 280, should notice that the Igranic Co. are making two different double chokes. Either of these chokes is suitable for the unit but the 0 and 1 terminals are arranged differently in the two cases. If in the case of the choke obtained the 0 and 1 terminals are not arranged as shown in the wiring plan and blueprint of the unit *no notice should be taken of the terminal markings.* The choke should be mounted in the position shown and the terminals should be connected up as shown *irrespective* of the letters 0 and 1. If in any doubt wire up in any way so long as the two windings occupy their proper place in the circuit and then, if there is any hum, reverse the connections to one only of the windings.

Imitated but never equalled!

You might just as well expect to get a perfect reproduction in a distorted mirror as hope to get "Cyldon" quality in a cheap imitation. There is hardly anything in the world that some man cannot make a little worse or sell a little cheaper, and the people who consider price only are this man's lawful prey. Be wise—buy on quality and insist on seeing the "Cyldon" trade mark on every condenser.



Look for this Trade Mark on every good Condenser

"THUMB" CONTROL — "CYLDON'S" LATEST ACHIEVEMENT

"Cyldon" Thumb-Control Condensers consist of one, two or more "Cyldon" Log Mid Line Condensers (Square Law can be supplied if required) mounted on a stout aluminium angle bracket. Mounted flush to the panel, the angle bracket forms a very effective anti-capacity shield. Rotors, Stators and anti-Capacity Earth-plate are all electrically separated. The Bakelite Control Drum is provided with detachable scales, reading from 0-180 degrees, and projects just through the front of the panel, the milled edge giving perfectly smooth control on a diameter of 4 1/2-in. equivalent to a vernier drive. Each outfit includes a panel plate with hair-line indicator, a steel drilling template, and very precise instructions.

PRICES

Semi-Shielded Single Model

Capacity Mfd.	Cat. No.	£	s.	d.
.0005	IT5	1	2	0
.0003	IT3	1	1	0
.00025	IT25	1	0	6
.0002	IT2	1	0	0

Write for our FREE BOOKLET, "Concerning Variable Condensers."

SYDNEY S. BIRD & SONS, LTD., Cyldon Works,
Sarnesfield Road, Enfield Town, Midd.

Telephone: Enfield 2071/2.

Grams: "Capacity, Enfield."

Goodall Ad.

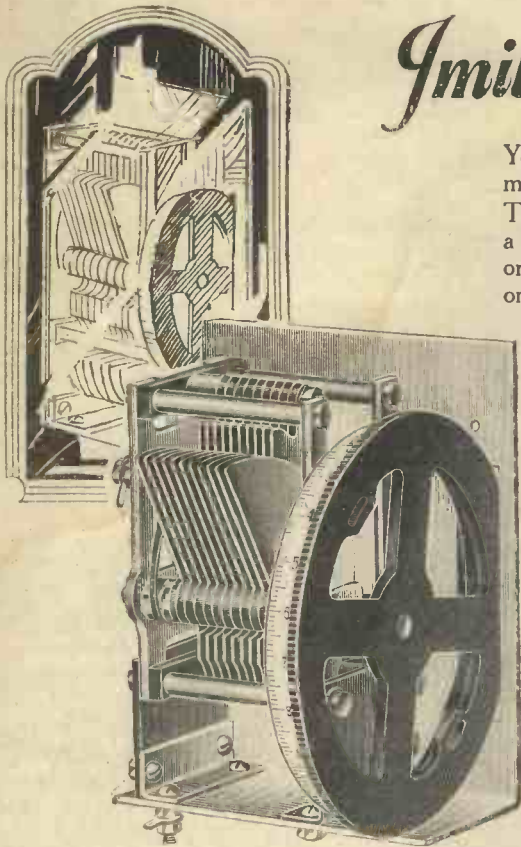

The Choice of the Critical!

Technical wireless experimenters — as well as ordinary broadcast enthusiasts find

HART

BATTERIES

FOR ALL WIRELESS CIRCUITS

a valuable aid to better reception

"HART" BATTERIES are supplied in a wide range of sizes and capacities—each worthy of the most critical selection. Write Dept. A.V. to-day for price list and FREE illustrated booklet of interest to all wireless users.

HART ACCUMULATOR Co. Ltd.
STRATFORD : LONDON, E.15

Birmingham: 105 Edmund Street. Bristol: 37 Victoria Street. Cardiff: 50 Charles Street. Glasgow: 167 Wellington Street. Manchester: 28 Chapel Street. Westminster: 36 Victoria Street, S.W.1. York: 6 Bridge Street



Goodall Ad.



A Perfect Combination!

—the Ericsson Family Two Loud Speaker Set and the Ericsson Super Tone. They combine to give the finest possible rendering of the "local" and 5XX or 5GB.

The set is beautifully made in sturdy Oak cabinet. All parts enclosed. Price £6-15-0. Royalties 25/-. The Ericsson Super Tone costs 45/-.

On sale at all good dealers, or direct from:—

ERICSSON TELEPHONES, LTD.,
67 73 Kingsway, London, W.C.2.

Ericsson

APPARATUS

Ericsson Ericsson Ericsson Ericsson Ericsson

Advertisers Appreciate Mention of "A.W." with Your Order

Letters to the Editor

The Editor does not necessarily agree with the views expressed by correspondents.

Correspondence should be brief and to the point and written on one side of the paper.

A Good Set

SIR,—Just a line in praise of the "Ether-searcher Three." I wired this set up as per instructions in AMATEUR WIRELESS, with one exception. Having two Lissen transformers on hand, I used both, instead of one R.C. coupling, and am surprised at the absence of distortion.

The following evening I tuned in seventeen stations at good loud-speaker strength, as follows: 5GB, Langenberg, Rome (?), Frankfurt, Glasgow, Hamburg, Manchester, Stuttgart, Leipzig, 2LO, Cardiff, Barcelona, Bournemouth, Dublin (?), Newcastle, Belfast. B. L. H. (Dorchester).

"Simpler Wireless"

SIR,—Allow me to congratulate you on your "Simpler Wireless" circuits for working straight off the mains. I started with the "Mains Three"; but while the quality and volume were very good, the volume was not quite enough for my requirements. Therefore, I set out to add another L.F. valve. After a week's experimenting, I succeeded in getting a third L.F. valve to work efficiently. I must say that the quality is marvellous. With the head within 6 in. of the loud-speaker it is impossible to detect any mains hum during intervals in the programme. It is hoped soon to have a moving coil speaker working on this set. 2BRJ (Clacton).

Mystery Stations

SIR,—With reference to "Thermion's" note on mystery stations in the December 17 issue, these stations are not "copyable." They are the new "radio

beacons," transmitting a characteristic signal for the purpose of enabling operators on board ship to take their bearings.

I do not happen to have a list, but the four mentioned are evidently the new beacons on the German and Dutch coasts.

The standard wavelengths for these beacons is 1,000 metres. There are only, so far, two beacons on the English coast,

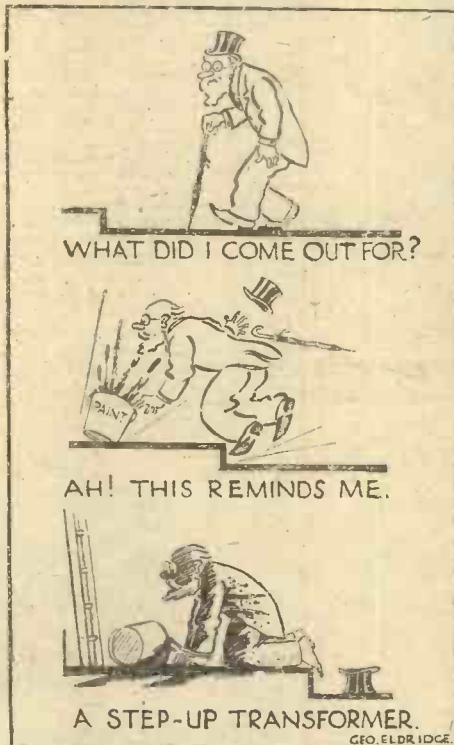

one at Round Island Lighthouse and the other on the Bar Lightship at the entrance to the Mersey. The British method is to repeat the call signal for one minute at definite intervals. Round Island is GGG, Bar Lightship is GGM.

Bar Lightship transmits for one minute at 0, 4, 8, 28, 32, and 36 minutes past each hour. H. S. R. (s.s. *Laurentic*).

The British Vocal Quartet

SIR,—With reference to Mr. Moseley's criticism of the British Vocal Quartet (December 10). As a very keen listener-in, I disagree with his remarks. I listened-in to their concert, and as a disinterested party I should like to say that it was the very reverse of what he said about Miss D. Bennett; her voice came floating out above the others practically the whole time. The contralto was the voice that need not have been in the quartet.

F. K. (Ramsgate).

WRNY Transmissions

SIR,—I was most interested in the recent account in AMATEUR WIRELESS concerning reception of American stations.

You may be interested to hear that I had an American station the other morning on the loud-speaker; judging by the wavelength, it would be WBZ. Reception lasted nearly two hours, and for the greater part of this time the signals came in at good loud-speaker strength.

There was, however, considerable fading and some interference from morse. The announcer was not heard at all. I have sent WBZ an account of the reception, and asked them to confirm it if transmitted from their station. The set used was a four-valve Browning-Drake, run entirely off 220-volt D.C. mains.

I had a letter from Mr. Gernsback this morning; he tells me that his station (WRNY, New York) will send out regular programmes on a wavelength of 32.90 metres, beginning on December 15. Your readers may be interested to know this.

C. A. O. (Barrow).

The "Utility" LOGARITHMIC CONDENSER

gives perfect smoothness of action, the moving vanes rotating on a ball-bearing spindle of novel design which is absolutely rigid. Electric continuity is ensured by the provision of a pigtail connection from the moving vanes direct to the terminal. The solid dielectric is reduced to the minimum and takes the form of two light thimbles, the walls of which are only about 1/32 of an inch thick. The Vernier pattern is fitted with the well-known "UTILITY" Micro-Dial with its ratio of 70 to 1, which makes tuning perfectly simple.

Write for attractive Free List of all "Utility" productions including Neutrodyne Condensers, Micro-dials, Switches, etc.

WILKINS & WRIGHT LIMITED
"Utility" Works, Kenyon Street, Birmingham

Utility
GUARANTEED
COMPONENTS

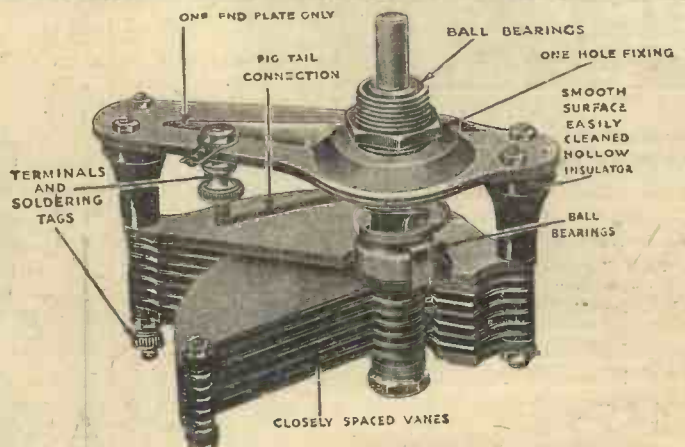

BRASS				ALUMINIUM			
Capacity	Ref. No.	Price including 4" dial	With Vernier	Capacity	Ref. No.	Price including 4" dial	With Vernier
.0005	W182	11 6	17-	.0005	W185	9 6	15-
.0005	W183	10 6	16-	.0005	W186	8 6	14-
.0002	W184	19-	15 0	.0002	W187	7 6	13-

Transformer troubles banished by

BROWNIE

Brownie Transformers are guaranteed 100% British. Made from the very finest materials, the characteristics and performance are equal to those of transformers costing twice the price. Ensure perfect tone and quality by building a Brownie Popular Transformer into your set. Write to Department 26 for our new free booklet "Wireless without Worry."



THE BROWNIE POPULAR TRANSFORMER.—The magnetic field is composed of special laminations of the softest iron procurable, and the accuracy of the windings on their moulded bobbin guarantee distortionless reproduction, free from resonance. Totally enclosed in a moulded case.

9/6

THE BROWNIE WIRELESS COMPANY (G.B.) LTD.
NELSON STREET WORKS, MORNINGTON CRESCENT, LONDON, N.W.1

VALVE HEATING from Air depolarising "AD" PRIMARY CELLS

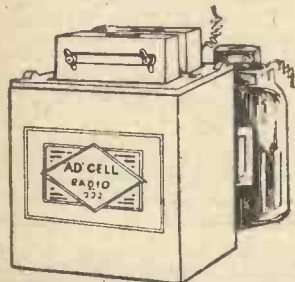

Operating EMF 1 volt or higher per cell, perfect simplicity; charged at home with sal-ammoniac. Most economical cell yet produced as the following examples will show.

No.	Output Not to Exceed	Life per Zinc when used 3 hours daily	Price per complete cell, with salt
222	1 amp. 3-5 hrs. daily.	350 days with 5 valves (each 100 m/a.)	30/-
229	300 m/a. 3-5 hrs. daily.	350 days with 3 valves (each 100 m/a.)	15/-
246	120 m/a. 3-5 hrs. daily.	350 days with 1 valve (100 m/a.)	5/6

Pro rata life for other types of valves 1 volt per cell, 2 volts 2 cells in series, etc.

PERFECT IN ALL RESPECTS for Country Sets or anywhere where attention to battery recharging is troublesome.

Ask your dealer to give fullest particulars or apply to

LE CARBONE

Coventry House, South Place, London, E.C.2.

FOR ALL GOOD RECEIVERS

The terminal which will give real Finish and Distinction to your Receiver. Beautifully finished and Bakelite insulated. Made in 30 different engravings.



Patented.

Type 'B' illustrated, sold in attractive carton carrying a year's guarantee.

Price 9d. each.

Type 'M' as type 'B' but non-insulated.

Price 6d. each.

Illustrated catalogue free on request.



Belling & Lee, Ltd., Queensway Works, Ponders End, Middlesex.



Price from 2/6



FORMO-DENSER

A sound variable condenser which fills a long-felt want. Specially designed to take the place of the hitherto generally used Fixed Condenser. For use as:

- Neutralising Condenser
- Aerial Condenser
- Grid Condenser
- Reaction Condenser
- Phasing Condenser
- Tone Control Condenser

5 Capacity ranges, and each in Baseboard and Panel models.

22 CRICKLEWOOD LANE, N.W.2

Phone Hampstead 1787

BUY FORMO HANDBOOK, Practical Circuits Blueprints of two Sets, etc., 1/-

Powquip for Purity and



It can be safely claimed that the STANDARD Model Transformer has positively no equal at the price. Recently designed, its amplification and tone have benefited to the extent of 25 per cent. Weight, 12 oz. Height, 3 3/4 in. Width, 2 1/2 in. Depth, 1 1/2 in.

The matchless ORCHESTRAL Model Transformer (centre illustration) stands foremost amongst any other makes on the market. It reproduces without the slightest suspicion of distortion. Each instrument comprising the orchestra is most clearly defined. Weight, 42 oz. Height, 2 1/2 in. Width, 3 1/2 in. Depth, 2 1/4 in.

STANDARD - 10/6
ORCHESTRAL 22/6
MANCHESTER 12/6



Perfect Performance

The popular MANCHESTER Model embodies all the features of the Standard type, but is larger and of heavier design. Its amplification is exceptionally good whilst clearness of speech and tone is remarkable. Weight, 14 oz. Height, 3 1/2 in. Width, 2 1/2 in. Depth, 2 1/4 in.

The ORCHESTRAL Model has been submitted to thorough tests on all the popular sets and can be specially recommended for use in ALL modern circuits wherever a good low frequency transformer is required.



POWQUIP TRANSFORMERS and L.F. CHOKES

The POWER EQUIPMENT Co. Ltd.
Kingsbury Works, The Hyde, BENDON, N.W.9

More About the Dorchester Beam Station

(Continued from the preceding issue)

THE long copper tubes carrying the feeder connections from the Dorchester transmitting panel to the beam aeri- als were extraordinarily well set out, but it was a matter of surprise to me that no capacity effects were experienced, although the engineer informed me that the feeder system as it stood was an essential part of beam wireless.

The elaborate precautions taken to keep the oil-cooling supply going to the main valves, which I referred to last week, are, of course, essential for the continuity of working, but, as each valve costs £100 and gives 2,500 hours' service, these precautions are worth while on the score of running costs.

The accuracy of the wavelengths of the stations given last week can be thoroughly relied upon, because a very careful wave-length check is kept by means of a specially constructed type MC1 Marconi wavemeter.

The Receiver

At Somerton, thirty miles from Dorchester, where the signals are received from Rio, Buenos Aires, and New York, a similar group of beam masts have been erected as at Dorchester. Just as a great conservation of energy is obtained by the use of reflectors at the transmitting end, so a great concentration of received energy is

effected by intercepting a large area of wave-front at the receiving end.

I made a point of asking the chief engineer whether it was necessary to have the transmitter and receiver so far apart. "When the beams were first erected we thought it was," he informed me. "But later experience has shown that even when the transmitter and receiver are only one mile apart there is no mutual interference."

The receiver referred to last week incorporated an extremely interesting rectifier. This is no ordinary rectifier. It is more a converter than a rectifier. For it changes the wireless wave into a telegraphic signal which is sent over the land-line direct to London. It is interesting to note that there is no L.F. amplification in the system, all the necessary "boosting" being done at high frequency.

Signalling to and from London is effected on a duplex system using a single line. All the actuating of the receiver is done away in South America, and signals are only intercepted at Somerton in order to ensure that "good stuff," as an engineer called it, is being sent over the line to London.

When the beam to India was first operated the engineers were much puzzled by a peculiar "jumbling" effect on the received signals. The cause was later

proved to be due to the fact that the transmitting power was too great, and the signals were going round and round the world, reappearing in a later part of the message! It must be realised that it takes but one-seventh of a second for a signal to travel right round the world.

By reducing the power it was found that the energy expended itself before it came round a second time!

Looking Ahead

Although at present the traffic is only carried on between London and New York and South America, provision is being made at Dorchester and Somerton to handle messages between London and Egypt, Japan and the Far East.

Other extraordinary possibilities were foreshadowed as being within the scope of the new beam. A telephony service between this country and North and South America and other foreign countries will probably be super-imposed on the telegraphic channels.

If and when moving pictures are exchanged between England and distant countries, it seems almost certain that the beam will be the medium whereby the marvel of television will become an everyday occurrence.



THE BEST OF SETS IS BETTER —

WITH A

BRITISH GENERAL

Super Shrouded TRANSFORMER

Guaranteed for 12 months to give perfect distortionless magnification. Registered design, superb nickel finish. Made in two ratios 5.1 for general use; 3.1 for 2nd stage purposes.

THE BEST THAT'S MADE **18/6** 5.1 or 3.1

From all reputable wireless dealers or direct from:

BRITISH GENERAL MANUFACTURING CO. LTD.

BROCKLEY WORKS, BROCKLEY, LONDON, S.E.4.

"A.W." SHORT-WAVE "SUPER SIX"

The wonderful efficiency of this receiver is due entirely to the use of superior components.



REMLER TWIN ROTOR CONDENSERS

Give a lowest minimum of capacity, ensuring a tuning range heretofore unattainable with a ratio of maximum to minimum of 165-1. Twin rotor brass plates, bakelite gears, and 4 in. dial, with removable scales for logging. No. 630, .00003 to .00035, 31/9 each.



YAXLEY POTENTIOMETER

A perfect instrument for those who require the best. Moulding of pure bakelite. Supplied complete with bakelite Arrow Knob. 200 or 400 ohms - 7/6 each

Ensure a copy of our new 1928 Radio Catalogue. The most instructive and interesting book available. Send 9d. in stamps to cover cost of postage.

The Rothermel Corporation, Ltd.

24 & 26 MADDOX ST., REGENT ST., LONDON, W.1
Telephone Nos. : Mayfair 0578 & 0579
Telegrams : Rothermel, Wesdo, London

Amateur Wireless HANDBOOKS

each 2/6 net

Loud-speaker Crystal Sets How to Make and Manage Them

Provides working instructions for building a number of highly efficient crystal sets; making an attachment for simple connection to existing wireless set; and designs for crystal sets embodying the crystal loud-speaker system.

Wireless—controlled Mechanism For Amateurs

This book is an illustrated practical guide to the making and using of short-range wireless control apparatus, and it has been written so simply that it can be understood by any enthusiast possessing an elementary knowledge of wireless.

The Wireless Man's Workshop By R. W. Hallows, M.A.

Written by a practical home constructor, this book—containing much useful wireless information—enlightens readers on the selection and right methods of using the tools and materials used in constructing wireless sets.

The Practical "Super-het" Book

Explains what the Super-het is, what it does, how it works, and how to build up a number of super-het sets made of tested, British-made components.

Perfect Broadcast Reception By Ernest H. Robinson (5YM)

Explains how most sets fall short of the ideal and how to obtain perfect reception. Is virtually a popular exposition of the main problems of transmission and reception. Very valuable alike to listeners and experimenters.

The Short-wave Handbook By Ernest H. Robinson (5YM)

Describes in very simple language the wireless apparatus used in short-wave work; shows how to make it and how to use it, and explains the technical principles with which the beginner will need to become acquainted.

The Practical Wireless Data Book

The intelligent novice, and particularly the home constructor and the keen wireless amateur who is always rigging up different circuits and experimenting for progress, will find this Data Book extremely helpful.

*Of all Newsagents and Booksellers,
2/6 net each, or 2/9 post free from
Cassell and Company Limited,
La Belle Sauvage, London, E.C.4.*

each 1/6 net

Wireless Telephony Explained

CONTENTS: The Electron; Induction and Electro-magnetism; Waves and How they Travel; Inductance and Capacity; Rectification; Amplification; Reaction and Beat Reception; Aerials and Earths; Transmission Systems; Receiving Sets; Useful Formulae and Data; Index.

Crystal Receiving Sets And How to Make Them

CONTENTS: A Simple and Efficient Receiving Set; A Single-slider Set; Set with Semi-circular Tuner; Crystal Set with Tapped Single Coil; A Loose-coupled Set; Set with Plug-in Basket Coils; Combined Crystal and Valve Receiver; Some Miniature Receiving Sets; Crystal Circuits; How Crystals Work; Making a Buzzer; Receiving C.W. Signals on a Crystal Set; Converting Low-resistance Phones; The Morse Code; Index.

Wireless Component Parts And How to Make Them

CONTENTS: Components and Their Varied Purposes; Crystal Detectors; Coils, Making and Mounting; Condensers; Variometers and Vario-couplers; Resistances or Rheostats; Transformers; Making a Test Buzzer; Index.

Wireless Telegraphy and Telephony And How to Make the Apparatus

CONTENTS: General Principles of Wireless Telegraphy; Some Informative Experiments; Tuning and Resonance Explained; Transmission and Reception; Various Detectors Explained and Described; Thermionic Valves as Detectors, Amplifiers and Generators; Making a Single-circuit Receiving Set; Making a Complete Short-wave Receiving Set; Making a Valve Panel for a Receiving Set; Making a Five-valve Amplifier; Wireless Telegraphy; Arrangement and Erection of Aerials; Index.

*Of all Newsagents and Booksellers,
1/6 net each, or by post 3d. extra
from Cassell and Company Limited,
La Belle Sauvage, E.C.4.*

Practical Guide to Wireless (1s. net, postage 2d.)

CONTENTS: An Outline of Present Broadcasting; The Aerial; Tuners and Tuning; The Crystal Set; The Valve and Valve Sets; Telephones and Loud-speakers; Current for Valve Filaments; Index.

A Useful Series for Wireless Amateurs

Cassell  Books

La Belle Sauvage, London E.C.4.



FIXED FOR LIFE!

Hydra Condensers are unmoved by atmospheric conditions. They are guaranteed accurate to within 5 to 10 per cent. of their rated capacities that remain constant through all variations of temperature. You can buy Hydra Condensers with the assurance that their capacities are fixed for life!

PRICES

Tested on 500 volts D.C.
 1 mfd., 2/6; 2 mfd., 3/6; 4 mfd., 5/3.
 Tested on 750 volts D.C., equal to 500 volts A.C.
 1 mfd., 3/-; 2 mfd., 4/-; 4 mfd., 6/9.
 Inquire for prices of condensers tested at 1,000, 2,000, 4,000, and 6,000 volts D.C.

HYDRA

From all good dealers, or direct
LOUIS HOLZMAN
 34 KINGSWAY, LONDON, W.C.2
 Telephone: Holborn 6209



**Make 1928
 a year of real
 harmony**

—buy The
**Orphean
 GEM**

**Full Size Full Tone
 Full Guarantee**

Hear one at your Dealers. List Free
LONDON RADIO MFG. Co., Ltd.
 Station Road, Merton Abbey, London,
 S.W.19

S.D.—12-6

RADIOGRAMS



MONTEVERDI'S ópera, *The Return of Ulysses*, will be broadcast from 2LO and 5XX on January 18. Monteverdi was an Italian composer who lived towards the end of the sixteenth century.

Mendelssohn's Oratorio, *Athalie*, will be broadcast from 5GB by the Birmingham Studio Chorus and Orchestra on January 15. The principals will be Stuart Vinden, Marjorie Parry, Rispah Goodacre, and Maud Gill.

Country, is to be heard by 2LO listeners on January 7. Their items include *The Long Day Closes*, *Comrades' Song of Hope*, *Absent*, and *Drink to Me Only*.

The Christmas Oratorio, under the direction of Albert Horton, will be relayed from St. Anne's Church, Soho, on January 7.

Some eminent Victorians will introduce a novelty to 5GB listeners on January 17, when an attempt will be made to revive the glories of the Victorian period. The music of Sullivan, Cowen, and others; the poetry of Arnold and Browning, and the work of Darwin, Huxley, and other scientists will be incorporated in a running commentary.

On January 21, Newcastle is giving a variety entertainment which will include several artistes well-known to 2LO and 5XX listeners, namely, Santa and Barbara (in vocal Spanish duets with guitars and castinets), Misha Motte (in impersonations), and George Foster (the concertina artiste).

In a variety programme from 5GB on January 18, Claude Martin will give *The Confessions of Edwards*, *the Jobbing Gardener*, by Barry Pain.

Hope Charteris and Eve Dixon will broadcast a pot-pourri of songs on January 12 from the Daventry Experimental Station.

The average Scots listener takes broadcasting more seriously than the average English listener, according to Mr. D. C. Thomson, B.B.C. Northern Area Director; there is a higher demand in Scotland for opera libretti and for the B.B.C. educational publications generally.

To develop the Scots voice in its finer qualities, the B.B.C. proposes to co-operate as fully as possible with such organisations as the Scots Vernacular Association, the Community Drama Festival, the Musical Festival movement, the Scottish Association for the Speaking of Verse, and the Scottish National Theatre Society. The Scots seem proud of the language of Burns!

A Glasgow critic of the B.B.C. programmes makes the suggestion, in all seriousness, that there should be co-operation with the gramophone companies with a view to having the broadcast programmes, apart from news, weather reports and similar items, confined entirely to gramophone record selections. One point he puts forward is the superiority of the artistes recorded to those who normally face the microphone.

DO YOU KNOW?

1. What fraction of 50y, a farad, is one "micro-micro"?
2. In what one city are there eight relay stations?
3. What type of microphone is used at all chief British and German stations?
4. What is "Flying Broadcasters Inc."?

Puzzle your friends with these queries; the answers will be given in next week's issue of "A.W."

Answers to Last Week's Queries: (1) 21/32 in. (2) 1/2 in. (3) Frankfurt-on-Main. (4) The weather report broadcasting station on the Pic-du-Midi, Pyrenees.

André Charlot, who is producing a series of revues for the B.B.C., will give the first three on January 12, 19, and 21.

The Neath I.L.P. Orpheus Male Voice Choir, which is one of the best in the West



A Short Waver!

DECKOREM

IMITATION IS THE SINCEREST FORM OF FLATTERY



Don't be put off with imitations of our original designs of Grid Bias Battery Clips. Ask for "Deckorem" in the Orange-and-Black cartons.

No. 1, for 9 or 15 volt batteries, 6d. per pair.

No. 2, for 4½ volt batteries 4d. each.

Price 2d. each.

Illustrated above is our latest type, Ref. No. 782,739, which has a variety of uses. Being made of blued steel spring, it never loses its grip. Holds battery firmly in position, yet allows for easy replacement when needed.

Obtainable from all Dealers, or

Write for 5 FREE Catalogues

9-10-11, CURSITOR STREET, CHANCERY LANE, E.C.4.

MORE RADIOGRAMS

Based on the argument that Monday night is the poorest night in point of attendance for the theatres, and the assumption that if the people are not in the theatres, movies or other places of amusement on that night, they must be at home, the logical conclusion is reached that on this night, with the possible exception of Sunday night, most people listen in.

The Kremlin is the Russian official radio-casting station. Few Russian families own wireless sets, so the Government supplies the deficiency by installing receiving sets for small communities, thus making radio a community affair. The Kremlin station programmes are carefully censored by the Soviet Government. Occasionally, foreign programmes are approved, and these are picked up and relayed through the Kremlin transmitter.

Radio was used in Australia recently to convey an important decision of the Court from Sydney, New South Wales, to New Guinea. The case had reference to shares in a coconut plantation in New Guinea, and the Chief Judge in Equity made an order restraining the defendant from selling any of his shares in the company.

Dancers at Brisbane, Queensland, recently jazzed to music broadcast by 2LO London. This was picked up by an Australian station and re-broadcast, this being the first time that 2LO London was audible in Australia on crystal receivers. The transmission was a remarkable success, the strength of the relay being equal to the broadcasting of some of the local stations.

Just as they have music rooms and concert halls, one of the large apartment hotels in Washington has a radio room in which chairs are arranged row upon row as in an ordinary assembly hall. On the platform in front is a receiving set and a loud-speaker usually tuned in on the principal local broadcasting station. Guests hear the programme, much the same as they sit around the lobby listening to the orchestra.

ELIMINATORS
too expensive!

ACCUMULATORS
away for charging!

BATTERIES
temporary life!

But now —
PERPETUAL POWER

Now! Permanent H.T. supply at small costs is ensured by installing this wonderful battery. Recharges itself overnight ready to supply abundant H.T. for the next day's programme.

Get this Free Book



Take the first step by sending for FREE Booklet describing every detail for installing and maintaining this super-efficient and money-saving battery.

DEFERRED TERMS ARRANGED. ORDERS OF 10/- OR OVER CARRIAGE PAID

For 2-Valve Sets: A.4. 90 volts... 25/1	For 3-5 Valve Sets: D.6. 308 volts... 37/3	Super Sets: F.6. 126 volts... 69/6
--------------------------------------------	-----------------------------------------------	---------------------------------------

Write now to:—
(Dept. C), WET H.T. BATTERY CO.,
12 Brown Street, London, W.C.1
STOCKED BY HALFORD'S CYCLE STORES

STANDARD
PERMANENT
H.T.
SUPPLY

The Vital Power in Radio!

M.B. 27

LAKER STEEL MASTS

are 100 per cent. efficient

They are made by engineers and supplied to H.M. Government, the B.B.C., and to Colonial and foreign stations throughout the world. There are 50,000 "Laker" Masts in daily use. By mass production we are able to offer a wonderfully efficient and handsome Steel mast at the extraordinarily low price of 22/6 complete, as illustrated. Send 1/6 extra for part carriage. We pay the rest. Buy a Laker Mast for good reception.

J. LAKER & CO., Engineers, Beckenham, Kent

30 ft. STEEL MAST 22/6

OUR BLUEPRINT SERVICE

Constructors of receivers described in this journal should make full use of our Blueprint Service and avoid all risk of failure.

A Cabinet for the "Melody Maker" for 10/6

Why pay a big price for a cabinet for the Cossor "Melody Maker"? We can supply you with a parcel of mahogany planed and cut the right size and ready for you to put together. All the necessary parts supplied, complete with baseboard and panel supports. A genuine bargain for the home constructor. Illustrated instructions enclosed. Only glue and screws required;

We also supply Lightning Polish (sample bottle 2/6, post free) with the guarantee that any worker can get the finest polish on his cabinet at the first attempt.

you cannot go wrong. The baseboard is supplied 21 by 9, but by cutting 1 in. off the length it is the size required by the "Melody Maker." The lid supplied in two parts for hingeing.

ASK AT ANY HOBBIES BRANCH FOR WIRELESS CABINET NO. 10 OR SEND POSTAL ORDER FOR 11/9 FOR ONE TO DEPT. 69, HOBBIES LTD., DEREHAM, NORFOLK.

CUT THIS OUT FOR CABINETS

and post to us for new FREE list illustrating Cabinets as shown in "Amateur Wireless" etc., etc.



NAME

ADDRESS

(Write in Block Letters)



CARRINGTON Mfg. Co., Ltd.

Camco Works, Sanderstead Road, South Croydon

Telephone: Croydon 0623 (2 lines)

500,000 LISTENERS
USE AND RECOMMEND LIBERTY DETECTOR

WHY?
TRY ONE AND GET THE ANSWER

Louder permanently than a cat-whisker sometimes.

From all Dealers or Post free.

Don't experiment — use a **LIBERTY**, the Original. Still the best, but be sure it's a **LIBERTY!**

Every one tested on broadcasting. Fully guaranteed.

RADI-ARC CO. BENNETT ST. LONDON, W.4

NOW **2/6**



GAMBRELL CENTRE-TAPPED coils are recommended for use in all circuits which are designed for extreme selectivity. Besides being excellent for this purpose, Gambrell Centre-Tapped coils can also be used with advantage in ANY circuit Standard fitting to all coil sockets. Occupy minimum baseboard space.

SIZE	PRICE	Approx. Turns
a2	4/10	18
B1	4/10	25
A	5/-	30
B1	5/3	40
B	5/6	50
C	6/9	75
C	6/3	100
E1	6/9	150
E	7/9	200
F	8/6	300
G	10/-	500

Prices Quoted are Standard Coils. Centre-Tapped, 6d. extra.

Use a Gambrell Coil Holder specially designed for use with these coils, and which does away entirely with flex leads. Price 1/9 each.

GAMBRELL BROS. LTD.
76 Victoria Street, London, S.W.1



7 x 5, 1/2	6 x 6, 1/2
7 x 6, 1/3	8 x 5, 1/2
8 x 6, 2/4	9 x 6, 1/7
10 x 8, 2/1	11 x 8, 2/3
10 x 9, 2/4	12 x 8, 2/6
12 x 10, 3/1	12 x 9, 2/10
14 x 12, 4/1	14 x 10, 3/5
14 x 7, 2/7	16 x 9, 3/6
16 x 8, 3/2	

GROXSONIA PANELS

GREATER EFFICIENCY & GREATER ECONOMY.

have a higher electrical resistance than carbonite. Compare these prices! Why pay more for a less efficient article?

"AMATEUR WIRELESS" says: "It is not affected by heat or damp. Its electrical properties are good. The surface leakage and the insulation resistance were both found to be infinite and the material, therefore, can be used without hesitation as an insulating panel."

Panels cut to any size. Call, write, or phone: Clerkenwell 7833, for quotations. Samples and prices post free to Trade.

GROXSONIA CO., 10 South St., Moorgate, E.C.2.
Agents—John Henry Smith, 130 Anlaby Rd., Hull. L. H. Helyar, 8 Chamberlin Rd., Norwich. A. Stredwick & Co., 27 The Market, Chatham.

D-XELLENT!

DX IN PLUG-IN COILS

From 1/- DX COILS, LTD., London, E.8

THE LITTLE CELLS THAT SATISFY
Eton Primary H.T. Battery. P1 Porous Pot Cells, S1 and S2 Sac Cells. All complete for assembly.

1-cell.	2-cell.	12-cell.	50-cell.
P1 6d.	3/3	5/9	14/-
S1 6d.	3/-	5/3	12/-
S2 4d.	2/6	3/10	9/6

Send 1/4d. stamp for booklet giving full particulars to—
THE ETON GLASS BATTERY CO.
46 ST. MARY'S ROAD - LEYTON - E.10

WET H.T. BATTERIES

Solve all H.T. Troubles
SELF-CHARGING, SILENT, ECONOMICAL

JARS (waxed) 2 1/2" x 1 1/2" sq. 1/3 doz.
ZINCS New type, 1 1/2 doz. SAOS 1/2 doz.
Sample doz. (18 volts) complete with bands and electrolyte 4/3, post 6d. Sample unit Ed. 10 page booklet free. Bargain list free.

AMPLIFIERS: 1 VALVE 19/-. 2 VALVE 30/-. 2 VALVE ALL-STATION SET, 44.

A: TAYLOR, 57 Studley Road, Stockwell, London.

"MELODY MAKER" COILS.

New Improved Model, complete with Stand and fixing screws, guaranteed wound to Messrs. Cossor's specification. Post 7/6 free. **KNIGHT & Co., 6 Chapel Street, London, E.C.2.** Phone Clerkenwell 4715.

CHIEF EVENTS OF THE WEEK

- LONDON AND DAVENTRY (5XX)**
- Jan. 8. Military Band Concert.
 - " 9. Light Orchestral Concert.
 - " 10. Vaudeville programme.
 - " 11. Musical Comedy programme.
 - " 12. Charlton's Revue.
 - " 13. National Concert, conducted by Sir Hamilton Harty, relayed from the Queen's Hall, London.
 - " 14. Popular Concert from the Kingsway Hall.
- DAVENTRY (5GB)**
- Jan. 8. Religious service from St. Martin-in-the-Fields.
 - " 10. The Liverpool Philharmonic Society's Seventh Concert.
 - " 11. *The Storm*, a poetic play by John Drinkwater.
 - " 12. Hallé Concert.
 - " 13. A Debate.
- CARDIFF**
- Jan. 9. The Merry-makers.
 - " 10. Modern Welsh Music, by Leigh Henry.
 - " 11. *Heart's Desire*, a comic opera en cassettole by Mabel Constanduros.
- MANCHESTER**
- Jan. 11. Music and Comedy.
 - " 12. Hallé Concert relayed from the Free Trade Hall.
 - " 14. *These Fathers*, a play in three acts by James Lansdale Hodson.
- NEWCASTLE**
- Jan. 12. The Electric Sparks Concert Party.
- GLASGOW**
- Jan. 9. A Ballad Concert.
 - " 12. A Farmyard programme.
 - " 14. *The Home Breaker*, a drama that takes the wrong turning, by A. F. Byslop.
- ABERDEEN**
- Jan. 12. Auld E'el Night.
- BELFAST**
- Jan. 9. Opera Bouffe.
 - " 11. *No Song, No Supper*, a musical entertainment in two acts by Prince Hoare.

WORTH WRITING FOR

A BOOKLET issued by the Jewel Pen Co., Ltd., of 21-22 Great Sutton Street, E.C.1, contains particulars of Red Diamond wireless apparatus.

A folder containing particulars of Emaco wireless cabinets has been received from the Enterprise Manufacturing Co., Ltd., of Electric House, Grape Street, Shaftesbury Avenue, W.C.2.

The Standard H.T. Battery Co., of 12 Brownlow Street, High Holborn, W.C.1, are issuing a booklet dealing with their wet H.T. battery.

LISENIN PRE-SET RESISTOR (REGISTERED DESIGN)



Specified by the designer of the MELODY MAKER. Made with the maximum capacity of 5, 7, 10, 30 and 50 ohms. 5 ohms suitable for all COSSOR valves for MELODY MAKER.

1/9 each
Postage 2d.
Refuse substitutes

COSSOR MELODY MAKER
coils wound to specification 7/6 each. Postage 4d.

POSITIVE GRIP TERMINALS

Plugs and Sockets complete ... 4d.
Spade Ends ... 4d.
Wander Plugs (as used in the Melody Maker) ... 2d.

Obtainable of your dealer. If he cannot supply give us his name, but refuse substitutes

THE LISENIN WIRELESS CO.
1 EDGWARE ROAD, LONDON, W.2

PANELS FOR WIRELESS SETS in PADAUK.
the ideal wood. Prices from 1/2d. ft. super according size. Crown Sawmills, Lanrick Rd., Poplar, E.14.

PREPAID ADVERTISEMENTS.
Advertisements under this head are charged THREEPENCE PER WORD, minimum charge THREE SHILLINGS.

DEPOSIT SYSTEM
As the Publishers cannot accept responsibility for the bonafides of advertisers in this publication, they have introduced a system of deposit which it is recommended should be adopted by readers when dealing with persons with whom they are unacquainted. It is here explained.

Intending purchasers should forward to the Publishers the amount of the purchase money of the article advertised. This will be acknowledged to both the Depositor and the Vendor, whose names and addresses must necessarily be given. The Deposit is retained until advice is received of the completion of the purchase, or of the article having been returned to and accepted by the Vendor. In addition to the amount of the Deposit, a Fee of 6d. for sums of £1 and under, and 1s. for amounts in excess of £1, to cover postage, etc., must be remitted at the same time. In cases of persons not resident within the United Kingdom, double fees are charged.

The amount of the Deposit and Fee must be remitted by Postal Order or Registered Letter (Cheques cannot be accepted), addressed to

"AMATEUR WIRELESS"
ADVERTISEMENT DEPARTMENT,
58, 61, FETTER LANE, LONDON, E.C.4

PATENTS.—Trade Marks, Advice Handbook free.—B. T. King, Regd. Patent Agent, 146, Queen Victoria Street, London.

WOOD HORNS FOR ALL SPEAKER BASIS AND GRAMOPHONE UNITS.—See AMATEUR WIRELESS, Dec. 24th for illustration of cheapest wood horn on the market. List: H. Maddison, 2a, Ronald's Road, N.5. Manufacturer of the "Allwoodorn."

HOME BATTERY CHARGERS for alternating or direct current. Charges both high and low tension Accumulators. Prices from 30/- Send for illustrated list. Rubben Magneto Works, Ardwick, Manchester, or 240 Deansgate, London, 38 Victoria Street, S.W.1.

THE PERFECT WET H.T.
ASSURED WITH OUR NEW INSULATING LINER

Jars, 1/3 doz., plain, 1/3 doz., waxed: special zincs, 1/- doz.: high capacity zincs, 1/5 doz.: perforated liners, 4d. doz. Post free on 3 doz. complete units and over including special divided carton suitable as a container. Send 1d. for sample complete unit, particulars and instructions. We stock seamless moulded cone parts, TELEPHONES AND LOUD-SPEAKERS RE-WOUND

SPENCER'S STORES, LTD.
5 Mason's Avenue, Coleman Street, London, E.C.2
Phone: London Wall 2292 (St. Bank)

BRITISH Dull Emitter GUARANTEED VALVES

ALL TYPES

WHY pay fancy prices or buy an unreliable Foreign Valve? These are good British made and guaranteed—at real pocket-saving prices	2v.06	amps. H.F. and L.F.
	2v.1	" H.F. and L.F.
	2v.25	" POWER.
	4v.06	" H.F. and L.F.
	4v.1	" H.F. and L.F.
	4v.12	" POWER.
	4v.25	" POWER.
	6v.1	" H.F. and L.F.
	6v.25	" POWER.

5/- ONLY EACH

Post free from
HOWARTH'S BRITISH VALVE DEPOT
288 DEANSGATE, MANCHESTER. (Trade Supplied)

BELLING-LEE DIAL INDICATORS



A neat, attractive designator and pointer for any tuning dial or control knob. Fitted by simply drilling one 3/16-in. hole above each dial and then screwing a nut on the back. Solid cast metal with raised polished letters showing white on black background. Price 6d. Fourteen different letterings ...

Made by the makers of the famous Belling-Lee Terminals.

Queensway Works, Ponders End, Middlesex.

CAMDEN Supertension CONDENSERS

No mass production methods are employed in the manufacture of Camden Supertension Fixed Condensers. Every Condenser is stamped with a Serial No. and accompanied with a guarantee of 6 months' real Service. Telegrams: KAMELECO Telephone: Runcorn 109 Send for list and prices to

Camden Electrical Co., Stanley Chambers Runcorn



Amateur Wireless Available until Saturday, JAN. 14th, 1928

COUPON

Protect your valves!

If your reception is unsatisfactory, see that your valve holders are guaranteed to absorb shock and eliminate microphonic noises. Valves must be protected by good valve holders, if they are to function perfectly.

When the valve pins enter the valve sockets the leg sockets of the Lotus Valve Holder immediately expand and automatically lock, and the floating platform in which they are fixed is suspended by four phosphor-bronze springs. Although these springs have great mechanical strength they are sufficiently resilient to absorb any external shock liable to damage the valve.

Lotus Valve Holders are used and recommended in the Mullard circuits in "Radio for the Million" and are ideal for use in the "Master Three" and the "Cosor Melody Maker."



REDUCED PRICES:—

- Valve Holder without terminals ... 1/6
- Valve Holder with terminals ... 1/9

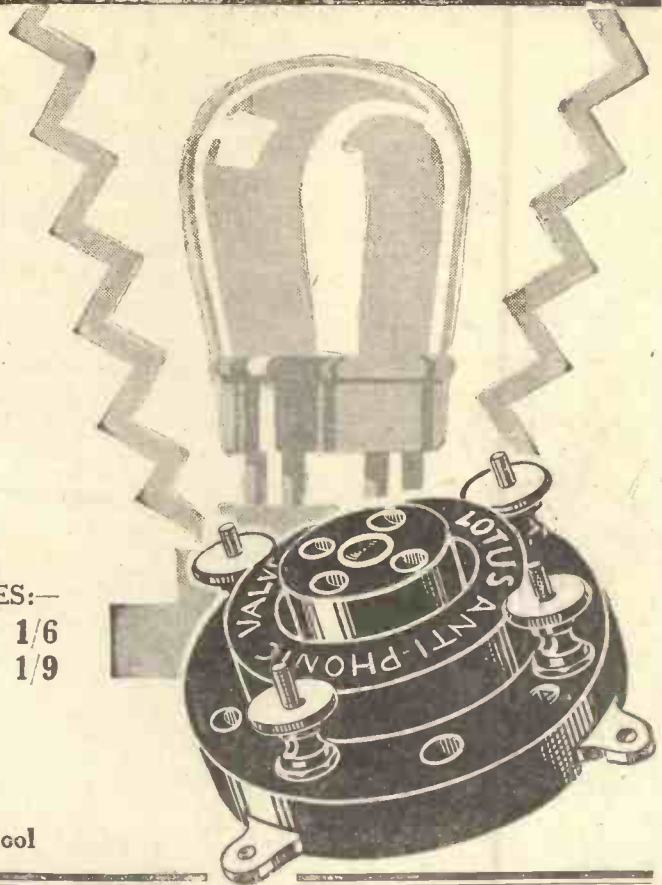

Made by the makers of the famous Lotus Remote Control, Lotus Vernier Coil Holder and Lotus Jacks, Switches, and Plugs.

Garnett Whiteley & Co., Ltd., Broadgreen Road, Liverpool

ABSORBS SHOCK — ELIMINATES MICROPHONIC NOISES

CAUTION

WEARITE COMPONENTS C.T.4.

COILS B.B.C. WAVELENGTH	-	-	10/6
5XX	-	-	12/6
H.F. CHOKE (STANDARD)	-	-	6/6
" " (SHORT WAVE)	-	-	4/6
STANDARD 6 PIN BASE	-	-	2/9
COPPER SCREEN AND BASE	-	-	10/6
PUSH-PULL BATTERY SWITCH	-	-	1/-
STANDARD THREE TWO-WAY CHANGE OVER SWITCH	-	-	6/-

GENUINE PAXOLIN BEARS THIS TRADE MARK

PERFECT INSULATION Look for it— 

MAHOGANY FINISH PANELS

PANELS.	TUBES.
9in. x 6in., 3/6 each.	2in. O.D. x 3in., 91d.
14in. x 7in., 6/-	2 1/2in. " x 3in., 1/-
18in. x 7in., 7/6	3in. " x 3 1/2in., 1 1/2
21in. x 7in., 8/9	3in. " x 4in., 1 1/4
12in. x 8in., 5/9	4in. " x 7in., 3/-
16in. x 8in., 7/6	3in. " x 6in., 2/3
26in. x 8in., 12/3	

Price List on Application

WRIGHT & WEAIRE, LTD.,
740 HIGH ROAD,
TOTTENHAM, N.17. Telephone: Tottenham 3132

K·D·K·A (PITTSBURG U.S.A.)

on a "Beriton" Valve "Almost any night"

Read what our correspondent says:—

"I should like to say that the H.F. Valve that I had from you gives every satisfaction and I can receive K.D.K.A. on one valve almost any night."

This is but one of many to be seen in our offices

Try BERITON in your set, you will appreciate the better reception—the lower filament consumption and the clarity of NON-MICROPHONIC. The All-British Dull Emitter which is rapidly displacing all others, whether British or Continental.

3 DAYS' FREE TRIAL

Money refunded in full if valves purchased are returned to us within 3 days.

TYPE H.F. L.F. and R.C. 2-, 4- and 6-volt. All 1 amp. Post Free 6/6

TYPE POWER, 2-, 4- and 6-volt, 0.25, 0.15 and 0.1 amp. respectively Post free 9/-

Fill in the name of the Company on all Postal Orders and cross "K & Co"



Beriton

MERCHANTS MANUFACTURERS CO., LTD.
(Dept. A.W.) 70 Birtlett's Buildings, Holborn Circus, London, E.C.1
Telephone: City 1499 TRADE ENQUIRIES INVITED

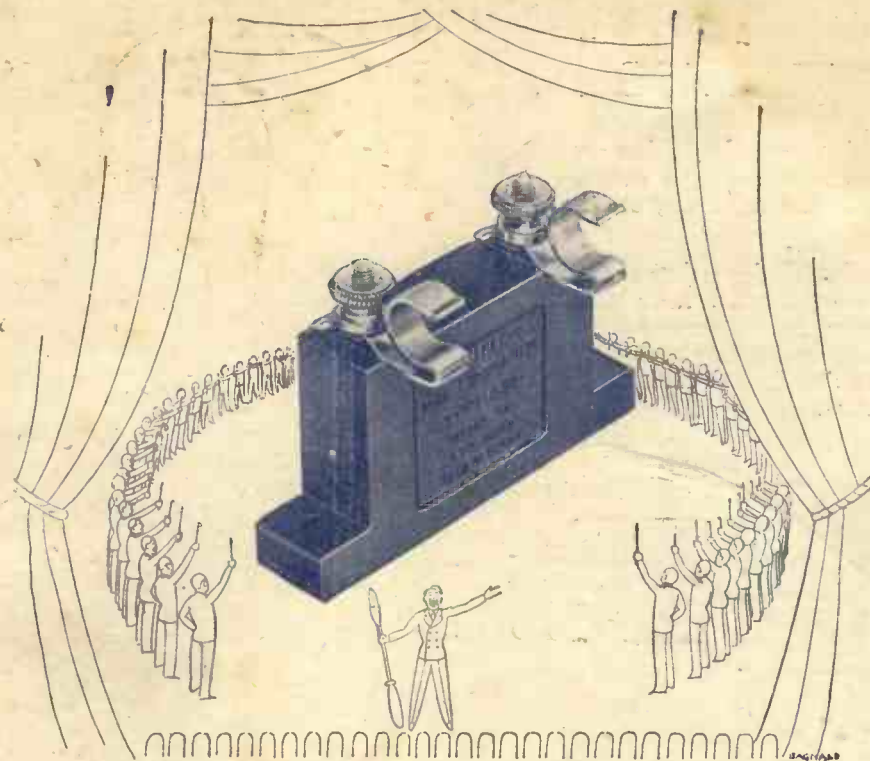

The Solderers' Chorus

THE vast army of constructors, expert and amateur alike, hail Dubilier as "the perfect condenser."

They have done so for years past. They know that Dubilier Condensers are old and trusted friends worthy of their implicit confidence because made of very high class materials by craftsmen who understand what they are about. They know that no reduction of price has been sought by the skimping of details. They are themselves painstaking and jealous over the sets they build and they rightly expect that the manufacturer has been so over the components he makes. That is why Dubilier Condensers are demanded wherever wireless sets are constructed. How else to account for the fact that there are more Dubilier Condensers sold than there are of all other makes put together?

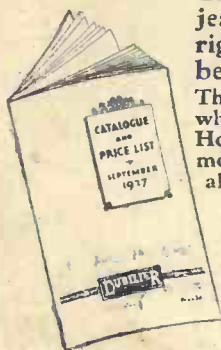

All Dubilier Products are fully described in the catalogue shown here. In addition there is a lot of information which you may find interesting. If your dealer has run out of copies we will forward you one free.



Dubilier Mica Condensers.
Types 610 and 620 (vertical):
0.0005 to 0.0009 mfd., 2/6
0.001 to 0.006 mfd., 3/-
0.007 to 0.009 mfd., 3/6
0.01 mfd., 4/-
0.015 mfd., 4/6

DUBILIER DICTA



No. 5.

Many years ago there dwelt on the outskirts of a far-off city an honest merchant. Daily would he sit by the wayside offering for sale unto those entering the city small singing birds.

"Take this bird," he would say, "treat it with kindness, and it will make melody to gladden your city home."

Now it so happened that the fame of this honest merchant spread abroad throughout that land, for the exquisite melody of his singing birds was it not a joy unto all that heard? Moreover, as he charged a fair and reasonable price for his birds he waxed prosperous.

Then there arose (as there usually does in such cases) a cunning merchant whose name was Haak. He made much study of the honest merchant's ways, and, being envious of his prosperity, he sought means whereby he might divert into his own coffers the shekels that fell to the lot of the honest one.

And he caught many sparrows of the city and did colour them to resemble the song birds. And he said that the Alchemists would give much to discover the secret of his dye. And he did take up his stand with his coloured birds farther down the highway, so those entering the city came to him first.

"Who'll buy? Who'll buy?" he piped from the wayside. "Are not my birds cheaper by far?" And many bought who, being deceived by the outward appearance, and attracted by the small cost, believed they were receiving true makers of melody at knock down prices.

And, as they passed on down the dusty road that led to the city, a wry smile played about the lips of the cunning merchant who was named Haak.

Advt. of The Dubilier Condenser Co. (1925) Ltd., Ducon Works, North Acton, London, W.3.

T.C.89