

206

BROADCASTING THE KING'S SPEECH

Amateur Wireless And Electrics

Vol. IV. No. 100.

SATURDAY, MAY 3, 1924

Price 3d

PRINCIPAL CONTENTS

EXPERIMENTS WITH
AERIAL AND
EARTHING SYSTEMS

A BROADCAST
RECEIVER WITH
"EVER-SET" CRYSTAL

ELIMINATING
UNWANTED SIGNALS

THE FRONT DOOR OF
YOUR SET

MAKING YOUR OWN
COILS

A FOUR-VALVE
CABINET RECEIVER

AN IMPROVED H.T.
BATTERY

THE WIRELESS
DOCTOR

EXPERT REPLIES TO
READERS' QUESTIONS

WELL ILLUSTRATED

Registered at G.P.O. as a Newspaper.

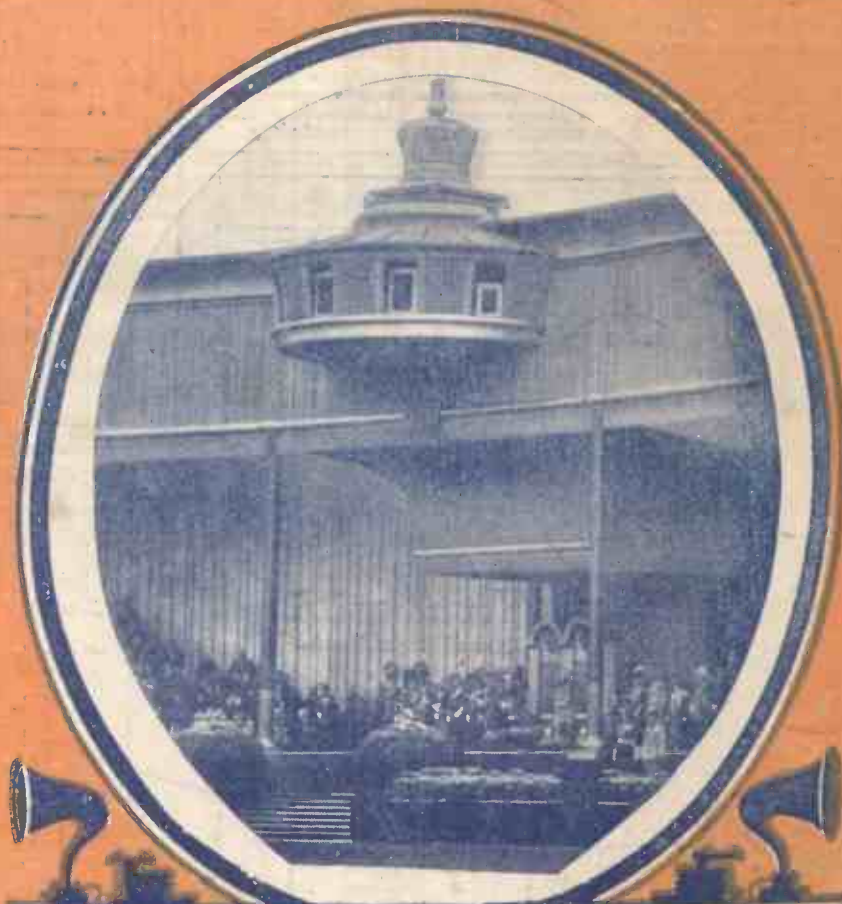

AN HISTORIC WIRELESS EVENT

The photograph shows the King making the speech which was broadcast to all parts of the Empire on the occasion of the opening of the British Empire Exhibition.

ECONOMIC ELECTRIC LTD.



**ENGRAVED
WHITE IVORY
DIAL**
3 in. diam.
Price 6d.



100 yd. COILS
Stranded copper
wire consisting of 4
wires, 25 gauge.
Price 1/6



**BASKET COIL
FORMER** with
plug mounting to
fit either Basket or
Honeycomb coil holders 1 9



**CRYSTAL
DETECTOR
COMPONENTS**
for panel mount-
ing .. 1/6

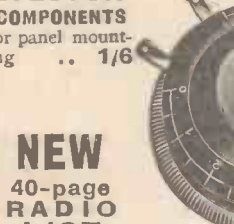

**NEW
40-page
RADIO
LIST**
mailed
post free, 4d.

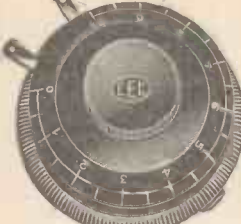

FILAMENT RHEOSTAT
With engraved bevelled
dial 3/6



POTENTIOMETER
250 or 450 ohms.
5/6

Head Office: 10, FITZROY SQUARE, LONDON, W.1

Showrooms: 303, EUSTON ROAD, N.W.1

Branch and Works: TWICKENHAM

HESTAVOX L.F. TRANSFORMERS

on test show a ratio of 4 to 1 and give amplification totally free from distortion. Tested on 1,000 volts between Primary and Secondary. The wire on both windings is accurately measured, thereby ensuring absolute standard results. Diagram showing the connections for wiring up supplied with every Hestavox Transformer. **£1**

Price





HESTAVOX D CRYSTAL SET

Well constructed in every detail, contained in polished mahogany cabinet, ebonite top, machine engraved, glass enclosed crystal detector, wavelengths 300 to 600 metres. Range 20 to 25 miles. Price, including B.B.C. Tax ... **30/-**

Subject to Trade Discount, Special Discount for quantities.

Hestavox Ltd.

32, Palmerston Road, Acton, W.3
2 minutes from South Acton station Phone: Chiswick 586

HESTAVOX ONE VALVE AMPLIFIER

for addition to same, £3 17 6, including all Royalties and Taxes.



TrueMusIc

Loud Speakers

Clear as Crystal

Headphones



If unable to obtain locally, write to us direct.

THE TELEPHONE MANUFACTURING COMPANY, LTD.
Hollingsworth Works, Dulwich, London
BRITISH EMPIRE EXHIBITION, WEMBLEY, 1924, Palace of
Engineering, B.E.A.M.A. Section, Stand C1, Avenue 11, Bays 6 & 7.

TUNGSTALITE'S TRIUMPH

REMARKABLE TESTIMONY

(Copy.) 24 Low Patrick Street,
Hamilton.
15/4/24.

Dear Sir,
Please send me another tube of your Super Crystal Tungstalite. It's an A.1 crystal, the best I ever tried, and everything you advertise it to be. Please find P.O. enclosed.

I remain, yours sincerely,
(Signed) JAMES PATERSON.

Guaranteed more sensitive than any other crystal. Ideal for long-distance work. Absolutely non-fading. Unaffected by heat. A genuinely synthetic sulphide.

Ask your Dealer for it or send 1/- P.O. for Sample Tube to:

TUNGSTALITE LTD.,
Electric Lamp House,
47, FARRINGTON ROAD, LONDON, E.C.1
Phone: Harbom 2557.
Grams: Tunglamp, Smith, London.

**DON'T ASK FOR CRYSTAL
ASK FOR TUNGSTALITE!**



1/-

Amateur Wireless

and Electrics

Vol. IV, No. 100

May 3, 1924

THE WIRELESS DOCTOR :: A NEW PROFESSION?

THERE is at the present time an opening which offers an unique opportunity to the experienced wireless amateur. When we think of the ever-increasing army of wireless enthusiasts, of the thousands of non-technical individuals who are now interesting themselves in a purely technical and scientific subject, it is surprising to find such a comparatively small number of *specialists* amongst them.

A New Profession

There is a demand in nearly every locality for the services of a man who thoroughly understands wireless and can carry out work in a professional manner. In short, the new profession is that of the "wireless doctor."

Wireless apparatus is more or less of a delicate and complicated nature and in the hands of the novice is subject to failures. When the enthusiast is not sufficiently advanced to correct little defects there exists a demand for someone who *can* do the job.

Although perhaps it is best to describe this new profession as a remunerative hobby, it may, of course, eventually prove the thin edge of the wedge and develop into bigger things. It may interest the reader to know that this is exactly what happened in the writer's case, and his only regret is that he has now been compelled to abandon "practice" in order to devote more time to experimental work.

Qualifications

In the first place, it is assumed that the reader is an enthusiast with considerable experience in the principles, construction and operation of the majority of receiving circuits. Having thus gained the requisite knowledge, the next step is to learn how to trace faults and carry out systematic tests. When testing any receiver it is absolutely essential to adopt a system, so that each circuit may be tested separately and in such a way that each fault may be located as accurately as possible. A certain number of tools and some apparatus are necessary, all of which are low in cost. The following is a list of those which might be considered as essential: Small screwdriver, small pliers, small screw wrench, pair of snips or strong scissors, blowpipe soldering outfit, small knife, small file, hydrometer and voltmeter, 4½-

volt dry battery, galvanometer, variable grid leak, various fixed resistances, various fixed condensers, assorted instrument wires, some systoflex, spare valve and crystals (tested), 2½- and 3½-volt bulbs and holder, packet of assorted brass screws and nuts, some adhesive tape and a pair of tested phones.

The Work

Other items will suggest themselves, but the above represents a fairly complete outfit. For instance, if it became necessary to fit extra terminals to a panel, a small breast drill and a quantity of terminals would be required, but such jobs are best left for the workshop. It is a good plan to include a low-frequency intervalve transformer and also a selection of high-frequency plug-in transformers, or a tuned-anode coil, all of which should be tested beforehand. The blowpipe soldering outfit should be as compact as possible, and should include some medium emery-cloth, which will also be required for various other purposes. The small gouge will be found extremely useful for cutting terminal recesses in wooden baseboards, etc. A hydrometer should be used in preference to a voltmeter, since this is really the best testing device for an accumulator. The voltmeter is anything but reliable, and will often give a high reading when the cells are run down, because the voltage required to operate it is momentarily present. By using a suction hydrometer it is an easy matter to ascertain if the cells contain the correct strength of electrolyte, so that it is confidently known if they are fully charged, half charged or discharged. The average readings of the instrument should be 1.215 fully charged and 1.17 discharged. In some types the readings are taken from coloured beads which float at certain specific gravities. A reliable instrument may now be purchased for about 7s. 6d., so that the price compares very favourably with that of the voltmeter. A high-reading voltmeter should, of course, be included for the purpose of testing H.T. batteries.

The variable grid leak should preferably be of the carbon pellet compression type. A very neat and efficient little instrument is now on the market at the modest price of 2s. 6d.

The fixed resistances should be complete

with holders, and the fixed condensers may be conveniently arranged in a small cabinet fitted with an ebonite panel to which are attached several pairs of terminals connected up to their respective condensers. The terminals should be marked .001, .002, .003 microfarad and so on, according to the values of the condensers. A 2- or 3-microfarad Mansbridge-type reservoir condenser should be included.

Inductive Reasoning

To gain proficiency in diagnosing faults it is advisable to carry out systematic tests on receivers which are known to be perfect. In this way one becomes acquainted with the various indications. Take, as an example, a simple crystal set. This, usually being the beginner's first receiver, will figure rather prominently among the doctor's cases. We will imagine that we have inserted the following advertisement in the local paper: "Mr. ———, fully qualified WIRELESS DOCTOR (address), examinations, advice, overhauls, maintenance. Minimum fee for call, 3s. 6d.," and that we have received an urgent call from a client who has made a crystal set which is anything but a success.

Preliminaries

Arriving at the house, we pause for a moment and make a mental note of the position and general arrangement of the aerial. If this seems all right, we introduce ourselves and inquire as to whether the lead-in has been soldered or merely hooked to the aerial wire. The earth connection is next examined, and if this is quite in order we direct our attention to the receiver. Here we must be prepared for the worst, but at the same time we must remember that it represents the enthusiast's best attempt—something which he is still proud of in spite of its failings. Any tendency to smile or frown should be suppressed.

There will be times when one is strongly tempted to shake one's head and say there is no hope, but do not forget that, apart from being human, you have advertised the fact that you undertake to make the thing work. The true doctor will take a fiendish delight in unravelling these wire entanglements, knowing that they are all part of the day's work. O. J. R.



Photograph of Coil Before and After Alteration.

EXCELLENT filters for use with high-resistance loud-speakers and phones can be made from ex-W.D. 1-in. spark coils.

Referring to Fig. 1, it will be seen that the high plate voltage of the last valve flows through the choke and not through the delicate windings of the instruments, the low-frequency telephone currents only taking this path via the large capacity condenser. The small condenser can be omitted if desired, but its addition makes for purity of signals. The writer finds that the filter also tends to eliminate unwanted noises, due in his case to trams cars which pass the house. A counterpoise earth failed to cut these noises out; they were as bad without the earth connection, and screening the set did not cure the trouble; now they are hardly noticeable.

Before dismantling the coil, test it on a 6-volt battery. The terminals on the contact-breaker panel are primary or battery connections and those on the front panel the secondary. Twist a short piece of bare wire around one of these, with its end about 1 in. from the other terminal. Connect the battery and adjust the contact-breaker; if a good fat spark is obtained then condenser and windings are O.K.

Dismantle the contact-breaker and remove the ebonite panels by taking out the brass screws in their edges. If the panels are gently prised up they will come

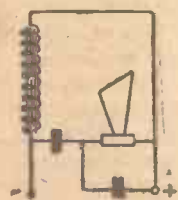

Fig. 1.—Circuit Diagram.

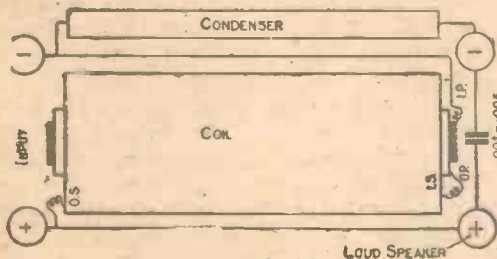

Fig. 2.—Connections of Coil.

away from the wax with which the box is filled and the leads can be cut close to the terminals marked "loud-speaker" shown in Fig. 2. On the under side of the front panel and between the original secondary terminals fit a .001- or .005-microfarad Dubilier condenser; the

already fitted, but at the opposite end, drill two holes and fit terminals.

For the sake of appearance the holes in the contact-breaker panel should be filled with black wax or shoemaker's heel-ball. A neater job could be made of this if a 1/4-in. wood panel was fitted after the wiring is completed.

Trace the outer lead of the primary (the small inner winding) and solder to

ELIMINATING UNWANTED NOISES!

A FILTER FOR LOUD-SPEAKER AND PHONES

capacity of this need not be critical. At the same distance from the panel edges as the terminals

the "in" lead of the secondary, thus putting the windings in series. The remaining connections are clearly shown in Fig. 2. Rubber-covered flex is the best wire for this purpose; this also facilitates the connection to the under side of the terminals on the front panel.

Before replacing the panel the Dubilier condenser should be connected across the terminals marked "loud-speaker." The top and bottom of the box can then be replaced. A final coat of black enamel, two ivory labels and a touch of red and black enamel on the terminal tops to distinguish them finish the accessory as shown in the photograph. A. J.

THE FRONT DOOR OF YOUR SET

WHAT strikes one as the most apparent difference between the amateur-built set and the commercial receiver? Is it not the lay-out and finish of the panel? And wherein can the amateur with a taste for beauty of line more happily give play to his æsthetic sense than in the designing and finishing of a really pleasing, well-balanced panel for his receiver?

Since efficiency is the first consideration in the selection of any component, the panel should have a high dielectric strength to prevent the escape of high-frequency currents. If it is of poor insulating quality the effectiveness of the best instruments can be materially reduced by the surface leakage of current and by the effects of body capacity.

The amateur constructor might use a piece of stiff cardboard, a sugar-box lid, an old bureau drawer—in fact, almost anything sufficiently strong to mount his instruments upon—but the results he would get would fall far short of those obtained by using a panel specially

designed for wireless work. It never paid anybody to take a chance on "any old panel" because it happened to be cheap, and in any case good instruments surely deserve to be mounted on good panels.

Ebonite is the best material for this purpose and consequently the one most widely used. But there are differing grades and qualities in this product as in most others, and the amateur would do well to buy only the best British ebonite or one of the standard hard-rubber products which have deservedly won popularity among amateurs and manufacturers alike.

The best of panels may easily be spoiled by an ill-arrangement of the controls which are to be mounted upon it. The writer favours a comparatively long and narrow panel.

A favourite size in the former case is 24 in. by 8 in., and the panel is mounted flush with the top of a straight-sided box-like cabinet. The tuning dials are arranged side by side towards the left-hand side of the panel; on the right are the filament rheostat controls, with valve windows or peep-holes immediately above them and telephone jacks for cutting out amplifiers immediately below. All terminals are relegated to a terminal strip at the back of the cabinet; the valves are invariably enclosed, a very wise and trouble-saving practice. A. J. B.

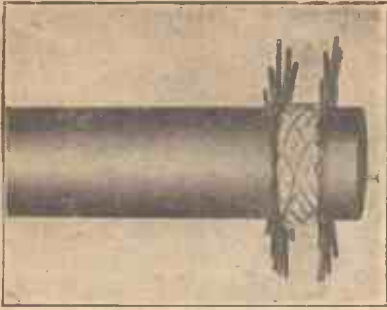

Fig. 1.—The Former.

MAKING YOUR OWN COILS

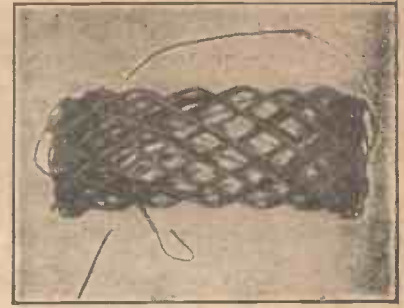

Fig. 3.—Coil Removed.

THIS article describes a method of constructing plug-in coils. There is no difficulty in their construction provided care is used; the cost per coil is small, and the finished article compares favourably with bought coils both in appearance and efficiency.

The materials required are few and easily obtained. The former is made with a piece of curtain pole 1 3/4 in. in diameter by 9 in. long and thirty-two 2 1/4-in. wire nails. Other materials required are bristol board 1/8 in. thick for coil supports, obtainable from any stationer's, wire, 1/4-in. empire tape and some coil plugs. The coil plugs and empire tape are obtainable at most wireless dealers'. The plugs are of the usual pattern, as shown in the photographs.

The former (Fig. 1) has two circles marked off 3/4 in. apart, the first circle being 1/2 in. from the end. These circles are divided into sixteen equal parts, and holes for the pins are drilled 1/4 in. deep, those in one circle being midway between those in the other circle (see Fig. 2). The nails are driven in, not too tight, and a piece of the bristol board is then placed round the former between the rows of pins.

Fig. 2 shows the method of winding. For coils up to seventy-five turns, use the factor five, which will give nine turns of wire to one complete layer; that is,

where there is a wire round every pin there will be nine turns on the former. For a fifty coil, therefore, we require five wires on each pin; $5 \times 9 = 45 + 5$ more turns. Use nine turns per layer, that is every fifth pin on alternate sides, for coils up to seventy-five; eleven turns per layer, that is every sixth pin, for coils up to 150; and 13 turns per layer, that is every seventh pin for coils above 150 turns (see Fig. 2). The most suitable wires, so that the coils should not be too large, are No. 26 S.W.G. d.c.c. for coils up



Fig. 2.—Method of Winding

to 75, No. 28 S.W.G. d.c.c. for coils up to 150, and No. 30 S.W.G. d.c.c. for coils above 150 turns.

When the required coil is wound it should be well brushed all over with shellac varnish, all surplus varnish being shaken off by twirling the former with the coil on. It should now be baked in an oven until thoroughly dry. When dry, the pins are carefully withdrawn, a thin-bladed knife being slipped under the bristol board, which is on the inside of the coil, to loosen it from the former. Care must be taken not to cut the first layers of wire. This part of the work must be

carefully done or the coil will be spoilt. Next cut the bristol board into strips 1 in. wide. One piece of board is cut the same diameter as the outside of the former; this piece is sprung into place inside the coil (see Fig. 3).

Another strip of board 1 in. wide is now placed round the outside of the coil, enough being left at the ends to attach the coil plug. A third piece of strip 1 in. wide by 2 in. long is placed between the outside of the wire and the curved part of the coil plug. The coil plug is now fixed temporarily in place. Fig. 3 shows the coil at this stage.

The coil is now ready for the binding. Start with the empire tape as close to the plug as possible, taking in the outside short piece and inner bristol board strip and continue binding to the other side of the plug. Now remove the plug, and finish the binding right round. The best means of securing the tape is with a touch of Chatterton's compound. A 50-coil takes about 4 yd. of 1/4-in. tape. Fig. 5 shows the coil at this stage.

The final operation is to connect the plug to the coil in the correct way. This is best done by trail and error. When the correct connections are found, screw the fixing plates tight on to the wires, trim up the bristol board flush with the edge of the plug, number the coil, and the job is finished (see Fig. 6). C. A. C.

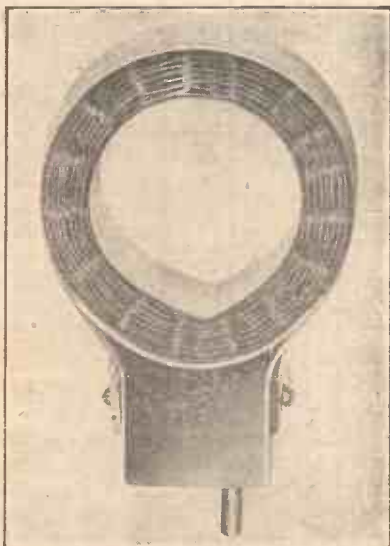

Fig. 4.—Coil Ready for Taping.



Fig. 5.—Method of Taping.



Fig. 6.—The Finished Coil.

EXPERIMENTS WITH AERIAL AND EARTHING SYSTEMS

IT is the writer's opinion that insufficient attention is paid to the aerial and earthing arrangements of a receiving station. The following remarks are based upon a number of experiments made during the past year with various systems.

The First Two Experiments

The first aerial to be erected was of the inverted L type 90 ft. long, with a 10-ft. lead-in to an upper window about 40 ft. above the ground level. The wire consisted of several strands of thin copper twisted together. The earth connection was made by soldering a wire to the main inlet pipe of a cistern at the top of the house; a 15-ft. lead was taken to the instruments. With this arrangement Birmingham and Manchester, each over 100 miles distant, have been heard using a variometer-tuned crystal set. London, 25 miles distant, was heard comfortably using two pairs of phones in series. When using a valve set all the B.B.C. stations were heard and also some Continental stations. The aerial showed no directional properties whatever.

A second aerial for use downstairs was next erected; it was of the inverted L type, 50 ft. long, with a 40-ft. down-lead. The wire was the insulated "disposals" variety, consisting of many strands of steel wire round a central copper core. No water-pipe being near the set, an earth connection was made to an old zinc bath filled with coke and buried about 2 ft. in the ground.

Results

Results with this arrangement were decidedly inferior to those obtained with the previous one; this was probably due to the fact that the earth connection was made only over a limited area and also that the experiments were carried out during the dry summer months. Transmissions on 200 metres could not be received. With a view to increasing its efficiency another earthing system was tried. About 30 ft. of bare copper aerial wire were buried a few inches below the surface of the soil in a flower-bed and running in a direction at right angles to the aerial; approximately 15 ft. were buried on each side of the aerial. An immediate increase in signal strength resulted, but still the results were not so good as those obtained with the first aerial.

Change with the Seasons

With the coming of the winter months, and consequently more rain, signal

strength increased noticeably, until now it is in excess of that obtained by the first aerial, results from which, by the way, have not changed throughout the year. Tuning with the second aerial is fairly critical and marked directional properties exist. It is interesting to note that amateur transmissions on 200 metres have been received with this earthing arrangement.

On raising the height of the aerial considerably a decrease in signal strength resulted; this was with the instruments situated on the ground floor.

A third aerial that has been erected consists of similar "disposals" wire and is of the double-wire inverted L type. It is very low, being only about 15 ft. high at one end and 20 ft. at the other. It has a short lead-in, the two wires being left unjoined at the receiving end for experimental purposes. An indoor earth is used, connection being made to a water-pipe. This aerial has a much higher natural wavelength than either of the other two, as was shown by using a crystal set on each in turn. When the valve set was used a remarkable flatness of tuning was observed, hardly any difference being

noticeable in the aerial tuning when a 75-turn coil was substituted for a 35-turn coil. This is probably due to the high capacity of the aerial.

The signal strength obtained was slightly less than that obtained on the other two. When, however, only one of the wires was used, an increase of almost 30 per cent. in signal strength occurred, together with an increase in selectivity.

Crystal Experiments

A crystal set attached to one wire of the aerial and tuned to the same wavelength as the valve set in operation on the other gave results almost equal to the addition of a low-frequency valve under ordinary conditions.

The valve set used throughout the experiments consists of a high-frequency valve, crystal detector and low-frequency valve, this arrangement having been found the most suitable for general reception.

In conclusion, for general reception the writer would recommend the inverted L type of aerial and an indoor "earth" where possible, provided that the earth lead is short. All connections should be soldered.

D. S. M.

MORE PHONE POINTS

THE question of polarity often puzzles people. It is not necessary to worry about which terminal is connected to which in a crystal set, as the current flowing is quite insufficient to depolarise the magnets. But in the case of a single-valve or multi-valve set this may be suffi-

The positive pole should always meet the current, as it were.

Low-resistance phones have much stouter windings and have a resistance of between 25 and 500 ohms.

As they are comparatively insensitive to the usual impulses, they are used with a

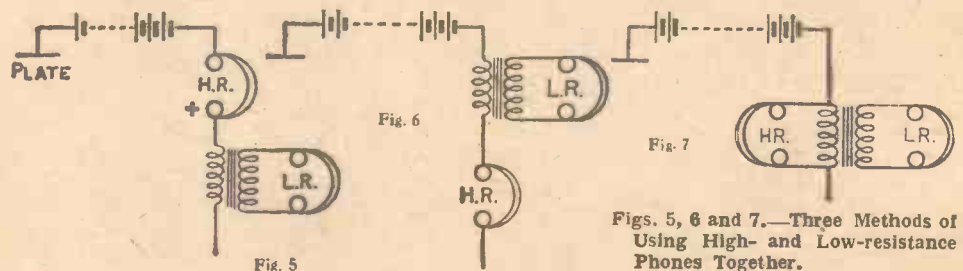

Figs. 5, 6 and 7.—Three Methods of Using High- and Low-resistance Phones Together.

cient to spoil the permanent magnets, and care, therefore, should be taken to connect them up the right way round. The positive pole should always be connected to + H.T. In the case where the phones are on the negative side, then the positive pole should be attached to the filament battery.

transformer which steps down the voltage to the requisite amount. Thus a transformer with primary of about 4,000 ohms and a secondary of 60 ohms would be quite suitable.

In the writer's opinion there is no (Concluded at the foot of third column on next page)

PRACTICAL ODDS AND ENDS

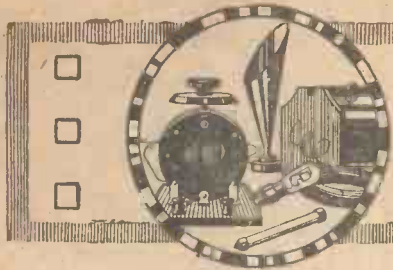

Tension for Coil-holders

It frequently happens that when coil-holders are mounted as shown in the accompanying illustration the weight of the larger coils used when receiving on the longer wavelengths causes the movable socket to drop over too freely, making it difficult to maintain a stable coupling.

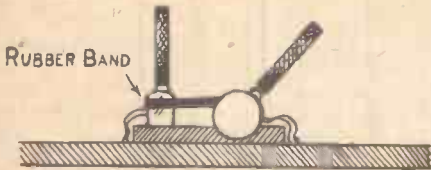

This may be effectively remedied by slipping an ordinary india-rubber band over the two sockets, thus adding the necessary tension to the moving coil and enabling the same to be adjusted to any position.

D. F. U.

Filament Rheostats

MANY amateurs are uncertain of the method of calculating what variable filament resistance should be used with different valves, but this is really quite simple. The resistance of the valve filament must first be found from the makers' rating and Ohm's law. In this case the formula $R = \frac{E}{C}$ is used. E and C are the voltage and amperes needed on the filament, and may be, for example, 4.5 volts and .6 ampere. (Valve manufacturers always give these particulars.)

Then $R = \frac{4.5}{.6} = 7.5$ ohms. In other words, the resistance of the filament is 7.5 ohms. Next the voltage of the filament supply must be taken into consideration. There must be sufficient resistance in the circuit for the current never to exceed .6 ampere (or whatever the filament consumption may be). Suppose a 6-volt accumulator is being used. Again Ohm's law comes to our aid. $R = \frac{E}{C} = \frac{6}{.6} = 10$ ohms. This means that the total resistance in the circuit (not taking account of the internal resistance of the accumulator, which is negligible) must be 10 ohms. But the resistance of the valve filament is 7.5 ohms, so an extra resistance of 2.5 ohms only is required. This means that a variable resistance of 3 ohms (minimum) will be suitable.

In the case of dull-emitter valves the

calculation is the same. From the makers' particulars calculate the resistance of the filament. Having decided what voltage battery to use, work out the resistance necessary to limit the current to the amount required by the filament. Subtract the resistance of the filament and the result is the resistance in ohms of a suitable rheostat. To be on the safe side, this may always be a little higher in value than the calculated resistance. Fixed resistances should not be used unless absolutely unavoidable.

R.

Novel Crystal Holder

CRYSTALS can be conveniently held between two brass springs similar to those used for holding the catwhisker arm. A detector made with such a holder is shown by the diagram. A spare bracket was obtained and placed so that the crystal was within reach of the catwhisker.

The jaws of this bracket were held apart and the crystal was dropped into the two opposing circular apertures which, in

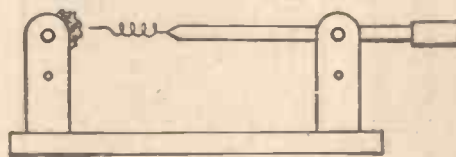

Novel Crystal Holder.

ordinary usage with the bracket, hold the swivel ball. A turn or two of the screw that is generally fitted farther down the bracket caused the jaws to grip the crystal tightly.

W. A.

Coil-holder Connections

COIL-HOLDER connections must be made with quite flexible wire or they soon break. Flex can be used quite

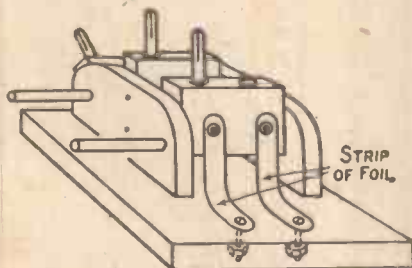

Coil-holder Connections.

successfully, but a neater connection can be made with copper-foil strips. The method of doing this is clear from the diagram.

L. H. C.

H.T. and L.T. Leads

BURNING-OUT valves by connecting the H.T. battery to the L.T. terminals is made impossible by the arrangement shown in the diagram.

A piece of ebonite $\frac{3}{8}$ in. by $2\frac{1}{4}$ in. by

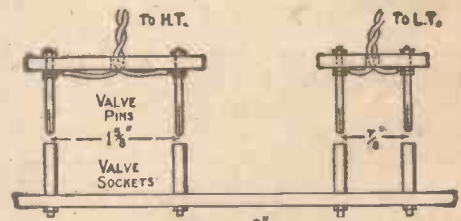

H.T. and L.T. Leads.

$\frac{5}{8}$ in. is obtained, and in the centre of this a 2 B.A. hole is drilled. Two more holes are drilled on each side, so that they are $1\frac{3}{8}$ in. apart. A piece of twin flex is put through the centre hole, divided, and each wire brought to a valve pin.

For the L.T. connections a similar device is made, but in this case the ebonite is $1\frac{3}{8}$ in. long and the pins mounted $\frac{7}{8}$ in. apart.

B. T.

Marking Ebonite Panels

IN marking out ebonite panels, do not use a centre-punch, which is liable to split the panel. Use an ordinary carpenter's rose-bit or countersinking tool. These can be revolved, and give a good start for any drill.

R. W.

"MORE PHONE POINTS" (continued from preceding page)

advantage in using L.R. phones, except that they are of rugged construction.

There are several ways of using H.R. and L.R. phones together.

Figs. 5 and 6 are suitable for valve sets when the valve used is of high internal impedance. Fig. 7 is suitable for crystal sets on strong signals and on low impedance valves.

Should the phones be weak, take a pencil and tap the diaphragm through the central hole. If it gives a hollow sound, remove the cover, slide off the diaphragm, and see if there are any washers between the diaphragm and the side of the case; if so, remove one and try again; if not, carefully rub down the side of the case evenly all round on emery, trying the diaphragm at intervals. If the test with the pencil results in a dead sound, remove the cover and insert a paper washer between the case and diaphragm.

A. G. W.

GREATER RANGE AND STRONGER SIGNALS

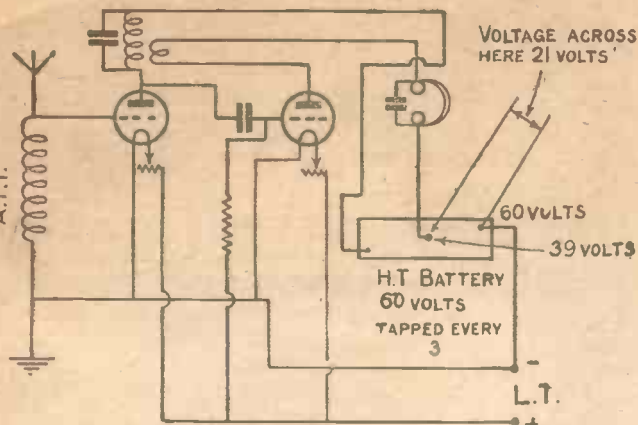

Fig. 1.—Supplying Different Voltages from One Battery.

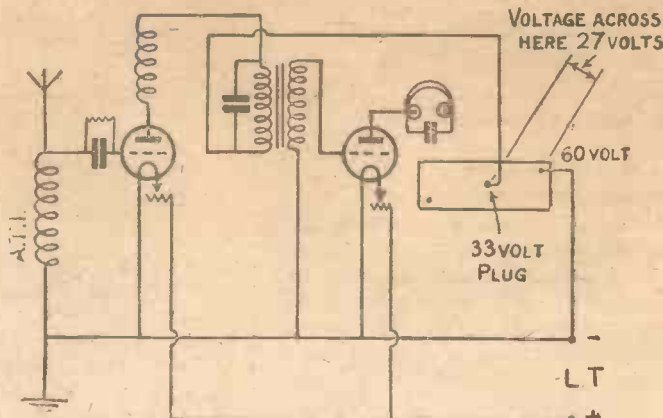

Fig. 2.—Different Voltages Applied to Detector and L.F. Valves.

THERE are very many types of valves on the market, all taking different plate voltages, and even two valves by the same maker picked from the same batch are often found to vary. Some will be found to give best results with, say, 52 volts, whilst another valve by the same maker will perhaps need 60 volts to obtain the best results. In addition to which

high-tension battery only. For instance, supposing you are using one high-frequency amplifier with a hard valve requiring 60 volts, and a soft detector requiring only 21 volts, by using three wander plugs instead of two both of these voltages can be selected from the one battery. In the case where a detector and a low-frequency amplifier are being used, where perhaps

of the plate-filament space. This implies that the primary winding, being in the plate circuit, should have at least 10,000 turns. For a step-up ratio of $2\frac{1}{2}$ to 1 the secondary must therefore have 25,000 turns, making a total of 35,000. Similarly for a $1\frac{1}{2}$ to 1 transformer the total turns will be 25,000.

In order to keep the size of such a transformer within reasonable limits it is obviously necessary to use wire of very fine gauge. In consequence it sometimes happens that the insulation is insufficient to stand the strain imposed upon it under working conditions. A breakdown can be detected by means of a voltmeter and a single dry cell. Test for a break in continuity by tapping first across the primary and then the secondary. Next test for faulty insulation by tapping across one terminal of the primary and a terminal of the secondary. Finally tap across from the transformer ends to the metal frame to see if there is any leakage in this direction.

Transformers frequently give rise to noises in the phones owing to hysteresis effects or eddy currents, caused by undue loading, or by induction from outside sources. In the latter case the trouble may be cured by enclosing the instrument in a metal case, which acts as a screen. Simple distortion can often be cured by connecting a high resistance across the secondary winding, particularly when using instruments having a higher step-up ratio than 3 to 1.

While experimenting with a tube filled with nitrogen made incandescent by an electric current, two Pennsylvania professors found that it would detect wireless signals. They connected a special transformer and phones, and heard a broadcast programme without an aerial, earth or tuning apparatus.

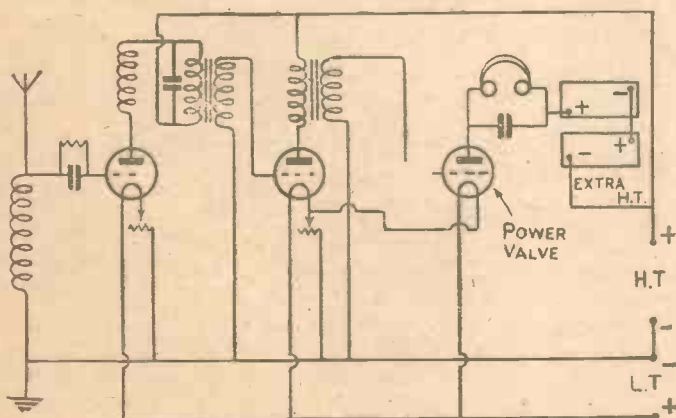

Fig. 3.—Extra H.T. on Last Valve.

27 volts is required by the detector valve and 57 by the L.F. amplifier, the appropriate wiring is given in Fig. 2.

Using a Power Valve

Where it is required to increase the sound by putting an extra high voltage on the plate of the last valve, which might be a power valve, this can be done as is shown in Fig. 3, and is effective on the last valve only. It will be found that with the proper use of H.T.

some valves are better amplifiers than others, and some are exceptionally good as detectors but are almost useless when used for amplification.

results can be improved easily as much as 40 per cent.

C. S. D.

The Use of Different Valves

The amateur who uses two distinct types of valve perhaps uses two high-tension batteries; otherwise he finds the mean of the voltages for the two different valves and contents himself with the results obtained. The first method is, of course, very expensive, and the latter is extremely inefficient.

Applying Different Voltages

In Fig. 1 a method is shown whereby the two different voltages required for the different valves can be found from one

TRANSFORMER HINTS

THE use of low-frequency transformers having a higher step-up ratio than 3 to 1 is generally inadvisable. In a three-stage amplifying set the best combination is a ratio of 1 to $1\frac{1}{2}$ for the first interval transformer and 1 to $2\frac{1}{2}$ for the next two. For efficient work the total number of winding turns (primary and secondary) should not be less than 25,000, and may advantageously be 35,000 or more, the reason being that the impedance of the output circuit of a valve should be approximately equal to the impedance

Brandes

The Name to Know in Radio.



*Result of
15 years'
experience*

—for the Lady

While not displaying interest in wireless technicalities, the lady generally has an ideal perception for good music, is intrigued with the opera and sport, and certainly has a consuming passion for fashion talks. It is your pleasure to see her vastly entertained—bring all of these by wireless and a Brandes. The "Matched Tone" feature ensures rich velvety tone with pure distinctness and the headband means a delightful comfort worthy of feminine consideration. *Your dealer has them—ask him.*

PRICE
25/-

BRITISH MANUFACTURE
(B.B.C. Stamped)
and conform to all
new licensing regu-
lations.

Manufactured at Slough, Bucks, by

Brandes Limited, Walmar House, 296, Regent St., London, W.1.
Glasgow—47, Waterloo Street. Newcastle—2/6, Post Office Chambers.

Matched Tone

TRADE MARK

Radio Headphones

Telephone—
Mayfair 4208 - 4209
Trade enquiries invited



HULLO EVERYBODY!!

Post Free Column

- Valve Windows 1/-
- Basket Coils (6) 200/3,500 2/6
- Waxless (5), 200/2,000 M. 2/6
- Twin Flex for Leads, 12 yds. 2/-
- Bell Wire, D.C.C., I.R.C., 10 yds. 10d.
- 100 ft. Aerial, 7/22 9/3
- Rubber Lead-in, 10 yds. ... 1/6
- Basket Coil Holder and Plug 1/9
- Do., 2-way on Stand 5/9
- 2-way for Igranio Coils 4/11
- Various Designs, 5/11, 6/11, & 7/-
- Shaw's Genuine Hertzite ... 1/3
- Spade Sorew Terminals doz. 1/6
- Pin do. doz 1/3
- Ebonite Dial and Knob ... 1/4
- Do., Extra Quality 1/8
- Ebonite Valve Holders ... 1/3
- Do., Cut from Solid 1/6
- Valve Sockets, Best, doz 1/3
- Do., Plain doz 1/-
- Terminals, Telephone, doz. 1/6
- Do., Pillar doz. 1/6
- Do., Small Pillar doz. 1/4
- Do., W.O. Patt. doz. 1/6
- (All above with Nut.)
- Insulating Sleeving, 3 yds. 1/3
- Tinned Copper, 3 yds., 14 or 16 gauge 9d.
- Do., 3 yds., 18 or 20 gauge 6d.
- Ebonite Coil Plugs, 2 for. Do. on Stand 2/-
- 100,000 ohm Resistance 1/6
- Switch Arm, 12 Studs and Nuts 1/6
- Ormond Fil. Resistance ... 2/6
- Fixed Condensers, .001 1/2
- Do., .001 to .0005 1/2
- Do., .002 to .005, 1/3, .006 (Above best quality.) 1/6
- Grid Leak and Condenser, .0003 2/6
- Ebonite Vario, D.S.O., 250-250 4/11
- Do., D.C.C. Ball Rotor. Ebonite (Inside Winding) 9/9
- Variometers 13/6
- Contact Stops doz 1/-
- Battery Clips doz 1/-
- Coil, 26 tpgs., 1,600 M. 2/6
- 4 Whiskers, 1 Gold 6d.
- Spear Point Whisker 4d.
- 12 yds. Empire Tape 1/-
- Plugs and Sockets doz. prs. 1/6
- Geocite Crystal 1/6
- Minicap Switch 8/-
- Radio Ins. Transformer ... 28/-
- Igranio Shrouded, L.F. 5-1 21/-
- Formo Shrouded, do. 18/-
- Formo Open Type, do. 12/6
- Royal, do. 20/-
- Tested on Aerial, do. 12/6
- Raymond, do. 12/6
- Ormond Fil. Rheostat ... 2/6
- Raymond, do. 2/-
- Rheostat and Dial 2/8
- Ajax Rheostat, 25.5 ohms ... 4/-
- Ajax with Vernier, 30.5 ohms 5/-
- Ajax Potentiometer, 464 ohm 6/6
- Igranio Rheostat 4/6
- Peerless Rheostat, 6 ohms 4/6
- Peerless " 15 ohms 4/9
- Peerless " 30 ohms 5/-

RAYMOND VARIABLE CONDENSERS

Our Air Dielectric Condensers are the simplest and MOST efficient on the market. Lowest in price, highest in quality, made for panel mounting, and are the most suitable condensers for Broadcasting or Amateur work. They have passed THE TEST for guaranteed capacities, are scientifically accurate and built for durability.

NEW MODEL

Post 6d. per set .073 in Spacers.

Cap.	Plates	Price.
.001	49	7/11
.00075	37	6/11
.0005	25	5/11
.0003	15	5/3
.0002	11	4/11
.0001	5	4/3
Vernier		3/11

PASSED NATIONAL LABORATORY TEST

Above new model specially adapted for taking up min. amount of space. All parts nickelled. One hole fixing.



One Hole Fixing. Prices include Knob and Dial. Without Dial 6d. set less.

Trade discount on Condensers 20% plus postage. Good terms for quantities.

"A" TYPE

Post 6d. per set .088 in Spacers.

Cap.	Plates	Price.
.001	57	6/6
.00075	43	5/9
.0005	29	5/-
.0003	19	4/6
.0002	13	4/-
.0001	7	3/6

(Vernier, 2/6. No dial.)

Above "A" type is a wonderfully cheap and reliable condenser. One hole fixing. Thousands of testimonials from satisfied users.

CALLERS ONLY

ALL POST ORDERS from OTHER COLUMNS

- Telephone, large each 11d.
- Telephone each 1d.
- Pillar 1d. & 11d.
- W.O. Patt. 2 for 21d.
- Large size each 3d.
- Various doz. 1/- & 1/6
- Valve Sockets doz. 101d. & 1/-
- Contact Studs doz. 6d.
- 2 B.A. Rod foot 3d.
- 4 B.A. Rod foot 21d.
- Valve Pins 2 a 1d.
- Brass Bushes 1d.
- Spade Tags, best quality doz. 3d.
- Screw Spade Terminals 1d.
- Pin Screw do. 4 for 9d.
- Stop Pins 2 a 1d.
- Plug and Socket pair 11d.
- Easyfix Cup 11d.
- Switch Arms, with 12 Studs, Nuts and Washers 101d.
- English Flash Lamp Batt. doz. 4/-
- H.T. Batteries, 36 v. 5/-
- H.T. Batteries, 60 v. 8/8 & 10/6
- Filament Res., with Dial 2/-
- Set of Names (12) 5d.
- 0-300 Dial 5d.
- Soales (Engraved 0-180) ... 3d.
- Multiphone Terminals 9d. & 1/-
- Insulators, Egg 6 for 6d.
- Aerial Wire, 100 ft. 1/10
- Extra Hard Drawn, 7/22 100 ft. 2/4
- Valve Windows 7d.
- Res. Dials 0-100 4d.
- Ebonite Dial and Knob 0-180 1/1 & 1/3
- Filament do. and Knob ... 9d.
- Filament Dial, 0-10 6d.
- Fixed Condensers to .001 10d.
- Do., .002 to .005, .006 1/8
- Ins. Screw Eyes 1d.
- 4 Cats Whiskers (1 gold) 3d.
- Cold Whisker 11d.
- Shaw's Hertzite 1/-
- Zincite, 6d.; Bornite 6d.
- Coil Holders 1/1 & 1/3
- Coil Plugs, Ebonite ... 7d. & 9d.
- Do., on Base 1/- & 1/3
- Best Valve Holders 1/3
- 3 makes, above, 10d., 1/- & 1/3
- Tinned Copper, 16, 18, 20g. Steeving, best 3 yds 1/-
- Copper Foil good 3d.
- Filament Res., good 1/8
- Rubber Lead-in 10 yds. 1/- & 1/3
- Bell Wire, D.C.C., I.R.C., 70 yds. 5d.
- Twin Flex 12 yds 1/6
- Heavy Rubber Lead-in yd. 2d. & 3d.
- Basket Coils (6) 200/3,500 1/9
- Waxless (5) 1/11
- D.P.D.T. Switches for Panel 1/6
- S.P.D.T. do. 1/3
- Telephone Cords 1/6 & 8d.
- Grid-Leak (2 meg.) 1/-
- Do., and Condenser .0003 1/9
- Empire Tape doz. yds. 9d.
- Adhesive do. roll 4d.
- A.A. Earth Clips 7d.
- Washers, 2 and 4 B.A. 3 doz. 2d.
- 100,000 ohms Res. 1/6
- Fine Variometer 2/6
- Nugraving Set 71d.
- Enclosed Detectors 111d.

THIS LIST subject to alteration without notice

HEADPHONES.

- Sterling B.B.C. high class (4,000) 25/-
- B.T.H., B.B.C. None better (4,000) 25/-
- Brunet. Very fine value (4,000) 17/6
- Brunet, for Crystal Sets (8,000) 19/11
- N. & K., genuine (4,000) 12/9
- Sidge, 4,000 ohms 12/9
- Premier B.B.C. Full of music. (4,000) 17/6
- Post 1/- pair.

CRYSTAL DETECTORS.

- Post 9d. each.
- Glass enclosed Whisker, Brass Fittings, 1/6, 2/3 & 1/-
- Glass enclosed Perikon, with Zincite and Bornite 1/8 & 2/2
- Nickel enclosed, 3/6, 2/6, 1/11
- Edison Bell Twin 5/6
- Burddept 5/-
- Post 3d. each.
- Lissen Grid Leak (Var.) 2/6
- Lissen Anode Resistance 2/6
- Lissen T1 Transformer 30/-
- Lissen T2 " 25/-
- Lissen T3 " 18/6
- Lissen Series " Parallel Switch 3/9
- Lissen Two-way 2/9
- Lissenstat Minor. Out of Stock.
- 100,000 ohms Resistance 2/6
- Edison Bell Fixed .001 1/3
- Do. .001 to .0005 1/3
- Do. .002 to .006 2/-
- Do. .0003 and Grid Leak 2/6
- Raymond Fixed .001 1/1
- Do. .0002 to .0005 1/1
- Do. .002 to .005 1/6
- Do. .006 1/6
- Do. .0003 and Leak 1/10
- Dubilier Fixed .001 3/-
- Do. .002 to .006 3/-
- Do. .0001 to .0005 2/6
- Do. .0003 and Grid Lk. 5/3
- Phone Cords, 54 in. ... 1/-
- Do. 72 in. Double 1/9
- Variometer 250/650, 3/-, 3/6
- Do. Ebonite 250/650 3/11

H.T. BATTERIES.

- 30 v. 4/3, 4/6.
- 36 v. 4/9, 5/8.
- 60 v. 7/8, 8/6, 10/6.
- Post 1/- extra.
- Discount to Trade and Members of Radio Clubs.
- All Proprietary articles stocked.
- Var. Condensers, brass goods, etc.

ERICSSON E.V. type, World Famous Continental Headphones, 4,000 ohms. 13/9

Post 1/- per pair.

VALVES.

- Marconi R. Ediswan Mullard O. 12/6
- Cosser P.2. Cosser P.2. Post 1/- each.

VALVES.

- Phillips R. 7/8
- French R. 6/11
- No post Orders.

SNIPSI EBONITE VARIOMETER

- 250/260, Ball Rotor. wound D.C.C. with knob 6/11
- Post 1/-.

N. & K. (The Goods) Best. Stamped Genuine

4,000 ohms 12/9 Pair Post 1/- pair.

Super Condenser with Three Plate Vernier



"IT" for very fine tuning.

- .001 12/6
- .0005 10/6
- .0003 8/6

Registered Post. 6d. Set.

FILOSTAT FOR ACCUMULATORS D.E. & R. VALVES

- Post 6d. each 2/6
- 4 v 40 a. ... 10/6 & 11/6
- 4 v 40 a. ... 17/6 & 19/6
- 4 v 60 a. ... 19/6 & 23/-
- 6 v 60 a. ... 28/- & 33/-
- 6 v 80 a. ... 35/- & 39/-
- Post 1/6 each.

LOUD SPEAKERS

- Sterling Baby 55/-
- Sterling Floral 60/-
- Amplion Junior 42/-
- Slide Loud-Speaker, complete, 25/-
- Post free.

SNIPSI COIL HOLDERS

- Plug-in type, Ebonite, Brass fittings on base. 3/3
- Two-way ... 4/6
- Three-way ... 4/6
- Post 1/- each.

BASKET COILS

- Set of 6 ... 1/11
- Set of 7 ... 2/3
- 200/3,600 metres. Post 6d. set.

WAXLESS.

- Set of 5 ... 1/11
- Set of 6 ... 2/3
- 200/2,000 metres. Post 6d. set.

DULL-EMITTERS

All makes in stock.

RIGHT OPPOSITE DALY'S GALLERY DOOR

K. RAYMOND 27, LISLE STREET, W.C.2

PHONE: GERRARD 4637

HOURS OF BUSINESS: DAILY - - 9 to 7.45 SUNDAYS, 10.30 to 1

On Your Wavelength!

Wembley Preparations

DOUBTLESS you heard some of the preliminaries of the Wembley broadcasting on Tuesday night. If you happened to have left your set on after ordinary transmission had finished you would have heard the announcement that Wembley was making a test. The announcer moved about into various positions to try the effect upon the microphone. "Now I'm right under it. How's that? I am moving away and going on speaking. How's it coming through? All right? Good! Thanks very much." And that sort of thing. As a matter of fact, an immense amount of preparation must be done before any great undertaking such as the broadcasting of the King's speech. Rehearsal after rehearsal is necessary to make quite sure that everything is perfect when the great day comes. All sorts of things have to be considered. The speaker can't be expected to remember that he is talking into a microphone as well as addressing a great audience. Therefore the instrument must be placed in such a position that it is as nearly as possible out of his sight and arranged so that if he speaks in the ordinary way every syllable will be picked up clearly and distinctly. There are other difficulties, for it must not be forgotten that between Wembley and 2 L O are miles of land line, which could (if used) have spoilt the whole business unless the most careful tests had been made beforehand with a view to avoiding the effects of induction and of interference from other sources.

A Splendid Achievement

The pains taken in the preparatory work resulted in a wonderful achievement when the King and the Prince of Wales made their speeches. Wishing to listen in the most critical way possible, I rigged up a large set with one stage of high-frequency amplification, a rectifier and two stages of note magnification. The set was carefully tested out on several evenings prior to the opening day with a view to eliminating distortion of every kind. I switched on quite early in the proceedings to verify my tuning, and then cut out until 11.15 as I had a good deal of work on hand. When I turned over the switches at that hour the curious noise made by the talk of a crowd came through to perfection. It was very much like what one hears from Covent Garden before the rise of the curtain when relaying is in progress. The main difference was that there was no "indoor effect"; I mean to say that there was no sort of echo such as occurs when a transmission comes from the inside of a great building. In a few moments there was an outburst of cheering, and one realised that the Prince was arriving. The

surmise was turned into a certainty by the order, quite distinctly heard, "Present Arms." It took one back to war-time days to hear the slap of hands against slings. I don't know what troops composed the guard, but without even seeing them do it I can testify that their "present" was jolly good!

The Speeches

Our Royal family is noted for its punctuality. As a matter of fact, you might have set your watch by the tremendous cheering which heralded the coming of the King and Queen, before it took place at 11.30 to the tick. There was no delay. Almost immediately the Prince began "Your Majesty, as president of this great Exhibition. . . ." The Prince is fortunate in possessing the ideal voice for broadcasting, coupled with the clearest diction. Every word of his was as plainly audible as if he had been standing beside one. It was a perfect little speech, and one felt that he said in the happiest way precisely what ought to have been said on this historic occasion. The end of his speech brought a tumult of cheering, and as soon as this had died away the King himself began. I imagine that a thrill must have passed through millions of listeners, not only in the British Isles, but also in Europe and even possibly in other continents, as they heard for the first time in history the voice of the King speaking to a vast audience both seen and unseen through the medium of wireless. It is quite certain that no other monarch has at any time spoken to anything like such a number of hearers, and the thing was made possible simply and solely by the microphone and by the utilisation of wireless. In the Stadium itself was an immense assembly, all of whom could hear plainly owing to the installation of huge amplifiers, which threw the speaker's words to the farthest corner. The microphone was also connected through a controlling apparatus with a land line running to 2 L O, whence every spoken word was broadcast over the length and breadth of the country either by direct wireless or by a combination of land line and wireless transmitting gear.

Success

There was a little induction at times, but on the whole the broadcasting of the two speeches was an unqualified success. If anyone failed to hear properly he must blame his set and not the transmission. One curious effect was noticeable, and this was a very strange echo. If you were using a not very powerful set you possibly obtained the impression that someone else was speaking in the distance at the same time as both the King and the Prince.

With a big set the reason for this strange effect became at once obvious. It was caused by an echo. I imagine that what happened was this: The speaker's voice thrown out by the loud-speakers arranged above the dais was reflected by the sides of the Stadium and so returned faintly to the microphone, which faithfully transmitted these sounds. I think that this must be the right explanation, for I noticed that when the King made a fairly long pause the last syllables that he had spoken came back in something rather less than a second. The velocity of sound is about 1,170 ft. a second, which would mean a journey of roughly 600 ft. out and the same distance back.

A Busman's Holiday

Like the rest of the world, I took a few days off at Easter and went down to the country. I know, of course, that I should not have thought about wireless at all, but should rather have spent my time in planting potatoes or whatever one does in a garden at this time of the year. As a matter of fact, I took a large set with me as a present to the people with whom I was staying, and my entire time was spent either in working the set or in making up gadgets for it in my host's splendid workshop. The locality to which I went was a small town in Wiltshire, which has the reputation of being something of a "blind spot." I was therefore a little nervous about what my set would do. We tried it first of all upon a frame aerial, for I was rather keen to see what one of these contrivances could accomplish. I think I have mentioned that in my own house such a thing is absolutely useless. If the frame had been up to the mark I believe that would have done fairly well, for what we did get through on it was not too bad. Unfortunately—it was a borrowed frame—there was a disconnection when it was rotated on its pivot. For this reason we did not bother much with it, but rigged up straightway a temporary aerial and a gas-pipe earth. On these the results were very encouraging, and it was decided *nem. con.* that a permanent earth and aerial should be installed forthwith. The next few hours saw us busily engaged in stringing up a 100-ft. length of 7/22 and in burying a biscuit-tin as near the bowels of the earth as time and our aching backs would permit. This having been done, we turned on the set with very satisfactory results. Down there Bournemouth is the big noise, with Birmingham and Cardiff an equal second. It seemed strange to find 2 L O taking a back seat, for one is so used to finding him swamping everything else. Every British broadcasting station came in at very good loud-speaker

:: :: *On Your Wavelength (continued)* :: ::

strength. When I say this I mean that if you put the spout of the loud-speaker out of the open window you could hear perfectly 50 yd. away. Bournemouth was actually audible at 120 yd. from the window, and this without a trace of distortion. What set was I using? I am afraid that I must make use of the words of an ex Prime Minister and ask you to wait and see. It is one of entirely novel design, which is both easy and cheap to make. The Editor of AMATEUR WIRELESS has earmarked it for his readers and a full description with many photographs will appear in the pages of this journal before very long. I will only tell you now that it is by far the handiest thing that I have ever used and that if you make it properly you can work it all out without the slightest trace of oscillation. In fact, whilst I was down in Wiltshire, I bet an expert five bob that he could not produce a squeak from it and won hands down!

Something Really New

One hesitates to claim novelty for anything in wireless nowadays, for if you do have a bright idea you are pretty sure to find that somebody else has had it several months before. Still I do think this set is something quite out of the ordinary, and I feel sure that you will agree when you come to read the description of it. One of its beauties is that, though it is not a unit set, it can be made up gradually as the state of your pocket or the amount of your leisure time permits, and that it is a complete working set as soon as the first steps are completed. You can then go on to make it into a really huge affair, which will bring anything that is within the receiving range of the most sensitive set. But I must not tell you any more or I shall be accused of poaching on somebody else's preserves.

The Fifth Symphony Concert

Despite its preponderance of Russian music, the fifth Symphony Concert at Central Hall proved highly successful. Conducted by L. Stanton Jefferies, his experience of the ways of the microphone ensured by far the best transmission. That the intricacies of Rachmaninoff's Piano-forte Concerto became in many cases a blurred mass of sound was not due to the soloist, but to the hall itself, which invariably causes the echoes to interfere with aerial music. Tchaikowsky's "Pathetic" Symphony is another work in which the dramatic pauses and delicate nuances become so many "fade-outs" when heard over the ether. For the rest, the quaint *L'Apprenti Sorcier* of Dukas and the more commonplaces of Grainger and Balfour Gardiner came over well.

A Marked Improvement

The raising of the ban against wireless by the most prominent of the concert

artistes has resulted in a marked improvement in the musical arrangements. 2 L O especially has benefited by the appearances of such players as Albert Sammons (violin), William Murdoch, the Australian pianist, Cedric Sharp ('cellist), and Beatrice Harrison. On the theatrical side we have had Athene Seyler, Reginald Back and Milton Rosmer, as well as Ann Trevor, the clever little film star and actress whose "Sweet Lavender" stood out so prominently last season.

The Amateurs

There seems to be a large amount of work going on on about 100 metres of late. I have amused myself with listening to some of these amateurs and find their experiments exceedingly interesting. Some of them appear to work all through broadcasting, although harmonics from 2 L O and 5 N O sometimes interfere.

I recently heard 5 X S, 2 P W and 2 X D very busy on this short wave and also one or two who did not give any call sign.

A station which interested me recently was a French station, 8 O B, who played gramophone records continuously for about half an hour. He came in very strong on 100 metres. I think that this is the first time I have heard this station, though I have not the slightest idea of his location.

There is a rumour that the next month or so will see whether or not amateurs will be moved off the wavelengths of 150-200 metres, which they have so ably developed, in order to make room for commercial stations, who have noted the possibilities of short-wave working. I rather wonder where they will be placed next—possibly to 100 metres.

There appears to be some misunderstanding as to the meaning of the term "dummy aerial licence" as issued to the majority of amateur transmitters. Such an aerial is composed of resistance, inductance and capacity, and should be as nearly non-radiating as possible; in fact, the radiation should not extend beyond the licensee's premises. Now in the London area there would appear to be about six hundred amateur transmitters, out of which it is pretty safe to assume that there are only two hundred radiating licences, the remainder being dummies. It is evident, however, that some of the holders of non-radiating licences do not hesitate to put their instruments on to the open aerial and add to the jamming already existent. The Post Office could greatly assist in clearing up this evil if they would leave open for public inspection an official list of transmitting stations.

Apropos my remarks concerning 6 N H's transmissions in these columns recently, your "Thermion" is in disgrace again. I mentioned that I could detect no difference between his 5- and 10-watt transmissions.

and he now writes and confirms that 5 D T found the same thing in daylight, but that a considerable difference was noticeable at night. My observations were made in daylight, so that I'm glad that they were confirmed.

6 N H goes on to suggest, however (and here's the rub!), that I might think that he misrepresented his input and that I should take my own instruments to his station and see for myself. I do not misbelieve 6 N H for one moment; nothing seems impossible in wireless.

A Dead Language and a New Science

Have you ever noticed how the conversation between wireless friends—on however remote a subject it may be—gradually and inevitably veers round to the common subject? An old school friend and I were discussing Latin tags the other night, when it occurred to us that, foreign to the science as they may at first appear, they were not wholly dissociated with wireless. Take, for example, the famous motto of the Black Watch—*nemo me impune lacessit* (no man shall injure me with impunity)—how well that might apply to the fragile valve! And for the user of reaction, what more apt than *crescit eundo* (it increases as it goes), especially if taken together with the injunction *ne quid nimis* (go not too far). Should he disregard the latter, *brutum fulmen* (a loud but harmless menace) is sure to be applicable; whilst the silent sufferer two or three aerials away may ruefully reflect that *accerrima proximorum odia* (the quarrels of near relations are the bitterest). As a reminder, too, to those forgetful amateurs who, on hearing no signals, disembowel their sets, only to discover that aerial and earth leads had not been connected, the receiver panel might be suitably engraved, *caret initio et fine* (it requires both beginning and end). Or if the condenser refuses to condense, why not label it *non compos mentis* (of unsound mind) and relegate it to the junk shelf? Under such an ignominious tag it might, for very shame, reform!

Harmonics Again

I have had several interesting letters from correspondents on the subject of harmonics, to which reference was made in these columns a week or two ago. Though such recognised authorities as Bangay and the author of the Admiralty book of wireless telegraphy lay it down that harmonics in wireless are quite different from those in music and that they occur only on one-third, one-fifth, one-seventh and so on of the fundamental, I have always had a lurking suspicion that this was not quite true. You can prove that they cannot occur on other waves, but experience has led me to believe that they do. Yet another case of theory and practice not going hand in hand. THERMION.

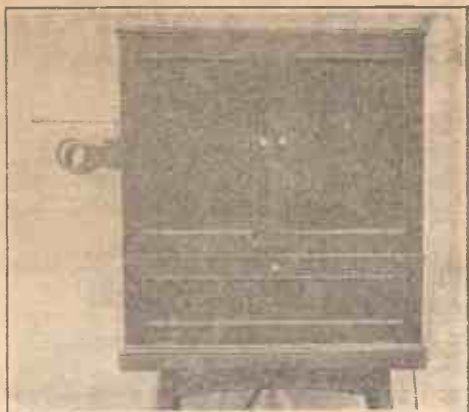

The Receiver Closed.

A FOUR-VALVE CABINET RECEIVER

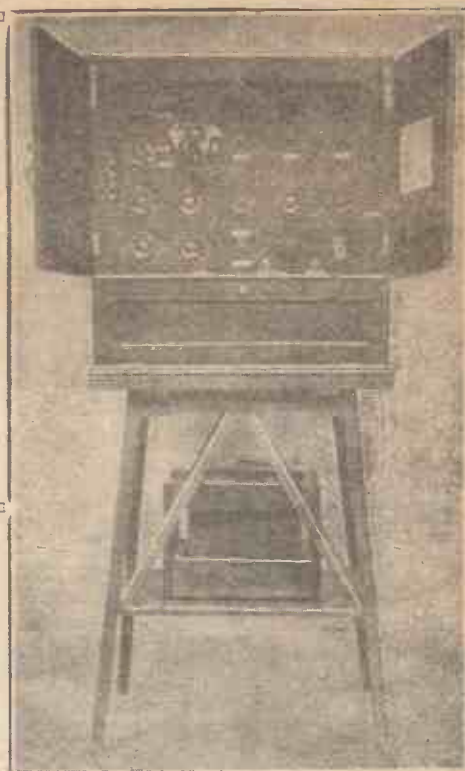

The Receiver Open.

THE object in building the set illustrated by the photographs was to obtain, if possible, the ultra efficiency of a full experimental circuit combined with the finish and appearance of the commercially-produced article.

Standard components were used throughout. As four valves were to be used the ordinary standard circuit was decided on, with one valve operating at H.F. and two at L.F., this combination giving ample power for operating the loud-speaker.

Tuning is carried out by means of plug-in coils so that operations can be carried out on any wavelength. The aerial circuit is tuned by a .001 microfarad condenser and the closed circuit by a .0005 condenser, while the tuned-anode coil, which is shunted by a .0003 condenser, is coupled to the reaction coil. As double circuit tuning is often difficult, a stand-by-and-tune switch was fitted and also a series-parallel switch. These two switches can be seen at left top corner of panel.

The valves are carried on an ebonite strip behind the panel and are viewed through ruby glass ports let into the panel. Any number of valves from one to four can be switched into circuit by means of the anti-capacity switches situated immediately under the valve

windows. A separate rheostat is provided for each valve. Those for the H.F. and detector are fitted with a vernier attachment. At the bottom right-hand corner of the panel are fitted jacks for telephones or loud-speaker, a double-throw switch putting either into circuit. Between these two jacks is mounted the potentiometer controlling the grid of the H.F. valve. This gives critical reaction effect and prevents oscillation. Immediately to the right of this is the master switch for L.T. battery.

The panel itself measures 20 in. by 15 in. by $\frac{1}{4}$ in. and is recessed 5 in. into the cabinet. From the top of the cabinet is hung a small electric pendant lit from the accumulator and controlled by a switch on the right side of the cabinet. On the ledge at the front of the panel are a voltmeter and an ammeter.

The cabinet is provided with a compartment underneath with a fall-down door. In this are housed the H.T. battery, telephones, spare coils, etc.

Situated some fifteen miles south of 2 L O, all broadcasting stations are easily received on the first two valves, while with three the loud-speaker is usually switched on for stations within a 200-mile radius.

With the loose-coupled tuner any station can be received without any interference from London, with possibly the exception of Cardiff. Eiffel Tower, Radiola, L'Ecole Supérieure and Brussels come in clearly about the same strength as Birmingham.

With four valves all Continental concerts are clearly received on the loud-speaker without any distortion.

One or two minor alterations have been made to this receiver since the photographs were taken, which no doubt will be apparent from the description.

J. H. F.

Working on a wavelength of 370 metres, a new American station, WGN, has been opened by the *Chicago Tribune*. Have you heard it?

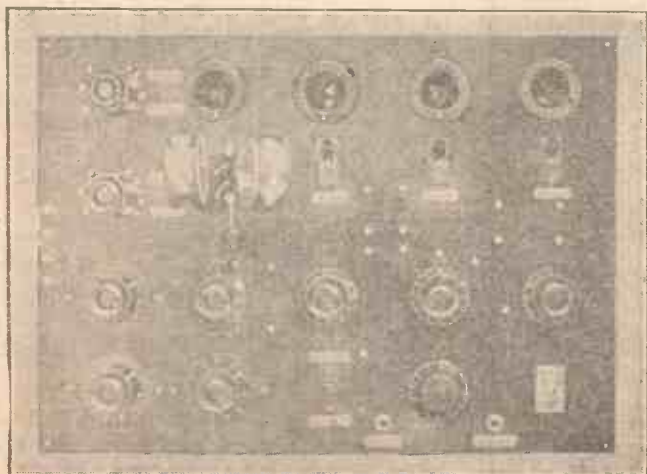

The Panel with Coils and Controls.

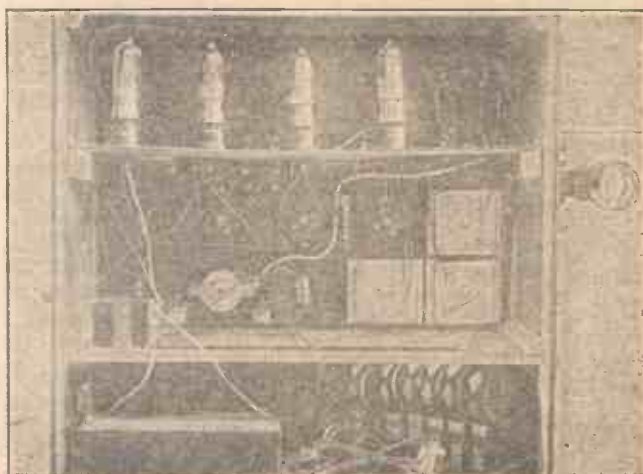

Rear View showing Valves and Components.

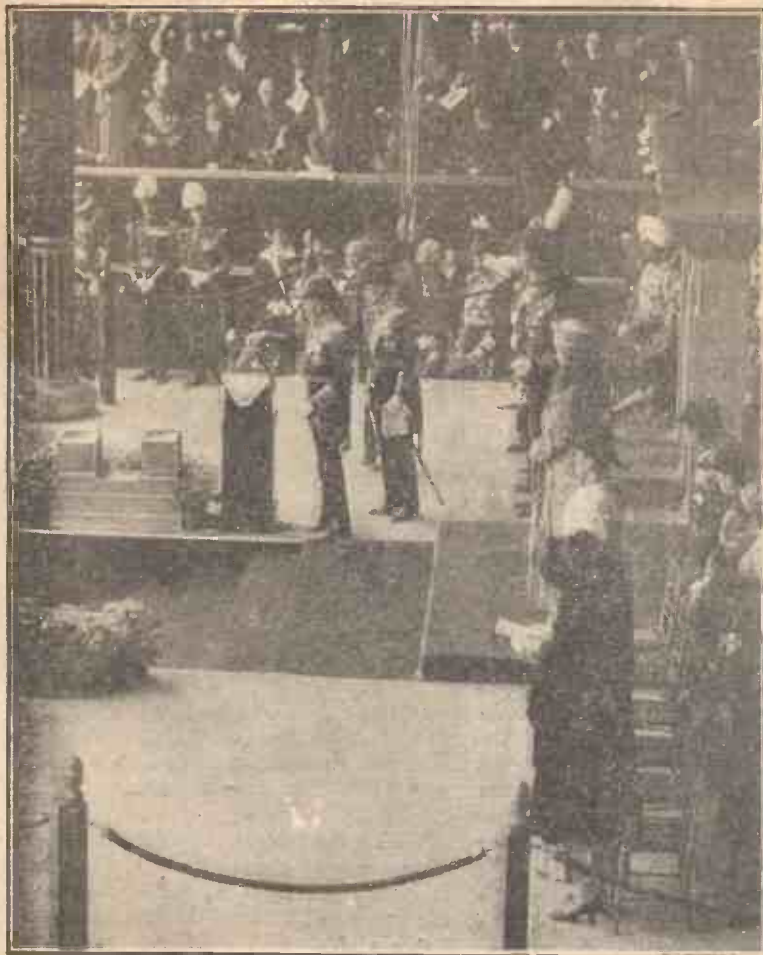

An historic photograph of the King opening the British Empire Exhibition. The two microphones for broadcasting the speech are in front of His Majesty and the microphone for the battery of loud-speakers throughout the Exhibition is suspended from the canopy.

TO broadcast the whole of the opening ceremony of such a magnificent and huge enterprise as the British Empire Exhibition is indeed a great undertaking. That the B.B.C. successfully carried out the scheme will stand for ever to their credit. It was the best thing they have yet done. Clear and distinct reception has been reported from all parts of the British Isles. In spite of the more or less experimental nature of the transmission, no hitch whatever occurred.

The King's Microphone

Elaborate arrangements had been made by the B.B.C., whose engineers left nothing to chance. Duplicate microphones and amplifiers were installed so that no last-minute accident should prevent the broadcasting of the King's speech. It was at first proposed to have a microphone on each side of the throne, about five feet from the King. Tests showed, however, that as the King would be standing on the left-hand side it would be better to put both the microphones there. This was an improvement in all respects. The Prince of Wales also stood on the left whilst addressing His Majesty.

Some hours were spent in testing the

THE British Empire Exhibition at Wembley was opened by His Majesty the King on April 23, 1924. The consent of His Majesty to allow his voice to be broadcast throughout the Empire is a milestone in the progress of wireless broadcasting, and the decision is one of far-reaching consequence. The success of the experiment is beyond question, and it is estimated that nearly 10,000,000 people heard the opening speech. After such an event as this it is not too much to expect that broadcasting will come to be regarded as an essential at all public functions of importance.

times. Not that all the testing was carried out with such serious matter—extracts from diaries on postal information and rhetorical advertisements for somebody's cough lozenges lent colour to the test!

Other Microphones

In all there were three microphone points in the Stadium, although four microphones and amplifiers were used. Two were placed in front of the throne, one at the entrance of the Royal tunnel, and another on the stand used by Sir Edward Elgar when he conducted his choir. It was thought that some interference might take place here, as opposite the microphone is a tunnel leading to the main Stadium entrance. People talking and walking in this passage could be heard clearly during the tests, but if anyone was there during the opening ceremony

BROADCASTING THE KING'S SPEECH

THE OPENING OF THE BRITISH EMPIRE EXHIBITION

microphones and amplifiers to ensure that everything was in working order. The familiar "Hullo, hullo, hullo! One, two, three, four, five, six, seven, eight, nine, ten," went over the test lines many

noises caused by them were drowned by the voices of the choir.

The B.B.C. used their own microphones and carried out the whole of the arrangements themselves. In the ordinary way the microphones are mounted on stands (photographs of them have appeared in past issues of AMATEUR WIRELESS), but at Wembley these were dispensed with. The microphones were in no way formidable in appearance. Each was arranged to look like a small box covered with cloth, as shown in the photograph herewith. One observer, in fact, said that they looked like small bird-cages with the covers on!

Preventing Vibration

All the microphones were placed on the usual supports of soft sponge to prevent vibration. They were of the Sykes' type and in appearance similar to a piece of iron rod about 5 in. or 6 in. in diameter. The only "wireless" looking things about them were four terminals and four wires, the latter being protected from vibration with cotton-wool. But even these harmless-looking pieces of apparatus were hidden from view by frames covered with cloth. Those on the Royal dais were finished in gold and the other two in blue.

Each microphone is connected by land-line to the

B.B.C. kiosk, the central control point for all transmissions. An amplifier is installed in the kiosk and a duplicate instrument (by the Post Office) between the kiosk and Savoy Hill. In the kiosk is installed a 100-watt transmitter of the type used at the relay stations. This is supplied by three-phase alternating current from the mains.

The Stadium Observer

An engineer in the Stadium acted as an observer and was in communication by telephone with the kiosk throughout the opening ceremony. Operators at the kiosk were kept informed of what was happening in the Stadium, and could thus switch in circuit the nearest microphone. This arrangement worked perfectly. In the actual transmitting stations all the engineers took particular care that their

apparatus was absolutely as efficient as possible.

Those who listened in before 10.30 a.m. on Wednesday week probably heard the B.B.C. stations testing through from Wembley. By means of ingenious switching arrangements it is possible to send a transmission from the Wembley kiosk to Savoy Hill by either land-line or wireless without any interruption. The system used is similar to that employed some time ago for relaying opera from the Old Vic. For this transmission a very short wavelength was used. Nearly the whole of the opening ceremony was transmitted from Wembley to Savoy Hill by wireless, the land-line being used for only a few minutes.

Items Broadcast

Everything went off smoothly from 10.30 a.m. onwards. The massed bands, which numbered close on three hundred men of the Brigade of Guards and Pipers, came through excellently, although at times the big drum seemed to predominate. An item by Sir Edward Elgar's choir of 10,000 voices was also received well.

During the preliminary items by the massed band and choir there was a considerable amount of laughing and talking amongst the 100,000 people in the Stadium. A few moments after the Prince of Wales started his speech (made audible all over the Stadium by an entirely separate public-announcing equipment installed by the Western Electric Company) there was complete silence everywhere, and as far as listeners could tell the Prince might have been speaking in a perfectly silent studio. The Prince's voice broadcast better than it came through the loud-speaking equipment at the Stadium, from which it sounded rather faint.

The King's Speech

The silence was even more complete when the King spoke. He was heard easily by listeners all over the country, who could not help but feel thrilled at the wonder of this great enterprise. The King's voice was slightly clearer than the Prince's.

After the speeches and the Bishop of London's prayer more items by the massed bands and choir were broadcast. Listeners did not hear the salute of twenty-one guns or the hum of an aeroplane overhead. This is surprising, for both were quite loud in the Stadium. Orders to soldiers were clear, and at one time voices of mounted police who got too near a microphone threatened to drown everything. It is estimated that nearly ten million people heard the King's voice for the first time. Such a large audience can only be made possible by organised broadcasting.

In the evening the King's speech was re-transmitted from a gramophone record made during the morning. Thus those who were unable to listen to the actual ceremony did not have to forgo the pleasure of hearing the King's voice. The speech was heard by at least one listener

in the United States (Poughkeepsie, New York).

Little Oscillation

Little trouble was caused by oscillation and no interference was experienced from other transmissions, as service and Post Office messages were not dealt with during the time the B.B.C. were broadcasting.

The B.B.C. kiosk, decorated in gay colours, is just outside the main Stadium entrance. At the side of it are two tall masts that support the aerial. The earth consists of copper plates buried in the ground around the kiosk. Visitors are not allowed in the kiosk, but the apparatus can be seen through the windows.

Future Programmes

By means of special lines connecting with the Post Office exchange it is possible to broadcast events taking place in almost any part of the Exhibition. Four special Amplion loud-speakers built in the roof of the kiosk will be used for reception. Special programmes, such as bands and conferences, will be broadcast from Wembley as opportunity arises.

LOUD-SPEAKERS AT WEMBLEY

The Western Electric Company's Public Address System

OF more direct interest to those who attended the opening of the British Empire Exhibition than the actual broadcasting of the ceremony were the huge loud-speakers installed by the Western Electric Company. Five of these, each 10½ ft. long, were arranged in a semi-circle over the Royal dais. Through them the whole of the speeches of both the King and the Prince of Wales were clearly heard by the 100,000 people in the Stadium.

A Special Microphone

The microphone into which the King spoke, a small affair only about 7 in. in diameter, was hung in front of the throne (see photograph on opposite page). It was suspended by means of spiral springs inside a wire-cage housing. Although looking simple enough in its gilt covering, this microphone was not without complicated points of design. It consisted of a heavy steel ring supporting a tightly stretched duralium diaphragm less than 2/1,000 in. thick, on each side of which was a small chamber containing carbon of special quality. This microphone was designed to do away with the distortion inherent in the usual carbon-type instrument.

It took some time to get the microphone in the best position, and Sir Travers Clarke (the chief administrative officer of the Exhibition) himself took a prominent part in the tests. At first the best reproduction was obtained when a speaker, standing in the position that would be occupied by the King, turned his head to the left. Of course, during the test, when the Stadium was empty, there was a considerable amount of echo, and that had to be allowed for. After several trials the best position of the microphone was found for both the King's and Prince's speeches.

Two Amplifiers

Leads from the microphone were taken underneath the dais, where the amplifying apparatus was situated. Two amplifiers were used, one with three valves and the other with four valves. The former gave three stages of amplification and the latter only one stage, the four valves being arranged in parallel. The two amplifiers give an output of 40 watts, enough to give speech in 14 million pairs of headphones!

(Concluded on page 562)

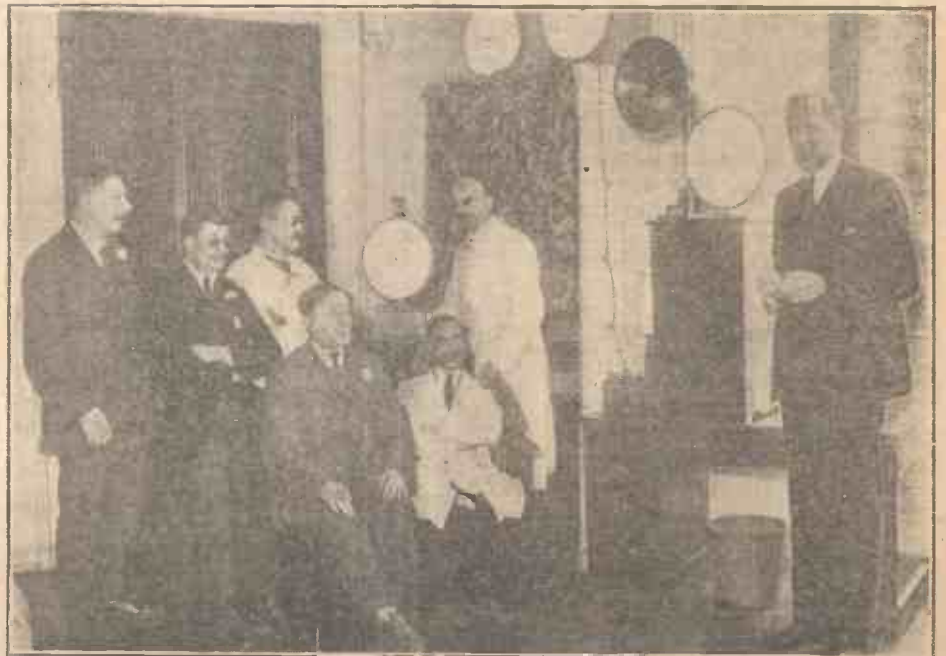

The blind inmates of St. Dunstan's listening to the King's speech broadcast from Wembley.

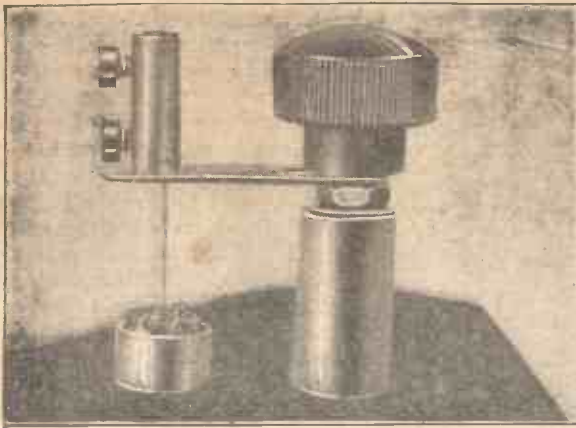

The Carborundum-steel Detector.

RECEIVING sets using the catwhisker type of crystal are very subject to the effects of vibration and quite a slight jar will often prove sufficient to upset adjustment, especially if the contact happens to be particularly light. The use of the carborundum and steel rectifying combination, as incorporated in the broadcast receiving set about to be described, entirely overcomes the chance of reception being disturbed by vibration. In ordinary circumstances nothing short of a deliberate attempt to put the detector out of action will cause any part of the programme to be missed.

A Stable Detector

Readers may ask why is the carborundum-steel detector not incorporated in every crystal receiving set and thus obviate once and for all the vibration trouble. The answer is that in order to obtain the maximum rectifying effect, or, in other words, to obtain loudest signals from the carborundum type of detector, a small current of electricity of definite value and direction must be passing through the crystal and contact during the time reception is in progress; this means a little extra complication in the set. The gain, however, in robustness of the completed instrument justifies, in the writer's opinion, the little extra trouble involved. If a good crystal is obtained the sensitiveness of the receiver will be quite equal to that of the ordinary catwhisker type.

Components

The necessary material and components for the construction of the set are as follow:

Polished hard-wood box, without lid, 7 3/4 in. long, 6 in. wide, by 5 1/4 in. deep inside. The wood should be about 3/8 in. thick. Matt-finish ebonite panel, 7 3/4 in. by 6 in. by 1/8 in. or 1/4 in. thick. Quarter-pound reel No. 22 s.w.g. enamelled-copper wire for winding the tuning coil. Half-ounce reel No. 36 s.w.g. enamelled Eureka resistance wire for winding the potentiometer. Fixed condenser .002 microfarad. Plug-in coil holder for hold-

A BROADCAST "EVER-SET"

ing loading coil (see Fig. 1). Ebonite strip, 4 in. long, 1 in. wide by 1/4 in. thick, for the tuning-coil clamping arm (see Fig. 2). Eight No. 4 B.A. telephone-pattern terminals complete with nuts and washers. A small on-and-off switch (this may be of any type suitable for panel mounting). Fig. 3 shows the switch used in the writer's set; it is called a miniature turn switch and has a base about 1 in. in diameter. A cardboard cylinder, 3 in. diameter by 4 1/4 in. long; this constitutes the tuning-coil former and is shown in Fig. 4.

An ebonite rod or tube 7/8 in. in diameter by 4 in. long; this is the former on which the potentiometer wire is wound (see Fig. 5). Three brass bushes with clamping nuts of the size made to pass a 2 B.A. rod. (These bushes are shown in Figs. 6 and 7). One vernier variable condenser spindle as shown in Fig. 8. Two 1 1/2-in. diameter 2 B.A. ebonite knobs for tuner and potentiometer control. Six white ivorine name plates. One ivorine scale 0-180 degrees. This is for the potentiometer and is to be altered as shown

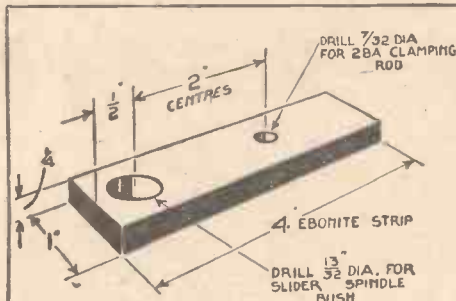

Fig. 2.—Details of Ebonite Strip.

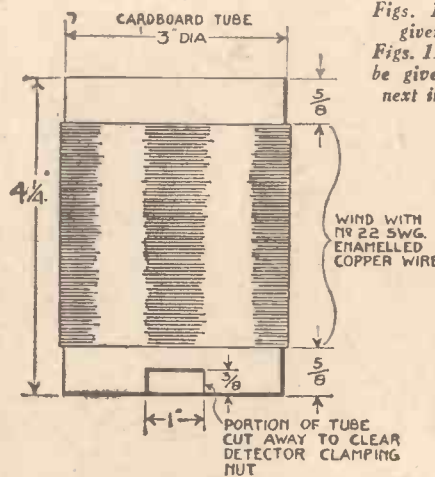

Fig. 4.—Details of Tuning Coil.

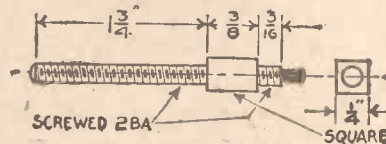

Fig. 8.—Condenser Spindle.

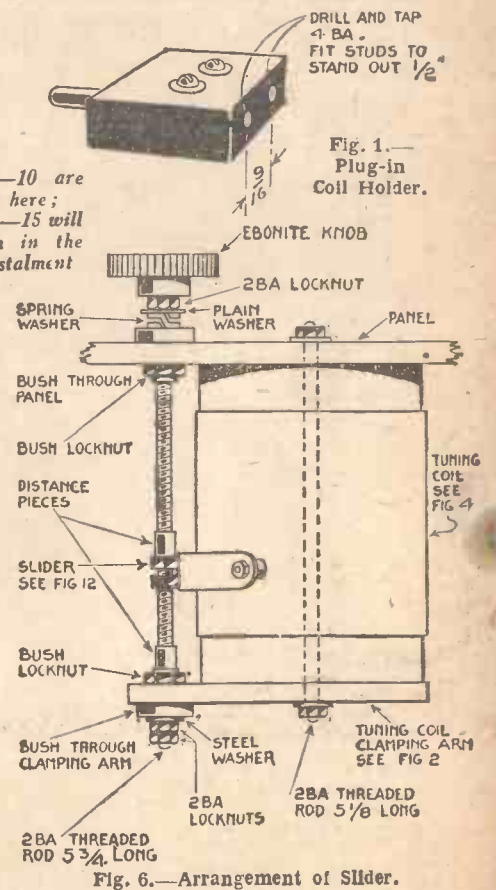

Fig. 6.—Arrangement of Slider.

Figs. 1-10 are given here; Figs. 11-15 will be given in the next instalment

Fig. 1.—Plug-in Coil Holder.

RECEIVER WITH CRYSTAL



in Fig. 9. One brass or ebonite tube $\frac{1}{8}$ in. in diameter by $\frac{3}{8}$ in. long; this is for the detector, as shown in Fig. 10, and should be sufficiently large in bore to pass a 2 B.A. rod. One small connector fitted with two set screws (also for the detector). One brass strip $1\frac{3}{4}$ in. long, $\frac{1}{2}$ in. wide by $\frac{1}{8}$ in. thick for the detector arm. One steel needle about $1\frac{1}{2}$ in. long. One crystal cup without screws. One carborundum crystal. One metal pointer for potentiometer. Brass strip $2\frac{1}{2}$ in. long, $\frac{1}{2}$ in. wide, $1/64$ in.

thick for potentiometer slider (Fig. 11). One $\frac{1}{8}$ -in. diameter brass rod 1 in. long (also for potentiometer slider). One brass strip $3\frac{1}{4}$ in. long, $\frac{1}{2}$ in. wide, $\frac{3}{8}$ in. thick for tuning-coil slider (Fig. 12). One small brass contact stud and nut (see Fig. 12). Twelve each large and small condenser-plate spacing washers for distance pieces on tuner and potentiometer slider spindles (see Figs. 6 and 7). Two No. 4 B.A. countersunk brass screws for securing potentiometer winding former to panel (see Fig. 5). Seven No. 2 B.A. brass

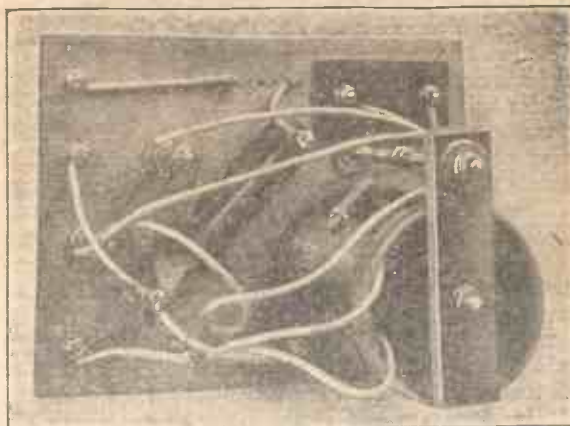

Back View of Panel.

nuts. Two No. 2 B.A. spring washers. Eight No. 2 B.A. plain washers. One No. 2 B.A. pillar terminal for coil-holder short-circuiting plug (Fig. 13). One brass strip $1\frac{1}{2}$ in. long, $\frac{3}{8}$ in. wide, $\frac{1}{4}$ in. thick (for coil-holder short-circuiting plug). Two No. 4 B.A. studs $\frac{3}{8}$ in. long, complete with nuts and washers, for securing coil holder to panel (see Figs. 1 and 14). Four No. 8 B.A. round-head screws, nuts and washers for securing switch and potentiometer scale to panel. Two No. 8 B.A. countersunk-head screws, nuts and washers for securing condenser to panel. One ebonite knob for holding detector contact-arm to detector post. One 2 B.A. steel washer. One $4\frac{1}{2}$ -volt box-type dry battery fitted with terminals. Four $\frac{3}{4}$ -in. wood screws for fixing panel to box. One length of 2 B.A. rod $5\frac{3}{4}$ in. long for tuner slider spindle (Fig. 6). One ditto $5\frac{1}{8}$ in. long for tuner clamping rod (Fig. 6). One ditto $1\frac{3}{4}$ in. long for detector post (Fig. 10).

One steel needle about $1\frac{1}{2}$ in. long. One crystal cup without screws. One carborundum crystal. One metal pointer for potentiometer. Brass strip $2\frac{1}{2}$ in. long, $\frac{1}{2}$ in. wide, $1/64$ in.

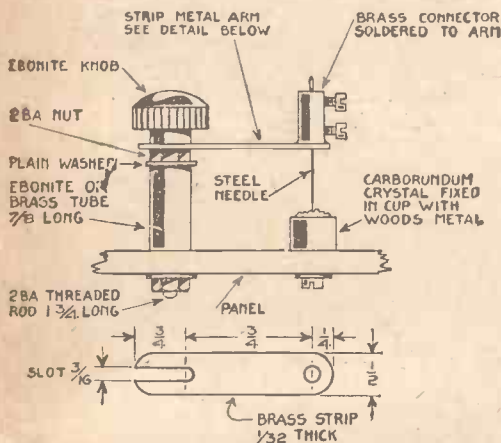

Fig. 10.—Detector and Slotted Arm

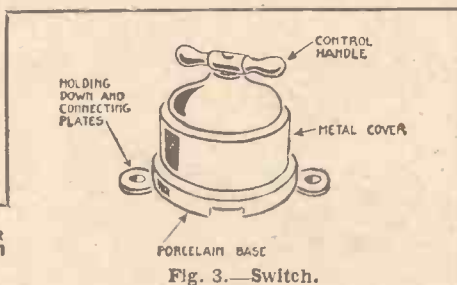

Fig. 3.—Switch.

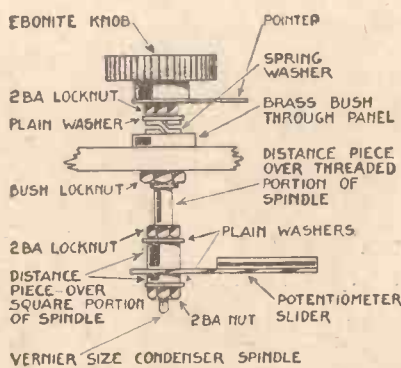

Fig. 7.—Details of Control.

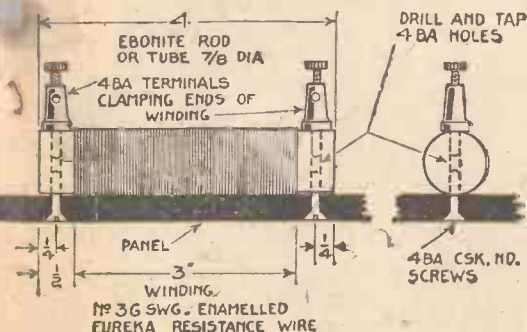

Fig. 5.—Constructional Details of Potentiometer.

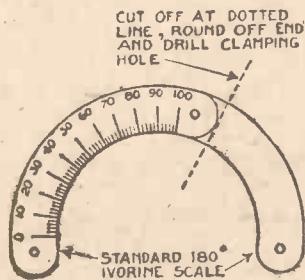

Fig. 9.—Scale.

Preparing the Panel

After trimming the edges of the ebonite panel to suit the containing box, drill it as indicated in Fig. 15, and also the holes for the switch, telephone condenser and scale. The plug-in coil-holder, tuner clamping arm and potentiometer winding former also require drilling as shown in Figs. 1, 2 and 5 respectively. With regard to the tapping called for in Figs. 1 and 5, a No. 4 B.A. "second" tap will be found suitable, or, alternatively, a home-made tap consisting of a short length of 4 B.A. threaded brass rod filed roughly to the shape of a tap will answer quite well.

Fig. 4 shows the winding details and dimensions of the tuning inductance; the cardboard tube should be cut with its edges square with the sides, so that when mounted in position on the panel it will stand upright; a small slot, as indicated in the diagram, is required in one end of the cylinder in order to clear the nut holding the detector post to the panel.

Winding the Tuner

To begin the winding make three small

holes $\frac{5}{8}$ in. from the slot end of the cardboard tube and anchor the end of the No. 22 copper wire through them; proceed to wind on the wire as evenly and tightly as possible until a length of approximately 3 in. has been covered; now make a second row of three holes and cut and anchor the wire, leaving a projecting length for connecting up purposes of about 7 or 8 in. To complete the inductance give both tube and winding a coat of shellac varnish and allow to dry thoroughly.

The potentiometer winding, as shown in Fig. 5, may now be proceeded with. Shorten the leg of the No. 4 B.A. terminals to about $\frac{3}{8}$ in. and screw it into one of the tapped holes in the ebonite rod or tube. Remove the enamel insulation for about $\frac{1}{2}$ in. from the end of the No. 36 Eureka resistance wire and clamp it securely between the terminal and the ebonite. The winding should be put on as evenly and tightly as possible. On completion of the 3 in. of winding cut and clean the end of the wire and clamp it securely underneath a second terminal shortened and screwed into the ebonite former.

A. P.

(To be continued)

PUTTING-UP AN AERIAL

"Hints" by Bosphor Pronz

1. **REMEMBER** to put the halyard through the pulley at the top of the mast and remember to tie *both* ends of this rope securely to the bottom of the mast before the mast is hoisted up into position. By forgetting to do these two simple things many a man has given up wireless before he has really started.

2. When your mast is fixed and you are ready to hoist the aerial, remember that your aerial wire is designed to pick up wireless messages, and is not intended to pick up a representative string of garden relics, including old tin cans.

3. Bear in mind that it is a bad omen not to trip headling over the guy ropes of your aerial mast at least twice during the course of erection.

4. Don't forget to fix aerial insulators at each end of every wire before you hoist the aerial. Egg insulators, so called because they are white outside, have a yellow central core and tarnish with age, make an efficient lay-out.

5. Never crow about the number of eggs on your aerial. You will only start all the other wireless enthusiasts in the neighbourhood crowing about all manner of wireless gadgets.

When corresponding with advertiser please mention "Amateur Wireless."

AROUND THE SHOWROOMS

Accumulator Carrier

GLANCING through Ward and Goldstone's new catalogue, I was interested to see a neat accumulator carrier illustrated. It takes the form of an expanding wire "trellis" provided with side and bottom plates. Whilst suitable for use with almost any size of accumulator, it folds flat when not wanted, being in appearance like a small camp-stool. Such a carrier is lighter than a wooden or metal crate and vastly more useful. I am sure every accumulator user would find one well worth its cost, which is only 3s. Ward and Goldstone's address is Frederick Road, Pendleton, Manchester.

"Bijouphone" Crystal Set

AN interesting point about the little "Bijouphone" crystal sets is that vario-



"Bijouphone" Crystal Set.

meter tuning is employed. Two aerial terminals are provided, having between them a small series condenser that greatly extends the wavelength range of each receiver. Each variometer tunes from about 250 to 700 metres.

Moulded ebonite is used for the tops and bottoms of the sets, the detector being of the glass-enclosed variety with nickelled parts. Wates Bros., Ltd., of 12-14, Great Queen Street, Kingsway, W.C.2, sell these sets at 7s. 6d. (B.B.C. royalty 1s. extra). One that I tested gave quite satisfactory results. A beginner could not do better than start with such a set.

C.A.C. "Micropotentiometer"

A SMALL panel-mounting potentiometer with a ball contact is the latest component put on the market by the C.A.C.

people. The resistance wire is wound on a rectangular-section former. Thick brass supports are used, which make the instrument very robust. Although only $3\frac{3}{4}$ in.

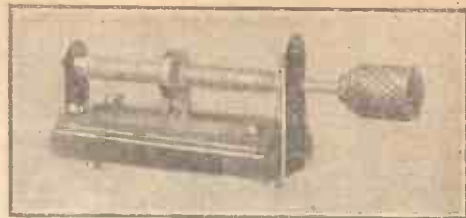

C.A.C. "Micropotentiometer"

in overall length, this potentiometer is wound to a resistance of 500 ohms. Its price is 6s. 6d., and it may be obtained from the City Accumulator Co., of 10, Rangoon Street, E.C.3.

Combined Mast and Frame Aerial

THE latest suggestion for outdoor aeri-als is to use an ordinary frame on a mast. Such an arrangement should give good results, as by means of a special pivot the frame can easily be made directional for any station. Mr. J. Abbey, of Watton, Norfolk, is putting on the market a combined frame aerial and mast, the latter being supplied in various lengths. Tested in Norfolk, one of these aeri-als gave as good signals with a three-valve set as an ordinary 100-ft. aerial. They should be of particular value in congested areas.

L.F. Choke Amplification

ALTHOUGH most people prefer transformer-coupled low-frequency amplifiers for general use, choke coupling should give purer signals and is therefore worth experimenting with. The connections employed are the same as for high-frequency resistance-coupled amplifiers, larger coup-

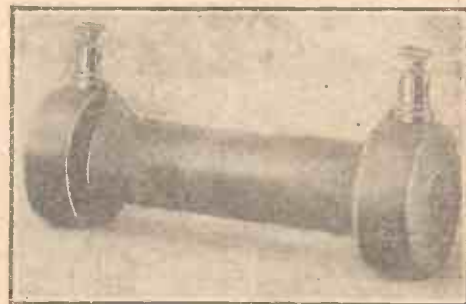

Low-frequency Choke.

ling condensers usually being used. Peto-Scott Co., Ltd., of 64, High Holborn, W.C., are making low-frequency chokes for use in such amplifiers. They consist, as can be seen from the photograph, of wire on a soft-iron core. VANGUARD.

AN IMPROVED H.T. BATTERY

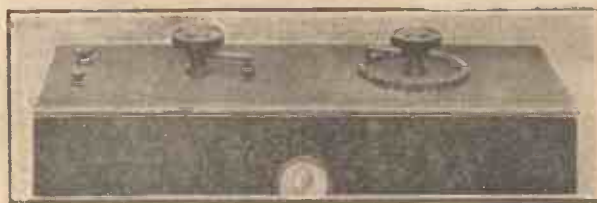

Fig. 1.—Photograph of H.T. Battery.

NEW ideas for valve sets, new methods of crystal reception, and novel ways for increasing the efficiency of receivers generally are constantly being published; a new and improved type of high-tension battery is something out of the ordinary, however, and the writer is indebted to Mr. Henry Warwick, of Cricklewood, N.W.2, for permission to publish a detailed account of the instrument he has evolved and constructed for use in his

Overall length 15 in., height 6 3/4 in., width 6 in. The case may be made in either teak or mahogany, with a top panel of ebonite, 1/4 in. thick, with carefully bevelled edges, overlapping the top edges of the case by 1/8 in. all round. The top surface of the ebonite panel should be finished a dull matt.

Drilling the Panel

It is an advantage completely to finish the polishing of the panel before attempting to drill it. The best method is completely to polish the panel first and then to make a tracing of the position of the holes to be drilled as indicated in Fig. 2. Holes will be required for the terminals + and -, for the vernier switch VS and contact studs, and for the main switch MS, with the necessary studs placed to form a complete circle.

The tracing should be made the full size of the panel, and the position of the holes to be drilled marked with a small centre punch and light hammer. The drilling will have to be done very carefully, one hole drilled out of place being sufficient to spoil the effect of the whole panel.

Fitting the Switches

The contact studs and switches used are the standard type; the contact studs are

The Containing Case

As mentioned, the containing case may be either of teak or mahogany, and the panel so mounted on the top that the edges overlap the sides of the case by 1/8 in. all round.

The reflector from an old pocket torch is polished up and fitted to the side of the case as shown in the photograph, a short length of springy brass being screwed on the inside of the case to make contact with the centre contact of a small pocket-lamp bulb.

The Battery

The battery consists of thirty pocket-lamp refills, each battery giving 4.5 volts when new. These should be placed in five rows of six deep and connected in series by means of small copper strips soldered from the short contact on one battery to the long contact on another. It will pay the reader to insulate each battery by wrapping a strip of insulating cloth ("empire" cloth) round each battery; the bottom of the case should also have sufficient paraffin-wax poured over to cover it completely. The battery may now be mounted in the case, strips of wood being pressed in at the sides of the batteries to prevent them moving about. It is most important that these batteries should not be jammed in the case too tightly on account of the fact that they are inclined to swell slightly after being in use.

Completing the Wiring

The diagram of connections is given by Fig. 3, from which it will be seen that the vernier battery VB is isolated from the main battery MB, being connected to the switch VS, which enables it to be cut out or brought into operation at will. The safety fuse is indicated at F. The connections from the battery to the contact studs, etc., should be carefully soldered.

Advantages

The greatest advantage gained is the ease with which the H.T. voltage may be varied without the necessity of making connections or even manipulating a wander plug. The other advantage is the fact that the voltage is more variable over the whole range of the battery and also that should one or other of the 4 1/2-volt units become defective it may be easily replaced.

A. W. HULBERT.

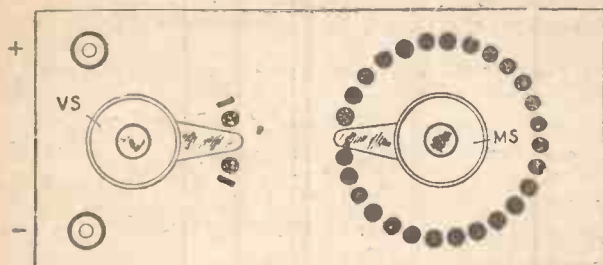

Fig. 2.—Plan of Panel.

exceedingly well equipped wireless laboratory.

The finished battery is shown by the photograph, Fig. 1. The switch on the right of the illustration is for varying the H.T. voltage from 9 to 135 volts, while the three-way switch on the left controls a 4.5-volt battery, which may be added to the main battery if required. By this means it is possible to obtain a variation of 4.5 volts over the whole range of the main battery. If desired, this extra battery may be cut out and the main battery only used, the right-hand switch giving a variation of 9 volts at a time. To anyone studying the illustration closely it would seem that an unnecessarily large number of tappings have been taken; actually every other stud is dead, to prevent a short when the contact arm of the switch passes from one stud to the other.

Another novel feature of the design is the safety fuse in the form of a small pocket-lamp bulb, which is fitted in a recessed reflector on the side of the case. This bulb is wired in series with the main battery, and as soon as an external short takes place, such as a valve inserted in the wrong way, the small screw bulb will immediately burn out, thus saving the valve or preventing damage to the H.T. battery.

Constructional Details

The first point for consideration is a suitable case for the battery; this must be sufficiently well made to enable the batteries to be packed in fairly tight. The dimensions of the case containing the battery under review are as follows:

4 B.A., fitted with nuts and washers, the switch-arm is a complete assembly with ebonite knob, etc., ready to mount in position. The main switch MS (Figs. 2 and 3) has thirty studs and the vernier switch three studs, two slightly longer studs being placed on each side to act as stops as shown in Fig. 2. The two main terminals indicated by + and - in Fig. 2 may be ordinary 2 B.A. terminals.

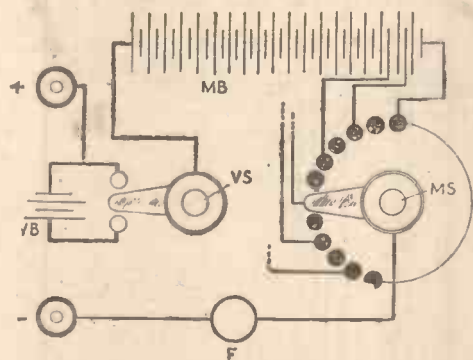

Fig. 3.—Diagram of Connections.

Radio Experimenter (Australia) defines an experimenter as one who unselfishly works for the general good of wireless science and quickly learns what he is doing—and why he is doing it



RULES.—Please write distinctly and keep to the point. We reply promptly by post. Please give all necessary details. Ask one question at a time to ensure a prompt reply, and please put sketches, lay-outs, diagrams, etc., on separate sheets containing your name and address. Always send stamped, addressed envelope and Coupon (p. 567).

Crystal-valve Combination

Q.—I wish to construct a receiver with the simplest apparatus, and do not wish to use more than one valve in conjunction with a crystal as detector. Which type of circuit would be best suited to this district?—N. E. C. (West Bromwich).

A.—As you are so near a broadcasting station, the best combination of valve and crystal would be the crystal as detector followed by the valve as a low-frequency amplifier. The crystal circuit would be coupled to the valve circuit by means of a low-frequency transformer. If you lived at a distance from a broadcasting station, say over thirty miles away, we would advise you to use the valve as a high-frequency amplifier, followed by the crystal as the detector.—P.

Inconsistent Tuning

Q.—I have a four-valve set, and I find that the tuning is very inconsistent. During the afternoon certain adjustments may be made for the Manchester station, but during the evening altogether different adjustments are necessary in order to receive the same station. This is more pronounced on distant stations. An explanation of this phenomenon offered me is that it is due to local re-radiating receivers. Will you please explain, in detail, the latter statement?—R. M. H. (Leicester).

A.—The explanation offered you is quite correct. Assume, for instance, that a certain station is transmitting on a wavelength of 400 metres. During the afternoon, when few listeners-in are using their receivers, you are able to tune your receiver correctly to 400 metres, and so receive the actual signal transmitted. During the evening quite a number of receivers in your locality are doubtless oscillating and re-radiating the signals that the sets are actually receiving. It should be borne in mind that although a receiver may

be receiving a signal on 400 metres, owing to reaction being employed, the same signal when re-transmitted by the re-radiating receiver will be on a wavelength a little above or a little below that of the original signal. It will be seen, therefore, that the original signal before reaching your aerial has been mutilated to a considerable extent, and that it is necessary to employ different tuning adjustments in order to receive when other sets in the locality are oscillating. When this state of affairs takes place it is often said that the signals are being heterodyned by local interference.—C.

Coils for Broadcast Reception

Q.—Could two coils of 100 turns each that I have been used for broadcast reception by placing a tuning condenser in series?—W. A. K. (Esher).

A.—No, a 100-turn coil cannot be used for broadcast reception even with a condenser in series. The only way you are likely to get down to the required wavelength is by placing the two coils in parallel, with a series condenser in the aerial circuit.—R.

Resistance for Accumulator-charging Board

Q.—I have a resistance frame as per enclosed sketch, and also an ammeter and voltmeter registering to 5 volts 5 amperes. I wish to charge accumulators at charging rates varying from 1 to 4 amperes. Will you please inform me what type of resistance wire to use, and also supply me with a diagram of connections. My lighting circuit is 100 volts.—S. D. (Burford).

A.—It should have been stated what number of cells were required to be charged at one time, as this affects the length of resistance wire. Assuming that only one 4-volt cell may need to be charged at a time the maximum volts to be dissipated at a charging

rate of 4 amperes will be $100 \div 4$ or 96 volts. Since resistance equals volts divided by current, 96 volts divided by 4 amperes = 24 ohms as the value of the series resistance which must be provided to keep the charging current to a maximum of 4

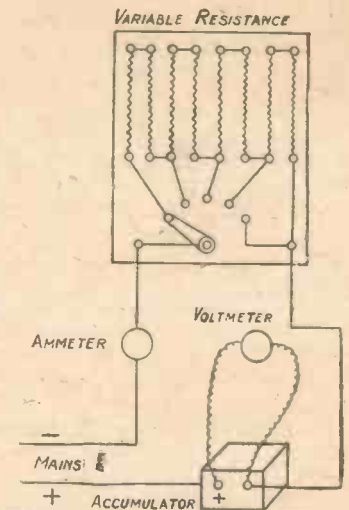

Resistance for Accumulator Charging.

amperes when in series with one 4-volt accumulator on a 100-volt circuit. Looking up a table of resistance wires it will be found that No. 21 S.W.C. Eureka will carry this current with a safe temperature rise of 200 deg. C., and as the resistance per yard of this wire is 0.837 ohm, there will have to be:
 total resis. = 24 ohms
 $\frac{24}{0.837} = 28.6$ yd. in order
 ohms per yard = 0.837 ohm
 to obtain the figure required. An illustration is given herewith showing the method of connecting up the resistance, accumulator and instruments to the 100-volt charging circuit.—Q.

Best Crystal-valve Set

Q.—I wish to use four pairs of phones and am undecided as to which of the following receivers would be most suitable. Crystal detector and one L.F. amplifier or crystal-valve dual amplification. Will you please advise?—L. E. E. (Surbiton).

A.—Although the dual-amplification circuit is the best from the point of view of efficiency, range of reception, etc., we cannot advocate its use unless only one pair of phones is employed, or a small loud-speaker. In most dual-amplification circuits the phones are connected in the plate circuit of the H. F. valve, and it will be found that if several persons are wearing phones connected to one of these receivers, any slight movement on their part will introduce undesirable capacity-reaction effects. This will cause the receiver to be very unstable. For this reason we advise you to employ the crystal as the detector, followed by the valve acting only as a low-frequency amplifier.—C.

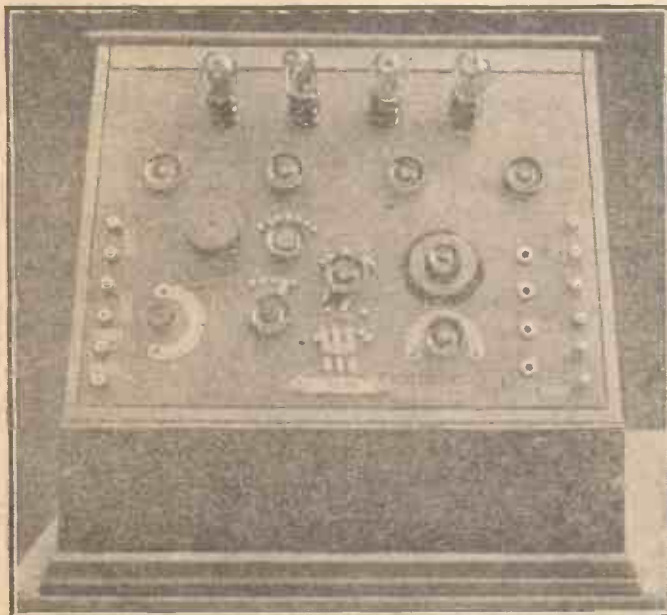

□ □ □
□ □ □

This self-contained cabinet set was constructed by Mr. H. C. Whitfield, of Battersea Park, S.W.11. Telephone jacks are used for selection of two, three or four valves as required.

□ □ □
□ □ □



THE call-sign 2 LO has been allocated to a broadcasting station at Sydney, Australia. Its wavelength will be 1,100 metres and its power 5 kilowatts.

The results of a competition held by a Manchester evening paper show that most competitors want light music and talks on sports and pastimes to be broadcast.

The Streets and Roads Committee of the Aberdeen Town Council has decided that those who have erected aerials across roads must see that they are taken down.

Wireless was introduced a few weeks ago into the ordinary curriculum of the Upper Standard School, Carlton, Notts. Already thirteen boys, whose ages range from 12 to 14 years, have made sets for themselves.

M. Belin, the French scientist, hopes to transmit the make-up of a newspaper in just the same way as photographs and handwriting. He has finished an apparatus for sending by wireless photographs of the Olympic games from Paris to the United States.

William Le Queux, the novelist, is going to Switzerland and will take a special receiver, it is reported, to the top of the Jungfrau, 13,000 ft. high, where he hopes to pick up the Bournemouth transmissions.

By the invention of a new alloy it has been found possible to load submarine cables with three or four times the normal traffic load. The alloy, which is called permalloy, takes the form of tape wrapped round the copper wire and inside the insulation of the cable. It is described in some circles as a "challenge to wireless."

It is reported that a new treatment for diseases by wireless has been quite successful. The treatment consists of sending wireless "vibrations," the frequency of which depends upon the case being treated, through the patient's body. It is stated that cripples have been completely cured and that a person, stone deaf at the age of seventy-eight, was made to hear.

Quite a large number of firms made arrangements to hire out wireless sets to people who wanted to hear the King's speech at Wembley.

The warrant for the arrest in London of a man charged with fraud was recently sent from India by wireless.

Arrangements for broadcasting a message to the Pope on May 4 are now complete. Cardinal Bourne will speak.

Mr. Thomas Hardy, the novelist, has been asked by the B.B.C. to prepare a programme for broadcasting from Bournemouth. He is considering the matter.

During the Children's Hour at 2 LO a short time ago a tea-party was given in the studio, with eight little listeners as the guests. All the remarks, conversation and laughter were heard by thousands of envious little listeners.

Mr. A. Birch, until recently the maintenance engineer at the Aberdeen station, has been appointed chief engineer of the Sheffield relay station, to succeed Mr. Harry Lloyd.

A number of loud-speakers have been placed in Roundhay Park, Leeds. Here the programmes are received from 2 Z Y. This seems to prove a greater attraction than the band performances.

A conference is in progress at Geneva with regard to the revision of the convention of wireless telegraphy drawn up in London in 1912. The preparation of a new international agreement for the allotment of wavelengths and the adoption of an international auxiliary language are two of the principal aims of the conference.

A broadcasting station is to be established in Honolulu, which will broadcast in English for the benefit of the islands of the Pacific.

The loud-speakers recently placed in Westminster Abbey have been a complete success, every word spoken from the pulpit being audible in all parts of the building. It is likely that similar arrangements will be carried out in St. Paul's and other cathedrals.

A memorandum, signed by enthusiasts in Paignton, Totnes and district, has been sent to the Plymouth station complaining of the weak signals received. It is stated that Plymouth cannot be received in these places with valve sets.

The National Homing Union Council are urging that wireless aerials should be corked, to prevent homing pigeons from flying against the wires. The G.P.O. have turned down a suggestion that corks on all aerials should be made compulsory.

A wireless set has been introduced into the waiting-room of the National Provincial Bank.

When the Dean of Manchester, Dr. J. G. McCormick, spoke from 2 Z Y recently he said, referring to difficulties

of speaking into a microphone, "You may exhort this little machine to repent of its sins, but it never turns a hair. You may suggest there are great things to be done in life, but it is quite unresponsive."

A trawler is setting out for Iceland this week to attempt to get in touch by wireless with the ice-bound ship *Bowdoin*. Its aerial will consist of eighty-four strands of spiralled wire spun into a cable not more than a $\frac{1}{4}$ in. in thickness.

On the occasion of the memorial service, held off the Grand Banks, Newfoundland, on the twelfth anniversary of the sinking of the *Titanic*, all ships in the neighbourhood kept their wireless silent for five minutes.

Bach's *Passion*, recently broadcast from 2 LO, was received on two loud-speakers in the Wesleyan Chapel, Manchester Square, London. One of the chapel officials has stated that in all probability the loud-speakers would become a permanent feature of the chapel.

At the time of going to press we learn that the B.B.C. are doing their best to make arrangements to broadcast the Budget speech of Mr. Philip Snowden, Chancellor of the Exchequer.

The St. George's Day programme was the first work in London of Major Corbett-Smith. It was as excellent as one expects from such a capable organiser.

No one except Mr. A. J. Alan knows what the B.B.I. is, but he will give a long and interesting account of this institution (?) at 10 p.m. on May 9!

On May 5 the programme will be opened by the Georgians Concert Party, which was prevented from performing at 2 LO on March 25 by the sudden illness of its producer, Mr. Robert Carr.

An invention by which stellar light is transformed into audible sound is to be demonstrated at the International Radio Exposition in New York this September. It is the invention of two experts of the French Military Wireless Laboratory of Paris.

Mr. Frank Dilnot, the well-known journalist, will speak at Vernon House, St. James's Street, on "Personalities of People I Have Met" on May 6. His talk will be phoned to 2 LO and there broadcast.

By the time this issue is in the readers' hands M. Coué should have broadcast.

Programmes from 2 LO have been altered slightly since the introduction of Summer Time. A dinner-hour transmission is given on Tuesday, Thursday and Friday from 1 p.m. to 2 p.m. Afternoon programmes are from 3.30 p.m. to 4.30 p.m. Special concerts for children will be given on Saturday from 4 p.m. to 6 p.m. The first news bulletin will be given at 7 p.m., with an interval from 7.30 p.m. to 8 p.m. From 8 p.m. to 11 p.m. concerts will be transmitted, except

on Savoy nights, when the bands will play from 10.30 p.m. to 11.30 p.m. As already announced, programmes will be given a lighter touch. Listeners should also "look out" for surprise features. Alterations in the programmes from provincial stations will be made in a few weeks' time.

Chess by wireless is the latest. During "off" times on Saturday afternoons the B.B.C. propose to broadcast chess matches. Two players at 2 L O will call out their moves, the idea being that two listeners with a chess set will move their pieces in unison. Each game, which will last about an hour, will be played with the idea of teaching beginners various moves.

During the "query programme" on May 7 the names of the artistes, orchestral items and even the announcer will not be disclosed.

On May 2 Sir J. Forbes-Robertson will give the third educational lecture from 2 L O on "Shakespeare."

The Rundfunkcenter broadcasting station works on a wavelength of 460 metres every evening from 8.30 to 9.45 B.S.T.

Up to the end of March there were approximately 720,000 licences issued. How long will it be before the million mark is touched?

Mr. H. P. Davis, vice-president of the Westinghouse Electric Manufacturing Company, predicts that within a few months it will be as easy to listen-in to London, Paris, Tokio and Melbourne as to tune to the local stations.

One of the chief Berlin hotels is fitting all of its rooms, of which there are some hundreds, with headphones for the reception of wireless concerts.

There are now thirty-seven distinct departments of the B.B.C.

We hear that Sir Frederick Sykes is interesting himself in the various problems affecting the Sheffield station.

Recently the Communion service was broadcast from a New York church.

Two firemen were electrocuted at Upper Monclair, America, as the result of an amateur's aerial being blown on to a 2,400-volt overhead cable. The aerial was being cut by the captain of the brigade when it touched his wrist, instantly killing him. The wire then blew against the face of another member of the brigade, who was attempting to drag the body of his chief away.

Modifications have recently been made at the Leafield station, and it is said that less interference is caused.

The United States Public Health Service now gives medical aid to ships at sea by wireless, as well as to ships in dock.

The nightingale is seldom heard in the North, and listeners there will be interested in the B.B.C.'s proposed attempt to broadcast the song of this bird.

EXPERIMENTAL SENDING LICENCES

An Official Announcement

THE Postmaster-General has recently been considering, in consultation with the various interests concerned, the question of revising the conditions applicable to experimental sending licences, with the view of reducing as far as possible the risk of interference by amateur stations with the reception of broadcast programmes, while at the same time affording liberal facilities for *bonâ fide* experimental work.

The conclusion has been reached that there is now little need for experimental work in spark transmission, and it has been decided that no licences for such work shall in future be granted. Existing permits will be amended as soon as possible. It has for some time past been the practice, when granting new sending licences, to prohibit the use of the 440-metres wave during the main broadcasting hours, and it has been decided to apply this restriction to all licensees.

As a set-off against these restrictions authority will be granted for the use of wavelengths between 115 and 130 metres (C.W. and telephony only) in cases where

the Postmaster-General is satisfied that *bonâ fide* research work is carried on and that the circumstances justify the concession.

The Postmaster-General takes this opportunity of pointing out that, under present conditions, it is impossible to ensure that broadcast programmes shall be completely immune from interference, but that much may be done to minimise the difficulties by using receiving sets which are capable of close tuning to the wave which it is desired to receive. If the receiving set is broadly tuned, and is consequently capable of receiving wireless signals within a margin of, say, 50 metres on each side of the desired wave, the number of extraneous signals likely to be intercepted will obviously be much greater than if the margin is only 5 metres.

It is reported that certain chauffeurs who park their cars near Marconi House during theatre hours fix up crystal sets, using a piece of flex as aerial and the chassis as "earth."

MARY PICKFORD AT 2 L O

An Impression by Louis Hertel

EVEN had one been unaware that Mary Pickford was due to broadcast from 2 L O on Saturday, April 19, it was obvious from the general atmosphere of orderly excitement in the studio that something special was expected; the collection of Press photographers complete with American accent and flash apparatus confirmed the impression still further.

"The World's Sweetheart" was due to address English listeners at 10.45 p.m. and at 10 p.m. "Uncle Rex" made a preliminary survey to ensure that the arrangements were complete. The R.A.F. band concluded their item, and the announcer tiptoed to the microphone to announce the two minutes' interval, as usual.

We sat round on the divans awaiting her entry. The two minutes dragged into four . . . someone donned a pair of ear-phones and we realised that Mary was broadcasting from the small studio. Ah, well, it couldn't be helped. The exigencies of a simultaneous broadcast prevented us hearing Mary actually deliver her message, but the word was passed round to "sit tight," as she was coming down to pose

for the photographers on the conclusion of her speech. Another five minutes and then the signal to the band, which struck up a selection from *Chu Chin Chow*. A few bars, and the studio door opened. Yes, this was Mary without a shadow of a doubt, a dainty little body in evening dress, her uncovered curls a golden confusion. She stood hesitating for a moment whilst Douglas reassured her with a whisper, and "Uncle Rex" motioned her to a divan at the rear of the microphone. Mary was undeniably nervous in this unusual atmosphere, but Douglas was full of curiosity and his whispered questions to his secretary betrayed a lively interest in this new sphere. Mary was just as we expected her to be—the films had not lied; if possible, she was even more appealing in the flesh than on the silver screen. She placed a hand on her husband's arm, and he reassured her with a smile. Against her massive husband we realised also what a child Mary looked, but those wonderful eyes and bewitching smile as we passed out betrayed the secret why she is the world's sweetheart.

No. 1 of a series dealing with Edison Valve manufacture.

Reasons why EDISWAN VALVES Are Better

Glass

Glass plays an important part in the construction of a Valve. The quality of the glass has a definite bearing upon its span of life—the thickness of the bulb must be regulated to a minute degree of accuracy. One important reason for the superiority of Edison Valves is the fact that the whole of the glass required is manufactured at their Ponders End Factory. From the preparing and heating to 1,200° C. of the mixture which produces the molten glass, to the blowing and final moulding, each stage of the process is carefully supervised. In this way, from the outset, extreme measures are taken to ensure Edison efficiency.



Have you had your FREE copy of Illustrated Booklet "The Thermionic Valve"? If not, send a postcard to-day.

Also manufacturers of the "Toovee," "Televox" Loud Speaker, Headphones, Batteries, etc. Write to-day for leaflets.

Your dealer holds stocks to supply you. If not, write us direct giving his name and address

Prices:

"R." ... 12/6

"A.R." 12/6

"A.R.D.E." 21/-

Dull Emitter.

"A.R..06" 30/-

Latest Dull Emitter. Current consumption at 2.5 volts .06 of an ampere.

Note the safety cap (Prov. Pat) which is now fitted to all Edison Valves. The filament pins are shorter in length than the plate and grid pins, thus avoiding any chance of making surface contacts with the wrong sockets.

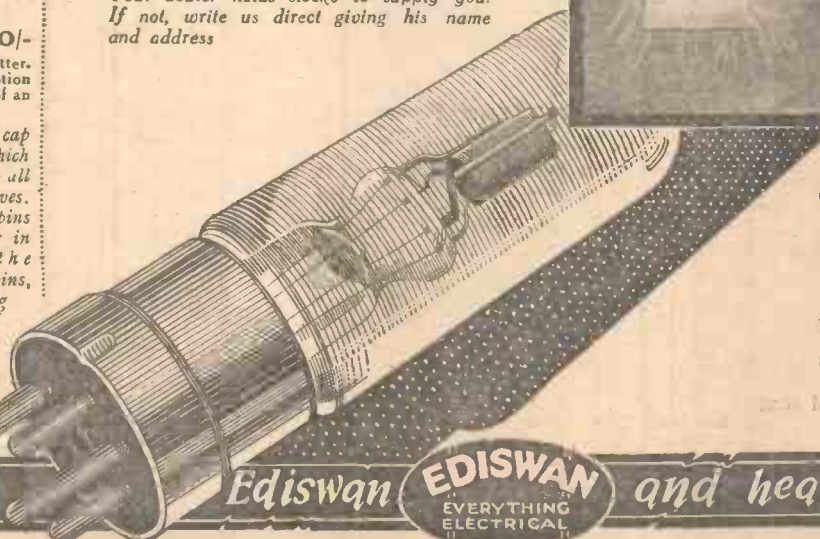

**THE EDISON SWAN
ELECTRIC CO., LTD.,**

Contractors to H.M. Admiralty
War Office, Royal Air Force,

123-5, Queen Victoria St., E.C.4.
and 71, Victoria Street, S.W.1.

Branches in all Principal Towns.
Works: Ponders End, Middlesex.

Use Edison Valves and hear Everything
EDISWAN
EVERYTHING
ELECTRICAL

Buy British

Goods Only.



German Transmissions

SIR,—In my letter in "A.W." No. 99 I gave you the times of the German concerts, and in mistake subtracted an hour from the ordinary British time instead of adding one to give British summer time.

The times of the concerts, *British summer time*, should read: 10 a.m. market reports. 12.45 p.m., exchange and news. 4.30 to 6 p.m., musical concert. 7.30 p.m., talks (not daily). 8.15 p.m., concert. 9.45 to 11 p.m., dance music, once weekly, Berlin Thursdays.—F. H. S. (Oberschmitten).

The Perfect Aerial

SIR,—Though your contributor M. A. L. mentions that the polar diagram of signal strength only applies when the "roof" of the aerial is long compared with the height, he would have run less chance of leading us astray if he had emphasised the fact that, in order to have directional effect, an aerial "roof" must be many times its height. In the ordinary amateur reception aerial, in which the ratio L/H lies between 2/1 and 5/1, the directional effect is practically negligible.

Screening and absorption effects apart, signal strength with a "P.M.G." aerial is in almost direct proportion to effective height, otherwise the height of the "roof" above the instruments. It is possible that the best use we could make of our 100 ft. would be to make it all "lead in"; that is to say, dispose the whole length vertically.—5 Y.M. (Pirbright).

Edison Loud-speaking Telephone

SIR,—I was much interested to see in your issue of April 12 the letter referring to Edison's loud-speaking telephone. I happen to have a pair of these receivers, and have recently made some slight tests with them.

A good description of the Edison phone is given in Tunzelmann's "Electricity in Modern Life," including a graphic account of some experiments. An extract may be of interest:

"The Telephone Co. had kindly connected the school-room for the evening with their exchange system, and in the course of the evening communication was established between the lecture room and the telephone exchange at Brighton. The loud-speaking telephone was placed on its stand in front of the platform and stood about 5 ft. above the ground. A cornet player had been sent down to Brighton and played some music opposite

a carbon transmitter, which was reproduced by the Edison instrument with the greatest clearness and so loudly as to be heard in every part of the lecture hall."

The chemical used for moistening the chalk cylinder is potassic iodide, but any easily decomposed electrolyte will do. The chalk should be only moist.

With an Edison receiver and a pair of 2,000-ohm wireless phones in parallel, I obtained fair results on a crystal. Both speech and music were quite clear though not very loud, although it could be heard about a yard from the instrument.

Should I get better results I will send particulars.—L. T. H. (Hampstead).

Interference

SIR,—I was much interested in your notes on spark interference in your issue of March 15. It is little realised, I am afraid, to what an extent this spark interference is adversely affecting the progress of wireless in country districts. While I am sixty miles equidistant from Cardiff, Bournemouth and Birmingham. Cardiff always suffers from spark interference; the interference is not loud though usually continuous. Bournemouth is also continuous but louder, and occasionally so loud as to render listening-in nearly impossible. Birmingham I never bother to tune in as the spark interference renders it useless. It is obvious that the 450-metre transmission is being grossly abused. The interference has greatly increased during the past year, and latterly I have frequently given up listening-in altogether owing to this interference—G. H. I. (Driffield).

Other Correspondence Summarised

J. W. C. (London, W.13), who lives only five miles from the London station, finds that he can tune out London when required by connecting a .0003-microfarad variable condenser in parallel with the reaction coil, which is coupled to the anode coil. He finds this better than a wave-trap connected between aerial and earth.

An Austrian reader, Mr. Gustav Walter, sends us particulars of three Austrian broadcasting stations and suggests that one of them was the station referred to by F. G. S. (Theydon Bois) in "A. W.," No. 96. Two are experimental stations, one belonging to Mr. Schrack, of Vienna, who works on wavelengths ranging from 400 to 800 metres, and the other at the "house of the 'Kriegsministerium,'" which works on various wavelengths.

Both stations transmit talks in German, but not orchestral items. Another broadcasting station is the "Radio-Hekaphon," of Czeija and Nisel, Vienna. This station transmits music on 600 to 700 metres. The old Austrian National Anthem is no longer used, and that heard by F. G. S. was most likely the German National Anthem.

J. A. C. (Lee, S.E.12) heard on Sunday, April 6, part of a church service broadcast between 7.15 p.m. and 7.30 p.m. No trace of this can be found in any of the B.B.C. station's programmes. Can any reader oblige?

W. S. (Sunderland) recently received KDKA on a single-valve set, his reception being confirmed by a letter from the station.

F. C. (Manchester) states that by placing a .001 microfarad variable condenser across IP and OP of the low-frequency transformer organ music is received very well, the notes acquiring a "roundness" which otherwise seems to be missing.

"LOUD-SPEAKERS, AT WEMBLEY" (continued from p. 553)

An elaborate volume control was provided, and a master switch allowed of the cutting-off of all the loud-speakers simultaneously. The loud-speaker horns were made of wood so as to avoid resonance effects. Each receiver is capable of carrying several watts without distortion and operates on the balanced armature principle. A valve detector was used across the output terminals of the amplifiers to indicate the volume.

Other loud-speakers are installed at various vantage points in the Exhibition grounds, notably in the Amusement Park. These were also used for making audible the opening speeches.

Distributing Band Music

Whenever there is a band playing within the Exhibition it is the intention of the Western Electric Company to distribute the music through all their loud-speakers. Moreover, should there not be a band playing at the moment, it is probable that gramophone records will be used instead. Thus there will seldom be a time when music is not available.

"A Wheelbarrow in a Large Garden" is almost a necessity, and the current issue of "Work" (3d.) contains an article describing one which, whilst being compact in design, has a large carrying capacity. Other articles in this number are: "Some Car Mascots and How to Make Them"; "Repairing Valves and Stop-cocks"; "A Mercury Break for a Spark Coil"; "Three Metalworking Kinks"; "Plaster Casting from Gelatine Moulds"; "Making a Crumb Tray"; "An Electric Bell and Indicator Movement"; "Simple Camera Repairs and Renovations"; "A Panelled Bedstead in Mahogany or Walnut."



Some of these transmissions are commercial or official. Wavelengths and times are liable to alteration without notice. The times given are according to British Summer Time.

London B.B.C. Station (2 L O), 365 metres. Weekdays, 3.30 p.m. to 4.30 p.m., concert. Children's concert from 5.30 p.m. to 6.15 p.m.; 7 p.m. to 7.30 p.m., news bulletin and talk; 8 p.m. to 11 p.m., concert, except on Savoy Band nights, when the band will play from 10.30 p.m. to 11.30 p.m. (on Saturdays until midnight). Concert from 1 p.m. to 2 p.m. on Tuesdays, Thursdays and Fridays.

Manchester B.B.C. Station (2 Z Y), 375 metres. Weekdays, 3.30 p.m., concert; 5 p.m., women's half-hour; 5.25 p.m., farmers' weather report; 5.30 p.m., children's hour; 6.20 p.m. to 7.15 p.m. and 7.45 p.m. to 10.30 p.m., concert and news. Sundays, 8.30 p.m. to 10.25 p.m.

Birmingham B.B.C. Station (5 I T), 475 metres. Weekdays, 3.30 p.m. to 4.30 p.m., concert; 5.30 p.m. to 6 p.m., women's half-hour; 6 p.m. to 6.45 p.m., children's hour; 7 p.m. to 10.30 p.m., concert and news. Sundays, 8.30 p.m. to 10.30 p.m.

Newcastle B.B.C. Station (5 N O), 400 metres. Weekdays, 3.45 p.m., concert; 4.45 p.m., women's half-hour; 5.15 p.m., children's hour; 6 p.m., scholars' half-hour; 7 p.m. to 10.30 p.m., concert, news. Sundays, 8.30 p.m. to 11 p.m.

Bournemouth B.B.C. Station (6 B M), 385 metres. Weekdays, 3.45 p.m. to 4.30 p.m., concert; 5.15 p.m. to 10.15 p.m., concert and news. Sundays, 8.30 p.m. to 10.15 p.m.

Cardiff B.B.C. Station (5 W A), 350 metres. Weekdays, 3.30 p.m. to 4.30 p.m., concert; 5.30 p.m. to 6 p.m., women's half-hour; 6 p.m. to 6.45 p.m., children's hour; 7 p.m. to 10.30 p.m., concert and news. Sundays, 8.10 p.m. to 11 p.m.

Glasgow B.B.C. Station (5 S C), 420 metres. Weekdays, 3.30 p.m. to 4.30 p.m., concert; 5 p.m. to 5.30 p.m., women's half-hour; 5.30 p.m. to 6 p.m., children's hour; 7 p.m. to 10.30 p.m., concert and news. Sundays, 8.30 p.m. to 10.45 p.m.

Aberdeen B.B.C. Station (2 B D), 495 metres. Weekdays, 3.30 p.m. to 4.30 p.m., concert; 5 p.m. to 6 p.m., women's half-hour and children's corner; 7 p.m. to 10.30 p.m., concert and news. Sundays, 8.30 p.m. to 10.30 p.m.

Sheffield (Relay) B.B.C. Station (6 F L), 303 metres. Programme relayed.

Plymouth (Relay) B.B.C. Station (5 P Y), 330 metres. Programme relayed from London station daily.

Königswusterhausen (L P), 2,800 metres. Daily, 8 a.m. to 9 a.m., Stock Exchange news; 12 noon to 1.30 p.m., news and concert; 5 p.m. to 6.30 p.m., Stock Exchange news.

Croydon (G E D), 900 metres. Daily.

Eiffel Tower (F L), 2,600 metres. Daily, 6.40 a.m. to 7 a.m., weather forecast; 11 a.m. to 11.30 a.m., weather forecast; 3.40 p.m., Stock Exchange news; 5.30 p.m. (Saturdays excepted), Bourse closing prices; 6.10 p.m., 7 p.m., and 7.20 p.m. (Sundays only), concert and news; 10 p.m., weather forecast.

Paris Concerts Radiola (S F R), 1,780 metres. Daily, 12.30 p.m., concert and news; 1.45 p.m., first Bourse report; 4.30 p.m., Bourse closing prices; 4.45 p.m., concert and news; 6.45 p.m., news; 8.30 p.m. to 9.30 p.m., concert; also concert from 2 p.m. to 3 p.m.; 10 to 10.45 p.m. on Sundays.

Rome (I C D), 3,200 metres. Daily, 11 a.m. Ecole Supérieure des Postes et Télégraphes, 150 metres. 3.30 p.m. to 4 p.m. (Wednesday and Friday), 7.45 p.m. to 10 p.m. (Tuesday and Thursday), 2.30 p.m. to 7.30 p.m. (Saturday), concerts.



Members of the Quality!

There are members of the Quality among Valves, too. Take the Cossor, for example. With its handsome nickelled cap solidly clamped to a moulded bakelite base, its bulb made from the finest grade of glass and blown to almost micrometer exactness—it looks what it is, a quality production throughout.

Manufactured in two types:
P.1. (For Detector and L.F. use) - 12/6
P.2. (With Red Top) for H.F. use - 12/6

And its performance is thoroughly on a par with its appearance. Insert a COSSOR Valve into any Receiver and observe the difference. Used as a Detector, for instance, you will soon appreciate that it possesses infinitely superior rectifying properties owing to its electron stream being almost entirely contained and usefully employed. As an Amplifier, the COSSOR P.1 is responsible for a remarkable degree of pure, sweet-toned

reproduction vastly superior to that produced by an ordinary Valve. And when used as a High Frequency Amplifier, the P.2 is a veritable magician, reaching out for long distance Stations and obtaining clear and sparkling music of a quality previously considered impossible.

Truly the COSSOR is a member of the quality—an aristocrat among valves you would do well to know.



Cossor Valves

KING'S SPEECH BROADCAST IN COURT

DURING the hearing of a summons at the Mansion House Police Court against Mr. Gordon E. Ward, of the City Accumulator Co., for obstruction with a wireless receiver, the magistrate, Alderman Sir John Baddeley, expressed a desire to hear the receiver, which was in court, in operation. Mr. Ward switched on the receiver, and the final sentences of the King's speech at Wembley, which was then in progress, and the cheering, etc., which followed, were heard clearly throughout the court.

It was alleged that Mr. Ward, whilst being photographed on the steps of St. Paul's Cathedral on April 3, caused a crowd to collect, thereby causing an obstruction.

The magistrate said that no doubt a technical obstruction had been caused, but he did not like the idea of a respectable man like Mr. Ward being taken to the police station and detained there so long. He ordered Mr. Ward to pay 4s. 6d., the costs of the case, but recorded no conviction.

THE RADIO SOCIETY OF GREAT BRITAIN

AN informal meeting of the Transmitter and Relay Section of the Radio Society will be held at 6.30 p.m. on Friday, May 2, at the Institution of Electrical Engineers, Savoy Place, at which a discussion will be opened by Capt. P. P. Eckersley.

Next Week's Broadcasting

May 4—10

Items Simultaneously Broadcast*

- Sunday. Children's Corner from Cardiff.
- Monday. Radio Association, Talk. The Savoy Bands.
- Tuesday. French Talk. The Savoy Bands.
- Wednesday. B.B.C. Dramatic Critic.
- Thursday. Radio Society of Great Britain, Talk.
- Friday. B.C.C. Cinema Critic. Sir Gilbert Greenall.
- Saturday. Major Tosswill. The Savoy Bands.

* Except where otherwise stated, all items simultaneously broadcast originate from the London studio.

London (2 L O)

- Sunday. Band of H.M. Grenadier Guards.
- Monday. British Composers' Night.
- Tuesday. "A Mixed Grill."
- Wednesday. Query Programme.
- Thursday. Popular Programme.
- Friday. Memories Programme.
- Saturday. Orchestral Concert.

WIRELESS IN PARLIAMENT

From Our Gallery Correspondent.

MEMBERS of the House of Commons are still concerned with the broadcasting, as they allege, of speeches of a political nature. Last week Mr. Hudson, a Labour member, asked the Postmaster-General whether he was aware that on April 2 a political lecture of a highly controversial nature was delivered from the Cardiff broadcasting station, in which the listeners-in received an *ex-parte* statement of the position at Dantzig and Vilna, and were told that the danger of war between Great Britain and France was a reason for more vigorous action by the League of Nations on the Silesian issue; and whether, seeing that the contract between the British Broadcasting Company and the Post Office excluded political propaganda, and in view of the disregard of this provision in the contract, he was now prepared to support a policy in which equality of treatment for all would be guaranteed in the matter of the broadcasting of political opinion?

Mr. Hartshorn replied that he understood that the lecture in question was one of a series which dealt with various foreign countries and were of a descriptive and historical, rather than political, character. No complaints had been received concerning any of these lectures. He was consulting the Broadcasting Board on the general question of the measures to be taken in regard to the broadcasting of speeches or lectures on political or controversial subjects.

Educational Broadcasting

The possibilities of broadcasting as an aid to education were raised by Mr. Baker, who asked the Postmaster-General whether he was aware that Germany was learning English by wireless, and that the lessons were given by a German and an Englishman, the latter replying in English to the questions in the native tongue; and whether, having regard to the great educational possibilities of such a procedure, he would recommend it to the notice of the Broadcasting Committee?

Mr. Hartshorn said that the British Broadcasting Company already gave French talks regularly from all their stations, and, in addition, a number of talks had been given in Spanish, German and Norwegian. The question of extending these facilities was under consideration by the company in consultation with educational authorities.

Continental Broadcasting

Mr. Baker also asked the Postmaster-General whether he was aware that broadcasting took place from three centres in

Paris, two in Brussels, three at The Hague, two in Berlin, and two in Madrid, in addition to many other towns in France, Belgium, Holland, Denmark, Germany, Czech-Slovakia and Switzerland, and whether, in these circumstances, he would have inquiries made and a report issued giving details of the transmissions, wavelengths, powers and times, with the names of the owners of such stations and the extent to which they were owned and controlled by the respective Governments?

Mr. Hartshorn, in reply, said that most of the details to which the hon. member referred were published regularly in the various wireless journals. This appeared to be the most convenient method of meeting the requirements of listeners in this country who wished to intercept foreign programmes, and he did not consider that the expense of issuing an official report on the subject would be justified. The majority of the broadcasting stations on the Continent were operated by private companies under Government control. Only two or three of them were Government owned.

Licence Receipts

Mr. Baker further asked the Postmaster-General whether the sum which he was entitled to retain from the receipts due to the issue of broadcasting licences was intended to recoup him for the cost of issuing licences and to pay for the services rendered by his department in safeguarding the interests of the licence-holders, and, if so, would he state what steps he had taken to minimise the interference by Morse during broadcasting hours?

Mr. Hartshorn, in reply, stated that the sum of 2s. 6d. which was retained by the Post Office in respect of each wireless receiving licence fee was intended to cover all work in connection with such licences, including issue, accounting, renewal, inspection, correspondence and administrative control. In the present state of wireless development it was not possible entirely to prevent interference by Morse transmission with the reception of broadcast programmes, especially where receiving apparatus of non-selective type was used.

Payments to the B.B.C.

Yet a further question by Mr. Baker was whether the Postmaster-General was aware that it was estimated that £300,000 would be paid to the Broadcasting Company in respect of wireless receiving licences for the twelve months ending March 31, 1925, this sum being ten times the amount taken in the estimates for the financial year just completed, and whether he would state what power he had to supervise the expenditure of the company?

Mr. Hartshorn replied that the payments to the British Broadcasting Company were made by instalments in arrear, and the provision in the vote for 1923-24 represented only a small proportion of a full year's income. As regarded the last para-

(Continued on page 566)

It is not by accident

that

**IGRANIC HONEYCOMB
DUOLATERAL COILS**

are in greater demand than any other inductance coils

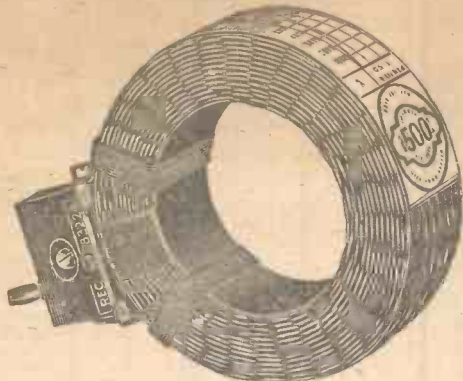

It follows from combining in them the results of

**The Scientist's Research
The Technical Designer's Knowledge
The Expert Craftsman's Skill**

The illustrations which have appeared in the various Radio Journals show that Captain Eckersley used IGRANIC COILS in the Receiving Set for His Majesty the King

Obtainable from all dealers. Write for Lists Z 179.

IGRANIC
ELECTRIC Co. Ltd.

147, Queen Victoria St.,
LONDON.

Works: BEDFORD.

Manufacture of Broadcasting Apparatus.

USE OF PATENTS

THE pioneer work of the Marconi Company in connection with wireless telegraphy and telephony is well-known, and as the result of many years of research work and considerable expenditure, the Company controls numerous patents relating to the manufacture or use of wireless telegraph and telephone apparatus.

The Company is prepared to grant a licence for the use of its patents in connection with the manufacture of broadcasting apparatus to any member of the British Broadcasting Company, Limited.

A large number of firms (including the principal manufacturers) are already so licensed and pay royalty for the use of these patents, and all apparatus manufactured under licence is so marked.

Any persons or firms manufacturing or offering for sale valve apparatus embodying patents controlled by Marconi's Wireless Telegraph Company, Ltd., without its permission, render themselves liable to legal proceedings for infringement.

Whilst hoping that it will not be forced to take legal proceedings, the Marconi Company wishes to give notice of its intention to protect its own interests and those of its licensees, and in cases of infringement the Company will be reluctantly compelled to take such steps as may be necessary to defend its patent rights.

Marconi's Wireless Telegraph Co., Ltd.,

Marconi House, Strand, London, W.C.2.

ARMSTRONG BRITAIN LTD
MONARCH LAUNDRY
LEVENSHULME
ESTD 1871, 1916 Manchester

"Gentlemen,
"No doubt you are aware for many months I have been on the look out for a satisfactory Detector Valve for my large Receiving Set supplied by you. I have tried almost every valve on the market (for some of which I paid as much as 35/-), but have not been satisfied until I tried the Thorpe at 10/-. It just does what I want, and makes no fuss about it.
"It is A TOPPING DETECTOR, bringing in all Stations of the B.B.C. Loud Speaker Strength without reaction. I am sorry to confess that I kept off it for a time thinking it could not be much good at the price.
"Thanking you in bringing it to my notice,
"I am, yours faithfully,
"B. H. BRITTAİN."

Copy of testimonial sent to a well-known Provincial Factor.

"A topping detector"

**-better than the best
at ONE THIRD the price**

We are publishing this testimonial because we feel there may be thousands of other people still clinging to the fallacy that an article of low price is necessarily of low quality.

If you have not yet tested the Thorpe K.I Valve buy one to-day, the results would even justify scrapping the valve now in use.

OF ALL DEALERS



Sole Agents:
BOWER ELECTRIC LTD., 15 Grape St., Shaftesbury Avenue, W.C.2

graph of the question, he would refer the hon. member to clause 7 of the supplementary agreement with the company which was laid before Parliament.

Cable v. Wireless

Mr. Black asked how much saving in cost would accrue by a general use of the wireless system as compared with the telegraph, both with regard to the cost of transmission and also with respect to the cost and upkeep of necessary plant; whether there was in contemplation any further laying down of telegraphic cables; and whether the future policy with respect to this matter had been determined?

Mr. Hartshorn said that there were more than 10,000 telegraph lines in this country, over 1,200 terminating in the Central Telegraph Office, London, alone. The number of telegraph channels of communication afforded by these wires was much larger still, and it was entirely impracticable to replace this system by wireless. There were, moreover, 73 wires, giving nearly 200 channels of communication, between the Central Telegraph Office and offices on the Continent. There was no present probability of maintaining these foreign services by wireless, and the Post Office, like other telegraph administrations and companies, did not contemplate discontinuing the provision of telegraph cables where required.

Interference

Capt. Terrell asked the Postmaster-General whether he was aware that the view was held that the interference with the local listening-in at Oxford was now worse than before the carrying out of the tests at Leaffield, which were officially stated to have improved conditions; and whether he would make still further efforts to abate this nuisance?

Mr. Hartshorn said that the effects of the modifications of the circuits in use at the Leaffield station which were recently made were still under investigation, and everything practicable would be done to minimise interference with broadcast reception by the working of the station.

Mention "A.W." please when you write to advertisers.

ANNOUNCEMENTS

"Amateur Wireless and Electrics." Edited by Bernard E. Jones. Price Threepence. Published on Thursdays and bearing the date of Saturday immediately following. It will be sent post free to any part of the world—3 months, 4s. 6d.; 6 months, 8s. 9d.; 12 months, 17s. 6d. Postal Orders, Post Office Orders, or Cheques should be made payable to the Proprietors, Cassell & Co., Ltd.

General Correspondence is to be brief and written on one side of the paper only. All sketches and drawings to be on separate sheets.

Contributions are always welcome, will be promptly considered, and if used will be paid for.

Queries should be addressed to the Editor, and the conditions printed at the head of "Our Information Bureau" should be closely observed.

Communications should be addressed, according to their nature, to The Editor, The Advertisement Manager, or The Publisher, "Amateur Wireless," La Belle Sauvage, London, E.C.4.

SOMETHING TO WRITE FOR

A. H. HUNT, Ltd., of Tunstall Road, Croydon, Surrey, have sent us a copy of their 48-page general catalogue, No. 52.

From Autoveyors, Ltd., of 84, Victoria Street, Westminster, S.W.1, we have received an interesting poster drawing attention to "Clix," which effects an infallible connection in any position.

An interesting 24-page catalogue (a new edition) has been received from Ward and Goldstone, of Frederick Road, Pendleton, Manchester. Any reader can obtain a copy by mentioning AMATEUR WIRELESS.

"Trix" H.F. plug-in transformers and anode inductances are described in leaflets sent us by Mr. E. T. Lever, of 33, Clerkenwell Green, E.C.1.

A completely revised edition of their wireless catalogue, which contains forty-eight pages, has been received from the Economic Electric Co., of Fitzroy Square, W.1. Readers of AMATEUR WIRELESS can obtain copies post free by enclosing 4d. in stamps.



Honor Oak Park Radio Society

Hon. Sec.—J. McVEY, 10, Hengrave Road, S.E.23. On March 28 Mr. H. J. Campin gave a lecture on the "Ideal Set for an Experimenter." The lecturer exhibited a set in an attaché case, with switching arrangements to use any number up to three valves, dual or a simple crystal circuit.

Southampton and District Radio Society

Hon. Sec.—M. D. METHVEN, 22, Shirley Avenue, Southampton. On March 27 experiments with tuned and untuned aerials were carried out with the society's new apparatus, much useful information being collected. Mr. E. Bateman also gave particulars of a new method of obtaining high-frequency amplification.

Nottingham and District Radio Experimental Association

Hon. Sec.—A. S. GOSLING, 63, North Road, West Bridgford, Notts. On April 3 Mr. L. H. Cocks delivered a lecture on "Direction-finding on Aircraft." Information respecting membership can be obtained from the secretary.

West London Wireless and Experimental Association

Hon. Sec.—H. W. COTTON, 19, Bushey Road, Hayes, Middlesex. At the meeting held on March 25 Mr. O. S. Puckle delivered a very interesting lecture entitled "Some Important Points in Radio Design."

Radio Society of Highgate

Hon. Sec.—J. F. STANLEY, 49, Cholmeley Park, Highgate, N.6. On March 28 Prof. A. M. Low gave a talk on "Sound and Wireless." He said in the course of his lecture that in order to interest the general public in wireless more attention must be paid to "sound" and not so much to "noise."

Honor Oak Park Radio Society

Hon. Sec.—J. McVEY, 10, Hengrave Road, S.E.23. On March 14 Mr. Lucy, of Messrs. Brown & Co., gave an informal but highly interesting lecture on "Telephones and Loud-speakers." Mr. Lucy opened his lecture by referring to public opinion regarding these pieces of apparatus. In dealing with loud-speakers the lecturer mentioned distortion due to horns, and explained the principle on which the "Frenophone" and "Crystavox" works, the mechanism of the latter being passed round for inspection.

Wimbledon Radio Society

Hon. Sec.—C. G. STOKES, 59, Church Road, S.W.19. On March 14 Mr. Wright, of the Igranic Electric Co., lectured on "Low-frequency Amplification Circuits." The lecturer explained the principles un-

derlying the actions of resistance, choke and transformer amplification at audio-frequencies, and proved most conclusively that transformer amplification is, in the long run, the cheapest and most efficient. It was shown how stray capacities are minimised in the construction of commercial L.F. transformers, and stress was laid on the importance of correct grid bias adjustment.

Liverpool Co-operative Radio Association

Hon. Sec.—J. KEARNS, 107, Walton Breck Road, Liverpool.

On March 14 Mr. A. G. Penlington delivered an interesting talk on "American Broadcasting." He contrasted the American and British systems, to the advantage of the latter, and contended that, notwithstanding our later entry into the field of broadcasting, we had effected a decided improvement upon the somewhat chaotic state of affairs which existed in the United States. He sketched the history of the science in America from the early days of the Marconi coherer to the present super-regenerative circuits, and paid a tribute to the inventive genius of such pioneers as Edison, Dr. Fleming, De Forest and Tesla.

Clapham Wireless Society

Hon. Sec.—F. COOKE, 13, Fitzwilliam Road, Clapham, S.W.4.

The secretary of this recently formed society will be pleased to supply prospective members with particulars of membership.

St. Pancras Radio Society

Hon. Sec.—R. M. ATKINS, 7, Eton Villas, Haverstock Hill, N.W.3.

At a meeting of the above society on April 10 Mr. J. S. Rowe gave a very interesting lecture on "Capacity." After a brief outline of the electron theory the lecturer proceeded to demonstrate certain properties of condensers. He then explained how to calculate the capacity of a condenser by the aid of a few simple formulae, and gave a list of the dielectric constants of some of the commoner insulating materials.

Tottenham Wireless Society

Hon. Sec.—F. R. NEALE, 11, St. Loys Road, Tottenham, N.17.

A new circuit, the "Ultraflex," recently designed by Mr. R. F. G. Holness, technical officer of the society, was demonstrated by him on April 16. The circuit embodies one valve and a crystal and brings in all the B.B.C. stations, the chief Continental stations, and distant amateurs. The selectivity of the set was remarkable. Its efficiency is extraordinary, as it is almost the first demonstration of a circuit which was previously completely designed on theory alone. Whilst at present a set for the expert, a little more investigation will doubtless simplify its working and enlarge its capabilities.

Southampton and District Radio Society

Hon. Sec.—M. D. METHVEN, 22, Shirley Avenue, Southampton.

On April 10 Mr. G. W. Walton, of the General Radio Company, Ltd., lectured on "Low-frequency Amplification," dealing with his subject in a very able manner.

North Middlesex Wireless Club

Hon. Sec.—H. A. GREEN, 100, Pellatt Grove, Wood Green, N.22.

"MEASURING Instruments Used by Radio Amateurs" was the title of a lecture given on April 2 by Mr. G. A. V. Sower. The lecturer showed several experiments designed to demonstrate the magnetic effect of an electric current. One of his experiments illustrated the effect on a magnet of a coil of wire carrying a current. Another demonstrated that a coil of wire carrying a current itself behaves like a magnet, with definite north and south poles. A knowledge of these fundamental principles being necessary to an intelligent understanding of nearly all electrical measuring instruments, the lecturer made no apology for performing these somewhat elementary experiments. He then went on to describe the various forms of volt and ampere meters and showed how it was that moving-coil instruments, though more accurate than the moving iron type, are not adapted to the measuring of high-frequency alternating currents met with in radio work.

Honor Oak Park Radio Society

Hon. Sec.—J. McVEY, 10, Hengrave Road, S.E.23. On April 4 Mr. McVey read a short paper on "How the Valve Works." After this there was an open discussion, particular interest being shown in the design of wave-traps and rejector circuits.

DISCOUNT SALE

of Cabinets, Transformers, Varlometers, Terminals, Phones, and other Wireless Components. List post free.

KENITE FOR RADIO PANELS

Half the price of Ebonite. Twice the efficiency. Panels 6 x 6 x 1/8, 1-1/2 x 6, 1/8; 12 x 10, 3/4, post free. Large and intermediate sizes at proportionate prices. Black only. Matt finish. 1/2 in. 25% extra.—CRAWFORD, 9, Coleman St., London, E.C.2. Telephone: London Wall 975

Silvertown Variable Condensers

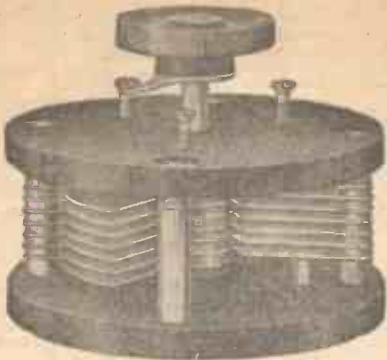

Quality guaranteed by over 50 years' electrical manufacturing experience.
MAKERS: The Silvertown Co., Ltd.,
106, Cannon Street, London, E.C.4.
Works: Silvertown, E.16.

These condensers are strongly constructed, and the greatest care is taken in the adjustment of the various parts. Capacities 0.0001, 0.0002, 0.0005, and 0.001 mfd. Moving vanes are shaped to give low minimum capacity. Fitted with a stop to allow of a movement of 180 degrees only. Any of the stock sizes can be supplied with dial and knob (instead of knob and pointer), at extra cost.

Prices 7/6, 8/-, 11/6 and 15/- each.

We also manufacture Vernier Condensers, Dual Condensers, and Dust-proof Condensers for use on table built up on the same lines as the above standard condensers.

SAY "SILVERTOWN" TO YOUR DEALER
WHEN BUYING Telephone Headpieces, Filament Rheostats, Crystal Holders and Buzzers, Potentiometers, Insulators, Fixed Mica Condensers, Intervalve Transformers, etc. etc.

WERE YOU SATISFIED WITH THE RESULTS
BROADCAST FROM WEMBLEY ON THE
OCCASION OF H.M. THE KING'S SPEECH?

IF NOT

BE READY

for the next big event, by having your set completely overhauled by the firm which specializes in repairs and renovations.

TRADE REPAIRS ALSO A SPECIALITY

HAMBLING, CLAPP & CO., Ltd.
11, AGAR STREET, CHARING CROSS
TELEPHONE: GERRARD 8806



25/- By post
1/- extra.

This is only the cost of a good pair of headphones, yet it enables all to hear in comfort.

THE FLEET RADIO STORES,
143-144, FLEET ST., LONDON, E.C.4

*Fit for
a King!*

THOUSANDS CLEARLY
HEARD the King's Empire
Speech because they used
the

**FLEET
LOUD SPEAKER**

RADIAX UNIVERSAL THREE

A tuned Anode reaction set which is up to the minute with detail refinements. Continually arriving testimonials confirm the magnificent results obtained. Suitable for all wavelengths and conditions; gives Paris (Radiola) on loud speaker as well as all British stations. Special switch cuts out third valve when not required. This set is easily built by home constructors. All components are assembled, panel ready drilled and engraved and every detail supplied, including complete instructions for assembling and operation and plan-diagram.

Price £7 5 0 | Price, assembled ready for use ... £10 17 6
(plus 37/6 Marconi Licence). | (plus 37/6 Marconi Licence, and B.E.C. Stamp, 20/-).

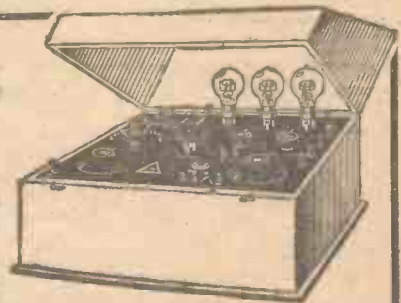

Not a Baby nor a Giant The RADIAX LOUD SPEAKER

A small input gives results which are easily 50 to 100 per cent. louder than many other good Loud Speakers.

And the Tone is admirable, pure and distortionless. The higher notes of piano or strings are given as clear as a bell, and it does not bark at you when the heavy brass comes in.

Its Price is Moderate. We believe there is no reliable speaker with a name which possesses capabilities of this one.

It is British. We are B.E.C. manufacturers. Price 55/-. Your money returned if not satisfied.

Send for Free Price List of Radiax Receivers, or 3d. stamp for Complete Catalogue of Receivers and Accessories.

RADIAX SPECIALITIES ARE OBTAINABLE FROM ALL REPUTABLE DEALERS.

RADIAX LTD.

20 Radio House, Percy St., Tottenham Court Rd.
LONDON, W.1
3 minutes Tottenham Court Road or Goadge St. Tube Stations.



THE "BREAK-NOT" HYDROMETER

7/6

ALL PARTS REPLACEABLE at SMALL COST

LIST ON REQUEST

Every one who uses an accumulator needs a Battery tester, and it must be a strong, accurate instrument and not a toy.

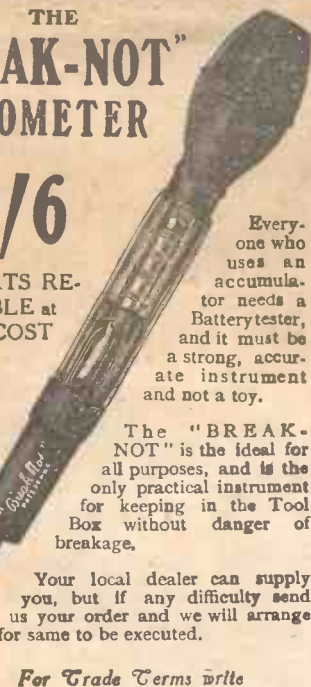

The "BREAK-NOT" is the ideal for all purposes, and is the only practical instrument for keeping in the Tool Box without danger of breakage.

Your local dealer can supply you, but if any difficulty send us your order and we will arrange for same to be executed.

For Trade Terms Write

S. GUITERMAN & Co., Ltd.

35/6 ALDERMANBURY LONDON, E.C.2

ACCUMULATORS

C.A.V. Fullers, etc. Guaranteed brand new and perfect but slightly soiled. We refund cash with carriage both ways if returned within 7 days.

IV-40a ...	17/-	6V-40a ...	25/-
4V-60a ...	21/9	6V-60a ...	32/6
4V-80a ...	27/6	6V-80a ...	40/-
4V-100a ...	32/6	6V-100a ...	47/6

Teak cases, polished and fitted with fuses and switch for 450 or 4500, only 8/6 each. Original cost, 21/6. Special Line, Best English Make, 6v, 60 amp. hour, 22/6 each. MAUDE RUBBER CO., 58, Praed St., W.2.

MAKE SUCCESSFUL SETS

Components make or may your set. Make sure beforehand by buying parts which are used and recommended by famous experimenters. Every one tested before despatch. Electrical and mechanical accuracy guaranteed.

WRITE FOR LIST. A postcard brings our complete List of Tested Components. Write for it now.

BOWYER-LOWE CO. LTD., LETCHWORTH BOWYER-LOWE COMPONENTS

TROUBLE: Poor reception
CAUSE: Battery run down
REMEDY: Use HOMCHARGER

Clip on after every concert and ensure maximum enjoyment from the next. Connects to any lamp socket or wall plug.—A.C. and D.C. types available. AT ALL DEALERS

THE CARPAX COMPANY, LIMITED 312 Deansgate, MANCHESTER

SKINDERVIKEN MICROPHONE

(THE SMALLEST IN THE WORLD)

TO THE GENERAL PUBLIC

If you cannot obtain this device from your local dealer write to the head office: MIKRO Ltd. 32a, Craven St., STRAND, W.C.

The new type Skinderviken Microphone with Carbon Electrodes only are obtainable at 5/- each.

Write for illustrated booklet:

"THE MARVELS OF THE MICROPHONE,"

which gives full details how to make your own amplifier for crystal sets. Price 6d. post free 6d.

Send P.O. (not stamps) to-day.

MIKRO Ltd., 32a, Craven St., STRAND, W.C.

ORIGINAL POST PAID HOUSE WE APPRECIATE POST ORDERS

SCREW SPADES 1/3 per doz.

TINNED COP. PER WIRE 24" x 1/16" x 1/16" square, 1/6 per doz.



INSULATED HOOKS 1/3 per doz.

ELECTRONE AERIAL WIRE 100 ft. 1/3

Headphones B.B.O. Mark, 4,000 ohms. Sterling "P" .. 25/- Brown's "P" .. 25/- Fellows .. 18/6 Siemens .. 25/- Brander .. 25/- 120 ohms ex-Govt. Sullivan's .. 10/-

H.T. Batteries With Wander Pings 60v, 8/- 36v, 4/10 20v, 4/- 15v, 2/- 4v, P.L. Btry. 6d. 60v, Ever-Rdy, 12/6 36v, 8/- 16v, 3/6 Siemens same price

Ebonite Panels Matt ground edges 9" x 6" x 3/16" 1/10 9" x 6" x 1/8" 2/2 12" x 9" x 3/16" 2/9 12" x 9" x 1/8" 4/6 12" x 12" x 3/16" 5/- 12" x 12" x 1/8" 5/6 15" x 9" x 1/8" 5/6 6" x 6" x 1/8" 10d Any Size Cut 8d. in. 1/4 d. 1/4

Coil Plugs Moulded type 8d. Ebonite .. 10d. superior 1/3 Narrow type 5d. Basket .. 1/3 Coil Formers, 21d

Switches Superior quality D.O.O. 2 1/2 8.C.O. 2/3 D.P.S.T. .. 2/0 S.P.S.T. .. 1/6 Ebonite 8.C.O. 1/3 Series parallel—Double-arm 2/2 Dewar D.Q.O. 2/8 D.P.S.T. 1/9 Utility 2-way 4/- 3w 6v, 4w 6v, 6w 8v.

Aerial Wire 7/22's 100' Bright .. 2/9 100' Enmlid. .. 3/0 4 strd. bright 1/1 Rbr. Id. in. 5d yd

Insulators Shell, 24" x 24" 6d. Reel, 2 1/4 d. Egg, 2d. Crystal type .. 8d. Lead-in Tubes 4" and 6" .. 9d. 9" 1", 12" and 15" 1 8 Simplex Type .. 1 8

Valve Holders Type A .. 8d. Plain legs .. 6d. Screwed 8 nuts 8d. Ebonite .. 10d. Polar type .. 1/3

450 Ohms Potentiometers Rheostat Type Superior Quality **3/9**

Orders 5/6 Value. CARRIAGE PAID

British Wires, etc. swa. doc. esp. dec. 18 1/11 2/11 3/5 20 2/8 4/4 4/2 22 2/8 5/9 4/7 24 2/11 3/10 1/1 26 2/4 4/2 5/8 28 2/9 4/9 6/6 30 4/10 5/4 7/6 32 5/6 6/- 8/8 36 5/- 8/9 12/ 40 17/- 14/8 20/-

SPECIAL VALUES Jacks 4-contact Bank of 2 - 1/6 " 8 - 2/3 Standard Plugs 1/3

6 BASKET COILS 300/2600 metres and 8 holders 5/6

EXPERIMENTS PARCEL Useful materials (worth 20/-) 5/6

NEW EBONITE CUTTINGS Per lb. 2/3

EBONITE VERNIER 2-coil holder Panel Type 7/6 A Microscopical Adjustment

L.F. Transformers Radio Inst. 25/- Silvertown .. 21/- Igranio 21/- & 20/- Burndept 25/- & 27/6 Reliability 12/- & 15/- Ferrand .. 17/6 Xtraordinary .. 10/- Targent 15/- & 17/6 " Royal " .. 20/-

Var. Condensers .001 panel type 7/- .00075 .. 6/- .0003 .. 5/- .0002 .. 4/6 Knobbed dial 1/- ex. Stocked "Fallon" & "J.B." usual prices Fernier, no dial 2/6 5 rands, 3.5 7 rands 3/6 "Polar types" 14/-

Terminals Mull-Pol Brass 2s. 4B.A. Standard. 2d. 4B.A. 5 piece 14d. Spado type, doz 5d. 300rds type 2s. Multiphone 4w. 9d. 6-way 1/- Refly spring 8d. 2B.A. Small type. 1d. Contact Studs 1d. Spring Washers 1d.

Coil Holders Ashley fixed 2/6 moving 3/6 Igranio 3 set 1/6 Ebonite 3 coil 6/- 2 coil 4/- Anode Holder 8d.

Fl. Resistances Good quality 1/6 Igranio 4/6, Vera. 7/- Ormond .. 2/- Burndept 5/- and 4/6 Zenith and Ajax 4/- Minicats .. 2/9 Spirals only 4d. Formers only 7d.

Accessories Gal. pulley 1/- Alum pulley 1d. Valve sockets 1d. Valve Pins 1d. Crystal Cups 2d. P. Wax block 6d. Resin Solder 8d. Solder tube 5d. All sizes, yd. .. Tape, yd. 1d.

Condensers Dutilier (usual Mullard, .. prices Blocking type 1/6 With leak 1/6 Mansbridge 1m.f. 1/6 2m.f. 1/6-1/36 m.f. 9d. Leaks 1-5m. 6d. Resistances, Anode 9d.

Write for "Complete supplementary Price List of Exceptional Values," sent Post Free. (9XL—New Issue.)

J. H. TAYLOR & CO., Electrical and Radio Engineers, Macaulay Street, Huddersfield. Telephone: 341. Telegrams: "Thorough," Huddersfield

TELEPHONES RE-WOUND

to 4,000 ohms. Guaranteed. All makes 5/-, except Brown "A" & Sullivan, Wax-filled, 10/- per pair. Ex-army converted to high resistance, 2/6 each earpiece. Re-magnetising 9d. per earpiece. Postage extra 6d. per pair. JOHN W. MILLER, 70-71, FARRINGTON STREET, E.C.4 Phone: CENTRAL 1950

VALVES 3/9 POST FREE

A limited quantity of new K.T.D. Telefunken Valves recently received offered at 3/9 each until supplies are exhausted. Fil. 2—3.5 Volts. Plate 50—150 Volts. Current consumption approx. 45 Amps. SEND NOW.

ELEFACTORS, Ltd., 86, Granville Road, Child's Hill, N.W.2 Phone: Hampstead 7919. Nearest station, Collier's Green

ADVERTISEMENT INSTRUCTIONS for "Amateur Wireless" are accepted up to first post on Thursday morning for following week's issue, providing space is available.

PREPAID ADVERTISEMENTS.

Advertisements under this head are charged THREEPENCE PER WORD, minimum charge THREE SHILLINGS.

DEPOSIT SYSTEM.

As the Publishers cannot accept responsibility for the bona fides of Advertisers in this publication they have introduced a system of deposit which it is recommended should be adopted by readers when dealing with persons with whom they are unacquainted. It is here explained.

Intending purchasers should forward to the Publishers the amount of the purchase money of the article advertised. This will be acknowledged to both the Depositor and the Vendor, whose names and addresses must necessarily be given. The Deposit is retained until advice is received of the completion of the purchase, or of the article having been returned to and accepted by the vendor. In addition to the amount of the Deposit, a Fee of 6d. for sums of £1 and under, and 1s. for amounts in excess of £1, to cover postage, etc., must be remitted at the same time. In cases of persons not resident within the United Kingdom, double fees are charged.

The amount of the Deposit and Fee must be remitted by Postal Order or Registered Letter (Cheques cannot be accepted), addressed to

"AMATEUR WIRELESS,"

ADVERTISMENT DEPARTMENT, LA BELLE SAUVAGE, LONDON, E.C.4

PATENTS and Trade Marks obtained.—H. T. P. Gee, Patent Agent, Member R.S.G.B., 61/62, Chancery Lane, London, W.C.1. Phone Holborn 182A.

HEADPHONE REPAIRS.—Rewound, remagnetised and readjusted. Lowest prices quoted on receipt of telephones, delivery three days.—The Varley Magnet Co., London, S.E.15. (1/3) VARIOMETERS, dry beech stator and rotor, close coupled 12s dozen sets. Complete sample, 1s. 6d.—Sleightholme, Wholesale Turners, Ingham Street, South Shields. (1/3) 13/ CRYSTAL SET 1-VALVE AMPLIFIERS.—Pledge Bros., 22 Woodstock Road, Oxford. (1/6) BROWN'S A 8,000 HEADPHONES.—Few pairs ex W.D. guaranteed O.K., 5s. pair. Registered post, 6d.—Williams, 99, Keogh Road, London, K.15. (1/6) ACCUMULATORS.—New and reliable repairs a speciality. Special terms to trade.—Lenham Accumulator Service, 2, Lenham Road, Lee, S.E. (1/6) WIRELESS INVENTORS.—Patents and Trade Marks advice. Handbooks and Consultations free.—King, Regd. Patent Agents, 146A, Queen Victoria Street, London. Phone, 692 Central.

STRONG WOOD POLES FOR WIRELESS, painted, 29 ft. 3 in. long, in 8 sections, fitted with improved strong galvanised iron sockets, 10s. complete. Satisfaction guaranteed. Prompt delivery. Cash with order. (Extra length 9 ft. 9 in. long, 8s. 6d. each, with socket.)—J. Byfield, Bridge Foot, Warrington. (1/2) TELEPHONE RECEIVERS & LOUD SPEAKERS rewound, 2,000 ohms, 8s. 6d.—M. E. Hampshire, 159, Hydenham Road, E.36. (1/2) TWO-VALVE WIRELESS SET, with coils stamped B.B.O., 6s. Photograph forwarded.—F. A., 144, Chatterlands Avenue Hull. (1/2) TOPICAL ARTICLES ON WIRELESS SUBJERBS (not home construction) wanted. Must be bright and well-informed.—Apply Box 43, Cassell's Advertisement Offices, La Belle Sauvage, London, E.C.4



CABINETS YOU WANT PICKETT'S CABINETS—they're good value, from 16 each, highly polished. Cabinet (A.M.) Works, Albion Rd. Bexley Heath, S.E. Write for lists

RADIO "KENITE" PANELS All sets should be built on "Kenite." Highest dielectric strength, rigid, thoroughly insulated. Black matt finish. 6" x 6", 1'-; 7" x 5", 1'-; 8" x 5", 1/2; 9" x 5", 1 1/2; 10" x 9", 2 1/4; 14" x 12", 4'-, 3/4" thick. Post free. Trade quoted. CROSSONIA COMPANY, 10 SOUTH STREET, E.O.2

BEGINNERS' GUIDE TO WIRELESS... BEST BOOK OBTAINABLE

If you wish to make your own receiver, or to improve the set you already have, you cannot do better than obtain this book. How to ERECT, CONNECT, AND MAKE ARRAYS, complete crystal and valve receivers, coils, tuners, etc.; also the latest two and three valve tuned anode receivers and one and two valve amplifiers 144 pages (including 28 diagrams). 1/3 post free. SAXON RADIO CO. (DEPT 12), SOUTH SHORE, BLACKPOOL...

SPENCER'S STORES

4-5, MASON'S AVENUE, BASINGHALL ST., LONDON, E.C.2 TELEPHONE:—LONDON WALL 2322

VALVES REPAIRED

6/6. Post free. PHONES 4,000 ohms, VERY SENSITIVE, GUARANTEED 12/-

AMATEURS and EXPERIMENTERS ALL OVER THE WORLD

The "MAXWELLTÖN" Vernier Crystal Detector is the only crystal detector which will positively increase your range and signal strength 100 per cent.

Fitted with Radial-arm and the most delicate and sensitive adjustment possible. A great scientific achievement. Try it on your Reflex circuits.

Complete with "MAXWELLTÖN" Crystal on Ebonite Base. Price within reach of all. Can be Panel mounted **3/6** by detaching from Ebonite Base. Post Free, British Isles.

Send at once for sample, and after proving its superiority and efficiency tell your friends.

Postal Orders to the

MAXWELL RADIO & OPTICAL CO.,
61, NEW OXFORD ST., LONDON, W.C.1.

Remember always that your set is only as good as its poorest PART

Profit

by the
experience
of others.

The
**BRITISH
EBONITE Co. Ltd.**
Hanwell, London, W.7

EXTRACTS FROM RECENT TESTIMONIALS

"Our client is very pleased with the panel. One of our staff who has been associated with the manufacture of ebonite for nearly 20 years considers it the finest piece of polished ebonite he has seen."

"We are immensely pleased with the panels supplied, the good effect of which is already felt."

Look for
Mark on



this Trade
all Panels

WE SUPPLY THE BEST COMPONENTS for CONSTRUCTORS

And the Most Efficient Complete Sets

Hot Wire Ammeters 0 to '5, new	12/-
Inter-Valve Transformers	16/8
Variable Condensers, '0003	7/6
" " '0005	9/-
" " '001	12/6
Filament Rheostats	2/6
Super Phones, 4,000 ohms	17/6
Valve Holders	1/-
Fixed Condensers, '0001 to '001	1/6
Ebonite Panels, 12" x 8 1/2" x 1/2"	4/6

or cut to your own size. Price on application.

1 Valve L.F. Amplifiers, £2 2 0

BUY BRITISH COMPONENTS—always the best—from

RADIO SUPPLIES LTD., 234, HIGH HOLBORN,
London, W.C.1.

Phone: Holborn 2188.

ESTABLISHED 1920.



without bother is now
within your reach.

The new FELLOWS PORTABLE SET is shown below. It requires no aerial or earth wires whatever, all being included in the case. Dry cells are also fitted inside so that there are no accumulators to require constant recharging.

It will give excellent results on several pairs of headphones and a Loud Speaker may be used when close to a Transmitting Station.

The compactness and high-class finish will be seen at once on inspection. Can be used indoors, or with equal facility in a punt, motor car or train.

THE FELLOPHONE PORTABLE THREE

Complete with headphones :

£14-0-0

In real cowhide, 15 Guineas.

Extras: B.B.C. tax, £1; Marconi tax, £1 17 6
and 3 Marconi D.E.3 Valves.

FELLOWS MAGNETO CO., LTD.
PARK ROYAL, N.W.10. Phone: Willesden 1560-1



The LISSENIUM AGE

Blinding the Vision of Your Receiver—

You will understand the analogy between sight and fine detection in your receiver, but perhaps it has never occurred to you that inefficient filament control blinds your detection so that some messages come no farther than your aerial. Just a little thought in the selection of your filament control, and your receiver might have been far more sensitive than it is.

LISSENSTAT CONTROL IS RAPIDLY SPREADING—

If you were indifferent to efficiency you would not care how you controlled your filament current. BUT IF YOU TRIED ONE LISSENSTAT YOU WOULD LOSE YOUR INDIFFERENCE—you would not rest until every other filament control device in your receiver had been taken out and replaced with LISSENSTAT (prov. pat.) control. For you would then know what selectivity was—what fine detection was—how unique filament control helped you with long distance reception—you would have a control which would enable you to regulate every critical change of electronic emission—AND THIS PERFECT CONTROL OF THE LISSENSTAT LASTS.

To those who make the mistake of thinking that LISSENSTAT control is the same thing as an ordinary rheostat—LET THEM TRY THE DIFFERENCE.

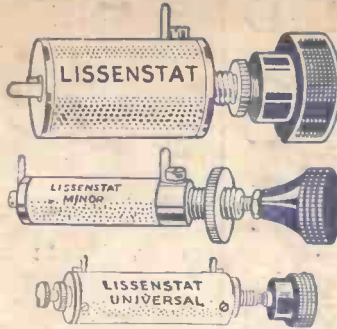

The LISSENSTAT (prov. pat.). This is the super filament control—ideal alike for dull emitter and all valves—improved detection in a way that HAS TO BE EXPERIENCED TO BE UNDERSTOOD **7/6**

THE LATEST DEVELOPMENT OF LISSENSTAT CONTROL—the LISSENSTAT MINOR (prov. pat.). There must be hundreds of thousands of inefficient rheostats in use. To provide something of the beautiful LISSENSTAT control at a popular price a new development of the LISSENSTAT has been introduced—the LISSENSTAT MINOR. This will make it worth while discarding any existing device—it is a perfect little control and will be much appreciated in use. Can be used for dull emitter and all valves (the LISSENSTAT itself is a still better control) **3/6**

HOW THE LISSENSTAT UNIVERSAL PROTECTS DULL EMITTER VALVES.—Gives full LISSENSTAT control, and by means of an ingenious arrangement a minimum resistance can be left in circuit when desired which will protect expensive dull emitters. A zero resistance can also be obtained when full battery pressure is required. Maximum resistance is 50 ohms (conservatively rated as all LISSEN Parts) **10/6**

CONSIDERATIONS IN AUDIO FREQUENCY AMPLIFICATION—WHERE LISSEN DESIGN SCORES

Power output and distortionless amplification depend upon the impedance of the audio frequency transformer equalling the internal impedance of the valve circuit before it, as nearly as possible. It is not necessary to match impedance exactly but it is desirable to get somewhere near it.

The windings of the LISSEN T₁ Transformer are such that the resonant point is far beyond the reach of all audible frequencies. It is the mistake of some designers to use wire which is too fine. The LISSEN Transformers are all heavily wound. The LISSEN T₁ is particularly so. It will give everlasting service under all possible conditions. The price of the LISSEN T₁ should be about £2 in comparison with the coils put in some transformers which are sold at high prices. The LISSEN T₁ is practically all coil. Its weight is COPPER WEIGHT, and not iron weight. It may be used throughout where superlative amplification is desired. SEE THE DIFFERENCE ON POWER WORK.

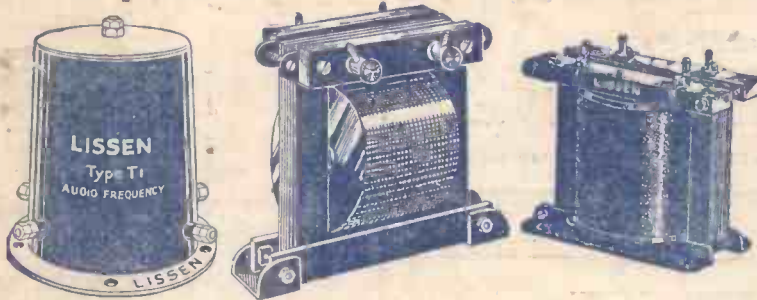

The LISSEN T₁ Transformer should always be used immediately behind the detector valve, and ALSO FOR FOWER AMPLIFICATION. Its impedance is obtained by means of the exceptional coil used, and not by means of a heavy iron core, which always tends to distort. The LISSEN T₁ TRANSFORMER AMPLIFIES A WHISPER IN A BACK-GROUND OF SILENCE **30/-**

AUDIO FREQUENCY IN REFLEX CIRCUITS.—It has been found that the LISSEN T₂ Transformer is a fine transformer in all these circuits—including the ST 100, where it yields pure and powerful amplification **25/-**

AN EXCELLENT LIGHT TRANSFORMER.—One of the best light transformers made is the LISSEN T₃. May be used for all stages. A really excellent transformer, and actually compares with many expensive transformers because of its skilfully balanced design **16/6** FIT A LISSEN TRANSFORMER—and make sure.

WHAT THE LISSEN VARIABLE GRID LEAK DOES—

It provides a leakage path for the excessive negative charge left in the grid by each radio frequency oscillation of a radio wave. If

the leak is unobtainable this negative charge will leak away too quickly and poor detection will result. With the LISSEN Variable Grid Leak it is possible to select the exact value of leak resistance. In this way the charge that accumulates on the grid can be closely regulated so that the free negative grid potential is always at the CORRECT VALUE FOR THE BEST OPERATION OF THE DETECTOR. Some circuits and some valves are not so susceptible to grid control as others, but it is always an excellent thing to be able to alter the leak resistance to suit every varying phase of the valve and circuit, so obtaining added sensitivity and clarity of signals under all conditions. The LISSEN Variable-Grid Leak can also be used across the secondary of a transformer or across the loud speaker if, and it is interesting to note the effect it has in improving loud speaker reproduction by suppressing any tendency for the higher notes of the musical scale to be disproportionately amplified. Positive steps at minimum and maximum resistance—LISSEN one hole fitting of course, 2/6, LISSEN Variable Anode Resistance, 20,000 to 250,000 ohms, same outward appearance as the LISSEN Variable Grid Leak **2/6**



YOU JUST GENTLY PULL OR PUSH

—and you hear these little switches 'make' with a reassuring click. The contacts do not short when changing over—there are no neater or handier switches. They have many uses. LISSEN ONE HOLE FIXING, OF

COURSE. Take up hardly any room. LISSEN two-way switch (prov. pat.) LISSEN Series Parallel Switch (prov. pat.) **2/9**

LISSEN MICA VARIABLE CONDENSER **17/6**

A SENTINEL BESIDE YOUR RECEIVER.—

It stands beside your receiver and acts as an impassable barrier to any unwanted signals. Any nearby broadcasting station can be easily eliminated, and 95 per cent. of all morse. In skilled hands any morse interference can be sufficiently subdued so that it does not interfere with reception of any desired station.

Can be used outside a set, or built into it. A separate tuning condenser is necessary—preferably use a really low-loss condenser such as the LISSEN MICA VARIABLE CONDENSER **17/6**

LISSENCEPTOR Mark 1 for broadcasting, **7/6** LISSENCEPTOR Mark 1 for 600 metres **7/6** LISSENCEPTOR Mark 2 for broadcasting and 600 metres combined (the Mark 2 type has a switch for more selective tuning) **15/6**



The extra efficiency of LISSENACON COILS is distinctly noticeable on long distance work and where extreme selectivity is desired.

IMAGINE A CURRENT—changing its phase hundreds of thousands of times a second. Think how the smallest leakage is likely to affect tuning. With short-wave coils it is particularly important to eliminate losses. Take a look at a LISSENACON coil—the unique air spacing tells of low distributed capacity. Observe the unusual thickness of the wire in the low wavelength coils. Note how the circumference of the shortwave coils is almost uniform with that of the larger ones.

LISSENACON TUNING CHART. Note the Intermediate Coils: 30, 40 and 60.

No. of coil.	TABLE I. Wavelength range when used as Primary Coils with Standard P.M.G. Aerial and .001 mfd. condenser in parallel.		TABLE II. Wavelength range when used as Secondary Coils with .001 mfd. condenser in parallel.		PRICE
	Minimum Wavelength	Maximum Wavelength	Minimum Wavelength	Maximum Wavelength	
25	185	350	100	325	4/10
30	235	440	130	425	4/10
35	285	530	160	490	4/10
40	360	675	200	635	4/10
50	480	850	250	800	5/-
60	500	950	295	900	5/4
75	600	1,300	360	1,100	5/4
100	820	1,700	500	1,550	6/9
150	965	2,300	700	2,150	7/7
200	1,885	3,200	925	3,000	8/5
250	2,300	3,800	1,100	3,600	8/9
300	2,500	4,600	1,400	4,300	9/2

USE A LISSEN PART WHEREVER YOU CAN—it will be understood that where parts are specified in any circuit by a technical writer, it would appear to confer too much preference if the parts of one maker only were specified. BUT THE FINAL DECISION IS IN YOUR HANDS AS TO WHAT VITAL PARTS SHALL GO TO THE MAKING OF YOUR FINISHED INSTRUMENT. Whatever results are obtained with mixed parts it is certain that better results will be achieved if all the parts are LISSEN, and the completed receiver will then reflect the wisdom and the courage of your own choice. Text Book of LISSEN Parts post free 8d.—Free to the trade.

LISSEN LIMITED
16-20, WOODGER ROAD, GOLDHAWK ROAD, SHEPHERD'S BUSH, LONDON, W.12.
BUILD—WITH THE AID OF LISSEN MASTER PARTS
Phone Nos.: Hammersmith 3380 3381 3382 and 1072