

SEE THE PRIZE ARTICLE ON pp. 170-172

# Amateur Wireless And Electrics

Q.A.Q  
[QUERIES  
ANSWERED  
QUICKLY]

No. 9

SATURDAY, AUGUST 5, 1922

Price 3d



*Photo: Midland Press Agency*

A Feature of the Midland Musical Festival held at Bournville (see page 172)

## CONTENTS OF THIS ISSUE

How I Received the First Broadcast .. .. .	163	Smoke Effects .. .. .	168
A Long-wave Tuner for 10s. ..	164	Cutting Glass Cylinders in the Lathe.. .. .	168
"Atmospherics": Their Elimination	165	Does Aerial Gauge Affect Signal Strength? .. .. .	169
A Variable Filament Resistance	166	Multi-crystal Detector .. .. .	169
The Beginner's Page, Inductance and Tuning .. .. .	167	Your First Valve Set and How to Use It .. .. .	170-172
Use for Old Dry Cells .. .. .	168	Broadcasting. The Present Position	175

*Radiograms ; Club Doings ; Forthcoming Events ; Correspondence*

E

**ECONOMIC ELECTRIC LTD.**

C

## DISCRIMINATING WIRELESS EXPERIMENTERS



**UNIVERSAL TUNER**

fully appreciate the outstanding features of "E.E.C." instruments. The design and finish are apparent, and the

**EFFICIENCY IS GUARANTEED.**

WE WANT YOU TO WRITE TO-DAY

For our 36-page Radio Catalogue containing 240 illustrations, also Wiring Diagrams of Crystal and Valve Sets. Mailed by Return for 4d.



**CRYSTAL RECEIVER, 24/9**

Head Office: 10, FITZROY SQUARE, LONDON, W.1

Telephone: MUSEUM 1055

Branch Showrooms: TWICKENHAM

New Showrooms: 303, EUSTON ROAD, N.W.1

Telephone: MUSEUM 1055

Branch Showrooms: TWICKENHAM

# MITCHELFONES

Are not a spasmodic production to meet a sudden demand, but have been on the market for over three months, and during this period 27,000 have been distributed to the trade, and consequently we have not been able to offer them direct to the retail buyer.

*1000 per week are now available, and we announce*

## DELIVERY FROM STOCK

You post your order, or call at our premises and get them at once. Think what this means to you—you, perhaps, who have been waiting and are still waiting.

*Standard resistance 4,000 ohms, double headgear with double headstraps, comfortable, highly efficient, and foolproof*

# 35/- per pair.

Special Terms to Traders and deliveries that will surprise you.

## MITCHELLS Electrical & Wireless Ltd.,

Postal Address: McDermott Road, Peckham, S.E.15.  
Retail Address: 188, Rye Lane, Peckham, S.E.15.

\*Phones: New Cross 1540/1541

# GREAT BRITAIN'S GREATEST WIRELESS STORE

SCIENTIFIC APPLIANCES  
DALE & HOLLINS.

All Wireless Radio Parts & Electrical Material

See full advertisement—last week and next week.  
Come to look at our show all the week and you will come in to Buy. Ask for List.

In Centre of London, top of Kingsway.  
11 & 29, SICILIAN AVENUE, SOUTHAMPTON ROW, W.C.2.

TELEPHONE DOUBLE HEAD SETS. Suitable for Crystal or Valve

2,000 Ohms, 32/6 ; 4,000 Ohms, 34/6. *In stock.*

MAKE up your own receiving sets. Our price for complete set of parts £1 18. carriage paid, comprising wound inductance with ebonite panel drilled for 20 studs, necessary studs, ebonite knobs, etc., crystal detector, terminals, wire for connecting. (No extras to buy; nothing to make.)  
*Stamp for List.*

P. H. BOYS & CO., 187, Goswell Rd., London, E.C.1

## THE "R & S" CRYSTAL RECEIVING SET

Complete with H.R. Telephones,  
100 ft. Aerial Wire and Insulators

Price 126/-

BRITISH VALVES :—"R," 26/6 ; "R.M.R.," 17/6 ; "Ora," 15/- ;  
Silicon or Enamelled Aerial Wire, 7/22, 100 ft., 6/6 ; 150 ft., 9/- ;  
Patent Ball and Socket Detector, 4/9 ; "Egg" Insulators, 5d.  
H.T. BATTERIES :—36 volt, 8/- ; 60 volt, 14/- ; 75 volt, 16/-.

RUSSELL & SHAW

38, Great James Street, Bedford Row, W.C.1

OUR PRICES CANNOT BE BEATEN



## DELIVERY FROM STOCK

HEAD 'PHONES

4,000 ohms total  
Double head receivers with  
Double head straps

# 30s. each

Postage 1/-

THOUSANDS IN USE.

CRYSTAL SETS

or BROADCASTING, as permitted by the Post Office

# £3-15-0 each

VALVE SETS

prices on application

SPECIAL TERMS TO TRADE,

# CHEAPEST AND BEST

SEND FOR LISTS TO

BRITISH CENTRAL ELECTRIC CO., Ltd.

6 and 8, ROSEBERY AVENUE, LONDON, E.C.1  
Telephone - Holborn 5848

# Amateur Wireless

## and Electric

No. 9

August 5, 1922

## How I Received the First Broadcast

**H**EARING one night at the local wireless club (Wireless and Experimental Association) that Marconi House had started broadcasting tests, I decided the next day to try to get him on a simple pre-war crystal circuit consisting of a single coil and detector.

### My Aerial

The aerial was merely 70 ft. of No. 22 S.W.G. copper wire slung from a top-story window, 30 ft. high, to a fence at the bottom of the garden, 10 ft. high. It was insulated at each end by a small R.A.F. ébonite insulator and a yard of cord. The 10-ft. down-lead was brought, a yard away from the wall of the house, to a first-story window, where it was soldered to a well-insulated rubber-covered lead-in wire. A connection 5 ft. long was then made to the usual earth—a water-pipe.

### The Inductance

A single-slider inductance 12 in. long by  $4\frac{1}{2}$  in. in diameter, wound with about No. 26 S.W.G. enamelled copper wire, together with a perikon (zincite-bornite) detector, was "dug up" from a store cupboard and well dusted. These, together with a pair of Brown's 8,000-ohm 'phones, were connected up and the circuit was buzzed.

### Tuning

Paris used to be my old favourite in the crystal days, so I naturally looked to him first for support. I had not completed the set in time for the morning time signals, but a weather report was about due (12.30 B.S.T.). Expecting to be nearly "all in" on the tuning coil, as the aerial was so short, I started from the

top of it, and sure enough there he was, wading through a long stream of figures and letters. These go to make up a vast amount of information on weather lore; but as I didn't want to know at the moment the state of the sea at Iceland or anything like that, I did not copy it. Nevertheless, I was very grateful to FL for his transmission, for it enabled me slightly to adjust the crystals to their most sensitive position; in addition, it also gave some idea as to the maximum wave-length range of the set—2,600 metres.

"-----" "-----"  
The next step was to "slide" down the inductance and try my luck on lower wave-lengths. Nothing doing until within an

inch of the bottom, then "-----", evidently a station tuning up, but as nothing came through but "der, der, der, daaars" (v's) it didn't help matters much with regard to knowing its wave-length. However, after going up and down several times a voice was heard about  $2\frac{1}{2}$  in. up, but it stopped before it could be brought to a readable strength. Roughly calculating the distance down from FL's adjustment, I surmised it to have been Croydon on 900 metres. After a short wait this was confirmed by very careful tuning; two or three turns up or down and speech became indistinct. Still, I was pleased with this result, as when on the resonant turn speech was comfortably readable (K6), and, in addition, I had my bearings more or less for the shorter waves.

Being told to listen in at 3 o'clock in the afternoon, on about 360 metres, if I wanted to hear Marconi House, I did so. I got him K8; the job was to tune him out. He was audible throughout the length of the coil. Among other things he gave an invitation to CQ, requesting him "to listen in that evening to a programme of special interest." That was good enough, I decided, to turn up early at the 'phones with a nice bright shining face.

### The Broadcast

Yes, you've guessed right, it was the first British broadcast under the new regulations. The messages were copied as received, but when "Carpentier has won" came through on the heels of the previous one, "Fight started," I began to think of the people who had paid to see "the big fight."

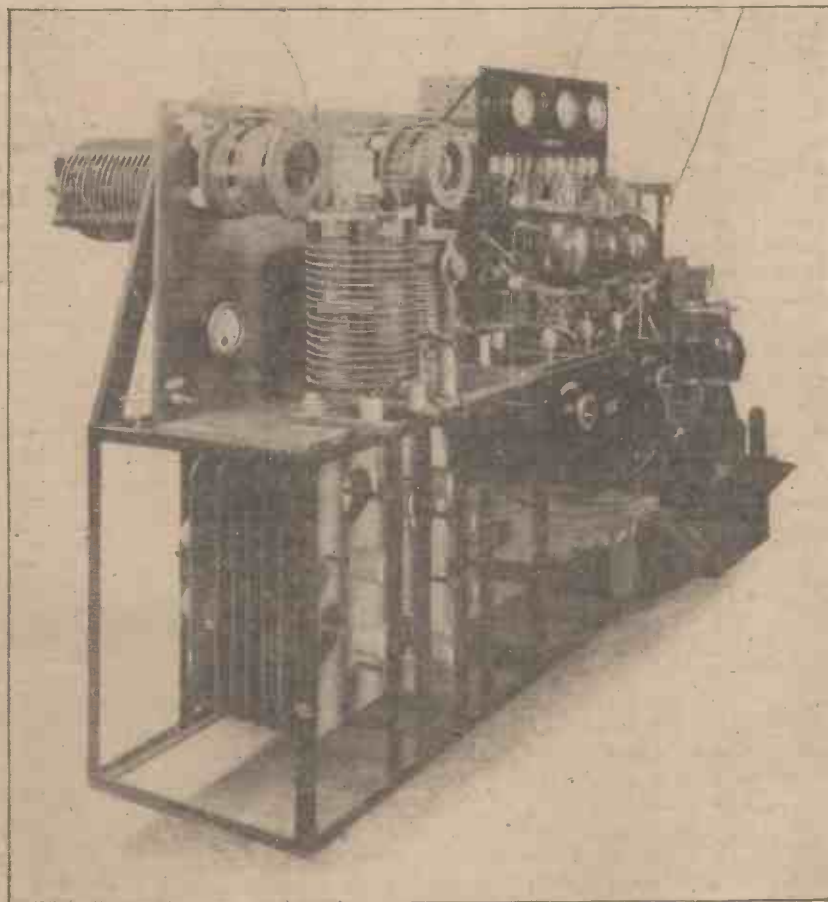

A MARCONI BROADCASTING APPARATUS.

On the left are seen the various tuning coils for altering the wave-length and the aerial ammeter for showing the amount of current passing into the aerial. The carrier-wave and modulating-wave transmitting valves are to be seen at the extreme right of the photograph.

# A LONG-WAVE TUNER FOR 10s.

An Accessory for Long-wave Reception

THE long-wave tuner which is about to be described is the outcome of considerable experience in the design and construction of tuning coils, and can be constructed by any amateur with the aid of a few small tools such as are to be found in almost every home.

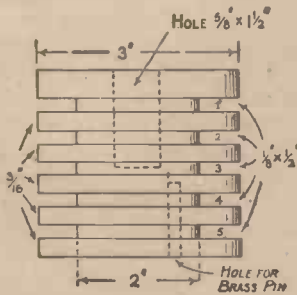

Fig. 1.—Hard-wood Former for Inductance.

It has several points to recommend it in addition to the foregoing. For example, the total cost need not exceed ten shillings. It is small and compact and exactly meets the requirements of the amateur who, while in possession of a satisfactory short-wave tuner for the reception of the broadcasting and telephony between, say, 300 and 1,500 metres, would very much like to bring in the high-power European and American stations between 2,000 and 25,000 metres.

The materials required are as follows: Two hard-wood formers, the larger one for the A.T.I. and the smaller one for the reaction coil, which can be obtained from any local wood-turner at a cost of 3s. to 3s. 6d. for both. One complete inductance switch with ebonite knob, price 2s. 9d. from any of the advertisers in this

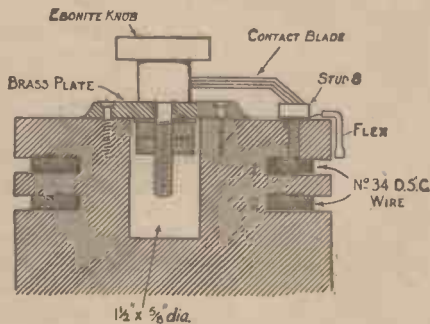

Fig. 3.—Part Section showing Method of Fixing Switch.

journal; eight inductance studs at 2d. each; four brass terminals B.A.4 or similar in size at 3d. each; about 3 oz. of No. 34 s.w.g. d.s.c. copper wire, and about a foot of rubber-covered flex.

Fig. 1 shows the circular hard-wood former for the A.T.I., and it will be observed that it has five grooves which in the illustration are numbered from the top downward. These grooves, in which the d.s.c. wire is to be wound, are 2 in. in diameter by 1/8 in. wide, and are spaced 3/16 in. apart. The over-all diameter of the former is 3 in. and its length 2 1/8 in. A hole 5/8 in. in diameter by 1 1/2 in. deep is turned out in the centre of the top to accommodate the spindle and nuts of the switch.

The switch is shown in Fig. 3. It is fixed in position on the top of the former by means of two wood screws passing through the holes in the plate which forms part of the complete switch. Fig. 3 also shows this clearly.

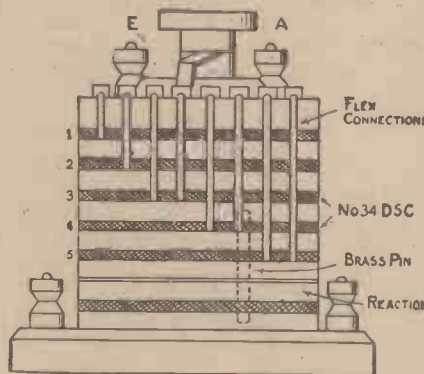

Fig. 5.—The Complete Instrument.

Fig. 2 shows the hard-wood former for the reaction coil and also the square wooden base which serves to support the whole tuner. This base is fixed to the reaction former by means of a wood screw and also carries two of the four brass terminals for connecting up the reaction coil to the terminals provided on every amplifier.

Fig. 4 is a view of the top of the A.T.I. former showing how the eight brass studs are situated so that the copper contact blade of the inductance switch will pass smoothly from one to the other. The other two 4 B.A. terminals will also be observed; in this connection it is just as well to mention that the screwed stems of these two terminals, as also the stems of the eight studs, should be cut to a little less than 1/2 in. in length, so that when screwed up tight in the holes provided for them in the top of the former they will not protrude into groove No. 1, which, of course, must be left clear to accommodate the d.s.c. wire. It is not necessary to tap out the holes in the top of the former to take the terminals and studs, as these

holes should be drilled smaller in diameter than the actual diameter of the terminal and stud stems; when the terminals and studs are screwed up they will be found to be perfectly rigid. Before screwing up the terminals and studs, however, a short length of the rubber flex, bared for about 1/2 in. at one end, should be slipped under each stud and one of the terminals to provide connections for the tappings to be taken from the d.s.c. wire which is to be wound in the five

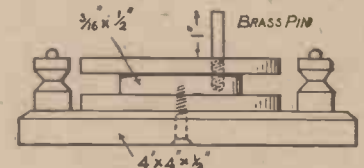

Fig. 2.—Hard-wood Former for Reaction Coil.

grooves. The second terminal is connected to the inductance switch by means of a thin strip of copper or brass inserted under the switch plate and terminal before the wood screws passing through this plate and the terminal itself are screwed home.

The actual winding of the wire can now be proceeded with in the following manner: Bare the loose end of the short piece of flex attached to the stud No. 8, and also remove the silk insulation from the beginning of the d.s.c. wire, then twist the two together to make good electrical contact (this is important, and the joint may be soldered, although this is not essential). Now proceed to wind 280 turns of the d.s.c. wire into groove No. 1. Then bare the loose end of the piece of flex attached to stud No. 7 and again remove the silk covering from the d.s.c. wire by gently scraping—do not cut the wire—then twist the flex and wire together

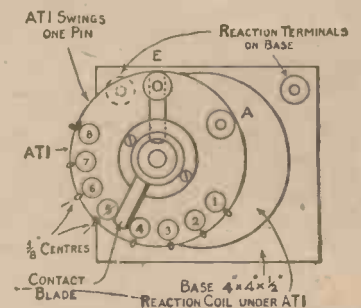

Fig. 4.—Plan of Tuner.

and wind another 280 turns of wire, this time into groove No. 2, and take off a third tapping to the flex attached to stud No. 6.

The remaining three grooves should be

wound in a similar manner, but a tapping should be taken from the middle point of each winding—that is, after every 140 turns. After winding the first 140 turns on groove No. 5 connection should be made to the last remaining stud, which is No. 1, and then a further 140 turns wound on. This completes the winding, and the end of the d.s.c. wire should now be connected to the piece of flex attached to the terminal on the top of the former. This terminal, by the way, is the one which should always be connected to the aerial, while the terminal in direct contact with the inductance switch is for the earth lead.

The reaction coil can now be wound with 400 turns of the same No. 34 d.s.c. wire. It is so proportioned relative to the A.T.I. that no tappings are required. The ends of the d.s.c. wire should be attached to the two terminals on the base which were mentioned previously.

Variation of the coupling between the A.T.I. and the reaction coil is obtained in a very simple manner.

A brass pin  $\frac{1}{8}$  in. in diameter is screwed into the top of the reaction former about  $\frac{3}{4}$  in. from the edge, as indicated in Fig. 2. This pin is left protruding about 1 in., so that it makes a fairly tight fit in a hole bored in the bottom of the A.T.I. former in a position similar to the pin in the reaction former. This forms an eccentric pivoting device, so that when the A.T.I. former is gently moved by hand it swings away from the reaction coil, which remains at rest on the base to which it is affixed, and which, as previously mentioned, supports the whole tuner.

Although the description of this particularly efficient long-wave tuner has of necessity been somewhat lengthy, it is by no means a difficult piece of apparatus to construct, and it will well repay the small amount of labour expended on it.

#### The Tuner in Use

Its performance at all times is most satisfactory, and signal strength is almost equal to that obtained on honeycomb coils. Eiffel Tower on 2,600 metres spark comes in quite clearly on the lower range, while Bordeaux on 23,450 metres C.W. requires only about half of a .001 variable condenser in parallel. American stations can be read using one valve and standard two-wire P.M.G. aerial. On more than one occasion Rome and Moscow have been heard when using one valve on a frame aerial 5 ft. square, while two valves (one note magnifier) bring in these two stations quite clearly. All the other well-known British and European stations such as Leafeld, Cleethorpes, Clifden, Carnarvon, Stavanger, Lyons, Paris, Hanover, Nauen, etc., are, of course, quite strong.

In conclusion, it should be pointed out that the hard-wood formers should be well soaked in shellac varnish or paraffin wax and baked thoroughly dry in an oven; but no varnish or wax should be applied to the windings.

W. R. C.

## “ATMOSPHERICS”

In this second article on the subject the author gives some practical hints on the elimination of these disturbances.

**A** DESCRIPTION of a few of the most common suggestions and devices for reducing atmospheric disturbances to a minimum will be useful.

By using a loose-coupler, as in Fig. 1, instead of connecting the detector and 'phones straight on to the aerial tuning coil, atmospheric are rendered weaker in proportion to the signals. The primary must be tuned to the required incoming signals and the secondary tuned to the primary exactly; the coupling must then be loosened as much as possible without unduly weakening the signals. The use of a loose-coupler also renders it much easier to tune out loud or unwanted signals which are jamming the required ones.

Fig. 2 shows a very simple scheme which is said to be somewhat effective. A loose-coupler is used, and the only addition to the normal circuit is the high-frequency choke B, shunted across aerial

are heard in the 'phones. When atmospheric and very loud signals come along, however, both crystals act equally, and as they are in mutual opposition the effect in the 'phones is mostly cancelled out. This device limits interference considerably, but does not eliminate it entirely.

Directional systems, like frame aerial receivers, which receive signals much more strongly from one direction than from others, will not be badly affected by disturbances from a source out of the line of action. Frame aerials, however, need to be used in conjunction with several valves in order to get audible signals and do not offer a practical solution in the case of the average amateur. Crystal detectors are far too insensitive to work with an ordinary frame aerial.

#### During Thunderstorms

When an actual thunderstorm is in progress near a receiving station it is advis-

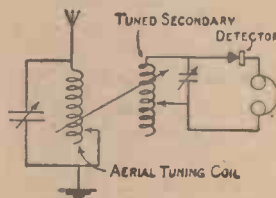

Fig. 1.—Loose-coupler Connections.

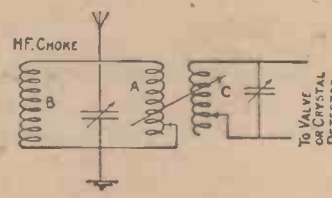

Fig. 2.—The Use of a High-frequency Choke.

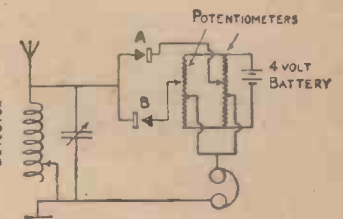

Fig. 3.—Balanced-crystal System.

and earth; this choke may be wound with two or three hundred turns of No. 38 gauge insulated copper wire on a cardboard tube. The inductance of B must be several times as great as that of the tuner A. Untuned impulses like atmospheric will pass from aerial to earth partly through A and partly through B; signals to which the coil A is tuned will, on the contrary, be mainly confined to A, and will not pass through B, with the result that signals in the secondary circuit C will be louder in proportion to the atmospheric.

A very well-known device, which is shown in Fig. 3, is known as the balanced-crystal system. A and B are two carborundum-steel detectors, placed opposite ways round and each supplied with its own potentiometer. Now a carborundum detector in order to be sensitive must have a certain small potential applied to it in a certain direction. The potentiometer of A is adjusted to make A as sensitive as possible to weak signals, that of B being adjusted to make B insensitive to anything but loud signals. Hence, for weak signals, only A is operative, and the signals

able to close down until it is over. Quite apart from the fact that the crashes that occur in the 'phones make comfortable reception hopeless, damage may be done to the set even if the aerial is not directly struck. This is because of the powerful electrical surges that are induced in the aerial circuit every time a flash of lightning occurs. If, as an experiment, the aerial switch be opened during a thunderstorm so as to leave a small spark-gap between the aerial and the earth-connection, then at each flash of lightning a spark will leap across the gap. Arrangements should be made whereby the aerial can be connected to earth by a stout lead outside the house going as directly to earth as possible. Many people use an external earthing switch, which is closed when the set is not in use, so that if the aerial is struck the lightning is conducted straight to earth without ever entering the premises. The earth lead may be a thick copper wire, or better, copper strip at least  $\frac{1}{2}$  in. wide connected to some large metallic object buried in damp ground.

E. H. R.

# A Variable Filament Resistance

**M**OST valve sets work best with the filament of the valve glowing at a certain brilliancy, the voltage at the terminals being somewhere between 4—6 volts.

Some of the more expensive valve receivers are fitted with a resistance for regulating the filament voltage, but for the smaller sets or for the home-made outfit the regulator described here will be found to give complete satisfaction.

The photograph shows clearly how compact and simple is the whole arrangement, while Figs. 1, 2 and 3 give the constructional details.

To make an entirely satisfactory job of the instrument the use of a lathe is necessary for one or two of the operations on base B and fixing ring R (Figs. 1 and 2).

## The Base

The base B (Fig. 1) is made of some heat-resisting material such as "Bakelite," a piece  $3\frac{1}{4}$  in. square by  $\frac{1}{4}$  in. thick being required. Holes are drilled in the corners of base to take four small countersunk screws for mounting the instrument on the panel or in the battery containing case. It is now necessary to clamp the base in the lathe, using a four-jawed chuck and getting the work running absolutely true. A hole  $\frac{5}{16}$  in. in diameter is drilled in the centre of the base to take the plate P, which will be described later.

The groove G is now turned, using a round-nosed tool in the slide-rest and lubricating the work with turps to prevent the tool overheating.

A high speed and a very light cut is advisable, and the turnings should come away in thin shavings. As soon as the tool shows signs of dragging it should be re-

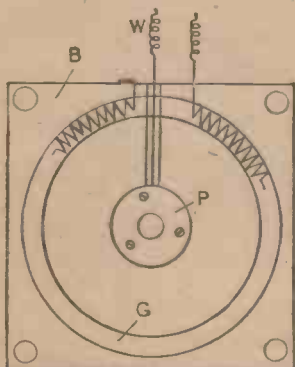

Fig. 1.—Details of Grooved Base showing Position of Coil.

sharpened or a glaze will form on the material and ruin the cutting edge of the tool. The groove should be turned out to a depth of  $\frac{3}{16}$  in., and must be kept as circular as possible to ensure the resistance coil being held firmly in position.

## The Fixing Ring

The fixing ring R, the purpose of which is to keep the resistance coil in place, is now turned up out of  $\frac{1}{8}$  in. sheet "Bakelite." Three holes, to take countersunk screws, are drilled in the ring, while the



Photograph of the Resistance.

edge of the ring is undercut as shown in Fig. 2. The ring, when placed on the base B, should have the undercut edge coincide exactly with the edge of the groove G, the two forming part of a circle in which lies the resistance coil. When the ring R is screwed down the resistance coil should be held firmly in position.

## The Resistance Coil

The resistance coil itself is made by coiling up a length of No. 20 S.W.G. Eureka wire on a brass rod  $\frac{1}{16}$  in. in diameter. A coil about 7 in. long is required, and after winding the coil should be stretched slightly to separate each turn.

A small hole should now be drilled through the side of the base B so as to break through into the groove G; one end of the resistance coil should be pushed through this hole as shown in Fig. 1. The end of the coil is cut off short, leaving just sufficient to bend over. The coil is then carefully laid in the groove G and cut off to length, the end being passed through a second hole in the side of the base, sufficient wire being left to connect up to the rest of the apparatus.

The ring R is then screwed down to fix the coil permanently in position.

A small boss P with a flat shoulder is turned in the lathe to form a bearing surface for the contact shown in Fig. 3. Three holes are drilled in the flange for the purpose of securing the plate to the base B, while the centre of the boss is drilled out

to  $\frac{3}{16}$  in., in which the spindle of the contact rotates.

## The Selector Arm

The contact or selector arm is shown in detail in Fig. 3, K being an ebonite knob into which is screwed a spindle, on the end of which is fitted the contact finger C. A small square shoulder is filed on the spindle to fit into a corresponding square hole in the contact C, which is held firmly in position by the nut N. A spring washer SW serves to keep the contact C always firmly against the resistance coil in every position, and also produces a steady pressure which makes the contact stay in any position irrespective of vibration.

The contact C is curved slightly at the end to provide a large surface for contact with the resistance coil; it is also filed thin three parts of its length, as shown in Fig. 3, to make it more springy.

It will be noticed that the knob K is knurled.

If a very sharp tool is used for turning up the knob K the ebonite will polish straight from the tool if a very light final cut is taken.

## Finishing

The top of the knob may be finally finished in the lathe by holding a cloth smeared with tallow against it as it revolves, or a matt finish may be obtained by holding the knob in the hand and rubbing it on a piece of "blue-back" emery cloth placed on a sheet of glass, the emery cloth being thoroughly moistened with turps. The only other thing to be done before the switch is assembled is to cut a groove in the base B to carry the connecting wire W from the plate P. With regard to connections the instrument is, of course, wired in series with the accumulator and

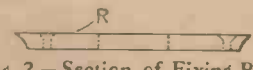

Fig. 2.—Section of Fixing Ring.

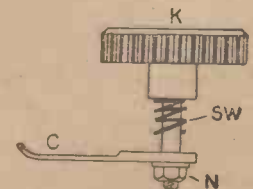

Fig. 3.—Details of Selector Switch.

the valve filament, one end of the resistance coil and the connecting wire W being used for this purpose.

It is intended that the switch shall be mounted inside the accumulator box or in the valve cabinet, so that the knob K is the only portion of the instrument projecting. This gives a neat appearance and also protects the resistance coil. W. H. A.

# The Beginner's Page

Inductance and Tuning:  
Some Simple Circuits

It has been explained that the flow of current along a wire produces a magnetic effect and also a still further effect known as induction; that is, a current flowing in a coil of wire would cause a second current to flow (in the opposite direction) in another coil near by.

This secondary coil, as it is called, need not be wound on a separate bobbin, but may be wound over the top layer of wire on the primary coil. This is done in the case of shocking coils and spark coils, which simply use a large current

combined form what is known as the capacity of the condenser.

Fig. 1 shows a simple circuit containing an inductance I, capacity or condenser C, and a spark gap SG, which consists of two metal rods or balls supported on insulators and separated by a small air space.

Supposing a current is induced in the inductance I, this will flow round and charge the condenser C until a point is reached where the voltage across the spark gap SG is sufficiently high to break down the air between the points when the

other words, both must be tuned to the same pitch or vibrate in sympathy. This is the whole secret of the success of commercial wireless telegraphy; with suitable apparatus it is possible to select any one particular transmitting station and tune all the others out, thus avoiding the confusion of getting an indefinite number of stations sending out waves at the same time.

### Tuning

Tuning is effected by altering the in-

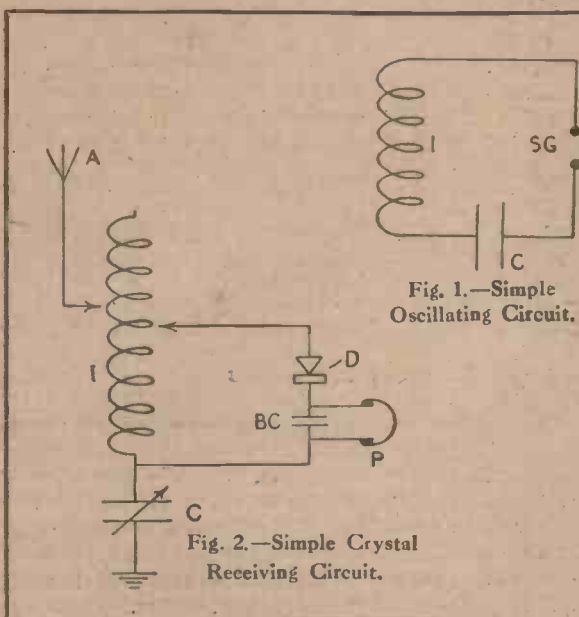

Fig. 1.—Simple Oscillating Circuit.

Fig. 2.—Simple Crystal Receiving Circuit.



Photograph showing the Famous "Amateur Mechanic" Set in Course of Construction by an Amateur (Mr. T. S. Porter).

of low voltage in the primary coil to produce a small current of extremely high voltage in the secondary coil.

### The Oscillating Circuit

Now for the transmission and reception of wireless waves it is necessary to have what is technically known as an oscillating-current circuit, in which the induction coil mentioned above and also a condenser plays the principal part.

The condenser is simply two metal plates placed close together and separated by an insulating medium such as ebonite, mica or waxed paper, known as the dielectric.

If these plates are connected to a generator of electricity, positive electricity will flow into one plate and negative electricity into the other until the condenser is fully charged. For any given voltage the amount of electricity which must flow before the condenser is fully charged depends upon the size of the plates, the distance between them and the nature of the dielectric, whether ebonite, glass, mica, paper, etc., and these factors

condenser will discharge itself, a spark passing the gap.

In the above example the arrangement forms the simplest possible closed oscillating circuit, and is shown purely for the purpose of demonstration. As it stands, it would be useless in itself for either reception or transmission of wireless waves.

### The Receiving Circuit

We will now proceed to examine the arrangement necessary for the reception of wireless signals.

It might be mentioned here that the transmitting station is designed to send out waves in the ether of a certain definite wave-length which is measured in metres.

In order to pick up the waves from a certain station, it is necessary to tune the receiving set to the same wave-length; in

ductance or the capacity of the receiving set, either one at a time or both together.

In Fig. 2 a very simple crystal receiving set is shown, A being the aerial, I the inductance, C the variable condenser, D the detector, BC the blocking condenser, and P the telephone headgear.

It will be noticed that the inductance of the circuit, and thereby the wave-length of the receiving set, is varied by moving two contacts up or down the inductance coil I, which is a single layer of enamelled wire wound on a cardboard mandrel, the insulation being scraped off where the contacts touch.

The natural wave-length of the circuit may be shortened by increasing the capacity of the condenser C, which is made variable for this purpose.

A. W. HULBERT.

## Use for Old Dry Cells

THE common or garden variety of dry cell can be induced to continue its activities by removing the cardboard covering, piercing the zinc cylinder in a few places top and bottom (care being taken not to damage the carbon element), and then placing it in a solution of sal-ammoniac in a jar.

The better-quality dry cells contain the carbon element in sack form, and should the zinc be in fair condition the following method can be recommended: Remove the sack from the zinc by breaking through the stopping at the top, when, with a little care, the carbon can be drawn out. If troublesome, push a table-knife down in a few places and work the sack about with finger and thumb; too much force may break the carbon pencil off. The sack after its removal must be cleaned off under a tap and left to dry.

The zinc cylinder also requires cleaning out and piercing in a few places up and down the side; about six small holes, three each side, will suffice. The sack will require two rubber bands, one at the top and the other near the bottom, to insulate the carbon from the zinc. It is advisable to place a small piece of rubber or waxed paper at the bottom of the zinc for the same purpose.

The sack being placed inside the zinc case, both should now be put in a jar and the jar filled up with a solution of sal-ammoniac. The solution should be made by dissolving 4 oz. of sal-ammoniac in warm water in a separate vessel, half-filling the jar, and adding boiling water to the level of the top of the sack.

C. C. S.

## Smoke Effects

A CURIOUS incident that happened some time ago while I was telegraphist in one of H.M. ships may be of interest. It happened while I was in a ship steaming south towards the Cape of Good Hope. Our captain was very keen on Stock Exchange reports, and insisted on Poldhu being read each night as long as possible. Poldhu used to send her nightly telegram of latest news at 11.30 G.M.T. and a repetition some time later. At the end of each news telegram were the Stock Exchange results—"kan-pax" as we used to call them. Well, for three nights out we managed to receive Poldhu, but the third night she was awfully weak—of course, there were no valve receivers then—but we had

got a crystal set which gave us some very good results. Well, three nights out, about 800 miles in a straight line, we managed to receive the necessary signals, but we held no hope for reception on the fourth night. As it happened this was the night that the "kan-pax" had a special interest for the captain, and he passed word that every endeavour was to be made to receive Poldhu on the fourth night, then about 1,000 miles away. So, it being my watch, I made everything soundtight, thoroughly overhauled the aerial, and meant to make an effort. When the time came I tightened up my phones, clamped up the silence cabinet, and held my breath. After a few seconds I heard someone who might have been Poldhu, and after sharpening up my tuning found that I could just manage to read her, and so I commenced writing down when suddenly she faded away. I naturally wondered what was the cause, when I heard her again, louder still. Again signals faded away. This varying reception was very distracting; I could not think what could be wrong, knowing that I had overhauled everything thoroughly. By this time the

captain had arrived to see if there was any luck, so I emerged from the cabinet, feeling very warm, and told him how things were. Happening to go outside the office for a breather I noticed columns of smoke issuing from the funnels, and as we were running with the wind the smoke was pouring up into the aerial. So here, I thought, was the cause of my varying signals. I went back and told the captain what I thought, and he immediately gave orders to alter course a few points and so carry the smoke clear of the aerial. I tried again to get readable signals, and after several attempts managed to catch the tail end of the first telegram. While Poldhu was sending messages to different ships I managed to get a very fine adjustment which enabled me to read every word when she sent her repetition.

This goes to show that smoke does have an earthing effect on the aerial, the effect varying with the density of the smoke. No doubt many amateurs whose aerials are rigged in smoky districts experience this loss of strength in signals; of course, it only affects weak signals, but it is a point to be considered.—S. S.

## Electrical Benchwork

### Cutting Glass Cylinders in the Lathe

IN instrument making and electrical work generally glass cylinders often form a necessary, or at least desirable, adjunct; a case in point is the glass covers used for some types of crystal detector. Glass tubing of a larger diameter than that used for water-gauge tubes is rarely procurable, and one naturally looks about for the most convenient means of obtaining tubing of the size required. There is in every household a great range of round glass bottles and jars, but unless one uses a diamond there is a certain amount of difficulty in cutting a glass cylinder evenly. The following method may, however, be used with every prospect of success.

A bottle suitable for the required cylinder should be selected and the length marked off. From sheet lead about  $\frac{1}{8}$  in. thick cut a 1 in. broad strip to fit round the bottle. The length of this strip can be easily ascertained by making it three times the diameter of the bottle. Lap the strip round the base end of the bottle and grip the whole securely in the lathe chuck. The edges of the strip need not meet; it is sufficient if the chuck jaws get a grip as shown in Fig. 1. The cutting tool is a triangular file with the end ground as

shown in Fig. 2, which shows the file mounted in the tool post of the lathe. A taper piece of steel has a V-groove filed along its length for the file to rest in; it also provides an easy means of bringing the tool point to dead centre.

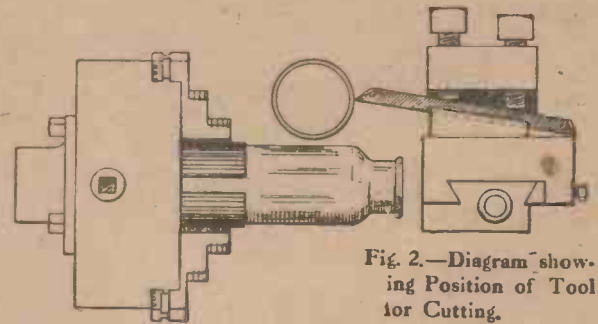

Fig. 1.—Bottle Mounted in Chuck.

Fig. 2.—Diagram showing Position of Tool for Cutting.

With the back gear in, advance the tool into cut, the mandrel being pulled round by hand. The tool will scratch a line round the bottle; a few drops of turpentine must be put on this cut and the feed increased, but when the cut is deep enough, take the bottle out of the chuck, grip by the lead wrapper, which should be slipped up to the groove, and smartly tap off the top of the bottle. Using this method it is surprising how soon a thick glass jar can be cut through.

J. H.



# Does Aerial Gauge Affect Signal Strength?

A SIMPLE experiment was carried out a little time ago by the writer to discover whether the thickness of aerial wire had any great influence upon the strength of signals. The experiment was certainly worth the trouble taken, for the results obtained were rather unexpected and

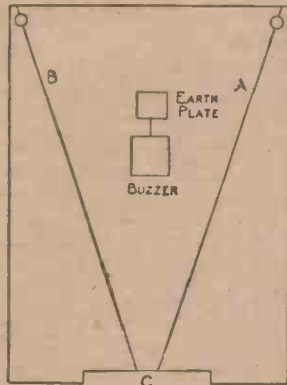

Diagram showing Arrangement of Wires for Test.

showed that in many cases the amateur is liable to err too much on the large (and incidentally expensive) side when putting up his aerial.

Single strands of bare copper wire were used of the following thicknesses:

Wire No. 1 ...	No. 18 s.w.g. ...	0.048 in. diam.
Wire No. 2 ...	No. 30 s.w.g. ...	0.012 in. diam.
Wire No. 3 ...	No. 37 s.w.g. ...	0.007 in. diam.
Length about 50 ft.		

The arrangement of the apparatus was as follows:

A buzzer with two dry cells was placed as a miniature transmitting station in the back garden. A wire was taken from one side of the make-and-break and joined to a brass plate about 6 in. square laid on the grass. Another wire was connected to the other side of the make-and-break, and pointed vertically into the air for about 2 ft. The lay-out is shown in the diagram. The receiving set was in the room situated at C. First a piece of the No. 2 wire was run out of the window down to the far end of the garden and made off to a reel insulator tied to one end of the back fence, as at B. A single-pole change-over switch was held in a vice near the window so that the wire could run straight out without touching anything; the inside end of the wire made off on the left-hand terminal of the switch.

In order to make sure that both the wires A and B should be of exactly the same length the outside end of the wire B was unhooked from the reel insulator and taken across the garden to the other corner where another insulator was arranged,

and the distance of this insulator from the fence was adjusted until the wire could be hooked on it comfortably. The wire was then taken back and made off on the first insulator. A length of wire No. 1 was then run out of the window and made off as at A.

The buzzer was arranged as nearly as possible equidistant from both wires. The lead to the instruments was taken from the arm of the change-over switch, so that, by throwing it alternately on one side and the other, each wire could be tested. An additional switch was arranged inside the room, so that the aerial could be connected to either a crystal or valve-receiving set.

It was found that when the buzzer was set working signals could just be heard on the crystal set and were fairly loud on the valve set. After comparing the two wires for loudness they were crossed over—that is, the far end of A was taken over to B and the far end of B was taken over to A to make sure that the transmitter was not nearer to one aerial than the other, and the signal strength compared again.

Wire No. 1 was then replaced by wire No. 3 and the same procedure gone through again. After this No. 1 was compared with No. 3. It was imagined that by testing wires differing so widely in diameter as 7 to 48 mils. (thousandths of an inch) a very noticeable difference in signal strength would be obtained, but this was not so. In fact, with the valve set, with which signals were fairly loud, it was impossible to tell any difference in strength, and in the crystal set the difference was only just noticeable and in favour of the medium-sized wire.

One thing was very marked, however—several C.W. stations could be heard with the valve set, and it was necessary either to alter the tuning considerably when using wires Nos. 1 and 3 alternately, because of the difference in self capacity, but, of course, this has no appreciable effect on signal strength.

It is far easier to judge the difference in signal strength when signals are weak than when they are strong. As there is no standard of signal strength, it is practically impossible to tabulate the results. The following con-

clusion can be stated very definitely, however.

In receiving stations, those using valves more especially, there is absolutely nothing to be gained by using wire thicker than No. 22 s.w.g. 0.028 in. in diameter. This wire is easy to handle and is not too heavy. Thinner wire has the disadvantage that it may be broken by pulling the halyards too tight. The writer does not see any great advantage in using phosphor or silicon-bronze wire. It is much more expensive, of course. Although it may be stronger, there is little likelihood of No. 22 wire being broken by snow or by a hurricane.

J. F. S.

## Multi-crystal Detector

THE crystal detector shown in the illustration has the advantage that for its construction no metal-working tools are required except a soldering iron. The crystal holders are revolver cartridges, preferably Webley-Scott S.A. rimless. It will be seen that any of one set of four

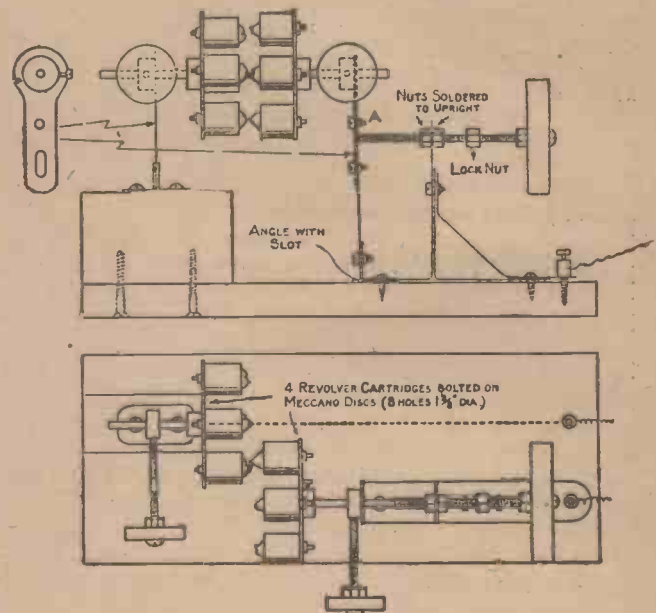

Elevation and Plan of Multi-crystal Detector.

crystals can be used with any one of the other set of four.

C. H. W.

Ask "Amateur Wireless" to send you a list of practical books. Sent gratis and post free.

# YOUR FIRST VALVE SET

The article (by Mr. Herbert H. Dyer, 22, Leopold Street, Derby) that won the prize of a

IT is evident from the number of inquiries that there is a general desire for advice as to the best set to commence with and the method of using it.

There are great possibilities in connection with wireless reception, but unless the limitations are realised there is likely to be a great deal of disappointment. This is the last thing I wish to see, but if people expect, as I know many do expect, to receive telephony satisfactorily with a simple crystal set they are bound to be disappointed unless they are within a few miles of a transmitting station.

Although I have been concerned professionally for some years with the use of three-electrode valves which now play such an important part in wireless, I took up reception simply as a hobby, and not being connected with any firm selling wireless apparatus, my advice is given purely as an amateur and entirely without bias or exaggeration. Unfortunately this is not always the case, and some people seem to forget that we don't all live in London.

I shall not attempt to describe such items as the erection of an aerial, the theory of the valve, the construction of coils, etc., but must leave you to read the excellent articles that appear from time to time on these subjects.

## The First Steps

Most probably your chief desire is to receive telephony, music, news, etc. There is no reason why you should not do this quite well, but I strongly advise you to proceed one step at a time if you wish to get the best out of this most fascinating pastime. By this means you will come to know your set and obtain results that one who is content simply to turn a handle will never get. To the latter I have no advice to offer, but you are not one of these, and I almost envy you the unlimited pleasure you will enjoy as you work up stage by stage to your multi-valve set.

I do not propose to deal here with the crystal which, whilst being satisfactory as a detector when properly adjusted, is inferior to the valve in many respects.

Valves are used in wireless reception for four purposes:—

- (1) To amplify the weak high-frequency signals received on the aerial. ("High-frequency" amplification.)
- (2) To "detect" these signals, that is, to alter their form so as to make them audible in the telephone. (Detection.)

- (3) To amplify the audible signals so as to get them louder in the telephone. ("Audio-frequency," of generally

and as some signals are audible with detection only, I propose to describe first a simple single-valve set with which you

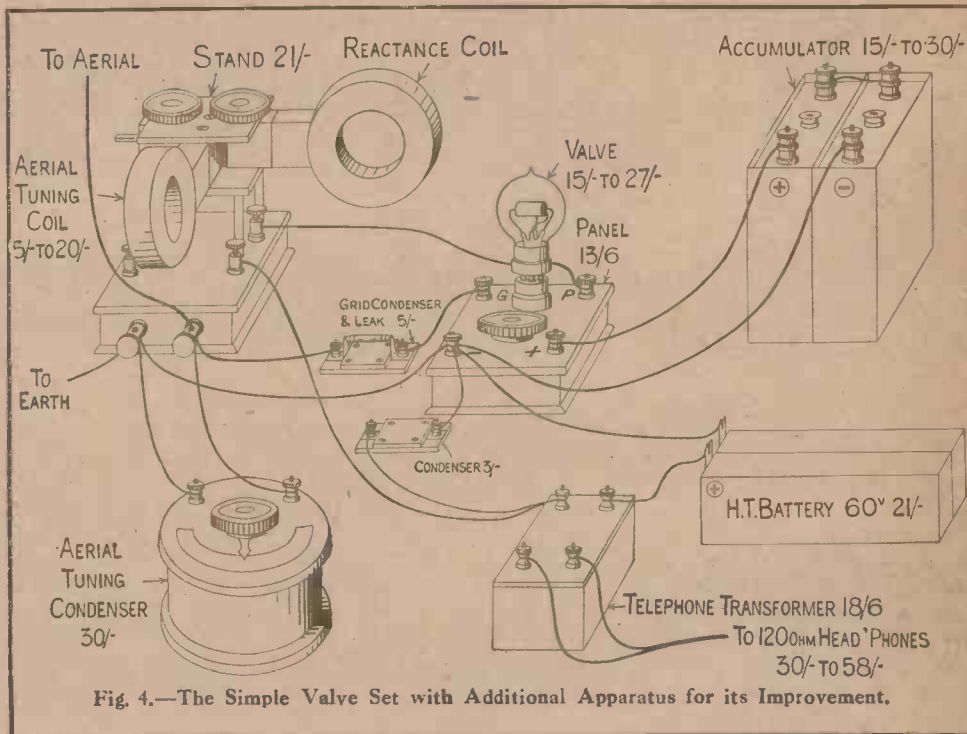

Fig. 4.—The Simple Valve Set with Additional Apparatus for its Improvement.

called "low-frequency" amplification.)

- (4) To generate high-frequency oscillations for combination with the received oscillations in "continuous-wave" telegraphy. (Heterodyning.)

Now "detection" is always necessary,

will be able to receive "spark" signals, for instance, the Paris time signals, weather reports, press, etc., in code.

Two distinct systems are employed in the transmission of wireless telegraph signals, these are known as "spark" and "continuous wave" (C.W.). The oscillations transmitted by either method are far too rapid to be heard even when properly "detected." In the case of "spark" transmission, however, these high-frequency oscillations are transmitted in groups at an audible frequency, and when "detected" we get a musical note in the telephone.

Fig. 1 shows the simplest possible single-valve set for the reception of these spark signals. The aerial circuit has to be electrically "tuned" to the frequency of the received oscillations, or, in other words, to the wavelength, by which is meant

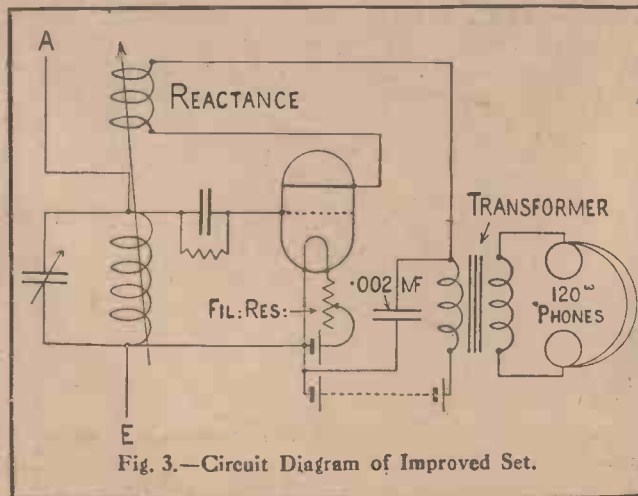

Fig. 3.—Circuit Diagram of Improved Set.

# T AND HOW TO USE IT

receiving set in Competition No. 1, announced in the early issues of "Amateur Wireless."

the length in metres of one complete oscillation. For this purpose a "tuning coil" is necessary. Different tuning coils will be required for different wave-lengths, and I advise you to use the interchangeable coils in preference to coils with tapings or sliders. It is obvious that to have a coil tuned exactly for each wave-length would mean an enormous number of coils. Fortunately this is not necessary, as by connecting a small variable condenser across the coil it can be made to receive longer waves. The higher the capacity across a given coil, within limits, the greater will be the wave-length for which the aerial circuit is tuned. For instance, using the largest of the "Burndept" coils on a certain aerial with a .0015 mf. rotary condenser connected across the coil, I get Carnarvon (14,000 metres) with 10°, Lyons (15,000 metres) with 20°, Annapolis, U.S.A. (16,900 metres) with 40°, and Bordeaux (23,450) with 145° on the condenser. Of course, these are not received on the set

shown in Fig. 1, but the aerial tuning will be the same no matter what the set consists of.

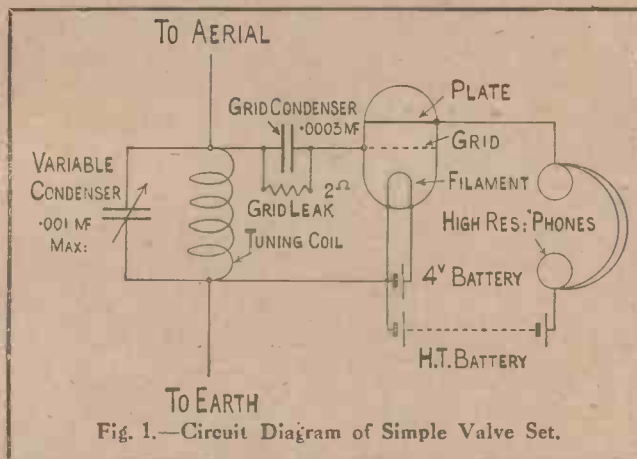

Fig. 1.—Circuit Diagram of Simple Valve Set.

Fig. 2 will give some idea of the appearance of the set, and I think from this you will have no difficulty in connecting it up. For multi-valve sets a telephone transformer and low-resistance telephones are preferable to high-resistance telephones, and as both are equally efficient I would advise the former, for you wish to make the best use of all your apparatus as you add further valves.

## The Set in Use

Having connected everything up and seen that all wires are as short as possible and well separated, and knowing that Paris is transmitting spark signals on 2,600 or 3,200 metres, you plug in a suitable coil, say, a "Burndept" 200 (the correct size of coil will depend upon the aerial), and, with the telephones on your head, turn the condenser fairly quickly from 0° to 180° and back several times. All being well, at one point in the swing you will hear faint musical dots and dashes. Moving the condenser very slowly round about this point you will soon find the exact position at which the signals are at their maximum strength. Make a note of the adjustment; it will be useful later. I advise you to play about with this set for some time, tuning in different spark stations.

## Improvements

I will now describe how, by certain additions to the arrangement shown in Fig. 1, you can make the set very much more sensitive. Great care must be taken, however, in the adjustment, or the valve will start oscillating, that is, acting as a generator and radiating energy from the aerial, which will interfere seriously with receiving stations in the vicinity.

The weak signals received on the grid of the valve cause comparatively large variations of current in the plate circuit, and if we make these plate-current variations act on the grid we shall get still larger variations in the plate circuit and so through the telephones. This is called "reaction," and is usually accomplished by connecting an additional coil in series with the telephones (or telephone transformer where low-resistance telephones are used), and coupling this coil with the aerial tuning coil, or in other words, bringing the two coils near to one another. This is shown in Figs. 3 and 4. A small fixed condenser must be connected across the high-tension battery and telephones, otherwise the high-frequency oscillations would be choked back. A filament resistance is also included, as it is usual to have a six-volt battery and to regulate the current by means of this resistance. As most valves will not stand more than four volts across the filament, I advise you, to start with, to use a four-volt battery and cut all the resistance out. If you get signals louder than you require you can insert a little resistance, and so increase the life of the valve and also of the battery.

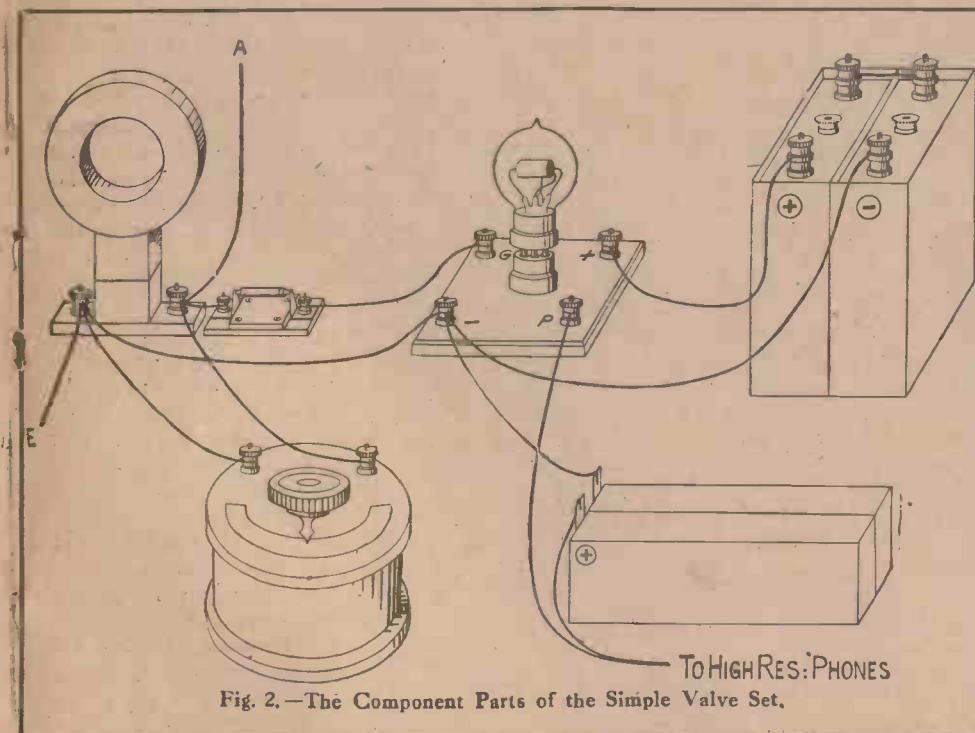

Fig. 2.—The Component Parts of the Simple Valve Set.

The holder of the reaction coil is hinged so that the coil can be placed at  $90^\circ$  to the aerial coil or brought close up to it as required (this is termed tightening the coupling). A "Burndept" 400 is suitable for the reaction coil at this wave-length. After adjusting to maximum signal strength by means of the condenser, move the reaction coil slowly nearer to the aerial coil. The strength of the signals will gradually increase, and if you go far enough the musical note will suddenly go off and the signals will come in very rough, though stronger. The valve is now oscillating, and you should immediately move the coil back slightly until you just bring in the musical note again. If, as you tighten the coupling, signals get weaker instead of stronger, reverse the wires on the terminals of the reaction coil and try again.

The note of a particular spark station is always the same, but you will find that with other adjustments of the condenser you get notes which vary considerably in pitch as you tighten the reactance coupling. These are C.W. stations, and to receive these at all means that your valve is oscillating.

I had hoped to tell you something about the reception of C.W. and telephony with a single valve, but space does not permit. I might say that with one valve I get the German time signals (spark) from Nauen (600 miles) and most of the European high-power C.W. stations, whilst I get fairly satisfactory telephony from Paris (300 miles), quite good telephony from Croydun (150 miles), and Writtle (100 miles), and can just hear The Hague concerts (300 miles), but the tuning is very fine.

If it is my privilege to write again for "Amateur Wireless" I shall be able to tell you something about the reception of these and other stations.

I can say without fear of contradiction that by far the best set to commence with is a single-valve set.

In Fig. 4 I have shown approximate prices. A single-valve detector panel, including valve-holder, filament resistance, grid condenser and leak, telephone condenser, and all the necessary terminals can be obtained for about £2.

Just one more word of advice—join a wireless society if there is one in your district, and if you do not get the results you expect do not be discouraged, but consult the members, who, you will find, are enthusiasts and ready to help you in any way.

*[Readers will observe that Mr. Dyer's opinion of the valve is rather inclined to be detrimental to the crystal, but excellent results are obtainable with the latter, as has been frequently shown in these pages.—ED.]*

**THE Handbook on Wireless** is acknowledged to be "Wireless Telegraphy and Telephony," published at the offices of this journal. The price is 1s. 6d. net.

## RADIOGRAMS

A NEW type of aerial for transmission purposes simply consists of a pair of wires some miles in length. It is claimed that this gives better results than the other type.

The first "Daily Mail" wireless concert from The Hague was heard with great clearness in many districts, though in London it was not heard very well.

A wireless concert was arranged for the entertainment of visitors to the Midland Musical Festival held at Bournville (see illustration on the front cover). The instruments were operated by students of the Stirchley Continuation School. Special music was transmitted to the festival by prominent Birmingham wireless amateurs.

The Marconi Company state that owing to the short notice at which many of the transmissions from Marconi House are arranged they regret that it is impossible to publish beforehand anything like a timetable of forthcoming concerts. The company, however, will be pleased to mail its latest arrangements to any interested persons who care to send stamped postcards for the purpose. It also invites criticisms of the transmissions by 2L O, together with technical data respecting the conditions under which the concerts are received.

All the electrical firms and even other organisations not closely associated with electrical apparatus are experiencing an extraordinary inflation of trade due to the wireless fever that has spread over Canada. Factories are running under pressure, with three shifts every twenty-four hours.

Many comments have appeared recently in the technical press concerning the comparative inefficiency of wireless—that is, the disproportion between the hundreds of kilowatts utilised at the transmitting end and the few microwatts picked up at the receiver. In an editorial one paper said recently: "It is only necessary to inspect the oil-cooling system of the high-frequency alternator, the water jacketing of the arc, or the red-hot anodes of the very latest transmitter, the 3-electrode valve, to realise that even present-day apparatus has far to go before it approaches the efficiencies now commonplace in low-frequency and direct-current work."

Under the auspices of the Glasgow and District Radio Club a wireless exhibition is to be held in Glasgow, probably at the beginning of November. The display of apparatus will be a most comprehensive one, and in addition to highly efficient modern sets, some strange and wonderful instruments, dating back to the early days of the science, will be on show. The exhibition will be public, and working demonstrations will be given. In addition, it is hoped to have lectures from a number of experts.

What is termed a gentlemen's agreement has been reached in the matter of broadcasting activities in and about New York City. Heretofore the stations have operated more or less without reference to the activities of others, but from now on they are to arrange their programmes so as not to interfere one with the other. Thus the most powerful station in regular operation, WJZ of Newark, N.J., operates the greater part of the evening. At 10.30 WJZ signs off for the evening, enabling smaller broadcasting stations to render their programmes. During the day WJZ works every hour for fifteen or twenty minutes, leaving the rest of the hour open for other stations.

Leafield, the first station of the Imperial chain, has now been equipped with the Elwell-Poulsen arcs similar to those at Lyons, Rome, Nantes, and so on. Arcs handle traffic with certainty and at low cost.

In many of the larger stores in America sales of wireless apparatus average £1,200 weekly in spite of the existing shortage of sets and parts.

Scotsmen claim that the first wireless press message in the United Kingdom was sent from the West Highlands. In 1895 the result of the parish council election held in the Bunessan district of the Island of Mull was sent by wireless to the mainland, whence it was transmitted by the ordinary telegraph to a Glasgow newspaper. The wire telegraph from Bunessan was under repair at the time, Sir William Preece being in charge of the operations. He was also carrying out experiments with a wireless set of his own construction, and when the message from Bunessan arrived he decided on a practical test by sending it across to the mainland on his own apparatus. The results were entirely satisfactory.

# OUR INFORMATION BUREAU

Expert Replies to Readers' Questions. Hundreds of Replies are sent by Post.

TO ENSURE A PROMPT REPLY PLEASE OBSERVE THE FOLLOWING RULES

Write distinctly, give all necessary details and keep to the point. Ask one Question at a time—never more than two. Send a Stamped and Addressed Envelope. Send the Coupon cut from page 178.

## Receiver for Broadcasts

Q.—I should be glad of some general advice with regard to apparatus suitable for reception of telephone broadcasts, including those from Writtle and Eiffel Tower.—C.A. (20)

A.—As you are quite a beginner and do not understand much about the subject, it is considered that the best service which can be rendered you is to advise as follows: (1) Obtain a copy of the new handbook, "Wireless Telegraphy and Telephony" (Cassell & Co., Ltd., price 1s. 6d.). This will give you a good general knowledge of the theory and principles, together with constructional details, of useful components and complete receiving sets in case you should decide to make them yourself. (2) For efficient reception of wireless telephony from the proposed new stations, the receiving tuner will require to be capable of tuning in waves between 350 and 450 metres. For maximum efficiency a set should be obtained which is just capable of covering this range without any spare or unnecessary overlap. The "short-wave tuner" (as described in the above-mentioned Handbook) will tune in waves from about 180 to about 600 metres, and will therefore prove effective. Improvement would be made by winding with slightly thicker wire than that specified, thereby reducing the maximum wave-length, though ability to tune in ship stations, etc., on 600-metre wave would be lost. Writtle now transmits on a 400-metre wave. (3) For reception of the Eiffel Tower telephony, on a wave-length of 2,500 metres, a much larger set of tuning coils will, of course, be necessary, and for this purpose the "single-circuit tuner" (as described in Chapter VII of the Handbook) is recommended. (4) Yes, you should certainly be able to receive good speech, etc., from Writtle with a three-valve set. (5) For short wave-lengths, either the single-layer solenoid inductance (that is, one layer of wire wound upon a cylinder of cardboard, etc.) or "basket-type" coils are preferred. Honey-comb and slab coils are more useful for the longer waves. (6) Any of the firms advertising in this journal may be relied upon to supply satisfactory materials, components, etc. It is not to their interests to do otherwise.—CAPACITY.

## High- and Low-resistance Telephones

Q.—Will you state what type of receiver is the most suitable and explain what the respective merits are of high- and low-resistance 'phones?—A. C. C. (57)

A.—For general all-round work double receivers having a total resistance of 4,000 ohms (2,000 each ear-piece) are very suitable, though receivers of half this resistance will also give good results. If low-resistance telephones are used, it becomes necessary to include a "step-down" transformer, the fine-wire winding of which is connected in the detector circuit, that is, where the telephones would normally be connected, whilst the telephones themselves are connected to the ends of the low-resistance or thick-wire winding. With telephones of 1,000 ohms each or over, a transformer is not required.

The usual resistance of commercial telephone receivers varies from 50 or 60 ohms

to 160 or 200 ohms, but as far as "wireless" is concerned all of these are "low resistance." When using two or more pairs of telephones in connection with a receiving apparatus it is an advantage to place them in series, especially if they are of varying resistances. There is, of course, quite an appreciable reduction in strength of signals in a telephone receiver if other 'phones are connected in circuit with it, either in series or in parallel. There is, however, if good signals are obtained, nothing to prevent 'phones up to 9 or 10 in number being connected in series and signals being easily heard in them all.

The telephones are connected in series with the detector, which, having a very high resistance, allows only a minute current to pass. Now the efficiency of the telephone depends very largely on the variation in the strength of the magnetic field due to flow of current through the windings of the polepieces. The amount of this variation depends on what is termed "ampere-turns," that is, it is a product of "current flowing" and "number of turns" through which it flows. Obviously, therefore, if the amount of current is minute, the greater the number of turns on the polepieces the better will be the result obtained.

The employment of very fine wire in order to get the greatest possible number of turns on the polepieces, in the limited space allowed, incidentally gives rise to a high resistance and leads to telephone receivers for wireless work being called high-resistance 'phones. Conversely, a low-resistance telephone is one with few ampere-turns, and if the minute current through the detector flowed through them very little effect would be produced. If, however, a step-down transformer is connected with its fine-wire winding in the detector circuit, and the low-resistance telephones are connected to the ends of the thick-wire winding, the result will be an increase in current through the windings of the telephones and consequently in strength of sounds emitted by the diaphragm. It is the usual practice for the "input" side of the transformer, which, as it is to be employed as a step-down transformer, will be the fine-wire winding, to have a total resistance approximately equal to the detector, either crystal or valve. An ordinary telephone induction coil used in a reverse sense will make quite an effective step-down transformer. Or a small spark coil, with interrupter short-circuited or screwed up tight, may be used.—CAPACITY.

## CORRESPONDENCE

### Indoor Aerial and Crystal Set

SIR,—I have just completed the construction of the short-wave receiving set described in the latest "Work" Handbook, and have already obtained what I consider to be a "freak" result.

My aerial is an indoor one, consisting of two 15-ft. wires hung about 6 ft. apart, with a single lead to the apparatus.

During the evening of Tuesday, July 25, I picked up 2MT Writtle, faint but clear. I distinctly heard the phrase, "Hullo, Walthamstow Radio Society! 2MT Writtle calling," and in addition to the music a considerable amount of speech came through, but as some amateur's howling valve was sounding in my ear like a siren I was unable to make anything out except that they had one or two special items and would welcome comparative reports.

This came in on my indoor aerial, using a "Rectarite" crystal as a detector, and I might add that the tail-end of my aerial points in the direction of Writtle, which is over twenty-five miles distant, the supposed maximum range with a full-size outdoor aerial.

Seeing that this concert takes place in daylight, I regard the short-wave receiving set as being extremely well designed.—H. G. E. (Islington).

### Can any Reader Explain?

SIR,—Kindly allow me to express an opinion on the points raised by G. B. (Sacriston) in his most interesting letter published in No. 5 issue.

Firstly, an elementary knowledge of the electron theory will be required to follow the theory which I have evolved. The electron theory is that all substances consist of a certain number of atoms, and each atom is composed of electrons. An atom of a given substance always contains the same number of electrons, and if it were possible to take away electrons from an atom the substance itself would change its form and become a different substance altogether. If this were possible, it would be an easy matter to change lead into gold. However, this is impossible at the moment, because immediately electrons become detached from their atom free electrons rush in to take their place and restore the balance. If all matter consists of electrons then the ether is composed of electrons, because ether is matter.

Now for the first query: "If electro-magnetic waves and light waves travel at the same velocity and through the same medium (ether), why do opaque bodies allow electro-magnetic waves to pass, but prevent the passage of light waves?" I think this can be explained by stating that opaque bodies absorb light waves to a greater extent than they do electro-magnetic waves; but this statement needs analysing before it can be convincing. It

can be proved that opaque bodies do oppose the passage of electro-magnetic waves to a certain extent by placing a small spark transmitter inside any opaque receptacle—a wooden box under a porcelain cover or inside a biscuit tin—and comparing the strength of signals received with those obtained when the transmitter is not shielded. But the method by which absorption takes place I believe to be as follows:

If the electron theory is accepted, and if we agree that all matter is composed of electrons, then it is only a step further to say that the whole structure of the opaque body vibrates to the frequency of the electro-magnetic waves acting upon it. These vibrations are passed to the ether on the far side of the opaque body and resume their journey. But if we assume that the electrons in an opaque body are denser than they are in air it will be seen that the amplitude of the electro-magnetic waves will be reduced while passing through the opaque body because of the energy expended by the waves in setting the body in a state of vibration; consequently there will be a loss of strength in the electro-magnetic waves after having passed through the obstruction.

Taking the electron theory as accepted, it now remains to be seen why light waves cannot pass through opaque bodies. One possible explanation is that an opaque body, being composed of electrons very densely packed together (as compared with those in air) the light waves of extremely high frequency find great difficulty in inducing the opaque object to vibrate to their frequency, and the waves are consequently damped out. This explanation, however, does not agree with that given in the case of X-rays, with which I shall deal shortly. Another explanation is based on the fact that the amplitude of light waves is very small when compared with the shortest electro-magnetic wave, although, of course, amplitude does not depend on wave-length. This being the case, and remembering that the electrons in the opaque body have a great density and consequently require some energy to vibrate them, it seems highly probable that although the light waves are able to set the electrons on the surface of the body vibrating to their own frequency, the energy expended in doing so very quickly reduces the originally small amplitude to nothing, and the light waves are completely damped out and therefore do not pass through the opaque body.

With regard to X-rays, although these waves are very short, I believe their amplitude is very great indeed compared with light rays. This being the case, they apparently pass through opaque objects in the same manner as electro-magnetic waves, that is by vibration of the electrons comprising the opaque body. If it is remembered that the X-rays throw shadows of denser bodies in the subject under examination, the theory seems feasible that waves of any description, using the ether as a medium, have their amplitude reduced in

direct ratio to the density of the object through which they are required to pass. Waves of very small amplitude appear to stand very little chance of getting through.

The foregoing possible explanations are merely theories, being based on the theory of the existence of the ether.—P. T. B. (Ware).

## CLUB DOINGS

### Proposed Wireless Society for Beckenham and District

It is proposed to form a Wireless Society for Beckenham and District, and anyone interested is requested to communicate with Mr. S. Graves, 9, Rectory Road, Beckenham.

### The Wireless Society of London

Hon. Sec.—LESLIE MCMICHAEL, M.Inst. R.E., 32, Quex Road, West Hampstead, London, N.W.6.

The Wireless Society of London held its last meeting of the session on June 14th at the Institution of Electrical Engineers, when a most interesting address was delivered by Sir Oliver Lodge, F.R.S. Although the Society does not hold any further general meetings until September, its activities are in no way curtailed, and new members and associates will come up for approval before the committee at their monthly meetings, and will be balloted for and elected *en bloc* at the first meeting of the next session.

At present the position of the Society with regard to the wireless exhibitions which are to be held in the early Autumn is undefined, but the Wireless Society of London will be well represented and the interests of its members and of the Affiliated Societies will be well looked after in connection with the social side of the exhibition. Application forms for membership can be obtained from the Hon. Secretary.

### Sutton and District Wireless Society

Hon. Sec.—MR. E. A. PYWELL, Stanley Lodge, Rosebery Road, Cheam.

Meetings are held every Thursday (8 p.m.) at the Adult School, Benhill Av., Sutton, where experimental work is conducted and papers are read.

Application forms for membership may be obtained from the Hon. Sec.

### Wireless Society of Highgate

(Affiliated with the Wireless Society of London).

Hon. Sec.—MR. D. H. EADE, "Gatra," 13a, Sedgemere Avenue, E. Finchley, N.

On Friday, July 7th, Mr. J. Stanley gave the fourth of his series of lectures on the theory of wireless telegraphy and telephony, dealing this time with detectors and telephones.

He first of all showed why signals could not be detected by simply connecting telephones in the receiving circuit, and explained that it was necessary for the high-frequency oscillations to be rectified and converted into low-frequency pulses. He then described how a crystal detector performs the function of rectification and explained the meaning of the characteristic curve of various crystals. In this connection he pointed out that in order to get certain crystals to work at the best point of their curve for rectification purposes, it is necessary to apply across them a steady voltage, and he showed how this could be done by means of a potentiometer and a small cell. Mr. Stanley went on to deal very carefully with the construction and action of the telephones, mentioning especially the Brown telephones. He described also the action of the blocking condenser usually connected across the telephone terminals. Finally he showed the advantages of increased selectivity which

could be obtained by using loose coupling between the aerial and a closed circuit instead of coupling direct on to the aerial.

On Saturday, July 8th, the society gave a demonstration at a garden party held by the Hornsey branch of the National Council of Women of Great Britain and Ireland at The Grange, Highgate. A number of special transmissions from London amateurs were arranged, and in addition the transmissions from Marconi House and 2FQ to other fêtes were picked up. Owing to the wet weather the demonstration could not be given on the lawn as was intended, but two leads about 100 yards long were taken from the receiving set to the hall of the house, where a loud speaker (kindly lent by Messrs. Brown) was placed, and a large number of people had the pleasure of listening to some excellent music by wireless.

The Hon. Sec. will be pleased to answer inquiries regarding the society, and to give particulars of the series of lectures now being held.

### The Fulham and Putney Radio Society

Hon. Sec.—J. W. DEWURST, 52, North End Road, West Kensington, W.14.

THE above recently formed Society held a meeting at their temporary headquarters on July 19th, when the officers were elected, the subscription fixed, and the meetings arranged for every Thursday evening at 7.30 p.m. Also it has been proposed to start a technical library and a workshop for the members. There is an aerial fitted to the Society's headquarters, and the founder, Mr. Houstoun, has promised a valve panel and other apparatus.

### Wolverhampton and District Wireless Society

Hon. Sec.—MR. GEORGE W. JONES, 8, Rosbery Street, Wolverhampton.

THE Secretary invites correspondence from the secretaries of other societies with a view to the interchange of lecturers.

### Manchester Wireless Society

Hon. Sec.—2, Parkside Road, Princess Road, Manchester.

THE above society has arranged to give a series of lectures on wireless for the benefit of those who wish to participate in the forthcoming broadcasting. The lectures will be augmented by actual demonstrations of wireless music and speech. All explanations will be made in simple non-technical language. The first two lectures were held on Saturday, July 22nd at 3 p.m. and 7 p.m., at the Rusholme Public Hall, Dickenson Road, Rusholme. Tickets, 1s. each.

### Proposed Wireless Club for Nelson and District (Lancashire)

WILL all interested please communicate with Mr. H. Turner, 14, St. Phillip Street, Nelson.

### Proposed Wireless Club for Barnes, Mortlake and Richmond District

CORRESPONDENCE on the above matter is invited by Mr. Eric A. Rogers, 122, Wood Street, London, E.C.2. Telephone: Central, 7643.

### Hackney and District Radio Society

Hon. Sec.—MR. E. R. WALKER, 48, Dagmar Road, South Hackney.

A MEETING of the above society took place at 111, Chatsworth Road, Clapton, on July 20th, when Mr. Ison delivered a lecture on the "Three-electrode Valve." He explained how the filament on becoming incandescent discharged electrons, and how these were controlled by the grid. The subject was capably handled and made clear even to the beginner.

(Continued in second column of next page)

# Broadcasting

## The Present Position

THE question of broadcasting was raised in the House of Commons on Thursday last when Mr. Kellaway, the Postmaster-General, stated that no licences have as yet been issued for broadcasting. Mr. Kellaway went on to say that it was understood that the principal manufacturers of wireless apparatus in Great Britain will combine to form a company or companies to provide broadcasting services; and that when the companies were formed they would probably desire to impose the condition that only British-made apparatus shall be sold by them. Intimation had been given to those concerned that this condition will be assented to for a period of two years. Further, *bona-fide* manufacturers in this country will be admitted to membership of any companies so formed, and the companies will make themselves responsible for raising the necessary capital and maintaining efficient services. Receiving apparatus which may be used under the licences shall be limited to types submitted by members of the broadcasting companies.

Proceeding, he went on to say that he should propose to the House that a proportion of the annual receiving-licence fee shall be paid to the companies financing the services. Provision would be made under which amateurs who had constructed their own receiving sets and those who have already purchased imported receiving sets will be allowed to use them. The general position with regard to broadcasting, therefore, may be summarised as follows: (1) That broadcasting licences will shortly be available; (2) that the manufacturers of apparatus in Great Britain will form an association, each member of which will contribute a part of the cost of broadcasting; (3) that no apparatus will be allowed to be imported for a period of two years; (4) the use of existing imported apparatus will be permitted; (5) the use of amateur-constructed apparatus will be permitted; (6) the cost of broadcasting will be paid for in part by the licences and in part by the inclusion of a fixed amount in the price of apparatus.

Readers will observe that the above is much on the lines announced in our article "Broadcasting and the Public" in last week's issue.

### CLUB DOINGS (continued from page 174)

Next week Mr. Valins will give a demonstration and lecture on H.F. Currents, Tesla coils and Wimshurst machines.

Applications for membership should be made to the secretary.

### Newcastle and District Amateur Wireless Association

*Hon. Sec.*—COLIN BAIN, 57, Grainger Street, Newcastle-on-Tyne.

A MEETING of the above association was held at headquarters on Monday, July 17th.

After the minutes of the last general meeting had been read and passed, the Chairman called on Mr. Colin Bain to deliver his lecture upon the relationship between wave length and frequency. Mr. Bain dealt with the subject in a most interesting and lucid manner, chiefly in order to assist those members who have but recently joined the ranks of wireless experimenters. Mr. Dixon, the chairman, then lectured on the various oscillations produced in "Spark" transmission, giving a very detailed account of the production of wave trains, dealing first with the induction coil, then the spark gap, and finally with the oscillations between the aerial and earth. He then explained the systems used by some of the large commercial spark transmitting stations, and the wave effects produced from each, illustrating each section of his lecture with very clear diagrams. A discussion followed upon the peculiar action of a tapped high-frequency transformer, which gave three high efficiency "peaks" at different wave lengths for the first tapping. Further experiments are being carried out with this transformer, the results of which, when completed, will be explained to the members.

### The Leicestershire Radio and Scientific Society

*Hon. Sec.*—J. R. CRAWLEY, 269, Mere Road, Leicester.

THE monthly meeting of the above society was held on July 17th. Mr. J. W. Pallett read a paper on "Continuous-wave Transmitters." With the aid of diagrams, Mr. Pallett showed a number of circuits as used in practical C.W. work, and concluded with a selection of slides kindly lent by The Marconi Co., depicting various types of actual gear including the well-known 2L.O.

### The Southwark and District Wireless Telephony Association

*Hon. Sec.*—MR. W. HELPS, Kings Hall, London Road, S.E.

THE above association held their first meeting on July 16th. It was well attended by enthusiasts, and wonderful results were obtained. Though the hall is 110 ft. by 50 ft., speech, singing and music intermixed with signals were heard loudly all over the hall. The next meeting of the association will be held on August 6th, when a competition will take place for home-made crystal sets, open to all amateurs. On August 20th a single-valve set competition will take place. For these competitions, transmission will take place at one end of the building on a single line aerial, and be received at the other end by a single line aerial. Gramophone music will be used for transmission, using about 6 watts. All communications and entries for competition to be sent to the secretary.

### Birmingham Experimental Wireless Club

*Hon. Sec.*—FRANK S. ADAMS, 110, Ivor Road, Sparkhill, Birmingham.

At a meeting held at Digbeth Institute on Friday, July 14th, Mr. L. J. Dore lectured on "Condensers in Radio-circuits."

Mr. Dore commenced with the electroscop

as a means of detecting static charges, and gave a description of the action of a condenser. He then described a large number of different methods of constructing condensers, which could easily be used by amateurs. Many of the ideas described were extremely ingenious, particular reference being made to methods of obtaining fine adjustment. Some particulars were then given of the uses to which condensers could be put in valve circuits, and the functions which they performed when inserted in various positions.

Intending members should communicate with the Hon. Sec.

### Leeds and District Amateur Wireless Society

*Hon. Sec.*—MR. D. E. PETTIGREW, 37, Mexborough Avenue, Chapeltown Road, Leeds.

A GENERAL meeting was held on July 14th at the Leeds University, when the Hon. Sec. delivered a paper on the subject of "Maritime Wireless Communication." The lecturer commenced his paper with a consideration of the great advantages that were resultant upon the installation of wireless apparatus at sea, and briefly reviewed the very many facilities that such apparatus readily presented. The subject was outlined historically from the day when Marconi installed his plant aboard the Italian cruiser *San Martin*, exactly 25 years ago to the day, through the progressive years that followed, until the present day, when wireless has become almost an essential part of a vessel's equipment. The various apparatus used from the very first days of marine wireless, down to the plant as used now-a-days were described practically and theoretically with the aid of diagrams which were distributed to the meeting. On the transmitting side, such apparatus as the plain aerial and tuned aerial sets using induction coils, power sets having fixed, rotary or quenched spark gaps using low-frequency alternating current; continuous-wave valve transmitters, rectified L.F.A.C. were considered, and some actual working ranges as may be obtained with such sets were submitted to the meeting. Receiving gear was treated in a similar manner, various apparatus including the magnetic and crystal detectors, valve and crystal circuits, low-frequency valve magnifiers, separate heterodynes to enable the reception of continuous waves to be carried out, complete three-valve receivers, and single four-electrode valve circuits were described. The performance of such apparatus was also considered, and a brief sketch of marine wireless and direction finding work then followed.

## Competition No. 2

WE promised last week to make an announcement with regard to Competition No. 2 in this issue, but there are certain difficulties in the way of our keeping the promise to the letter.

We propose therefore making a special feature of some of the efforts that have been submitted to us in connection with this competition and ask all interested readers to look forward to the number which we publish in a month's time. We promise them some more interesting matter in connection with this competition.

**A**LAD, living at Plumstead, said to be overflowing with energy and very keen on practical wireless, would like to enter into an apprenticeship. Inquiries addressed to "Apprenticeship," c/o Editor, "Amateur Wireless," will be forwarded to him.

# We can supply YOU with ALL COMPONENT PARTS

for your wireless set straight from stock

If you wish to save money, send for our Complete List — TRADE SUPPLIED

Aerial Wire, 7/22 bare copper stranded in 100 ft. hanks	5/6 per hank
Ring Pattern Insulator, 2 in. by 1 in., 1/4 in. hole	6d. each.
1/4 in. sq. Section Brass Rod for Sliders, cut in 13 in. lengths, and drilled each end ready for fixing	8d. each.
Inductance slider, complete with plunger	1/- each.
Cardboard Cylinder, 12 in. by 4 in. diameter	10d. each.
No. 24 enamelled wire, H.C., true to gauge	2/8 per lb.
Large or small Condenser Plates (Aluminium)	1/5 doz.
Large Spacer Washers for condensers, cut true to 1,000 of an inch	9d. doz.
Small spacer washers Ditto	6d. doz.
Ivoryine Scales	1/- each.
Condenser Box in Polished Oak or Mahogany, 3 1/2 in. by 3 1/2 in. by 2 in.	5/- each.
0003 mf. Condenser complete—assembled in polished mahogany or oak boxes	17/6 each.
All necessary parts for above condenser—no drilling or fitting required, but unassembled	15/- each.
Ditto, but without box	11/- each.
Ditto, but without ebonite top, and box suitable for panel mounting	10/- each.
Crystal detector, mounted on Ebonite, complete with Crystal	5/- each.
Large or Small Contact Studs	1/- doz.
Valve Legs, complete with nut and washer	3d. each.

Instrument Wire at Rock-bottom Prices

## J. B. BOWER & CO., Ltd.,

WIRELESS MANUFACTURERS,

15, Kingston Road, WIMBLEDON, S.W.19.

Phone: WIMBLEDON 1030.

Works: MERTON.



## FOR YOUR AERIAL

- 100 ft. 7/22 COPPER WIRE
- 4 REEL INSULATORS
- 20 yard Skein ROPE CORD
- 1 MAST PULLEY
- :: LEAD-IN TUBE ::

COMPLETE

Post Free **10/6** British Isles

HENRY J. BREWSTER & CO.  
11, Queen Victoria Street, - London, E.C.4

## RELIABLE APPARATUS AT POPULAR PRICES

CRYSTAL SETS, VALVE SETS, etc. EVERY NECESSITY & LUXURY FOR THE WIRELESS EXPERIMENTER.

Fully Illustrated List of Wireless Goods, post free, 4d.

## H. D. BUTLER & CO., LTD.

Office: BANK BUILDINGS, 222, GT. DOVER ST., S.E.1  
(Opposite Boro Tube Station).

Works: CANONBURY, LONDON, N.1

Telephone: Hop 3029.

Teleg.: "Ingenuity," Phone London."

# RADIO K.B. EQUIPMENT

IMMEDIATE DELIVERY—IMMEDIATE SATISFACTION

VARIABLE CONDENSERS (with Scale and Pointer).

CAPACITY	FOR PANEL MOUNTING		IN POLISHED MAHOGANY CABINET (ASSEMBLED) 5
	SET OF PARTS	ASSEMBLED	
.0015	27/-	30/-	33/6
.001	21/-	24/-	31/6
.00075	17/-	20/-	26/-
.0005	14/-	17/-	22/6
.0003	11/-	14/-	19/-
.0002	8/-	11/-	16/-
.0001	7/-	10/-	14/6
.00005	3/6	5/-	9/-

ENGRAVED EBONITE DIAL .. .. . 3/3 extra

LAMINATED SWITCH ARMS (Complete) .. .. 2/5 each  
FILAMENT RESISTANCES (Panel Type) .. .. 4/- each

### "K.B." UNITS.

DETECTOR PANEL .. .. .	£1 14 6
CONDENSER PANEL .. .. .	£1 14 0
L.F. AMPLIFYING PANEL .. .. .	£2 3 0
H.F. " " .. .. .	£1 13 6

Price includes Engraved Panel and Polished Mahogany Cabinet. Parts also supplied.

### "K.B.II." 2-VALVE RECEIVER (1 Rect., 1 L.F.)

COMPLETE from Aerial to Earth	£15 15 0
PANEL ONLY	£8 8 0

LARGE STOCKS OF ABOVE NOW IN HAND. ALSO STOCKS OF ALL OTHER AMATEUR REQUIREMENTS.

Carriage extra on orders under £2.

CATALOGUE POST FREE, 4d.

"Listen in" at our Showrooms: Open 9 a.m. till 7 p.m.

## THE "K.B." RADIO EQUIPMENT COMPANY,

Head Offices and Showrooms: 109, High Rd., Kilburn, N.W.6.

Bus Services 8, 16, 28 and 51, Pass Door. [3 min. Kilburn Park Station (Bakerloo Rly.)

TRADE SUPPLIED.

## MAKERS' PRICES!!

- Aluminium Condenser Vanes, fixed and moving, 1d. each; 1 doz., 9d.; 6 doz., 4/3; 12 doz., 8/-.
- Large Spacer Washers, 5d. doz.; 6 doz., 2/4.
- Small Spacer Washers, 3 doz., 9d.; 12 doz., 2/8.
- Terminals, 4 B.A. with nut and washer, 2d. each; 1/6 doz.
- Contact Studs, with nut and washer, 1/2 in. x 1/4 in., 9d. doz.
- Ebonite Knob, drilled, 6d.
- Ebonite Slider, with plunger, 6d.
- Aerial Wire, 7/22 bare copper stranded, 100 foot hank, 4/-.
- Ring Patt. Insulators, 2 in. x 1 in.—1/4 in. hole, 4d. each; 3/- doz.
- Crystal Detectors, on ebonite, with crystal, 4/- and 5/- each.
- Condenser Rods, set of 4 with nuts, 8d., 10d. and 1/- set.
- Valve Legs, with nuts and washers, 2d. each; 1/8 doz.
- Ebonite Valve Holders, 1/2.
- Crystal Cup, with screw, 2d. each; 1/8 doz.
- Mullard Ora Valves, 15/-.

New 4,000 ohm Double Headphones. **30/-** very best quality, limited supply

Postage extra. All orders executed in rotation, but I endeavour to supply by return

## M. RAYMOND

27, LISLE STREET, LEICESTER SQUARE, W.C.2

Phone Gerrard 4637.

(Opposite Daly's Gallery Door.)

## WIRELESS VALVES SIMPLY EXPLAINED

By JOHN SCOTT-TAGGART

The only complete book on valves which has ever been offered to the public at such a low price. It provides the information the amateur wants. It is written in a simple style, and it contains nothing that cannot be understood by the beginner.

140 pages. 56 diagrams. Price 2/6 net, cloth 3/- net.

## THE CONSTRUCTION OF WIRELESS RECEIVING APPARATUS

By PAUL D. TYERS.

A book which is selling by thousands

It explains how to make the parts of a valve or crystal set without the use of expensive tools

Buy your copy now and make your own set. Price 1/6 net.

Our books are sold by all wireless dealers of standing, or may be obtained post free by return from

## RADIO PRESS, LTD., Publishers of Authoritative Wireless Books,

35, Norfolk Street, London, W.C.2.



EXPERIENCE

# Wireless Telephone HEAD SETS

IMMEDIATE DELIVERY FROM STOCK

**DESIGN.** These telephones are of the highest grade diaphragm type and have been specially designed for the reception of wireless broadcasting.

**CONSTRUCTION.** Every part is of standardised construction and thoroughly well finished. The cases are of polished aluminium. The terminals are fitted with insulating caps. The set is light and comfortable to the head.

**SENSITIVITY.** These telephones are highly sensitive, being of 4,000 ohms resistance. The diaphragms in every set have been accurately adjusted for maximum sensitivity. Other diaphragm type telephones may cost more but none are more sensitive.

**PRICE.** Each set complete with two earpieces and flexible connections,

CARRIAGE PAID **35/6** IN THE U.K.

Do not confuse these high grade telephones with the cheap inferior imitations you may be offered. **CALL AND SEE THEM.** Let us show you their perfect internal construction.

ORDER AT ONCE TO SECURE DELIVERY

## RADIO INSTRUMENTS LTD.,

Managing Director, **J. JOSEPH, M.I.E.E.**  
 Late Manager to **Mr. H. W. Sullivan**  
 Telephone: Regent 1908.

**ONLY ADDRESS.**  
*Works, Offices, Showrooms:*  
**12a, Hyde Street,  
 NEW OXFORD STREET,  
 W.C.1.**

Chief Designer, **W. A. APPLETON,**  
 M.B.E., M.I.R.E.,  
 late Admiralty Technical Research Officer.  
 [E.P.S. 3A]  
 Telegrams: *Instradio, London.*

**WIRELESS** Prompt Deliveries.

**ELECTRICAL SUPPLY STORES,**  
 5, ALBERT TERRACE, KING CROSS,  
 HALIFAX.

Lists two stamps. **SERVICE**

## COMPLETE SET OF PARTS TO BUILD

### Combined Crystal and Valve Receiver

- 4 in. by 3 in. Prepared Cardboard Former... .. 6d.
- 1 lb. No. 20 D.C.C. Copper Wire... .. 9d.
- 2 oz. No. 26 S.C.C. Copper Wire... .. 6d.
- 3 in. of 1/4 in. Brass Rod fitted with Ebonite Handle... .. 2/6
- Velvet 4-leaf Laminated Switch Arm... .. 10d.
- 7 Studs, each fitted with 2 Nuts... ..

The Most Suitable Valve Panel to use with above.

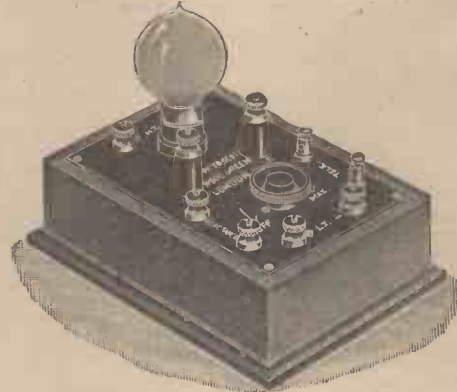

COMPLETE SET PARTS

**15/9**  
Post 9d.

Contains Velvet Filament Rheostat ready made, Sphinx Tubular Grid Leak, 2 Meg., Grid Leak Condenser, Insulating Sleeving, Wire and all Terminals; blue print. Polished Mahogany Cabinets to fit (extra) 3/6.

## BUILD YOUR OWN CONDENSER.

Set of Parts Complete.

- '001 21/-
- '005 14/-
- '003 11/-
- '002 8/-
- '001 7/-

Supplied with Knob Pointer and Scale for Panel Mounting. If required for Box Mounting Send 1/- extra.

Send 6d. for our ENLARGED ILLUSTRATED CATALOGUE "A" with list of stations. Cramped full of the latest and best.

## PETO SCOTT, The Condenser King,

FEATHERSTONE HOUSE, 64, HIGH HOLBORN, LONDON, W.C.1.

## DON'T MAKE haphazard purchases till you have sent for our CATALOGUE of

RADIO, ELECTRICAL & MECHANICAL SUPPLIES.

**SCIENTIFIC SUPPLY STORES**

8, NEWINGTON CAUSEWAY,  
LONDON, S.E.1.

We stock everything for the Experimenter who wishes to build his own Set.

WIRELESS INSTRUMENTS, ACCESSORIES and MATERIALS

## At What Station does the train of Oscillations stop?

### A Prize for the Best Answer

Watch these Advertisements for Winners

Write on a separate piece of paper (one side only).

Endorse "Competition" top of left hand corner of paper

- Aerial Wire, 7/22's Enamelled Hard Drawn, Copper, 8/- per 100 ft.
- Aerial Pulleys, 2/6 each.
- Aerial Insulators, Shell type, 2 1/2 in. x 2 1/2 in., green, 1/6 each.
- Reel type, 2 in. diam., white, 5 1/2 d. each.
- "Batteries." For H.T. Make your own. Flash Lamp Batteries, 5/- doz.
- Buzzers for Morse practice, 3/- each.
- Condensers. Fixed. Exceptional quality. Terminal connections; from '001 to '002, 2/9 each.
- Condenser Vanes. Not rubbish. Best Aluminium, 1/- doz.
- Condenser Spacing Washers. Accurate. Small, 4d. doz.; large, 8d. doz.
- Condenser Screwed Rod. Brass, 12 in. lengths, 2 B.A., 9d. each. 4 B.A., 6d. each.
- Contact Studs. Studs, not rubbish, 2/- doz.
- Copper Foil Sheets. 9 in. x 3 in., 6d. each
- Diads, Ebonite, graduated 0-180, 2/6 each.
- Ebonite. Best quality. Any size, rod or sheet, 5/- per lb.
- Filament Resistances. For panel mounting. A speciality. 4/- each.
- Inductance Tubes. 12 in. long. Specially impregnated. 2 1/2 in., 6d.; 3 in., 7d.; 3 1/2 in., 8d.; 4 in., 10d.; 4 1/2 in., 1/2; 5 in., 1/2; 6 in., 1/6 each. Postage 9d. each.
- Inductance Slider Rod, 1/4 in. square in 12 in. lengths, 7d. each.

- Insulating Tubing, 8d. per yard.
- Ivoryine Scales. 0 to 1800. Engraved (not printed), 1/2 each.
- Ivoryine Tablets. Set of 6, 8d.
- Knobs. Ebonite. 1 1/4 in. diameter. Superior finish. Knurled, 8d. each.
- Mica. Pure Ruby. Pieces, 3 in. x 3 in. x .002 in. thick, 6d. each.
- Paraffin Wax, 1/- per lb.
- Resistance Wires. "Elsi" brand. 22's (1 ohm per yard), 24's (1 1/7 ohms per yard), and 28's, enamelled (1 ohms per yard), 2d. per yard.
- Switch Arms. Exceptionally strong and well made, 3-leaf, 2/6 each.
- Terminals. A very neat wireless terminal. Polished, complete with nut and washer, 2/6 dozen.
- Tin Foil. Free from lead. Sheets, 26 in. by 12 in., 4d. each.
- Valve Sockets. With nut and washer. Fine finish, set of four, 10d.
- VALVE PANELS. Single valve. Mahogany case. Balze-covered base, ebonite top. Containing grid, leak and condenser, telephone condenser. Filament resistance, and with terminals to allow the addition of extra panels. A beautiful piece of workmanship. Price, 29/6 each.

- Valve Holders. Best quality ebonite, 1/6 each.
- Valves. 4 pin vertical filament, 10/6 each.

### SUPERIOR QUALITY WIRE. British Made.

All wire wound free. Post extra.

S.W.G.	S.C.C.	D.C.C.	Single Silk	D. Silk	Enamelled
12	1/10	1/11	4/-	5/4	1/8
14	1/11	2/-	4/1	5/4	1/9
16	2/-	2/1	4/2	5/6	1/10
18	2/1	2/2	4/4	5/6	1/11
20	2/2	2/3	4/8	6/2	2/6
22	2/6	2/11	5/-	6/8	2/8
24	3/-	3/6	5/6	7/4	2/8
26	3/7	4/1	6/8	8/2	3/2
28	4/4	4/7	7/2	9/-	3/6
30	5/-	5/6	8/-	10/-	3/10
32	6/-	7/3	9/2	13/-	4/2
34	7/-	8/3	11/6	14/-	4/4
36	8/8	11/2	14/-	15/6	4/8
38	11/3	13/2	16/-	19/-	5/3
40	15/-	18/-	18/6	22/6	6/6
42	17/3	21/-	31/6	34/-	9/-

} At per lb.

Carriage extra. Please remit ample postage, balance returned. Orders over £2 carriage paid. Money back if not satisfied.

'Phone Cent. 4209. **J.L. CARTWRIGHT & Co.,** Manufacturing Electrical and Radio Engineers, Dept. A, 130/132, London Road, Manchester. Grams: Pladuram, Manchester. Special Terms to the Trade.

**FORTHCOMING EVENTS**

**Hackney and District Radio Society.** Aug. 3, 8 p.m. At 114, Chatsworth Road, Clapton. Meeting.

**Tuxford and District Amateur Wireless Society.** Aug. 3. Morse practice. "Elementary Talk on Magnetism." "The Making of Simple Wireless Apparatus." Aug. 10. Morse practice. "Magnetic Induction." "Hints on Making Apparatus."

**South Shields Y.M.C.A. Amateur Wireless Society.** Aug. 4, 8 p.m. At Y.M.C.A. Buildings, Fowler Street, South Shields. Meeting.

**Aug. 11, 8 p.m. At Y.M.C.A. Buildings, Fowler Street, South Shields. Meeting.**

**Southend and District Wireless Club.** Aug. 7. Garden fête in the Rectory, Leigh-on-Sea. Public demonstration.

**Ilkley and District Wireless Society.** Aug. 10, 7 p.m. At Regent Café. Meeting.

**Stockton and District Amateur Wireless Society.** Aug. 10. Monthly meeting.

**Hackney and District Radio Society.** Aug. 10, 8 p.m. Meeting.

**Ilford and District Radio Society.** Aug. 10. "Reaction," by Mr. J. F. Payne.

**TELEPHONY TRANSMISSIONS**

**The Hague, Holland (P C G G),** 1,070 metres. Aug. 3, 8 to 9 p.m.; Aug. 6, 8 to 9 p.m.; Aug. 7, 8 to 9 p.m.; Aug. 10, 8 to 9 p.m.

**Writtle (2 M T),** 400 metres. Aug. 8, 8 p.m.

**Amateur Wireless And Electrics**

**Querist's Coupon Available until Saturday, August 12, 1922**

**SPECIAL NOTE TO ADVERTISERS**

**AMATEUR WIRELESS FOR AUGUST 12th.**

*will go to press early in consequence of Bank Holiday*

Instructions and copy must reach us by **THURSDAY, AUGUST 3rd**, at latest.

**ANNOUNCEMENTS**

"Amateur Wireless and Electrics." Edited by Bernard E. Jones. Price Threepence. Published on Thursdays and bearing the date of Saturday immediately following. It will be sent post free to any part of the world—3 months, 4s. 6d.; 6 months, 8s. 9d.; 12 months, 17s. 6d. Postal Orders, Post Office Orders, or Cheques should be made payable to the Proprietors, Cassell & Co. Ltd.

General Correspondence is to be brief and written on one side of the paper only. All sketches and drawings to be on separate sheets.

Contributions are always welcome, will be promptly considered, and if used will be paid for.

Communications should be addressed, according to their nature, to **The Editor, The Advertisement Manager or The Publisher, "Amateur Wireless," La Belle Sauvage, London, E.C.4.**

**PREPAID ADVERTISEMENTS.**

Wanted, quotations for valve wireless sets complete. State delivery.—Harry Macrae, North Bridge Arcade, Edinburgh. 16s

New Wireless Headgear Receivers, 4,000 ohms, post free, 24s. 6d. Also all parts and accessories. Special terms for quantities.—Write Blakey, 5, Alma Road, London, S.E.16. 15s

Tuning Inductances, 12 in. by 4 in., wound with 24-gauge enamel copper wire and shellacked, 3s. 10d. each; limited number only.—Harrington, 14, Park View, Down Lane, Tottenham. 1s

Aerial Wire, No. 16, per 100 ft., 3s. 6d., carriage paid.—Harrington, 14, Park View, Down Lane, Tottenham. 1s

Aerials, stranded, 7/22 bare copper, 6s. 8d.; enamelled, 8s. 100 ft.—Warren & Clark (below). 12s

Ebonite Sheet, 1/4 in., 1d. sq. in. post free.—11a, Sidney Avenue, N.13 (above). 12s

To Manufacturers of Electrical Goods.—Quotations for all wireless parts and complete installations in quantities; strict confidence observed.—J. Taylor, Electrician, 13, Goldsmong Terrace, Nottingham. 13s

Why Pay More? Aerial wire, 16 s.w.g., best hard drawn copper, 3s 3d. per 100 ft., post free.—Gibson, Factor, Somercotes, Derbyshire. Established 1849. Telephone 19.

Insulators, best quality white, 2 in. by 1 in. (1 in. hole), reel type, 3s. 3d. doz., carriage paid.—Gibson, Factor, Somercotes, Derbyshire.

Mast Rope, real Manila, maximum strength, length 108 ft., 3/4 in. thick, 3s. 9d.; 1/2 in., 4s. 6d.; carriage, 1s. 3d.—Gibson, Factor, Somercotes, Derbyshire. 4s

Xmas Chocolate Clubs.—Spare time agents wanted. Good remuneration. No outlay. Best makes only supplied. Particulars free.—Samuel Driver, South Market, Hunslet Lane, Leeds. 10r

You want to build your own set? Here you are then. Inductance tube, 12 by 4, 2s.; 1 lb. enamelled wire for same, 2s. 8d.; brass rod, drilled, with terminals, 1s.; mounted crystal detector, 5s. 6d.; pair high-resistance phones, 35s.; two ebonite sliders, 1s.; variable condenser, 12s. 6d.; 100 ft. aerial wire, including insulators, 4s. Here you have complete station for £3 3s. 8d., carriage paid. Assembled, 4gns.—Colloy Installations, 4, Clonmell Road, Tottenham. 14r

Broadcasting Double Headphone Receivers, 4,000 ohms, highly efficient, superior finish, 27s. 6d.; complete apparatus of every description 25 per cent. under usual prices; send your inquiries.—Direct Wireless Supply, 49, Heaton Road, Peckham, London. 17s

Wireless.—Half the pleasure in wireless lies in building your own set. Send stamp to-day for complete lists and get to work at once.—Electrical Supply Stores, 5, Albert Terrace, King Cross, Halifax.

Aerial Wire.—Our speciality, 7/22 hard drawn standard copper, guaranteed, 100 ft., 5s. 3d.; 140 ft., 7s.; 100 yd., 13s., carriage paid.—Fairbrother and Co., Vulcan Street, Leeds. 19r

**TO WIRELESS EXPERIMENTERS. PATENT YOUR INVENTIONS.**

They may prove very valuable. Particulars and consultations free. **BROWNE & CO.**, Patent Agents, 9, Warwick Court, Holborn, London, W.C.1. Est. 1840. Tel. Chancery 7547.

**WIRELESS AMATEURS AND RETAILERS PARTS SUPPLIED FROM STOCK**

List free. Condenser Plates, 1/6 doz. pairs (post 3d.). **FRASER, SENTINEL HO., SOUTHAMPTON ROAD, LONDON**

**HONEYCOMB COILS**

In sets of eight coils, Wave Range, with 001 Condenser, 800 to 7,000 metres.  
Price .. £1 7s. Unmounted  
" .. £2 10s. Mounted  
Send for Lists.

These coils are hand wound and combine maximum efficiency with lowest possible self capacity. There is a big demand for these coils, but at present they can be supplied from stock by—

**CHAMP, KAY AND CO., 95, SALTISFORD, WARWICK.**

**INSTRUMENT WIRES FROM STOCK**

Cut this out for reference.

S.W.G.	S.C.C.	D.C.C.	S.S.C.	D.S.C.	EN.
47	—	—	110/-	120/-	41/-
46	—	—	97/-	107/-	26/-
45	—	—	64/-	80/-	20/-
44	—	—	50/-	66/-	16/-
43	—	—	40/-	52/-	13/-
42	—	—	31/-	33/-	9/-
41	—	—	30/-	32/-	8/-
40	14/-	17/-	18/-	22/-	6/6
39	12/6	15/-	17/-	21/3	6/3
38	11/-	13/-	16/-	19/-	5/3
37	10/-	12/-	14/6	17/3	4/11
36	8/6	10/-	13/9	15/-	4/8
35	7/9	9/3	12/9	14/-	4/6
34	6/10	8/-	11/3	13/9	4/4
33	6/2	7/6	10/6	13/-	4/3
32	5/10	7/2	9/1	12/10	4/2
31	5/6	6/10	8/9	11/6	4/-
30	5/-	5/4	7/9	9/10	3/10
29	4/9	5/-	7/6	9/6	3/8
28	4/3	4/6	7/2	9/-	3/6
27	4/2	4/5	7/-	8/6	3/5

Prices per lb. Bolts free—Postage extra. Orders of £2 or over. Carriage paid, G.B. Terms—Cash with order.

Other Sizes on Application. **AERIALS, 7/22 per 100 ft., 6/- FINE WIRE SUPPLIES.**  
**A. E. DAVIS, 41, Arlington Road, Brixton, S.W.**

**The Universal Electric Supply Co. Ltd.**  
4 BROWN ST OFF MARKET ST  
MANCHESTER

G.P.O. Box No. 519.

**Large Illustrated CATALOGUE** 30th Edition, Post Free 6d.

**INDUCTANCE TUBES.**  
Length 12 in.  
Dia. 2 1/2 in. .. 6d. 4 in. .. 1/-  
3 in. .. 8d. 5 in. .. 1/6  
3 1/2 in. .. 10d. 6 in. .. 2/-

**SMALL CONDENSERS.**  
"001 & "005 .. 3/-

**ANODE RESISTANCE.**  
50,000 & 25,000 ohms 3/6

**VARIABLE ANODE RESISTANCE.**  
20,000 to 100,000 ohms. 7/6

**FILAMENT REHEAT.**  
5/-

**CONDENSER PARTS.**  
Fixed and Moving Vanes, 2/6 dozen.

**CENTRE ROD.**  
4 1/2 in., 4/6 each.

**LAMINATED SWITCH ARMS.**  
2/6

**VALVE SOCKET, 1/9.**

**VALVE SOCKET TERMINALS.**  
1/8 per set of 4.

**CONTACT STUDS.**  
Small size 2/- doz.  
Large size 3/-

**AERIAL INSULATOR.**  
1 1/2 in. 1/8 2 1/2 in. 2/6  
2 1/2 in. Reel Type, 4d.

**AERIAL WIRE.**  
Per 100 feet.  
3/30 .. 4/- 7/22 .. 5/-  
3/19 .. 4/6 3/18 .. 4/6  
7/30 .. 7/6

**REGULATING SCREW, 1/-**  
**EBONITE KNOBS, 1/- & 1/6.**

**INSULITE SLIDERS, 1/-.**  
**KNIFE SWITCHES.**  
S.P. 1 way, 1/9; 2 way, 3/4  
D.P. 1 way, 3/9; 2 way, 5/-

**GRID CONDENSER [and LEAK, 7/6.**

**BLOCKING CONDENSER, 5/-**  
**GRID LEAK, 3/-**

**PLUG CONNECTOR, 2-Pin, 1/6.**

**CRYSTAL CUP.**  
Single Cup Type .. 6/6  
Three .. .. 21/-

**SINGLE RECEIVER,**  
With Head Band and Cord.  
150 ohms .. 34/-  
500 " .. 27/6  
1,000 " .. 30/-  
2,000 " .. 32/6

**DOUBLE RECEIVER,**  
With Head Band and Cord.  
2,000 ohms .. 35/-  
4,000 " .. 37/6  
8,000 " .. 45/-

**SKELTON BUZZER.**  
Extremely sensitive for Crystal Testing. 2/6

**HIGH TENSION BATTERIES.**  
15 volts .. 3/6  
Variable Type, 150 v., Tappings every 3 v., 7/6.

**ACCUMULATORS.**  
Volts, Amps.  
4 40 28/-  
4 60 35/-  
6 40 42/-  
6 60 52/-

**POSTAGE EXTRA.**



### HEADGEAR RECEIVERS

Designed and manufactured by leading Telephone Manufacturers. Backed by many years experience. Highest efficiency, concentrated magnetic field, instantaneously adjusted to the ears, comfortable in wear, either receiver detachable from headband, protected terminals, light weight, twin series cord.

**A.T.M. LOUD SPEAKING RECEIVERS.**  
Three types of Amplifying Horn.

**A.T.M. CRYSTAL DETECTOR SETS.** Highest Grade. Maximum Efficiency Moderate Cost.

Ask your dealer for

**A.T.M. Broadcasting Apparatus**

**AUTOMATIC TELEPHONE MANUFACTURING CO., LTD.**

Head Office & Works:  
Milton Road, Edge Lane, Liverpool.

London Office:  
60, Lincoln's Inn Fields.

## Exide BATTERIES FOR WIRELESS

We specialise in the manufacture of batteries for filament current supply to Valves, and high-tension batteries for application, of Anode Potential. We can supply these batteries in glass, ebonite, or celluloid containers to any desired voltage.

Exide batteries can be relied upon for Wireless work, and retain their charge over very long periods.



Prices and Particulars upon application.

6 v. 80 ampour Exide Battery

**THE Chloride ELECTRICAL STORAGE COMPANY LIMITED.**

Head Office:  
CLIFTON JUNCTION,  
MANCHESTER.

London Showrooms:  
219/229, SHAFTESBURY  
AVENUE, W.C.2.

### QUALITY RIGHT!! PRICES RIGHT!!

A. E. G. & Telefunken Valves, tested 10/6	Sq. Brass Rod, 12" x 1/4" x 1/4" ... 6d.
Valve Holders, Screwed Legs & Nuts 1/6	Enamelled Wire, for Inductances, 23 gauge, 1/2 lb. ... 1/6
Condenser Vanes, Aluminium flat (accurate size and gauge), per doz. 1/-	Crystals (special selected), Bornite, Carborundum, Silicon, C. Pyrites, Galina, etc., etc. ... 6d.
Do., Large Spacers (true to .001") .. 5d.	Crystal Cups, Brass, with Fixing Screw ... 6d.
Do., Small Spacers (true to .001") .. 3d.	Fusible Alloy (for fixing crystals) Helleisen, 35 v. H.T. Batteries, with Plug ... 8/6
Do., Scales Ivorine, 0 to 180°... each 1/-	Headphones, Double, British make, Adjustable Headgear, excellent for speech and music, 2,000 ohms, 30/-; 4,000 ohms 32/6
Do., Ebonite Tops & Bottoms (bushed) 1/-	Filament Resistance panel mounting 4/-
Inductance Tubes, 12" x 3" .. 6d.	Switch Arms, laminated, with bush and spring ... 2/6
" " 12" x 4" ... 9d.	
" " 12" x 5" ... 1/-	
Sliders, Ebonite, with Plunger ... 6d.	
Aerial Wire, Stranded, 7/25 100' ... 4/6	
Do., Egg Insulators (high insulation) 8d.	
Do., Reel best quality 4d	
Do. Pulleys, Aluminium, with cord 1/6	
Panels, Tuners, Transformers. Postage extra. Demonstrations Daily.	

Office & Showrooms:  
**THE ESSEX WIRELESS CO. 499, GROVE GREEN RD., LEYTONSTONE, E.11.**  
(Wholesale & Retail)  
Telephone—WANSTEAD 749. (1 min. from Station, G.E.R.)

## DAVIS & TIMMINS LIMITED

34a, York Road, King's Cross, N.1

## SCREWS AND TERMINALS FOR WIRELESS SETS

## FOR TOOL BARGAINS

CALL or WRITE TO-DAY to:

Before buying elsewhere compare our prices. Remember, we have the Largest Stock of Tools to select from in London. We guarantee you satisfaction, so you can safely shop by post. Bargain List sent post free.

**GEORGE ADAMS,** D:PT. A/W, 255-6, HIGH HOLBORN, LONDON, W.C.1.

## THAT BOOK YOU WANT ON WIRELESS OR ANY OTHER TECHNICAL SUBJECT

Foyles have it or will quickly obtain it. 1,000,000 Vols. (Second-hand and New) on Technical and every other conceivable subject in stock. Books sent on approval. Write for Catalogue 10s (free) mentioning requirements. Books Purchased.

**FOYLES, 121, Charing Cross Rd., London.**

## L. WITHERS GREEN, LTD. 110, VICTORIA STREET, LONDON, S.W.1.

Components for Wireless Sets by return. All Goods BRITISH MADE.

NOTE OUR PRICES:

Contact Studs, 1/4" x 1/2" ... 11d. per doz.	Valve Holders ... 1/3 each.
Spacer Washers (large) ... 3d. ..	Egg Insulators ... 5d. ..
Spacer Washers (small) ... 3d. ..	Fusible Alloy (for mounting Crystals) ... 6d. bar.
Valve Sockets ... 3d. each.	

Aerial Wire, Condenser Segments, etc. etc., at equally low prices. Carriage Free on lots of 10/- and over.

Free Advice by our Expert Staff. Trade Inquiries Solicited.

**WHATEVER YOU WANT WE HAVE IT AND AT THE RIGHT PRICE**

Telephone: VICTORIA 2053.

Telegrams: ARROBALLA, VIC. LONDON.

Radio brings it: **MAGNAVOX** tells it

# MAGNAVOX

## THE WORLD'S FINEST LOUD SPEAKER

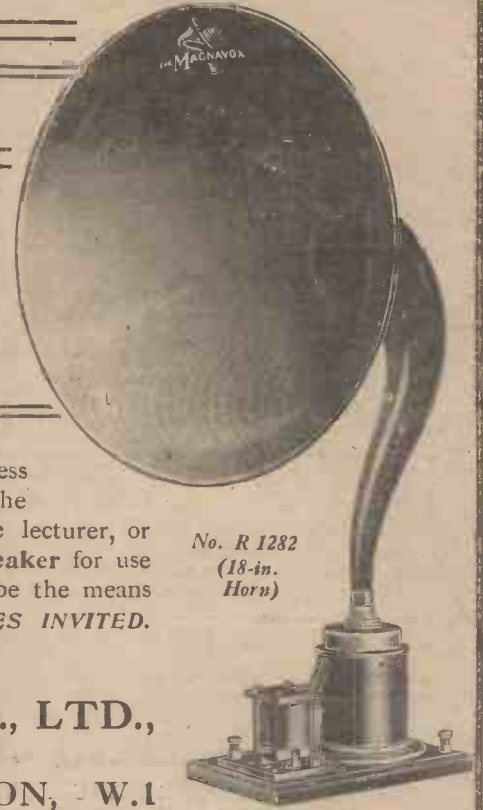

No. R 1232  
(18-in.  
Horn)

To enjoy, and get the greatest possible satisfaction from your Wireless Receiving Set, equip it with a **Magnavox Loud Speaker**. Hear the voice of the singer faithfully reproduced, the perfect intonations of the lecturer, or the natural sound of music. The introduction of the **Magnavox Loud Speaker** for use with Radio Receiving Sets marks a most important development, and will be the means of making broadcasting extremely popular.

INQUIRIES INVITED.

SOLE AGENTS FOR THE UNITED KINGDOM:

**STERLING TELEPHONE & ELECTRIC CO., LTD.,**  
Telephone House,  
210/212, TOTTENHAM COURT ROAD, LONDON, W.1

Telephone: Museum 4144 (7 lines).

Telegrams: "Cucumis, Westdo, London."

NEWCASTLE-ON-TYNE:  
9, Clavering Place.

WORKS:  
Dagenham, Essex.

CARDIFF:  
8, Park Place.

ORDER EARLY  
—IF EARLY DELI-  
VERY IS REQUIRED

# WIRELESS

COMPLETE RECEIVING SETS  
AND ACCESSORIES OF ALL MAKES

WE HOLD

the largest stock of ex-Government wireless apparatus in the country.

SPECIAL ATTENTION

and assistance given to all interested in receiving broadcast wireless music, telephony, and Morse signals.

Illustrated Catalogue

16 Pages. 100 Illustrations.  
Post 6d. Free

When writing please mention this publication

**LESLIE McMICHAEL LTD.,**

Providence Place, West End Lane, Kilburn, N.W.6.

Bus Services 1, 8, 16, 28, 31, all pass West End Lane.

Telephone: HAMPSTEAD 1261.

Nearest Tube Station: KILBURN PARK (Bakerloo).

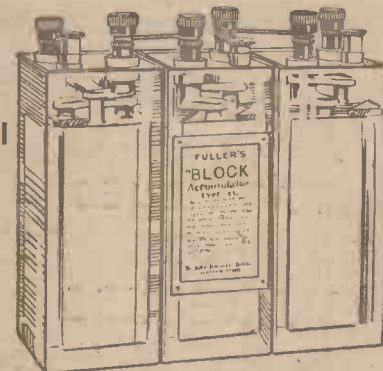

INSIST ON HAVING A

## FULLER "BLOCK" TYPE ACCUMULATOR

FOR YOUR WIRELESS SET!

The only Accumulator on the market that will hold its charge from 12 to 18 months when not in use.

4-volt 40 amp. hours, £1 12 6, plus 1/3 carriage  
6-volt 40 " " £2 8 9, " 1/6 "

Note:—These prices are 33% below those of the actual makers.

8,000 Sold. 20,000 still in stock.

Descriptive and Instructive Pamphlet on request from—

**The CITY ACCUMULATOR Co. (Dept. 14),**  
79 Mark Lane, E.C.3 (Avenue 91)

ALSO SUPPLIED BY—

Selfridge & Co., Ltd., Wireless Section; A. W. Gamage, Ltd., Wireless Dept.; Barnsley British Co-operative Society, Radio Section; Richford and Co., 153, Fleet Street, E.C.3.; The South Wales Wireless Installation Co., Ltd., 13, West Bute Street, Cardiff.

SIGNALS AMPLIFIED 100,000 TIMES

# Amateur Wireless And Electrics

FREE  
POST  
REPLIES

No. 10

SATURDAY, AUGUST 12, 1922

Price 3d

## PRACTICAL

## INFORMATIVE

SOME OF THE PRINCIPAL FEATURES OF THIS ISSUE



*Photo: Handley-Page*

Direction Finding (see page 190)

	Pages
USING "SURPLUS" W.D. APPARATUS: The Air-craft Pattern Spark Transmitter . . . . .	183
MAKING AND CALIBRATING A WAVEMETER . . . . .	184
THE VELOCITY OF LIGHT . . . . .	184
AN UP-TO-DATE VALVE PANEL . . . . .	185
WHAT SET SHALL I BUY? . . . . .	185
THE BEGINNER'S PAGE: The Crystal and the Valve . . . . .	186
A SLAB-INDUCTANCE TUNING STAND . . . . .	186
THE ARMSTRONG SUPER-REGENERATIVE CIRCUIT . . . . .	187
ANOTHER FREAK RECEIVER . . . . .	188
ALTERNATOR FREQUENCIES . . . . .	188
BRASS TURNING WITHOUT A LATHE . . . . .	189
WIRELESS TERMS . . . . .	189
LOCATION & DIRECTION FINDING	190

Radiograms. Correspondence. Information Bureau. Club Doings. Forthcoming Events.

## INTERESTING

## ENTERTAINING

E E C

CONOMIC ELECTRIC LTD.

DISCRIMINATING  
WIRELESS  
EXPERIMENTERS



**UNIVERSAL TUNER**

fully appreciate the outstanding features of "E.E.C." instruments. The design and finish are apparent, and the

**EFFICIENCY IS GUARANTEED.**



**CRYSTAL RECEIVER, 24/9**

WE WANT YOU TO  
WRITE TO-DAY

For our 36-page Radio Catalogue,

Containing 240 illustrations, also Wiring Diagrams of Crystal and Valve Sets,  
Mailed by Return for 4d.

Head Office: 10, FITZROY SQUARE, LONDON, W.1.

Telephone: MUSEUM 1055

Branch Showrooms: TWICKENHAM

New Showrooms: 303, EUSTON ROAD, N.W.1.

Branch Showrooms: TWICKENHAM

## MITCHELFONES

Are not a spasmodic production to meet a sudden demand, but have been on the market for over three months, and during this period 27,000 have been distributed to the trade, and consequently we have not been able to offer them direct to the retail buyer.

*1000 per week are now available, and we announce*

### DELIVERY FROM STOCK

You post your order, or call at our premises and get them at once. Think what this means to you—you, perhaps, who have been waiting and are still waiting.

*Standard resistance 4,000 ohms, double headgear with double headstraps, comfortable, highly efficient, and foolproof*

35/- per pair.

Special Terms to Traders and deliveries that will surprise you.

### MITCHELLS Electrical & Wireless Ltd.,

Postal Address: McDermott Road, Peckham, S.E.15.  
Retail Address: 188, Rye Lane, Peckham, S.E.15.

Phones: New Cross 1540/1541.

GREAT-BRITAIN'S GREATEST WIRELESS STORE

## SCIENTIFIC APPLIANCES

HENRY J. DALE. W. HOLLINS.

11 & 29, Sicilian Avenue, Southampton Row, London, W.C.1.

Top of Kingsway. In Centre of London. Corner of Bloomsbury Square.

ELECTRICIANS. OPTICIANS. MECHANICIANS.

ACTUAL MANUFACTURERS at our Works, East Street, W.C., thus saving all intermediate profits.

*The Store for all Electrical and Scientific Material*

WIRELESS & RADIO MATERIALS, VALVES. 'PHONES. PARTS and FITTINGS

Immense Stock constantly adding to, and Making; Specially for the Amateur to Build up a Set Complete and Perfect.

EBONITE. BATTERIES. AERIALS. INSULATED WIRES. CRYSTALS. ENGRAVED DISCS. MICA. HANDLES. SWITCHES. TERMINALS. STUDS.

Scientific Appliances, 11 & 29, Sicilian Avenue, London, W.C.1.

Call and see us. View our Show Windows. Send for List post free 2d.

### Splendid Value in Second-hand Appliances

Every Branch of Optical and Applied Science

## FOR YOUR AERIAL

100 ft. 7/22 COPPER WIRE  
4 REEL INSULATORS  
20 yard Skein ROPE CORD  
1 MAST PULLEY  
:: LEAD-IN TUBE ::

COMPLETE

Post Free **10/6** British Isles

HENRY J. BREWSTER & CO.  
11, Queen Victoria Street, - London, E.C.4

### TRADE Grelco MARK



**CRYSTALS**  
CALENA, BORNITE, GRAPHITE, SILICON, COPPER PYRITES, CARBORUNDUM. Per packet 6d. ZINCITE, TELLURIUM. Per packet 1/-.

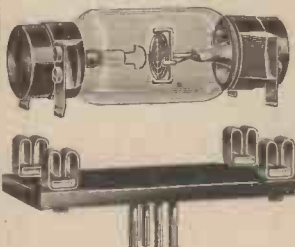

**VALVES**



**CRYSTAL CUPS**  
Turned brass. Well finished. With Milled Screw at side to fix Crystal. Each 6d.

**A.E.G.**  
Fil-current 2-3 volts. Plate 60/80v.

**STEADY and RELIABLE.**

**A.E.G. and S.H. Valves for Radio Reception.** Excellent make and finish. Exceptionally good for Rectifying and Amplifying. Can easily be adapted to fit standard type of holder.

**PRICE 10/6 EACH. ADAPTER as shown PRICE 3/- EACH.**

**S.H.**  
Fil-current 3-4 volts. Plate 60/80.

**NO PARASITIC NOISES.**

WE RECOMMEND YOU TO GIVE THEM A TRIAL

Every Wireless and Electrical Part can be seen and inspected at our well-equipped Showroom. No Pressure to Buy. But an Opportunity to Purchase at most Competitive Prices.

GRAFTON ELECTRIC COMPANY

(Showrooms)  
54, Grafton Street  
TOTTENHAM COURT ROAD  
LONDON, W.1

TELEPHONE: MUSEUM 241  
TELEGRAMS: GRAFECTRIC, EUSROAD, LONDON

# Amateur Wireless

## and Electrics

No. 10

August 12, 1922

## Using "Surplus" W.D. Apparatus

### I.—The Air-craft Pattern Spark Transmitter

IN spite of the fact that it is over three years since the cessation of hostilities there is still a considerable amount of ex-

The particular form of make-and-break is shown in Fig. 2, C being the iron core of the induction coil, B the armature blade, CS the contact screw, and R the rubber shock absorber. It will be seen, by referring to the sketch, that the armature does not vibrate freely as in most spark coils, its play being

Other advantages are the very constant vibration obtained, which is unaffected by any momentary variation in the battery voltage, and also the almost entire absence of arcing at the contacts after the make-and-break has been properly adjusted. If the instrument is in fair condition it should only be necessary to connect it up to a 6-volt accumulator, adjust the contacts slightly and obtain a fat spark at the spark-gap. This latter is adjustable and is fitted in a small compartment inside the case, the adjustment of the gap being observed through a small window.

The end of the case opens on hinges, disclosing the make-and-break and the spark-gap. When the case is closed the joints are sealed by means of rubber linings, which entirely deaden the sound of the spark discharge and the make-and-break. The hinged portion of the case, which, by the way, is ebonite, carries two terminals which are connected to the battery and sending key, the circuit being completed by connecting a wire from the other terminal on the battery or accumu-

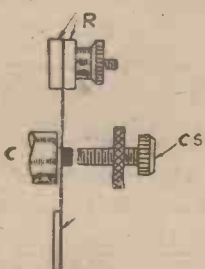
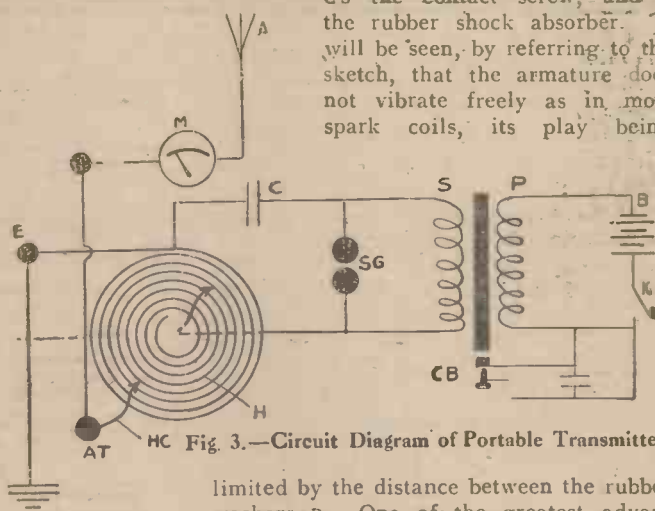

Fig. 2.—Make-and-break of Portable Transmitter.



limited by the distance between the rubber washers R. One of the greatest advantages of this type of break is the fact that it is possible to have only a very small

Government apparatus on the market, including aircraft pattern receivers and transmitters, which have the advantage of being particularly light and compact.

Various advertisers in "Amateur Wireless" are selling these sets at very reasonable prices, and it is proposed to describe some of the most useful from time to time.

In many cases some slight modification only is necessary to adapt the instruments for private use, while in others the low price paid makes it worth while securing the set for the sake of the component parts, such as potentiometers, variable condensers, reactances, etc.

This article deals with the "Sterling," aircraft-pattern spark transmitter which will prove a most efficient little instrument for those possessing a transmitting licence and who wish to communicate with another station within a 30-mile radius.

The photograph Fig. 1 gives a good idea of the compact nature of the set. The case contains a  $\frac{3}{4}$ -in. spark coil, fitted with a high-efficiency make-and-break, a spark-gap, condenser, direct-coupled inductance, radiation meter and terminals.

The spark coil is designed for 6 volts and takes anything from 2—5 amperes according to the adjustment of the make-and-break.

space between the contact blade B and the core C without the slightest chance of the blade sticking.

lator to the free terminal on the sending key. A refinement in the shape of a variable resistance may be added if desired

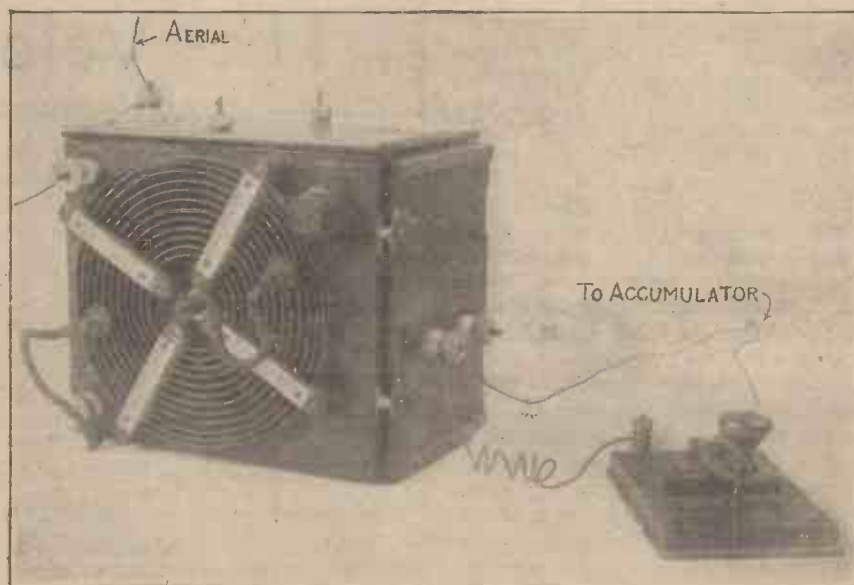

Fig. 1.—Photograph of Transmitter and Key.

to cut down the voltage slightly. Some coils work much better with the voltage just under 6; a variable resistance is very useful in cases where maximum efficiency is desired.

The connections are shown in Fig. 3, and consist of the battery circuit, the secondary circuit of the induction coil, and the open and closed oscillatory circuits, B being the 6-volt battery, K the transmitting key, P the primary winding of the induction coil, and CB the make-and-break. The secondary circuit consists of the secondary winding of the induction coil S,

the spark-gap SG, the condenser C, and the helix ribbon H.

The closed oscillatory circuit is comprised of the condenser C, the helix H, and spark-gap S.G., and is capable of oscillating when a spark bridges the gap.

The open oscillatory circuit is simply the helix H and the aerial and earth. The aerial in the case of an aeroplane would be about 40 ft. long and trailing from the under side of the fuselage, while the earth is simply the mass of metal comprising the engine and metallic parts of the aeroplane, and serves more or less as a

balancing capacity. The reader will probably wonder how it is that the helix is common to both the open and the closed oscillatory circuits and yet functions as a transformer for the high-frequency currents. An inductance of this pattern is known as an auto-jigger. When a high-frequency current is oscillating in a portion of its length a second oscillation is induced in the remainder of the coil, and acts like a close-coupled oscillation transformer.

[The conclusion of this article will be given in next week's issue.]

## Making and Calibrating a Wavemeter

WITH a coil of known inductance, a variable condenser, crystal and phones, a useful wavemeter can be rigged up. The circuit is as shown in Fig. 1.



Fig. 1.—Circuit Diagram of Wavemeter.

First calculate from the formula:

$$1,885 \sqrt{L \times C}$$

(L = inductance and C = capacity) the wave-length range your coil and condenser will give you. For example, condenser .0001 to .001, and coil, say, 2,000 mh. = 850 LC to 2,550 LC approx. Next prepare a chart on squared paper (Fig. 2) as follows: Mark off the condenser degrees equidistant on the vertical edge. Start at, say, 900 metres and square the units as follows: 9<sup>2</sup>, 10<sup>2</sup>, 11<sup>2</sup>, 12<sup>2</sup>, etc., = 81, 100, 121, 144. 100 - 81 = 19; 121 - 100 = 21. There will be an increase of two in every case after the first number of squares is found; the others need not be worked out. Your wave-length scale starts at 900 metres, therefore count 19 squares and mark 1,000 m. from this mark. If 19 squares is too large and half is taken then the increase will be halved.

When the scale is prepared start the calibrating as follows: Set your receiver to a known wave-length adjustment within the scale or get a station on a known wave that can be relied upon, say 9FA on calibration waves. Then listen in on the wavemeter circuit, coupling it closely at first to the C.W. receiver and vary the condenser until a rustling noise is heard, which will be very sharp tuning on the shorter waves. This point will be more quickly found if the aerial terminal of the receiver is tapped with a moistened finger.

The clicks heard when a set is oscillating will be heard in the wavemeter when it is in tune and sufficiently coupled. The tuning must be completed without the finger or capacity effect will give a false tune, though the difference is usually small.

The wave-length is marked on the chart at the point corresponding with degrees—wave-length. Two or more such points are plotted and joined and produced, when any wave-length between the limits can be found. To use the wavemeter it is set to the wave-length, and while listening in its phones the receiver is tuned until the hiss is heard; then transfer on to the receiver and listen for signals. Different values of coils may be used and scales plotted.

If a calibrated condenser is available

the chart can be plotted without the aid of the receiver. A buzzer can be used, when

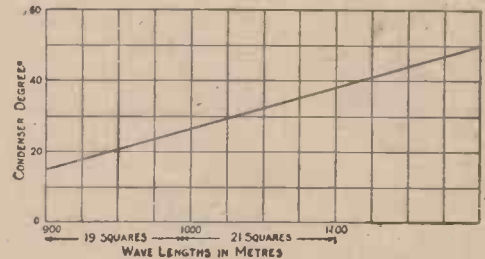

Fig. 2.—Chart for Purpose of Calibration.

the crystal and phones will not be necessary, but beware of harmonics. W. W.

## The Velocity of Light

BOTH the propagation of light and of wireless waves are now generally accepted as wave movements in the ether. The rate of propagation of light waves has been determined in several ways, one of which is outlined below.



Method of Determining the Velocity of Light.

The planet Jupiter, represented by J in the diagram, has several satellites or moons which revolve round the planet in a plane nearly coincident with that of the planet's orb round the sun. Consequently one or other of these satellites frequently passes into the shadow of the planet and so becomes invisible to observers on the

earth. When the earth E and Jupiter J are on the same side of the sun the time of disappearance of one of the moons into the shadow of the planet is observed. Suppose the time at which the phenomenon should happen six months hence to be calculated by considering the period which the satellite takes to revolve round the planet, it is found that when the half-year has elapsed the observed time of disappearance and the calculated time do not agree. The eclipse occurs about 1,000 seconds late. This is because the earth's position relative to Jupiter has undergone a change. It has made half its complete orbit round the sun and is now at E', and the light message has to travel across the orbit before reaching us. The extra journey takes 1,000 seconds. The distance across the earth's orbit is 186,000,000 miles, and hence the velocity of light is 186,000 miles per second. R. C. B.



# AN UP-TO-DATE VALVE PANEL

An Instrument Provided with Double-tuning Units for Long- and Short-wave Reception

WHEN using a piece of apparatus to which one is unaccustomed exceptional results are not to be expected, but sometimes the unexpected happens, as was the case in making a test of the double-tuning unit shown in the lower photograph on this page and submitted by the Economic Electric, Ltd., Fitzroy Square, W.C.1. As the time happened to be convenient it was decided to make an attempt to get the Dutch concert.

In order to see that everything was in order a preliminary trial was made for the 600-metre commercial wave, and without any difficulty signals were obtained from the South of France. Fort Mengham at Brest was as clear as though it were in the immediate vicinity.

Certain now that all was in order and with the Dutch concert due to begin, every effort was concentrated on this. The actual commencement was not obtained, but apparently about a third of the way through it came in. It was faint but distinct, and considering that only one valve was in operation, and this was the first trial of the apparatus, the results were rather exceptional. Later on the 3-valve amplifier was brought into use, and the

with a change-over switch for long and short waves. The right-hand switch on the panel is for the aerial tuning con-

centre of the panel and placed underneath is an additional adjustable loading coil. The valve used is of the usual R type.

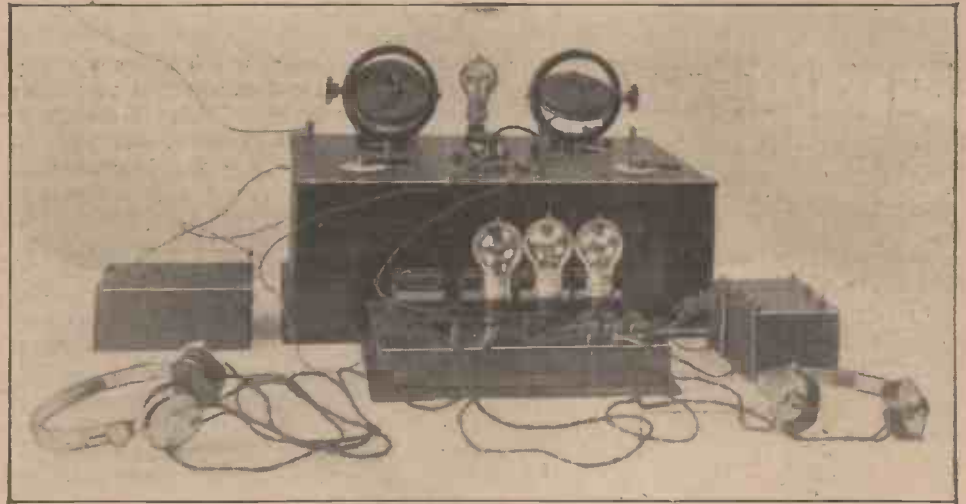

Long- and Short-wave Receiver with Amplifying Unit.

denser. The left-hand switch is for a variable grid condenser, which gives very fine selectivity. The left-hand coils are the

In both cases the photographs show the apparatus connected up exactly as it was when the tests were made.



The Receiver as a Single-valve Detector

concert was then heard with the 'phones lying on the table.

The receiver is of the double-unit type,

short-wave primary and secondary of the loose-coupler, and the right-hand coils are for the long-wave loose-coupler. In the

## What Set Shall I Buy?

A QUESTION frequently asked is, "What is the best set for me in (name of town) to receive good signals, music, etc., and how much would it cost?" This does not give nearly enough detail. When a correspondent asks this question he should also state:

1. Approximately how much he is prepared to spend on the set, and whether he wants one or more pairs of telephones.
  2. The maximum height and length of aerial he can erect.
  3. The distance from the nearest broadcasting stations. These stations will shortly be in operation at London, Cardiff, Plymouth, Birmingham, Manchester, Edinburgh or Glasgow, and Aberdeen.
  4. Details as to the location of his aerial—that is, whether it is in a hollow or on a hill, surrounded by trees or telephone wires, etc.
  5. Whether he can get accumulators charged locally (for valve set).
- Without information of this kind it is impossible to give a satisfactory reply.

# THE BEGINNER'S PAGE THE CRYSTAL & THE VALVE

THE action of the crystal briefly is as follows: The currents induced in the aerial by the oscillatory waves from the transmitting station are of extremely high frequency and alternating in character. They would, therefore, produce no

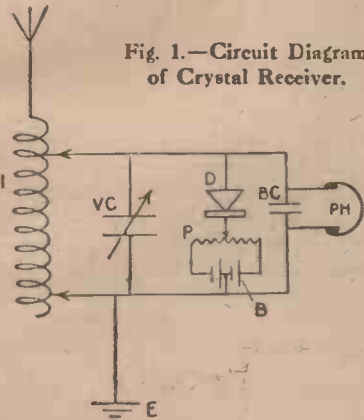

Fig. 1.—Circuit Diagram of Crystal Receiver.

effect in the telephone receivers; the diaphragms of which are only capable of vibrating at a comparatively low frequency. The purpose of the crystal is to act as a non-return valve or rectifier, thus transforming the high-frequency alternating current into a low-frequency unidirectional one, capable of producing a sound in telephones. Various crystal combinations are used, including bornite-zincite, galena-graphite, galena-copper, silicon-platinum and carborundum-steel. The last mentioned was at one time the standard "stand-by" on all ships, and signals have been received remarkable distances with a good crystal.

### Crystal versus Valve

In many ways the crystal can still hold its own against the valve receiver, at least among amateurs, both on account of reliability and the fact that no expensive battery is required. The addition of a small battery and potential in the crystal circuit, however, will improve the working of practically any crystal, but at the same time the expense is nil, on account of the fact that a worn-out pocket lamp battery is quite sufficient for the purpose. Fig. 1 shows a typical crystal receiver with the crystal battery and potentiometer in circuit, the aerial being directly connected to the tuning inductance I. The other connections are clearly shown, VC being the variable condenser, D the detector, P the potentiometer, B the battery, BC the blocking condenser, PH the telephones, and E the earth.

It will be noticed that a movable slider is connected to the detector, by means of which the potential may be varied.

A testing buzzer should be used, and the position of the slides on the potentiometer adjusted until the strongest signals are obtained.

Valves, on account of certain advantages, are completely superseding crystals in all commercial work. The principle of working of the valve will be understood by a reference to Fig. 2, which shows a valve connected up for demonstration purposes. A filament F is heated from the current derived from the filament battery FB, while a second battery HTB is connected between the filament F and the metal sheath S (sometimes called the plate), this second battery being known as the high-tension battery.

As long as the filament is heated to incandescence so electrons will be given off, and as these electrons are negative, they will be attracted to the plate S by making this positive. This is done by connecting the positive terminal of the high-tension battery HTB to the plate S, and the negative terminal of the battery to the filament F, as shown in Fig. 2.

Now the space between the filament and the plate may be regarded as an ordinary conductor of electricity, for as long as the filament is heated so will a current flow

from the high-tension battery. This current may be measured by placing an ammeter in the circuit as shown by A.

Not only does the valve act as a conductor of the current from the high-tension battery, but it has the property of only allowing the current to flow in one direction. Suitably connected up, it can

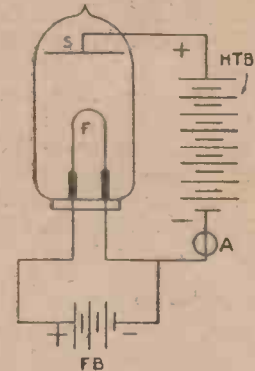

Fig. 2.—Diagrammatic Explanation of the Working of the Thermionic Valve.

therefore be used as a detector in the same manner as an ordinary crystal, and, in fact, the original valve as invented by Dr. Fleming was in use for many years as a detector in various commercial stations. A. W. HULBERT.

## A Slab-inductance Tuning Stand

THIS tuning stand was designed with a view to a maximum of simplicity in constructional details and a minimum of cost. It would seem that both were attained since the cost was about eight-pence and the time necessary for its mak-

taken that the holes indicated by the arrows A are drilled with  $\frac{1}{8}$  in. clearance. If this is not attended to the moving element will, of course, stick, and the coil holders will not grip the cards upon which the coils are mounted. With refer-

Two Sectional Views of Slab-inductance Stand.

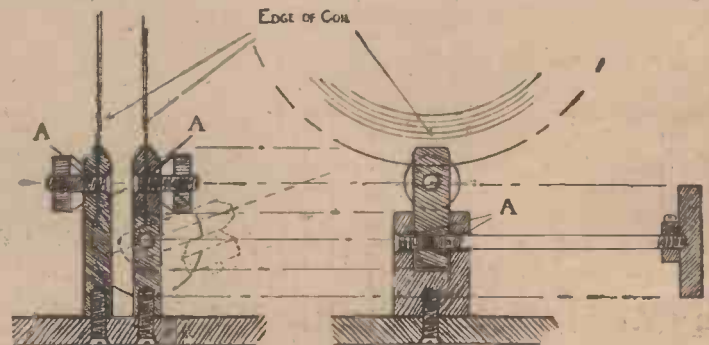

ing was about two hours. It is remarkably smooth in action, and the results seem hardly consistent with its small size.

The whole stand, with the exception of the ebonite manipulating knob, was cut from a disc of ebonite 2 in. in diameter by  $\frac{1}{4}$  in. thick. The drawings are practically self-explanatory, but care must be

ence to the coils, these may be mounted on discs of card which have previously been baked and immersed in melted paraffin wax. The fixed holder may be about  $\frac{5}{16}$  in. broad. All screws are  $\frac{1}{8}$  in. Whitworth brass.

The holes in the ebonite should be countersunk very slightly as shown. N. B.

# The Armstrong Super-regenerative Circuit

First Detailed Information of an Epoch-making Discovery

VERY considerable interest has been aroused in English wireless circles by reports from America of the wonderful results obtained by the new Armstrong circuit for valve reception.

Since 1915 Armstrong's work on thermionic valves has placed him in the front rank of wireless engineers, and there is, no doubt, substantial foundation for the claim that his latest contribution represents a tremendous step forward in the development of wireless reception.

It must, of course, be realised that the discovery will be fully protected by Letters Patent, and that its general use is prohibited by the penalties for infringement laid down by the law.

## Thousand-fold Amplification

From the information at present to hand it is claimed that, by utilising the improved circuit arrangements, signal amplification has been obtained many thousands of times greater than can be obtained by the ordinary use of back-feeding or retro-active coupling.

In the usual type of back-coupled valve it is well known that regenerative amplification continuously increases as the coupling between the grid and plate circuits is tightened until the critical point is reached at which the valve commences to self-oscillate. This is due to the fact that the amplified energy flowing in the plate circuit (under the stimulus of the signal energy applied to the grid) is fed back to the grid so as to "boost" the signal impulse to a larger and larger degree as the back-coupling is increased. When the amount of energy so "handed back" is sufficient to compensate fully for the energy losses or "damping," then the point of self-oscillation is reached.

## Surging Currents

If the coupling is adjusted to this position, the first impact of a signal on the grid circuit suffices to set up a continuous oscillating current in the plate circuit, which theoretically will continue for ever at a constant amplitude.

If, however, the back-coupling is initially set at a closer value than the critical point, the result of applying a single impulse to the grid circuit is to set up a state of affairs in which the plate circuit will progressively feed more and more energy back into the grid circuit, each pulse of energy so back-fed being reflected in an increased plate current, which in turn gives a correspondingly bigger kick to the grid, and so on. The obvious result is that very soon there will build up a tremendously large surging of

current in the plate circuit which will persist continuously and which theoretically should increase in value to infinity.

In practice, however, the dimensions of the valve limit the amount of current which can pass through, and so the amplifying ratio is clogged or choked down to the maximum value that the valve can pass.

## Persistent Oscillation

When the valve has been given this degree of coupling, and before any impulse has been applied to the grid, the whole system is in a state of extreme sensitivity, since the smallest impulse on

termed, the "negative resistance"), or (2) alternatively, by periodically varying the damping (that is, the rate of dissipation of energy) of the circuit, or (3) by utilising both these methods simultaneously.

The rate of this periodical variation of either of the factors just mentioned may be at a frequency either above or below the frequency of audibility, and various means may be utilised for imposing it.

The advantage of the method lies in the fact that, as previously stated, by allowing the process of amplification to progress for a very short interval, and then rapidly cutting it off, the valve is never allowed to choke itself up by starting to self-

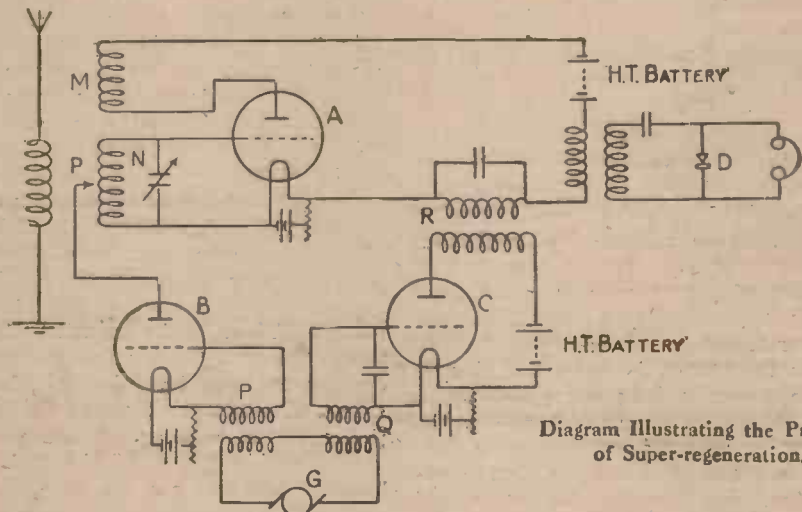

Diagram Illustrating the Principle of Super-regeneration.

arrival is sufficient to set the valve into continuous or persistent oscillation.

The fundamental principle of the Armstrong arrangement lies in utilising the valve at this point of extreme sensitivity, that is, at a point on its characteristic curve where the amplification slope is at a maximum, and in maintaining it there in such a way as to prevent the process of actual self-oscillation from setting in, whilst at the same time fixing the whole system into a stable condition so that it can be maintained at all times just in that state.

When this condition has been attained, the valve is stated to be in the super-regenerative state, and is capable of producing an extraordinary degree of amplification.

## The Method

The manner in which this condition of affairs is secured in the Armstrong circuit is (1) by periodically altering either the amount of back-coupling or normal regenerative action (or, as it is sometimes

oscillate each time a signal impulse is applied, but is continuously working at the point of maximum amplification throughout the whole duration of each signal impulse. In this way each impulse received on the grid is reflected by the maximum possible current surge in the plate which persists as long as the signal lasts but no longer. In other words, the valve is operating at its optimum efficiency, and is passing a current only limited in value by the dimensions of the valve.

At the termination of each signal impulse, the plate current stops abruptly. There is no persistent self-oscillation, it will be remembered. As soon as the next signal reaches the grid, the maximum plate current is again instantaneously built up.

## Details of Operation

The diagram shows a typical circuit in which the desired effect is secured by method (3) referred to above, that is, by periodically altering both the degree of

back-coupling and the degree of damping in the grid circuit.

The circuit illustrated is not the most practical working circuit possible, but is given in order that the underlying principles of super-regeneration may be more clearly seen.

The valve A is of the ordinary type back-coupled at M, N the tuned grid circuit being coupled to the aerial.

Two auxiliary valves marked B and C are employed, both being energised from an alternator G through coupling coils P Q as shown. The frequency of the generator G determines the rate at which the coupling and damping factors are periodically altered.

In the first place, the generator G, being coupled through Q to the grid circuit of the valve C, large current variations of the same frequency as the generator will be created in the plate circuit of that valve. These current variations are linked to the plate circuit of the amplifying valve A through the coupling R, and will therefore give rise to corresponding voltage variations on the plate of A, alternately augmenting and diminishing the steady voltage from the high-tension battery. The magnetic flux between the coils M N is affected accordingly, and the amount of back-coupling is thereby varied from a maximum to a minimum to give the desired results.

In the second place the grid of the valve C is also being simultaneously energised at the same frequency from the generator G. The plate of this valve is connected by a tapping P to the grid circuit of the amplifier A.

When the grid of the valve B is given a positive potential from the generator G, the total resistance of the plate-filament path of the valve B is much smaller than when the grid of B is at a negative potential value. But the plate-filament path of this valve is in parallel with the grid inductance coil of the amplifier A.

Accordingly the total resistance or reactance of the grid circuit of the amplifier A is dependent upon the fluctuating condition of the shunt path through the valve B. In other words, the damping of the grid circuit of the amplifier is being varied at the same rate as the degree of back-coupling is being varied across the coils M N.

The amplified high-frequency currents are detected by any suitable circuit such as D.

**More Simple Arrangements**

Whilst the principles underlying the new method of super-regeneration are most clearly to be seen from the somewhat complex arrangement shown in the diagram, in actual practice a far more compact form is employed in which a single valve is so connected to exterior circuits as to perform simultaneously all the functions of amplification, periodical variation of the damping and back-coupling factors and detection.

W. TOCK

# Another Freak Receiver

THE materials required for this set are of the simplest and merely comprise: One and a half oz. of No. 26 d.c.c. wire. One small galena or other crystal.

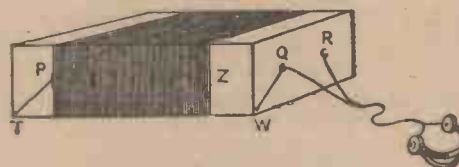

Fig. 1. - Match-box Receiver.

One match-box.  
Several small paper fasteners (about 1/4 in.).

Four large paper fasteners (about 1/2 in.).  
A small strip of thin brass.

The screw cap of a "Brasso" tin.

The amount of wire, etc., depends on the size of the match-box used; the best is one of the largest. Let us suppose that in this case one of the largest is being used. At each end of the box make two holes about 1 in. apart, and through these holes put the large fasteners. About a 1/4 in. from the end on one side of the box put a small fastener P (Fig. 1), with the head inwards and through the cover only. Take the wire and wrap the end round the fastener P on the outside, leaving about 6 in. for wiring. Then begin to wind the wire round the box. Every five turns put in another fastener, head inwards, bare the wire a bit and wrap it round the fastener, and continue winding. When you have got to within 1/4 in. of the end put in another fastener, cut the wire, bare the end and wrap it round the last fastener.

Through the inner box part put a fastener S, as shown in Fig. 2, so that its head will touch the head of the fastener Z when the box is closed.

The detector is easily made with the piece of galena, the strip of brass, and the screw-cap. Take the screw-cap and cut four slits in the side to about half-way

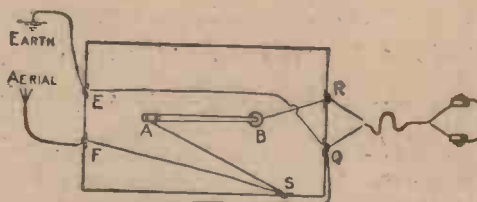

Fig 2 - Diagram of Connections.

down as in Fig. 3. Bore a hole in the bottom of the cap and fasten it down to the inside part of the box with a small fastener as B (Fig. 2). Then put the crystal in the cap and bend down the edges, thus holding the crystal firmly. Take the strip of brass and cut it into the

shape of Fig. 4, boring a hole in the wide end. Then bend it to the shape shown in Fig. 5, and fasten it with a fastener at the proper distance from the cup.

Having completed the tuning coil and the detector the next thing is the wiring. Through the outer cover in the bottom corner bore a small hole T (Fig. 1), and through it thread the wire from P. Run wire along the inside of the outer cover so that it comes out at W at the other end, then join it to Q. Next attach a wire to the cup B and connect it to R on the inside. Then attach a wire to the strip A and connect that wire to the fastener S; connect the fastener S to the fastener F, and attach a wire to Q on the inside and join it to E.

If desired, a small knob can be glued on to the box between E and F for the purpose of tuning.

The head 'phones are attached to the terminals R and Q, the aerial is attached to F and the earth to E.



Fig. 3. - Crystal Cup.

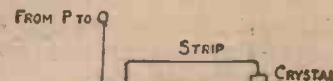

Fig. 5. - Detector.

Fig. 4. - Detail of Detector.

In use the point of the strip A should be moved about until signals are heard. Tuning is then effected by pulling the inner part of the box out. F. D.

# Alternator Frequencies

FOR readers who are interested in, or have to deal with, alternating-current generators such as are used for wireless transmission the following simple formulae will be of interest:

When the number of poles of any A.C. generator is known, the required speed to produce a desired frequency is found by the following formula:

$$2 \times 60 \times \text{frequency} \div \text{number of poles} = \text{revs. per minute.}$$

When the number of poles and the revs. per minute are known the resulting frequency will be determined by the formula:

$$\text{revs. per minute} \times \text{number of poles} \div 2 \times 60 = \text{frequency in cycles per second.}$$

The number of cycles per revolution can be obtained by dividing the number of poles x 2. H. A. W.

# ELECTRICAL BENCHWORK Brass Turning without a Lathe

THE amateur whose tools are limited frequently has to employ improvised methods of accomplishing work. The available brass rods for the tuning coil made recently were just too large in diameter to be screwed  $\frac{1}{4}$  in. diameter for the brass end nuts. However, I got over the difficulty in a simple manner by

handle of the brace while I turned down the brass rod to the correct dimension with a graver tool made from an old file. The hole in the supporting board was quite a tight fit at the outset, but by the application of a little grease soon worked quite freely.

Success in the accomplishment of this

on the square rod, but it is conceivable that they may not be. Such bushes are only slices off thick commercial brass tube, which is not very accurate in the matter of bore. Where a bush does not fit the rod reasonably well one may be soldered to the rod temporarily. Otherwise the rod will work in the bush quite nicely.

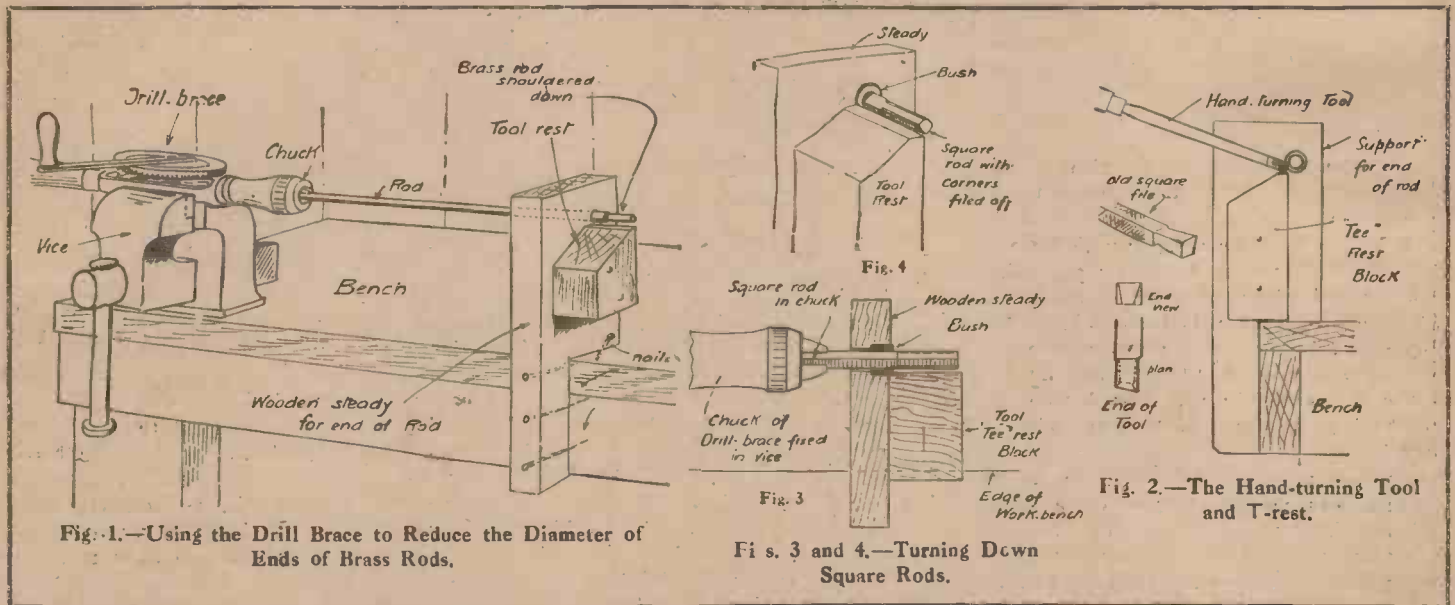

Fig. 1.—Using the Drill Brace to Reduce the Diameter of Ends of Brass Rods.

Figs. 3 and 4.—Turning Down Square Rods.

Fig. 2.—The Hand-turning Tool and T-rest.

using the hand-drill brace in the vice. This tool was one of the  $\frac{1}{2}$ -in. capacity type such as have been put on the war-surplus market of late, and had a two-jaw chuck. The brace was held in the bench vice in a horizontal direction with the chuck jaws pointing to the right. A piece of 1-in. board was then notched, drilled with a hole to suit the rod at the correct height above the bench level, and nailed in position. To the right-hand face of this support a block was also nailed to form a rather primitive but quite useful T-rest (see Figs. 1 and 2). My boy turned the

work led to the adoption of a similar method in the case of the square spindles of the variable condenser. These rods were shorter and had to be turned down at each end to pass through the end bearing plates of the condenser. For the first reduction of the end, from  $\frac{1}{4}$  in. square to  $\frac{7}{32}$  in. and  $\frac{1}{16}$  in. round, the chuck of the drill-brace being of the two-jaw type, made it quite easy to hold by the square end. One of the bushes purchased for spacing the condenser plates was pressed into service to form a bush in the wooden steady (Fig. 3). These happened to be a tight fit

Before the work of turning down is commenced corners of the end of the square brass rod to be operated upon should be filed off as shown in Fig. 4, so that a rough octagonal section is obtained. This will be found less troublesome to reduce to the truly cylindrical shape required.

For the other  $\frac{1}{4}$ -in. round stay rods for the end plates of the condenser the arrangement of steady shown in the first sketch was all that was necessary; these rods were shouldered down at the ends to  $\frac{1}{16}$  in. for the reception of No. 2 B.A. nuts.

HENRY GREENLY.

## WHAT WIRELESS TERMS MEAN.—VI

Some Technical Words Explained as Correctly as Popular Language Allows

**HETERODYNE.**—The blending of oscillations produced by the valve of a receiving station with the incoming oscillations produced in the aerial by a transmitting station using continuous waves to produce a frequency audible in the telephones. Frequencies produced by valves are of the order of millions per second, and as the telephones and human ear will only respond best to frequencies of the order of say, 1,500, they could not normally be detected. For example, if a receiving valve be adjusted to a frequency of 1,000,000 and the incoming frequency is 1,001,000

the blending of the two will result in the production of what is called a "beat" frequency of 1,000 which will be audible. This is done by means of varying the condenser (capacity), and coil (inductance), of the circuit, or in other words "tuning."

**POTENTIAL.**—The pressure or voltage of an electric current. It may be simply explained thus. If two tanks are connected by a pipe, the one full and the other empty, a flow of water will be maintained from the full tank to the empty one because of the difference in the pressure. This flow will only continue whilst

such difference of pressure exists. So too with an electric current. So long as there is anything in a circuit making use of the current so long will the current flow because of the difference of potential.

**DIRECT CURRENT.**—That type of current which is said to maintain a flow in the same direction all the time, as distinct from alternating current. The type of current obtained from accumulators and dry cells, and the only type that can be used for charging accumulators. By convention direct current is said to flow from positive to negative.



The Wing-tip of an Aeroplane Directed by Wireless to Cross the Track of the Steamer.

**M**OST people are aware that we are on the eve of witnessing great developments in the application of wireless to the needs of modern life. The extent to which wireless has already been successfully applied to these needs is not, however, so widely appreciated.

For the moment interest is mainly focused on the vast possibilities of the wireless telephone and the immediate schemes for utilising it by a system of broadcasting. It is perfectly natural that this aspect should contain a primary appeal for us. We all want to know what is

But scarcely less urgent is the desire to get our knowledge direct, or "at first hand," as we say. And this is one of the things that the wireless telephone promises to bestow on each one of us—information at first hand from remote places. When to this are added the free gift of a constant stream of first-class music "on tap" in our homes, and the pleasurable intellectual stimulation afforded by the operation of an efficient wireless telephone, one can readily understand why this particular aspect of wireless has cast such a potent spell over our imaginations.

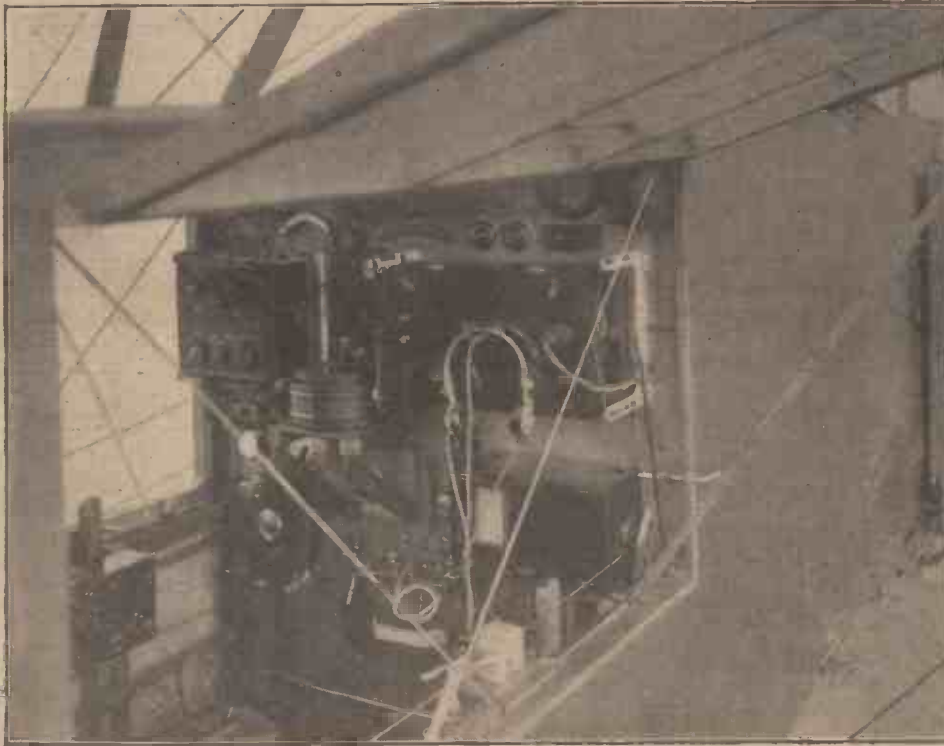

Spark and Continuous-wave Transmitting and Receiving Instruments in the Cockpit of an Aeroplane.

# LOCATION AND FIND

An Instructor in Aerial Navigation Discusses of the

going on in the "outside" world. The instinct of curiosity, although attributed almost exclusively (out of courtesy, no doubt) to the fair sex, is indeed deeply rooted in all.

But there are other aspects, which will presently begin to assert their importance and deep interest for the amateur. Of these particularly are the methods of "direction-finding" and navigation by wireless. The manifold applications to commercial and social life of a means of navigating moving craft of all kinds by wireless will be apparent to every reader.

## The Amateur and Direction Finding

For those readers who are on the way to becoming experimenting amateurs, I will say at once that I have never yet met an amateur of this class (and most amateurs belong to this class ultimately) whose soul did not thrill at the idea of locating, as he sat alone in his own private den, the exact direction of the source of each of the numerous messages that poured into his receiver from out of the mysterious ether. One amateur, working on his own, can ascertain the direction of any transmitting station that is within the range of his receiver. Two amateurs, working in collaboration at some distance apart, can determine the actual positions of transmitting stations.

Of course, as in every other department of wireless science, the first successful achievements in direction-finding were made in connection with wireless telegraphy. Some of the earliest experiments that were made constituted an attempt to ascertain, at a fixed receiving station, the direction in which a particular fixed transmitting station lay. Later, by employing a second receiving station at some distance away from the first, it became possible to determine the position of the fixed transmitting station. An application of the same principle enabled the position to be found, at any particular moment, of a moving transmitting station.

## Practical Value

At first the practical value of this system was demonstrated in the case of ships, which, of course, may be regarded as moving wireless stations. By this means also the speed and direction of motion of a ship at sea could be ascertained by those on land. Assume, for instance, that there are two direction-finding stations on the Yorkshire coast, at, say, Whitby and Scar-

# DIRECTION FINDING

As the Methods Employed in the Navigation of the Earth

orough. A ship suddenly transmits wireless signals, and the two operators at these stations work their instruments and discover that she is situated at a point  $x$  in the North Sea.

Assume also that, a quarter of an hour later, the same ship transmits again. The shore operators now find that she is at a point  $y$  in the North Sea, and that this second position  $y$  lies 5 miles to the left of the position  $x$ . From such data it will be obvious that the ship in question is steaming in a westerly direction at an average speed of 20 miles per hour (that is, 5 miles per quarter hour). Assuming, further, that the ships keep a steady course and speed, the shore operators can tell exactly at what time and at what point she will reach the coast.

Immediately following the use of direction-finding wireless in connection with ships came the application of the same system to the problems of aeronautics. It became possible to determine, by means of direction-finding stations on the ground, the position, direction of flight and speed of all airships, seaplanes and aeroplanes that carried (and used) wireless transmitters.

## New Methods

From what has already been said, it will not come as a surprise to the reader to learn that these developments in the main took place during the early stages of the war. It will be noticed that the direction-finding stations were receiving stations on the ground. Thus the experts of each country were able to sit down quietly at their direction-finding instruments and, without betraying their own whereabouts, "listen in" for transmitting signals from moving enemy craft. As soon as such signals were heard, and their position, etc., ascertained, the "listening" country sent out its own craft in silent pursuit. Full of thrilling interest are the numerous tales that could be told of the use of wireless in this connection. There were times when it was as much as one dared to do to "open one's mouth" in the ether!

But this condition of things rapidly began to develop into a kind of stalemate between the wireless organisations of the

countries concerned. In the case of aircraft in particular, it became especially desirable that some means should be developed that would enable a machine to ascertain its own position without having to transmit to ground direction-finding stations, in the course of doing which its position was also automatically revealed to enemy direction-finding stations.

This stimulated a keen inquiry into the possibility of devising new methods. Under the stress of war the inquiry was fruitful. A new system was invented for aircraft which functioned in exactly the reverse way to the one we have just been considering. In the first system, it will be remembered, the direction-finding instruments were employed in fixed receiving stations. If the pilot of an aeroplane lost



Photo: Marconi Wireless Telegraph Co.

Interior of Direction-finding Station at Croydon Aerodrome.

his way over a strange country, or over the sea, he had to transmit to those stations and ask for his position. Whilst he was actually transmitting, the operators at those stations ascertained his position from the waves received. One of the operators then called him up on a special transmitting apparatus and acquainted him with it.

## Secrecy

In the new system the reverse process took place. In this case the direction-finding instrument was fitted in the air-



A Vickers-Vimy Aeroplane Fitted with Complete Wireless Telegraphy Installation.

craft, and fixed transmitting stations were situated on the ground. Thus, by means of the signals transmitted at regular intervals from these stations, an aeroplane fitted with the new direction-finding gear could determine its own position at any moment during flight. Also, with a modified form of the same gear, an aeroplane could be guided to fly direct to the aerial of a distant transmitting station!

All these developments took place whilst telegraphy was still the "common tongue" in the world of wireless. To-day we have telephony—which, so far as direction-finding and navigation are concerned, merely means a substitution of speech for the Morse code. The essential operations of the two systems described above remain unaltered, except for certain practical improvements that have been effected in constructional detail.

In modern commercial aviation, however, secrecy being no longer a matter of essential importance, it has been found best to employ the earlier system. This is because of the shortness of the air routes that have so far been developed for commercial purposes. From the London air terminus at Croydon many machines fly daily between this country and the Continent, each of which is fitted with a wireless-telephony receiver and transmitter. Ground direction-finding stations are erected at Croydon and Pulham, and ample demonstration has already been given of the practical value of these stations in facilitating the navigation of passenger aircraft on these routes.

The stations, in conjunction with a "lighthouse chain," are also being employed in connection with the new aerial night services that are now being established. For long-distance air services, however, such as the pending transatlantic service, or the proposed Imperial airship service to India and Australia, the latter system will certainly be used. The numerous high-power transmitting stations already installed in various parts of the world will act as "beacon" stations for the navigation of aircraft operating over these very long distances.

It must not be imagined from this that direction-finding instruments are something out of the reach of the amateur. On the contrary, I predict that within a short time enterprising firms will be producing amateur directional aerials at a low cost. And (looking some distance ahead) the directional aerial will be the amateur aerial *par excellence* of the future.

[Further articles on this subject will explain the practical working details and the construction of amateur experimental apparatus.—ED.]

Every reader of "A.W." should have at hand for reference a copy of the "Work" Handbook, "Wireless Telegraphy and Telephony: and How to Make the Apparatus," 1s. 6d. net.

## RADIOGRAMS

SOME successful experiments on the wireless transmission of photographs have been carried out by Dr. Korn, of Berlin. The system makes use of a code instead of transmitting the photographic images themselves, as in the case of the Belin system. Dr. Korn's transmission is in the form of a coded message, which must be decoded or "translated" into a picture. First of all, the original photograph is reproduced in half-tone; that is to say, it is broken up into dots of various sizes, just as it is reproduced for printing purposes. The half-tone photograph is then placed in the coding machine which, by means of an optical system and selenium cell, combined so as to classify the dots into seven-teen or more sizes, assigns a given letter or word to each size of half-tone dot and prints the letter or dot on a paper tape. The letters and words on the paper tape are then transmitted by wireless and received in the usual manner. The message is finally decoded by means of a special typewriter which has the necessary arrangement of keyboard and handles a sheet 12 in. by 15 in. The typewriter turns out an arrangement of large and small dots which constitutes the coarse photograph, and by reducing it to the desired size the image is sharpened accordingly.

Telephone subscribers of Peking and Tientsin, China, are able to talk to each other by wireless from their house or office telephones, the conversation taking place over wire lines to the central office and then by wireless between the two cities—a distance of over 80 miles. The system was installed by the China Electric Company recently and tested successfully.

One wireless time signal apparatus of a type that indicates the time to a large number of people takes the form of a miniature Eiffel Tower with an electric light at the top. As the time signals are received, an operator presses a key so that the light flashes in accordance with the intercepted signals. An appreciable loss of time takes place because of this relaying, but it is estimated that the interval of lost time is not greater than one-hundredth second. Another form is in the shape of a metal frame, with a glass face carrying the necessary lettering to indicate the elapsed minutes, such as "10.46," "10.47," and so on to the final dash at 11 o'clock. A system of light controls the flashing of the proper minute reading, while a lamp on top of the frame and an electric bell are actuated when the final 11 o'clock dash is received.

In the "Meteorological Magazine" it is stated that the broadcasting by wireless in India of information as to an approaching cyclone was recently picked up by no fewer than 450 wireless stations in Bengal. The value of these wireless storm warnings is shown by the fact that eight large ships were able to alter their courses and so avoided the storm, which was one of the worst known in the Bay of Bengal for many years, the velocity of the wind reaching 100 miles per hour, a very unusual velocity even in tropical cyclones. By a further development of such wireless communication, as between shore and ship and between the vessels themselves that are equipped with wireless, it is hoped that in the near future it will be possible for a ship fitted with wireless nearly always to avoid these dangerous storms.

According to "The Scientific American" an Ukrainian engineer is reported to have discovered a method by which wireless messages may be sent to a definite receiving station without the danger of being intercepted by other stations. It is stated that by means of a simple apparatus the so-called "locked-power line" of magnetic field may be straightened out and grouped into parallel rays. These rays are said to do away with the necessity of aerials.

A part of the after-dinner concert to about five hundred teachers was given by wireless at the Imperial Hotel from Marconi House on July 29. The transmitting station for the concert was Marconi House, 2 L O, and the reception at the Imperial Hotel was done with a frame aerial. In addition to the usual tuning gear, there was a three-stage Magnavox power amplifier and Magnavox loud speaker, but the signal strength was so great that there was no need to use more than two stages of amplification. Miss Gladys Seager, Mr. T. J. Milne (violin), and Mr. John Collingwood (baritone) were the artists, and their contributions were listened to with the greatest interest and heard with ease and enjoyment throughout the hall.

The first French wireless station at the Eiffel Tower required 3 h.p.; this was raised to 75 h.p. in 1910, to 150 in 1914, and to 300 before the end of the war. The station erected at Bordeaux has 1,500 h.p. The horse-power of a station now being established at St. Assize is 2,000, and that of a station under construction in the United States is 10,000.



# OUR INFORMATION BUREAU

Expert Replies to Readers' Questions. Hundreds of Replies are sent by Post.

TO ENSURE A PROMPT REPLY PLEASE OBSERVE THE FOLLOWING RULES

Write distinctly, give all necessary details and keep to the point. Ask one Question at a time—never more than two. Send a Stamped and Addressed Envelope. Send the Coupon cut from page 194.

## Telephony Reception

**Q.**—Having constructed the "Amateur Mechanic" receiving set I find it quite efficient on wave-lengths of 900 metres and over but particularly desire to be able to receive the radio-telephony from the proposed English broadcasting stations.—J. O. (146)

**A.**—The receiving set referred to was designed for the reception of telegraphic (Morse) signals on wave-lengths from 600 to about 6,000 metres, and in general has been found very satisfactory for this purpose. Theoretically it is quite capable of receiving telephony, but on account of the short wave-lengths employed by such stations, generally between 300 and 500 metres, it is impossible to tune down to the desired wave-length. In the case of transmissions on 900 metres (Croydon and other air-stations), 1,000 metres (amateurs) and 1,070 metres (the Dutch Concert), the requisite tuning can generally be managed, but because of the comparatively large unused portions of both primary and secondary coils in the set, the overall efficiency is low, whereas for low-power telephony the highest efficiency and sensitiveness are required. It will readily be seen therefore that the set referred to is not suitable for reception of short-wave radio-telephony. The speech and music radiated from Eiffel Tower (wave-length 2,500 metres) and the occasional transmissions from Nauen (4,000 metres) may be received effectively on this set as far as the tuning arrangements are concerned, but on account of the distance the addition of "valves" (and possibly the substitution of one for the crystal detector) will usually be found necessary. Until such time as the proposed new stations actually commence operations, thus enabling tests to be made, it is impossible to state with any degree of accuracy just what apparatus will be essential at various distances from the transmitting stations; but for those who are desirous of constructing a set which can certainly be made use of even though certain additions are afterwards found necessary, the "Short-wave Receiving Set" as described in the new "Work" Handbook "Wireless Telegraphy and Telephony" (price 1s. 6d.) will be found to meet the case. This set will tune in signals from about 150 to about 700 metres and, with the addition of a valve panel (also fully described in the Handbook), affords a means of carrying out interesting and instructive experimental work in connection with the use of a valve as (a) a H.F. amplifier, (b) detector and (c) a L.F. amplifier. When using the valve as the detector, reaction effects may readily be obtained by connecting the primary circuit of the set to the grid and filament respectively of the valve and using the existing secondary coil as the reactance coil. When using the valve as a L.F. (low-frequency) amplifier (following the crystal rectification) it is advisable to employ a "step-up" iron-core transformer between the usual telephone terminals of the receiving set and the "input" (grid-filament) circuit of the valve panel. With the above-mentioned two sets quite good results may be obtained, and as stated, they afford considerable scope for experimental work in connection with the effective reception of short-wave radio-telephony. If desired the "Short-wave Set" may be modified slightly to enable waves up

to about 1,100 metres to be received, the primary coil being made  $3\frac{1}{2}$  in. in diameter by 5 in. long and wound with No. 28 s.w.g. d.c.c. wire and the secondary coil being made  $2\frac{1}{2}$  in. in diameter by  $4\frac{1}{2}$  in. long and closely wound with No. 36 s.w.g. d.c.c. copper wire. The primary should be tapped off on the sub-multiple system (with two tuning switches) and the secondary in 10 or 11 equal sections connected to multi-point tuning switch. The secondary condenser as per article may be used or one of the rotary-vane type substituted—capacity 00025 to 0003 mfd.—CAPACITY.

## CORRESPONDENCE

### Wireless Broadcasting and Amateurs

**SIR.**—With the advent of wireless broadcasting there is, without doubt, a very great number of the public, both young and old, who desire to become more conversant with this branch of science. Also there will be a vast number of "home" installations set up; some will be of a very simple character, whilst others will be of more or less elaborate construction, according to the abilities of the person launching out to fathom the ether. There will, of course, be many difficulties to be overcome before any kind of apparatus of home construction is completed. For the person who does not desire to know anything more of wireless than the manipulation of a "fool-proof" receiving instrument, much cannot be said, but for the genuine experimentists, who wish to discover or know the "why and the wherefore," there is something to be said; that is, there is help awaiting them if they will only avail themselves of the opportunities which are open for them.

This help may be found in any of the amateur wireless societies or associations of which many now exist, and those which have been in existence for any time have been affiliated to the Wireless Society of London. Of course, no one is under any obligation at present to join such an association, if they are going in for the reception of "broadcasting." Just one further point, and one that cannot be too strongly emphasised. It is certainly most advisable for any person who anticipates using valve circuits or apparatus to become acquainted both theoretically and practically with them before endeavouring to search the ether, for if one has not attained even the most elementary knowledge of the functions of the oscillation valve, then there is a likelihood of causing disturbances in the ether

that neither themselves nor others will get much enjoyment for their labours.—Yours faithfully, HORACE W. COTTON, Hon. Sec., The West London Wireless and Experimental Association (19, Bushey Road, Harlington, Middlesex).

### Crystal Reception

**SIR.**—Towards the end of last year I decided to carry out a few experiments with crystal receivers. After using various circuits I came to the conclusion that the simple circuit, without a variable condenser and using an inductance with a slider, was the one which gave the most satisfaction. My aerial at that time was a twin wire 30 ft. long at one end and 12 ft. at the other. Using a combination of zincite and copper pyrites, stations like GNI, GNF, GCC came in very loud. On the French side FFB, OST, and FFH were quite good. Long-wave stations like BYB, MPD, POZ, and FL simply roared in, and SAJ was quite readable. I think, however, that ship stations were the best as far as signal strength was concerned. I have pages and pages of ships' calls recorded in my log, but the outstanding feature was the ss. *Kaikyu Maru* (J K K); this ship, when 300 miles of Hull, was louder than GNF or GLV, and it was practically impossible to receive from any other station on 600 metres while J K K was transmitting. The ss. *City of Alton* (K O N Z) also came in very strongly. Local telephony was picked up very well indeed with this simple detector, and on one or two occasions I heard 2IX on an indoor aerial. In conclusion, I would remind beginners that a good deal of experience can be obtained with a crystal receiver, which often comes in useful when using valves. Although I have valves installed I frequently switch over to crystals, and am always satisfied with the results obtained.—LISTENER-IN (Derby Wireless Club).

## FORTHCOMING EVENTS

Wireless Society of East Dorsetshire. Aug. 15. At Branksome Liberal Club, Salisbury Road, Upper Parkstone. General meeting.  
York Wireless Society. Aug. 16, 8 p.m. At Grand Picture House Café. Preliminary meeting.

### TELEPHONY TRANSMISSIONS

Marconi House (2 L O), 360 metres. Aug. 10, 7 and 7.30 p.m.  
The Hague, Holland (P C G G), 1,085 metres. Aug. 10, 8 to 9 p.m.; Aug. 13, 8 to 9 p.m. 1,070 metres. Aug. 16, 7 to 8 p.m.  
Writtle (2 M T), 400 metres. Aug. 15, 8 p.m.

## BARLAW RADIOPHONES

### THE "O.K." CASKET SET

£4 15 0 complete

NEATEST CHEAPEST  
MOST RELIABLE

The Tuner with two Rotary Switches, all Terminals and Crystal Detector of improved design, are mounted on ebonite and enclosed in polished mahogany case. Efficient Double Head Telephone, Aerial Wire and Insulators are all included.

Send for Descriptive Pamphlet to:

THE  
BARLAW ENGINEERING CO., LTD.,  
47, VICTORIA STREET, S.W.1.

Telephone:  
Victoria 6999.

Telegrams:  
Engibarac, Vic., London.

The Trade Supplied

## An Apology

OWING to the extraordinary demand for my Head-phones, I regret to notify my clients that at present my stock of Brown's and Sullivan 'Phones is exhausted. A fresh consignment is, however, expected shortly. All orders will be executed in strict rotation.

I have large stocks of the goods enumerated below, which can be supplied on demand. I stock "NO RUBBISH"—the large and increasing repeat orders prove that my motto "VALUE FOR MONEY" is justified.

- Aluminium Condenser Vanes, best quality, accuracy guaranteed, 1 doz., 9d.; 4 doz., 2/8; 6 doz., 4/3; 12 doz., 8/6.
- Ebonite Slider and Plunger, 6d.
- Ebonite Knob, tapped, 2 B.A., 6d.
- Large Spacer Washers, 1 doz., 5d.; 6 doz., 2/4.
- Small Spacer Washers, 3 doz., 9d.; 12 doz., 2/8.
- Terminals, 4 B.A., doz., 1/6.
- Terminals, various kinds, all with nuts and washers, doz., 1/8, 1/10.
- Crystal Detectors on Ebonite, 4/- and 5/-.
- Valve Holders, 4 legs, best type, each, 1/.
- Valve Legs, 1fd. each; per doz., 1/2.
- Contact Studs, per doz., 8d. and 9d.
- Crystal Caps, each, 2d.; per doz., 1/8.
- Aerial Wire, 7/22, bare copper, stranded, 100 feet, 4/-.
- Switch Arms, special line, complete, 1/3.

### French 'Phones

Extraordinary value in above. 4,000 ohms, highly sensitive, beautifully finished, complete with cords.

30/- PAIR

Sold on money-back principle.

**M. RAYMOND,**  
27, LISLE STREET, LEICESTER  
SQUARE, W.C.2.  
(Opposite Daly's Gallery Door).

Phone: Gerrard 107.

## CLUB DOINGS

### Sunderland and District Amateur Radio Society

Hon. Sec.—MR. H. BURNLEY, 8, Briery Vale, Ashbrook, Sunderland.

THE above society have changed their name to that of the Sunderland Y.M.C.A. Radio Society, with headquarters at the Y.M.C.A.

### Proposed Doncaster and District Wireless Society

WILL all those interested please communicate as soon as possible with Mr. H. Slack, 35, Flowitt St., Doncaster.

### Guildford and District Wireless Society

Hon. Sec., MR. ROWLAND T. BAILEY, 46, High Street, Guildford.

ON July 29th the members of the above Society gave some demonstrations in aid of Chiddingfold Hospital Saturday Fund. On the whole the day proved successful. Mr. F. A. Love of Guildford (2 H. X.) very kindly gave three transmissions of music in the afternoon, and at 7 p.m. gave out cricket results, etc. A call from Marconi House (2 L. O.) and the reception of their three concerts at 5, 6, and 9 p.m. also added to the success and popularity of the demonstrations. A 4-valve "set" was used, and performed the duties expected of it most admirably.

The Society is still anxious to increase its membership, and anyone interested is invited to come to the club rooms at 46, High Street, Guildford, on any Monday evening at 7 p.m.

### "RADIORA" VALVE RECEIVER

Finest materials and workmanship, including Mullard Valve, Variable Condenser, Variable Tuner and Reactance, Grid Condenser and Leak, Best Double Head, Phones, 4,000 ohms, Aerial Wire and Insulators.

Everything necessary to receive. Everything right away.

Price £7 2s. 6d. carriage paid.

C. H. VINES, Wireless Engineer, 337, Charles Road, Small Heath, BIRMINGHAM.  
5 Years' Experience—Actual Manufacturer. SEND FOR LISTS.

### WIRELESS AMATEURS AND RETAILERS

#### PARTS SUPPLIED FROM STOCK

List free. Condenser Plates, 1/6 doz. pairs (post 3d.). FRASER, SENTINEL NO., SOUTHAMPTON ROW, LONDON

### PREPAID ADVERTISEMENTS.

Table Stand Tuners.—Ebonite panel, coil holders on polished teak box, with nine shellac impregnated silk-taped mounted coils, 200-25,000 metres, 40s. Photo, stamp.—Debenham, 6, Loampit Vale, Lewisham.

Type 6 Panel Unit Receivers, with taped tuning coils, complete, 50s. Specification, stamp.—Debenham, 6, Loampit Vale, Lewisham.

Ebonite Sheet.—Any size cut.  $\frac{1}{2}$  in., 3s. 6d.;  $\frac{3}{4}$  in., 5s. 3d.; 1 in., 7s.;  $\frac{3}{2}$  in., 10s. 6d. per square foot. Carriage paid 10s. lots.

Aerials.—R.A.F. 40/36 rubber covered on wind-up reels with 2 ebonite insulators, 2s. 6d.; post, 9d.

Phones.—Best quality; 4,000 ohms, 45s.; post, 9d.

Valve Holders.—Best quality, 1s. 9d.; cheaper, 1s. 6d.; post, 2d.—Renshaw & Marsden, Electrical Engineers, Blackburn.

Xmas Chocolate Clubs.—Spare time agents wanted. Good remuneration. No outlay. Best makes only supplied. Particulars free.—Samuel Driver, South Market, Hunslet Lane, Leeds.

You want to build your own set? Here you are then. Inductance tube, 12 by 4, 2s.; 1 lb. enamelled wire for same, 2s. 8d.; brass rod, drilled, with terminals, 1s.; mounted crystal detector, 5s. 6d.; pair high-resistance phones, 35s.; two ebonite sliders, 1s.; variable condenser, 12s. 6d.; 100 ft. aerial wire, including insulators, 4s. Here you have complete station for £3 3s. 8d., carriage paid. Assembled, 4 gu.—Colloy Installations, 4, Clonmell Road, Tottenham.

Aerial Wire.—Our speciality, 7/22 hard drawn standard copper, guaranteed, 100 ft., 5s. 3d.; 140 ft., 7s.; 100 yd., 13s., carriage paid.—Fairbrother and Co., Vulcan Street, Leeds.

Cylindrical Coil Winding Machine, winds up to 6 in. diameter by 18 in. long, 17s., carriage paid. Large stocks, drills and taps.—R.E.P. Engineering, Robert Street, Sheffield.

Receivers for Wireless.—Brand new aluminium watch-type telephone receivers, highly sensitive, 150 ohms, brass terminals and clip for headband on back, 5s.; also first-class ebonite watch-type; quite new, Stalloy diaphragms, 150 ohms, fine-braided cord and clip for headband attached, 8s. Postages, 9d.—Adolph and Tayforth, Works, 12, Leverington Street, Clerkenwell, E.C.1.

### Hornsey and District Wireless and Model Engineering Society

Hon. Sec.—MR. H. DAVY, 134, Inderwick Rd., Hornsey, N.8.

A MEETING of the above was held on July 18th. The first demonstration of the club set was given. A good selection of Morse messages were heard and taken down by the advanced members. Also all members enjoyed the music, etc., from 2MT and 2FQ. The set is of the progressive type. At present it consists of a detector panel and single-note magnifier. Meetings of the society are held Tuesdays and Fridays, 7.30 p.m. Applications for membership are invited.

### Proposed British Wireless Relay League

MR. Y. W. P. EVANS, Hon. Sec. of the Manchester Wireless Society, has obtained permission from the Postmaster-General to form a British Wireless Relay League, which a great many amateurs with transmitting licences have been looking forward to. Mr. Evans will be pleased to hear from those interested with a view to forming such a League as early as possible. With a good organisation and assuming that the forthcoming transmitting tests between the Manchester Wireless Society and the American Amateurs are a success, there is a possibility of the scheme providing data for the advancement of amateur wireless in general. Letters should be addressed to Mr. Y. W. P. Evans, 2, Parkside Road, Princess Road, Manchester. A suitable agenda will be drawn up and distributed to those in favour of the League, not later than August 25th. Suggestions will be welcomed and any assistance will be appreciated.

### The West London Wireless and Experimental Association

Hon. Sec.—HORACE W. COTTON, 19, Bushey Road, Harlington, Middlesex.

MEETING held Thursday, July 20th. Owing to the large number of new members, Mr. J. R. Bruce commenced a series of elementary instructional chats, which dealt with inductances in various forms, and methods of construction. He minutely explained the making of formers which included the winding, various methods of tappings, finishing and mounting of coils, and gave some data for a very efficient loose coupler which from personal use and experience he has found most effective and efficient. The next chats of this series will be on "A Single Valve Panel" and "Reactance Inductance" on August 31st.

(Continued on page 196)

## ANNOUNCEMENTS

"Amateur Wireless and Electric." Edited by Bernard E. Jones. Price Threepence. Published on Thursdays and bearing the date of Saturday immediately following. It will be sent post free to any part of the world—3 months, 4s. 6d.; 6 months, 8s. 9d.; 12 months, 17s. 6d. Postal Orders, Post Office Orders, or Cheques should be made payable to the Proprietors, Cassell & Co. Ltd.

General Correspondence is to be brief and written on one side of the paper only. All sketches and drawings to be on separate sheets.

Contributions are always welcome, will be promptly considered, and if used will be paid for.

Communications should be addressed, according to their nature, to The Editor, The Advertisement Manager or The Publisher, "Amateur Wireless," La Belle Sauvage, London, E.C.4.

**Amateur  
Wireless**  
(And Electric)

Querist's Coupon Available until  
Saturday, August 19, 1922

*Listen in to*

# William Le Queux's

**Thrilling  
Wireless  
Drama**

**THE VOICE FROM THE VOID**  
WILLIAM LE QUEUX'S  
NEW WIRELESS ROMANCE

GET  
YOUR COPY  
NOW

NOW RUNNING IN

# PEARSON'S WEEKLY

CLUB DOINGS. (Continued from page 194)

**Walthamstow Amateur Radio Club**

Hon. Sec.—R. H. COOK, 49, Ulverston Road, E. 17.

On July 25th the Marconi Scientific Instrument Co., Ltd., kindly sent Mr. Oswald Carpenter, of their Research Dept., to give a lime-light lecture, and to demonstrate wireless telephony. Mr. Carpenter used for the demonstration a "Magnavox" loud speaker, and a "Magnavox" power amplifier. This was the first time that this apparatus had been demonstrated before an English wireless Society.

2. M.T. (Writtle) gave the club a special call, and his music and speech was heard all over the large hall, and in the grounds outside. 20M and 2BZ also kindly transmitted.

**Ealing Wireless and Scientific Association**

Hon. Sec.—MR. WM. FRANK CLARK, 52, Uxbridge Road, Ealing, W. 5.

At the last meeting, held July 22nd, Mr. Snell gave an outline of the electron theory of matter and explained how very important this subject is in the theory of wireless.

**Stockton and District Amateur Wireless Society**

Hon. Sec.—MR. W. F. WOOD, 4, Birkley Square, Norton on Tees.

This society held its usual monthly meeting on July 13th, when the secretary gave a short paper entitled "The Transmission of Electrical Energy." The next monthly meeting will be held on August 10th.

Owing to pressure on our space we are obliged to hold over a number of Club Doings.

**WHY DID THE GRID LEAK?**

**A PRIZE FOR THE BEST ANSWER**

Write on a separate piece of paper (one side only). [Endorse "Competition" top of left-hand corner of paper

Watch these Advertisements for Winners

- Aerial Wire, 7/22's Enamelled Hard Drawn Copper, 6/- per 100 ft.
- Aerial Pulleys, 2 1/2 in., 1/-, 5 in. with tackle hook and bucket, 2/6.
- Aerial Insulators, Shell type, 2 1/2 in. x 2 1/2 in., green, 1/6 each. Reel type, 2 in. diam., white, 4 1/2 d. each.
- Batteries. For H.T. Make your own. Flash Lamp Batteries, 5/- doz.
- Buzzers for Morse practice, new improved line, best quality, 4/6.
- Condenser Scales, 1/- each.
- Condenser Dials, engraved fine finish 1/9 each.
- Condensers. Fixed. Exceptional quality. Terminal connections: from '0001 to '001, 2/9 each.
- Condenser Vanes. Not rubbish. Best Aluminium, 1/- doz.
- Condenser Spacing Washers. Accurate. Small, 4d. doz.; large, 8d. doz.
- Condenser Screwed Rod. Brass, 12 in. lengths, 2 B.A., 9d. each. 4 B.A., 6d. each.
- Contact Studs. Studs, not rubbish, 2/- doz.
- Copper Foil Sheets. 9 in. x 3 in., 6d. each.
- Core Wire, soft iron, 2/4 per lb.
- Ebonite. Best quality. Any size, rod or sheet, 5/- per lb.
- Film Resistances. For panel mounting. A speciality. 4/- each.

- Inductance Tubes. 12 in. long. Specially impregnated. 2 1/2 in., 6d.; 3 in., 7d.; 3 1/2 in., 8d.; 4 in., 10d.; 4 1/2 in., 1/;-; 5 in., 1/2; 6 in., 1/6 each. Postage od. each.
- Inductance Slider Rod, 1/2 in. square in 12 in. lengths, 7d. each.
- Inductance Sliders, ebonite only, 6d. each.
- Insulating Tubing, 6d. per yard.
- Ivory Scales. 0 to 180°. Engraved (not printed), 1/2 each.
- Ivory Tablets. Set of 6, 9d.
- Knobs. Ebonite. 1 1/2 in. diameter. Superior finish. Knurled, 7d. each.
- Mica. Pure Ruby. Pieces, 3 in. x 3 in. x '002 in. thick, 6d. each.
- Paraffin Wax, 1/- per lb.
- Resistance Wires. "Elsi" brand. 22's (1 ohm per yard), 24's (1.7 ohms per yard), and 28's, enamelled (4 ohms per yard), 2d. per yard.
- Switch Arms. Exceptionally strong and well made, 2.6 each.
- Terminals. A very neat wireless terminal. Polished, complete with nut and washer, 2/8 dozen.
- Tin Foil. Free from lead. Sheets, 26 in. by 13 in., 4d. each.
- Valve Sockets. With nut and washer. Fine finish, set of four, 8d.
- Valve Holders. Best quality ebonite, with nuts, 1/4 each.
- Valves. 4-pin vertical filament, 10/6 each.

Wood's Metal, 8d. per packet.  
Crystals. Carborundum, galena, bornite, copper pyrites, silicon, iron pyrites, manganese, 8d. per packet.  
**SUPERIOR QUALITY WIRE. British Made.**  
All wire wound free. Post extra.

S.W.G.	S.C.C.	D.C.C.	Single Silk	D. Silk	Enamelled
12	1/10	1/11	4/-	5/4	1/8
14	1/11	2/-	4/-	5/4	1/9
16	2/-	2/1	4/2	5/6	1/10
18	2/1	2/2	4/4	5/6	1/11
20	2/2	2/3	4/8	6/2	2/6
22	2/6	2/11	5/-	6/8	2/8
24	3/-	3/6	5/6	7/4	2/8
26	3/7	4/1	6/8	8/2	3/2
28	4/4	4/7	7/2	9/-	3/6
30	5/-	5/6	8/-	10/-	3/10
32	6/-	7/3	9/2	13/-	4/2
34	7/-	8/3	11/6	14/-	4/8
36	8/8	10/2	14/-	15/6	4/8
38	11/3	13/2	16/-	19/2	5/3
40	15/-	18/-	18/6	22/6	6/6
42	17/3	21/-	31/6	34/-	9/-

At per lb.

Carriage extra. Please remit ample postage, balance returned. Orders over £2 carriage paid. Money back if not satisfied.

Phone Cent. 4209. ] **J. L. CARTWRIGHT & Co.,** Manufacturing Electrical and Radio Engineers, Dept. A, 130/132, London Road, Manchester. Grams: Pladuram, Manchester.  
Special Terms to the Trade. No Catalogues yet.

**COMPLETE SET OF PARTS TO BUILD Combined Crystal and Valve Receiver**

- 4 in. by 3 in. Prepared Cardboard Former .. .. . 6d.
- 1 lb. No. 20 D.C.C. Copper Wire .. .. . 9d.
- 2 oz. No. 26 S.C.C. Copper Wire .. .. . 6d.
- 3 in. of 1/2 in. Brass Rod fitted with Ebonite Handle.. .. . 9d.
- Velvet 4-leaf Laminated Switch Arm .. .. . 2/6
- 7 Studs, each fitted with 2 Nuts .. .. . 10d.

The Most Suitable Valve Panel to use with above.

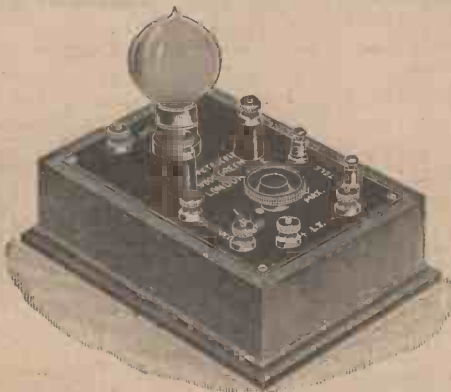

COMPLETE SET PARTS

15/9 Post 9d.

Contains Velvet Filament Rheostat ready made, Sphinx Tubular Grid Leak, 2 Meg., Grid Leak Condenser, Insulating Sleeving, Wire and all Terminals; blue print. Polished Mahogany Cabinets to fit (extra) 3/6.

**BUILD YOUR OWN CONDENSER. Set of Parts Complete.**

- '001 21/-
- '005 14/-
- '003 11/-
- '002 8/-
- '001 7/-

Supplied with Knob Pointer and Scale for Panel Mounting. If required for Box Mounting Send 1/- extra.

Send 6d. for our ENLARGED ILLUSTRATED CATALOGUE "A" with list of stations. Crammed full of the latest and best.

**PETO SCOTT, The Condenser King,** FEATHERSTONE HOUSE, 64, HIGH HOLBORN, LONDON, W.C.1.

To all WIRELESS CLUBS AND SOCIETIES

We are prepared to give special terms to you for components. Write for particulars.

To all AMATEURS everywhere

All our goods are British Made and our prices the lowest possible for first-class quality. Inferior materials and workmanship mean inferior results. Tell us of your difficulties—we will advise you gladly free of charge.

To the TRADE

May we quote you for any standard or special components or apparatus. Our deliveries are up to time and our prices will surprise you.

**L. WITHERS GREEN,**

110, VICTORIA STREET, WESTMINSTER, S.W.1.

PHONE: VICTORIA 2053

**OUR PRICE FOR THIS OUTFIT**

Carriage **£7 15 0** Paid

**READ THE SPECIFICATION OF THE WONDERFUL F. & B. SINGLE VALVE SET**

EVERYTHING INCLUDED.

NO EXTRAS TO BUY.

Well finished wood base, upon which is mounted Inductance Coil and Slider, Valve Base, Mullard Valve, Filament Resistance, Grid Condenser and Leak, with all necessary terminals and connections made, and insulation to all back connections. 6 volt 20 ampere Accumulator for the low tension and 60 volt high tension Battery. 100 feet of 3/20's Aerial Cable with necessary insulators, leading-in tube and earthing clip. Pair of Double Head Receivers, 4,000 ohms total resistance, included. We also supply a very reliable crystal set, everything included, £4 15 0.

ORDERS EXECUTED IN ROTATION — SEND AT ONCE TO SAVE DELAY  
**FOX & BRATBY, Ltd.,** 34, Duke Street, St. James' Mail Order Department, PICCADILLY, S.W.1

# 30/-

with immediate delivery from stock

## MULLARD TELEPHONE HEAD SETS

specially made for the reception of wireless broadcasting, are thoroughly well-made and fit securely and comfortably to the head.

### British Manufacture

The two high resistance ear pieces (4,000 ohms total) are flexibly attached to the fully adjustable, double head bands.

The set is nicely finished in nickel plate and supplied complete with standard flexible cords

A large stock is available at once but is being rapidly booked up. Send the coupon to-day to secure immediate delivery.

*These telephones are made by the makers of the famous ORA valve and Mullard valve accessories*

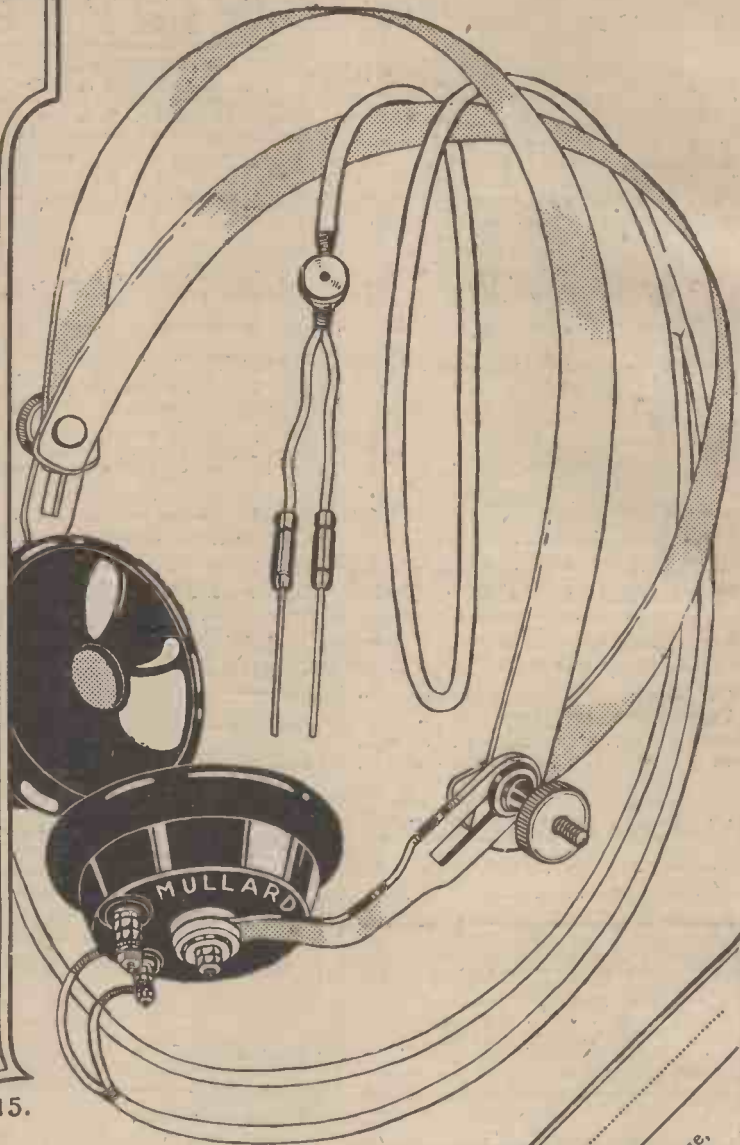

E.P.S.

15.

# Mullard Radio Valve Co. Ltd.

Claybrook Road, Hammersmith, W.6.

Contractors to H.M. Admiralty  
War Office, Royal Air Force & Post Office.

Telephone: Hammersmith 312  
Codes: ABC(5Ed)  
Telegrams: Radiovalve Hammer Lond



Name and Address	Quantity	Description	Price
To the <b>MULLARD RADIO VALVE CO. LTD.</b> 35, Claybrook Road, Hammersmith, London, W.6.		Telephone Head Sets	30/- per set
		ORA Valves	15/- each
		Grid A Resistances	5/- "
		Anode A or B Resistances	2/6 "
		BA Condensers, .0003 mfd.	7/6 "
		Combined Resistance and Condenser	5/- "
	Valve Bases with Terminals	1/3 "	
	Valve Sockets	9d. per pair	
	Terminal Clips		

Please send me post free

I enclose (Cheque, Money Order, P.O.) value to cover the cost.

Name of usual Wireless dealer

**SEND THIS TO-DAY**



**POST PAID FROM STOCK**

Best French make 4,000 ohms	...	30/-	each
„ English „ 8,000 „	...	32/-	„
Liberty (U.S.A.) 2,200 „	...	35/-	„
Loud Speakers (high resistance)	...	85/-	„
Transformers—inter valve	...	35/-	„
Filament Resistances, English	...	5/6	„

Trade Inquiries Invited

**PLENIPHONE CO.,**

28, Watling Street, London, E.C.4.

**ENAMELLED WIRES**

40	42	44	46	47 S.W.G.
6/6	8/-	12/6	19/6	30/- lb.
<b>AERIALS—H.D. COPPER</b> .. 7/22 7/30				
PLAIN .. 4/- 5/- 100 ft.				
ENAMELLED .. 5/- 6/6				

Terms:—Cash with Order. Postage extra. " "

**HORROCKS & ASPIN, 12, Schwabe St., Rhodes, Manchester**

**WIRELESS VALVES SIMPLY EXPLAINED**

By JOHN SCOTT-TAGGART, F.INST.P.

Price 2/6 net, Cloth 3/- net,

**"CONSTRUCTION OF WIRELESS RECEIVING APPARATUS"**

By PAUL D. TYERS.

Price 1/6 net. All books post free.

**RADIO PRESS Ltd., 35, Norfolk Street, London, W.C.2.**

**WIRELESS**

The following is a complete list of material to make one complete receiving set, which we guarantee, if constructed to the instruction sent with each order. It is more interesting and fascinating to make up your own Set.

If we have no account with you please remit cash with order.

Induction Tube 12" x 4" dia.	...	1/-
Hard Wood Polished Base 12" x 9" x 1"	...	2/2
Supports for Induction Coil	...	1/6
Condenser	...	3/-
Crystal Detector	...	3/6
Terminals Patent Spring	...	2/-
Best quality Black Enamelled Wire. No. 24s. 150 yards	...	2/6
12" Square Section Brass for Slider	...	6
Insulated Slider	...	1/-
Screws and Ivoryine Labels marked 'Phones, Earth, Aerial	...	1/3
Complete Set of Material	...	<b>18/5</b>
Aerial Wire. No. 18. 120 ft.	...	2/3
4 Insulators for Aerial	...	3/6
Highly Sensitive Double-headed Tele-phones, 4,000 ohms, complete with Cord, which are fitted with Two plug-type Metal Tags	...	32/6
Ditto wound for 2,000 ohms	...	30/-

Batteries are not required with this Set

Send for our Lists

Any of the above can be obtained separate Postage extra

**THE COLBRAD ENGINEERS,**  
Highfield Chambers, Broad Street, Pendleton,  
**MANCHESTER.**

**L.F. INTERVALVE, L.F. TELEPHONE,**  
25/-, Post Free, Guaranteed. 25/-

**INTERVALVE & TELEPHONE TRANSFORMERS**

SUPPLIED FROM STOCK FROM

M.E.C., WIRELESS LABORATORIES, CROWN HILL ROAD, LONDON, N.W.10.

**WIRELESS BARGAINS**

Aerial Wire, 7/22s, enamelled stranded copper wire, 100 ft.	5/6
Condensers, variable, 1000, ebonite top and bottom, ebonite knob, ivoryine scale 0° to 180°, exceptional bar-gain.	each 14/6
Condensers, variable, 1000. Same details as above	each 9/6
Ebonite Bevelled Dial for above	each 3/-
Condenser Vanes, absolutely accurate, aluminium, 3 1/2 diameter	doz. 1/3
Condenser Spacing Washers, accurate, small doz.	4/1d.
Doz. Ditto Ditto Ditto large	doz. 8/1d.
Contact Studs, highly polished, medium	1/9 doz.; large 2/3
Crystal Cups, excellent finish, nut and washer	each 5/1d.
Ebonite, the best, any thickness	per lb. 4/9
Insulators, reel type, 2 in. diameter	each 5d.
Switch Arms, 2-leaf laminated blade, extra quality	each 2/3
Terminals, highly polished nut and washer	doz. 2/3
Ebonite Valve Holders, screw legs, 2 nuts, the best	each 2/4
Wire, No. 24s, enamelled, the best	per lb. 2/6
Insulate Sliders, ebonite, spring and contact	each 7/1d.

Carriage paid on all orders over £2. Stamp for list.

**WRIGHT BROS., 38a, Cross St., Sale, Manchester.**

**LOWEST PRICES ON RECORD**

Best Quality French Double Head Phones with Cords 4,000 ohms, Guaranteed. Results Perfect. Call and test Personally at our Showroom. 25/- per pair.

Ebonite Knobs, drilled and tapped 2 B.A.	each	5d.
Ebonite Slider, with plunger, 1st quality	each	9d.
Contact Studs, 4 B.A., with nut and washer	doz.	1/-
Ebonite Valve Holders	...	each 1/2
Switch Arms	...	each 1/6
" " (1st quality)	...	each 2/6
A Few Ex Army Crystal Sets, very posh	each	50/-
Inductance Coils, wound and insulated, 12 by 4, 4/- each; 12 by 6	each	6/-

Do not fail to ask for our Catalogue, free. These prices do not include postage.

**WILL DAY, LTD.,**

Actual Makers and Experts of all Wireless Sets and Apparatus,  
**19, Lisle St., Leicester Square, W.C.2.**  
Phone 4577 Regent. Telegrams: Titles Westrand.  
Note our Address carefully.

**RECEIVERS**

A large stock of low-resistance receivers, 100 to 200 ohms, each ex-Post Office and Government watch pattern, for sale, 3s. 6d. and 5s. 6d. each, post free. Ebonite panels cut, engraved and drilled to order. Mahogany and teak cases.

<b>Details of Single Valve Panel:—</b>	£ s. d.
Ebonite panel, 8 by 6, drilled and engraved	4 6
Ten terminals with nuts and washers	2 0
Mahogany case, hand polished for above	6 0
Valve legs with nuts and washers, set	1 0
Telephone blocking condenser	3 6
Grid leak and condenser	4 6
Filament resistance	4 0
Mullard valve	15 0
Variable condenser, .0005 with scale and pointer	17 6
High-tension batteries, 30 v. with tapping and plugs, Siemen's manufacture	10 0
Accumulator, 4 v. 40 amp., Fuller block	1 12 6
Double headphones, 4,000 ohms, London manufacture	1 17 6
Insulating sleeving and connecting wire	1 6
Aerial-wire, 7/22 silicon bronze, 100 ft.	7 6
Reel insulators, six	2 0
Leading-in tube	1 0
Leading-in wire, C.T.S., per yd.	9

A complete station ready for assembling for .. £7 10 9  
Carriage extra. Any item sold separately.

**W. H. ACAR, Telephone & Telegraph Engineer,**  
2, Finsbury Avenue, E.C.2.  
Tel. London Wall 3305. Established 10 years.

**INDUCTANCE TUBES.**  
Length 12 in.  
Dia. Dia.  
2 1/2 in. .. 6d. 4 in. .. 1/-  
3 in. .. 8d. 5 in. .. 1/6  
3 1/2 in. .. 10d. 6 in. .. 2/-

**SMALL CONDENSERS.**  
1000 & 10005 .. 3/-

**ANODE RESISTANCE.**  
50,000 & 80,000 ohms 3/6

**VARIABLE ANODE RESISTANCE.**  
20,000 to 100,000 ohms, 7/6

**FILAMENT RHEOSTAT.**  
5/-

**CONDENSER PARTS.**  
Fixed and Moving Vanes, 2/6 dozen.

**CENTRE ROD.**  
4 1/2 in., 4/6 each.

**LAMINATED SWITCH ARMS.**  
2/6

**VALVE SOCKET, 1/9.**

The **Universal Electric Supply Co Ltd**  
4 BROWN ST OFF MARKET ST  
**MANCHESTER**

G.P.O. Box No. 510.

Large **Illustrated CATALOGUE** 30th Edition,  
Post Free 6d.

**SINGLE RECEIVER,**  
With Head Band and Cord.  
120 ohms .. 24/-  
500 .. 27/6  
1,000 .. 30/-  
2,000 .. 32/6

**DOUBLE RECEIVER,**  
With Head Band and Cord.  
2,000 ohms .. 35/-  
4,000 .. 37/6  
8,000 .. 45/-

**SKELETON BUZZER.**  
Extremely sensitive for Crystal Testing, 2/6

**HIGH TENSION BATTERIES**  
15 volts .. 8/6  
Variable Type, 36 v., Tappings every 3 v., 7/8.

**ACCUMULATORS,**  
Volts. Amps.  
4 40 28/-  
4 60 35/-  
6 40 42/-  
6 60 62/-

**POSTAGE EXTRA.**

**VALVE SOCKET TERMINALS.**  
1/8 per set of 4.

**CONTACT STUDS.**  
Small size 2/- doz.  
Large size 3/- "

**AERIAL INSULATOR.**  
1 1/2 in. 1/3 2 1/2 in. 2/6  
2 in. Reel Type, 4d.

**AERIAL WIRE.**  
Per 100 feet.  
3/30 .. 4/- 7/22 .. 5/-  
3/19 .. 4/6 3/18 .. 6/6  
7/30 .. 7/6

**REGULATING SCREW, 1/-**  
**EBONITE KNOBS, 1/- & 1/6.**

**INSULATE SLIDERS, 1/-.**

**KNIFE SWITCHES.**  
S.P. 1 way, 1/9; 2 way, 2/4  
D.P. 1 way, 3/9; 2 way, 6/-

**GRID CONDENSER and LEAK, 7/6.**

**BLOCKING CONDENSER, 5/-**  
**GRID LEAK, 3/-**

**PLUG CONNECTOR, 2-Pin, 1/6.**

**CRYSTAL CUP.**  
Single Cup Type .. 6/6  
Three .. 21/-



Radio brings it: **MAGNAVOX** tells it

# MAGNAVOX

## THE WORLD'S FINEST LOUD SPEAKER

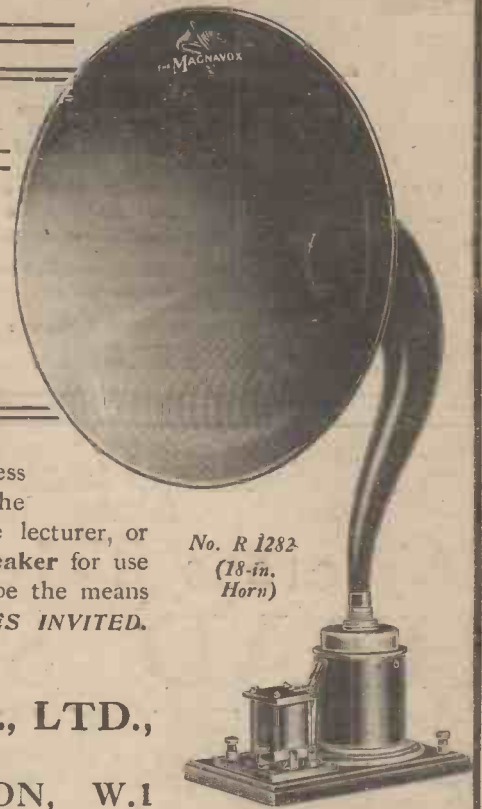

**T**O enjoy and get the greatest possible satisfaction from your Wireless Receiving Set, equip it with a **Magnavox Loud Speaker**. Hear the voice of the singer faithfully reproduced, the perfect intonations of the lecturer, or the natural sound of music. The introduction of the **Magnavox Loud Speaker** for use with Radio Receiving Sets marks a most important development, and will be the means of making broadcasting extremely popular.

No. R 1282  
(18-in.  
Horn)

**INQUIRIES INVITED.**

**SOLE AGENTS FOR THE UNITED KINGDOM:**

**STERLING TELEPHONE & ELECTRIC CO., LTD.,**

Telephone House,

210/212, TOTTENHAM COURT ROAD, LONDON, W.1

Telephone: Museum 4144 (7 lines).

Telegrams: "Cucumis, Westdo, London."

**NEWCASTLE-ON-TYNE:**  
9, Clavering Place.

**WORKS:**  
Dagenham, Essex.

**CARDIFF:**  
8, Park Place.

**ORDER EARLY  
—IF EARLY DELI-  
VERY IS REQUIRED**

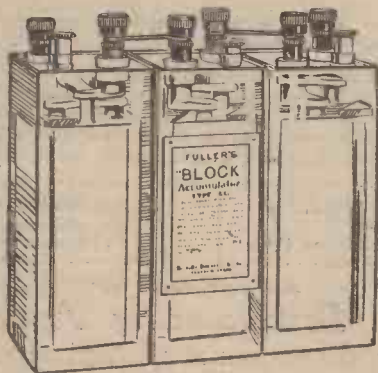

**INSIST ON HAVING A**

## FULLER "BLOCK" TYPE ACCUMULATOR

**FOR YOUR WIRELESS SET!**

The only Accumulator on the market that will hold its charge from 12 to 18 months when not in use.

4-volt 40 amp. hours, £1 12 6, plus 1/3 carriage  
6-volt 40 " " £2 8 9, " 1/6 "

Note:—These prices are 33% below those of the actual makers.

**8,000 Sold. 20,000 still in stock.**

Descriptive and Instructive Pamphlet on request from—

**The CITY ACCUMULATOR Co. (Dept. 14),**  
79 Mark Lane, E.C.3 (Tel. No. Avenue 91)

ALSO SUPPLIED BY—

**Selfridge & Co., Ltd.,** Wireless Section; **A. W. Gamage, Ltd.,** Wireless Dept.; **Barnsley British Co-operative Society,** Radio Section; **Richford and Co.,** 153, Fleet Street, E.C.3.; **The South Wales Wireless Installation Co., Ltd.,** 18, West Bute Street, Cardiff.

# Exide BATTERIES FOR WIRELESS

We specialise in the manufacture of batteries for filament current supply to Valves, and high-tension batteries for application of Anode Potential. We can supply these batteries in glass, ebonite, or celluloid containers to any desired voltage.

Exide batteries can be relied upon for Wireless work, and retain their charge over very long periods.

Prices and Particulars upon application.

6 v. 80 ampour  
Exide Battery



**THE Chloride ELECTRICAL STORAGE  
COMPANY LIMITED.**

Head Office:  
CLIFTON JUNCTION,  
MANCHESTER.

London Showrooms:  
219/229, SHAFTESBURY  
AVENUE, W.C.2.



# Amateur Wireless And Electrics

**FREE  
POST  
REPLIES**

No. 11

SATURDAY, AUGUST 19, 1922

Price 3d

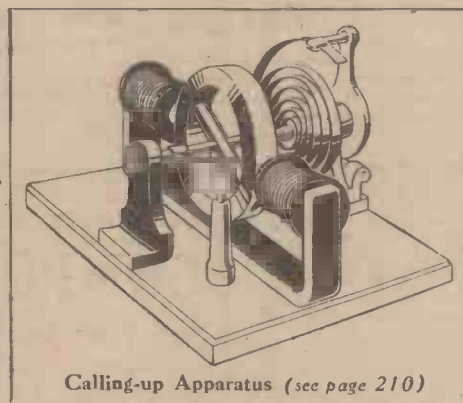

Calling-up Apparatus (see page 210)

**CHIEF  
CONTENTS**

**WELL  
ILLUSTRATED**

	Page
A BEGINNER TO BEGINNERS . . . . .	203
MAKING A HIGH-NOTE TESTING BUZZER . . . . .	204
THE BEGINNER'S PAGE: More about the Valve . . . . .	205
USING "SURPLUS" W.D. APPARATUS . . . . .	206
SPACING - WASHERS FOR CONDENSERS . . . . .	206

	Page
INDUCTANCE AND CAPACITY: Interesting Mechanical Analogies . . . . .	207
EVERYDAY CARE OF APPARATUS . . . . .	208
WHY USE A DETECTOR? . . . . .	209
WIRELESS TERMS . . . . .	209
AUTOMATIC CALLING APPARATUS . . . . .	210

RADIOGRAMS . CORRESPONDENCE . INFORMATION BUREAU  
CLUB DOINGS . FORTHCOMING EVENTS, Etc.

# ECONOMIC ELECTRIC LTD.



**CRYSTAL DETECTORS, 7/6**



**HEAD RECEIVERS  
From 21/-**



**ENCLOSED  
CRYSTAL  
DETECTOR, 12/6**



**INDUCTANCES,  
50/-**



**VALVE HOLDERS, 1/9**



**INDUCTANCES, 50/-**

**Head Office: 10, FITZROY SQUARE, LONDON, W.1.**

*New Showrooms:*  
**303, EUSTON ROAD, N.W.1.**

*Telephone:*  
**MUSEUM 1055**

*Branch Showrooms:*  
**TWICKENHAM**

Write  
To-day for 38-  
Page **WIRELESS**  
List Post Free  
4d.  
240 Illus-  
trations.

## MITCHELFONES

Are not a spasmodic production to meet a sudden demand, but have been on the market for over three months, and during this period 27,000 have been distributed to the trade, and consequently we have not been able to offer them direct to the retail buyer.

*1000 per week are now available, and we announce*

### DELIVERY FROM STOCK

You post your order, or call at our premises and get them at once. Think what this means to you—you, perhaps, who have been waiting and are still waiting.

*Standard resistance 4,000 ohms, double headgear with double headstraps, comfortable, highly efficient, and foolproof*

**35/- per pair.**

Special Terms to Traders and deliveries that will surprise you.

### MITCHELLS Electrical & Wireless Ltd.,

Postal Address: McDermott Road, Peckham, S.E.15.  
Retail Address: 188, Rye Lane, Peckham, S.E.15.

'Phones: New Cross 1540/1541.

**GREAT BRITAIN'S GREATEST WIRELESS STORE**

# Exide

## BATTERIES FOR WIRELESS

We specialise in the manufacture of batteries for filament current supply to Valves, and high-tension batteries for application, of Anode Potential. We can supply these batteries in glass, ebonite, or celluloid containers to any desired voltage.

Exide batteries can be relied upon for Wireless work, and retain their charge over very long periods.

Prices and Particulars upon application.



**6 v. 80 ampour  
Exide Battery**

## THE Chloride ELECTRICAL STORAGE COMPANY LIMITED.

Head Office:  
CLIFTON JUNCTION,  
MANCHESTER.

London Showrooms:  
219/229, SHAFTESBURY  
AVENUE, W.C.2.

## We can supply YOU with ALL COMPONENT PARTS for your wireless set straight from stock

*If you wish to save money, send for our  
Complete List — TRADE SUPPLIED*

Aerial Wire, 7/22 bare copper stranded in 100 ft. bunks	5/6 per hank
Ring Pattern Insulator, 2 in. by 1 in., 1/4 in. hole	... 6d. each.
1/2 in. sq. Section Brass Rod for Sliders, cut in 13 in. lengths, and drilled each end ready for fixing	... 8d. each.
Inductance slider, complete with plunger	... 1/- each.
Cardboard Cylinder, 12 in. by 4 in. diameter	... 10d. each.
No. 24 enamelled wire, H.C. true to gauge	... 2/8 per lb.
Large or small Condenser Plates (Aluminium)	... 1/6 doz.
Large Spacer Washers for condensers, cut true to 1,000 of an inch	... 9d. doz.
Small spacer washers Ditto	... 6d. doz.
Ivory Scales	... 1/- each.
Condenser Box in Polished Oak or Mahogany, 3 1/2 in. by 3 1/2 in. by 2 in.	... 5/- each.
0003 mf. Condenser complete—sembled in polished mahogany or oak boxes	... 17/6 each.
All necessary parts for above condenser—no drilling or fitting required, but unassembled	... 15/- each.
Ditto, but without box	... 11/- each.
Ditto, but without ebonite top, and box suitable for panel mounting	... 10/- each.
Crystal detector, mounted on Ebonite, complete with Crystal	... 5/- each.
Large or Small Contact Studs	... 1/- doz.
Valve Legs, complete with nut and washer	... 3d. each.

Instrument Wire at Rock-bottom Prices

## J. B. BOWER & CO., Ltd.,

WIRELESS MANUFACTURERS,  
15, Kingston Road, WIMBLEDON, S.W.19.

Phone: WIMBLEDON 1030.

Works: MERTON.

# Amateur Wireless

## and Electrics

No. 11

August 19, 1922

## A BEGINNER TO BEGINNERS

The Magic of the First Signal :: The Single-valve Panel :: Adding the Amplifier

A VERY short time ago the last thing in the world I thought about was wireless, and now I find it exceedingly difficult to think of anything else. The story of my rapid entanglement is not without its curious side. With a long and somewhat tedious railway journey in front of me I looked to beguile at least a portion of the tedium of the journey with a booklet on gardening, a subject I have always taken a keen interest in. I had, as usual, cut things rather fine and had only a bare minutes to snatch up my book, thrust the money in the bookstall-keeper's hand, and dash for the train. Imagine my horror at discovering, when the train was well under way, that the volume I had so precipitately taken to myself was a handbook on wireless. As, however, I had neglected to provide myself with any other form of literature I plunged into the unknown.

### My Initiation

From about half-way through the volume the delights of gardening began almost imperceptibly to recede, and it was with amazement that I found that I had reached my journey's end with almost annoying celerity. From that moment I never turned back. My gardening friends have sought in vain to stem the tide of what they term misguided enthusiasm, but I have gathered round me another and no less enthusiastic band. Even one of the gardening friends came to talk of myosotis and left, after monopolising my telephones for the greater part of his visit, with sundry catalogues and all the wireless literature I possessed.

### The First Signal

Can one ever forget the magic of the first signal? It is true that to the uninitiated it conveys but little in matter, but as a vehicle of romance, why it's wonderful. I don't know who sent that ticking whisper, but I can always imagine. As signals cross and recross the path to the aerial that, insignificant though it may be, is wholly mine, the fascination of these murmuring and conflicting tongues is immense, immeasurable.

And then the first audible word, even if it be only "Hullo, Lympne!" Isn't it almost breathless, the excitement? I think

the gentleman who works that transmitter at Croydon deserves—well, anything. He has, I feel sure, been the good fairy to most of us. And that curious sense of eavesdropping when he tells Lympne that his wave-length is short. But he has got a nice voice, hasn't he?

I don't know Morse, but I want very much to reach Bordeaux with the longest wave-length in the world. It's true I shouldn't know when I was there unless by instinct, but the want to get there exercises much the same effect as the desire for Samarcand and Bokhara. They sound so alluring. I fear I shall never know Samar-

moving-coil holder. That has had the effect of removing the necessity of near approach; but the reason, except that it is caused by bodily capacity, remains inexplicable.

I don't think that sufficient insistence is placed on the fact that the usual cheap accumulator is unfitted for more or less prolonged illumination of more than one valve. Nor is it shown with sufficient clearness that if, recognising this fact, you use more than one accumulator the negative of the second should also be connected to earth. We want all this made abundantly clear. It was a golden rule in the

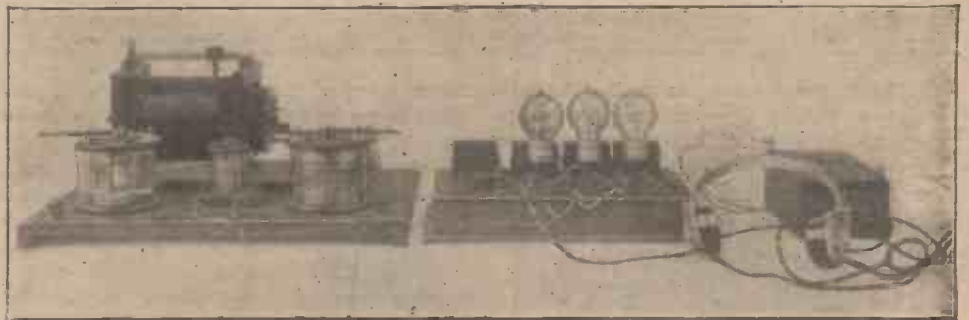

A Crystal Set in Conjunction with a 3-valve Amplifier.

cand or Bokhara, but I do hope to reach Bordeaux by—wireless.

### Curiosity

I started with a single-valve panel, and for a week the inner sanctuary of its works remained inviolate. But one day I opened it, took it all to bits, and put it together again. And it worked! I often open it now, and it is no longer the beautiful polished thing that it was. Two more valves with transformers group themselves forlornly about it—well, not really forlornly, but they look rather like that. The whole table's a maze of wires. I know it oughtn't to be like that. Every book says it mustn't be like that, but somehow I rather like it. I'm always drawing wiring diagrams on bits of paper, but that, I think, is merely a symptom of the disease. I did notice that if I leant over the apparatus it made some inexplicable difference, and now I move my coupling by means of a wooden penholder suitably affixed to the

war that a message should be worded as if the recipient were a congenital idiot. The same might well apply in elementary handbooks.

### How to do It

Now I think if I were to aspire to instruct the beginner in the method of addition of an amplifier (H.F.) I should put it something like this: Disconnect from the aerial terminal the wire that goes through the grid leak and condenser to the grid of your existing valve. The plate or anode terminal incidentally is the one that is unevenly spaced from the three others. Bring this wire out either through a hole in the side of the box, or better, through a hole in the top of the panel, and attach it to the IN secondary of your H.F. transformer. If the terminals of the transformer are not marked, it is probably a matter of indifference which you attach it to, but you must know which are the two primary terminals of the trans-

former and which are the two secondary ones. If you are in any doubt, test in the following way: Attach a short piece of wire from one of the terminals to the positive of a 2-volt cell. To another terminal of the transformer attach one end of the telephone cords. With the other end of the cords touch the negative of the cell. If you are connecting up the primaries or secondaries you will hear a sharp click. If you are connecting up a primary to a secondary you will hear nothing. Now you have one end of the transformer secondary connected to the grid of your original valve. Connect the other end to earth or the negative terminal of the accumulator, it doesn't matter which. Now connect the primary terminal of the transformer that is opposite to the secondary terminal connected to the grid of your original valve to the plate terminal of your new valve. Connect the other primary of the transformer to H.T. positive. Connect your aerial to the grid terminal of your new valve.

Now for the variable condenser. You must take a lead from the grid of your new valve (already connected up with the aerial) to the fixed-plate terminal of your

condenser. The whole thing is now complete. If your variable condenser is in parallel, the wave-length will be increased; if in series, the wave-length will be reduced. In parallel the aerial and the aerial inductance are connected to the fixed plates and the earth to the moving plates. In series, the aerial is connected to the fixed plates and the lead from the A.T.I. to the moving plates. The lead to earth is removed and the grid of the amplifying valve is connected to the moving plates of the condenser.

This is not technical, but it is clear.

**In the Future**

And now to beginners like myself I would say: "Study your own particular apparatus. No hard-and-fast rule can be given you. You have, every one of you, your own peculiar aerial on its own peculiar site with its own peculiar earth. I am seventy-six miles from London, S.W., and with two valves I can get Croydon, Lympne, Pulham, Le Bourget, Paris, and the Dutch concert, and all really well. It took me nearly a month, and I can't yet get Writtle, but I intend to!"

BEGINNER.

of the current through the instrument is therefore from the battery or accumulator to the terminal F, and the metal plate to the contact screw S, across the contacts and the diaphragm D to the pole-piece P, and through the magnet winding to the terminal T (Fig. 2), and thence back to the battery.

Due to the fact that the snap-on lid clamps the diaphragm securely all round, it is possible, as mentioned previously, to have the diaphragm very close to the magnet, thereby producing a high-pitched note.

With regard to the construction of the magnet M, this is wound on a metal former made up by soldering two metal cheeks to one arm of the metal strip P. This strip should measure 5/8 in. wide by 1 1/2 in. long, and may be cut from sheet-iron 3/32 in. thick. This is bent up as shown in Fig. 3; that portion forming the core of the magnet should be insulated by means of waxed silk, which should also be gummed on to the inside of the cheeks. The magnet is wound with No. 36 d.s.c. wire, the last layer but one being covered with a strip of varnished silk. The final layer of wire should be wound on very carefully and secured by looping the last turn under itself, the complete coil then being soaked in melted paraffin wax.

The complete coil and iron core P should now be placed on a surface plate or other flat base and the heights of the two pole-pieces carefully measured. The arm or pole-piece on which the coil is wound must be 1/8 in. shorter than the other. The height of the other pole-piece must be such that it just reaches a shade higher than the ledge in the ebonite case B, so that when the metal diaphragm D is in position direct contact is made with the pole-piece P.

The diaphragm D may be one taken



Fig. 3.—Pole-piece and Coil.

from an old telephone receiver, the only addition being a contact stud soldered in the centre. Both this and the contact on the screw S should be of german silver or other suitable alloy. The actual sparking may be considerably reduced by fitting a small condenser C (Fig. 2) in the case and connecting this across the contacts.

The ebonite case B can easily be turned up by anyone possessing a lathe, or one may be purchased from an electrical dealer. The battery voltage may be anything from 2 to 4 volts, and when the buzzer is used exclusively for testing faults in the circuits the terminals may be dispensed with and a length of twin flexible lead soldered on permanently. W. H.

# Making a High-note Buzzer

THERE are various ways of constructing a testing buzzer: one way is to take the hammer and armature off an electric bell and fit a strip of steel spring with a german-silver contact to act as a vibrating armature.

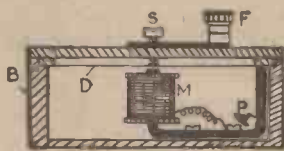

Fig. 1.—Section of Complete Buzzer.

Small buzzers may also be purchased in shops stocking electrical sundries, but these have contacts of inferior metal which burn away and are continually getting out of adjustment.

The following article deals with a new type of buzzer, one which utilises a circular armature or diaphragm instead of the usual flat strip of metal. Due to the fact that this diaphragm is supported all round, it is possible to have the magnet almost touching the diaphragm, resulting in a more sensitive instrument and one capable of producing an extremely high-pitched note.

The overall dimensions of the instrument are also considerably less than the standard instrument, and having a minimum of working parts it is very easy to make.

Fig. 1 gives an idea of the general

appearance of the instrument were it possible to see it in section. A circular ebonite case B, with a snap-on lid, is fitted with an electro-magnet M, which is wound on a strip of soft iron P which serves the double purpose of a core for the magnet and also a support. The soft iron strip P is bent round and mounted on the bottom of the ebonite case with the aid of two screws, the opposite arm to that carrying the coil M being in contact with the diaphragm D, which rests on a ledge turned in the ebonite case. The distance between the diaphragm and the pole of the magnet M is approximately 1/32 in.

The lid of the ebonite case B is undercut to enable the diaphragm to vibrate.

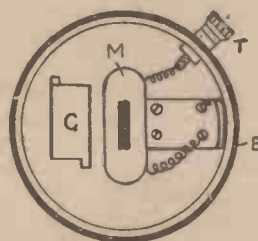

Fig. 2.—Details of Interior showing Connections.

Mounted on the top is a contact screw S and a terminal F. The other terminal (not shown in Fig. 1) is connected to one end of the magnet winding, the other end being earthed to the pole-piece P. The passage

## “Wireless Telegraphy and Telephony”

The most Practical Handbook for the Amateur. The price is 1/6 net.

# THE BEGINNER'S PAGE MORE ABOUT THE VALVE ::

IN the last article of this series it was explained how the valve may be used as a detector on account of the fact that the valve only allows the current to flow in one direction. During the war, however, it was discovered that the valve is not only suitable for detecting, but also for amplifying the incoming signals. It can also be used as a generator of high-frequency continuous waves, and in this form the valve is of the utmost importance, doing away with much expensive plant previously used for the production of continuous waves or C.W. as they are technically termed.

### The Valve as a Magnifier

In order to use the valve as a magnifier, it is necessary for a metal gauze, known as the "grid," to be interposed between the filament and the sheath or plate. This has the effect of preventing any flow of electrons from the filament to the plate, and therefore the valve acts as a non-conductor of electricity, no matter to what potential the plate be charged positively.

The ordinary valve allows a current to pass from the plate to the filament because there is a constant stream of electrons from the filament to the plate. If, however, the grid is inserted between the filament and the plate, the electrons which are attracted from the filament by the positively charged plate fall on the grid, charging it to a negative potential and thereby shielding the space between the filament and the plate. It is obvious that no current can flow from the plate to the filament unless the negative potential on the grid be reduced. If the shielding effect of the grid is reduced by applying a positive potential so that it becomes neutral, then a current will pass from the plate to the filament. By means of a small negative charge on the grid it is therefore possible to control a comparatively large current in the plate circuit from the high-tension battery.

The amount of energy required to reverse the potential of the grid and allow the plate current to flow is very small. By suitable connections it is possible to utilise the comparatively weak signals received in the aerial to control the current from the high-tension battery.

A simple receiving circuit with the valve connected up as described above is shown in Fig. 1 in which the aerial A is connected by means of a variable contact to the aerial tuning inductance ATI.

connected to the earth E through the variable condenser VC and to the lower end of the aerial tuning inductance ATI.

This completes the aerial circuit. The valve circuit consists of the secondary of the oscillation transformer OT, the grid



Photograph showing Accessory Apparatus to the Valve at the Back of the Valve Panel.

condenser GC, plate S, filament F, high-tension battery HTB, potentiometer P, potentiometer battery PB, and the telephone headgear PH. The filament is heated by means of a 6-volt battery FB, the voltage being regulated by means of the filament resistance FR.

The above description of the action of the audion or thermionic valve may seem unnecessarily complicated, but once grasped the principle is extremely simple.

There are, of course, certain other factors which have to be considered in valve work; it is not, however, proposed to deal

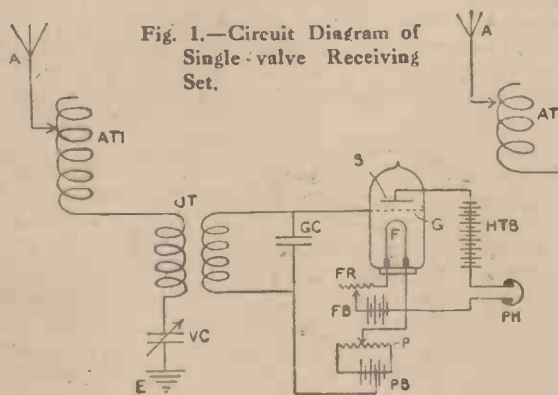

Fig. 1.—Circuit Diagram of Single-valve Receiving Set.

has led the authorities to specify that amateur sets must be "non-radiating."

### Multiple Valves

It is not necessary to limit the number of valves used for the reception and magnification of signals, the usual number being three valves suitably connected up. As many as six or seven valves are used under certain conditions, but the magnification is almost too great in these cases, the signals being very loud but distorted.

Multiple-valve sets were used to a great extent during the war on direction-finding apparatus for the detection and position-finding of hostile aircraft. They are also used to-day on commercial aircraft for navigation by wireless and for the transmission and reception of speech.

For the reader of limited means the most inexpensive valve set is the one using a valve of the three-electrode pattern for amplifying the signals and a crystal detector for rectifying the current in order to produce a note in the telephone receivers.

Such an arrangement is clearly shown in Fig. 2, an examination of which will show that the connections are similar in many ways to the single-valve receiver described in an earlier number, with the addition of a crystal detector. In this case the valve is used purely for amplifying and the crystal for rectifying the incoming signals.

By referring to the illustration it will be seen that the apparatus consists of the aerial circuit, A being the aerial, ATI the aerial tuning inductance, VC the variable condenser, the primary of the oscillation transformer OT and the earth connection E.

The secondary winding of the oscillation transformer OT is connected to the grid condenser GC, the grid G, and the potentiometer P.

Three separate batteries are shown, the

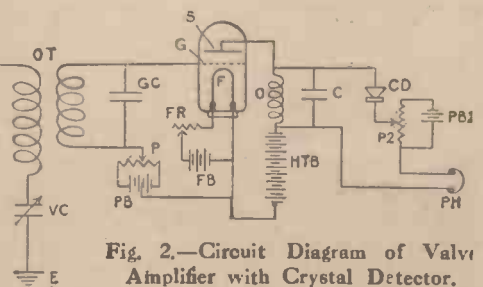

Fig. 2.—Circuit Diagram of Valve Amplifier with Crystal Detector.

with them here for fear of confusing the reader regarding the main principles underlying valve reception of wireless waves.

Valves used for receiving signals are, under certain conditions, capable of transmitting waves at the same time, and this

potentiometer battery PB, the filament battery FB, and the high-tension battery HTB.

The filament resistance FR is connected in series with the filament F, while the high-tension battery is connected by its

positive terminal to the plate S of the valve, an inductance O and capacity or condenser C being connected across as shown. The signals are rectified by means of the crystal detector CD, the most sensitive potential being obtained by adjusting the potentiometer P2, which is shunted across the potentiometer battery PB2.

The telephone receivers PH should be of high resistance, and the crystal combination zincite-bornite or some other suitable mineral.

The set as described above may seem at first sight to be unnecessarily complicated, but it is really extremely simple and very effective.

In the set described above it will be noticed that several separate batteries are used, but in actual practice the connections are arranged so as to use one high- and one low-tension battery. This somewhat complicates the wiring, but it is desirable on the grounds of economy.

With regard to general care of valve sets it is most essential to switch the filament battery off when the set is not in use.

Do not forget the high-tension battery is also capable of quickly running down if not switched off; this is an expensive battery to replace and should therefore be taken care of.

The life of a valve depends to a very great extent on how it is treated. Keeping the filament glowing at full brilliancy all the time will quickly blacken the bulb and cause the efficiency of the valve to decrease considerably.

The filament resistance should be adjusted so that the voltage across the filament is just sufficient to give the required amplification and no more.

It will be found after a little practice in tuning that very strong magnification is not desirable; in fact, it does not signify that the signals will be clearer because they are extremely loud.

In conclusion, the reader should not lose interest in the theory of wireless because the practical side seems so much more interesting. Before one can get anywhere in the designing and estimating of even a simple set it is necessary to have at least a grasp of the elementary principles underlying the action. A. W. HULBERT.

### Spacing-Washers for Condensers

A SHORT time ago the writer noticed that the rollers from an old bicycle chain were just the right depth for spacing condenser plates.

A single chain yields over 100 washers of the following dimensions: diameter,  $\frac{5}{16}$  in.; depth,  $\frac{5}{32}$  in.; diameter of hole,  $\frac{3}{16}$  in. Used one at a time between  $\frac{1}{32}$ -in. plates, these give a spacing of  $\frac{1}{16}$  in.; or if two washers are used between each plate, a spacing of just over  $\frac{1}{8}$  in. is obtained.

The fact that the washers are of steel slightly decreases their value. L. E. O.

## Using "Surplus" W.D. Apparatus

### The Conclusion of the Article on the Spark Transmitter

THE tuning of the open and closed oscillatory circuits is effected by means of two adjustable tuning clips of a similar pattern to those shown in Fig. 4. These clips

terminals with a view to tightening up any connections that may have worked loose or come unsoldered.

The hot-wire ammeter, although very strongly constructed, will sometimes burn out, and the repair and recalibration is beyond the capabilities of

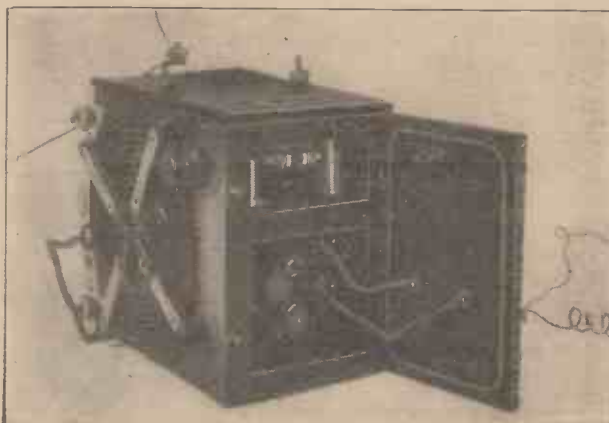

Fig. 6.—Transmitter with End Open showing Make-and-break, etc.



Fig. 4.—Details of Tuning Clip.

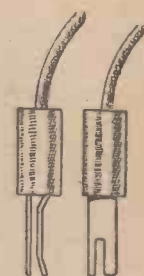

Fig. 5.—Improved Tyre of Tuning Clip.

may be clamped in any position on the helix. Fig. 3 on page 183 of the last issue shows that one clip is directly connected to the aerial terminal AT, while the other is in the closed oscillating circuit, both clips being on a short length of flexible lead.

An ammeter (not shown in the photographs) is wired in series with the aerial, and is of the hot-wire pattern designed to give an indication of the current in the aerial circuit. It is, therefore, a radiation indicator, the connections being as in Fig. 3 (page 183), M being the ammeter. When the set is working, a maximum reading will obviously be given when both the open and closed oscillating circuits are accurately in tune.

With regard to possible troubles which are likely to be found with a second-hand transmitter of the "Sterling" pattern, the most common will be pitted contacts, caused through using too high a voltage and thereby causing the contacts to arc across. The whole make-and-break should be dismantled and the contact screw and the corresponding contact on the armature be carefully cleaned up with a smooth file. It is most essential, when putting the make-and-break together again, to see that the surfaces of the contacts are absolutely parallel to each other; unless this is so, trouble will be caused by sparking between the points. Another trouble is often to be found in the tuning clips; these are often bent and damaged. The writer has replaced those on his own instrument with the prong type shown in Fig. 5, which is so clear as to need no further description, both the side and the front view of the clip being shown.

It is also a good plan to run over all

most people. It was mentioned that under good conditions the range of the "Sterling" transmitter was about 30 miles.

This was on the assumption that a crystal receiving set was used; with a valve it



Fig. 7.—Transmitter with Top Removed.

is possible to pick up signals from nearly twice the distance. In conclusion, the writer would like to remind electrical experimenters that the spark coil on the "Sterling" transmitter is particularly well made and suitable for many purposes besides wireless work. It might be mentioned also that they are capable of giving an exceedingly violent shock.

The photographs on this page, Figs. 6 and 7, clearly show the prominent features of the transmitter. H. A.

# Inductance and Capacity

Interesting Mechanical  
:: Analogies ::

IN simple electrical circuits we speak of the quantity and pressure of the electricity, and also of the resistance of the circuit, and there is no difficulty about grasping the exact meaning of the terms

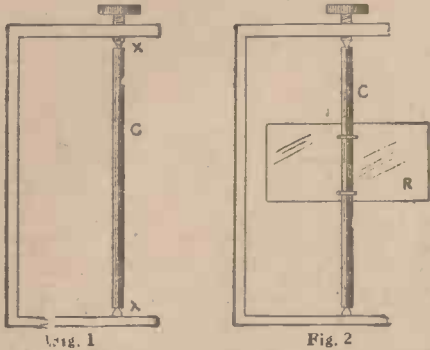

Fig. 1.—Mechanical Analogy of Circuit without Resistance, Inductance or Capacity.

Fig. 2.—Circuit with Resistance.

used. In wireless circuits we introduce two other quantities, namely, inductance and capacity, and the amateur has some difficulty in picturing in his mind the exact meaning of these terms. However, by means of a simple piece of apparatus, which can be rigged up in a few minutes, an almost perfect mechanical analogy can be obtained.

### Experimental Apparatus

The apparatus consists of a simple iron stand fitted with two steel centres, one of them being a screw centre in order to allow of the interchange of various steel rods which are mounted between the two centres.

We start first with a plain steel rod C (Fig. 1) and adjust the centres so that the rod is quite free to turn. Now, in all cases, we assume that the mass of steel in the rod represents the current (or number of amperes) with which we are working. The rod may be twisted by means of the fingers applied to the upper end of the rod, and we will assume that in all cases the twisting force of the fingers is the E.M.F. or voltage which tends to revolve the rod or current.

### Direct Current

In our first case the centres offer very little friction, and we may say that the contrivance represents a circuit containing only current without resistance, inductance, or capacity. If we apply a little E.M.F. by twisting with the fingers continuously in one direction we have an analogy for a direct current without resistance, induction, or capacity. We shall find that the rod may be started rotating and kept rotating with very little effort.

Under such conditions an electric current may be started at once and kept up with very little energy. If there were absolutely no resistance at X and no air friction the rod would keep up its rotation for ever after it had been once started. In the same way, if we could get an electric circuit of no resistance the current would flow for ever when once started. If we pinch the rod between the fingers we are introducing enormous friction and the rod stops; in the same way a current is stopped by the sudden introduction of enormous resistance by breaking the circuit.

### Resistance

Now replace the plain rod by one fitted with a light metal vane R (see Fig. 2). This vane will offer continuous air resistance during rotation. We may compare this vane with the resistance of an electrical circuit. The rod can be rotated as before, but a little more twisting force will be required, or rather the same force

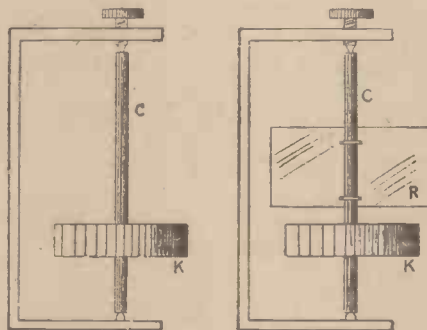

Fig. 3.—Circuit with Inductance.

Fig. 4.—Circuit with Resistance and Inductance.

will not rotate the rod as fast as before; in other words, the current is less when the resistance is greater, and the E.M.F. is constant.

### Inductance

For our third case we take a rod fitted with a heavy lead disc K (Fig. 3). Now this disc does not cause much air resistance owing to its solid shape, but it possesses considerable "inertia"—that is, it requires considerable force to set it in motion or to stop it when it is already in motion. This property of inertia is possessed by all bodies and depends on their weight and shape. It is well known that a machine or a flywheel requires considerable force to start it moving, yet when once going it is easy to keep it in motion. This mechanical inertia represents inductance or electric inertia in an electrical circuit, the effect of which is to oppose momentarily the starting or stopping of a current. In our apparatus we have an analogy for a circuit with inductance only.

On rotating we find it somewhat difficult to start, but when we get up speed, the rod, etc., will revolve with very little energy being applied to it. Now introduce great friction or resistance by suddenly grasping the rod with the hands; it will be found impossible to stop the rotation instantly, the rod will still revolve a little before coming to rest. This is comparable with the continuance of the current in a circuit containing inductance; the current flows on and will set up a momentary spark across the air gap at the switch.

Now let us apply a resistance vane R and the inductance disc K (Fig. 4). This combination will require a greater effort to set in rotation but a smaller one to stop it. This is because the action of the vane is always such as to prevent rotation. In our electric circuit possessing resistance and inductance the tendency of the current to keep on after breaking the circuit is less, the greater the resistance.

### Capacity

Now let us introduce "capacity." Take another steel rod as before, but in this case attach a helical steel spring S to the rod (Fig. 5). This spring is somewhat similar to the hair spring of a watch; the centre is attached to the rod, while the end is attached to the framework of the stand. A pointer P will be helpful in indicating the motion of the rod. If we apply twisting force (E.M.F.) to the top of the rod there will be rotation of the rod (current) until the untwisting force of the spring is equal to the twisting force applied to the rod. The amount of twist (charge) that can be given to the rod depends on the flexibility of the spring (capacity) and on the twisting force (charging E.M.F.)

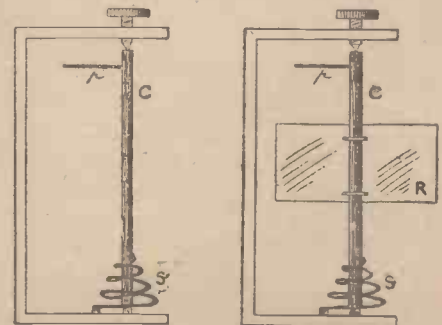

Fig. 5.—Circuit with Capacity.

Fig. 6.—Circuit with Capacity and Resistance.

applied. When the rod has been twisted as much as possible clamp the rod (insulate it) to prevent it moving. The apparatus now represents a charged condenser. Release the clamp and the rod will fly round, this indicating the discharge of the condenser. Now, although the apparatus

was charged by a steady direct pressure, when the condenser discharges it flies round a little past its normal point of rest, then returns, and returns too much, and thus makes a number of oscillations before coming to rest. This is exactly equivalent to the discharge of an actual condenser.

It should be noticed that with capacity the rod tends to return to its original position, whereas with inductance it tended to go on. In other words, induction and capacity are directly opposed to each other.

Now let us fit up the apparatus with resistance and capacity, as in Fig. 6. On twisting the rod (E.M.F.) it will require greater force to twist C at the same speed as before. When the rod is released it will take longer to return to its original position owing to the resistance offered by the air. This is equivalent to charging or discharging a condenser through a resistance. Now consider the case where we have inductance and capacity, as in Fig. 7. Apply the twisting force as before. Both the inductance and the capacity tend to resist the rotation. If after rotating the rod a little the twisting force be removed it will be noticed that the inductance tends

to rotate the rod still further, whereas the capacity is endeavouring to reverse the rotation and the rod will momentarily come to rest. At this instant the force with which S is tending to untwist will be at

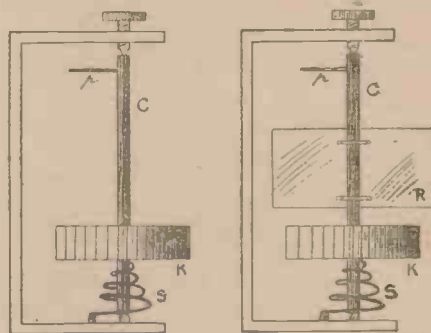

Fig 7.—Circuit with Inductance and Capacity.

Fig 8.—Circuit with Resistance, Inductance and Capacity.

a maximum, whilst the momentum of the lead disc will be zero, hence the rod will begin to rotate backwards. When it has reached its original position, S will have untwisted and its force will be nil, but the lead disc will be moving at a good

speed and will cause the rod to rotate beyond its normal position of rest, until finally it is stopped by the action of the spring. The rod will then start swinging back again. This oscillating motion would continue for ever if there were no resistance at the pivots and no air friction or friction in the spring. In practice, however, the rod will eventually be brought to rest. The above represents the discharge of a condenser with large inductance and small resistance, the condenser being alternately charged and discharged until the energy has been dissipated in heat, the several chargings and dischargings being the result of one initial charge.

Fig. 8 represents a circuit possessing capacity, inductance and resistance. On rotating the rod and then allowing it to untwist, the effect is similar to that of the previous case, except that the swinging is "damped"—that is, the oscillations rapidly decrease and soon cease. This is equivalent to discharging a condenser through a circuit possessing inductance and large resistance, and the greater the resistance the less the number of oscillations.

R. E. M.

## EVERYDAY CARE OF APPARATUS

MANY amateurs think that once they have installed an efficient receiving set there is nothing further for them to do except to listen to concerts. This is quite wrong, however, for in order that signal strength may be at a maximum periodical overhauls are necessary. Apart from considerations of efficiency in receiving concerts amateurs should remember that their licences are granted for experimental work. Many people just fix up a set to receive signals without attempting to understand the apparatus or trying to make improvements. It is the object of this article to point out the chief points that need attention.

### Care of the Aerial—

Let us begin at the beginning with the aerial, the most important point if we are to receive good signals. All joins in wire should have been soldered and so do not need much attention. See that the wire is free from all obstruction, such as overhanging trees. It is surprising how quickly young branches grow. The mast and spreaders, if any, should be examined for cracks and splits. The ropes may need renewing, and all pulley-blocks should run quite freely. These overhauls should take place at least every six months, otherwise you may find everything blown down in an unexpected storm. Another matter in this connection is that the insulators should be periodically cleaned.

### —and of the Earth

The earth may be considered next. Most beginners do not pay sufficient attention to this, which is often the source of a lot of trouble. The connection should be well soldered to a main water-pipe if possible. See that the wire has not corroded owing to the action of the damp. This is most important in the case of buried plates.

### Corrosion of Studs, etc.

If the tuner has tappings controlled by a switch, the contact studs should be cleaned frequently. They soon become dirty and therefore make bad contact. The windings should also be wiped, as dust will conduct high-frequency currents with consequent loss of signal strength. Variable condensers can be cleaned very well with an ordinary pipe-cleaner.

Valve legs and holders soon become coated with an oxide film, and should be carefully cleaned with emery-paper. Filament resistances should be adjusted so that the contact arm is not too loose, otherwise you may accidentally cut out too much resistance and burn out your valve, which is rather an expensive hobby at present.

### The Grid Leak

The grid leak is another troublesome piece of apparatus, as most of them are very unstable, chiefly owing to a temperature that is not by any means uniform. If possible, they should be tested with a

"megger" and replaced if the resistance has altered much. The grid condenser should not need any attention.

### Accumulators

Most amateurs complain that their accumulators give them a lot of trouble, but in many cases this is their own fault. Accumulators are very delicate things and will soon let you down unless they receive proper attention. They should never be run below the voltage marked on them, and must be recharged as soon as they are run down. Charge them at the rate indicated on them. The makers know what they are talking about in spite of what many people think to the contrary. If you are not using them they should be given a small charge at least every fortnight to keep them in good condition. The way some people look, or rather do not look, after their accumulators shows their appalling ignorance and thoughtlessness. They do not deserve to be successful in wireless.

### Telephones

If your 'phones are not of the adjustable-diaphragm type they may need new diaphragms after a lot of use. Remember that 'phones are also delicate, and do not throw them about like some people do.

In conclusion, if you forget to pay attention to your set try a little Couéism, saying, "I will only have clean contacts and good results."

D. S. R.



# WHY USE A DETECTOR?

**M**ANY amateurs are not clear as to the reason for employing a detector in a receiving set.

Oscillatory frequencies now generally employed vary between about 20,000 cycles per second and 2,400,000 cycles per second, which means that the wave-lengths vary between 15,000 metres and 125 metres. To

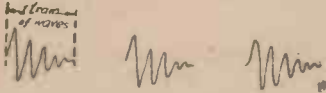

Fig. 1.—Diagrammatic Representation of Wave Trains.

use a smaller frequency or a larger wave-length the aerial system would have to be so large as to make it an impracticable proposition for it to be erected. This fact will be made more clear when one considers that the aerials erected on ships have a wave-length of only 600 metres.

The frequencies used in transmission are therefore high, and obviously the fre-

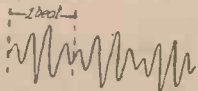

Fig. 2.—Diagram Explanatory of Beats.

quencies of the currents caused to oscillate in the receiving circuit are also high.

Now, because we desire to hear messages sent out by the transmitting station, we have to employ the current oscillating in the receiving circuit to actuate some device which in turn will produce air waves at a frequency sufficiently low for the human ear to be able to distinguish. The device employed is the telephone.

As is well known, all objects have their own natural frequency—that is, the frequency at which they vibrate most easily. Most telephone receivers have a natural frequency of about 800 cycles per second,

and the human ear prefers frequencies between 800 cycles and 3,000 cycles per second. Thus the oscillatory frequency of each wave received in the aerial, varying as before mentioned between 20,000 and 2,400,000 cycles per second, is much too high—firstly, to actuate the telephone diaphragm, and secondly, when causing air waves, for the human ear to distinguish.

A spark transmitter sends out series of damped trains of waves, and the continuous waves received from an arc or a valve transmitter are broken up by the receiving valve into series of trains of waves. Trains of waves from a spark transmitter, and also from a C.W. transmitter, are shown diagrammatically in Figs. 1 and 2 respectively. A small number of trains form dots and a larger number dashes. In the case of C.W., instead of "trains," we speak about "beats" (see Fig. 2).

Now, the train frequencies—that is, the frequency of each train instead of the frequency of each wave, which is at an oscillatory frequency—vary between 100 cycles and 1,000 cycles per second. If, therefore, we can make each train instead of each wave cause an attraction of the telephone diaphragm we shall produce air waves at an audible frequency. Two things are therefore necessary for an incoming signal to successfully actuate the telephones:

(1) The oscillatory current caused by the ether waves picked up by the aerial must be turned into a current flowing in one direction only.

(2) The amplitude of the telephone current must vary at audible frequency.

Both these things are accomplished by means of the detector.

A detector always has the property of allowing current to pass through it in one direction only. So that when an alternat-

ing electro-motive force is applied to a detector a current in either a positive direction only or in a negative direction only will pass through the detector and telephones. This effect is shown in Fig. 3, where the positive halves of the waves have passed through the detector and the negative halves have been eliminated.

Owing to the large number of turns of

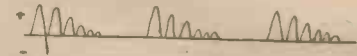

Fig. 3.—Diagram showing the Effect of Detector.

wire round the magnets, the telephones offer a great impedance to any oscillatory current. Because of this impedance there is not time for each pulse of rectified current to pass separately through the 'phones, but they are all stored up, as it were, until the end of each train, when they all pass through as one pulse, as there is always a comparatively large space of time between each train.

Thus with the aid of the detector we have pulses of current passing through the



Fig. 4.—The Resultant Effect of Half Waves.

coils of wire round the magnets, which pulses occur at a frequency of from 100 cycles to 1,000 cycles per second, these being low enough to cause the telephone diaphragm to vibrate at an audible frequency. C. R.

IN rewinding telephones for wireless use, a very good result can be obtained by fixing the spool in the spool-winder of a sewing machine. It is understood, of course, that the type of spool referred to is the new style, which is about 1/2 in. wide. With a little practice an instrument can be wound in twenty minutes or so.

## WHAT WIRELESS TERMS MEAN.—VII

Some Technical Words Explained as Correctly as Popular Language Allows

**FREQUENCY.**—The speed at which an oscillating current, such as used in wireless, changes its direction. The frequency is one of the factors which must be known in calculating wave lengths. Short waves have very high frequency and long waves a lower frequency, but in both cases the frequency of the changes of direction is in the neighbourhood of millions per second.

**DIELECTRIC.**—The material or substance occupying the space between the plates of a condenser such as air, oil, mica, ebonite, waxed paper, etc. One of the principal factors in determining the electrical value of a condenser. The dielectric strength of such substances is their

power to maintain the insulation between the plates and prevent the condenser breaking down.

**HIGH-TENSION BATTERY.**—A number of cells, usually of the dry type, connected in series to produce, say, from 30 to 100 volts. This voltage is applied to the plate of the valve by connecting the positive end to the plate and the negative to earth. The battery is made variable by tappings taken at various points so as to give different voltages depending upon the type of valve used. A very small amount of current is taken from this battery, and if properly made it will last a long time.

**EARTHING SWITCH.**—A double-pole change-over switch used for putting the aerial to earth in case of danger from lightning. It has six connections and an arm which may be swung over from one side to the other. The aerial and earth are connected to the two centre terminals, aerial to the left, earth to the right. The left-hand top terminal is connected to the aerial terminal of the set, and the right-hand terminal to the earth terminal. The bottom left-hand terminal of the switch is also joined to the right hand centre terminal. When the switch arm is up the aerial and earth are connected to the set, when down, the aerial is connected to earth.

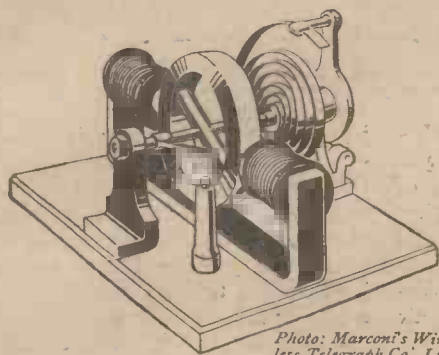

Photo: Marconi's Wireless Telegraph Co., Ltd.

Fig. 6.—Diagram of Automatic Transmitter.

# AUTOMATIC CALLING APPARATUS AND ITS USE IN WIRELESS

ITS NEED ABOARD SHIP :: HOW THE BROADCASTING  
PENDULUM RELAY TO CALL SUBSCRIBERS :: NO  
RELAYS FOR GIVING THE S.O.S. AT

SINCE the year 1914, as a result of the International Convention of Safety of Life at Sea, all foreign-bound ships of over 1,600 tons are compelled to carry wireless equipment and to maintain a more or less continuous watch day and night.

So far as the great ocean liners are concerned, the wireless traffic is always sufficiently heavy to keep their operators

busily engaged. Not only is there a large service of business and personal messages to be sent and received on behalf of the huge colony of passengers, but, in addition, the ether is continuously laden with signal energy containing the latest news from everywhere, calls from sister ships, weather reports, and many other items, which, since the introduction of wireless, have become a daily necessity to the

smooth running of life at sea in such ships.

In the case, however, of the smaller craft much of this routine work is quite unnecessary. Apart from "official" calls, the main object of many a weary hour spent with the 'phones is simply to ensure that no possible appeal of S.O.S. shall pass unheeded.

The above-mentioned regulations which originally laid down the minimum number of hours of continuous watching that must be kept by all such craft, even where the wireless staff is confined to one unfortunate W.T. operator, made the concession that "if an efficient automatic calling apparatus is invented" the continuous watch might be maintained by means of it.

The problem of devising an instrument, which on the receipt of any given code-call by wireless would automatically ring an alarm, or otherwise attract the attention of an operator "off duty," is, however, by no means an easy task.

The difficulty is increased at sea by the fact that the ship is subjected to constant movement and vibration. These factors are not present, however, to the same extent on

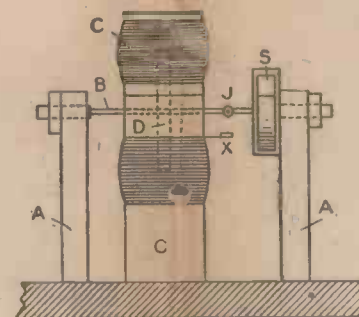

Fig. 1.—End View of Tuned Relay.

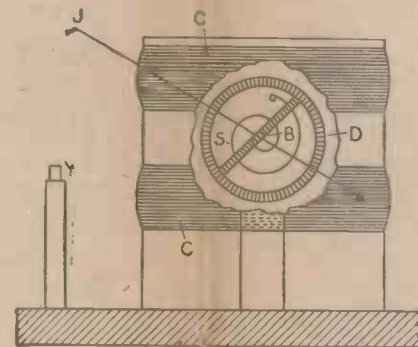

Fig. 2.—Side View of Tuned Relay with Part of Electro-magnet Broken Away.

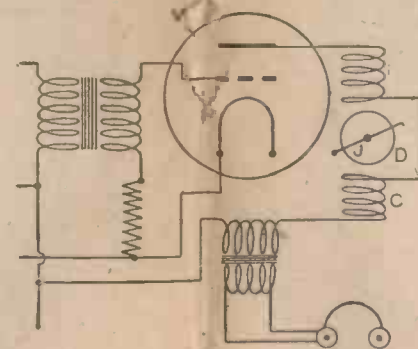

Fig. 4.—Circuit Diagram showing Connections of the Calling-up Apparatus.

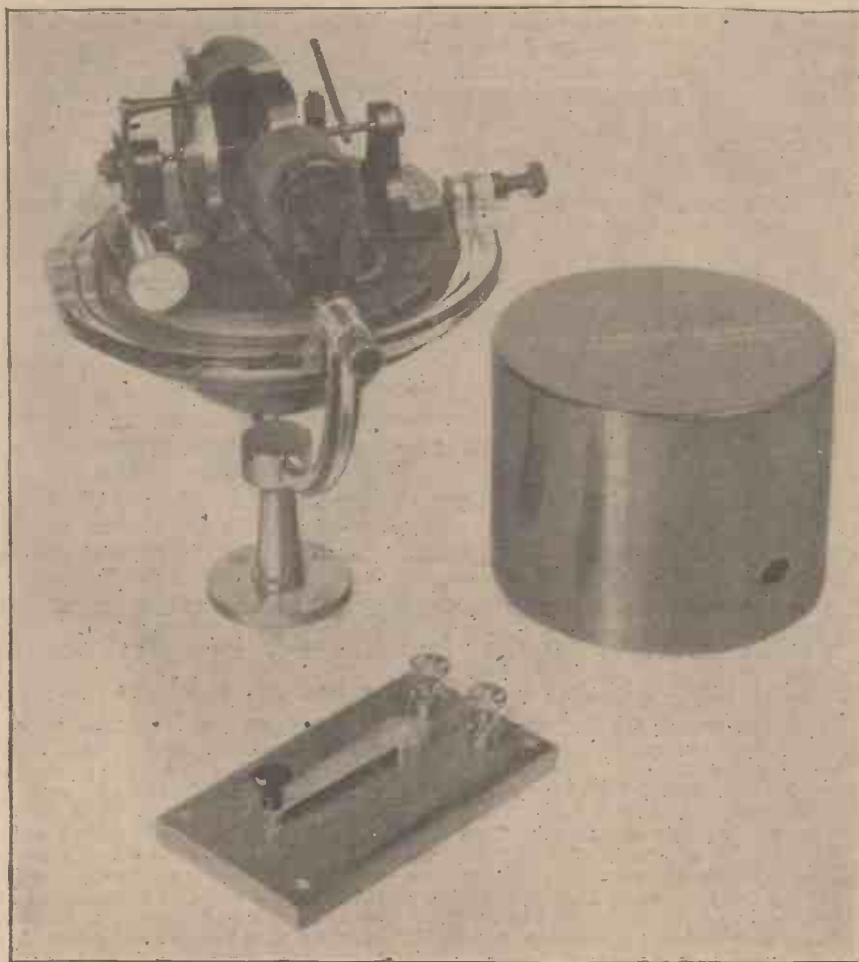

Photo: Marconi's Wireless Telegraph Co., Ltd.

Fig. 3.—Transmitter for Sending the Tuned Calling Signals.

# APPARATUS WIRELESS

## OPERATOR MIGHT USE THE PENDULUM TUNED CIRCUIT

a ground station, and the problem of automatically and audibly attracting a land subscriber's attention by means of a specified code call (for instance, before broadcasting) has been solved in several ways.

### Calling Up Before Broadcasting

One such method consists in fitting two or more suitably tuned relays to the receiving instrument. By arranging that the call shall consist of a series of, say, from six to ten "dots" followed by a series of from five to eight "dashes," it would be possible to close first one relay having a short period of vibration corresponding to the "dot" intervals, and then a second relay having a slightly longer period of corresponding to the "dash" intervals. The closing of the second relay then rings an alarm bell, or actuates some other signal which attracts the attention of the operator.

The form of relay used for this purpose consists of a light pendulum adapted to be swung to and fro, in synchronism with the dot interval, by means of an electro-magnet periodically energised by the transient rectified currents from the

detector. A series of ten properly spaced "dots" suffices to swing the first pendulum far enough to cause it to touch a second fixed contact, where it is held fast. The second series of impulses, consisting of "dashes," then acts similarly upon a second, slightly longer, pendulum.

When this, in turn, has been swung into permanent contact with a co-operating

fixed point, a local circuit containing an alarm bell is closed, and the bell continues to sound until the operator attends to the call.

### Difficulties

The main difficulty to be overcome in such an arrangement lies in making the



Photo: Marconi's Wireless Telegraph Co., Ltd.

Fig. 7.—The Local Relay which Permanently Closes the Alarm Circuit.

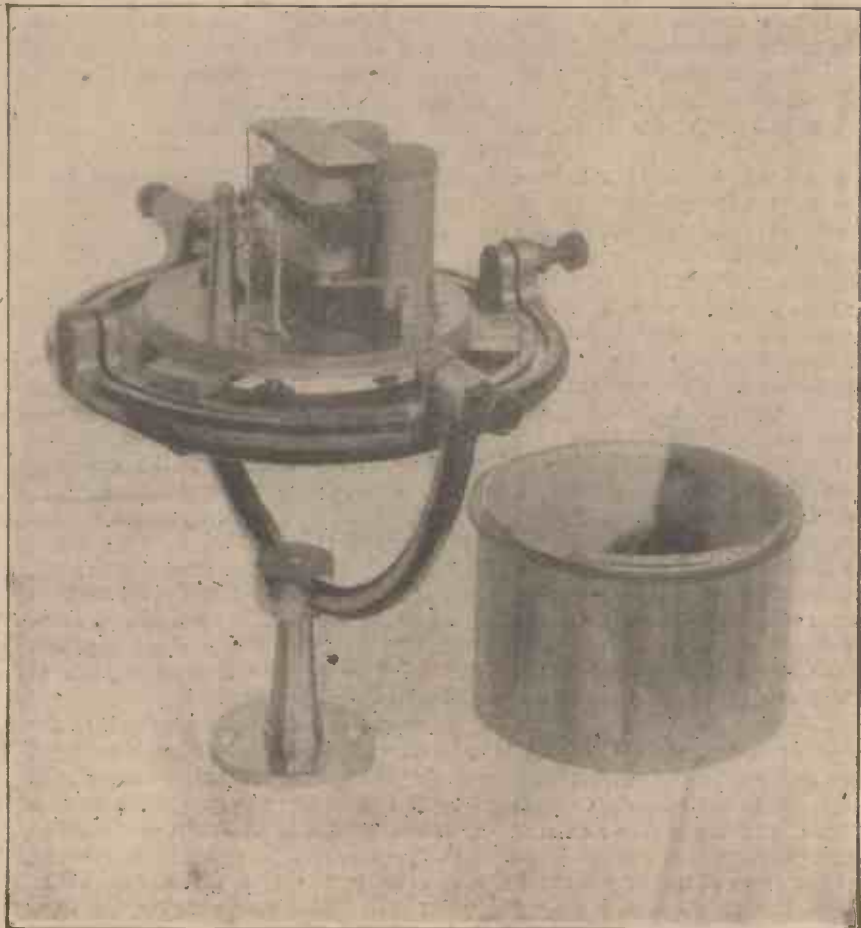

Photo: Marconi's Wireless Telegraph Co., Ltd.

Fig. 5.—The Receiving Relay whereby a Wireless Call is Automatically made Audible.

tuned relays sufficiently selective to respond only to the predetermined series of dots and dashes. If, for example, the first relay is not made sufficiently selective it will be apt to respond to all and sundry signals instead of to the specified code-call only. The pendulum must be very accurately tuned, and its associated electro-magnet so adjusted that the necessary contact is closed only when, for example, a series of six "dots" is followed by a series of five "dashes."

The second relay is normally out of circuit, so that it is unaffected by any signals until after the first relay has been closed. If, however, the second relay is also carefully adjusted so that it will only respond to the specified number of "dash" signals, the subscriber can rest assured that his calling-bell will only ring when the proper code sequence has been transmitted from the broadcasting station.

#### Calling-up Ships at Sea

The use of pendulum relays is, however, impossible at sea, as they are far too sensitive to the varying motion and constant vibration of the ship to function with sufficient accuracy.

In the Marconi automatic caller, as fitted to marine sets, the receiver is provided with a tuned relay of a particular kind. This is shown diagrammatically in end view in Fig. 1 and in side view in Fig. 2, a part of the electro-magnet being broken away in the latter figure in order to show the parts more clearly. A photograph of the actual apparatus is shown by Fig. 3.

Mounted on fixed bearings AA (see Fig. 1) is a spindle B carrying a vibrating ring D, which is controlled by spiral springs S so adjusted as to oscillate freely at a given frequency. The ring D, which is secured to the spindle by a radial bar, is permanently magnetised, so that the two poles are at opposite ends of a diameter. It is mounted inside an electro-magnet C.

A light finger, carrying a contact piece J, shown more clearly in Fig. 2, is also mounted on the spindle B, and vibrates to and fro when the ring D oscillates. A separate contact piece Y is adjustably fixed below the finger J.

As will be seen, the contact JY can only be closed when the ring has built up a sufficient amplitude, under the influence of the series of timed signals, as will enable it to swing the arm J down over the distance JY, which can be initially set to any desired value.

The energising coils of the electro-magnet C are inserted in the plate circuit of the last valve V of the receiving set, as shown in Fig. 4, and the spring and ring D are so arranged that when there is no plate current the poles of the ring D are at right angles to the position they occupy when fully attracted by the electro-magnet (that is, when the normal plate current is flowing through the coils).

The purpose of this is to avoid any strong signal from giving too violent an

initial swing to the ring, and so bridging the contact JY prematurely. When the valve filament is lit and the high-tension plugged in, the normal plate current flows through the magnet coils, and the magnetised ring is held against the pull of the spiral spring S, at right angles to its "resting" position.

#### The Effect of Signals

Every received signal results in a transient diminution of the plate current, and a corresponding slight swing of the ring takes place. It will be seen, therefore, that the utmost effect of the strongest "stray" or signal will be merely to stop down the plate current to zero. The time interval of such a "stray" will not be sufficient, however, to allow the magnetised ring to swing over far enough to make the contact JY. Before it can do so the plate current will be restored and the resulting field of the electro-magnet will drag the ring back to its "held" position.

For the same reason, any irregular succession of impulses representing the ordinary messages transmitted in Morse will not build up the amplitude of swing of the magnetised ring to any appreciable extent, certainly not sufficiently to bridge the contacts JY. Small swinging movements will occur; but as they are not timed to the natural frequency of swing, they ultimately damp out, just as a pendulum will not vibrate over a considerable arc under the influence of successive small taps unless these are administered in strict synchronism with its natural period of vibration.

Only a series of signal impulses strictly timed in accordance with the periodicity of the spiral spring will enable the balance wheel or ring to develop sufficient amplitude to close the calling contact.

#### Timing

In order to secure this strict timing a similarly tuned balance wheel is used at the transmitting end to send the signals. A photograph of the actual instrument, together with a diagram of its essential parts, is shown by Figs. 5 and 6. The balance wheel is first started into motion by operating the ordinary sending key a few times. Once it has started swinging, it maintains a constant rate, just as does the balance wheel of a watch, and automatically makes and breaks the key contact so as to transmit a short impulse at the end of each swing.

As each such signal is received at the receiving station it augments the swing of the ring D until the contacts JY are closed. The first momentary closing of these contacts energises a local circuit of the relay, Fig. 7, containing a holding magnet, which in turn closes the circuit of an alarm bell, which continues ringing until switched off by the operator who comes to attend to the call.

It may be mentioned that other calling devices of a more intricate nature have been devised.

D. ALCASE.

## CORRESPONDENCE

### Your First Valve Set

SIR,—I have received a number of inquiries relating to my article in "Amateur Wireless" of August 5. I shall be pleased to reply to specific questions provided they are confined to the article in question, but I am sorry I cannot undertake to answer general inquiries. Querists are requested to enclose a stamped addressed envelope. —Yours faithfully, H. H. DYER (22, Leopold Street, Derby).

### Can any Reader Explain?

SIR,—Your correspondent (G. B., Sacriston) appears to think that wireless waves are the manifestations of a different medium from that in which light is propagated. Not at all—wireless waves and light waves are propagated in the ether at the same rate, namely, 186,000 miles per second. The only difference is in the frequency and wave-lengths. Energy is radiated inversely as the fourth power of the wave-length, namely, the longer the wave the less is the radiated power. It may be asked then, why not always use short wave-lengths in wireless? The answer is, the shorter the wave-length the easier they are absorbed by any obstruction. In this case your correspondent takes an opaque (to light) jar, and in it places a tiny transmitter in the shape of an electric bell. The waves generated by this transmitter are comparatively long, and therefore penetrate very easily the walls of the container. On the other hand, light waves, which are only a few millionths of an inch in length, are very easily stopped by the opaque substance in the jar. If it were possible to ring the bell for a very long time your correspondent would find that a certain amount of other fairly long waves had been generated in the jar, which, although far shorter than the wireless waves generated, would cause a rise in temperature of the air in the jar. These waves we call heat waves, and he will find that the jar is by no means opaque to these heat waves, which are much longer than those of light, therefore the temperature of the jar itself would rise; in other words, these heat waves would be radiated off through the opaque jar. The reason that very long wave-lengths are used in transmission over long distances is because these long waves are able to pass through practically everything with the greatest of ease, and they are not actually reflected or refracted. When we say we see something we mean that by the process of evolution the eye of a human being has been adapted for the reception of a very small band of ether vibrations of a certain frequency and length; for all we know there may be other creatures on this earth who can see waves below this length, for instance, heat

(Continued on page 213, third column)

# RADIOGRAMS

NAUEN is at present being equipped with seven additional antennæ towers, each 210 metres high.

A wireless receiver set has been installed in Buckingham Palace.

The Paris police have found a wireless outfit among the apparatus of a group of burglars.

P.O. wireless experts have visited Bourne, Lincolnshire, with reference to the proposed great wireless station for direct communication with Australia. The aerials will be a mile long and half a mile broad.

New York City is to have its own broadcasting station, for which the sum of £10,000 has been allocated. The aerial is to be erected on the roof of the Municipal Building.

There are now 350 broadcasting stations in the United States.

Amundsen's expedition to Wrangel Island will take with it a wireless outfit capable of receiving messages within a radius of 2,000 miles.

The Postmaster-General for the present has declined to issue permits for the use of wireless receiving apparatus for public entertainments in cinemas, etc.

A pamphlet entitled "The Wireless Weather Manual: A Guide to the Reception and Interpretation of Weather Reports and Forecasts Distributed by Wireless Telegraphy in Great Britain," which has just been published by the Meteorological Office, is obtainable from H.M. Stationery Office, Imperial House, Kingsway, or through any bookseller.

The receiving station at Clifden, which had been in the hands of Irish rebels, was burned down by them recently. Within a few hours the work of Clifden was taken over by Ongar.

An enterprising fair proprietor has installed a wireless station among the booths and roundabouts, where the public can listen-in to wireless concerts at 6d. a time.

On Friday last the manufacturers of wireless broadcasting apparatus met at Marconi House to approve the formation of a single broadcasting company. It is now expected that there will be little delay before the inception of broadcasting.

At the annual meeting of Marconi's Wireless Telegraph Company on August 15 the shareholders were asked to sanction the payment of the final dividends of 5 per cent. on the preference shares, making 12 per cent., and 10 per cent. on the ordinary shares, making 15 per cent. for the year 1921. The dividend for the year 1920 was the same as that now proposed.

Three wireless exhibitions are to be held during the autumn, two of which will be housed at the Central Hall, Westminster. The third is arranged to take place at the Horticultural Hall.

There is to be a wireless exhibition in Paris from August 25 to October 2 of all kinds of wireless receiving apparatus and of processes of manufacture. Lectures on wireless telegraphy will be given by experts.

Direct wireless communication between France and New York was established the week before last from the great wireless station at Saint-Assise.

The conclusions reached by the Radio Research Sub-committee on Wireless Telephony may be summarised as follows:

Wireless telephony over long ranges is in a very elementary stage. Its establishment on a commercial basis within a measurable period is unlikely. For ranges of, say, 1,000 miles the committee thinks that, in certain remote localities, where there is little interference, wireless telephonic services might be set up. For a specific message over any distance—long or short—the wireless telephone is greatly inferior to the wireless telegraph in accuracy, speed, and cost and is likely to remain so. Articulation by wireless may, at its best, compare well with that over a trunk land line, but unusual words have to be repeated or spelled. For ranges of the order of 200 miles there is prospect of a wireless telephone system some day approaching requirements.

Wireless telephony is not recommended as a substitute for other means of telegraphic communication, except where there is no other economic way. For example, broadcasting of information (where one

costly transmitting station supplies many inexpensive receiving stations) seems a practical commercial problem, especially where land lines are lacking. Secrecy seems impracticable.

CORRESPONDENCE (continued from page 212)

waves, or waves above this length which we know as X-rays.

As to the fact that wireless waves apparently follow the contour of the earth, whereas light waves do not, your correspondent must remember that all these wireless waves are of enormous length as compared with light waves. Wave-lengths for far-distance transmission are always long; these are radiated out into space from the point of transmission and are reflected from the upper layer of the atmosphere; under favourable conditions they are reflected and reflected all the way round the earth.—H. D. C. (London).

[This correspondence is now closed.—ED.]

## Atmospherics

SIR,—For three days, August 6, 7 and 8, atmospherics were particularly strong, as doubtless many amateurs noticed. It will be remembered that wretched weather prevailed on these dates, and on the evening of the 7th atmospheric disturbance in my own set was at its worst. The maximum interference coincided with the arrival here (in Birmingham) of a thunderstorm which, after lasting about an hour, passed over in a northerly direction. At the same time the atmospherics began to decline, until on the following day they were practically normal. Subsequently I learned that the storm passed over the length of England, and occupied approximately the same period as that during which atmospherics were bad. Now, from this experience it appears that not only can the existence of a thunderstorm somewhere be registered by wireless, but also its magnitude, its location, and possibly the speed and direction in which it is travelling can be roughly determined by the varying intensity of the atmospheric disturbances. If that is so, there is obviously a new sphere for wireless in the realm of meteorology apart from the transmission of weather news in the ordinary way. What I would like to know—and perhaps some of your readers who have had experience in direction-finding can enlighten me—is this: Is it possible to determine, by means of a revolving frame aerial, the direction whence atmospherics are proceeding by reason of varying intensity at different angles? Presuming that it is so, it should not be impossible for two direction-finding stations working in conjunction to estimate with more or less precision the whereabouts of a thunderstorm? It is a likelihood well worth investigating, for anything that may be productive of further knowledge regarding atmospherics and the disturbances to which they are due will undoubtedly be valuable.—L. P. (Birmingham).

# OUR INFORMATION BUREAU

Expert Replies to Readers' Questions. Hundreds of Replies are sent by Post.

TO ENSURE A PROMPT REPLY PLEASE OBSERVE THE FOLLOWING RULES

Write distinctly, give all necessary details and keep to the point. Ask one Question at a time—never more than two. Send a Stamped and Addressed Envelope. Send the Coupon cut from page 216.

## Type of Aerial

**Q.**—Which is the best type and construction of aerial? Should the lead-in consist of high-tension cable?—C. B. (108)

**A.**—The inverted "L" type of aerial is probably the most efficient arrangement, especially for amateur use where the amount of wire is limited and ease of erection is an important consideration. A useful variation, however, where difficulties are experienced in the matter of the "down-lead" from an "L" type aerial, is the "T" aerial, in which the down-lead is taken from the exact centre of the aerial proper. Stranded 7-22 enamelled copper wire is recommended. The "down-lead" may consist of similar wire to the aerial, but the insulation at the lead-in point should be of the best, that is, ebonite, paxolin or glass tube, or, alternatively, rubber-covered wire taken through the window-frame. Your suggestions are duly noted.—CAPACITY.

## Resistance of Telephones

**Q.**—Please advise as to best resistance value of telephones for use with a 2-valve receiving set.—P. L. (104)

**A.**—A great deal depends upon the construction of the telephones apart from their actual resistance. High-resistance phones (that is, resistance from 1,000 to 8,000 ohms) should be placed directly in the anode circuit in case of a one- or two-valve special one-to-one transformer merely for the purpose of preventing the steady flow of an appreciable current through the phone windings even when no signals are being received, as the current not only strains the insulation of the windings, but tends to demagnetise the permanent magnets unless care is taken that the current flows in the correct direction. Low-resistance phones may usually be considered as more robust in the matter of the windings; they must, however, be used in conjunction with a step-down transformer, as the actual efficiency of any telephone receiver is, of course, a matter of "ampere-turns," and where the turns are comparatively few (as in phones of say 120 ohms resistance) the current flowing through those turns requires to be of as high a value as possible.—CAPACITY.

## CLUB DOINGS

### The Lowestoft and District Wireless Society

**Hon. Sec.**—L. W. BURCHAM "Gouzeacourt," Chestnut Avenue, Lowestoft.

A LECTURE dealing with sound ranging was recently given. This lecture proved very interesting and showed how British science played a great part in winning the war. Another interesting evening was also spent on a discussion on short-wave reception and the efficiency of the Reinartz tuner.

### North Middlesex Wireless Club

**Hon. Sec.**—E. M. SAVAGE, "Nithsdale," Eversley Park Road, Winchmore Hill, N.21. THE 93rd meeting of the club was held at Shaftesbury Hall, Bowes Park, on July 12th. A special instruction class for beginners was held from 7.30 p.m. to 8.30 p.m. Mr. Holton then read some interesting correspond-

ence on "Atmospherics." Mr. Holton explained the nature of lighting, as far as it is understood, and showed how a lighting arrester works. Mr. Wordham also contributed to the discussion, and explained how he had endeavoured, with considerable success, to screen his aerial from interference from high-tension overhead wires.

### Stoke-on-Trent Wireless and Experimental Society

**Hon. Sec.**—F. T. JONES, 360, Cobridge Road, Hanley, Stoke-on-Trent.

AT a meeting of the Stoke-on-Trent Wireless and Experimental Society on July 27th, it was unanimously decided to change their headquarters to the new Y.M.C.A. building in Marsh Street, Hanley, as since the wireless exhibition held under the auspices of the society a few months ago the membership has nearly trebled. It was also decided to send a delegate to the conference of the Midland Wireless Societies to be held about the end of August, to arrange the interchange of lecturers. Mr. W. J. Forster read a paper on "Electrical Measuring Instruments."

After first elucidating some of the more common electrical terms, the lecturer explained the working principles and construction of various types of ammeters, voltmeters, wattmeters, and energy meters as used in modern power station practice and by consumers. He clearly pointed out the difference between pressure measuring instruments and current measuring instruments. Some actual instruments were available, the insides of which the members were able to inspect for themselves. In the subsequent discussion, the importance of measuring instruments in wireless work was emphasised.

### Wakefield and District Wireless Society

**Hon. Sec.**—MR. ED. SWALE, II, Thornes Road, Wakefield.

A MEETING of the above was held at 8.0 p.m. on July 21st, when Mr. Burbury, Jr., dealt with "The Formation of a Valve Receiver" in a clear and concise manner, with blackboard illustrations. Applications for membership, are invited.

### Newcastle and District Amateur Wireless Association

**Hon. Sec.**—COLIN BAIN, 51, Grainger Street, Newcastle-on-Tyne.

A GENERAL meeting of the above Association was held at headquarters on July 24th, when Mr. Dixon gave a lecture upon wave lengths and wave meters in general. After dealing with the advantages obtained by using a wave meter, Mr. Dixon went on to describe the Park wave meter. He explained in detail the method of using this instrument to tune the receiving set preparatory to receiving another transmitting station. He then went on to describe the honeycomb inductances contained in the meter which he stated were effective to 8,000 metres, dealing at the same time with the combinations possible with parallel fixed condensers. With the aid of diagrams Mr. Dixon explained in a most interesting manner the method of calibrating external inductances by cutting out the

internal inductances, and of calibrating condensers by comparison with the standard condenser contained in the wavemeter.

He then went on to deal with the static-potentiometer method. He demonstrated how different capacity condensers effected the position of the tapping and observed that "he had obtained very satisfactory results on wave lengths as high as 25,000 metres.

After further explanation of the large-capacity grid condenser and the low-resistance grid leak to prevent howling, the method of using the meter as a separate heterodyne was put forward.

The members were then informed of the case of the local amateur who was using a valve receiving set without the P.M.G. Licence. Owing to his instrument howling incessantly he was located from the Berwick and Stockton-on-Tees direction-finding stations.

### North Middlesex Wireless Club

**Hon. Sec.**—E. M. SAVAGE, "Nithsdale," Eversley Park Road, Winchmore Hill, N.21.

THE 96th meeting of the club was held on July 26th in Shaftesbury Hall, Bowes Park. The chair was taken at 3.30 p.m. by Mr. G. Evans, who introduced Mr. Haynes, who had kindly consented to lecture on the "Johnson-Ralibek Loud Speaker."

Mr. Haynes had brought to the hall the instrument which formed the subject of his lecture, and this was on view during the evening. He described the action of the instrument, and illustrated his remarks by diagrams drawn on the blackboard. He also explained the construction, more particularly with regard to the agate cylinder which forms an essential part of the instrument, and drew the attention of the audience to the importance of obtaining even electrical contact between the agate cylinder and the steel spindle on which it is fixed.

The instrument was then set in operation, and a demonstration given on its capabilities. The principle on which it works is most interesting, quite apart from its possible commercial application, and it was evident from the questions put to Mr. Haynes at the close of his lecture that several members had already decided to experiment in the same direction.

### The Bristol and District Wireless Association

**THE Hon. Sec.** of the above society is now MR. L. F. WHITE, 10, Priory Road, Knowle, Bristol.

### The Fulham and Putney Radio Society

**Hon. Sec.**—J. WRIGHT DEWHURST, 52, North End Road, West Kensington, London, W.14. THE monthly meeting of the above society was held at their temporary quarters, 232, Putney Bridge Road, on August 3rd. The attendance was well represented and several new members were enrolled. Amongst other business it was proposed that the society become affiliated to the Wireless Society of London as soon as the question of suitable accommodation was settled. At the next meeting it is hoped to have a three-valve set loaned by Mr. Houstoun working, and to receive some amateur transmissions.

## COMPONENTS FOR WIRELESS SETS BY RETURN

ALL GOODS BRITISH MADE

**AMATEURS note our PRICES**

Contact Studs, 1" x 1" ...	11d per doz.	Valve Holders ...	1/3 each
Spacer Washers (large) ...	3d .. ..	Egg Insulators ...	6d ..
Spacer Washers (small) ...	3d .. ..	Fusible Alloy (for mounting	
Valve Sockets ...	3d each	Crystals) ...	6d bar

Aerial Wire, Condenser Segments, etc. etc., at equally low prices.

Carriage FREE on lots of 10/- and over.

To Wireless Clubs and Societies :

We are prepared to give you special terms. Get your Secretary to write us.

To the Trade :

Best Trade Discounts and prompt deliveries. (Free advice by our Expert staff.)

**L. WITHERS GREEN,**

110, VICTORIA ST., WESTMINSTER, S.W.1. [PHONE: Victoria 2053]

The very latest Book about Wireless!

## RADIO FOR AMATEURS

By A. HYATT VERRILL.

With 200 illustrations, 7/6.

An up-to-date, concise, simply written book, covering every phase of radio communications; the whys and wherefores, the various instruments, their functions, operations, construction, and their cost.

It will tell you everything you want to know.

HEINEMANN.

LONDON.

## ROBERT WRIGHT & CO.,

ELECTRICAL ENGINEERS,

34 and 36, Oxford Street, W.1.

Phone Museum 5134.

MANUFACTURERS OF R.W. WIRELESS APPARATUS AND ACCESSORIES.

### THE R.W. SINGLE-VALVE RECEIVING PANEL,

complete with condensers, filament, rheostat, etc., mounted on ebonite and enclosed in polished mahogany case ... £3 3s.

### THE R.W. SINGLE-VALVE RECEIVING SET,

complete from aerial to earth, including above panel, together with aerial, H.T. and L.T. batteries, valve, head phones, coil holder, and 4 concert coils and all necessary gear for a complete receiving station ... £11.

CATALOGUE ON REQUEST. WORKS—CRICKLEWOOD

## EBONITE!!! SHEET 1/4 in. 4/-, 1/2 in. 6/6, 3/4 in. 10/- ANY SIZE CUT.

IMMEDIATE DELIVERY. Enclose ample postage. Balance returned in full.

PHONES (150 ohms). A Great Bargain, complete with cords, 22/6 pair, post gd.  
CRYSTAL RECEIVER. Comprising first-class sliding inductance, detector, blocking condenser and terminals on polished base, complete, 32/6, post 1/-.  
TELEPHONE TRANSFORMERS, 15/- each. In polished box with terminals, 20/-, post 6d.  
REEL INSULATORS (Porcelain), 2 in. diam. 4d. each. [post 6d.  
AERIAL WIRE. 7/22 enamelled, A1 quality, 150 ft. 10/-, 100 ft. 7/6, post 1/- and 9d.

**A COMPLETE SET for £3 16 6**

As a Special Advertising Offer we will forward, carriage paid, 1 pair Headphones, Crystal Receiver, 100 ft. 7/22 Aerial Wire, 4 Reel Insulators, and 1 Telephone Transformer, all as advertised above, for £3 16 6.

Don't think this too good to be true. The Price is Low, but Quality is A1.

ALL ABOVE GOODS IN STOCK. NO WAITING!

Houghton's Wireless & Electrical Supplies  
HIGH STREET, BLACKWOOD, MON.

## NOTICE

MESSRS. S. G. BROWN, Ltd., HEREBY GIVE NOTICE that the only Telephones of their make acquired from the Disposal Board which have been RE-CONDITIONED by them and are GUARANTEED are those advertised by Messrs. L. McMichael, Ltd.

The "Brown" Telephones advertised as "New and unused," at prices below their list quotations, are of an obsolete type which is not fitted with the all-aluminium diaphragm. They were supplied to the British Government during the war. They have not been re-conditioned by S. G. Brown, Ltd.

Please note that all "Brown" Telephones are numbered and bear an index letter to indicate the year of manufacture. The numbering of the "A" Type Telephones began a year ago at E 27,000, so that all "A" Type Telephones bearing higher numbers than this have been manufactured during the last year. Hence buyers of "Brown" "A" Type Telephones are afforded here an indication of the date of an instrument's manufacture.

## S. G. BROWN, LTD.

Works:

VICTORIA ROAD, NORTH ACTON, LONDON, W.3

London Showrooms: 19, Mortimer Street, London, W.1

Telephone: Museum 4950

Wireless is attracting all men. The Amateur is entering the field in great numbers, and he wants to know all about it. He will require Materials, Parts, Tools. He will also want to sell surplus material.

## "AMATEUR WIRELESS"

is out to cater for this class of reader, who will be eager for knowledge and bargains. To meet him, use the Sale and Exchange columns, which he is sure to search. Rate 3d. per word, 3s. minimum, prepaid. Latest date Saturday mornings.

Address:

The Advertisement Manager,  
"Amateur Wireless,"  
La Belle Sauvage,  
Ludgate Hill, London, E.C.4.

## DAVIS & TIMMINS LIMITED

34a, York Road, King's Cross, N.1

## SCREWS AND TERMINALS FOR WIRELESS SETS

# WHY WORRY?

Call Here and Save  
10/- in the £1

Please Note: All postage extra

Aluminium Condenser Vanes, accurate to gauge. Fixed and moving, 1d. each; 1 doz. 9d.; 4 doz. 2/8; 6 doz. 4/3; 12 doz. 8/-; per gross pairs, 14/-

Large Spacer Washers, 5d. doz.; 6 doz. 2/4; 12 doz. 4/-

Small Spacer Washers, 3d. doz.; 6 doz. 14/-; 12 doz. 2/6.

Sets of Rods, 1 square 3 round, screwed 2 BA, complete with nuts and washers '0015, 1/8 set; '001, 1/3 set; '00075, '0003, '0002, 1/- set; '0001 and '00005, 10d. set

Knobs for Square Centre Spindle, drilled 2 BA, 4d. (extra quality 6d.)

Ebonite Slider and Brass Plunger, large size, extra quality, complete with 1/4 brass rod 13 in. length 9d. (postage 9d.)

Contact Studs 1/4 x 1/4 complete with nut and washer, 5 BA, 9d. doz.; 3 doz. 2/-; 6 doz. 3/9; 12 doz. 7/-

Filament Resistances, worth 5/-. My price 3/8.

Switch Arms, complete with knob, collar, spring nuts, etc., 1/-; extra quality 1/8.

Ebonite up to 1/4 in. 4/6 lb. Cut to any size. Parts to make your own Crystal Detector (including ebonite base), 2/3:

Headphones, 4,000 ohms, complete with cords, good quality, 22/6, 25/- 30/-; best French make; every pair tested and guaranteed.

Inductance Coils, wound No. 24 enamel wire, shellac varnished, 12 x 4, each 3/6 (post 1/-).

Screwed 2 BA Rod, 4d. foot; nuts, 3/- gross.

Valve Legs, complete with 2 nuts and washer, best quality; 4 for 5d.; 1/1 doz.: 13/- gross.

Ebonite Valve Holders, with 4 screwed legs, 1/-

Crystal Cups, 2 screws, 2d. each; 1/6 doz.

Aerial Wire, we have hundreds of hanks to clear, 7/22 stranded copper, 100 feet, 3/6 (post 1/-).

Lovely Termina's, large size, complete with nuts and washers, 3d. each; 2/6 doz.

Terminals, 4 BA with nut and washer, 2d. each; 1/6 doz.; 16/6 gross.

Centre or side spindles, bushes, etc., made while you wait, to suit your own requirements.

TRADE SUPPLIED.

**M. RAYMOND,**  
27, LISLE STREET, W.C.2.

Right Opposite Daly's Gallery Door,

To avoid mistakes, this address is close to Charing X Road and Leicester Square Tube.

## FORTHCOMING EVENTS

Stoke-on-Trent Wireless and Experimental Society. Aug. 17. Meeting.

Tuxford and District Amateur Wireless Society. Aug. 17. Morse practise. Lecture: "Elementary Principles of Wireless Telegraphy." Aug. 24. Morse practise. Lecture: "Elementary Theory of the Valve." Hints on apparatus, &c.

Paddington Wireless and Scientific Society. Aug. 24. Field day.

Ilford and District Radio Society. Aug. 24. Lecture by Mr. E. E. Hale: "Short-Wave Reception—with Special Reference to Damped Waves."

## TELEPHONY TRANSMISSIONS

The Hague, Holland (P C G G), 1,085 metres. Aug. 17, 8 to 9 p.m.; Aug. 20, 2.30 to 5 p.m.; Aug. 24, 8 to 9 p.m.

Writtle (2 M T), 400 metres. Aug. 22, 8 p.m.  
Eiffel Tower (F L), 2,600 metres. Each afternoon (Saturdays and Sundays excepted).

## ANNOUNCEMENTS

"Amateur Wireless and Electrics." Edited by Bernard E. Jones. Price Threepence. Published on Thursdays and bearing the date of Saturday immediately following. It will be sent post free to any part of the world—3 months, 4s. 6d.; 6 months, 8s. 9d.; 12 months, 17s. 6d. Postal Orders, Post Office Orders, or Cheques should be made payable to the Proprietors, Cassell & Co. Ltd.

General Correspondence is to be brief and written on one side of the paper only. All sketches and drawings to be on separate sheets.

Contributions are always welcome, will be promptly considered, and if used will be paid for.

Communications should be addressed, according to their nature, to The Editor, The Advertisement Manager or The Publisher; "Amateur Wireless," La Belle Sauvage, London, E.C.4.



Querist's Coupon Available until Saturday, August 26, 1922

## HELLO! HELLO!! HELLO!!!

We can supply all Wireless Sets or Parts from Stock at the Right Price. Finest Quality Only. No Rubbish

Call or write for Price List (Stamp):

**PARK RADIO SUPPLIES CO.**  
10 Station Road, Finsbury Park, N.4

## HIGH GRADE VARIABLE CONDENSERS

'0005 mfd. for Panel Mounting...	10/6
Ditto, mounted in Mahogany Cabinet	16/6
Filament Resistances	4/-
Valve Holders	1/6
Headphones, 4,000 ohms	30/-
Grid Condenser and Leak in Mahogany Cabinet	7/6

All Carriage Paid

WEATHERALL & Co., Estab. over 25 years.  
28, Woodbridge Street, Clerkenwell, London, E.C.1

Copper Foil, .001 and .002, 4 in. wide...	4d. foot
Condensers	2/6 each
Detectors, mounted on ebonite, with solid gold spring	4/6
Aerial Wire, 18 gauge, Silicon Bronze	2/- 100 ft.
Crystal Set, mounted on polished base, with Detector and Condenser as above, size of tuner coil 12 in. by 4 in.	45/- each.

All Parts Stocked and Guaranteed.

**SELHURST WIRELESS STORES,**  
21, Selhurst Road, Selhurst.

## "PALMERFONES"



These super-sensitive Head Phones are the result of many years' experience, and over 30,000 of these have been purchased during the last four months, and repeat orders are being given which prove their excellent value.

### DELIVERY FROM STOCK

Every set is thoroughly tested, and all are guaranteed in perfect condition, readily adjusted to any position. Very light and comfortable. Standard resistance 4,000 ohms. Each complete with double head gear, with connecting cord, 29/6, cash over counter; 29/6, price by post. We also supply 120 ohm, 2,000, 5,000 and 8,000 Head Phones.

Aerial Wire, 100 ft. 7/22, with 2 Insulators	4/6
Wireless Masks, in 4 sections	4/6 each
Federal Loud Speakers	65/-
Brown Loud Speaker	110/-
Dictograph Radio Head Phone 3,000 ohms	35/-
Magnavox Loud Speaker Junior type	110/-
Magnavox Loud Speaker Senior type	£20
2 Valve power Amplifier, complete with valves, but less batteries	£22 10s.
3 Valve power Amplifier, complete with valves, but less batteries	£24
Lightning Arresters	2/- each
Leading in Tube, 6 inches long	2/-
Crystal Auto coupled Tuner complete	£1 18s.
Crystal Tuner Double Slide Auto Coupled Complete	£2 13 6
Valve Legs with nuts and washer	3d.
Valve Pin	2d.
Switch Arms	2/6
Ebonite Valve Holders, 4 legs	1/-
Contact Studs, per dozen	8d.
Ebonite Slider and Plunger	8d.
Aluminium Condenser Fixed and Moving Vanes, per dozen pair	2/-
Condenser Spacer Washers, large and small, per dozen pairs	1/3
Condensers Complete	4/6
Crystal Cups, small and large	2d. & 6d.
Ebonite knobs 1 1/2 in. dia. knurled edges tapped 2 B.A.	6d.
Terminals Complete Small and medium sizes per dozen	1/8
" " Large " " "	2/-
Crystal Detector	5/6
Square Brass centre rods for Condenser	6d.
2 B.A. Brass Screwed Rods 12 in. lengths	5d.
Ivory Scales	6d.
Aerial Earth and Phone Labels	3d.
Insulators, large shell type	8d.
Insulators, Porcelain, small egg shape	4d.
" " 2 in. reel type	3d.
Square Brass Rod in 13 in. lengths	5d.
Brass Nuts, 2 B.A., 3 B.A., and 4 B.A., per doz.	4d.
Inductance Tube	5/-

Case Refunded if Not Satisfied.

## GEORGE PALMER,

Wireless and Sound Transmission Specialist,  
47, Gerrard Street, London, W.1. Phone: Regent 1475.

## ELECTRADIX RADIOS.

IMMEDIATE DELIVERY FROM OUR HUGE STOCKS

Everything from a Recorder to an Earth Clip.

The best equipped City depot.

COME AND SEE US

9, COLONIAL AVENUE is first opening on left in the Minories, nr. Aldgate Station, Metropolitan Railway.

**LESLIE DIXON & CO.** Tel: 49 Avenue 4566.  
9, COLONIAL AVENUE, MINORIES, E.1





# EXPERIENCE

**DISTORTIONLESS AUDIO FREQUENCY INTERVALVE TRANSFORMER**

Designed and built on scientific lines.

**25/-**

Telephone Transformer, 20s.

**WINDING AND INSULATION** is by a patented process turn being specially insulated from adjacent turns as well as between layers. Tested at 1,000 volts.

**DIMENSIONS** are reduced to the smallest limit consistent with absolute reliability: 3 1/2 in. wide, 2 1/4 in. over feet, 3 3/8 in. deep. The unusually heavy wire eliminates a common weakness in other designs where efficiency and reliability are sacrificed to space.

**CONSTRUCTION** is on exactly similar lines to power transformers. The closed core is built up from best quality Stallöy iron laminae.

**IMMUNITY FROM BREAKDOWN** is assured by scientific design and careful construction coupled with high insulation, large gauge wire, and efficient dimensions. Comparative tests confirm the superiority of our designs.

ORDER AT ONCE TO SECURE IMMEDIATE DELIVERY.

**TELEPHONE TRANSFORMERS** at 20s. each. Why pay more for imported articles of less efficiency? Get wireless equipment of latest improved designs made by British radio engineers of established reputation.

**OTHER PRODUCTS** include Short Wave Anode Reactances, Efficient Tuning Inductances, Precision Air Condensers, H.F. Transformers and all wireless components. Every article is manufactured at our own works under the direct supervision of the directors.

## RADIO INSTRUMENTS, LTD.,

**ONLY ADDRESS.**  
 Managing Director, **J. JOSEPH, M.I.E.E.**  
 Works, Offices, Showrooms: **12a, Hyde-Street, NEW OXFORD STREET, W.C.1.**  
 Chief Designer, **W. A. APPLETON, M.B.E., M.I.E.E.,** late Admiralty Technical Research Officer.  
 Telephone: Regent 1908. Telegrams: Instradio, London. [E.P.S. 2]

# BUILD YOUR OWN CONDENSERS

## NOTE REDUCED PRICES

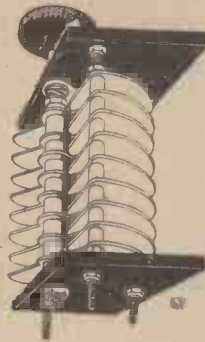

SETS OF PARTS				
Approx. Capacity in Microfarads.	No. of Plates	Ready to assemble for Panel Mounting. Add 1/- each size for Cabinet Mounting.	Price as assembled for Panel Mounting. Add 6d. if required for Cabinet Mounting.	Complete in Polished Mahogany Cabinet ready for use.
.0015	85	24/-	27/-	35/-
.001	57	18/-	21/-	27/6
.00075	43	14/-	17/-	22/6
.0005	29	11/-	13/8	18/6
.0003	19	8/-	11/8	16/6
.0002	13	7/-	9/-	14/-
.0001	7	6/-	8/-	12/8
.00005	3	—	4/8	9/6

(Prices are for parts with Ivorine Scale and Pointer. Bevelled Dial, 3/6 extra.)

Illustration shows for Panel Mounting

**THIS WEEK'S SPECIAL OFFER (DELIVERY FROM STOCK)**  
**FRENCH HEAD-PHONES, 4,000 ohms ... 35/-**

**CRYSTAL DETECTOR**  
 (as illustrated). Ready for use with crystal.  
**Price 4/6**



SEND FOR ILLUSTRATED CATALOGUE (A) with list of stations. Crumbed full of the latest and best.



**THE CONDENSER KING**

**DON'T FORGET THE NEW ADDRESS:—**

Featherstone House, 64, High Holborn, London, W.C.1.

Still at 17, Frome Rd., Wood Green.

**TELEPHONE DOUBLE HEAD SETS.** Suitable for Crystal or Valve  
 2,000 Ohms, 32/6; 4,000 Ohms, 34/6. In stock.

MAKE up your own receiving sets. Our price for complete set of parts £1 1s. carriage paid, comprising wound inductance with ebonite panel drilled for 20 studs, necessary studs, ebonite knobs, etc., crystal detector, terminals, wire for connecting. (No extras to buy; nothing to make.)  
 Stamp for List.

**P. H. BOYS & CO., 187, Goswell Rd., London, E.C.1**

## SCIENTIFIC APPLIANCES DALE & HOLLINS.

**All Wireless Radio Parts & Electrical Material**

See full advertisement—last week and next week.  
 Come to look at our show all the week and you will come in to Buy. Ask for List.  
 In Centre of London, top of Kingsway.  
**11 & 29, SICILIAN AVENUE, SOUTHAMPTON ROW, W.C.2.**

## WE PUBLISH PRIZE WINNERS, Issue 29th July, 1922

Question: "Why was Sol annoyed" (Solenoid).  
 One of our Single Valve Panels has been sent to:  
**MR. C. C. JUDSON,**

The White Cottage, Carlton Road, Weymouth,

for the following:

"Because he (a Jew) was placed next to the (H)Ammeter."

Aerial Wire, 7/22's Enamelled Hard Drawn Copper, 6'-

per 100 ft.

Aerial Pulleys, 2 1/2 in., 1/-, 5 in. with tackle hook and

bicket, 2/6.

Aerial Insulators, Shell type, 2 1/2 in. x 2 1/2 in., 1/6 each.

Reel type, 2 in. diam., white, 4d. each.

"Batteries." For H.T. Make your own. Flash Lamp

Batteries, 5/- doz.

Buzzers for Morse practice, new improved line, best

quality, 4/6.

Condenser Discs, Ebonite, 3 1/2 in. diam., 1/- each.

Condenser Dials, engraved fine finish 2 1/2 in. dia., 1/9 each.

Condensers. Fixed. Exceptional quality. Made with

copper foil: from .0002 to .001, 2/6 each.

Condenser Vanes. Not rubbish. Best strong Aluminium.

Fixed 3 1/2 in., Moving 2 1/2 in., 1/- doz.

Condenser Spacing Washers. Remember they must be

accurate. Small, 4d. doz.; large, 6d. doz.

Condenser Screwed Rod. Brass, 12 in. lengths, 2 B.A.,

9d. each, 4 B.A. 6d. each, 2 B.A. and 4 B.A. nuts 7d. doz.

2 B.A. or 4 B.A. washers 2d. doz.

Contact Studs. Studs, not rubbish, 1/8 doz.

Copper Foil Sheets. 9 in. x 3 in., 4d. each.

Core Wire, soft iron, 2/4 per lb.

Ebonite. Best quality. Any size, rod or sheet, 5/- per lb.

Filament Resistances. For panel mounting, with knob

pointer and good contact. A speciality. 4/- each.

**HEAD RECEIVERS.** Light, sensitive, of good design and

superior finish. Tested and guaranteed perfect. Complete

with cords. 140 ohms 30/- each, 4,000 ohms 32/-

each, 8,000 ohms 33/- each. Postage 9d. each. Illustrated

pamphlet, 3d. each.

**Inductance Tubes.** 12 in. long. Specially impregnated.

2 1/2 in., 4d.; 3 in., 7d.; 3 1/2 in., 8d.; 4 in., 10d.; 4 1/2 in.,

1/-; 5 in., 1/2; 6 in., 1/6 each. Postage od. each.

**Inductance Slider Rod.** 1/2 in. square in 13 in. lengths,

Not jagged but smooth. 6d. each.

**Insulating Tubing,** 6d. per yard.

**Ivorine Scales.** 0 to 1800. Engraved (not printed), 1/2

each.

**Ivorine Tablets.** Set of 6, 9d.

**Knobs.** Ebonite. 1 1/2 in. diameter. Superior finish.

Knurled, 7d. each.

**LOUD SPEAKERS.** Exceptionally efficient. 70 ohm, 2,000

ohm, 4,000 ohms. £2 10s. each.

**Mica.** Pure Ruby. Pieces, 3 in. x 3 in. x .002 in. thick,

6d. each.

**Paraffin Wax,** 1/- per lb.

**Resistances Wires.** "Elsi" brand. 22's (1 ohm per

yard), 24's (1 1/2 ohms per yard), and 28's, enamelled

(4 ohms per yard), 2d. per yard.

**Switch Arms.** Exceptionally strong and well made, 2/6

each.

**Terminals.** A very neat wireless terminal. Polished,

complete with nut and washer, 2/6 dozen.

**Tin Foil.** Free from lead. Sheets, 26 in. by 13 in., 4d. each.

**Valve Sockets.** With nut and washer. Fine finish, set

of four, 9d.

**Valve Holders.** Best quality ebonite, with nuts, 1/4 each.

**Valves.** 4-pin vertical filament, 10/6 each.

**Wood's Metal,** 8d. per packet.

**Crystals.** Carborundum, galena, bornite, copper pyrites,

silicon, iron pyrites, manganese, 8d. per packet.

### SUPERIOR QUALITY WIRE. British Made.

All wire wound free. Post extra.

S.W.G.	S.C.C.	D.C.C.	Single Silk	D. Silk	Enamelled
12	1/10	1/11	4/-	5/4	1/8
14	1/11	2/-	4/-	5/4	1/9
16	2/-	2/1	4/2	5/6	1/10
18	2/1	2/2	4/4	5/6	1/11
20	2/2	2/3	4/8	6/2	2/6
22	2/6	2/11	5/-	6/8	2/8
24	3/-	3/6	5/6	7/4	2/8
26	3/7	4/1	6/8	8/2	3/2
28	4/4	4/7	7/2	9/-	3/6
30	5/-	5/6	8/-	10/-	3/10
32	6/-	7/3	9/2	13/-	4/2
34	7/-	8/3	11/6	14/-	4/4
36	8/8	10/2	14/-	15/6	4/8
38	11/3	13/2	16/-	19/-	5/3
40	15/-	18/-	18/6	22/6	6/6
42	17/3	21/-	31/6	34/-	9/-

At per lb.

Phone Cent. 4209.] **J. L. CARTWRIGHT & Co.,** Manufacturing Electrical and Radio Engineers, Dept. A, 130/132, London Road, Manchester. Grams: "Pliduram, Manchester."  
 Special Terms to the Trade. No Catalogues yet. WORKS: BERRY STREET.

# ELECTRADIX RADIOS



Hundreds of Head Sets in Stock. All with cords. Sterling Brown Phones, Marconi Standard 2,000 ohms, 51/- pair; 4,000 ohms, 52/- pair; Brown's A 120 ohm L.R. head 'phone, 40/- pair. Sullivan's L.R. ditto, with 6 ft. cord plug and jack, 22/-.

High Res. Head Sets, 1,500 ohms, 26/-; 4,000 ohms, 30/-, complete.

Second-hand 80 ohm head-sets guaranteed, 15/-.

Single L.R. receivers, 4/6.

Cords for double 'phone, new, 2/6 and 3/9; Used, 1/6. 4-way plugs, 2/-.

Microphone Transmitters, breast plate, 12/6; Hand, 2/6. Insets, 9d.

Aerials.—Wire and every accessory in stock.

Condensers.—Fixed and variable in all sizes.

Relays.—G.P.O., 21/-; Weston M.C., £2 10s.

Morse Inkers, 45/-. Sounder Sets for making rectifiers, 12/6 each.

Panel Switch, Flush Fitting, D.P., 3/6. Plugs and Jacks, 1/6 pair. 60 volt Battery, 4 1/2 volt units, in polished mahogany case, six sockets, two plugs, 17/6. Finest set ever offered.

Receivers, all new. Marconi Trench, 50 D.C. Cost £40. Complete, £5 10s.

Amplifier Receiver, Mark II, 2 valve, with variable condenser, £7 10s. Single valve panel, 35/6. 3-valve Amplifier, Mark IV, £8. H.T. Motor Generators to 1,600 volts, £15. 1 kw, 220 to 25 volts, £30.

## EVERYTHING FOR WIRELESS.

Call at our Electrical Showrooms and inspect.

**LESLIE DIXON & CO.,**  
9, Colonial Avenue, Minories, E.1.

**L.F. INTERVALVE, L.F. TELEPHONE,**  
25/- Post Free, Guaranteed. 25/-

## INTERVALVE & TELEPHONE TRANSFORMERS

SUPPLIED FROM STOCK FROM  
M.E.C., WIRELESS LABORATORIES, CROWN HILL ROAD, LONDON, N.W.10.

## LOOK!—HEADPHONES

Double Head Receivers, best French, 4,000 ohms, 27/6. British, 4,000 ohms, brand new, not re-conditioned or Government surplus, 37/6.

## READERS, LTD.,

4, Parton Street, Red Lion Square, W.C.1.

## INSTRUMENT WIRES FROM STOCK

Cut this out for reference.

S.W.G.	S.C.C.	D.C.C.	S.S.C.	D.S.C.	EN.
47	—	—	110/-	120/-	41/-
46	—	—	97/-	107/-	26/-
45	—	—	64/-	80/-	20/-
44	—	—	50/-	66/-	16/-
43	—	—	40/-	52/-	13/-
42	—	—	31/-	33/-	9/-
41	—	—	30/-	32/-	8/-
40	14/-	17/-	18/-	22/-	6/6
39	12/6	15/-	17/-	21/3	6/-
38	11/-	13/-	16/-	19/-	5/3
37	10/-	12/-	14/6	17/3	4/11
36	8/6	10/-	13/9	15/-	4/8
35	7/9	9/3	12/9	14/-	4/6
34	6/10	8/-	11/3	13/9	4/4
33	6/2	7/6	10/6	13/-	4/3
32	5/10	7/2	9/1	12/10	4/2
31	5/6	6/10	8/9	11/6	4/-
30	5/-	5/4	7/9	9/10	3/10
29	4/9	5/-	7/6	9/6	3/8
28	4/3	4/6	7/2	9/-	3/6
27	4/2	4/5	7/-	8/6	3/5

Prices per lb. Bobbin free—Postage extra.  
Orders of £2 or over. Carriage paid, G.B.  
Terms—Cash with order.

Other Sizes on Application.  
AERIALS, 7/22 ... per 100 ft., 6/-  
FINE WIRE SUPPLIES.  
**A. E. DAVIS,** 41, Arlington Road, Brixton, S.W.

## CONDENSERS (Improved Type)

In Celluloid Case.  
001 ... 24/- 0005 ... 15/-  
Vernier ... .. 4/6

PHONES 4,000 ohms ... 27/6

## FILAMENT RESISTANCES, 4-

## SMALL VALVE PANEL

Suitable for converting Crystal Sets to Valve Sets ... 12/6

Wireless Supplies of Every Description

**B. L. HOUSTON,** 65, FNDELL ST., LONDON, W.C.2.  
and at 232, PUTNEY BRIDGE ROAD, S.W.  
Phone: REGENT 4911.

## WIRELESS AMATEURS AND RETAILERS

PARTS SUPPLIED FROM STOCK  
List free. Condenser Plates, 1/6 doz. pairs (post 3d.).  
**FRASER, SENTINEL HO., SOUTHAMPTON ROW, LONDON**

## "CLIMAX BARGAINS"

4,000 ohm Coupled Head Phones, tested perfect, 22/6, half price. 3 valve panel, £3. Valves, 10/6, 0'001 Condensers, 21/- Set Valve diagrams, 1/6. 4v. 24a. accumulators, 12/6, and others. Twin-bell wire, 6/- 100 yd. 8v. 2 amp. dynamos, 17/6.  
Cash with Order. Postage extra. 2023 Park.  
**CLIMAX ENG. CO., 182, Church St., Kensington.**

## PREPAID ADVERTISEMENTS.

**Ebonite Sheet.**—Any size cut. 1/4 in., 3s. 6d.; 1/2 in., 5s. 3d.; 3/4 in., 7s.; 1 in., 10s. 6d. per square foot. Carriage paid 10s. lots.

**Aerials.**—R.A.F. 40/36 rubber covered on wind-up reels with 2 ebonite insulators, 2s. 6d.; post, 9d.

**Phones.**—Best quality, 4,000 ohms, 4s.; post, 9d.

**Valve Holders.**—Best quality, 1s. 9d.; cheaper, 1s. 6d.; post, 2d.—Renshaw & Marsden, Electrical Engineers, Blackburn. [21 r]

**Xmas Chocolate Clubs.**—Spare time agents wanted. Good remuneration. No outlay. Best makes only supplied. Particulars free.—Samuel Driver, South Market, Hunslet Lane, Leeds. [10 r]

**Why Pay More?** Aerial wire, 16 s.w.g., best hard drawn copper, 3s. 3d. per 100 ft., post free.—Gibson, Factor, Somercotes, Derbyshire. Established 1849. Telephone 19.

**Insulators,** best quality white, 2 in. by 1 in. (3/4 in. hole), reel type, 3s. 3d. doz., carriage paid.—Gibson, Factor, Somercotes, Derbyshire. [1 s]

**Manila Rope,** real Manila, maximum strength, length 108 ft., 1/2 in. thick, 3s. 9d.; 3/8 in., 4s. 6d.; carriage, 1s. 3d.—Gibson, Factor, Somercotes, Derbyshire. [4 s]

**Valves, condensers, aerials, insulators, batteries, accumulators, terminals, cotton-covered and enamelled wires from stock.** Price list free.—Geo. Young, 2, Whitworth Terrace, Rusholme, Manchester. [2 s]

**Head 'Phones with cords** (4,000 ohms), fine quality, 28s. 6d. Crystal detector, mounted (silicon), 4s. 6d. 'Phone plug and jack, 1s. 6d. All post free. Complete receiving set, includes 'phones, variable condenser, single slider coil all finely finished, £3 15s. Carriage extra.—Roberts, 2, Midmoor Road, Balham. [4 s]

**Wireless Bargains.**—Solid ebonite knobs, standard pattern, 6d. Filament resistances for panel mounting, complete, 3s. 9d. Cheap resistances, suitable for wireless or small electric models, 1s. 6d. Valve holders, solid ebonite, 1s. 6d. Contact studs, 1/4 in. by 1/2 in., 1s. 3d. Aerial wire, 7/25 copper, 50 yards, 4s. Porcelain reel insulators, 2 in. diameter, 4d. Tubes, impregnated with wax, 6 1/2 in. diameter by 1 1/2 in. long, 6d. Postage extra on all goods.—Box No. 3, c/o "Amateur Wireless." [5 s]

**Type 6 Panel Unit Receiving Set,** complete with coil tuner, 50s. Specification, photo, stamp.—Debenhams, 6, Loampit Vale, Lewisham. [3 s]

**Make the "Long Wave Tuner for 10s."** (see page 164, "Amateur Wireless," Aug. 5). The two hard wood formers, 3s. 6d. (post free, 4s. 3d.). —"Bonds," Wood Turners, 449, Harrow Road, London, W.10. [7 s]

**Valve Receivers and Improved Panels,** made by experienced ex-R.A.F. wireless operators at low rates. All tested and guaranteed. Valve receiver, £5 5s. Special design panel, £2. For further particulars write, Ex-R.A.F., 201, Leavesden Road, Watford. [6 s]

**Free. Morse Code,** how to master it quickly. Stamped envelope to Grimshaw, Legh Street, Golborne, Lancs. [10 s]

**B.A. Screws, Nuts, and Washers,** assorted gross. 2s.; list, 2d.—J. H. Bennett, Station Road, Willesden Junction. [24 r]

**Reliable Apparatus,** reasonable prices. Superior filament rheostats, 5s.; laminated switch arms, complete, 2s. 3d.; crystal detectors, remarkably efficient, 5s. 6d.; single valve set, complete aerial to earth, £10 10s.; crystal set, 300-2,600 metres, £4 5s. All accessories stocked; postage extra.—Manufacturers, K.E. Wireless Service, 10, Glenview Road, Lewisham. [9 s]

**Inductance Coils.** Tune to 3,500 metres. Polished mahogany ends and base. Best quality wire. 22s.; post free. Stamp for illustrated pamphlet.—Davis Brothers, Thornton Dale, Yorks. [18 s]

**INDUCTANCE TUBES.**  
Length 10 in.  
Dia. Dia.  
2 1/2 in. .. 6d. 4 in. .. 1/-  
3 in. .. 8d. 5 in. .. 1/6  
3 1/2 in. .. 10d. 6 in. .. 2/-

**SMALL CONDENSERS.**  
'0004 & '0005 .. 8/-

**ANODE RESISTANCE.**  
50,000 & 80,000 ohms 3/6

**VARIABLE ANODE RESISTANCE.**  
20,000 to 100,000 ohms, 7/6

**FILAMENT RHEOSTAT.**  
5/-

**CONDENSER PARTS.**  
Fixed and Moving Vanes, 2/6 dozen.

**CENTRE ROD.**  
4 1/2 in., 4/6 each.

**LAMINATED SWITCH ARMS.**  
2/6

**VALVE SOCKET, 1/0.**

The **Universal Electric Supply Co. Ltd.**  
4 BROWN ST OFF MARKET ST  
MANCHESTER

G.P.O. Box No. 519.

**Large Illustrated CATALOGUE** 30th Edition, Post Free 6d.

**Large Socket TERMINALS.** 1/8 per set of 4.

**CONTACT STUDS.** Small size 2/- doz. Large size 3/-

**AERIAL INSULATOR.** 1 1/2 in. 1/8 2 1/2 in. 2/6 2 in. Reel Type, 4d.

**AERIAL WIRE.** Per 100 feet.  
3/20 .. 4/- 7/20 .. 5/-  
3/19 .. 4/6 3/18 .. 6/6  
7/20 .. 7/6

**REGULATING SCREW, 1/-**  
**EBONITE KNOBS, 1/- & 1/6.**

**INSULITE SLIDERS, 1/-**

**KNIFE SWITCHES.** S.P. 1 way, 1/9; 2 way, 2/4 D.P. 1 way, 3/6; 2 way, 6/-

**GRID CONDENSER and LEAK, 7/6.**

**BLOCKING CONDENSER, 5/-**  
**GRID LEAK, 3/-**

**PLUG CONNECTOR, 2-Pin, 1/6.**

**CRYSTAL CUP.** Single Cup Type .. 6/6 Three " .. 21/-

**SINGLE RECEIVER,** With Head Band and Gerd.  
120 ohms .. 24/-  
500 .. 37/6  
1,000 .. 30/-  
2,000 .. 32/6

**DOUBLE RECEIVER,** With Head Band and Gerd.  
3,000 ohms .. 36/-  
4,000 .. 37/6  
8,000 .. 45/-

**SKELTON BUZZER.** Extremely sensitive for Crystal Testing, 2/6

**HIGH TENSION BATTERIES.** 15 volts .. 8/6

Variable Type, 36 v., Tappings every 3 v., 7/6.

**ACCUMULATORS.** Volts. Amps.  
4 40 29/-  
4 60 35/-  
6 40 42/-  
6 60 52/-

**POSTAGE EXTRA.**



Radio brings it: **MAGNAVOX** tells it

# MAGNAVOX

## THE WORLD'S FINEST LOUD SPEAKER



No. R 1282  
(18-in. Horn)

To enjoy and get the greatest possible satisfaction from your Wireless Receiving Set, equip it with a **Magnavox Loud Speaker**. Hear the voice of the singer faithfully reproduced, the perfect intonations of the lecturer, or the natural sound of music. The introduction of the **Magnavox Loud Speaker** for use with Radio Receiving Sets marks a most important development, and will be the means of making broadcasting extremely popular.

**INQUIRIES INVITED.**

SOLE AGENTS FOR THE UNITED KINGDOM:

**STERLING TELEPHONE & ELECTRIC CO., LTD.,**  
Telephone House,  
210/212, TOTTENHAM COURT ROAD, LONDON, W.1

Telephone: Museum 4144 (7 lines).

Telegrams: "Cucumis, Westdo, London."

NEWCASTLE-ON-TYNE:  
9, Clavering Place.

WORKS:  
Dagenham, Essex.

CARDIFF:  
8, Park Place.

**ORDER EARLY  
—IF EARLY DELIVERY IS REQUIRED**

# SPECIAL WIRELESS PLUGS & JACKS

### FOUR-PIN VALVE SOCKETS

With several special features. All terminals marked at top and bottom. Earthing clips for valve caps are fitted. Special insulating fillets give the maximum creeping distance between terminals. Suitable for mounting above or below panel as desired.

PRICE 2/6 EACH

### CONDENSER AND GRID LEAK

A very neat combination of a Dubilier condenser with a Mullard patent resistance. Either may be used singly. A compact little unit ready for mounting. No special clips are required.

PRICE 7/6 EACH

Condenser, 2/6. Resistance, 5/-

### INTERVALVE TRANSFORMERS

An ironclad pattern of the smallest possible dimensions compatible with efficiency. Particularly well made and attractive in appearance. Easily mounted. Silent in operation. Amplification by this transformer is particularly good. Sealed, and fully guaranteed while seal is intact. Tested at 1,000 volts between windings.

PRICE 29/- EACH

WE offer a complete range of plugs and jacks specially designed for Wireless purposes.

The mere act of inserting the plug connects the telephone to any desired valve, disconnecting the intervalve transformer (thus cutting out a source of inefficiency) and only lighting up the filaments of the correct number of valves.

They are a great asset to the experimenter, enabling him to carry out important tests with a minimum of time and bother and a maximum of certainty.



Illustrated descriptive leaflet on application.

**C. F. ELWELL, Ltd.,**  
CRAVEN HOUSE, KINGSWAY, W.C.2

Trade Terms on Application.

### THE ARISTOPHONE

The supreme wireless receiving set. Made in a variety of models, including a wide range of beautiful self-contained cabinets. Write for the Aristophone Booklet.

Prices on Application

### THE ARISTOPHONE SOUND PROJECTOR

For the enjoyable reproduction of musical items, this beautifully made instrument is essential. It represents a notable achievement in scientific acoustics. Both the reproducer and the sound amplifying chamber are designed on entirely new lines, resulting in a purity of tone quite unapproached by any "loud speaker." A really nice looking cabinet with louvre front.

PRICE £7-10-0.

### ELWELL AMPLIFYING UNIT

Comprising valve socket and ironclad intervalve transformer, mechanically and electrically combined in one unit. When fitted with a valve this unit contains all that is necessary to give one stage of amplification to your existing set.

PRICE 39/6 ONLY

[E.P.S.] 31

# Amateur Wireless And Electrics

FREE  
POST  
REPLIES

No. 12

SATURDAY, AUGUST 26, 1922

Price 3d

The photograph shows the demonstrators at the first of a series of popular lectures which the Manchester Wireless Society



are giving in order to make the public more readily understand the various instruments that are used in wireless

Photo: Francis Fielding, Manchester

## Some of the Principal Features of this Number

IS A CRYSTAL SET GOOD ENOUGH?	Page 223
MAKING A SINGLE-VALVE AMPLIFIER	224
WHAT WIRELESS TERMS MEAN . . .	225
DO YOU WISH TO TRANSMIT? . . .	226
A PAGE OF USEFUL IDEAS: Solutions of Constructional Difficulties . . .	229

LOCATION AND DIRECTION FINDING: Methods Employed in Navigation .	Page 230
YOUR RECEIVER AS A BAROMETER	231
MOUNTING WITHOUT EBONITE . . .	231
THOSE CALL SIGNS IN CODE . . .	231
BUILDING A SHORT - WAVE TRANSMITTER. . . . .	232

*Radiograms, Information Bureau, Club Doings, Forthcoming Events, Correspondence, etc.*

# E CONOMIC ELECTRIC LTD.



**CRYSTAL DETECTORS, 7/6**



**HEAD RECEIVERS  
From 21/-**



**ENCLOSED CRYSTAL DETECTOR, 12/6**



**INDUCTANCES, 50/-**



**VALVE HOLDERS, 1/9**

Head Office: 10, FITZROY SQUARE, LONDON, W.1.

New Showrooms: 303, EUSTON ROAD, N.W.1.

Telephone: MUSEUM 1055

Branch Showrooms: TWICKENHAM

Write To-day for 36-Page WIRELESS List Post Free 4d. 240 Illustrations.

## MITCHELFONES

Are not a spasmodic production to meet a sudden demand, but have been on the market for over three months, and during this period 27,000 have been distributed to the trade, and consequently we have not been able to offer them direct to the retail buyer.

*1000 per week are now available, and we announce*

### DELIVERY FROM STOCK

You post your order, or call at our premises and get them at once. Think what this means to you—you, perhaps, who have been waiting and are still waiting.

*Standard resistance 4,000 ohms, double headgear with double headstraps, comfortable, highly efficient, and foolproof*

### 35/- per pair.

Special Terms to Traders and deliveries that will surprise you.

### MITCHELLS Electrical & Wireless Ltd.,

Postal Address: McDermott Road, Peckham, S.E.15.  
Retail Address: 188, Rye Lane, Peckham, S.E.15.

Phones: New Cross 1540/1541.

GREAT BRITAIN'S GREATEST WIRELESS STORE

# LORNETTE 'PHONES

2,000 Ohms.

THE IDEAL 'PHONE FOR LADIES

No more disarranging of hair.  
No cumbersome weight on the head. Beautifully finished. Equal in reception and clarity of tone to any double headphone.



25/-



Postage paid.  
With Ebonised Handle.

Also supplied with handles of Tortoiseshell, Ivory, Mother-of-Pearl, etc.  
Prices on application. Special Terms to the Trade.

Manufactured exclusively by  
**THE ECON MANUFACTURING COMPANY LIMITED,**  
6, Holborn Viaduct London, E.C.1.  
Phone: City 4148.

TRADE **Grelco** MARK

### ALL AMATEURS' REQUIREMENTS IN STOCK

 <p><b>CRYSTALS</b> CALENA, BORNITE GRAPHITE. SILICON. COPPER PYRITES. CARBORUNDUM. Per packet 6d. ZINGITE. TELLURIUM. Per packet 1/-.</p>	<p><b>SIEMENS HALSKE AND A.E.G. VALVES, for Rectifying and Amplifying</b> ... each 10/6</p> <p><b>ADAPTER, to fit R Type Holder</b> ... each 3/-</p> <p><b>CLIPS only</b> ... per set 6d.</p> <p><b>AERIAL WIRE, Stranded:</b> 7/25 ... per 100 ft. 3/6 7/22 ... " " 5/-</p> <p><b>AERIAL INSULATORS, Small Egg Type (very light)</b> ... each 6d.</p> <p><b>REEL INSULATORS</b> ... 3d.</p>	 <p><b>CRYSTAL CUPS</b> Turned brass. Well finished. With Milled Screw at side to fix Crystal. Each 6d.</p>
<p><b>EBONITE LEAD IN INSULATORS, with Terminals</b> ... 2/-</p> <p><b>FILAMENT RESISTANCES, Panel Mounting, Best Quality</b> ... 4/-</p> <p><b>VALVE HOLDERS, with Screwed Legs and Nuts</b> ... 1/-</p> <p><b>IVORINE SCALES, Engraved, 0-180</b> ... 9d.</p> <p><b>KNOBS, Fluted, with Brass 2BA Bush in Centre</b> ... 4d.</p> <p><b>HELLESEN 36 v., H.T. BATTERIES, with Plug</b> ... 8/6</p> <p><b>INDUCTANCE SLIDERS, with Plunger</b> ... 6d.</p> <p><b>PERIKON DETECTORS, Complete, Mounted on Ebonite</b> ... 4/-</p> <p><b>BRASS SQUARE ROD, 12 in. x 1/4 in. x 1/4 in.</b> ... 6d.</p> <p><b>CONDENSER VANES, Moving and Fixed, Aluminium. Per doz.</b> 1/-</p> <p><b>Do. SPACERS (Large), Accurate, Clean Cut.</b> " 5d.</p> <p><b>Do. Do. (Small), " " " " 3d.</b></p> <p style="text-align: center;">Postage Extra.</p>		
<p><b>CRYSTAL SETS, from 15/-</b></p>		<p><b>HEADPHONES, H.R. Double, 32/6</b></p>

## GRAFTON ELECTRIC COMPANY

(Showrooms)  
54, Grafton Street  
TOTTENHAM COURT ROAD  
LONDON, W.1

TELEPHONE: MUSEUM 241  
TELEGRAMS: GRAFECTRIC, EUSROAD, LONDON

# Amateur Wireless

## and Electricians

No. 12

August 26, 1922

## IS A CRYSTAL SET GOOD ENOUGH?

**M**ANY people seem to imagine that crystal receivers will be of very little use for getting "broadcast" messages, and are wondering whether they would be well advised to purchase such sets. Some considerations and practical experiences may



The Simplest of all Crystal Sets with Single-knob Control.

be of use to those readers who are at present inclined to hesitate over this matter.

### The Introduction of Crystals

In the first place it may be pointed out that when the crystal detector was first introduced it was regarded as a great advance in sensitivity over previous apparatus; at the present time very many ships use it exclusively. This latter would not be the case if it were not a thoroughly reliable instrument and had not very definite practical advantages over the valve. These advantages, it is true, are in the nature of simplicity and economy of maintenance rather than of efficiency, but these are also considerations of great moment to the majority of those who would like to possess broadcast receivers.

It is possible that those who decry the crystal are thinking only of the reception of The Hague concerts and the transmissions of the numerous amateurs who so frequently send out gramophone records from various places in the neighbourhood of London and elsewhere. In these cases the powers used are very small, and the distance from The Hague to London is nearly 200 miles. For such work valves and amplifiers are very necessary, but

when it comes to the proposed broadcasting stations with large power and separated only by distances of about 200 miles, I do not hesitate to say that there should be no point in England where good reception could not be obtained with a crystal receiver, provided a reasonable aerial could be fitted in a situation not heavily screened by trees or hills.

### Results with Crystals

Turning to actual results, my own experience is as follows: I have a single-wire aerial which is rather unusually long, as it has a horizontal length of 110 ft. at a height of 40 ft., the down-lead being of the latter length, as my apparatus is in a basement room. The aerial is completely surrounded by trees of greater height than itself, and is attached to one of them. At the other end it is suspended from an attic window, so that it does not rise above the roof level at any point. The house is nearly at the top of a low hill ten miles from London. A gas-pipe serves for the "earth" connection.

With this aerial I am able to receive the concerts from Writtle, forty miles away, on Tuesday nights, using only a crystal, but the sound is undoubtedly faint. When it comes to Marconi House in London—which one may presume is a fair example of what may be expected from the proposed broadcasting stations—the signals are of great strength, and I can still receive them perfectly clearly after substituting for my outside aerial 15 ft. of wire slung anyhow inside the basement room already mentioned. If the aerial is removed altogether, and only an "earth" connection used, it is still possible to distinguish spoken words from Marconi House ten miles away.

From the above results it appears obvious that people living in flats in large towns which are broadcasting centres will

have no difficulty in receiving signals with crystal sets attached to short aerials within their rooms, using earth connections to water- or gas-pipes. In the near suburbs, say up to twenty miles, quite small aerials on the roof, or in the back patch, will give efficient results. Farther out, where gardens are larger, and large aerials can easily be erected, the crystal set will again give good results.

### Expert Adjustment

Lest it be contended that the results described are only possible to an expert in crystal adjustment I should mention that for many months past I have never used a crystal which is capable of adjustment, but all my tests have been carried out with crystals sealed in cartridges. It cannot be claimed that these cartridges have proved remarkably sensitive. They are the zincite and copper pyrites combination, and were put together and sealed without any special adjustment. Those below a certain standard of sensitivity were rejected and the remainder have a fair general average, but are not, as a rule, anything like so good as the best that could be got from an adjustable crystal in the hands of an expert.

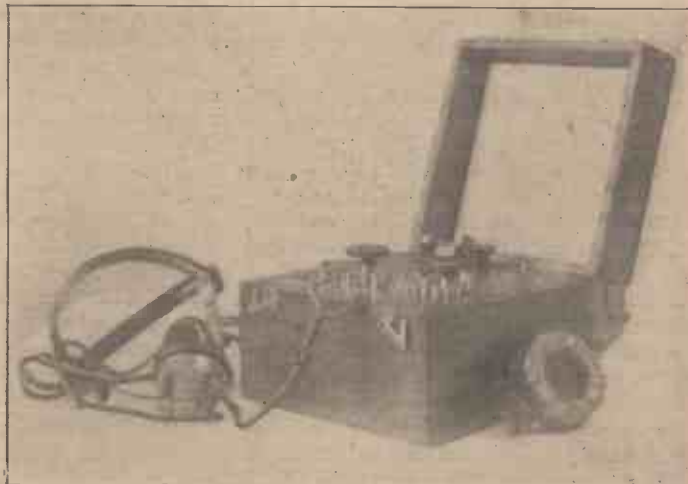

Another Simple Crystal Set.

I hope these remarks will serve to reassure those who have begun to imagine that wireless reception is beyond the means of moderate incomes and that valves are essential.

H. R. R. M.

# Making a Single-valve Amplifier

The Construction of an Efficient Apparatus Described

THE advantage of an amplifier based on the unit system is that additional amplifiers of exactly similar construction can be added from time to time, the terminals being so arranged that it is only necessary to connect one set to the next by means of four strips of brass (see Fig. 1). This

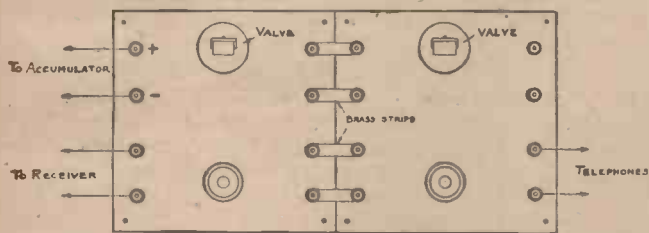

Fig. 1.—Apparatus Constructed on the "Unit" System.

makes a very neat job, and although the set is always complete it can be added to *ad lib.*

The material and parts required are as follow:

A piece of ebonite 6 in. by 6 in. by  $\frac{3}{8}$  in.

A wooden box 6 in. by 6 in. by 2 in. deep.

Four valve legs (or a valve holder can be purchased complete which only requires screwing to the ebonite panel, suitable holes being drilled in the panel to allow the legs to pass through).

Eight terminals (medium size).

One intervalve transformer (low-frequency).

One condenser (about 0.001 micro-farad).

One filament rheostat.

Two or three feet of bare copper wire of about 22 S.W.G.

One yard of insulating sleeving, and, of course, a valve.

**The Ebonite Panel.**—This must be squared up with a fine file. If the ebonite is polished it is better to remove the polish with fine emery powder and oil, finishing off with fine pumice powder and oil. If care is taken a nice matt surface will result. The objection to polished ebonite is the danger of surface leaks, and it is well worth while removing this polish, besides giving the finished article a more professional appearance.

Fig. 2 gives the dimensions for the holes which have to be drilled in the panel. A little difficulty may be experienced in marking off on the ebonite, and the writer has found the following method to be simple and satisfactory.

Take a sheet of white paper and make a copy of Fig. 2 full size. Paste this on to the sheet of ebonite and allow it to dry thoroughly. It is then ready for drilling,

and is much clearer than if marked out direct on the ebonite. When the drilling is finished remove the paper with warm water.

When drilling ebonite with a twist drill it is advantageous slightly to grind off the two corners at the end of the drill, as this prevents the drill from splitting it. A rub or two with an oil-stone is sufficient.

If separate valve legs are used, great care must be taken to see that they are correctly spaced, as otherwise the valve will not fit. A very simple and satis-

factory way of doing this rather tricky job is to take a piece of wax (candle wax will do), make it soft, and press it flat on to the place where the valve legs are to go. If a valve is now pressed on to the wax it will give the exact position for the holes. See that no wax adheres to the valve, or a bad contact may result.

The next matter is the wooden box. This should be made of mahogany if possible, but any moderately hard wood will do. Two pieces 6 in. by 2 in. by  $\frac{3}{8}$  in., and two pieces  $5\frac{1}{4}$  in. by 2 in. by  $\frac{3}{8}$  in., will be required. Also a piece  $5\frac{1}{4}$  in. by  $5\frac{1}{4}$  in. by  $\frac{1}{4}$  in. will be required for the bottom. A triangular piece of wood should also be glued in each corner of the box to take the screws which hold the panel down (see Fig. 3).

**Intervalve Transformer.**—If first cost is not a consideration it is preferable to purchase this transformer. They cost anything from 17s. 6d. to 30s. each. Readers who desire to make one for themselves should refer to the description given in "Wireless Telegraphy and Telephony," by E. Redpath, and published by the proprietors of this journal.

**Filament Rheostat.**—It is a distinct advantage to be able to control the filament of each valve separately in a set, and the amateur possessed of ordinary mechanical ability should have no difficulty in making a filament rheostat.

A disc of hard wood, fibre or ebonite, 2 in. in diameter, must be prepared with a groove turned in the periphery to a depth of about  $\frac{1}{8}$  in. Drill a hole in the centre of the disc  $\frac{1}{4}$  in. diameter full, and two

smaller holes of sufficient size to allow a 4 B.A. screw to pass through, as shown in Fig. 4. It is also advisable to insert a

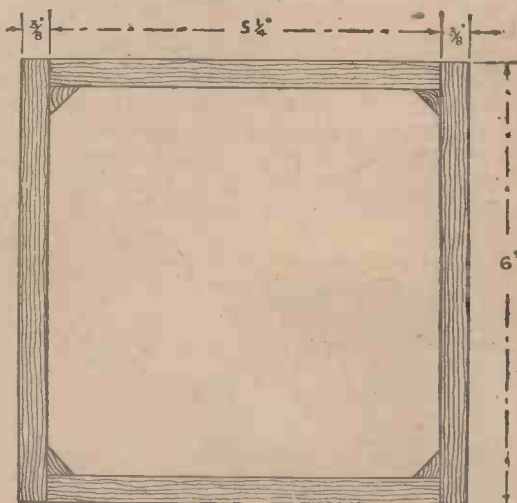

Fig. 3.—Plan of Containing Case with Panel Removed.

small cheese-headed screw at the position marked A, so as to act as a stop to the switch arm. Procure about 6 ft. of 20 S.W.G. Eureka resistance wire and wind it in the form of a spiral coil round a blacklead pencil, leaving about  $\frac{3}{4}$  in. free at each end. Make a loop in each free end of sufficient diameter to take a 4 B.A. cheese-headed screw. Drill and tap two

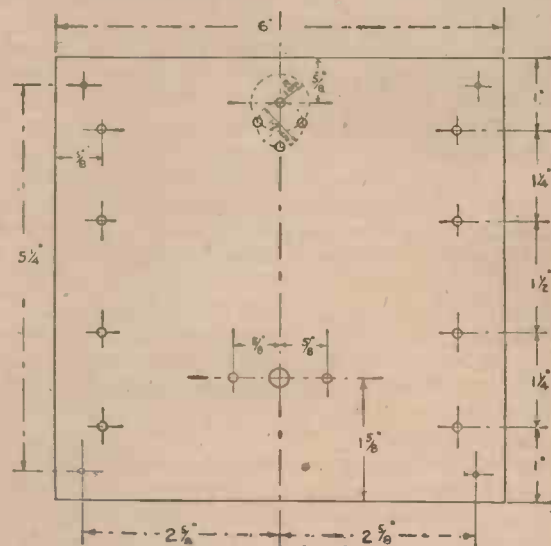

Fig. 2.—Lay-out of Ebonite Panel.

holes in the periphery of the disc about  $\frac{3}{4}$  in. apart and attach the coil with two 4 B.A. screws. Cut out a piece of springy brass or copper  $\frac{3}{8}$  in. by  $1\frac{1}{2}$  in. long, and



drill a hole in one end  $\frac{1}{4}$  in. clear. Round off each end, and in the undrilled end make a small dent with a blunt screwdriver and a hammer. This gives a smooth action to the switch arm. This arm is attached to the disc by means of a brass cheese-headed Whitworth screw  $1\frac{1}{4}$  in.

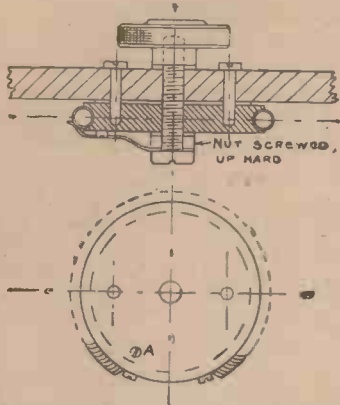

Fig. 4.—Section and Plan of Filament Rheostat.

long by  $\frac{1}{4}$  in. in diameter, a nut, two or three washers, and an ebonite knob. The last item can be purchased for about 9d. Fig. 4 shows the method of assembling.

**Condenser.**—This condenser, which has a fixed capacity, is to be inserted across the primary winding of the transformer. The capacity is not very critical, but should be in the neighbourhood of 0.001 micro-farad. Such a condenser can be purchased for 2s. or 3s.

**Assembling.**—First attach the intervalve transformer in the position shown in Fig. 5. This must be screwed on to the under side of the panel by screws inserted from above.

Secondly, detach the ebonite knob from the filament rheostat and screw the disc to the under side of the panel, allowing the  $\frac{1}{4}$ -in. Whitworth screw to project through the panel.

Between the disc and the ebonite panel

insert a disc of stiff cardboard about 2 in. in diameter by  $\frac{1}{16}$  in. thick. This prevents the coil of resistance wire from coming in contact with the ebonite. If the threads of this screw are now smeared with shellac and the ebonite knob screwed down until it comes in contact with the brass washer, a satisfactory job will result.

Thirdly, attach the four valve legs and the eight terminals.

The position of the condenser largely depends on the type of transformer used, but if this is enclosed in a box the best position is on the bottom of the box. Alternatively, it can be attached to the under side of the panel near the two lower terminals on the left-hand side looking from above.

Fig. 5 shows the method of wiring up the set. It is advisable to solder all joints after the set has been tested to see if everything is in order.

**Remarks.**—The amplifier is attached to the receiver as follows: From the two terminals on the receiver set to which the telephones are usually connected take two pieces of insulated wire and connect to the two lower terminals on the left-hand side of the amplifier. If this does not give results the wires must be changed over. The top terminal on the left-hand side is connected direct to the positive pole of the accumulator, and the terminal immediately underneath to the negative pole of the accumulator. Opposite these two terminals on the other side of the panel are two other terminals which are not used when the amplifier is used as a single unit, but are placed in this position to afford a ready means of connecting the low-tension battery should another amplifier be added, when it is only necessary to connect with

brass strips, as shown in Fig. 1. The two lower terminals on the right-hand side are for the telephones. No additional high-tension battery is required, as the current is supplied from the receiver set.

As explained at the commencement of this article, additional amplifiers can be

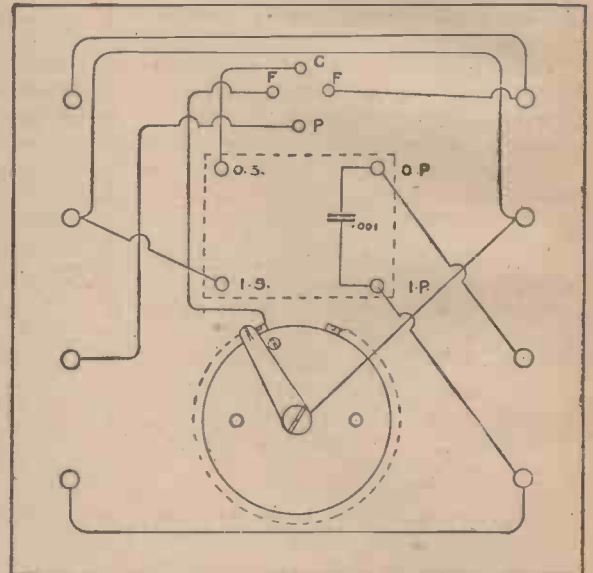

Fig. 5.—The Wiring of the Complete Set.

added from time to time, without any alterations to the existing arrangement, simply by removing the telephones and connecting the four terminals on the right-hand side of the panel to the four terminals on the left-hand side of the panel it is desired to add by means of four brass strips.

**Note.**—This amplifier is arranged for use with high-resistance telephones (2,000 to 8,000 ohms), but if it is desired to use low-resistance telephones a telephone transformer must be inserted between the telephone terminals and the telephones.

A. G. A.

## WHAT WIRELESS TERMS MEAN.—VIII

### Some Technical Words Explained as Correctly as Popular Language Allows

**CRYSTAL DETECTOR.**—An instrument used in the simplest type of receiving set for the detection of signals. It may consist of one or more crystals of a certain type on which light contact is made with a metal point, the combination having the property of rectifying the oscillating current received in the aerial into unidirectional current. Certain crystals require an electric current applied to them before they will function. Carborundum is of this type, others such as galena, zincite and bornite, and certain patent crystals do not require a battery.

**VALVE.**—The most modern instrument used in wireless telegraphy. It has the appearance of an electric lamp, but in addition to the filament contains a thin metal spiral, called the grid encircling the filament, and a metal tube encircling both, called the plate. This type is called the three-electrode valve. Under proper

conditions these valves will transmit energy, receive and rectify oscillatory currents, amplify received currents, and perform various other functions. As a rectifier only it is not better than a crystal. A type of valve with two electrodes is used for the conversion of alternating to direct current. The principle governing the operation of the valve is known as the electron theory, which teaches that metal in a state of heat discharges free electrons at high speed.

**CONDENSER.**—An instrument used to store electricity at high pressure. Its construction comprises two parallel metal surfaces separated by a dielectric. In order that it may be of convenient size the surfaces usually consist of a series of plates coupled together. Condensers having one set of plates fixed and the opposite set movable are called variable, and are used for tuning purposes

in wireless-receiving instruments. Small fixed condensers are also used in receiving sets to "by-pass" high frequency currents, that is, to allow them freely to pass where, but for the condenser, they would be obstructed by impedance, as in the case of a high-tension battery. They are also used in a path in which direct currents as well as oscillating currents are flowing, in order to prevent the passage of the former beyond a given point but to allow freedom to the latter.

**HONEYCOMB COILS.**—A type of tuning coil used for the reception of wireless signals wound in the form of a lattice or honeycomb. These coils have considerable freedom from self-capacity. They are wound to a definite wave length, a number of them being required to cover a range of wave-lengths. There are several methods of winding them, some of which have been patented.

# Do You Wish to Transmit? ||| THE P.M.G.'s REGULATIONS

IN accordance with the Postmaster-General's regulations, low-power spark transmitting sets, operating on a wave-length of 180 metres with a power input of 10 watts, may be used by *bona-fide* amateur experimenters subject to certain conditions which, briefly stated, are as follow:

## The Application

1. Evidence of British nationality and two references as to character are required.
2. The apparatus must be approved by the P.M.G. and subject to inspection.
3. Definite experimental work must be in view, particulars of which must be given.
4. The applicant must establish (by examination if necessary) that he is capable of (a) manipulating the apparatus; (b) sending and receiving Morse at a minimum speed of twelve words per minute. (In case of an examination a fee of five shillings is charged.)
5. A knowledge of official regulations as set out in the P.M.G.'s handbook for wireless operators is required. (This handbook is issued by H.M. Stationery Office, price 9d., and may be obtained through a bookseller).
6. The transmitting station must also be properly equipped for reception.
7. The secrecy of correspondence must be preserved.
8. The dimensions of the aerials are limited as follows: Height, not more than 100 ft. above the ground; length of wire (including leading-in wire), 100 ft. for a single-wire aerial, 140 ft. of wire in the case of an aerial consisting of two (or more) wires.
9. Full particulars, together with diagram of connections, of both transmitting and receiving apparatus, also details as to source of power, wave-length, etc., must be submitted.

An official application form dealing with the above and other subsidiary items may be obtained on application to the Secretary, General Post Office.

## Fees

Small fees are payable, amounting, in the case of a 10-watt transmitting station, to £1 10s. for the first year (that is, 10s. initial licensing fee and annual fee of 20s.) and £1 per annum thereafter, payable on the expiration of twelve months from date of issue of permit.

## Conditions

Normally, actual transmission is restricted to two hours per day, but whereas up to the present experimenters have been required to choose a definite two-hour period (say from 8 to 10 p.m. daily) it is now understood that, provided proper care

is taken to prevent interference with other stations, the allotted time may be spread out at the discretion of each experimenter.

In order to detect and promptly prevent interference transmission should be frequently interrupted whilst the operator "listens in" on the same wave-length as that on which his transmission takes place, the receiving apparatus being adjusted to maximum sensitivity.

It is to be noted particularly in connection with the above (item 3) that a licence or permit will not be granted for apparatus intended merely for the purpose of effecting communication between two or more stations, but only for definite experimental work.

## Methods

In view of the recent successful amateur Transatlantic transmission on short waves employing the very small power (for such a distance) of one kilowatt, during the progress of which both spark and continuous-wave signals were clearly received by amateurs in this country upon the regulation aerial and, in some cases, comparatively simple valve-receiving apparatus, it is suggested that herein there is a wide scope for amateur experimental work.

As a result of the above-mentioned tests it appears that continuous-wave methods proved the more successful, but very little work has been done by amateurs in this country in the matter of short-wave transmission and reception, either by spark or C.W. methods.

## Wave-length

This is considered to be due largely to the fact that C.W. and wireless-phone transmission have proved a very great attraction, and for such (by qualified experimenters) the P.M.G. authorised the use of a wave-length of 1,000 metres, which was gladly accepted, being generally considered more suitable for longer distances, besides being much easier in the matter of manipulation and tuning adjustments.

On the other hand, a considerable amount of interference is experienced on the 1,000-metre wave-length, from Government and commercial stations principally, which is quite avoided on a wave-length of 180 metres.

It is now understood to be the intention of the P.M.G. to allow amateur experimenters to make use of waves from 150 to 200 metres (for spark, C.W. and wireless-phone transmission) and a fixed wave-length of 440 metres for C.W. and wireless-phone transmission only. This latter to be in lieu of the present 1,000-metre wave which will doubtless be withdrawn from such use.

To assist would-be experimenters the

following suggestions are put forward to indicate some of the experimental work which might be undertaken and which necessitates the use of transmitting and receiving stations, observing that, for experiments in connection with the transmitting apparatus alone, the P.M.G. recommends and is usually prepared to allow, without much formality, the use of a non-radiating transmitter circuit—that is, a circuit consisting of an inductance, capacity and resistance, and usually termed a "dummy aerial"—to which the apparatus in question can be connected and certain tests and experiments carried out, but which preclude the actual radiation and subsequent reception at a distance.

## Experimental Work

It is therefore considered that experiments in connection with:

1. Maximum range obtainable with various power input up to a limit of 10 watts and various types of receiving apparatus (crystal and single- or multi-wave sets).
  2. Minimum power with which readable signals can be transmitted over a distance of, say, 5 miles.
  3. Variation in signal strength and/or distance during day and night hours on short wave-lengths with a view to comparison with similar variations observed between commercial stations employing long waves, as reported in the technical press from time to time.
  4. The use of very short waves (say from 5 to 50 metres in length) and possibilities regarding the directional and reflectional properties of same. (Special permission will doubtless be required for this.)
  5. The use of short-wave directional receiving apparatus employing frame or other unusual types of aerials.
  6. The use of "balanced-capacity" or "counterpoise" aerial systems in which an upper and lower wire are employed, both being entirely insulated from earth.
  7. Improved methods of two-way working with the object of facilitating communication and preventing interference by doing away with the necessity for switching over from sending to receiving.
  8. Observation of interference caused in short-wave signalling due to atmospheric and methods to be adopted to obviate or minimise it.
- These would prove extremely interesting and instructive, and quite likely to lead to an appreciable advance in this branch of the science, besides affording genuine reasons for the existence of the amateur experimental transmitting station.
- On another page of this issue very complete constructional details of a suitable transmitter for experimental work are given.

E. REDPATH.

# THIS OFFER WILL BE WITHDRAWN ON SEPT. 2nd

HENRY J. BREWSTER & COMPANY (Mfrs. of "Aerowave" Specialities) have decided to make the following offer as part of their Advertising Campaign, knowing that satisfied customers are the best possible recommendation.

**FOR ONE WEEK ONLY**  
we will accept  
**HALF THE USUAL PRICES**

### SINGLE VALVE RELIANCE No. 1 SET (£12 12 0 less 50%)

*SPECIFICATION*

- 1 Polished Walnut Cabinet
- 18 in. x 6 in. Ebonite Panel with all terminals
- 1 Filament Resistance
- 1 Mullard "Ora" Valve
- 1 Vernier Condenser
- 1 Grid Leak and Condenser
- Set of Tuning Coils covering all wave lengths
- Set High Resistance Head Phones (4000)
- 1 H.T. Battery (30 volts)
- 1 Accumulator (4 volts)
- Complete Aerial Equipment
- Full Instructions and Blue Print

Price This Week, £6 6 0

### TWO VALVE RELIANCE No. 2 SET (£15 15 0 less 50%)

*SPECIFICATION*

- 1 Polished Walnut Cabinet
- 1 10 in. x 8 in. Ebonite Panel with all terminals
- 1 Separate Filament Rheostat
- 2 Mullard "Ora" Valves
- H.F. Transformer Sockets
- Grid Leak and Condenser
- Set of Tuning Coils covering all wave lengths
- Set Head Phones (H.R. 4000 ohms)
- Bye Pass Condenser
- 1 Accumulator (4 volts)
- H.T. Battery (30 volts)
- 1 Variable Condenser
- Complete Aerial Equipment
- Full Instructions and Blue Print

Price This Week, £7 17 6

### THREE VALVE RELIANCE SUPER SET (£30 0 0 less 50%)

*SPECIFICATION*

- Heavy Polished Walnut Cabinet, Sloping Front
- Ebonite Panel, 14 in. x 12 in.
- 3 Separate Filament Rheostats
- 3 Mullard "Ora" Valves
- Grid Leaks and Condenser
- Variable Condensers
- 2 Bye Pass Condensers
- Complete Set of Tuning Coils for all wave lengths
- Accumulator (4 volts 60 amps.)
- H.T. Battery (60 volts)
- L.F. Transformer
- 1 Set H.R. Head Phones (4000 ohms)
- Complete Aerial Equipment
- Full Instructions and Diagrams

Price This Week, £15 0 0

NETT CASH WITH ORDER. CARRIAGE PAID. DELIVERY WITHIN 7 DAYS GUARANTEED.

IF YOU ARE NOT COMPLETELY SATISFIED WITH YOUR PURCHASE AND RETURN THE APPARATUS TO US UNDAMAGED WITHIN 7 DAYS, WE WILL REFUND YOUR MONEY IN FULL.

#### NOTICE TO THE TRADE

WE cannot allow the usual Trade discount off these prices. It must be understood that we are selling at these prices as an advertisement. We shall be pleased to give quotations to Traders who wish to take advantage of this advertisement by stocking

**"RELIANCE"**  
Radio Apparatus

### NOTE

Only one of any of these Sets can be supplied to each customer at the reduced prices.

## FILL IN & POST ORDER FORM NOW

Letters containing cash should be registered. Cheques and Money Orders must be crossed and made payable to:

To HENRY J. BREWSTER & CO.  
11, Queen Victoria St., London, E.C.4

Please forward, carriage paid, one RELIANCE SET No. .... for which I enclose Cheque Money Order value £ : : , on condition that it I am not satisfied my money will be returned in full.

Name.....  
Address.....  
Date.....

.....WRITE CLEARLY.....

# HENRY J. BREWSTER & CO.

*Makers of "Aerowave" Specialities*

Telephone :  
CITY 768

11, Queen Victoria St., London, E.C.4

Works :  
BESTWOOD  
NOTIS.

WE ARE EXHIBITING AT THE FIRST ALL-BRITISH

# WIRELESS EXHIBITION

## AND CONVENTION

**HORTICULTURAL HALL,**

Vincent Square, Westminster, S.W.1.

**SEPTEMBER 30th to OCTOBER 7th.**

(Saturday)

(Saturday)

10 a.m. to 10 p.m. daily.

Admission

**1/3**

Including Tax

**SPECIAL TRADE DAY, October 2nd**

Admission 1/3, including tax.

**SPECIAL PUBLIC DAY, October 3rd**

Admission 5/-, including tax.

(Public admitted both days after 6 p.m. at usual price)

The only Exhibition whose CONVENTION will be held under the auspices of the WIRELESS SOCIETY of LONDON

Auckland, G. Z., & Son.  
Automatic Telephone Manfg. Co., Ltd.  
Bertram Day & Co., Ltd.  
Bower, J. B., & Co., Ltd.  
British Thomson-Houston Co., Ltd.  
British Wireless Supply Co.  
Brown, S. G., Ltd.  
Burndept, Ltd.  
Chloride Electrical Storage Co., Ltd.  
Coomes & Co.  
Cossor, A. C., Ltd.  
Dublier Condenser Co. (1912), Ltd.  
Ever Ready Co. (Great Britain), Ltd.  
Elwell, C. F., Ltd.  
Econ Manfg. Co., Ltd.  
Economic Electric, Ltd.  
Fellows Magneto Co., Ltd.  
Gambien & Partners, L. A.

Gambrell Bros., Ltd.  
Gamage, A. W., Ltd.  
Graham, A. & Co.  
General Radio Co.  
Hambling, Clapp & Co.  
Harwell, Ltd.  
Hart Accumulator Co., Ltd.  
H.P.R. Wireless, Ltd.  
Igranio Electric Co., Ltd.  
Isted, T. H., Esq.  
"K.B." Radio Equipment Co.  
Marconi Scientific Instrument Co., Ltd.  
Marconi Wireless Telegraph Co., Ltd.  
McMichael, L., Ltd.  
Metropolitan-Vickers Electrical Co., Ltd.  
Mitchells' Electrical & Wireless, Ltd.  
Mullard Radio Valve Co., Ltd.  
Ooram G.E.C. Lamp Works.

Peto Scott & Co.  
Pettigrew & Merriman, Ltd.  
Radio Communication Co., Ltd.  
Radio Instruments, Ltd.  
Radio Service, Ltd.  
Radio Press, Ltd.  
Rogers, Foster & Howell, Ltd.  
Siemens Bros. & Co., Ltd.  
Stanley, Prince & Co.  
Sterling Telephone & Electric Co., Ltd.  
Sullivan, H. W., Esq.  
Telephone Manfg. Co., Ltd.  
Tingey, W. R. H., Esq.  
Wates Bros.  
Western Electric Co., Ltd.  
Wireless Equipment, Ltd.  
Wireless Press, Ltd.  
Wireless Supplies Co.  
Zenith Manfg. Co., Ltd.

Organisers: BERTRAM DAY & CO., LTD., 9 and 10, Charing Cross, London, S.W.1, *Wireless Publicity Specialists.*

## HEAD 'PHONES



Each Set complete with two Ear-pieces and Flexible Connections.  
4,000 ohms resistance.

**PRICE 28/- POST FREE.**

*Each Set is Guaranteed*

THE "BEAVER" COMPLETE SET OF CONDENSER PARTS—FOR '0005 M.F.—contains:—

Ebonite Top and Bottom Plates, Machined.	10 Large Spacing Collars.
10 Aluminium Moving Plates.	30 Small " " "
11 Aluminium Fixed Plates.	1 Bronze Coil Spring.
1 Square Centre Spindle.	1 Ebonite Knob Drilled and Screwfitted.
3 Stay Rods Screwed both ends.	2 Brass Nuts for Centre Spindle.
	14 Small Nuts.

**PRICE 11/- PER SET, POST FREE.**

### SPECIAL TERMS TO TRADE

*Postal Orders and Cheques to be crossed London Joint City and Midland Bank.*

**BEAVER ELECTRICAL SUPPLY CO.,**

'Phone: GERRARD 1900. 109, REGENT STREET, LONDON, W.1.

**QUALITY PRICE** **RIGHT**  
and see you get  
The ADDRESS

**COMPLETE SETS** of Metal Parts with Knob and Engraved Scale for making **VARIABLE CONDENSERS**

...001	... ..	10/6
...0005	... ..	8/-
...0003	... ..	6/-

Postage 9d. per Set extra.

**OAK CASES FOR CONDENSERS, 3/- and 3/6 each.**  
Postage 9d.

**HEAD 'PHONES, 4,000 ohms**

The greatest bargain ever offered.  
One quality only—THE BEST.

**25/- per pair.**

Complete with Cords and ends. Call and test these at our Showroom. Postage 1/- extra.

**Build Your CRYSTAL SET**

12-inch Coil, Base and Ends in Teak Rod and Slider. Crystal Detector and Terminals. First class finish throughout.

**16/-.** Postage 1/6.

100 feet Aerial, 4 Insulators, 10 yards leading-in Wire.  
**7/6.** Postage 1/6.

**You Cannot Beat us for Price and Quality.**

We stock the one and only Crystal for **BEST RESULTS, HERTZITE.** Other crystals also supplied.

Don't fail to secure this, **IT IS MARVELLOUS.**

**Every Accessory for Wireless in Stock at Lowest Prices; consistent with Best Quality.**

**CATALOGUE FREE.**

**WILL DAY LTD.**

**19, LISLE STREET, LEICESTER SQUARE, W.2**

'Phone: Regent 4577. Telegrams: Titles, Westrand, London.

# A PAGE OF USEFUL IDEAS

## PRACTICAL SOLUTIONS TO CONSTRUCTIONAL DIFFICULTIES

### A FRAME AERIAL HINT

**M**OST amateurs will find when constructing a frame aerial a difficulty in winding the wire sufficiently tight. Here is a suggestion which, if properly carried out, will solve the problem. Suppose you have decided to make an aerial of the cross type with 4 ft. sides. Let your lengths of wood be 47 in. by 2 in. by 1 in., then cut four pieces of hard wood 2 in. by 1 in. by  $\frac{1}{2}$  in. and nail these on the

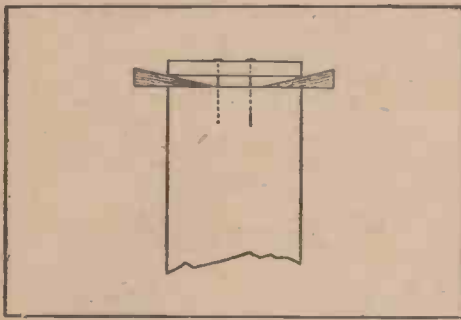

Wedges for Frame Aerial.

ends of the cross with  $1\frac{1}{2}$ -in. wire nails of thin gauge. Then proceed to lift these top pieces and insert wedges a little way as shown in the illustration. Then wind on the aerial wire and fasten it to two terminals. Now take your hammer and carefully drive home the wedges as far as they will go and you will find the wire tight enough to give a musical note. The same instructions are applicable to aerials of the box type.

E. T.

### INDOOR INSULATORS

**A** USEFUL idea for indoor aerials is shown by the accompanying sketches which are self-explanatory. The glass pins

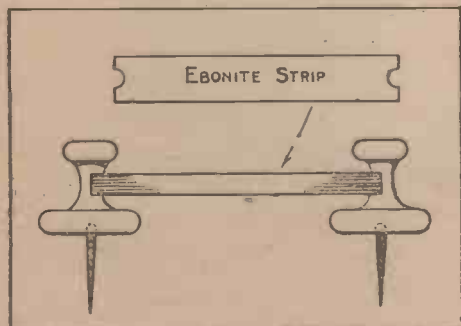

Indoor Insulator.

can be obtained from any photographic dealer.

E. G.

### ROTARY SWITCH

**T**O those who are constructing their own switchboard the following description of a switch handle will be of interest.



Fig. 1.—Switch Knob.

The materials required are a  $\frac{1}{8}$ -in. brass rod (nuts and washers to fit), a piece of strip brass  $\frac{1}{4}$  in. by  $\frac{1}{16}$  in., three ebonite knobs (which can be bought for a few pence or turned up in a lathe)  $1\frac{1}{2}$  in. in diameter, with a flange underneath 1 in. in diameter and  $\frac{1}{4}$  in. deep.

Cut off a piece of the strip brass, the length of which should be  $\frac{3}{4}$  in. plus the radius of the circle over which the switch is to operate. Mark  $\frac{1}{2}$  in. from one end and drill a  $\frac{1}{16}$ -in. hole for the spindle. Round off both ends with a file. Measure from the centre of the hole just drilled the length required for the arm and bend down the remainder, which should be

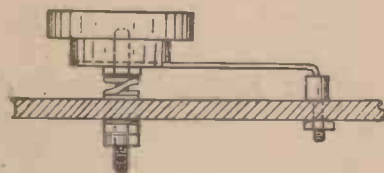

Fig. 2.—Construction of Rotary Switch.

about  $\frac{3}{8}$  in. to make contact with the studs.

For the spindle cut off a piece of the threaded brass rod about  $1\frac{1}{2}$  in. long (allowing for  $\frac{3}{4}$ -in. panel) and round up the ends, if necessary, with a file.

Across the centre of the flange of the ebonite knob cut or file a groove just large enough to take the switch arm, that is to say,  $\frac{1}{8}$  in. deep and  $\frac{1}{4}$  in. wide (see Fig. 1). In the centre of this drill and tap a hole for the spindle, which should be screwed home tight after dipping the end of same in shellac varnish when there will be no fear of its working loose. When assembled with nuts and washers to suit the height of the contact studs (see Fig. 2) this will form a very neat, cheap and easily-made article.

C. J. P.

Every reader of "A.W." should have at hand for reference a copy of the "Work" Handbook, "Wireless Telegraphy and Telephony: and How to Make the Apparatus," 1s. 6d. net.

### INDUCTANCE SLIDER

**B**Y making use of the interior of an old L.B.C. lampholder quite good inductance sliders can be constructed. In the illustration the block A is of ebonite or hard wood, and measures 1 in. by  $\frac{3}{4}$  in. by  $\frac{1}{2}$  in., and has a  $\frac{1}{4}$ -in. by  $\frac{1}{4}$ -in. groove cut along one face to enable it to slide along the usual  $\frac{1}{4}$ -in. by  $\frac{1}{4}$ -in. rod. B is a brass plate 1 in. by  $\frac{3}{4}$  in. by  $\frac{1}{32}$  in. drilled with four holes at the corners to take the

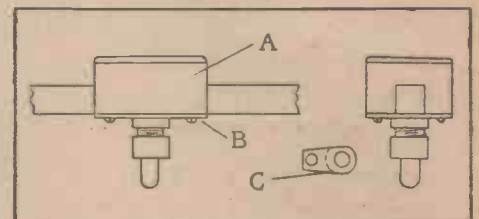

Inductance Slider.

brass securing screws. To the centre of the plate is soldered the large hollow screw from the lampholder.

The pear-shaped piece C is cut and filed till circular, and is then screwed down over the plunger, which has its end rounded as in the diagram.

L. E. O.

### AN IMPROVED SWITCH ARM

**A** LENGTH of steel spring has a small rectangle of brass soldered to one end, as at P in the figure, whilst the lower end of the spring is drilled to fit over the screw. This device is fitted behind the ordinary pear-shaped brass arm, and will be found to make the switch move smoothly

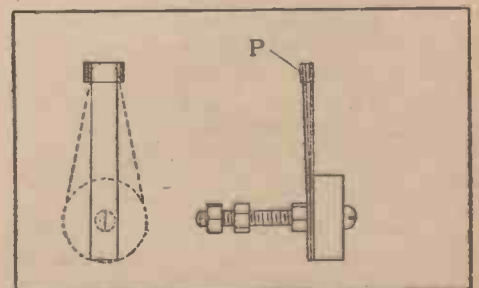

Improved Switch Arm.

and silently over the studs. The ends of P should be bent upwards to secure a smooth motion.

O. L.

# Location and Direction Finding

An Article (continued from No. 10) on the Methods Employed in Navigation

## Principles of Direction Finding Explained

THE simplest form of directional aerial is a plain loop of wire. A directional aerial is, in fact, often referred to as a "closed" or "loop" aerial. If, for instance, you ran a single wire along the four edges of the door in your room and connected up a receiver to the two loose ends you would have at once a crude direction-finding apparatus. Such an aerial, of course, would not be capable of picking up signals from ordinary transmitting stations, because a much larger aerial would be required to tune to the wave-lengths of such stations. If, however, signals of a suitable wave-length were being received, the experimenter would immediately observe a number of curious phenomena which are never experienced in connection with an ordinary "open" aerial of everyday use. In the first place, he would find that as he swung the door on its hinges the strength of the signals in his telephones would vary. The signals would, perhaps, reach their loudest strength when the door was closed, and become faint—ultimately dying away altogether—as he brought the door back gradually to a "wide-open" position. In doing this he would be experiencing the directional effect of a closed aerial.

Without going into the theory of this phenomenon its simple manifestation may be stated as follows: When the plane of a symmetrical loop aerial is pointed towards a transmitting station the loudest signals will be heard in the receiver connected to it; as the loop aerial is swung away from this position on a vertical pivot the received signals become weaker and weaker until, when its plane is at right angles to the source of transmission, they die away to zero.

This at once gives us the clue as to how such an aerial may be put to practical use in determining the direction of incoming signals. We will assume that we are listening in on a loop aerial capable of picking up good signals. The loop is wound on a big frame, through the centre of which a spindle passes, thus enabling us to revolve it at will on a vertical axis. On connecting up our receiver we hear signals from a transmitting station of whose whereabouts we know nothing. We rotate the aerial slowly, and the signals get louder. We reverse the direction of rotation and the signals get weaker, disappearing altogether at a certain point. If, now, we leave the aerial in that exact position and draw a line through it, as it were, at right angles to its plane, we know that the position of the station to which

we have been listening lies somewhere along that line. Of course we could have (theoretically) got the same result by rotating the aerial until we heard the maximum strength of signals in our telephones. In this case the "position line" would be a

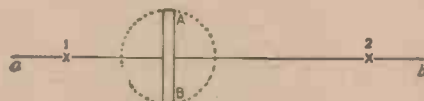

Fig. 1.—Diagram showing the Use of the Frame Aerial in Direction Finding.

continuation of the plane of the aerial. In practice, however, it is almost impossible to judge the exact maximum strength of signals with such an aerial, whereas the minimum or zero point can be found with great accuracy.

So far, however, we have only found the line of direction. And, if we regard the loop, as having a front and back to it, it must be remembered that we do not

that it cuts through the plane of the aerial from either side at right angles to it. The nature of the problem is illustrated in Fig. 1. AB shows a plan of our vertical frame aerial which is capable of being rotated as indicated by the dotted circle.

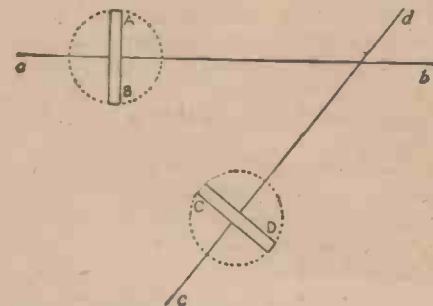

Fig. 2.—Diagram showing how the Exact Point of Location is Found.

The position shown in the diagram represents the zero point of signals received



Photo: Marconi's Wireless Telegraph Co., Ltd.

Receiver (including the "Radio-goniometer") Used in Conjunction with the "Balanced Aerial" Directional System.

even know if the transmitting station lies on the line in front of the aerial or behind it. All we know of our direction line is

from an unknown station X. The position of X will therefore be somewhere along the line *ab* (extended indefinitely), which

cuts the plane AB at right angles. It may, however, be on either side of that line; for example, at either of the points 1 or 2.

Having got as far as this, however, a little thought will show how easily our difficulty can be overcome by the aid of a second directional aerial at some distance from our own. As can be seen from Fig. 2,

CD is also in the zero position with reference to signals from X, hence X must lie along the line *cd*. Since X therefore lies somewhere on *ab* and somewhere on *cd*, it follows that its position will be revealed at the point of intersection of these two lines.

M. E.

(To be concluded.)

## Your Receiver as a Barometer

TO how many wireless enthusiasts has it occurred to utilise their receiving sets as barometers? To most it will probably come as a surprise to learn that by the exercise of a little calculation, and by a careful observation of natural electric phenomena, one may to a certain extent be able to foretell the weather.

The explanation of this has yet to be made, since scientists up to the present time have been unable to discover the natural law which governs it. The fact remains that that form of electrical energy which we call static has a direct connection with the condition of the weather. The Russian professor, Popoff, who made one of the earliest attempts to utilise electrical disturbances in the ether, demonstrated that naturally-produced electromagnetic waves were associated with barometric changes. The instruments available in those days could give no indication of any atmospheric disturbances at great distances; but since the perfection of receptive devices, experienced wireless operators have learned to predict the approach of unsettled weather.

As far as can yet be ascertained, an unsettled state produces "cross" air currents which, conflicting with each other, generate charges on the clouds. When these charges have grown sufficiently strong they break down the intervening insulation, and a spark jumps between clouds which may be only a few feet or many hundred feet apart. These phenomena make themselves known by slight crackling noises in the head-phones, and may be heard even during the major changes of weather during the winter. Thus storm centres moving toward the seaboard receiving stations have been detected by wireless two or three days before their arrival on the coast.

The hot, oppressive weather of summer causes many local thunder showers, and one may note the electrostatic discharges in the later afternoon almost any day. At such times, the arrival of a storm is usually heralded at the receiving station only by extremely loud clicking and crashing noises, for, as is well known, thunderstorms which pass within a few miles frequently are never actually seen. These summer storms may be heard in the receiver and then die out without ever reaching the place where the observer is stationed. They may even be detected by

the small crystal receiving sets, but the kind of storm which may register itself some two or three days prior to arrival is generally perceptible only on the more elaborate valve sets.

Autumn, winter and spring are the periods where one can most accurately predict weather changes by the use of the radio receiver, and the following points will show the method of deduction:

A gradual increase in the strength of the natural electrical disturbances will indicate that the storm is approaching.

A lessening in the strength of the disturbances means that it is moving away.

A consistency in the strength of the signals indicates that the storm is moving along a path which is approximately equally distant from the observer at all points.

A. J. B.

## Mounting Without Ebonite

A Use for Old Mahogany

EBONITE is costly and difficult to work. One wants "taps," and those of us whose resources are more or less confined to a pair of pliers, a gimlet and a screw-driver, know nothing of taps, and, knowing nothing, distrust the unknown. Fortunately, there is a way out that is open to the least skilful and the neediest of us which, if it does not lead us to the maximum efficiency of the expert, is still efficient by the standards we beginners set ourselves. I read somewhere of an adventurer, and I use the word in its most gallant sense, who used oak in place of ebonite with results that were far from unsatisfactory. He also made use of these comforting words, "The oak was old and dry, and it is well known that some woods in this condition are equal to ebonite in insulative properties." Well, it wasn't well known to me, and those who write the elementary handbooks for our enlightenment are remarkably reticent on the subject.

I seized upon the precedent with avidity. My panel, which contains two stages of H.F. amplification, a rectifier and one stage of L.F. amplification, is made of mahogany  $\frac{1}{2}$  in. thick and forty years old.

This panel is in its turn mounted at right angles by means of three steel brackets on an old oak stand 1 in. thick. The oak stand is again mounted on four castors which have porcelain wheels. These not only allow me to wheel my apparatus about and attend to its concealed wirings, but they act as efficient insulators. The mahogany and oak cost two shillings each. They are both charmingly easy to work, and there is no danger of splitting. I certainly have not noticed any leakage. The only concession I have made to insulation is exhibited by valve legs encased in rubber bicycle-valve tubing.

A voltmeter is incorporated in the panel and shows the voltage under load as well as without load. Where possible all leads are of the stoutest gauge of copper wire that can be inserted in the larger size insulated sleeving. I find that a thin smear of vaseline on the end of the wire effects wonders in the way of easy fitting. For attaching the ends of the flexible leads I make use of the "solderless nipple" as used for the Bowden wires. This fitment is retailed at twopence and does away with the need of soldering, a job which I hate and cannot do. I find that a panel 2 ft. by 1 ft. just accommodates the four valves with all transformers and switches, and would, if I wished, provide sufficient room for two variable condensers as well.

As for results, I get the Paris telephony and music sufficiently strong to be heard in a fair-sized room by resting one telephone earpiece on the end of a hornless gramophone. The Hague is very clear and Croydon deafening. My station is seventy miles S.S.W. of London.

BEGINNER.

## Those Call Signs in Code

NO doubt there are many amateurs with valve sets who hear concerts but do not know where they come from, because the call signs given are not in letters but words. An example of this mystery code is that of the now famous 2MT; when beginning the programme the call is always given as "Two Emma Toc." A large number of letters in the alphabet sound very much alike on the telephone; for example, P, B, C, D, E, G, and T. Although "P for Percy," "B for Bertie," "C for Charlie" is a good way to distinguish them, a quicker way is to alter the sound of the individual letters, making them so that no two rhyme. Below is the alphabet written in this code:

Ack	Beer	Cork	Don
Eddie	F	G	H
Ink	Jug	K	L
Emma	N	O	Pip
Quod	R	Esses	Toc
U	Vic	W	X
	Y	Zed	

J. E. M.

# BUILDING WAVE TRA

The first of two articles in which plete detail the making of a trans the design of this set close attention General's requirements as outlined page 226 of this

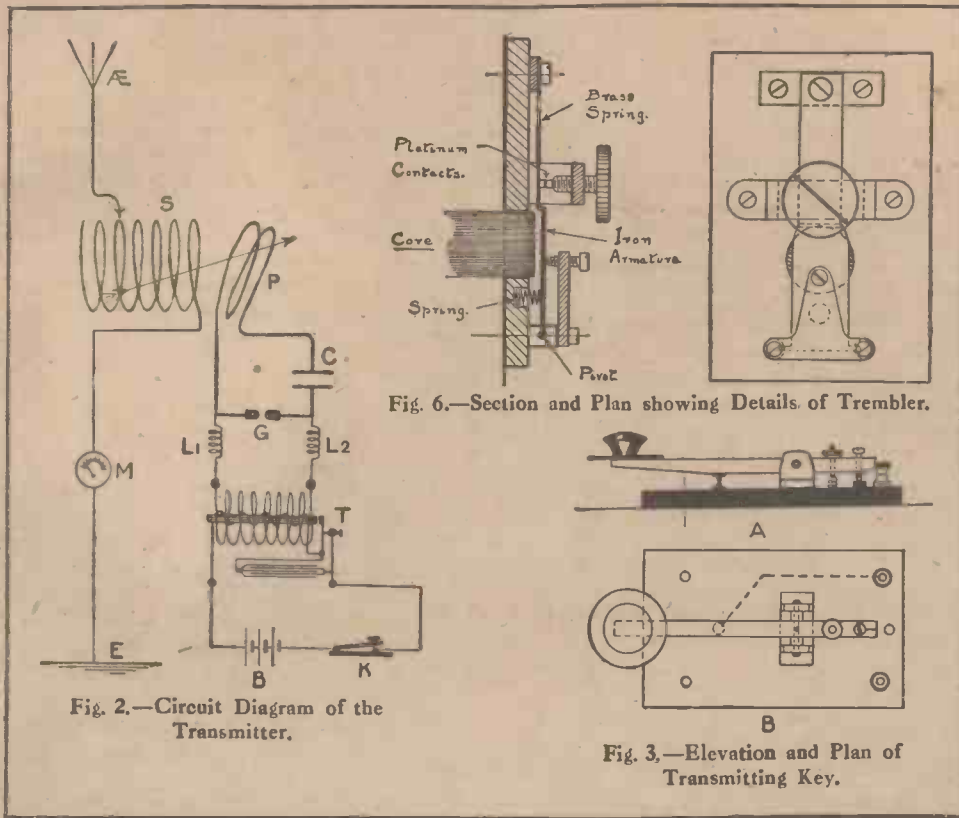

**A** COMPLETE transmitting set is illustrated in the photographs Figs. 1a and 1b, and the diagram of connections Fig. 2. This set is inductively coupled, and consists essentially of three circuits:

1. The charging circuit, comprising a 6-volt accumulator battery (B), transmitting key (K), spark coil (T), and air-core chokes (L1 and L2).
2. The closed oscillatory circuit, comprising the spark-gap (G), condenser (C), and primary of oscillation transformer (P).
3. The open-oscillatory or radiating circuit,

which comprises the aerial (Æ), secondary of oscillation transformer and aerial-tuning inductance combined (S), tuning lamp or hot-wire ammeter (M), and earth or counterpoise (E). All of the components shown diagrammatically in Fig. 2 are visible in the photograph Fig. 1a except the air-core chokes, which were not fitted when the photograph was taken. It will be seen that the complete set is fairly compact and may be set up either on a table or bench, fitted upon a bracket or (as in the photograph) mounted with part against a flat backboard and part standing upon the operating bench beneath.



Fig. 1a.—Photograph of Complete Transmitting Set;

- The constructional details of the components will now be given in full in the order in which they occur in:
1. The charging circuit.
  2. The closed-oscillatory circuit.
  3. The radiating circuit.

**Item B: The Accumulator Battery**

This, of course, must be purchased, and may be either a 4- or 6-volt set. As the total power input to the transmitter is limited to 10 watts, the 4-volt battery may dis-

charge at the rate of 2½ amperes, whereas the 6-volt battery will only be required to discharge at the rate of 1⅓ amperes, and therefore need not have so large an "ampere-hour" capacity.

**Item K: The Transmitting Key**

This also may be purchased quite reasonably or, if workshop facilities permit, may be made in accordance with Fig. 3 (A and B), which, it is thought, will readily be understood without further explanation.

**Item T: The Spark Coil**

A very suitable type of coil for a low-power transmitter of this description is the motor-car ignition coil, which usually functions well on 4 volts, and is provided with a trembler or interrupter capable of being adjusted to vibrate at a fairly high speed, thus producing a clear note at the receiving station which greatly facilitates the reception of signals.

A common mistake in connection with the selection of a spark coil for transmission is made in the matter of the length of spark necessary. What is required is an appreciable current to charge up the condenser to a potential sufficient to break down the insulation resistance of a spark gap and permit a spark to occur with consequent oscillatory discharge of the condenser. It will be seen, therefore, that the voltage is determined by the setting of the spark-gap. As for the set now under discussion the gap will not be greater than one to one and a half millimetres, there is no object in employing a coil capable of giving, say, a 6-in. spark.

The secondary winding of a coil designed for transmission work should consist of rather thicker wire than usually employed, a method which has been found to yield a shorter but more intense spark.

For those readers who prefer to construct their own spark coil the following details and accompanying diagrams are given.

Referring to Fig. 4, c represents the core of No. 24 S.W.G. soft charcoal-iron wires, rolled and bundled tightly together and finally bound with two layers of silk



# A SHORT-TRANSMITTER

Mr. E. Redpath describes in commutator suitable for amateur use. In has been paid to the Postmaster- in an article by Mr. Redpath on issue of "A.W."

insulating tape. The completed core should be 5 in. long by  $\frac{5}{8}$  in. in diameter.

The primary winding P is placed directly upon the silk tape covering the iron core and consists of two layers of No. 18 S.W.G. d.c.c. copper wire, wound closely for a length of  $4\frac{1}{4}$  in., leaving clear spaces of  $\frac{1}{4}$  in. at one end of the core and  $\frac{1}{2}$  in. at the other. At the commencement and finish of the winding, lengths of wire (say, 6 in. or 8 in.) are to be left for connecting up; later, the winding being temporarily tightly tied with tape to prevent the turns from slipping out of place. The whole is to be soaked in molten paraffin wax and then hung up to drain and set.

An insulating tube of ebonite E,  $\frac{3}{8}$  in. to 1 in. inside diameter by  $\frac{3}{2}$  in. to  $\frac{1}{8}$  in. thick by 5 in. long, into which the core, complete with the primary winding, should be a neat sliding fit is provided. If found rather on the slack side an extra layer of insulating tape will put matters right, and when in place (with  $\frac{1}{4}$  in. of bare iron core projecting at one end of the tube) molten paraffin wax should be poured in to secure all in position and to seal up the end not required for the trembler.

The secondary windings consist of approximately  $1\frac{1}{2}$  lb. of No. 32 S.W.G. d.s.c. high-conductivity copper wire wound in sections, each  $\frac{1}{4}$  in. thick by  $1\frac{1}{4}$  in. bore by  $2\frac{3}{4}$  in. outside diameter. The sections are very similar in appearance to the "slab" type of tuning coils now available for receiving purposes.

Mounted upon the ebonite tube E, these sections are arranged and connected so that all the turns are in the same direction and in series, each section being separated and insulated from its neighbour by two waxed discs of thin blotting or filter paper. Note the method of joining up the sections as shown in Fig. 5a.

To enable these sections to be wound expeditiously, a winding machine or former should be constructed as shown in Fig. 5b. The reel of No. 32 wire should rotate upon a convenient spindle in a bath of molten paraffin wax and the wire be run on to the former through a soft rag held in one hand, or the wire may be

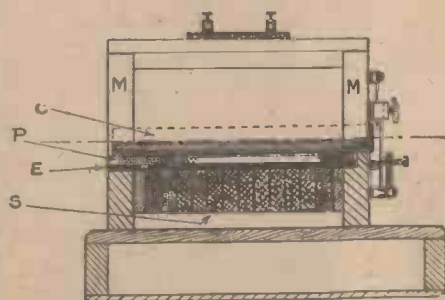

Fig. 4.—Part Section of Coil.

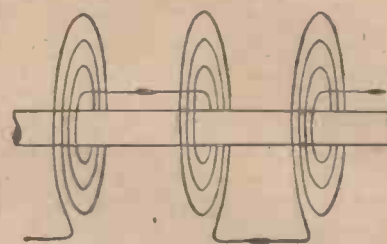

Fig. 5a.—Diagram showing Method of Winding Coil.

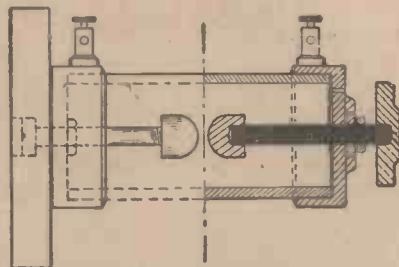

Fig. 7.—Details of Spark Gap.

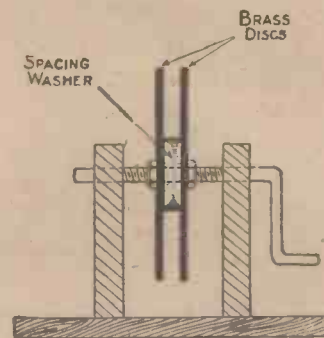

Fig. 5b.—Coil Winder.

arranged merely to pass through a trough or bath of molten wax.

The outermost sections of the coil should be of slightly reduced diameter—that is, of fewer turns. When assembled, the spaces thus left and the further spaces between the secondary and the coil ends may be filled up solid with waxed cotton and blotting-paper discs respectively.

MM represent the two coil ends ( $\frac{1}{4}$  in. thick), which may be of well-dried and wax-impregnated teak or mahogany or of ebonite.

Beneath the baseboard a "false bottom" is to be fitted to provide a space for the condenser, which may be built up of sixty to eighty sheets of tinfoil, each 6 in. long by  $2\frac{1}{2}$  in. to 3 in. wide, separated by waxed typewriting or similar thin, tough paper and arranged with alternate sheets projecting for 1 in. at opposite ends to enable respective sets to be connected together. The complete assembly should be pressed together under a hot iron. Instead of building up a condenser of this description, which entails a good deal of work, a very serviceable two micro-farad condenser, complete in metal case and ready for securing beneath the baseboard of the coil, may be purchased quite cheaply from advertisers in this journal.

Details of the trembler or interrupter are shown in Fig. 6, which

together with the diagram of connections (Fig. 2) will enable the coil to be completed and connected up without any particular difficulty. The interrupter may be attached directly to the coil end or, as shown in Fig. 6, may be built up on a separate piece of ebonite and subsequently screwed to the coil end over the projecting core,

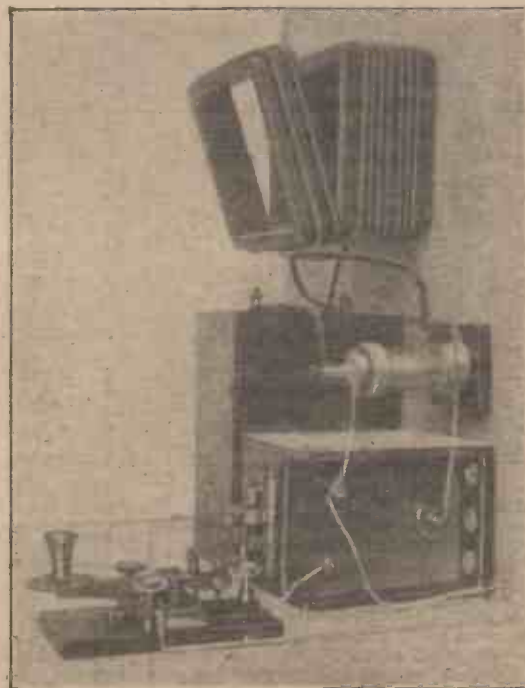

Fig. 1b.—Another Photograph of the Transmitter.

which should be left  $\frac{1}{4}$  in. longer for this purpose.

The purpose of the spark coil in a wireless transmitting set is to step-up the voltage of the current supplied by the accumulator battery, so that a considerable amount of electrical energy may be stored in the high-tension condenser until released by the passage of a spark across the spark-gap.

The action of the coil in fulfilling this purpose is as follows: When the transmitting key is depressed, current from the battery (say,  $1\frac{1}{3}$  amperes at a pressure of 6 volts) flows across the trembler contacts and through the primary winding of the coil, thus strongly magnetising the iron core and setting up a strong magnetic field about the same. As the growth of this magnetic field is comparatively slow, only a slight effect is produced in the secondary winding. Immediately the core is magnetised, however, the armature attached to the trembler blade is attracted, the platinum points open and thus break the primary circuit, and the magnetic field collapses with great rapidity, setting up a high-voltage current in the secondary winding.

For the production of a  $\frac{1}{4}$ -in. spark the voltage required is in the neighbourhood of 15,000 to 20,000 volts, and as the output must, of course, be less than the input, it will be seen that the current flowing at this voltage from the secondary terminals of the coil will be less than  $1/1,500$  of an ampere.

The large-capacity condenser, connected across the contacts of the trembler, facilitates the rapid cessation of current at "break" by absorbing the current due to the inductive effect of the winding, and prevents excessive sparking at the contacts.

The completed coil may be enclosed in a neat square box of polished wood with a small panel of  $\frac{3}{8}$ -in. ebonite attached or let into the top, carrying two brass terminals connected to the ends of the secondary winding. It is advised that the coil be carefully tested before the panel and terminals are fitted. Supposing the maximum spark obtained on test to be  $\frac{3}{4}$  in. long, the terminals should be spaced just a little less than this distance apart, so that if a disconnection in some outer circuit should occur the insulation of the spark coil will not be unduly strained, as a spark will take place between the terminals before any serious damage is done.

E. REDPATH.

[The concluding instalment will appear in the next issue.]

### Do You Like Work?

NO? But have you seen "WORK," the weekly journal for all interested in Handicraft? It is full of practical information, and the Publishers, CASSELL & CO., Ltd., La Belle Sauvage, Ludgate Hill, London, E.C.4., will be glad to send you a specimen copy gratis & postfree.

## RADIOGRAMS

BROADCASTING stations are to be erected at London, Birmingham, Manchester, Newcastle, Cardiff, Edinburgh or Glasgow, and Aberdeen. There are rumours to the effect that both Edinburgh and Glasgow are to have stations.

The wireless control of models will be a feature of the coming Radio Wireless Exhibition and Convention.

An invention is announced of a special form of typewriter that is operated by wireless. By the use of this machine signals received in Morse are automatically translated and reproduced as ordinary words on paper.

With the new interest aroused by the announcement of the almost immediate start of broadcasting, manufacturers of apparatus are being inundated with orders, and in most cases it is impossible to keep pace with the demand.

Mr. M. B. Sleeper, the American wireless expert who was recently on a visit to this country, in an interview before his return said that the United States Government had found it impossible to impose any fees on receiving sets. He thought the British Government were making a great mistake in imposing the present fee of 10s. Moreover, it would be a further mistake to increase it to £1, as is suggested.

The Postmaster-General's refusal to permit places of public entertainment to provide broadcasting concerts has caused a great deal of dissatisfaction, and as a result many contracts for the installation of apparatus have been cancelled. It is expected, however, that the refusal is only temporary.

The name of the new broadcasting company will be The British Broadcasting Company. There will probably be six manufacturers on the board of directors, with an independent chairman. A well-known public man has been invited to become chairman.

The broadcasting programmes are to include children's stories.

Marconi House is to be the broadcasting station for the London centre.

Lessons in French sent by wireless telephone from French stations broadcast to pupils in English schools are said to be a possibility in the near future.

An interesting article appears in the "Electrician" entitled "The Valve Tangle," in which some attempt is made to explain the position of valve patents. The following statements are on our contemporary's authority: There is no master patent; the Forest patent was allowed to lapse in this country, and there are now only constructional patents. On valve circuits for telephony reception there are no master patents. "The situation is obscure, but it may be stated that there are only two concerns who know what they are doing and can stand by their acts." On the one hand, the Marconi Co. is famous for the number of its patents, and has at least one firm licensed under them. On the other hand, there is what is termed the Elwell group, consisting of the Metropolitan Vickers Co., the Radio Communication Co., and the Mullard Radio Valve Co., and C. F. Elwell, all of which are financially interlinked. As regards the possessions of these two groups, Marconi's have patents which seem to cover regenerative reception and self-oscillation for transmission. The Metropolitan Vickers Co. own the heterodyne patent, and, as is well known, an action against the Marconi Co. has been begun.

The statement in the daily press to the effect that broadcasting was definitely to begin on Monday last was of a somewhat premature nature, for up to the end of last week the articles for the formation of the new broadcasting company had not been placed before the Postmaster-General, and until these have been approved by him the licence for broadcasting cannot be issued. In the London district a start will be made within a few days of the time these lines are in print, for all the broadcasting apparatus is ready. In the provinces, however, six or seven weeks must elapse before the regular work is entered upon, though there will, no doubt, be a number of experimental transmissions in the meantime.

Definite information of the broadcasting times and programmes are not yet available, but it is expected that there will be a six-hours' programme on each week-day evening from 5 till 11, and a Sunday programme lasting the whole day, probably beginning in the morning with a sermon.

# OUR INFORMATION BUREAU

Expert Replies to Readers' Questions. Hundreds of Replies are sent by Post.

TO ENSURE A PROMPT REPLY PLEASE OBSERVE THE FOLLOWING RULES

Write distinctly, give all necessary details and keep to the point. Ask one Question at a time—never more than two. Send a Stamped and Addressed Envelope. Send the Coupon cut from page 236.

## Adding Valve to Crystal Set

Q.—Please advise on some matters relating to the short-wave receiving set described in the Handbook "Wireless Telegraphy and Telephony."—F. C. (1737)

A.—The short-wave tuner (as described in Chapter VIII) should prove very serviceable for reception of the speech, etc., from the proposed new broadcasting stations, as the wave-lengths to be used are nicely covered by the range of the tuning coils. If it is desired to use this set in conjunction with a single-valve panel (such as is described in the Handbook), querist is advised to apply the valve as a high-frequency amplifier between the primary and secondary circuits, followed by the crystal as rectifier. The method of doing this is shown in the accompanying diagram, in which AT1 represents the present primary coil, L and S the inductance and condenser respectively of the secondary circuit, D the present crystal detector and T the telephones, whilst HT is the high-tension battery with usual reservoir condenser in parallel. If desired, additional

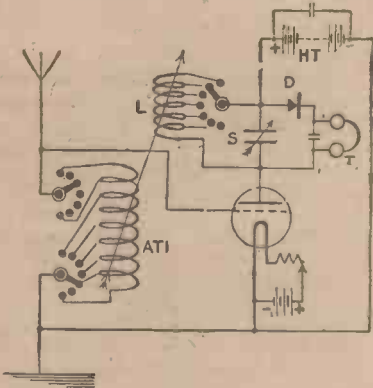

Adding Valve to Short-wave Crystal Set:

valves may be employed as L.F. amplifiers by removing telephones and connecting the primary of a step-up iron-core transformer to telephone terminals, the ends of the transformer secondary being connected to grid and negative side of filament of first L.F. valve, and the telephones being inserted in anode circuit of this (or subsequent) valve between anode itself and positive side of H.T. battery. Should the coupled tuner be preferred, a reactance coil 2 in. outside diameter by 2 in. long, closely wound with No. 36 or 38 s.w.c. d.s.c. copper wire, should be constructed and mounted so as to slide into the secondary coil (not into the primary as shown in querist's rough sketch). A variable condenser of, say, .0002 mfd. max. capacity will be suitable. For the tuner to cover wave-lengths from 600 to about 7,500 metres, querist should construct the coil as described in Chapter VII, and use in conjunction with a series-parallel variable condenser having a maximum capacity of, say, .0003 to .0005 mfd. and a reactance coil consisting of a former 4 to 4½ in. in diameter by 7 in. long, closely wound for 6 in. of its length with No. 30 or 32 s.w.c. d.s.c. copper wire, and provided with, say, four equal tapplings to facilitate self-oscillation over the complete range of wave-lengths.—CAPACITY.

## Short-wave Receiver

Q.—Please advise regarding testing of the short-wave set described in the Handbook "Wireless Telegraphy and Telephony," and also say if same can be used in conjunction with a valve panel.—H. B. (428)

A.—The result of the fourth test as mentioned in your letter certainly appears peculiar. With crystals in good contact and secondary switch removed from studs, the only path for current from potentiometer is via the secondary condenser, and if same is in good order a slight click should be heard, due to the charging of this condenser. Have you tried with several different pieces of mica insulation under secondary switch arm, and with secondary condenser temporarily disconnected? Also are you certain that the connections to the condenser are in order and not reversed? In the latter case, of course, a permanent short-circuit will occur. The reference to the "coupling lever" in connection with this condenser is an error. The murmuring sound reported is no doubt due to the application of rather too much potential to the crystal. Vary the potentiometer carefully until this sound just ceases, and then try on the aerial for 600-metre signals. Yes, the valve panel may be used with this set, the valve being used either as (a) detector, (b) H.F. amplifier, or (c) L.F. amplifier. The first-named is recommended, and the gear should be arranged as described and illustrated in reply to F. C. on this page.—CAPACITY.

(that is, earth) the aerial, I still hear the words very clearly, but lacking only in strength.

Secondly, with the above aerial connected with a single wire, average height about 18 ft. and 30 ft. long, slung in between two houses to the bottom of the garden, where it is again badly screened by trees, to form a sort of T aerial, I can listen comfortably, after adjusting the crystal, to 2MT. This I did on Aug. 9, and heard all the music well and nearly all the words. I think it is quite good, as there was considerable disturbance due to storms in the distance. Thirdly, I get ships on Morse all day. Time signals from FL (on 2,600 m.) and Perth (on 600 m.) come in well every morning, and a few days ago, when the 1,000 (G.M.T.) FL time signals broke down, I heard the following: "I apologise for the time signals from FL breaking down," in speech directly the signals had stopped. This again I consider to be good. The last item of importance is Croydon and its satellites. Speech comes through very well, and if the crystal is well adjusted the words are very clear. One often hears them calling up an aeroplane or the Havre station telling them "that there are low clouds at 800 ft." etc.

In conclusion, I would like to offer two hints to users of crystal sets: (1) If you don't use a loose coupler, and I, for one, am not in favour of it, then do use a two-slider type of tuner. Do not be content with a single slider; (2) purchase or make the most delicately adjustable crystal detector that you can afford. The whole of my success depends upon being able to vary the contact pressure to a nicety. Several beginners overlook this important point, which cannot be emphasised too much.—W. E. W. (London, N.).

## CORRESPONDENCE

### Cutting Glass Cylinders

SIR,—With reference to the article on cutting glass cylinders in No. 9 issue, a much simpler method is to tie a piece of strong cord securely round the bottle in the position desired, insert a piece of metal rod between the cord and the bottle, and twist the string till it is tight as possible. Then pour boiling water into the bottle, when it should crack in an even circle.—R. L. B. (Ashtead).

### Crystal Reception

SIR,—As a strong supporter of the simple crystal receiving set, I am writing to let readers of "Amateur Wireless" know a few positive facts as to what has actually been obtained on a crystal set, especially with regard to telephony. In the first place I, of course, like all other keen amateurs in London, receive 2LO very strongly. This in itself is not much to write about, but wait—I do not have to use an outside aerial, but only an indoor one, 18 ft. long, suspended under the rafters. If I disconnect this aerial during a concert from Marconi House, I still hear it well, and further still, if I short circuit

## The Broadcasting Company

THE statement printed below has been issued to the press by the Committee of Manufacturers who are at present engaged in creating the Broadcasting Company.

The Committee have observed that a number of unauthoritative statements have been made with regard to broadcasting, and desire it to be known that until the British Broadcasting Company is registered, and the board of that company has been appointed, no authoritative statement,

in so far as the Broadcasting Company is concerned, can be made with regard to the future of broadcasting.

The memorandum and articles of association of the company are in course of preparation, and as soon as these are approved the company will be registered and the Board appointed. Thereafter a full statement will be issued.

GEO. PELLIS,

Secretary (*pro tem.*),

The British Broadcasting Company,  
Marconi House, W.C.2,  
17th August, 1922.



## FORTHCOMING EVENTS

**Ilford and District Radio Society.** Aug. 24. Lecture by Mr. E. E. Hale: "Short Wave Reception, with Special Reference to Damped Waves."

**Tuxford and District Amateur Wireless Society.** Aug. 24. Morse practise. Lectures: "Elementary Theory of the Valve," "Hints on Apparatus." Aug. 31. Morse practise. Reception on society's apparatus.

**Ilkley and District Wireless Society.** Aug. 28, 8 p.m. At the Regent Café, Cowpasture Road, Ilkley. Morse practise.

**Leeds and District Amateur Wireless Society.** Aug. 28, 8 p.m. Informal meeting.

**South Shields Y.M.C.A. Wireless Society.** Aug. 30, 7.30 p.m. General meeting.

**Croydon Wireless and Physical Society.** Aug. 31. Meeting.

**Nottingham and District Radio Experimental Association.** Aug. 31. Meeting.

**West London Wireless and Experimental Association.** Aug. 31. At Belmont Road Schools, Chiswick, W. Meeting.

## TELEPHONY TRANSMISSIONS

**Elfler Tower (FL),** 2,600 metres. Each afternoon (Saturdays and Sundays excepted).

**The Hague, Holland (P C G G),** 1,085 metres. Aug. 24, 8-9 p.m.; Aug. 27, 2.30 to 5 p.m.

**Writtle (2 M T),** 400 metres. Aug. 29, 8 p.m.



## CLUB DOINGS

### Stockton and District Wireless Society

THE usual monthly meeting was held in the Concert Hall in the Malleable Workmen's Institute, Stockton, on August 10th. After the usual business was transacted the president distributed the prizes given by members of the society for the most expert readers of the Morse code open to members under the age of eighteen years. The remainder of the evening was taken up by a lecture given by Mr. W. B. Ward (of the Middlesbrough Wireless Society) on "High Frequency," which was illustrated by apparatus brought by the lecturer for this meeting.

### Ilkley and District Wireless Society

*Hon. Sec.*—MR. E. STANLEY DOBSON, "Lorne House," Richard Place, Ilkley.

THE third meeting of the above society was held at the "Regent Café," Cowpasture Road, Ilkley, on Aug. 10th, when it was decided to arrange a programme of lectures and demonstrations for the coming winter session. All members are asked to co-operate in this and also in procuring permanent headquarters, which are the most important requirement of the society. In order to enable members to listen in to The Hague Concerts, it has been necessary to transfer the monthly meetings to the second Monday in each month, and the Morse practice classes will be held on the intermediate Mondays.

## Liverpool Wireless Society

*Hon. Sec.*—MR. C. L. LYONS, 76, Oldhall Street, Liverpool.

A VERY successful and interesting meeting of the above society was held at The Royal Institution, Colquitt Street, Liverpool; on Aug. 10th.

The early proceedings were devoted to the answering of the question box which had been passed round, and Mr. Hyde explained away the difficulties of the questioners, illustrating his answers by very clear blackboard diagrams.

The evening was concluded by Mr. A. W. Robinson bringing into operation a "Burn-dept" 3-valve receiving set (1 H.F., 1 Rect., 1 L.F.), very kindly lent to the society for the evening. Very successful reception of both telegraphy and telephony was obtained, which was perfectly audible to all present, and which, in view of the fact that the instruments were operated in conjunction with an indoor aerial of but moderate dimensions, reflected great credit upon both the operator and the manufacturers of the set.

The next meeting will be held at the Royal Institution, Colquitt Street, Liverpool, at 7.30 p.m. on Thursday, August 24th.

## Blackpool, Fylde, Lytham and St. Annes Wireless Societies

*Hon. Sec.*—C. SHEFFIELD DOEG, "The Poplars," 6, Seventh Avenue, South Shore, Blackpool.

A BRANCH is now open in the south-west area of the Fylde District for the benefit of members who otherwise would have to travel upwards of ten miles to reach the Blackpool headquarters. On July 13th Mr. B. D. Taylor submitted for examination a home-made loud speaker, an adaptation of a motor-car petrol filler, and on July 20th he demonstrated the capabilities of a home-made but very well-constructed and compact single-valve set.

One of the many problems which the Society is tackling is the evolving of a circuit to prevent badly manipulated amateur stations causing interference.

## Otley and District Wireless Society

*Hon. Sec.*—MR. NOEL C. WESTON, 24, Guycroft, Otley, Yorks.

THE second meeting of the above society took place on Aug. 3, when Mr. Deny gave a short lecture on "Audible and Visual Methods of Signalling," giving useful hints on the use and abuse of the Morse key.

## Ipswich Y.M.C.A. Wireless Club

### Change of Address

THE address of the secretary, Mr. S. A. Samuels, is now 91, Orwell Road, Ipswich.

## Wireless Society of Hull and District

*Hon. Sec.*—MR. H. NIGHTSCALES, 16, Portobello Street, Hull.

A MEETING of the above society was held on August 14th, when Mr. Nicholson gave a lecture on "Accumulators, Their Use and Abuse." Judging by the numerous queries raised at the conclusion the lecture was of great use to many members.

The lecturer laid stress on the following

Amateur  
Wireless  
And Electrics

Querist's Coupon Available until  
Saturday, Sept. 2, 1922

points: (a) Buy a good accumulator; (b) buy it from a firm of repute; (c) let that firm keep it in condition.

The next meeting is an open one, and will be held on Friday the 25th inst., at 7.30 p.m., at the Signal Barracks, Park Street.

## Ilford and District Radio Society

*Hon. Sec.*—A. E. GREGORY, 77, Khedive Road, E.7.

THURSDAY, July 13th.—At the request of several of the members Mr. E. E. Hale had prepared a lecture on "Don'ts." Mr. Hale commenced with the aerial and worked through the set to the telephones, emphasising the things an amateur should not do under any circumstances, and criticising the experiments that while permissible are, from an amateur's point of view, best left alone.

Thursday, July 27th.—Mr. A. J. Thompson gave a lecture entitled "Aerials, Earths, and Wiring." The lecturer condensed his information exceedingly well, and his explanations of the different types of aerials in use with their respective merits and demerits were of the best.

Saturday, July 29th.—By the courtesy of the Electrical Engineer to the L.C.C. Tramways, a party of members was enabled to pay a visit to the Council's Generating Station at Greenwich.

## ANNOUNCEMENTS

"Amateur Wireless and Electrics." Edited by Bernard E. Jones. Price Threepence. Published on Thursdays and bearing the date of Saturday immediately following. It will be sent post free to any part of the world—3 months, 4s. 6d.; 6 months, 8s. 9d.; 12 months, 17s. 6d. Postal Orders, Post Office Orders, or Cheques should be made payable to the Proprietors, Cassell & Co. Ltd.

General Correspondence is to be brief and written on one side of the paper only. All sketches and drawings to be on separate sheets.

Contributions are always welcome, will be promptly considered, and if used will be paid for.

Communications should be addressed, according to their nature, to The Editor, The Advertisement Manager or The Publisher, "Amateur Wireless," La Belle Sauvage, London, E.C.4.

## WIRELESS EXHIBITION

under the auspices of

### The South London Wireless and Scientific Club

will be held

On 24th, 25th and 26th August

At ST. JOHN'S INSTITUTE

Larcom Street, Walworth, S.E.17

5 mins. Southwark Town Hall  
5 mins. Elephant and Castle

Open from 2 o'clock to 10.30 Thursday  
and Friday. 12 o'clock to 10 Saturday.

## SPECIAL ATTRACTIONS

Wireless Controlled Airship  
in operation by the inventor,  
Capt. de Villiers

WIRELESS CONTROLLED TORPEDO BOAT.  
BROADCAST RECEPTIONS, NUMEROUS TRADE  
AND AMATEUR EXHIBITS.

FRAME AERIAL TRANSMISSION AND RECEPTION.  
"COME AND HEAR YOUR OWN VOICE BY RADIO."  
MAGNAVOX AND OTHER LOUD SPEAKERS.

Light Refreshments at "Light" Prices.

Sec.: W. G. ANSELL,  
69, Larcom Street, S.E.17

Admission 1/-  
including tax.

# BROWN'S 'PHONES

Ex-Government. New. Unused. All Aluminium Diaphragms. Reconditioned and Guaranteed by S. G. Brown, Ltd.  
**WE ARE THE ONLY SUPPLIERS OF THESE HEADPHONES**

Prices quoted include Cords.

High Resistance, 55/- per pair. Low Resistance, 50/- per pair. Immediate delivery.

## BROWN'S UNUSED EX-GOVERNMENT 'PHONES

We also have a large stock of these which have not been reconditioned by Messrs. S. G. Brown, Ltd.

Prices quoted include Cords.

High Resistance, 4,000 ohms, **43/6** per pair. Low Resistance, 120 ohms, **37/6** per pair. **IMMEDIATE DELIVERY.**

**WE HOLD** the largest stock of Ex-Government Wireless Apparatus in the country.

**WE SUPPLY** also NEW Complete Sets and Accessories.

Visit our Stand No. 43, All-British Wireless Exhibition, Horticultural Hall, Sept. 30—October 7. The only Exhibition we are showing at.

### ILLUSTRATED CATALOGUE

**6d.** 16 pages. 100 Illustrations **6d.**  
 Also 4-page leaflet of complete sets  
 post free. post free.

When writing, please mention this publication.

## LESLIE McMICHAEL, Ltd.,

Providence Place, West End Lane, Kilburn, N.W. 6.

Bus Services 1, 8, 16, 28, 31, all pass West End Lane.

Telephone: HAMPEEAD 1261. Nearest Tube Station: KILBURN PARK (Bakerloo).

## OUR PRICES CANNOT BE BEATEN A FIRST CLASS RECEIVING SET IN POLISHED CABINET

Complete with double head 'Phones, 4,400 ohms, Federal make, Silicon Detector, all Terminals, etc., plated, 150 ft. Copper Aerial and two Insulators, also pocket inside cabinet for 'phones. Broadcasting range, 250 to 3,200 metres, or 25 miles telephony and 800 miles Telegraphy. Wiring diagram and instructions with each set. Price complete, £4 0 0 net, cash with order.

Price, without 'phones, £2 10 0 " " " " "

**CRYSTAL DETECTOR**, Swivel Arm, Terminals, Cup, etc., all plated and mounted on ebonite base, ready for use, 5/- each. **FILAMENT RESISTANCES**, for panel mounting, a speciality, 4/- each. **VALVE HOLDERS**, best quality ebonite, with nuts, 1/6 each. **KNOBS**, ebonite, 1 1/2 in. diameter, superior, 7d. each. **BRASS RODDING**, screwed 12 inch lengths, 0, 2, 3 or 4 B.A., 9d. each. **CONDENSER SPINDLE**, 1/2 in. sq. X 2 1/2 in. long, screwed 2 B.A. X 1 in. one end and 2 B.A. X 1/2 in. at other end, 6d. each. **CRYSTAL CUPS**, excellent finish, nut and washer, 5 1/2d. each.

Prices of all component parts on application and delivery from stock. Kindly forward sufficient to cover postage, any balance returned. Carriage paid on all orders over £2. All orders dispatched in strict rotation.

**T. W. HALL & CO.** (Manufacturers), 58, HARDMAN STREET, DEANSGATE, MANCHESTER.

# BUILD YOUR OWN CONDENSERS

NOTE REDUCED PRICES



SETS OF PARTS				
Approx. Capacity in Microfarads.	No. of Plates	Ready to assemble for Panel Mounting. Add 1/- each size for Cabinet Mounting.	Price assembled for Panel Mounting. Add 6d. if required for Cabinet Mounting.	Complete in Polished Mahogany Cabinet ready for use.
.0015	85	24/-	27/-	35/-
.001	57	18/-	21/-	27/6
.00075	43	14/-	17/-	22/6
.0005	29	11/-	13/6	18/6
.0003	19	9/-	11/6	16/6
.0002	13	7/-	9/-	14/-
.0001	7	6/-	8/-	12/6
.00005	3	—	4/6	9/6

Prices are for parts with Ivorine Scale and Pointer. Bevelled Dial, 3/6 extra.

Illustration shows for Panel Mounting

**THIS WEEK'S SPECIAL OFFER (DELIVERY FROM STOCK)**  
**FRENCH HEAD-PHONES, 4,000 ohms ... .. 35/-**

### CRYSTAL DETECTOR

(as illustrated). Ready for use with crystal. Price 4/6



SEND FOR ILLUSTRATED CATALOGUE (A) with list of stations. Crammed full of the latest and best.



THE CONDENSER KING

DON'T FORGET THE NEW ADDRESS:—

Featherstone House, 64, High Holborn, London, W.C.1.

Still at 17, Frome Rd., Wood Green.

# ! "CLIMAX" !

## SUPER 3-VALVE CONCERT SET

Enclosed in beautifully finished solid Mahogany Polished Cabinet with hinged lid. To see it is to be astounded at its value. Actual Makers.

### Set alone £7 15 0

**OTHER ITEMS OF SPECIAL INTEREST**

Ora valves, each... ..	15 0	.001 Condensers ... ..	2 10
4,000 ohm 'phones ... ..	£1 2 6	.005 " " " " " " " " " "	15 0
4 v. 40 A.H. accumulators	18 6	Filament resistances ... ..	3 9
H.T. Battery ... ..	7 6	Marconi 2,000 ohm 'phones...	18 6

**THE CLIMAX ENGINEERING CO.,**  
 182, Church St., Kensington, W.8. 'Phone Park 2023  
 Station—Circle or Tube—Notting Hill Gate.

## SCIENTIFIC APPLIANCES

HENRY J. DALE. W. HOLLINS.

11 & 29, Sicilian Avenue, Southampton Row, London, W.C.1.

Top of Kingsway. In Centre of London. Corner of Bloomsbury Square.

ELECTRICIANS. OPTICIANS. MECHANICIANS.

ACTUAL MANUFACTURERS at our Works, East Street, W.C., thus saving all intermediate profits.

The Store for all Electrical and Scientific Material

WIRELESS & RADIO MATERIALS,  
 PARTS and FITTINGS

Immense Stock constantly adding to, and Making; Specially for the Amateur to Build up a Set Complete and Perfect.

EBONITE. BATTERIES. AERIALS.  
 INSULATED WIRES. CRYSTALS.  
 ENGRAVED DISCS. MICA. HANDLES.  
 SWITCHES. TERMINALS. STUDS.

Scientific Appliances, 11 & 29, Sicilian Avenue, London, W.C.1.

VALVES. 'PHONES.

Call and see us. View our Show Windows. Send for List post free 2d.

Splendid Value in  
 Second-hand Appliances

Every Branch of Optical  
 and Applied Science

## COMPONENTS FOR WIRELESS SETS BY RETURN

ALL GOODS BRITISH MADE

AMATEURS note our PRICES

Contact Studs, 1/2" x 1/2" ... ..	11d per doz.	Valve Holders ... ..	1/3 each
Spacer Washers (large) ... ..	3d " "	Egg Insulators ... ..	6d " "
Spacer Washers (small) ... ..	3d " "	Fusible Alloy (for mounting	
Valve Sockets ... ..	3d each	Crystals ... ..	6d bar

Aerial Wire, Condenser Segments, etc., etc., at equally low prices.

FREE ADVICE BY OUR EXPERT STAFF.

Carriage FREE on lots of 10/- and over.

To Wireless Clubs and Societies:

We are prepared to give you special terms. Get your Secretary to write us.

To the Trade:

Best Trade Discounts and prompt deliveries.

**L. WITHERS GREEN,**

110, VICTORIA ST., WESTMINSTER, S.W.1. [PHONE: Victoria 2053.]



# 30/-

with immediate delivery from stock

## MULLARD TELEPHONE HEAD SETS

specially made for the reception of wireless broadcasting, are thoroughly well-made and fit securely and comfortably to the head.

*British Manufacture*

The two high resistance ear pieces (4,000 ohms total) are flexibly attached to the fully adjustable, double head bands.

The set is nicely finished in nickel plate and supplied complete with standard flexible cords

A large stock is available at once but is being rapidly booked up. Send the coupon to-day to secure immediate delivery.

*These telephones are made by the makers of the famous ORA valve and Mullard valve accessories*

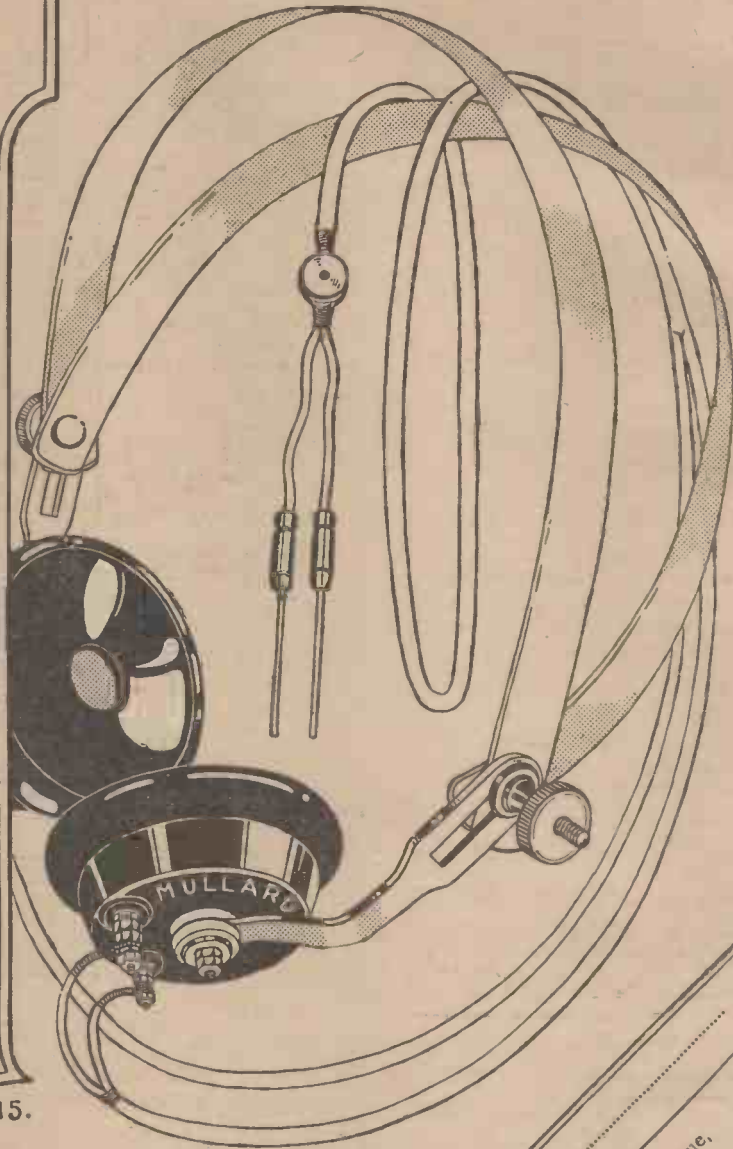

E.P.S.

15.

# Mullard Radio Valve Co. Ltd.

Claybrook Road, Hammersmith, W.6.

Contractors to H.M. Admiralty  
War Office, Royal Air Force & Post Office.

Telephone: Hammersmith 312  
Codes: ABC(S Ed)  
Telegrams: Radiovalve Hammer Lond



Name and Address		Please send me post free		I enclose (Cheque, Money Order, P.O.) value	
Quantity	Description	Price		to cover	the cost.
.....	Telephone Head Sets	30/- per set			
.....	ORA Valves	15/- each			
.....	Grid A Resistances	6/- "			
.....	Anode A or B Resistances	2/6 "			
.....	BA Condensers, 0.002 mfd.				
.....	Combined Resistance and				
.....	Valve Bases with	7/6 "			
.....	Terminal Clips	6/- "			
.....	Valve Sockets	1/3 "			
.....	Terminal Clips	9d. per pair			

Name of usual Wireless dealer

**SEND THIS TO-DAY**

# WIRELESS



**POST FREE**

2,000 ohms - - 24/-  
4,000 ohms - - 25/-

## SPECIFICATION.

**CORDS.**—Twin conductor Tinsel, 3 ft. long between butt and fork, 12 in. long from fork to each Receiver. Instrument end fitted with 2-Plug Type Metal Tags.

**RECEIVERS.**—Arranged in series and wound to 2,000 ohms, 4,000 ohms, or as required. Magnets of specially treated Tungsten Steel Mounted in Aluminium Cases and fitted with Adjustable Steel Head Bands of extremely light but serviceable pattern.

□ □ □

**THE NEW SYSTEM PRIVATE TELEPHONE COMPANY, Ltd.**  
212-214, GREAT PORTLAND STREET, W.

Telephone: Mayfair 3779  
Telegrams: Telepathic Wesdo, London.

# A Perfect Aerial for 10/6

- 100 feet 7/22 Stranded Copper Wire.
- 100 feet 7 Stranded Steel Insulated Cord for guys and bracing (as pliable as string, but of enormous strength).
- 2 Six feet Spreaders with porcelain insulators fixed.
- 1 Steel Coil Spring.
- 1 Mast Pulley.
- 1 10-inch Ebonite leading-in tube, with brass rod and terminals.
- 1 bottle "Flux" for soldering joints.
- Plan, with complete instructions, for erection of various types of Aerial.

*Carriage Paid.*

**TEN SHILLINGS AND SIXPENCE**

Cannot be purchased elsewhere at double the price.  
. . . All material guaranteed finest obtainable. . .

**Econ Manufacturing Company, Ltd.**  
6, HOLBORN VIADUCT, LONDON, E.C.1

*Phone: City 4148*

## RELIABLE APPARATUS AT POPULAR PRICES

CRYSTAL SETS, VALVE SETS, etc. EVERY  
NECESSITY & LUXURY FOR THE WIRE-  
LESS EXPERIMENTER.

*Fully Illustrated List of Wireless Goods, post free, 4d.*

## H. D. BUTLER & CO., LTD.

Office: BANK BUILDINGS, 222, GT. DOVER ST., S.E.1  
(Opposite Boro Tube Station).

Works: CANONBURY, LONDON, N.1  
Telephone: Hop 3029. Teleg.: "Ingeniuity, 'Phone London."

## SPECIAL THIS WEEK ONLY

**AERIAL WIRE** (Bright Drawn), 3/6 100 ft.  
" " (Enamelled), 4/6 100 ft.  
—Including 2 Insulators—  
*Postage extra.*

**HENRY J. BREWSTER & CO.,**  
11, Queen Victoria St., London, E.C.4.



**SIMPLICITY**

**“K.B.” UNITS**  
**EFFICIENCY**

**ECONOMY**

IMMEDIATE DELIVERY

IMMEDIATE SATISFACTION

By means of these units you can build up a complete one to seven valve receiving set in easy stages to suit your pocket, while in the meantime the units already bought are in themselves a complete receiving set, whatever their number may be. All you have to do is to place the units side by side straight across and connect with the brass links provided.

**HERE THEY ARE:—**

<p><b>UNIT No. 1.</b></p>  <p><b>CONDENSER PANEL.</b> No. Required : Optional. <b>Price.</b> Complete (as shown) 34/- each. Set of Parts (panel only) 22 6 per set. Mahogany Cabinet 6/- each.</p>	<p><b>UNIT No. 2.</b></p>  <p><b>DETECTOR PANEL.</b> No. Required : One. <b>Price.</b> Complete (as shown) 34/6 each. Set of Parts (panel only) 20/- per set. Mahogany Cabinet 6/- each.</p>	<p><b>UNIT No. 3.</b></p>  <p><b>L.F. AMPLIFYING PANEL.</b> No. Required : 2, 2 or 3. <b>Price.</b> Complete (as shown) 43/6 each. Set of Parts (panel only) 33/- per set. Mahogany Cabinet 6/- each.</p>	<p><b>UNIT No. 4.</b></p>  <p><b>H.F. AMPLIFYING PANEL.</b> No. Required : 2, 2 or 3. <b>Price.</b> Complete (as shown) 33/6 each. Set of Parts (panel only) 18/6 per set. Mahogany Cabinet 6/- each.</p>
--	---	--	--

We also hold large stocks of complete Receiving Sets, Coilholders, Coils, Variable Condensers (Assembled and in Parts), Valve Holders, Filament Resistances, H.T. Batteries, Accumulators, Aerial Insulators; in fact ALL AMATEUR REQUIREMENTS.

**TRADE INQUIRIES INVITED. CATALOGUE A/W, Post Free, 4d.**

**COME AND “LISTEN IN” AT OUR SHOWROOMS. Open Daily from 9 a.m. till 7 p.m.**

**THE “K.B.” RADIO EQUIPMENT COMPANY**

Head Offices and Showrooms : 109, High Road, Kilburn, N.W.6

Bus Services—8, 16, 28 and 51, pass door.

3 Minutes Kilburn Park Station (Bakerloo Railway)

**WIRELESS HEADPHONES**

4,000 ohms Total Resistance. :: Delivery from Stock.

**DOUBLE HEADBAND, each receiver detachable instantaneously.**

Guaranteed highly efficient, complete with flexible cord and ready for use.

**36/- PER SET.** Postage 1/- ex'ra.

**LOWTH & SMITH, Ltd.,** 3, HANGING DITCH, MANCHESTER.

Our Speciality—WIRELESS

**ELECTRICAL SUPPLY STORES**

5, Albert Terrace, King Cross, Halifax, England.

Our Motto—PROMPT SERVICE

LIST, TWO STAMPS

**WE PUBLISH WINNERS. AUGUST 5th ISSUE**

Question: At what station does the train of oscillations stop?

Best answer: Crystal (Palace).

SENSITIVE

Sent by:—S. W. BASTOWE, 18, Moysers Road, Streatham, S.W.16, who has been presented with a parcel of goods chosen by himself.

EFFICIENT

**HEAD RECEIVERS AND LOUD SPEAKERS**

**OUR AIM**

Maximum efficiency with low production costs enabling us to sell both Receivers and Loud Speakers at most attractive prices.

All are tested before leaving works and any not meeting the test are rejected.

**PHONES**

140 ohm .. .. 30/-  
4000 „ .. .. 32/-  
8000 „ .. .. 33/-

Complete with Cord

**LOUD SPEAKERS**

70 ohm }  
2000 „ } £2 10 0  
4000 „ }

Complete with Cord.

Delivery, 1st week in September.

EXTRACTS FROM OUR PRICE LIST. (4d. post free.)

Condenser Vanes, 1/- dozen; postage, 2d. dozen. Valve Holders, best moulded ebonite, complete with nuts, 1/4 each; postage, 3d. each. 1 1/2-in. diam. Knobs, 7d. each; postage, 3d. each. Aerial Pulleys, 1/- each; postage, 3d. each.



LIGHT



Of Substantial Construction

Cent. 4209. Phone ] **J. L. CARTWRIGHT & Co.,** Manufacturing Electrical and Radio Engineers, Dept. A, 130/132, London Road, Manchester. Grams: Pladuram, Manchester. WORKS: BERRY STREET.

LIBERAL DISCOUNTS TO THE TRADE

# "PALMERFONES"

## These Super-Sensitive Head Phones

are the result of many years experience, and over 30,000 of these have been purchased during the last four months, and repeat orders are being given which prove their

### EXCELLENT VALUE

PRICE ... 29/- over counter - 29/6 by post  
WE ALSO SUPPLY 120, 2,000, 6,000 and 8,000 ohms HEAD PHONES

- "Federal" Head Phones, 2,200 ohms, 35/..
- Diograph Radio Head Phones, 3,000 ohms, 35/..
- Federal Loud Speakers, 65/..
- Brown Loud Speakers, 110/..
- Magnavox Loud Speaker, "Junior" Type, 210/..
- Magnavox Loud Speaker, "Senior" Type, £20.
- 2-Valve Power Amplifier, complete with valves, but less batteries, (for Magnavox), £22 10s.
- 3-Valve Power Amplifier, complete with valves, but less batteries (for Magnavox), £35.
- Crystal Tuner, auto coupled, complete with condenser and crystal, £1 18s.
- Crystal Tuner, double slide auto coupled, complete with condenser and crystal, £2 13s. 6d.
- Ebonite Valve Holders, 4 legs, with nuts and washers, 1/..
- Ebonite Valve Holders, complete, best quality, 1/9.
- Ebonite Slider and Plunger, 8d.
- Ebonite Knobs, 1 1/2 in. dia., knurled edges tapped 2BA, 6d.
- Ebonite Sheets, various thicknesses (cut to any size), 4/6 per lb.
- Switch Arms, complete, 2/6.
- Condenser, fixed and moving vanes, aluminium, per doz. pairs, 2/..
- Condensers Spacer Washers, large and small, per doz. pairs, 1/3.
- Condensers, complete, 4/6.
- Condensers (Dubilier), 0.001, 0.002 and 0.003, 3/- each.
- Ditto ditto fitted with grid leaks, 7/6 each.
- Condenser, "Veda," with grid leak, 5/- each.
- Condenser, "Veda," fixed .001, 2/6.
- Condenser, Vernier, 7/6.
- Condenser, Variable, .0005, 12/8.
- Contact Studs, with nuts and washer, per doz., 8d.
- Crystal Cups (small and large), each, 2d. and 6d.
- Crystal Detector, 5/6.
- Lightning Arresters, 2/..
- High-Frequency Transformer (former 8 divisions) 4/6.



## DELIVERY FROM STOCK

Every Set is thoroughly tested, and all are guaranteed in perfect condition, readily adjusted to any position. Very light and comfortable. Standard resistance 4,000 ohms

EACH COMPLETE WITH DOUBLE HEAD GEAR WITH CONNECTING CORD

- Leading-in Tube, 6 in. long, 2/..
- Copper Foil, 4 x .002, per lb., 2/8.
- 2-Coil Holder, with extended arm, complete for panel mounting, 12/9.
- 3-Coil Holder, with extended arm, complete for panel mounting, 17/6.
- Inductance Tube, 5/..
- Valve Legs, with nuts and washer, each set, 3d.
- Valve Pin, 2d.
- Terminals, complete, small and medium, per doz., 1/8.
- Terminals, complete, large, per doz., 2/..
- Square Brass Centre Rods for Condenser, 6d.
- Sets of Rods, 1 square 3 round, screwed 2BA, complete with nuts and washers, 1005, the set, 1/8.
- Ditto ditto .001, 1/3.
- Ditto ditto .0003, .0002, .00075, the set, 1/..
- Ditto ditto .0001, .00005, the set, 10d.
- 2 B.A. Brass Screwed Rods, 12-in. lengths, 5d.
- Brass Nuts, 2BA, 4BA, and 5BA, per doz. 4d.
- Tuning Bar Square Brass Rod, in 13-in. lgths., 5d.



- Insulators, porcelain, small egg shape, 3d.
- Insulators, porcelain, 2-in. reel, 4d.
- Insulators, large shell type, 8d.
- Ivory Scales, 6d.
- Aerial, Earth and Phone Labels, each, 3d.
- Aerial Wire, 100 ft. 7/22, with 2 insulators, each set, 4/6. [2/6.]
- Aerial Silicon Bronze Wire, 18 gauge, per 100 ft., Wireless Masks, in 4 sections, 11 ft., 4/9.
- Filament Resistance, 5/..

CASH REFUNDED IF NOT SATISFIED

**GEORGE PALMER,** WIRELESS AND SOUND TRANSMISSION SPECIALIST,  
47, GERRARD STREET, LONDON, W.1.

## WIRELESS ITEMS TO NOTE

- 7/22's Aerial Wire, enamelled, copper wire ... 100 ft. 5/6
  - 7/22's Aerial Wire, bare, ditto ... 100 ft. 4/6
  - Condensers, variable, ebonite plates, ebonite knob, ivory scale 0° to 180° ... each 16/6
  - In mahogany cabinet, complete ... 19/8
  - Condenser, .0005, as above, minus cabinet ... 12/8
  - In mahogany cabinet ... 15/6
  - Contact Studs, highly polished, nut and washer doz. 1/9
  - Terminals, highly polished, nut and washer ... doz. 2/3
  - Insulite Sliders, ebonite, spring and contact... each 7/6d.
  - Ebonite, any thickness ... per lb. 4/9
  - Circular Condenser Disc, 4 in. diameter, 1/2 in. thick ... each 1/2
  - Ivory Scales, 0° to 180°, The Best ... each 10d.
- Carriage paid on orders over £2. Stamp for list. Trade supplied.

**WRIGHT BROS.,** ELECTRICAL ENGINEERS,  
38a, Cross Street, Sale, Manchester.

**L.F. INTERVALVE,** L.F. TELEPHONE,  
25/-, Post Free, Guaranteed. 25/-

## INTERVALVE & TELEPHONE TRANSFORMERS

SUPPLIED FROM STOCK FROM  
M.E.C., WIRELESS LABORATORIES, CROWN HILL ROAD, LONDON, N.W.10.

## WIRELESS AMATEURS AND RETAILERS PARTS SUPPLIED FROM STOCK

List free. Condenser Plates, 1/6 doz. pairs (stock 3d.).  
FRASER, SENTINEL HO., SOUTHAMPTON ROW, LONDON

## SPECIAL PURCHASE

2,000 PAIRS SUPER-SENSITIVE HIGH-RESISTANCE HEADPHONES  
4,000 OHMS. BRAND NEW. DELIVERY FROM STOCK. £1 7s. 6d. POST FREE.

**OLIVER'S WIRELESSORIES,**  
196, Wandsworth Bridge Road, Fulham, S.W.6.  
Phone, Putney 1257.

## WE SPECIALISE IN ACCESSORIES.

Condenser Vanes, 1d. each, 9d. doz., 8s. gross. Contact Studs, with nut and washer, 8d. doz. Spacer Washers, 3d. and 5d. doz., 2s. 8d. and 4s. 6d. gross. Ebonite Knobs drilled and tapped 2 B.A., 6d. each. Ebonite Valve Holders, with nuts, 1s. 3d. each. Valve Legs, with nut and washer, 1 1/2d. each, 1s. 4d. doz. Crystal Cup, with screw, 2d. each, 1s. 6d. doz. Special Alloy for fixing crystals, 6 in. stick, 8d. Postage extra.

**BLACKHEATH ELECTRICAL SUPPLIES,**  
2a, Russell Place, Old Dover Rd., Blackheath, S.E.3.

## WE ARE BROADCASTING

All kinds of pressed, stamped, machined and die-cast parts for wireless. SPECIALITY: "NUBIANITE" moulded, insulators, knobs, valve-holders, coil-holders, etc. Tougher than ebonite.

**ACCUMULATORS**  
Specially made for wireless. No surplus junk. Manufacturer or Amateur supplied. "Transmit" your requirements to us. List 4d. Returned on first order over 5s.  
**THE NICKOLLS TOOL & MFG. COMPANY,**  
133, Lennox Street, Lozells, Birmingham.

**INDUCTANCE TUBES.**  
Length 12 in. ..  
Dia. Dia.  
3 1/2 in. .. 6d. 4 in. .. 1/-  
3 in. .. 8d. 5 1/2 in. .. 1/6  
3 1/2 in. .. 10d. 6 in. .. 2/-

**SMALL CONDENSERS.**  
.0004 & .0005 .. 3/-

**ANODE RESISTANCE.**  
50,000 & 82,000 ohms 8/6

**VARIABLE ANODE RESISTANCE.**  
20,000 to 100,000 ohms, 7/6

**FILAMENT REBOSTAT.**  
5/-

**CONDENSER PARTS.**  
Fixed and Moving Vanes, 2/6 dozen.

**CENTRE ROD.**  
4 1/2 in., 4/6 each.

**LAMINATED SWITCH ARMS.**  
2/6.

**VALVE SOCKET, 1/9.**

The **Universal Electric Supply Co**  
4 BROWN ST OFF MARKET ST  
MANCHESTER

G.P.O. Box No. 519.

Large **CATALOGUE** 30th Edition,  
Post Free 6d.

**VALVE SOCKET TERMINALS.**  
1/3 per set of 4.

**CONTACT STUDS.**  
Small size 2/- doz.  
Large size 3/- ..

**AERIAL INSULATOR.**  
1 1/2 in. 1/8 2 1/2 in. 2/6  
2 in. Reel Type, 6d.

**AERIAL WIRE.**  
Per 100 feet.  
3/20 .. 4/- 7/22 .. 5/-  
3/19 .. 4/6 3/18 .. 5/6  
6 7/10 .. 7/6

**REGULATING SCREW, 1/-**

**EBONITE KNOBS, 1/- & 1/6.**

**INSULITE SLIDERS, 1/-**

**KNIFE SWITCHES.**  
S.P. 1 way, 1/3 ; 2 way, 2/4  
D.P. 1 way, 3/6 ; 2 way, 6/-

**GRID CONDENSER and LEAK, 7/6.**

**BLOCKING CONDENSER, 5/-**

**GRID LEAK, 3/-**

**PLUG CONNECTOR, 2-Pin, 1/6.**

**CRYSTAL CUP.**  
Single Cup Type .. 6/6  
Three .. 21/-

**SINGLE RECEIVER,**  
With Head Band and Cord.  
100 ohms .. 24/-  
500 .. 27/6  
1,000 .. 30/-  
2,000 .. 32/6

**DOUBLE RECEIVER.**  
With Head Band and Cord.  
2,000 ohms .. 35/-  
4,000 .. 37/6  
8,000 .. 45/-

**SKELTON BUZZER.**  
Extremely sensitive, for Crystal Testing, 2/6

**HIGH-TENSION BATTERIES.**  
15 volts .. 8/6

Variable Type,  
36 v., Tappings every 3 v., 7/6.

**ACCUMULATORS.**  
Volts. Amps.  
4 40 28/-  
4 60 35/-  
6 40 42/-  
6 60 52/-

POSTAGE EXTRA.



Specially designed for Broadcasting

### HEADGEAR RECEIVERS

Designed and manufactured by leading Telephone Manufacturers. Backed by many years experience. Highest efficiency, concentrated magnetic field, instantaneously adjust'd to the ears, comfortable in wear, either receiver detachable from head-band, protected terminals, light weight, twin series cord.

**A.T.M. LOUD SPEAKING RECEIVERS.**

Three types of Amplifying Horn.

**A.T.M. CRYSTAL DETECTOR SETS.**

Highest Grade. Maximum Efficiency Moderate Cost.

Ask your dealer for

### A.T.M. Broadcasting Apparatus

**AUTOMATIC TELEPHONE MANUFACTURING CO., LTD.**

Head Office & Works: Milton Road, Edge Lane, Liverpool.

London Office: 60, Lincoln's Inn Fields.

## DAVIS & TIMMINS LIMITED

34a, York Road, King's Cross, N.1

## SCREWS AND TERMINALS FOR WIRELESS SETS



**VALVE HOLDERS**, mounted on ebonite, screwed legs and nuts, as illustrated, each 1/-  
 Grid Leaks, Tubular type (2 megohms) ... 2/-  
 Condenser Vanes, flat; accurate gauge and size; per doz. 1/-  
 Do. Spacers, large (true to .001") per doz. ... 5d.  
 Do. " small ( " " " ) " " " ... 3d.  
 Do. Ivorine Scales, 0-180°, ... 1/-  
 Do. Ebonite Tops and Bottoms (Bushed) ... 1/-

Inductance Tubes, 12" x 3" ... 6d.  
 " " " 12" x 4" ... 9d.  
 " " " 12" x 5" ... 1/-  
 Sliders, ebonite with plunger ... 6d.  
 Square Brass Rod, 12" x 1/4" x 1/8" ... 1/-  
 Enam. Wire, 23 gauge, 1/2 lb. ... 1/-  
 Crystals, Galena, Bornite, Silicon, Carborundum, Zincite, etc. ... 6d.  
 Crystal Cups, with fixing screw ... 6d.  
 Aerial Wire, stranded, 7/25, 100 ft. 3/8  
 Hellesen 36v. H.T. Batteries, with Wander plug ... 8/6  
 Headphones, English adjustable headgear, excellent for speech and music, 2,000 ohms 30/-, 4,000 32/6  
 A.E.C. & Telefunken Valves tested 10/8  
 Egg Insulators ... 6d.  
 Panels, Tuners, etc. Postage extra.

THE **ESSEX WIRELESS CO.** 499, GROVE GREEN RD., LEYTONSTONE, E.11. (1 min. from Station, G.E.R.)  
 Telephone—WANSTEAD 749.

### OUR PRICE FOR THIS OUTFIT

Carriage **£7 15 0** Paid

### READ THE SPECIFICATION OF THE WONDERFUL F. & B. SINGLE VALVE SET

EVERYTHING INCLUDED.

Well finished wood base, upon which is mounted Inductance Coil and Slider, Valve Base, Mullard Valve, Filament Resistance. Grid Condenser and Leak, with all necessary terminals and connections made, and insulation to all back connections. 6 volt 20 ampere Accumulator for the low tension and 60 volt high tension Battery. 100 feet of 3/20's Aerial Cable with necessary insulators, leading-in tube and earthing clip. Pair of Double Head Receivers, 4,000 ohms total resistance, included. We also supply a very reliable crystal set, everything included, **£4 15 0**.

NO EXTRAS TO BUY.

ORDERS EXECUTED IN ROTATION — SEND AT ONCE TO SAVE DELAY  
**FOX & BRATBY, Ltd.,** 34, Duke Street, St. James' Mail Order Department, PICCADILLY, S.W.1

### DON'T MAKE haphazard purchases till you have sent for our CATALOGUE of

**RADIO, ELECTRICAL & MECHANICAL SUPPLIES. SCIENTIFIC SUPPLY STORES**  
 8, NEWINGTON CAUSEWAY, LONDON, S.E.1.

WIRELESS INSTRUMENTS, ACCESSORIES and MATERIALS

We stock everything for the Experimenter who wishes to build his own Set.

### FOR TOOL BARGAINS

CALL or WRITE TO-DAY to;

Before buying elsewhere compare our prices. Remember, we have the Largest Stock of Tools to select from in London. We guarantee you satisfaction, so you can safely shop by post. Bargain List sent post Free.

**GEORGE ADAMS,** DEPT. A/W, 255-5, HIGH HOLBORN, LONDON, W.C.1.

### GRIFFIN'S BUSINESS FORMULA: QUALITY + EFFICIENCY + DESPATCH = CONFIDENCE

#### "Griffin" Super CRYSTAL SETS

Approx. Range 300/2000 meters.

Price 38/- A REAL BARGAIN

Accumulators, Fuller Block.

Volts.	Amps.	£	s.	d.
4	40	1	12	6
6	40	2	8	9
8	40	3	5	0
10	40	4	1	3
12	40	4	17	6

Other makes at Standard Prices.

#### TELEPHONES—High Resistance

Excellent Value	4,000 Ohms	30/-
Sterling's	120 Ohms	48/-
Brown's	4,000 "	52/-
"	120 "	60/-
"	8,000 "	67/6
Sullivan's	4,000 "	42/6

#### MAGNAVOX LOUD SPEAKERS

Junior £10 10 0  
 Senior £20 0 0

Order Quickly

#### CONDENSERS—Ebonite Mounted

	Circular or sq. Mah. Box	
.001	.0005	.0003
28/6	25/-	22/-

Partly assembled for Panel Mts.  
 .0003 12/9

Coilholders—3 Coils, 21/-  
 Aerial Wire per 100 ft. bare copper stranded, 7/22, 4/-

Inductance Tubes—Wound; 12 x 4 7/-; 12 x 3 6/-

Crystal Detectors.  
 Griffin latest design 10/-  
 Reliable Type 5/6.

Insulators—Shell 1/6, Egg 10d., Reel 2d. & 1 1/2d. each. Resistances for Panels 4/9.

Ebonite Knobs—6 1/2d. ea. Sheet and Rod 5/- lb.

Terminals—Small 2/-, Large 3/- doz. 2 BA Brass Rod 1/4 per ft. 1/6.

Spacers doz. 7d. and 4d.  
 Spindles for Condensers 9d. & 4 1/2d. ea.  
 Sliding Plungers—6 1/2d. each. Superior quality 2/-

"Griffin" Cabinets and Panels, etc., to your own specification in Mahogany and Oak.

LET US QUOTE YOU, VALVES.—All makes at Standard Prices.

WIRE Enamelled  
 .24 .28 .30 .32 .34 s.w.g.  
 2/8 3/6 3/10 4/2 4.4 per lb.

WIRE d.c.c.  
 .28 .30 .34 .36 .38 .40 s.w.g.  
 4 7 5/6 8 3 10 2 13 2 18/- per lb.  
 Other Gauges see our List

Terms Cash. Delivery Free over £2. Write for comprehensive List of all Accessories, post free 3d. (returned on first order).  
**GRIFFIN WIRELESS SUPPLIES CO.,** 80, NEWINGTON CAUSEWAY, LONDON, S.E.1.  
 Telephone: HOP 1806. Telegrams: IFFINGRACO, LONDON. TRADE INQUIRIES INVITED.  
 (2 minutes from Elephant and Castle Tube Station.)

# "LISTEN-IN" ON THE STERLING No. 1 CRYSTAL W/T RECEIVING SET



**Immediate  
Delivery**

*The Sterling No. 1 Crystal Receiver has been specially designed for use in connection with the Wireless Telephony Broadcasting Scheme and is suitable for a range of about 25 miles.*

The set comprises:

- 1. TUNER.**—This consists of an inductance which can be varied by means of tappings taken to stud switches. Two of these are fitted, one for coarse and the other for fine adjustment. A separate coil is provided which can be plugged into a fitting at the back of the instrument (as illustrated) for reception of time signals, etc., from Eiffel Tower.
- 2. DETECTOR.**—This is of the crystal type, requiring no battery, and is designed to give universal adjustment over all parts of the crystal.

The apparatus is mounted on ebonite panel and fitted in polished walnut case.

The equipment includes one pair of No. R1258 DOUBLE HEAD TELEPHONES wound to a total resistance of 2,000 ohms the pair.

**Sterling Telephone and Electric**  
TELEPHONE HOUSE, Co., Ltd.,  
210/212, Tottenham Court Road, London, W.1.  
Telephone No.: 4744 Museum (7 lines). Telegrams: 'Cucumis, Wesdo, London.'  
Works: DAGENHAM, ESSEX.  
BRANCHES: NEWCASTLE-ON-TYNE: 9, Clavering Place.  
CARDIFF: 8, Park Place.

**PRICE - £7 12 6**

## Exide BATTERIES FOR WIRELESS

We specialise in the manufacture of batteries for filament current supply to Valves, and high-tension batteries for application, of Anode Potential. We can supply these batteries in glass, ebonite, or celluloid containers to any desired voltage.

Exide batteries can be relied upon for Wireless work, and retain their charge over very long periods.

Prices and Particulars upon application.



6 v. 80 ampour Exide Battery

**THE Chloride** ELECTRICAL STORAGE COMPANY LIMITED.

Head Office:  
CLIFTON JUNCTION,  
MANCHESTER.

London Showrooms:  
219/229, SHAFTESBURY  
AVENUE, W.C.2.

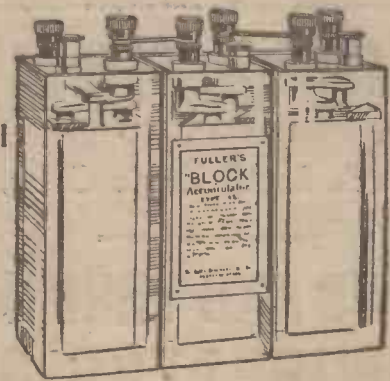

## INSIST ON HAVING A FULLER "BLOCK" TYPE ACCUMULATOR

FOR YOUR WIRELESS SET!

The only Accumulator on the market that will hold its charge from 12 to 18 months when not in use.

4-volt 40 amp. hours, £1 12 6, plus 1/3 carriage  
6-volt 40 " " £2 8 9, " 1/6 "

Note:—These prices are 33% below those of the actual makers.

**8,000 Sold. 20,000 still in stock.**

Descriptive and Instructive Pamphlet on request from—

**The CITY ACCUMULATOR Co. (Dept. 14),**  
79 Mark Lane, E.C.3 (Tel. No. Avenue 91)

ALSO SUPPLIED BY—

Selfridge & Co., Ltd., Wireless Section; A. W. Gamage, Ltd., Wireless Dept.; Barnsley British Co-operative Society, Radio Section; Richford and Co., 153, Fleet Street, E.C.3.1  
The South Wales Wireless Installation Co., Ltd., 18, West Bute Street, Cardiff.