

Amateur RADIO

For all two-way radio enthusiasts

50MHz – expectations
realised

Construction:
simple add-on
audio filter

Making the most
of the minima



On test: Icom IC761A HF transceiver

R. WITHERS COMMUNICATIONS LTD

Manufacturers, importers and suppliers of world famous communications products
584 HAGLEY ROAD WEST, OLDBURY, WARLEY, WEST MIDLANDS B68 OBS
 021-421 8201/2/3. VODAFONE 0836 514009. PRESTEL MBX 214218216 FAX 021-421 2468
 Amateur Radio. Business Radio. Radio Telephones. Sales. Service Accessories and antenna systems.



YAESU



**THE TECHNICALLY ORIENTATED
 RADIO COMMUNICATIONS
 SPECIALISTS.**

**100kHz TO 950MHz IN ONE BOX!
 (ALL MODES)**

YAESU FRG9600/RWC MK3 HF-UHF SERIES

After many months of research and development RWC LTD are pleased to announce their latest HF modification for the Yaesu FRG9600 which now includes LF/HF/VHF/UHF coverage from 100kHz to 950MHz and improved Meter and a typical receiver sensitivity now $>2\mu\text{V pD HF}$ 15/60-950MHz all @ 12dB SINAD. (Please contact us for detailed specifications)

We have fitted a High performance HF Front-End modification by AKD. The new HF section is fitted internally with a tuning circuit and a band change Switch on the rear apron to enable band change whereby the display changes to read actual frequency (e.g. HF-60MHz). The standard SO239 antenna connector has now been changed for an 'N' connector for coverage from 60-950MHz and a SO239 connector fitted for coverage 100kHz-60MHz. (UHF coverage is now standard as per our original MK2 modification to 950MHz)

As an 'N' connector is not fitted to all RWC FRG9600s for VHF-UHF coverage it is possible to use a wide-band discone antenna such as the ICOM AH7000 which is supplied with low-loss coaxial cable and 'N' connectors. A dipole or long-wire antenna can be used for HF coverage with very good results. **This facilitates use of two antennas for all bands.**

All modifications are Fully Guaranteed for twelve months from date of purchase modification providing our modifications seals are unbroken. See the reviews or s.a.e. for a copy!

RWC LTD 1987

We reserve the right to change specifications due to continuous development and modification of this product.



YAESU FRG9600/RWC MK3

AM-FM (WIDE & NARROW) LSB, USB. 100kHz-950MHz
 BROADCAST MONITOR AND SCANNING RECEIVER



No other radio is available with these features and facilities at this price! Check it out! Send large SAE for copy of reviews & further information

FRG9600 MK2 Model 60-950MHz 'N' connector @ £499.00 + 5.00 carriage. (Modified unit only)

FRG9600 MK3 Model 100kHz-950MHz 'N' connector and SO239 for HF @ £599.00 + £5.00 carriage. (Modified unit only)

RWC Exclusive Base Station Complete HF-UHF Package FRG9600 MK3 Model, Icom AH7000 ant, G5RV HF multiband, PA4C ac-13V dc adaptor, inclusive carriage UK £699.00.

Overseas dealers please note we will soon be offering conversion modules. Apply now for a franchise in your country.

**Tel: 021 421 8201 (24hr answerphone)
 Telex: 337676. TELEX-G**



AH-7000

SUPER WIDEBAND
 OMNIDIRECTIONAL ANTENNA

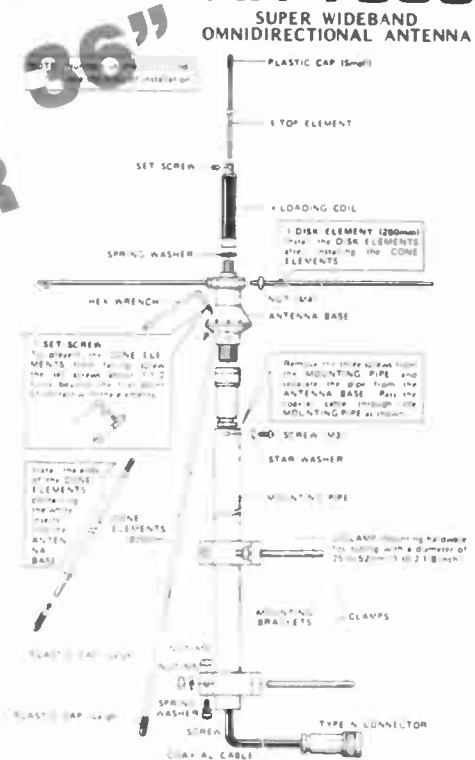

SPECIFICATIONS	
Frequency coverage	100kHz - 29.7MHz
Power	200 watts
Impedance	50 ohms
Supplier connectors	Type N
Supplied coaxial cable	50 Ohm 150 ohm
Type of antenna	Discone
Length	1.1 meters
Weight	1kg

Icom AH7000 @ £82.50 (inc free carriage UK mainland).

YAESU/RWC FRG9600 Options

PA4C ac adaptor £16.50 inc post.

FIF232 RS232 computer interface @ £75.00 inc post.

Raycom GP900 900-950MHz 3dB, base station ant @ £22.00 inc post.

AM-FM wide & narrow IF filters POA.

RWC 9600 MK2 owners HF mod @ £99.00 inc carriage (send unit).

FRG9600 existing owners HF & UHF mod - 100kHz-950MHz. Send unit carriage paid @ £129.00. (UK owners only.)

YAESU FRG9600 Service Manual (inc Cat Prog) @ £12.50 inc post.

Raycom VHF-UHF Discone 60-600MHz SO239 connector @ £27.50 inc carriage.

RWC Modified Video Unit. 6.00MHz IF video (modified from NTSC) @ £27.50 inc post.

Please call or telephone for other available options.

ASK FOR COLOUR BROCHURE & SPECIFICATIONS



Amateur RADIO



Editor:

Anita Ley

Assistant Editor:

Jane Berry

Editorial Assistant

Lisbeth Stedman

Advertisement

Manager:

Marian Vidler

Advertisement

Executive:

Karen Turner

Subscriptions:

01-760 0409

Accounts:

Clare Brinkman

Publisher:

Peter Williams

On sale:

Last Thursday of the month preceding cover date

Next issue:

Cover date

November 1987 on sale

29 October 1987

Published by:

Amateur Radio Magazines, Sovereign House, Brentwood, Essex CM14 4SE, England (0277) 219876

Printed:

In England

ISSN: 0264-2557

News Trade Sales by:

Argus Press Sales & Distribution Ltd, 12-18 Paul Street, London EC2A 4JS. 01-247 8233

Front cover:

Icom IC761 (p19). Photo by Jay Moss-Powell G6XIB

Whilst every care is taken when accepting advertisements we cannot accept responsibility for unsatisfactory transactions. We will, however, thoroughly investigate any complaints. The views expressed by contributors are not necessarily those of the publishers.

Every care is also taken to ensure that the contents of *Amateur Radio* are accurate, we assume no responsibility for any effect from errors or omissions.

© Copyright 1987
Amateur Radio Magazines

6 Straight and Level

All the latest news, comment and developments on the amateur radio scene

14 DX Diary

Don Field G3XTT with this month's DX news

16 Useful additions to your PSU

Steven and John Goodier suggest a few refinements to last month's PSU project

19 Angus McKenzie Tests

G3OSS reviews Icom's new IC761 – a multimode HF transceiver for those with standard size fingers!

26 SWL

Trevor Morgan GW4OXB looks at how the invasion of the computer has changed amateur radio

28 A simple add-on audio filter

Add extra selectivity to your receiver at a very low cost

33 Making the most of the minima

Dave Reynolds proves that the wrong end of the sunspot cycle and a small garden needn't keep you out of the action

38 Bits to Build

George Dobbs continues his series with the construction of a kanga that doesn't jump!

42 Open the Box

A tongue-in-cheek look at the inhabitants of FM repeaters

44 50MHz – expectations realised

Ken Ellis reports the results of the latest opening on the 6m band

47 Project Book

Martyn Williams solves the problem of second harmonic radiation on the 50MHz band

48 On the Beam

Glen Ross G8MWR with all the latest news from VHF, UHF and microwaves

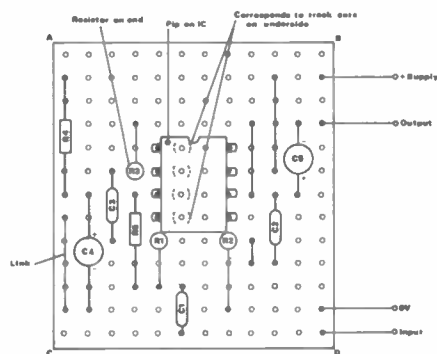

Coming next month

What's in store for you

50 Secondhand

Hugh Allison G3XSE looks at some more common problems found in secondhand equipment

53 Free Classified Ads

The market for buying and selling

SERVICES

12 Subscription order form

15 Newsagents order form

43 Radio and Electronics World

subscription order form

55 Free classified ad form

58 Back issues order form

58 Advertiser's Index

58 Advertising rates and

information

We regret to inform readers that due to constantly rising production costs, and to enable us to maintain the high standard of content in *Amateur Radio*, the price of the magazine will be £1.45 from this issue

VISA
PHONE
0474 60521

P.M. COMPONENTS LTD

SELECTION HOUSE, SPRINGHEAD ENTERPRISE PARK, SPRINGHEAD ROAD, GRAVESEND, KENT DA11 8HD

TELEX
966371
TOS PM

INTEGRATED CIRCUITS

AN103	2.50	LA4430	2.50	AL1327Q	1.10	TA7609P	3.95	TC4760	2.50	10A4050	2.95
AN124	2.50	LA4461	3.95	SN7474	2.95	TA7611AP	2.95	TC4800	2.50	10A4600	2.50
AN214	2.50	LC1720	3.28	SN7421	1.80	TA7629	2.90	TC4800	6.95	TD4903	3.18
AN235	1.95	LC1730	3.50	SN76032N	3.95	TA310A	3.50	TC4830S	1.95	TEA1009	1.35
AN239	2.50	LC1737	6.50	SN76110N	0.89	TA320A	3.50	TC4900	2.50	UPC41C	3.49
AN240P	2.50	LM323K	4.95	SN76115N	1.25	TA350A	1.95	TC4940	1.65	UPC566H	2.95
AN247	2.50	LM324N	4.45	SN76223DN	1.30	TAA550B	1.95	TD4440	2.20	UPC575C2	2.78
AN260	2.95	LM380N	1.80			TAA570	1.95	TD41001	2.95		
AN262	1.95	LM3808N	1.78	SN76227N	1.05	TAA621	3.95	TD41003A	3.95	UPC1001H	1.05
AN264	2.50	LM3837	2.95	SN76228N	2.95	TAA6320S	1.95	TD41006	2.50	UPC1020H	2.95
AN271	3.50	LM390N	3.50	SN76533N	1.65	TAA700	1.70	TD41010	2.18	UPC1024H	2.95
AN303	2.95	LM1011	3.18	SN76650N	1.15	TAA930	3.95	TD41005	2.25	UPC1024H	1.50
AN313	3.50	M5155L	2.95	SN76660N	0.90	TBA120AS/B/C	1.00	TD41035	2.50	UPC1025H	1.95
AN330	2.95	M51531L	2.95	STK011	7.95	TD41037	1.95	TD41037	1.95	UPC1028H	1.95
AN315	2.25	M51521L	1.80	STK014	7.95	TD41104	2.15	TD41180	2.15	UPC1032H	1.50
AN316	3.95	MB3705	1.80	STK015	5.95	TBA231	1.30	TD41200	3.95	UPC1156H/75	1.50
AN331	3.95	MB3712	2.00	STK018	7.95	TBA395	1.50	TD42150	2.95	UPC1158H	0.75
AN342	2.95	MB3756	2.90	STK025	11.95	TBA396	0.75	TD42160	2.50	UPC1181H	1.95
AN362L	2.50	MC1307P	1.80	STK032	7.95	TBA440N	2.58	TD42521	3.28	UPC1182H	2.95
AN612	2.15	MC1310P	1.95	STK037	11.95	TBA480Q	1.25	TD42522	1.95	UPC1185H	3.95
AN6362	3.95	MC1327	0.70	STK085	8.95	TBA510	2.50	TD42523	2.95	UPC1191V	1.50
AN740	3.50	MC1327Q	0.95	STK415	7.95	TBA510Q	1.95	TD42524	1.95	UPC1350C	2.95
AN7145	3.50	MC1349P	1.78	STK433	5.95	TBA520	1.10	TD42530	1.95	UPC1353C	2.95
AN7150	2.95	MC1350P	1.75	STK435	7.95	TBA520Q	1.10	TD42531	1.95	UPD2134LC	2.50
AN7151	2.95	MC1351P	1.75	STK437	7.95	TBA530	1.10	TD42532	1.95		
BA521	3.35	MC1357	2.35	STK439	7.95	TBA530G	1.10	TD42540	1.95		
CA1052E	1.95	MC1358	1.58	STK461	11.50	TBA540	1.25	TD42541	2.15		
CA3066	4.35	MC1495	3.00	STK463	11.50	TBA540Q	1.95	TD42550	2.95		
CA3123E	2.95	MC1496	1.75	STK0015	7.95	TBA550	1.95	TD42551	1.95		
CA3131EM	1.95	MC1723	0.90	STK0029	7.95	TBA560C	1.45	TD42560	2.50		
CA3140S	1.18	MC3357	2.75	STK0039	7.95	TBA560Q	1.45	TD42561	2.50		
ETTS616	2.50	MC3401L	2.50	TA7061AP	1.50	TBA570	1.00	TD42562	1.95		
HA1137W	1.95	MC4106P	2.95	TA7072	2.65	TBA651R	2.50	TD42563	2.95		
HA1156W	1.50	MC1418BC	7.95	TA7073	3.50	TBA673	1.95	TD42564	1.95		
HA1306	1.50	ML231B	1.75	TA7108P	1.50	TBA720A	2.45	TD42565	4.50		
HA1322	1.95	ML232B	2.50	TA7120P	1.65	TBA750	1.95	TD42566	4.50		
HA1339A	2.95	ML239	2.95	TA7137P	1.00	TBA800	0.89	TD42567	4.50		
HA1365W	2.78	SMS5807	8.78	TA7146P	1.50	TBA820M	0.75	TD42568	2.75		
HA1377	3.90	SAA500A	3.90	TA7176AP	2.95	TBA820Q	1.45	TD42569	2.45		
HA1406	1.95	SAA5010	5.35	TA7193P	3.95	TBA820M	0.75	TD42570	2.95		
HA1551	2.95	SAA5020	5.75	TA7203	2.95	TBA820Q	1.45	TD42571	2.95		
LA1210	0.90	SAA5020	5.75	TA7205AP	1.15	TBA890	2.50	TD42581	2.95		
LA1230	0.95	SAB3210	3.50	TA7208P	1.95	TBA950/2X	1.50	TD42582	2.95		
LA3201	0.95	SAB5958	1.78	TA7222AP	1.80			TD42583	2.95		
LA4101	0.95	SA850	2.85	TA7227P	4.25	TBA990	1.49	TD42584	2.95		
LA4102	0.95	SA8590	2.78	TA7228P	1.95	TBA990Q	1.49	TD42585	2.95		
LA4140	2.95	SL9019	7.95	TA7231P	1.80	TCA270	1.90	TD42586	2.95		
LA4031P	1.10	SL917B	6.85	TA7234P	2.95	TCA270SQ	1.90	TD42587	2.95		
LA4400	3.50	SL1310	1.90	TA7314P	2.25	TC4650	2.50	TD42588	2.95		
LA4420	2.50	SL1327	1.10					TD42589	2.95		

SEMICONDUCTORS

AA12	0.25	BC1821B	0.10	BD237	0.40	BF493	0.35	MRF453	17.50	TV106	1.50
AC126	0.45	BC183	0.10	BD242	0.65	BF595	0.23	MRF454	26.50	TV106/2	1.50
AC127	0.20	BC183L	0.09	BD246	0.75	BF597	0.23	MRF455	17.50	ZR0F112	16.50
AC128	0.28	BC184LB	0.09	BD376	0.32	BF639	0.23	MRF456	2.95	ZR0F110	6.50
AC128K	0.32	BC20	0.28	BD379	0.48	BF675	0.23	MRF477	14.95	2N1308	1.35
AC141	0.95	BC207B	0.25	BD410	0.85	BF681	0.25	OC166W	2.80	2N1711	3.00
AC141K	0.34	BC208B	0.20	BD434	0.65	BF688	0.30	OC23	9.50	2N2119	0.28
AC142K	0.46	BC212	0.09	BD436	0.45	BF690	1.90	OC25	1.90	2N2626	0.55
AC176	0.22	BC212L	0.09	BD437	0.75	BF691	1.75	OC26	1.50	2N2905	0.40
AC176K	0.31	BC213	0.09	BD438	0.75	BF742	0.35	OC28	5.50	2N3053	0.40
AC187	0.25	BC213L	0.09	BD510	0.95	BF743	0.35	OC29	4.50	2N3054	0.89
AC187K	0.28	BC214	0.09	BD518	0.75	BF810	0.25	OC32	5.50	2N3055	0.35
AC198	0.40	BC214C	0.09	BD519	0.65	BF811	0.75	OC42	1.50	2N2702	0.12
AC188K	0.37	BC214L	0.09	BD534	0.45	BF816A	1.15	OC44	1.25	2N3703	0.12
AD142	0.80	BC237B	0.15	BD535	0.45	BF860	0.60	OC45	1.00	2N3704	0.12
AD143	1.25	BC238	0.15	BD538	0.65	BF892	0.85	OC70	1.00	2N3705	0.20
AD149	0.70	BC239	0.15	BD575	0.95	BF929	0.30	OC71	0.75	2N3706	0.12
AD161	0.50	BC251A	0.15	BD587	0.95	BF984	0.28	OC72	2.50	2N3708	0.12
AD162	0.50	BC252A	0.15	BD588	0.95	BF985	0.32	OC75	1.50	2N3733	9.50
AF106	0.50	BC258	0.28	BD597	0.95	BF986	0.35	OC81	1.00	2N3773	2.75
AF114	0.95	BC258A	0.39	BD599	1.90	BF988	0.25	OC84	1.50	2N3792	1.25
AF121	0.90	BC264	0.40	BD598	1.90	BF918	1.30	OC139	12.50	2N4280	3.50
AF124	0.65	BC300	0.30	BD701	1.25	BF950	0.32	OC171	4.50	2N4427	1.95
AF125	0.35	BC301	0.30	BD702	1.25	BF951	0.32	OC200	4.50	2N4444	1.18
AF126	0.32	BC303	0.28	BD707	0.90	BF959	0.70	OC201	5.50	2N5294	0.42
AF127	0.65	BC307B	0.09	BDX32	1.50	BFY48	1.78	OC205	10.00	2N5296	0.48
AF139	0.40	BC327	0.10	BDX53B	1.65	BR100	0.28	R2008B	1.45	2N5298	0.60
AF150	0.60	BC328	0.10	BF115	0.75	BR110	0.45	R2009	2.50	2N5485	0.45
AF178	0.95	BC329	0.10	BF119	0.95	BR103	0.55	R2010B	1.45	2N5486	0.45
AF239	0.42	BC338	0.09	BF127	0.39	BR303	0.95	R2322	0.55	2SA329	0.95
AU106	6.95	BC347A	0.13	BF154	0.20	BRC4443	1.18	R2323	0.68	2SA715	0.55
AY102	2.95	BC461	0.35	BF177	0.38	BRY39	0.45	R2540	2.48	2SC495	0.80
BC107A	0.11	BC478	0.20	BF160	0.27	BSW64	0.95	RCA18029	0.85	2SC496	0.80
BC107B	0.11	BC527	0.20	BF173	0.22	BSX60	1.25	RCA16339	0.85	2SC784	0.75
BC108	0.10	BC547	0.10	BF158	0.28	BT100A/2	0.85	RCA16334	0.95	2SC789	0.55
BC108B	0.12	BC548	0.10	BF178	0.28			RCA16335	0.85	2SC793	0.95
BC109	0.10	BC549A	0.10	BF179	0.34	BT106	1.49	RCA16336	0.85	2SC931	0.95
BC109B	0.12	BC550	0.14	BF180	0.29	BT110	1.20	RCA16337	0.85	2SC932	1.98
BC109C	0.12	BC557	0.08	BF181	0.29	BT119	3.15	S2066D	0.95	2SC1034	4.50
BC114A	0.09	BC558	0.10	BF182	0.29	BT120	1.65	SKESF	1.48	2SC1096	0.80
BC115	0.55	BC639/10	0.30	BF183	0.29	BU105	1.95	T6021V	0.45	2SC1106	2.50
BC116A	0.55	BCY33A	19.50	BF184	0.28	BU108	1.60	T6029V	0.45	2SC1124	0.95
BC116A	0.50	BD115	0.30	BF185	0.28	BU124	1.25	T6036V	0.55	2SC1162	0.95
BC117	1.95	BD124P	0.59	BF194	0.11	BU125	1.25	T9022V	0.55	2SC1172	2.20
BC119	0.24	BD131	0.42	BF195	0.11	BU126	1.60	T9029V	0.55	2SC1173	1.15
BC125	0.25	BD132	0.42	BF197	0.11	BU204	1.55	T9011V	0.75	2SC1307	1.75
BC139BC	0.20	BD133	0.40	BF198	0.16	BU205	1.30	T9015V	2.15	2SC1364	0.50
BC140	0.31	BD135	0.30	BF199	0.14	BU208	1.39	T9034V	2.15	2SC1413A	2.50
BC141	0.25	BD136	0.30	BF200	0.40	BU208A	1.52	T9038V	3.95	2SC1449	0.50
BC142	0.21	BD137	0.32	BF201	0.40	BU208B	1.85	THY15/80	2.25	2SC1628	0.75
BC143	0.24	BD138	0.30	BF241	0.15	BU226	1.20	THY15/85	2.25	2SC1678	1.50
BC147B	0.12	BD139	0.30	BF242	0.15	BU226	1.20	THY15/85	2.25	2SC1945	3.78
BC148A	0.99	BD140	0.30	BF256LC	0.38	BU407	1.24	TIP29C	0.43	2SC1983	0.85
BC148E	0.09	BD144	1.10	BF257	0.38	BU408	1.50	TIP30C	0.43	2SC1987	0.80
BC149	0.09	BD150C	0.29								



PHONE
0474 60521
3 LINES



P.M. COMPONENTS LTD
SELECTRON HOUSE
SPRINGHEAD ENTERPRISE PARK, SPRINGHEAD ROAD
GRAVESEND, KENT DA11 8HD

TELEX
966371
TOS PM

A SELECTION FROM OUR STOCK OF BRANDED VALVES (Cont'd)

DL63	1.00	ECL85	0.95	HB230	1.85
DL70	2.50	ECL80S	0.95	HB291	1.90
DL91	3.95	EF22	3.50	HF93	1.95
DL92	1.95	EF37A	2.50	HF94	1.95
DL94	1.10	EF39	1.90	HF95	1.95
DL96	2.50	EF40	3.50	HL32	3.50
DL97	2.50	EF41	3.50	HL33D	3.50
DL98	2.50	EF42	3.50	HT6C	3.50
DL99	2.50	EF43	3.50	HT6D	3.50
DL100	2.50	EF44	3.50	HT6E	3.50
DL101	2.50	EF45	3.50	HT6F	3.50
DL102	2.50	EF46	3.50	HT6G	3.50
DL103	2.50	EF47	3.50	HT6H	3.50
DL104	2.50	EF48	3.50	HT6I	3.50
DL105	2.50	EF49	3.50	HT6J	3.50
DL106	2.50	EF50	3.50	HT6K	3.50
DL107	2.50	EF51	3.50	HT6L	3.50
DL108	2.50	EF52	3.50	HT6M	3.50
DL109	2.50	EF53	3.50	HT6N	3.50
DL110	2.50	EF54	3.50	HT6O	3.50
DL111	2.50	EF55	3.50	HT6P	3.50
DL112	2.50	EF56	3.50	HT6Q	3.50
DL113	2.50	EF57	3.50	HT6R	3.50
DL114	2.50	EF58	3.50	HT6S	3.50
DL115	2.50	EF59	3.50	HT6T	3.50
DL116	2.50	EF60	3.50	HT6U	3.50
DL117	2.50	EF61	3.50	HT6V	3.50
DL118	2.50	EF62	3.50	HT6W	3.50
DL119	2.50	EF63	3.50	HT6X	3.50
DL120	2.50	EF64	3.50	HT6Y	3.50
DL121	2.50	EF65	3.50	HT6Z	3.50
DL122	2.50	EF66	3.50	HT6AA	3.50
DL123	2.50	EF67	3.50	HT6AB	3.50
DL124	2.50	EF68	3.50	HT6AC	3.50
DL125	2.50	EF69	3.50	HT6AD	3.50
DL126	2.50	EF70	3.50	HT6AE	3.50
DL127	2.50	EF71	3.50	HT6AF	3.50
DL128	2.50	EF72	3.50	HT6AG	3.50
DL129	2.50	EF73	3.50	HT6AH	3.50
DL130	2.50	EF74	3.50	HT6AI	3.50
DL131	2.50	EF75	3.50	HT6AJ	3.50
DL132	2.50	EF76	3.50	HT6AK	3.50
DL133	2.50	EF77	3.50	HT6AL	3.50
DL134	2.50	EF78	3.50	HT6AM	3.50
DL135	2.50	EF79	3.50	HT6AN	3.50
DL136	2.50	EF80	3.50	HT6AO	3.50
DL137	2.50	EF81	3.50	HT6AP	3.50
DL138	2.50	EF82	3.50	HT6AQ	3.50
DL139	2.50	EF83	3.50	HT6AR	3.50
DL140	2.50	EF84	3.50	HT6AS	3.50
DL141	2.50	EF85	3.50	HT6AT	3.50
DL142	2.50	EF86	3.50	HT6AU	3.50
DL143	2.50	EF87	3.50	HT6AV	3.50
DL144	2.50	EF88	3.50	HT6AW	3.50
DL145	2.50	EF89	3.50	HT6AX	3.50
DL146	2.50	EF90	3.50	HT6AY	3.50
DL147	2.50	EF91	3.50	HT6AZ	3.50
DL148	2.50	EF92	3.50	HT6BA	3.50
DL149	2.50	EF93	3.50	HT6BB	3.50
DL150	2.50	EF94	3.50	HT6BC	3.50
DL151	2.50	EF95	3.50	HT6BD	3.50
DL152	2.50	EF96	3.50	HT6BE	3.50
DL153	2.50	EF97	3.50	HT6BF	3.50
DL154	2.50	EF98	3.50	HT6BG	3.50
DL155	2.50	EF99	3.50	HT6BH	3.50
DL156	2.50	EF100	3.50	HT6BI	3.50
DL157	2.50	EF101	3.50	HT6BJ	3.50
DL158	2.50	EF102	3.50	HT6BK	3.50
DL159	2.50	EF103	3.50	HT6BL	3.50
DL160	2.50	EF104	3.50	HT6BM	3.50
DL161	2.50	EF105	3.50	HT6BN	3.50
DL162	2.50	EF106	3.50	HT6BO	3.50
DL163	2.50	EF107	3.50	HT6BP	3.50
DL164	2.50	EF108	3.50	HT6BQ	3.50
DL165	2.50	EF109	3.50	HT6BR	3.50
DL166	2.50	EF110	3.50	HT6BS	3.50
DL167	2.50	EF111	3.50	HT6BT	3.50
DL168	2.50	EF112	3.50	HT6BU	3.50
DL169	2.50	EF113	3.50	HT6BV	3.50
DL170	2.50	EF114	3.50	HT6BW	3.50
DL171	2.50	EF115	3.50	HT6BX	3.50
DL172	2.50	EF116	3.50	HT6BY	3.50
DL173	2.50	EF117	3.50	HT6BZ	3.50
DL174	2.50	EF118	3.50	HT6CA	3.50
DL175	2.50	EF119	3.50	HT6CB	3.50
DL176	2.50	EF120	3.50	HT6CC	3.50
DL177	2.50	EF121	3.50	HT6CD	3.50
DL178	2.50	EF122	3.50	HT6CE	3.50
DL179	2.50	EF123	3.50	HT6CF	3.50
DL180	2.50	EF124	3.50	HT6CG	3.50
DL181	2.50	EF125	3.50	HT6CH	3.50
DL182	2.50	EF126	3.50	HT6CI	3.50
DL183	2.50	EF127	3.50	HT6CJ	3.50
DL184	2.50	EF128	3.50	HT6CK	3.50
DL185	2.50	EF129	3.50	HT6CL	3.50
DL186	2.50	EF130	3.50	HT6CM	3.50
DL187	2.50	EF131	3.50	HT6CN	3.50
DL188	2.50	EF132	3.50	HT6CO	3.50
DL189	2.50	EF133	3.50	HT6CP	3.50
DL190	2.50	EF134	3.50	HT6CQ	3.50
DL191	2.50	EF135	3.50	HT6CR	3.50
DL192	2.50	EF136	3.50	HT6CS	3.50
DL193	2.50	EF137	3.50	HT6CT	3.50
DL194	2.50	EF138	3.50	HT6CU	3.50
DL195	2.50	EF139	3.50	HT6CV	3.50
DL196	2.50	EF140	3.50	HT6CW	3.50
DL197	2.50	EF141	3.50	HT6CX	3.50
DL198	2.50	EF142	3.50	HT6CY	3.50
DL199	2.50	EF143	3.50	HT6CZ	3.50
DL200	2.50	EF144	3.50	HT6DA	3.50
DL201	2.50	EF145	3.50	HT6DB	3.50
DL202	2.50	EF146	3.50	HT6DC	3.50
DL203	2.50	EF147	3.50	HT6DD	3.50
DL204	2.50	EF148	3.50	HT6DE	3.50
DL205	2.50	EF149	3.50	HT6DF	3.50
DL206	2.50	EF150	3.50	HT6DG	3.50
DL207	2.50	EF151	3.50	HT6DH	3.50
DL208	2.50	EF152	3.50	HT6DI	3.50
DL209	2.50	EF153	3.50	HT6DJ	3.50
DL210	2.50	EF154	3.50	HT6DK	3.50
DL211	2.50	EF155	3.50	HT6DL	3.50
DL212	2.50	EF156	3.50	HT6DM	3.50
DL213	2.50	EF157	3.50	HT6DN	3.50
DL214	2.50	EF158	3.50	HT6DO	3.50
DL215	2.50	EF159	3.50	HT6DP	3.50
DL216	2.50	EF160	3.50	HT6DQ	3.50
DL217	2.50	EF161	3.50	HT6DR	3.50
DL218	2.50	EF162	3.50	HT6DS	3.50
DL219	2.50	EF163	3.50	HT6DT	3.50
DL220	2.50	EF164	3.50	HT6DU	3.50
DL221	2.50	EF165	3.50	HT6DV	3.50
DL222	2.50	EF166	3.50	HT6DW	3.50
DL223	2.50	EF167	3.50	HT6DX	3.50
DL224	2.50	EF168	3.50	HT6DY	3.50
DL225	2.50	EF169	3.50	HT6DZ	3.50
DL226	2.50	EF170	3.50	HT6EA	3.50
DL227	2.50	EF171	3.50	HT6EB	3.50
DL228	2.50	EF172	3.50	HT6EC	3.50
DL229	2.50	EF173	3.50	HT6ED	3.50
DL230	2.50	EF174	3.50	HT6EE	3.50
DL231	2.50	EF175	3.50	HT6EF	3.50
DL232	2.50	EF176	3.50	HT6EG	3.50
DL233	2.50	EF177	3.50	HT6EH	3.50
DL234	2.50	EF178	3.50	HT6EI	3.50
DL235	2.50	EF179	3.50	HT6EJ	3.50
DL236	2.50	EF180	3.50	HT6EK	3.50
DL237	2.50	EF181	3.50	HT6EL	3.50
DL238	2.50	EF182	3.50	HT6EM	3.50
DL239	2.50	EF183	3.50	HT6EN	3.50
DL240	2.50	EF184	3.50	HT6EO	3.50
DL241	2.50	EF185	3.50	HT6EP	3.50
DL242	2.50	EF186	3.50	HT6EQ	3.50
DL243	2.50	EF187	3.50	HT6ER	3.50
DL244	2.50	EF188	3.50	HT6ES	3.50
DL245	2.50	EF189	3.50	HT6ET	3.50
DL246	2.50	EF190	3.50	HT6EU	3.50
DL247	2.50	EF191	3.50	HT6EV	3.50
DL248	2.50	EF192	3.50	HT6EW	3.50
DL249	2.50	EF193	3.50	HT6EX	3.50
DL250	2.50	EF194	3.50	HT6EY	3.50
DL251	2.50	EF195	3.50	HT6EZ	3.50
DL252	2.50	EF196	3.50	HT6FA	3.50
DL253	2.50	EF197	3.50	HT6FB	3.50
DL254	2.50	EF198	3.50	HT6FC	3.50
DL255	2.50	EF199	3.50	HT6FD	3.50
DL256	2.50	EF200	3.50	HT6FE	3.50
DL257	2.50	EF201	3.50	HT6FF	3.50
DL258	2.50	EF202	3.50	HT6FG	3.50
DL259	2.50	EF203	3.50	HT6FH	3.50
DL260	2.50	EF204	3.50	HT6FI	3.50
DL261	2.50	EF205	3.50	HT6FJ	3.50
DL262	2.50	EF206	3.50	HT6FK	3.50
DL263	2.50	EF207	3.50	HT6FL	3.50
DL264	2.50	EF208	3.50	HT6FM	3.50
DL265	2.50	EF209	3.50	HT6FN	3.50
DL266	2.50	EF210	3.50	HT6FO	3.50
DL267	2.50	EF211	3.50	HT6FP	3.50
DL268	2.50	EF212	3.50	HT6FQ	3.50
DL269	2.50	EF213	3.50	HT6FR	3.50
DL270	2.50	EF214	3.50	HT6FS	3.50
DL271	2.50	EF215	3.50	HT6FT	3.50
DL272	2.50	EF216	3.50	HT6FU	3.50
DL273	2.50	EF217	3.50	HT6FV	3.50
DL274	2.50	EF218	3.50	HT6FW	3.50
DL275	2.50	EF219	3.50	HT6FX	3.50
DL276	2.50	EF220	3.50	HT6FY	3.50
DL277	2.50	EF221	3.50	HT6FZ	3.50
DL278	2.50	EF222	3.50	HT6GA	3.50
DL279	2.50	EF223	3.50	HT6GB	3.50
DL280	2.50	EF224	3.50	HT6GC	3.50
DL281	2.50	EF225	3.50	HT6GD	3.50
DL282	2.50	EF226	3.50	HT6GE	3.50
DL283	2.50	EF227	3.50	HT6GF	3.50
DL284	2.50	EF228	3.50	HT6GG	3.50
DL285	2.50	EF229	3.50	HT6GH	3.50
DL286	2.50	EF230	3.50	HT6GI	3.50
DL287	2.50	EF231	3.50	HT6GJ	3.50
DL288	2.50	EF232	3.50	HT6GK	3.50
DL289	2.50	EF233	3.50	HT6GL	3.50
DL290	2.50	EF234	3.50	HT6GM	3.50
DL291	2.50	EF235	3.50	HT6GN	3.50
DL292	2.50	EF236	3.50	HT6GO	3.50
DL293	2.50	EF237	3.50	HT6GP	3.50
DL294	2.50	EF238	3.50	HT6GQ	3.50
DL295	2.50	EF239	3.50	HT6GR	3.50
DL296	2.50	EF240	3.50	HT6GS	3.50
DL297	2.50	EF241	3.50	HT6GT	3.50
DL298	2.50	EF242	3.50	HT6GU	3.50

STRAIGHT & LEVEL

STRAIGHT

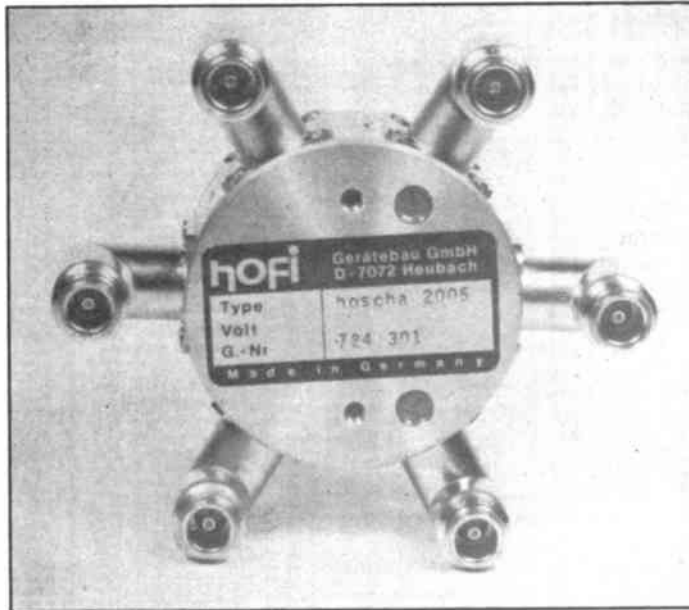

NEW COAXIAL SWITCHES

A new range of 5 way coaxial switches is now available in the UK. Hofi professional switches are engineered to the highest electrical and mechanical standards. Manually operated or remotely controlled switches are available with either SO239 or N type sockets fitted.

Hofi switches offer a new standard of guaranteed performance to the professional and amateur user. Every unit is supplied with an individual certificate of performance giving factory guaranteed figures for insertion loss and isolation. High operational reliability is guaranteed by the use of a unique double contact system giving high power transfer and excellent performance to UHF frequencies. Rugged construction and the use of corrosion resistant materials ensure long life.

The remotely controlled system is available with a weather protecting cover for the switch unit, an easy to operate control box and, as an option, a remotely controlled switch box to enable a rotator to be controlled via the same 8 way control cable, thus effecting considerable savings in the use of multi-way cable.

Technical specifications include power handling up to

3kW, insertion loss at a low 0.04dB and an SWR better than 1.06 at 50 ohms.

Hofi switches are available from £54.00 from the Sole UK Distributors: *Winchester Communications, Trinder House, Free Street, Bishops Waltham, Hants SO3 1EE. Tel: (04893) 3404.*

FOUR CHANNEL SCOPE

The new Kenwood CS2110, available ex-stock from Thurlby Electronics, is a low-cost 100MHz oscilloscope with four input channels.

Each channel has its own vertical position control, and accurate timing measure-

ments are assured by guaranteed time difference figures of less than 0.5 nanoseconds (nS) for CH1/CH2 and less than 1nS for channels 1/2 to channels 3/4.

The CS2110 has a maximum sensitivity of 1mV/div and a maximum sweep speed of 2nS/div. Full dual timebases with separate and comprehensive controls for the B trigger signal are provided. Alternate sweep operation (with optional B ends A) provides a convenient method of viewing both the expanded and non-expanded waveforms simultaneously.

A 20kV acceleration potential is used for the display. This provides a sharp, high-intensity trace even in bright lighting conditions and with low duty cycle waveforms. The rear panel sockets include an intensity input (Z modulation), a CH1 output socket for driving a frequency counter, and gate signals for the A and B timebases. A calibration loop is provided.

The CS2110 is lightweight and compact, weighing only 7.4kg and measuring only 284 x 138 x 400mm (11.2 x 5.4 x 15.7in). The auto-switching power supply unit can operate from line voltages between 90V and 264V without any adjustment.

For further information please contact: *Thurlby Electronics Ltd, New Road, St Ives, Huntingdon, PE17 4BG. Tel: (0799) 26699.*

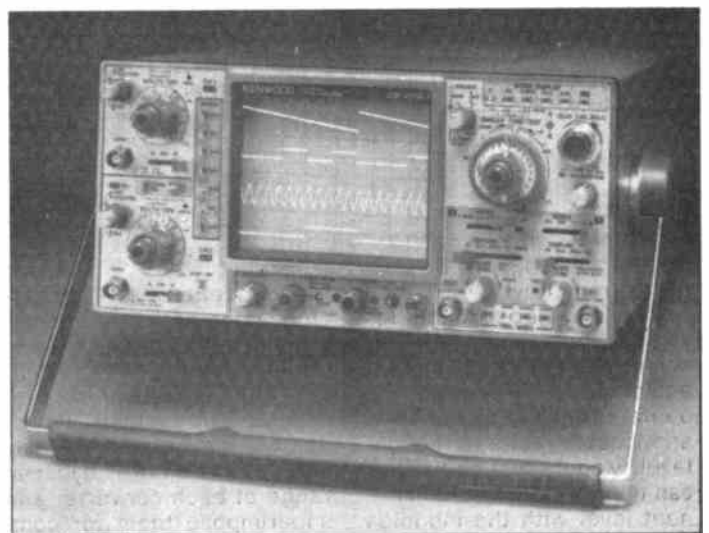

All the latest news, views, comment and developments on the amateur radio scene

MODULAR RECEIVERS

Racal Communications Limited has launched the first of a new series of high performance, modular receivers which will cover the frequency range from VLF to UHF.

The RA3700 Series receivers are meant for inclusion in a European communication system. Operating in the HF band, 15kHz to 30MHz in selectable 10Hz or 1Hz synthesized steps, the receivers have been designed and developed for point-to-point communications, radio surveillance, direction finding and for use in computer-controlled systems. The new receivers may be used in fixed or transportable roles on land, at sea or in the air, and operate in LSB, USB, AM, FM and CW modes.

The highly modular design allows the same frame and plug-in modules to be configured to assemble receivers to meet a variety of different applications. The family, which includes single and dual receivers, also has a range of optional modules to enhance the receiver facilities.

The new receivers available today include the RA3701 single receiver, the RA3702 dual receiver, both with front panel controls, and the RA3703 single receiver and RA3704 dual receiver, both remotely controlled.

Each of the receivers includes a serial ASCII remote control interface with a built-in capability of addressing up to 100 receivers. Slave receivers may be controlled by computer, by the MA3700 control unit, or by the RA3701 and the RA3702 which have built-in controller facilities. All front panel operating functions, except power on/off switching, can be controlled remotely.

Test and repair facilities also feature strongly. The comprehensive built-in test equipment (BITE) may be operated locally or remotely and locates faults to module level. Module test and repair can be carried out to component level with the modules

plugged into the receiver, eliminating the need for special-to-type test equipment. Modules can be changed on site by the operator; no realignment is needed, and repair time is consequently low.

For further information contact: *Racal Communications Ltd, Western Road, Bracknell, Berkshire RG12 1RG.*

LOW COST DSO

New from ITT Instruments is the OX750B, a low cost, compact digital storage oscilloscope which offers a digital performance based on two 8-bit 2MHz A/D converters and an analogue performance of a 20MHz dual-trace oscilloscope.

Ideally suited to field service, the OX750B is housed in a rugged case weighing only 10kg and measuring just 450 x 310 x 160mm. The instrument is suitable for users with little oscilloscope experience - having an ergonomically designed front panel and controls with analogue and digital sections as well as signal acquisition and analysis functions clearly segregated.

A major feature of the OX750B is its comprehensive range of built-in signal analysis facilities. The memory can hold up to 2048 samples per channel, 2000 of which may be displayed on the screen while the remaining 48 are used for the reference position. To facilitate analysis, the OX750B incorporates a horizontal digital expansion of up to x 32 (in six steps) and an interactive cursor which allows the user to select that part of the stored signal required for analysis. Luminous intensity of the trace is constant and remains independent of the expansion factor. Also provided are vertical digital trace shift and digital expansion capabilities. The OX750B can capture one or two signals individually or simultaneously across the entire dynamic range of each converter and superimpose them for com-

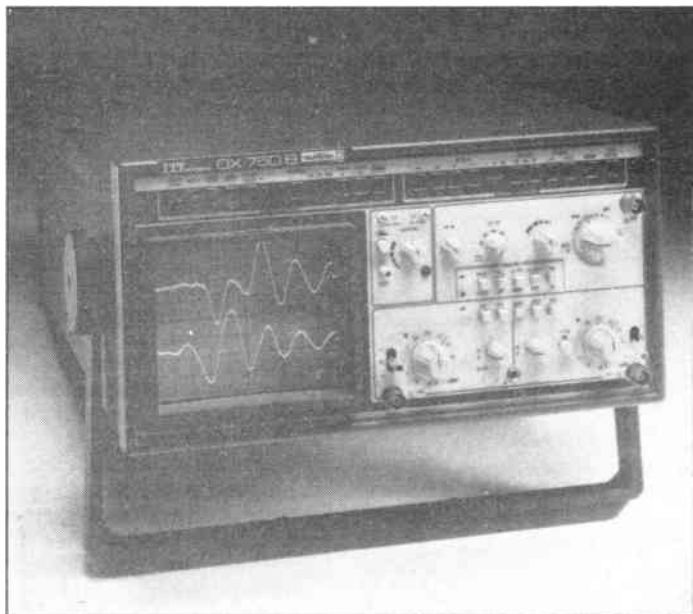

parison. In addition, an incoming signal can be compared with a stored reference signal.

The OX750B is an essential working aid in electronics laboratories and is ideal for studying physical phenomena such as shock, vibration, mechanical fractures and deformation, drop-outs and switching spikes.

For further information please contact: *ITT Instruments, 346 Edinburg Avenue, Slough, Berkshire, SL1 4TU. Tel: (0799) 26699.*

Rx/Tx CHIP

A new data communications product from Mullard, the SCC2698 OCTART, is now available from Online

Distribution. It is a CMOS LSI device offering eight universal asynchronous Rx/Tx channels on a single chip. There are four dual-channel blocks, each with 10 I/O port lines and a 16-bit counter timer. Interface and configuration logic are common to all blocks.

Data rate is 1Mbit/s. The OCTART has an on-chip baud rate generator which can produce 18 different baud rates, from 38.4K baud to 50K baud. The SCC2698 also has a power-down mode which helps keep power consumption to a minimum.

For further information contact: *Online Distribution Ltd, Melbourne House, Kingsway, Bedford MK42 9AZ. Tel: (0234) 217915.*

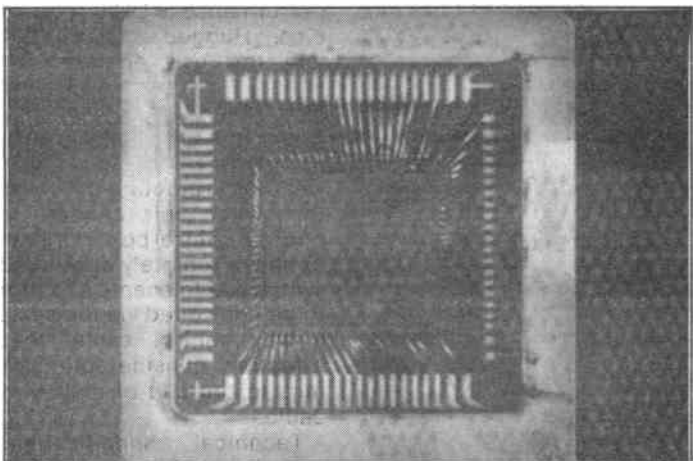

BOOKS · CATALOGUES · BOOKS · CATALOGUES

AMATEUR RADIO SATELLITES — THE FIRST TWENTY-FIVE YEARS

by Arthur C Gee

Twenty-five years have passed since amateur radio satellites first appeared on the radio amateur scene. The last few months have seen numerous tributes to the passing of this memorable quarter-century.

In response to the interest shown, Arthur C Gee G2UK, the chairman of AMSAT-UK, has assembled some of the records of these years, to provide a fascinating glimpse of AMSAT's own view of its initiation and growth.

The 34-page brochure contains many black and white photographs of history — making moments in the past, from the early days of Project Oscar to AMSAT as it is today. A very interesting read.

AMSAT-UK HQ, 94 Herongate Road, Wanstead Park, London E12 5EQ, £2.75 inc P & P and VAT.

AN INTRODUCTION TO ANTENNA THEORY

by HC Wright

This inexpensive book starts with first principles, explaining the mathematics involved in this subject in a straightforward manner, illustrating each topic with plentiful diagrams.

The basic concepts of receiving and transmitting antennas are dealt with in a way which emphasises the mechanisms and minimises the complicated, technical aspects involved.

This is a handy guide for the radio enthusiast, at a very affordable price.

Bernard Babani (publishing) Ltd, £2.95. ISBN 0-85934-173-9

ANTENNAS VOLUME 1

by E Roubine and JC Bolomey

The first part of a complementary two-volume treatise on antennas, this book was inspired by a series of lectures given at the École Supérieure d'Électricité.

The task the authors faced was to pare down the enormous body of work on this subject and yet present a comprehensive overview of modern technical knowledge in the field.

Volume 1 deals with the general principles which underly the physical bases of antenna function. Although this is a classic subject, it is dealt with in a strikingly innovative and economical manner.

This volume itself divides into two parts, a theoretical introduction and an explanation of the general properties of antennas.

The various subjects

involved include the basic elements of optics. Each is examined in conjunction with the complex mathematical formulae involved, which suggests that this is a book for serious students of electronic engineering or practising engineers.

Kogan Page Ltd, £27.50. ISBN 0-946536-22-8

POWER SELECTOR GUIDE

by J CJ Van de Ven

This guide is the second of a new generation of pocket guides, specially compiled for the electronics designer, engineer or hobbyist.

The specifications of many thousands of electronic devices are presented in tabular form with the aid of a new computer system.

Devices can be selected by reference to their electrical properties, thus enabling the reader to choose equivalent devices to replace unavailable items, without being tied to a particular manufacturer's products.

Bernard Babani (publishing) Ltd, £4.95. ISBN 0-85934-180-1

PRACTICAL MICROPROCESSOR INTERFACE

by SA Money

This comprehensive guide to microprocessor

interfacing examines in detail the various techniques used to transfer data to and from the central processing unit.

Invaluable to anyone well-grounded in electronics wishing to connect a micro-processor based system to an external device, the author includes plentiful explanations of the machine-level control functions necessary.

Interface software is also examined, and in addition test routines and start/initialisation procedures are approached in this thoughtfully presented book, along with appropriate diagrammatic explanation.

This book is certain to become a much referred to guide for those involved in this field.

Blackwell Scientific publications Ltd, £20.00. ISBN 0-00-383329-1

CMOS CIRCUITS MANUAL

by RM Marston

CMOS digital ICs are currently the most popular of the digital IC types, and this book is intended to introduce the reader to progressively more complex types of CMOS ICs.

Consequently, the book can be used equally by the complete beginner or electronics expert. The

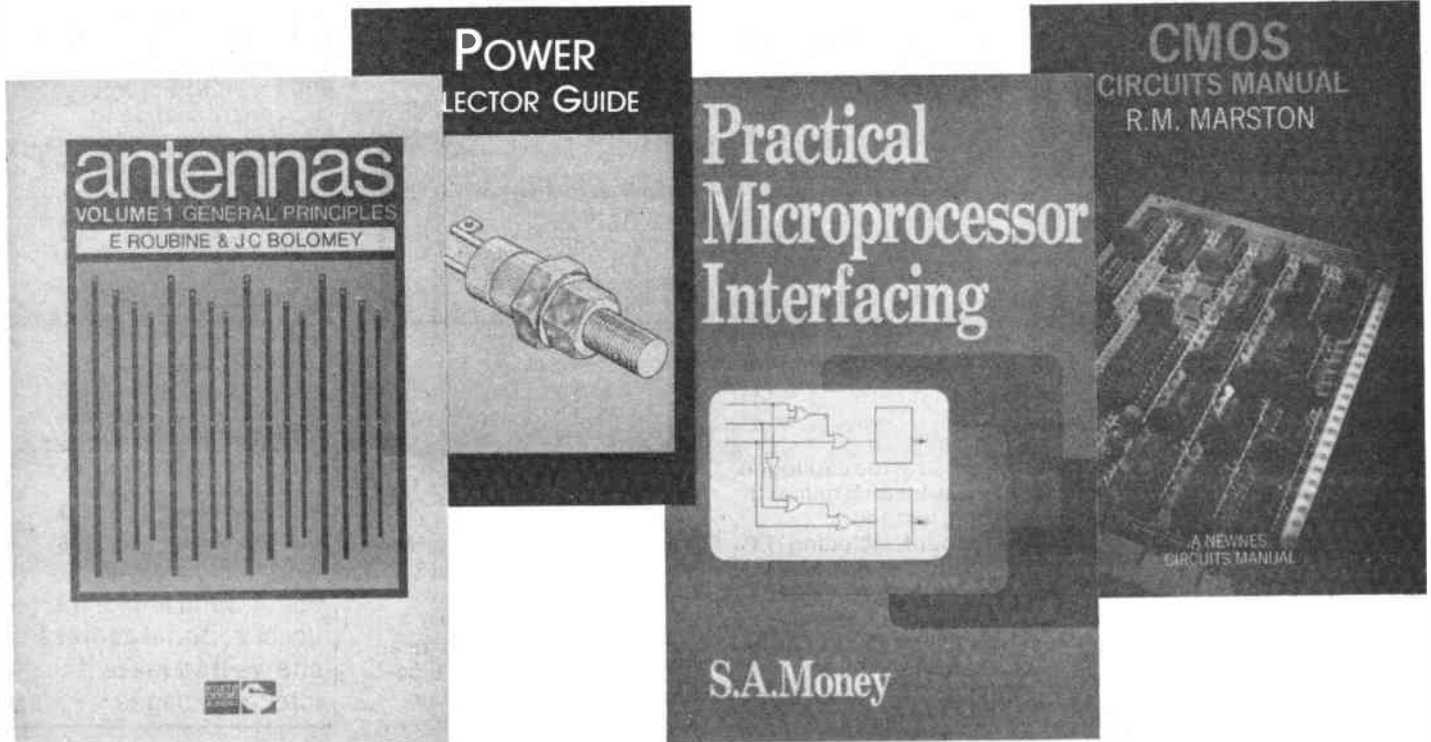

BOOKS · CATALOGUES · BOOKS · CATALOGUES

author has designed, built and evaluated all of the included circuits, and ensured that all use inexpensive and internationally available devices.

Unfortunately, the book itself could not be described as inexpensive, as the 190-page paperback costs £9.95. If this is a book you need, you'll have to grit your teeth and think of the quality rather than the quantity.

Heinemann Newnes, £9.95.
ISBN 0-434-91212-3

HUGHES ELECTRICAL TECHNOLOGY

revised by I McKenzie Smith

The first revision for ten years of this standard reference text includes a great deal of new material, reflecting the tremendous changes that have taken place in electronics fundamentals within the last decade.

The current emphasis on semiconductor technology has been acknowledged, with the inclusion of FETs and op amps as well as the function transistors included in the fifth edition. Digital systems are covered, and an introduction to microprocessors and programming has been added.

Intended for student use, this text uses worked examples throughout, with examination standard questions concluding each chapter, to test the reader's grasp of the subject. This is a welcome revision of a most useful book.

Longmans Group UK Ltd,
£12.95. ISBN 0-582-41372-9

AN INTRODUCTION TO DISTRIBUTED AND PARALLEL PROCESSING

by JA Sharp

This book is based on notes prepared for a final year undergraduate course in computer programming.

The concept of parallelism is introduced, and the ways in which computers have developed to exploit parallel processing are discussed.

In the second part, distributed processing is examined, and part three examines the programming

of such systems. The final part looks at possible architectures for the next generation of computers.

This book will be of interest not only to undergraduates, but also to students of electrical engineering and electronics, and those working in related areas.

Blackwell Scientific Publications Ltd, £14.95. ISBN 0-632-01462-8

Siemens

Siemens Ltd have produced a catalogue containing various articles which describe applications of various Siemens components. Each is examined in detail, and diagrams illustrating the circuits and their characteristics are included.

A components service lists new publications of data books, short form catalogues and other technical components literature that may be of interest.

Siemens Ltd,
Siemens House,
Windmill Rd,
Sunbury-on-Thames
Middlesex TW16 7HS.
Tel: (09327) 85691.

Feedback Instruments

Feedback Instruments Ltd has produced a new 12-page colour catalogue highlighting the products supplied by the company's recently formed Test and Measurement Division.

Instruments covered in the catalogue include oscilloscopes, logic analysers, analogue and digital multimeters, counters and timers, signal sources, phase meters, component analysers, recorders, power supplies, fibre-optic testers, temperature monitors, impedance testers and static meters.

Manufacturers represented in the catalogue cover many leading names in electronic test and measurement, including ITT Metrix, Thorn-EMI, Thandar, Hameg, Lloyd Instruments and Technotrend, as well as Feedback Instruments' own manufactured products.

In addition, a special 'stop press' supplement covers the

company's two latest product lines: counter/timers and communication test equipment from Racal Instruments and LCR meters from Wayne Kerr.

Feedback Instruments,
Park Road,
Crowborough,
East Sussex TN6 2QR.
Tel: (08926) 3322.

Solartron

A new booklet has been released outlining in detail how engineers may use an IBM PC via the RS232 interface to communicate with and control Solartron Instruments' 3530 Series Orion data logging system.

The 11-page booklet highlights a software program that enables an Orion data logger to be controlled when connected to an IBM PC via the RS232 interface.

The program features the automatic transmission of a standard channel and task set-up to the Orion and its immediate execution. The data received from the logger is displayed on the PC's VDU screen. The method by which user commands may be sent at any time to the Orion is also described.

The example program described in the booklet is written using IBM PC Basic.

The booklet is available on request from Solartron with a copy of the demonstration program from the company's local data acquisition sales engineer.

Solartron Instruments,
Victoria Road,
Farnborough,
Hants GU14 7PW.
Tel: (0252) 544433.

RR Electronics

RR Electronics have produced a quick reference selector guide for PMI brand op amps, based on an exclusive joint RR/PMI design.

Printed on both sides of a heavy-duty A4 plastic sheet, the guide is easy to use: it takes less than a minute to pick out the right model for an application. You just decide the key parameter for your application: slew rate, supply

current, etc, plus the value you need.

On the chart, the part numbers are listed next to the value you decided on. You then check that the other parameters for your selected op amp are acceptable.

RR Electronics is a subsidiary of Electrocomponents Group plc.

RR Electronics Ltd,
St Martins Way,
Cambridge Road,
Bedford MK42 0LF.
Tel: (0234) 47211.

Argo

Argo Electronic Components Ltd have published their latest catalogue covering their extended range of aluminium instrument control knobs, dials and shaft locking devices. Included in the catalogue for the first time are several slow motion and dual speed dials, some of which have setting accuracies of 0.1° (ie 6 minutes of arc).

Argo's *Designers' Guide* also includes the range of wire wound general purpose and precision rotary potentiometers, previously manufactured by May Precision Components Ltd.

Other interesting items in the guide include a solution to disintegrate epoxy and polyester resin; a shaft shear to cut (without shock) 7 different diameters of component shafts and a range of instrument trolleys.

The guide concludes with details of custom made aluminium control knobs, manufactured without any tooling charges.

Argo Electronic Components,
Stiron House,
Electric Avenue,
Westcliff on Sea,
Essex SS0 9NW.

If your company is launching something you think our readers would like to hear about, send it in to the usual editorial address and we'll squeeze it into these pages.

CLUB NEWS

Welsh convention

This year's Welsh Amateur Radio Convention, hosted by the Blackwood and District Amateur Radio Society, will be held at the Oakdale Community College, Blackwood, Gwent on Sunday October 4th.

Doors will be open at 10am, the official opening being at 11am by Mrs J Heathershaw G4CHH, President of the RSGB. The programme will include VHF and HF features, and Morse test facilities will be available – after application to the RSGB. Admission is £1.50 at the door. Further details can be obtained from RB Davies GW3KYA, tel: (0495) 225825.

Surplus sale

For those in search of a bargain, the Farnborough and District Radio Society is holding a surplus equipment sale on October 28th. Club meetings are at 7.30pm for 8pm at the Railway Enthusiast Club, Howley Lane, Farnborough. To find out more contact the club secretary, Tim, on Camberley 29231.

The Sheffield Award

The Sheffield Amateur Radio Club is reinstating the Sheffield Award, piloted in the mid '70s. The award is available to both licensed transmitting amateurs and SW listeners.

The award is given for one of the following:

In the UK, establishing two-way contact with thirty Sheffield stations. SWLs should log the same number, but must include in their log extract the calls of the stations being worked by the Sheffield operator.

Stations in Europe but outside the UK must make two-way contact with ten Sheffield stations. SWLs should follow the above procedure.

Stations outside Europe should establish two-way contact with ten Sheffield stations. SWLs should follow the rules outlined in the UK section. A Sheffield station is defined as being one within

the Metropolitan District boundary.

Bonus points are given for working club members – they count as two contacts and a contact with an SARC organised special event station scores as five contacts.

A microwave section is also included, and an award given for any station who has worked five Sheffield stations on the bands from 1.3GHz up.

A copy of the relevant log entries, examined and certified accurate by a local amateur, and dated and signed by both operator and the witnessing amateur, should be sent to SARC Awards, c/o G3PHO, 146 Springvale Road, Sheffield S6 3NU, enclosing £1 or the equivalent of £1.50 in IRCs if overseas.

Club meetings are held every Monday at 8pm in the Firth Park Pavilion, Sheffield. Tuition for Morse and the RAE takes place between 7pm and 8pm. Details can be obtained from Alan G8ZHG on (0742) 395287. The club AGM is on October 12th.

70cm contest

A 70cm contest is being held by the Dunstable Downs Radio Club on October 3rd and 4th. Later in the month, the meeting on October 16th will be concerned with satellite TV equipment, and at the end of the month, on October 30th, a junk sale is being held.

Perhaps the ideal place to find the spare parts for your satellite TV equipment?

Meetings are held every Friday at 8pm, at Chews House, 77 High Street South, Dunstable, Beds. For more information, contact Tony G0COQ on (0582) 508259.

Construction Competition

The Bury Radio Society meet every Tuesday at the Mosses Centre, Cecil Street, Bury, Lancs. Main meetings are held on the second Tuesday of the month, while other meetings are informal.

The main meeting for October will be an event not to miss, as the Rev George Dobbs G3RJV is making a guest appearance to judge the club's Construction Competition.

Further details on this and other scheduled events are available from G1VQE, 29 Harrow Close, Blackford Bridge, Bury, Lancs BL9 9UD.

Welsh Amateur Radio

This year's Welsh Amateur Radio Convention which is hosted by this Society will be held at the usual venue – Oakdale Community College, Blackwood, Gwent, on Sunday, 4th October. Doors will be open at 10.00am and the official opening will be at 11.00am by Mrs J Heathershaw G4CHH, President of the RSGB.

The programme will include

VHF and HF features, and Morse test facilities will be available (applicants must apply through the RSGB). There will be the usual trade stands, bring and buy and the RSGB stand. Admission is £1.50 at the door, which includes automatic entry to the raffle (£300 in cash prizes). Talk-in will be on S22 – take exit 28 off the M4.

Further details can be obtained from R B Davies GW3KYA, 16 Vancouver Drive, Penmain, Blackwood, Gwent NP2 0UQ. Tel: (0495) 225825.

VHF Field Day

Members of the South Dublin Radio Club set up station on a site near the RTE Irish Television mast on Kippure Mountain (Locator IO63 UD) for VHF Field Day. The group, using the club callsign EI2SDR/P, operated the 2m and 70cm bands only, but enjoyed many contacts into the UK and the continent. While the site is at nearly 2000 feet asl, the weather was perfect and it was possible to see the coast of GW land without too much difficulty!

The photo shows members of the club preparing for a busy day set in beautiful surroundings.

G3PGA Memorial Trophy

Members of the old South London Mobile Club commissioned a trophy in memory of their last Chairman, George



Dorling G3PGA. The trophy is held by the Wimbledon and District Amateur Radio Society and is awarded each year to the winner of the Society's constructors' competition. The winner for 1987 is Peter Horbaczewskij G4Z XO, for his conversion of a PMR rig for 2 metres based on synthesized control logic he designed himself.

G4Z XO received the award from Susan Dowdeswell, daughter of the late Eric Dowdeswell G4AR, who was also a member of WDARS and, for many years, a regular contributor to the amateur radio press.

Edgware's Golden

The Edgware and District Radio Society celebrate its 50th anniversary this year, and to commemorate the event they are holding a celebration dinner on 17th October.

Guests at the dinner will include Joan Heathershaw G4CCH, president of the RSGB and Angus McKenzie G3OSS and his wife Fiona.

The club usually meets on the 2nd and 4th Thursdays of each month for 8.00pm at the Watling Community Centre, 145 Orange Hill Road, Burnt Oak, Edgware. A club net is held at 10.00pm every Monday on 1.978MHz, and slow Morse transmissions are made at meetings and by G3ASR on 1.978MHz (AIA/J3E) on Mondays, 8.30-10.00pm (4-14 words per minute) and on every 1st and 3rd Thursday at 7.30-9.00pm (8-18 words per minute).

Further information on the club and its activities can be obtained from the club secretary, Ian Cope G4IUZ, 30 Drovers Way, Hatfield. Tel: Hatfield 65707.

Wirral and District ARC

The Wirral and District Amateur Radio Club dropped us a note to tell us what was happening in their area of the woods, but unfortunately omitted to tell us where they meet and at what time. Consequently, this information will have to be obtained from Mr Court G1UHO on (051) 625 5490.

However, they did tell us that they have a Quiz Night arranged for October 14th and an Equipment Display on the 28th, so if you're interested, give Mr Court a 'bell' on the above number.

BARTG discussions

The annual general meeting of the British Amateur Radio Teleprinter Group (BARTG) is to be held on Saturday, November 7th at 2pm in the Churchill Room, London House, Mecklenburgh Square, London WC1. All members are invited.

One issue to be discussed is an increase in membership fees for next year; 1987 subs remain at £7 for UK members, £10 for Europe and £16 for overseas airmail until the end of the year, and BARTG say that it's still not too late to join! For further details, contact Mrs Pat Beedie GW6MOJ, 'Ffynnonlas', Salem, Llandeilo, Dyfed SA19 7NP.

RAE classes in Birmingham

The Wythall Radio Club will be continuing their successful series of RAE classes at their club HQ in Wythall House, Wythall Park, Silver St, Wythall, south of Birmingham, off the A435.

Starting in September on Thursday evenings at 7.30, the tutor will be Colin G6NPS. The course is designed for absolute beginners and anyone who wishes to attend is most welcome.

Since starting RAE classes, the Wythall Radio Club have seen nearly 50 amateurs through the exam.

For details of the RAE class and other club activities, phone the Club Secretary, Chris G0EYO, on (021) 4307267 or QTHR.

Thriving Club

The Coventry Amateur Radio Society usually meet for 8.00pm at Baden Powell House, 121 St Nicholas Street, Radford, Coventry.

Meetings for October include the club's AGM on the 2nd, Morse tuition and time on the air on the 9th and 23rd, a quiz night on the 16th and an indoor (!) direction finding game on the 30th.

Visitors are always welcome, and further details are available from the club secretary, Bill Hahn G3UOL; 91 The Chesils, Coventry CV5 9NA. Tel: (0203) 414684.

Repeat that, please . .

Feedback, the journal of the Bury Radio Society has announced that it has obtained RSGB approval to set up a digipeater to celebrate its 50th anniversary.

The proposal has now been forwarded for vetting by the various government departments, which means that it could be running by the end of September this year. Initially, it will operate on 2 metres, but only until December, when the experiment ends.

In these circumstances, the society is looking for a kind soul to lend them a transceiver for the period, preferably crystal controlled. The only requirements are that it should be reasonably sensitive, stable and have good bandpass characteristics.

The unit is promised a good home! Contact *Feedback's* editor, G4GSY, if you can help on (061) 761 5083.

Worthing workshops

The Worthing and District Amateur Radio Club holds its AGM on October 7th. The club's recently introduced workshop evenings have proved to be a great success, covering subjects such as capacitors, resistors, inductors and even valves.

All details of forthcoming events can be obtained from G4GPX QTHR, on Lancing 753893.

Chelmsford nets

The Chelmsford Amateur Radio Society is also holding its AGM in October - it must be a good month for such meetings. It will take place on October 6th, and the club members will presumably have recovered by then from their DF hunt, which was held in July, for two ingeniously hidden stations (one of which was only found with help after dark).

The club holds a 2 metre FM net beginning at 7.45pm on Tuesdays, on 145.255MHz, and a 10 metre SSB net on 28.325MHz, starting at 8.30pm. Meetings are held at the Marconi College in Arbour Lane.

For more information about club events please contact Roy G3PMX or Ela G6HKM on (0245) 360545.

Wartime radio

Fareham and District ARC is going back in time for its meeting on October 21st. G3AUV is giving a talk on his wartime experiences in the Radio Security Service, for those with a touch of nostalgia for the past.

G4JEV will be talking about

the TM1000 ATU on October 7th. Both of these talks will be given at the club's regular meeting place, Portchester Community Centre, Westlands Grove, Portchester, Hants at 7.30pm. A Morse class is also held from 6.30pm.

For details contact the club secretary, G3CCB, on Fareham 288139.

In the past

Industrial architecture is the theme of John Batchelor G3XMV when he gives his talk to the Southgate ARC on Thursday, October 8th.

The club returns to the present day for an informal evening on October 22nd.

These meetings are to be held at 7.45pm at the Holy Trinity Church Hall (Upper), Green Lanes, Winchmore Hill, London N21. Any enquiries should go to DC Elson G4YLL on (0992) 30051.

DX techniques

Wimbledon and District Amateur Radio Society is holding a talk on DX techniques, given by Nigel Cawthorne G3TXF, to take place on October 30th. All W&DARS meetings are held on the second and last Fridays of each month at 7.30pm in St Andrew's Church Hall, Herbert Road, Wimbledon, London SW19.

Radio active

An 'activity evening' is scheduled for Tuesday October 13th at the Verulam Amateur Radio Club.

On October 27th Mr D Beattie G3OZF will give a talk entitled 'DX working and DX edge'. For further information contact Hilary G4JKS, on St Albans 59318.

All club meetings are at the RAF Association Headquarters, New Kent Road (off Marlborough Road), St Albans, on the second and fourth Tuesdays of the month.

Eisteddfod events

Instead of bursting into song, Newport Amateur Radio Society is preparing for the Royal Welsh National Eisteddfod by giving awards for contacting the club call-sign, GB2EC.

Club members will hold GB2EC on a monthly rota from October until the Eisteddfod begins in July '88, a total of ten stations. GB2EC will be active on HF and VHF. All contacts will receive a QSL card. The

STRAIGHT & LEVEL

GW4EZW club callsign, will qualify for one contact only.

For further information contact NARS via Box 33, Newport.

Video night

Bath and District ARC is holding a video night on October 14th and a constructor's competition on October 28th.

Club meetings are held at the Englishcombe Inn, Englishcombe Lane, Bath on

Wednesdays at 8pm. Club contact is H Welchman G6E1Y, on Bath 28010 day-times and Bath 318128 evenings.

Knotty, knotty...

Felixstowe and District ARC is a bit tied up on October 5th, with a lecture on knot tying for the radio amateur. If you are at a loose end, this could be just the thing for you...

Later in the month, on the

19th, the club is holding a social.

All club meetings take place at 8pm in the Scout Hut, Bath Road, Felixstowe, unless otherwise specified. Further details are available from Paul Whiting G4YQC on (0473) 642595, daytime only.

Irish races

The fund raising committee of the Irish Radio Transmitters Society is looking for members to get sponsorship

for the society's Race Night, in the form of advertisements in the book which will form the race card.

Admission to the evening is £1.00, which includes the race card and light refreshments. Bar facilities will also be available.

Subscriptions and details of advertisements should be sent to Tony EI6EW, PO Box 462, Dublin 9. All cheques should be made payable to IRTS.

LOOK WHAT YOU GET EVERY MONTH IN



Amateur RADIO

- ★ **DX DIARY** Don Field G3XTT with all the news of rare DX, contests and DXpeditions
- ★ **ON THE BEAM** Glen Ross G8MWR with all the news and comment from bands above 50MHz
- ★ **G3OSS TESTS** Angus McKenzie – the fairest, most comprehensive reviews available anywhere

MORE NEWS, MORE FEATURES, MORE FUN, MORE STYLE THAN ANY MAGAZINE AVAILABLE ON THE MARKET TODAY

Make sure of your copy by placing a regular order at your newsagents or by taking out a post free, inflation proof subscription, with early delivery to your door each month

AMATEUR RADIO SUBSCRIPTION ORDER FORM

To: Subscription Department • Amateur Radio •
1 Clarendon Road • Croydon •
Surrey • CR0 3ST Tel: 01-760 0409

PLEASE SUPPLY: (tick box) for 12 issues, all rates include P & P
 Island World-Surface Europe-Air World-Air
 £18.90 £18.70 £22.45 £27.50

NAME
 ADDRESS

 Postcode

PAYMENT ENCLOSED: £ - Cheques should be made payable to Amateur Radio. Overseas payment by International Money Order, or credit card

CREDIT CARD PAYMENT VISA EXPIRY DATE

..... /

Signature

THE HAMGEAR PMX PRESELECTOR



Introducing our new HF band preselector and antenna tuning unit combined, covering 1.7 to 34 MHz completely. The ATU section allows endless experiments with various lengths and types of antenna and offers correct matching of these antennas to your receiver.

The pre-amp section has a gain of 20 DBS which can be controlled down to zero gain, then on down to minus 15 DBS, allowing a boost just where the RX might need it or an attenuation where the band dictates.

The PMX can also be supplied with a built-in calibrator, having outputs at 1 MHZ, 100 KHZ and 10 KHZ, with harmonics of these throughout the HF spectrum.

Casework is all metal with brushed aluminium engraved panel.

Prices are:

Unpowered PMX.....	£69.00
Mains powered PMX.....	£78.00
Mains powered PMX with calibrator	£97.00

All prices include U.K. postage.

Send for 4-page information on this PMX series.

HAMGEAR ELECTRONICS
125 Wroxham Road, Norwich NR7 8AD.
Tel: Norwich (0603) 405611.

RADIO AMATEURS EXAMINATION TO ALL RAE STUDENTS

- 1) Are you finding home study difficult?
- 2) Would you like some C&G style practice questions?
- 3) Do you need some extra questions to supplement your college or correspondence course?
- 4) Would you like a Q&A manual designed to progress with an RAE course?
- 5) Are you having difficulty recognising circuits?
- 6) Could you do with some worked through examples on the scientific calculator?

IF THE ANSWERS TO ANY ONE OF THE ABOVE QUESTIONS IS YES, THEN YOU MUST OBTAIN THE NEWLY PUBLISHED THIRD EDITION RADIO AMATEURS' QUESTION & ANSWER REFERENCE MANUAL THIRD EDITION BY REG PETRI. T ENG MI.ELEC I.E. G8CCJ

WITH ADDITIONAL SECTIONS ON CIRCUIT RECOGNITION AND USING THE SCIENTIFIC CALCULATOR CONTAINING OVER 340 PAGES, 23 SECTIONS, 20 OF WHICH CONTAIN APPROXIMATELY 1100 PROGRESSIVE MULTIPLE CHOICE QUESTIONS AND ANSWERS. THE OTHER SECTIONS INCLUDE COMPUTER PROGRAMS FOR RAE FORMULA, CIRCUIT RECOGNITION, WORKED THROUGH, EXAMPLE, ON THE SCIENTIFIC CALCULATOR AND THE C&G SYLLABUS. ISBN 0 9509335 2 x size A5 (210 x 148mm)

Available By Return Post From:

WP PUBLICATIONS
11 WAYVILLE ROAD
DARTFORD, KENT DA1 1RL
price £6.95 & £1 p&p UK

ALSO AVAILABLE a suit of computer programmes for the Commodore 164 only. Contains formula for the RAE and the morse tutor.
Tape £5.95 inc p&p Disc £6.95 inc p&p

C.M.HOWES COMMUNICATIONS

Eydon, Daventry,
Northants NN11 6PT.
(mail order only)

Phone: 0327 60178

PLEASE NOTE: DUE TO EXPANSION, WE HAVE MOVED!

Our range of good quality radio kits enable you to build yourself many interesting projects. We have receivers, transmitters, transverters, filters, ATUs, mics, speech processors, oscillators, and more, sitting on the shelf at our new mail order premises. If you haven't got a copy of our summer catalogue, why not send an SAE for one? Alternatively, why not call on one of our stockists and see the kits for yourself? One or other of our stockists will be at most rallies this year, and we will be attending some 1 in person too.

UK Dealers include:—

Bonex Ltd, Acton, London 01-992 7748
J. Birkett, Lincoln 0522 20767
MGR Services, Birkenhead 051-653 3437
Southdown Radio, Eastbourne 0323 639351
Ward Electronics, Birmingham 021-328 6070

Watch out for our new 2 to 6m transverters!

73 from Dave G4KQH, Technical Manager.



EASY TO BUILD KITS BY MAIL ORDER



DX DIARY

News for HF operators compiled by Don Field G3XTT

Looking back on August I see from my logbook that conditions on the higher bands continued to be good, particularly on twenty and fifteen. There now seems to be general agreement among the experts that we are past the sunspot minimum and can look forward to steady improvement over the next few years. Highlights during the month included FR5ES/J who was very active on 20 metres, both SSB and CW, and 4X6TT who turned up from a number of rare spots including XX9TTT and 4X6TT/DU1.

CQ worldwide

October is best known by HF DXers as the month of the CQ Worldwide SSB DX contest, the premiere contesting event of the year. This is the one that draws contestants to remote islands or obscure countries in order to amass record-breaking scores. Of course, most of us can't afford either the time or the expense of such trips, but we can benefit by working those intrepid contest expeditioners.

Some of these operations are truly massive in their scale. I have seen American groups describing how they have chartered aircraft to take literally tons of gear and supplies to faraway places just for the contest. The Finns have done their share as well. The OH0W operations from the Aland Islands a few years back involved building several hundred foot plus towers on an uninhabited island, setting up radiotelephone communication with the

mainland in order to be able to telephone amateurs around the world for contest skeds, flying a station out to Market Reef by helicopter in order to get some extra multipliers, and so on.

DXpeditions

At the time of writing a number of would-be DX peditioners have already announced their intention of going to distant lands for this year's contest. Fred Laun K3ZO, will return to Thailand where he lived for several years, along with K3TW, to operate in the contest. NP4JV, currently in Guam, will travel to Midway Island and operate as NP4JV/KH4. N1GL will be operating from Aruba as P40A.

WB7FRA plans to operate from Tunisia as 3V8FRA or, possibly, TS8FRA. The story behind this operation alone is an interesting one. WB7FRA was having trouble getting authority for an operation from Tunisia. In the end he wrote to the QSL managers of everyone who had operated from there in recent years. From the clues which he received from this exercise, he then spent several hundred dollars on telex and telephone calls to the authorities in Tunisia before getting the licence. Let's hope it pays off for him in the contest!

The K3KG contest team will put on a major effort from Barbados as 8P9HR, with some CW and WARC band operation promised before the contest. Undoubtedly there will be many more expeditions that have yet to be notified. Even the Russian

groups often get out and about to rare Asiatic republics or out of the way zones such as zone 23. All in all an event not to be missed. Unfortunately your scribe will be missing it this year, due to business commitments. Pretty bad planning, you might say!

Make a date

I haven't actually mentioned the contest dates above. In case you aren't in the know, the contest always runs on the last full weekend in October (which, this year, is 24/25th), and lasts a full 48 hours from midnight GMT on the Friday. The contest exchange consists of signal report plus CQ zone (the UK is in zone 14). Score 1 point for each European contact, 3 points for each contact outside Europe. Contacts with your own DXCC country do not count for points, but do for multiplier credit. Multipliers are DXCC countries plus zones on each band added together. Single or multi-band entries are accepted, and there is a QRP category. I can help with sample log and cover sheets if required, in return for an SAE.

Details next month of DXpeditions for the CQWW CW contest, on the last weekend of November.

The ultimate challenge

Hard on the heels of the Jubilee DXCC award comes a challenge which makes the Jubilee award seem positively pedestrian. To celebrate 25 years of the *DX News Sheet* (founded by Geoff Watts, and now published by

the RSGB) the current editor, G4DYO, is sponsoring a special award for DXNS subscribers. Points will be scored for working DXCC countries, CQ zones, and countries on Top Band. The basic target, however, to be achieved in the six months between 1/9/87 and 29/2/88, is 230 DXCC countries, all 40 CQ zones, and 50 countries on 160. Definitely not one for the faint hearted!

County hunting US style

If the *DX News Sheet* challenge looks rather too daunting, how about something rather different? If you have ever strayed up to the top end of 20 metres you may well have come across the US County Hunters Net which operates throughout the day on or near 14336kHz. County Hunting is exactly what it appears to be, only in the USA there are some 3077 counties, many of which are very small and have no resident amateurs. As a result it can take a very long time indeed to work them all!

The County Award programme is run by *CQ Magazine*, of CQWW contest fame, and there are various levels of award for working 500, 1000, 1500, 2000, 2500 and 3000 counties, as well as the one for working the whole lot. Over 500 amateurs have worked all counties. The majority of these are American amateurs, but quite a few have been from elsewhere and DX amateurs (the UK is, DX in this context) are always made especially welcome in the nets.

Before diving in, though, it's

worth spending some time listening to the nets and knowing a bit more about what is going on. Confirmed contacts with the relevant number of counties are required for the awards. Many of these will be with mobile stations, and one of the main purposes of the nets (there are also 40 and 80 metre nets and one which meets on 20 metres CW) is to 'run' mobile stations who go out and operate for the benefit of county hunters. This procedure is much the same as you will hear on 3760kHz in the Worked All Britain nets. Accurate logging of all contacts is essential. However, to cut down the cost of QSL cards for the mobile station, it is normal to send him (via the special Mobile QSL Bureau in Iowa) a county hunter reply card on which you fill in the QSO details, he signs to confirm that the details are correct, and which is then returned to you. These cards can carry details of up to 10 QSOs, or 20 if all were on the county line (when the contact counts for both counties).

Non-US amateurs

For non-US amateurs, the easiest way to handle this is to find yourself a US county hunting enthusiast who is willing to act as your QSL manager. This is quite normal practice, and you will usually find a willing volunteer via the net once you have made it clear that you intend to take county hunting seriously.

While you are busy collecting counties towards the awards, you may start to wonder what the peripatetic mobiles get out of it. Well, apart from the sheer satisfaction of helping their fellow amateurs achieve new goals, there are awards which they themselves can be awarded for giving out counties to others. These and a whole series of other awards related to mobile operating are sponsored by the Mobile Amateur Radio Awards Club, which has very strong links with the county hunting fraternity.

If all this has whetted your appetite I would suggest, as I said above, that you listen in on the county hunters net and try to follow what is going on. You can also write to the Mobile Amateur Radio Awards Club via Bill Olsen WB0UPU, 2221 Ogden Court, St Paul, Minnesota 55119 for

information and a copy of their *County Hunter's Operating Procedures*. County hunters' handbooks, directories and special logbooks (not essential) are available from the B&B Shop, 1348 Pinewood Drive, Woodbury, Minnesota 55125, though I don't know what these cost.

Basic information about the County Awards Programme can be obtained via Dorothy Johnson WB9RCY, of *CQ Magazine*. Her address is 333 South Lincoln Ave, Mundelein, Illinois 60060. Applications for the various classes of the County Awards must be made using the official record book, which is available from *CQ Magazine* for \$1.25. This lists all the counties by state, with space to enter call sign, band, mode, etc. The Mobile QSL Bureau is at PO Box 1806, Des Moines, Iowa 50306.

All the above may appear to have a distinctly American flavour, which is hardly surprising, but US amateurs are some of the most friendly in the world, and Europeans who have become involved in county hunting have found that it has opened up a whole new world and enabled them to make many new friends. Good hunting.

More new countries?

The subject of Aruba has apparently reared its head again and the ARRL DX Advisory Committee will soon be taking another vote on whether Aruba should count separately from the Netherlands Antilles (the last vote resulted in a tie). W2GD (who operates from Aruba as P40GD) has pointed out that when Surinam as at the same stage in its path to independence the ARRL recognised it was being separate. The Aruba Radio Society will shortly apply to the IARU for separate membership. And, finally, no less an organ than the Wall Street Journal now regards Aruba as independent, though bemoaning the confusion this will cause by removing the 'A' from what it had previously referred to as the 'ABC' islands (Aruba, Bonaire and Curacao). We shall, once again, have to wait and see.

On the other hand, it seems there is a move by seven of the smaller Caribbean countries to amalgamate to form just one country which would give them more clout on the

international scene. The seven are Antigua, St Lucia, Grenada, St Vincent, Dominica, St Kitts, and Montserrat. The last of these has yet to gain its independence from Britain, so don't start making any immediate changes to your country list!

DX news

There has been plenty of activity from China recently, particularly on 20 metres in the afternoons. However, there are reports that BY0AA in the autonomous region of Urumqui may be off the air for some time due to political problems in that area.

An operation from St Paul island off Canada (which counts as a separate country) which was due to have taken place in August has now been rescheduled, probably for late October. Look out for the call sign CY9SPI. VE3FXT reports that operations from Sable Island, close to St Paul, may become scarce as the lighthouse has now been converted to automatic operation and it is feared that RF could interfere with the control circuits!

OH1RY starts his Pacific fling on 18th October when he will be in Fiji as 3D2RY. His itinerary then takes him to C21NI, T30, ZK2, ZK1 and FO8 before returning to Europe in mid-November. Last year Pekka made a special effort on 40 and 80 metres. Expect him to do the same again.

VU2GDG has received permission to operate from the Andaman Islands from 5-26th October and expects to go there with four other operators. They will be active on all bands, both CW and SSB. This is the group which put on an excellent operation from the Laccadive Islands a few

years back, so expect great things.

JG1FVZ/5NO will be in Nigeria until March 1988 and promises lots of Top Band activity in particular. SU1ER also expects to be more active on Top Band this season.

Robin DU9RG and his wife have been issued with the call signs V85GO and V85CG for an operation from Brunei which may take place during October. Both EA0JC (King Juan Carlos) and JY1 (King Hussein) have been reported active again recently. Keep your ears glued to the bands and you may have the chance of putting royalty into the log.

Canadian stations now have permission to operate on the 18 and 24MHz bands. Several have been worked in the UK during the evening on 18MHz. And while on the subject of the WARC bands, it is reported that FJ8XD is often to be found on 18074kHz from 0850GMT at weekends.

Apart from the CQWW Contest and a couple of RSGB events, the main HF contests in October are the VK-ZL-Oceania contests. The SSB leg will be held from 1000GMT on 3rd October until 1000GMT on the 4th, and the CW leg a week later. As its name implies, the aim is to work stations in the Pacific area, and the contests always bring plenty of VK/ZL activity on to the bands.

JOTA.

That just about completes the round-up. Don't forget Jamboree on the Air on 17/18th October. And finally, for the prefix hunters, look out on 3/4th October for the unusual HX prefix which will be used by 'white stick' operators in France.

NEWSAGENT ORDER FORM

Amateur
RADIO

To (name of newsagent)

Please order a copy of *Amateur Radio* for me every month

NAME

ADDRESS

Newstrade distributors: Argus Press Sales & Distribution Ltd, 12-18 Paul Street, London EC2A 4JS. (Tel: 01-247-8233)

USEFUL ADDITIONS TO YOUR PSU

by Steven Goodier G4KUB and John Goodier G4KUC

In last month's issue of *Amateur Radio* a complete high current power supply was described including PCB layout and full wiring details. It was thought that some constructors may wish to add monitoring devices to the output, so this supplement to the original article describes the addition of both voltage and current meters. It also offers suggestions about RF protection and recommends a cheaper alternative transformer. Of course both meters and the RF protection could be added to almost any existing power supply.

Voltmeter

Probably the simplest of the additions is the fitting of a voltmeter to monitor the output. *Figure 1* shows the diagram for both meters and a low pass filter for RF protection. As can be seen, the volt meter M1 is fitted across the supply and was based around a 1mA meter with an in-line resistor to set the correct reading. Alternatively, Maplin can supply a 0-15 volt meter stock number RX29A.

The volt meter is wired across the output terminals of the power supply. If you purchase the 15 volt Maplin meter then no calibration should be needed. If you decide to use a 1mA meter, then a resistor will have to be added. With the meter used a 15k resistor gave a full scale reading of 15.5 volts. If wished the resistor can be replaced with a 47k potentiometer and this can then be used to calibrate the meter to any point on the scale. 1mA meters are available from many sources and Maplin stock a suitable type stock number RW94C.

Other meter movements could be used, for example 0-100 μ A or 0-100mA, but you will have to experiment with the value of the in-line resistor R1.

Current meter

A much more useful addition to the power supply is a current meter. There are three ways you can go about fitting such a device, either purchase a ready calibrated 0-25 amp meter, use a 1mA meter with a 30 amp commercial shunt, or use a 1mA meter and a homemade shunt. We will only deal with the homemade version, and the circuit diagram *Figure 1* shows this choice. The components list deals with all three.

In *Figure 1* M2 is the current meter which is placed in line with the positive output lead. Across the meter is a large current shunt and there is also a low value resistor R2 in-line with M2; this is used for calibration and will be dealt with later. *Figure 2* shows the construction of the shunt and was made on single sided PCB, which is then bolted to the back of

the meter. The size of the PCB and the position of the mounting holes will depend very much on the size of meter used, so this is something you will have to work out for yourself. The PCB was simply made by scarring lines onto the copper track with a sharp knife and then lifting the unwanted copper away with a hot soldering iron. This leaves the wanted copper pads which can then be marked and drilled.

In the prototype the shunt was made from about 350mm of 10 amp cable; this was secured to the board via thick copper stand-offs. The length of the cable will depend on the type of wire used and the above length is only given as a guide. The reason for using stand-offs was that when it comes to calibrating the meter you will have to keep unsoldering one end of the shunt, trimming it and soldering it back into place. R2 is also secured to the board via standoffs, but start by using a wire link as R2 may not be needed. Construction is very easy and is shown in *Figure 2*.

Calibrating the meter

It is important to mount the meter into its final position on the panel before calibration can take place. Make sure all solder joints are of good quality as any resistance will affect the final accuracy of the meter. To align the meter you will need a constant current source and a multimeter with a 5 or 10 amp range. The idea is to place the multimeter in series with the meter you use to align and adjust the shunt to obtain the same reading as that shown on the multimeter. The process for setting is as follows:

1. Set the meters up as shown in *Figure 3*. Remember that M2 is the meter we wish to align and should be fixed to the power supply.
2. Draw an exact amount of current from your load. When setting up the prototype I used the station transmitter and adjusted the output to draw 4 amps as shown on the multimeter's 0-5 amp scale.
3. Check the reading on M2. The meter I used had a scale from 0 to 10 and I wanted the meter to read 0-20 amps, so I had to use a $\times 2$ scale. 4 amps would read 2 on the scale, ie $2 \times 2 = 4$. When I checked the reading on M2 it was just over the 2 mark so I had to slightly shorten the shunt. If, however, when checking M2 you find the reading below the expected place, then your shunt is too short and should be replaced with a longer one.
4. Continue to shorten the shunt until the reading is within about an amp of what you want. If you are careful it is possible to cut the shunt to precisely the correct length. It is a bit like SWRing an aerial.

When adjusting the prototype the shunt was cut to within 1 amp of the wanted reading and I then replaced the link on the board with an 18 ohm resistor; this brought the reading down to precisely the correct point. If you are going to use this method of alignment then it is wise to arm yourself with a number of low value resistors.

If you don't have a transmitter which can draw about 4 amps, then the load can be made up from high current resistors. If you use a 50 watt 2R2 resistor this will draw 6.2 amps from a 13.8 volt supply. All you need to do is align the meter as described above, but set the reading to just over the 6 amp mark. The resistor will dissipate approximately 85 watts so you will have to cool it in cold water.

Calibration may sound a little confusing, but in practice is very simple and quick. If you make a mistake all you have to do is cut another wire shunt and start again. In the prototype the meter was probably accurate to about 500mA, which is not too bad for a 0-20 amp meter. If wished the meter could be calibrated 0-30 amps or whatever the user wishes, it's just a matter of cutting and experimenting with the shunt.

RF protection

I have never had any problems with RF affecting the power supply, and my unit runs a TS440S on all modes from 3.5 to 28MHz, plus a 2m transverter. If your supply is mounted in a metal box, then the only place RF can enter is via the mains lead or the leads connecting the power supply to the equipment. If, however, you should encounter RF problems, and this is usually indicated by a drop in output voltage or the tripping of the protection circuits when the transmitter is keyed, then you should think about fitting some form of filter.

The simplest way to protect the supply is to make a choke by wrapping the leads around a ferrite ring, which should cure the problem. Alternatively you could fit the low pass filter shown in *Figure 1*. I must admit I have stolen the filter design from the excellent article 'Fixed Voltage High Current Power Supplies' by Roger Alban GW3SPA, which appeared in *Amateur Radio*, August 1986. L1 is a 10mH choke and can be made by winding 40 turns of 20swg wire on a 23mm diameter toroidal core. C1, L1 and C2, which form the filter, are mounted directly onto the output terminals.

Alternative transformer

The original article recommended a 16.5 volt 42 amp transformer which is fine if you wish to draw more than 25 amps

from your supply, and represents excellent value for money. However, it was felt that a second transformer should be recommended for those wishing to draw a maximum of 16 amps, and Jaytee Electronic Services stock a 0-18-0-18 volt at 8.33 amps per winding. When the secondaries of the transformer are wired in parallel it will provide 0-18 volts at 16.66 amps. Using an 18 volt secondary on the transformer will result in about 25.5 volts being developed across the smoothing capacitors.

The transformer can be obtained from Jaytee Electronic Services, 143 Reculver Road, Beltinge, Herne Bay, Kent CT6 6PL. Stock No 73014 300VA 18+18 volts 8.33 amps. At the time of writing the price was £18.66 including VAT and postage. This price drops to £12.49 for six plus.

Conclusion

Adding the two meters puts the finishing touch to the power supply. As meters are a little expensive I would personally go for the current meter, but if you are rolling in it, it is worth adding both.

To give your power supply a real professional touch it is possible to fit a digital volt and current meter. I would have loved to have tried this, but the funds were not available. There are many LCD digital panel meters available and Maplin Electronics stock three suitable types. I think it would be possible to arrange the meter to read both voltage and current at a flick of a switch. Accuracy should be down to about 0.1 volts and 100mA. I have not been able to test these meters so I am unable to give detailed advice, but if anybody has got one running I would be interested in hearing from you.

COMPONENTS LIST

Volt Meter (M1)

0 - 15 Volts Maplin RX92A
or
1mA panel meter Maplin RW94C
R1 - 15k resistor or 47k pot (see text)

Current Meter (M2)

0 - 25 amp meter Maplin RX93B
or
1mA 75 ohm meter RS259-814
30 amp shunt RS257-565
or
1mA panel meter Maplin RW94C
Home made current shunt (see text)
R2 - low value resistors, 10 ohm to 30 ohm (see text)

RF Filter

C1 - 0.1µF disc
C2 - 0.01µF disc
L1 - 10mH choke (see text)

Miscellaneous

10 amp cable for shunt
20swg wire
Small PCB
23mm diameter toroidal core

Cores available from: TMP Electronics, Unit 27, Pinfold Works, Pinfold Lane, Buckley, Clwyd. SAE for details. Also available from Cirkit.

Transformer

300VA 18+18 volts 8.33 amps
Jaytee 73014

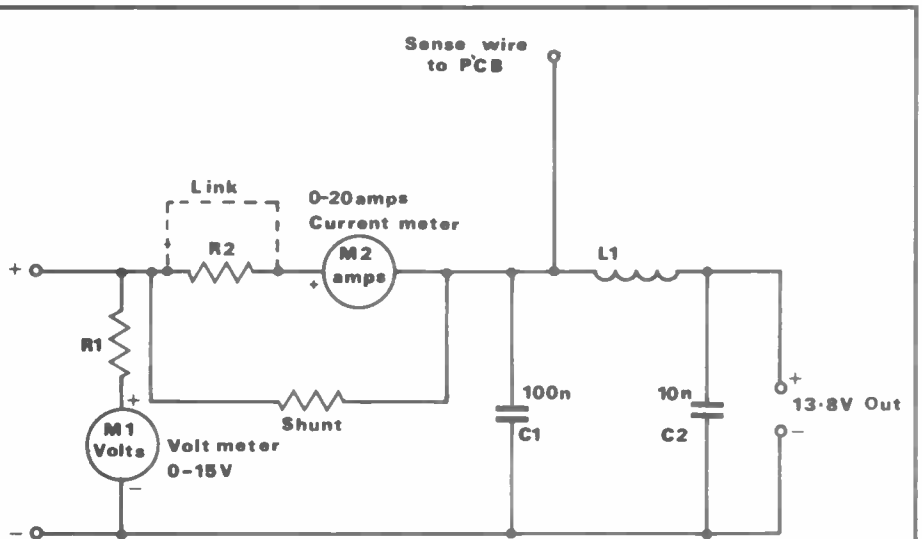

Fig 1 Showing full circuit diagram of the additions to the power supply. The RF filter C1, L1 and C2 is wired directly across the output terminals

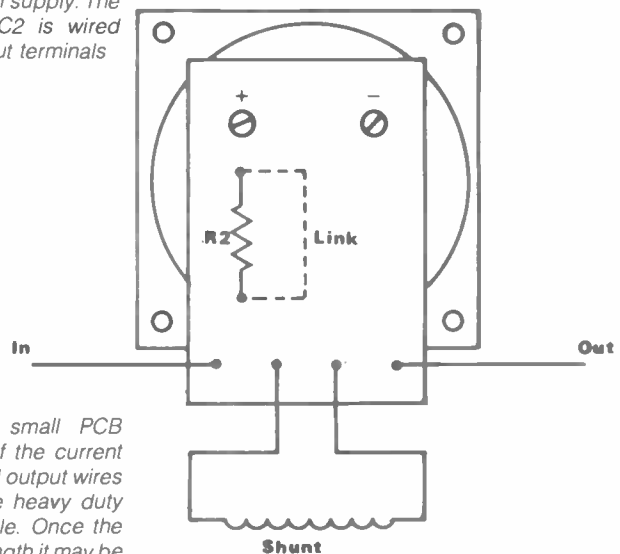

Fig 2 Showing the small PCB attached to the back of the current meter M2. The input and output wires to the board should be heavy duty and as short as possible. Once the shunt has been cut to length it may be neatly coiled up

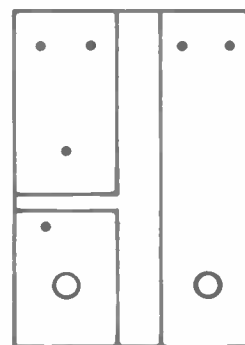
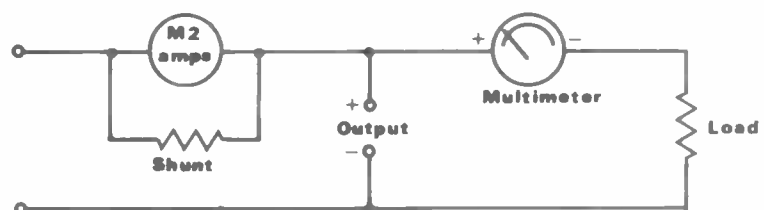

Fig 3 Showing the set-up needed to align the current meter M2. The load can take the form of the station transmitter. The multimeter is wired in series with the positive supply lead and should have a 5 or 10 amp range



ANGUS McKENZIE

TESTS

I remember an amateur some years ago who had sold all his old valve HF gear, and who asked my advice about what rig he should buy to replace it. He was interested in CW, and required superb front end performance together with very good filtering. I suggested that he should try the Icom IC740 and that I could lend him one that I had in my shack, but he said that it was far too small and would look ridiculous on his bench! 'It can't be any good because it can't have much inside it compared to my old Yaesu'.

For those who feel that they want something larger, Icom have introduced their new IC761. I am being slightly sarcastic here, for to be fair this new, largest ever Icom rig is very much a base station model which includes a very heavy duty mains power supply, and a special version of Icom's automatic ATU circuitry. Everything is far more spaced out than usual with Icom, and I was very impressed with the internal layout, as well as that of the front panel. The rig is not only a 100W output transceiver, coping with all amateur bands and modes from 1.8 to 28MHz, but is also a very high quality general coverage communications receiver having an outstandingly good Tx front end.

The transceiver can be operated with the IC2KL solid-state linear, which can then be followed by the high power AT500 automatic ATU, both of these accessories changing band with the rig completely automatically.

Many people have grumbled that they have to have awfully small fingers for the convenient operation of many of Icom's other products, but I find that the IC761 is in a totally different class ergonomically from its predecessors, for even the direct frequency access matrix number pad has well spaced buttons on it, which are easier to use.

Front panel facilities

Mode can be chosen by pressing any one of several buttons in a vertical line immediately to the left of the huge VFO knob. These buttons tended to be slightly sticky in operation on the review sample. The mode buttons have second functions which are selected by pressing a 'function' button first, ie SSB normal or reverse sideband, AM or FM, CW wide or narrow and RTTY wide or narrow. In the case of CW and RTTY narrow, a filter button on the right of the receiver can switch between 500Hz or optional 250Hz bandwidth filters for both 9MHz and 455kHz IFs (250Hz b/w 9MHz IF type IC-FL101, £52, and 250Hz b/w 455kHz type IC-FL53A £104).

When AM is selected, the 9MHz IF filtering is normally bypassed, whilst filters at 455kHz give 6kHz or 2.6kHz bandwidths. If the optional 9MHz IC-



ICOM IC761

Multimode HF transceiver

FL102 is installed, then a 6kHz bandwidth for -6dB, and 20kHz at -60dB is introduced at the second IF, which gives greatly improved blocking and skirt selectivity performances. Pushing the filter button in and out on FM makes no difference, but the SSB bandwidth is decreased from a nominal 2.6 to 2.4kHz for -6dB.

The large and surprisingly heavy tuning knob gives 10Hz steps with 5kHz per rotation, but if rotated above only a moderately fast speed, the rate increases to 25kHz per rotation with 50Hz steps. A tuning step button, when depressed, allows the VFO to give 1kHz steps with the very rapid rate of 500kHz per rotation. You can, of course, put in any desired frequency in increments of 100Hz by using the number pad.

As there is no decimal point, you have to insert five figures for frequencies below 10MHz, or six figures for frequencies above 10MHz, unless you want a 1MHz point, in which case you punch in the MHz followed by 'enter'. I personally much prefer the ICR7000 system with its decimal point, which means you can put in whatever frequency you actually want, without the necessity for extra noughts.

There are two VFOs, and Icom provide their usual facility of A=B, A or B and split operation between Rx and Tx. 32 memories are included, which can store frequency and mode, and these are selected by a click step rotary on the front panel after one has selected memory on a VFO/memory cycling button. Additional buttons select memory write: memory to VFO; transmitter or receiver incremental tuning; MHz or band up and down, depending upon whether general coverage Rx amateur bands or Rx is selected; scan; and fixed

mode scan. Three more buttons select passband tuning/IF shift, wide or narrow filter and notch filter in/out. The notch filter and PBT have their own rotary pots, the latter having a centre indent, whilst the incremental tuning knob allows a QSY of up to ± 9.9 kHz, which can be completely cleared with an appropriate button, or which can be toggled in or out with the RIT or Delta Tx buttons.

Passband tuning and IF shift

When the PBT button is in the in position, a rotary pot allows a fixed bandwidth IF to be placed anywhere between a long way LF to HF of the normal position. This position can thus give a degree of apparent LF cut whilst widening the HF audio response, or the opposite, which would be HF audio cut with an extended audio LF end. However, when the PBT switch is in the out position, the rotary gives just LF or HF cut, depending upon its selected position, thus decreasing the overall IF bandwidth from one skirt only. It is extremely useful to have this facility, which had been provided once before by Icom on the IC740, but which I miss on some of their other models. It is extremely useful when one has to cope with winking out difficult and weak DX stations on SSB or CW.

The rest of the front panel

Three dual concentric pots, well spaced from each other, adjust RF/AF gain, AF tone and squelch (all modes) and RF carrier/mic gain. RF output is adjustable with this last control to a maximum of around 100W down to a minimum of just over 5W, which is presettable internally. Single rotaries work in conjunction with push buttons for

G3OSS TESTS

the selection and adjustment of noise blanker level with wide or narrow bandwidth, CW electronic keying speed with instant or variable delayed break in, VOX delay (CW and SSB), VOX gain and anti VOX, monitor gain and frequency calibration adjustment. A 10kHz marker can also be switched in if required. Additional push buttons select audio processing/compression on Tx, and automatic ATU in/out. One can of course select VOX or MOX operation, and a toggle is provided on the front panel for Tx/Rx switching, although of course this can be achieved either with PTT on the mic, or by external control.

A three position rotary switch selects one of three front end gain positions, RF pre-amp, on/off or off with 20dB attenuation. I very much approve of the facility of switching out the pre-amp, as this allows the equipment to give a wider dynamic range window than you would get by the simple use of a switchable RF attenuator, with the pre-amp always operating, as in the Kenwood TS930S and 940S models. Icom's philosophy is much more sensible and greatly helps the performance on the LF bands.

AGC can either be switched off for manual RF gain control, or be switched to fast or slow time constants with another three-position rotary. A meter switch allows the front panel meter to read on Tx SWR, RF output power, ALC level, audio compressor level, PA current and PA voltage. The meter acts as a normal S meter on Rx.

The digital frequency readout is only given in 100Hz increments, and I would have preferred resolution down to 10Hz as is available on the TS940S etc. Higher resolution is useful so that you can tell another station how far out of correct netting they are, and 70Hz, for example, can be very noticeable audibly, but would not be indicated on the Icom's frequency display. The display, however, is excellent, the white on black frequency and red on black other indications including basic status, being visible from virtually any angle at a considerable distance.

The standard Icom 8 pin mic socket is provided to work with mics such as the

supplied HM36, with which it worked extremely well.

A stereo 6.3mm jack socket has the tip and ring sections independently fed by separate resistors from the main audio feed line. This allows either stereo or mono headphones to be used, as when a mono jack is pushed in, the ring would be shorted to earth, but the tip would be fed separately. This is an excellent idea – simple but most effective.

Casework and rear panel

The rig is housed in a substantial metal case, and one can take off the top and the bottom very easily. The speaker is mounted in the top panel, but I feel it could have been rather larger than it is, as there is plenty of space inside. A little pull-out bug hutch cover on the top panel conceals seven pairs of tiny pre-sets which are used in combination with a pre-set/auto switch, and are required for use with the automatic aerial tuning unit. The pre-sets allow the ATU to start with a 1:1 SWR, which is pre-determined for an optimum frequency on each band or group of bands. When the pre-sets have been set up, the switch should be set to the 'auto' position. The cover was extremely difficult to open without wrecking ones nails, and as it would be used only rarely, the stiffness would not ease up. Consequently YL operators in particular would find this very tiresome.

Although it is simple to insert optional filters internally, it is a little more time consuming if you have to put in the artificial speech frequency readout board, type IC-EX310, which costs an additional £44. The instructions are extremely good for installing accessories, and Fiona commented that although she had to remove the top and bottom covers and take out the power supply, everything was very straightforward, and there were no wires that could be easily trapped etc.

The rig has two feet under the front, which can be pulled out to lift the front up by 4cm or so. One side of the rear panel includes the large PA compartment with the fan cooled heatsink and IEC mains input socket with fuses, above which is a 13.8V dc socket for delivering up to 2A,

whilst the other side includes all the interfaces. A remote computer interface socket is mounted immediately under the heatsink, however.

The antenna socket is a 50 ohm SO239, below which are several pairs of phono sockets for ALC, relay, Rx in and out (normally linked), transverter RF interface and finally a spare. A large earth wing nut is provided below all these. A stereo 6.3mm jack is used for directly connecting a paddle key, but can be used with a normal key. There are two accessory sockets, ACC1 providing phone patch or RTTY audio in/out, FSK, external PTT ALC, squelch on/off data and earth interconnections. There is also a pin to give up to 1A at 13.8V dc. The ACC2 socket is for interfacing with the IC2KL linear etc, and provides band switching data, linear PTT control, ALC return, 8V dc and 13.8V dc. This socket also contains a transverter enable/PA disable pin which cuts the PA out etc. When the 8V pin output is fed back to it externally. This enables the transverter socket as well, but it has to be remembered that the transverter RF drive level is extremely low, and many models on the market will require an external RF drive pre-amp. A 3.5mm jack socket is provided for driving external speakers.

The remote computer interface socket allows almost all of the rig's functions to be computer driven with an RS232 interface. I did not try this, but it is wired up to the same convention as is already available with other Icom products.

Ergonomics

One only has to look at the front panel, and study the spacious rear panel with all the interfacing to appreciate that this rig has some of the best ergonomics to be found on any modern rig. How often have I heard people grumbling on the LF bands that they cannot get their fingers around tiny Japanese buttons, but with this rig everything is spaced out so much better. One or two pre-sets are in the form of tiny axels, which are normally almost completely countersunk into the front panel, but when given a push these spring out for ease of adjustment. These include VOX gain and calibration, for example. Many of the other rotaries are large, and complement buttons which are also larger than usual. The rig is extremely well presented, and quite nice to look at, for it does not have the cluttered appearance present on some rigs that have so many unnecessary bells and whistles. I found that this rig did not have redundant functions, and that operation was far more obvious than on rigs such as the Yaesu FT767 which almost requires a course in microprocessor button control for many of its more esoteric facilities!

I very much liked the feel of the VFO, and it had the same fly wheel feel to it as I can remember from my old AR88 days, but the tuning action did have one annoying snag – the transfer from 5 to 25kHz per rotation occurred at too slow a

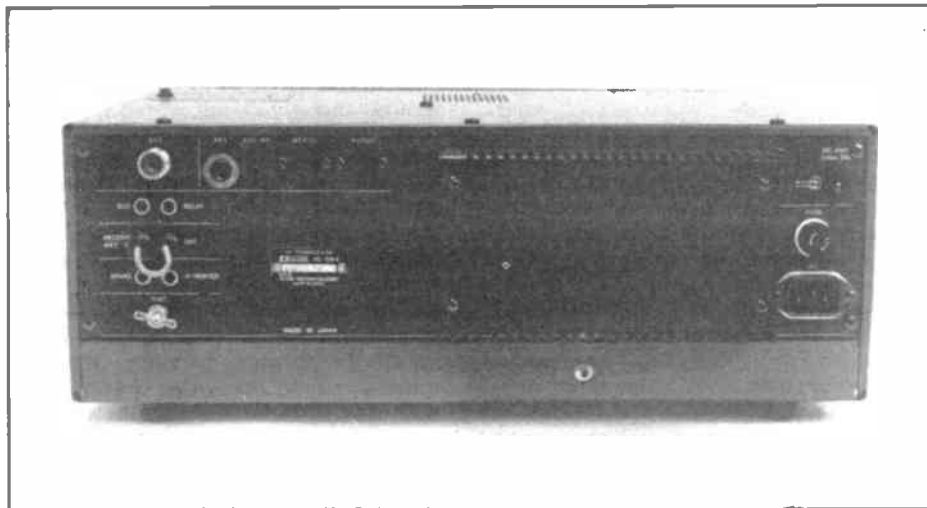

turning speed. When tuning across a band, I suddenly felt the rig shifting at a rate of knots, and it was sometimes difficult to find a required station if I had not noted where I was first.

There is one particular piece of Icom ergonomics that I once again have to criticise very considerably, and that is a change of equivalent carrier frequency injection and frequency indication when switching from upper to lower sideband, and also to CW. This is absolutely infuriating when you want to check somebody's sideband rejection, or especially when you want to use the SSB mode for enhanced carrier detection of AM broadcast stations. With the TS940S I frequently switch sidebands on SSB when listening to DX short wave broadcasts, in order to obtain the clearest sound which is most free of interference. This is often far superior in terms of distortion than actually using AM detection.

Icom have greatly improved their filter switching ergonomics, although I would still have preferred a rotary switch like that on the TS440S for selecting filters.

The passband tuning and IF shift facilities work superbly well, and the skirt selectivity is so amazingly good on SSB that I found that I did not particularly miss the variable selectivity provided on rigs such as the TS930 and 940, and one or two earlier Yaesu rigs. PBT in any case is almost the equivalent of variable selectivity, as it can narrow the passband from either one skirt or the other, although not both. It was superb on 80m and results did seem slightly better here than on my own 940S.

Subjective reception quality

Although the lab tests showed that this is not the most sensitive HF rig available, subjective tests showed that the sensitivity is easily good enough on the HF bands if one has a reasonable antenna system. What I must praise as highly as ever before however, is my feeling at all times that the front end was virtually bomb proof. With the pre-amp switched out, not only were the LF bands incredibly clean sounding, but long wave and medium wave reception was unusually good, even without an external LF ATU. There were far fewer intermodulation products on medium wave than I have heard from almost any other rig, and AM quality was in general very clean.

The optional AM 6kHz filter is excellent here, but of course it will cut off HF if you want to listen to short wave music broadcasts etc, and once installed at the 9MHz IF, you cannot bypass it again from the front panel to restore some HF. FM quality was adequate on 10m, but was hopelessly inadequate for 10kHz channelling, and one heard the usual mess on the CB band. Could Icom not have provided an 'H' filter option which could be switched in with the filter switch as an alternative on FM, for the existing FM filter has a 15kHz bandwidth, and therefore is only suitable for 20kHz, or even wider, channelling.

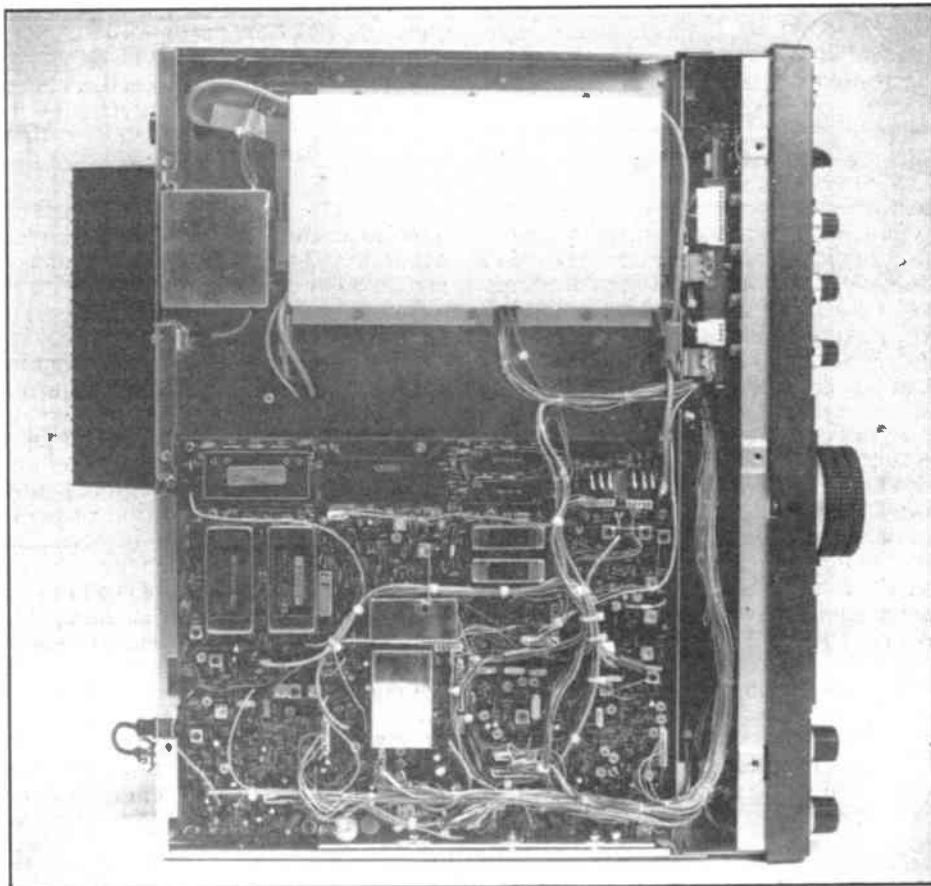

CW reception is absolutely superb, and the narrow filters proved very effective indeed. Many an HF wireless set, however, is not at all happy on weak CW if it has a very poor reciprocal mixing performance, and it is in this area that once again I praise the Icom very highly, for there was much less crud around weak CW signals than I have heard on many a competitive rig. The notch filter was very effective here, and if you have the patience to use the 250Hz optional filter, you may well get some stunning results.

The 10Hz tuning steps proved to be much more linear than usual, and did not deviate at all when I checked the audio beat frequency on a Hewlett Packard counter with 0.1Hz resolution, whilst developing Rugby locked synthesizer frequencies from my Marconi 2091 signal generator. This remarkable frequency linearity and superb stability helped make this rig quite a lot easier to test in the lab.

Although audio quality was generally quite impressive, with the AGC speeds well chosen, it was not quite as clean as I am used to hearing from my Kenwood TS940S. This, however, is a particular fad of mine, which you might care to ignore! I appreciated the addition of a tone control with a wide adjustment range, and the squelch control worked very well.

The notch filter worked particularly well and gave a deeper null than usual, although it required some very careful fine adjustment to obtain the best notch. Perhaps Icom should have used a slightly

geared down twiddling ratio! Returning to SSB, whilst the normal selectivity position gave a very good sound quality on most transmissions, and was slightly wider than usual for Icom, the narrow SSB position provides a very steep skirt indeed with slightly less bandwidth, and is thus particularly useful for DX working. I really enjoyed listening to all modes with this rig, except for FM between 27 and 28MHz! This noise blanker incidentally worked very well, and there was quite a range of adjustment. The optional speech frequency readout will be a boon to white stick operators, as will the direct frequency insertion key pad.

Comments on the transmissions

I received some excellent quality reports on all modes, although I did get the usual comment from my 80m net friends that they rather disliked the compressor quality. However, the built-in processor came into its own on the HF bands when working DX. The transmission has plenty of punch to it, and generally sounded clean, unless I was being received extremely strongly. I found that the SSB filter switch also affected the Tx filtering, and most stations preferred the wider bandwidth. I used the rig with my Bencher paddle, and was extremely impressed with the break-in keying and the general feel of CW operation. I obtained some excellent reports on the keying, and break-in seemed to be almost instantaneous.

I have now found that the dots and dashes from my Bencher were again wrong with this rig, as they had been with

G3OSS TESTS

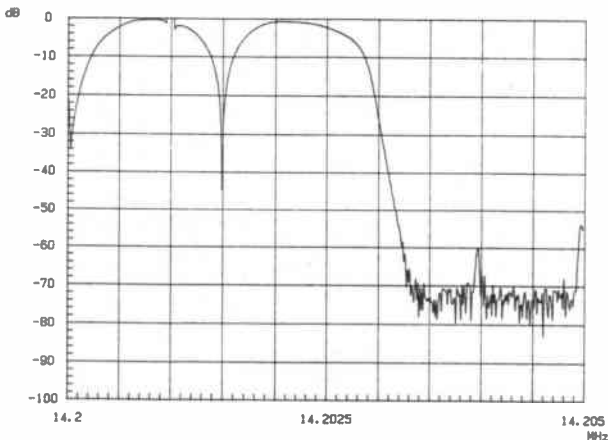

RF/AF sweep with 1kHz probe tone on USB notch filter at 1.5Hz beat. Nb Superb null

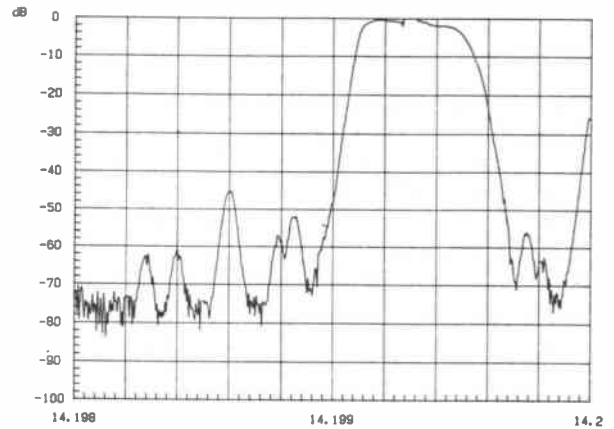

RF/AF selectivity plot. CW narrow with 700Hz LF offset carrier

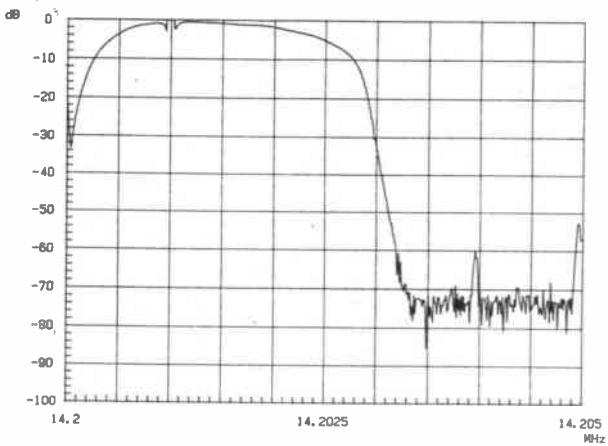

RF/AF selectivity plot. USB wide filter and IF shift out

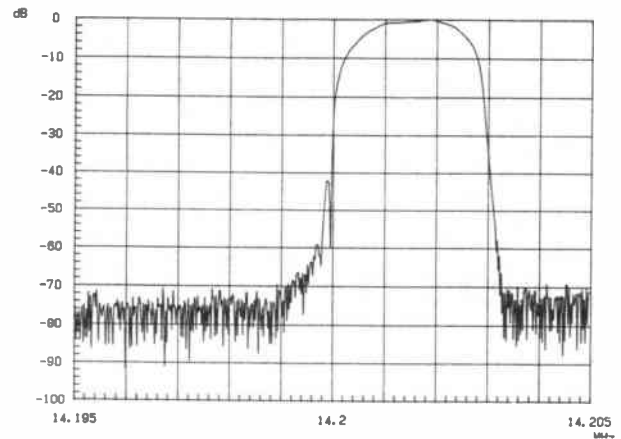

AF/RF Tx response: USB with audio sweeping from -to+5kHz

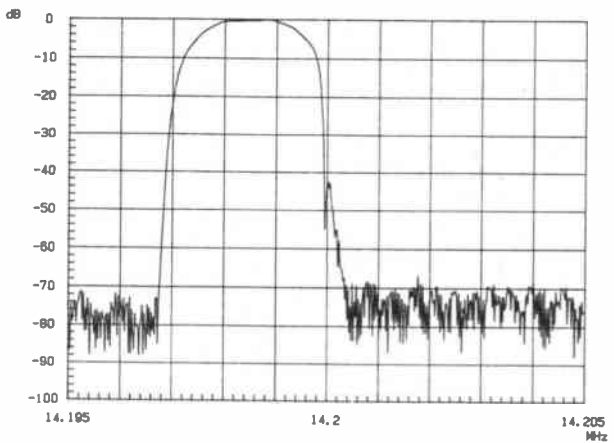

AF/RF Tx response. LSB with audiotone sweeping from -to+5kHz

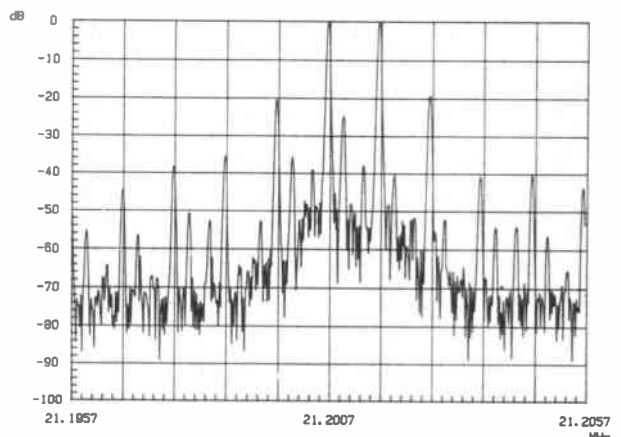

Tx two-tone test 700/1700Hz USB 110W PEP into ALC tuner unit

the Yaesu 767, so this time rather than standing on my head, we changed over the paddle wires, which meant that we had also to change the dit and dah connections on my Morsematic, which I use with the TS940S etc. I now have no doubt that the next HF rig that I test in a hurry with the Bencher will have the original Morsematic connection standard, but forewarned is forearmed!

Receiver laboratory tests

RF sensitivity was measured on amateur bands from 1.8 to 28MHz, and the sensitivity was very satisfactory at all frequencies, although the receiver was

not the most sensitive one that I have tested. The sensitivity reduced by between 7 and 10dB with the pre-amp switched out, and by a further 20dB when the attenuator was switched in. FM sensitivity was not quite good enough for 10m if one has a very quiet location in the country, but this is partly because the filter was rather on the wide side. The AM sensitivity was surprisingly good at best, but I noted a sudden reduction of sensitivity below 1.6MHz of around 18dB, although this improves by 10dB or so below 500kHz, the sensitivity varying quite a lot across the long wave band.

I do not see the necessity of this large

medium wave attenuation, for despite my closeness to BBC Brookmans Park and IBA Saffron Green, I did not have to use the 20dB attenuator on medium wave. In many areas of the UK it would be useful to have the higher sensitivity on medium wave, which would allow DX reception during the day time from very modest antennas.

The RF input intercept point was so good on the LF bands that I had to take extra special care with all the test equipment in order to measure the best intercept point I have yet come across on a receiver. Even with the RF pre-amp on, measurements were superb, and quite

G3OSS TESTS

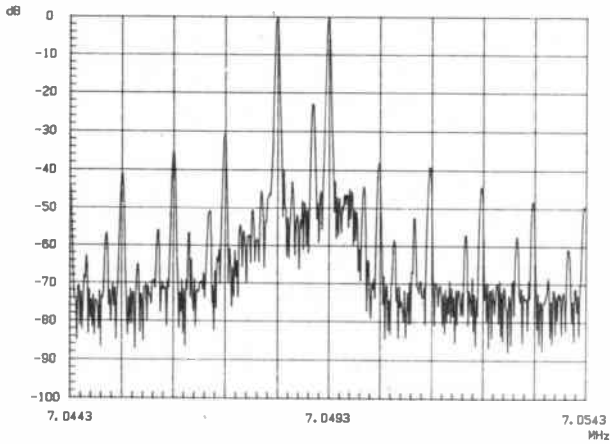

Tx two-tone test 700/1700Hz LSB 100W PEP into ALC tuner out

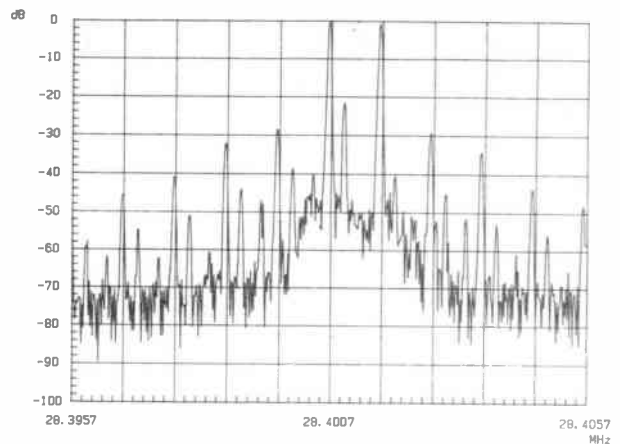

Tx two-tone test 700/1700Hz USB 100W PEP into ALC tuner out

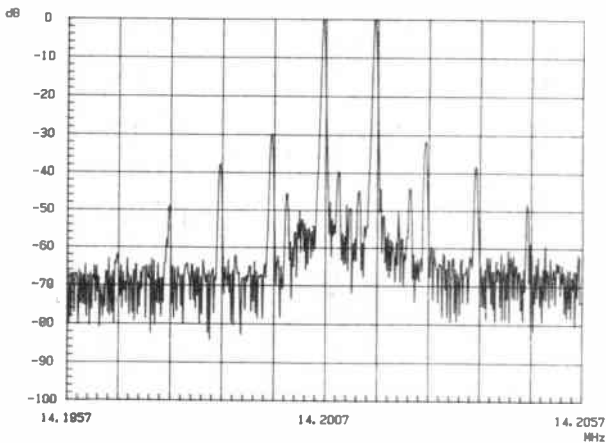

Tx two-tone test 700/1700Hz USB 1W PEP low level test

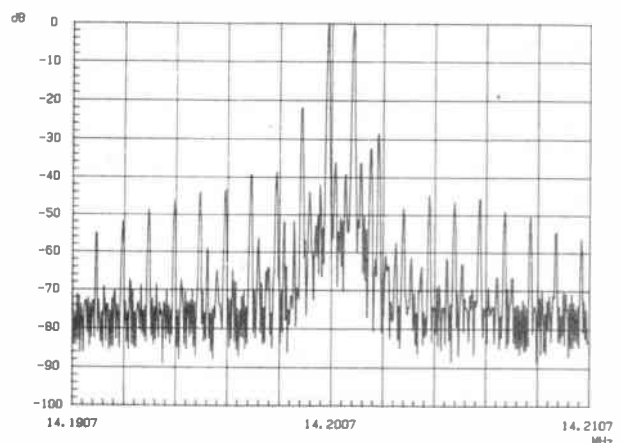

Tx two-tone test 700/1700Hz USB 125W PEP into ALC

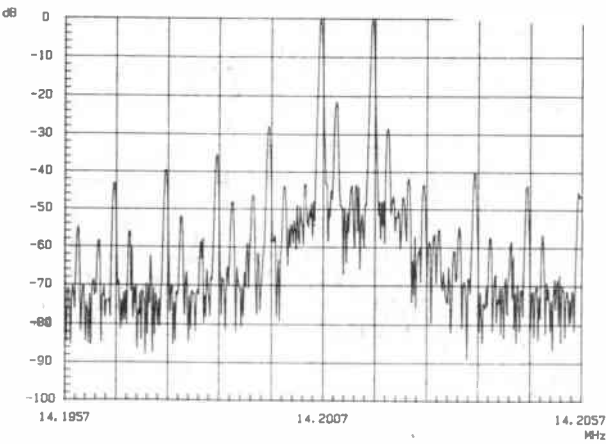

Tx two-tone test 700/1700Hz USB 100W PEP below ALC

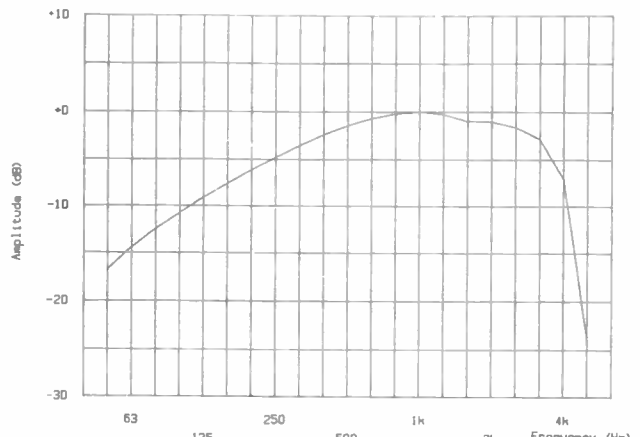

AM received audio response

extraordinary if signals were allowed to go straight through to the mixer. Figures between +27 and +31dBm were noted with pre-amp off, and with the pre-amp on, no figure was worse than +16dBm. The medium wave attenuation would of course make the figure even better for frequencies between 500kHz and 1.6MHz, which is why I was able to wrinkle out so many medium wave DX stations.

The reciprocal mixing performance again was astonishingly good, the rig turning in some of the best figures for a synthesizer close in. By 200kHz spacing, we got precious near the limits of my test equipment, a measurement of 124dB

ratio between the noise floor of the receiver and the off channel signal level required to increase this noise by 3dB giving this astonishingly high ratio. Please bear in mind that the actual signal source used for this measurement has to be impeccable, and the one I used must be better than around -165dBc per Hz bandwidth at 200kHz offset to give the measurements quoted.

We carried out selectivity tests both on the computer set up and with my new plotting technique, and the Marconi plot shows an extremely good selectivity curve at the skirts. Note the amazing steepness of the curve. The computer

tests in fact were very good indeed, and the -60dB bandwidth measurements could not have been measured so well if there had been any synthesizer noise problem, as I have noted in the past when testing another manufacturer's rigs.

The CW 500Hz filter also measured very well indeed (see plot), but the 250Hz optional filter did not arrive in time for the laboratory tests, nor did the 9MHz AM filter.

Even without the latter though, AM selectivity was quite good, and if the 9MHz filter is as good as earlier Icom ones, then the AM 6kHz selectivity should have almost a knife edge!

G3OSS TESTS



FM selectivity was typically much too wide, although it is worth noting that it was again extremely steep outside its bandwidth. I noted with some surprise that there was only 23dB difference between S1 and S9 on SSB, and 14 μ V for S9 is a little bit on the optimistic side! Matters would of course be more realistic if the RF pre-amp is switched off, but then S1 would be around 3 μ V, which is extremely mean. However, the +20, 40 and 60dB markings were all surprisingly accurate. On FM, there was only 15dB difference between S1 and 9, and somewhat surprisingly S1 was extremely sensitive, S9 being at just under 2 μ V, which is incredibly optimistic. I also noted just 5dB steps for each 20dB above S9, which is again ridiculous.

I spent some time checking the distortion of the audio stages and detectors. Harmonic distortion on SSB on a 1kHz beat note measured just 1%, which is extremely good, but when I applied an intermodulation test with two RF carriers spaced 100Hz apart, giving audio beats around 1kHz, third order products of around -26dB were noted with slow AGC, and as poor as -19dB with fast AGC. When I checked the Trio TS940S in an identical way, third order distortions were 6dB better, whilst 5th and 7th order were some 15dB lower. This obviously contributes to the Trio rig sounding cleaner than the Icom. I noted with a degree of fascination that second order intermodulation distortion at 2.1kHz was some 55dB down on the fundamental levels, and since audio harmonics were also at a low level, it is clear that the odd order close in intermodulation products are developed in the IF stages, and probably in the final mixer and 455kHz filters. AM distortion was generally at around 3% at high modulation levels at middle frequencies, but as the modulation frequency decreased, distortion increased, as will be seen from the test results. Even so, the results are a great improvement on those of the much older IC751 and R71 models, although the 751A was good.

Distortion on FM was at low levels, and a lot cleaner than usual. A reasonable amount of audio power was available, although I would have liked even more from a mains rig, but note the useful power increase of just over 50% into 4 ohms.

Overall frequency response within the audio amplifier was just about ideal on SSB and FM, with a reasonable degree of LF and HF cut, but the AM wide response showed too much LF cut for reasonable reproduction of music, the HF end extending very flat up to 3kHz, and nosediving above 4kHz without the optional AM filter in at 9MHz.

An interesting check was carried out on the notch filter, which was very carefully notched on a 1.5kHz beat tone. Using the same 1kHz probe tone carrier combined with the sweep tone as used for the selectivity tests, the notch filter plot shows both the remarkably deep maximum null and the actual notch shape, which is just about optimum for most users.

With the RF pre-amp switched on and with the measurement taken on the 28MHz band on SSB, the AGC threshold was at 0.7 μ V EMF/2. This is just below the point at which the S meter read S1.

One of the most remarkable findings in the lab tests was the extraordinary frequency accuracy of the entire rig, both on Rx and Tx. At no time from a minute or so after switch on to hours later was the frequency accuracy more than 10Hz out, and within a few minutes after the beginning of all the tests this stability was held to within a few Hz on the 28MHz band. This is truly remarkable, and there is a calibration pre-set on the front to set zero beat on WWV if you want to, but I did not even bother to touch it!

Transmitter laboratory tests

With the ATU switched out, typical power outputs between 100W and 110W were noted on all bands on FM and on SSB when driving the rig fairly hard into ALC with a long whistle. However, the powers quoted in the chart are for single tones with the ALC meter usually around one third scale, resulting in somewhat lower measurements. With the two tone tests on SSB, powers as high as 125W were noted at most. The power could usefully be wound down to between 5 and 10W depending on band.

We carried out the main two tone plots at 14.2MHz, and it is interesting to compare the 125W PEP performance with signals way into ALC producing rather high third order distortion, and high order products also rather on the high side with the 100W PEP performance

which is quite a lot better (nb only 1dB less RF output). The 1W very low level plot is good, but not spectacularly so. The poorest performance was actually at 21MHz, and quite frankly -20dB third order is not really good enough, and there seems to be a problem at this frequency on Icom rigs, for the 751 and 751A both gave similar problems on the 21MHz band. Is there some form of resonance in the PA circuitry somewhere which is affecting 21MHz? Plots at 3.7, 7.05 and 28.4MHz all showed substantially better performances into ALC with the third orders averaging at -28dB, although the higher order products did not seem to go down fast enough.

A careful examination of a plot taken of a 1kHz tone set to give full output shows an amazing carrier rejection down to about -70dB, with alternate sideband rejection to -78dB ref full upper sideband carrier. The second harmonic component spaced 2kHz away from the carrier was at -49dB, showing the modulator to have quite a low even order distortion.

We plotted the transmitted responses of the entire transmitting chain from mic input socket to SSB carrier output with my usual technique, from which you can see that the selectivity curve with the normal SSB filter is very similar to that of the Rx curve using the reciprocal technique. Brief checks with the SSB filter switched to the narrow position showed the skirt to be somewhat steeper, the difference down the LF side being between 10 and 15dB lower down, and at the HF side up to 25dB lower down, with bandwidth only reduced by 200Hz or so.

Tests on the FM mode showed that the deviation was extremely accurately set at marginally below 5kHz maximum for a 1kHz tone, and the absolute maximum deviation was reached at around 400Hz. At HF, maximum possible deviation fell quite sharply, which would avoid nasty splatter into adjacent channels. The maximum attainable FM signal to noise ratio was around 48dB, with transmitted distortion at a minimum of 3.2% at a deviation of 2.5kHz. Distortion came in at higher deviations quite rapidly, whereas noise came in at lower deviations. We checked the cleanness of the transmitted spectrum on all the usual bands, and noted second harmonic content to be between 63 and 70dB below the fundamental, the third harmonic content being between -62dB and < -74dB. Higher harmonics were not visible on the Marconi 2382 analyser, nor did we note any particular spurious. We carried out a drift test in which full power was transmitted for several minutes. To our amazement, the frequency did not vary more than a few Hz.

Conclusions

Reviewing a top performance rig is not at all easy, for one has to test it by the highest standards, and when comparing the performance with the best competition, one usually has to resort to ones

G3OSS TESTS

memory of other rigs. In the case of the IC761, I was able to compare it directly with my own TS940S which has all the Lowe Electronics modifications. Having written the review, I mulled over these conclusions overnight, and find that I cannot recommend the Kenwood over the Icom or vice versa, for they are so different in concept, and where one rig's ergonomics in a particular area are awkward, the other rig excels, but perhaps the opposite is true for other areas. The same applies to the technical performance, for whilst the Icom front end reciprocal mixing and selectivity measurements are better, the audio quality of the Kenwood seems a lot better to me. The Icom front panel is possibly slightly less cluttered, as is their rear panel, but the Kenwood TS940S offers more interfacing possibilities. I have absolutely no doubt that the IC761's built in auto ATU is far superior to any other built-in one, for it is so incredibly fast, taking typically around one and a half seconds to match once you have selected a new band. The ATU performance seems identical to that of the various Icom auto ATUs previously reviewed. The two most tiresome features on the Icom are the sideband switching anomalies, and the VFO tuning rate speeding up at too low a revolution speed, both of which became maddening in general use.

High power

If you want high power, and like the idea of a linear such as the IC2KL, you will also need a high power ATU, and it seems logical to consider the Icom AT500. In this case, you are paying for a superb built-in ATU that you do not need as you would have the high power one after the linear, and so you should also at least consider the IC751A with this system. However, you can purchase the Kenwood TS940S without its optional auto ATU, but with the Kenwood linear type TL922. You could then use this system either with the Icom AT500 or some other high power ATU.

The price of the Icom 761 without options is £2459 including VAT, so this becomes one of the most expensive rigs ever marketed, for I think that only the Collins KWM380 costs more, and I don't recommend the Collins anyway. With the Icom, you would be buying a beautifully made piece of equipment with a fabulous Rx performance, but with the Tx performance not quite up to the highest quality. Don't forget that for the price you have not only the built-in auto ATU, but a massive power supply and computer interface facility, as well as all the multimode and general coverage facilities. A very fine rig indeed which receives a strong recommendation, but please compare the entire review carefully with my review of the TS940S over two years ago.

Very many thanks to Icom UK Ltd for the loan of the review sample so shortly after its arrival in the UK, and for sending on the various options as they arrived.

Also thanks to Fiona for helping me with several days worth of testing! This is a review which I have much enjoyed doing,

and I will miss having the rig around in the future, for it did work so well with my IC2KL and AT500.

Icom IC761 Laboratory Test Results

Receiver Tests

RF sensitivity for 12dB sinad SSB pre-amp on (off)		
1.95MHz		-120dBm (-113dBm)
3.75MHz		-122dBm
7.05MHz		-121.5dBm
10.1MHz		-122dBm
14.2MHz		-120.5dBm
21.3MHz		-122.5dBm
28.55MHz		-123dBm
RF sensitivity for 12dB sinad FM pre-amp on		
29.6MHz		-118.5dBm
RF input intercept point/100kHz spacing pre-amp on (off)		
1.93MHz		+17dBm (+31dBm)
3.75MHz		+20.5dBm (+30dBm)
14.2MHz		+22dBm
28.55MHz		+16dBm (+27dBm)
Reciprocal mixing ratios. Noise floor/off channel signal		
5kHz		93dB
10kHz		98dB
20kHz		106dB
50kHz		114dB
100kHz		119dB
200kHz		124dB
Selectivity		
SSB		
-3dB	normal filter	narrow filter
-6dB	2.2kHz	2.0kHz
-40dB	2.5kHz	2.4kHz
-60dB	3.2kHz	3.0kHz
	3.6kHz	3.4kHz
500Hz CW Filter		
-3dB	0.37kHz	
-6dB	0.4kHz	
-40dB	0.6kHz	
-60dB	0.71kHz	
FM		
12.5kHz channelling	5dB average	
25kHz	73dB average	
S meter		
SSB		
S1	-107dBm	FM
S3	-104dBm	-117dBm
S5	-99dBm	-111dBm
S7	-93dBm	-108dBm
S9	-84dBm	-105dBm
S9+20	-84dBm	-102dBm
S9+40	-62dBm	-97dBm
S9+60	-42dBm	-92dBm
ARC threshold	-22dBm	-88dBm
FM capture ratio	-110dBm	
FM 3dB limiting threshold	5dB	
Product detector distortion	-124dBm	
FM discriminator distortion	1%	
2.5kHz deviation	0.7%	
4.5kHz deviation	2.4%	
AM distortion		
90% modulation (slow AGC)		
100Hz	12%	
300Hz	6.7%	
1kHz	3.1%	
Notch filter depth	>40dB	
Max audio output power for 10% THD		
8 ohms	2.8W	
4 ohms	4.3W	

Transmitter Tests

Power output SSB single tone carrier slight ALC			
	Direct	Via ATU	Max FM power
1.93MHz	76W	68W	100W
3.75MHz	82W	73W	105W
7.05MHz	85W	79W	108W
10.1MHz	90W	84W	110W
14.2MHz	91W	85W	110W
21.2MHz	100W	92W	110W
28.4MHz	90W	80W	105W
FM max deviation		6kHz at 400Hz	
FM max deviation at 1kHz		4.96kHz	
FM max s/n ratio		48dB	
Max Tx frequency error		>10Hz	
SSB carrier suppression ref full output		70dB	
Alt sideband rejection for 1kHz tone		78dB	
Typical second harmonic distortion in modulator		0.35%	
Dimensions without projections		424mm(w) x150mm (H) x390mm (D)	
Weight		17.5kg	

SHORT WAVE LISTENER

TREVOR MORGAN GW40XB

The hobby of listening to radio transmissions has many facets and, through this column, I try to introduce newcomers to some of these varied and individually interesting sides of our hobby. To some readers, many of these 'diversions' are outside their scope of interest or an area which they have tried and forgotten. But, as they say, you can't please all of the people all of the time.

Over the past ten years, we have seen the growth of one of the most technically innovative and exciting aspects in radio since the development of the transistor. Up to that time, the computer was the domain of the highly skilled technician and the tool of the industrial world (and Readers Digest!).

However, when Clive Sinclair marketed the ZX80 home computer in kit form, he started something that has resulted in the common use of micro computers in the hobby world and a rate of technical development that even those involved didn't think possible.

A simple matter

Previously, logging was a simple matter of entering details into a book. Records were kept on thousands of cards in indexed cabinets. If you were interested in Morse, you learned the code. These areas, and practically every other area, of the hobby has been invaded by the micro.

Such a highly developed piece of equipment, quite naturally, instills a sort of fear into those who come up against it for the first time. Many of the 'older' ones among us had become set in our ways before this 'thing' appeared on the scene. We were quite happy with our shelves full of carefully labelled log books! However, times change, and the micro is here to stay despite our arrogance.

Like many others, I was brought up in an age when handwriting was something to be proud of and using a typewriter was for the

businessman, not for the log keeper (have you seen one recently written in real copper-plate?). This new machine was just another 'super typewriter' really. Wasn't it?

When I got my first micro, it was with the same idea as many others... it'll speed up the listing of contest stations and make things quicker. Oh no it didn't. For the first couple of months I spent more time learning how to use the darned thing than I spent actually using it!

Seriously speaking

Seriously speaking, the computer has become, to me at any rate, a very useful tool. I use the term 'tool' as I am not by any means a computrologist, mainly due to a) I haven't got the necessary time, b) some nice chaps write and sell programs for the purposes I use it for, and c) I'm basically non-technical.

To the listener, the computer opens up a whole new world in the hobby. Previously un-tapped sources of information become available, like Radio Teletype (RTTY) and Slow Scan Television (SSTV), high speed Morse becomes translatable and so on.

Probably the best supported computer, as far as programs go, is the Spectrum. Although the original marque is no longer produced, the new Spectrums still accept most of the programs currently available. Although the new models (by Amstrad) do not have the direct input/output sockets that were on the original Sinclairs, adapters (interfaces) are available.

Setting up for reception is very simple, requiring a simple lead from the headphone or extension speaker socket of the receiver to the input of the computer. Once the program is loaded using the tape recorder, this lead replaces the recorder lead and you are in business.

For our purposes, it is not necessary to have a special monitor, as a simple black and

white portable television is quite adequate and a connecting lead is supplied for this purpose.

It takes a bit of practice to get the tuning right for the computer to accept the signal and translate it into the video form, but once you have the hang of it, it comes easy. The programs have a 'menu' which explains the reception modes available and you can get a printout of the information displayed on the screen using a simple cheap printer.

Of course, the Spectrum isn't the only micro suitable for communications reception and, some would say, probably not the best, but it's certainly one of the cheapest and best supported for programs and accessories or spares. Entering the world of computerised communications need not be a painful process and can bring a previously unexplored area of the hobby into your life. There will be frustrations when programs inexplicably disappear from the screen (called 'crashing', probably because of the noise the operator makes as his ashtray hits the wall!), and there will be moments of delight when a picture of a castle in Germany appears like magic on the screen.

There's an old phrase that says 'don't knock it 'til you've tried it'... I've tried it... I like it... and I think you will too!

Prefix awards

And so to this month's awards presentations, and the first is to Angela Sitton G0HGA, of Stevenage who, having lost the use of the transceiver causing severe withdrawal symptoms, resorted to practising her Morse by logging 250 prefixes to get the Bronze award. Some nice catches were among them too with CU2, HT1, IQ9, KY2, LU5, SN8, T77, VK2, YB0, YT3, YZ9, 5A7 and 5T3 coming to the net. Angela has been finding fifteen the best band for the DX and can't wait for the rig to come back from the doctor.

Barrie Musselwhite ILA068,

of Warminster was the next in line, with his claim for Bronze on twenty metres only. Best catches in Barrie's list were AP2, AL7, CQ8, PP5, TK5, VK6, V85, YT1, YZ7, ZS6, 5T5 and 8P6. Nice fishing, Barrie... now for the Silver?

Next in with his first prefix claim is Brian Wright ILA226, of Leicester, Brian has only been into the hobby for two years, but has built the Howes DCRX 80m receiver and has a lot of fun with it. The main station receiver is the Lowe SRX30 with a 30m end-fed wire antenna. Catches for the first effort included AA4, AG3, CS1, CX4, HP3, JX9, KH6/TF, PY6, T77, YT3, ZP5, ZV2, 5B4, 9K2 and 9Y4... which ain't a bad start!

A nice list

So to Philip Begley ILA077, of Huntingdon who claimed Bronze and Silver for mixed bands/modes. A nice list from Phil with A22, A71, AA2, AC8, AP2, A73, C31, C23, HC5, HH7, HP9, J37, J73, JW5, PJ7, TG9, TU2, TZ6, XJ3, YB4, 8P6, 9J2, 9Q5 and 9L1 included in the showings. Twenty featured plenty of DX with fifteen showing that summer was here at last!

For something of a change, Bob Cowell ILA193 of Blackpool put in a claim for the Broadcast Monitors award for 100 stations. Some of the less obvious ones were Ghana, Ruanda, Sri Lanka, Rangoon (Burma), and Surinam. Bob's now threatening to have a go at the prefixes next so I'd better get the pen out!

A very nice letter came from Patricia Bates of North Walsham, Norfolk, in response to my review of the MBR7 receiver a couple of months back. Apparently, Pat was looking for a cheap receiver to keep her mind busy while she awaited the results of the RAE. Although she agrees that the MBR7 has its limitations, she has, nevertheless, had QSLs from over thirty broadcast stations and has also had QSLs from amateurs logged on 2 metres FM. A recent 'lift' on that band

enabled her to log mobile stations working through repeaters in Somerset, Lincoln and Northampton. Not bad for a cheapy. Good luck with the RAE, Pat.

Another review was mentioned by Jim Lawrence ILA183, of Halstead. Jim has been using a Royal Blue SWL antenna lately and, apparently, had better results than me with it. He has it mounted at 18ft and has received some very good SSTV signals from SP3RHZ, UT1UR with OE1HHB, EA2JO and I2II with G4DXG. RTTY yielded DL5FAG, ON4ABT, YU2OH, plus EA3ELD with K2ZTO and OE6HFD, and all with the Technical Software RX4 program. Also logged were plenty of continental Morse signals, but Jim finds the mode unreliable unless the sender is first rate. Now he's trying FAX with the G4IDE unit.

UBA bands

Marc Domen, the UBA Contest Manager in Belgium, sent in the results of the UBA SWL Trophy Contest 1987. In the phone category, BRS32525 took first place with BRS28198 and BRS88825 also in the final list. On the Morse front, ONL383 was a clear winner with BRS52686 running fourth. Nice to see the Brits up there. The 1988 Trophy Contest will be held on March 26th/27th for phone and May 28th/29th for CW. Full details are available from Marc Domen, Gebr. Blommestraat 14, B-2200 Antwerpen, Belgium.

October is the month when the Scouts throughout the world think of the Jamboree on the Air which, this year, falls on the weekend of the 17th/18th (ILA members please note the date). The idea is for Scout stations to make contact and exchange greetings using the medium of amateur radio. Of course, not all scout troops have a captive amateur and many amateurs offer their services over the weekend to get the Scouts into the Jamboree.

This is not a contest, but a Jamboree or gathering of the Scouts and is very often the excuse for some playful interchange between the parties. Well worth listening in to. Purely coincidentally (of course) GB2WFF will be on the air again, operated by yours truly and listeners are

invited to send in logs of the Scout stations heard over the weekend. Just for fun, you can score one point for each station logged in your own country, two points for stations abroad and ten points for each of GB2WFF, GB2COD and GB2GP.

There are trophies and certificates for the entrants and the fifty pences that you send in with your logs will go to MENCAP. So, have a bit of fun, enjoy the Jamboree and help the mentally handicapped all in one go.

A very nice letter this month from Dr Harold Cones, President of the Great Circle Shortwave Society, USA. Harold will be off to Toronto, Canada, for the three day meeting of the American Association of Radio Clubs. As he is travelling there by train, he'll be able to relax on the trip and catch up with the reading! We worry about travelling to a rally fifty miles away... Harold is travelling some 400 miles! It will be interesting to hear how it goes there.

The Welsh Award

One award that will interest the Americans as well as our intrepid award hunters is the Welsh Award, which is being offered by the Carmarthen Amateur Radio Society. The award is for three stations heard or worked in each of the Welsh counties of Clwyd, Dyfed, Gwynedd, Gwent, Powys, West Glamorgan, Mid Glamorgan and South Glamorgan, making 24 contacts in all. Contacts can be on any one band or mode or mixed, and log extracts/photocopies should be verified by two licensed amateurs.

The fee for the award is £1.50 or 8 IRCs. The certificate is very attractively presented in three colours on heavy vellum. Claims should be sent to The Awards Manager, Carmarthen ARS, PO Box 4, Carmarthen, Dyfed SA31 1AA, Wales.

Last month I mentioned getting a proper logbook as part of your receiving station. Many new listeners do not realise, at first, how useful the logbook can be. Not only is it a record of the stations you have heard but also, if properly kept, a memorandum of propagation condition changes over a period. For instance, radio Japan may be heard at 2200 UTC on

11.800kHz on the 25m band. Tuning into their broadcast (which, incidentally, is a relay transmission from Moyabi, Gabon) on a regular basis, will give you a record of how conditions from that area change.

Listening to their other broadcasts during the day and logging these over a couple of weeks will also give you a good idea of how conditions can change due to man made or natural noise or fading. It's a good idea to keep a record of weather conditions over the area covering your station and theirs on the days of reception to see how conditions are affected (you can use the midday weather maps on TV for this or the forecast in the morning papers... the *Today* coloured chart is good).

Logbook layout

The layout of a logbook is a purely personal matter, I feel, as your own interests play a great part in what, exactly, you want to record. A typical sheet may be headed; DATE: TIME: FREQUENCY: MODE: STATION: REPORT: CONDITIONS: COMMENT: REPORT SENT: QSL RECEIVED. There are standard logbooks available, but these tend to give space to some points and none to others. Think of what you want to enter and make your own logsheet up, have it photocopied and keep the sheets in a binder.

Whereas the report for amateur stations is based on the RST code (Readability, Signal strength and Tone of note on CW), the professional stations require a report based on the SINPO code (Signal strength, Interference, Noise, Propagation disturbance (fading) and Overall report), which is based on a maximum of five points for each section. A report of 2/5.4.4.3.3 would show reception of a signal to be varying from S2 to S5 on the meter, a little man made and natural noise, fading as shown in the 'S' score and an overall value of 3 out of five. Some stations just ask for the SIO sections which is a more accurate report really if you look at it.

S meter readings are only relative to the other signals received, so don't place too much faith in them. You can, however, quote a station as being S5 on one day but only

S3 the next if your receiving set-up is unchanged.

The frequency the station was received on is important and stations will often refuse a verification if this is wrong compared to their records... and they spend a lot more than you on getting it right! Listen to the announcements at the beginning or end of a transmission. Stations give their standard frequencies but, and it's rare, if you do receive a station on an unusual unannounced frequency, send a report in giving full details! But remember, analogue read-outs can be way out and even digital readouts can be off.

Reporting to broadcast stations means that you must spend a bit of time listening to their programmes. This can be pleasant or tedious, depending on the content. These stations do read reports *if they are interesting*, so don't just send in a card bearing a simple report.

Tape recordings of broadcasts are rarely appreciated as they take a lot of valuable time to set up and listen to. If the station asks for one, go ahead, if not, send a good written report. Don't forget to let them know what equipment you were using. The type of receiver (eg SW100 kit-built direction conversion receiver), aerial and its area of coverage (eg 135ft end-fed wire at 40ft running N/S), whether filters were used to overcome noise, etc. A picture of you in the shack is a nice touch.

Listening to Radio Free China, Taiwan, recently, I heard mention of a Canadian listener who had gone to the trouble of logging regularly over a month and sending the station a graph showing the changes in reception at his station over that period. He probably took a lot of trouble in preparing the graph, but it attracted the attention of the station staff! You don't have to be that precise, but...

Never a dull moment

Like other hobbies, listening is as interesting as the effort you are prepared to put into it. In my opinion, there can never be a bored listener... there's too much going on to get bored. Admittedly, some of the programme contents may be a little bit so, but the hobby can never be. Have a good month.

A SIMPLE ADD-ON AUD

Many receivers both old and modern can benefit from an audio bandpass filter. Using one of these filters can add extra selectivity to the receiver, which can be very useful when interference levels are high. Whilst extra filtering can be added to the IF stages of a superhet this can be very costly. This is because the narrow band filters which are required are almost invariably crystal, and by their very nature they are expensive. On the other hand, if there is already sufficient filtering in the IF stages of the receiver to remove the audio image, then an audio filter is the ideal solution.

Direct conversion Rx's

In addition to their use of superhets, they can also be used to good advantage in direct conversion receivers. This type of receiver is becoming very popular amongst QRP operators and home construction enthusiasts.

As they rely totally on the audio filtering for their selectivity, it is

obviously very important. In fact, many of these sets only have a low pass filter, and the addition of a bandpass filter can give a large and worth-while improvement in selectivity.

In fact, for either type of receiver an audio filter is useful. This is particularly true on CW where the narrow bandwidth which can be achieved enables signals to be picked out of the interference with comparative ease.

These filters can be made quite easily, as they can be made from as little as a single integrated circuit, together with only a handful of other components. The cost will be only a couple of pounds, if the components are not already available in the junk box. With this in mind, it becomes a very attractive proposition as it will cost very little, can be built quite easily, and will perform well.

The design

When the initial ideas for the design of the filter were being formulated, it was decided that it had to be both simple and

effective. With this in mind, a circuit using a single IC was used. This would give quite a reasonable performance, but if necessary it could be improved by cascading two stages. By doing this the skirt response would be improved, giving a sharper fall off.

The circuit itself is shown in *Figure 1*. From the diagram it can be seen that it is fairly simple, only using five capacitors, five resistors, an IC, the board and a few odd bits of wire. As the circuit is not difficult, it is possible to build it up and try it out in an evening.

The design parameters are quite straightforward. It should have a unity gain, a Q of five and a centre frequency of 750Hz. With these parameters it should be ideal for use with CW, as the centre frequency of 750Hz provides comfortable listening, whilst the Q of five gives it a bandwidth between the -3dB points of 150Hz. Although this may seem quite narrow, the skirt selectivity is such that it should be quite possible to use it in most applications.

The circuit possesses a high input impedance and a low output impedance. This means that it can be driven from almost any low level audio source, and it should be possible to drive either high impedance headphones or further audio stages if required. However, it should not be used to drive a low impedance load. Even though the circuit has a low impedance output, the output of the 741 itself is not enough to supply sufficient current without distorting. Normally it should not be used to drive loads of below 1kohm. The output coupling capacitor has been chosen with this in mind.

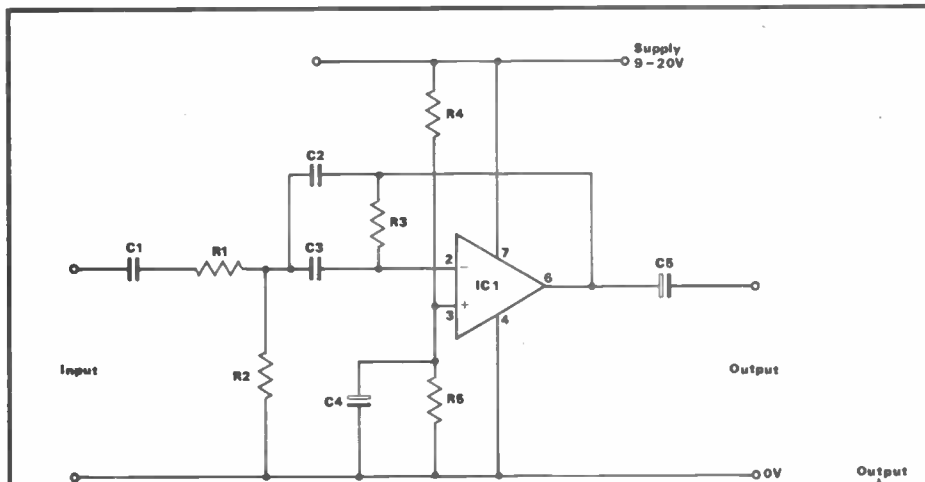

Fig 1 Circuit diagram of the filter

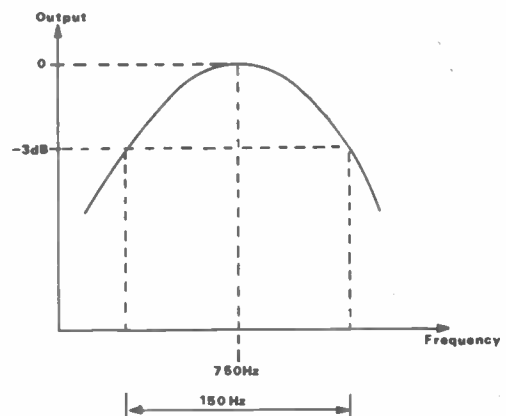

Fig 3 Calculated filter response

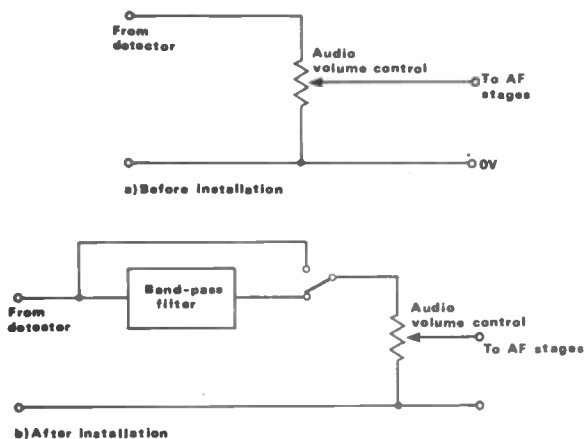

Fig 2 A method of installing the filter

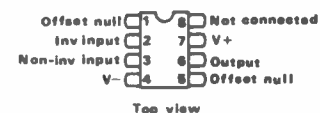

Fig 4 Pin-out for a 741 operational amp

IO FILTER _____ by Ian Poole G3YWX

Building the filter

The construction of the filter should not present any difficulties. It can be built up on plain Veroboard using pin and wire techniques, or alternatively a small printed circuit could be made up for it. Another medium, which was used for the prototype was stripboard, and a layout for this is shown in *Figure 6*.

When using this method however, great care should be taken when making the track cuts to ensure that they have actually been cut. It is quite easy, particularly when using a drill or special stripboard track cutter to leave just a whisker of copper joining the two sections of tracks. Needless to say, this can lead to some rather interesting effects!

As there are no high frequencies used in the circuit, it is fairly tolerant to layout. Obviously it is worth keeping the output away from the input and observing the standard precautions, but beyond this there is little else that should be done. If any problems of instability are encountered, the most likely cause is poor supply smoothing, however, this is unlikely.

When buying the components it is necessary to use high tolerance components for the filter network. The resistors R_1 , R_2 and R_3 should be 5% types and the capacitors C_2 and C_3 should be 5% polystyrene types. If lower tolerance components are used then the performance of the filter may be impaired, so the small extra cost of purchasing the correct components is well worth it.

Although many of the components will be available out of the junk box, some

may not. If any components are required they can all be bought from Electrovalue, 28 St Judes Road, Englefield Green, Egham, Surrey TW20 0HB. Tel: (0784) 33603. However, suitable components should be available from most stockists such as Maplin, Cirket etc.

Fitting the filter

The filter is quite easy to fit and use. Ideally, it should be fitted in between two of the low level audio stages. Probably the easiest place to fit it is just before the volume control. If this is done then the minimum amount of modification is required, and it is easier to put the set back to its original state if for any reason this is necessary. The arrangement for actually fitting the filter so that it can be switched out of circuit is shown in *Figure 2*.

Alternatively, the filter may be connected into the headphone output. This will have its drawbacks, one of which is that high impedance phones will have to be used, and further amplification may be needed. In addition to this, care will have to be taken not to overdrive the filter as this may result in distortion. However, it is quite a convenient point from which to test it before actually fitting it into the receiver.

In use

Once built, the filter worked first time. The first thing which was noticed was that with the receiver turned on and no signals present, the noise had a different 'tone'. This was because of the reduced bandwidth.

With signals present it gave a definite improvement in copy, particularly when

signals were close to the noise level or being swamped by QRM. In fact it was found that it could be used for SSB signals in some circumstances. It also produced much better results on CW, for which it was intended.

Conclusion

The filter was very effective on CW and it was particularly useful when QRM levels were high. It gave enough extra selectivity to sort out the wanted signals from the background noise on many occasions. The filter was made even more attractive by the fact that most of the components could be found in the average junk box. The main exceptions to this would possibly be the polystyrene close tolerance capacitors C_2 and C_3 . However, even if all the components had to be bought new it would cost under £3 to build the board.

Another advantage of the filter was its simplicity. This means that it could be built up quickly and easily. It should also mean that there is less likelihood of finding any problems.

With all of these points in mind it proved to be quite an enjoyable project to build as well as being very useful in operation.

COMPONENTS LIST

C1	10nF
C2,3	10nF polystyrene 5% or better
C4,5	10 μ F electrolytic
R1	110k 5% or better
R2	2k2 5% or better
R3	220k 5% or better
R4,5	5k6
IC1	μ A741

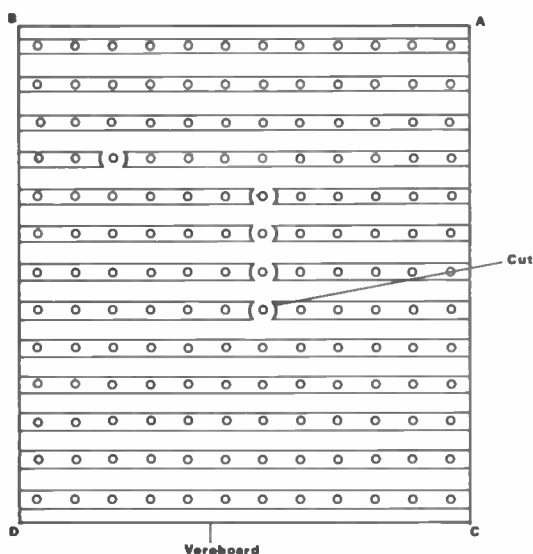

Fig 5 Underside view of veroboard showing track cuts

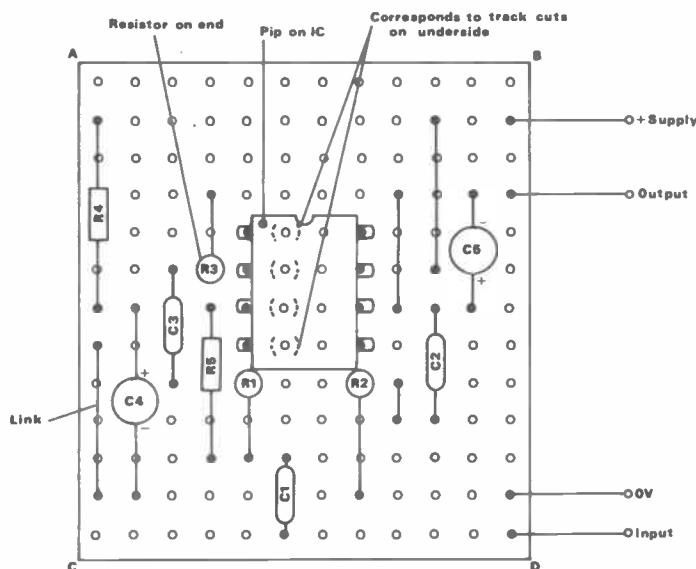
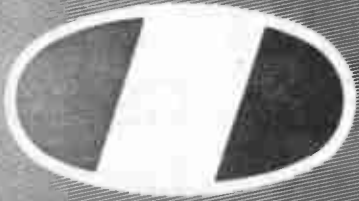

Fig 6 Component layout



ICOM

ON TOP OF THE WORLD

Yes, ICOM radio-communication equipment was literally on top of the world early in July this year as part of Richard Branson and Per Lindstrand's record-breaking trans-atlantic hot-air balloon crossing.

Yet again Virgin chose to use ICOM equipment after successful operation on the previous years' powerboat Blue Riband attempts. ICOM (UK) were in from the start earlier this year when the whole affair was a closely guarded secret.

Firstly the most suitable rigs had to be chosen from the extensive ICOM range and then installed in the confines of the Virgin balloon capsule. A receiving station at the GPO tower in London was set up to monitor calls and plot the balloon's progress. When the big day came it was a huge relief after the weeks of postponement and then suddenly ICOM was 27,000 feet above the world.

Virgin realise that ICOM design and manufacture radio equipment that is efficient, reliable and to the high standard essential in this kind of operation. ICOM equipment is available in base-station, mobile and handheld formats operating on all Amateur frequencies from HF to microwave.

If you are thinking of starting or expanding your station you will find an ICOM model to suit your requirements, if it's good enough for the Virgin Atlantic Flyer you can be sure it's good enough for you. Once again ICOM are proud to have teamed up with Virgin and salute the brave and happily successful new world record.

ICOM (UK) LIMITED
Dept. AR, FREEPOST,
Herne Bay, Kent
CT6 8BR.
Tel: 0227 363859



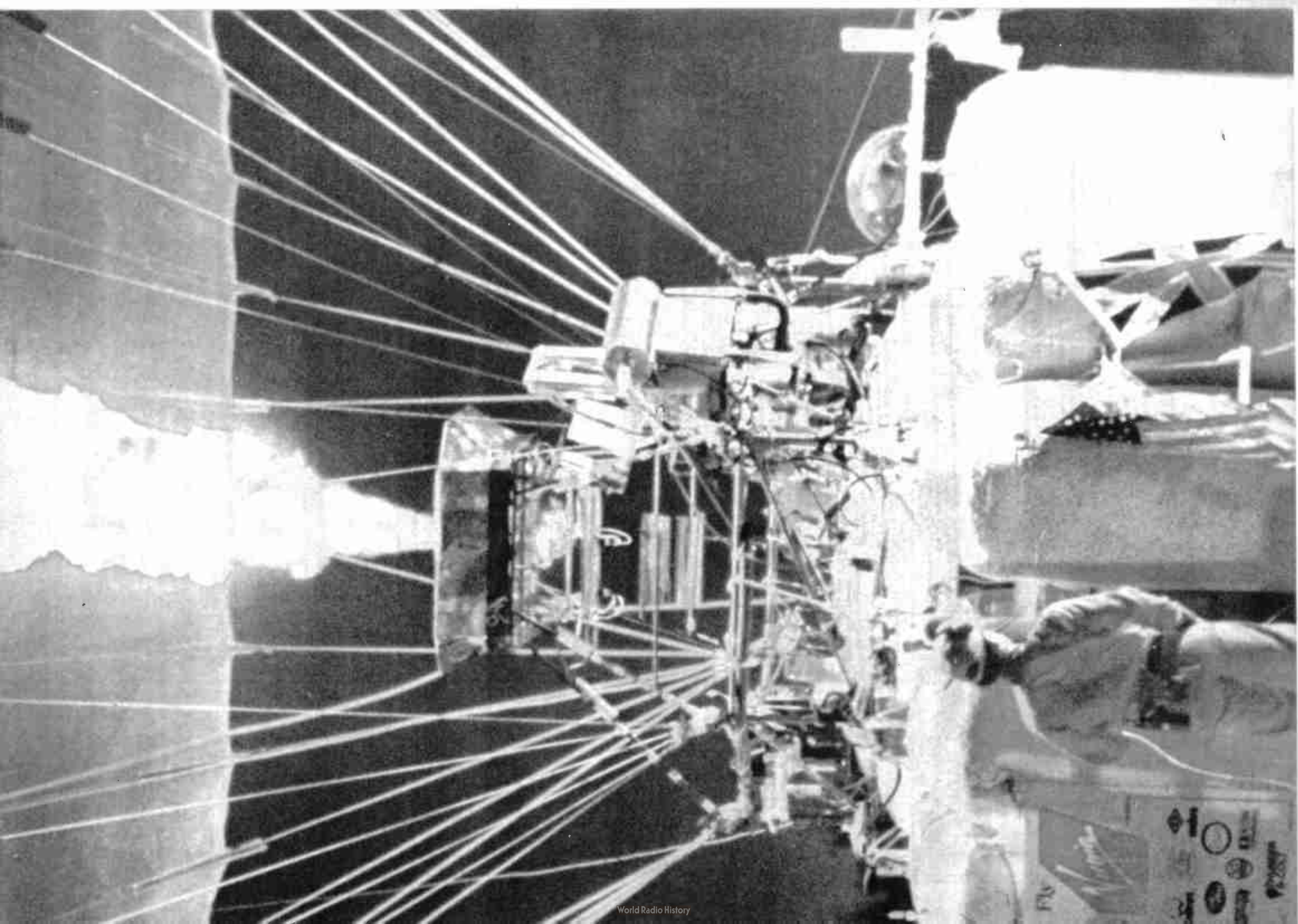

JUST PUBLISHED

THE SECRET OF LEARNING MORSE CODE

By Mark Francis

A COMPLETE COURSE – OVER 90 PAGES – SEMI/STIFF BOUND

A brand new book covering a subject that causes many people problems. The author, Mark Francis, breathes new life into the subject and provides fresh hope for all those that are having difficulties with Morse or thought the code was beyond them. This book has been long over due. It treats the subject of learning the code in a simple, but comprehensive manner. The recommended methods ensure that anyone can learn Morse code in the minimum of time. The title is well chosen and really does explode some of the pitfalls and myths surrounding the learning of Morse. The book forms a complete course with many practice passages for both sending and receiving. It also goes beyond the initial learning stages and takes you through your first QSO's, covering abbreviations, procedures etc. Running to almost 100 pages with plenty of illustrations, this book looks set to fill a big gap in the market.

£4.95 + 90p p&p

**4 PUBLICATIONS
YOU SHOULDN'T BE WITHOUT!**

UK LISTENERS CONFIDENTIAL FREQUENCY LIST LATEST EDITION

This publication has now sold well over 3500 copies since it was advertised only a few months ago. Now the recent updated version is selling even better. No self respecting listener should be without a copy. If you enjoy exploring the short wave bands then this publication will add to your enjoyment. It covers the hf spectrum from 2 to 30 MHz and gives details of transmissions outside the amateur bands. Specially designed for the UK and European listener it sets out in a very easy way a comprehensive list of hundreds of interesting transmissions that will keep you occupied for days on end! Only a fraction of the cost of other similar publications it contains details of Marine, Air, Military, Embassy, Press and News agencies. Many listings have time schedules included together with comprehensive RTTY details. It tells you the frequencies used by civil and military aircraft whilst flying the Atlantic, when and where to pick up the press bulletins, long distance marine traffic etc and much more. Send today for your copy of this worthwhile publication.

£5.95 p&p 90p

NEW 4th EDITION VHF-UHF AIRBAND FREQUENCY LIST

This frequency manual is without doubt the most comprehensive list of VHF/UHF aircraft listings available in the UK. Of vital importance to the airband enthusiast or indeed any keen VHF/UHF listener it sets out in a very easy to follow manner full details of a whole host of stations. Every known UK airfield quencies, etc. Included are Civil, RAF, USAF, MOD, Naval fields on both VHF and UHF bands. There are also air to air frequencies, the Red Arrows frequency, and much more. Send today for your copy and find out just how much you have been missing!

£5.95 p&p 90p

THE COMPLETE UHF-VHF FREQUENCY GUIDE 26-2000 MHz

Many listeners have asked for a guide to the wide VHF/UHF spectrum and to meet this request we have recently published this frequency manual. It covers the range 26 to 2000 MHz and has been specially prepared for the UK listener. Anybody who has used a scanning receiver will know that the wide frequency range involved means that it is difficult to know exactly where to listen. This guide takes all the guessing out of monitoring. It lists all the services throughout the spectrum together with both simplex and duplex frequency splits. If you've spent your hard earned money on a scanning receiver or are considering buying one you'll find that this publication contains a wealth of information that has previously remained un-published!

£4.95 p&p 75p

HF OCEANIC AIRBAND RADIO SUPPLEMENT NEW SECOND ADD.

Prepared in response to many requests for more information about the air traffic on the hf bands this little guide sets out to explain to the beginner how the hf band works in relation to air traffic. It contains full details of the world aircraft frequency bands in the range 2 to 23 MHz together with control frequencies and those commonly used for Oceanic control. Also included are many VOLMET frequencies, the Search and Rescue frequencies used by RAF helicopters and Nimrods, the Hf RT network, London Company frequencies, European control centres etc. An ideal companion for the hf airband listener. Send today for your copy.

£2.95 p&p 60p

**WATERS
& STANTON
ELECTRONICS**

18-20 MAIN ROAD, HOCKLEY, ESSEX – 12 NORTH STREET, HORNCHURCH, ESSEX.
MAIL ORDER TO: 18-20 MAIN ROAD, HOCKLEY, ESSEX TEL: (0702) 206835



MAKING THE MOST OF THE MINIMA

David Reynolds G3ZPF proves that the wrong end of the sunspot cycle and a small garden needn't keep you out of the action . . .

Anyone who operates on the HF bands will obviously be aware of the effect of the solar cycle on band conditions. Having just passed through the minima of the current cycle, DX contacts on 15m and especially 10m are few and far between and even 20m is below par. Fortunately, the overall picture is not nearly as bleak as it may appear, since the LF bands have really come into fine form for DXing in recent years.

Since many amateurs do not have aerial supports higher than about 30ft, it might seem that the large amounts of garden needed for a 40m, 80m, or even a 160m dipole, coupled with the desirable heights quoted in textbooks, any DX working will be the preserve of a fortunate few. Certainly a brief listen to the madness at the top end of 80m would put anyone off bothering, but DXing with low aerials from small gardens is possible. Difficult sometimes, but still possible.

Over a number of years I have managed to work over 100 countries on each of the bands from 80 to 10 metres (pre-WARC) with low wire dipoles. 160m was not attempted because until very recently I have not had any gear for the band. Because of this my comments will be specifically directed to 80 and 40 metres, although much of it should be relevant to 160m too. Nevertheless, with varying allocations around the world and split frequency working being the norm on 160m, readers would be advised to seek the counsel of an experienced operator on the band to avoid treading on anyone's toes.

Aerials

I'm sure that I am not the only person to have looked through the books and magazines and come to the conclusion that none of the aerials described would fit into my garden. Magazine articles which refer to QTHs with a 'modest' garden turn out to mean about 100ft long. Whilst that may indeed be modest in certain areas, here in the Midlands you are fortunate to have one in excess of 40ft long. To my mind, the failing of all publications is that they tend to give the impression that unless the aerial is constructed *exactly* as described, it will not work *at all*. Fortunately, this turns out to be far from the truth and I have found it possible to take great liberties with the construction and siting of aerials, and

still achieve worth-while results.

In describing aerials I have found to be of use, the fact that I have absolutely nothing to do with the radio and electronics industry will inevitably lead to my having done things which will make certain people's toes curl. This is not an attempt on my part to refute any established texts, but an attempt to show that no single solution can be applied in very restricted sites without a good deal of experimenting.

Two QTHs which seem superficially identical may give totally different results from the same aerial. In other words suck-it-and-see, but hopefully the following will give some useful pointers and encouragement to those who currently consider their situation to be hopeless.

Since the assumption is that space is

very limited, there will be little chance of erecting a horizontal dipole, which tends to suggest either a vertical or an inverted vee. With limited space, a vertical would be shielded by buildings unless roof mounted, and in any case a considerable number of radials seem to be necessary to achieve good results. Furthermore, to have any chance of really low angle radiation, a vertical is said to have to be physically at least one quarter wavelength long, which is pretty big on 80m or 160m. The radials too would need to be at least one quarter wavelength long, so with them in a circle you need as much space as would be taken up by a horizontal dipole in any case.

In his book *HF antennas for all locations*, G6XN describes the use of vertical dipoles on the HF bands with the lower half compressed into a loaded

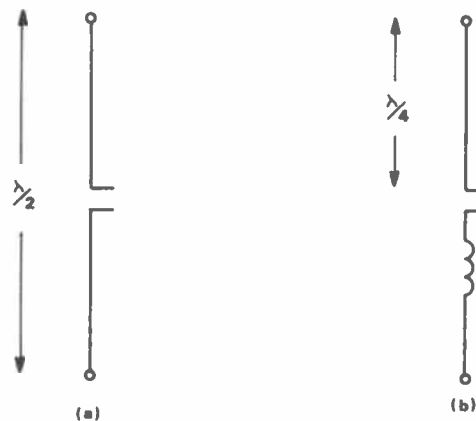

Fig 1 A verticle dipole can have the 'earthy' side of it loaded to reduce the height to the feed point

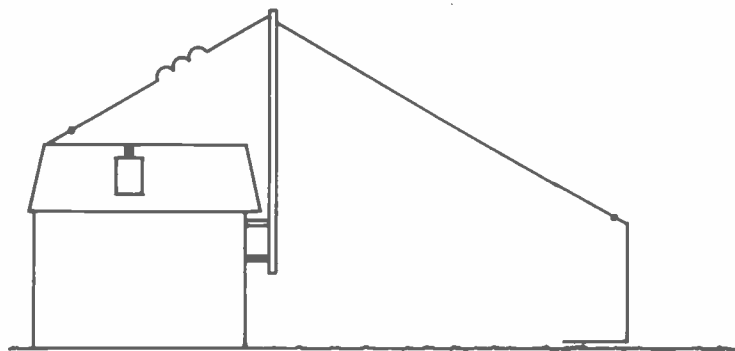

Fig 2 There seems to be no reason why the verticle in Fig 1b cannot be rotated through 90° and fed as an assymetric dipole where space is limited

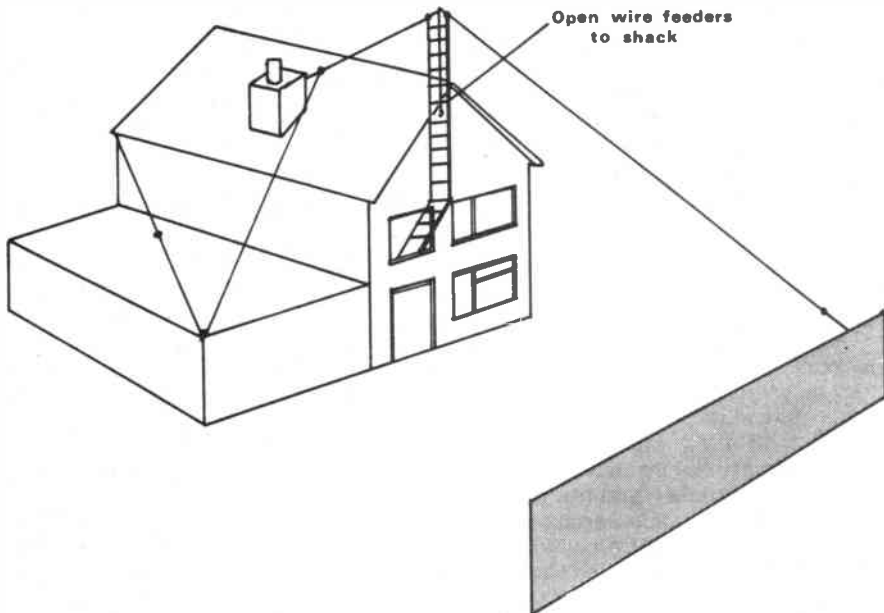

Fig 3 An 84ft tuned doublet bent into the available space. Even though rather short for 80m it still proved possible to work into New Zealand

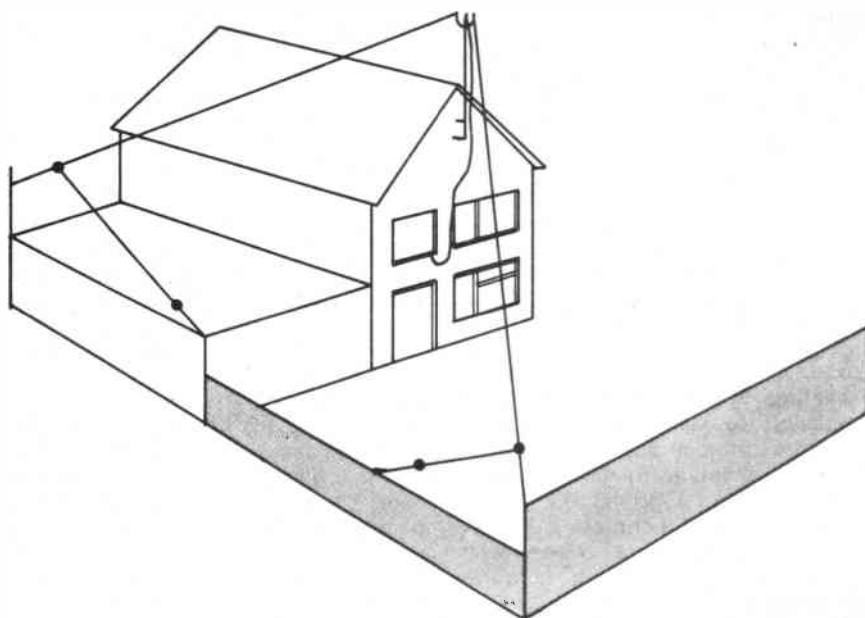

Fig 4 A full size 80m inverted vee still worked well with the ends bent back on themselves

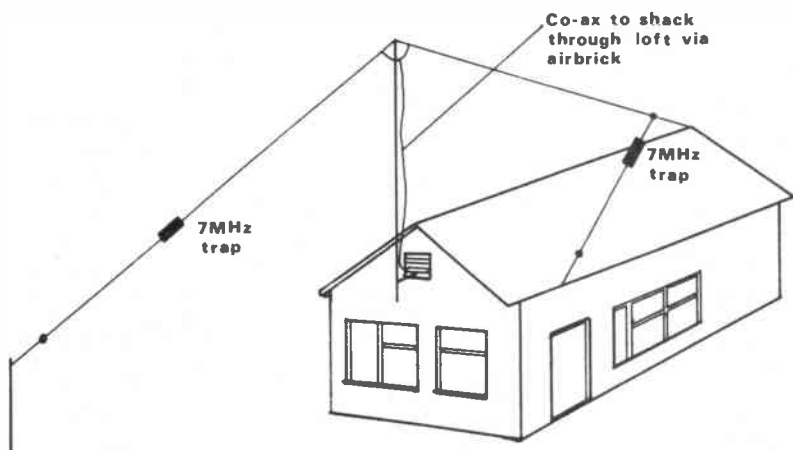

Fig 5 A W3DZZ aerial squeezed into a 40ft garden. In such a layout it is unlikely to give a reasonable match on bands other than 40 or 50 metres

counterpoise (Figure 1), although it occurs to me that the arrangement could be turned through 90 degrees as an asymmetric dipole (Figure 2). Personally, I've never made any use of verticals at LF, because if you get them working well they do not tend to be very good for inter-G working. This means putting up another wire for that purpose, but with limited space any more than one aerial aloft would inevitably result in there being some interaction between them.

This biased me towards an inverted vee, although its ability to receive close-in signals equally well is obviously a drawback when DX working. Another factor which makes me prefer centre-fed types of aerial is the vertical aerial's dependence on earth conductivity. In the February 1986 *Radcomm*, G3VA gives an enlightening account of the results from a biconical monopole as part of his *Technical Topics* feature. The graphs show that the belief that low angle radiation from verticals is an inherent feature is ill-founded, but that like most things in life, it all depends.

Inverted vees

In very restricted QTHs this type of aerial has much to recommend it. The overall length of the garden required is reduced, only one high support is needed (often the house), and the ends of the aerial are easily accessible for adjustment. Where a balanced ATU is available and the use of open wire feeders is convenient, all adjustments can be carried out from the comfort of the operating chair, and one aerial can be used on all bands. With tuned feeders it is possible to get excellent results even when the top length is less than one quarter wavelength long on the lowest band used, and I used an 84ft top to great effect on all bands for a time. This was fully described in *Short Wave Magazine* of July 1982, and is illustrated in Figure 3.

For inverted vee aerials to be effective, the apex angle should not be less than 90 degrees. Knowing the length of the aerial it is possible to work out the length of garden required, but this can still be quite large for 80m. With full length aerials I have been able to bend the legs quite dramatically to fit available space and Figure 4 shows a much bent 80m inverted vee which still worked well. Physically shortened aerials with loading coils can prove to be a problem, as their ends are very sensitive to local effects and are best used when they can be erected in a straight line. Even so, aerials which are only slightly loaded can sometimes be bent to suit and Figure 5 shows a W3DZZ type fitted into a small garden.

It may be worth pointing out that although the W3DZZ is often referred to as an all-band aerial, it is basically just an 80/40m dipole with the L/C ratio of the traps chosen to give a reasonable match on 20m and 10m. 15m gives a reasonable VSWR from the 40m section but unless erected completely in the clear it is highly unlikely that you will get all band coverage.

For those with very limited space indeed there are some 80/40m 'com-

pressed' trap dipoles available with an overall length of only 84ft. This is obtained by using traps with a very high L/C ratio to load the 80m section (Figure 6). It is quite possible to make such an aerial for yourself, using short lengths of co-ax as the high voltage capacitors. One commercially available compressed dipole has the advantage of being adjustable without cutting. The Sagant EL40X comes complete with a plastic carry pouch and would be ideal for /A or /P working. The price to be paid for the reduced length is the restricted bandwidth on 80m, where there is only about 75kHz between the 2:1 VSWR points. You can change ends of the 80m band at the expense of a trip down the garden and bending back the ends of the aerial to shift the resonance, although you'll need it mounted as an inverted vee for this to be convenient. The ends are very sensitive to local effects, so keep clear of objects which can become waterlogged during rainstorms (trees, wooden posts, roof tiles etc) or the resonant frequency will shift whenever it rains. Remember that the ends of an inverted vee can give a nasty burn, so keep them high enough to be clear of children and pets.

Following a previous article on aerials I was contacted by G3IJL who drew my attention to a helical aerial he found useful on the LF bands. Figure 7 shows the principle and it is claimed to be useable down to a tenth of a wavelength. As that is only 24ft on 80m the device will obviously be of interest to those who have to use indoor aerials. According to the literature the whole of the 80m band should be coverable below 2:1 VSWR if a length of 60ft can be accommodated. It might be tricky to homebrew an aerial of this type unless a suitable spring material is available. The only idea I had was using one of those toys which 'walk' downstairs, which seem to be made from the same material, and which were even sold under the same name as the aerial (Slinky) when I was a kid. G3IJL is certainly well pleased with his, even though he has only 18ft for use, even on 80m, although the bandwidth is then rather narrow.

Greyline propagation

With any minimal set-up, the possibility of enhancing signals is going to be of particular interest, and this can happen around sunrise or sunset, especially if the station at the other end of the QSO is also in twilight. The mechanism by which this occurs was explained in my article published in *Amateur Radio* of March 1986. Basically the enhancement in signals stems from partial refraction of the skywave through a dissipating 'E' layer, but readers are referred to the earlier article for a full description. Notice the use of the term refracted for the bending of RF waves, rather than reflected.

Simple RAE theory often depicts the layers of the ionosphere as RF mirrors, but although the end result is often the same, there are fundamental differences. RF is not reflected from the lower surface of the layer, but is gradually turned within the depth of the layer

(Figure 8). Depending on the incidence angle of the RF, many miles of raypath lie within the ionised layer. The layer can be thought of as a 'cloud' or charged particles and is obviously a highly unstable region for RF. Normally RF travels along great circle paths around the globe, but there are many recorded instances, both at HF and LF, where signals have definitely not arrived on the expected beam heading.

The content of some professional papers submitted to the CCIR, or at least the parts I can understand, indicate that curved paths caused by disturbances in the ionosphere are generally confined to signals passing through the auroral regions, but that the predominant mechanism on multi-hop paths occurs from side scatter off irregularities on the earth's surface. I realise that few people will have highly directive aerials at LF, but those that do are often unable to steer them and there is perhaps the possibility of them missing an enhanced signal because of being set up on the expected heading, whilst an inferior aerial with a much broader radiation pattern would fare much better than normal.

Calculation of twilight times

The onset of twilight for your own QTH is quite easily determined by looking out of the window, but to determine it for other QTHs is not so simple. Over the years a number of mechanical aids have been produced which give reasonable accuracies, and with the introduction of microcomputers several people have written programs to find sunrise and sunset times. The mechanical aids and simpler programs take no account of the variations in time from year to year, giving values for a 'typical' year, although it is possible to write programs giving high degrees of accuracy.

The maths involved in higher accuracies is fairly mind boggling, but is fully described in NAO technical note 46, published by the Royal Greenwich Observatory. The term 'note' is quite misleading as it is quite a lengthy publication, but the maths is explained in a very readable manner, with a listing given for a programmable calculator.

Since the mechanism of greyline contains a fair number of uncertainties, readers may well be wondering about the point of finding sunrise and sunset times to any great accuracy. It seems to me that when studying an uncertain situation it makes sense to obtain high accuracy on as many variables as possible in order to limit the variability of the overall result to the point where meaningful conclusions can be drawn. In recent years I have known paths peak well into full daylight at one end, so presumably the low levels of solar activity mean that ionisation is taking rather longer. Another factor relating to accuracy is that some parts of the world have greyline conditions with the UK which last for literally just a few minutes, notably the G/ZL path, and any program which was only accurate to about plus/minus 20 minutes at each end could hardly be used as a sound basis for further work.

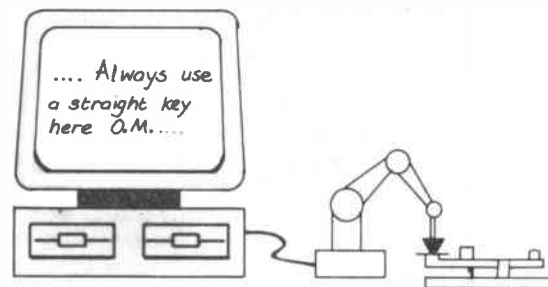

My first program was produced on an Apple 2 micro, and was described in an article in *Short Wave Magazine* of October 1982. The listing contained a line-by-line description of program operation and, judging by the comments subsequently received, several of the readers were able to convert it for different types of micro. Since then I have been exchanging letters with Gwyn G4FKH, which resulted in my using a program on a BBC micro to output a series of charts.

These charts could then be used by non-micro owners to construct overlays for world maps and were published in *Amateur Radio* magazine of March 1986. They not only gave the general case for world-wide use, but also a more accurate set of tables specifically for the G/ZL path on 160m. There was obviously a tradeoff in the amount of interpolation required by readers against the page areas required, but hopefully the adopted approach represented a sensible compromise.

One mechanical aid currently available which uses the world map plus overlay approach is called the 'DX-Edge', and is made in the USA, although they are stocked by the RSGB. It consists of a world map with separate overlays for each month of the year. The overlays show the transition from daylight to darkness as a single line, which is hardly realistic, but nevertheless it represents a useful tool for general purposes and comes with notes describing how to use it effectively.

As with everything in life, you can't get something for nothing and so enhanced propagation must have its snags. The first snag is that as the seasonal 'wobble' of the earth is only about 24 degrees each side of vertical there will be certain parts of the earth which can never fall on a greyline path with the UK. For that to happen the wobble would need to be plus/minus 45 degrees or more - and then our winters would be very bleak indeed.

The second snag is that the word has been out for many years in amateur circles about greyline paths, so dawn and dusk are the times that most people come on the bands. Fortunately, there are a couple of dodges to avoid the mayhem and idiocy which can occur. At sunrise the Europeans get their sun up first, and so conditions for them start to fade slightly before those for the UK, giving a few minutes relative peace which can sometimes be used to advantage.

Since most people find it hard to get up in the mornings, doing so yourself is another way of cutting down the odds. Assuming that you can struggle out of

bed by 0500 GMT in September, the chances are that a fair amount of DX can be worked with ease, on 40m at least, because most of the sane members of the human race are still stacking up the zzzzzs. As the year progresses and the sunrise time gets later, then more and more amateurs manage to stir themselves, making the competition that much more intense, and breakfast time TV puts timebase hash on the bands. Even then it is still possible to work DX effectively right in the thick of it, by tuning around and catching the DX on his first CQ call before the world and his wife

realise what is going on.

As I live alone there are no problems in operating during the small hours, but I can appreciate that for anyone with a family there are likely to be repercussions. Even so, with the headphones on, and with the key contacts fairly close, it is possible to operate without waking anyone else, and I did this for some time whilst still living with my parents.

Operating techniques

When using modest power to indifferent aerials there is no chance of blasting your way through a pile-up. A

certain amount of cunning, and luck, will be needed to get yourself noticed. What follows might not be everyone's opinion of a good idea, but it certainly worked quite well for yours truly and may give some ideas to newcomers. As mentioned before, I have not done any serious work on 160m so my comments will be confined to 80m and 40m, and since the bands have very different characteristics it seems convenient to deal with each one separately.

40m: Most people remark that 40m is wall-to-wall noise because of the problems created by a narrow allocation with several broadcast stations operating within it, in spite of it supposedly being an amateur allocation only. Not only does the enormity of the in-band signals cause a problem, but out of band signals in the nearby broadcast section present phenomenal signal levels at the input to the receiver, and lead to overload of all but the very best of them.

An artificially high noise level masks weaker signals, but it is important to realise that much of this noise is generated *within* the receiver. Most transceivers have an inbuilt 20dB attenuator to help with this problem, because although the wanted signal goes down by 20dB, internally generated hash goes down much further and the weaker signals can then often be heard. I managed to work well over 100 countries on this band using a TS520 transceiver, which has only average front end performance, so there is no absolute requirement for a top grade transceiver.

To a certain extent, an indifferent aerial will result in lower received signal levels anyway, which helps the front end, and the irony is that the chap with a monster array needs an equally good receiver front end to get the best from it. Furthermore, most of the monster aerial brigade seem to be in Europe and the QRM levels there from other amateurs is an order of magnitude greater, thus causing them more problems. A directional aerial will help greatly with cutting down signals from unwanted directions and it is this facet rather than their gain which makes them so widespread in Europe.

I found that I operated exclusively CW on 40m, and that most DX activity seemed to be as well. It is essential to have a CW filter, even though they can be quite expensive, but at the very least an audio CW filter should be used. These are much cheaper and work quite well, but as the receiver AGC is acting on all signals passing the SSB filter, some funny effects can occur as the receiver gain is backed off by a signal that is not audible via the AF filter.

It is not necessary to be a 40wpm man to go DXing on CW. 15wpm will do fine, and is often an advantage in a pile-up as it stands out from the tinkling noise of hordes of high speed signals.

Many DX stations operate split frequency, but unlike SSB only need an offset of 2kHz or so. This means that even if you don't have twin VFOs then judicious use of the IRT allows you to join in. If the rig has ITT as well, then so much the better as you won't have to tune off

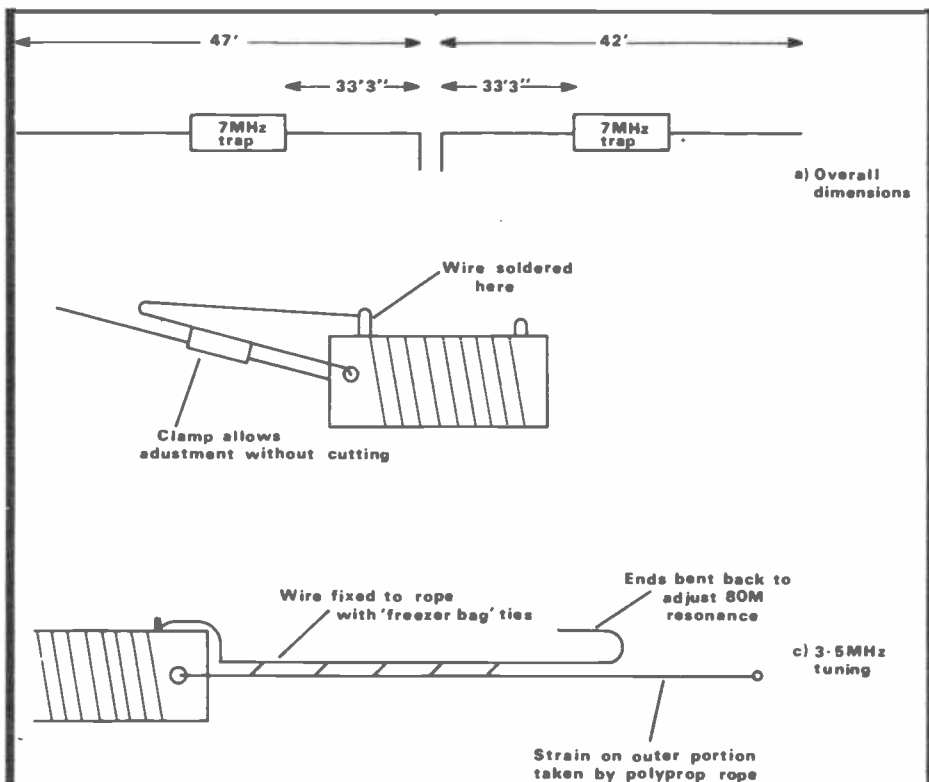

Fig 6 The Sagant EL40X can be adjusted without cutting and is an ideal IA or IP aerial

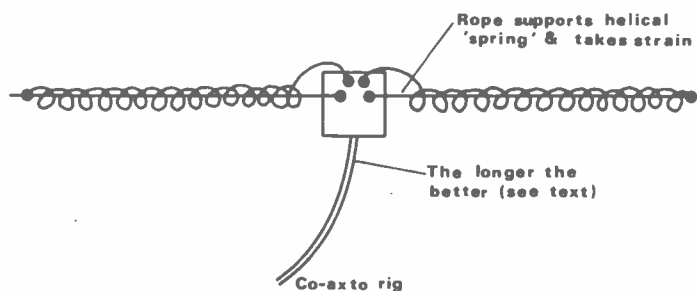

Fig 7 General layout of 'slinky'. A helical dipole for limited space. Manufactured in the UK

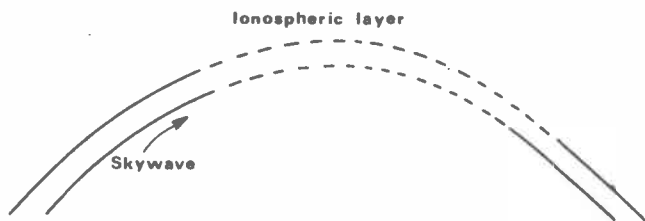

Fig 8 Signals are not reflected from the lower surface of ionospheric layers, but refracted within them. For low angles of incidence, several miles of raypath are within the layer

the DX to set the transmit frequency and then re-find him with the IRT. An indication that a DX station is operating split frequency is finding a horde of stations just sending 'DE callsign' spread over a few kHz.

Since most DX stations seem to listen above their own frequency, a tune around below the pile-up should reveal the DX, together with the inevitable few who can never seem to realise what is going on. Listen when the DX signs, which will often turn out to be something along the lines of 'DE callsign U3', meaning that he/she is listening 3kHz above the transmit frequency, and slightly beyond. It then remains to set up the Tx in the right area and get stuck in.

Sometimes it is possible to hear the station currently being worked by the DX and set up your Tx frequency on his. When he has finished working the DX you should be exactly where the DX has his receiver tuned and will hopefully be among the first to be heard. I did say hopefully, because you will certainly not be the only one trying this out, but it does cut down the odds somewhat and being devious is what operating a minimal set-up is all about.

Whenever you are operating split frequency, it is only common courtesy to check that someone else is not using your transmit frequency for an entirely separate QSO. A simple 'QRL??' is all that is required to prevent tempers fraying.

In the SSB portion anyone working the USA will inevitably have to operate split frequency as the W stations will be above our allocation for 40m. Unless, that is, you have twin VFOs, in which case you have to rule this out, although on a couple of occasions I did manage to work a station 25kHz away by swinging the VFO knob back and forth. Very tricky, but it sometimes works as a last resort.

For those who find it impractical to get up early in the morning, then the 0000 to 0100 GMT slot is quite a good time to come on the band. Granted you won't get the dawn/dusk enhancement of signals, but at midnight most of the BC stations seem to close down, plus the local TV, and the front end of the receiver has an easier time of it. By midnight UK it is usually dark in the USA too, and a CQ call on the key will invariably bring back a W station if the band is anything like correct. The Caribbean area will be workable too without much trouble, even on an inverted vee.

The point to realise is that the really big guns will be after far bigger fish, unless they are working a regular sked and so there tends to be plenty of opportunity for everyone. With indifferent aerials on HF, calling CQ rarely produces anything and you have to chase around for contacts, but on 40m CW at least, things seem much easier.

It is actually very useful to have a real monster pile-up chasing a really rare spot because that means that a CQ call can well attract several DX stations of lesser rarity who are scratching around for contacts because most of the Europeans are busy. There comes a point where a pile-up becomes so big, or so

unruly, that you have to accept the fact that no matter how much you'd like to, there is no chance at all of working the guy. Tune around the band and put out a few calls.

80m: The top end of this band is generally a madhouse if the conditions are good. Unfortunately, much of the 80m DX activity seems to be on SSB, unlike 40m, and after about 85 countries worked on the key I had to grit my teeth and try SSB. Although the DX portion is intended to be the top 25kHz of 80m, for some strange reason most Europeans tend to gather in the top 2.5kHz, or even the top 250Hz on occasions. With DX signals very weak and Europeans very strong, once a pile-up ensues, very few people can actually hear whether the DX has come back to them or not. Unlike the CW end where most DX goes split frequency to avoid this, the SSB types tend to opt for using the 'list' type of operation. As an idea it has a few good points, especially if the DX station operator is inexperienced, but human nature has sullied the ideal to the point where it is a technique despised by many operators.

Generally, one or two regulars of the band, normally Europeans, gather on a frequency and call 'CQ DX'. If a reply is forthcoming they make their QSOs before one of them sets up as MC and asks everyone to call him. After collecting several callsigns he then takes them one by one and gets them to call the DX station while, sometimes, the rest keep quiet. Fine so far, but what tends to discredit the whole thing is that the DX station cannot really hear the list station too well, or vice versa, and then the 'QSO' degenerates to 'you are 1-2-3-4-5 by 1-2-3-4-5-6-7-8-9' type of report, often repeated several times.

Eventually the mumbles in the noise are counted correctly by the parties concerned, although sometimes the thing gets so protracted that another station will shout out the report, thus completing the travesty. It is especially galling to be reading the DX perfectly and to lose propagation while several 'QSOs' of this type take place. Given the choice I'd sooner do my own hunting, but often the SSB DX cannot be found 'on the loose'.

With an experienced operator at the DX end, preferably working split frequency, contacts take place far more quickly than with the list type of operation, and this is what happens down on the CW end of 80m. One thing which never ceases to amaze me though, is when an east coast W gets a monster pile-up on CW. That would never happen on 40m, and is perhaps indicative of how little DX there is sometimes on the CW end, although I've often found Caribbean stations just a few kHz from such hordes.

With an inverted vee at only 30ft on 80m I did begin to notice that it really ought to be much higher. There were occasions when Europeans were working DX which I could not even hear. That never happened on 40m. In terms of wavelengths, the 30ft apex is only half as high as on 40m and it shows, but I still managed to work ZL from time to time in spite of everything.

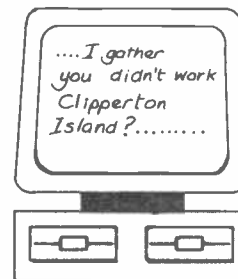

In conclusion

Conditions on the LF bands will not be as good as they are now for several years, and the HF bands are unlikely to be full of DX for a couple of years yet, apart from 20m, so why not give LF DXing a try? I was very sceptical of what could be achieved initially, but the results have surpassed my wildest hopes and I've had a great deal of fun too. True, there were times when I wondered why I bothered, but if you worked the world in a week, then what would you do.

Propagation prediction using home computers continues to fascinate me, and programs become more sophisticated as the power of microcomputers increases. During my search for professional papers about greyline propagation I received a letter from the Rutherford Appleton Laboratory, which helped enormously with references. Part of that letter reads thus...

'Undoubtedly there are many instances of strange propagation, some over long distances and some related to twilight. It is useful to have these cases documented and the amateurs can serve a useful role in this respect, as they did for instance in the 1950s in studying the incidence of trans-equatorial forward scatter and as they continue to do through their sporadic-E and auroral backscatter studies. Phenomena of sufficient recurrence must ultimately attract the interest of the professionals.'

Although concluding that the majority of strange effects will not ever have their causes fully understood, it seems that amateurs could have something to offer in this field. I'd be interested in hearing from anyone interested in the topic.

References

- The Winfield Wonder Wire: *Short Wave Magazine* July 1982
- Calculation of sunrise/set: *Short Wave Magazine* October 1982
- Calculating Greyline Paths: *Amateur Radio* March 1986
- Computing sunrise/set & twilight: *Astronomy Magazine* April 1984
- CCIR proceedings. Propagation in Ionised media: Published by the ITU. ISBN 92-61-01441-0. Dewey system No 538.56/104 (82) (VI)
- NAO Technical note 46: Royal Greenwich Observatory, Herstmonceux Castle, Hailsham, East Sussex BN27 1RP.
- Slinky, A helical Dipole*: The Blacksburg Group, PO box 242, Blacksburg, VA 24060, USA
- Sagant EL40X, a compressed trap dipole: Used to be stocked by a number of UK dealers including Icom (UK) and ARE DX-Edge. A greyline calculator: stocked by RSGB.

BITS TO BUILD

A Kanga that does not jump – A practical variable frequency oscillator

Amateur radio construction can be very satisfying but it can also be profoundly frustrating. The amateur invests a little money and probably quite a lot of time on a project which, if it works, can bring a real sense of fulfilment and often increased knowledge of how the bits and pieces we use in this hobby work. That is... if it works. I sometimes meet people who tell me that they are useless at construction: whatever they build never seems to work, and such people often give radio construction up as a bad job.

But even seasoned constructors will tell you of the projects they have built that did not work, or took many hours of fiddling before they were satisfied with the results. They usually add that this is all part of the learning process and that they have learned more from the projects that failed first time than from the ones which worked as soon as they were switched on. I wonder if they really thought that when they were struggling to get the things to go?

Sometimes I am asked about the best way to begin radio construction and my

standard advice is to tackle a project that should work first time. Experience suggests that one of the newcomers best 'tools of the trade' is confidence. Many times I have seen thwarted constructors turn, as if by magic, into successful constructors once they have completed a project which worked. If constructors do not expect a project they have built to work, very often it does not work.

In this respect, I have often advised the use of a kit. Kits are very much a mixed blessing. Some of them are little more than 'electronic lego' for adults. Most of them work well but at the end of the process not much may have been learned about the circuit which has been built. But kits do have two distinct advantages. The first being that the circuit should, if the supplier is reliable, work without a lot of fuss and trial and error. The second is that the components, and usually a printed circuit board, are provided. Seasoned constructors tend to forget that beginners may find it difficult to find the right components to build a project. It takes some time to come to know the best sources of

supply for the bits and pieces that an amateur radio constructor requires. Beginners may also be unsure about what they actually want: which are the correct components and if substitutes can be used.

The variable frequency oscillator

Of all the circuits which cause problems and frustrations to the constructor, the Variable Frequency Oscillator (VFO) must come high if not top of the list. Oscillators capable of being tuned across a small portion of the radio frequency spectrum are commonly required as frequency sources in transmitters and receivers. The requirement is an oscillator which is capable of being tuned over the desired range and will maintain stability at any setting. The latter is usually the problem. Most constructors, including me, have built VFOs which happily oscillate, conveniently cover the desired frequency range but simply will not stay still. A drifting VFO is useless.

Much has been written in the amateur radio literature about the stability of variable oscillators. Some writers advise their favourite circuits, others give tips about the type of components to use. Although the choice of circuit is important and particular components are required for the frequency determining sections of a VFO, my experience suggests that the way in which the VFO is actually constructed is as important as any other factor. Physical rigidity and stability of the completed oscillator go a long way towards making it frequency stable. The simple advice is: choose a reliable circuit and build it like a battleship in a strong screened box.

The Kanga VFO

Kanga Products is a new company in the amateur radio market which specialises in producing kits and semi-kits for the constructor. In their literature I

Fig 1 Circuit diagram

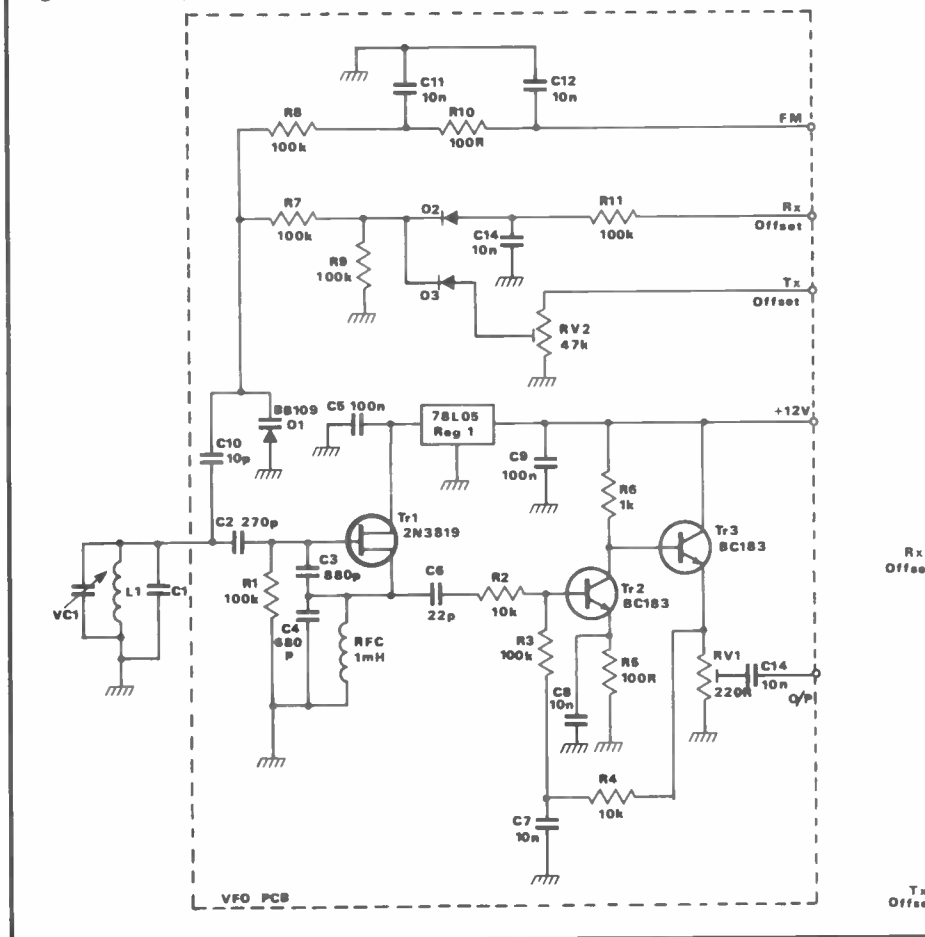
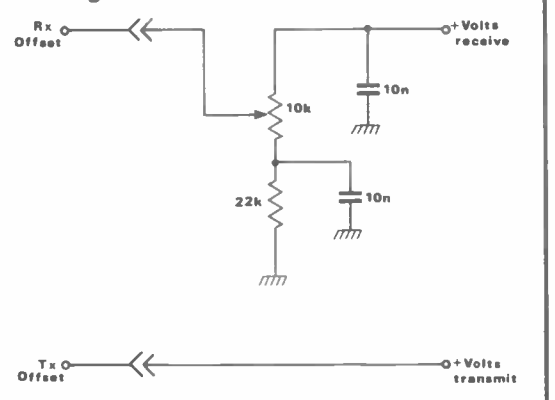

Fig 2 IRT connections



discovered that they supply a VFO kit and what follows is a description of that kit and my observations on its use.

Kanga supply a kit based upon a known, tried, reliable VFO circuit. The circuit is suitable for oscillators in the range between 1MHz and 10MHz. The kit comes complete with the components and a good quality glass fibre printed circuit board. It does not include the tuning capacitor nor the tuning coil but these components depend upon the frequency coverage required by the individual constructor. Apart from that, they would be very expensive if supplied as new stock and can often be obtained from radio rallies or junk boxes.

The kit also comes complete with a very suitable screened box. This is a diecast aluminium box, just the right size to hold the printed circuit board and the associated tuned circuit. It is also a diecast box with straight sides... That might not seem important but as a user of diecast boxes, most of the ones I find have sloping inside walls which does not help in the mounting and drilling processes.

The circuit

The circuit of the VFO is shown in Figure 1. There is nothing too unusual about it. It is the Colpitts circuit which many of us have come to use whenever we want to make a stable VFO. Some constructors add a clamp diode to the gate of the FET oscillator but Kanga tell us that they have found this can be a cause of thermal drift. The oscillator stage, TR1, receives a stabilised supply voltage from a small, three lead 78L05 regulator.

The oscillator is followed by a two stage dc coupled amplifier. The dc coupling and feedback has the ability to cope with large variations of transistor parameters. The total RF output is high and can be up to 5 volts peak to peak, which is useful for driving diode ring mixers. The lack of RF negative feedback allows greater gain through these two stages.

The resistor R3 provides a little simple attenuation and its value could be varied if required, although adjustment of the output is available by VR1 on the output. The best way to set the output is to adjust the value of R2 so that the desired voltage is achieved with VR1 at about three-quarters setting. In practice, for most applications, adjustment of VR1 is all that is required.

Frequency range

Kanga supply a table (See Table 1) for the more common VFO ranges used in amateur radio applications. The VFO can be used over the range between 1.8 and 10MHz with easily attainable stability. It could be used up to 30MHz but the stability of a VFO over 10MHz can be a real problem. It must certainly be built with good quality components and be made very rigid. A better choice over 10MHz is a crystal mixer VFO - perhaps Kanga will offer one sometime?

To alter the frequency range, suitable values must be used for VC1, L1 and C1. Although C1 is shown as a single

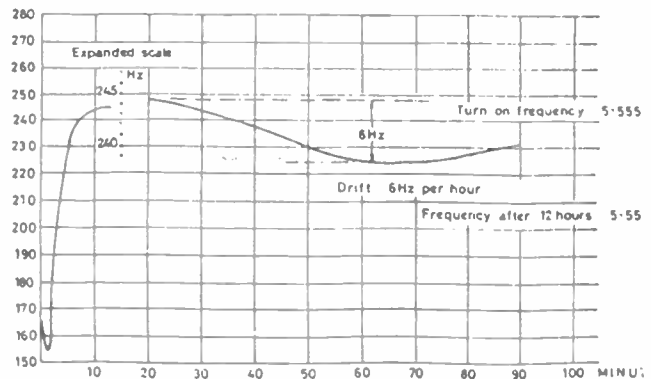
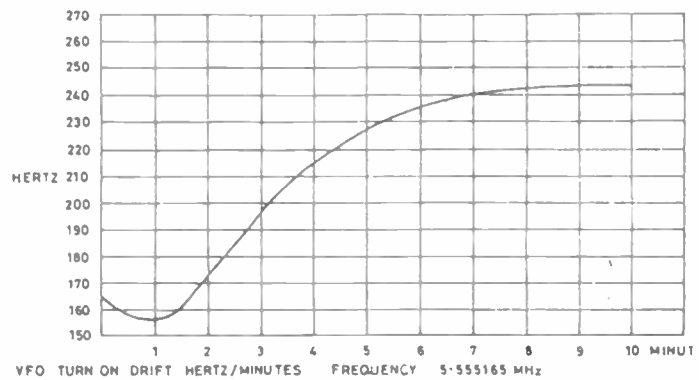

Chart 1 Showing frequency stability of prototype VFO

capacitor in parallel with VC1, series and parallel fixed capacitors may be used in conjunction with VC1 (75pF in Table 1) to obtain the desired range without having to remove plates from the variable capacitor. It is very important to remember that such capacitors are prone to temperature variation. Good quality silver mica, or the cheaper polystyrene capacitors should be used in these frequency control circuits. Temperature stable capacitors, such as the NPO types, are also useful... if you can find them.

Kanga provide some useful advice on stability and thermal compensation with the kit. Fuller information on the choice of tuned circuit values in Colpitts Oscillators can be found in Chapter 3 of *Solid State Design for the Radio Amateur* (ARRL).

Kanga VFO - Table of Values

R1, 3, 7, 8, 9, 10, 11,	100k
R2, 4	10k
R5	100Ω
R6	1k
VR1	200Ω horizontal preset
VR2	47k horizontal preset
C1	See Table 1
C2	270pF polystyrene
C3, 4	680pF polystyrene
C5, 9	0.1μF
C6	22pF ceramic plate
C7, 8, 10, 12, 13, 14	0.01μF ceramic
C11	10pF
Tr1	2N3819 (or E5555)
Tr2, 3	BC183
REG 1	78L05
D1	BB109
D2, 3	1N4148
RFC	1mH

All resistors ¼ watt

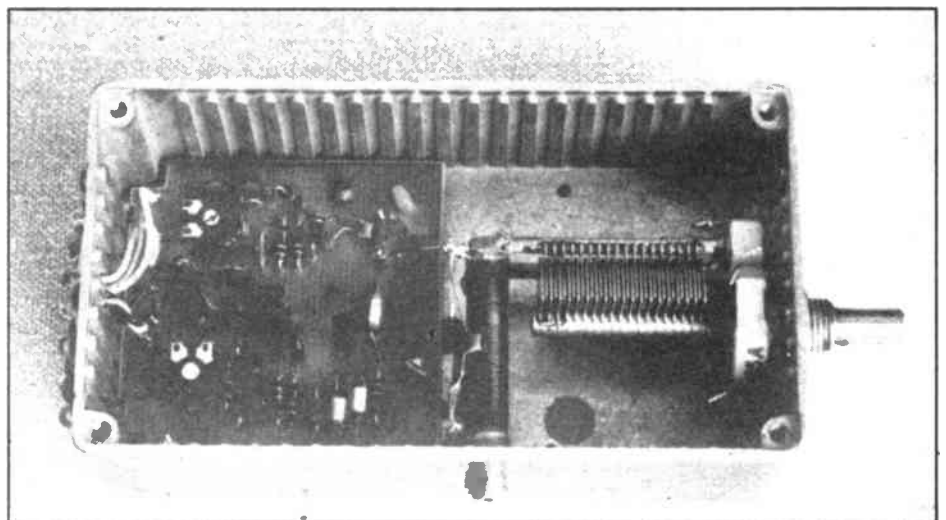

Frequency offset

One of the things I welcomed in the Kanga VFO kit was the inclusion of an IRT facility. IRT (Independent Receiver Tuning) or RIT (Receiver Incremental Tuning) is important if a VFO is to be used in a transceiver or receiver project. This facility allows the frequency of the oscillator to be moved a few kilohertz either side of the transmitting frequency enabling the tuning in of stations not accurately netted to the transmit frequency. In this VFO it is done by biasing a Varicap Diode (D1) on transmit and then supplying a biasing voltage on receive which can be altered with a front panel control. To enable this circuit to work, supply lines are required for the transmit condition and the receive condition. These are commonly available in transceiver circuits. To aid stability, these supplies ought to be stabilised. If the available supplies are simple 12 volt supply lines from other circuits, the constructor is advised to add a 78L08 regulator to give a stable 8 volt line on transmit and receive.

External circuits

The simple external suggested circuits are shown in Figure 2. On transmit, 8 volts is supplied to VR2 which is used to set the transmit frequency offset. On receive the supply is fed via a potentiometer, which becomes the front panel IRT control.

The circuit also provides for Frequency Modulation to be applied to the

VFO. Audio from a modulation amplifier can be applied to the FM input port via a low leakage $0.1\mu\text{F}$ capacitor. If the IRT or FM facilities are not required, the capacitor, C11, should be removed from the board. If FM is required, but not IRT, remove D2 and D3. If FM is not required remove R8.

Results

I found the kit very easy to build. The instructions provide a simple layout drawing for the printed circuit board. This might not be enough for a complete beginner, as the constructor has to identify the components from their listed values and then insert them into place. However, a complete beginner is not likely to want to build a VFO.

I tried the VFO out in the range 3.5 to 3.8MHz and used it to drive a simple QRP transmitter. The results were very pleasing. Chart 1 shows the frequency stability of a prototype VFO built for 5.0 to 5.5MHz. My results suggest that the circuit was just as stable at 3.5MHz, using the correct tuned circuit. The IRT worked well and the frequencies accurately relocated between transmit and receive.

The results were good and the price is fair. I might even be tempted to get another Kanga Kit the next time I want to build a VFO instead of starting from scratch myself.

Sources

The Kanga VFO Kit is available from: Kanga Products, 3 Limes Road, Folkes-

tone, Kent CT19 4AU, at £9.75 including postage.

VC1 variable capacitor - A suitable quality airspaced variable capacitor at £2.75 + 20p postage is available from J Birkett, 25 The Strait, Lincoln LN2 1JF. Tel: (0522) 20767. Other capacitance values are available in a similar price range from J Birkett.

Table 2

Kanga VFO suggested coil data

1.8 to 2.00MHz:

C1 440pF (total)

VC1 100pF

L1 88 turns 32swg enamelled wire close wound on $\frac{1}{4}$ in dia former (without core)

3.5 to 3.8MHz:

C1 18pF

L1 20 turns 26swg enamelled wire close wound on $\frac{1}{2}$ in dia former (with core)

5.0 to 5.5MHz:

C1 100pF NPO

L1 30 turns 26swg enamelled wire close wound on $\frac{1}{4}$ in dia former (without core)

7.0 to 7.3MHz:

C1 220pF

L1 8 turns 26swg enamelled wire close wound on $\frac{1}{2}$ in dia former (with core)



The popular, sub-pocket size now comes to three Circuitmate meters making them extra handy for the service engineer.

The DM10 has a DCV range of 200mV to 1000V, ACV of 200V and 500V. DC current ranges 200 μA to 200mA and resistance ranges of 200ohm to 2 Megohm. Plus a diode test function. All at remarkably low cost.

SMALL IN SIZE BRILLIANT IN PERFORMANCE

The DM15B and 20L extend the ranges and add a continuity test with beeper. While Model DM20L also has a 20MHz logic probe to detect 25ns pulses and measures transistor hFE. Ideal for bench or field, these mini multimeters reach the heights of performance but don't step into the depths of your pocket.

Like to hear more?

Beckman Industrial

INSTRUMENTS of NOTE

Beckman Industrial Ltd, Queensway, Glenrothes, Fife, Scotland
KY7 5PU Tel: 0592 754811 Telex: 72145



WIRRAL BASED COMMUNICATIONS

YAESU CIRKIT AERIALS CMHOWES ALINCO ICOM
 WOOD & DOUGLAS
 MICROWAVE MODULES
MGR SERVICES
 BUSINESS RADIO
 NEW & SECONDHAND MARINE RADIO
 SPECTRUM COMMS
 HEATHERLITE
 PART EXCHANGE
 CELLPHONES
 MET ANTENNAS
 BEST PRICES

Northern Agents
 for
Microwave Modules
 Call us about the
 special Mini-Break
 offer



48 SHREWSBURY ROAD, BIRKENHEAD, WIRRAL, MERSEYSIDE
 TEL: 051-653 3437



— Callers by appointment only —

L F HANNEY

77 Lower Bristol Road, Bath, Avon
 TEL: 0225 24811

Your electronic component
 specialist for Avon,
 Wilts & Somerset

Closed Thursdays

SEND NOW FOR OUR LATEST
 100 PAGE INTERNATIONAL
 CATALOGUE

**1,000s MAJOR & MINOR
 ELECTRONIC COMPONENTS**

Audio, Hi-Fi, Stylish Car Radios, Amps, Kits, Meters,
 Scopes, Test Gear, Transistors, Disco, Hardware Tools,
 Computer Bits. Send £1.00.

SMITH ELECTRONICS
157 CHAPEL STREET, LEIGH
LANCS WN7 2AL. TEL: (0942) 606674

RADIO AMATEURS EXAM? PASS FIRST TIME!

Before you enrol check the benefits of
 RRC'S unique Home Tuition Service

RRC has helped thousands of students to success in their
 examinations with this unique system of postal tuition, one which
 guides you, step-by-step, to qualify in the shortest possible time.
 Only The Rapid Results College offers you all these advantages:

- A qualified personal tutor
- Study material prepared by specialists
- Completely self-contained courses
- Handy pocket-sized booklets
- Personal study programme
- Regular marked tests
- Courses regularly updated
- 48 hour despatch
- Free advice before you enrol
- Telephone Helpline
- Free 'How to Study' Guide
- Instalment Plan
- Free Postage on course material
- Worldwide Airmail Service
- Extra tuition free if you don't pass first time

POST COUPON TODAY FOR FREE RADIO AMATEURS PROSPECTUS
 Please send me my prospectus as quickly as possible.

Mr/Mrs/Miss/Ms _____

Address _____

Postcode _____
RRC The Rapid Results College 
Dept JS16 Tuition House London SW19 4DS FREE ADVICE 01 947 7272 9am-5pm
 PROSPECTUS 01 946 1102 24hour Recordall Service quoting Dept No JS16

OPEN THE BOX

We all know that there are at least as many listeners to repeaters as there are active amateurs. Here then is a listener's guide to repeaters, giving you a profile of the most common types of operator you will hear. Just switch on the local box, settle into a comfy chair and see how many you can spot.

The guardians

It's helpful to know that on any repeater there is generally someone who thinks he owns it and who is guaranteed to chirp up, whoever is on the box and whatever the subject matter under discussion. These people are known as Guardians of the Box or GOBs for short. Sometimes infuriating, sometimes endearing and very occasionally quite useful. The problems start when their authority is questioned. The GOB (Orifice Maximus) is the only person who can tell you how to get from Ashby Magna to Matlock, and woe betide anyone else who dares to try. There you are, in contact with a guy who seems to know what he's talking about, when up pops the GOB and probably two or three of his mates, telling you that you'd be much better off turning left at the next roundabout, past the gasworks and over the flyover, rather than past the abattoir and left at the Rat and Trumpet. In no time at all our hapless enquirer is heading back in the direction he came from with his steering wheel and head spinning.

Another inhabitant of the local box is the WUM, or Wind-up Merchant (Spoofus Giganticus). This guy makes a point of coming up with deadpan comments with the aim of provoking argument. The trouble is that everybody knows that it's a wind up, but can't help not only nibbling the bait, but swallowing it hook, line and fisherman as well.

Wind-ups

The best wind-ups can last for days, and the best by far on our box was the great End-Fed Dipole Debate of '86. I forget which of our clutch of WUMs started it, but the arguments about whether there is any such thing as an End-Fed Dipole continued with unabated fervour for the best part of a week. Everyone knew it was a wind-up, but no-one could resist the temptation to get involved.

Another chap who'll put in an appearance is the Phantom Whistler (Puckerus Sonicus). The best place to listen for him is on the input. He has a strike rate of about 5 to one as he strives to hit the right note, missing it more often than not. He finally gets it right, but probably not until after someone else has raised the box in the meantime.

The Phantom Whistler is often a variant on another well known type, the Nearly Man (Completus Eventualii). These are essentially practical people, full of ideas that are wonderful in their conception, but rather lacking in their execution. The Nearly Man will have a bench full of uncompleted projects. The 23cms converter has been 'going to be completed this weekend' for the last 3 months, having been overtaken by the three-quarters completed Packet project, not to mention the RTTY interface and SSTV. 'Come to think of it, a toneburst wouldn't be a bad start – but isn't it so much better to have several prestige projects on the go at once, rather than just doing one simple thing at a time?'

Comets

Another feature of any repeater is the appearance of 'comets'. As you know there are two sorts of comets, those that come round at regular intervals, and those that appear once and are never seen or heard again. These interstellar visitors from far-off places like Sidcup or Halifax, make contact with one or two of us, and then disappear never to raise our box again. Often they are on holiday, or in town for an interview, or sometimes just lost. The periodic comets on the other hand are people whom you hear regularly every few months, either because their work, often as a service engineer or a truck driver, brings them on the same run only infrequently, or because someone fancies a change of frequency and puts 70cm on in the car instead of 2m every so often.

More threatening than the comets are the Invaders who arrive for short periods of time with venomously strong signals from across the North Sea. Their arrival promotes madness and frenzy amongst the local population. These Invaders have alien names like Oscar Zulu or Papa Alpha and have an extraordinary effect on normally sane people, who start to ask for QSL cards to confirm the DX contact. The salient point which seldom seems to be grasped here is that the repeater is actually no further away than it was the day before, or the day before that. I reckon that some form of the law of relativity comes into play here, which contrives to delude people into believing that their local box is varying its distance from them somehow. Beware the Invaders, their arrival induces mania.

Reformed Cbers

Another guy to watch out for is the reformed Cber (Former Wallius). Some manage to cover their tracks pretty well, and you couldn't really tell where they came from. Others . . . well, the hints are

very much there. You're most unlikely to hear a full-blooded 'one-nine for a copy breaker, c'mon' but the occasional reference to 'the personal' and 'twigs' are the giveaways. Confirmation is provided at an 'eyeball' when you'll see the patches on the denim jacket and if you're very lucky, you'll witness them carrying two short planks.

Forgetful

There's also the bloke who, no matter how many times you work him, will always forget your name (Homo Amnesius). It's amazing how many of us have an encyclopaedic memory for callsigns with an equally well-developed propensity to forget names. This mixture of being elephantine on the one hand and an anti-matter version of Leslie Welch on the other is unique to the amateur fraternity.

Listen out too for the Toy-Boy (Gadgetus Visacardus). He's the one whose wallet is bigger than his brain, who takes pride in acquiring the latest, biggest, or more likely smallest, piece of equipment on the market and demonstrating it to all and sundry. The idea is never to spend £50 when £500 will do. There you are, happily chatting away on your converted 'Wessie', when up pops the Toy-Boy with a rig so new that the adverts are still in the original Japanese. These rigs are always priced, not in pounds and pence, but in the algebraic formula P0A. This is basically because the distributors either haven't worked out how much they can get away with charging for it, or daren't admit that they have! They mustn't worry. The Toy-Boys operate on the principle that the more expensive a rig is, the better it must be. The other factor here is that the price of a rig is in inverse ratio to its size. I'm waiting for a four figure price-tag on a rig you can barely see. Remember the story of the King's new clothes? Methinks it's becoming true in Amateur Radio.

Fanatical

Some people on repeaters seem only to live for amateur radio. They are extremely busy all the time (Freneticus Activitus). It is their busyness that characterises them. Quite often they're club secretaries cajoling people into doing this, that or the other, and upbraiding them when they don't. Amateur radio is their bread and butter, nay, their life-blood and everything else is secondary to it. How they find the time for it I do not know – a Raynet exercise one day. Don't forget the Club committee on Wednesday, the Morse class on Thursday and JOTA isn't far off now . . .

Amateur radio, despite modest advances, is still a world of male domination. A visit to the local club

ROGER WILLIAMS OFFERS A LAYMAN'S GUIDE TO THE INHABITANTS OF FM REPEATERS...

confirms this beyond reasonable doubt and a listen to the local box provides additional confirmation. For a start, just listen to the comments about wives and girlfriends on the air. Ouch! Don't we put them down something chronic. 'She who must be obeyed' or conversely 'the slave', and even our jargon contributes to the diminishing of women through the phrase XYL and I'm sure we fool nobody by ascribing the role of 'station manager' to our partners. The number of male natter-nets which we have the nerve to end apologetically because the Sunday roast is ready is astounding. Quite why more women haven't tested the resonant frequency of saucepans on male heads frankly amazes me.

Women?

But, you protest, aren't there more women amateurs around than before? Well, yes, there may be, but aren't nearly all of them partners of existing licensees trying to keep up with their men folk? When we see an RAE class full of men struggling to gain a B licence so that they

can emulate their class A wives we will know that the women's movement has achieved a famous victory. As it is there is no shortage of patronising men to answer a call made by a woman operator.

Another character to look out for is Time-Out Man (Wafflius Indeterminus). He's the one in auto-waffle mode with whom you start a QSO /M just as you leave work, to have the transmission handed to you for the first time just as you're pulling into the garage at home. You then have to sit in the garage for five minutes, responding to the one or two remarks he made that you can remember. This in itself is not too important, as most of his 'over' consists of comments on the weather, what he can see out of the car window, what kind of day he had, and equally riveting details of how much fluff he found in his navel the previous night. He will talk mostly about the traffic conditions and other drivers. The day I hear another amateur critical of his own driving, I'll probably hand my licence in. Quite how anyone who talks on the radio whilst driving is in a position

to be critical of others I really do not know, but it happens a lot doesn't it?

Lastly of course, there is the Old Timer (Homo Supperannuatus). Every box has one and ours is a frail white-haired G2+ 2, who refuses to retire to the natter-nets on 80m, and who still prefers to mix it with the younger souls on the repeater.

Well, those are all the main repeater residents that I can think of. I haven't mentioned the wallies because they are always best ignored.

Tongue in cheek

It's at least possible that I've put my personal safety at risk in writing this piece - on the other hand, you may conclude that I've been in wind-up mode all along. Nevertheless, perhaps I should say that any relationship to any person living, dead, and especially mobile FM, is purely coincidental. Will those who think differently form an orderly queue with their libel writs outside my front door. It'll be interesting to see who turns up, and even more interesting to see who they think they are!

THE PERFECT COMPLEMENT TO AMATEUR RADIO

Packed with construction projects and the latest technology plus pages of readers' classified ads



Take out a **POST-FREE (UK)** sub while offer lasts

- Delivery to your door by publication date each month
- Inflation proof - price guaranteed for 12 months

On sale NOW at your newsagent and at equipment dealers

RADIO & ELECTRONICS WORLD SUBSCRIPTION ORDER FORM

To: Subscription Department • Radio & Electronics World • 1 Clarendon Road • Croydon • Surrey • CR0 3SJ. Tel: 01-760 0409

PLEASE SUPPLY: (tick box) for 12 issues, all rates include P & P

Inland World-Surface Europe-Air World-Air
 £16.20 £18.10 £21.85 £28.80

NAME

PAYMENT ENCLOSED: £

Cheques should be made payable to Radio & Electronics World. Overseas payment by International Money Order, or credit card

ADDRESS

CREDIT CARD PAYMENT **EXPIRY DATE**

.....Postcode.....

/

Signature

50MHz

By the time this column appears in print the main 1987 sporadic season will be virtually over, but the outstanding DX results will be of interest for many years to come. The comparative reports received confirm the expectation that sporadic E propagation would be best at solar activity minimum, taking into consideration the increased activity and monitoring this year. Your scribe regrets that it has not been possible to publish all the reports received due to space limitations, but they are all being forwarded to Ray Cracknell G2AHU, Co-ordinator of the RSGB Reporting Club, where they will be analysed and included in the official records.

The transequatorial propagation season (TEP)

In the June issue of this magazine I reviewed TEP during cycles 19,20 and 21, giving some results obtained by those of us who had specialised in this form of propagation over the years. During previous sunspot cycles some results have been achieved during the minimum period, and readers are referred to the article in the RSGB Bulletin, June 1965—*Transequatorial Radio Propagation during the years of the quiet sun*, by RC Cracknell ZE2JV (now G2AHU) and RA Whiting ZC4WR.

50MHz transequatorial tests 1987

Tests are being organised over the Europe-Africa circuit running from the last weekend in September to the first weekend in November 1987. The possibility of TEP being extended by sporadic E to cover Europe as far north as latitude 56N has been demonstrated at both sunspot maximum and sunspot minimum, and the idea has been inspired by the establishment of a record for the greatest distance worked within one year each side of the official sunspot minimum.

The northern TEP zone encompasses the Mediterranean and the regularity of Es northwards from there is very good and lasts occasionally through to early December. Papers by G3USF and others

show that October is the most favourable month and there were reports of the reception of the 50MHz beacon, ZE1AZC, as far north as Dundee in 1964.

Southern TEP

The southern TEP zone lies in a belt approximately 15-25 degrees south. As with the northern zone, southern extensions are also possible. For the purposes of these tests it is desirable that all available 50MHz beacons, and particularly those within the main TEP zones, be beamed across the equator for the period from early September to late November, and all participating stations concentrate their activity during the weekends from the end of September until early November, use 50110kHz as a calling frequency and 28.885MHz for crossband contacts (or move off as QRM develops).

Botswana activity

It is difficult to specify the optimum time. There are two main types of TEP: the afternoon type, which provides strong clear signals more frequently than the more regular evening type, which often carries severe fading. Early morning TEP around 0600Z has also been experienced. However, it is of interest to note that the JA-ZL contact took place in the afternoon.

We have been assured that Dave A22KZ will be active from Botswana, and ZS3AK will also be active and hopes to have a beacon in operation by early September. The beacon, ZS6SIX, will be operative from just outside Pretoria on 50025 with 65 watts to a six element yagi. ZS6LN should be operative from just outside Pietersburg, just south of the Zimbabwe border, as should ZS6WB and ZS6PW from Pretoria. Others will no doubt join in when the band opens and we are hopeful that Malawi, Zambia and Zimbabwe will be active crossband.

In the main TEP zone north of the Equator activity is being requested from France, Spain, and Portugal and stations within the main zones should work stations in the opposite zone without any

real difficulty. Those of us further removed from the equator however look eagerly for the additional chance of sporadic E or even tropospheric extension, and will reap an even greater reward if and when an opening occurs. All readers of this item are asked to invite any known suitably equipped station, particularly from the rarer parts of Africa, to participate in these tests, and the 50MHz reporting club will be very pleased to hear about the results you may achieve.

VHF News

I have received copies of VHF News, of July 8th and 26th from Hal Lund ZS6WB, PO Box 27746, Sunnyside 0132, South Africa, who would welcome your news. (I am sending him copy of this column). He writes: 'The Pretoria 6 metre beacon project is progressing. Because of the TEP experiments the initial priority is to get it operating beamed towards Europe. Operating on 50.0225 it will run about 50 watts into a four element beam at about 15 metres height and we hope to have it on the air around September 1st. There will also be a beacon on the air from Windhoek, ZS3, beaming north on a frequency of 50.0275. South African operators have been invited to operate during the tests concentrating during Saturday and Sunday evenings from 1700 to 1830UTC.

New QTH

By the time this appears in print I shall be operating from my new QTH (see address at the end of this column), on the rising ground to the north-west of Folkestone, and hope to take an active part in the forthcoming TEP tests to follow up the successes I had during 1947 from the Suez Canal Zone as MD5KW, and the Isles of Scilly during the peak of sunspot cycle 21.

In case it should be thought that TEP results will be confined to the Southern Counties of the UK we quote from ZE2JV and ZC4WR's article in the RSGB Bulletin, June 1965, detailing the reports from D Douglas BRS26325 of Dundee, Scotland (see Table).

The value of beacon transmitters in radio propagation studies over the years has been proved beyond question, and much thought had gone into the design of ZE1AZC, a small transmitter built into the aerial itself producing 40 watts FSK into its ground plane aerial. Built by ZS1LA, it operated for over nine months continuously without maintenance.

We have mentioned the probability of TEP being extended by other modes of propagation. Some of the oddities of propagation shown up by MD5KW in 1947 and ZE1AZC were never suspected at the time, but the coming experiments should hopefully add to our knowledge

Reception of 50MHz beacon ZE1AZC, Salisbury, Rhodesia

13.9.1964	0530/0536	S6	Slow fading	14.9.1964	0428/0436	S8	Slow fading
19.9.1964	2132/2149	S2	Rapid fading	20.9.1964	2100/2106	S3	Rapid fading
21.9.1964	0010/0016	S2	Rapid fading	24.9.1964	2110/2112	S4	
26.9.1964	0600/0600	S7	Slow fading	27.9.1964	0532/0536	S4	Rapid fading
1.11.1964	2232/2246	229	Rapid fading	2.11.1964	2350/2358	349	High noise
13.11.1964	0510/0512	339		20.11.1964	2140/2150	229	
2.12.1964	2330/2335	339	High noise level				

by Ken Ellis G5KW

of this fascinating mode of propagation. Good luck to those who will take part and please send in your reports either to me or to Ray Cracknell.

The extensive aurora of 25.8.87

I had hoped to include reports of an extensive aurora which occurred on Wednesday 25th August, and to a smaller extent during the following evenings, but despite sending some SAE letters out to stations known to have taken part, to date I have had no replies! I was alerted by Charlie Newton G2FKZ, shortly before 1800Z, that the Scottish beacon GB3RMK on 50.080 was being received by G3JVL at Hayling Island. I switched on and it was coming in at my QTH 57A. I had QSOs with: GM3WOJ, 1805Z, 57A, 55A, readable SSB; GM4SEU, 1821Z, 35A, 35A, readable SSB; GM3ZBE, 1822Z, 33A, 33A, readable CW; GM4DGT, 1845Z, 35A, 35A, readable CW. All the signals came from a few degrees west of north.

This is the first time since February 8th/9th last year that I have had auroral signals at my QTH (SE Kent). Discussing this with Charlie Newton, he told me that

the opening over the period was due to a coronal hole, with an A index of A40, which persisted for several days and diminished slowly. GM4IPK from Edinburgh had 104 auroral QSOs, G4IJE worked 7 Scottish stations, and the Scottish beacon, GB3RMK, was heard in the south by aurora around 0800Z on 28th and 29th August. This is most unusual. A full report of this aurora on the other bands will have been included on the GB2RS News of Sunday 6th.

From our mailbag

PL Crosland G6JNS writes at length about 50MHz operation in European countries and their inclusion in the 'Countries Worked Table'. He also asks what constitutes a proper QSO? His feeling is that the exchange of signal reports and locator square should be the minimum. 'When is a contact a QSO?' is a very controversial subject but I am not prepared to comment myself!

John Baker GW3MHW reports: '... with just the RK34 and 5 watts I contacted WB2CZB, VE1BNN, WB2FXN, W1WHL and W2CAP/1'. SJ Damon G8PYP of Dorset used ten watts to two loft dipoles

to contact nine countries including: C30DAW, 9H1BT, CT1WW, GM8FXX and GU1IIV. G4GLT of Leics had QSOs with all the usual east coast stations and also with stations further inland, including: W4OO, WB8KRY, with 36 QSOs on 21st July with W/VE stations. Geoff Brown GJ4ICD of St Helier, Jersey, sent in another long report. During the period July 1st-20th he worked 55 USA squares and 19 countries: G, GU, GJ, GW, GM, PA0, USA, OY, EA, CT, YU, 9H1, ZC4, GI, E1, VE, F, LA and CT3. Full reports have been sent to the 50MHz. Reporting Club.

Jeremy G3IMW of London N4 is more interested in observing and recording propagation than going 'all out' for contacts. To date he has received 21 QSL cards for QSOs during the June DX openings.

That about sums it up for now. Apologies are due to those whose reports have not been published, but they have all been sent in full to Ray Cracknell, Co-ordinator of the 50MHz Reporting Club. 73 and good DX on 50MHz de Ken Ellis, 18 Joyes Road, Folkestone, Kent CT196NK. Tel: (0303) 53276.

TX - 3 RTTY/CW/ASCII TRANSCEIVE

The high performance, low cost system

Split-screen, type-ahead operation, receive screen unwrap, 24 large memories, clock, review store, callsign capture, RTTY auto CR/LF, CW software filtering and much more. Uses interface or TU. **BBC-B/Master** and **CBM64** tape £20, disc £22. **SPECTRUM** tape £35 inc adapter board.

For **VIC20** we have our RTTY/CW transceive program. Tape £20

RX - 4 RTTY/CW/SSTW/AMTOR RECEIVE

This is still a best-selling program and it's easy to see why. Superb performance on 4 modes, switch modes at a keypress to catch all the action. Text and picture store with dump to screen, printer or tape/disc. An essential piece of software for trawling the bands. Uses interface. **BBC-B/Master**, **CBM64** tape £25, disc £27. **VIC20** tape £25. **SPECTRUM** tape £40 inc adapter board. The **SPECTRUM** software-only version (input to EAR socket) is still available £25.

TIF INTERFACE Perfect for TX3 and RX4, it has 2-stage RTTY and CW filters and computer noise reduction for excellent reception. Transmit outputs for MIC, PTT and KEY. Kit £15 (assembled PCB + cables, connectors) or ready-made £25, boxed with all connections. Extra MIC leads for extra rigs £3 each. State rig(s).

WORLD AND UK/EUROPE MAP LOCATOR Maps, great circles, distances, bearings, contest scores. Lat/long, locators, NGR, hundreds of placenames. **BBC-B/Master**, **ELECTRON ONLY**. Tape £10.

MORSE TUTOR £6, **LOGBOOK** £8, **RAE MATHS** £9 for BBC, SPECTRUM, ELECTRON, CBM64, VIC20.

All **BBC** and **CBM64** programs are available on **DISC** at £2 extra.

Prices include VAT and p&p, 1st Class inland, airmail overseas, normally by return. Eire, CI, BFPO deduct 13%.

technical software (AR)

Fron, Upper Llandwrog, Caernarfon
LL54 7RF. Tel: 0286 881886



RF CONNECTORS & ADAPTERS

PL259 Plugs to take 10.3mm coax, UR67/H100 etc	50p ea
Reducers for above to take 5mm coax, UR76/43/RG58 etc	15p ea
Reducers for above to take 7mm coax, UR70 etc	20p ea
PL259 Plugs with built-in 5mm reducers	50p ea
Couplers 2 x SO239 sockets back to back, in line	70p ea
Coupler as above but 2 x PL259 plugs back to back	75p ea
Elbow coupler PL259-SO239, a plug & socket at right angles	£1.00 ea
SO239 Chassis socket square 4 hole fixing	50p ea
SO239 Chassis socket, round hole fixing	50p ea
BNC PLUGS, 50 ohm, standard quality for 5mm coax	60p ea
4 pin Microphone plugs, female, the bit on the end of the mic	70p ea
4 pin Chassis sockets to match above, male	60p ea
6 pin Microphone plugs, female	£1.00 ea
6 pin Chassis sockets to match above, male	£1.20 ea
7 pin Microphone plugs, female	£1.20 ea
7 pin Chassis sockets to match above, male	£1.20 ea
8 pin Microphone plugs, female	£1.20 ea
8 pin Chassis sockets to match above, male	£1.20 ea
T Connectors 3 x SO239 outlets	£1.20 ea
T Connectors, 2 x SO239 and 1 x PL259 outlets	£1.30 ea
ADAPTERS SO239 socket on one end with BNC plug on other	£1.60 ea
Adapter, PL259 plug on one end with BNC socket on other	£1.60 ea
BNC Couplers 2 sockets back to back, in line, 50 ohm	£1.40 ea
BNC Coupler, 2 x plugs back to back in line, 50 ohm	£1.95 ea
BNC T Connectors, 3 x BNC socket, 50 ohm, outlets	£2.50 ea
BNC T Connector, 2 x sockets & 1 x plug out, 50 ohm	£2.50 ea
N TYPE Chassis socket, 50 ohm with PTFE, round hole fix	£1.30 ea
N COUPLERS 2 x N Sockets back to back in line, 50 ohm *	£2.50 ea
N Coupler, 2 x N plugs back to back, in line, 50 ohm *	£3.00 ea
N ADAPTERS N male plug to BNC female socket, 50 ohm *	£2.80 ea
N Adapter, N male plug to SO239 female socket, 50 ohm	£2.50 ea
N Adapter, N female socket to BNC plug, 50 ohm *	£2.80 ea
N Adapter, N female socket to PL259 plug, 50 ohm	£2.80 ea
TRANSRADIO N plug, 50 ohm to take UR67/H100/RG213 etc *	£2.40 ea
TRANSRADIO N plug, 50 ohm for 5mm coax UR76/43/RG58 etc *	£2.40 ea
TRANSRADIO Chassis N socket, 4 hole fix, 50 ohm *	£1.80 ea
TRANSRADIO Line 50 ohm sockets for UR67/H100/RG213U etc *	£2.30 ea
TRANSRADIO BNC plugs for 5mm coax UR76/43/RG58, 50 ohm *	£1.00 ea
TRANSRADIO BNC Plugs for 10.3mm coax, H100/UR67 etc, 50 ohm *	£3.60 ea
TRANSRADIO BNC Chassis single hole 50 ohm sockets, open back *	70p ea
TRANSRADIO PL259 plugs for 10.3mm coax, H100/UR76 etc *	£1.15 ea
GREENPAR BNC Chassis socket, 4 hole, 50 ohm 5mm coax entry *	65p ea
GREENPAR BNC as above but mini (RG174) coax entry, round hole *	65p ea
* Indicates PROFESSIONAL MILGRADE ITEM	SAE FOR FULL LISTS

SAE FOR LARGE LISTS OF SURPLUS CRYSTALS
POSTAGE IS EXTRA AT ONLY 50p per ORDER FOR ANY QUANTITY

W H Westlake, Clawton, Holsworthy, Devon
(0409) 253758

Bored with a humdrum existence? Tired with a tedious life?

Fancy straying from the straight and narrow or even crossing to the wrong side of the tracks? Yes, we thought as much . . .

So what's the solution? Where's the sparkling new package to break the dreary mould? Why it's here! . . .
4x4 Magazine!

4x4 has all that's best in off-road and four-wheel-drive action. Lacking only a mushroom cloud in terms of spectacle, it's guaranteed to excite and entertain, but beware! . . . This magazine contains explicit material which some readers, especially those of a trail disposition, may find disturbing. You have been warned!

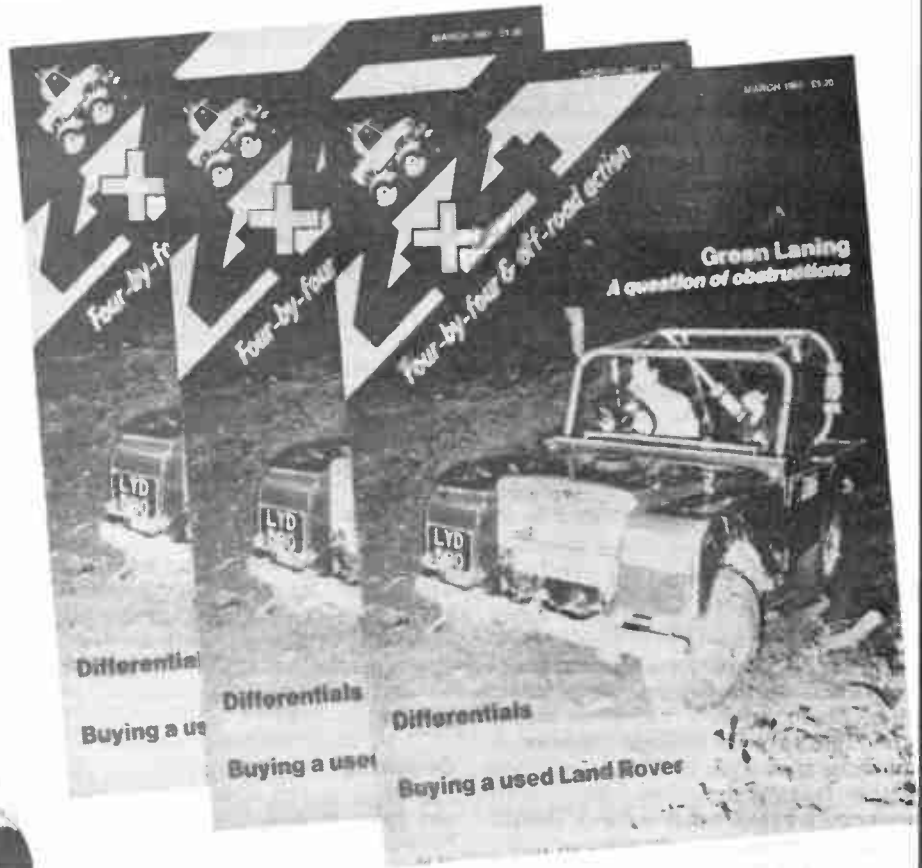

Place a regular order with your newsagent or take out a subscription

ON SALE AT YOUR NEWSAGENTS 2nd THURSDAY EVERY MONTH

4x4 SUBSCRIPTION ORDER FORM

TO: Subscription Department · 4x4 · 1 Clarendon Road · Croydon · Surrey · CR0 3SJ

PLEASE SUPPLY: (tick box) for 12 issues, all rates include P & P

Inland £17.70 World-Surface £19.80 Europe-Air £25.10 World-Air £32.75

PAYMENT ENCLOSED: £ —

CREDIT CARD PAYMENT Signature _____

Expiry Date /

NAME _____ ADDRESS _____

Postcode _____ AR10

Cheques should be made payable to 4x4 Magazines. Overseas payment by International Money Order or credit card.

PROJECT

BOOK

by Martyn Williams

This is the second in our series of constructional articles on equipment for use on the 50MHz band. One of the problems to be faced is that of second harmonic radiation getting into your neighbour's domestic VHF radio at around 100MHz. As well as messing up the broadcasts there are also some other users there who may take a more positive dislike to your sudden appearance on the Fuzzbox system, and who are in a position to get real nasty about it if they so decide! The problem is unlikely to occur unless you are running more than ten watts, but the answer to it is so simple that you may as well make sure of a clean signal right from the outset of operations.

Filtering

The device to be described is probably the simplest and cheapest filter imaginable and consists of no more than a short length of co-ax and a T connector, and it can be used on any band by simply scaling the length of cable and following the simple instructions. The idea relies on the fact that if, for any given frequency, we take a quarter wavelength of co-ax (allowing for the velocity factor, of course), and short circuit one end of it, the other end will show a very high impedance at the frequency chosen and

at all *odd* harmonics of it. At the *even* harmonics it will appear to be a short circuit.

Using it

If we now cut the cable to our aerial and fit a T piece the main feed can be taken through the top arm of the T, and the co-ax trap can be fitted to the tail; *Figure 1* shows this. The following adjustment *must* be made on receive or you risk blowing up your rig. Start with a length of co-ax about 40 inches long with the remote end *open* circuit, and get a fairly local station to give you a signal on the band. Now reduce the length of the co-ax by cutting off a quarter of an inch at a time. At first you may notice no difference on the S meter, but keep cutting away until the S meter drops to the lowest value you can obtain. As you approach this point start cutting even shorter lengths of cable, and the moment you notice a tendency for the meter to rise - stop.

Checking

Now bare the end of the cable and short the inner and outer together. The 50MHz signal should now return to the original signal strength, and as a final check try removing and re-inserting the filter on the T piece whilst watching the S

meter on an incoming signal; there should be little if any difference in the reading. With the filter connected there will be second harmonic attenuation of around 25 to 30dB which is equivalent to a second harmonic power reduction of around 1000 times, and this is obtained with an insertion loss of nearly zero. Not bad for such a simple device. It is now safe to transmit with the filter in circuit.

Other uses

If your neighbour is getting problems due to front end overload, the same filter can be fitted across the down lead to his TV or VHF radio. In this case set up the filter on your rig as before, but do not short circuit the end. Leaving it open circuit will provide a virtual short at 50MHz and so keep your fundamental out of his receiver without reducing the signal strength of the signals he wants. You can adjust the unit at his QTH if you wish by attaching it to his FM aerial cable, tuning in a broadcast station close to 100MHz and cutting to length as before for maximum reduction of the received signal. After this is done remember to solder the short circuit.

The same idea can be used to fit a trap to your neighbour's receiver or TV set to reduce interference from rigs on other bands. For use on two metres simply start with a length of co-ax about fifteen inches long and set up an *open* ended length of co-ax by tuning to a strong signal in the middle of the band, and going through the reduction routine.

To avoid going past the optimum point you might like to try this little dodge. Once the S meter is getting towards a minimum reading, simply remove the outer covering of the co-ax for a length of an inch or so. Then, while watching the S meter, simply push the outer braid back along the co-ax. If you have gone past the correct point it is easy to return to it. Once you have found the correct point leave the end open circuited and bind it firmly with adhesive insulating tape. Now fit it to your neighbour's down lead.

More bands

One of the beauties of this trap is that it works well on odd harmonics. Once set up on two metres it will also keep you out of trouble on 70cms and 23cms, which are the third and ninth harmonics of two metres. You could set up a filter for 70cms using a length of co-ax about five inches long, but the trimming becomes rather difficult and it is usually easier to use a two metre version operating at the third harmonic.

To set up a trap for any other frequency simply remember the ground rules: start with a physical quarter wave of co-ax, this means you do not even need to know the velocity factor of the cable you are using; trim to length and then leave the remote end open circuit to provide a low impedance on the feeder or short circuit to provide a high impedance. If you want to calculate exact lengths the velocity factor of thin cable is usually about 0.66 and thick cable is around 0.83. To find the length required multiply the physical quarter wavelength by the velocity factor of the cable.

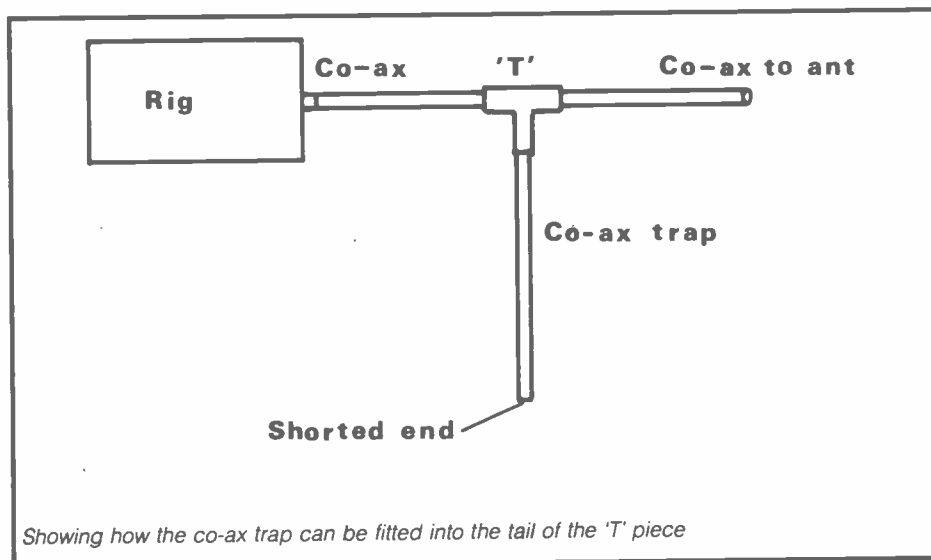

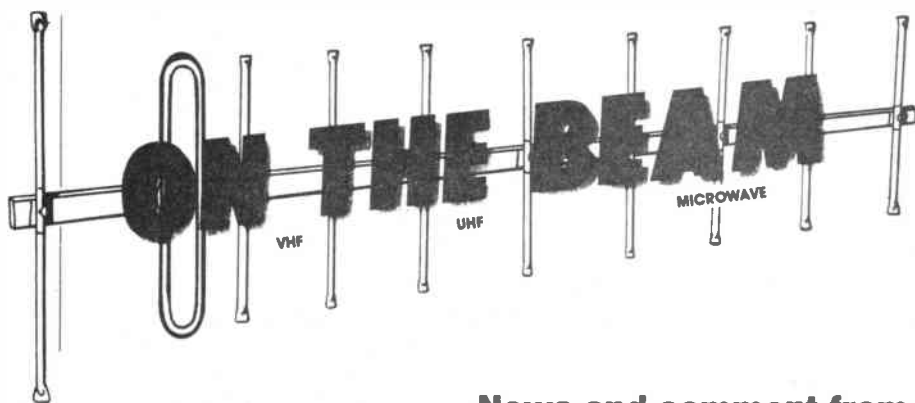

News and comment from Glen Ross G8MWR

The big news on the VHF, and indeed to a lesser extent the HF world, is the recent launching of the new Russian satellites, which are known as RS10 and RS11. These have been expected for some time but have been delayed on several occasions for various reasons. The launch eventually took place at 0742UTC on June 23rd from the launching site at Plasetsk in the northern part of Russia. As is now common the launch actually took part in two stages, the first part putting the satellite into an elliptical orbit of 1000km by 200km. A second stage was then used to place the unit into a near circular 1000km apogee by 985km perigee orbit. The other parameters are an orbit time of 105.0245 minutes, with 26.382 degrees of increment and 82.926 degrees of inclination.

The unexpected

It had been assumed from the information available that there would be two independent units launched as in the past, but this proved to be wrong as both the systems are housed in the one satellite, although operating independently of each other. There are three transponder modes on each unit, and these are Mode A with 145MHz uplink and 29MHz down, Mode K using 21MHz up and 29MHz down, and Mode T, which operates with 21MHz up and downlink on 145MHz. There are also combination modes such as KA with uplink on both 21 and 145MHz and down on 29MHz, and just to confuse you even more there is Mode KT with 21MHz up and combined 29 and 145MHz down. You need a computerised database just to keep track of the modes, never mind the orbits!

RS10 modes

There are so many links, modes, combinations and beacons that it takes a lot of figures to sort it all out. However, here we go. Mode A uses an uplink between 145.86 to 145.9MHz with the non-inverting downlink between 29.36 and 29.4MHz. Mode K uses 21.16 to 21.2MHz

as the uplink with the non-inverting downlink from 29.36 to 29.4MHz. Moving to Mode T we have uplink on 21.16 to 21.20 and the non-inverting downlink between 145.86 and 145.9MHz. Mode KTA uses 21.16 to 21.2MHz for the uplink with simultaneous downlinks, both non-inverted, between 29.36 and 29.4MHz and also between 145.86 and 145.9MHz. Lastly we have Mode KA, this uses combined uplinks of 21.16 to 21.2 and also 145.86 to 145.9MHz with the downlink between 29.36 and 29.4MHz.

RS11 modes

Having got the hang of RS10 modes you will have no difficulty remembering those for RS11, which are: Mode A with uplink between 145.91 to 145.95MHz with a non-inverting downlink from 29.41 to 29.45MHz; Mode K uses 21.21 to 21.25 for the uplink and a non-inverting downlink between 29.41 and 29.45MHz; Mode T which uses uplink between 21.21 to 21.25MHz and non-inverting downlink between 145.91 and 145.95MHz. We also have the combination modes with KA having combined uplinks between 21.21 and 21.25 plus 145.91 to 145.95MHz and downlinks on 29.41 to 29.45MHz; and Mode KT having uplink between 21.21 to 21.25 and combined downlinks, also non-inverting, between 29.41 to 29.45 and 145.91 to 145.95MHz.

The beacons

There are a number of these on each unit and they are used in combination with the different modes being used at the time. On RS10 they are on 29.357, 29.403, 145.857 and 145.903MHz. The equivalent frequencies for RS11 are 29.407, 29.453, 145.907 and 145.957MHz. There is also reputed to be another beacon on 435.395MHz and your guess is as good as mine as to what information one is supposed to convey.

More clever stuff

If you cannot find someone to talk to on one or other of the choices shown above (I don't believe you were really trying),

then you can talk to the satellite itself by calling it on one of the robot modes. Just why you should want to talk to a pile of electronic components is beyond me, but everyone to their own thing. Now let us try and sort this lot out. First the telemetry and robot channels are both downlink frequency interchangeable, but the chances are that you will find RS10 robot downlink on 29.403 or 145.903... but they might be on 29.357 or 145.857MHz if the telemetry output is using the other frequencies. You probably think that I am making all this up as I go along, but it is all the real thing, believe it or not.

Using the robot

You may call into the robot on either 21.2MHz if you have an A licence, or else on 145.820MHz if you are class B. Just to confuse you even more you have to make an allowance for Doppler shift of the signal. The satellite will tell you where it is listening by sending 'CQ, CQ, CQ de RS10 QSU 21120MHz (or wherever)' and you reply with RS10 de ***** (where ***** is your call) followed by AR. You must make sure that the AR are sent 'barred'; that is without a gap between the letters. If this gets in OK a response will be obtained from the satellite with your report and a serial number. Instructions to you such as QRQ, QRO or QRZ will be sent if the satellite cannot make sense of your input, and these should be complied with.

Clever stuff

The robot is a clever beast and will match the speed of your input over a range of 8 to 65 words per minute when it replies to you. Up to 128 call signs and reports can be stored in memory and later dumped to the ground station when, presumably, you will get a QSL card to confirm that you have spoken to an orbiting heap of components. You thought that was the end didn't you, but you forgot about RS11. This has all the same tricks as the robot on RS10, but listens on 21.13 or 145.83MHz and transmits on 29.407 or 145.907, according to how it feels at the time. If it wants to be awkward it will use the alternative beacon mode frequencies, and don't forget to call it RS11 when you contact it otherwise it will not talk to you.

The telemetry

The easy bit. The telemetry is sent in 16 lines and is prefixed with the name of the unit being measured, ie RS11. If the unit is under the command of the ground station, then an extra dot is added at the start of the letter, so you may read IS or SS, NS or RS. Now let us look at the individual lines and the information they give you. Line 1 is prefixed IS or NS (or SS or RS if under ground control). If IS or SS the telemetry is using 90 minute periods, if NS or RS then the period is fixed at 10 minutes.

The following figure gives the power supply voltage, normally 20 volts, as a figure which has to be divided by four to get the actual value. Line 2, IR or NR, gives the sensitivity of the two metre Rx. If IR, then a 20dB input attenuator is in

ON THE BEAM

use, if NR then the input is normal. The following figure gives the two metre transmitter power output, the figure being divided by ten to get the power in watts. Line 3, ID, shows 10dB attenuation in the transponder Rx while ND shows full sensitivity. The following figure shows 29MHz power output in watts by dividing the figure sent by 10. Line 4, IG, shows that the 21MHz transponder is OFF and NG means it is on. The following figure gives the voltage on the AGC line of the 21MHz Rx, a division by five being required.

The second part

Line 5 showing SU means the two metre Rx is OFF, NU means it is on. The following figure gives the two metre AGC line voltage and has to be divided by five. Line 6 shows the status of the service frequency IW, if it is OFF, NW when on. The following figure gives the AGC voltage when divided by five. Line 7 shows the low frequency beacon power, IK means 1 watt and NK 300 milliwatts. Line 8 shows the higher frequency beacon power as IO for 1 watt and NO for 300 milliwatts. Line 9 of the data shows the status of the first memory board, with AS when OFF and MS when ON. The following figure gives the temperature of the 29MHz transponder in degrees Celsius when divided by ten. Line 10 is the status of the second memory board,

being MR when ON and AR when OFF. The following figure gives the temperature of the two metre transponder in °C when divided by 10.

The third part

Line 11 shows AD if the special frequency is loading the memory, and when the input is accepted it changes to MD. The following figure, when divided by ten, shows the temperature of the twenty volt power supply. Line 12 does the same thing for the second memory board with AG meaning open and MG being closed. The following figure divided by ten gives the temperature of the nine volt power supply. Line 13 indicates the memory board beacon, with MU for beacon 1 and AU for beacon 2. The following figure divided by five shows the nine volt line voltage of the other transponder. Line 14 gives the sensitivity of the 21MHz Rx. AW shows 10dB attenuation and MW if full sensitivity. The following figure divided by five gives the supply line voltage for the 21MHz robot Rx. Line 15 shows the sensitivity of the two metre uplink Rx, with AK indicating 10dB attenuation and MK full sensitivity. The following figure divided by five gives the two metre robot Rx line voltage. Line 16 shows the power output of the special services Tx, with AO meaning 1 watt and MO being 300 milliwatts. The following figures are to

do with the number of callsigns stored, with 100 indicating a full house. Sometimes you will get G and K prefixes thrown around, but nobody has told us what these indicate.

There is more...

Not for this month there isn't! Next month we will get down to seeing if it all works. If you make any contacts through it please let me know, somehow I think you will be far too busy sorting it all out to actually talk to anyone...so that's why they have a robot up there. All information to 81 Ringwood Highway, Coventry or Prestel 203616941; and the best of luck.

Guess what?

Ed: what?

Glen Ross' copy is too short again

Ed: Put in a filler

ANOTHER FILLER?

Ed: Yes. And make sure you point out to him

that we need another 100 words each month

... You said it

**NEXT
MONTH**

Amateur
RADIO

all the regulars. . .

DX Diary
On the Beam
Secondhand
SWL
Straight and Level
Your letters and
features covering
the whole of
Amateur Radio

■ ANGUS MCKENZIE TESTS

G3OSS reviews the new SSB Products LT2S 144MHz high quality transverter

■ HF ANTENNAS FOR SMALL GARDENS

Don Field G3XTT continues his series with a look at some full sized arrays worth considering when space is at a premium

■ A LOOK AT TWO NEW PADDLES

George Dobbs G3RJV reviews some new paddle keys that are a product of that fine tradition of British precision engineering

DON'T MISS THE NOVEMBER ISSUE

On sale 29 OCTOBER

SECONDHAND EQUIPMENT GUIDE

by Hugh Allison G3XSE

At Longleat I met a reader carrying a Codar preselector/RF amplifier. He seemed quite pleased since he had been looking for a self-powered variant, as distinct from the 'take the volts (ie heater and HT) out of the parent receiver' type; not too handy for him with an all solid-state, 12 volt only receiver. He had bought a non-working mains one for a very reasonable 25 pence, and seemed fairly confident that he could repair it.

A few weeks later I met him again at another rally and naturally asked him how the Codar preselector was going.

'Typical', he replied, 'Thought I'd got a bargain because the mains transformer had gone. The spare I've got is only a 6.3 volt heater transformer and the HT winding's gone in the one fitted in it'. He didn't believe me when I told him that he could repair it. How is it done? By using the 'heater only' transformer backwards (see Figure 1).

Take care

Great care must be taken not to overload the existing, broken, transformer. All the so-called 'iron losses' of the replacement backwards transformer will have to be met from the heater winding of the broken one, but you can often get away with it, probably due to it not having to produce HT current anymore.

I've also used this trick in a home-brew HF SSB rig to generate the negative bias

where I wanted it. There was no room (or lead out wires) left in the power supply area, but where I needed the negative bias there was a heater wire. A small ex-mains adaptor transformer used backwards produced a couple of hundred volts in just the right place.

On the subject of broken transformers, their death after years of trouble free use may often be due to a disease called 'green spot'. This is where a small flaw in the varnish insulating the winding wire has allowed the wire to oxidise to an extent where the wire left will not carry the current required of it, and it fuses. Careful examination of the whole of the outer winding, particularly if exposed, and the top and bottom of the inner windings can often pinpoint the failure, due to the characteristic green spot often produced.

It is then sometimes possible to tease out one turn round the broken area and reconnect the ends to repair the transformer. The winding often goes near the outside, where you can see it, since this is the area most exposed to the atmosphere.

Trio JR310

The Trio JR310 is a valve amateur bands only receiver, dating from the early 70s. It is also a good example of decent amateur gear holding its value. In 1971 a standard JR310 would have set you

back £77, today you would be lucky indeed to pick one up for under £65. Not a bad devaluation over 16 years; I wish cars kept their value like that! The receiver is a double superhet, covering as standard 3.5 to 30MHz (old bands) with a 5.355 to 5.955MHz first IF and 455kHz second. Some importers added Top Band as an extra. A narrow filter was also available (the 'standard' receiver has the switch on the front panel, but the filter was an accessory—don't let the presence of this switch fool you into thinking the filter is fitted).

Practically

In use we are talking 20dB signal to noise for a microvolt; not wonderful sensitivity but adequate. The problem is the preselector knob. Until you get to know your particular receiver, it might be possible to miss a weak station on a dead band if this knob wasn't peaked correctly after changing bands. The preselector is extremely sharp. Stability is excellent, being in the region of 200Hz in the first hour and nothing after that. The VFO (running the standard 5.5 to 4.9) is quite a sophisticated animal, containing the only transistors in the receiver, two FETS and two bipolars.

A companion transmitter was available, the JT310. These are as rare as chocolate soldering irons, so don't go thinking you will pick one up at the drop of a hat.

On the subject of servicing, I've seen several where the owners have commented on a slow deterioration over the years, and on examination the fault has been nothing more exciting than the 5.5MHz IF coils (which are peakable on the front panel) going out of alignment. In such cases a quick tweak restores the equipment's former glory. Obviously, there are random failures, but they really are a cinch to repair, there being loads and loads of room to wave AVO probes around. Also, the handbook sports a good, clear, easy to follow circuit diagram.

Talking of servicing, never, ever invert a JR310 receiver with the covers off. The audio output valve (6BU8) sticks out proud of all the stronger mechanical gubbins and will break. Believe me, it will!

Portable short wave receivers

I have recently had in for repair a fair number of smallish domestic radios that cover, as well as the more normal long, medium and VHF, some chunks of the short wave bands. Although originating

Fig 1 Using transformers backwards

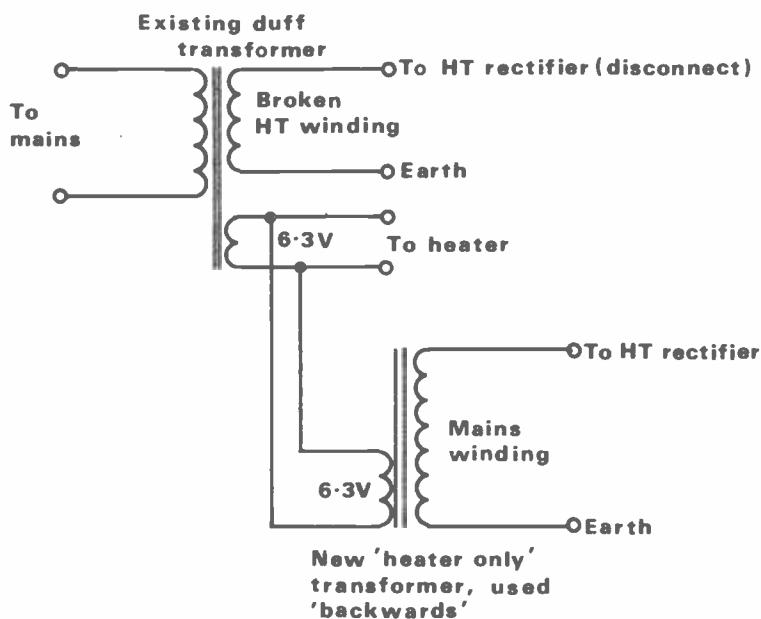

from several manufacturers and made in different countries, quite a few feature a lot of wax inside. It is probably there to ensure stability. However, it can cause problems when a repair is carried out on the set using a soldering iron, which melts the wax if left in the area too long. The wax then flows into the variable capacitor, to later set hard. This causes the shaft on the variable to be difficult to turn (or completely impossible) so the drive cord snaps.

Problems also arise if the set is left in a hot area. I hate re-stringing dial cords; I'm an electronics engineer, not a knitter. The problem gets worse, of course. Most of the variables are special to type, ie specific to that set, and you cannot get spares. Thus, the variable capacitor has to be de-waxed. This is easy if you have an ultrasonic bath, otherwise heat up the shaft through it with your soldering iron, and keep continuously rotating it end stop to end stop until the wax resets. Moral: Beware wax in radios. Go in and out with the soldering iron as quickly as possible, and don't overheat the set.

HW8

I think a thunderstorm started it. Quite a few amateurs found out shortly afterwards that their HW8s had gone deaf, requiring a quarter of a volt or so of surge up the aerial hole to get a weak chirp out of the headphones. The more able types soon found out that the FET in the receiver RF stage was a short in all directions and, after confidently changing it for a new one, were astounded to find their rig still deaf. Naturally, your scribe knew the answer, though I must confess that the first one I came across caused me three hours of brain numbing confusion.

If you refer to *Figure 2*, you will see that the coils are dc switched (note that this is a simplified diagram). What happens is that the bandswitch makes contact on the chosen range, thus biasing on the appropriate steering diode via the selected coil. When the FET blows, it takes with it the steering diodes. Some go short, some go open circuit; either way this is bad news. For a start an open circuit diode will not provide dc across the FET, so there is no action. A shorted diode will only allow operation on one band at best, since on the other bands it still allows the drain to 'see' the trimmer on the shorted band. Normally all the diodes go, some open, some short, thus giving a remarkably deaf receiver. IN4148s seem to do the trick.

Confessions . . .

I must confess to always having to give repaired HW8s an airing on the bands prior to giving them back to their rightful owners, purely to ensure customer satisfaction, you understand. Oh, all right, I love playing with them! Super little boxes, but what a price! They seemed to have been in the £70s last year, but I am pleased to say that this year I've seen dozens change hands in the £60 price bracket and, lately, two at £50 dead

Fig 2 Simplified HW8 Rx RF switching

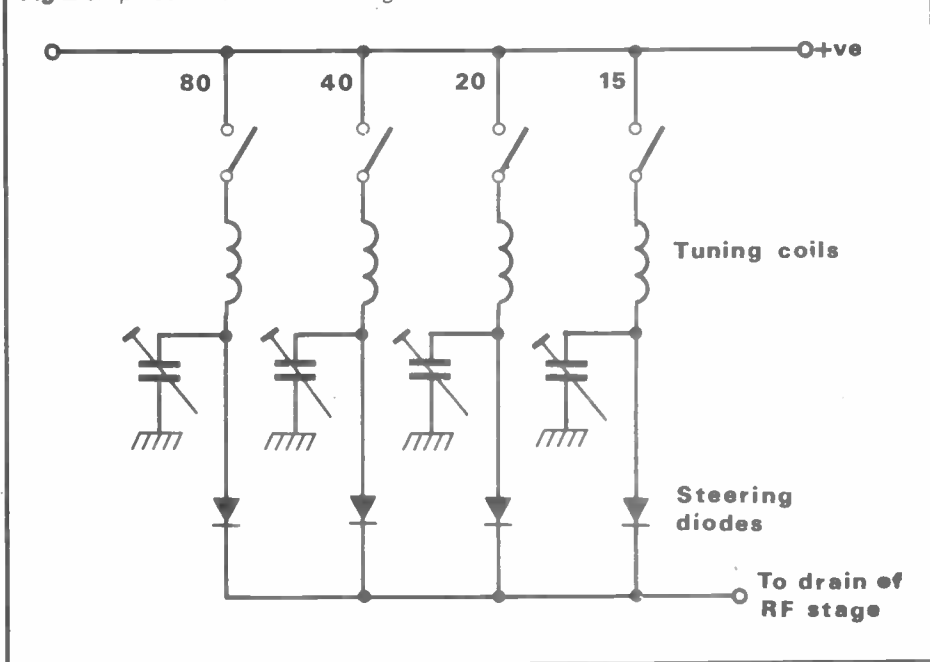

(dead on £50, not dead sets!). An HW8 is a Heathkit CW – only, low power transceiver covering 80, 40, 20 and 15 metres, 12 volt powered, which has a homodyne receiver, ie it isn't a superhet. It takes headphones only.

Remember, Heathkits are kits, and I've seen particularly badly built examples. One that springs to mind had the main PCB on the wrong side of its mounting brackets, resulting in the board being more than a little bowed. For the sake of undoing a couple of screws I'd recommend a look at the standard of internal construction prior to handing over the money. Look for blobby joints, burnt out tracks or bowed boards in particular.

747s

Your scribe was on the phone recently ordering a dozen 747s. A visitor looked on in awe. 'Who does that man buy for?' he asked a colleague, thinking I was buying rather large aeroplanes of the Jumbo variety.

The actual 747s in question were integrated circuits. They are merely two examples of the industry standard op-amp, the 741, in one package. Be very, very careful when replacing 747s. Some have two totally independent positive supplies, one to each op-amp within the chip, and some have them interconnected *within the chip*. Check by AVO-ing between pin 9 (V+ chip B) and pin 13 (V+ chip A) on your replacement chip.

Now look at the circuit diagram of the equipment you are repairing. If these pins are commoned up, normally there is no problem. I've had one example of a piece of equipment that was designed for common supplies to a 'split' chip that oscillated when fitted with a commoned chip, but only one, so we will call that a rarity. The real hassle is where pin 9 goes to one supply and pin 13 to another. Obviously, the circuit was thus designed

for a 'split' 747 and fitting a commoned one can cause disaster.

I recently saw someone plug a commoned up one into a 'designed for split' oscilloscope power supply. It punched a hole in the top of the 747 when it exploded on being turned on. Another design used a 747 in the modulator of FM rigs, one half chip doing the modulating proper (ie the mic amp bit) while the other half of the 747 was the toneburst. What's the problem? Well, the toneburst bit only runs for the desired half second, and is switched by its rail. Pop in a commoned 747 and the mic amp supply then runs the toneburst.

All of the foregoing applies to both the round, canned, 10 pin circular variety and the 14 pin dual in-line. Note the pin numbers above are for dual in-line. In a can it's pins 2 for A, 8 for B. Manufacturers' type numbers are no great guide towards identifying common or split supplies. One data book I have suggests that you use the date code on the chip, since they changed from one type to another on a specific date! Personally, I'd rather check with an AVO.

Finally

One final story. I first came across a dead 747 in a two metre Palm 2 handportable. This 747 was of the metal round can variety. I'd just changed a load of early memory chips in a VDU – these were all round metal can devices with 8 pins. I, not unnaturally, assumed that this was an 8 pin device – the leads come out of the 747 in a circular pattern but go into the board dual in-line style. You wouldn't believe how much hard work it is getting a 10 pin device out of a board when you've only unsoldered 8 of them! Incidentally, no mod on either Palm 2 or 4 is nearly always caused by a dead 747. I don't know why, but I've had several of both in like this.

ECW for KITS

- | | |
|---|--|
| ▷ K2622 – AM/FM Antenna Amp. 22dB gain from 10MHz to 150MHz from this kit. Complete with metal case. 12–15V d.c. supply voltage direct or via coaxial input. 50–75ohm impedance lines. £12.13 per kit | ▷ K2032 – 3 digit DPM. Three digit digital panel meter module, +999 to –99mV full scale, zero adjust, overload indication. 1mV resolution and 0.1% linearity. 20uV/°C temperature stability. Compact unit easily built-in to other equipment. £28.54 per kit |
| ▷ K2554 – Quality FM Tuner. Varicap tuning from 85–108MHz. 1.2uV sensitivity, 70dB S/N ratio. AFC, AGC and output for digital frequency display. £32.02 per kit | ▷ K1803 – Universal Preamp. For signal matching, low-level input boosting, etc. 40dB gain, adjustable output. 20Hz–20kHz bandwidth. 40mV full scale input. £6.84 per kit |
| ▷ K2553 – Stereo Decoder. Works with K2554 tuner kit, includes stereo indicator signal, stereo on/off and 19kHz filter. Excellent stereo radio reproduction. £17.99 per kit | ▷ K2576 – 40W Power Audio Amplifier. No adjustments necessary and non-critical power supply from 2x6 to 2x18V unbalanced. 250mV input sensitivity. 10Hz–50kHz bandwidth. (+/-3dB). Protected against short circuit and thermal overload. £18.83 per kit |
| ▷ K1771 – Short Range Transmitter. Miniature FM transmitter for short distance communications. Inputs from all mics., pre-amps, etc. 1Megohm input impedance, 5mV sensitivity. 100–108MHz adjustable output frequency. 9–12V d.c. supply. £9.20 per kit | ▷ K2623 – Lab. Quality 24V/3A Power Supply. Short circuit protected bench power supply, adjustable output from 0 to 24V in three current ranges – 0.5, 1.5 and 3.0A. 0.05% line and 1% load regulation. – Indispensable! £40.14 per kit |
| ▷ K610 – LED VU Meter. VU level display using a 12-LED bar-graph. Adjustable input sensitivity for all types of signals. £15.47 per kit | ▷ Look at these other examples from our extensive range: |
| ▷ K1798 – 16 LED Stereo VU Meter. Stereo VU display, twin 16-LED high resolution bar-graph output. Internal adjustable pre-amp to give sensitivity from 100mV to 10V full scale. £26.75 per kit | K2574 – Up-down counter – four digit £67.22 |
| | K2579 – Universal start/stop timer £12.65 |
| | K1682 – Microprocessor Universal timer £77.58 |
| | Toroidal transformers from £14.15 |
| | Membrane keypads – 12 or 16 keys £13.20 |
| | Prototype cards, various patterns 160x100mm £5.79 |

ECW

Prices include VAT & Postage. For your order, please make cheques payable to **ELECTRONIC & COMPUTER WORKSHOP LTD**
Unit 1, Cromwell Centre, Stepfield, Witham, Essex CM8 3TH. Tel: (0376) 517413



CAP CO ELECTRONICS LTD
63 Hallcroft, Birch Green
Skelmersdale, Lancs
WN8 6QB
Tel: 0695 27948

**Stay Tuned Forever with a CAP.CoATU –
Once Bought – Never Replaced**



ANTENNA TUNING UNITS

SPC-300D 1Kw p.e.p.	£225.00
SPC-3000D 3Kw p.e.p.	£325.00
NEW PRODUCT – VHF A.T.U.	
SPC-100 1Kw p.e.p.	£59.95
CAPCITORS	
CAP-25S S.GANG 250 pfd	£15.50
CAP-25T T.GANG 250 pfd	£18.95
CAP-10S S.GANG 500 pfd	£21.95
CAP-25D DIFF 500 pfd	£18.95
8Kv 2.5mm plate spacing - 2.00 p & p	
CAP-31S S.GANG 250 pfd	£17.95
CAP-31T T.GANG 250 pfd	£22.95
CAP-12S S.GANG 1200 pfd	£25.95
12kv 4.5mm plate spacing - 2.50 p & P	
ROLLER COASTER - 2.00 p&p	£22.95
28 micro henries	
BALUNS 4:1, 1:1 - 2.00 p&p	£16.50
Fully encapsulated	
AERIAL KIT - 1.00 p&p	£5.30
Clip-on Spreaders	
URNS COUNTER - 100 p&p	£22.50
Digital	

ANNOUNCING ANOTHER FANTASTIC NEW PRODUCT

HOW WOULD YOU LIKE AN AERIAL THAT OUT-PERFORMED A FULL SIZE DIPOLE AT THE CORRECT HEIGHT, A VERTICAL, IS AS GOOD AS A BEAM AND ONLY AN 'S' POINT OR TWO DOWN ON A QUAD, DOES NOT NEED AN ATU, NO, NOT EVEN ONE OF OURS? YOU WOULD? THEN READ ON.

THIS AERIAL WORKS AT GROUND LEVEL, WILL FIT INTO THE TINIEST OF GARDENS, IN A FLAT OR ON A BALCONY. IT IS IDEAL FOR EMBASSIES, GOVERNMENTS AMATEURS, SHIPS LARGE OR SMALL, MOBILE & PORTABLE IT COVERS 1 TO 30 MHZ – DOES NOT CONTAIN LOSSY TRAPS OR HIDDEN DUMMY LOADS – HAS A BAND WIDTH FROM 3KHZ TO 48KHZ DEPENDING ON FREQUENCY IN USE THE SWR AT THE HIGHEST IS 1.2 TO 1 AND 1 TO 10 MOST FREQUENCIES – WILL HANDLE FROM 100 WATTS TO 1 KW CONTINUOUS DEPENDING ON MODEL USED. THIS IS NOT A GIMMICK, NOT A TOY, IT IS A REAL TECHNOLOGICAL BREAKTHROUGH, WE KID YOU NOT. SEEING AND HEARING WILL BE BELIEVING. TO THOSE WHO ARE SCEPTICAL COME AND SEE FOR YOURSELVES AT STAND 26 LEICESTER AMATEUR RADIO SHOW

ALL OUR PRODUCTS ARE MANUFACTURED BY US AND ARE THE RESULT OF LENGTHY PERIODS OF R & D AND TESTING.

PLEASE DO NOT PURCHASE INFERIOR COPIES HOPING THAT THEY WILL PERFORM TO OUR HIGH STANDARDS, USE CAPACITORS AND ROLLER COASTERS PROVEN TO WORK, BUT THE BEST – BUY CAP CO.

WE ALSO STOCK INLINE METAL COUPLERS 0.75p. FLEXIBLE COUPLERS £2.50 and REDUCTION DRIVES £2.16.

PLEASE PHONE ABOVE NUMBER FOR YOUR LOCAL STOCKIST.

FREE CLASSIFIED ADS

FREE CLASSIFIED ADS CAN WORK FOR YOU

We are pleased to be able to offer you the opportunity to sell your unwanted equipment or advertise your 'wants'.

Simply complete the order form at the end of these ads. Feel free to use an extra sheet of paper if there is not enough space. We will accept ads not on our order form.

Send to: **Amateur Radio Classified Ads**, Sovereign House, Brentwood, Essex CM14 4SE.

DEADLINE AND CONDITIONS

Advertisements will be published in the first available issue on a first come first served basis. We reserve the right to edit or exclude any ad. Trade advertisements are not accepted.

FOR SALE

■ Sony ICF200D, with air band, syncro tuning, wide and narrow filters, 32 memories, boxed as new with manuals, carriage extra, £200. Tel: 01-570 5603

■ 934MHz Reftec MK II Cept 40 rig, Nevada mag mount co-lin, 26 ele Yagi beam, £220 ono. Would consider p/ex for 2 metre multimode or 2 metre SSB rig. Ian, Chester. Tel: (0244) 535725

■ *One wires and waves, a practical wireless publication*, £2.50, includes postage and packing. Wanted: One Kenwood R1000 receiver, about £200, in good condition. Tel: Clochan 378

■ AOR AR2002 VHF/UHF scanning receiver, 25 to 1300MHz, hardly used, less than 12 months old, boxed as new, complete with PSU, removable whip antenna, 12 volt lead for mobile use. Also free VHF/UHF guide to frequencies book, £380 (save up to £100). N Lewis (GIUQK) Tel: Daytime (0386) 556105 Nighttime (0386) 554525 (ask for Neal)

■ F1102, immaculate condition and just 3 year old, £500. No offers or time wasters. Please Tel: Arthur (061) 624 2808

■ Icom ICR71E communications receiver with fitted FL44A SSB crystal filter and remote control. Absolutely mint condition, £695 ono. Andy Benedek, 5 Church Cottages, Essendon, Herts AL9 6AS. Tel: after 6pm (07072) 61452

■ TR9000 144MHz m mode, c/w mic, mtg/bracket, £250. 144MHz linear, MML100S, £100. SEM ATU transmatch, £45. 28MHz. Pre-amp, MMA28, £5. SEM auto HE pre-amp, £5. Yaesu desk mic, scanning option, MD1B8, £35. All items good condition. One owner from new, offers considered, postage at cost. G4VJK, John King, 36 Haroldslea Drive, Horley, Surrey RH6 9DU. Tel: (0293) 783556

■ Sony 7600D digital tuning, FM, LW, MW, SW, continuous up to 26100kHz. Boxed, mains adaptor. External aerial, manual and wave guide, used for one month only, bargain at £145. Tel: 01-352 5379

■ Eddystone 770R MKII 19MHz to 165MHz, £125. Hamsterland HQ170, 1.8MHz to 54MHz, £125. Microdot CW, RTTY, ASCII, £150. R208, 10MHz to 60MHz, £90. MS1 mobile stand & charger for 2500, £25. SMC monitorscope, £70. All in good condx with manuals, or exchange any for 70cms equip, heavy duty rotator HF linear, good quality SWR, power meter or WHY? McCallum G4VNG. Tel: (0733) 231639

■ Yaesu FT290R MKII, with accessories (NiCads, charger, l/s), £340. Microwave Modules MML144/30LS 30W linear amplifier, £65. Drae 4A PSU, £30. Hansen FS300V SWR/power meter, £20. Commodore C64 computer, with PSU, joystick, data recorder, and assorted software, £95. Citizen DP560 dot matrix printer (uses 3 inch paper), £25. All items in excellent condition. Contact Mark Lees G8XQB. 12 Alesia Road, Luton LU3 3QH. Tel: (0582) 574073 (after 6.30pm)

■ Exchange electronic organ, Technics SXU50 (cost new £1725), many features, including voice setting computer, program chords, techni chord etc, excellent cond, home use only, for HF rig, p/ref gen coverage, value approx £800. Tel: Dover (0304) 821790

■ 3 Hand-held Pye Pocketfone, UHF 70cms transceivers, with 12 volt charger, spare batteries and service sheets, sell or swap for 2 or more hand-held VHF transceivers, 150 to 200MHz, 5 watts minimum, might consider Marine sets. Tel: Leeds 664331

■ Collins R392/URR HF Rx, 0.5-32MHz in 32 1MHz bands. 25 valves with transistorised output stage. Rx operates with 24-28 volts dc heaters and HT. Supplied with 240V ac-24V dc PSU, which contains a 10 watt amplifier and a separate speaker. Rx is hermetically sealed and ruggedised, as it was designed for parachute delivery. Very sensitive (2 RF stages), and very stable. Exterior good condition, interior as new, £200. Buyer collects if

poss. G4JMF QTHR. Tel: (051) 355 3854 home, (051) 339 4181 X336 office

■ AR88 RCA receiver, vgc, service manual and spares available, offers? Prefer exchange for 2m transceiver in working condition. Tel: (051) 339 9663 after 6pm, Wirral area

■ Sony ICF7600D portable receiver, complete with mains PSU, boxed, £110 ono. Tel: Pete 01-393 9115 Epsom

■ FT902DM, dc-dc converter, £550 ono. FL2100Z, as new, £600 ono. Datong FL3, £90. Datong ASP £50, plus all manuals. G0BGY Jim. Tel: 01-949 5549, after 6.00pm

■ SEM QRM eliminator, £50. Datong AD370 active ant, £50. G4WBW QTHR. Tel: Kidsgrove 6656 evenings or weekends

■ DX302RX, 10kHz to 30MHz, digital read-out, AM, USB, LSB, CW, Mains/battery, S meter, absolutely mint condition, little used, been stored, £155 ono. Zenith Royal D7000 Rx, 11 wavebands, VHF, FM, LW, MW, 7 shortwaves, mains/battery BFO for SSB, interesting Rx, £85 ono. Tel: Kenilworth 54556

■ Uher 4400 Report stereo IL prof tape recorder, c/w mains supply unit and circuits, as new, used one hour only, £100 ono. G6HXB QTHR. Tel: (0895) 32601

■ FT790R with matching FL7010 10W linear amplifier, both boxed and in vgc. Very little used and never used portable or mobile, £275 the pair. Rod, Kenilworth; Tel: (0926) 53393

■ Marconi 22, Philco 444 GEC BC635 3V kit set, old and new crystal sets, R107 Rx, AVO valve tester 19 set, 100s early p/w mags. Tel: Dean (0594) 54239/36021

■ One unused CV56B magnetron, £10. Also ten EF50 valves, unused, made by Mullard £2 each. Eight CV7006 equivalent to OC72, £1.50 each, all unused. Philip. Tel: (0232) 702567

■ R107 Receiver 1.2MHz/17.5MHz. R206 receiver 60kHz/30MHz, receiver type C No 4 medium wave Naffi set WW2, all accessories for WS19 available (except aerial rods), ATU No 8 (WSB47), goodness tester for WSB70, remote ATU for WS22, headgear for WS31, remote controls E (WS19) and L (WS62) valves APP3 (10), American WW2 altimeter, type RT7-APN1, frequency meter, type BC221, many other items available for swap etc, see wants section. Tel: (0908) 73114

■ Stalker XX (20) home base, FM, AM, USB, LSB, m/band, h/band, Ch9 scan, RF gain, mike gain, 240V or 13.8 volt supply + digital clock. Auto or manual on/off, excellent Rx and Tx. Genuine reason for sale, being rather large for front seat of mobile, £80. Tel: (0228) 23408, after 6pm.

■ FT980 inc SP980 Yaesu FIF232C manual, as new, any sensible offer secure in excess of £900. Tel: (0480) 53775

■ Type 13A dual beam scope with complete set of probes and leads. In good working condition but with broken graticule, no manual or info, £25 ono. Big and heavy hence buyer collects. Also, Solartron CD568 scope, non working but was stored for long time so possibly not serious (but not sure!) offers? Buyer collects, again due to size. Both items WHY? ring Jon Tel: (0243) 605779

■ KW202 receiver (160-10m) and matching speaker, manual, mint condition, little used, £130 plus carriage. KW traps and balun (new), £20 plus carriage. Write: W Besnick G4GQW, Normanby, Sinnington, York YO6 6RH. Tel: Kirbymoorside 31766

■ AR2001 25 to 550MHz Rx, £250. Also Chinon CE5 camera, flash, power winder, 50mm, 225mm 200m lenses, plus two metal cases, £150. Tel: Mark (0302) 868176 (Doncaster)

■ Eddystone comm receiver, model 7704/2, covers 150MHz - 500MHz, several new valves, recently checked over, covers military air bands, weight 54lbs, £75 ono, vgc. I will pay cost of delivery to you, requires a discone aerial to operate. Mr George

Jacob, 23 Waterloo Gdns, Penylnn, Cardiff CF25 5AA. Tel: (0222) 487299 evenings

■ PRO-31 UHF, VHF hand portable scanner, £140 ono. Tel: David, Newtownards (0247) 810665

■ Mullard high speed valve tester recently serviced complete with all manuals and almost a thousand test cards, offers around £85 or would like to ex. or p/ex something vintage or military, eg W/S 18, 22, 19, R206, R107, AR88, Collins, etc. Also Cossor pattern generator, 405-line, 7-10MHz, gwo, £20. Can deliver for cost of petrol or meet you half way. K E Franklin, 50 Abingdon street, Burnham on sea, Somerset TA81PJ. Tel: (0278) 784205

■ FRG7700 receiver, perfect condition, service handbook and user manual, original packing, recent service and calibration, checked by Yaesu agents, £215. Transformer, 240 ac input, 245V 40 amp output, £20. D J Thompson, 112 Lexton Drive, Southport, Lancs PR9 8QW. Tel: (0704) 20003

■ Closed circuit TV system, Sharp mini camera with one 16mm 1:1.6 lense and one 8mm 1:1.3 lense, with manual iris, 20 feet of cable, Sharp 9in B&W monitor, with 3 camera inputs. System is in excellent working order, but unfortunately no manuals, £100 ono. Buyer to collect or pay carriage. Will consider swap for radio paging equipment. Tel: Bristol (0272) 515596 after 6pm, ask for Mark

■ FT277ZD Mk 3 Sommerkamp (101) ZD HF rig, AM, SSB, digital readout, fan CW-N filter fitted, G5RV full length, only been used for SWL, £380 ono. Spectrum 128K, incl games interface, data cassette player, boxed as new, £70 ono. Cheeta Mk 5 Midi keyboard, plus interface, £80 ono. RAM music machine, £35 ono. Both items boxed as new. Contact Dave. Tel: (0703) 456248

■ FRG7700 with FRV7700, 118-130, 140-150, 70-80, £295. Swap AOR2002 for TS430 with cash adjustment. Tel: Northwich 44670

■ Cobra 148GTL DX, boxed, as new condition, must be seen, £110 no offers. Tel: Mansfield 559759

■ Sony 2001D, little used, boxed, showroom condition, £200 or exchange for Sony AIR7. 7 Norwich Drive, Cheltenham. Tel: (0242) 524259

■ Yaesu FT726R, fitted 50MHz, 2m, 70cm modules, sat unit and CW filter, complete with SP102 speaker, orig box with handbooks, £950. Tel: (061) 427 5931, Manchester area

■ Yaesu FRG7700 general coverage synthesized receiver with twelve channel memory, in excellent condition, with user manual and original packing, £250. Wilkinson. Tel: (0482) 898322

■ Breml BRS26 regulated power supply, input 220/240V ac, 50Hz, output 13.8V 3 amp, constant 5 amp surge, fused for protection, 100% solid-state, convert house ac current 220V into 13.8V ±5% dc, 13.8V 3 amp output, on/off power, any offers please. G8CQC, buyer collects. Mr R Mills, 48 Lady Bank, Birch Hill, Bracknell, Berkshire RG12 4BH. Tel: Bracknell 412239

■ Realistic DX302 communications receiver, 10kHz-30MHz coverage, all usual modes, hardly used, mint condition, boxed, £185 ono. Realistic PRO30 scanner, hand-held, VHF, UHF, Air band, boxed, £90 ono. Richard Hodson, 99 Oxford Road, Garsington, Oxford OX9 9AD. Tel: Garsington 562

■ Philips D2999 World Radio, 150kHz-2999MHz, digital, LW, MW, VHF, 3in and 7in speakers, mint, manuals, £100. Heathkit active antenna HD1424, assembled and tuned by Heathkit UK Ltd, £30, or £120 both. Tel: Tyneside (091) 5267902

■ Sommerkamp TS802 2m h/h transceiver, requires repair, offers or WHY? Speaker mic, Sommerkamp impedance 32 ohm, excellent condition, £8. 2m linear, Wood & Douglas kit, built up, working order, £5. Tel: Jim. Tamworth (0827) 51591

■ Icom R71E, as new, boxed, the best Rx, 32 mem, FM circuit, man, bargain, £550. H A White, 13 Roundwood Drive, Welwyn Garden City, Herts AL8

FREE CLASSIFIED ADS

JJZ. Tel: Welwyn Garden City 322862

■ PNP Communications RTTY terminal unit, boxed and working, with nine LED tuning indicator, for the Dragon 32 or VIC 20 computer, uses BMK software, £26 ono. Mr Vince Bobin G1FBH QTHR. Tel: (0548) 2543

■ Complete Yaesu HF system, consisting of FT707 all mode (including FM) HF transceiver, FC707 antenna tuner, FV707DM external VFO, FP707 power supply, MMB2 mobile bracket, £600 complete. The transceiver has also been fitted with full switchable 11m band 26-28MHz. May be interested in all mode 11m equipment, ie Cobra 148GTL DX, PPresident Jackson etc, with cash adjustment. Tel: Bradford (0274) 880895 evenings only

■ Datong Morse tutor, first time pass, as new, £35. Class D wave meter, 6V ac, with manual, £10. HS-HF5 vertical antenna, 80m to 10m, hardly used, £45. W Lankshear, 57 St George's Road, East Looe, Cornwall PL13 1ED. Tel: Looe 2823

■ Yaesu FT709R 70cm hand-held with speaker mic, FNB3, FNB4, charger, £229. Yaesu FT708R 70cm hand-held with speaker mic, charger, £149. Yaesu FT290R 2m multimode with NiCads, charger, mobile bracket, W&D linear, mobile antenna, £269. G4WVX Bruce, QTHR. Tel: (06286) 64415

■ Ham International Jumbo with original mic, both in mint condition, plus 20m of heavy duty coaxial cable and 19ft Alcom aerial, only 40 FM channels at present, however simple adaption if AM USB/LSB channels required. Has been checked and passed by professional rig doctor. All this for the bargain price of £100. Phone now for details. 23 Bracken Way, Thundersley, Benfleet, Essex SS7 3RA. Tel: (0268) 743018

■ Trio/Kenwood R2000 HF receiver, 100kHz to 30MHz, 2 years old, very good cond, manual and box included, £375. Mr G J Gill, 19 Fountains Road, Bramhall, Cheshire. Tel: (061) 440 8418

■ Due to new licence I have a Trio QR666 receiver for sale complete with manuals. Buyer to collect, or deliver within a short distance. Please phone (0272) 875250, ask for Phil. If not in leave number for return call

■ Tagra BT122 27MHz vertical and horizontal beam aerial, with changeover box from vertical to horizontal, brand new, still in box, not used, in perfect order, £115, should be £140. Also brand new Prinz Astral 400 telescope, focal length 700mm, objective lens 60mm x 233 magnification, complete with tripod and Barlow lens and sighting scope, £100, still in box. Glenside, Lon Street, Ffruid, Trearddur Bay, Holyhead, Gwynedd LL65 2YR. Tel: (0407) 860575

■ Lewis disco amp with spare PA module, £100 or WHY? Daiwa LA2065 2m linear with preamp, £85. Pye A200 low band amp, offers? Martyn G4SUI, 112 Leeds Road, Mirfield, West Yorks WF14 0JE. Tel: (0924) 495916

■ Trio TH21E 2m h/h mini transceiver, brand new, 12 month g'tee, cost £199, c/w two antennas, charger, nicad packs etc, boxed as new, must sell, £150 ono. Tel: (0761) 70180, Bath, Avon BA3 1NY

■ Getting wed sale! TS520, SP520, Nye Viking ATU, SWR bridge, Shure 444D, MC-35S Ross h/phones, 1kW dummy load, Yaesu FF501, LPF hi-mount key, matched pair 6146BS, Rx 12BY7As 100m 75Ω twin, 100m 300Ω slotted ribbon plus loads of bits. All you need is A ticket, £550 ovo. Peter. Tel: Days (0642) 456327 buyer to collect

■ FT221R very nice condition with digital readout, YC221, £360. No offers. Buyer collects or pays S'cor. Tel: (029 922) 279 (Clows Top)

■ AMT2, RTTY, CW, Amtor, ASCII, terminal unit by ICS Electronics, complete with BBC B computer software on EMPROM: All connecting cables including lead suitable for FT726R, FT757GX etc, instruction manuals, mint condition, £199.00 ono. GM4SUF Phillip Gane, Ardmore Lodge, Edderton, Ross-shire, Scotland IV19 1LB

■ AEA/ICS CP-1 terminal unit, RTTY/CW with G3WHO EPROM software for BBC micro £150. MBM 48/70 70cms yagi (Jaybeam, as new), £18. NEC 12in green screen monitor, perfect, £40. PBM (Jaybeam) 18/70, 70cms parabeam, yagi (as new), £18. Sony C7 beta VCR with service manual, recent new heads (ex cond), £125. Paul G4XHF. Tel: (0293) 515201

■ Polaroid Polavision instant movie outfit, c/w zoom lens, movie camera replay monitor, in new condition, original box, offers or swap FRG7 Rx or

sim, or any deal considered re amateur radio gear WHY? NW London area. Tel: 01-906 4206

■ Swap Kenwood TR9500 and BO9 system base for 70cms, as new, and Yaesu FT221R 2 metre multimode VFO and Xtals base set for Yaesu. FT726R, preferably with 6m module. Also have FT101B modified for 10MHz, c/w mike, manual, spare fan. Works well but case tatty, hence £125, buyer to pay p&p as it weighs 30lb. Phone me for a chat. Tel: Andy after 5-30pm (0481) 49112 or write GU1WDT QTHR. (New call book)

■ Magazines: *Short Wave Mag*, complete volumes 22 (1964), 24 (1966), 25 (1967), 26 (1968), all in binders. Volumes 20 (1962), 23 (1965), 29 (1971), 30 (1972), not bound. *Practical Wireless* 1976, 1977, 1978, all complete. 1971 to 1975 and 1979, all missing some issues. Sensible offers, buyer collects. Tel: Camberley 64760

■ FDK725X 2m FM mobile, 30W, 144-148MHz. 5/8 + 5/8whips and gutter mount, Heatherlite mobile safety mike to suit FDK (Scanning) Drae VHF wave meter, all in good cond, £160 ono. Lack of use forces sale, would consider exchange for IC2E. Tel: 01-247 6097 daytime only

■ ZX Spectrum 48K computer with Saga 7 Emperor keyboard, books, magazines and games, still boxed and in good condition, cost £300, sell £100. Mel G1VAQ, 29 Wansford Road, Driffield, East Yorkshire YO25 7NB. Tel: (0377) 46113

£25. Ham International TW232DX base station microphone with speech compression. New, 1/2 price at £20, five RAE books, £8 or offers. Tel: John (08482) 314

■ Trio R820 ultimate Rx, cost £840, as new, boxed, £450. Wanted: Braun TC1000, any B/O radios, Bosch, Telefunken, Tandberg, 1960 to 1970 portables for private collection. Roy Trent, The Cottage, Lomax Farm, Pilsforth, Bury, Lancs. Tel: (061) 761 3907

■ A new AOR2002 radio, 25 to 1300MHz, I have its AOR service manual and will post it, free to first cheque rec for £400, it's a few months old, from lowe, so ring any time from 9 to 9 day or night. Tel: (04735) 5526, ask for Pete

■ BT approved call recorder, as new save scribbling, £40. Yaesu dc converter for 101, 901, 902 etc, £40. Pye 70cms boot mount Wessie, vgc wkn on 70cm, £50. Will sell or swap, call for haggle. Wanted CBM 64 programs. Martyn Bolt G4SUI, 112 Leeds Road, Mirfield, West Yorkshire. Tel: (0924) 495916

■ Datong DF unit with aerials for 2m and 10/11, ready to use, £185. Pye 70cm hand-held with spare Nicad and base charger, £75. Pye W15 low band rig ideal for 4 or 6, £40. Lewis disco amp with spare PA module, £100, will swap, sell, haggle WHY? Martyn Bolt, 112 Leeds Road, Mirfield, West Yorkshire, WF14 0JE. Tel: (0924) 495916

■ Icom R7000 VHF/UHF scanning receiver, as new, boxed, manual, bargain, £700 ono. Mr AC Burge, 3 Mowhan Street, Lisburn Road, Belfast BT9 7HJ. Tel: (0232) 681962

■ Swan 350A HF transceiver, American rig with valves, 125 watts, spare PA, little used, with photostat manual, £125 plus carriage. Tel: (021) 354 9972 G3MDQ

■ Yaesu FT757GX MkII & FP757GX, continuous tuning from 500kHz to 30MHz, cond spanking new, never been used as a transmitter, only receiver, 4 months old must be seen, £950 no offers. Tel: 01-232 2331, ask for Terry

■ FT790 with Tokyo 30W linear, £350 or exchange for HF transceiver same value. Eddystone 840C, new valves, gwo, swap for HF transceiver same value, or 10m multimode of same value. Martin G6ZHV. Tel: Telford 580573

■ Ham multimode Two, good working order. Ham Concord Two, both sets like new, boxed with manual for conversion to 10m, £50 each. Tel: Nottingham 874235

■ Marconi signal generator TF144G, £25. Marconi RC oscillator TF1370A including spare set, £30. Xtal calib no 7, £8. Thermal noise generator CT82 15KHz 160MHz, £10. Dawe white noise generator 419C, £35. Stabilised power supply, valved R98, £15. Armstrong hi-fi tuner/amp, model 226, £40. Philips radio 1937 model 727A, Bakelite cabinet gwo and cond, £50. Pye radio 1950 P76 gwo, £30. Regentone twin speaker radio, 1949, model U353 in gwo and appearance, £40. K Hindie. Tel: (061) 962 7577

WANTED

■ Panasonic RF9000 Rx, cash offered. Sony CRF330K, Trio 5000. Icom RA70, RA71 or similar, even non-working considered. Tel: (0462) 33690

■ Radofin teletext adaptor TAD110, anyone got a user or operational manual for this? Write to Art Simpson, 1 Worsfold Close, Coventry CV5 9FT, copy will suffice, all costs reimbursed. Tel: (0203) 403353

■ Exchange FRG9600 scanner, fitted video unit with PSU, 6 mths old, boxed as new for FT707 plus FC707 ATU. Also for possible exchange Icom 720A all band tcvr, fitted FM, with PS20 PSU, both boxed in vgc, for FT902DM or FT101ZD plus FC902 ATU and gen cov receiver, ie FRG7700 or WHY? Tel: Stalham (0692) 82075 daytime only, ask for Ian

■ Good condition, working order, SP102. Price etc to Bob, 41 Poets Corner, Margate, Kent CT91TR. Tel: (0843) 225445

■ Can anyone supply me with a five digit counter, condx unimportant as long as working okay. Price range £15 to £25. Also wanted info on Tandberg Huidra 9 BC Rx. All letters will be replied to: Peter Holmes, 5-4 Greenydkes House, Edinburgh EH16 4JJ

■ Valves VP2, HD24, 240QP, TH2, PM2HL, 954s, 955s, WW11 items: TCS12 dc PSU. Bendix TA12 Tx r/control, RAI-B Rx r/control, and dc PSU. USA. Dynamotors, any type. Command (ARC5) Tx, Rxs PSU. BC453, 454, 455 etc. Racks, control gear etc.

ADVERTISERS PLEASE NOTE

Please ensure that your telephone number (if applicable) and address are included in the appropriate section of your ad.

If you do not wish to have your address published, please include it but state 'not for publication'.

Any ads submitted without an address and/or telephone number will not be printed. This condition has become necessary because a small number of ads have been submitted by bogus readers, causing considerable inconvenience to the holders of the telephone numbers quoted.

■ Realistic TRC1001 hand-held transceiver, 40ch, 4 watt, Nicads, case, charger, extension mike lead, antenna adaptor, in box cost £150, accept £70 ono, or part exchange for 2mtr hand-held tcvr or Trio 2300 or Yaesu FT207 or WHY? Steve G1YRE, Woodbridge, Suffolk. Tel: (03943) 7669

■ Electronic organ, Technics SXU50 (cost new £1725), many features, voice setting computer, arpeggio, solo synth, etc. Value approx £800, exchange for gen coverage transceiver or WHY? Also 2 metre 12 ele beam, rotator, 20ft mast, £55 the lot. Datong D70 Morse tutor, £35. Tel: Dover (0304) 821790

■ Hallicrafter S27 receiver model (S27D), RBK radio receiving equipment for amplitude and frequency modulated signals, frequency range 27.8 to 143MHz, re-aligned condition, working air traffic control received met (etc) reports, new S23 electrolytics and many capacitors replaced, buyer collects. Any offers write to Mr R Mills, 48 Lady Bank, Birch Hill, Bracknell, Berkshire RG12 4BH. Tel: Bracknell 412239

■ Kenwood MA4000 dual band (70/2m) mobile antenna with built-in duplexer. New, 1/2 price at

Amateur RADIO SMALL ADS

ETESON ELECTRONICS



15B Lower Green,
Poulton-le-Fylde, Blackpool
Tel: (0253) 885107

Open: 9.30am - 12.30, 1.30 - 5.30. Closed Wed & Sun.
Electronic Component Specialists.

A wide range of electronic components, IC's, capacitors,
transistors, resistors, plugs and sockets etc.

IAN FISHER COMMUNICATIONS OF STANHOPE

CB Works, The Market Shop, Market
Place, Stanhope (0388) 528464

Main Distributors of 27MHz CB radios and the
NEW DELTA 1 series 2 model transceiver with
the latest cybernet board. Also the NEW
Nevada range of 934MHz aerials to suit, also
934MHz pre-amplifiers and VSWR meters and
GREENPAR BNC and 'N' type plugs.

Large stocks of coaxial cable, plugs, sockets
and adaptors.
All available via mail order. Retail/Wholesale

OPEN: MON-SAT 10.30am-6.00pm
SUN 2.30 - 4.30
RING FOR DETAILS
(0388) 528464

AGRIMOTORS

MERTON CB AND RADIO CENTRE
MERTON GARAGE AND POST OFFICE, MERTON.
Nr OAKHAMPTON, DEVON EX20 3DZ

OPEN 6 DAYS 9-6 LUNCH 1-2pm THURSDAY 9-1
(SUNDAYS BY APPOINTMENT)
SPECIALIST IN 934 MHz
SUPPLIERS OF ALL 27MHz AND 934 MHz EQUIPMENT
AMATEUR EQUIPMENT CATERED FOR
08053 200

**MRZ
COMMUNICATIONS LTD
STOKE-ON-TRENT**

**DESK DC SUPPLY AND BASE
FOR ICOM PORTABLES**

ICOM-AMATEUR/PMR/MARINE/AIR
YAESU - AMATEUR
UK AND EXPORT





TEL: (0782) 619658
7 DAY SERVICE

DW ELECTRONICS G3 XCF
Amateur Radio Supplies
71 Victoria Rd, Widnes 
Tel: 051-420 2859

Open Mon-Sat 9.30-5.30 (closed all day Thurs)
We supply YAESU, ICOM, Tonna, Jaybeam,
Microwave Modules, Datongs etc

D.P. HOBBS (Norwich) Ltd
13 St Benedicts Street, Norwich Tel: 615786

Open Mon-Sat 9-5.30
Closed Thurs 1.00pm
Stockists of:



YAESU, FDK, ICOM, JAYBEAM
& Electronic Component Specialists

WORKSHOP SERVICE MANUALS

Any Music Audio, Mono TV	£7.00
Any Colour TV	£10.00
Any Video Recorder	£30.00

State Make/Model/Type. Plus 50p post & see enquiries any others.

MAURITRON (AR)
8 Cherry Tree Road, Chinnor Oxfordshire OX9 4QY

JAPANESE Ic's (PART OF OUR RANGE)

AN301 £3.50, AN7140 £2.20, AN7145 £1.95, AN7146 £2.20, BA532 £1.80,
BA536 £2.40, HA1377 £2.20, HA1398 £2.75, HA13001 £2.95, LA4480 £1.80,
LA4481 £1.80, LA4807 £4.25, LC7137 £2.75, M51515 £2.50, M51517 £2.80,
MB3705 £1.80, MB3712 £1.50, MB3722 £3.50, MB3730 £2.50, MB3731 £3.50,
MB3756 £2.80, MB8719 £3.85, STK461 £7.50, STK463 £8.40, TA7205AP
£1.00, TA7222AP £1.30, TA7229 £3.25, TA7240 £2.95, TA7607 £2.85, TA7614
£2.75, TA7628 £2.95, TA7640 £1.75, UPC375 £1.00, UPC1001 £2.20,
UPC1031 £1.95, UPC1158 85p, UPC1181 £1.10, UPC1182 £1.10, UPC1185
£2.50, UPC1188 £2.75, UPC1230 £2.50, UPC1277 £2.75, UPC1395 £3.60.

Free Ad Voucher removed

**VALUABLE
SPACE FOR
SALE!**

**Telephone
the advertising
department on:
0277 219876
for details**

VALVES WANTED

Especially large audio types

PX4, PX25, PP3/250, KT66, KT88 complete collections or shop clearance etc welcome.

PLEASE STATE PRICE REQUIRED, CASH WAITING.

MARTIN BILLINGTON

39 Highlands Rd, Horsham, West Sussex RH13 5LS
Tel: 0403 864086

USED AMATEUR EQUIPMENT BOUGHT SOLD EXCHANGE. SAE FOR LATEST LIST. SECONDHAND PRICE GUIDE UPDATED MONTHLY. USEFUL GUIDE FOR BUYING/SELLING £2.00. ATU MODS ADD TOP BAND TO SEM KW ETC. £6.50

**CALL MARTYN G4SU.
GEEFOR ENTERPRISES.
112 LEEDS ROAD, MIRFIELD,
WEST YORKS. WF14 0JE.
TEL: 0924 495916**

PERSONAL CALLERS BY ARRANGEMENT.

**Booth
Holdings
Bath**

**GOLF CLUBLANE
SALTFORD BRISTOL
Tel: 02217 2402**

Open Tues-Sat 9am-9pm

Closed Monday

"934 MHz STOCKIST"

R. WITHERS COMMUNICATIONS LTD

Manufacturers, importers and suppliers of world famous communications products
584 HAGLEY ROAD WEST OLBURY, WARLEY, BIRMINGHAM B68 0BS
021-421 8201/2/3. CELLNET 0860 323056. PRESTEL MBX 214218216 FAX 0215614074
Amateur Radio. Business Radio. Radio Telephones. Sales. Service Accessories and antenna systems.



YAESU



**THE TECHNICALLY ORIENTATED
RADIO COMMUNICATIONS
SPECIALISTS.**

RADIO SERVICE ENGINEERS

£8,000-£15,000 per annum plus expenses

Ray Withers Communications Ltd, based near Birmingham are a small, but very dynamic, marketing lead company. Due to increasing business we are urgently seeking service engineers for field work and bench servicing on the latest portable, mobile, and based transceivers often employing CTCSS tone equalch, as well as general Amateur Radio equipment servicing.

Do you have the flexibility and skill required for this well paid position? Practical ability would be even more important than formal qualifications; if for instance you are a radio amateur who can, with confidence, build and repair your own equipment, you could be ideal!

A basic knowledge of radio is essential, and a practical test may be given. If you want to improve your career prospects, then come and show us what you can do!

We are conveniently situated close to junction 3, M5. We use modern test equipment and work in a small friendly environment, with a team of talented people.

Please send a written application or call Ray Withers personally, on the above telephone number.

WE OFFER YOU THE CHANCE TO GROW WITH AN EXPANDING COMPANY, PROVIDING BUSINESS AND AMATEUR RADIO ENTHUSIASTS WITH TOMORROW'S RADIO TECHNOLOGY TODAY . .

RF DEVICES AT ROCK BOTTOM PRICES!

Nobody beats us!

Over 30,000 RF devices at low prices

REPLACEMENT RF TRANSISTORS

MRF454 HF/SSB 80W	£20.00
MFR450 HF/SSB 50W	£11.60
MRF238 VHF/FM 25W	£12.80
MRF475 HF/SSB 20W	£2.99
2SC1969 HF/SSB 18W	£2.50
2SC2043/1307 HF 16W	£2.00
2SC1947 VHF 3.5W	£7.60
2SC1946A VHF 32W	£14.30
BLW 60R HF/VHF 50W (Special)	£7.50

REPLACEMENT RF POWER MODULES

M57704/SAU3 UHF 15W	£36.00
M57712/37 SAV7 VHF/FM 25W	£39.00
M57713/SAV8 VHF/SSB 15W	£39.00
M57716/SAU4 UHF/SSB 15W	£49.00
M57719 VHF/PMR 15W	£29.00
M57727 VHF/SSB 38W	£45.00
M57749/SAU11 934/FM 7W	£29.00

Send £1.00 p&p or SAE for full list
All prices inc. VAT
Many Ic's and other types in stock

RAYCOM LTD

**DEPT AR 584 HAGLEY RD WEST
QUINTON BIRMINGHAM
B68 0BS**

021 421 8201-3

(24hr answer phone)

MORSE CODE PREPARATION

Cassette A: 1-12 wpm for amateur.
Cassette B: 12-28 wpm for professional examination preparation. Each cassette is type C90.
Price of each cassette (including booklet) £3.95.
Morse key with separate battery (PP3) - driven solid-state oscillator and sound transducer produces clear tone for sending practice. Price of key with electronic unit £8.95.
Price includes postage etc. Europe only
MH ELECTRONICS (Dept AR)
12 Longshore Way, Milton, Portsmouth PO4 5LS

FOR SALE

**Established Amateur
Radio Business**

APPLY 051-420-2559

MERSEY SIDE AREA

PSSS....

**ALL THE SUPER
BARGAINS ARE
ON THE
INSIDE-FRONT
COVER OF THIS
MAGAZINE!!**



2 METRE COLLINEAR UVRAL X2 5/8 over 5/8

An omni directional antenna giving low angle radiation. The ideal base station vertical. Ruggedly constructed for long life.

Technical Specification

Gain	: 6 dB
Impedance	: 50 Ohms
Max Power	: 100 Watts
Length	: 3.14 metres
SWR 144 to 146Mhz	: Less than 1.5
Wind Loading	: 4.6 Kgf at 100mph
Weight	: 1.2 Kgs
Mounting Diameter	: 25mm
Termination	: Free 'N' Socket

Send cheque or postal order for
£29.95 plus £2.50 postage to:

**BUCKLEYS (UVRAL) LTD.,
BETA WORKS,
RANGE ROAD,
HYTHE, KENT CT21 6HG
Tel. No. (0303) 60127/60128**

D & D ELECTRONICS (Kennington)

The sort of shop you used to see in Lisle St. All sorts of surplus supplies, so come along and browse or send SAE for info. sheets.

**3a Braganza Street, London SE17 3RD
Tel: 01-793 0054 (Open 6 days a week)**

** COMPONENTS **

RF Transistors, Resistors, Capacitors, Test Equipment, Semiconductors and others too many to list here. All top quality Devices, NOT surplus. For further details & competitive price lists send SAE to:

DESIGN ELECTRONICS

**5 Briar Close, Heckmondwike WF16 9JH
(No callers, Mail Order Only)**

**NEXT ISSUE
ON SALE
29th OCT '87**



£1 BAKERS DOZEN PACKS

Price per pack is £1.00.* Order 12 you may choose another free. Items marked (sh) are not new but guaranteed ok.

1. 5 - 13 amp ring main junction boxes
2. 5 - 13 amp ring main spur boxes
4. 5 - surface mounting switches 5A 250V
5. 3 - electrical switches, white flush mounting
7. 4 - in flex line switches with neons
9. 2 - mains transformers with 6V 1A secondaries
10. 2 - mains transformers with 12V 1A secondaries
11. 1 - extension speaker cabinet for 6 1/2" speaker
13. 12 - glass reed switches
17. 2 - ultrasonic transmitter receivers with circuit
19. 2 - light dependent resistors
25. 4 - wafer switches - 6p 2 way, 4p 3 way, 2p 6 way, 2p 5 way, 1p 12 way small one hold fixing and good length 1/2 spindle your choice
28. 1 - 8 digit counter mains voltage
30. 2 - Nicad battery chargers
31. 1 - key switch with key
32. 2 - aerosol cans of ICI Dry Lubricant
34. 96 - 1 metre lengths colour-coded connecting wire
39. 1 - long and medium wave tuner kit
41. 8 - rocker switch 10 amp mains SPST
45. 1 - 24 hour time switch mains operated (s.h.)
49. 10 - neon valves - make good night lights
50. 2 - 12V DC or 24V AC, 3 CD relays
51. 1 - 12V 2 CD miniature relay very sensitive
52. 1 - 12V 4 CD miniature relay
54. 10 - rows of 32 gold plated IC sockets (total 320 sockets)
55. 1 - locking mechanism with 2 keys
56. 1 - miniature uniselector with circuit for electric jigsaw puzzle
60. 5 - ferrite rods 4" x 5/16" diameter aerials
61. 4 - ferrite slab aerials with L & M wave coils
63. 1 - Mullard thyristor trigger module
66. 1 - magnetic brake - stops rotation instantly
67. 1 - low pressure 3 level switch can be mouth operated
69. 2 - 25 watt pots 8 ohm
70. 2 - 25 watt pots 1000 ohm
71. 4 - wire wound pots - 18, 33, 50 and 100 ohm your choice
77. 1 - time reminder adjustable 1-60 mins clockwork
85. 1 - mains shaded pole motor 1/2" stack - 1/2 shaft
89. 1 - mains motor with gear box 1 rev per 24 hours
91. 2 - mains motors with gear box 16 rpm
96. 1 - thermostat for fridge
98. 1 - motorised stud switch (s.h.)
101. 1 - 2 1/2 hours delay switch
103. 1 - mains power supply unit - 6V DC
104. 1 - mains power supply unit - 4 1/2 V DC
107. 1 - 5" speaker size radio cabinet with handle
112. 1 - heating pad 200 watts mains
114. 1 - 1W amplifier Mullard 1172
115. 1 - wall mounting thermostat 24V
118. 1 - teak effect extension 5" speaker cabinet
120. 2 - p.c. boards with 2 amp full wave and 17 other reeds
121. 4 - push push switches for table lamps etc.
122. 10 - mtrs twin screened flex white p.v.c. outer
124. 25 - clear plastic lenses 1 1/2" diameter
127. 4 - pilot bulb lamp metal clip on type
128. 10 - very fine drills for pcbs at 120v
129. 4 - extra fine screw drivers for instruments
132. 2 - plastic boxes with windows, ideal for interrupted beam switch
134. 10 - model aircraft motor - require no on/off switch, just spin to start
137. 1 - 6 1/2" 4 ohm 10 watt speaker
142. 10 - 4 BA spanners 1 end open, other end closed
145. 2 - 4 reed relay kits 3V coil normally open or c/o if magnets added
146. 20 - pilot bulbs 6.5V.3A Philips
154. 1 - 12V drip proof relay - ideal for car jobs
155. 3 - varicap push button tuners with knobs
169. 4 - short wave air spaced trimmers 2-30f
172. 10 - 12V 6W bulbs Philips m.e.s.
178. 3 - oblong amber indicators with hilopats 12V
180. 6 - round amber indicators with neons 240V
181. 100 - p.v.c. grommets 3/8 hole size
182. 1 - short wave tuning condenser 50 pf with 1/2" spindle
188. 1 - plastic box sloping metal front, 16 x 95mm average depth 45mm
193. 6 - 5 amp 3 pin flush sockets brown
195. 5 - B.C. lampholders brown bakelite threaded entry
196. 1 - in flex symmetrical for electric blanket soldering iron etc.
197. 2 - thermostats, spindle setting - adjustable range for ovens etc.
199. 1 - mains operated solenoid with plunger 1" travel
200. 1 - 10 digit switch pad for telephones etc.
201. 8 - computer keyboard switches with knobs, pcb or vero mounting
206. 20 - mtrs 80 ohm, standard type co-ax off white
211. 1 - electric clock mains driven, always right time - not cased
216. 1 - stereo pre-amp Mullard EP9001
232. 2 - 12V solenoids, small with plunger
236. 1 - mains transformer 9V 1 amp secondary C core construction
241. 1 - car door speaker (very flat) 6 1/2" 15 ohm made for Radiomobile
241. 2 - speakers 6" x 4" 4 ohm 5 watt made for Radiomobile
243. 2 - speakers 6" x 4" 16 ohm 5 watt made for Radiomobile
244. 1 - mains motor with gear-box very small, toothed output 1 rpm
245. 4 - standard size pots, 1/2 meg with dp switch
249. 1 - 13A switched socket on double plate with fused spur
266. 2 - mains transformers 9V 1/2 A secondary
267. 1 - mains transformers 15V 1/2 A secondary p.c.b. mounting
291. 1 - ten turns 3 watt pot 1/2 spindle 100 ohm
296. 3 - car cigar lighter socket plugs
300. 1 - mains solenoid with plunger compact type
301. 10 - ceramic magnets Mullard 1" x 3/8 x 5/16
303. 1 - 12 pole 3 way ceramic wave charge switch
305. 1 - tubular dynamic microphone with desk rest
308. 1 - T.V. turret tuner (black & white T.V.)
310. 2 - oven thermostats
313. 5 - sub miniature micro switches
314. 1 - 12" 8 watt min fluorescent tube white
316. 1 - round pin kettle plug with moulded on lead
411. 1 - 1 1/2A magnetic trip saves repairing fuses
453. 2 - 2 1/4" 60ohm miniature speaker or microphone
454. 2 - 2 1/4" 80hm miniature speaker or microphone
457. 2 - small plastic cases, could hold desk mic, small extension speaker etc.
463. 1 - mains relay 2 c/o 8A contacts with plastic dust cover
464. 2 - tubes Holts plastic filter/sticker
465. 3 - 5A 3 pin rubber/nylon plug tops
466. 4 - common cathode, 7 segment displays .5"
473. 1 - 5" speaker with built in tweeter, 4ohm, Radio mobile



Es-Electricity Board. Guaranteed 12 months.

VENNER TIME SWITCH

Mains operated with 20 amp switch, one on and one off per 24 hrs. repeats daily automatically correcting for the lengthening or shortening day. An expensive time switch but you can have it for only £2.95 without case, metal case - £2.95. adaptor kit to convert this into a normal 24hr. time switch but with the added advantage of up to 12 on/off per 24hrs. This makes an ideal controller for the immersion heater. Price of adaptor kit is £2.30.

SOUND TO LIGHT UNIT



Complete kit of parts of a three channel sound to light unit controlling over 2000 watts of lighting. Use this at home if you wish but it is plenty rugged enough for disco work. The unit is housed in an attractive two tone metal case and has controls for each channel, and a master on/off. The audio input and output are by 1/2" sockets and three panel mounting fuse holders provide thyristor protection. A four pin plug and socket facilitate ease of connecting lamps. Special price is £14.95 in kit form.

12 volt MOTOR BY SMITHS

Made for use in cars, etc. these are very powerful and easily reversible. Size 3 1/2" long by 3" dia. They have a good length of 1/2" spindle - 1/10 hp £3.45 1/8 hp £5.75 1/6 hp £7.50



25A ELECTRICAL PROGRAMMER

Learn in your sleep. Have radio playing and kettle boiling as you wake - switch on lights to ward off intruders - have a warm house to come home to. You can do all these and more. By a famous maker with 25 amp on/off switch. A beautiful unit at £2.50



THIS MONTH'S SNIP

3" floppy disk drive unit plug in and with all electronics. Japanese made, brand new. We supply data showing how this can be used with the BBC, Spectrum, Amstrad and other popular computers. Special price £2750 Data only £2 refundable if you purchase the drive.

12V Battery Operated Siren (or you can work this off a 2V transformer). Makes a shocking noise, will frighten away any intruder. Japanese made one 50p each, 2 for £1, ref BD106. American, storage soiled but unused and guaranteed perfect, only 20p each, 5 for £1, ref BD221.

Wonderful Breakdown Value - Hand Held Stereo Unit Contains two beautiful miniature moving coil loud speakers. These could also be used as microphones, also contains many other useful parts including mini stereo amp, transistors, condensers, rocker switches etc. To use this as a personal amplifier simply add a stethoset only £1, ref BD29.

Sprt Motor Powerful mains operated induction motor with gearbox attached. Shaft has square hole which gives very easy coupling and quick release if required. Shaft speed 5rpm. Price £5, ref 5P54.

Geared Motor. Very powerful. Has 2 inch stack. Fitted gearbox gives final speed of 60 r.p.m. Should be suitable with motor gearing to operate garage door etc. Mains operated. £4.00 + £1 postage. Ref: 4P15

Nickel Cadmium Rechargeable Battery. D size. High 4 amp power capacity. £2 each. Ref: 23141

20V - 0 - 20V 1A Mains Transformer Upright mounting. Primary thermal cutout to interrupt the supply if transformer overheats. Price £2, ref 2P138.

4 Books for £1. Book 1 describes the Mullard Unilex amplifier and gives details of a suitable cabinet. Book 2 describes several useful pieces of test equipment which could be quite easily constructed. Book 3 is electronic projects. Book 4 describes short wave receivers which can be easily constructed and is intended for mainly beginners. Our ref BD400.

Transformer in Waterproof Metal Case 24V 5A output. Ideal for garden lighting or to operate pond pump etc. Case has cable glands for mains in and low voltage output leads. Price £5 plus £1 post, ref 5P88.

Mains Relay With transparent plastic cover. Could be pcb or clip mounted, has single 8-10A c/o contact. Real bargain 2 for £1, ref BD486.

Panel Meters Engraved vul. approximately 1 3/4" square. Luminare these from behind and you will have a really super looking panel. Real bargain 2 for £1, ref BD366.

POWERFUL IONISER
Generates approx. 10 times more IONS than the ETI and similar circuits. Will refresh your home, office, shop, work room etc. Makes you feel better and work harder - a complete mains operated kit, case included. £9.50 + £2 P&P.

TELEPHONE BITS
Master socket (has surge arrester - nging condenser etc) and takes B.T. plug £3.95
Extension socket £2.95
Dual adaptor (2 from one socket) £3.95
Cord terminating with B.T. plug 3 metres £2.95
Kit for converting old entry terminal box to new B.T. master socket, complete with 4 core cable, cable clips and 2 BT extension sockets £11.50
100 meters 4 core telephone cable £8.50

J & N BULL ELECTRICAL
Dept AR, 250 PORTLAND ROAD, HOVE, BRIGHTON, SUSSEX BN3 5QT
MAIL ORDER TERMS: Cash, P.O. or cheque with order. Orders under £20 add £1 service charge. Monthly account orders accepted from schools and public companies. Access & B-card orders accepted. Brighton 0273 734648 or 203500.

£2 POUNDERS*

- 2P2 - Wall mounting thermostat, high precision with mercury switch and thermometer
- 2P3 - Variable and reversible 8-12v psu for model control
- 2P4 - 24 volt psu with separate channels for stereo
- 2P6 - 100W mains to 115V auto-transformer with voltage tapings
- 2P8 - Mains motor with gear box and variable speed selector. Series wound so suitable for further speed control
- 2P9 - Time and set switch Bonad, glass fronted and with knobs. Controls up to 15 amps. Ideal to program electric heaters
- 2P10 - 12 volt 5 amp mains transformer
- 2P12 - Desk or table precision motor - has balanced rotor and is reversible 230v mains operated 1500 rpm
- 2P14 - Mug Stop kit - when thrown emits piercing squeak
- 2P15 - Interrupted Beam kit for burglar alarms, counters, etc.
- 2P17 - 2 rev pr minute mains driven motor, ideal to operate mirror ball
- 2P18 - Liquid/gas shut off valve mains solenoid operated
- 2P19 - Disco switch-motor drives 8 or more 10 amp change over micro switches supplied ready for mains operation
- 2P20 - 20 metres extension lead, 2 core - ideal most Black and Decker garden tools etc.
- 2P21 - 10 watt amplifier, Mullard module reference 1173
- 2P22 - Motor driven switch 20 secs on or off after push
- 2P26 - Counter resettable mains operated 3 digit
- 2P27 - Goodmans Speaker 6 inch round 8ohm 12 watt
- 2P28 - Drill Pump - always useful couples to any make portable drill
- 2P31 - 4 metres 96 way interconnecting wire easy to strip
- 2P32 - Hot Wire amp meter - 4 1/2 round surface mounting 0-10A - old but working and definitely a bit of history
- 2P34 - Solenoid Air Valve mains operated
- 2P38 - 200 R.P.M. Geared Mains Motor 1" stack quite powerful, definitely large enough to drive a rotating aerial or a tumbler for polishing stones etc.
- 2P43 - Small type blower or extractor fan, motor inset so very compact. 230V
- 2P48 - Our famous drill control kit complete and with prepared case.
- 2P49 - Fire Alarm break glass switch in heavy cast case
- 2P51 - Stereo amplifier, 5w per channel
- 2P55 - Mains motor, extra powerful has 1 1/2" stack and good length of spindle
- 2P62 - 1 pair Goodmans 15 ohm speakers for Unilex
- 2P64 - 1 five bladed fan 6 1/2" with mains motor
- 2P66 - 1 2kw tangential heater 115v easily convertible for 230V
- 2P67 - 1 12v-0-12v 2 amp mains transformer
- 2P68 - 1 15v-0-15v 2 amp mains transformer
- 2P69 - 1 250v-0-250v 60 mA & 86.3v 5A mains transformer + 50p post
- 2P70 - 1 E.M.I. tape motor two speed and reversible
- 2P72 - 1 115v Mullin fan 4" x 4" approx (s.h.)
- 2P82 - 9v-0-9v 2 amp mains transformer
- 2P84 - Modern board with press keys for telephone redialler
- 2P85 - 20v-0-20v 1/4 A Mains transformer
- 2P88 - Sangamo 24 hr time switch 20 amp (s.h.)
- 2P89 - 120 min. time switch with knob
- 2P90 - 90 min. time switch with edgewise engraved controller
- 2P94 - Telephone handset for EE home telephone circuit
- 2P97 - mains transformer 24V 2A upright mounting
- 2P98 - 20m 4 core telephone cable, white outer
- 2P99 - 500 hardened pin type staples for telephone cable
- 2P101 - 15V mains transformer 4A upright mounting
- 2P105 - capillary type thermostat for air temperature with c/o switch
- 2P107 - membrane keyboard, telephone type
- 2P108 - mains motor with gear box giving 110rpm
- 2P109 - 5" wide black adhesive pvc tape 33m, add £1 post if not collecting
- 2P1231 - 25A rotary switch, surface mounting, cover engraved, high, medium, low, off
- 2P1281 - 5A noise filter mains for computer or amplifier
- 2P1341 - 9V 500mA psu, plugs into 13A socket
- 2P1381 - mains transformer 20V-0-20V 1A

OVER 400 GIFTS YOU CAN CHOOSE FROM

There is a total of over 400 packs in our Baker's dozen range and you become entitled to a free gift with each dozen pounds you spend on these packs.



* A classified list of these packs and our latest "News Letter" will be enclosed with your goods, and you will automatically receive our next news letters.

£5 POUNDERS*

- 5P1. 12 volt submersible pump complete with a tap and switch, an ideal caravan unit.
- 5P2. Sound to light kit complete in case suitable for up to 750 watts.
- 5P6. 12V alarm bell with heavy 6" gong, suitable for outside if protected from direct rainfall. Ex GPO but in perfect order.
- 5P12. Equipment cooling fan - mini anal type mains operated.
- 5P13. Ping pong ball blower - or for any job that requires a powerful stream of air - ex computer. Collect or add £2 post.
- 5P15 - Uniselector 4 pole, 25 way 50 volt coil
- 5P18 - motor driven water pump as fitted to many washing machines
- 5P20 - 2 kits, matchbox size, surveillance transmitter and regular size FM receiver
- 5P23 - miniature (appr. 2 1/2" wide) tangential blow heater, 1-2kw
- 5P24 - 1/2 hp motor, ex computer, 230V, mains operation 1450rpm. If not collect add £3 post
- 5P25 - special effects lighting switch. Up to 8 channels of lamps can be on or off for varying time periods
- 5P27 - cartridge player 12V, has high quality stereo amplifier
- 5P34 - 24V 5A toroidal mains transformer
- 5P35 - modem board from telephone auto dialler, complete with keypad and all ICs
- 5P37 - 24 hour time switch, 2 on/off and clockwork reserve, on Elec. Board loading up to 50A. Add £3 post & packing.
- 5P41 - 5" extractor fan, very quiet runner (s.h.), gntd 12 mths.
- 5P45 - pack of 8 cooler clock switches
- 5P48 - telephone extension bell in black case, ex-GPO
- 5P52 - mains transformer 26V 10A upright mounting, add £2 post
- 5P54 - mains motor with gear box, final speed 5rpm
- 5P58 - Amstrad stereo tuner FM and LM and AM
- 5P60 - DC Mullin type fan 18 to 27V, only 3W
- 5P61 - drill pump mounted on frame, coupled to mains motor
- 5P62 - 2 1/2 kw tangential blow heater, add £1.50 post if not collecting
- 5P72 - 1 - turntable, base size appr. 17 1/2 x 9 1/2, suitable for VDU or similar
- 5P81 - 1 - stepping motor, 48 steps 7.5", 10-14V, bi-directional
- 5P86 - 1 - 200W mains transformer with 2 100 1A secondaries
- 5P88 - 1 - 24V 5A mains transformer in waterproof case

LIGHT CHASER KIT motor driven switch bank with connection diagram, used in connection with 4 sets of xmas lights makes a very eye catching display for home, shop or disco, only £5 ref 5P56.



Hello, what's this then? The new Sony Shortwave radio.

Not exactly imposing, is it?

What happened to all the knobs and dials...serried ranks of

valves, throbbing into the night...dirty great drums of copper wire humming away like there's no tomorrow - it hasn't even got a cats whisker!

Oh, well...better have a look at the old instruction book. 'The Sony Computerised World Band Receiver.' There's never a computer in there!

What else has

it got...dual display panel, yes, yes, get on with it...oh, a 15 station memory. Wonder if it remembers where I left me mother-of-pearl cuff-links?

Now then. 'First switch on.' Oh, very droll I'm sure...time for a fag while it warms up...hello, it's going already...

How peculiar. Right, a quick whizz round the dial for a basin full of the old hum and whistle, just to set the mood.

"Good Evening, this is Radio New Zealand."

Get off the line you great Antipodean fool!

I haven't had a good crackle yet.

"Sayonara, and welcome to Japan Today."

Oh, this is hopeless. I ask you. Where's the romance, the adventure? Switch on, tune in and bang, you've got

the Kenyan Top 40, clear as a bell

Where's the fun there?

You can keep your phased loop lock, your crystal clear reception and easy

tuning.

No, no,

no, sorry Sony. Give me a room full of watts, a coat-hanger aerial and a set hot enough to cook your breakfast on. I don't know...oh dear, oh dear...

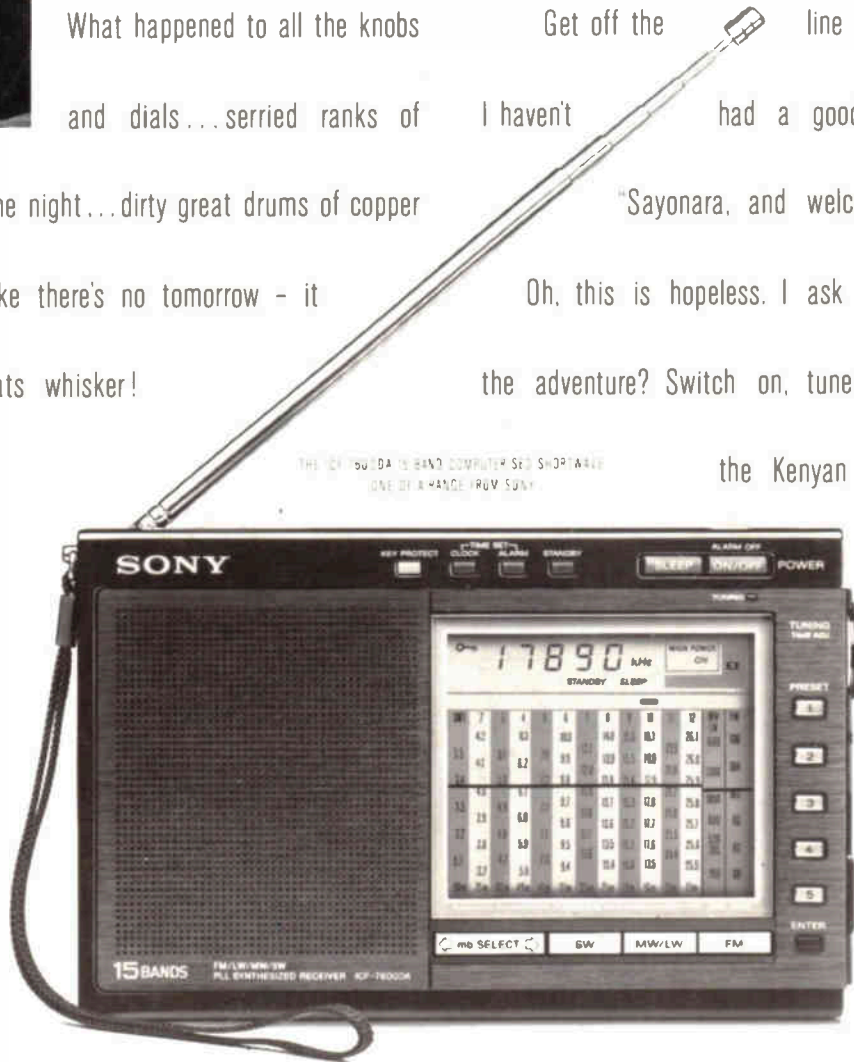

THE NEW SONY SHORTWAVE. NOW ANY RADIO HAM CAN MASTER IT.