

*Amateur*

# RADIO

For all two-way radio enthusiasts

**On test: Yaesu FT73R  
70cm FM handy talky**

**Longleat 1987**

**Cocos Island  
DXpedition**

**Repairing valve  
receivers**

**Yaesu FT767 and  
transverters reviewed**

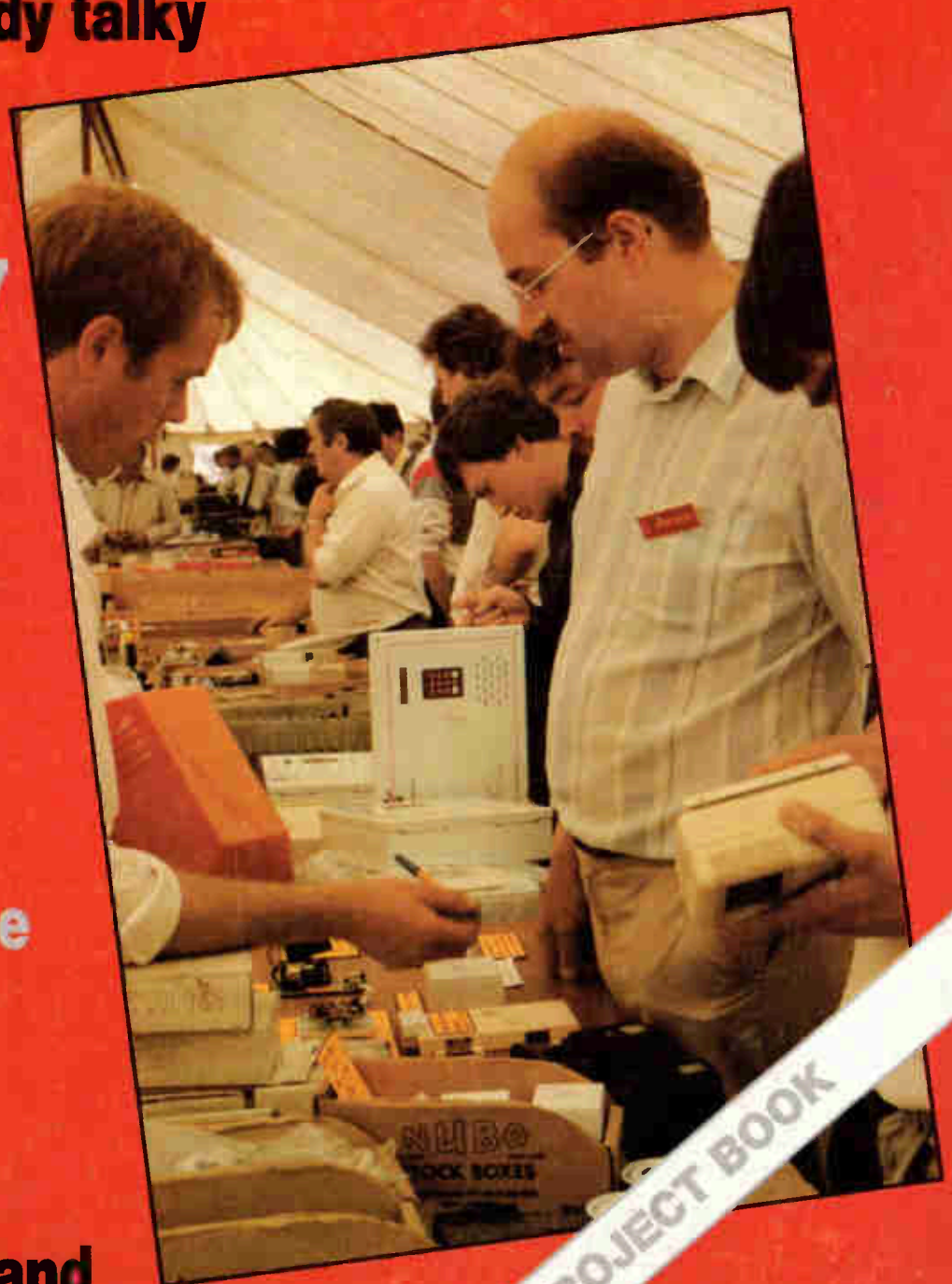

PROJECT BOOK

# R. WITHERS COMMUNICATIONS LTD

Manufacturers, importers and suppliers of world famous communications products

584 HAGLEY ROAD WEST OLDBURY, WARLEY, BIRMINGHAM B68 0BS

021-421 8201/2/3. VODAFONE 0836 504587. PRESTEL MBX 214218216 FAX 0214212468

Amateur Radio. Business Radio. Radio Telephones. Sales. Service Accessories and antenna systems.



YAESU



**THE TECHNICALLY ORIENTATED  
RADIO COMMUNICATIONS  
SPECIALISTS.**

## ...RWC NEWS FLASH!!

**PRICES DOWN** ● — ● Due to better exchange rates ● — ● we can now offer many brands at reduced prices ● ● for a change, prices are coming down — ● — ● this rarely happens ● time to take advantage? ● ● ● Compare our prices — ● ● some amazing reductions on Hand Helds — — — reductions on scanners ● — — popular models at the moment are — ●

FRG9600 Mk 1/2/3 — ● — FT209R — ● — FT23R — ● — FT73R — ● — FT727R — ● — FT767 — ● — FT757 Mk1 — ● —  
All at lower prices than the competition — ● ● ● call now ● ● ● —

### ★ HANDHELD TRANSCEIVERS ★ WE OFFER MORE TO CHOOSE FROM ...

★ = Extended RX available, TX for Export Only

★ KENPRO KT220EE 2MTR 5W LCD H/H .....	£199.00	P/P £10.00
KENPRO KT400EE 70CM 2W H/H .....	£199.00	P/P £10.00
★ CTE 1600 2MTR 3W (SAME AS IC2E) .....	£165.00	P/P £10.00
★ ICOM MICRO 2E 2MTR 2.5W EXT RX .....	£229.00	P/P £10.00
★ ICOM IC28E 25W MOBILE EXT. RX .....	£349.00	P/P £10.00
★ YAESU FT209R 2MTR FNB3 NICAD .....	£199.00	P/P £10.00
YAESU FT290R MK1 2MTR M/MODE .....	£319.00	P/P £10.00
YAESU FT290R MK1 C/W NICADS .....	£339.00	P/P £10.00
YAESU FT290R MK2 2MTR M/MODE .....	£399.00	P/P £10.00
YAESU FT690R MK2 6MTR M/MODE .....	£369.00	P/P £10.00
YAESU FT690R MK2 C/W NICADS .....	£389.00	P/P £10.00
★ FT23R 2MTR HANDHELD FNB10 inc charger .....	£239.00	P/P £10.00
★ FT73R 70CM HANDHELD FNB10 inc charger .....	£249.00	P/P £10.00
FT727R DUAL BAND HANDHELD .....	£385.00	P/P £10.00

### ★ BASE STATIONS ★

YAESU FT26R WITH 2M .....	£799.00	P/P FREE
YAESU FT757GX MK 1 .....	£749.00	P/P FREE
YAESU FT757GX MK 2 .....	£899.00	P/P FREE
ICOM IC275E 2M BASE STATION (Probably the best 2m Base Station available) .....	£899.00	P/P FREE
FT767 Super multi band base station .....	£1390.00	P/P £10.00

FULL RANGE OF MATCHING ACCESSORIES IN STOCK

### ★ SCANNING RECEIVERS ★

WE OFFER THE LARGEST RANGE AND OPTIONS

YAESU FRG9600 MK1 60-905 MHZ .....	£459.00	P/P £10.00
YAESU FRG9600 MK2 60-950 MHZ .....	£499.00	P/P £10.00
YAESU FRG9600 MK3 100 KHZ-950 MHZ .....	£599.00	P/P £10.00

### ★ YAESU FRG9600 MK3 PACKAGE: ★

MK3 Receiver, ICOM AH7000 Super Discone Antenna, PA4C AC Adapter, 1/2 size G5RV. Complete H/F-UHF Broadcast/Amateur/PMR Receiving Station £699.00 inc. carriage. Options: PAL Video Unit (at £27.50, BBC CONTROLLER PROG, £49.50 inc. post. Existing owners please note we offer extended coverage, improved sensitivity, HF mod, see or phone for more details.

### ★ ICOM ICR7000E ★

25-1300MHZ SPECIAL PRICE £862.50 carr. £10.00. ICR7000E with AH7000 antenna at £942.50, carr. £10.00.

**THE WORLD'S BEST KNOWN SCANNERS, DIRECT FROM THE DISTRIBUTORS**

Bearcat Scanners are value for money and the most popular.

### ★ BEARCAT ★

UBC100XL LB/AIR BAND VHF/UHF Handheld .....	£219.00	POST FREE
UBC175XL as above, desk-top FREE DISCONE .....	£209.00	POST FREE
FDK AIR BAND SYNTHESIZED H/H 118-136 MHZ .....	£139.00	POST £3.00
FDK VHF-FM SYNTH. H/HELD 139-174 MHZ .....	£145.00	POST £3.00
REGENCY HX850 AM-FM VHF-UHF H/H SCANNER .....	£235.00	POST £3.00
REGENCY MX7000 AM-FM VHF-UHF D.TOP SCANNER .....	£399.00	POST £5.00

(Coverage the same as the AOR2002)

WE STOCK ALL CURRENTLY AVAILABLE MAKES OF SCANNING RECEIVERS

### ★ SPECIAL MOBILE ANTENNA OFFER ★

SUN KG309SE2 5/8 Ant c/w Moulded SO239 Lead and guttermount assy..... £20.00 inc post

### ★ 6 METERS ★

SPECIAL OFFER for PYE A200 Linear Amplifiers. We have various models available. Tested working with 3 month guarantee. For 4m, 6m and 2m. .5W to 10W input, 10-60W output. All modes, mod kits available for 6m conversion.

Prices range from .....	£39.00	P/P £3.50
6M DIPOLE KIT .....	£9.50	P/P £3.00

**Important.** Please confirm your order before sending payment as we do not wish you to be disappointed if the model you require is sold out or the price has gone up! Special offers are subject to availability. we DO NOT advertise products or models that are NOT normal stock items. The above offers will be sold on a first come first served basis. Please DO NOT DELAY, as with previous offers we always get hundreds of enquiries when the offers are SOLD OUT! Instant Credit available Subject to Status.

Mail Order welcome, you may order by Access, Visa, Diners Club, Amex or CWO for immediate despatch. Please call for further details or brochures. Prices variable and are subject to change without prior notice.

ALL PRICES CORRECT AT TIME OF GOING TO PRESS.

E&OE.

Tel: 021 421 8201 (24hr answerphone)

Telex: 337676 G TELEX-G







PHONE  
0474 60521



# P.M. COMPONENTS LTD

(SELECTRON HOUSE, SPRINGHEAD ENTERPRISE PARK  
GRAVESEND, KENT DA11 8HD)

TELEX  
966371  
TOS PM

## INTEGRATED CIRCUITS

AN124	2.50	MC1351P	1.50	STK433	5.95
AN2140	2.50	MC1352P	1.00	STK435	7.95
AN239	2.50	MC14518BCP	2.30	STK437	7.95
AN240P	2.50	STK39	7.95	STK463	7.95
AN264	2.50	MC1357	2.50	STK461	11.80
AN812	2.15	MC1358	1.95	STK463	11.80
AN362L	2.50	MC14518CP	1.80	TA7061AP	1.80
AN7140	2.50	7.80	TA7108P	1.80	
AN7145	3.05	MC1495	3.00	TA7120P	1.85
AN7145M	3.05	MC1496	1.25	TA7129P	2.50
BA521	3.35	MC145106P	1.80	TA7130P	1.80
CA1352E	1.75	7.95	TA7137P	3.95	
CA3086	0.48	MC1723	2.50	TA7176AP	2.95
CA3123E	1.95	MC3357	2.75	TA7193P	3.95
CA2140T	1.15	MC3401L	2.50	TA7203	2.95
ET16015	2.80	MDP1603	6.00	TA7204P	2.15
HA1339A	2.95	ML2212B	1.75	TC9A90	2.80
HA1366M	2.75	SA1025	7.20	TA7222AP	1.80
HA1377	3.50	SA1560S	7.95	TA7227P	4.25
HA1566W	1.80	MSM5807	8.75	TA7270A	2.50
HA1551	2.95	PLL02A	5.78	TD4444	2.20
LA1230	1.95	SA500A	3.50	TD41001	2.95
LA4102	2.85	SA1025	7.20	TD41002A	2.95
LA4102	2.85	SA1560S	7.95	TD41003A	3.95
LA4031P	1.95	SAS570S	1.75	TD41006A	2.90
LA4420	1.95	SASS580	2.65	TD41010	2.15
LA4430	2.50	SA/SB/T/U	1.00	TD41035	2.50
LA4400	2.50	SL901B	7.95	TD41037	1.95
LA4422	2.50	SL301B	1.80	TD41044	2.15
LA4461	3.50	SL1310	1.10	TCEPP100	2.50
LC7120	3.25	SL1327	1.10	TD41170	1.95
LC7130	3.50	SL1327O	1.10	TD41190	1.95
LC7131	3.50	SN76003N	3.95	TD41270C	3.95
LC7137	5.50	SN76023N	3.95	TD41327	1.70
LM1011	3.15	SN76033N	3.95	TD42002	1.95
LM324N	0.48	SN76110N	0.85	TD42003	2.95
LM3808N	1.80	SN76131N	1.25	TD42020	2.95
LM3808N	1.75	SN76131N	1.25	TD42030	2.80
LM3901	2.95	SN76226DN	2.30	TD42140	3.95
LM3901N	3.50	SN76227N	1.95	TD42151	1.95
M5153L	2.30	SN76533N	1.05	TD42160	2.80
M5155L	2.30	SN76533N	1.05	TD42521	3.25
M51521L	2.50	SN76544N	2.15	TD42522	2.85
MB3712	1.80	SN76650N	1.85	TD42524	1.95
MB3756	2.80	STK014	7.95	TD42530	1.95
MC1307P	1.05	STK015	8.95	TD42532	1.95
MC1310P	1.95	STK025	11.95	TD42539	1.95
MC1327	1.70	STK078	11.95	TD42541	1.95
MC1327O	0.95	STK085	8.95	TD42560	2.15
MC1349P	1.20	STK415	7.95	TD42571	2.95
MC1350P	0.95				

TBA651R	2.50	TD42581	2.95
TBA720A	2.45	TD42582	2.95
TBA750C	2.65	TD42593	2.95
TBA800	0.89	TD42600	0.50
TBA810AS	1.65	TD42610	2.50
TBA810P	1.65	TD42640	3.50
TBA820M	0.75	TD42680A	2.75
TBA820Q	1.45	TD42690	2.45
TBA890	2.50	TD43310	2.95
TBA920	1.65	TD44600	2.50
TBA950/2X	1.80	TD49503	3.15
		TD43560	3.95
TBA990	1.49	TEA1009	1.35
TBA990Q	1.49	UPC566H	2.95
TCA270	1.80	UPC575C2	
TCA270SO		UPC1025H	2.75
		UPC1028H	1.95
		UPC1032H	1.50
		UPC1155H	2.75
		UPC1158H	0.75
		UPC1167C2	1.95
		UPC1181H	1.25
		UPC1182H	2.95
		UPC1185H	3.95
		UPC1191V	1.50
		UPC1350C	2.95
		UPC1353C	2.45
		UPC1365H	3.95
		555	0.35
		556	0.80
		723	0.35
		741	0.35
		747	0.50
		748	0.35
		7808	0.80
		7805	0.85
		7812	0.65
		7815	0.65

## NEW BRANDED CATHODE RAY TUBES - Please allow additional £3 per tube for carriage

A1865/20	65.00	D14-173GR	68.00	M19-103W	68.00	M50-126GV	68.00
AW36 11	25.00	D14-181GM/98	68.00	M20-110GH	68.00	M50-120LC	68.00
CME222GH	19.00	D14-181GJ	68.00	M23-112GM	68.00	S6AB	45.00
CME1428GH	45.00	D14-181GM	68.00	M23-112GV	68.00	SE4/D-P7	45.00
CME1428W	39.00	D14-181GM50	68.00	M23-112GK	68.00	SE42BP3IAL	55.00
CME1523W	39.00	D14-182GH	68.00	M23-112KA	68.00	SE42BP31AL	55.00
CME1431GH	39.00	D14-200BE	68.00	M23-112L	68.00	SE5Fp31	65.00
CME1431W	39.00	D14-200GA/50	68.00	M24-120GM	68.00	T948N	65.00
CME202GH	45.00	D14-210GH	75.00	M24-120L	68.00	T948H	65.00
CME2024W	45.00	D14-210GH/50	75.00	M24-120HAR	68.00	V4150LC	55.00
CME2325W	45.00	D14-310W	110.00	M28-120H	68.00	V5004GR	59.00
CME3128W	45.00	D14-320GH/82	68.00	M28-13LC	68.00	V5004LD	59.00
CME3132GH	45.00	D14-340GH/KM	68.00	M28-13GR	68.00	V6001GH	55.00
CME3155W	45.00	D14-340KA	68.00	M28-13GR	68.00	VH07DP31	59.00
CRE1400	25.00	D16-100GH/65	68.00	M28-13IGR	68.00	V6008GH	59.00
CV1450	35.00	D16-100GH/79	68.00	M28-13IGR	68.00	V6034WA	59.00
CV1526	19.00	D16-100GH/82	68.00	M31-101GH	55.00	V604CLA	59.00
CV2185	15.00	D16-100GH/97	68.00	M31-182GR	55.00	V6048U	48.00
CV2191	19.00	D16-100GH/97	68.00	M31-182GV	55.00	V6052GR	55.00
CV2193	39.00	D18-160GH	68.00	M31-184W	65.00	V6064BP31	55.00
CV5119	65.00	D21-10GH	65.00	M31-184GH	65.00	V6064CLA	55.00
CV5320	65.00	DB7 36	35.00	M31-184P31	65.00	V6069GH	55.00
CVX389	55.00	DB7 36	35.00	M31-186W	65.00	V6070P31	49.00
D9-110GH	39.00	DG7 32	35.00	M31-190GH	55.00	V7016A	65.00
D10-210GH	45.00	DG7 32	35.00	M31-190GR	55.00	V7030	59.00
D10-210GH/65B	68.00	DH3 91	55.00	M31-190LA	55.00	V7031GH	59.00
D10-230GH	65.00	DH3 91	55.00	M31-191GH	55.00	V7031P67A	59.00
D10-230GM	35.00	DP7 5	35.00	M31-191W	45.00	V7035A	49.00
D10/293GV/90	55.00	DP7 6	35.00	M31-220W	59.00	V7037GH	45.00
D13-30GH	49.00	D13-30GH	49.00	M31-270GV	65.00	V8004GR	65.00
D13-47GH/26	68.00	F16-101GM	75.00	M31-271P31	65.00	V8006GH	65.00
D13-47GH	68.00	F16-101LD	75.00	M31-271W	65.00	V8010A	65.00
D13-51GL/26	65.00	F21-130GR	75.00	M31-271W	65.00	2BP1	13.50
D13-51GM/26	65.00	F21-130LC	75.00	M36-141W	75.00	3BP1	11.50
D13-450GM/01	55.00	F31-10GM	75.00	M36-170LG	75.00	3DP1	11.80
D13-471GH/26	55.00	F31-10GR	75.00	M38-103GR	65.00	4EP1	11.50
D13-510GH	59.00	M38-120W	75.00	M38-120W	75.00	3H/OBM	55.00
D13-511GH	59.00	F31-10LD	75.00	M38-120WA	75.00	3WP1	18.50
D13-630GH	59.00	F31-12LD	75.00	M38-121GHR	65.00	5BP1	9.00
D14-150GH	75.00	F31-13LD	75.00	M38-121LA	75.00	5BHP1	30.00
D14-172GH/84	59.00	M14-100LC	185.00	M38-122GW	65.00	5BHP1FF	30.00
D14-172GR	55.00	F41-123LC	185.00	M38-142LA	65.00	5BHP2	10.00
D14-172GV	55.00	F41-141LG	185.00	M38-341P31	65.00	6EP7.5	39.00
D14-172V	55.00	F41-142LC	185.00	M38-344P31	65.00	12CSP4	45.00
D14-173GM	53.00	M47-120W	59.00	M40-120W	59.00	13BP1	13.50
		M14-100GM	45.00	M43-12L/G/01	65.00	13BP4	17.80
		M14-100LC	45.00	M44-120LC	65.00	17DWP4	17.80
		M17-151GVR	175.00	M50-120GH	65.00	32U/1085	68.00
		M17-151GR	175.00	M50-120GR	65.00	1273	39.00
						1564	39.00
						55451GM	75.00
						9442E1	80.00
						95447GM	75.00
						95449	75.00
						7709631	79.50

## SEMICONDUCTORS

AA112	0.25	BC208B	0.13	BD520	0.68	BR103	0.55	TIP30C	0.43
AC126	0.45	BC212	0.09	BD538	0.68	BR303	0.95	TIP31C	0.95
AC127	0.20	BC212L	0.09	BD597	0.95	BRC4443	1.15	TIP32C	0.42
AC128	0.28	BC213	0.09	BD701	1.25	BRV39	0.45	TIP33C	0.95
AC128K	0.32	BC213L	0.09	BD702	1.25	BT100A/02	0.85	TIP34B	0.95
AC141	0.28	BC214	0.09	BD707	0.90	BT106	1.40	TIP41A	0.45
AC141K	0.36	BC214C	0.09	BDX32	1.80	BT116	1.20	TIP41C	0.45
AC142K	0.45	BC214L	0.09	BF115	0.35	BT120	1.85	TIP42C	0.47
AC176	0.48	BC237B	0.09	BF119	0.85	BU105	1.05	TIP47	0.85
AC187	0.25	BC238	0.09	BF127	0.39	BU108	1.89	TIP120	0.80
AC187K	0.28	BC239	0.12	BF154	0.39	BU124	1.25	TIP142	1.75
AC188	0.28	BC251A	0.15	BF158	0.39	BU125	1.25	TIP146	2.75
AC188K	0.37	BC252A	0.15	BF160	0.27	BU126	1.89	TIP161	2.95
AD149	0.70	BC258	0.25	BF167	0.27	BU204	1.59	TIP295S	0.80
AD161	0.39	BC258A	0.39	BF173	0.22	BU205	1.30	TIP305S	0.55
AD162	0.39	BC284	0.30	BF177	0.38	BU208	1.39	TIP305S	0.55
AD161/2	0.90	BC300	0.30	BF178	0.28	BU208A	1.52	TIP391	1.20
AF106	0.50	BC301	0.30	BF179	0.34	BU208D	1.85	ZFR0112	18.50
AF114	1.95	BC303	0.28	BF180	0.29	BU326	1.20	2N1100	0.50
AF121	0.50	BC307B	0.09	BF182	0.29	BU326S	1.50	2N1308	1.35
AF124	0.65	BC327	0.10	BF182	0.29	BU407	1.24	2N1711	0.30
AF125	0.65	BC328	0.10	BF183	0.29	BU500	2.25	2N1919	0.28
AF126	0.65	BC337	0.10	BF184	0.28	BU508A	1.95	2N2905	0.40
AF127	0.65	BC338	0.09	BF185	0.28	BU526	1.90	2N3053	0.40
AF139	0.40	BC347A	0.13	BF194	0.11	BUY20	2.15	2N3054	0.59
AF150	0.80	BC461	0.35	BF195	0.11	BUY29	1.30	2N3072	0.12
AF178	1.95	BC52	0.20	BF197	0				



**PHONE**  
0474 60521  
3 LINES

**P.M. COMPONENTS LTD**  
**SELECTRON HOUSE**  
**SPRINGHEAD ENTERPRISE PARK, SPRINGHEAD ROAD**  
**GRAVESEND, KENT DA 11 8HD**

**TELEX**  
966371  
**TOS PM**



**A SELECTION FROM OUR STOCK OF BRANDED VALVES**

A1714 24.80	EBC41 1.05	EL95 1.75	M8163 5.50	QOV03-20A 1.00	U191 0.70	2A151A 11.50	6A17 2.00	6GK6 1.95	12BA6 1.50	431U 4.50
A1996 11.80	EBC41 1.80	EL153 12.18	M8190 4.50	QOV03-20B 32.00	U192 1.00	2B22 69.50	6AK5 1.95	6GM6 0.95	12BH7A 2.85	572B 55.00
A2087 11.80	EBC90 0.90	EL183E 3.80	M8195 6.80	QOV06-40A 27.50	U251 1.00	2C38A 32.50	6AK6 2.50	6GS7 2.15	12BH7A 2.30	6146A 7.50
A2134 14.95	EBC91 0.90	EL183P 3.80	M8196 5.80	QOV07-50 65.00	U251 0.75	2C38BA 39.50	6AL5 0.50	6GV7 2.50	12BL6 1.75	6146B 3.20
A2293 6.80	EBF0 0.85	EL504 1.95	M8204 5.50	QOV07-50 65.00	U801 0.85	2C42 29.50	6AM4 3.28	6GW8 0.85	12BY7A 2.75	6386 14.50
A2426 35.00	EBF80 0.85	EL504 1.95	M8223 4.50	QOV07-50 65.00	U801 0.85	2C51 0.75	6AM5 6.00	6H3N 2.50	12CA5 1.95	6883B 9.95
A2599 37.80	EBF83 0.85	EL509 5.28	M8225 4.50	QOV07-50 65.00	U801 0.85	2C51 0.75	6AM6 1.95	6H6 1.95	12CX6 1.95	6973 5.95
A2792 27.50	EBF89 0.70	EL509 5.28	M8225 4.50	QOV07-50 65.00	U801 0.85	2C51 0.75	6AM6 1.95	6H6 1.95	12D06B 3.50	705A 8.00
A2939 37.80	EBF89 0.70	EL509 5.28	M8225 4.50	QOV07-50 65.00	U801 0.85	2C51 0.75	6AM6 1.95	6H6 1.95	12D06B 3.50	725A 275.00
A2990 11.50	EBF93 0.95	EL802 3.65	ME1401 29.80	QOV07-50 65.00	U801 0.85	2C51 0.75	6AM6 1.95	6H6 1.95	12D06B 3.50	7527 89.50
A3042 24.00	EBL1 2.80	EL821 6.90	ME1402 29.80	QOV07-50 65.00	U801 0.85	2C51 0.75	6AM6 1.95	6H6 1.95	12D06B 3.50	7703 395.00
A3283 24.00	EBL21 2.00	EL822 12.95	ME1501 14.00	QOV07-50 65.00	U801 0.85	2C51 0.75	6AM6 1.95	6H6 1.95	12D06B 3.50	803 14.95
AC/TH1 4.00	EC52 0.75	EL880 22.50	MH4 3.50	QOV07-50 65.00	U801 0.85	2C51 0.75	6AM6 1.95	6H6 1.95	12D06B 3.50	805 39.00
ACT72 59.78	EC70 1.75	EM80 0.70	MHL D5 4.00	QOV07-50 65.00	U801 0.85	2C51 0.75	6AM6 1.95	6H6 1.95	12D06B 3.50	807 2.90
AC/SP/2EN	EC80 0.90	EM81 0.70	M54B 5.80	QOV07-50 65.00	U801 0.85	2C51 0.75	6AM6 1.95	6H6 1.95	12D06B 3.50	810 85.00
AC/SP/2EN	EC81 1.05	EM85 3.95	MU14 3.50	QOV07-50 65.00	U801 0.85	2C51 0.75	6AM6 1.95	6H6 1.95	12D06B 3.50	813 27.50
AC/SP/2EN	EC86 7.95	EM85 3.95	N7 12.85	QOV07-50 65.00	U801 0.85	2C51 0.75	6AM6 1.95	6H6 1.95	12D06B 3.50	813 Philips 35.00
AH221 39.00	EC86 1.00	EM85 3.95	N7 12.85	QOV07-50 65.00	U801 0.85	2C51 0.75	6AM6 1.95	6H6 1.95	12D06B 3.50	829B 14.50
AH238 39.00	EC86 1.00	EM85 3.95	N7 12.85	QOV07-50 65.00	U801 0.85	2C51 0.75	6AM6 1.95	6H6 1.95	12D06B 3.50	832A 14.50
AL60 0.80	EC90 1.10	EN32 16.80	N37 9.50	QOV07-50 65.00	U801 0.85	2C51 0.75	6AM6 1.95	6H6 1.95	12D06B 3.50	833A 95.00
AN1 14.00	EC91 5.50	EN91 1.65	OA2 1.15	QOV07-50 65.00	U801 0.85	2C51 0.75	6AM6 1.95	6H6 1.95	12D06B 3.50	866A 2.00
ARF2 0.70	EC92 1.95	EN92 4.50	OA3 2.80	QOV07-50 65.00	U801 0.85	2C51 0.75	6AM6 1.95	6H6 1.95	12D06B 3.50	872A 20.00
ARF24 1.25	EC93 1.95	EN92 4.50	OA3 2.80	QOV07-50 65.00	U801 0.85	2C51 0.75	6AM6 1.95	6H6 1.95	12D06B 3.50	883 60.00
ARF35 2.00	EC95 7.00	ESU872 28.00	OB2 1.15	QOV07-50 65.00	U801 0.85	2C51 0.75	6AM6 1.95	6H6 1.95	12D06B 3.50	884 5.80
AZ11 4.50	EC97 1.10	EY51 0.60	OB2WA 2.50	QOV07-50 65.00	U801 0.85	2C51 0.75	6AM6 1.95	6H6 1.95	12D06B 3.50	892 15.00
BL63 2.00	EC8010 12.00	EY81 2.35	OC2 2.80	QOV07-50 65.00	U801 0.85	2C51 0.75	6AM6 1.95	6H6 1.95	12D06B 3.50	927 3.20
BS450 67.00	ECC32 3.50	EY83 1.95	OC3 1.70	QOV07-50 65.00	U801 0.85	2C51 0.75	6AM6 1.95	6H6 1.95	12D06B 3.50	931A 17.50
BS810 58.00	ECC33 3.80	EY84 5.80	OC3 1.70	QOV07-50 65.00	U801 0.85	2C51 0.75	6AM6 1.95	6H6 1.95	12D06B 3.50	954 1.00
BS814 55.00	ECC35 3.80	EY86/87 0.80	OC4 1.00	QOV07-50 65.00	U801 0.85	2C51 0.75	6AM6 1.95	6H6 1.95	12D06B 3.50	958A 1.00
CIK 27.00	ECC81 1.80	EY88 0.85	OM4 1.00	QOV07-50 65.00	U801 0.85	2C51 0.75	6AM6 1.95	6H6 1.95	12D06B 3.50	1299A 0.80
C3JA 20.00	ECC81 Special 1.95	EY91 5.50	OM5B 3.00	QOV07-50 65.00	U801 0.85	2C51 0.75	6AM6 1.95	6H6 1.95	12D06B 3.50	1619 2.50
C6A 20.00	quality 1.95	EY500A 1.50	ORP43 2.70	QOV07-50 65.00	U801 0.85	2C51 0.75	6AM6 1.95	6H6 1.95	12D06B 3.50	1625 3.00
C1112G 70.00	ECC82 0.85	EY802 0.70	ORP43 2.70	QOV07-50 65.00	U801 0.85	2C51 0.75	6AM6 1.95	6H6 1.95	12D06B 3.50	1626 3.00
C1108 75.00	ECC82 Mul- 1.80	EY802 0.70	ORP43 2.70	QOV07-50 65.00	U801 0.85	2C51 0.75	6AM6 1.95	6H6 1.95	12D06B 3.50	1627 25.00
C1134 32.00	ECC82 1.80	EY802 0.70	ORP43 2.70	QOV07-50 65.00	U801 0.85	2C51 0.75	6AM6 1.95	6H6 1.95	12D06B 3.50	1628 25.00
C1148A 115.00	ECC82 1.80	EY802 0.70	ORP43 2.70	QOV07-50 65.00	U801 0.85	2C51 0.75	6AM6 1.95	6H6 1.95	12D06B 3.50	1629 25.00
C1150/1 135.00	Philips 1.95	EY802 0.70	ORP43 2.70	QOV07-50 65.00	U801 0.85	2C51 0.75	6AM6 1.95	6H6 1.95	12D06B 3.50	1630 25.00
C1534 32.00	ECC83 0.85	EY802 0.70	ORP43 2.70	QOV07-50 65.00	U801 0.85	2C51 0.75	6AM6 1.95	6H6 1.95	12D06B 3.50	1631 25.00
CCA 2.80	Philips 1.95	F6064 2.95	PC800 1.10	QOV07-50 65.00	U801 0.85	2C51 0.75	6AM6 1.95	6H6 1.95	12D06B 3.50	1632 25.00
CC30 2.80	ECC83 0.85	G104/800 2.95	PC800 1.10	QOV07-50 65.00	U801 0.85	2C51 0.75	6AM6 1.95	6H6 1.95	12D06B 3.50	1633 25.00
CL33 2.80	Philips 1.95	G55/K 4.00	PC900 1.25	QOV07-50 65.00	U801 0.85	2C51 0.75	6AM6 1.95	6H6 1.95	12D06B 3.50	1634 25.00
CV Nos Prices on request	ECC84 0.75	G180/2M 6.95	PC900 1.25	QOV07-50 65.00	U801 0.85	2C51 0.75	6AM6 1.95	6H6 1.95	12D06B 3.50	1635 25.00
D3a 29.80	ECC85 0.75	G232 Mullard 3.95	PC900 1.25	QOV07-50 65.00	U801 0.85	2C51 0.75	6AM6 1.95	6H6 1.95	12D06B 3.50	1636 25.00
D83 1.20	ECC86 2.75	G240/2D 9.00	PC900 1.25	QOV07-50 65.00	U801 0.85	2C51 0.75	6AM6 1.95	6H6 1.95	12D06B 3.50	1637 25.00
D2411 22.00	ECC86 2.75	G240/2D 9.00	PC900 1.25	QOV07-50 65.00	U801 0.85	2C51 0.75	6AM6 1.95	6H6 1.95	12D06B 3.50	1638 25.00
DA42 17.50	ECC87 0.95	G240/2D 9.00	PC900 1.25	QOV07-50 65.00	U801 0.85	2C51 0.75	6AM6 1.95	6H6 1.95	12D06B 3.50	1639 25.00
DA80 4.80	ECC88 1.95	G240/2D 9.00	PC900 1.25	QOV07-50 65.00	U801 0.85	2C51 0.75	6AM6 1.95	6H6 1.95	12D06B 3.50	1640 25.00
DA100 125.00	ECC89 0.95	G240/2D 9.00	PC900 1.25	QOV07-50 65.00	U801 0.85	2C51 0.75	6AM6 1.95	6H6 1.95	12D06B 3.50	1641 25.00
DAF91 0.45	ECC90 1.95	G240/2D 9.00	PC900 1.25	QOV07-50 65.00	U801 0.85	2C51 0.75	6AM6 1.95	6H6 1.95	12D06B 3.50	1642 25.00
DAF91 0.70	ECC90 1.95	G240/2D 9.00	PC900 1.25	QOV07-50 65.00	U801 0.85	2C51 0.75	6AM6 1.95	6H6 1.95	12D06B 3.50	1643 25.00
DAF96 25.00	ECC90 1.95	G240/2D 9.00	PC900 1.25	QOV07-50 65.00	U801 0.85	2C51 0.75	6AM6 1.95	6H6 1.95	12D06B 3.50	1644 25.00
DC70 1.78	ECC90 1.95	G240/2D 9.00	PC900 1.25	QOV07-50 65.00	U801 0.85	2C51 0.75	6AM6 1.95	6H6 1.95	12D06B 3.50	1645 25.00
DC90 1.20	ECC90 1.95	G240/2D 9.00	PC900 1.25	QOV07-50 65.00	U801 0.85	2C51 0.75	6AM6 1.95	6H6 1.95	12D06B 3.50	1646 25.00
DCX4-1000 12.00	ECC90 1.95	G240/2D 9.00	PC900 1.25	QOV07-50 65.00	U801 0.85	2C51 0.75	6AM6 1.95	6H6 1.95	12D06B 3.50	1647 25.00
DCX4-5000 12.00	ECC90 1.95	G240/2D 9.00	PC900 1.25	QOV07-50 65.00	U801 0.85	2C51 0.75	6AM6 1.95	6H6 1.95	12D06B 3.50	1648 25.00
DET16 28.50	ECC90 1.95	G240/2D 9.00	PC900 1.25	QOV07-50 65.00	U801 0.85	2C51 0.75	6AM6 1.95	6H6 1.95	12D06B 3.50	1649 25.00
DET18 28.50	ECC90 1.95	G240/2D 9.00	PC900 1.25	QOV07-50 65.00	U801 0.85	2C51 0.75	6AM6 1.95	6H6 1.95	12D06B 3.50	1650 25.00
DET23 35.00	ECC90 1.95	G240/2D 9.00	PC900 1.25	QOV07-50 65.00	U801 0.85	2C51 0.75	6AM6 1.95	6H6 1.95	12D06B 3.50	1651 25.00
DET24 35.00	ECC90 1.95	G240/2D 9.00	PC900 1.25	QOV07-50 65.00	U801 0.85	2C51 0.75	6AM6 1.95	6H6 1.95	12D06B 3.50	1652 25.00
DET25 22.00	ECC90 1.95	G240/2D 9.00	PC900 1.25	QOV07-50 65.00	U801 0.85	2C51 0.75	6AM6 1.95	6H6 1.95	12D06B 3.50	1653 25.00
DF1 1.00	ECC90 1.95	G240/2D 9.00	PC900 1.25	QOV07-50 65.00	U801 0.85	2C51 0.75	6AM6 1.95	6H6 1.95	12D06B 3.50	1654 25.00
DF2 0.80	ECC90 1.95	G240/2D 9.00	PC900 1.25	QOV07-50 65.00	U801 0.85	2C51 0.75	6AM6 1.95	6H6 1.95	12D06B 3.50	1655 25.00
DF6 1.28	ECC90 1.95	G240/2D 9.00	PC900 1.25	QOV07-50 65.00	U801 0.85	2C51 0.75	6AM6 1.95	6H6 1.95	12D06B 3.50	1656 25.00
DF7 1.25	ECC90 1.95	G240/2D 9.00	PC900 1.25	QOV07-50 65.00	U801 0.85	2C51 0.75	6AM6 1.95	6H6 1.95	12D06B 3.50	1657 25.00
DH63 1.20	ECC90 1.95	G240/2D 9.00	PC900 1.25	QOV07-50 65.00	U801 0.85	2C51 0.75	6AM6 1.95	6H6 1.95	12D06B 3.50	1658 25.00
DH77 0.80	ECC90 1.95	G240/2D 9.00	PC900 1.25	QOV07-50 65.00	U801 0.85	2C51 0.75	6AM6 1.95	6H6 1.95	12D06B 3.50	1659 25.00
DF79 0.80	ECC90 1.95	G240/2D 9.00	PC900 1.25	QOV07-50 65.00	U801 0.85	2C51 0.75	6AM6 1.95	6H6 1.95	12D06B 3.50	1660 25.00
DM149 2.00	ECC90 1.95	G240/2D 9.00	PC900 1.25	QOV07-50 65.00	U801 0.85	2C51 0.75	6AM6 1.95	6H6 1.95	12D06B 3.50	1661 25.00
DK91 1.20	ECC90 1.95	G240/2D 9.00	PC900 1.25	QOV07						

# STRAIGHT & LEVEL



## SONY RANGE

Sony's impressive range of short wave receivers has been boosted by the introduction of three new models.

At the top of the new range is the ICF PRO80 - styled like a walkie-talkie and complementary to the Sony AIR 7, the PRO80 includes most of the facilities of the well known ICF2001D.

The ICF PRO80 offers 115kHz - 223MHz continuous coverage, 40 memories, 10 key tuning and six way scan tuning. It also has an auto/manual squelch control. The retail price is £349.95 including VAT.

The ICF7600DA is a 15 band

receiver, FM/MW/LW/SW x 12, with LCD frequency read-outs, dial pointer and band indicator, and 15 station presets. It also has a clock and timer. The ICF7600DA is a sister to the popular ICF7600D but offering the option of analog tuning for those who prefer a dial. The retail price is £159.95 including VAT.

The WA8800 is a multipurpose short wave radio cassette with a 10 band tuner (FM/MW, 8 x SW), with auto reverse stereo cassette deck, LCD alarm clock and two built-in speakers. The WA8800 will be available from September and will cost £199.95 including VAT.

For further information contact: *Sony UK Ltd, Sony House, South Street, Staines, Middlesex. Tel: (0784) 67371.*

## PCB WORKSTATION

Mega Electronics Ltd announce the introduction of a comprehensive but low-cost system for the prototyping of printed circuit boards.

This new system, which is introduced as the SENO Workstation, represents a totally new and unique concept: it is the ultimate in simplicity, yet embodies all of the components required for the design and production of high-quality printed circuit boards. Moreover, it utilises chemicals which are completely safe, and which may be disposed of by conventional means.

Priced at only £45, the SENO Workstation contains every essential element for PCB prototyping. It includes: artwork materials, for PCB design and circuit layout; PCB laminate materials; cleaning block; spraywash facilities, which obviate the need for mains water; an environmentally-safe board etching system; and chemicals which are contained in unique, simple to use disposable applicators.

Moreover, the chemicals are themselves non-hazardous and non-toxic, and do not require special disposal procedures or precautions.

The applicators have been especially developed to simplify the use of these chemicals and to remove problems associated with their disposal.

The SENO Workstation is packaged in an enclosed tray designed to conform with industry standard racking systems, for easy storage. Together with its ribbed cover, the tray provides an effective, economical and convenient substitute for the processing and spray wash tanks conventionally used in the PCB production environment. Options include chemicals for the application of tin, silver or nickel to the PCB tracks, and all the necessary materials for label making.

Combining non-toxicity with simplicity and low-cost, the SENO Workstation represents the most economical means of producing prototype PCBs, enabling the creation of high-quality printed circuit boards at extremely low cost. Typically, a 6 x 4 in. board would cost only 36p to produce. Its UK introduction follows the conclusion of a marketing agreement with the German company ITC Kapets KG, under the terms of which Mega have been appointed sole UK agency for the SENO range of PCB processing chemicals.

For further information contact: *Mega Electronics Ltd, 9 Radwinter Road, Saffron Waldon, Essex CB11 3HU. Tel: (0799) 21918.*

## 6 or 4m TRANSVERTERS

Noddfa have brought out two new transverters which are suitable for converting the FT290, or similar two metre rig with 1/2 watt RF output, to 6 or 4 metre 2.5 watt low harmonic output and low noise RF protected receiver circuitry. All loose RF coil cores have been locked in position to prevent vibration during mobile operation from de-tuning the transverter.

The prototype has been tested by submerging it for 48 hours in a fish-pond without any leakage past the watertight seal. Consequently, it



# All the latest news, views, comment and developments on the amateur radio scene

could be used outside quite safely if desired. Unlike traditional mounting techniques that involve passing screws through the printed circuit board, which in the case of impact could shatter the board, the Noddfa transverter features a unique impact absorbing buffer system which spreads the load over the entire side of the PCB. This means that there is a far greater resistance to impact damage than conventional ham gear.

Like 'Black Boxes' in the aviation industry which always survive a crash, Naddfa believe that their equipment should withstand the worst possible treatment that radio amateurs could put it through. Should a unit malfunction after being blown from a top of an aerial mast in a gale, Naddfa will be pleased to replace it free of charge.

The transverter is expected to sell at around £200, and include an RF filtered power supply.

Further information can be obtained from Naddfa, on receipt of an SAE, from: Lower Road, Harlech, Gwynedd LL46 2UB.

## MARCO EXPANSION

Waltons, of 55a Worcester Street, Wolverhampton, a retail Electronics outlet owned by the Dennes family since 1947, has been purchased by Marco Trading of Wem, Shropshire.

Marco, established since 1972, have made this acquisition to further its retail operation. They already have a retail outlet in Wem, but are perhaps better known for their mail order business which has an illustrated catalogue of over 100 pages covering some 6,000 lines.

Marco also have a wholesale division offering a service to manufacturers etc, together with an export/import section with many world-wide contacts.

The photograph shows, from left to right, Mr Jack

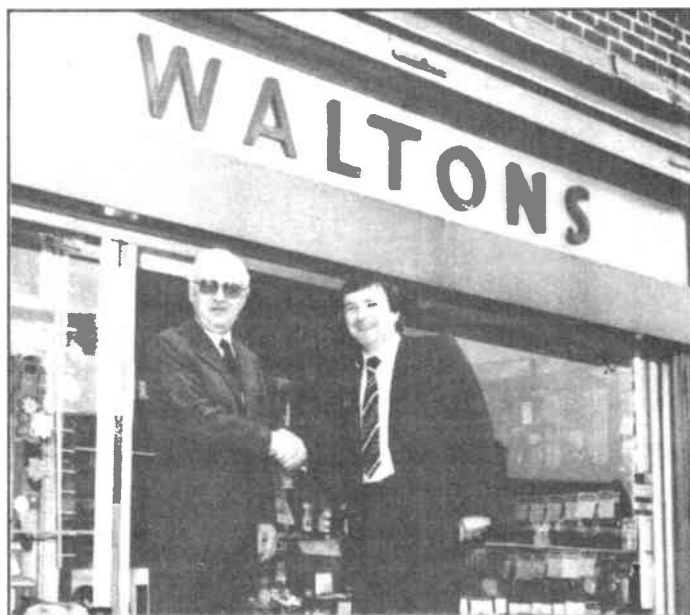

Dennes (retiring proprietor) and Mr Martin Cox (Marco Director).

For further information contact: Marco Trading, The Maltings, High Street, Wem, Shropshire SY4 5EN. Tel: (0939) 32763.

contact: South Midlands Communications Ltd, SM House, School Close, Chandlers Ford Industrial Estate, Eastleigh, Hampshire SO5 3BY. Tel: (0703) 255111

## TAPING ROYALTY

A home taping royalty of 10% will be added to the price of blank audio tapes as part of a new copyright law, the United Kingdom announced yesterday. The proceeds of the royalty will be distributed to the performers, composers and producers of sound recordings. The new legislation will be introduced during the 1987-88 session of Parliament.

Commenting on the move, Ian Thomas, IFPI's Director General said: 'As the international organisation of the recording industry, IFPI welcomes the British government's firm commitment to copyright reform, and in particular its proposal to deal with the home taping problems.

Although a royalty does not represent a totally satisfactory solution to the problem of private copying, such a move will bring the United Kingdom into line with the majority of its EEC partners. Three member states (France, Germany, Portugal) already have such a royalty.'

## SMC MERGER

From the 1st July, Amateur Electronics and South Midlands Communications are amalgamating. With the combined talents, expertise and stocks of both companies it is expected that their range of equipment and service should be enhanced. The merged group will trade with the title South Midlands Communications Ltd and the shop in Birmingham at Alum Rock Road will trade under the name SMC Birmingham.

SMC will now be the sole UK distributor for the Yaesu range of products, and will have a vast range of spares to cater for both guarantee work and repairs. They will also be supplying the Yaesu products to all authorised Yaesu dealers. Any Yaesu equipment sold retail with foreign or photocopied manuals or with different type numbers, ie, FRG965 in place of FRG9600, will not have the support of spares and back up of the SMC Group.

For further information



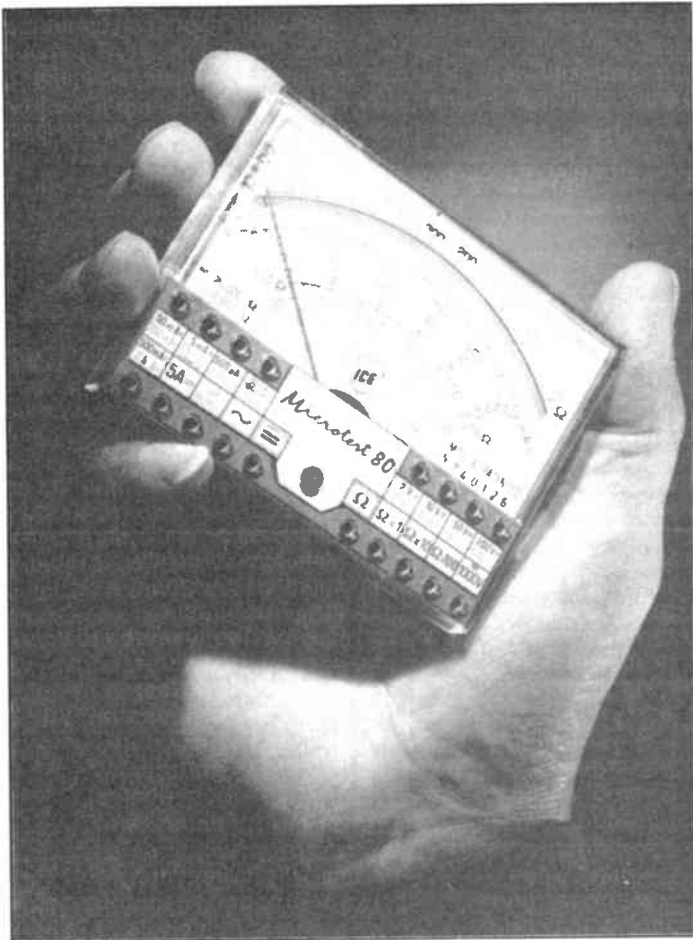

## ITALIAN MULTIMETERS

Available exclusively in the UK from Electronic Brokers is a range of multimeters and accessories from ICE, one of Italy's foremost manufacturers of electronic instruments.

The ICE family is a compact range of competitively priced instruments with the capability to measure an extremely wide spectrum of electrical parameters to a high degree of accuracy, but with none of the drawbacks found in other low-cost units.

The three types of multimeter – the 680R, the 680G and the Microtest 80 – share many features in common. All units offer: a compact and lightweight body in a solid, robust case; a wide range of measurement capabilities with high sensitivity and high accuracy; superior direct contact range switching mechanism; and a large mirror scale meter.

All three models are fully protected against overload with fuse, are temperature compensated and are fully screened against magnetic fields. They all have low servicing costs, and are sold with a 12 month warranty backed up by an after sales

service.

They differ in that the M80 offers 40 measuring ranges, the 680G has 48 measuring ranges and the 680R has 80. All three offer sensitivity of 20k $\Omega$ /V, but whereas with the 680G and M80 the dc accuracy is 2%, with the 680R it is 1%.

At present Electronic Brokers is the exclusive UK stockist of the ICE range of analogue multimeters, although it is seeking further distributors.

For further information contact: *Electronic Brokers Limited, 140-146 Camden Street, London NW1 9PB.*

## CHANGE OF ADDRESS

Due to the continued expansion of C M Howes' product range, they have run out of space at their present location. Consequently, they are relocating the business in new, larger premises.

As from the 26th June 1987 their address will be: *C M Howes Communications, Eydon, Daventry, Northants NN11 6PT. Tel: (0327) 60178.*

Mail sent to their old address after this date will still reach them, as it will be redirected.

## READING UP...

Newnes *Radio and Electronics Engineer's Pocket Book*, by Keith Brindley, is an invaluable compendium of facts figures and formulae, the author's main criterion being to include information he personally finds himself having to look up. He has therefore included anything of relevance to radio and electronics referred to in literature.

A considerable amount of new material relating to recent developments in radio and electronics has been added, including new sections on batteries, cables and connectors. All the broadcasting information has also been updated.

In an endeavor to include anything of relevance to radio and electronics, a number of tables of units, conversion factors and symbols, etc have been included. On the other hand, anything for which a calculator is more suitable has been discarded.

A most useful book for anyone interested in electronics, the *Radio and Electronics Engineer's Pocket Book* costs £6.95 and is published in a durable hardback cover.

For further information please contact: *William Heinemann Ltd, 10 Upper Grosvenor Street, London W1X 9PA. Tel: 01-493 4141*

Around the World there are thousands of radio stations sending signals. If you are receiving, the nineteenth edition of the *Guide to Broadcasting Stations*, by Philip Darrington, will tell you who's where. It lists stations broadcasting in the long, medium and short wave bands, dealing with them by frequency and geographical location in alphabetical order.

The publication, which has

sold over 300,000 copies, includes a variety of information on reception reports, world time broadcasts in English, clubs and magazines.

In short it is a publication for listeners world-wide who want to get more enjoyment and information from the radio. And at £6.95 it won't break the bank either.

For further information please contact: *William Heinemann Ltd, 10 Upper Grosvenor Street, London W1X 9PA. Tel: 01-493 4141.*

If you are a newcomer to Packet radio, *The Packet Radio Handbook*, by Jonathan L Mayo KR3T, will serve as the ideal introduction to the capabilities and limitations of Packet radio.

However, if you're an experienced Packet radio operator it will provide you with a thorough review of basic techniques along with information on how you can expand your operation.

Although the book has been produced for the American market, it provides you with the background you need to understand the basic concepts of Packet radio, information on the inner workings, the operational aspects and a look into the future of the mode.

The book provides information on setting up and operating on Packet, and a mini-course on the mode that includes the development and history.

Published by TAB Books Incorporated and selling at £13.45, it is an ideal introduction to a new and exciting era of communication.

For further information please contact: *J Wiley & Sons Ltd, Baffins Lane, Chichester, West Sussex PO19 1UD. Tel: (0243) 784531.*





## CLUB NEWS

### International Short Wave League

The International Short Wave League '87, which commenced operations on January 1st this year, currently offers the membership twelve differing DX Awards, these being available free to members and are applicable to both amateur and broadcast interests.

The monthly journal *Monitor* (42 pages plus cover), includes features covering transmitting topics, amateur bands review, a series on amateur radio satellites, TV DXing, broadcast bands DXing, broadcast scene and Cathay Quest – all about Chinese regional broadcast transmitters.

Each month broadcast band members survey a set band, duly reporting results together with other logs, whilst amateur band members may submit a Maxilog when endeavouring to gain the DXer of the Month title, others listing up to a maximum of forty call signs logged.

The ISWL '87 LSB Net operates every Saturday morning on, or near, 3685kHz. A CW Net is in process of formation. Services available to members include a QSL Bureau, tape section, contests and IBIS (ISWL '87 Broadcast Band Identification Service). A range of League supplies may be obtained from HQ.

A membership certificate is issued to all who become members, details being available post free (sample copy of *Monitor* 60p) from the Hon Secretary, 10 Clyde Crescent, Wharton, Winsford, Cheshire CW7 3LA.

### GB4PLS

On the 7th, 8th and 9th of August the Exmouth Amateur Radio Club will be operating a Special Event Station GB4PLS (Pleasure and Leisure Show) at Bicton Park, East Budleigh, Devon.

This event is to be part of a much larger show depicting pleasure and leisure activi-

ties in the South West (hence the callsign), and will include attractions such as exhibitions of art and craft, food and drink, pets and accessories, flowers and pools, plus features such as folk dancing, custom car display, fashion shows, marching bands and majorrettes, and various competitions and demonstrations in addition to all the usual attractions of Bicton Park.

All visitors will be welcome and talk-in will be provided following a call on S20. For further information contact R F Maynard G4YRM, at Exmouth Amateur Radio Club, 6th Exmouth Scout Hut, Marpool Hill, Exmouth.

### Mid Sussex ARS

The Mid Sussex Amateur Radio Society meet on Thursday at Marle Place, Leylands Road, Burgess Hill for 7.45pm. The society have their own fully equipped shack and a full programme of events, from contest operating to construction, is arranged.

Activities for August include participation in the 144MHz and 432MHz low power contests on the 8th and 9th and an operating evening in the club shack on the 27th. On the 13th and 20th the club shack is closed for the summer break.

Anyone interested in amateur radio as a listener or an operator is very welcome to join the club. For further details ring Mike G0GNV on Burgess Hill 41407.

### Sheffield ARC

The Sheffield Amateur Radio Club meet on Mondays at 8.00pm in the Firth Park Pavilion, Sheffield. Activities arranged for August include a day trip to the RSGB mobile rally at Woburn on Sunday the 2nd, a talk on 'Test Equipment on a shoestring' by Tom Haddon G4KMA on the 17th and a home brew aerial competition on the 24th.

Further details about the club or any of the events can be obtained from Alan Pemberton G8ZHG at 3 Richmond Hall Crescent, Sheffield, South Yorkshire S13 8FN.

### Dunstable Downs

The Dunstable Downs Radio Club meetings are held every Friday for 8.00pm at Chews House, High Street South, Dunstable, Bedfordshire.

Events scheduled for

August include an attempt at making a radio contact with their twin town, Wolfsburg in Germany, on the 4th, a talk on the 7th and the club summer Bar-B-Q on the 22nd.

Further information on the club can be obtained from the secretary, Tony G0COQ on Luton 508259.

### Bristol ARC

The North Bristol Amateur Radio Club meet on Fridays for 7.00pm at the Self Help Enterprise, 7 Braemar Crescent, Fulton, Bristol.

Meetings scheduled for August include a natter night and committee meeting on the 7th, a 40m activity night on the 14th and a bank holiday natter night on the 28th.

Further information on the above is available from Alan Booth G4YQQ on (0272) 690404.

### Southgate ARC

The Southgate Amateur Radio Club, G3SFG, meet on the second and fourth Thursdays of each month for 7.45pm at the Holy Trinity Church Hall (Upper), Green Lanes, Winchmore Hill, London N21.

Dates for meetings in August include the 13th and 27th, the latter being an informal evening.

For further information on the club as a whole or its activities, contact D C Elson G4YLL on (0992) 30051.

### GB3TP/GB3EY

The Aire Valley Repeater Group meet on the 1st Tuesday in the month at the Victoria Hotel, Cavendish Street, Keighley for 8.00pm.

GB3TP, the 2 metre repeater, is situated in the Aire Valley, near Keighley. GB3EY is the proposed 10 metre repeater, ready for installation on the Eriy Moor TV mast near Huddersfield, awaiting the licence. It is hoped that it will be operational by the end of 1987.

Further information is available from Mrs K A Conlon G1IGH, 76 Deanwood Crescent, Allerton, Bradford.

### QZZ

The latest issue of QZZ, the newsletter for the Radio Society of Harrow, recently landed on the editorial desk with a thud, which is probably due to the heavy puns on the Editor's page.

Waffle aside, the newsletter includes a variety of informa-

tion of interest to the membership including club news, a contest corner, RSGB news and a variety of light-hearted rhetorics from various personalities (Uncle Oscar and Grubby Gremlin of note).

The club meets on Fridays from 8.00pm at the Harrow Arts Centre, High Road, Harrow Weald and usually have a variety of activities arranged.

Further information on these activities and the club membership is available from the chariman, Bob Pickles G3VCA on (0895) 673287.

### Hilderstone RS G0HRS

HRS has a growing interest in radio foxhunts – on Top Band – challenging everyone to get the soldering iron out and build a receiver. Keep an eye open for events, in which everyone is welcome. Technical/map reading prep sessions are available if you need them.

The 'resident tutor', Ken Smith G3JIX, plans to offer a post RAE practical course entitled *Practical Radio-Electronics*, in which numerous projects, fault-finding and bits of 'how-it-works' will be covered. Astronomy is a subject covered on another evening.

Details are available from the club secretary, G0CLO, tel: (0843) 69812, or you can join at the Hilderstone AEC as the courses will be run as normal adult education courses.

### WEM Carnival

A special event station, callsign GB0WEM, will be on the air on Saturday, 5th September to commemorate the 1987 Carnival in the North Shropshire market town of Wem, some ten miles north of the county town of Shrewsbury.

The station will be active throughout the day, with both phone and RTTY transmissions on HF, 2 metres and, possibly 70cm.

Some equipment has been loaned for the occasion by the Salop Amateur Radio Society and a special QSL card will be available to all stations contacting GB0WEM.

The International Locator for Wem is IO82PU (formerly YM17a) and its WAB square is SJ52.

Any queries should be made to Eric G0WRU (ex-G1WEI), on (0939) 33638.

# LONGLEAT 1987

## RALLY REPORT

Date: 28th June

Venue: Longleat House, Warminster Wiltshire

The 30th Longleat Mobile Rally, organised by the Bristol RSGB Group, was again a resounding success. With more than 12,000 attending, the rally was thriving from the

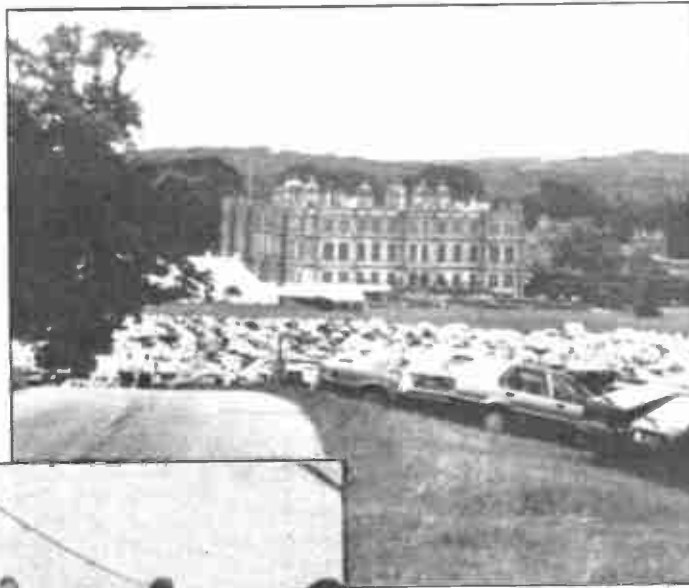

nick-nacks, including antennas and aerial wires were also available.

All in all the traders seemed to have a good day, and the organising committee have received nothing but praise since the event for the



minute the gates opened. Since its beginnings in 1958, when a then impressive 300 people attended, the rally has gone from strength to strength. It is little wonder why when the venue offers so much for an enjoyable day out by the whole family.

### More than a rally

In addition to the beautiful house, grounds, safari park and boat trips etc, the Bristol RSGB Group supplied entertainment on the rally site in the form of the Bristol Morris Men and the Midsomer Norton Marching Brass. All of which was made more enjoyable by the warm, fine weather.

More than 80 stands were held by traders, clubs and magazines (we were there too!), and business was brisk throughout the day. A number of satisfied amateurs were spotted laden with their latest purchases and a satisfied

smile, even if their wallets were feeling a little slim.

Items of note on sale included some impressive Morse keys imported from Germany on the Winchester Communications stand, and a selection of high power valves which often seem difficult to obtain; perhaps a new supply has been injected into the market by the MoD recently. Talking of MoD surplus, a variety of useful

success of the rally.

Mrs Joan Heathershaw, President of the RSGB, went along and, being free from her official duties, had time to talk to the amateurs themselves. She was even provided with a private conference area so that she could talk to people away from the general hubbub of the rally if she so wished. Whatever she chose to do with her time, we're sure she enjoyed attending a rally that flies a flag for the RSGB's organisation of these events.

Morse tests were not held on the rally site this year, as a permanent Morse test centre has been set up in Bristol. Anyone wishing to take their test at this venue are invited to contact the RSGB through the usual channels to make a booking.

### We were there too

Although we were tied to our workstations behind the *Amateur Radio and Radio and Electronics World* stand, we were able to meet a number of authors and readers who have far too long remained just a name and a callsign. Our sole purpose in attending these events is to meet as many of you as we can, so if you see us, come up and say hello – we promise not to bite.

Finally, it leaves us only to thank and congratulate Brian Goddard and his team for a fine rally. We have already decided on going next year and can only hope you will do the same. **Ed.**





# IS THERE A FUTURE FOR 4m?

The recent rise in popularity and addition to the licence schedule of the six metre band has called into question the future of one of the older, but less used VHF bands, namely four metres. Traditionally four has always been a quiet band, but when experimental six metre permits were first issued many four metre enthusiasts were attracted to the new allocation, leaving four metres somewhat neglected, largely due to the suggestion that permit holders should have experience of four metres. However, now that six is widely available some are drifting back to the old band. In addition a certain amount of four metre activity is occurring as the rise of six metres has attracted attention to the lower VHF spectrum and encouraged the production of suitable commercial equipment.

## History

The four metre allocation was first made in 1956, at a time when a great deal of attention was being paid to the low VHF spectrum. Amateurs in the USA and Canada already had a six metre allocation; in France and the Soviet Union they were permitted to operate between 72 and 72.8MHz and elsewhere the five metre band (56-60MHz) was still in existence.

From the start, four metres was a secondary allocation, with the army as the primary users. Although today it is little used by them, it is still occasionally possible to hear signals emanating from TA exercises. It is believed that amateurs were originally permitted to use the band because it was then used for CW training of army radio operators and it was thought that the QRM caused by amateurs would increase the value of such training. This would explain the reason for it being a class A only allocation, despite a 1979 ITU decision that class B licence holders should be permitted to use all allocations above 30MHz. At the time the Home Office claimed that the ITU decision was inapplicable since four metres is a UK amateur allocation, not an international one.

The relatively low number of countries with a four metre allocation is one reason for its smaller number of adherents. Apart from the UK and Eire the only countries with a regular four metre allocation are Gibraltar, Cyprus Crown Territory (where there is presently a beacon, but nobody with equipment) and Iceland (where there is no activity at present). An expedition to Andorra in 1968 were permitted to use four metres and worked several English and Irish stations via sporadic E, but no one there has operated on the band since then.

Its low frequency makes four considerably more prone to E openings than two metres and it is often possible to hear East European FM broadcast stations such as Gdansk (70.310MHz). Most summers ZB2 is also worked via the

same mode.

There are quite a number of continental VHF enthusiasts equipped with receive converters and suitable antennas who are willing to attempt crossband tropospheric and meteor scatter contacts, using two metres or ten metres to reply. Some people have worked a considerable number of countries in this way.

## Equipment

At one time almost all equipment for four was home built. But, although it has always been something of a constructors band, there are now a number of manufacturers who supply equipment ready built, or in kit form.

Microwave Modules have for some time produced a pair of 10W transverters for four metres, one with a two metre IF, and the other for use with a ten metre transceiver. There are quite a number of people using these on the air with IC202s and FT290s, or with HF rigs. For some reason they don't advertise these, but as far as I know they are still available. Until recently they also produced a 100W linear amplifier. Unfortunately, that was discontinued, but BNOS have displayed their faith in the future of the band by bringing out a new 100W linear this year. This is capable of producing full output with 500mW-15W input and has an in-built preamplifier, making it a very versatile piece of equipment.

Lowe Electronics recently imported a number of Mizuho MX4 SSB/CW handhelds. Although these are actually modified six metre transceivers with a power output of only 200mW they have, like the two metre version (the MX2) an extremely sensitive receiver and a fairly clean signal.

For those who are willing to make use of kits, Spectrum Communications market a range of four metre converters, transverters and pre-amps which are available in kit or ready-built form. Similarly, Cirkit make four metre preamplifier and converter kits and have introduced a transverter kit as a spin-off from their new six metre transverter. Wood and Douglas also claim to be able to supply any of their range of two metre kits for four metre use.

On the aerial front, Jaybeam still make their four element yagi which has formed part of many four metre stations for several decades. MET market three and five element yagis for the band, and for those who use both four and six metres, Sandpiper sell a range of dual-band antennas as well as a range of single-band 4m aerials with up to six elements.

## The future

Despite the fears of some amateurs, there is still plenty of hope for the future of four metres. Many of the bands most ardent proponents are holders of G0 or late G4 callsigns, suggesting that it is not true that it is an 'old-timers band'.

In some areas private nets using

modified PMR rigs on AM or FM are springing up. This is an excellent way of providing a means of communication between friends without much risk of QRM and without tying up the main rig. It is often possible to get a secondhand Pye Westminster or Cambridge crystallised up and modified for four metres for less than £20, making it a viable proposition for Raynet groups, several of which already use four metres in this way. Just recently AJH Electronics have begun advertising several surplus PMR rigs for this purpose, although it is possible to get such equipment much cheaper if you are prepared to ferret around the junk stalls at rallies.

Of course, the main reason why four metres has never taken off in popularity in the same way that two metres and seventy centimetres have is that class B licence holders are not permitted to use the band, and there is no likelihood of this changing in the foreseeable future. Many four metre acolytes claim this can only be a good thing since one of the virtues of the band is the ability to interchange between phone and CW without any worries. But there is nothing to stop class B stations from working crossband to four any more than there is (or ever has been) any legal way of preventing them doing so with six metres.

At the moment one thing which helps to ensure activity on four is the regularity of RSGB four metre contests. For those who have only ever tried contests on two metres or HF, a four metre contest can be a breath of fresh air. They tend to start later, finish earlier and are considerably more polite. What is more, the QTH element in the exchange, which was removed from two metre contests three years ago, still exists for contests on four. The result, as one four metre enthusiast put it, is that 'four metre contests are more *civilised*'. This year the RSGB are experimentally holding a four metre contest on the same day as one of the big two metre contests and it will be interesting to see how that affects activity.

There are presently a surprising number of amateurs who are fully equipped for four metres who simply do not come onto the band because of the low level of activity. Fortunately a group of people in the Midlands have rectified this problem by making Tuesday evening four metre activity evening. This now has the support of the RSGB VHF committee, making Tuesday evening a time when it is possible to go onto the band with the likelihood of finding stations to work.

For amateurs who want a haven from the bedlam of HF or the other VHF bands, a four metre transverter provides the answer without costing too much. It is a band where polite operating practices are not yet out of date and where over-used repeaters, jammers and CB terminology are completely unheard of.  
**by David Dodds GM4WLL**



# DX DIARY

News for HF operators compiled by Don Field G3XTT

DXers can be a secretive lot, hiding away by their rigs, so it was good to see a bunch of them out and about at the Longleat rally. The Western DX Group, a collection of DXers from Devon and South Wales had laid on a hospitality tent, and quite a gathering of the clans took place with 38 DXers signing in. G3MIR and G3LQP met for the first time since sharing a station in Singapore some 33 years ago! At least one other acquaintance was renewed after a gap of over 20 years. And for myself it was a pleasure to meet several people who have been callsigns in pile-ups on many occasions, but whom I have never previously eyeballed. Mind you, getting them all to stand together for a photo call was about as difficult as getting them to stand by in a pile-up on twenty!

## Take a break

DXing does, of course, have a social side, just as any other hobby, though some of its more serious adherents can never ever be prised away from the rig while the bands are open. However, if you are partial to the occasional off-air ragchew and missed the Longleat get-together, then at least aim to get along to this year's HF Convention, to be held once again at the Belfry Hotel on the A40 just west of Oxford.

This year's event takes place on Sunday, 27th September and the format is much as previous years, with a high-calibre lecture stream plus quizzes, special interest groups (WAB, BYLARA, G-

QRP, etc), RSGB bookstall and much else. The lecture programme kicks off at 1030 and the hope is that Einar, LA1EE, will be there to talk about his operation from Peter 1st Island earlier this year. As on previous occasions, there will be no trade stands as the emphasis is very much on the social side. Unfortunately there will be no buffet in the evening this year.

Enough of the commercial, though do drop me a line if you need more details.

## Band conditions

Now to the state of the bands. Ten metres was producing some excellent openings during June, including some to North America and the Caribbean (well, with W6JKV/YV0 on Aves Island workable on 6 metres, it would have been rather surprising if ten hadn't been quite lively!).

The spate of Pacific DX on twenty metres has continued, so that I'm beginning to think I must be the only UK DXer not to have worked KH3 on the band. And T19CF and T19US turned up as predicted from Cocos Island (see last month's column). A whole bevy of special prefixes were active from Poland for the Pope's visit, and the island chasers got some new ones by way of YE9Z (Bali), ED9EXP (Alboran Island), FV7NDX (St Marcouf) and others. Not so much on the LF bands due to summer static, though 3A2GL was coming in very loudly on Top Band CW one evening. So, plenty for everyone as usual.

The burning question, of course, is what does August hold and are you going to miss a nice juicy one by daring to go away on holiday? Having said earlier that DXers can occasionally be sociable and leave their shacks for the odd day out, holidays are definitely bad news because they are invariably the cue for that rare one you desperately need to turn up on the bands, work everybody but you, and disappear.

Table 1 summarises what there is to look forward to during the month, and I gave details of several of these last month.

Note particularly the OH0MA operation from Market Reef, which will number GM3YOR, G4EDG and G4JVG among the operators. Steve G4JVG was the first UK amateur to operate from Market Reef and this will be his second trip.

Market Reef is little more than a few rocks plus a lighthouse, lying between Sweden and Finland, and getting ashore can be a hazardous business, so don't be surprised if the group experience delays in getting on to the island. They will make a special effort on ten metres as many amateurs need OJ0 on that band, but there are also plans to put up a good Top Band antenna to cover the other end of the spectrum.

No more details have surfaced about the proposed operation from the Saharan Arab Democratic Republic since I mentioned it in the June column, other than that the callsign will be S0RASD.

Keep your ears glued for this one early in the month. When oddities like this appear on the bands it is safest to work them first and worry later about whether they will actually count for anything!

Since DL7FT's operations from Mount Athos have been accepted by the ARRL, Bob G4VGO has re-submitted documentation from his July 1985 operation as SV0BV/A. If the ARRL decide that all is well, Bob hopes to return to Mount Athos at the earliest opportunity for a further operation.

Incidentally, DL7FT turned up from Taiwan as DL7FT/BV during June. His Taiwanese licence apparently required that he speak English at all times, and it also forbade him from working stations in the USSR.

## China again

JR1HHL, JA7OAI and JK1GDD will operate from Urumqui in China in the rare zone 23 from 16-18th August, using the callsign BT0CQ. They will use all HF bands and modes, and JR1HHL will handle the QSLs. The best openings to China of late have been during the afternoon on twenty, though there have been some morning openings on fifteen. Either way, this one shouldn't be too difficult to work.

JX9CAA is currently very active from Jan Mayen Island and will be there until October. LA5NM is his QSL manager. KH9AC is reported to be active again from Wake Island after a short break. And VP8BNO (G3JXE), who was active from the Falklands earlier in the year, expects to



return there in mid-August armed with more equipment. He is rumoured to be particularly interested in giving out contacts on LF and he worked VE1ZZ on Top Band back in June.

ZS6ME is reported to be trying for an operation from Marion Island (ZS8MI) in August, though I wouldn't hold your breath. Richard G3CWI (ex VP8ANT), should be in Chile for a 9 month tour of duty by the time this appears, and hopes to get on the air with borrowed equipment. He has hopes of activating Wollaston Island off the Chilean coast later in the year, which would be a new one for the IOTA gang. The YZ9 prefix may be used until 31st August by Yugoslavian stations to celebrate the Student World Games in Zagreb.

### Zaire

Tom 9Q5NW is now extremely active, having got his KT34 in the air and his Alpha 76C linear up and running. He is planning LF antennas as well, though he anticipates that the QRN on Top Band will rule out operation on that band. I remember hearing Tom on 160 when he was TU2NW, and he didn't seem to be able to hear any European stations at the time, so I guess he may be right. However, he has always been a big signal on 80 and 40 from his previous postings in Africa, so this should be one to look out for come the autumn. Tom hopes to make a side trip to Tchad at some stage during his stay in Zaire.

XU1SS has been very active again recently. Look for this one on 21170 or 21230kHz from 1130GMT on Tuesdays, Thursdays, Saturdays and Sundays. QSL to JA1HQG. 3C1MB is reported by *DX News Sheet* to have made some 12,000 QSOs in the first 18 months of his three year tour of duty in equatorial Guinea, so no excuse for still needing this one!

Chris OE2CHN was reported to be embarking on a world trip in early July, lasting through until October. His itinerary takes him through Asia and the Pacific, including Singapore, Indonesia, Australia and New Zealand during August. Most of the callsigns were unknown at the time of writing. Chris was not taking any gear of his own, but hoping to operate

from the stations of resident amateurs in those various countries. Listen for him mainly on SSB.

And Leo K8PYD is planning a major five week trip in the autumn, taking in Japan, China, Nepal, India and Hong Kong. He will try to operate from as many of his stopovers as possible. Leo has made a number of trips in the past to various parts of the World, and always seems to manage to put out a good signal.

Now some for the island hunters. I2ZBX/IM0 should be operational from Maddalena Island by the time this appears, and will be there until 16th August. He is a white stick operator, so I2RFJ will handle the QSLs. IS0WON will operate from Toro Island from 21-27th August. And IT9VDQ will apparently be operating /IH9 from Pantelleria Island sometime during August.

On the down side, P29PR and 5A0A are now QRT, and Box 88 in Moscow has apparently said that there will definitely be no operation from Afghanistan by Russian amateurs. P29PR, who is now back in the UK, reports that there are only half a dozen amateurs left in Papua New Guinea, and P29AR will leave in September. Bob was able to work into the UK on 80 while in P29, but found the path difficult on Top Band. Funnily enough your scribe heard him on 160 back in January 1986, but before I had come to my senses and realised it wasn't a UP2, I was hearing Bob fading back into the noise.

### Roll of honour

Last month I mentioned the DXCC Honour Roll listings which appear in *QST Magazine*. Some 41 UK callsigns appear in the mixed and phone listings, though there are none in the CW Honour Roll. Newcomers since the last Honour Roll listing are Dennis G3MXJ, and Peter G3YJI. Congratulations to both. Of course, not all successful DXers actually flaunt their success publicly, and I know of at least one UK amateur who has worked every country on the current list and has never applied for DXCC.

Another, related, tale of success is that of G2ATM who recently worked his 320th all time country by way of

WY5L/KH3 who came back to a CQ call on twenty. It has taken Stan 23 years of persistent DXing to get this far, during which time he has never used a beam or linear, but has run barefoot into monoband groundplanes. Well done!

### Ten metres

In case you were of the view that ten metres is a waste of time during the sunspot minimum years, how about this. *DX News Sheet* reports that DJ1ZU worked no less than 140 countries on the band during 1986, and so far this year (as of late June), G4JBR has worked 110. Indeed, Pete worked 91 during 1985, running just 100 watts to an 80 metre dipole. Something for the sceptics among you to consider!

### Peter and Paul Rocks

The *DX Bulletin* recently carried an interesting piece about the operation from St Peter and Paul Rocks earlier this year by PY1BVY and PY1ZT. This operation generated a lot of controversy in the amateur radio press, mainly due to the SSB station working to lists and not sticking to the previously advertised frequencies. It was interesting, therefore, to hear the operator's point of view.

To set the scene, you need to know that the Peter and Paul Rocks are tiny volcanic outcroppings lying almost on the equator, some 600 miles from the Brazilian coast. Landing is possible only during the months of December to June, and even then there is no landing stage as such which, with tides of up to fifteen feet, makes landing a hazardous business as previous expeditions have

discovered. Average temperature is in the 80s, there is no drinking water to be had, the volcanic rocks are extremely sharp, and the resident crabs do not welcome intruders. Not a recipe for the ideal package holiday!

Ron PY1BVY and Paul PY1ZT report taking four and a half days to reach the island, and then having to wait another 36 hours before it was possible to make a landing. This involved taking ashore, a little at a time, the FT7B, FT101E, FT901DM, two keyers, a 1500 watt generator, fuel, wire for antennas, 3 multi-band verticals, plus, of course, shelter, food, etc. The best site turned out to be the ruined platform of a lighthouse which had once stood on the rocks, and this necessitated carrying all the above gear (some 500 pounds weight in all) up the sharp rock to the highest point.

Split frequency operation with the SSB station proved impossible due to the remote VFO and the VFO memory circuit of the FT901 having been damaged in transit. However, some 6000 QSOs were made in all, including many on both ten metres and Top Band. Getting off the island then proved quite as difficult as the landing, followed by a further four and a half days of slow sailing back to Brazil.

Clearly the DX community owes Ron and Paul a vote of thanks for their operation.

### It's a wrap

Well, that concludes for another month. By next time we will be embarking once again into the main DX season. Meanwhile, with the rig running and DX Diary within easy reach, 73 de Don.

**Table 1** What to look forward to

now to 13th Aug	DL4BBO/CT3 (CW only)
now to 16th Aug	I2ZBX/IM0 (Maddalena Is)
now to 31st Aug	YZ9 prefix by YU stations
25 July-2 Aug	OH0MA (Market Reef)
1-2 August	YO DX Contest
1-3 August	GJ6UW/P (Summer Isles)
7-9 August	GJ6UW/P (Monach Isles)
8-9 August	WAE DX CW Contest
8-23 August	GB2SMC Orkneys
9-22 August	I4ALU/IF9 (Favignana Is)
15-16 August	SEAnet SSB Contest
15-16 August	SARTG RTTY Contest
16-18 August	BT0CQ by Japanese ops
16-18 August	YB42RI (Indonesia)
21-27 August	Toro Island by IS0WON
29-30 August	All Asia CW Contest

# SERVICING VALV

Prevent the maintenance of thermionic equipment becoming a d

A few weeks ago, a young SWL was complaining to me of the high cost of buying a reasonable quality communications receiver.

'Why not get an old Drake or Eddystone?', I asked.

'I would, but if they go wrong you can't get them repaired', he replied.

'Maintain them yourself', I replied. His eyes took on a glazed look.

Even more recently, an item on *That's Life* featured a man who had an old valve broadcast receiver which he could not

get repaired. The programme researchers found a collector who could do the repair, but the two incidents made me realise that the maintenance of thermionic equipment is now a dying art.

At first thought, with all new domestic equipment now being solid-state, this may not seem important. However, many hi-fi buffs still prefer the sound of equipment with flowing heaters, the older transmitters and receivers are by far the most economic way of getting on

the air and, for full legal power limit, RF linear amplifiers valves still cannot be bettered. Perhaps, therefore, there are still good reasons to know a little about servicing thermionic equipment.

The principles are not difficult, and are the same whether applied to a vintage four valve broadcast receiver or a complex communications receiver, such as an AR88 or an Eddystone. Fault finding need not be time consuming either, for with practice it should be possible, in the vast majority of cases, to isolate the faulty stage within fifteen minutes and the defective component a few minutes later.

## Simple equipment

The equipment used is also quite simple, for apart from simple hand tools the only necessity is a multimeter and, although a signal generator is also useful, it is not essential, for the broadcasting authorities supply an abundance of strong signals suitable for alignment, and a simple oscillator can easily be constructed for IF adjustment.

Armed, therefore, with these few necessities, let us tackle our first repair—a broadcast receiver which is doing a remarkable impression of the Do-Do bird. We will approach the task in a way which will ensure that all faults will be revealed, and follow this with a full alignment to restore the set to full working order.

More complex equipment, such as the valved communications receivers are really no more difficult to service, for to gain the additional gain and selectivity necessary, the only real difference is that two or more similar stages may be used instead of one in a broadcast receiver.

At this point it would be wise to remind newcomers to servicing this type of equipment that, when switched on, voltages of between two and three hundred volts will be present which, although are unlikely to be fatal, can nevertheless give a very unpleasant electric shock.

Provided, however, that reasonable precautions are taken, such as using well insulated meter prods and only using one hand when working on high voltage circuits, such shocks are unlikely.

## First impressions

The first task is a physical inspection of the equipment with power off. This is not as futile as it may seem, for it is here that some of the most unusual faults are found. Many years ago, in one 'dead' receiver, I found a mouse's nest—neatly

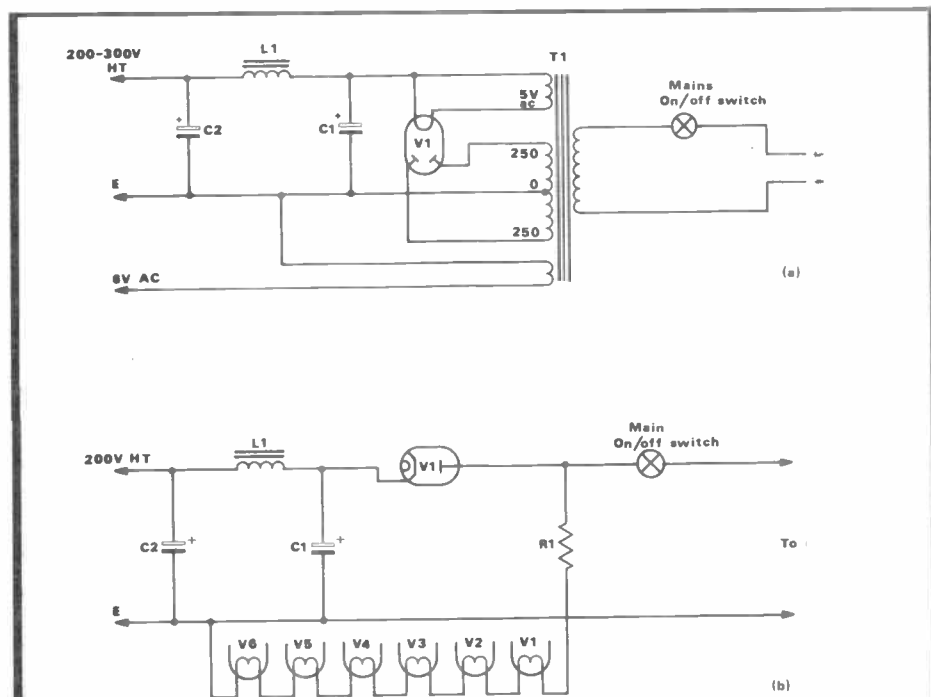

Fig 1 Typical power supply circuits for a) ac only; b) ac/dc receivers. C1, C2 are typically 8 to 16µF CH1 is usually 5 to 10Hz

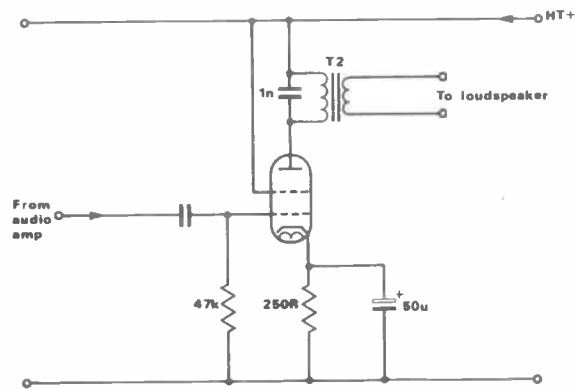

Fig 2 Receiver audio output stage with typical values shown. The valve may be: 6V6; 6F6; 6AQ5; 6BW6; 35L6 or similar



# IVE RECEIVERS

ving art – make it a DIY job. Ken Williams explains how. . .

lined with the remnants of the loudspeaker cone. At the same time it is also useful to brush out the dust, dirt and debris which has accumulated over the years.

## ac only and ac/dc receivers

Remove the chassis from the case and identify the mains transformer. If none is present, then the receiver is an ac/dc model, which means two things:

1. The chassis is connected directly to one side of the mains supply.
2. The valve heaters and panel lights will be in series.

For your own peace of mind, check that the chassis is connected to the 'neutral' side of the mains supply or, better still, install a 1:1 isolation transformer. The heaters of the valves will be, as said, all in series, but as the total voltage required will not equal the mains supply voltage, the difference is absorbed in a resistor. This is usually a large, tubular, tapped, vitreous component, however, in some early receivers a 'line cord' was used in which the requisite resistive element was enclosed in the mains lead. The author has earned many a copper replacing line cords and valves for customers who have 'only shortened the mains lead' for domestic reasons.

## Switching on

It is now time to apply power to the receiver. On doing so, wait for a few moments and then check that all the valves are alight. If it is an ac only receiver and any are not, switch off, remove the valve and check heater continuity. If faulty replace, but if not return it to its position and try waggling it in its socket; sometimes dirt prevents continuity. If that fails, look under the chassis and examine the valve base for broken wires or dry joints. If no valves are alight, look for a defective mains fuse.

In an ac/dc receiver, it requires only one defective valve or voltage dropping resistor to extinguish all. In this case check each individually using the multimeter (a famous law of nature says that the last item examined will be faulty!). With the faulty component(s) replaced, all valves should be glowing and we can proceed to examine the high voltage line.

## High voltage checks

With power on and waiting a moment or two to allow the receiver to reach operating temperature, we can switch the multimeter to its 250 volt range and check that the high tension voltage is present. The most convenient place for

this is on the electrolytic smoothing capacitor.

If the voltage is showing less than about 200 volts and the rectifier valve anode is not glowing (which would indicate that the smoothing capacitor was short circuit), it is probable that the rectifier valve is causing a voltage drop due to low emission. Other possibilities in an ac only set is that half of the mains transformer is open circuit. Measure the ac voltage to earth on each of the rectifier anodes, where about 250 volts

should be expected. If both voltages are the same, it is unlikely that the transformer is faulty. A short circuit in a winding would cause the transformer to overheat.

If a replacement is available, replace the rectifier valve. If not, replace by silicon rectifier diodes soldered directly across the valve holder. These, however, suffer far less voltage drop than the valve which they replace. Furthermore, the smoothing capacitors will probably be close to the end of their lives. It would be

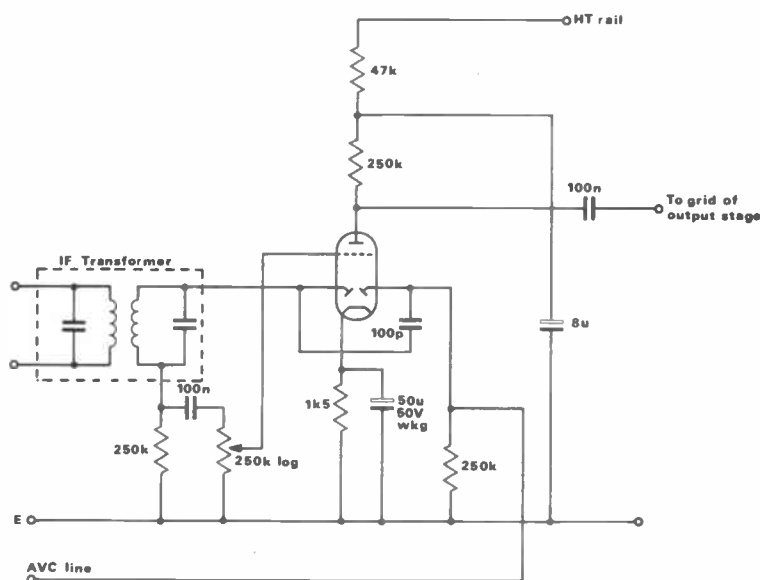

Fig 3 Typical Det/AVC-AF amplifier circuit using a double diode triode valve

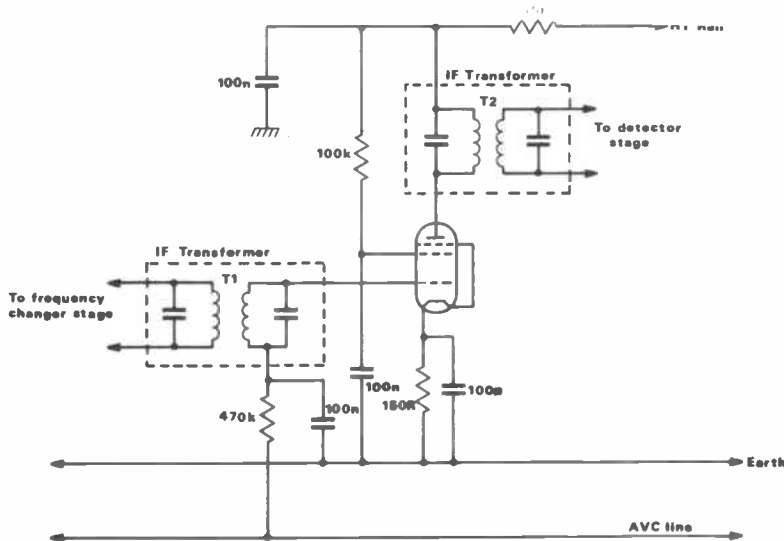

Fig 4 Typical IF amplifier circuit. On broadcast receivers T1 and T2 would be tuned to about 465kHz, but communications receivers may use other frequencies. The adjustment on the IF transformers may be made by using preset capacitors or more commonly iron dust or ferrite cores for the inductances

wise, therefore, to replace these as well. Suitable types can still be obtained from 'Electromail'.

A faulty smoothing capacitor also causes a loud hum in the loudspeaker, but this effect may also be caused by a heater/cathode short elsewhere in the receiver. If the receiver is ac/dc, then a resistor to substitute for the rectifier heater will also have to be wired across the valve holder. The value required can easily be calculated from Ohm's Law.

### The audio output stage

With HT voltage now available, we can now look at the audio output stage. This is usually a 6V6 or 6F6 (octal base); 6AQ5 (B7G); 6BW6 (B9A) or equivalents.

With the meter set to the 250V dc range, measure the voltages on anode and screen grid. These should be very close

to the HT rail voltage. If no voltage is found on the anode, check the continuity of the audio output transformer primary. If there is no voltage on the screen examine the wiring, for it is usually connected directly to the HT rail. With both these voltages present, measure the voltage on the cathode. This should be in the order of 5 to 15 volts. If this is low, disconnect the cathode decoupling capacitor and check again. If still low, replace the valve. If the voltage is high (30 volts or more), measure the value of the cathode bias resistor. This is normally in the order of 250 ohms.

With all voltages present and correct, touch your meter prod on the grid of the valve and you should hear a click or buzz in the loudspeaker. If not, check the loudspeaker connections and voice coil continuity.

If, when doing this, the meter registers a slight positive voltage, this may be caused by leakage of the input coupling capacitor. Check by disconnecting and, if faulty, replace. The output stage should now be in working order.

### The detector and audio amplifier

The detector and audio amplifier stages normally use a double diode-triode. Typical valves in this position are: 6Q7, 6R7 (octal); 6AT6 (B7G) or equivalents.

The anode load in the audio amplifier is typically of quite high value (often 250,000 ohms) so the voltage indicated on the multimeter will be relatively low. Provided that over 70 or 80 volts are indicated, all should be well. If no voltage is present, this could be caused by an open circuit anode or decoupling resistor, but more probably by a short circuited decoupling capacitor. Simple continuity checks with power off should determine the faulty component.

A high (approaching HT rail) voltage would indicate a faulty valve or an open circuit cathode resistor.

The volume control is normally in the grid circuit of this stage, and if it is rotated to maximum, a loud click or buzz should be heard if the wiper arm is touched. If no sound is heard or the rotation causes loud crackles, replace the control. Care should be taken when approaching this component, for it is often attached to the mains on/off switch.

At this point there are few, if any checks which can be made on the diodes, so we now move on to the intermediate frequency (IF) amplifier.

### The intermediate frequency amplifier

The IF amplifier is a simple RF amplifier tuned to a single frequency, usually between 450 and 465kHz. The basic voltage checks should show an anode potential of about 20 to 50 volts below HT rail voltage, a screen grid voltage of between half and three quarters HT and a cathode voltage of one to 3 volts. Any serious discrepancies from this would indicate either a faulty valve (anode and SG high, cathode low or nil) or an open circuit resistor or short circuited decoupling capacitor.

If a signal generator is available, inject a strong (1-5 millivolts) signal at IF frequency via a 1nF capacitor onto the anode of the preceding stage. This should cause a loud output from the loudspeaker. If all is well, or if a signal generator is not available, proceed to the frequency changer stage.

### The frequency changer

The frequency changer circuit comprises two separate sections: a mixer and a local oscillator. Although a few receivers use separate valves for each task, it is far more common for both functions to be accomplished by a single valve, usually a triode hexode or a triode pentode.

As with previous stages, the first task is to check the voltages on the valve: hexode anode (20 to 50 volts less than HT rail); screen grid (half to three quarters

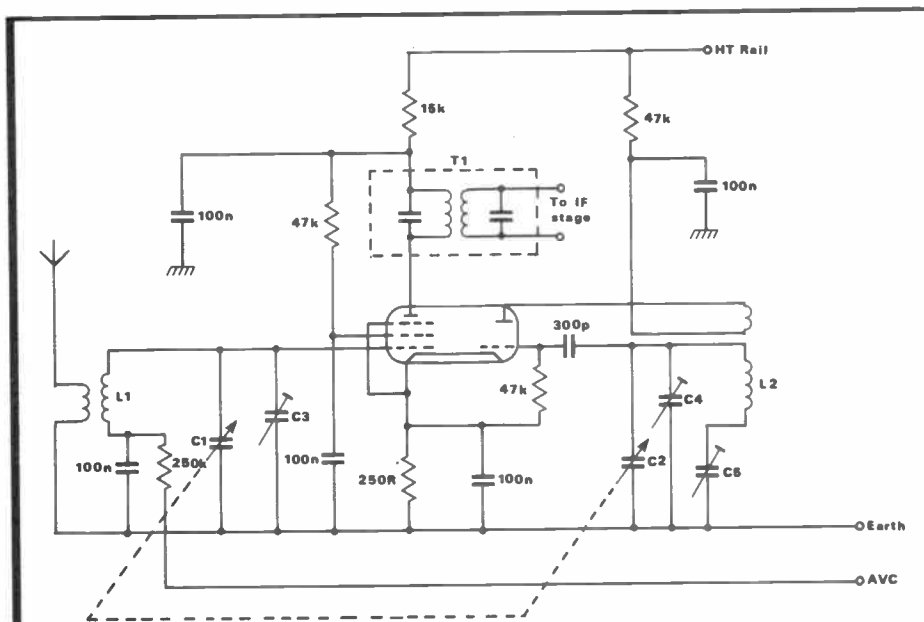

**Fig 5** Schematic of typical frequency changer stage. Although this shows a triode-pentode, in practice for all practical purposes, there will be no difference for a triode-hexode. C1, C2 in the ganged tuning capacitor, C3, C4, are trimmers and C5 a padder capacitor. C3, C4 may be omitted if adjustable cores are used for L1, L2

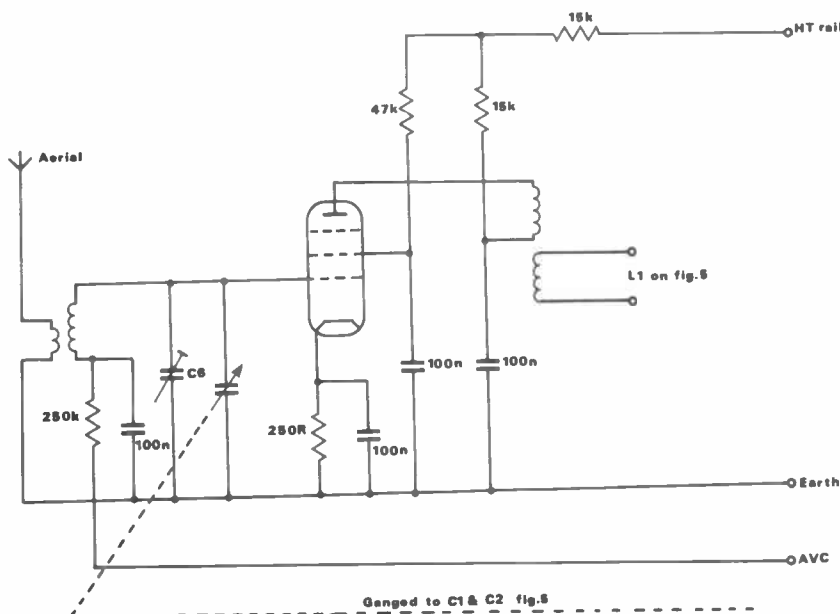

**Fig 6** Schematic diagram of typical RF stage



of HT rail); cathode (1-5 volts); and triode anode (above half HT rail). Should any of these vary widely from those quoted, take remedial action as described previously.

If the receiver has no RF stage, an aerial may now be connected and an attempt made to receive signals. If signals can be tuned, then the set is obviously working. However, if some indefinable signals which cannot be tuned are received, then the local oscillator will not be operating. Causes for this include: low emission of the valve; grid circuit resistor or capacitor faulty; faulty wave change switch or a mechanical short circuit on the tuning capacitor. The latter may be due to metal swarf or a bent vane, either of which should be found by visual inspection.

If it is suspected that the grid capacitor is faulty, due to their low cost and difficulty to test, it is usually more convenient to discard the suspected component and replace it with a new one.

Wavechange switch faults can frequently be cleared by a liberal dose of switch cleaner, however, if the fault is other than dirty contacts a mechanical repair may be necessary. If the receiver has an RF stage, a quick test is to connect a short aerial to the grid of the mixer via a small capacitor. If all is well, stations should be received and tuned, although second channel interference and IF breakthrough may be present. We can now proceed to the RF stage.

### The RF stage

With the exception that the input and output circuits are tuneable, the RF stage is very similar to the IF stage and very similar voltages may be expected. Should all voltages check correctly and signals are very weak or absent, suspect the wavechange switch.

### Other faults

The receiver should now be receiving signals, however, other faults may exist which have not so far been detected. These include: *Microphonic valves* From time to time, for various reasons, parts of the internal structure of a valve may become loose. This may often be noticed as a bell-like ring or crackle if the set is tapped. The faulty valve can normally be identified by tapping each in turn. Replacement is the only cure. Other intermittent faults can often be located by tapping, but for safety's sake, do this with an insulated rod.

### Instability

When a station is tuned it may sound as if a beat frequency oscillator is in use when it is switched off, or none exists in the receiver. This is usually due to the IF stage bursting into oscillation from one of two causes; either a decoupling capacitor has developed an internal open circuit; or a screening fault. The latter may be due to the absence of a screening can or, in older receivers, the metallising of the valve has become disconnected from the valve pin. Wrapping and securing a couple of turns

of bare wire around the junction between envelope and base will usually effect a cure.

### AVC check

To avoid continual volume control adjustment with varying signal strength, almost all receivers are equipped with automatic volume control (AVC) circuits. These comprise an additional detector diode which generates a negative voltage corresponding to the signal strength which is applied to the grid circuits of the IF, RF and mixer stages. The action of this circuit can most easily be checked by connecting a multimeter on a low dc voltage range across the AVC detector output and tuning to a strong signal. Provided that some voltage is present which appears to vary with the incoming signal strength, all will be well.

### Low sensitivity

If, when repairs are complete, the receiver still seems to lack sensitivity, it is probable that a full realignment is necessary. This I described in an article in the April 1985 issue of *Amateur Radio*. If, during the alignment, any broken cores are found, again refer to your back copies of *Amateur Radio*, for Hugh Allison G3XSE, described a number of ways of dealing with this problem in the June 1987 issue.

### Conclusion

By following the procedures outlined in this article, virtually any fault should have been located and rectified.

## WIRRAL BASED COMMUNICATIONS

YAESU

AERIALS

CMHOWES

ICOM

WOOD & DOUGLAS

MICROWAVE  
MODULES

**MGR  
SERVICES**

BUSINESS  
RADIO

MASTS

COMPUTER  
SUPPLIES

NEW &  
SECONDHAND

MARINE  
RADIO

PART EXCHANGE

CIRKIT

CELLPHONES

BEST  
PRICES

Northern Agents  
for  
**Microwave Modules**  
Call us about the  
special Mini-Break  
offer



48 SHREWSBURY ROAD, BIRKENHEAD, WIRRAL, MERSEYSIDE  
TEL: 051-653 3437



— Callers by appointment only —





# ANGUS McKENZIE

---

# TESTS

---

In the December 1986 issue of *Amateur Radio*, I reviewed the basic FT767 HF transceiver in considerable detail. At the time, the transverters were not available, but I promised to cover them as soon as I could get a complete set for review. The dealer who kindly supplied me with the original review sample was unfortunately not able to supply any transverters subsequently, as they were extremely difficult to obtain and sold even before they arrived! Most helpfully, SMC came to the rescue at the end of April, and supplied me with a complete FT767 with transverters for 50, 144 and 432MHz bands all included.

## The transverters

Each of the transverters slides into its receptacle in the back panel, and all that is visible after insertion is the large heatsink and antenna socket for each one. Up to three transverters can be left plugged in at any one time, and perhaps we may see Yaesu eventually add transverters for 70 and 1296MHz. Both the 50 and 144MHz models have SO239 sockets, whilst the 432MHz model employs an N type having lower loss at UHF than an SO239.

The 50MHz transverter transceives from 50 to 54MHz, but can be programmed to receive up to 60MHz, thus making it possible to monitor various frequencies above the 6m band in order to check for aurora and sporadic E. The 144MHz transverter covers just 144 to 146MHz, whilst the 432MHz one covers 430 to 440MHz.

All the transverters are, of course, powered from and completely controlled by the main rig.

The HF auto ATU is of course disabled when you are using the transverters, but digital output power readings are still available if you press the appropriate button. When indicating power output in watts, the frequency readout disappears. The digital output power readings were slightly on the optimistic side by a watt or two, but this is accurate enough for normal use.

Each of the transverters works in a totally different way to models that we have become used to in the UK, such as muTek and Microwave Modules versions, as the transverter IF outputs are all at the fixed 45.028MHz first IF of the main rig, thus bypassing the first local oscillator and mixer stages.

This means that within each transverter, the first mixer has to be fed with a synthesized local oscillator frequency developed from the main rig's synthesizer, and virtually all the fine tuning is carried out within the transverter. There seems to be quite a lot of gain in each of the transverters, and it seems to me that the transverters' own IF roofing filters are far too wide.



## YAESU FT767

With its VHF and UHF transverters

### Transverter facilities

Somewhat surprisingly, the main rig has only 10 memories, but they will store repeater shift information, which can be useful. The microprocessor controlled logic allows you to set up different repeater shifts for the different transverters, so that when you call up any of the transverters, you are automatically on the right shift when you switch to the repeater mode.

If you want to change frequency from an HF band to the 50MHz one, then this is quite simple, for you just push the band button up until you see the last frequency that you used when on 50MHz. However, if you left this at, say, 59MHz, then tuning to the bottom end of the band is very laborious, so you may find it much faster to tap the required frequency into the matrix pad.

This is not plain sailing, however, especially for the 144 and 432MHz transverters, since you have to worry about blinking digits and frantically pushing buttons to get the right one blinking, and then push the number that you wish it to be. You have to repeat this process for the new frequency, and then enter it with an appropriate button. In order to access 432.2MHz from an HF band, you might well have to press up to 10 buttons in sequence, if your original HF frequency was a completely random one; we found this very tiresome.

One useful facility is that for each mode you can select different channeling steps, and so you can choose 2.5kHz for FM, which will be convenient for both 2m and 70cm.

Please see the original review for details of facilities, as they are all available for the HF bands as well.

### The transverter philosophy

Many mono band multimode rigs do not have really good facilities for CW, and they almost always omit switchable filters for varying the selectivity on SSB. Buying a mono band rig is also a very expensive way of getting on to a band, and you can spend over a thousand pounds on a superb rig like the Icom IC275 for 2m, which is the only multimode 2m rig available as far as I know that has a narrow CW filter option; so useful for contest working. If you have an HF transceiver which incorporates all the facilities that you want, but your only problem is that it cannot transceive higher than 30MHz, then a transverter is an excellent way of getting on to a band.

A really good transverter will have what I describe as a bomb proof front end, and a first mixer driven with a crystal controlled oscillator of impeccable stability and purity. The transverter should not have more than 20dB gain, so as to avoid a severe degradation of system intermodulation performance. In my opinion, it is absolutely vital for the main transceiver to have a stepped RF attenuator available with it (preferably 10dB steps), which allows you to improve the system intercept point with only very slight degradation of front end sensitivity if you are in trouble with excessively strong local stations.

This problem frequently occurs in a 144MHz contest, when some portable

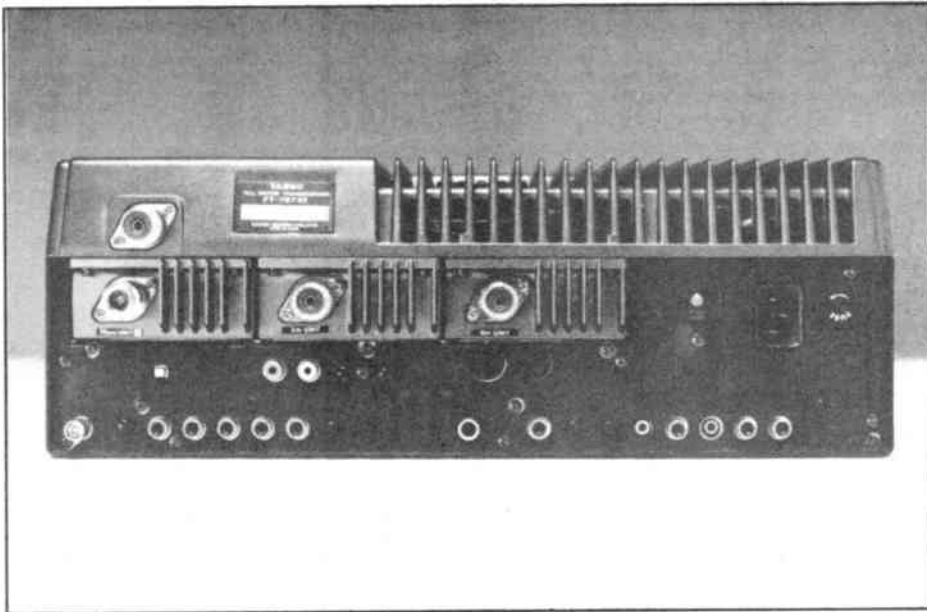

contest stations use stacked antennas and a huge linear, and thus spray out a very high ERP over a very wide angle. This type of annoying operating virtually makes it a necessity for stations in the beam of such a portable to have extremely good receiving systems. A muTek transverter has not only a noise figure of only 2dB, which is excellent, but an astonishing RF input intercept point of around +2dBm. Putting this into a receiver with a +13dBm intercept point will mean that the main receiver will limit the system intermodulation to a system intercept point of around -7.5dBm. Back off the gain of the transverter, either with its IF gain pre-set, if there is one, or insert 10dB attenuation in the transceiver front end, and you restore the system intercept point to that of the transverter itself, whilst losing 0.75dB or so in noise figure.

In the case of the Yaesu FT767 combined with its various transverters, there is no way of attenuating the signals from the transverters, and Yaesu should

have incorporated a 10/20dB stepped attenuator at the point where the transverters feed into the 45MHz IF strip. Although the 2m transverter intercept point measured quite well, the 50MHz one in particular was extremely poor, and now that we are likely to see many more stations on the band I am deeply concerned that there will be some intermodulation problems with the 50MHz transverter. Putting matters into perspective, the muTek transverter, now no longer available alas, is in practice nearly 30dB better than the Yaesu, which should make you sit up a bit!

Each of the Yaesu transverters for the FT767 developed the local oscillator frequency for the first mixer from the synthesizer in the main rig. Separate circuitry sorts out the relevant frequencies, which are varied by the tuning knob etc. This means that any synthesizer noise in the main rig will multiply its way up to create noise within the transverter, but this noise is reciprocal mixing noise, which only shows up in the presence of

strong signals close in frequency to the tuned one on Rx, or alternatively noise will be produced on Tx either side of the tuned frequency in the presence of modulation. This will sound like a form of puffing on CW or SSB, and is especially noticeable on the 144MHz transverter at  $\pm 10$ kHz of the tuned frequency.

I took a spectrum analysis of this effect on Tx to show you how relatively poor the 144MHz transverter is compared to that of the 50MHz one, whilst the 432MHz model can be seen to be the best of the lot, which frankly is rather unexpected because of its much higher frequency. Figures 1,2 and 3 relate to the performances of the three bands, the actual carrier position being on the extreme left margin, so that the 1kHz audio tone SSB modulation is at half a division in from the left. Note that on the 144MHz plot the noise within the 300Hz bandwidth drops very rapidly as you go to the right (higher in frequency) ref the modulation, but the noise then comes up again to reach a surprisingly high peak level at around 11kHz HF of where the carrier would be on the left margin.

As you separate even further from the modulation, you can see the noise collapsing rapidly down to around -80dBc, but note the rise again at the extreme right hand end, the second harmonic of what I suggest is a 10kHz area problem in the phase locking system somewhere in the synthesizer. The effect is only slightly noticeable on 50MHz, and virtually absent on the 432MHz plot, taken by beating down the transmitted signal to one of 1MHz within my analyser capability. Of course I had to ensure that my own beat down local oscillator was clean, and I used my extremely low noise muTek 432.2MHz 35mW source.

Considering all the above factors, I have to come to the conclusion that I do not like a VHF front end that is synthesizer controlled in the manner used by Yaesu, and they would have been far better off with straight crystal controlled transverters changing the frequency down to the 28 to 30MHz band. One would then have had cleaner frequency changing and the potential of a much better dynamic range, as you could then use the RF pre-amp and attenuator switches of the main rig.

If Yaesu had designed a much better synthesizer, however, their philosophy has its advantages, for one could also have a narrow first roofing filter immediately after the first mixer, which could greatly increase the dynamic range performance by reducing intermodulation from off channel signals. However, this again seems to be a point missed by Yaesu, for you have to take the test off channel signals a very long way off channel to gain an improved input intercept point measurement.

### Subjective tests

I first used the FM mode on all three bands and obtained good reports of audio quality. When receiving FM, qual-

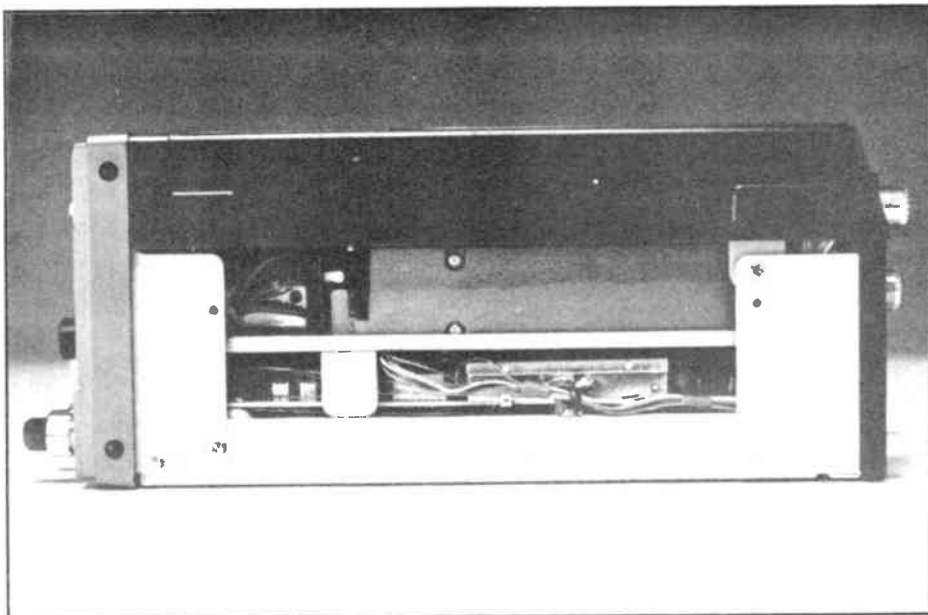



# G3OSS TESTS

ity was again very good and sensitivity was certainly adequate on 50MHz, but slightly poorer than expected on 144MHz and very good on 432MHz. The endless requirement for button pushing to get repeater shifts and to cancel them was rather annoying, and I missed the much more straightforward systems on simpler rigs. It took quite a long time to puzzle out how to set up all the shifts in the various band memories so that I could get the right shift for each of the bands. To be fair, it always does take quite a time to grasp the complexities of a new rig, but I am suggesting that the Yaesu ergonomics here are a little bit too complicated. It is probably the increasingly extensive use of dual function buttons which tends to be a problem initially, especially if the instruction book is not totally clear, although this one is certainly not too bad.

On SSB the extremely poor reciprocal mixing performance was very much in evidence, and I only had to tune to GB3VHF to hear the appalling side band noise of the 767 transverter system as I tuned away from the beacon. I would describe it as great lumps of noise which could completely mask a weak DX station. Apart from this, I noticed strange Rx sprogs at  $\pm 21$ kHz or so from the GB3VHF beacon in the form of little Wrotham beacons, and various other strange carriers caused by synthesizer beats were also apparent.

I did not notice any problems that I would associate with IM products, but the sensitivity on SSB was adequate rather than good by today's standards, since turning on a masthead pre-amp made a very considerable difference to the system sensitivity, whereas it hardly changes it with my muTek installation.

I did not note any particular problems with the 432MHz transverter, which seemed to have a noticeably better sensitivity than the 144MHz one. The 50MHz transverter worked very well, and at the time of testing there were insufficient strong stations on the band to cause any RF intermodulation problems. In the band 50 to 52MHz I did notice two fairly strong sprogs, one at a subjective strength 4 being at 50.380, whilst another was slightly weaker but had a hummy, raspy sound on it at 50.676. There were very slight sprogs on the 144MHz band, but none were in an awkward place. No spurious were noted between 432 and 433MHz.

It was useful having the narrow CW filter option, for this helped pull very weak CW signals out of the noise on all three bands. The passband tuning and tone controls were also a very great help here, showing that an HF transceiver with good facilities, combined with a transverter, can prove superior to an average multimode mono band rig on its own.

Returning to FM, I found the IF bandwidth on the main rig much too wide to cope with 12.5kHz channelled stations on 144MHz, and if this spacing or even the closer 10kHz channelling is ever chosen for 50MHz, this will be a

**Fig 1** FT767/50 Tx reciprocal mixing. Carrier half division from left, and slight noise humps near centre and right margins

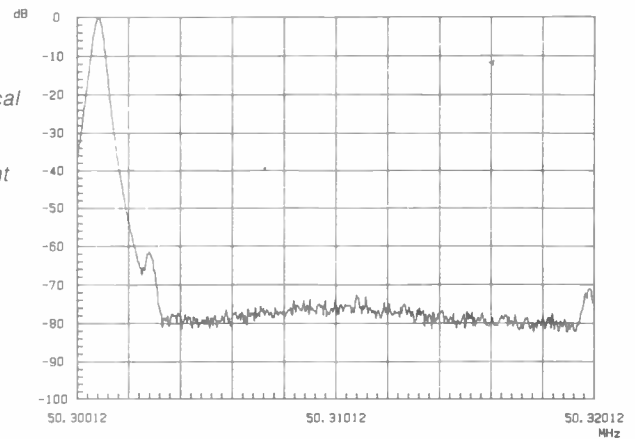

**Fig 2** FT767/144 Tx reciprocal mixing. Carrier half division from left. Note very bad noise hump at around 5 divisions from left

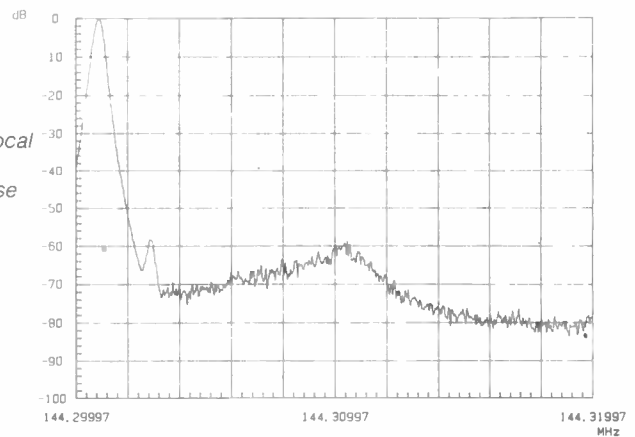

**Fig 3** FT767/432 Tx reciprocal mixing. Carrier half division from left. Excellent off-channel characteristics compared with 50 and 144MHz modules

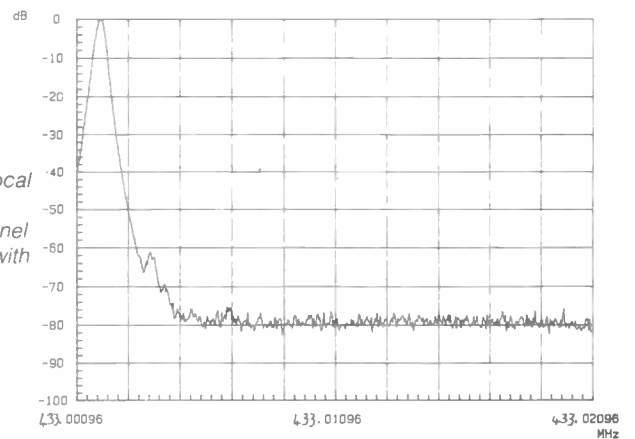

disadvantage. If you are interested in FM then I would advise you to investigate the provision of an F or G filter for the FM strip. Another minor irritation was the absence of any independent linear control relay sockets on each of the transverters, which could allow you to operate the external linears and masthead pre-amps by other than the RF sensing mode, one which can be very annoying on SSB and CW. It would have been so simple for Yaesu to have added this.

Once I had got used to all the buttons, switches and rotary controls, I found it a very fascinating rig to work, and if you just want to have all the band available at a touch (or three!), then I think you will enjoy this combination. However, if you

are interested in technical performance, then I have to recommend that you look elsewhere.

## Laboratory tests – the 50MHz unit

The RF input sensitivity measured very well on SSB, and should be good enough for any requirement, although on FM it did not show up quite so well, although it was adequate. I am most concerned about the very poor RF input intercept point measurements, which I double checked manually having taken the original ones on a computerised testing program. At 100/200kHz offsets for the interfering carriers, the intercept point of  $-34.5$ dBm is amongst the worst I have measured for any VHF rig in quite a while, for it is many dB worse even than the

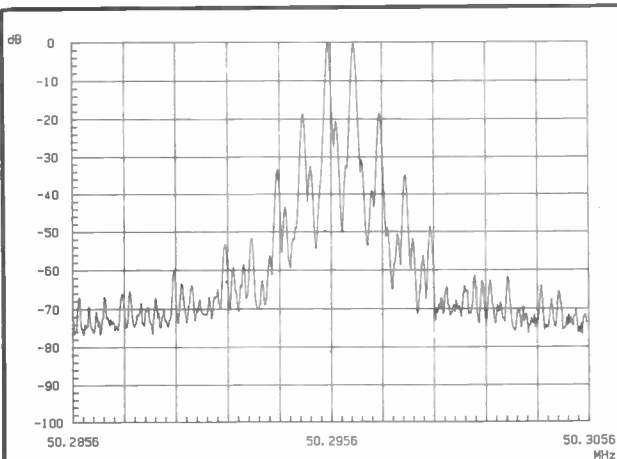

**Fig 4** FT767/50 Tx two tone test. 11W PEP 700/1700Hz tones into ALC. Resolution bandwidth 100Hz. 2kHz per division

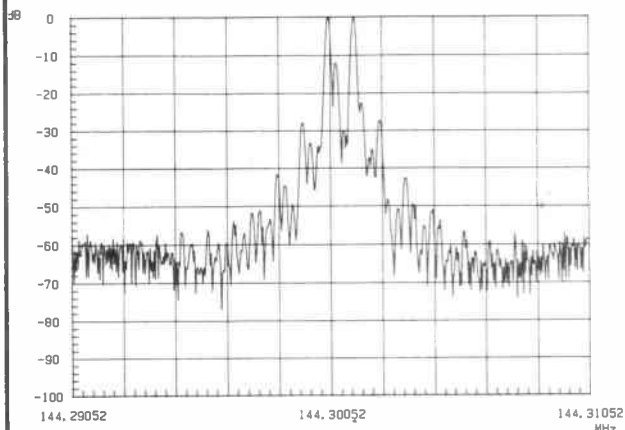

**Fig 5** FT767/144 Tx two tone test. 10W PEP 700/1700Hz. NB audio distortion. Resolution bandwidth 2kHz per division

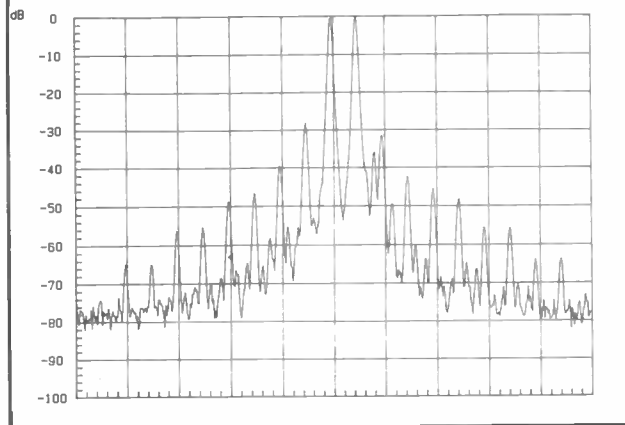

**Fig 6** FT767/432 Tx two tone test. 11W PEP 700/1700Hz tones well into ALC. Resolution bandwidth 100Hz. 2kHz per division

FT290 MkI (note that the MkII is a lot better). When I checked the intercept point with offsets at +1/+2MHz, the intercept point improved by over 14dB, becoming equivalent to that of a performance typical of earlier Microwave Modules transverters. Putting it another way, the performance close in is over 35dB inferior to a muTek/Kenwood TS940S combination.

The reciprocal mixing performance seemed to be a lot better on 50MHz than on 144MHz, and I was able to tune in to GB3NHQ, which is extremely strong, without any of the strange sideband noises showing up. On SSB the S meter gave S9 for an input signal of 3µV; a little bit too sensitive perhaps, but useful, with S1 21dB more sensitive. One particular point merits much praise: the fact that

any frequency error was less than 10Hz, which is truly remarkable at 50MHz in terms of overall receiver frequency accuracy.

Maximum power output on FM and SSB was around 11 to 12W from 50 to 54MHz. Harmonics were all below -70dBc, but I did notice some 45MHz IF breakthrough at -64dBc. FM peak deviation and other parameters are controlled by the main rig, and the maximum was just below 5kHz for 1kHz modulation.

Looking at the two tone plot taken with the PA driven into ALC, Figure 4 shows that the third order intermodulation is rather high at -19dB, and so speech transients are just slightly rough, but the products get to -60dB by the 11th order, which is quite good. As with the receiver, frequency accuracy on transmit was

superb, being within 10Hz with only an extremely small drift after a few minutes.

## 144MHz unit

The RF sensitivity on SSB measured well, although it was not quite in the same class as rigs such as the Kenwood TR751E and Icom IC275E, let alone transverters such as the muTek and Microwave Modules in front of a good receiver. On FM the sensitivity was about average, similar to that of a normal 2m FM rig. The front end intermodulation performance measured extremely well and was only 6dB inferior to the muTek.

It is most certainly good enough for normal usage, and the intercept point measured is so much better than on the 50MHz model that it leaves me quite puzzled. As on Tx, the Rx reciprocal mixing performance is very poor, a huge noise hump coming up at 10kHz offset; the figure of 65dB ratio being about the worst I have measured on a 2m transceiver. Note that the figure is actually better for a 5kHz offset than for 10kHz, which is most curious.

All the more astonishing is the fact that once you get more than 20kHz off channel, the reciprocal mixing performance becomes superb, thus showing that most parts of the synthesizer are very promising, and there must be perhaps just one area causing the problem, as in the curate's egg (good in parts).

I was a little surprised that the S meter was not as sensitive on 144MHz as it had been on 50MHz, for S9 was not reached until the input signal was at 8µV. This is rather mean and the 50MHz sensitivity would have been more appropriate, although there was 21dB difference again between S1 and S9. After a few minutes, the receiver showed just a 70Hz frequency error, and this is a small offset indeed.

The typical transmitted power across the band again averaged at around 11W on all modes. Two tone tests at around 10W PEP showed an excellent performance, better than many dedicated mono band rigs, for -60dB was reached by the 7th order. At 1W the lower orders were slightly better still, but higher orders were slightly worse, the overall result again being very good. However, you can see in the plot that some second harmonic distortion seemed to be introduced in the mic amp or modulator, and this shows up as pimples in between the two main tones.

We also checked the carrier rejection and alternate SSB breakthrough, and both of these were at extremely low levels, we did not note any particular out of band spurs on Tx. However, on Rx there was an image response from 90MHz above the band of around -74dB, which might cause a problem if there is anything strong nearby at around 235MHz.

Transmitter heat drift caused the output frequency to shift by a maximum of 100Hz from switch on over a period of 10 minutes or so, and this is an excellent performance, the output frequency



## G3OSS TESTS

never being in error by more than 80Hz. The FM characteristics were identical to those noted for the 50MHz transverter and for the main rig, as the transverters do not influence modulation on FM.

### 432MHz unit

This model had by far the best RF input sensitivity, and both the SSB and FM measurements were very good. The RF intermodulation performance was just adequate, and there was no significant difference between measurements from 100/200kHz spacings and 1/2MHz spacings. The performance should be good enough for normal use, but will not be adequate in a contest, especially if you have a masthead pre-amp on the go when there are strong local stations on the band. The reciprocal mixing performance was very good for a UHF rig and the closer in figures are very satisfactory indeed, with the far out ones showing no problem at all. They were clearly far better than those of the 144MHz transverter. S9 was reached at 5 $\mu$ V, which is an acceptable level. The frequency accuracy averaged around 300 to 400Hz in error, and there was a very slow warm up drift noted.

The typical maximum output on all modes was around 11W across the entire band. Two tone tests on SSB showed that low order intermodulation products were at quite low levels, but much further away from a carrier, high order ones were about average and acceptable. This is quite a good performance for a solid-state PA running at 11W PEP. At 1W PEP results were superb, for the high order products virtually disappeared. This rig should therefore be extremely clean on the 432MHz band, especially if the power is turned down, and it could therefore be suitable for driving a high power valve linear. After quite a warm up the output frequency was just 300Hz out, which is excellent. Note that in the transmit reciprocal mixing plot shown earlier, the off channel noise performance was excellent, thus confirming my impression that the 432MHz transverter is easily the best of the lot.

### Conclusions

I very much looked forward to testing these three transverters, for I had high hopes for them, despite my reservations noted in the original review of the FT767. Unfortunately, I can only recommend the 432MHz transverter module which is excellent on Tx and Rx, with just the slight criticism of the input intercept point on Rx. The 144MHz model has such a poor reciprocal mixing performance, judging by both this sample and one tested by a close friend of mine, that I could only recommend it for those who want 2m for local contacts, or for working slightly more distant stations that are likely to be easily audible. You will be likely to have difficulty with receiving very weak signals if there are some very strong locals around, or very strong hill top contest stations blasting away in your direction!

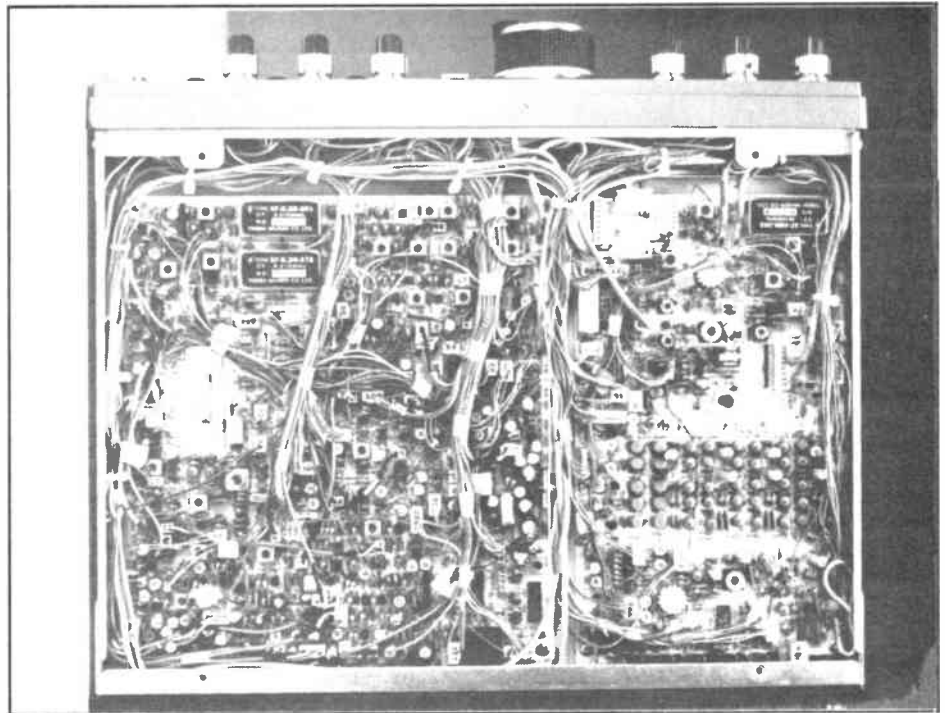

Yaesu really will have to do something to improve on the design of their synthesizers, for it is quite unusual that one can actually see the problem so easily on a spectrum analysis. The 50MHz system will be highly satisfactory if you are not likely to have very strong locals around, but I am not quite sure what will happen when we get really massive F layer propagation near the next sunspot peak. You may find that the poor intercept point will cause you quite a lot of radio frequency intermodulation.

In principle Yaesu's transverters are an excellent idea, and this is the first HF rig that I have come across into which one can plug these three bands. It is such a pity that Yaesu have not got it quite right, but hopefully there will be a MkII which will show significant improvements. I am so very sorry to disappoint

readers with this rather critical review, and I admit to feeling very disappointed myself.

Both the 50 and 144MHz transverters cost £169 including VAT, but the 432MHz one costs £215. I consider these prices to be quite obviously well worth considering one or more of the transverters.

### Thanks are due

Many thanks to my wife, Fiona, for helping with a very difficult review, and to SMC Ltd for their very great help in lending the review samples and showing a considerable degree of integrity, as they had already had one critical report of the 144MHz transverter before I asked to review it. Quite frankly, it always gives me a very warm feeling towards a company that accepts the occasional critical review without fuss.

### FT767 Transverters Laboratory Test Results

	50MHz transverter	144MHz transverter	432MHz transverter
RF sensitivity level for 12dB sinad SSB	-128dBm	-126dBm	-128dBm
RF intercept point 100/200kHz spacing	-34dBm	-4dBm (affected by RM noise)	-20.5dBm
RF input intercept point +1/2MHz spacing	-20dBm	not tested	-20dBm
Reciprocal mixing of noise floor to off channel carrier for 3dB noise increase			
5kHz	No suitable	69dB	78dB
10kHz	oscillator	65dB	86dB
20kHz	available	84dB	89dB
100kHz		117dB	109dB
RF input for S9	-98dBm	-89dBm	-93dBm
Typical max Tx power	12W	11W	11W

# YAESU FT73R

## 70cm FM handy talky



In the February 1987 issue of this magazine I reviewed the Yaesu FT23 handy talky, which is the 2m equivalent of this latest 70cm model. It is identically styled, and comes complete with a charger, carrying strap, soft case and FNB10 NiCad rechargeable battery (7.2V), and finally a twee little rubber duck only 70mm long, including the BNC plug. The FT73R weighs 430gm, and measures 55 by 139 by 32mm, excluding the antenna.

### Top panel

There are three small rotaries, one for adjusting the squelch, one for volume on/off and the third to tune in 12.5 or 25kHz selectable steps. This tuning knob rotates in very light click steps, and is very easy to use. Two miniature jack sockets are fitted for inserting an external loudspeaker mic type MH12a2b, which is available as an optional extra. A 50 ohm BNC socket is fitted for antenna

connection, and there is just one push button to select low or high power on Tx.

### The front panel

There are just eight buttons at the top of the front panel, arranged in two lines of four. One of these buttons is a function select, which causes the other buttons to operate in their second function mode. Two of the buttons allow up or down steps, and thus duplicate the knob on the top, but in the second function mode they step the frequency up or down 1MHz after the function button is depressed. You hold the button down to move more than 1MHz. Other buttons, with second functions in brackets, operate the following: reverse repeater (channel steps); tone (tone squelch set), but NB only if the optional tone squelch unit is fitted; cyclic repeater  $\pm$  shift or simplex (frequency lock); VFO/memory recall (memory write); and memory 0 direct access (priority operation).

Memory 0 is a general calling channel which can only be accessed by depressing the appropriate button. You can VFO from the call channel, which will be of very great convenience to blind operators, for otherwise this rig would almost be unusable by them. However, if you select any of the other memories (1 to 9), you cannot VFO from them, as both the up and down buttons and the tuning knob change the memory channels. The memories can store a repeater shift if required.

The rig covers the entire band from 430 to 439.9875MHz, and commercial versions will be available for use on PMR frequencies to DTI specifications. On the left side cheek are the usual rather rubbery feeling PTT and 1750Hz repeater access tone buttons.

Three different NiCad battery packs are available, the 7.2V/600mAh one being normally supplied (FNB10). The FNB9 gives 7.2V, but only has 200mAh capacity, whilst the FNB11 gives 12V and 600mAh. This 12V model allows the rig to give 5W output, whereas the one supplied gives a nominal 2W in the high power position. Various accessory chargers, dry battery packs, and a mobile dc charging and supply lead are available as options.

The front panel display indicates frequency, memory channel number selected, and basic status functions. The display was very easy to read and also includes a signal strength meter, which comes in pairs of blocks. This also acts as a power output meter, which can reassure you of the state of your batteries.

### Subjective tests

When I first tuned around the band from the shack on the ground floor, and heard a repeater, followed by accessing another, which was around 30km away,

and then accessing many others when I was on the landing at the back of the house, I was absolutely astounded at the sensitivity of the receiver, and of the efficiency of the tiny rubber duck. I had several QSOs via repeaters using the rubber duck, and my voice was said to be clear but noisy. I then plugged the rig through to my Kenwood dual band vertical collinear, which is around 35ft above ground level, and all the London and Home County repeaters were audible, and the slightly weaker ones, such as GB3BN, sounded stronger than they have done on any other Japanese dedicated FM rig.

The audio quality from the little speaker was surprisingly good, but maximum volume was very limited. Only the 7.2V battery was supplied for review, but a 12V battery would probably give a lot more audio power. Selectivity was excellent for 25kHz channelling, and I did like the ergonomics very much, other than the tiresome way of shifting several MHz up or down the band! An external loudspeaker mic also worked very well with the rig.

When I was operating with an outside aerial, the transmitted speech quality was said by several stations to be excellent, and the optimum distance of my mouth from the front of the rig was between 3 and 5cm. The rig feels quite solid in the hand, but does not weigh too much, and can easily fit into one's trouser or jacket pocket. For portability it is clearly much more appropriate than the larger FT709R.

### Good styling

Although the buttons are very small, most users would find them easy to press, provided one's finger was steady. When you depress one of these buttons you hear a reassuring pip from the rig, which is another good point. Fiona and I both feel the rig is well styled, and I enjoyed using it a lot.

One point is worth making concerning the advisability of transmitting high power into a very small rubber duck. I have discussed the radiation hazards to eyes with a top expert in the field concerning the higher power version of the rig, using the 12V NiCad, when feeding directly into the mini rubber duck. It would be normal for you to hold the front of the rig fairly close to the mouth, which would mean that the antenna would be extremely close to the eyeball. The front of the eye contains inadequate 'heat sinking', and the actual lens has no blood supply at all, and therefore can become quite warm, and eventually develop a cataract. 5W is below the maximum recommended level, which I believe is 7W, but don't forget the wavelength is rather short.



## G3OSS TESTS

Short periods of transmission should not be a problem, and at least the battery would limit longer periods! If you must use high power, then I suggest you use a longer antenna, either a quarter wave or a collinear, which would spread the field vertically, and so greatly reduce the field in the neighbourhood of the eyeball and brain. I am not trying to practice scare tactics, but I just want to make you aware of the RF hazard problem with higher field strengths.

### Laboratory tests

The RF sensitivity right across the entire band was the best I have yet measured on a 70cm FM rig, and it was around 2.5dB better than a lot of its competition. The RF input intercept point was quite satisfactory in the context of a hand-held, and I would doubt whether you would get any problem showing up. The selectivity was very satisfactory for 25kHz channelling, but was even better for 50kHz, although I suspect that the measurements were limited by reciprocal noise, and that the true selectivity was even better.

The maximum sensitivity on the S meter allowed an indication for -114dBm, with the maximum 'blobs' showing at -92dBm, thus allowing for an indicated range of 22dB.

The limiting threshold was at an extremely low level, so all audible signals were equally loud. Audio distortion for normal deviation levels was quite acceptable, but a high deviation did cause quite an increase of distortion. On 7.2V dc the maximum audio power output was very limited at only one third of a watt, and the manufacturers only specify half a watt with the 12V battery.

The reproduced frequency response from a 750 $\mu$ S pre-emphasised signal was extremely well shaped, showing a fairly steep bass roll off below 200Hz, and a moderately steep roll off above 3kHz, which is just about how I like it in a hand-held on this band, bearing in mind the channelling. The received frequency accuracy was very good indeed, and the squelch was very sensitive.

The receiver is stated to take 19mA when squelched, as Yaesu have incorporated an automatic battery saving circuit. A bleeper comes on, incidentally, when the battery voltage is below 6.5V, so it is not a bad idea to have a spare battery at hand as the rig takes a lot of juice on high power (around 1.6A at 12V, or 1.1A at 7.2V).

The transmitted frequency accuracy just after switch on was very good indeed, being only 30Hz high, but this drifted downwards by around 100Hz per minute for the first three minutes or so, after which the drift slowed down. When on long receive sessions, the frequency slowly drifted up again, but never to the original positive one. Maximum output was around 2.5W from the bottom of the band to the middle, and never fell below the specified 2W even at the very top end, even on high power; low power typically being 450mW on a fully charged battery.



The repeater shift was very accurate, and the toneburst frequency was just 3.5Hz high, which is well within specifications; the deviation being just right. Typical speech deviation was just under 5kHz peak, and I just managed to achieve 5.6kHz with a mighty big shout.

### Conclusions

I have no doubt at all that this is now my favourite 70cm hand-held, for it is compact, has a superb overall performance, offers excellent facilities and is so much better than the by now outdated thumbwheel models. It is quite clearly going to be an extremely good seller, and

perhaps it will be responsible for very many more amateurs making use of a rather underused band. I most strongly recommend purchase, for you will also find that the 70cm band is excellent, almost throughout the entire country, as there are plenty of repeaters around. It is only fair to add that I have not yet seen the Icom  $\mu$ 4, nor the equivalent Kenwood model, but I feel sufficiently confident that you are not going to be disappointed with this one. The price is £269 including VAT.

Very many thanks to Amcomm in West London for the loan of the review sample, and to Fiona for helping with all the tests.

### Yaesu FT73R Lab Test Results

#### Receiver Tests

RF sensitivity, level for 12dB sinad at 3kHz deviation	124.5dB average
Quieting at 12dB sinad point	14.5dB
RF input intercept point	22dBm
Selectivity $\pm$ 25kHz	average $\pm$ 58.5dB
$\pm$ 50kHz	average $\pm$ 65.5dB
Capture ratio	4.2dB
Audio distortion at 3kHz deviation	1.9%
Max audio output power for 10% THD 4 and 8 ohms	0.34W
3dB limiting threshold	130dBm

#### Transmitter Tests

Max Tx output power /7.2V battery	2.5W typical
Low power output	0.45W typical
Toneburst frequency	1753.5Hz
Toneburst deviation	4kHz
Max speech deviation	5.6kHz
Typical speech peak deviation	4.5kHz
Tx carrier frequency accuracy	$\pm$ 30Hz to $\pm$ 300Hz over 10 minutes or so

# DXpedition to Cocos (Keeling) Island

The opportunity to re-visit Cocos (Keeling) Island arose quite suddenly, and just as quickly I had made a firm commitment to go. Bob Winn W5KNE (QRZ DX) was very keen to taste his first ever DXpedition and although Cocos (Keeling) was a long way from down-town Texas, he would be assured of instant pile-ups. In short we were going.

The background to the invitation to visit Home Island (where the Clunies-Ross family have their family home), was the idea of forming a new radio club VN9YY. The club would have all the usual amateur radio amenities: a couple of operating positions and antennas covering all bands, which would give the station real DX capability, with RTTY and other special modes possibly being added later. Visiting radio amateurs would then be able to utilise these facilities (subject to the usual regulations) and thus experience the thrill of *being* DX.

Behind the idea was Cress, best known as VK9YC, who some years ago was very active on all bands. We had become friendly over the air, which was helped by the fact that I had operated as VK9YS on a previous visit to the atoll. He intended spending a couple of weeks on Home

Island preparing the various antennas and getting a couple of operating positions ready. Cress suggested that I should go with him, and I was very tempted. However, I was reluctant to do so for two reasons: firstly I had agreed with Bob that we would activate VK9Y and Bob only had a certain time slot available which was inflexible; and the other reason was the little matter of Peter 1st and the possibility of it being active whilst I was on Home Island. No, if I was to work the 3Y it would have to be as VK9NS.

So it was that Cress went to Cocos (Keeling) in his available time and Bob and I waited and firmed up on our dates. Bob and I would get to Home Island after Cress had left, then we would walk in, plug the rigs in and operate!

Ever notice how often 'the best laid schemes of mice and men gang aft a-glee'? The telephone rang and at the other end was Cress calling from Cocos (Keeling) – I swear he was almost in tears. His two week slog of climbing towers, chopping down trees, hanging antennas, assembling an 8 ele log periodic, and assembling and rigging a 70ft lattice tower had ended in near disaster.

The tower, complete with heavy duty rotator and beam, had been raised almost vertical. In a twinkling, something had sheared and down came the tower, a bit quicker than it had gone up. It was a miracle that nobody had been maimed. Cress detailed the situation – call the whole thing off he suggested. Perhaps in a few months time he could get back and try again to get things organised.

However, in discussion it seemed that things were maybe not so bad. The tower had not been badly damaged, in fact it had almost been repaired; a few more hours of welding should fix things. The beam was a mess, but all the main damage was to the back section of the boom and last two elements, and he thought he could get a complete back section sent up from Perth on the next plane.

So, Cress worked on, repaired the tower and stripped the mangled back section of the log periodic. That is how Bob and I eventually found it, awaiting a bit more work and that new back section. Using parts of the back section, repairs were carried out on the rest of the beam.

On arrival at Perth. John VK6JJ had agreed to meet me and help me get around during my short stop over. Since the plane was due to arrive at 3.30am, it was decided not to stretch the bounds of friendship too far – John would meet me at around 7.30am, which seemed a more reasonable time of day. The plane arrived on time, I had travelled via Sydney and Alice Springs, a distance of several thousand km, plus the Norfolk/Sydney leg of around 1000km. Luggage was available very quickly in an almost deserted terminal.

Finally I had all my cases, boxes, etc except for one! I waited in vain for the FL2100Z box to appear on the carousel. A rather pretty girl close by was going through a nail biting routine and exhibiting the usual stress systems, and I was feeling much the same as we both duly presented ourselves at the traffic counter. Forms had to be filled out with details of lost effects and so on. However, it became quickly apparent that our things had been off-loaded at Alice Springs.

I hope the girl did better than I, as my package never arrived in time. I was well on my way to Cocos (Keeling) before it finally reached Perth via Melbourne!

John arrived as promised, and although we had never met before we quickly became friends. We made a start dealing with the various things which had to be done. It looked as though we had another major hiccup: we had called into the hotel to pick up Bob, but the receptionist said that although Mr Winn had a booking, he had not shown up. Reactions were immediate and predictable, what the h... had happened to Bob; waylaid in Hawaii by hula girls, missed his plane, changed his mind?

Cocos (Keeling)  
West Island  
runway

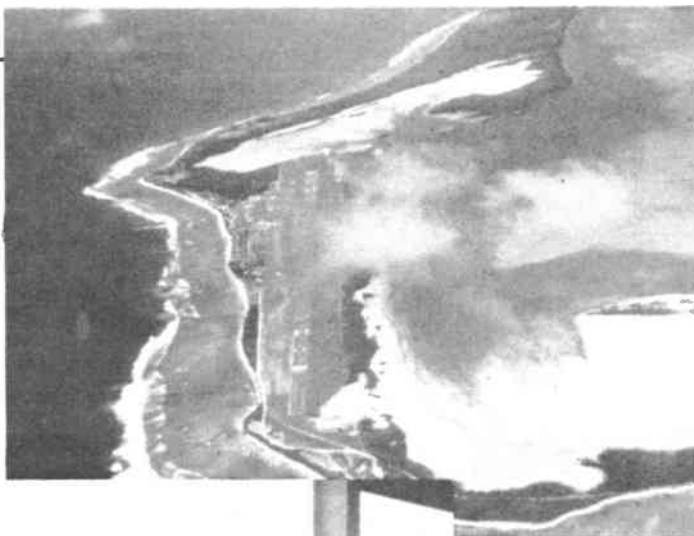

Bob Winn  
(W5KNS)  
who operated  
as VK9YW

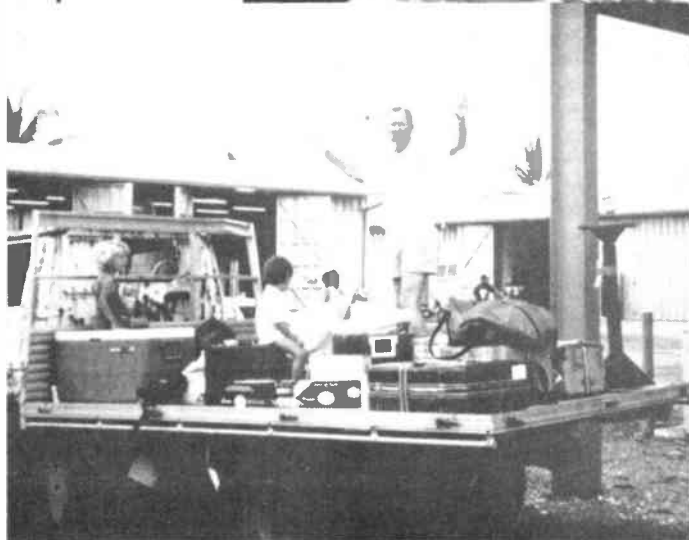



In any case I had to go through the motions and get myself organised. A courtesy visit to the Department of Communications then get my Cocos (Keeling) visa, buy my plane ticket, get my amplifier, then try to ensure that my 100kg of luggage travelled on the same plane as I was on. This might be a good time to mention that Cocos (Keeling) and Christmas Islands are served on a weekly basis by a government charter service. Perth – Cocos (Keeling) – Christmas Island one week. Then Perth – Christmas Island – Cocos (Keeling) the next. Government requirements have first call on all the available freight capability. Excess baggage can easily be left behind to make for the perfect DXpedition: operators on Cocos (Keeling) and equipment in Perth!

However, I digress – DOC was the next priority. Our arrival at DOC held a surprise: there was Bob, with outstretched hand, glad you could make it! Then John and I explained that, according to his hotel, he had not arrived yesterday. Bob gave his opinion of the said hotel! On arrival, at Perth, he had telephoned the hotel. The receptionist had told him that he didn't have a reservation and in any case they were full! John and I grinned at each other – this might end up by being one of those days!

Next in line was the visa requirement and we all duly appeared at the Department of Territories Office. There were no problems since we were both listed for the flight the next day. Our passports were handed over and then duly returned with the necessary visa stamp. To travel to Cocos (Keeling) one needs: an invitation; a visa; a return ticket; a place of abode; and a return entry permit for Australia – not necessarily in that order.

The charter ticket took a bit longer; cash was the word, no bankcards etc, so Bob had to go bank hunting. In my case I had Australian travellers cheques, so they were okay. However, I rocked the system a bit as I wanted to travel to Christmas Island after Cocos (Keeling), stay a week or so then return to Perth. As it happened the mathematics of it all was a bit too much and I ended up by being over charged. However, that was duly sorted out on my return and I await the refund.

Our next headache was baggage as I wanted my excess to go cargo rate, which was half the excess baggage rate. After quite a lot of the usual messing around, it was all left in the cargo area, and we had a fairly firm okay that it would travel with us. As events proved we were lucky, and no last minute changes occurred leading to the off-loading of excess baggage.

The rest of the day was spent relaxing and listening to John make yet another telephone call, gradually working his

way up the available hierarchy of the airline company, trying to get a firm promise for delivery of the missing linear. However, it was finally delivered by taxi to John's house some two hours after we had left Perth.

Next morning the VK6JJ shack looked empty as John removed his FL2100Z. Hurriedly wrapped in an old bed cover for maximum protection, I would carry it as hand baggage! John meanwhile threatened me with a fate worse than death: 'If you lose it, break it, bend it or otherwise damage it . . . I will be very annoyed', or words to that effect! Seriously though, many thanks John, it is not the easiest thing in the world to lend ones ham gear. Without his generosity the DXpedition would have been less successful.

Finally we were checking-in, and the girl behind the counter was very brusque and un-smiling. Efficiently she took my two tickets and passport – it was difficult to ask her what she was doing, her look and reaction had me frozen to the floor. It was quite obvious that I was very stupid to tell her that she had removed my means of getting back to Australia from Christmas Island. Not to be outdone, why had I given her two tickets? When I

pointed out that she had to ensure that I had a return ticket, things looked grim.

Whichever way one looks at things one never really learns. It was a tactical blunder of the highest order. My hand luggage had to be no more than 4kg. The excess baggage, including the linear, was calculated to the nearest three decimal points. But finally we were on our way, and I think John was looking forward to a normal life again.

The flight to Cocos (Keeling) was a leg of about 2,700km, and it turned out to be very comfortable and pleasant. All the hassles of the last few days were behind his, and Bob and I caught up on reading and talking DX. Finally, our destination was near and we reached for our cameras in readiness. Soon we were looking at the Cocos (Keeling) atoll and clicking away with cameras. When one considers that the atoll is only 10 feet asl, it is easily understood why it used to be so difficult to find when arriving by sea. In the old days it was often the appearance of birds making their way home at sunset that led the way. However, in these days of satellite navigation and computer controlled flight paths, these remote destinations appear dead-ahead on track.



Ground problems were overcome by additional ground stakes

After all the hard work this was the final operating desk of VK9YS

A partial fly around showed the beauty of the lagoon and the weather side of steady surf in great detail. The colour range is tremendous, ranging from white to deep dark purple with all the range of blues and turquoise in between. Soon we were at the terminal, and John and Vicky Clunies-Ross were there to meet us. We all adjourned to the community recreation hall to do some more relaxing. We also had a wait ahead of us as formalities were completed and baggage and cargo unloaded.

Finally, our baggage was available and a visit to the cargo shed released our 'cargo', and after loading it on to John's truck we were on our way. Soon we were at the jetty on the lagoon side of West Island, and we had an 8km trip across the lagoon ahead of us. Another loading and unloading session had everything aboard the launch 'Merdeka', and we were on our way to Home Island.

On arrival the ham gear was carried to the ham shack area and our various personal belongings lodged in our respective bedrooms. It looked as though VK9YS and VK9YW would be a reality soon.

The next couple of days and, for that matter, almost every day of our stay were spent trying to get better organised. It became apparent that despite the efforts of Cress and John in previous weeks – there was still a lot to do.

The large brick built building was over 100 years old and had served many purposes in its life. More recently it had

been a school for the Cocos Malay children of Home Island. Four or five largish airy classrooms were on the second floor, various store rooms being on the ground floor below. Each of the old class-rooms had power points, and a couple had large substantial tables ideal for the rig, keyer, linear etc. Bob and I decided to operate in separate rooms and quickly made a simple rule: no band change without notification to the other. This is the best insurance I know to avoid possible damage to receiver front ends. It was also a good decision, as often I was on SSB and Bob on CW, or vice versa. There was little distraction to operating, unless one counts the lagoon outside and the swaying palm trees!

Outside one 60 foot tower carried an 18/30MHz 7 element log periodic (about 3 or 4 years old). Several other antennas were anchored to the tower at a lower level. A 40m loop, and a full sized G5RV were also available. The other end of the 5RV ended in the trees. The other tower lay along the ground at right angles to the building, which in due course would have to be raised.

Neither of us had problems in assembling our respective stations. I had brought my Icom 740 (used on Heard Island) and soon had the station ready to go. The operating position was going to be comfortable and there was plenty of room for logs etc. However, it soon became apparent that grounding was a problem, and that being on the second floor was not the best idea. An immediate

stop and a couple of hours later had two separate grounds installed using 6 foot galvanised star pickets. These were driven in by John using a power shovel. Short heavy duty wire connected this ground up to each operating position.

Soon it was realised that the 18/30MHz log periodic beam was pretty useless. John climbed the tower, and we soon had the beam on the ground. In the seven element beam we had at least 10 disconnected element sections, the balun was a mess, which at least confirmed the diagnosis. Some hours later every one of the elements had been pulled apart, cleaned and reassembled. In addition the old balun was discarded. I opted for the old and reliable co-ax RF choke technique to feed the beam. Soon after the beam was back up again pointing North, and an immediate pile-up was the result. In fact thousands of contacts were made on this beam on 15m and many on 10m. Its limitation was now the lack of 20m capability and that it was fixed.

As the days went on I climbed the tower again and again, gradually working my way through the defunct 'Armstrong System' freeing and greasing each bearing point. Finally we had a beam which could be turned through about 300 degrees - a vast improvement over the previous situation.

Meanwhile, it was found that the parts for the other beam had not arrived with us as promised. An error had been made in Perth and the box had been delivered to the wrong cargo shed. However, the beam parts duly arrived on the aircraft the following week, along with another 100 metres of co-ax.

Gradually contacts were being made and totals increased, both of us stuck to the same frequencies each time, whichever bands we worked. There was quite a bit of mutual interference mainly due to antenna coupling, as all the antennas lead back to the same mast. But bit by bit improvements were made, increasing antenna separation, and a 20m dipole was erected by Bob. I had already built a 20m ground plane and mounted it on the roof of the building.

Throughout the week the rigging of the other mast was checked, guy points laid out and holes dug and tie points concreted in. John laboured hour after hour on these and other jobs, and I think I heard him mutter bl.... hams occasionally! Finally it was the weekend and Saturday was the tower raising day. The beam was not ready, but that could not be helped. The raising of the tower, complete with half beam and rotator, became a simple exercise. Plenty of people, adequate guying and a power vehicle to pull the mast vertical. However, John and I had our moment of disagreement. I did not agree with the half beam being put on top as I thought the stress would be considerable due to the gross imbalance. In addition I thought that it would be an impossibility to mate the two sections of the boom when the back section became available on Tuesday.

However, John was confident that it could be done and a couple of hours later

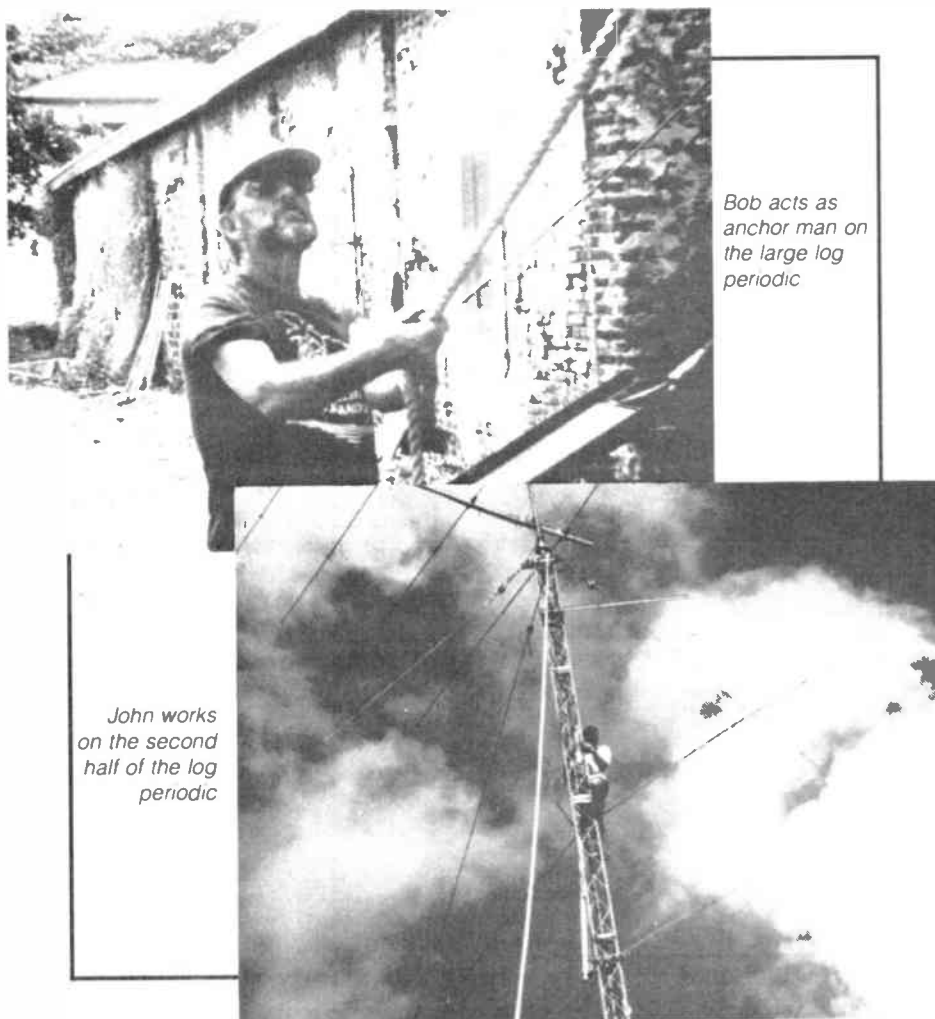

Bob acts as anchor man on the large log periodic

John works on the second half of the log periodic



the tower was vertical. It became a matter of tidying up, collecting tools and so on while we looked forward to getting the other half of the beam. Meanwhile, a counter-weight was installed to balance the strain of the incomplete beam atop the rotator on this new tower.

Having the other tower was really very good, and a further moving around of antennas enabled station separation (in an antenna sense) to be greatly increased. An 80m sloper was built and the full sized G5RV was moved and its centre put at around 65 feet, and it worked very well. In addition an inverted L for 160m was installed, but not matched.

By this time the routine was fairly well established.

The morning call to prayer for the Muslim Community of the Cocos Malay Kampong was a great wake up call. Almost without fail every morning I appeared on 80m in time for the sunrise slot. Most mornings I would switch on and people were already calling me. As possibly the only sour note of the whole operation, I must comment on the behaviour of the European stations on 80m. In retrospect there is no real excuse, VK9YS had superb 160m and 80m capability with an experienced DX operator, and yet I was driven off the band on several occasions.

Split frequency operation was quite difficult due to multiple slots occupied by various broadcast and other stations in the area. You try telling the pile up 'I am listening 3785 to 3793 but don't call on 3786, 3788 and so on'. So called top DX 80m operators would not get off my frequency. I think it fair to say that VK9Y would be more rare DX than say EI or ON.

The big-guns liked their daily QSO and having worked me on 80m wanted me on 160m, in the same sunrise slot of course. 7 QSL cards from a well-known ON4 low band DXer leaves me angry and upset. That 5kHz slot is very small, and I can only comment that thankfully I don't chase 80m DX in Europe. Still, despite it all many low band contacts were made and there is tremendous potential from Cocos Island. Disappointing though was the low number of USA contacts.

160m was very rewarding and easy since I used CW most of the time and I often regretted not having worked more CW on 80m, but it was almost impossible to find a decent CW channel due to broadcast QRM. It was very exciting for me to work things like GM, SP, HR, GI, DL and so on 160m, all with those few magic minutes of propagation, then silence until the next morning. 40m was a good band, but I never found the secret combination that would let me work split to the USA on SSB on a continuous basis. From 7150kHz up through the hundreds of broadcast stations there is hardly a clear spot, I even tried listening around 7280kHz one day. Maybe much of it was cross modulation products in the receiver. However, I have always thought that the Icom 740 was pretty good in that respect.

RTTY operation was an amazing experience. Since I acquired a computer a couple of years ago my typing has

improved and I now use more than one finger. In fact I am proud to say that my typing has improved 100%. However, I was quite unready for the RTTY pile-up and I could have worked many more stations had the available time not been so limited. Judging by the comments already received with QSL cards, many were very happy to work a new one on RTTY (sounds familiar somehow).

The back end of the beam appeared on the Tuesday plane and Bob and I set to work to assemble the two element back section. As the section grew in size, Bob and I realised we had a major undertaking on our hands. Without the sheer determination and physical strength of John, and the efforts of Bob and I the beam would never have been completed. After two days of solid hard work and a great deal of frustration and one more attempt, John lodged the back section of the boom into the existing front section. We held our breath and it took several more hours before the boom was completely mated and as long again to undo a hiccup in the phasing lines. Finally, with the beam pointing North, the co-ax was plugged into the rig and it sounded great. A quick SWR check found it was very flat across 20m, 15m and a great deal of 10m. It was going to be handy antenna with today's solid-state transceivers.

Sometime previously I had discovered that the transformer in the beam controller had burned out. Brand new on switch on, a burning smell and a blown fuse signalled trouble. I had already removed the transformer, stripped the core and counted the turns ready to rewind if I could get some wire. John took it over to a friend on West Island who kindly rewound it, but for some strange reason decided to test it. There was a loud bang and a cloud of smoke. I asked John how his friend had tested it with no iron core fitted!

I had seen a couple of old reel to reel recorders lying around and with John's permission salvaged a power transformer. By applying 240 volts to the 190 volt primary tap I got the needed 50-0-50 ac for the rotator. A used car battery with about 9 volts showing was used to supply dc for the indicator.

We were not quite home and dry yet though, the rotator did not work and finally I diagnosed a broken rotator cable. Once more up the 70 foot mast, I un-plugged the cable and brought it back to the shack. Two wires were open circuit

and I was sure the cable had been pinched when the mast fell during the first attempt to raise it. I took off the plug at the rotator end and two wires were disconnected (this may have been the cause of the original transformer burning out). Half an hour later, with the plug completely remade, I climbed the tower yet again. Shortly after we were in business, one more climb to tighten the beam to the rotator clamp with the beam and indicator on North. As far as I remember that was the last time I climbed that tower.

All that remains to be said is that a beam with a rotator and beam indicator is capable of magic, and with only a couple of days left it worked well. It made up for much of the hard work and I simply lost track of the times I climbed both towers, lost track of how many times Bob and I stopped operating to do a bit more antenna work, or yet more re-organisation. Finally with some 18,500 QSOs between us on 6 bands, CW, SSB and a bit of RTTY, it was all over.

I packed the rigs and all the rest of the bits and pieces ready for the trip out in a few hours time, and climbed into bed about 0430 to grab a couple of hours sleep. As a last laugh, as I was tidying away odd tools and plugs etc, in a box I found a reel of 27swg enamelled wire exactly right for the controller transformer. Amazing isn't it?

Bob was on a tight schedule and I was highly tempted to stay another couple of weeks. Two weeks of un-interrupted operating would have worked wonders. We now had a station with great all band capability. However, my next stop was Christmas Island, perhaps Bob and I had done our share. Let the others who follow do some more and VK9YY will have tremendous DX Potential.

Thanks are due to Cress, John and Vicky Clunies-Ross, John VK6JJ, Heather VK2HD, Ken VK5QW, Kan JA1BK, Gin JA1ACB, to Kirsti for her patience, and all the members of the HIDXA Club.

As is usual with DXpeditions to the Pacific area, many JA stations are worked. They are without any doubt the most disciplined of the World's DX chasers. Ask a JA pile-up to stand by, it happens. Ask a JA pile-up to come in call areas, it happens. Pick up and acknowledge part of a call, most will wait until the QSO is completed. So it was that we both worked many JA stations, in fact I made some 3,138 JA QSOs.

*Rough breakdown of QSOs made from the VK9YS log*

Band	SSB	CW	Total
160m	6	82	88
80m	655	9	664
40m	481	666	1147
20m	3961	1154	5115
15m	1762	1217	2979
10m	219	8	227
	7084	3136	10220
RTTY			87
			10307

# 2 NEW MOBILE MASTERPIECES

## IC-900 Super Multiband FM System.

This new addition to ICOM's Ham radio equipment is a multiband FM transceiver system that allows the mobile operator to customize a communications system for his favourite bands. Up to 5 optional band-units can be installed with the IC-900 for instant access to a wide range of frequencies from the 28MHz HF band to the 1240MHz UHF band. Only a small remote controller is necessary for control of all these bands. A flexible optical fibre is used between the Remote Controller and the Interface Unit. The IC-900 has independent, full duplex capability on all bands, providing simultaneous receive and transmit operation. The function display on the Remote Controller shows two separate operating frequencies simultaneously. The IC-900 system transceiver is equipped with 10 fully programmable memory channels in each Band Unit. The system can therefore store up to 50 different memory channels.

This revolutionary new concept in Multiband operation is available from your ICOM dealer. Also feel free to contact ICOM (UK) LTD for assistance or information. The IC-900 Multi-band system consists of a Remote Controller, Interface Unit A, Interface Unit B and a series of specially designed Band Units.

UX19	28—30MHz	10 watts
*UX59	50—54MHz	10 watts
*(No mobile operation allowed in UK)		
UX29	144—146MHz	25 watts
UX29H	144—146MHz	45 watts
UX49	430—440MHz	25 watts
UX129	1240-1300MHz	10 watts



## IC-1200, 23cms FM Mobile.

To complete the range of VHF UHF FM Mobiles this new model is now available for the 23cm Ham band, it is based on similar features to the already existing IC-28E 2m and IC-48E 70 cms mobile units. This Mini-mobile transceiver will fit easily anywhere in your vehicle or shack. Power output is 10 watts or 1 watt low. The IC-1200 is so new we do not even have a picture of it, however, the large front panel LCD readout is designed for wide angle viewing and front panel controls are straightforward to make mobile operation safe and easy. The IC-1200 is a superb example of ICOM's dedication to exploring new communication equipment.

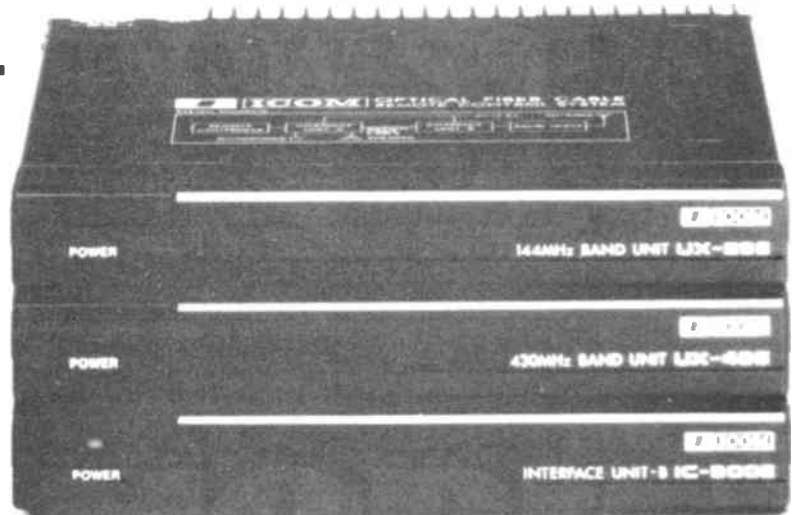

Telephone us free-of-charge on:

**HELPLINE 0800-521145.**

— Mon-Fri 09.00-13.00 and 14.00-17.30 —

This is strictly a helpline for obtaining information about or ordering ICOM equipment. We regret this service cannot be used by dealers or for repair enquiries and parts orders. Thank you.



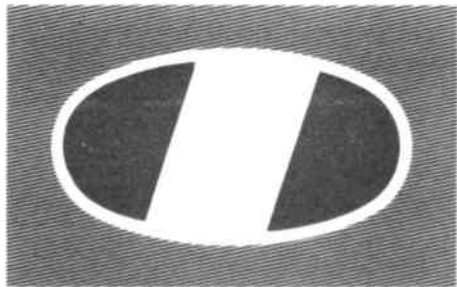

# ICOM

# Communications

### VHF/UHF FM Handportables

If you want a handheld with exceptional features quality built to last and a wide variety of interchangeable accessories, take a look at the ICOM range of FM transceivers all ICOM handportables come with a nicad battery pack AC wall charger flexible antenna and wrist strap

### Micro 2E/4E

These new micro sized 2 metre and 70 centimetre handportables give the performance and reliability you come to expect from ICOM

Measuring only 148 x 50 x 30 the Micro fits in your pocket as easily as a cassette tape The Micro 2E/4E features an up/down tuning system for quick frequency adjustments 10 programmable memories a top panel LCD readout up to 2.5 watts of output (optional)

### IC-2E 2 metre Thumbwheel Handportable

This popular handheld from ICOM is still available For those amateurs who require a straightforward and effective FM transceiver the IC-2E takes some beating Frequency selection is by means of thumbwheel switches (with 5Khz up switch) simplex or duplex facility Power output is 1.5 watts or low 150 milliwatts (2.5 watts possible with BP5A battery pack)

### IC-02E/04E 2 metre and 70cm Keypad Handportable

These direct entry CPU controlled handhelds utilise a 16 button keypad allowing easy access to frequencies memories and scan functions Ten memories store frequency and offset these handhelds have an LCD readout and power output is 2.5 watts or low 0.5 watt 5 watts is possible with the IC-BP7 battery pack or external 13.8v DC

### IC-12E 23cm Handportable

Similar in design and style to the 02E/04E this 1296Mhz handheld utilises ICOM's experience in GHz technology gained by the excellent IC-1271E base station Power output is 1 watt from the standard BP3 nicad pack external 13.8v DC powering is available to the top panel jack With the growing number of repeaters on 23cm The IC-12E makes it an ideal band for rag chew contacts

**ALSO AVAILABLE FOR ICOM HANDPORTABLES ARE A LARGE RANGE OF OPTIONAL EXTRAS INCLUDING A VARIETY OF RECHARGEABLE NICAD POWER PACKS, DRY CELL BATTERY PACKS, DESK CHARGERS, HEADSET AND BOOM MIC, LEATHERETTE CASES AND MOBILE MOUNTING BRACKETS.**

You can get what you want just by picking up the telephone Our mail order department offers you free same day despatch whenever possible instant credit interest free H P Barclaycard and Access facility 24 hour answerphone service



## Datapost



**ICOM (UK) LIMITED**  
Dept AR, Sea Street,  
Herne Bay, Kent CT6 8LD.  
Tel: 0227 363859.

# SHORT WAVE LISTENER

TREVOR MORGAN GW40XB

Obtaining your amateur radio licence is the accepted step up from being a short wave listener. However, this does not mean that every listener should become a licensed operator, nor that licensed operators should then become such to the exclusion of everything else, including their previously enjoyed listening. There are very many operators today who have never had any listening experience, but there are many more who first entered the hobby by way of short wave listening. At one time this was the accepted norm, but seems to be less so nowadays.

Over the past couple of years I have received many letters from newly licensed amateurs stating that their time spent listening has helped them at examination time, or been useful when they've been struggling in a packed band. Technical aspects aside, there's no doubt that through developing a good listening technique during a period when bands are not at their best can pay dividends when working the DX.

Just listening to some operators calling CQ constantly while stations are trying to break in and make a contact can be infuriating. This is quite different to hearing an operator pausing for any callers and then making his call again, in which case he is obviously just not able to hear distant or low powered signals. This may be due to equipment, aerials or conditions that may be affecting him. There's a whole world of difference between him and the chap who just doesn't listen!

Watching operators in action can frequently reveal the ex-listener by the way he scans the bands slowly and deliberately, pausing at the slightest trace of a signal and waiting to hear if it is another station or just one of the other noises that clutter the bands. These techniques pay off in contests particularly and you

can often see familiar names in the top scorers.

Whether you intend taking your examination in the future or not, a good listening technique is one of the most important things you can develop. One of the keenest listeners who has written to me over the years has never yielded a soldering iron in anger as he has no interest in the 'mechanics' of radio, yet he is constantly at his receiver or fiddling with his aerials to get the best from it and has a room full of awards. He has no desire to take his licence and says he hasn't the 'know how' to pass the exam. He's been listening since the days of cats' whiskers and yet probably knows more about DXing than many top operators. As he puts it, 'I'm a contented listener, happy with the hobby I took up over fifty years ago'. And I can't say better than that!

The G-QRP club caters for those people interested in operating at low power. In the United Kingdom this means using a dc input of 5W or less to the final stage of the transmitter. However, this side of the hobby is not exclusive to the licensed operator and many listeners send valuable reports to QRPers who appreciate accurate reports of reception of their miniscule signals.

The recognised areas of operation on low power CW are 3.560, 7.030, 14.060, 21.060 and 28.060, and these frequencies are usually buzzing with activity day and night. Naturally, many of the stations you will hear will be within this country or Western Europe, but the DX is often there when you least expect it. I often work into the United States on low power and have had reports from Russia on my signals when doing so, so QRP does get around.

If you want to know more about this aspect of listening, why not drop a line to Rev George Dobbs, St Aidan's Vicarage, 498 Manchester Road, Rochdale, Lancs OL11 3HE, who can let you know

more about the G-QRP club.

So, to this month's mailbag. I was very pleased to hear that Dave Howes of Rochester has been demobbed from Maggie's army. However, his period of leisure was not wasted as he now has the Gozo award to add to his collection. He is currently awaiting the arrival of a card from JY1 (King Hussein of Jordan) to really make life worthwhile! Apparently, my review of the Hamgear preselector recently relieved his pockets of some beer money, but he says it was well spent, but he would have liked a co-ax connector and switchable mains input – no pleasing some people!

George Jacob of Cardiff is a newcomer to the hobby who has a very nice set-up: the R2000/VC10 with an end fed wire tuned by a KX3 ATU. George is interested in the broadcast bands and air bands as well as amateurs, and is also keen on getting into the marine areas. I have suggested the discone as a good aerial for the VHF/UHF sections. The discone is a fairly small aerial and can be roof mounted with ease and has a wide band coverage. For the SWL version, it's not usually too expensive either.

Keith Chapman of York is another newcomer to the column, but has been a keen operator on 934MHz. He comments that parts of the VHF/UHF spectrum could well become PMR unless the amateurs use them more frequently. I don't know what things are like in York, but 2m in Swansea is very sparsely used. However, there is much greater use made of 70cm. Keith mentions that the content of QSOs on the higher bands seems to be much more 'social' than on the HF bands... bet he's been listening to contests!

Luciano Marquardt of Hereford mentions some nice ones heard recently, including SV0AC/SV9, KQ8U, PY2GOU, YV8DQ, A61XL, SV2WT, KP4AM, CR6UA and A4XKC on twenty and 6W6JX, KM5X and HK6DOS on fif-

teen. Luciano also queries the details of the prefix awards presented through this column.

For those who have joined us recently, the *Amateur Radio Prefix Awards* are presented for having logged 250 (Bronze), 500 (Silver), 1000 (Gold) and 2000 (Premier) amateur prefixes. The definition of a prefix is that part of the callsign that signifies the location of the station, ie G, GW, GI, GD, GM are all separate prefixes, and these are also sub-divided by numbers so that G1, G2, G3, G4 etc are also counted separately. Some countries use a prefix with a number in it, such as A4X or 4X4. The best list of prefixes to use as a guide is Geoff Watts *Prefix, Country, Zone List* which is available for £1 per copy and is updated regularly.

To claim an award, you submit a list of the required number of prefixes, date, time and frequency heard on. It is not necessary to send log sheets or QSL cards. Computer loggings are acceptable. Remember, each prefix will only be accepted *once* per list and lists are cumulative, ie the first 250 goes towards the 500 and so on. There are no fees for the awards, but please send a first class stamp for the return of your certificate or trophy! *Do not* send envelopes. Lists will be returned with the awards unless you say otherwise. Send your claims to *Amateur Radio Awards*, 1LA, 1 Jersey Street, Hafod, Swansea SA1 2HF.

That brings us nicely to this month's claims, and they are both from Trevor Newstead 1LA098, of Morecambe, who claims both Bronze and Silver Awards for 20 metres only! Despite the agony of studying for the RAE and taking the exam, Trevor had time and patience left to find AA4, AH6, AL7, AP2, CS3, CU3, K2AAA/CU7, CX9, C31, FF6, HH2, HL86, I2DMK/P/ID9 (Ealie Is), JW8, LY7, PP5, PZ8, SV8CS (Zande Is), TV6EA1 (Brescou Is), VP2, VP9, VQ9,



V31, YT3, YZ6, 8P6, 9K2 and 9T4 amongst a very impressive list. Now all Trevor has to do is pass the Morse test.

A couple of months ago I mentioned a 'phone in system' for getting news of possible DX. I now have the full details.

The *DX News Sheet Voicebank* is a British Telecom service paid for by the RSGB as a service to DXers. There are two numbers – one is for incoming calls for you to leave your message and the other is for you to hear messages already on the recorder. The system accepts up to 48 one minute messages, which are retained for 72 hours unless deleted by the controller, after which they are erased automatically. The idea is to supply a regularly updated DX news service, and those using the input are asked to keep items to news of rare DX or urgent information.

Dialling 01-725 7373 gets you into the system on the receiving side only and allows you to hear the current information. Trying this for the first time, I found that the system seemed to be working very well and there were some very inter-

esting items on the recording about DX actually being worked only 30 minutes before I rang. If your phone is in the shack and you hear of some choice DX being worked, it would be a simple matter to quickly tune in and log some good stations.

The service is excellent, but the cost per individual call could be horrendous if you are a really keen type living well away from London. The only real alternative is to get listening... *Hard!*

A short time ago I saw an advertisement for a 'new' aerial. As it was intended for the SWL, I decided to get hold of one to try out. The aerial is called the 'Royal Blue' and is a folded dipole made from alloy tube. It is stated as being suitable from 2-30MHz and it is recommended that it is fed with 50 or 75 ohm co-ax. It is also claimed that the aerial is useful for the 'flat dweller'.

The aerial is supplied with a mast clamp for masts up to 2in in diameter, and a short boom to offset the aerial from the mast by about a foot. The coaxial cable connector housing is of the standard plastic dipole type. As previously stated, the aerial is

intended as a small space alternative to a full sized aerial. However, it is over six feet long, but would stand in a corner of a room or lay on top of a wardrobe in a flat.

For test purposes, the aerial was set up on top of a ten foot mast that was being used to tune up a mini-beam, so was conveniently sited by the shack. It was also tested in the shack, just standing in a corner. The receiver used was the FRG7700 with ATU which enabled A/B comparisons to be made. The G5RV was used as a reference.

A signal was found on 20m from UA3CR in Moscow who was putting in a 5/8 signal to the main station transceiver. The FT7700 was tuned to the same signal and an S8 signal was also recorded on the meter. Switching to the Royal Blue had me thinking that I had disconnected the aerial somehow as *nothing* was heard, save for background mush!

I checked all the leads and tried the G5RV again with the same result. UA3CR was still there with S8. Once again I switched to the Royal Blue with the same result. I began very slowly trimming the ATU

and suddenly it was there. S7 on the meter! Apparently, the Royal Blue has a very narrow bandwidth so precise tuning is necessary. The same method was used to receive on other bands with the same results. The Royal Blue was consistently down between one and two points from the G5RV. Due to the difference in size, I suppose this is to be expected anyway.

The aerial was then brought indoors and the whole procedure repeated. Signal loss was more marked, being 2-3 points less than the G5RV, but it did receive pretty well. The cost of the Royal Blue is £25 and the materials used probably take up a good portion of that, so it's not really bad value. However, I suggest you try the old 'wire around the picture rail' ploy first as this often brings good results and this aerial does not exactly blend in with the furniture for indoor use. As for external use, I think a good vertical ground plane would do just as well or even a helically wound vertical.

Well, that's it for this month. Have a good month on the bands and plenty of exotics. 73, Trevor.



The popular, sub-pocket size now comes to three Circuitmate meters making them extra handy for the service engineer

The DM10 has a DCV range of 200mV to 1000V, ACV of 200V and 500V, DC current ranges 200µA to 200mA and resistance ranges of 200ohm to 2 Megohm. Plus a diode test function. All at remarkably low cost

## SMALL IN SIZE BRILLIANT IN PERFORMANCE

The DM15B and 20L extend the ranges and add a continuity test with beeper. While Model DM20L also has a 20MHz logic probe to detect 25ns pulses and measures transistor hFE. Ideal for bench or field, these mini multimeters reach the heights of performance but don't step into the depths of your pocket

Like to hear more? 

**Beckman Industrial**  
*INSTRUMENTS of NOTE*

Beckman Industrial Ltd, Queensway, Gurnthorpe, Wakefield, Wetherby, West Yorkshire LS23 7BQ. Tel: 0592 753811 Telex: 72145



# AVAILABLE APRIL

4th EDITION OF

## U.K. LISTENERS CONFIDENTIAL FREQUENCY LIST

LARGER, SMARTLY BOUND  
with semi-stiff cover.

Completely revised:- Now includes even more  
information on MILITARY, CIVIL, AIR,  
MARITIME, PRESS BULLETINS, RTTY etc.

**£5.95 + p.p 75p**

**4 PUBLICATIONS  
YOU SHOULDN'T BE WITHOUT!**

### UK LISTENERS CONFIDENTIAL FREQUENCY LIST LATEST EDITION

This publication has now sold well over 2500 copies since it was advertised only a few months ago. Now the recent updated version is selling even better. No self respecting listener should be without a copy. If you enjoy exploring the short wave bands then this publication will add to your enjoyment. It covers the hf spectrum from 2 to 30 MHz and gives details of transmissions outside the amateur bands. Specially designed for the UK and European listener it sets out in a very easy way a comprehensive list of hundreds of interesting transmissions that will keep you occupied for days on end! Only a fraction of the cost of other similar publications it contains details of Marine, Air, Military, Embassy, Press and News agencies. Many listings have time schedules included together with comprehensive RTTY details. It tells you the frequencies used by civil and military aircraft whilst flying the Atlantic, when and where to pick up the press bulletins, long distance marine traffic etc and much more. Send today for your copy of this worthwhile publication.

**£5.95 p&p 75p**

### NEW 4th EDITION VHF-UHF AIRBAND FREQUENCY LIST

This frequency manual is without doubt the most comprehensive list of VHF/UHF aircraft listings available in the UK. Of vital importance to the airband enthusiast or indeed any keen VHF/UHF listener it sets out in a very easy to follow manner full details of a whole host of stations. Every known UK airfield quencies, etc. Included are Civil, RAF, USAF, MOD, Naval fields on both VHF and UHF bands. There are also air to air frequencies, the Red Arrows frequency, and much more. Send today for your copy and find out just how much you have been missing!

**£5.95 p&p 50p**

### THE COMPLETE UHF-VHF FREQUENCY GUIDE 26-2000 MHz

Many listeners have asked for a guide to the wide VHF/UHF spectrum and to meet this request we have recently published this frequency manual. It covers the range 26 to 2000 MHz and has been specially prepared for the UK listener. Anybody who has used a scanning receiver will know that the wide frequency range involved means that it is difficult to know exactly where to listen. This guide takes all the guessing out of monitoring. It lists all the services throughout the spectrum together with both simplex and duplex frequency splits. If you've spent your hard earned money on a scanning receiver or are considering buying one you'll find that this publication contains a wealth of information that has previously remained un-published!

**£4.95 p&p 40p**

### HF OCEANIC AIRBAND RADIO SUPPLEMENT NEW SECOND ADD.

Prepared in response to many requests for more information about the air traffic on the hf bands this little guide sets out to explain to the beginner how the hf band works in relation to air traffic. It contains full details of the world aircraft frequency bands in the range 2 to 23 MHz together with control frequencies and those commonly used for Oceanic control. Also included are many VOLMET frequencies, the Search and Rescue frequencies used by RAF helicopters and Nimrods, the Hf RT network, London Company frequencies, European control centres etc. An ideal companion for the hf airband listener. Send today for your copy.

**£2.95 p&p 35p**

**WATERS  
& STANTON  
ELECTRONICS**

18-20 MAIN ROAD, HOCKLEY, ESSEX - 12 NORTH STREET, HORNCURCH, ESSEX.  
MAIL ORDER TO: 18-20 MAIN ROAD, HOCKLEY, ESSEX TEL: (0702) 206835





# BITS TO BUILD

## CASING THOSE PROJECTS BY REV G DOBBS G3RJV

From time to time I have been invited to judge construction competitions at local radio clubs. Very good occasions they are too – radio clubs which do not have an annual construction competition ought to think about one. It is always difficult to make such judgements, and like any judge, I feel likely to make a few friends and a lot of enemies.

One of the most difficult judgements is to choose between function and appearances. Some items are things of beauty: finely finished and aesthetically pleasing to the eye. Others are rough and ready: barely finished and crudely housed. So often the beautifully turned out items prove to be light on electronic content and originality and the crudely finished projects interesting and innovative pieces of radio equipment. What does the poor judge do? The builders of beautiful equipment are proud of their products and they look obvious winners, but the ugly sisters on the display table may be more worthy of recognition.

I automatically sympathise with the fine electronic items crudely housed, because my metalworking leaves much to be desired. It may be my lack of skill, but in truth when I have succeeded in getting a project to work well, that is the point at which I get my satisfaction. I often regard the final housing of the circuitry as an inconvenience rather than an enjoyable part of the process. So, it has not been a small source of satisfaction, not to say amusement, in recent years when some items of my homebuilt equipment have been praised for their smart appearance.

### The lazy constructor's guide

What has happened is that over the years I have been building radio equipment for pleasure and I have stumbled into methods of housing equipment

which require the minimum of effort and skill. I felt that perhaps some of the readers of *Amateur Radio* would like to share some of these ideas, and in order to do this I will describe the mounting and housing of a small unit I have recently added to my operating table.

The first essential is a sturdy and smart box or case to house the circuitry and provide the mounting for external controls. In the past I have spent many frustrating hours working away on ill fated pieces of aluminium in attempts to produce an acceptable case. I have called this 'aluminium GBH'! It is, indeed, a thing of the past because I have not made a case of my own for several years. I had always assumed that commercially produced cases were outside my price range and limited in choice. However, in recent years I have come to make almost exclusive use of that excellent little

company Minffordd Engineering, which makes a very comprehensive range of boxes and cases suitable for the amateur radio constructor. Their prices are right too – I suspect I could not make my own cases much cheaper.

I had been using Minffordd cases for some time before I called on their establishment in North Wales. I enjoyed the visit because it confirmed what I had assumed: Minffordd Engineering is a small scale hardworking family business. The owner, Phil, together with his wife, Jan, do all the work themselves. The workshop is small and a hive of activity. Phil and Jan moved from London to North Wales several years ago buying run down premises and setting themselves up in light engineering and electrical contracting.

A delightful family who work hard to provide a useful and inexpensive service which we radio amateurs can use to our advantage. Most of my projects find their way into cases made by 'Phil the Box' (see left).

### Box ranges

The two ranges of most interest to the amateur radio constructor are their *all-aluminium boxes* and the *equipment cases*. Both are cases of the two part 'wrap round' construction. The Aluminium Boxes are the cheaper range and include boxes suitable for complete external cases as well as small boxes for internal screened sections of circuits. The equipment cases, although still inexpensive, are the smarter range made up in the form of a base/front/back panel in aluminium, with a top and side section of leather grain PVC coated steel. Armed with a suitable Minffordds case and a few hand tools, it is possible to produce a pleasant finish to most amateur radio construction projects.



A Minffordd equipment case

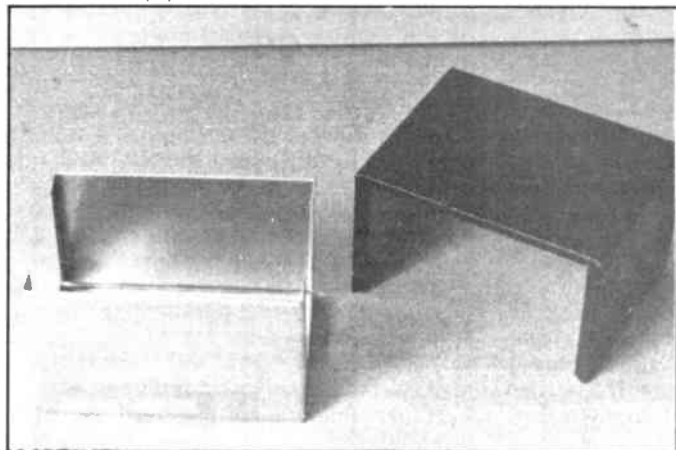

A Minffordd all aluminium box

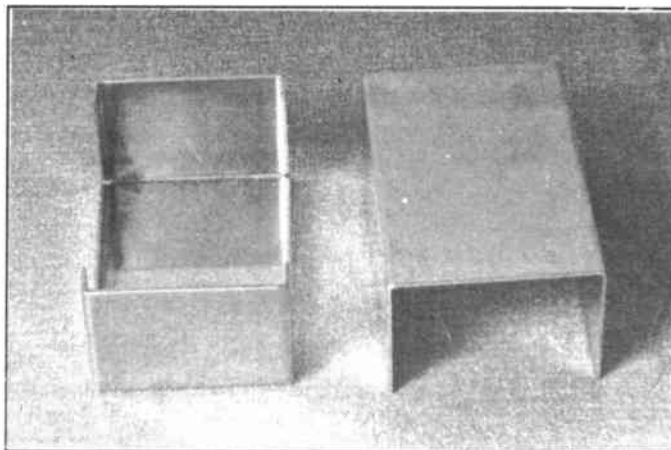

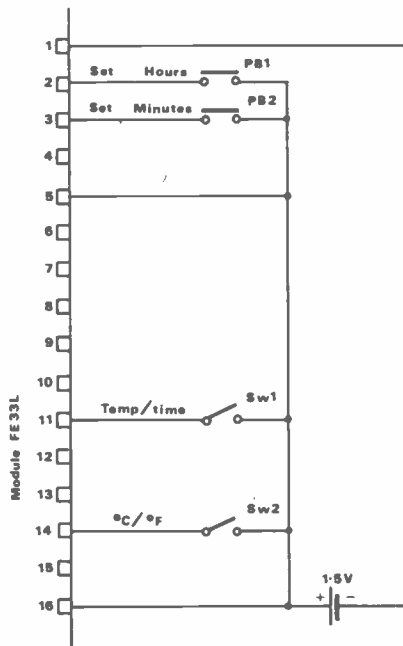

(a) Layout of controls

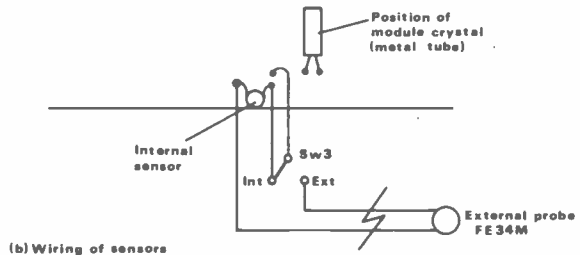

(b) Wiring of sensors

**Fig 1** Temperature/time module connections

## An example: a temperature and time module

When working on the HF bands I have noticed how many European stations seem to be able to quote the temperature when they exchange standard information. 'WX es 22C' is sent with the conviction of someone who has the facts at his finger tips. When I saw a reasonably priced electronic thermometer module, I thought it might be just the thing to have alongside the clock on the operating desk. The module that caught my eye was the Maplin Electronic Supplies 'Precision Gold Temperature Module'. This handy little module displays temperature in °F and °C and also includes a 12 hour clock. I would have preferred a 24 hour clock, but you cannot have everything for £6.95. It is possible to add an external temperature probe for another £2.50. This promised a useful little display unit giving the time and the temperature both inside and outside the shack in °C or °F.

### COMPONENTS

Temperature Module (FE33L) – Maplin  
 External Sensor Probe (FE34M) – Maplin  
 SW1/2 – Miniature toggle switch  
 SW3 – Miniature toggle changeover switch  
 PB1/2 – Miniature push-on switch  
 Equipment case type J2 – Minfordds

### TOOLS

Reamer – Maplin's FG11M or similar  
 Hand nibbler – Maplin's FG09K or similar  
 Minfordd Engineering, Sun Street, Ffestiniog LL41 4NE. Tel: (0766) 762572.  
 Maplin Electronic Supplies Ltd, PO Box 3, Rayleigh, Essex SS6 8LR. Order Desk Tel: (0702) 552911

The whole module, including the LCD display, is mounted on one printed circuit board and only draws 15µA from a 1.5 volt battery. The module also offers high and low settings for a temperature alarm and serial data output for those who want to do clever things with the unit. The connection layout I used is shown in *Figure 1a*. I used the minimum of controls for my application, which included the *hour* and *minute set*, *temperature/clock switch*, *°F/°C switch* and a switch for *internal/external* temperature measurements. The temperature can be sampled every 10 seconds or one every second. After trying both, I wired the module to sample every second. The function switches are miniature toggle switches and the time setting controls are miniature push-on buttons.

*Figure 1b* shows the method of wiring the external sensor. One of the leads from the internal sensor has to be unsoldered and a switch inserted to choose between the two sensors. The sensor on the printed circuit board looks rather like a small capacitor and is mounted to the left of the module crystal, which is a small metal tube with two wires coming from the base. The sensor wire nearest the crystal is unsoldered and lifted. This wire end is then connected via a length of wire to the centre contact of a change-over switch (SW3).

The two change-over positions on SW3 are connected: one to the original solder point for the wire removed from the internal sensor, the other to one side of the external sensor lead. The remaining side of the external sensor lead is connected to the remaining wire on the internal sensor. This is shown in *Figure 1b* and also clearly shown in the leaflet which is supplied with the module. The external sensor probe has about 3

metres of wire, and in my case I placed it outside the shack window.

### Boxing the module

The box chosen to hold the module was a Minfordd's J2 equipment case, which measures 4½in (wide) x 2¼in (deep) x 2in (high). The J2 case only costs £1.50. The three miniature toggles are mounted in a vertical line on the front panel to the right of the display – see photograph. The two miniature push buttons to set the time are mounted on the back of the case. When making circular holes for controls in aluminium panels, I have found that drilling the holes using the correct sized drill can be a problem. Aluminium is soft and the hole can end up oversized or even oddly shaped if the drill slips or the panel is moved during the drilling process. My favoured method is to drill the hole somewhat smaller than required and ream it up to the correct size.

Small hand operated tapered reamers are not expensive and a very simple to use on aluminium. In fact Maplin Electronic Supplies sell a suitable reamer (FG11M). It is also important to have the drilling position clearly marked and indented to provide a firm register for the drill. I use a small centre punch and lightly tap an indentation. A sharp pointed handtool will also do the same job. Placing the point of the twist drill into the indentation should prevent drill slippage.

Making the hole on the front panel for the display is somewhat more of a problem. It is possible to buy a plastic Bezel to fit the module. I bought one but did not use it. The problem is to obtain a good clean rectangular hole in the panel. There are many methods, the commonest of which is to 'chain drill'; that is drill a series of small holes on the inside of the marked out rectangle, bend or punch out the centre and straighten up the sides with a file.

One of the most useful little tools I have for aluminium working is a Hand Nibbler. This tool does just what its name describes: it nibbles metal. With the nibbler I merely drill one hole inside the rectangle to be removed and insert the working end of the nibbler and 'nibble away'. Using this method it is possible to produce quite a neat cutout shape in an aluminium panel, although I usually work along the waste side of the marking line and file the edge for a final finish.

Before finishing off the front panel, I put all the controls onto the panels and



## BITS TO BUILD

solder the required connections. SW1/2/3 can be added to the front panel and PB1/2 inserted in the back panel. Some sort of connection point is required for the external probe. The smart constructor will obviously add a small plug and socket on the back panel, but I simply added a double screw connection block to the back.

The module has to be mounted onto the front panel with the display clearly visible through the window. The mounting points for the module are not easy to use, so I cheated – I used two strips of thin plastic foam (about the size and shape used for draught excluding strip) and with double sided sticky tape I fastened both ends of the module to the reverse side of the front panel. I did wonder how long it would stay in place – but after three months it is still there! The module has a built-in battery holder. Having mounted and wired up all the controls, I am sorry to say you will have to remove them all again to complete the front panel – but leave the wires in place.

### The final finish – Is it cheating?

There are many ways to finish off a front panel. In former days I used to spray the front with a car paint spray can, but this produces a far from durable surface. Even when the metal is primed first, the paint seems to chip off in use. Some constructors favour keeping the aluminium finish and either use an abrasive pad or caustic soda to clean up the surface. This can produce a nice effect, but the problem comes when adding lettering or legends. Letraset or similar rub down lettering is a favourite, but unless protected with a vanish (a lot of fuss) it easily rubs off.

My method is a slight cheat and uses a false front made of thin card or stiff paper. This has several advantages: a colour can be chosen, the card hides any bad workmanship – even wrongly drilled holes can be hidden, and the card will take all kinds of lettering, even handwritten legends.

When I have removed the controls and the box contents, I take a piece of card, slightly larger than the front panel. The front panel is laid down onto the card and

the outer edges of the panel and the holes are marked from the back of the panel. Use a ball point pen and press on hard enough for the markings to show through the card.

The card is removed and cut to size; the outer edges can be trimmed to exact size with a cutting knife when the card is finally attached to the panel. The holes are carefully cut out with either a fine modelling knife or a small pair of pointed scissors. The lettering can now be added to the card, which is much simpler than trying to letter the actual front panel. Attach the card onto the panel, lining it up with the correct placement of the holes. I use Pritt paper glue, which provides a firm enough bonding.

The final secret is to add a clear film over the panel and the lettering for protection and attractive finish. The ideal finishing medium is the clear sticky backed plastic film sold for covering books. It is rather fiddly to use and care must be taken to avoid bubbles and bumps in the surface, but the final finish is attractive and durable. The film protects the card, prevents the lettering being rubbed off and gives a nice sheen to the panel. Cut the film to be used slightly oversize and smooth it round the outer edges of the panel to provide a little extra bonding between the card and the panel.

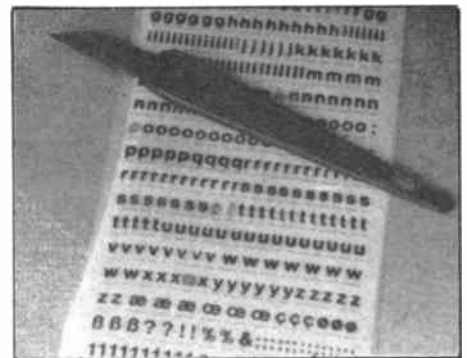

Front panel materials

The controls are then replaced on the panel. Take care not to overtighten any nut fixings because this can wrinkle the film on the card. If possible, place a washer between such nuts and the panel surface. The photograph shows that the effect can be attractive and functional.

The little temperature/time module has been a real asset in the G3RJV shack, my wife is always checking the outside temperature and one of my sons even began to make a day record of temperature on a graph. Even if you do not decide to use this module, the method of mounting it is the standard method which I now use for all my constructional projects and it is easy – even for the likes of me.

The completed time/temperature module

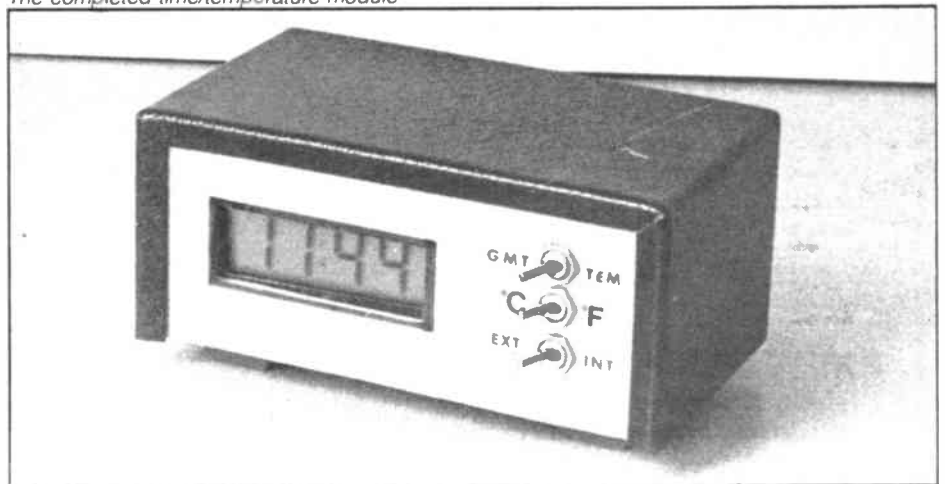

## TAR AERIALS AND COMMUNICATION

Specialists in Aerial Components, lashings & masts. Dealers in Jaybeam, ICOM, Yaesu and others. Visit the

**THE COMMUNICATIONS CENTRE,  
KING WILLIAM STREET, AMBLECOTE,  
STOURBRIDGE, WEST MIDLANDS, DY4 4CY  
Telephone : 0384 390944/370987**

## NEWSAGENT ORDER FORM

Amateur  
**RADIO**

To (name of newsagent)

Please order a copy of *Amateur Radio* for me every month

NAME .....

ADDRESS .....

Newstrade distributors: Argus Press Sales & Distribution Ltd, 12-18 Paul Street, London EC2A 4JS. (Tel: 01-247-8233)

# 10m FM PA

by H C Goble G4FDQ

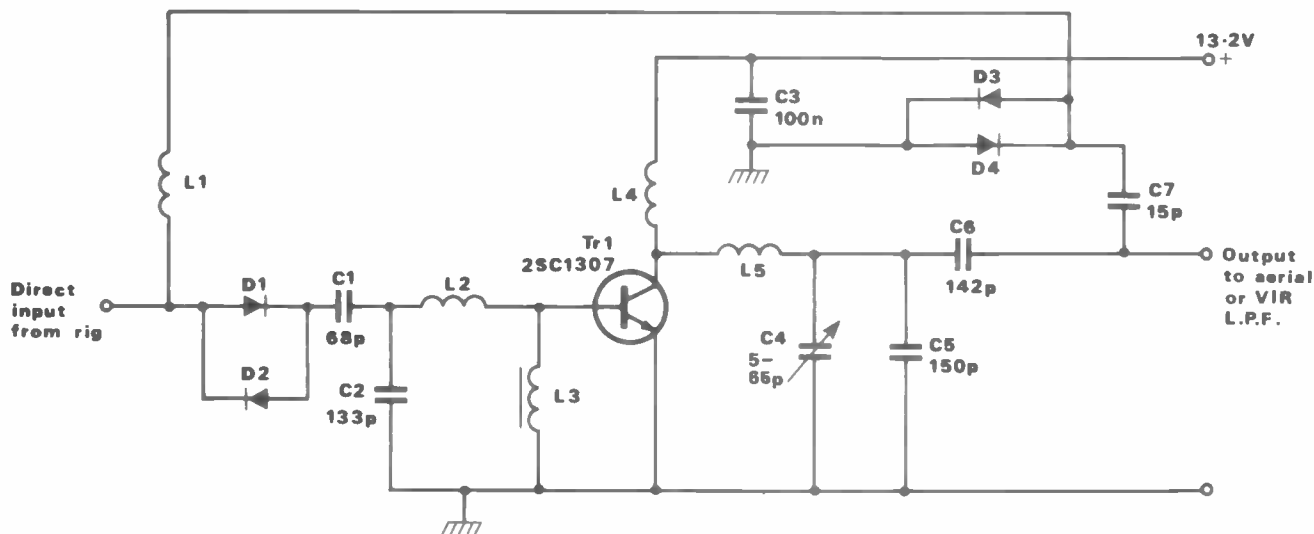

Fig 1 Circuit diagram of the 10m FM 25-30W PA

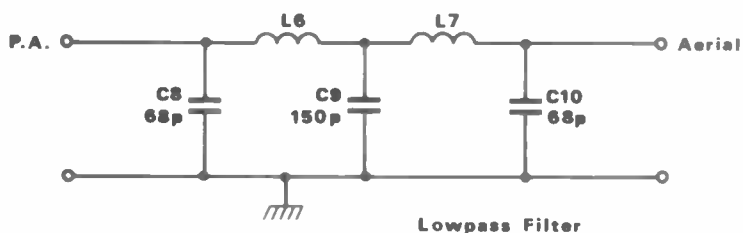

Fig 2 Circuit diagram of the lowpass filter

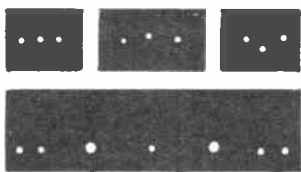
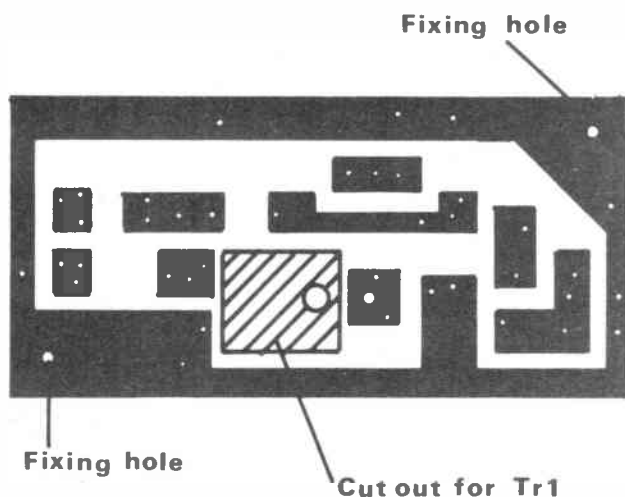

Fig 3 Lowpass filter single sided PCB (actual size)



Fig 4 Power amp single sided PCB (actual size)



This amplifier was designed and built by Eddie G0ECW to increase the output of his converted CB rig. However, it is not claimed to be an original design, as parts of the circuit come from basic circuitry normally used for this type of output stage.

The PA is connected directly to the rig and no changeover relays are required; the 13.2 volts supply is also permanently connected. The device used is the 2SC1307 RF transistor, or a direct equivalent.

The circuit is quite conventional, with the input and output tuned to 50 ohms impedance. On receive the signal passes through the series tuned circuit formed by L1 and C7 (tuned to 29.6MHz). Diodes 1 and 2 stop the receive signal getting into the PA. On transmit, diodes D1 and D2 conduct switching on the PA, diodes 3 and 4 then clamp, stopping any output getting back to the PA input. The only trimming capacitor is C4, which is peaked when setting up to give maximum output.

The amp itself has a narrow bandwidth, but it was thought best to follow it with a low pass filter. This has a roll-off at 30MHz and permits full use of the band, whilst simultaneously attenuating any unwanted harmonics.

### Construction details

The PCB can be etched in the normal way using single sided copper clad board. For those who are not familiar with this, it can be fabricated by first cutting the board to shape from the diagram, which is actual size. The islands on which the components are fitted can then be cut out of small pieces of board, and cemented accurately in place on the copper side using Superglue. The hole through which the transistor is fitted should be made before etching or assembling, whichever method of



construction is used. The fixing holes should also be drilled at this time.

The coils can then be wound, taking care to follow the details in the components list. Note that L1 and L5 are mounted just off the board as shown in Figure 8.

The transistor needs altering slightly, as shown in Figure 9. The centre pin is common to the fixing tab, so when it is removed the collector is connected from the fixing tab, as shown in Figure 7.

The only thing to do now before assembling is to place the board in position centrally on the flat part of the heatsink and mark the two board fixing holes on the heatsink. These are then drilled and tapped (6BA). Mount the board and lay the transistor in position so that the fixing rests on the heatsink. Make a mark through the hole onto the heatsink and drill and tap it (6BA). At this point it is wise to mount the transistor loosely in place, and then mark the places where the pins and the solder tag (collector) will later be soldered on the PCB. It can then be removed and the components put in place.

As all of the components are mounted on the copper side, the board can be left in place on the heatsink. The coils can be soldered in place first, followed by the diodes and capacitors. Care should be taken to leave spaces for the transistor pins to be soldered in. This can now be done after mounting the transistor using the mica washer and insulating bush, the solder tag and the heatsink compound as detailed in Figure 7.

All that is needed now is to fit the co-ax input and output using 50 ohm cable and the supply leads.

### Testing

Check all the soldered joints, making sure that there are no short circuits. Connect 4½-5 watts to the input and connect the output through a power meter or SWR power meter to a dummy load. Switch the supply on, and with PTT pressed in, peak C4 to maximum. If possible monitor the signal on a receiver, and then test it on the air.

### Low pass filter

The PCB can be made using either of the methods shown for the amp. The coils are then wound on the ferrite cores and fitted to the board, keeping the leads as short as possible. The capacitors are then fitted followed by the input and output leads. The finished filter can be separately housed in the amplifier box in the output lead, or fitted externally in a screened box.

### Casing the project

Many of you will have your own methods of producing a case to house the project, but George Dobbs describes a method which can result in a very neat professional looking piece in this month's *Bits to build* feature on pg35.

The original project, however, was housed in a home produced case using aluminium sheeting and a discarded audio cassette case, which conveniently supplied a plastic front and rear panel and four feet to boot.

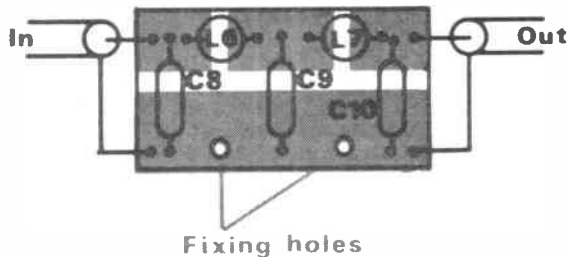

Fig 5 Component layout of the lowpass filter PCB

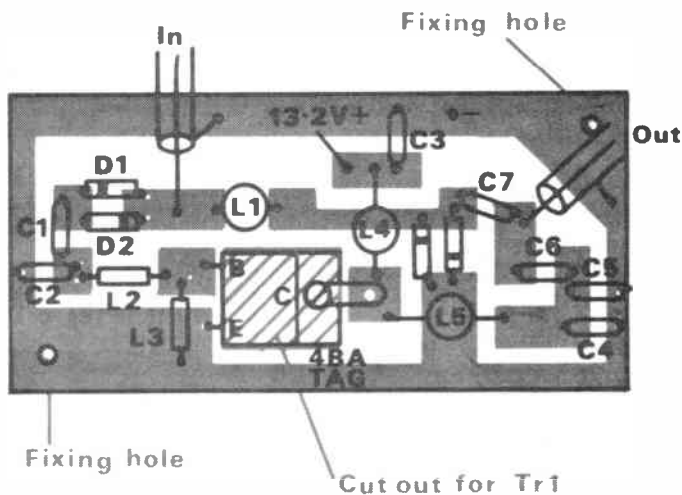

Fig 6 Component layout of the power amp PCB

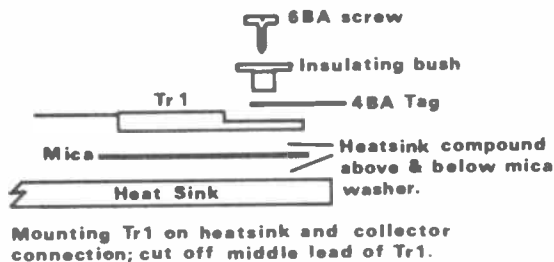

Fig 7 Connection instructions

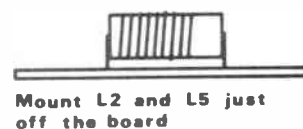

Fig 8 Mounting diagram

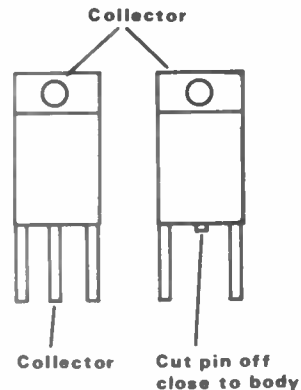

Fig 9 Altering the transistor

### COMPONENTS LIST

C1 - 68pF	ceramic
C2 - 100pF +33pF	ceramic
C3 - 0.1µF 16VW	ceramic
C4 - 5 - 65pF	trimmer
C5 - 150pF	ceramic
C6 - 120pF +22pF	ceramic
C7 - 15pF	ceramic
C8,10 - 68pF	silver mica
C9 - 150pF	silver mica
L1 - 13 turns 26 swg 3/16in ID close wound and glued	
L2 - 8 turns 18 close wound 3/16in ID	
L3 - 2½ turns 26 swg on 6 hole ferrite core (Cirkit 55-25111)	
L4 - 5 turns 26 swg 3/16in ID, 3/16in long	
L5 - 6 turns 16 swg close wound 3/16in ID	
L 6,7 - 9 turns 24 swg on a T50-6 Toroid	
D1 - D4 IN4148 diodes	
TR1 - 2SC1307	
Heatsink 4.5°C/W (Marplin FL41U or RS 401 - 497)	

# FORMATION OF THE IARU

by Mike Wade

Amateur radio is such a wide and varied pursuit that there is a general tendency today for most amateurs to specialise in one or more technical aspects of the hobby. One of the least studied aspects is perhaps the story of how it has outgrown restrictions in the past to become the first instantaneous direct citizen-to-citizen link across national boundaries, with the eventual chance of diluting broadcast adversarial propaganda with a growing experience of understanding via direct personal communication.

When Marconi started his marine communication company in Britain the Post Office monopoly on telegraphs meant that his company could not charge for messages. However, this was overcome by charging a rent for the use of the equipment, a trained operator and Marconi shore stations. This enabled the company to restrict the use of their shore and ship stations to other ships with Marconi sets, except for distress calls.

Freedom of communication was beginning to suffer from commercial competition as well as from the telegraph monopoly. Marconi's chief competitor in Europe was Telefunken, which was supported by the German government, and these restrictions prompted the calling of the Berlin International Wireless Telegraphy Conference by Germany in 1903, at which the desirability of freedom of communication regardless of who owned or operated the equipment was discussed. Commercial monopolies were now the ones preventing free communication. Not until 1912 did the Marconi company agree to unrestricted intercommunication.

## Confidential reports

It is believed that confidential reports by Post Office delegates to the 1903 conference influenced the government to bring in the Wireless Telegraphy Act 1904, which was the first piece of wireless telegraphy legislation in the World and thus the first to affect wireless experimenters. The Post Master General had said that the act gave wireless experimenters the greatest freedom and they would only have to register, but it turned out that licence applicants had to prove to the PMG that their sole object was to conduct experiments in wireless telegraphy, and were subject to such special terms, conditions and restrictions as the PMG thought necessary. But the licence was free and unless a reason to the contrary could be produced, the PMG was obliged to grant it.

In 1910 call signs were introduced and by March 1913 there were 942 licences. When the number reached 1,963 in 1914 there appeared to be a change in policy from an obligation to grant licences to a process of selection requiring appli-

cants to be 'persons' having the necessary scientific qualifications', as well as the introduction of a licence fee. According to John Clarricoats in *World at their Fingertips*: 'Powerful influences at the Post Office, Admiralty and War Office had commenced to lay down a policy which, in the opinion of many, was contrary to the intention of those who drafted and sponsored the 1904 act'.

This may have been why Bene Klein followed the example of the Liverpool and Derby Wireless Clubs and set up the London Wireless Club (forerunner of the RSGB) in July 1913. This was soon negotiating with the Post Office about the then rather steep licence fee of a guinea (1.05), as well as agreeing to check licence applicants for suitable qualifications.

At the first general meeting of the London Wireless Club it was decided to change the name to the Wireless Society of London and to encourage scientists as well as experimenters to become members. As wireless telegraphy was then still so new it was only natural to concentrate on the scientific aspects of improving the equipment, but this concentration on experimentation as opposed to communication was to lead to many problems for the later amateur radio pioneers, when the basic freedom of international communication was needed to develop the art.

The restrictions were already beginning to show in the requirement that communication was to be with not more than five other stations in general, and this was probably stipulated to protect the Post Office monopoly.

## The Post Office view

To get an insight into the Post Office view of communications, it must be

remembered that it was still only achieving its monopoly in the early 1900's as at first only the telegraph system was Post Office owned. Private telephone networks operated in many parts of the country, and it was not until a court action in 1880 that they also had to get licences to operate and pay 10% of their revenue to the Post Office as it was deemed that they were in fact covered by the monopoly. Although they merged into the National Telephone Company, the Post Office took control of all trunk lines in 1896 and it was not until the end of 1911 that nationalisation was complete.

The Glasgow Corporation had led a movement pressing the Post Office to allow cities to run their own phone systems, and eventually 13 licences were granted to cities including Glasgow, Portsmouth and Hull. The movement failed financially as the National Telephone Company would not interconnect. Subscribers were given little consideration as they had to have two phones to get a complete service, one for local and the other for trunk calls.

Although the 1903 agreement of 'Freedom of Intercommunication' had been signed by Britain and other nations at the 1906 International Wireless Telegraphy Convention in Berlin, apparently the principle behind that agreement was obviously not being applied to telephones or experimental wireless telegraphy stations.

The 1911 nationalisation of the phone network was no doubt the culmination of the idea that Sir W H Preece (Post Office Engineer in Chief) was referring to when in a speech in 1898, he said 'It is the function of the Post Master General to work for the public every system of intercommunication of thought which affects the interests of the whole nation.'

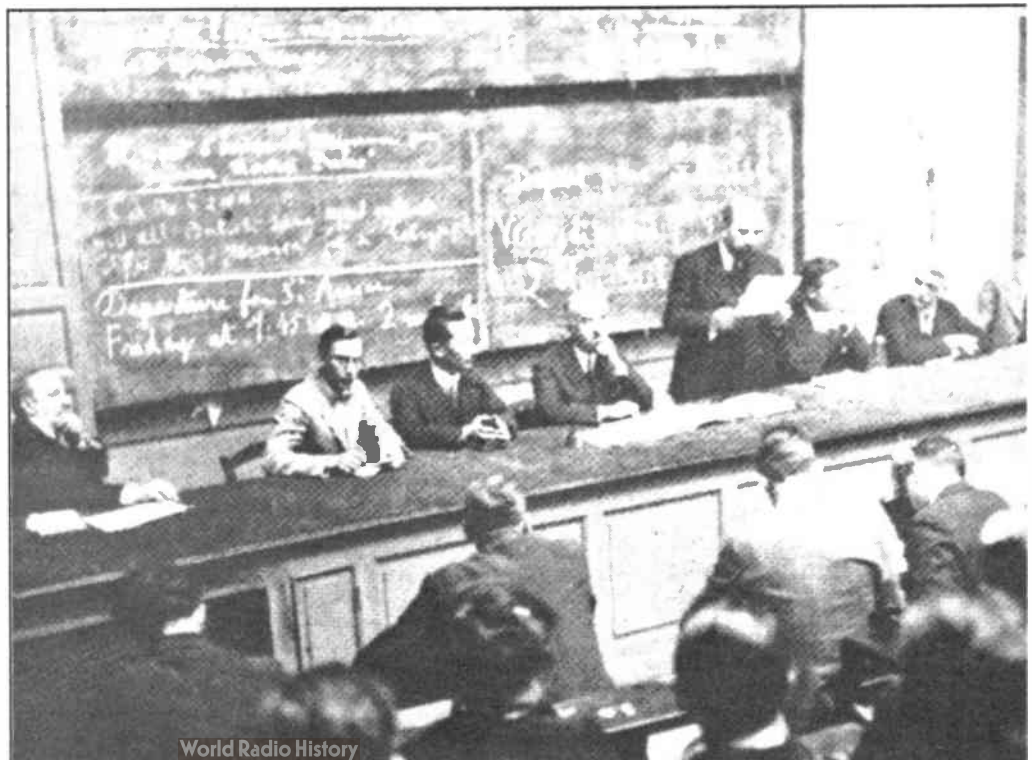



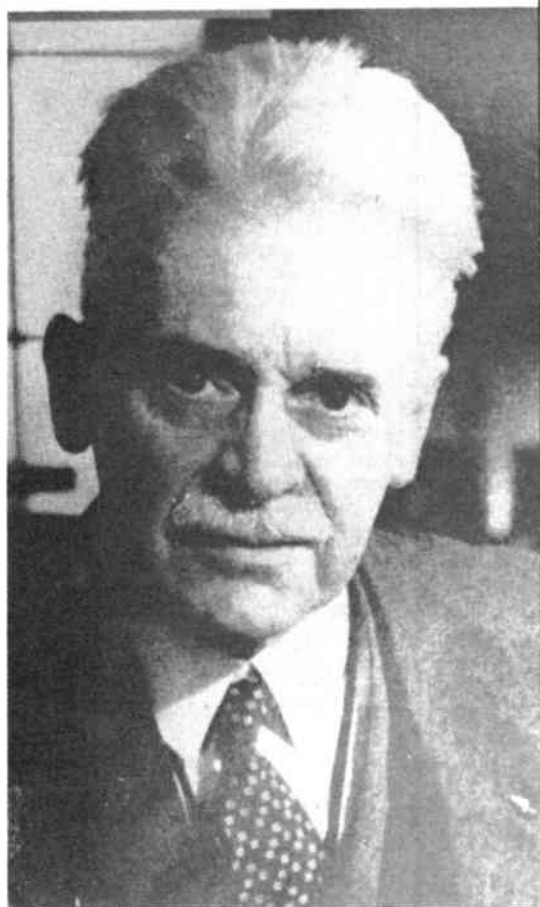

Hiram Percy Maxim. First President of the ARRL

Telephony is an Imperial business. It ought to be in the hands of the State'.

It was against this background that the increase in private wireless telegraphy stations in Britain was being considered just before the 1914-1918 war. In addition, the increase in rivalry between Britain and Germany was being manifested in a number of spy trials and the Agadir incident in 1911. The Foreign Secretary, Sir Anthony Grey, publicly warned Germany that Britain would side with France if hostilities began and war fever gripped the country.

#### Depew Bill

The 1903 Berlin Wireless Telegraphy Conference had less of an effect in America until later on when interference from private wireless telegraphy stations to government and commercial stations caused restrictive legislation to be put forward, an example of which was the Depew Bill. This sought to cure interference by registering government and commercial stations only, and making amateur interference illegal.

The US amateur began to realise that if he was to exist legally he had to communicate, as well as experiment. Radio clubs and the magazine *Modern Electrics* by Hugo Gernsback took up the struggle. The Junior Wireless Club of America also helped to cause the eventual failure of the bill in the House of Representatives. The United Wireless Trust and US Navy continued to try and abolish amateur radio with the Alexander Bill in 1911 which was fought by the Radio Club of America and the Wireless Association of Pennsylvania.

When US delegates returned from the London Conference of 1912 they brought back regulations which they disclosed confidentially to the legislators who

produced a revised Alexander Bill. At last amateur stations were included, but only on two hundred metres and below. So, in August 1912 the US amateur had his first legal restrictions as well as final legal recognition in a licence limited to one kilowatt.

According to Clinton de Soto in *Two Hundred Metres and Down*, the aim of the legislators was to restrict amateur operation to what was then scientifically known as only short range wavelengths on fixed power, with the intention of amateurs gradually losing interest and hopefully becoming extinct.

Ironically, it was the very wavelength and power restrictions giving a range of less than fifty miles in some cases with a kilowatt spark that brought into being the need to relay information for emergencies and message handling, culminating in the formation of the American Radio Relay League in 1914 by Hiram Percy Maxim. The change of the majority of US amateurs from being experimenters to becoming a group of communicators was already taking place.

In July 1914 the US magazine *Popular Mechanics* said 'It is pointed out by the organisers of the League that up to the advent of wireless telegraphy it was necessary to rely on either a telephone or telegraph company of the Federal Government for transmitting intelligence from one part of the country to another. The coming of wireless telegraphy has made it possible for the private citizen to communicate across great distances without the aid of either the Government or a corporation, so that the organisation of the Relay League actually marks the beginning of a new epoch in the interchange of information and the transmission of messages'. It is not known what remarks were made by Sir William Preece when he read his copy!

The continual building of relay routes, including trunk lines, necessitated a regular communication to ARRL members and *QST* magazine was started in 1915.

#### World War I

In April 1917, American amateurs received their notification to close down for World War I and amateurs now took up what was to become the traditional role of operators and experts in communications in the armed forces.

Ironically, when the armistice was signed in November 1918 US amateur radio found itself fighting one of its greatest battles for survival, when the by now well-known representative Alexander brought in another bill which was the strongest attempt to hand over control of all radio in the US to the Navy. If the need for communication and organisation amongst amateurs hadn't been understood before, it certainly was by now.

Although the attack was aimed with military precision at a time of strategic amateur weakness when they were not even on the air, a new stage of awareness appeared to have been reached and the bill eventually failed in committee. In April 1919 receiving was again allowed.

In July the Navy had another try with a bill to give it control over all international radio traffic, which again failed.

It took a joint resolution by Representative Greene directing the Secretary of the Navy to remove the restrictions on the use and operation of amateur radio stations throughout the US to finally get the transmitting ban removed, which was announced on 26th September 1919.

It is a credit to the American democratic system at that time that civilian control was finally able to be re-established over communications because that historic action, giving American amateurs back their freedom to operate, was later to provide the strength in international frequency negotiations to allow amateurs in Europe a chance to exist on reasonable amounts of spectrum. In fact later on, once the US Navy began to see its function as more accurately expressed in defending freedom rather than in controlling it, it became one of the most helpful allies of the US amateur radio movement in those negotiations.

A similar delay in relicensing amateurs after World War 1 occurred in Britain, where a secret government interdepartmental committee had met to consider changes in the licensing system so as to keep wireless experimentally-minded rather than allowing it to become a form of communication, accessible to many. The first of these changes was the substitution of permissive power, instead of the obligation to grant licences. A Morse speed of 12wpm was recommended, although communication for its own sake was not encouraged but the idea of 'an object of scientific value' was preferred.

Eventually, after *Wireless World* and wireless clubs took up the cause with many speeches being made at the Wireless Society of London, licences were reintroduced, but limited to ten watts and communication with only five other stations and 100ft aerials. Although higher power licences were eventually granted the details tended to be arrived at only after negotiations on an individual basis, with higher fees for higher powers and times of operation strictly limited.

Because US amateur operating conditions were relatively free and not affected by a monopoly they were able to make themselves genuinely useful in their localities with message handling for their communities and during emergencies. This strong ideal of service without bureaucracy enabled American society to have a clearer understanding of their amateurs' achievements and useful capabilities, leading to government understanding and support. The British tendency to restrict amateur conditions to that needed for pure technical achievement prevented this understanding from developing.

In 1921, in an effort to distinguish themselves from early broadcasting, US amateurs started calling their hobby 'Citizen Radio' for a time, a name that was to ricochet around the private communications world until the present day.

To deal with the American broadcasting situation regarding interference, which did contain dangers for the movement, the first National Radio Conference was held in 1922 in Washington, and was attended by the famous US amateurs, Maxim, Godley, Steward and Warner.

It was soon realised that the primary conflict was not between amateur and broadcaster but between corporate and private interest, but by discussion agreements were reached on quiet hours and wavelengths, and considerable support was given by the US government to the amateurs.

Although amateurs had thought of transatlantic operation before the first World War, the first attempt in February 1921 was a failure and this prompted the ARRL to send Paul Godley 2XE to Britain with an American superhet receiver for the next test in December 1921. When Godley set up his 800ft aerial in Scotland on 8 December 1921, embarrassingly the first US station heard was an American pirate spark: 1AAW on 270 metres, but 1BCG came through on 200 metres with a congratulatory message.

British amateurs heard the Americans even with their 100ft aerial restrictions. In fact, the transmitting restrictions may have been the reason why the British could not confirm all their transmitters heard in the US in the next tests in December 1922; for as well as the official RSGB kilowatt station 5WS and the French 8AB, the Americans also claimed hearing 2FZ! Just what was the Manchester Wireless Society doing at 5 o'clock on a December Wednesday morning?

The transmitting restrictions caused many leading British amateurs to form alternative groups to the RSGB, and it was probably because the British were bogged down in administrative problems that the French stole the glory when Leon Deloy 8AB achieved the first two-way contact across the Atlantic with the Americans: Reinartz 1XAM and Schnell 1MO in November 1923. Even the Americans had to delay to get special permits to reply on 100 metres to Deloy, who really should be credited with successfully jumping the electronic and administrative hurdles together.

During the following period British amateur pioneers achieved some of the most outstanding communication feats, even with their restrictions; their only weakness was perhaps in not making themselves more aware of British Government thinking when the British amateur position regarding spectrum could have been disastrously affected had it not been for the strong American amateur position.

Hugh Ryan G5BV proved in the December 1923 tests that the official amateur wavelength of 200 metres would also work across the Atlantic and decided to start the first DX column in *Experimental Wireless* in November 1923.

All this success must have prompted the Post Office to cancel all current licences and issue new ones in about January 1924. The new licences gave the use of 150 to 200 metres, as well as the

removal of the five station restriction, but the shocker was that international work was forbidden except by special permit! About a year later a bill to amend the Wireless Telegraphy Act 1904 and take account of broadcasting was found to have had some clauses slipped into it which would have further restricted amateur radio. The RSGB decided to oppose this together with the press and fortunately were successful.

Although the Americans eventually overcame the concern of their military over amateur radio, it seems the British were still suffering from military worries as the Post Office decision to require trans-oceanic permits to limit international communication was advised by the British Armed Services.

All these problems brought to light one of the most striking differences between the American and British view of personal communication. The Americans believed that to communicate was an inherent right of the individual which was only to be limited by administrations for technical reasons. The British mostly had to accept that the right to communicate could only be granted by permissive power from the Post Office or government authority.

Some of the American worries about amateur radio in Europe then were expressed by De Soto: 'Not all European amateurs were youthful enthusiasts of the American type; they were frequently mature men with a laboratory background who might conceivably incline towards an antagonistic theory of government followed in a nearby country, and might have a tendency towards political intrigue'.

It was while considering the worsening legal conditions for genuine amateurs in Europe that the Americans took a crucial decision. They could have taken the insular view that they were satisfied with their technical success, generous frequencies and government support and left it at that. But because the technology would soon have become useless internationally without the freedom for the private individual to use it to communicate, no matter which country he lived in, they took a bold step.

Hiram Percy Maxim of the ARRL decided on Paris in 1924 as the venue for a meeting with radio amateurs from eight other countries to discuss forming the International Amateur Radio Union. Gerald Marcuse 2MN took it upon himself to represent the RSGB. It was decided that for the plan to succeed it must be submitted to an international meeting of radio amateurs and Dr Pierre Corret of the French Inter Club Committee agreed to organise the first International Radio Amateur Congress in Paris in 1925.

The International Radio Legal Committee, recently formed to study the legal and jurisdictional problems of radio, was also planning to hold a conference in 1925 and it was decided to hold a joint conference.

Many of the greatest names in international amateur radio were among the delegates from 23 nations, as well as the Reuters Press Agency and the Havas

Press Agency, when the congress met on 14th April 1925. In the first joint session it soon became clear that the delegates were divided into two groups with distinctly diverging interests: the Radio Legal Committee and the genuine radio amateurs, who thereafter met separately.

The most important work was in the first subcommittee chaired by Hiram Percy Maxim U1AW with Jean Mezger F8GO as secretary, when the formation of the IARU was considered by about 50 delegates. Fortunately the Americans and others were aware that many private licence holders in Europe then were scientists and distinguished radio men who, although of great standing, did not see that the organisation should consist of two-way communicating amateurs. This was insisted on however and was unanimously agreed by this committee, as well as the need for individual memberships until strong national societies were formed in sufficient numbers to form a federation.

At this meeting the amateur pioneers served notice to the World that the freedom of intercommunication which governments and companies had agreed for themselves way back in 1903 would at last now also be formally requested for private individuals. Countries where amateurs were still technically illegal were also represented, such as Belgium. Holland, where licences were still unavailable, sent their amateur traffic manager Rudolphe Tappenbeck as a delegate. Britain was well represented by RSGB members on many committees with Fred Hogg G2SH on wavebands, Stan Lewer G6LJ on call signs, and P K Turner of *Experimental Wireless* on auxiliary languages. The latter commit-

*Glasgow Corporation telephone advert (courtesy of Telecom Showcase)*



A RAPID WAY TO INCREASE  
YOUR BUSINESS:

HAVE A  
CORPORATION TELEPHONE  
INSTALLED.



tee recommended Esperanto for international telephony use as well as for translations of congress reports and articles.

When it is realised that congress delegates consisted of representatives not only of radio magazines from Britain and France, but also authors, music composers, song writers, playwrights and a director of the School for Radio Amateurs from Poland, there is some evidence for supposing that some delegates thought this conference might be the start of much broader forms of communication between all sorts of sections of different countries, perhaps to augment the rather stiff limited diplomatic discussions which had so recently failed so disastrously in preven-

ting national disagreements.

Whatever the exact situation, some of the delegates were not radio amateurs at all but embassy officials, legation councillors and representatives from national communication ministries. When the reports of some of these people reached their governments, considerable discussions must have taken place. The results of the congress were soon to be seen in the national propositions forwarded to the Berne Bureau, in preparation for the International Frequency Conference in Washington in 1927.

Belgian amateurs became legal for the first time in June 1925 and no longer had to operate in secret, but Switzerland made amateur regulations so severe and licence fees so high that few Swiss

amateurs could afford them. In March 1926, ten Swiss amateurs had their stations, correspondence and QSLs confiscated by the authorities because they had been communicating abroad.

Despite this and other opposition, very fortunately for radio amateurs around the World today, the IARU was successfully formed and has spread. It is perhaps instructive to realise that the different sections of IARU today that are recognised as representing amateurs at international frequency conferences came out of the insistence of private individuals that they would not give up their inherent right to two-way communication with other individuals, regardless of national boundaries or differences.

# LOOK WHAT YOU GET EVERY MONTH IN

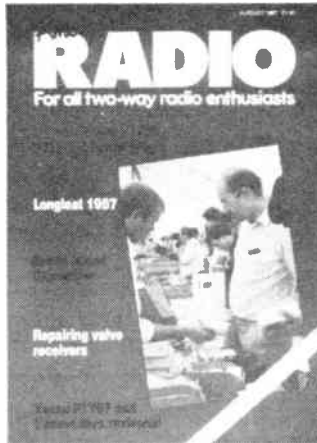

## Amateur RADIO

- ★ **DX DIARY** Don Field G3XTT with all the news of rare DX, contests and DXpeditions
- ★ **ON THE BEAM** Glen Ross G8MWR with all the news and comment from bands above 50MHz
- ★ **G3OSS TESTS** Angus McKenzie – the fairest, most comprehensive reviews available anywhere

**MORE NEWS, MORE FEATURES, MORE FUN, MORE STYLE THAN ANY MAGAZINE AVAILABLE ON THE MARKET TODAY**

Make sure of your copy by placing a regular order at your newsagents or by taking out a post free, inflation proof subscription, with early delivery to your door each month

### AMATEUR RADIO SUBSCRIPTION ORDER FORM

To: Subscription Department • Amateur Radio •  
1 Clarendon Road • Croydon •  
Surrey • CR0 3ST

Tel: 01-760 0409

PLEASE SUPPLY: (tick box) for 12 issues, all rates include P & P

Inland	World-Surface	Europe-Air	World-Air
£16.80	£18.70	£22.45	£27.50

NAME .....

PAYMENT ENCLOSED: £

Cheques should be made payable to Amateur Radio Overseas payment by International Money Order, or credit card

ADDRESS .....

CREDIT CARD PAYMENT      EXPIRY DATE

.....

/

..... Postcode .....

Signature .....

# 50MHz

The RSGB VHF Committee has decided that records should be kept for 50MHz as they are for other VHF and UHF bands. For this purpose 50MHz had to be considered as a special case as it covers frequencies where mode confusion is very likely to occur, where variations through the solar cycle are profound, and where in Region I IARU, television still occupies the band in some countries with the result that many countries in Europe can only be worked crossband.

It was therefore decided to initially establish British records and then to liaise with the Region I Record co-ordinator with a view to establishing 50MHz records for the region as a whole.

The general conditions to be applied to the British 50MHz records are:

1. There should be two sections to each record:
  - a. Two-way QSOs between stations each operating in their allotted section of the 50-54MHz band.
  - b. Crossband QSOs provided that one transmission took place within the 50MHz band and the other used a frequency above 28000kHz.
2. Records will apply to any 50MHz contacts since the band was first allotted in 1946.
3. All records will have to be verified according to a procedure approved by the RSGB VHF Committee.
4. To break a record any existing recorded distance must be exceeded by more than the maximum error in calculation. Within the limits of error a record might be declared to be equalled.
5. To qualify for a record, a complete QSO must take place. In addition, to qualify for a two-way record, communications must be established on 50MHz. If another band is used in any way then only crossband records can be recognised.

## Records that may be established

### Maximum Distance

This will apply to any mode worked from Britain provided that:

- a. There is no artificial medium (eg satellite or repeater).
- b. The distance be measured by the shortest great circle distance between stations claiming the record.
- c. The location of any portable or mobile station can be verified.

### Maximum Distance Worked at Sunspot Minimum

The same conditions as for the maximum distance record will apply to this record, with the addition that the QSO must have taken place during the period of 12 months either side of the month of the official minimum, once this has been established.

### Maximum Distance Within the British Isles

This record is applicable to the whole of the British Isles including Ireland, the

Channel Islands and all other islands recognised as part of the British Isles. Expeditions are to be encouraged and will be recognised for this record.

### Maximum Distance by Aurora

The distance for this record will be the great circle distance between stations, and there will be two sections:

- a. Normal aurora working with beams directed at the reflecting medium.
- b. Auroral Es for distances significantly greater than possible by normal aurora with beams more or less direct during proven aurora conditions.

### Maximum Distance by Meteor Scatter

This record is applicable for one hop MS propagation only, and is not applicable to MS extensions from other modes. Full reports must be exchanged.

## Claiming a record

1. The 50MHz Reporting Club is responsible for the administration and the keeping of records. Any amateur may claim a record or report that a record has been broken or a 'notable first' has taken place.

2. In addition to records, 'notable firsts' will also be recorded. For example, the first transatlantic 50MHz QSO between G6DH and W1HDQ is a 'notable first'. Others remain to be recorded, while some like Britain to Australia and New Zealand should provoke keen competition during the rising sunspot cycle, as only crossband contacts have so far been worked.

3. Claims and reports should be sent to the 50MHz Reporting Club Co-ordinator.

Old Timers in particular are invited to supply relevant information, and a volunteer willing to research back copies of magazines would be particularly welcomed.

R G Cracknell G2AHU, 50MHz Co-ordinator for the Reporting Club is assisting in recording information. He intends restarting a Countries/Continents/States of USA ladder, which will be a continuation from the one started by Steve G4JCC when he was Secretary and Editor of the UK Six Metre Group (Steve is now Chairman of the group). For inclusion in the ladder only countries with operators licensed for 50MHz operation or official permit holders will be considered. Doubtful cases will not be included until evidence is produced of being genuine. The following lists the countries considered genuine and already contacted by UK and EI operators. As other countries are confirmed as genuine they will be added to the list: CT1, CT2, C30/31, EI, G, GD, GI, GJ, GM, GU, GW, LA, OX, TF, VE, V2A, W/K etc, YV0, ZB2, ZC4/4BY and 9H1.

The ladder will start next month, so please send your list to: Ken Ellis G5KW, 29 Stanbrook Road, Northfleet, Kent DA11 0JW. Tel: (0474) 322191.

## This month's reports

Dr Dave Newman G4GLT of Barden Hill, Leics writes, 'There has been lots of excitement this year and it will prove to be a bumper year for DX in general compared to previous years.'

'My summary of DX worked so far is as follows: 30/5-C30DAW; 5/6-9H1CG; 11/6-ZC4VHF/5B4; 14/6-W6JKV/V2A; 14/6-N4HSM/V2A; 15/6-4U1ITU XB; 17/6-N4VA; 17/6-VO1MP St John's; 17/6-W4WH; 17/6-W5HUQ-EM90 Square; 18/6-N4EJW, K1TOL, K2QWD and K2QIE. On the 19/6 the following beacons were heard: W2CAP/P1 50.070 at 1755Z; W1AW (fast CW practice) 50.080 at 2008Z; K1NFE/B 50.060 at 2009Z. The reception of these beacons gives an indication that an opening is in progress, or imminent.'

'Stations worked during a superb opening between 1802-2025Z included: K1WHR; KS2T; WA1VTA; N2AVR; K1GPJ; K1ZFE; W4CKD; N1DVC; W2PN; KA1CDZ; VE3NPB; WA1OUB; W9IP/2; K1LPS; AF1T; KS2T; WA2ZPX; K2YOF; W3GUF; W2BXA; K1LPS; KA1LX and K2QIE.'

'At 1710Z on 24th June I was tuning around 50.110, beaming towards the Caribbean, and heard a weak CW signal. I called QRZ DX, and W6JKV/YV0 came back to me first on CW, then on SSB at 1710Z with a 559/559 and at 1702 on SSB with a 56/57. Jim said that he was calling CQ beaming to the States when he heard me calling QRZ, so he turned his beam round to reveal an extensive opening into the UK. I last heard him at 1910Z. He said I was the first to work him on Avis Island.' (Your scribe managed to work Jim on 25th at 1825Z). 'The FY7THF beacon was also heard on: 28/5, 2012-2105Z; 5/6, 1749-1756; 6/6, 1745-1810; 11/6, 1258-1447; 12/6, 1802-2029; 13/6, 1952; 14/6, 1455-1500; 18/6, 1740 and on 19/6 at 1753.'

Dave must be congratulated for this very interesting write-up which will be of historical value; particularly the times of receiving the FY7THF beacon, which gives times of possible openings to the central Americas area. As we move into the new sunspot cycle, Charlie Newton reports that Bolder have revised their earlier report, and now consider that the minimum between cycles 21-22 was September 1987, and that the peak of cycle 22 will be 1990-1991.

Allan Duncan GM4ZUK of Aberdeen writes, 'The recent GB2RS item regarding the contacts made when Alex GB3ZBE and myself were /P at the Cairn'o Mount about 35 miles SW of Aberdeen, and about 1500 feet asl. I am told you may have been to this site in the past by Len GM2FHH, so perhaps you know the site I mean?'

Yes, I went portable there during July 1955 when we had the biggest 'lift' that had been experienced to date on 144MHz starting early in the morning



by Ken Ellis G5KW

with extended groundwave stretching down through the Midlands to the South, and then Tropo to the Continent and to Scandinavia. I had QSOs to nine countries outside the British Isles including several 'all time firsts', but after nightfall a heavy mist came down and we had to await daylight before tackling the trip down to Braemar.

It has an excellent take-off to the South, but despite this we were very disappointed by the number of groundwave QSOs. This was also not helped by the number of people who seem to sit on the calling frequency on 59.200MHz, making it nearly impossible to make QSOs to the South. The best DX on groundwave, or extended groundwave if you want to call it that, was G3OHH who was only 529. Even stations in the North of England, who one would expect to be strong signals on 70 or 144, were relatively weak. Even allowing for the lower ERPs, this does not fully explain these generally poor groundwave signals.

Having listened to a dead band for most of the afternoon, we were tuning for crossband signals when suddenly many G stations appeared on 10 metres, including G4VXE in Cheltenham. Around 3 or 4 minutes later many Gs were heard calling on 6m at very strong signal strengths. I then found a clear frequency (50.190) and called CQ. Immediately a large number of stations were calling, and around 26 stations were worked in a 20 minute opening. This short skip E was very powerful, with all signals at least 59+30dB; even those who said they had 2½ watts to a loft dipole! Some signals were so strong they could have been in the car park next to us.

It is interesting to plot the track of the stations worked on a map, as the E area cover appears to track across North London along to the Clacton area and then to East Anglia, whereupon strong TV carriers are heard. It is interesting to note that these short E openings to G-GM seem to just precede a stateside opening from G at least, but not necessarily from GM.

Other similar openings have occurred from my home QTH, one such opening occurred just before the outstanding opening of 19/6/87 at 1800Z when Alex GM3ZBE worked 24 VE, W1, W2 and W3 stations in an opening which lasted around 2 hours.'

A copy of a letter from WB4OSN to GJ3YHU, dated 14th June 1987, makes interesting reading. WB4OSN wrote: 'It was a very pleasant surprise to QSO with you today on 50MHz. You were the only UK station that I was able to work. I suspect that I was being called by another UK station that I was unable to pull through as a result of the QRM on the band, which brings me to the point of why

I have written you this letter.

It seems that this QRM problem is only going to get worse with increased population on the band. On this side of the pond, for the past several years, there has been an attempt to initiate a 'DX window'. The policy was to keep 50.100 to 50.125 free of US to US and US to VE QSOs. Unfortunately, there has been no way of enforcing such a plan. What I propose is that the area of 50.025 be reserved for weak CW work.'

Does anyone have any comments on this proposal?

Extracts from a letter dated 28th June, from Ray Cracknell G2AHU to the Chairman of the RSGB VHF Committee also discussed this problem:

'Attached are copies of letters from two well-known 50MHz DXers. Both highlight a problem that is already apparent to us. For example, at 1734Z on 24th June I thought I was in QSO with W6JKV/YV0 on Avis Island, and was mighty puzzled to receive the message that he'd 'be on six from LX on Monday. Normally I'd have welcomed the first French station I'd heard on 50MHz (if he were legal), but not on top of YV0!

When the original beacon plan for 50MHz was being prepared, I advocated that the beacon band be reduced to 50020-50080kHz and that this was incorporated in the plan. Thus I support WB4OSN's suggestion of going to the area of 50.025 for weak CW work, but suggest that 50001-50019 should be reserved for inter-continental CW DX working only. Further, 50081-50100 remains prime CW spectrum, and its use should be encouraged. I also support WA1OUB's proposal that 50100-50125kHz be reserved as a DX only window. Such a measure will become very important as F-layer propagation improves once again, and I am sure that for E working our contacts are largely restricted to the Eastern boundaries of USA and Canada due to the advantages that stations in that area have in working us with the backs of their beams towards the QRM.

'Actually, during the FB opening on 19th June, a W9 was worked and a W6 was heard in Britain which only bear out this theory, and that those farther West do not expect to hear us. In the main British stations are very good at keeping the area clear. Continental crossband working is confined to 50140-50300, and 50200 is used for local contacts. Nevertheless, in view of the rapid increase in the use of 50MHz, it would be wise to write all these practices into a band plan.'

### 50MHz expectations realised

During the last few months I have recorded in this column some of the DX highlights of previous years on 50MHz, propagation information from some of

the acknowledged experts in that field, comments on 'what to expect and when' during the future, and particularly the Summer sporadic E season; which started earlier than usual - April 8th.

During the last six weeks the outstanding results obtained have surpassed our expectations, and indicate the probability of an unusual and outstanding season.

### Welcome to Class B

The granting of permission for Class B operators to operate on 50 and 70MHz could not have come at a better time, and despite a few pessimistic overtures by a minority of the original 'Permit Holders', to date, (as far as I can ascertain) no upheaval has taken place, and in general the high standard of self-discipline established by the original permit holders has been maintained. Hopefully it may continue as the future of the band in UK depends on our rigid adherence to the regulations which have, of necessity, been enforced by the DTI, in view of the fact that Band I TV is still operating in some European countries. *RadCom* stated in the July '87 issue that: 'If we cause interference to the broadcasters, the inevitable results will be that our nice new 50-52MHz amateur band will disappear overnight. *We're not kidding!*'

Remember that the power limits at 50MHz are 14dBW carrier and 20dBW ERP, that's 25 watts of anything other than SSB and 100 watts peak envelope power on SSB. But that does not mean you can run 25 or 100 watts out of your transmitter unless you're using a dipole. The power limits relate to 'effective radiated power' (that's the ERP bit in the schedule), which takes into account antenna gain and feeder loss.

So, knowing all that, how do we establish whether or not the station is legal? Let's take the example of the 50MHz set-up at RSGB headquarters GB2RS. Up on the roof at Potters Bar they have a three-element antenna which, according to the manufacturers, has a gain of 6dB over a dipole (ie 6dBd). The loss in the 50MHz feeder turned out to be 1.7dB. The 50MHz rig at GB2RS has an output of 10 watts on FM and CW, and 15W PEP on SSB. The question is, can the Tx be run at its maximum power or should they wind the wick down when they go on the air and call CQ? Their 'antenna factor' is 6-1.7, which is 4.3dB. We have 10dBW on FM and CW and 11.76dBW on SSB. By adding the antenna factor to the Tx output in dBW, we can see if they are OK. For FM and CW - 10+4.3 is 14.3, which is 0.3 above the legal limit. For SSB 11.76 plus 4.3 is 16.06, which is slightly less than 4dB below the legal limit. In other words, if they go on the air on FM or CW they must reduce the Tx power by 0.3dBW-1.07W. On SSB there is no problem.

# PROJECT

# BOOK

by Martyn Williams

One of the joys of amateur radio is indulging in mobile operating, one of its sorrows is in sorting out the interference problems! Most operators use two metre FM and this has a good built-in rejection of pulse type interference, but if you want to use VHF or HF SSB, then you really have problems on your hands. It seems that in recent car designs everything is electrically operated or computer controlled and the possible causes of interference are enormous. All the problems can be beaten however, so let us take the possible causes one at a time and see what can be done.

## Installation

This is perhaps the most important anti-interference step you can take and there are several important points to bear in mind. Make sure that the metal casing of the rig is firmly bonded to the car metalwork, and do not rely on earthing via the co-ax to the aerial mounting. Always run a separate feed to the rig directly from the battery. This is necessary because the normal car feed will be carrying a wierd assortment of pulses, crashes and bangs, and a common feed will send these straight into your rig. Route all wiring to and from the rig as far away as possible from all other cabling and *never* let it get entangled with the mess of cabling that lives behind the modern dashboard.

## The battery

This can actually be the cause of interference. It must be kept clean and correctly filled because a cell which is only half-filled with acid will have a much higher resistance than a correctly filled one. This in turn means that the pulse currents flowing through the cell will generate higher voltage spikes on the supply cables to the equipment. A faulty cell can cause untold problems and, if after everything else has been tried you still have interference, then try replacing the battery with a borrowed one. You may find that your problems have ended.

Another thing to check is the condition of the earth strap from the battery to the car bodywork. If it looks at all suspect replace it with the heaviest earth strap you can obtain. As a last point, keep all battery connections, including the car end of the earth strap, clean and tight; a smear of Vaseline or grease will help to maintain the good condition of the connectors.

## Ignition noise

This is the well known machine gun effect and varies with the speed of the engine. Most cars are now fitted with resistive leads, but these are not always effective at the higher frequencies. Perhaps the easiest answer is to fit suppressor type plug caps, but if you do this replace the existing plug leads with plain wire types or you may get ignition problems.

Remember that there is also some radiation through the ceramic body of the plug. This can be overcome by using the type of plug suppressor that has a metal sleeve which pushes over the metal body of the plug. This also has another unseen advantage in that, because it keeps the plug body clean, it reduces any problems due to tracking; a sure source of noise on the HF bands.

If these measures do not do the trick, remember that there are inductive plug suppressors available which are intended for VHF use. Good ones can be a bit pricey, but if that is what it takes. . .!

## High voltage

Remember the 'Old Timers' spark transmitters? You have one under the bonnet; it is called the ignition coil. The supply to this is controlled by the contact breaker in the distributor, and the switching transients caused by this system are impossible to keep out of the car's cabling. It is essential to fit a suppressor capacitor on the battery side of the coil, and the inductive type is also available for this purpose.

The high voltage circuit, usually around 25,000 volts, is earthed via the battery *not* the coil case, and due to this many coils are now enclosed in a plastic case which will, of course, allow direct radiation of all that RF energy. You can try enclosing the coil in a metal case, but the best answer is to replace it with a metal can variety. Even these are often painted and, if so, remove the paint from under the fixing strap to ensure a good earth.

## The distributor

There is not a lot that you can do here except to make sure the contact breaker is correctly set and that the condenser is in good condition to minimise sparking at the contact points. If you find that you are getting radiation from the distributor it can be cured by fitting a well earthed metal can over the body of the unit with

suitable clearance holes for the leads. In the very worst cases you may have to run the spark plug leads in screened cables, with the screening bonded to the metal cover of the distributor.

## The alternator

The noise from this is recognisable as a high-pitched whine which varies with the speed of the engine. Check that the suppressor capacitor is still connected (they have a nasty habit of falling off the spade connector), and that the earthing clip is clean and tightly fixed. Inductive suppressors are also available for use here. If all else fails, try connecting a 2000 $\mu$ F or higher value electrolytic capacitor across the supply leads to the rig. A further improvement can be made by fitting a choke capable of carrying enough current to run the rig in the positive supply line on the battery side of the electrolytic, so making an LC filter network.

## The instruments

Most car instruments are run from a stabilised line which is produced by a mechanical chopper switching system, which can cause horrendous noises. Fitting .01 $\mu$ F disc ceramics from input and output terminals to earth will usually cure the problem, but in extreme cases replace the unit with a regulator using something like a 7805 chip.

The new image is to have a rev counter fitted, and this provides a virtually incurable problem. These units may be wired in series or across the low voltage supply to the ignition coil and rely on the pulses we are trying to eliminate to operate them. The problem is made worse by the fact that the pulsed wiring comes into the back of the instrument panel and this is a major reason for keeping the rig wiring well away from the dash.

## Mechanical systems

Hash type noises can be generated by such things as the windscreen wipers, heater blower motor and electric window winders. These can usually be suppressed by fitting the usual metal-cased suppression capacitors close to the motors. A fairly regular ticking noise is often generated by the electric fuel pump, which also responds well to the capacitor treatment. A lot of pumps are mounted under the car, and in these cases make sure that the earth connections via the fixing bolts are in good condition.

## Bondage

No, not that sort! Nearly all the earth returns in a modern car are made via the bodywork, with different currents flowing in different parts of the metalwork. Various scratchy noises can often be traced to poor joints, and some extra bonding can be an advantage. Make sure the earth strap from the engine to the bodywork is in good condition, as not only can this cause interference problems due to the high voltage ignition returned through it, but it can also be the cause of poor starting.

The exhaust system is normally



mounted on flexible rubber blocks and usually forms a quarter wave aerial around fifteen metres. Use flexible bonding straps in at least two places along its length to cure this problem. Another cause of interference is radiation through the bonnet of the car caused by poor earthing at the hinges. The answer here is to place bonding straps made from the outer sheath of UR67 across the hinges.

#### Steering and brakes

The steering column of most cars looks like a quarter wave at ten metres, passes close to the ignition system and then comes straight into the car bringing all those nasty pulses with it. The answer is to bond the column to the bodywork

where it enters the car. Remove paint from the column and attach the earth strap by compressing it under a circular clamp.

A loud screaming noise can be caused by build-up of static on the tyres and this can be cured by injecting some anti-static powder through the valve stem. A similar noise generated when braking can be cured by drilling a small hole through the brake linings and inserting a small carbon brush or section of rod.

#### The aerial

This can actually generate interference due to the corona discharge of high voltages built up on the bodywork of the car. This is caused by the pointed end of the rod and can be cured by soldering a

small nut or ball to the end of the aerial. It may also be worth trying one of the static discharge straps sold in the motoring shops.

A point worth remembering is that if you have mounted your mobile aerial on the bumper of the car, do not rely on a rusty bumper fixing bolt to complete the earth circuit; do the job properly and fit a heavy earthing strap between the bolt and the car body.

#### Remember

The usual metal can and flying lead type of capacitor may work well on the HF bands, but on VHF it is well worth fitting .01µF ceramic discs, using the shortest possible leads, as these can make a dramatic improvement.

## L F HANNEY

77 Lower Bristol Road, Bath, Avon  
TEL: 0225 24811

Your electronic component specialist for Avon, Wilts & Somerset

Closed Thursdays

## RADIO AMATEUR LICENCE

Start training now - No previous knowledge required. Study for 3-6 months. Post Coupon now for free brochure - without obligation:

**Radio & Telecommunications Correspondence School, 12 Moor View Drive, Teignmouth, Devon. Tel: 06267 - 79398.**

(AR.8)

NAME .....

ADDRESS .....

..... POST CODE .....

## THE HAMGEAR PMX PRESELECTOR

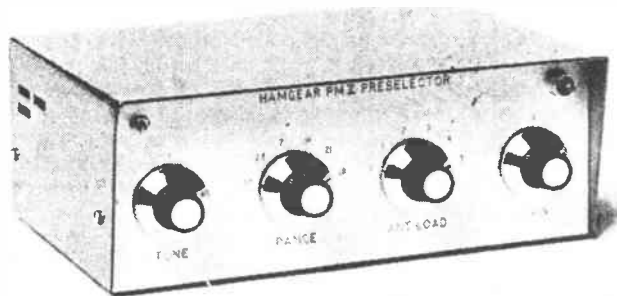

Introducing our new HF band preselector and antenna tuning unit combined, covering 1.7 to 34 MHz completely. The ATU section allows endless experiments with various lengths and types of antenna and offers correct matching of these antennas to your receiver.

The pre-amp section has a gain of 20 DBS which can be controlled down to zero gain, then on down to minus 15 DBS, allowing a boost just where the RX might need it or an attenuation where the band dictates.

The PMX can also be supplied with a built-in calibrator, having outputs at 1 MHz, 100 KHZ and 10 KHZ, with harmonics of these throughout the HF spectrum.

Casework is all metal with brushed aluminium engraved panel.

Prices are:  
Unpowered PMX ..... £69.00  
Mains powered PMX ..... £78.00  
Mains powered PMX with calibrator ..... £97.00

All prices include U.K. postage.

Send for 4-page information on this PMX series.

**HAMGEAR ELECTRONICS**  
125 Wroxham Road, Norwich NR7 8AD.  
Tel: Norwich (0603) 405611.

## RADIO AMATEURS EXAM? PASS FIRST TIME!

Before you enrol check the benefits of RRC'S unique Home Tuition Service

RRC has helped thousands of students to success in their examinations with this unique system of postal tuition, one which guides you, step-by-step, to qualify in the shortest possible time. Only The Rapid Results College offers you all these advantages:

- A qualified personal tutor
- Study material prepared by specialists
- Completely self-contained courses
- Handy pocket-sized booklets
- Personal study programme
- Regular marked tests
- Courses regularly updated
- 48 hour despatch
- Free advice before you enrol
- Telephone Helpline
- Free 'How to Study' Guide
- Instalment Plan
- Free Postage on course material
- Worldwide Airmail Service
- Extra tuition free if you don't pass first time

### POST COUPON TODAY FOR FREE RADIO AMATEURS PROSPECTUS

Please send me my prospectus as quickly as possible.

Mr/Mrs/Miss/Ms .....

Address .....

..... Postcode .....

**RRC** The Rapid Results College   
Dept. IS14, Inver House, London SW19 4DS. FREE ADVICE: 01 947 7277 (9am-5pm)  
PROSPECTUS: 01 946 1107 (24 hour). Record all Service quoting Dept. No. IS14.



## News and comment from Glen Ross G8MWR

Those of you who have been agitating for class B operators to have entry to the HF bands, have always been told that this is not possible due to international regulations stating that you can only be allowed to operate on frequencies above 30MHz. It looks as though our Canadian friends are now going to drive a horse and cart through this regulation if new proposals they are making are accepted. This could then provide the precedent on which to base your own fight for limited use of the HF end of the spectrum.

The Canadian idea is to have a licence similar in structure to our class B with power levels of up to 100 watts on all bands above 30MHz and the right of all operators to use home brewed gear. The thought that this actually needs to be written in to an *amateur* radio licence is a bit mind boggling!

### The HF bit

The extra facility involved would be the granting of the use of the HF bands with a power limit of 250 watts of CW and RTTY, plus phone privileges in the range of 29 to 29.7MHz. To qualify for this HF extension would require passing a Morse test at seven words per minute. Full class A type operating would require a further thirty hours of study and the usual twelve words per minute Morse test. All these ideas have been submitted to the Canadian department of communications, but the response is not yet known.

### Up in space

A fully professional satellite, which amateurs could use, is due to be launched next year by the European Space Agency. This is known as Olympus and will have four systems on board, one of which is a 'direct access' type which is freely available for use by anyone. The only snag is that the frequencies involved are just outside some of the amateur bands.

A letter in the *International Amateur Radio Union Magazine*, which is sent to all member societies, including the RSGB, suggests that national adminis-

trations should be approached for the relevant dispensation to operate through this satellite. As far as I know there has been no approach from the RSGB to the DTI on our behalf. If you want to get involved in this new activity, perhaps you might care to try a letter to RSGB showing your interest; and the best of luck!

### Crystal gazing

The poor old crystal ball took a hammering in *Radcom* with reference to its predictions as to what we would get on 50MHz. In fact, about the only thing it was wrong about was a possible power increase of around 2dB, and even the RSGB say this is possible in the near future. So, where did it go wrong? I still have faith in both it and the 'usually well informed sources', that also received some scathing comment, and I am prepared to put them to the test again this month. Some months ago I said, after receiving a tip off, that as soon as we got 50MHz some sticky fingered gentlemen would want to start putting repeaters and such things on it. We have only had the band for three weeks, at the time of writing, and sure enough, here they come. Not wasting any time are they?

### Caught a Packet?

The RSGB Packet Working Group are considering the transfer of the Packet repeater network from two metres to 50MHz as from the 1st January 1988. Not only that, but they want 350kHz set aside for exclusive Packet use. That is one sixth of the total band or, at the time the proposal was first made, some four months ago, 350 out of the 500kHz that was then available; ten out of ten for greed. To be charitable to the PWG we must assume that the RSGB informed them of the new band allocation a long time before they told the rest of us. In that case why the delay in a general release of the news?

### The thinking

Let us have a look at the criteria on which the decision is made and see how they stand up to scrutiny. The first point

is that the band must be a primary allocation.

The second is that it should be available to all, and the third is that the band should have good propagation characteristics over short distances but should not cover long distances except under exceptional circumstances. The band that meets all these requirements except the first is seventy cms and that clause is probably only there because the group know that it would take a long time to get agreement from other users, such as the Ministry of Defence, to get permission for the network.

### The IARU

The main argument for getting away from two metres is that the IARU are not in favour of Packet repeaters on the band, and that we must comply with international regulations. If this is the case then virtually every country in Europe is defying the regulations, as two metre Packet operation is very widespread. Another point is that we have been flouting the regulations for many years in that our seventy cms repeater system does not conform to the requirements because the input and output frequencies are reversed, and the frequency split between in and out is non standard.

### The real reason

The PWG knows as well as you do that there will be no mass move from two metres, and that all they are really looking for is a lot more space on a band that will allow class B operation on a world-wide basis when conditions are right.

Now this is a thoroughly good idea, but why can't they be honest about it? And why try to grab so much of the band for exclusive use? Perhaps it is all due to the current high level of interest in Packet operation amongst the top brass of the Society.

The main thing to bear in mind is that the PWG have the power to push this through, if they so decide, without reference to what the rest of us may feel. You certainly will not be asked for your views on the subject, but you can make them known by writing to G3XDV of the Repeater Group or to David Evans at the RSGB. Any comments on the crystal ball accuracy this month, John?

### Wallpaper

Due to recent pressure on space we have not been able to give an update on the certificates.

A lot of people have been writing to ask for information on the awards, so perhaps a quick run down will not come amiss. If you want full information on all the categories please send a stamped self addressed envelope to the address at the end of the column.

The basic idea is that to get an award you have to qualify in terms of squares, countries and counties worked plus at least one QSO exceeding a certain distance. This is to make sure you cannot get an award by simply square bashing, you have to indulge in some balanced operating.



## ON THE BEAM

### Requirements

The certificates are issued in Bronze, Silver and Gold classes for all bands above 144, and requirements for 50 and 70MHz are being sorted out. The awards can also be endorsed to your requirements, such as QRP only, mobile only, etc.

The figures in the following list are in the order Countries, Counties, Squares, kms. 144 Bronze 7,20,20,500; 144 Silver 14,35,40,800; 144 Gold 21,50,60,1200. 432 Bronze 5,15,15,400; 432 Silver 10,25,30,600; 432 Gold 15,40,45,900. 1296 Bronze 3,10,10,300; 1296 Silver 6,15,20,500; 1296 Gold 9,20,30,700.

A collection of three Gold awards will get you the coveted Platignum award, of which we have so far issued just one. All contracts must be since January 1st 1986. Contacts via repeaters do not count and you do *not* require QSL cards to back your claim; if you cheat you only cheat yourself.

### New awards

Chris GM1KHU from Inch in Aberdeen gets a 144 SSB Silver which includes a best contact with SP9CSO. G1SUC from Bedlington gets a 144 Silver, with a best DX to DL9SBM at 1020kms. G1LSB weighs in with a claim for 432 Bronze, his best DX being with DL9FAW at 491kms. This was soon followed by a claim for 432 Silver, with a best contact to

OK1KEI at 1089kms.

G1CRH from Huntingdon claims a 144 Silver and says that he found little difficulty getting the counties, but the 14 countries were a different matter. The big lift last September brought the goods for Phil and many others. G6LPS runs just ten watts to a 14 ele beam at 30 feet and claims a 144 Silver, with best DX SM7FJE at 1095kms, so proving that you do not need high power to get results. G1ITE goes for Gold on 144 with a best contact we would all have been glad to get, SV1OE at 2200kms.

### Still more

Another low power exponent is Stuart G1VTR. Running just 12 watts to a 17 ele at 22 feet and being only 120ft asl made a Bronze on 70cms a bit of a struggle, but the best DX was DG8EAJ at 430kms. A 144 Bronze award goes to G6WEM from Southend-on-Sea with the best contact being Y23FN at 868kms; a good sea take off is a great start and a later claim ups the rating to Silver.

Back to Chris from Inch, GM1KHU, who goes for a 144 Bronze endorsed for Auroral contacts only; the only one so far issued. G6STI from Hayes goes for a 432 Silver with OK1KHI at 1129kms. Those of you who thought that you could not work real DX on 70cms had better check some of these claims to see how wrong you were.

Being a Gentleman I have kept the best until last. Hazel G1NOD (and those of you who have spoken to her will know what a self confessed real nut case she is), has thrown discretion to the winds, sold the dog into slavery and banished her husband from the rig until she could get her 1296 Bronze. It was worth the effort because it gives her a clean sweep, as first YL to get awards on 144, 432 and 1296, congratulations.

### Close down

That is it for this month – out of space again. Write and let me know of your experiences on 50MHz, particularly on the DX front. The QTH, as always, is 81 Ringwood Highway, Coventry, or on Prestel using 203616941.

**Don't miss the next issue of**

*Amateur*  
**RADIO**

**on sale on Thursday 27 August**

**NEXT MONTH**

*Amateur*  
**RADIO**

### all the regulars. . .

DX Diary  
On the Beam  
Secondhand  
SWL  
Straight and Level  
Your letters and features covering the whole of Amateur Radio

### ■ ANGUS McKENZIE TESTS

G3OSS reviews the new Kenwood TW4100E 2m/70cm dualband FM mobile and the Sony ICF PRO80 all wave portable tranny

### ■ USER REVIEW

Ken Michaelson reviews the Pakratt PK232 multimode data controller

### ■ HF ANTENNAS FOR SMALL GARDENS

Don Field G3XTT with a few solutions to the common location problem

**DON'T MISS THE SEPTEMBER ISSUE**  
**On sale 27 AUGUST**

# COMPUTER EQUIPMENT

Lowest cost brand new bargains

## PLESSEY Model T24 V22/V22 bis MODEM.

Compact automatic modem featuring the latest technology & the highest possible data rate over the ordinary phone system. Offers:

- \*Both V22 & V22 bis compatibility
- \*1200/2400 Baud operation with auto bit rate recognition
- \*Operates on both ordinary phone line (PSTN) or private circuit (PC)
- \*Auto call & auto answer (V25 compatible)
- \*British Telecom approved
- \*Duplex operation allowing simultaneous transmission & reception of data at 2400 Baud in both directions over a single phone line

£350.00

\*Compact size: 9" x 9" x 2 1/2"  
\*Local & remote test

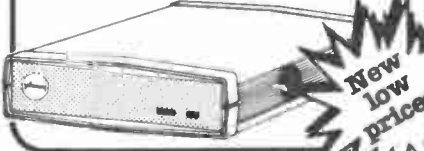

**New low prices**

## HITACHI Model 305S/SX 3" disc drives.

With SHUGART compatible interface (34 way edge connector) & suitable for BBC with DFS, AMSTRAD 664/6128, TATUNG EINSTEIN & many others. Will usually replace 5 1/4" drives directly. 250k (double density unformatted) per side reversible; 40 track; standard power connector for 12V & 5V; overall power consumption typically 3.7W. Supplied BRAND NEW with connector pin-out details etc. but uncased without PSU. Data cables are available for AMSTRAD & BBC (£7.50) and an Installation pack including data & power cables with instructions is available for the TATUNG EINSTEIN (£12.00)

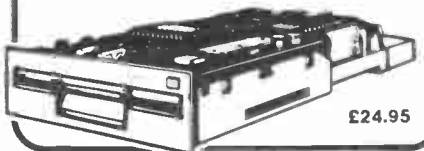

£24.95

## ITT SCRIBE III WORD PROCESSING SYSTEM.

Professional system originally selling at around £6000 without printer. Now offered with software included & a variety of different options available. This system is available from us ALL BRAND NEW at the cost of current budget systems, but with office-quality performance & features.

- SOFTWARE INCLUDED:**
- \*DATABASE — allows information storage & retrieval by user-selectable criteria
  - \*EDITING — including easy reformatting, global search & replace, save & move, cursor control etc.
  - \*AUTOMATIC LETTERWRITING — with merge, glossary file for much used phrases etc.
  - \*MATHS FUNCTIONS — screen maths allows addition of rows, columns & complete tables
  - \*PROGRAMMABLE COMMANDS — allows format changes, accessing record block files, prompts etc.
  - \*HELP FILES — quicker to use than the comprehensive manual supplied
  - \*BASIC COMPILER
- HARDWARE INCLUDED:**
- \*SCREEN/WORKSTATION — dual processor (16 bit TI 9995 & 280H) with 128k memory, 12" green screen 25 x 80 character display with slow scrolling, QUME printer interface
  - \*KEYBOARD — low-profile keyboard additionally has 43 clearly marked dedicated function keys
  - \*DISC DRIVES — dual SHUGART 5 1/4" DSDD drives each 430k capacity formatted
- £290.00

- OPTIONS:**
- \*10mbyte MiniScribe WINCHESTER disc drive (£149)
  - \*NEC Model 7700 55cps daisy wheel printer (£390)
  - \*128K additional memory with spelling check software (£35)
  - \*Communications hardware & software (£49)
  - \*\*COLOUR LEAFLET AVAILABLE\*\*



## TOSHIBA Model T300 system

(semi-compatible with IBM PC). With 6MHz 8068 processor, 192KB RAM (easily upgraded to 256KB), single half-height 5 1/4" floppy disc drive (640KB), high resolution green display, serial & parallel interfaces. Included are MS-DOS Ver. 2, MICROSOFT T-BASIC, good manuals & comprehensive diagnostic disc. Available options include a colour monitor and memory extension.

**BRAND NEW. £249.00**  
AS ABOVE, but with dual floppy disc drives. **£295.00**

## TOSHIBA Model T100 CP/M system.

With 64KB RAM, dual 500k (unformatted) 5 1/4" floppy disc drives, serial & parallel interfaces & MICROSOFT BASIC in ROM. **BRAND NEW. £149.00**

## VICTOR SpeedPac 286 IBM PC ACCELERATOR.

Half-wide 80286 accelerator card for IBM PC or PCXT, VICTOR VPC, and compatibles. Features 8KB cache memory & 7.2MHz 80286 processor. Offers AT/Personal System 2 performance for a fraction of the cost. Runs up to 7.5 times faster.

**£199.00**

## CANON Model A-1300 twin 5 1/4" disc drives.

Cased BRAND NEW half height drives, DSDD, 80 track, 640KB per drive, SHUGART compatible interface. Without PSU per pair. **£99.50**

## FUJITSU Model M2230AS 5 1/4" WINCHESTER disc drives.

6.66 MB capacity (unformatted), 16/32 sectors, 320 cylinders, with ST506 interface. **BRAND NEW. £75.00**

\*VAT & CARRIAGE must be added to all items. Carriage is £3.00 + VAT for 3" disc drives; otherwise, please enquire.

\*All equipment offered here has been bought by us as new surplus from manufacturers & OEMs; often in large quantities. Items offered are full-specification equipment, but may not be the current model. We aim to offer the best value available anywhere, and all items in this advertisement are guaranteed for 6 months.

MATMOS Ltd., 1 Church Street, Cuckfield, W. Sussex RH17 5JZ. (0444) 414484/454377  
COMPUTER APPRECIATION, 111 Northgate, Canterbury, Kent CT1 1BH. (0227) 470512 TELEX 986134 COMPAP

**matmos & COMPUTER APPRECIATION**

# C.M.HOWES COMMUNICATIONS

Eydon, Daventry, Northants NN11 6PT. (mail order only)

Phone: 0327 60178

**PLEASE NOTE: DUE TO EXPANSION, WE HAVE MOVED!**

Our range of good quality radio kits enable you to build yourself many interesting projects. We have receivers, transmitters, transverters, filters, ATUs, mics, speech processors, oscillators, and more, sitting on the shelf at our new mail order premises. If you haven't got a copy of our summer catalogue, why not send an SAE for one? Alternatively, why not call on one of our stockists and see the kits for yourself? One or other of our stockists will be at most rallies this year, and we will be attending some in person too.

UK Dealers include: —

- Bonex Ltd, Acton, London 01-992 7748
- J. Birkett, Lincoln 0522 20767
- MGR Services, Birkenhead 051-653 3437
- Southdown Radio, Eastbourne 0323 639351
- Ward Electronics, Birmingham 021-328 6070

**Watch out for our new 2 to 6m transverters!**

73 from Dave G4KQH, Technical Manager.



**EASY TO BUILD KITS BY MAIL ORDER**

World Radio History



# SECONDHAND EQUIPMENT GUIDE

by Hugh Allison G3XSE

It's not often that your scribe buys a pig in a poke, but I've just bought a real lemon. Digging about at an amateur radio car boot sale I spied an Azden PCS2800, which is a fairly desirable genuine ten metre FM box (ie, not a naughty CB). The seller was quite honest, and even without being asked told me that it wasn't working. Since it looked in showroom condition physically and a fiver seemed reasonable, money changed hands and it was mine.

On the workbench it quickly became obvious that the micro was not very well at all. Despite being given volts and instructions up all the right pins, it wasn't doing anything. The micro in question started life as a TMS1000 type chip. These are mask programmed devices, which means it's special to type. The actual number printed on it was MP4402. No sweat, ring up the importers and order a new one. Do you know how much they are? I shall not spoil your enjoyment of this excellent magazine by telling you, suffice it to say that I put the phone down in a state of shock, and several hours later I'm still shaking.

If you've got micro controlled Azden rigs, take good care of it (no powering up the back-up memory with anything but the correct batteries, for instance). I understand the different Azden rigs have different mask programs, but the prices are all, roughly, extortionate! To be fair, I expect special to type chips for any rig to cost a bit, but last year I repaired a kid's toy by fitting a TMS1000 chip at a tenth of the price. However, if anyone has another duff PCS2800 that they are scrapping I'd appreciate the micro out of it!

## Sexing transistors

Ordinary (bi-polar) transistors come in two sexes, npn and pnp. Easy, nearly all of us know that, and we probably also know that you cannot stuff one sort in a rat hole normally occupied by the other sort. At the above mentioned boot sale there was another seller with piles of assorted, duff, all transistor TV's priced between 10 and 50 pence. I bought several in a vain attempt to keep up with my son's growing collection of computers. Every TV had a line output fault, as the sets had been designed for a pnp line output transistor yet, in every one, was a brand new, good, npn one! After fitting the correct replacement, I then went on to repair what I presume was the original fault before it was 'mended'.

Next on the bench was an old Pye Lynx transistor TV camera. Why had someone put a BC108 (nnp) in an AF114 (pnp) rat

hole? Does someone know something new that I've missed out on?

I must admit to making a wally out of myself with the Lynx. I'd picked up a computer style monitor, sold as not working, for 10p at the RSGB VHF Convention. Incidentally, Convention excellent, car boot/flea market area a shambles. It was no bad I'm not certain if there was supposed to be one or not, and if not, why not? Cars with people trying to flog from their boots everywhere - let's have one designated area for it, please. However, I digress, the monitor turned out to have an open circuit potentiometer, which I replaced and up came a raster, super.

Then came the Lynx, no video, wrong sex transistor found and changed. The scope then showed video and nice big handfuls of Sync pulses coming out. Being a lazy so and so, the monitor was still on the bench, so I connected the Lynx up to it. Up comes a nasty, horrible picture, all bloomy and indistinct. Who then spent twenty minutes trying to fix a perfectly working camera? Who'd put video up a TTL (ie 5 volt) computer monitor?

## Pye Lynx

On the subject of Pye Lynxs, I get quite a few letters from understandably confused people about these cameras. The good news is that they are really well built, rugged and reliable - they last for years. A big (one inch) videcon gives reasonable pictures, good enough for amateur television use, computers etc, and they are also cheap; never pay more than £25 for a Lynx with lens, or £35 for the newer, normally silver boxed 'super Lynx'.

What is not generally realised is that these cameras really are old. Because they are fairly small and compact, and given that they look only slightly dated, it isn't realised that they were about in the 405 line days. It's easy to tell an early line one, look underneath. If the Belling Lee (TV type) co-ax plug has a sign near it saying 'RF Output', then beware. Most of these are only giving out video modulated 45MHz signals. Lynx's marked 'Video Output' or similar are probably 625 line, standard one volt peak to peak machines.

I quite like these cameras, they certainly are easy enough to work on as they contain only discrete components (no weirdo integrated circuits etc), and spares are plentiful. I bought a box of six duff ones for a fiver at the British Amateur TV Convention earlier in the year, out of which I got five going. The

only bad thing about them is that the output socket is underneath. With a TV type co-ax plug in it the camera tries to stand on its two front feet and your co-ax. Consequently a tripod is definitely needed.

## Geloso

In the valve days of ancient times, Geloso made a range of modules (actually chassis jobs) for amateur use. Their VFOs and amateur front ends for receivers are dead stable; you could probably chuck one down a lift shaft and it would still be on frequency after it hit the bottom. Some of their VFOs have 6V6 output valves in them and will run several watts in their own right, consequently making a fine little QRP rig.

Their front ends for receivers and reasonable devices too, and anything incorporating one of these is capable of good results. You often see these modules quite cheap at rallies and, if contemplating a valve rig, they could be well worth the £2.50 to £5 normally asked. The only drawback is the leaflets that sometimes accompany them. How's your Italian?

Geloso also made a few rigs. Their GR209R receiver is a superbly built device - chuck this down the lift shaft and you'd damage the lift, not the receiver. They look good, work great and have all sorts of knobs and dials. Normally they are 80 metres to 10, old bands only, although some have Top Band fitted. If you have the room, and a strong table, they are well worth considering at £40 to £50. I've seen several on offer at rallies this year, and each one has sold quickly at this sort of price.

## Trio 2700 2 metre FM mobile

These crystal controlled rigs are quite fine little boxes. OK, bigish boxes, compared with today's matchboxes. The receivers are normally sensitive, a teeny bit prone to blocking but not a problem in practice, and the transmitters chuck out nigh on ten watts, or one on low power. Here lies the problem with one example I bought recently, that the seller had given up with. Normally on low power the dial lights up green, and on high it lights up white. The seller told me he had agro with the power levels out: they were all low.

When I got it on the bench it was true - the high power was 1 watt and the low non-existent. I was just reaching for the AVO when a colleague strolled up. Ten seconds later he had swapped the green and white bulbs over, tweaked a pot and all was well. What had happened at some

stage, I guess, was the white bulb must have blown, since the rig would normally exist in the high power mode. Someone must have then put the green bulb into the white socket and it all went wrong from there. I must admit I was about to go off up the wrong path.

## Duff NiCads

I bought a handful of Tempo two metre rigs from a bloke at a rally. He had lent them out and the people who had borrowed them did not realise that the 'off' marked on the volume control doesn't do anything (5 watt models only, on the 1 watt it does). The off is the mid point between the high and low of the power switch.

In consequence the NiCads, a row of pencells, had been left connected to an on, but muted, rig, and eventually got to such a state that they wouldn't recharge. I tried all the old tricks: a quick whack across a low voltage, high current source (ie half a second across a car battery), produced no results, as did a long slow charge.

I was on the point of chucking them and buying replacements when a friend suggested scrubbing them under a hot tap. What happens on a continuous discharge over a long period is that the cell gives off crystals out of the top insulator area. Some of these crystals conduct, thus shorting out your cell even

when removed from the rig. A good scrubbing dissolves away the crystals and you are in with a chance. In this case the cells will now give two thirds their rated charge, which is better than nothing at all.

## Tempo rigs

These are mainly sold in the States by Henry Radio—you've probably seen them advertised in various American magazines. Remember that the American two metre band is bigger than ours, and most of the FM action over there is above 146MHz.

Although this doesn't apply to synthesized rigs, bear in mind when buying a crystal controlled Tempo rig that the rocks may be totally useless here, in fact worse than useless, you will get the Worked All Copshops award as they lock you up for transmitting on Police frequencies.

Secondly, the rig may be tweaked up higher in the band, and a walk round the front end and Tx output area may transform a mediocre rig into a good 'un. The FMH2 (1 or 2 watts out) and the FMH5 (1 or 5 watts out) are both worth looking out for. Price wise they go for £30, and £35 respectively seems about reasonable for a no crystal or UK crystal example, but with NiCads. Add say a fiver for one that has been fitted out with UK channels as well.

## Disintegrating potentiometers

I received an interesting letter from a reader who had experienced a strange phenomena. Since his letter wasn't dated April the first, I shall assume it is true. He had moved his shack into the loft last Autumn, and pressure of business prevented him using the gear throughout winter.

He finally turned on his well-known two metre multimode after several months inactivity, to be greeted with a very distinct lack of action. Opening it up he was startled to have a handful of small round things fall out, which were the centres of all the potentiometers!

I've repaired a few of these boxes where the centres have been intermittent due to having come loose, but I've never had one drop out, never mind the whole lot. He speculated that the paxolin body of the pot might have absorbed moisture in the Autumn and this froze during winter, forcing the centres out. Has anyone else suffered from this?

Talking of freezing I was once involved in repairing some early bat and ball type TV games that were ruined by being stored in an unheated warehouse during a cold snap. One of the chips was only specified for non operational storage down to minus five centigrade, and the whole lot had gone. Moral: rigs should winter in warm areas. Bring it into the house during cold spells.

## K W TEN-TEC LTD

### TRANCEIVERS

CORSAIR II  
ARGOSY II  
CENTURY 22

### LINEAR AMP

TRITON

### ANTENNA TUNER

MODEL 229A

### H F MOBILE WHIPS

Helium-filled

### AIRBAND TALKIES

CAA Approved

DUMMY LOAD,  
MICROPHONES,  
FILTERS, REMOTE VFO  
etc

K W TRAPS, K W TRAP DIPOLES, BALUNS, ANTENNA SWITCH,  
PRECISION MORSE KEYS

### LATEST NEWS FROM K W

FRITZEL BALUNS, H.F. BEAMS & VERTICALS NOW IN STOCK.  
(EXCELLENT GERMAN ENGINEERING)

A NEW TRANSCEIVER - IN ADDITION TO THE CORSAIR II,  
ARGOSY II, & CENTURY 22, THE "PARAGON" IS EXPECTED  
SHORTLY. THIS IS A 200 WATT INPUT TRANSCEIVER WITH  
GENERAL COVERAGE RX CW/SSB/FSK/AM/FM (OPTIONAL)  
AND MANY ADDITIONAL FEATURES.

Write or 'phone for Price Lists and/or brochures —

## K W TEN-TEC LTD

Vanguard Works

Jenkins Dale, Chatham, Kent ME4 5RT

Tel: (Medway) 0634-815173; Telex: 965834

## SHINY MAGAZINES

For the saucy clothing  
enthusiast, consisting  
of superb colour  
photography,  
readers letters,  
stories, illustrations,  
bizarre fashions and  
where to purchase  
— and much more.

Published monthly

Send £6 cheque or P/O to:

## G & M FASHIONS LTD

PO Box 42, Romford,  
Essex RM4 1QT



# FREE CLASSIFIED ADS

## FREE CLASSIFIED ADS CAN WORK FOR YOU

We are pleased to be able to offer you the opportunity to sell your unwanted equipment or advertise your 'wants'.

Simply complete the order form at the end of these ads. Feel free to use an extra sheet of paper if there is not enough space. We will accept ads not on our order form.

Send to: **Amateur Radio Classified Ads**, Sovereign House, Brentwood, Essex CM14 4SE.

## DEADLINE AND CONDITIONS

Advertisements will be published in the first available issue on a first come first served basis. We reserve the right to edit or exclude any ad. Trade advertisements are not accepted.

## FOR SALE

■ Yaesu FT102 in excellent condition, £525 ono. Want to find out more about it or interested. Tel: (0272) 790011 eves

■ FDK multi 700AX 2m FM tcvr, variable pwr 1-25W, 144MHz 147-995, immaculate cond, in org box comp with handbook, mobile brkt, home base stand, £145 ono. Tel: (0623) 552912 Mansfield, Notts.

■ FRG9600 all mode scanning receiver, modified 60-950MHz, no gaps, as new, £325.00 ono. Icom AH7000 Discord, super wide band omni directional antenna, stainless steel cover 25-1300MHz, £45 ono. Tel: 01-672 9056

■ FT708R 70cm portable rig, £190 ono. Tel: Brighton (0273) 418345

■ SP600 .54/54MHz, £125. FTDX 560, very little use, set of spare valves, £150 ono. MM 2m 100 watt linear, £75. MM 2m pre-amp, £10. RAI-B Rx, £50. AVO sig/gen, £10. TCS121 Tx/Rx, £85. Pye T401, 401, plus mobiles, hi-band AM xtailed, spares, Tr1936R VHF aircraft set, complete, £55. Other gear, SAE for list. Wanted: T1154 front plate, scrap R1155 for panel parts, RA17L circuit. RAI-B r/control. Cain, 18 Oaky Balks, Alnwick NE66 2QE. Tel: (0665) 602487

■ Yaesu FT7B plus YC7B digital display, very good condition, with manual, also desk mic. Will swap for a base type HF transceiver, either analogue or digital, cash either way. Ask for Shaun. Tel: (021) 5251254

■ Racal RA17L, cased and with manual, professionally serviced and aligned, vgc, £145. A Daiwa AF606K all mode active filter, boxed as new, £48. Frank. Tel: Swanley 63968

■ Trio TS820 with digital frequency readout, equal to TS820S, complete with YG88C CW filter and MC35S noise cancelling microphone, recent new driver and 6146B PAs, excellent, £440. Will deliver for cost of petrol. Also ICS FAX-1 decoder, requires G/C receiver and Epsom compatible printer, £200. G3RDG. Tel: 01-455 8831 QTHR

■ Two Clearstone CH800 VHF/FM hand-held transceivers with NiCads, six channels, untuned, £80 each or will swap both for 2 metre FM mobile or VHF/FM mobile scanner. Tel: (021) 4293326

■ Dressler ARA500 active antenna, cost £139, bargain £70. Tel: (0792) 467384

■ Jaybeam 70cm 18 ele parabeam aerial. Good cond, £15. Tel: (021) 3605429 B'ham

■ 857 Communications receiver, VHF 54-176MHz/CB 40chs, cost £27.95, £14.50. SAE please. Tom Smyth, 14 Crichton Park, Tamlaght, Enniskillen, Co Fermanagh

■ Belcom LS102L, perfect working order, unmarked condition, mobile bracket, Belcom mike, boxed with manual, £180. Tel: Nottm 874235

■ General coverage transceiver, ie Icom 720A etc, cash offered. Sony CRF320 for sale. Tel: (0462) 33690

■ *Wires and waves Book*, A Practical Guide, £2.50. Tel: Clochan 378

■ Trio R1000 recvr, 200kHz to 30MHz, with FM, mark on front panel but works well, £190. Heath wattmeter, AW1U, audio 5mW to 50W, £20. Heath solid-state voltmeter, 1M-17u, in case, £18. 2m linear amp, MML/144/2S, £30. G3UCE. Tel: Hest Bank 822125

■ Racal RA17L comms receiver, 0.5MHz to 30MHz, perfect working order, £160 ono. WHY. Tel: Wishaw (0698) 357869 before 8pm any day

■ Icom IC271E 2m base station, full muTek front end, 25 watts output, 32 memories, 2 VFOs, immac condx, £600. KDK 2m FM mobile Tx/Rx, 1/15 watts output, memories, scan 14-148MHz coverage, £140. Doug Mellor G0GXT QTHR. Tel: (0298) 79481

■ Sony 2001D receiver with air band, synchronous tuning, 32 memories, etc. Mint condition, boxed with manuals, only selling because I have upgraded, £200, carriage extra. Tel: 01-570 5603

■ 160ch FM CB, 8 watts, will do new 40, £50. 5 digit freq counter, 12V, £15. 26-30MHz, 3 ele beam, £15.

PA7E 934 base ant, £25. 934 mobile ant, £15. ATV conv 70cms to UHF TV, new unused, £15. Eddystone 150Hz-30MHz, AM, SSB comm Rx, vgw, heavy must collect, £40. 2m 16ch scan Rx, 240V-12V, 2 spare xtals, £45. Tel: Chris (0227) 711172 eve, Canterbury

■ G4ENA 160 metre mobile SSB transceiver kit, all new components, only few missing, complete with case, £75. GW3WSU CS Beynon Bungalow, No 1 Racal-Decca Tx station, Llanoarfarn, Barry, S Glam, CF6 9AE. Tel: (04468) 261

■ Daiwa PS300 PSU, 30amp variable, cross needle meter, £150. Marconi TF995 sig gen, AM/FM/CW to 220MHz, £55ono. 1kw 3 way ant, SW, £10. Kenwood noise cancelling microphone, £5. Stolle upper support bearing, £10. FT290R mobile mount, £10. Pye 3ch transceiver, £15. Pye PF1 battery charger, £5. Micranta transistor checker, £10. Tel: (0602) 788239

■ Plessey type 72 switches, 3 bank, 3 pole, interchangeable, 30 way silver contact, very high spec, £25 ono, seven to clear. Also Superstar 2000, four blocks of fifty, 25.9 to 28.3, plus mike, imac cond, hardly used, £120 ono. Also 100W linear, 26 to 30MHz, £30 ono, inc p+p. Also Zenith speech processor + power mike, switches straight thro', £45 ono inc p+p WHY? SP Martin, 24 Collingwood Close, Worle, Western-Super-Mare, Avon BS229PQ. All letters will be answered or enclose phone no and time and I will phone you

■ FDK725X, 144-148MHz, plus Heatherlite mobile safety mike to suit, (a must nowadays). ½ and ¾ whips, gutter mount, Drae VHF wave meter, £215 ono. Would consider part exchange for FT707 + FM or FT77 + FM and cash adjustment, (reason for sale!) Tel: 01-247 6097 daytime only

■ Yaesu FT757GX, Yaesu FC757AT, Yaesu FP757HD, mint condx, hardly used, £945, collect or carriage extra. Tel: (0670) 859553 anytime after noon till 10pm

■ Yaesu SP980 extension speaker, immaculate condition, £55 or exchange SP102 perhaps. Also FT980/757ATU coupling cable, ideal as spare, £10. Tel: (0396) 832233

■ Microwave Modules RTTY to TV receive converter, in as new condition, complete with plugs cables and instructions, £145 ovno. John Redfern GW4RZU, 24 St Brides View, Roch, Haverfordwest, Pembro SA626AZ. Tel: (0437) 710544

■ FT290 with case, NiCads, charger, etc + ¾ wave mobile antenna, as new, all boxed, £250 or p/x. Exchange for photographic or darkroom equipment. Tel: Milton Keynes (0908) 79630 (G6XXL)

■ Yaesu FT901DM HF all mode transceiver, excellent condition, £50 ono. Trio TW4000A 2m 70cm, dual band FM transceiver, £375. Tel: Weymouth (0305) 789022. G0FAJ QTHR

■ Swap Trio TS430 FM + mobile mount, for Trio TS711, Icom IC275 etc, or sell for £750. Yaesu FT209RH 2mtr h/held, FNB4 NiCads, and charger, £250. Sinclair Spectrum 48K, £70. Solartron LM1450 digital voltmeter (bench), £30. Will consider FT707 + cash for 430. SC Stevens, 13 Jevington Gardens, Eastbourne, East Sussex. All letters will be answered

■ Yaesu receiver, FRG7000, boxed, instruction manual, £220 ono. Scanning receiver, PRO2002, £175 ono. Both excellent condition. Tel: (0926) 54556 Kenilworth, after 6pm

■ Trio R2000 communication, HF 150kHz to 30MHz, with SSB, LSB, FM, AM, CW, programmable memory scan store, not 6 months old, with box, manual, offers over £400. Nato 200, suitable to convert to 10 metres, £135 ovno. Tel: (0283) 221870

■ FDK multi 2000 2 metre Tx/Rx, FM/SSB, £80.00. Tel: Bedford (0234) 742414

■ Alinco VHF FM portable transceiver, ALM203E, plus dc-dc convertercase, NiCad battery case, charger, charger cable, mobile stand, speaker mic, 2nd NiCad battery pack, plus ¼ watt ant, total value

new £328, Rx 140 to 160, Tx 144 to 146, Boxed as new, for quick sale £220 ovno. G1UAD, Terry. Tel: Bishops Waltham (04893) 4960

■ Icom GT1 personal Tx/Rx, cost over £750, mint cond, offers or exch Trio, Icom Tx/Rx general coverage, cash adj either way. All letters answered. Mr F J McNally, 3E Langlands Court G51 4XJ

■ Icom 701 tcvr with matching PSU and speaker keyboard and desk mike, mint condition, original packing with instr manual, prefer buyer collects, £500. Tel: Stoke on Trent (0782) 313448

■ Eddystone 770R MK2, 19 to 165MHz, superb condition with full manual, 2-4-6 mtrs, Aircraft etc, exchange for 2mtr linear with pre-amp, must be 10 watts input, or HF Rx Racal with cash difference, or swap for AR88, Trio 310, Eddystone 888 or EA12 or 940C. KW77 or Hamerlund HQ170 or similar WHY? Cash difference if req. Value £80, but no rubbish. Distance no problem. Tel: Barnsley 283008 and leave me your phone no. All calls answered.

■ Standard C58 2m portable, cw all extras, £300. Trio TR7010 2m SSB mobile, £75. Pair brand new 4CX250 valves c/w VHF bases and chimneys, offers. Shure 444 base mic, £20. Exchange possible WHY? Tel: Wallingford 36720, evenings

■ FT290R, NiCads, charger, mint cond, used as base rig only, £260. Also Tono amp/pre-amp, 1-3W in, 30-40W out, as new, hardly used, £50, or £300 for both. Would accept IC201 or similar base rig part exch. Tel: Dover (0304) 821790

■ Complete RTTY terminal ZX81, with 16K memory, Maplin Keyboard, Scarab interface and program, variable band rate, ST5 TU, 170 and 425 shifts, several tapes. All in neat metal cabinet. Buyer collects. Hastings area, £85. G4ERA QTHR or Tel: (0424) 812350

■ Alinco ALM203E h/held 2m Tx/Rx, 4A power supply, dc/dc conv, SWR meter, NiCad battery charger, all under guarantee, £250 ono. AC Robinson, 15 Hampton Grove, Fareham, Hants PO15 5NL. Tel: Titchfield (0329) 45133

■ Icom HF all band transceiver, mobile or base, with Icom IC-P15 supply unit. Also all band HF antenna coupler. Tokyo HC200 and YH55 headphones. All boxed and manuals in mint cond, very little use from new, can deliver, £700. Tel: (0909) 481964, evenings.

■ Drake T4XC R4C, AC4 power supply, Rx with extra 1.5kHz SSB filter, MS4 speaker, works on WARC bands with extra crystals, transceiver or separate connecting leads, all in mint condition and boxed, £500. G4LW, 118 Bradford Road, Trowbridge, Wilts. Tel: Trowbridge 3166

■ National company HRO receivers in pristine to grotty condition, offers. Copy of manual for dynamic mutual conductance tube tester required. Expenses paid. Tel: St Albans 39333

■ Zycomm FM 2572L 25 watt, 12 channel FM rig, good for 4m conversion, £250 ono. Motorola MX350 4 channel VHF FM rig, good for 2m conversion, £35. Waltham W154 combined portable B+W TV, tape and 3 band radio, radio section needs repair, otherwise all OK, £60 ono. Radio mags, assorted types, 1967 to 1987, 10p each or 12 for £1. 10GHz WBFM rig kit, £13 ono. Withers 27MHz to 29MHz conversion board, ex rig hence only, £8. 70cm to 2m converter with pre-amp, partly built, £10 ono. 2m/6Y/70cm/12Y combined Jaybeam Yagi, never used, £30. 2m FM 4 channel rig with NiCads and charger, £25 ono. I also have other gear for sale. Prefer buyers to inspect and collect, otherwise postage extra. Mr P Coles G1SFS, 23 Chestnut Walk, Bishopsworth, Bristol 3, Avon. BS13 7RJ

■ R390A/URR high grade professional receiver, based on Collins 51J3 series, complete with operating, maintenance and service manuals, sensible offers wanted. Scarabs Systems RTTY terminal unit with Spectrum interface and software, £50. Microwave Modules MM2001 RTTY to TV

# FREE CLASSIFIED ADS

converter, £100. Hallicrafter SX28 super skyrider receivers, £40, £60. Offers wanted for National HRO junior, senior, MX and 5T models. Tel: St Albans 39333

■ R2000 Trio, memory cost over £500, £360. Full details. Boxed Concord II suitable to convert to 10 meters, £90. Nato 2000, as new, offers over £125. Tel: (0283) 221870

■ Dressler active antenna, ARA30, 200kHz to 40MHz, as new, purchased Feb 1987, cost £122. Sell for £80. Tel: Kirkham 683098 Lancs.

■ ICR70 receiver, unmarked condition, with service manual, £320. FL44A high performance SSB filter for above, £50. Yaesu FT790R all-mode 70cm transceiver, covers 430-440MHz, 1 watt out, memory, scanning 2-VFOs, aerial socket fitted to rear (front socket retained), little used, £250. Alinco ELH730G 30 watt 70cm linear amplifier, no pre-amp, 1 watt input, auto switching £50. Allan G3RDC, 47 Crick Road, Hillmorton, Rugby CV21 4DU. Tel: (0788) 69447 evenings

■ R1000 general coverage communications receiver, and Jaybeam Triband vertical aerial, £295. Tel: Bromsgrove 33173

■ One *Wire and Waves*, £2.50, includes post and packing. Wanted: one Trio 59RDS, about £40. Tel: Clochan 378

■ Rx converters, Microwave Modules 2 metre to 20 metre and 70cms to 10 metre, £25 each, in as new cond. Six element discone aerial, VHF/UHF, ideal for scanner or converters, good cond, £12. I am open to near offers on these. I also have 100 78rpm records in good cond. Dance bands, vocal etc, £25. Wanted: cheap 70cms hand-held, 1/2/3 channels, may swap p/x above. Tel: Tamworth (0827) 58004, ask for Stan

■ 30 plus domestic valve radios from 40s and 50s, swap for Rascal RA17 receiver in good working order. Bring your own truck. Tel: Horringer 441 Suffolk

■ Rascal RA17C comms receiver, 0.5-30MHz, vgc, £160 or would exchange for tubular mast, cash adj either way WHY? Also, could anyone give me advice as to whether an FM board can be fitted to FT277ZD Euro eqn of FT101ZD? Tel: (0698) 357869 or write P O Box 3, Wishaw, Scotland. All letters answered

■ FRG7700 receiver with FRT7700 ATU and service manual, both as new, £285. *World Radio and TV H/Book*, 1987 edition, £9.00. Bound volume 1973/74 *Radio and Electronics Constructor*, good condition, offers. *TV explained* by Miller and Spreadbury, 1957, band I/III, offers. *DX TV Reception*, by Roger Bunney, offers. Geared tuning condenser for HRO, good condition, offers. T/former, 230/250V in, 115V out, offers. Buyer collects or pays carriage. Borthwick, 92 Linglie Road, Selkirk, Selkirkshire

■ Trio 9R59DS com Rx, 0-30MHz, gwo, needs slight attention to tuning band spread knob, hence £40.00 ono. Realistic DX160 com Rx, 0-30MHz, gwo, gco, £35.00 ono. Marko CB747, AM, FM, LSB, USB, S/low low, mid, high, S high, + legal 40FM, built in SWR meter, fitted roger beep, ideal for 10m FM conversion, £50.00 or £100.00 the lot, or swap the lot for Pan-International Crusader 'X' 12 band professional Rx or hand-held scanner. Andrew Nevill, 1 Humber Street, Old Goole, North Humberside DN14 5UJ. Tel: Goole 2235

■ Yaesu FT100, good condition and working order, with new spare valves £250 or swap R600 WHY? possible 2m multimode. Tel: (0952) 57670

■ FDK multi quartz 16 FM 2m xcvr, excellent cond manual, mobile mount, original box, xtals fitted for R0-R7, S17-S23, £65. MM xverter, 10m-2m, 10W out, model MM144/28, ex cond, £65. Alan G1EBH. Tel: Basildon (0268) 45573 after 6pm

■ Geared tuning condenser for HRO receiver, good condition. Transformer 230/250 in 115V out. T/former ex CR100 200/250, input 600V, 6.3V/5V output. Ericsson BBC headphones (vintage) home brew ATU for amateur bands, transmit, receive, offers. Borthwick, 92 Linglie Road, Selkirk, Selkirkshire TD7 5BD

■ Yaesu FRG7 or sim, all modes gen/con Rx, 0-30MHz, must be in gwo. Swap for my panasonic NV-8170 VHS video cassette player, stereo, Dolby, no RF modulator gwo. Andy. Tel: (0228) 29810 Carlisle

■ Yaesu FT200 transceiver ant, tuner FC902 and power supply, all perfect working order and good condition, price £350 or best offer. 16 Seapark

Drive, Clontarf, Dublin. Tel: 393896

■ Heathkit U-matic memory keyer, full iambic touch capacitance paddles, very versatile, fully digital state of the art keypad entry, ten memory buffers, also teaches Morse at any speed. Brand new, £85, costs £120 new, 12V reqd. Steve GM4GTU QTHR. Tel: (0224) 743039 evenings (Aberdeen area)

■ HF5 vertical antenna, 80m to 10m, hardly used, original packing with clamps and instructions, £45. Also Minolta camera and case, with wide angle and telephoto lenses, with gadget bag to carry the lot. Would exchange for Yaesu FT790R or similar FM 70cms set in good condition. W Lankshair, 57 St Georges Road, East Looe, Cornwall PL13 1ED. Tel: Looe 2823

■ Ex service trans receive equip type TV3 W5845 EDX with various assorted spare parts, including M/Gens switch and fuse panels, offers. Buyer collects. Tel: Ingatstone 353425 after 7pm

■ FT790R 70cm multimode with NiCads charger, manual, carrying case, boxed, £250. Burgess Hill, QTHR G1010. Tel: (044) 4642122

■ FT223 FM 2m transceiver 10W, xtal controlled 14 xtals installed with man etc. £75. Old wireless, late 1940s, large, £15. Console TV, late 1940s, with built-in wireless, £15. No offers. Tel: Oxford 735821

■ FT208R 2 metre FM hand-held transceiver, NiCads + charger plus spare set of NiCads, complete with manual & box, good condition, £135. Tel: Terry (0462) 35248 after 6pm

■ VHF station consists of Trio 2300, power supply, Microwave Module MML144/25 linear amplifier, Daiwa crossed needle power SWR meter, rotator, 12 element ZL special, plus HB9CV mini beam, £200. May sell separately, Mike Poulton G1PTN. Tel: (061) 7750253

■ Yaesu FRG9600 Mk2, coverage 100kHz-950MHz, with PA4C ac adaptor, using ADK HFC1 HF converter to aerial socket, five months old, £400 or nearest offer. Jack Wingrove, 114 Wakehurst Road, London SW11 6BT. Tel: 01-228 4835

■ Complete handbook for Telequipment D31 and D31R scope, £2, post free. Also hundreds of new boxed valves, cheap. Write for prices. Also Hitachi CCTV camera fitted with Cosmicr 25mm 1:1.9 lens, £45. Do you own American TCR32 radio? Have new C1335 - TCR-32 control unit for it, £30. New, unused Kenwood VFO120, boxed, £60. Also Bendix TA12G, WW2 Aircraft transmitter, complete, good condx, £20. Buyer collects. Nev Kirk G3JDK, 54 Allendale Rd, Rotherham S65 3BY. Tel: (0709) 541606

■ G4QG selling Heathkit SB200, £250. Heathkit Cantenna oil filled dummy ariel, 1kW, woden deluxe 1250V mains transformer, £18 (Heavy). 4-way SO329 co-ax switch, £15. 813 (3), 805 (4), £15 ea. Buyer collects or pays Securicor. A R Street, 14 High Park Road, Tyde, Isle of Wight PO33 1BP. Tel: 62472

■ Yaesu FT2700RH 2m/70cm mobile dual-bander (full duplex cross-band), including Welz duplexer, £335.00. Yaesu FT709R 70cm hand-held with FNB3 (3W), FNB4 (4W) and speaker mic, £250.00. G4WVX, Bruce QTHR. Tel: (06286) 64415

■ Yaesu FT726R 2m, 70cm and Sat unit, complete with MD1 desk mic, £900 ovno. Buyer collects. Mark, G6PMN QTHR. Tel: 01-236 8861 daytime

■ Yaesu FT290 multimode with NiCads, charger and 10W matching FL2010 linear, all virtually unused, £315. TET HB23M, 10/15/20m HF antenna (still in packing), £115. Kenpro KR500 elevation rotator, £90 (as new). J/beam D15/23 1296 (23cms) Yagi, £30 (new). VHF comms (German) 2 metre antenna polarisation switch unit (new) £30. Paul G4XHF. Tel: (0293) 515201 (pref evening)

■ Standard C5800 2 metre multimode, 25 watts, mobile transceiver, with mike mobile mount, manual, very sensitive £350 ono. Tel: 01-693 0722 (Dulwich) ask for Dave

■ FT290, £230. FT790, £230. MM432/30K, 1 watt input, £100. All accessories, all mint condition. G1BAS, Kettering. Tel: (0536) 743748

■ LMW solid-state PA approx 8-9W out, £50. EME (German) twin-2C39 tube PA, 150W out, with blower, 'official' power supply, V and A meters etc, very smartly finished in Radiospares instrument case, with spare tubes, not heavily used, superb machine, wicked price new, which means my price of £275 ono represents a considerable discount. LMW bipolar pre-amp (not masthead), in black

diecast box with BNCs, £15. EME (German) high-spec coaxial relay, mounted on diecast box, £40. Fortop 24cm FM/TV transmitter, 1249 and 1255MHz, 1.5W out, £120. Wood & Douglas 24cm FM/TV sound and vision receiver, £100. Fortop 70cm TV transmitter, 10W output, crystallised 435 & 438.5MHz, £100. Microwave Modules 70cm ATV converter, Band 1 output, £20. Clarion JC-10 933-935MHz personal radio system transceiver, 5W FM, with accessories, £200. All the above equipment is in virtually as new condition and guaranteed working. Andy Emmerson G8PTH/G9BUP, Northampton. Tel: (0604) 844130

■ ZX Spectrum + computer, £80.00. Concorde Ham Internat, recently set-up, perfect, £90.00. BRL200 linear never used, £90.00. Commodore tractor printer, 4022P, pwo, £90.00. Ricoh 500G camera 35mm, £60.00. Wide/ang lens, cased, £40.00. Mirage zoom lens, cased, £60.00. Super Star 2200, LSB/USB, AM/FM, CW/H/L, MIDS/L/L, HH/10kHz shift + converted 10m bands, £300. Rotel convert 10m FM, £80.00. Ferguson ST31 cassette recorder LEDs, level, £45.00, perfect. Contact Bob. Tel: 01-859 2649 and mention 'Chas' of Middle Park Avenue who has no phone, RAIBC

■ Yaesu FT290R with NiCads, charger, case plus matching FL2010 10W linear, all perfect condition, £300. TET HB23M 10/15/20 metre 2ele HF beam, brand new, still in packing, £105. Jaybeam MBM48/70 70cms antenna, new, £25. Jaybeam D15/23 23cms Yagi, new, £30. VHF comms/uKw 2 metre antenna polarisation switch unit, £29. Paul G4XHF. Tel: (0293) 515201 (evenings preferred)

■ ATV complete station for sale, camera and monitor plus transceiver, 1.5 watts, 70cms antenna, £100. Tel: Coventry (0203) 456128 evenings

## WANTED

■ *Newnes Complete Wireless*, part 5 only. Also the four special binders to hold all thirty two parts. Contact Tom Valentine, 38 Gramplan View, Montrose, Angus DD10 95X. Tel: (0674) 76503

■ G5JCV, suitable for sporadic equivalent. Full details. Tel: (0283) 221870

■ Urgently required to assist disabled person: Datong Morse keyboard. Please help if you can, we are desperate to acquire the keyboard so the disabled person can fulfil a dream and make it a reality. Please, please help. Tel: Winchester 64810

■ Antenna matching unit, TenTec 277 or 278 or similar small unit. Dig out that old unused gear and give me a ring. Barrie G4ZAW. Tel: (0227) 373511

■ Wanted for BC348Q Dynamotor unit, rear socket, case or rough set. Exchange complete R1155E odd capacitors, leaky. R1147A, another similar unidentified much earlier. Wanted: plug in coils, Eddystone 358X, or self exchange set, works well. 52 Bramble Lane, Mansfield, Notts.

■ Secluded QTH lines with tower and scope for LF antennas, no close neighbours, privacy essential, property must be attractive in good repair with garage. Immediate decision upon inspection. Cash purchase please. Tel: (0323) 897313

■ Icom R7000 VHF/UHF receiver, must be of excellent condition, reasonably priced please. Tel: (0206) 394336 after 7pm

■ HF set, must be vgc and inc handbook, FT401B, FT501, FT101E or EE, FT200 inc PSU, KW204, KW200E inc PSU, or TS520, or if you have one a FT620B, must have handbook and be in vgc. 2m multi, pref more than 3W out, must be vgc inc handbook and box. Swap for mint FR100B Rx inc handbook, plus Computer Genie by Lowes, inc RTTY Tx/Rx, CW, Rx only, plus two other programs, mint and boxed, plus valve QVQ06-40A. Tel: (0482) 446640 after 7pm, not QTH

■ FT707 or similar solid-state QRO HF rig capable of 12V operation, for club use, plus 3.5-30MHz ATU. Write Peter GOGTB, 48 Lincoln Road, Stevenage, Herts SG1 4PJ. Tel: (0438) 724991 or 350136 or 352932

■ Private collector wants early wireless sets round Ekco Bakelite crystal sets etc. AR88 set wanted for spares. Circuit of Hallicrafter or manual super Skyrider receiver 1938. Any Ekco or Murphy pre 1950 export sets wanted, have few post war valve radios to go. I collect only pre 1948 gear. Tel: Clacton on Sea 429779

■ Operating instructions and data on Lafayette radio tube and transistor tester, model TE-21. Cost and details to: Tom Valentine, 38 Gramplan View,





# Amateur RADIO SMALL ADS

## JAPANESE IC'S (PART OF OUR RANGE)

AN301 £3.50, AN7140 £2.20, AN7145 £1.95, AN7146 £2.20, BA532 £1.60, BA536 £2.40, HA1377 £2.20, HA1398 £2.75, HA13001 £2.95, LA4460 £1.90, LA4461 £1.80, LA4507 £4.25, LC7137 £2.75, M51515 £2.50, M51517 £2.80, MB3705 £1.80, MB3712 £1.50, MB3722 £3.50, MB3730 £2.50, MB3731 £3.50, MB3756 £2.60, MB8719 £3.85, STK461 £7.50, STK463 £8.40, TA7205AP £1.00, TA7222AP £1.30, TA7229 £3.25, TA7240 £2.95, TA7607 £2.95, TA7614 £2.75, TA7628 £2.95, TA7640 £1.75, UPC575 £1.00, UPC1001 £2.20, UPC1031 £1.95, UPC1158 95p, UPC1181 £1.10, UPC1182 £1.10, UPC1185 £2.50, UPC1188 £2.75, UPC1230 £2.50, UPC1277 £2.75, UPC1365 £3.60. ADD 60p POST AND PACKING AND THEN ADD 15% VAT TO TOTAL.  
**T POWELL 16 PADDINGTON GREEN LONDON W2 1LQ**  
**OPEN MON-FRI 10AM-5PM, SAT 9AM-12 NOON.**  
**TELEPHONE: 01 723 9246**  
**ACCESS/VISA. TELEPHONE ORDERS ACCEPTED OVER £5.00**

## HEATHKIT U.K.

Spares and service centre.  
 Cedar Electronics, Unit 12, Station  
 Drive, Bredon, Tewkesbury,  
 Glos. Tel. 0684 73127

## JAYCEE ELECTRONICS LTD

JOHN GM30PW  
 20 Woodside Way, Glenrothes,  
 Fife KY7 5DP  
**Tel: 0592 756962**  
 Open: Tues-Sat 9-5  
 Quality secondhand equipment in stock. Full  
 range of TRIO goodies. Jaybeam - Microwave  
 Modules - LAR.

## ETESON ELECTRONICS

**E.E.** 15B Lower Green,  
 Poulton-le-Fylde, Blackpool  
**Tel: (0253) 885107**  
 Open 9.30am - 12.30, 1.30 - 5.30. Closed Wed & Sun.  
 Electronic Component Specialists.  
 A wide range of electronic components. IC's, capacitors,  
 transistors, resistors, plugs and sockets etc.

## USED AMATEUR EQUIPMENT? I Buy, Sell & Exchange!



SELLING? I pay the BEST POSSIBLE PRICES  
 for your Clean Used Equipment!

BUYING? I have the BEST SELECTION of top  
 Quality Used Equipment Available!

For the Deal You've been Looking for, Phone Dave, G4TNY  
 ANYTIME ON HORNCHURCH (04024) 57722 (0836) 201530 9am -  
 7pm Mon - Sat or Send SAE

**G4TNY AMATEUR RADIO**  
**132 Albany Road, Hornchurch, Essex RM12 4AQ**

## PNP Communications Communications Interface for RTTY - Morse - AMTOR

Our popular range of communication modules is now  
 available, fully boxed and tested under the model  
 number.

### CTU 20

The CTU20R is RTTY only & costs **£82.50** whilst the  
 CTU20RM is for morse as well and costs **£75.25**  
 For shortwave listeners the MF2-DX gives the option  
 of 170Hz, 425Hz or 850Hz shift reception and costs  
**£56.95**

Send a large (A4) SAE for full Cat  
 Please add VAT at the current rate.  
 Access & Barclaycard (VISA) welcome.

**62 Lawes Avenue, Newhaven**  
**East Sussex BN9 9SB**  
**Tel: (0273) 514465**

## D.P. HOBBS (Norwich) Ltd

13 St Benedicts Street, Norwich Tel: 615786  
 Open Mon-Sat 9-5.30  
 Closed Thurs 1.00pm  
 Stocks of:  
**ICOM**  
 YAESU, FDK, ICOM, JAYBEAM  
 & Electronic Component Specialists

## MORSE CODE PREPARATION

Cassette A: 1-12 wpm for amateur.  
 Cassette B: 12-25 wpm for professional examination  
 preparation. Each cassette is type C90.  
 Price of each cassette (including booklets) £3.95.  
 Morse key with separate battery (PP3) - driven solid-state  
 oscillator and sound transducer produces clear tone for sending  
 practice. Price of key with electronic unit £8.95.  
 Price includes postage etc. Europe only  
**MH ELECTRONICS (Dept AR)**  
 12 Longshore Way, Milton, Portsmouth PO4 8LS

## WORKSHOP SERVICE MANUALS

Thousands stocked. Most makes. Models, Types, Audio, TV,  
 Video, Test, Amateur etc. SAE Enquiries/Quotation. Bumper  
 Catalogue £3.00 including free phonograph speed disc,  
 details unique. Repair and Data Guides

### MAURITRON (AR)

8 Cherry Tree Rd, Chinnor, Oxon OX9 4QY

# Amateur RADIO

This method of advertising is available in  
 multiples of a single column centimetres -  
 (minimum 2cms). Copy can be changed  
 every month.

## RATES

per single column centimetre:  
 1 insertion £7.00, 3 - £6.60, 6 - £6.30, 12 - £5.60.

# SMALL ADS

## AMATEUR RADIO SMALL AD ORDER FORM

**TO:** Amateur Radio · Sovereign House  
 Brentwood · Essex CM14 4SE · England · (0277) 219876

**PLEASE RESERVE**.....centimetres by.....columns

**FOR A PERIOD OF** 1 issue.....  3 issues.....  6 issues.....  12 issues.....

**COPY** enclosed.....  to follow.....

**PAYMENT ENCLOSED:** (Add 15%VAT).... £ —

Cheques should be made payable to  
 Amateur Radio. Overseas payments by  
 International Money Order and  
 Credit Card

**CHARGE TO MY ACCOUNT**.....

**CREDIT CARD EXPIRY DATE**  /

**COMPANY** .....

**ADDRESS** .....

**SIGNATURE** ..... **TELEPHONE**.....

**C P I**



**VALUABLE  
SPACE FOR  
SALE!**

**Telephone  
the advertising  
department on:  
0277 219876  
for details**

## RF DEVICES AT ROCK BOTTOM PRICES!

**Nobody beats us!**

Over 30,000 RF devices at low prices

### REPLACEMENT RF TRANSISTORS

MRF454 HF/SSB 80W	£20.00
MFR450 HF/SSB 50W	£11.60
MRF238 VHF/FM 25W	£12.80
MRF475 HF/SSB 20W	£2.99
2SC1969 HF/SSB 18W	£2.50
2SC2043/1307 HF 16W	£2.00
2SC1947 VHF 3.5W	£7.60
2SC1946A VHF 32W	£14.30
BLW 60R HF/VHF 50W (Special)	£7.50

### REPLACEMENT RF POWER MODULES

M57704/SAU3 UHF 15W	£36.00
M57712/37 SAV7 VHF/FM 25W	£39.00
M57713/SAV8 VHF/SSB 15W	£39.00
M57716/SAU4 UHF/SSB 15W	<b>£49.00</b>
M57719 VHF/PMR 15W	£29.00
M57727 VHF/SSB 38W	£45.00
M57749/SAU11 934/FM 7W	£29.00

**Send £1.00 p&p or SAE for full list  
All prices inc. VAT  
Many Ic's and other types in stock**

## RAYCOM LTD

**DEPT AR 584 HAGLEY RD WEST  
QUINTON BIRMINGHAM**

**B68 OBS**

**021 421 8201-3**

**(24hr answer phone)**

## Selectronic

The UK's leading suppliers of  
934MHz personal radio equipment

**203 High Street  
Canvey Island, Essex,  
Tel: 0268 691481**

**(Open Mon-Sat 9-5.30)**

Amateur radio equipment also in stock

## MRZ

### COMMUNICATIONS LTD STOKE-ON-TRENT

**DESK DC SUPPLY AND BASE  
FOR ICOM PORTABLES**

**ICOM-AMATEUR/PMR/MARINE/AIR**

**YAESU - AMATEUR  
UK AND EXPORT**



**ICOM**

**TEL: (0782) 619658  
7 DAY SERVICE**

## AGRIMOTORS

**MERTON CB AND RADIO CENTRE  
MERTON GARAGE AND POST OFFICE, MERTON.  
Nr OAKHAMPTON, DEVON EX20 3DZ**

**OPEN 6 DAYS 9-6 LUNCH 1-2pm THURSDAY 9-1  
(SUNDAYS BY APPOINTMENT)**

**SPECIALIST IN 934 MHz**

**SUPPLIERS OF ALL 27MHz AND 934 MHz EQUIPMENT  
AMATEUR EQUIPMENT CATERED FOR**

08053 200

## DW ELECTRONICS G3 XCF

Amateur Radio Supplies

**71 Victoria Rd, Widnes**

**Tel: 051-420 2559**



Open Mon-Sat 9.30-5.30 (closed all day Thurs)  
We supply YAESU, ICOM, Tonna, Jaybeam,  
Microwave Modules, Datongs etc

## IAN FISHER COMMUNICATIONS OF STANHOPE

**CB Works, The Market Shop, Market  
Place, Stanhope (0388) 528464**

Main Distributors of 27MHz CB radios and the  
NEW DELTA 1 series 2 model transceiver with  
the latest cybernet board. Also the NEW  
Nevada range of 934MHz aerials to suit, also  
934MHz pre-amplifiers and VSWR meters and  
GREENPAR BNC and 'N' type plugs.

Large stocks of coaxial cable, plugs, sockets  
and adaptors.  
All available via mail order. Retail/Wholesale

**OPEN: MON-SAT 10.30am-6.00pm**

**SUN 2.30 - 4.30**

**RING FOR DETAILS**

**(0388) 528464**

## NORTH WALES AMATEUR RADIO MART

**AMATEUR RADIO - CB RADIO - MARINE  
RADIO - PMR**

**25 ABBEY STREET  
RHYL**

Open Monday-Saturday 11am-5.30pm  
All repairs and accessories available ex  
stock Mail order welcome

**Tel: 0745-51579**



**Booth  
Holdings  
Bath**

**GOLF CLUBLANE  
SALTFORD BRISTOL  
Tel: 02217 2402**

Open Tues-Sat 9am-9pm

Closed Monday

"934 MHz STOCKIST"

## 2 METRE COLLINEAR UVRAL X2 5/8 over 5/8

An omni directional antenna  
giving low angle radiation. The  
ideal base station vertical.  
Ruggedly constructed for long life.

### Technical Specification

Gain	- 6 dB
Impedance	- 50 Ohms
Max Power	- 100 Watts
Length	- 3.14 metres
SWR 144 to 146Mhz	- Less than 1.5
Wind Loading	- 4.6 Kgf at 100mph
Weight	- 1.2 Kgs
Mounting Diameter	- 25mm
Termination	- Free 'N' Socket

Send cheque or postal order for  
**£29.95 plus £2.50 postage to:**

**BUCKLEYS (UVRAL) LTD.,  
BETA WORKS,  
RANGE ROAD,  
HYTHE, KENT CT21 6HG  
Tel. No. (0303) 60127/60128**



## PSSS....

**ALL THE SUPER  
BARGAINS ARE  
ON THE  
INSIDE-FRONT  
COVER OF THIS  
MAGAZINE!!**



## D & D ELECTRONICS

(Kennington)

*The sort of shop you used to see in  
Lisle St. All sorts of surplus supplies, so come  
along and browse or send  
SAE for info. sheets.*

**3a Braganza Street, London SE17 3RD  
Tel: 01-793 0054 (Open 6 days a week)**

## NEXT ISSUE

OF

**RADIO**

**ON SALE**

**Thursday 27th**

**August**







## £1 BAKERS DOZEN PACKS

Price per pack is £1.00.\* Order 12 you may choose another free. Items marked (sh) are not new but guaranteed ok.

1. 5 - 13 amp ring main junction boxes
2. 5 - 13 amp ring main spur boxes
4. 5 - surface mounting
5. 3 - electrical switches, white flush mounting
7. 4 - in flex line switches with neons
9. 2 - mains transformers with 6V 1A secondaries
10. 2 - mains transformers with 12V 1A secondaries
11. 1 - extension speaker cabinet for 6 1/2" speaker
13. 12 - glass reed switches
17. 2 - ultrasonic transmitters receivers with circuit
19. 2 - light dependent resistors
25. 4 - wafer switches - 6p 2 way, 4p 3 way, 2p 6 way, 2p 5 way, 1p 12 way small one hold fixing and good length 1/2 spindle your choice
28. 1 - 6 digit counter mains voltage
30. 2 - Nicad battery chargers
31. 1 - key switch with key
32. 2 - aerosol cans of IC Dry Lubricant
34. 96 - 1 metre lengths colour-coded connecting wire
39. 1 - long and medium wave tuner kit
41. 8 - rocker switch 10 amp mains SPST
45. 1 - 24 hour time switch mains operated (s.h.)
49. 10 - neon valves - make good night lights
50. 2 - 12V DC or 24V AC, 3 CO relays
51. 1 - 12V 2 CO miniature relay very sensitive
52. 1 - 12V 4 CO miniature relay
54. 10 - rows of 32 gold plated IC sockets (total 320 sockets)
55. 1 - locking mechanism with 2 keys
56. 1 - miniature unselector with circuit for electric jigsaw puzzle
60. 5 - ferrite rods 4" x 5/16" diameter aerials
61. 4 - ferrite slab aerials with L & M wave coils
63. 1 - Mullard thyristor trigger module
66. 1 - magnetic brake - stops rotation instantly
67. 1 - low pressure 3 level switch can be mouth operated
69. 2 - 25 watt pots 8 ohm
70. 2 - 25 watt pots 1000 ohm
71. 4 - wire wound pots - 18, 33, 50 and 100 ohm your choice
77. 1 - time reminder adjustable 1-60 mins clockwork
85. 1 - mains shaded pole motor 1/2" stack - 1/2 shaft
89. 1 - mains motor with gear box 1 rev per 24 hours
91. 2 - mains motors with gear box 16 rpm
96. 1 - thermostat for fridge
98. 1 - motorised stud switch (s.h.)
101. 1 - 2 1/2 hours delay switch
103. 1 - mains power supply unit - 6V DC
104. 1 - mains power supply unit - 4 1/2 V DC
107. 1 - 5" speaker size radio cabinet with handle
112. 1 - heating pad 200 watts mains
114. 1 - 1W amplifier Mullard 1172
115. 1 - wall mounting thermostat 24V
118. 1 - teak effect extension 5" speaker cabinet
120. 2 - p.c. boards with 2 amp full wave and 17 other recs
121. 4 - push push switches for table lamps etc.
122. 10 - mtrs twin screened flex white p.v.c. outer
124. 25 - clear plastic lenses 1 1/2 diameter
127. 4 - pilot bulb lamp metal clip on type
128. 10 - very fine drills for pcbs etc.
129. 4 - extra thin screw drivers for instruments
132. 2 - plastic boxes with windows, ideal for interrupted beam switch
134. 10 - model aircraft motor - require no on/off switch, just spin to start
137. 1 - 6 1/2" 4 ohm 10 watt speaker
142. 10 - 4 BA spanners 1 end open, other end closed
145. 2 - 4 reed relay kits 3V coil normally open or c/o if magnets added
146. 20 - pilot bulbs 6.5V 3A Philips
154. 1 - 12V drip proof relay - ideal for car jobs
155. 3 - varicap push button tuners with knobs
169. 4 - short wave air spaced trimmers 2-30F
172. 10 - 12V 6W bulbs Philips m.e.s.
178. 3 - oblong amber indicators with lilliputs 12V
180. 6 - round amber indicators with neons 240V
181. 100 - p.v.c. grommets 3/8" hole size
182. 1 - short wave tuning condenser 50 pf with 1/2" spindle
184. 1 - three gang tuning condenser each section 500 pf with trimmers and good length 1/2" spindle
188. 1 - plastic box sloping metal front, 16 x 95mm average depth 45mm
193. 6 - 5 amp 3 pin flush sockets brown
195. 5 - B.C. lampholders brown bakelite threaded entry
196. 1 - in flex simmerstat for electric blanket soldering iron etc.
197. 2 - thermostats, spindle setting - adjustable range for ovens etc.
199. 1 - mains operated solenoid with plunger 1" travel
200. 1 - 10 digit switch pad for telephones etc.
201. 8 - computer keyboard switches with knobs, pcb or vero mounting
206. 20 - mtrs 80 ohm, standard type co-ax off white
211. 1 - electric clock mains driven, always right time - not cased
216. 1 - stereo pre-amp Mullard EP9001
232. 2 - 12V solenoids, small with plunger
236. 1 - mains transformer 9V 1 amp secondary C core construction
241. 2 - car door speaker (very flat) 6 1/2" 15 ohm made for Radiomobile
241. 2 - speakers 6" x 4" 4 ohm 5 watt made for Radiomobile
243. 2 - speakers 8" x 4" 16 ohm 5 watt made for Radiomobile
244. 1 - mains motor with gear-box very small, toothed output 1 rpm
245. 4 - standard size pots, 1/2 meg with dp switch
249. 1 - 13A switched socket on double plate with fused spur
266. 2 - mains transformers 9V 1/2 amp secondary
267. 1 - mains transformers 15V 1/2 amp secondary p.c.b. mounting
291. 1 - ten turns 3 watt pot 1/2 spindle 100 ohm
298. 3 - car cigar lighter socket plugs
298. 2 - 15 amp round pin plugs brown bakelite
300. 1 - mains solenoid with plunger compact type
301. 10 - ceramic magnets Mullard 1" x 3/8 x 5/16
303. 1 - 12 pole 3 way ceramic wave charge switch
305. 1 - tubular dynamic microphone with desk rest
308. 1 - T.V. turret turn (black & white T.V.)
310. 2 - oven thermostats
313. 5 - sub miniature micro switches
316. 1 - round pin kettle plug with moulded on lead
453. 2 - 2 1/2 in. 80ohm loudspeakers
454. 2 - 2 1/2 in. 80ohm loudspeakers
463. 1 - mains operated relay with 2 sets c/o contacts
464. 2 - packets resin filler/sealer with cures
465. 3 - 5A round 3 pin plugs will fit item 193
466. 4 - 7 segment L.e.d. displays
470. 4 - pc boards for stripping, lots of valuable parts
473. 1 - 5" 4ohm speaker with built in tweeter Radio mobil
480. 1 - 3A double pole magnetic trip, saves repairing fuses
496. 4 - 1000uf 25V axial electrolytic capacitors

**POWERFUL MOTOR** (p.m. in stack) fitted with gearbox with final speed 60 r.p.m. Mains operated. Suitable to operate garage doors etc. Price £4.00. Our ref. 4P15.

## CAR STARTER/CHARGER KIT

Flat Battery! Don't worry you will start your car in a few minutes with this unit - 250 watt transformer 20 amp rectifiers, case and all parts with data £17.50 post £2.



Ex-Electricity Board. Guaranteed 12 months.

## VENNER TIME SWITCH

Mains operated with 20 amp switch, one on and one off per 24 hrs. repeats duty automatically correcting for the lengthening or shortening day. An expensive time switch but you can have it for only £2.95 without case, metal case - £2.95. adaptor kit to convert this into a normal 24hr. time switch but with the added advantage of up to 12 on/off's per 24hrs. This makes an ideal controller for the immersion heater. Price of adaptor kit is £2.30.

## SOUND TO LIGHT UNIT

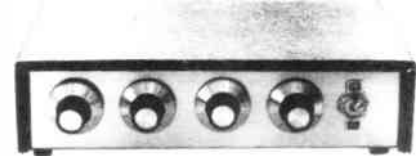

Complete kit of parts of a three channel sound to light unit controlling over 2000 watts of lighting. Use this at home if you wish but it is plenty rugged enough for disco work. The unit is housed in an attractive two tone metal case and has controls for each channel, and a master on/off. The audio input and output are by 1/4" sockets and three panel mounting fuse holders provide thyristor protection. A four pin plug and socket facilitate ease of connecting lamps. Special price is £14.95 in kit form.

## 12 volt MOTOR BY SMITHS

Made for use in cars, etc. these are very powerful and easily reversible. Size 3 1/2" long by 3" dia. They have a good length of 1/2" spindle - 1/10 hp £3.45 1/8 hp £5.75. 1/6 hp £7.50

## 25A ELECTRICAL PROGRAMMER

Learn in your sleep. Have radio playing and kettle boiling as you wake - switch on lights to ward off intruders - have a warm house to come home to. You can do all these and more. By a famous maker with 25 amp on/off switch. A beautiful unit at £2.50

## THIS MONTH'S SNIP

3" floppy disc drive unit plug in and with all electronics. Japanese made, brand new. We are told that this is suitable for use with the BBC, Commodore, Amstrad and most other popular computers, and we supply with technical information. Special snip price £29.50 including post and VAT.

## 12V BATTERY OPERATED SIREN

(Or you can work this off a 24V transformer). Makes a shocking noise, will frighten away any intruder. Japanese made one 50p each, 2 for £1, ref. RD106. American, storage sealed but unused and guaranteed perfect, only 20p each, 5 for £1, ref. BD221.

## WONDERFUL BREAKDOWN VALUE - HAND HELD STEREO UNIT

Contains two beautiful miniature moving coil loudspeakers. These could also be used as microphones, also contains many other useful parts including mini stereo amp, transistors, condensers, rocker switches etc. To use this as a personal amplifier simply add a stethoscope, only £1, ref. BD29.

## SPIT MOTOR

Powerful mains operated induction motor with gearbox attached. Shaft has square hole which gives very easy coupling and quick release if required. Shaft speed 5rpm. Price £5, ref. SP54.

## NICKEL CADMIUM RECHARGEABLE BATTERY

The high capacity (4 Amp-hour) 'D'-size. £2 each. Our ref. 2R141.

## 20V-0-20V 1A MAINS TRANSFORMER

Upright mounting. Primary thermal cutout to interrupt the supply if transformer overheats. Price £2, ref. ZP138.

## 4 BOOKS FOR £1

Book 1 describes the Mullard Unilux amplifier and gives details of a suitable cabinet. Book 2 describes several useful pieces of test equipment which could be quite easily constructed. Book 3 is electronic projects. Book 4 describes short wave receivers which can be easily constructed and is intended for mainly beginners. Our ref. BD400.

## TRANSFORMER IN WATERPROOF METAL CASE

24V 5A output. Ideal for garden lighting or to operate pond pump etc. Case has cable glands for mains in and low voltage output leads. Price £5 plus £1 post, ref. SP68.

## MAINS RELAY

With transparent plastic cover. Could be pcb or clip mounted, has single 8-10A c/o contact. Real bargain 2 for £1, ref. BD466.

## PANEL METERS

Engraved vs. approximately 1 1/2" square. Luminate these from behind and you will have a really super looking panel. Real bargain 2 for £1, ref. BD366.

## TRANSMITTER TUNING CONDENSOR

180pf made for a very famous RAF transmitter, only £1 each. Unused but mounting brackets will need a bit of cleaning up due to storage. Our ref. BD424.

## MAGNETIC READ/WRITE UNIT

A read/write head mounted on a thumb operated lever is made to traverse magnetisable paper. The paper is held between top and bottom rollers which can be span for localisation of the written message - new and unused only £1 each, BD381.

## IONISER KIT

Refresh your home, office, shop, work room, etc. with a negative ION generator. Makes you feel better and work harder - a complete mains operated kit which we guarantee is ten times more powerful than other popular kits. Price includes case and instructions. £9.50 plus £2.00 post.

## TELEPHONE BITS

Master socket (has surge arrester - ringing condenser etc) and takes B.T. plug ..... £3.95  
 Extension socket ..... £2.95  
 Dual adaptors (2 from one socket) ..... £3.95  
 Cord terminating with B.T. plug 3 metres ..... £2.95  
 Kit for converting old entry terminal box to new B.T. master socket, complete with 4 core cable, cable clips and 2 BT extension sockets ..... £11.50  
 100 mtrs 4 core telephone cable ..... £8.50

## J & N BULL ELECTRICAL

Dept AR, 250 PORTLAND ROAD, HOVE, BRIGHTON, SUSSEX BN3 5QT

MAIL ORDER TERMS: Cash, P.O. or cheque with order. Orders under £20 add £1 service charge. Monthly account orders accepted from schools and public companies. Access & B/C card orders accepted. Brighton 0273 734648. Bulk orders: write for quote.

## £2 POUNDERS\*

- 2P2 - Wall mounting thermostat, high precision with mercury switch and thermometer
- 2P3 - Variable and reversible 8-12v psu for stereo control
- 2P4 - 24 volt psu with separate channels for model made for Mullard UNILEX
- 2P6 - 100W mains to 115V auto-transformer with voltage tappings
- 2P8 - Mains motor with gear box and variable speed selector Series wound so suitable for further speed control
- 2P9 - Time and set switch. Boxed, glass fronted and with knobs. Controls up to 15 amps. Ideal to program electric heaters
- 2P10 - 12 volt 5 amp mains transformer
- 2P12 - Disk or Tape precision motor - has balanced rotor and is reversible 230v mains operated 1500 rpm
- 2P14 - Mug Stop kit - when thrown emits piercing squeak
- 2P15 - Interrupted Beam kit for burglar alarms, counters, etc.
- 2P17 - 2 rev pr minute mains driven motor, ideal to operate mirror ball
- 2P18 - Liquid/gas shut off valve mains solenoid operated
- 2P19 - Disco switch-motor drives 6 or more 10 amp change over micro switches supplied ready for mains operation
- 2P20 - 20 metres extension lead, 2 core - ideal most Black and Decker garden tools etc.
- 2P21 - 10 watt amplifier, Mullard module reference 1173
- 2P22 - Motor driven switch 20 secs on or off post push
- 2P26 - Counter resettable mains operated 3 digit
- 2P27 - Goodmans Speaker 6 inch round 8ohm 12 watt
- 2P28 - Drill Pump - always useful couples to any make portable drill
- 2P31 - 4 metres 98 watt interconnecting wire easy to strip
- 2P32 - Hot Wire amp meter - 4 1/2 round surface mounting 0-10A - old but working and definitely a bit of history
- 2P34 - Solenoid Air Valve mains operated
- 2P38 - 200 R.P.M. Geared Mains Motor 1" stack quite powerful, definitely large enough to drive a rotating aerial or a tumbler for polishing stones etc
- 2P43 - Small type blower or extractor fan, motor inset so very compact, 230V
- 2P46 - Our famous drill control kit complete and with prepared case
- 2P49 - Fire Alarm brass glass switch in heavy cast case
- 2P51 - Stereo amplifier, 3w per channel
- 2P55 - Mains motor, extra powerful has 1 1/2" stack and good length of spindle
- 2P62 - 1 pair Goodmans 15 ohm speakers for stereo
- 2P64 - 1 five bladed fan 6 1/2" with mains motor
- 2P66 - 1 2Kw tangential heater 115v easily convertible for 230V
- 2P67 - 1 12v-0-12v 2 amp mains transformer
- 2P68 - 1 15v-0-15v 2 amp mains transformer
- 2P69 - 1 250v-0-250v 60 mA & 86.3v 5A mains transformer + 50p post
- 2P70 - 1 E.M.I. Tape motor two speed and reversible
- 2P72 - 1 115v Muffin fan 4" x 4" approx. (s.h.)
- 2P75 - 1 2 hour timer, plugs into 13A socket
- 2P82 - 9v-0-9v 2 amp mains transformer
- 2P84 - Modem board with press keys for telephone radiotele
- 2P85 - 20v-0-20v 1/2 A Mains transformer
- 2P88 - Sangamo 24 hr time switch 20 amp (s.h.)
- 2P89 - 120 min. time switch with knob
- 2P90 - 90 min. time switch with edgewise engraved controller
- 2P94 - Telephone handset for EE home telephone circuit
- 2P95 - 13A socket on satin chrome plate
- 2P97 - mains transformer 24V 2A upright mounting
- 2P98 - 20m 4 core telephone cable, white outer
- 2P99 - 500 hardened pin type staples for telephone cable
- 2P101 - 15V mains transformer 4A upright mounting
- 2P105 - capillary type thermostat for air temperature with c/o switch
- 2P108 - mains motor with gear box giving 110rpm
- 2P109 - 5" wide black adhesive pvc tape 33m, add £1 post if not collecting

## OVER 400 GIFTS YOU CAN CHOOSE FROM

There is a total of over 400 packs in our Baker's dozen range and you become entitled to a free gift with each dozen packs.

A classified list of these packs and our latest "News Letter" will be enclosed with your goods, and you will automatically receive our next news letter.



## £5 POUNDERS\*

- 5P1 - 12 volt submersible pump complete with a tap and switch, an ideal caravan unit.
- 5P2 - Sound to light kit complete in case suitable for up to 750 watts.
- 5P6 - 12V alarm bell with heavy 6" gong, suitable for outside if protected from direct rainfall. Ex GPB but in perfect order.
- 5P12 - Equipment cooling fan - mini small type mains operated.
- 5P15 - Unselector 4 pole, 25 watt 50 volt coil
- 5P18 - motor driven water pump as fitted to many washing machines
- 5P20 - 2 kits, matchbox size, surveillance transmitter and FM receiver
- 5P23 - miniature (appr. 2 1/2" wide) tangential blow heater, 1-2kw
- 5P24 - 1/2hp motor, ex computer, 230V, mains operation 1450rpm. If not collect add £3 post
- 5P25 - special effects lighting switch. Up to 6 channels of lamps can be on or off for varying time periods
- 5P27 - cartridge player 12V, has high quality stereo amplifier
- 5P34 - 24V 5A toroidal mains transformer
- 5P35 - modem board from telephone auto dialler, complete with keypad and all ICs
- 5P37 - 24 hour time switch, 2 on/off's and clockwork reserve, ex Elec. Board loading up to 50A. Add £1 post
- 5P41 - 5" extractor fan, very quiet runner (s.h.), gntd 12 mths.
- 5P48 - telephone extension bell in black case, ex-GPO
- 5P52 - mains transformer 26V 10A upright mounting, add £2 post
- 5P54 - mains motor with gear box, final speed 5rpm
- 5P58 - Amstrad stereo tuner FM and LM. AM
- 5P60 - DC Muffin type fan 18 to 27V, only 3W. Brushless
- 5P81 - drill pump mounted on frame, coupled to mains if not collecting
- 5P62 - 2 1/2kw tangential blow heater, add £1.50 post if not collecting
- 5P73C high pressure mains operated gas or water valve with tube connection suitable soldering
- 5P74 - 8rpm 80W mains motor and gearbox with instant stop
- 5P79 - 30rpm 80 watt mains driven motor with gearbox
- 5P82 - 1 25rpm mains 80w motor with gearbox
- 5P84 - 1 delay time switch, adjust 0 - 20 seconds
- 5P69 - 1 light box size 14" x 12" for circuit tracing pcb's. Add £3 for postage and packing
- 5P72 - 1 turntable for vdu or scope
- 5P81 - 1 stepper motor bi-directional, 7.5" steps 12-14V coil
- 5P86 - 1 mains transformer with 2 x 100V 1A secondaries. Add £1.50 post
- 5P88 - 1 24V 5A mains transformer in waterproof case, ideal for garden lighting, pond pump etc.

**LIGHT CHASER KIT** motor driven switch bank with connection diagram, used in connection with 4 sets of xmas lights makes a very eye catching display for home, shop or disco, only £5 ref 5P56.



**DAVTREND LTD  
SANDERSON CENTRE  
GOSPORT, HAMPSHIRE  
PO12 3UL  
0705 520141**

MAKE SURE YOU RUN THE BEST PSU AVAILABLE WHEN DXING, Our range includes ...



6 amps 13.8V  
Price **£65.00**



24 amps 13.8V  
Price **£125.00**

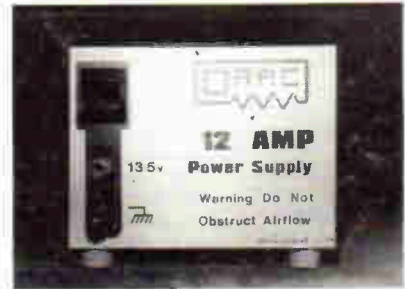

12 amps 13.8V  
Price **£86.50**

All PSUs are fully regulated, short circuit protected and incorporate an overvoltage crowbar circuit.

**BENCH POWER SUPPLIES**

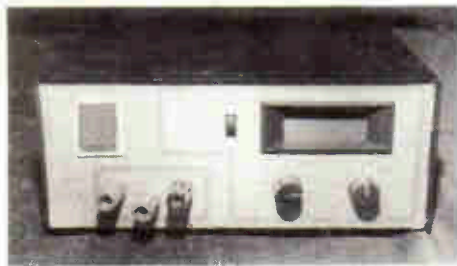

- BP 301** 0 to 30 volts continuously variable at 20mA to 1 amp. **£89.34**
- BP 302** 0 to 30 volts continuously variable at 40mA to 2 amp. **£114.11**

**AERIAL SWITCHES/WAVEMETER**



- VHF WAVEMETER ..... **£27.50**
- 3 WAY VHF SWITCH SO239 ..... **£15.40**
- 3 WAY UHF SWITCH N TYPE ..... **£19.90**
- 2 METRE PRE SET ATU (not shown) ..... **£14.50**

... and now the **NEW DRAE SSTV SYSTEM**



- ★ FOUR STORAGE MEMORIES
- ★ 128 x 128 PIXELS
- ★ VIDEO or UHF outputs
- ★ 13.8 Volts OPERATION

**Prices for TX & RX Unit £320.00 RX only £195.00 TX Module £135.00**

**CUSTOM BUILT POWER SUPPLIES?**

Enquiries welcomed from O.E.M. & Commercial Manufacturers: we manufacture: Switch Mode PSUs, DC to DC converters, AC to DC converters. Products already supplied for telecommunications equipment, radio manufacturers, medical equipment used on ships and aircraft. Ring Dave White now for full details

**0705 520141**

