

*Amateur*

# RADIO

For all two-way radio enthusiasts

**TRIO 9130  
and 9500,  
by G3OSS**

**How to rig  
aerial masts**

**Sporadic-E:  
The best  
openings**

**Pass the RAE**

**Ideas with  
computers**



**ICOM IC-251E PLUS FRONT END BOARD  
—BEST EVER COMBINATION?**

# FOR THE PROFESSIONAL AMATEUR

*Now available from all leading Amateur and CB Radio Stores*



**ProTel**

Unit 1, Earlsfield Lane, Grantham  
Tel: (0476) 76928

405-407 Lordship Lane, London, N17  
Tel: 01-808 5656

TRADE ENQUIRIES WELCOME

**OCT**  
#1 in Electronics and Communications



#### 4 Current comment

It's about the only part of the magazine that's written by the Editor. All good stuff though (it says here) and it explains what's in this issue.

#### 6 Your letters

Some say this is the most interesting part of the magazine.

#### 9 SWL

Conclusions to the Spratly Island tragedy, and a round up of what's possible in and around the listening scene.

#### 10 Straight and level

News and views reported upon by the vast and experienced staff of *Amateur Radio*.

#### 12 Sound analysis: Icom IC-251E plus Mutek board

Nigel Gresley gets his hands on what he considers to be about the best transceiver front end board combination ever. Also, what's involved in fitting the Mutek board, and how it can greatly improve the quality of the 251E.

#### 20 The Sporadic E story

Explanation of what it is, and how it could help get that juicy DX out of the sky. By Julian Moss, G4ILO, who maintains that by now we'll be into the latest E season.

#### 26 Angus McKenzie Report: Trio 9130 and 9500

Two VHF multimodes reviewed, one a very nice 144MHz device, and the other a mobile 10w 432MHz unit. Written and tested, of course, by G3OSS. Plus the comparison chart of specifications etc.

#### 33 How much that used radio?

Hugh Allison, G3XSE, visits as many amateur radio rallies as possible throughout the season, and picks up much information on secondhand prices of rigs, and other equipment. Here, he summarises what can be picked up, and what prices you might be expected to pay. Useful if you're in the market for a budget priced thingie.

#### 34 How hams shaped radio history

We normally try and avoid that expression. However, David Lazell pinpoints a number of important happenings that have helped develop amateur radio into what it is today.

#### 40 A fresh look at wire aeriels: 4

John D. Heys, G3BDQ, explains asymmetrically fed wires, now not so popular with amateurs. Fortunately, many amateurs like to experiment, and here's how to play around with what could be the most effective radiator for your set up.

#### 46 Rigging aerial masts

Erecting a good, strong and stable aerial isn't as difficult as it may seem at first thought. Follow a few simple rules and things are made easier, especially following a good read of this article by Ken Williams.

#### 52 In the lab and the shack

The second of Angus McKenzie's (G3OSS) series that takes us through the workings of his laboratory, explaining as he goes, how specifications are worked out, and how they can be checked. This month: some more front end measurements.

#### 56 Starting from scratch: Procedures

Continuing story of how two amateurs carry out a typical conversation over the air. Much information to be gleaned, and much to learn on the way, by novices and experienced amateurs alike. By Nigel Gresley.

#### 60 Pass the RAE: 4

More by Nigel Gresley. This about the approach to the RAE, and all of which you should understand before you take that long walk to the college!

#### 64 Ham byte

Playing with computers in the shack, by John Morris, G4ANB. Plus, how to make a computer pretend to be a teleprinter,

and writing an RTTY programme (sorry, program). Special this month is a "programmette" great circle distance and bearing calculator in Microsoft Basic.

#### 67 Club news

News and views from amateur radio clubs and societies countrywide.

#### 68 Dealer profile: Arrow

Our roving reporter Peter Dodson visits Arrow Electronics of Brentwood, in Essex.

#### 71 Free classified ads

Advertise, free of charge, your wireesses, amplifiers, antennae, and in fact, anything you wish to sell. Well, almost anything.

**Editor:** Christopher F. Drake

**Technical Editor:** Nigel Gresley

**Art Editor:** Frank Brzeski

**Graphic Design:** Gina Satch

**Contributors:** Angus McKenzie G3OSS, John D. Heys G3BDQ, John Morris G4ANB, Julian Moss G4ILO, David Lazell, Ken Williams, Hugh Allison G3XSE, Peter Dodson.

**Advertisement Manager:** Linda Beviere

**Ad Executive:** Rose Kirtland

**Production Co-ordinator:** Alison Pezarro

**Managing Director:** Eric Rowe

Published by Goodhead Publications, 27 Murdock Road, Bicester, Oxon OX6 7RG. Telephone Bicester (08692) 44517.

Printing by Wiltshires (Bristol) Ltd., Bristol. Typesetting by Arty Type, Grosvenor House, Eastgate, Whittlesey, Peterborough PE7 1AE.

Distributed by COMAG Ltd., West Drayton, Middlesex.

© Goodhead Publications, a division of Goodhead Publishing Ltd.

*Front cover: The Icom IC-251E transceiver, one of the most popular of VHF 144MHz multimodes, with that certain something that improves its quality, the Mutek front end board. Pictured by Jay Moss-Powell.*

Whilst every effort is made to ensure the correct reproduction of advertisements, neither the Publishers nor their advertisement contractors accept any responsibility for errors in, or non-appearance of the final reproduction of advertisements.

Advertisements are accepted and reproduced on the understanding that the Publishers' "Conditions of Acceptance" apply in all cases. Copies of these conditions are also available from the Advertisement Offices.

All material printed in this magazine is the copyright of the Publishers and must not be reproduced in any form or affixed to as any part of any publication or advertising whatsoever without the written permission of the Publishers.

# CURRENT COMMENT

Introducing you to this month's issue

Well, we have had a really good month here at Swinging Bicester. First, the mast carrying the VHF and UHF antennas decided it was bored with standing up straight and came over all kinky when we had a good old blow early in May – net effect was that we wrote off a newish 16-element Tonna for 144MHz and our venerable old Multibeam for 432MHz (well, we always had our doubts about *that* antenna but we'd worked some nice DX with it and it was a bit sad to see it all mangled up).

**“...wrote off a newish 16-element Tonna for 144MHz and our venerable old Multibeam for 432MHz.”**

We also did a pronounced injury to our pair of 23-element 1296MHz Tonnas, which was exceptionally boring because we were just getting the hang of that band at the time – the Bicester QTH isn't exactly brilliant but GB3NWK was a whacking great signal on 1296 and things were looking most promising. The moral of the story is that we really shouldn't have used an unguayed 11ft stub mast made of distinctly dubious one-inch ally... oh well, it'll give us something to do.

**“The wind is howling across the steppes of Oxfordshire, and you'd think it was March.”**

At the time of writing this the wind is howling across the steppes of South Oxfordshire and you'd think it was March, or last June or July even... Conditions haven't been exactly brilliant, so we haven't missed any tasty morsels on VHF.

The other nasty was that, just before the demise of the antennas, we were about to have a bash in the 432/1296/2320MHz contest early in May; we'd got our 400w pair of 4CX-250Rs running nicely and every-

**“...an almighty bang and everything went dead.”**

thing seemed set to go. One hour into the contest, and we were just about to call GD3WOH/P for a new county and a new square when there was an almighty bang from the power supply and everything went very dead. Yes, folks, one of the smoothing electrolytics had decided that Oxfordshire was really a very boring place and it wasn't going to stick around any more – bang, and it had gone to the Great Electronic Junk Heap In The Sky.

**Not man enough for the job**

Ripple current, folks. That's wot did it in – it simply wasn't man enough for the job and it must have got a bit hot and bothered – result, the top seal blew clean off. At least we had some fuses in there somewhere... The surge took out three of the diodes in the rectifier stack as well, so it really wasn't our day. Hmmm – Technical Bod is going to have a fair amount of work to do when he isn't slaving over wirelesses and what-have-you!

**“Sporadic E – we really ought to have some on 144MHz by the time this issue reaches the newsagents.”**

Anyway, back to the sordid present; what journalistic and technical delights have we got in store for you? There's our review of the Icom 251E mit Mutek board, and as you'll see from the report this is a very sanitary machine indeed – very much the best thing we've seen on 144MHz, even though we did have a few nightmares getting hold of the right test gear to prove it. There's a spiffing article on Sporadic E, of which

we really ought to have had some on 144MHz by the time this mag gets into your hot and stickies, and there's also A Good Thing on rigging aerial masts and whatnot... and yes, we *have* read it and yes, we *will* do the job properly next time.

**“Every reader's letter gets read carefully, and in this issue we have featured some, along with answers...”**

Actually, we haven't told the Chairman but we're agitating for a 60-foot tower here at the office so that we can really bang a hole in the bands. Thing is, he doesn't believe us when we tell him that it's absolutely essential to the healthy financial future of the magazine, to build confidence in our readers, show them that we're active on the wireless and really with it etc. etc. He thinks we'll just sit about working the DX, so we've got to make it stick, haven't we? Just send in lots of nice letters folks; that'll do it. (*You lot must think I was born yesterday – you can have a tower if you all take a 10% cut in your excessive salaries – Managing Director*).

Ouch. Excessive? I can just about afford a 10K at the end of the month. Anyway, what else do we have for you? There's a new thingie all about secondhand prices and such, and also the second of our Dealer Profiles where we take a look at your Local Friendly Dealer and suss out what makes him tick. In this issue is the story of Arrow of Brentwood who many of you will, no doubt, know and love – turn to page 68 for all the details.

**New series about secondhand prices**

Just looking ahead to next month. We've got ourselves more or less sorted out for a competition with jolly good prizes and things. We're also working on a number of special

offers, and we're probably going to kick off with some very high-grade coax at rock-bottom prices. It isn't all sewn up yet though, so watch this space.

Every reader's letter gets read carefully, and in this issue we have featured a number of letters, along with answers (where possible) supplied by our staff. You can send in your technical queries as well, remember. We've also received some interesting photographs and we'll print the best ones. If you have some, don't keep them to yourself. We took a photo of the remains of our antenna system, but in the end we couldn't bear to print it; anti-publicity and all that. Anyhow, it's a good excuse to put up something better.

**“...it's absolutely essential to the healthy financial future of the magazine.”**

Marvellous isn't it? I just stopped to have a cup of tea and see what the technical department were up to (you have to keep an eye on them, you know, otherwise you never know what fiendish tricks they're getting up to) when one of the secretaries ran in and said there was a lot of wire all over the car park and was it anything to do with us? Cardiac arrest, ran outside, and discovered 80 metre trap dipole had finally succumbed to arctic gale and broken at egg insulator near patriotic Goodhead Publications flagpole above the marble columns. Net result, shattered balun and 132ft of wire wrapped lovingly around cars, *Rally Sport* magazine Editor's office, *Rally Sport* Editor etc, etc. Also, no sked on 80 metres tonight with mate in Germany.

Here's a magazine for you to read anyway.

73 de Chris Drake



# DATONG

**New**



**AUTOMATIC WOODPECKER BLANKER MODEL SRB2**  
 All too often in the past the appearance of the Woodpecker has wiped out that elusive DX, just when it was within your grasp. Now for the first time there is a really effective antidote, and at a highly competitive price.  
 With Model SRB2 fitted in series with the antenna and loudspeaker of your receiver or transceiver everything is the same until the Woodpecker appears. Then after a few seconds a magical difference becomes apparent; the receiver comes back to life again and you can copy the original signal. What happens is that the receiver's antenna and loudspeaker are momentarily disconnected during each Woodpecker pulse.  
 No synchronisation, pulse width, or 'in/out' adjustments are required. Instead the blanker's exclusive circuitry (patent applied for) analyses the Woodpecker's signals, and produces blanking signals to suit. It can even remove multiple Woodpeckers at the same time (a situation which occurs fairly often.)  
 Because blanking occurs at both RF and AF, serious receiver desensitisation is avoided and yet the unit is also effective on AM broadcast signals as well as SSB and CW (of course, if the Woodpecker pulses are very wide then fast CW may become uncopiable).  
 A built in r.f. activated transmit relay will handle the output for normal HF transceivers and three push button switches are fitted for: power on/off, selectable 10 or 16 Hz pulse rate, and before-and-after comparison. The unit uses the same case design as Model ANF (see this ad.), and a panel LED tells you when the unit is actually blanking. Price: £75.00 plus VAT (£86.25 total). Expected availability early July.

**AUTOMATIC NOTCH FILTER MODEL ANF**  
 Model ANF is a unique dual-mode audio filter designed to connect in series with a receiver's loud speaker.

As an automatic notch filter it will make a continuous tone disappear within about half a second. You just leave it permanently in circuit and forget about problems from "tuner-uppers".

As a CW filter its 4 pole tunable filter dramatically pulls out weak signals from noise.

At all times the 10 LED bargraph-type display shows the filter's centre frequency. In auto-notch mode for example, you can see the notch filter sweeping over the full tuning range every second, until it finds a tone to notch out.

Performance is independent of receiver volume setting thanks to a built-in compandor chip, and the notch depth is typically well over 40 db. Price: £59.00 plus VAT (£67.85 total). Available now. Free data sheet on request.



**AUDIT FILTERS**  
 MODELS FL2, FL3, FL2/A

Model FL3 represents the ultimate in audio filters for SSB and CW. Connected in series with the loudspeaker, it gives variable extra selectivity better than a whole bank of expensive crystal filters. In addition it contains an automatic notch filter which can remove a "tuner-upper" all by itself.

Model FL2 is exactly the same but without the auto-notch.

Any existing or new FL2 can be up-graded to an FL3 by adding Model FL2/A conversion kit, which is a Fully tested auto-notch module in P.C.B. Form.

Datong filters frequently allow continued copy when otherwise a QSO would have to be abandoned.

Prices: FL2 £78.00 with VAT £89.70, FL3 £112.50 with VAT £129.37, FL2/A £34.00 with VAT £39.67



**COMPACT RECEIVING ANTENNAS**  
 MODELS AD270/370

Datong Active Antennas solve the age-old problem of finding space for a 'good' receiving aerial. Model AD370 mounted on a roof top or Model AD270 in a loft will give similar sensitivity to much larger conventional aerials yet are only 2 1/2 and 3 metres long respectively. Moreover they do not suffer from interference picked up by the feeder cable; such pick-up can be a problem with conventional dipoles because it is hard to maintain good balance over a band of frequencies.

Although active antennas were introduced to the amateur market by Datong only a few years ago they have long been used by military and commercial receiving stations. The performance specifications achieved by the Datong AD270/370 are very close to those of "professional" active antennas selling for ten times the price - a point which is not lost on our many professional customers. The advanced design ensures two things: that you don't miss signals through inadequate sensitivity and that the antenna does not invert signals which are not there. Datong Active Antennas represent an advanced solution to a common problem and so far as we know have no serious competition in terms of performance at the price. (Reviewed in Rad. Com., June 1982)

AD270 £41.00 with VAT £47.15 AD370 £56.00 with VAT £64.40



**GENERAL COVERAGE RECEIVER CONVERTER MODEL PC1**

Once upon a time it was the norm to use a ten metre receiver to receive the two metre band. Now, large numbers of special purpose two metre SSB rigs are in use and conversion the other way becomes a very attractive possibility.

With the addition of Model PC1 each of these two metre SSB rigs becomes a really good general coverage receiver (from 50 kHz to 30MHz!). Two metre SSB rigs are not cheap and it makes good sense to get the most out of them. They also tend to have very good performance in terms of sensitivity, selectivity, and big signal handling. Each of these features is just as vital for short wave reception and Model PC1 is designed not to degrade them at all. The result, your two metre SSB rig receives below 30 MHz as well as it receives on two metres. And compared to many medium cost general coverage sets, that is saying a lot!

Try this test. Listen on twenty metres after the band goes dead in the evening. With many general coverage receivers the band never dies. It remains populated with phantoms generated by the receiver from the many very strong signals on forty metres. This is the kind of effect that the higher quality receivers minimise, and that goes for PC1 plus a good two metre rig. Review: Rad. Com., April 1982.

PC-1 £119.50 with VAT £137.42



MODEL PC1



ALL DATONG PRODUCTS ARE DESIGNED AND BUILT IN THE U.K.

**PRICES**

All prices include delivery in U.K. basic prices in £ are shown with VAT inclusive prices in brackets.

FL3	112.50	(129.37)	AD370	56.00	( 64.40)	Codecall (Linked)	28.00	( 32.20)
FL2/A	34.00	( 39.67)	AD270+MPU	45.00	( 51.75)	Codecall (Switched)	29.50	( 33.92)
FL1	69.00	( 79.35)	AD370+MPU	60.00	( 69.00)	Basic DF System	149.00	(171.35)
FL2	78.00	( 89.70)	MPU	6.00	( 6.90)	Basic Mobile DF System	159.00	(182.85)
PC1	119.50	(137.42)	DC144/28			Complete Mobile DF System	214.00	(246.10)
ASP	72.00	( 82.80)	DC144/28 Module	28.00	( 32.20)	PTS1	39.99	( 45.99)
VLF	26.00	( 29.90)	Keyboard Morse Sender	119.50	(137.42)	Model ANF	59.00	( 67.85)
D70	49.00	( 56.35)	RFA	29.50	( 33.92)			
D75	49.00	( 56.35)	ModelSRB2	75.00	( 86.25)			
RFC/M	26.00	( 29.90)						
AD270	41.00	( 47.15)						

Access Orders  
 Tel: (0532) 552461

Data sheets on any products available free on request -

**DATONG ELECTRONICS LIMITED**

Dept A.R., Spence Mills, Mill Lane, Bramley, Leeds LS13 3HE, England. Tel: (0532) 552461

# LETTERS

## In the resistance

I was interested in your article, in April *Amrad* about end-fed antennas. I discussed it with a relative who, during WW2, was radio operator to a resistance unit in the Balkans. His normal antenna set-up consisted of a random-length of wire, tied to a stone and flung over a tree branch. The radio was usually strapped to the back of a donkey.

We also discussed F. Thorley of Rotherham's letter in "Q&A" (p.34) about "Morse getting through". My relative informed me that he was able to read incoming signals even though the enemy was jamming, by detecting the small changes in the amplitude of the jamming signal.

Try as I will, however, I can't find any of the regular component suppliers who stock a reasonably-priced stone or donkey, (though one offered to place them on order). Also, I cannot find, in my licence schedule, any mention of amplitude modulated QRM. Can any reader help?

**P. Thompson, G6MEN, Merseyside.**

## Datong mod

Everyone seems to enthuse over the Datong D70, including your good selves (issue 2). Practising in many short sessions in different places I found the volume control combined with the on/off switch a slight disadvantage.

I believe I have had the audacity to improve this wonderful instrument by fitting a separate on/off switch. Congratulations on your wonderful magazine.  
**E.G. Culverwell, Kirkham Preston, Lancs.**  
*Picture shows the new on/off switch positioned between the letters/numbers switch and delay control.*

## Getting the length

I am a short wave listener of some 86 years and am interested in your article in April's *Amateur Radio*, on the subject of "End fed wire aerials". I have a 20ft pole at the bottom of my garden, and a pole on the shack at 40ft,

but the length of the garden is only 65ft and the width only 15ft.

To get what you call "a 190 footer", how do I go about it? Would three lengths of 65ft to the same two poles be alright, the wire being 3ft from each other, which would give me 195ft, together with about 30ft down lead into the shack, making a total of 225ft to the ATU? Would this length be suitable for 15, 20, 40, and 80 metres? Would it be a good idea to start at the bottom of the 20ft pole, thus getting 20ft of vertical as a start, making the total length 245ft? I have a Drake R7 receiver.

**A.M. Chapman, Grimsby, South Humberside.**

*The sketch map with your letter is helpful and makes the situation very clear.*

*I am afraid that you must not fold back aerial wires too make up length. End-fed wires are best if straight, and if bent, the angle must never be less than 90 degrees. I am sure that your idea as outlined would not work very well for the aerial currents would cancel out along the wires and it would make a poor antenna.*

*All I can suggest is that you take your wire up to the top of the 40ft mast from the shack and then slope it down to the 20ft pole some 65ft away. This will allow you almost 100ft of wire which if connected to an ATU would work well on all bands. Many amateurs I know would be very pleased to have such an aerial for they are unfortunately condemned to live in blocks of flats where outside antennas are taboo! Do not drop the far end down near the ground. That pole is not high so do not let the end of the wire get any closer to the ground.*

*Good luck with your DXing. Later articles may contain information on aerials more suited to your particular circumstances, so keep an eye on Amateur Radio! - G3BDQ.*

## Strain of exams

I read with interest the letters in the April edition regarding the current "R" licence requirements. When I left university at the age of 22 I

swore that I would never sit another exam; the strain on the nervous system is high and I do begrudge the amount of time needed to study, particularly when 50% of the information "crammed" for an exam will never, in practice, be used.

Consequently, it is unlikely that I shall ever hold an amateur licence, especially if I have to learn Morse code, in which I am not the slightest bit interested.

It does appear, therefore, that I am doomed to remain simply an enthusiastic, albeit frustrated, "CBer" unless the rules are modified. Although I am a qualified electronics engineer, my job in telecoms requires me to use very little of the knowledge of things electronic, which I began to acquire at the age of 12. My evenings, however, are often spent in the repair of CB transceivers and, before anyone is tempted to write an angry letter with the phrases "screwdrivers in the wrong hands" and "a little knowledge . . .", let me assure them that I have spent a lot of money on equipment and lack only a spectrum analyser. Since one would cost somewhat more than a new car, it may be some time before I have one.

It may be of interest to know that the majority of repairs arise through badly designed voltage stabilising circuits, where zeners or series-pass transistors are grossly under rated.

Shifting the subject slightly to your article about computers, I have a very well known, fairly expensive model which produces a carrier on 27.98125MHz so strong that it swamps the transceiver in my car 100 yards away! If any readers, by the way, can design a 27MHz front end through 10.4MHz mixer to 10.695 crystal IF stage, which has in excess of 70 dB dynamic range and linearity good enough to prevent intermodulation products when transceivers are in close proximity (50 yards), there is a big demand because no CB manufacturer has yet produced one, to my knowledge.

Finally I must say how interesting your magazine is. This issue was given to me by another enthusiast. I am pleased to see that the number of grammatical errors and copying errors is very low and the format of the magazine is good as it stands.  
**Name and address supplied.**

I note from "Current Comment" in the April issue that thoughts are being given to publication of a series about dealers.

I would hope that, if such a series emerges, it is not confined to those dealers who market "black boxes" and ancillary bandware. Those dealers who supply the bits and pieces for those who construct their own equipment should also be the subject of a survey, the results of which would, I believe, be of interest, particularly if a form of grading table was published. Such a table could, I suggest, be based on the lines of how quickly traders despatch orders, give service and ideal promptly with enquiries.

In the latter connection I would mention that an enquiry to a well-known trader has elicited no response despite two letters accompanied by SAEs being sent and a telephone call being made. The trader concerned apparently does not seek further business even though he does advertise his wares in one particular radio journal.

*Amateur Radio* is just what the doctor (sorry, amateur SWL) ordered. I look forward to reading many, many more issues.

**W.E. Caughey, G12DZG, Belfast.**

## Nothing technical

Congratulations - *Amateur Radio* is exactly what I have been looking for. As a newcomer and being in the 50-plus age group, I want straightforward down to earth explanations, not a load of highly technical jargon as per some of the other magazines.

In your April issue, I particularly enjoyed "Pass the RAE" and "Starting from

# LETTERS

Scratch – Formulae”. Both articles were most helpful. Also, “Building an ATU” was explained in simple terms that even a thick old codger like me can understand. My wife reckons if I can understand these things everyone else will have no trouble!  
**George James,**  
**Holmes Chapel, Cheshire.**

## Slightly mad

It was only be chance that I picked up a copy of your magazine (March) and find it quite a refreshing change after subscribing for many years to the more “elite” magazines.

Some of the articles in those magazines require at least a B.Sc to understand them and others just seem slightly mad, eg, “Morse keyer using approximately 25ics and discrete components, when an ordinary up and down key would do the same job (or better) with just a little practice”! I noticed in the correspondence section a reference to an article on the RCA AR88D receiver – do you have a back copy available? Anyway, best of luck with this new venture.

**Harry Cain, G3DVF,**  
**Alnwick, Northumberland.**  
*Back numbers are still available, although they're running down fairly quickly. – Ed.*

## We perfect readers . . .

Just two comments about the April issue. Page 9; the aerial on that broadband pre-amp has taken root. Page 65 first paragraph: SWR should, ideally, be zero? Where is the “infinitely large” reflected power going to be dissipated? We perfect readers can just about live with it. 73.

**Ron Wheatland, G3SZW.**  
*“Infinitely large?” Oh yes, we understand now. We meant 1 to 1, of course. – Ed.*

## Critique

I would like, if I may, to offer some constructive criticism regarding the test report on the Datong Morse keyboard. My first criticism is aimed at the person in charge of layout. With so much blank paper within the article itself, could not some other place

be found for the “review” label? Placed as it is, it certainly detracts from the photograph. I feel the blank spaces could well have been utilised in providing larger reproductions; as it is, one needs a magnifying glass to make out some of the symbols on the front panel.

Regarding the review itself, on the whole I found it quite a welcome change from those aimed at readers with a degree or whatever. It would seem to be a user's review rather than an engineer's. However, the fact that your office staff are merely “average” CW operators is no reason to skip over or miss out entirely, points that should have been covered, and would have been of considerable interest to those contemplating buying the unit, or for academic interest.

The fact that many instructors, for whatever reason, fail to teach; and many operators fail to learn, All of the Morse code does not make the less common characters obscure. All of those depicted in the reproduction are as much a part of the code as is the alphabet and have certainly been around for much longer than the vast majority of the world's CW operators (whether they use them or not). The one exception is the “open bracket” sign which was recommended for use by the 1958 Geneva Convention. It is widely used commercially, though for some reason seldom taught. The fact that it is included, would I should have thought, warrant mention.

As this is a Morse-only keyboard, I would have questioned the location of the shifted characters. Datong obviously have their eye on the European market by including accented (barred) letters – no mention was made of these, other than their being “obscure”. It would seem logical to place these as a shifted version of the normal character ie accented A as a shifted A, CH as a shifted H etc etc; alternatively, the punctuations could, where appropriate, follow either a normal typewriter, or even a

teleprinter pattern.

Could it be that Datong have chosen to place these characters where they have in order to make the “mergers” simpler. For example: O(—)/ : (—...); K (—)/Close brackets (—, —); Y (d.—)/ Open brackets (—, —) etc etc. Though why E/VE IVA?

Despite a magnifying glass, I am not able to determine the character above the A. Is it a plus sign (+)? If so, what character code is generated when this is selected. AR is conventionally written as a plus sign; as there is a key dedicated to AR, what of the shifted A?

Mention is made of four memories which can store up to 64 characters. This is not a lot really. Are these Morse or ASCII characters? Manufacturers of keyers containing memories appear to be confused in this respect. A typical specification is Memory 4096 bits (approximately 500 Morse characters). This is somewhat optimistic, as 4096 divided by 500 equals 8 which, surprise, surprise is a Byte, the length of an ASCII character. The average length of a Morse character is 14.5 bits (elements or Dot periods). 4096 divided by 14.5 is approximately 280. In practice, a 4K memory will hold approximately 300-325 Morse characters. Does the Datong MK, actually hold 64 characters?

I could of course raise these points with Datong, but you reviewed the machine!

Two rather flippant references were made to FOC, implying that fast Morse, or even the use of the MK would result in an application for membership dropping through the letter box. The use of this keyboard, or any other means of producing fast code, will not in itself achieve this. The ability to send fast code proves nothing except that in so doing, the operator has the means so to do. Whether he has the ability to send readable Morse by whatever means, is another matter. More importantly, could that operator copy fast code such that it could be read and understood by a third party. This after all is

the object of the exercise.  
**C.W. Mann,**  
**Fife, Scotland.**

*Many thanks for your comments; we take your points, although we very seldom hear things like open brackets or accented letters on the amateur bands. AR and the + sign are both sent in the same way, so we don't quite know why and we must admit we didn't spot it in the review!*

*Your points about FOC noted, and we certainly didn't mean to be flippant; we admire what they stand for and would like to attain their standards ourselves – ED.*

## Blue glow

The nearest I have seen to Mr. Spooner's blue glow (March issue) around the anode of his 4CX250B was when I was doing television repairs and a friend had a similar effect on the tube EHT cap, but having a much higher voltage than the 2Kv on the 4CX250B there was, in addition to the blue glow, a superb display of wavy tracking for about 1in. all round the cap which changed direction continuously.

The tale I got from him was that whilst cleaning the dust from the TV set he had pulled the wire from the EHT cap and being one of the uninitiated, had soldered it back on using a liquid type of flux which had splattered. We tried using all sorts of cleaning material, but never did cure it, and the only answer we found was to smear the cap and the affected part of the tube with a silicone jelly (MS4?) but it would only last for about nine months before it required another application.  
**J. Stuart, G4SDE,**  
**Rotherham, S. Yorks.**



# LETTERS

## **RSGB a monopoly!**

I was interested to find a new amateur radio magazine now available which is free of the monopoly opinions of the amateur society that issues *Radcomm*.

I feel it is long overdue that radio amateurs should have a forum for discussion and information dissemination amongst themselves, so that opinions can be gauged, and even represented to those in authority.

Over the last 10 years, as a licensed amateur, I have on three occasions asked the Home Office for particular facilities, which have always been refused, not because the HO were being obstructive, but, because as they told me, all representation must come only from the RSGB, and it appears that individual amateurs are ignored by the HO a situation which the RSGB appears to applaud.

The first occasion which led me to write was for the approval to install an amateur repeater, and I was told that all applications had initially to be considered by the RSGB. Since the society's approval was for a given area (which causes much difficulty in crowded areas, and those with topographical problems), it seems that decisions may be made in favour of groups that are in RSGB membership, and against those not in membership. My application was, consequently rejected by the HO, and an RSGB application granted.

This is far from satisfactory and I hope a wider body of opinion will eventually cause the HO to adopt a better system of licence issuing.

Most recently, I asked the HO if Class B stations could be allowed to use Morse transmissions – and licensed to receive them! – in order to advance the self-training aspect of the licence. The reply rejected this out of hand, but added the rider that a discussion was currently taking place with the RSGB in order to do just this!

I certainly don't claim a monopoly in having such an idea, but the fact that such suggestions (which don't coerce amateurs to do something) can only be made

by an amateur society seems entirely unreasonable. Furthermore, even the specialized societies such as BARTG, BATC, FM Groups, ARMS etc. are unable to represent views to the Home Office about their direct interest, but have to make a representation to the RSGB, and only then if the RSGB are convinced through three or four different committees in cascade will the proposal go to one of the two people entitled to represent all radio amateurs in the UK.

Having spoken to the RSGB about this, I was once told that, additionally, only a limited number of proposals can be put forward each meeting with the HO and only a limited number of meetings are permitted, so all proposals must take their turn; and I presume that precedence is given to RSGB-originated ideas over all others.

It would be my fondest wish that of all the state monopolies, this will be the one to be terminated next. I hope you may be the means of doing it!

**Alex Gordon, G8FYO,  
18 High St., Ludham,  
Norfolk.**

## **Weird noises**

On the vexed subject of weird and unidentifiable noises on the amateur bands, does anyone have an explanation for what I can only describe as a "bubbling" which roams up and down 14MHz apparently aimlessly? Whatever it is, unlike the Woodpecker, it seems to be "aware" of QSOs, being carried out – or is it just my imagination? Also, on the same band, who the hell is putting out that AM signal, in Chinese??

Finally, on 14MHz again (it's my favourite band) I've noticed several unmodulated carriers swishing up and down, leaping from one frequency to another with some agility, even when the band is absolutely dead otherwise. Since I can't believe that any self-respecting ham would get up at 3.30am simply to twiddle the tuning knob of his

transmitter about all over the plate, what on earth is it?

**Dave Gregory,  
Leeds, W. Yorks.**

*For your information sire, the AM is Radio Peking, and the unmodulated carriers are probably ionosonde transmitters sussing out vertical incidence frequencies to calculate things like MUFs – Ed.*

## **Help wanted**

A couple of questions: Your series of articles on some of the older receivers, Racal RA17 etc – do you plan to include Eddystone, and in particular the 880/2 and 680X?

Also, I am trying to identify/locate a suitable sweep generator for IF alignment (new or secondhand) for use with the above mentioned receivers and others. Have you any suggestions?

**R.L. Devereux,  
14 Keepehatch Road,  
Wokingham,  
Berkshire RG11 1QL.**

*Regarding the Eddystone, yes we could run a feature, but we can't find anyone to write it! Second, about the sweep generator, we can't help you. Can any readers help? – Ed.*

## **The hi-fi cost?**

As a new short wave listener, who at present knows nothing at all about the technicalities of radio, (but hoping to change that eventually), I would like to ask the more knowledgeable members of our hobby for their advice. What concerns me greatly is the relative cost of 'radio amateur' gear compared with ordinary 'hi-fi' gear.

For instance, I have bought a short wave receiver, (SRX30D), which covers 200kHz to 30MHz, plus FM. It works beautifully and gives me a lot of pleasure, but I have no idea how much work or material has gone into its production for its purchase price of £215.00. I have not looked, nor do I intend to look, inside the cover, in case I invalidate the guarantee.

What I see for my money is one fairly small receiver, which contains its own built-in speaker. Contrast this, if you will, with the latest stacked hi-fi decks in the

shops. The latest Amstrad one, for instance, consists of a stereo tuner, stereo amplifier, graphic equaliser, dual tape deck, and turntable, all built into a cabinet complete with glass doors and cover. There are two speaker enclosures, each of which contains two speakers, plus an infrared remote control to operate the set with. And all this costs less than £200.

Now, as I said, I am not qualified to judge these two items except by looking at what I see, but, even allowing for the volume sales of the hi-fi unit lowering its price somewhat, there still seems to be an inordinate difference in the value-for-money aspect of these goods. So, my question to the more knowledgeable members of our hobby is this – are we being ripped-off? I would be grateful if anyone, even the manufacturers, could explain the apparent discrepancy to all your readers.

I must add that I have no connection with Amstrad in any way – there are many other similar units on the market at a similar price; I just happened to quote theirs. **C.H. Kirk,  
Leeds.**

*Ah yes. We'd guess it has something to do with relative sizes of production runs and the fact that service back-up costs a lot, but what do dealers think? Any offers? – Ed.*

**Have readers any ideas for useful circuits or other equipment that would be of interest to others? If so, let us see them and where possible, we will publish your ideas in future issues of Amateur Radio. What's more – we might even pay you some real money for the privilege. – Editor.**

Well, you'll all have seen the (nearly) last word on the Spratly Island affair – tragic and very sad, and we'd like to think that the least that will be done is the removal of the ghastly place from the DXCC list.

We'll probably never know now who did the shooting, and it's too late to do anything about it – all we can do is offer our condolences to the families of the bereaved and hope to heaven that no one tries to follow in their footsteps.

## Prosecuted for "installing"

Anyway, what's been happening in the world of the SWL? There's one slightly disturbing thing we heard of recently, where someone who was studying for the RAE and who had bought a commercial transceiver was prosecuted by British Telecom, apparently for "installing" the thing. Now if this was a general case it makes half the Class B licences in the country outside the law for owning HF rigs from which they transvert – it probably renders a good number of Class A amateurs in the same boat, since no doubt they own gear which could be used outside the amateur bands. We always considered that the offence was in *using* as opposed to *owning*, and indeed we still feel that this is the case – all we can really say is that from what we've heard over the years it's unusual for BT to drop a brick in quite this way and we must confess to wondering whether there isn't slightly more to this case than meets the eye, as it were. We've heard several stories of people being done apparently on pretty flimsy grounds, and a time or two we've thought "hello hello hello, there's a

## For the short wave listener

good story here" but every single time the facts have turned out just a little bit different from how the case first appeared. In this particular case, it so happens that the editor of a CB magazine who we know is a friend of a friend of a friend, as it were, of the bloke who was done, and it turns out that he's a pretty active SSB CB DX-fiend as well as being an aspiring amateur. Whether or not BT knows this we don't know and can't find out – but we feel pretty safe in saying that if you're a short-wave listener there is *no* offence in owning, say, an HF transceiver – you can use the receive side of it for listening to amateur transmissions until you're blue in the face and it doesn't constitute any sort of offence under the Wireless Telegraphy Acts.

## "...and went on the air before you had your ticket"

The offence would obviously come if you plugged the mic in and went on the air with it before you had a ticket – in which case you have no-one to blame but yourself if BT vans screech to a halt outside your residence and they throw the book at you. Our advice would be to take the mic out and lock it away somewhere until the magic bit of paper flops through the letterbox.

It would be a silly law anyhow, because it must be obvious to all concerned that there's no harm in owning the thing – it isn't going to do terrible things to anyone simply because it's potentially a transmitter. British law may be an ass at times, but it isn't that daft.

Anyway, what about the state of the bands? Conditions have been really rather disturbed this last month, and 28MHz has been a real wipe-out. 21MHz has been pretty patchy too, and there have been days when nothing at all has shown up on the band. There was a large solar flare on the 15th of May, which caused a sudden ionospheric disturbance for about an hour, and this also produced an aurora a couple of days later which didn't exactly help. Mind you, we gather that one or two VHF chaps up north worked a bit of DX but it wasn't a major event and even the IC-251E which we were reviewing at the time wasn't able to hear a single solitary peep of an auroral signal on 144MHz.

14MHz has carried the brunt of the DX – it's been open for a full 24 hours a day for some time now, and conditions have been fairly reasonable. The word from the Clever Chaps seems to be that it'll stay in reasonable shape for some while but 21MHz will be decidedly patchy. Mind you, when signals do appear they ought to be quite strong and solid.

## Some pretty choice DX

Seven MHz keeps on truckin' – lots of noise but some pretty choice DX as well. We've been logging VK and ZL quite regularly in the early evening, and the USA and Canada around midnight GMT.

Before the antenna blew down (groan, yawn, now what the hell do we do for an SWL column?) we were doing quite nicely on 80 – we'll come back to it next month...

One letter asked us why amateurs use LSB on some bands and USB on others and were there any rules about it? Yes, sir, there are – well, not rules but the convention is that stations transmitting on frequencies below 10MHz use LSB and those above 10MHz use USB. Yes, we *know* all the ship-to-shore stuff on 80 metres uses USB and we don't quite know why that should be! Any offers from the professionals out there? Anyway, that's the ITU convention in the matter.

## Good book on simple aerials

Oh yes – shock, horror, we actually had a couple of letters more for this column – trouble is, they both asked virtually the same question!! Basically, they wanted to know whether there was a good book on nice simple aerials suitable for the SWL – one of them said that he found most things quite unintelligible and offered us some high-grade RF connectors if whatever we recommended helped. Well, sir (doff hat, bow, scrape, lick boots, pray hard) the best one we know is called "Simple Low-Cost Wire Antennas" by Messrs. William I. Orr, W6SAI, and Stuart D. Cowan, W2LX. We bought ours about four years ago and it's positively dog-eared by now – all we can say is that it's a superb little book and everything we ever tried in it has worked like the proverbial charm. It's published (or at least ours was – we hope it's the same publisher) by Radio Publications Inc of the USA, but according to *Radcom* you can get it from the RSGB. Try it, honourable sir, and if it doesn't help we'll keep trying until you do!

*The RSGB's DX News Sheets continue the tragic saga of Spratly Islands with this (possibly) final information. More information on these News Sheets from the RSGB at Alma House, Cranborne Road, Potters Bar, Herts EN6 3JW.*



**Spratly Is.** The survivors are now in Hong Kong undergoing medical treatment having been picked up by the freighter "Linden" after 10 days in a life-raft. The group had been in the process of leaving the Amboyna Cay area when they were fired upon. DJ4EI was killed immediately, DJ3NG died only hours before the rescue. An extensive air search had taken place but in the wrong area. Spurious reports being put out on the 20m freq, apparently by a stn in Indonesia, did nothing to help the situation. The DU group are still expected to appear from Spratly, but will probably not count for DXCC. At Visalia the question of Spratly's deletion was discussed. The DXAC had considered its deletion on grounds of changed administration but it was generally agreed that such a course did not make sense.

# STRAIGHT AND LEVEL

After the antenna debacle that Chris was going on about in Current Comments, we're wondering whether any of our antennas are going to be straight and/or level by the time the weather gets better. Seriously, we plan to run an article on antennas, rotators and masts because it seems to us that there isn't enough information to go on when it comes to deciding what will stay up and what won't; some of the things the makers tell you don't exactly inspire confidence, do they? Are there any consulting engineers out there who'd like to write the definitive article for us? From the proceedings of the previous week, it doesn't look as though we're exactly well qualified to do it ourselves. . .

Getting back to more serious things, the Spratly Islands fiasco that we mentioned last time turned really tragic with the news that two of the team died and one was seriously injured in the attack. Not good. It made us wonder whether DX and DXpeditions haven't got more than a bit out of proportion, when you get to the point that people end up risking their necks and coming a gigantic cropper, and we have to say that if we were the ARRL we'd remove Spratly Island from the DXCC list pretty damn quick.

From all the staff of *Amateur Radio* we offer our sincere sympathies to the families of those who lost their lives in this business.

After our last issue, in which there were bandplans for VHF and UHF, we got not a few letters and phone calls asking us why, if the segment 144.845MHz-144.995MHz was supposed to be a beacon sub-band, were Raynet using frequencies like 144.85 and 144.875MHz? A good question, we thought, and it's a sure-fire fact that listening for weak beacon signals percolating out of the noise ain't compatible with FM stations beavering away at whatever Raynet do. We honestly cannot understand why the bandplan in Region 1 doesn't make some provision for the beacon sub-band to be on its own without having some Raynet frequencies stuffed right in the middle of it – or, to put that the other way round, why the hell were

## News and views from the world of the radio amateur, compiled by the staff of Amateur Radio.

Raynet allocated two frequencies slap in the middle of that bit of the band where we sit with the cans on and the wick turned up trying to see whether the beacons are there or not?

### Firing up the big rig

One which we can hear about 50% of the time from here is HB9HB on 144.865MHz (or at least we could before the thing handed its dinner bucket in – RIP, May 4th 1983) but there's no way in the world we can get anywhere near it if there's a load of FM on 144.850MHz. Similarly, one beacon that we can't usually hear from Bicester is FX0THF on 144.895MHz – the fact that we can't usually copy it means that it's dead useful because if *we do* start to hear it coming through we know it's worth firing up the big rig and having a crack at some of the French QTH squares we haven't filled in yet. However, any hopes of copying it shoot straight out of the window when people pop up with S9 FM signals on 144.875MHz.

It wouldn't be so bad, but in about three and a half years of listening we've never heard a single solitary Raynet emergency, or even a formal exercise, on that frequency. There's a local group who have a net there on Thursday evenings and who solidly refuse to move off it even though we ask them ever so politely; they say "we've been here for six years and we aren't moving now" or words to that effect. Several mobiles in the Oxford area use it for nattering amongst themselves on the way home – you're clobbering everyone within line of sight, and especially those on good sites with gainy beams and good receivers!

*The beer can special antenna erected by Bob McTait in Bahrain which, we gather, radiated well. The antenna, that is, not Bahrain. The other picture shows the full extent of the precarious-looking (but stable, we gather) aerial. Mind you, isn't Bahrain supposed to be a dry country?*

The other good one you hear is mobiles who use it and then say they're Raynet members and this is their frequency. As we understand it, Raynet can use 144.850 and 144.875MHz during exercises and emergencies; we don't quite see how two or three mobiles yacking to each other on the way home constitutes either of those things. Maybe some high-up in Raynet would like to write to us and explain precisely why their

members do these things – either way, it's behaviour like this that explains why Raynet in our neck of the woods has a not-too-good image amongst the rest of the amateur fraternity.

But we wonder where the blame really rests for all this – who the hell devised a bandplan whereby Raynet uses a couple of frequencies slap in the middle of the beacon sub-band? We don't know much about Raynet, but we do know that many groups don't have vast amounts of cash to spend and who use things like Pye Westminster and Bantams with

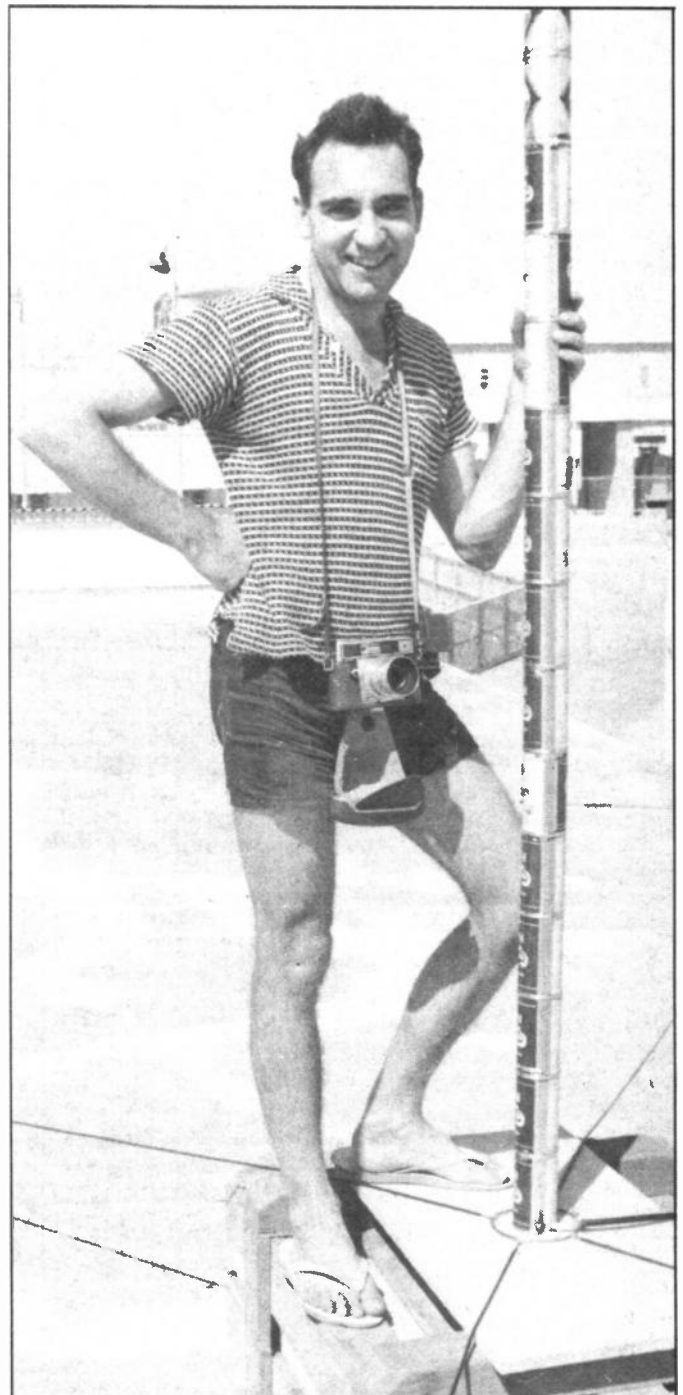



a few crystal-controlled frequencies. Maybe you can't blame them for using the channels they've had for years and can't afford to replace. And, as our local Raynet controller was saying to someone on the air last week, where could they move to? Apparently the all-mode sector in the London area is pretty chocker, and driving around Liverpool last month we couldn't find a quiet frequency to QSY to from the repeater for about two minutes.

Be all that as it may, we would suggest to whoever devises bandplans – presumably the whole of Region 1

at one of those mammoth conferences like the one they had at Brighton a couple of years ago – that something gets done pdq about this conflict. Either ask Raynet to move to 432MHz, or narrow the beacon sub-band (thinks – could you space beacons at 2.5kHz instead of 5?) or persuade Raynet only to use .85 and .875 for genuine Raynet-related work instead of casual chats, or set fire to clubs who use those for nets? Come on, fellas, play the game – there must be a solution somewhere, and we'd respectfully suggest to the RSGB that they get cracking on this one before there's blood shed. Maybe someone in Raynet would care to make a few comments and tell us all about what that organisation does, because it's also a fact that some people have some rather negative ideas about it.

### Guildford gets cable TV

Grouse over, what's next? We were intrigued to see that Her Britannic Majesty's Gummint have given the go-ahead for a pilot cable television scheme in the Guildford area, apparently on the coaxial-cable tree-and-branch scheme or whatever it's called. The thing that bothers us is the fact that cable television has caused an enormous number of problems in the States both in terms of radiation from said cable getting into amateur receivers and wiping things out, and also (surprise, surprise) amateur transmissions getting into the cables and wiping out about a million TV sets at once.

We gather that the "ingress" and "egress" specifications in the proposed UK scheme aren't exactly brilliant to start with and we wonder who's going to enforce maintenance and adherence to proper specs in the long term. Certainly there could be some knotty problems for the amateur fraternity, and we devoutly hope that the RSGB is doing its best for us. There was something somewhere in *Rad-Com* recently if we remember rightly, suggesting that those with any ideas and suggestions should communicate them to one G3ZNU of the VHF Committee – sounds like a good idea to us, and can we further suggest to amateurs in the Guildford

area that the day this lot comes on line you all fire up every linear you have and fire 26dBW in as many directions and on as many frequencies as you can? That should make somebody sit up and take notice. . .

### "It would have put some muscle into the wretched Acts of 1949 and 67"

Talking about Her Majesty's Gummint, we'll have had a General Election by the time this hits the bookstalls – the point being, of course, that since the Telecommunications Bill didn't get as far as the Royal Assent, along with things like the Data Protection Bill and the Police Bill and the Goodhead Publications (Refund of Tax & Emoluments) Bill, it bites the proverbial dust. This strikes us as a tragedy. That Bill would have done quite a lot, in indirect ways, for radio amateurs and it would have put some proper muscle into the wretched Wireless Telegraphy Acts of 1949 and 1967. It looks as though we'll have to make do with this feeble legislation for a while longer, or maybe never, depending on whether it was the Toady Party or the Laborious Party that got into No.10. Not that we're being political, you understand, but what with both our antennas and the Telecommunications Bill falling to the ground we feel a bit – well, miffed.

Talking about antennas, how about this one? Bob McTait, ex-5B4HK, MP4BBA, 9H1BA and eagerly awaiting a G4, sent us a pic of his "Beer Can Special", which was built in Bahrain in 1965. Apparently there was a distinct shortage of materials for antenna manufacture, and he and a couple of mates "drank themselves silly for a while" (he says) to obtain enough metal beer cans to make this vertical. Bob says it radiated extremely well, even on the local cable radio network, and even more so when they made an ATU (we dread to think what they made that out of . . .) Nice one, Bob – actually, isn't Bahrain a "dry" country???? As long as you didn't get a public flogging and they didn't make a film called "Torture of a



*Nigel Curzon, man in charge of South Midlands Communications of Totton, Southampton, takes a minute to swot up on things technical in the showroom of his premises. The picture arrived just a little too late to be included in last month's article on this lively company. This picture shows the old showroom, incidentally.*

Radio Amateur" or something!

Bob offers the title "Chatterbox" for this column – which is one of the very few entries we've had so far.

Just space for one more thing this month. A friend of ours brought back from the VHF Convention a German book called *UHF Compendium*, which has just been translated into English. It looked very interesting to us – it was a compilation of current and state-of-the-art stuff on receivers, transmitters and antennas and it looked really good. Well, most of it; some of the claimed gain figures for their antennas looked more than a *touche* optimistic to us and Technical Bod mumbled a few inarticulate things about the way they abuse 4CX250Bs, but the receiver chapter looked mucho interesting. We believe, although we don't know for sure, that the RSGB are stocking this tome and it'd be worth giving them a bell to see whether they do if you're into GaAsFETS and fancy things on 1296 and 2304MHz.

Oh yes, a "super-final" to leave you with. Bob McTait was listening to some Americans in a net on 14MHz and one person said during the course of it: "I can hear Dave, but he can't hear me". The net controller replied: "Better put some DX grease on your antenna. . ."

See you next time.

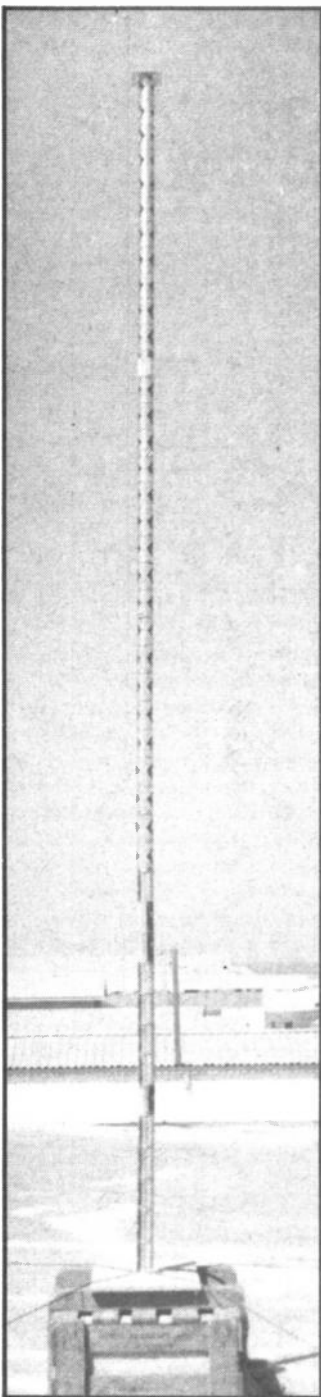



# ICOM IC-251E + MUTEK BOARD

You'll remember from our last issue (assuming that it didn't send you straight off to sleep, or scurrying in the general direction of your wireless station) that we were wingeing fearfully about the quality of some SSB signals on VHF and UHF. Technical Features was sounding off at great length, and G Three Old Smelly Socks in his brilliant linear review was pointing out some of the reasons why.

Not so many years ago, it was a pretty safe bet that if someone's signal was loud enough with you that you could hear whiskers plus and minus vast amounts, it was an even chance that the receiver was as much to blame as the transmitted signal, and it wasn't really safe to criticise one of your locals for having a wide SSB signal in case it turned out that it was your manky old 40673 front end that was really to blame by making *all* loud signals seem half a yard wide!

Historically speaking (*here we go again, get on with reviewing the rig will you? - MD*) it's all down to the solid state revolution in the sixties and seventies. In those days people were using things like Nuvistors and quiet triodes for VHF and

**The best combination ever? Nigel Gresley puts this VHF multimode transceiver through some tests, and describes the "unexpected" delights of how the Mutek front end board makes an already good rig even better.**

UHF amplification, simply because solid state things either weren't available for such high frequencies or, if they were, you'd have needed to take out a second mortgage to buy one. The performance of such antique beasts was pretty respectable too - you could usually get down to a noise figure of around 3dB with a 6CW4 Nuvistor triode if you took your time over it, and on 144MHz there's no real point in a better noise figure than that in any urban area of the country. I well remember when I got my first ever MOSFET and rushed to build a 144MHz converter to use it - I guess I was more or less expecting a really dramatic improvement. A year or so later I still hadn't got it to perform anything like as well as the 6CW4!

In those days, SSB on VHF was about as rare as a brilliant article in *Practically Wireless* - when you found one, you marvelled more that it was there at all than anything else. There certainly wasn't the tremendous interest then in SSB DX-chasing on 144MHz that there is now, and you also have to remember that the VHF bandplan was completely different in those days.

The bottom line of all this is that not a single solitary soul amongst the merry 144MHz band of brothers appreciated that their Nuvisitors and things possessed one very good and important property – thundering good signal handling properties – because there weren't that many strong signals to handle, and there were even fewer strong SSB signals. What happened then, more or less simultaneously, was the advent of transistors of one sort or another and also the advent of the commercial multimode black box. The first ones weren't multimode. Some were for FM and the famous (or notorious) Liner 2 was an SSB machine. Oh brother, what a device! When it first came it was hailed as a triumph, and whatever else you say about the Liner 2 it's that rig more than any other which sparked off the interest in VHF SSB in this country.

**“There certainly wasn't the tremendous interest then in SSB DX-chasing on 144MHz that there is now . . .”**

However, by today's standards its performance was – well, *dreadful*. Some fearless folk hung a couple of 4CX250Bs on the back of one to produce 400 watts, and that was when the fun really started – you could end up with one local SSB signal apparently monopolising the whole of the 144MHz band. Now whether this really was the case (it probably was) or whether it just looked that way because the receive side of the Liner had about as much in the way of strong signal performance as a

MOSFET has a screen grid (it did, or didn't), either way the situation wasn't very satisfactory and SSB got the reputation of being rather injurious to anyone else's fun and games on the band. Contests especially really made the fur fly – it only needed a major contest, with kilowatts on every Welsh mountain, and most receivers of the day just quietly expired. It was a wonder anyone worked anyone else.

What it was down to, you see, was that the early generation of solid state devices were very poor at coping with lots of strong signals. Nowadays we'd call it intermod and we'd say that the third-order input intercept was pretty awful, but in those days it just felt as though a strong signal or two made any hope of copying the weak ones down in the noise pretty fruitless. Sensitivity wasn't the problem; there's no real difficulty in achieving sensitive receivers and there never was, but it's what happens to the ability to copy weak signals (which is what you want a modicum of sensitivity for in the first place)

*Right: Looking inside with the SMPS removed, ready for the board. It's a doddle to fit, and you can have one for about £65.*

*Below: The Mutek board in place on the spare lugs. There's an instruction sheet which shows you, step-by-step, how to fit one if you're doing it yourself.*

## SOUND ANALYSIS

when there are some super-strong ones not very far up or down the band.

Although no one really twigged it at the time, valves are superb in this department as we'll see shortly. To get really good signal handling with solid state devices takes a lot of knowledge and good components intelligently used, but good strong signal handling is inherent in valve circuitry and always was. The first generation of bipolar transistors and MOSFETS were

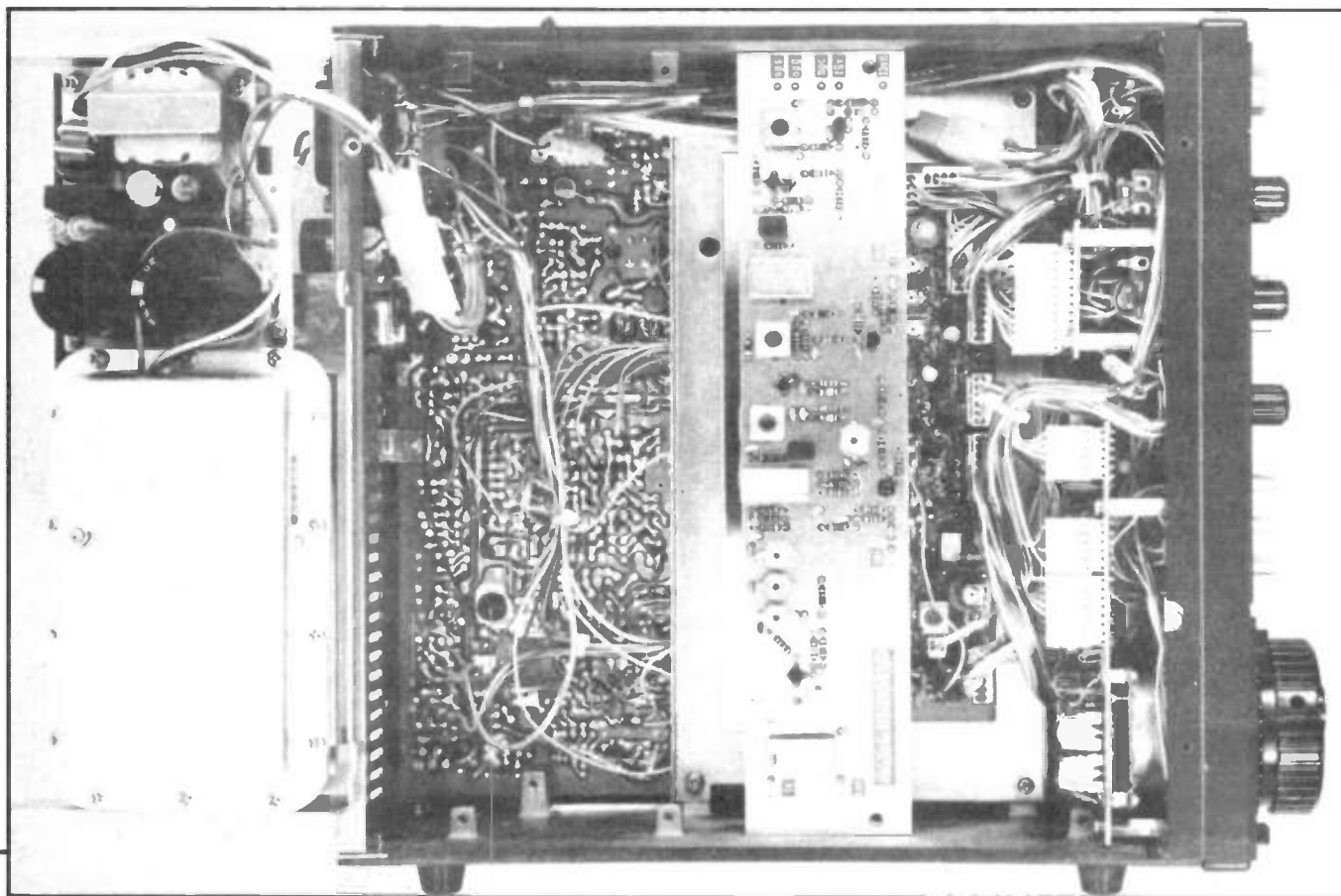
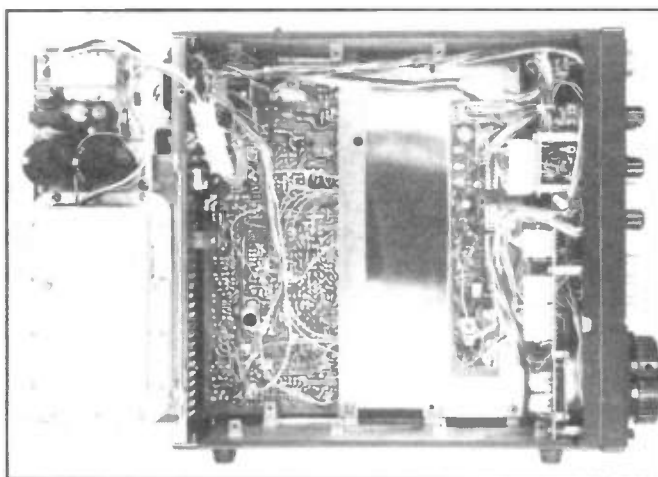



## ICOM IC-251E + MUTEK BOARD

frightful and the second generation wasn't that much better – the thing was that you could set them up for low noise and good sensitivity or good (well, reasonable) signal handling but *not* both at once. It was relatively recently that it's become possible to get both out of solid state devices, and then you need to pay an awful lot of attention to an awful lot of things.

Anyway, what about the Icom IC-251E? The reason for all the background info is that you'll need to know why it's important to go for a receiver that's both sensitive and capable of handling stacks of strong signals both in and out-of-band. Now it's fair to say that the majority of 144MHz commercial multimodes can't do this. If you look at yer actual TS-700, FT221 or whatever, you generally find that the noise figure of the front end (which is bound up with the ultimate level of signal you can, or can't copy) is around 6 to 8dB. Usually this is down to a number of things, chiefly the noise figure of the RF amplifier device and also how the first mixer is set up.

Now, the first mixer in all of these wireesses is usually a dual-gate MOSFET, which means that the manufacturer can keep his mixer simple and cheap, but it also means that the strong signal handling properties of it will be pretty low tech. It's usually the first mixer that sets the limit on signal handling (particularly in the sense of something called the dynamic range, which we'll get to shortly). There is another angle on all this, which is where you put the main filtering of the rig, but we'll come back to that.

**“The first interesting thing we noticed was that the 251E seemed rather light in weight”**

So the thing to remember at this point is that the commercial black box usually has a not-too-good noise figure (which means you may have problems hearing the real weakies), and also a not-too-funky performance at the other end of the range, ie when your mate down the road comes on with a pair of 4CXs to a 16-ele or whatever and puts a lot of signal down your coax. The range in between these points, ie the point at which you can just about copy someone down in the noise and the point at which the rig is starting to cough a bit because matey down the road is running rather a lot of urge in your general direction – is known as the **dynamic range** and we'll see how it's defined in a second.

One commercial multimode you could get a few years ago was the Yaesu FT221, and in its bog standard form it was about as good or bad as any other commercial 144MHz multimode black box. Now it so happens that the FT221 is built in what's called “modular” fashion, ie the various

elements of its circuitry are put together on printed circuit cards which plug into a so-called “mother board” and this makes it rather easy to get at it and play about with it. An enterprising chap called Chris Bartram, G4DGU, got hold of a circuit that if we remember rightly was mostly designed by another clever chap, Ian White, G3SEK, and grafted it on to a new plug-in board which replaced more or less the entire front end of the FT221. This sold so well that Chris went into business making it, along with other goodies. They then moved down to Devon into a new factory and gained one hell of a reputation as purveyors of very high grade RF bits and bobs to the cognoscenti.

The replacement board for the 221 brought about a minor revolution in standards, and every serious contest merchant and hard-nosed DX chaser with a 221 bought one. Personally, I was amazed at the improvement – for the first time you could find little gaps in between the S9+++ strong signals in contests where it was possible to work weak DLs and such with no bother at all; you could also tune around strong signals and find out which were sanitary and which weren't. It was also a bit of a shock to discover how many high power signals were more than a bit naff, but we've winged about that enough already and the MD will confiscate my wireless if I'm not careful (*oh no, matey, nothing so obvious – just wait till next pay day – MD*).

What? After all my hard work? Oh well, there's no justice in this world. Never was. Wait until I'm MD and there'll be free 4CX250s for all staff and one day off a week to work the DX. Sorry, where were we? Oh yes, strong signals (*you'll get a strong signal from me in a minute if you don't get on with it – CD*).

Persecution, that's what it is. Anyway, the Bartram modification (his company is called Mutek Limited) made the FT221 head-and-shoulders better than anything else for miles around. What Chris had done was to analyse carefully the requirements for good performance and then incorporate them on his board, and it was the first time that this level of technology had been available to the 144MHz addict unless he rolled his own. Not surprisingly, there were pleas for Mutek to do the same trick for other rigs, and indeed one enterprising bod adapted the 221 board for use with the Icom rigs, the 211 and 251. However, this isn't exactly the easiest job in the world, and there were sighs of relief all round when Mutek brought out a replacement board for the 211E and 251E late last year.

**“... most receivers of the day just quietly expired. It was a wonder anyone worked anyone else”**

Which is really what this article is all about. The Icom 251E is a development of the 211E, which was available some years back; it was a nice looking rig but it had its faults, not least acute deafness, pretty feeble signal handling and a general lack of vim and vigour. The 251E replaced it a while ago, and in its unmodified form was, and is, more than somewhat better. However, when the Mutek board for it came out we began to get the feeling that here was something really special – so it was decided that a review was definitely in. *Looking inside the Icom IC251E from the top: the row of presets can be set up and forgotten!*

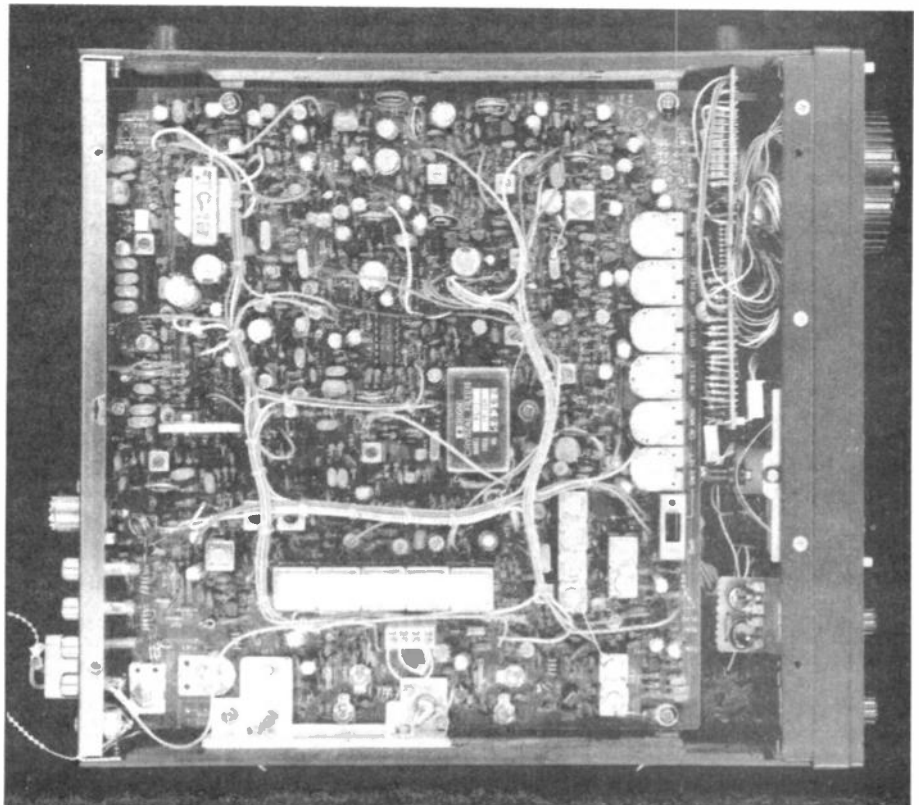

order. First thoughts were to get hold of an unmodded bog standard 251E and measure it in glorious detail – then to purchase ye olde Mutek board and repeat the dose. However, the lads at Thanet, helpful and efficient as ever, offered us *two* rigs for review, one as standard and one fitted with the board by them. Which struck us as pretty damn fine – we wouldn't expect much in the way of variation between two new wirelesses hot off the production line and it saved us a bit of work. It also saved us having to do the reviews in strict sequence, and meant we could compare the results side by side in the lab and on the air. The 251E is available from Thanet either with or without said board, and if you buy it with, you can be dead sure that everything's to spec and that you'll be working the DX in as little time as it takes to suss out how to drive it.

So in due course a fat box arrived on The Desk (damn near broke it – it isn't every day we get two rigs in the same box arrive for review) and there was a certain flurry of excitement. Tech Face emerged from his den blinking in the unaccustomed light and waving his paws around for the circuit diagrams and things – he grasped them and scurried off back to the Nice Cosy Place gibbering to himself and drooling slightly. Self and willing assistants unpacked both wirelesses and set them lovingly in place on the desk side by side – cor, lummy, just like Christmas Day.

The first interesting thing we noticed was that the 251E seemed rather light in weight – nothing like the heft of the old 211E. Hmmm, I thought, does it have a separate power supply box like the old 701 and such? If so, where is it? Don't say Thanet forgot to send it? I asked Technical Features to step out and see. Full of scorn, he said that the 251E has a switched-mode

power supply, the first we've seen in an amateur wireless, and so big heavy mains transformers don't feature – bye bye big iron. The thing turned the office scales to 11½ pounds, which is nice and light – has to be a plus point if you're hefting gear up a mountain. SMPSs need to be carefully screened so that harmonics of the switching frequency don't find their way into suspicious places and cause snags, and the 251's has the noisy bits in a nice screened box

**“Almost as if there was some slippage in the coupling between the knob and the gubbins it was controlling . . .”**

General impression was of a conventional multimode with some typical Icom features. There are dual VFOs with 100Hz steps – when you switch on they come up at 145MHz and 145.6MHz respectively, and form part of the system for working repeaters. Not content with that, if you leave the rig plugged in, the memories stay updated with whatever you left in them, so it's just like the classic VFO-controlled rigs. There are also some very nice scanning features built in; you can programme frequencies into memories and scan between them, with the option of stopping on a signal that's enough to lift the squelch and listening to it for about 15 seconds, or stopping permanently on the first signal to lift the squelch. In typical Icom fashion the

*The bottom of the un-Mutek'd 251E – the Mutek front-end board fits over the shiny screening panel on the just-visible lugs, near the centre/sides of the casing.*

facilities are well thought out, and unusually the squelch works very well indeed on SSB – it was a joy to use the 251 when doing something else, waiting for something interesting to turn up.

Anyway, we're getting ahead of ourselves. The first job was to sit down and read carefully through the manual and suss out all the features. Icom manuals are usually pretty good, and this one is no exception. The complex VFO and scanning arrangements *need* a read through and some “hands on” practice but an hour of it you're away. After a bit of getting used to it, we could operate the box quite fluently. Facilities available are USB and LSB, FM and CW – on FM the meter can either function as a centre-zero discriminator meter or an S-meter. There isn't an AM facility, and we don't feel that's a great loss, and the CW filter is the same as that used for USB – pity, but outboard filters such as the Datong will do the job if you're a CW addict.

So it was time to plug in and get the feel of things. We deliberately started off with the standard 251 and the usual antenna and spent an hour or so gathering first impressions. Which go something like this. Nice; it was one of those rigs we felt quite at home with pretty quickly. The dual VFOs and the scanning worked out well and logically from the word go, and were extremely versatile. You could scan at different rates to suit the mode in use, and you could even adjust the scanning speed – we felt it was just about right as set up, taking you through signals at a nice steady pace. One button gave you start and stop control. The controls seemed nice and well-placed to us, and as usual the Icom shaft-encoded synthesised VFO behaved impeccably. Well, almost. The manual tuning knob is marked in five steps of 10, giving options of 1kHz and 100Hz steps for SSB and 5kHz and 1kHz steps for FM. Good; couldn't be better.

Now we like to set the tuning knob so that as our finger passes the finial, that corresponds to the frequency in exact kHz. In other words, when the display (very nice one, phosphorescent green and adjustable in intensity) says 144.300.0MHz the finger hole is at the top of the dial. The reason is that when we QSY it's nice to count the turns so that you can get on frequency without staring at the display all the time. What we found was that if we QSY'd to, say, 144.230.0MHz the finger wasn't at the top of the dial any more, it was somewhere else – almost as though there was some slippage in the coupling between the knob and the gubbins it was controlling. Further investigation revealed that the effect didn't happen if you turned the knob slowly but any attempt to QSY in a hurry meant that the VFO got left behind, as it were, and you didn't get there any more quickly even if you turned the knob so fast it felt as though your finger was about to catch fire. There isn't really any mechanical mechanism that could cause slippage in a shaft-encoded VFO like this, and we woz baffled; we tried the other rig at this point and it did exactly the same thing. So if you're on SSB

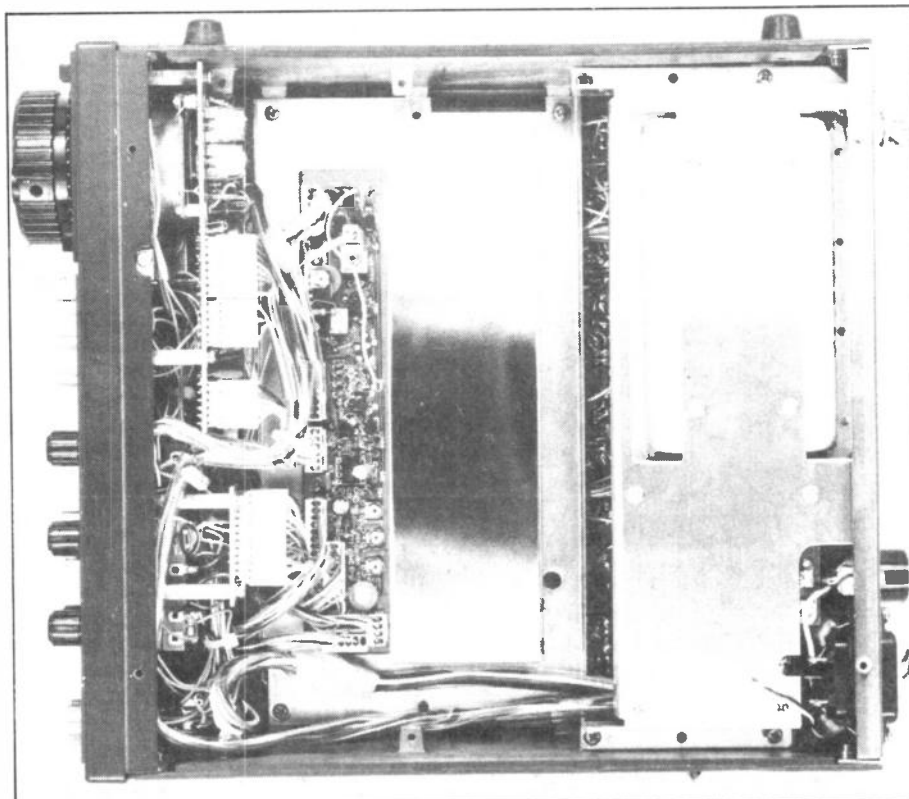

Block diagram of the IC-251E

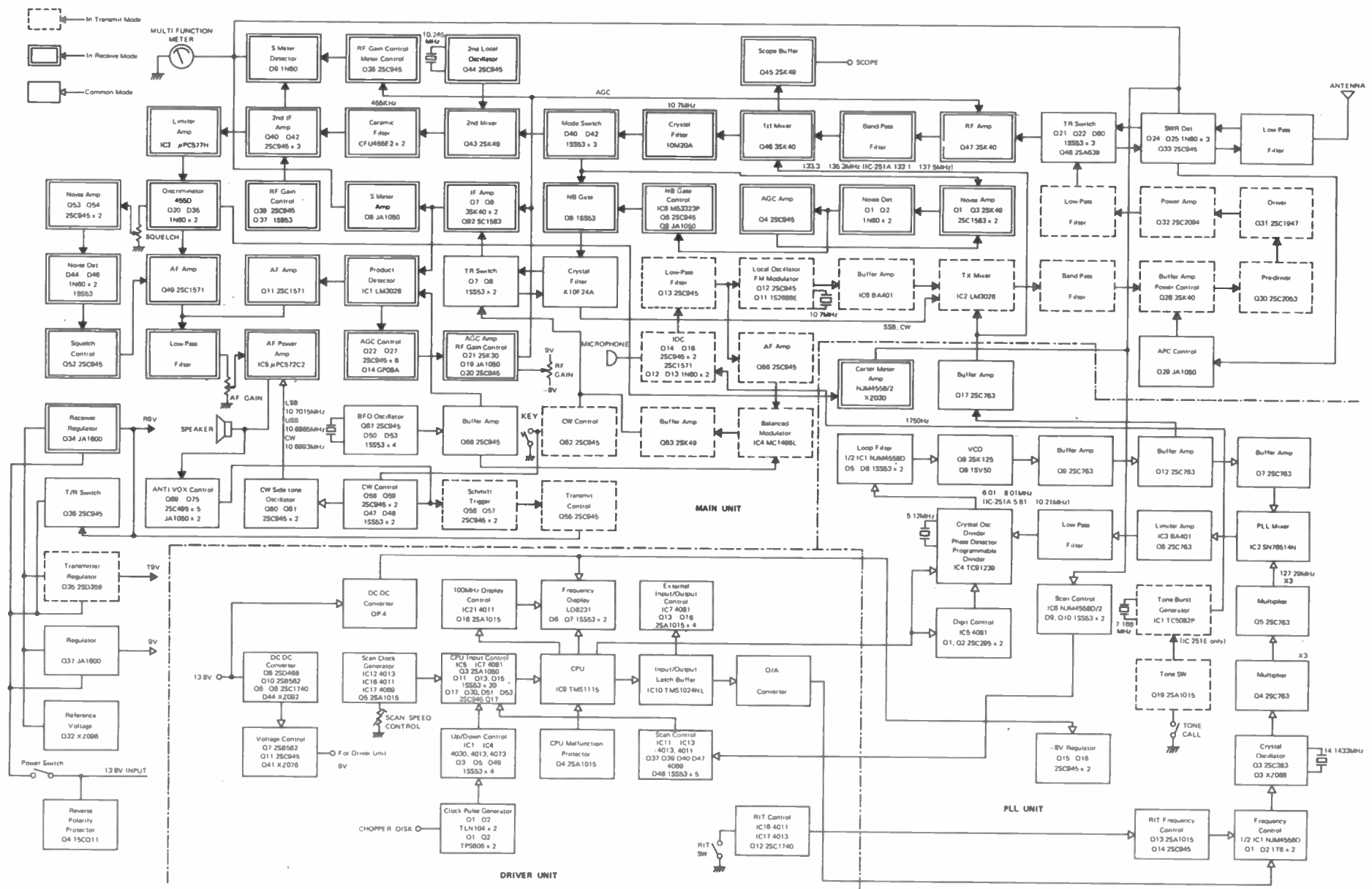

DRIVER UNIT

PLL UNIT

MAIN UNIT



## ICOM IC-251E + MUTEK BOARD

and you want to QSY in a hurry, we'd suggest switching to FM and doing it that way – it seems as though the control logic can't cope with anything other than a leisurely rotation of the knob and you'll find that if you tune any faster the digits don't change any more quickly – there's a sort of "optimum QSY speed" on this rig! Very weird. Tech Bod thought that a small adjustment to a couple of presets might have cured it, but the manual doesn't give any details on how to set the system up properly so we didn't try it. Thinks: must ask Thanet what the fix is for this.

Other than this problem, which was more disconcerting than anything else (OK, so we did have a pint at lunchtime – must speak to the landlord about the strength of his stock-in-trade) the rig's handling was delightful. We'd have liked to have a provision for switching off the AGC, and that was about the only moan we had.

**"It seemed quieter somehow. But as soon as a signal came up, the impression went clean out of the window"**

Overall impression at that stage was that the receiver seemed much like any well-bred multimode. There wasn't an opening at the time, nor a contest, but the beacons we could hear seemed about as strong as we'd expect and the signals we did hear sounded OK in the internal speaker. Next step was to try some contacts, and we spent a happy early evening nattering (and they call it work). Reports said that the audio was a bit woolly and hollow and also that the signal was more than a bit wide and ragged round the edges. We had the mic gain set at the recommended 12 o'clock position, but some chats and a test or three suggested that about 9 o'clock was about a million times better – in fact, the optimum setting turned out to be more like about 8.30. Reports then said that the signal was nice and narrow, and a couple of people commented that the audio was "punchy" although a bit muffled still. After a good few contacts, the overall impression was that the microphone supplied was letting the side down a bit, being a bit honky and edgy, but the RF side was excellent – no sprogs, whiskers or what-have-you. We've heard quite a few 251s in use on the band and we know what people mean. It would have been very interesting to try a different microphone but we didn't have a spare connector for the multi-pin socket on the 251 and anyway we know one guy locally who uses a Shure 444 with his 251 and it sounds absolutely superb, so we can rest

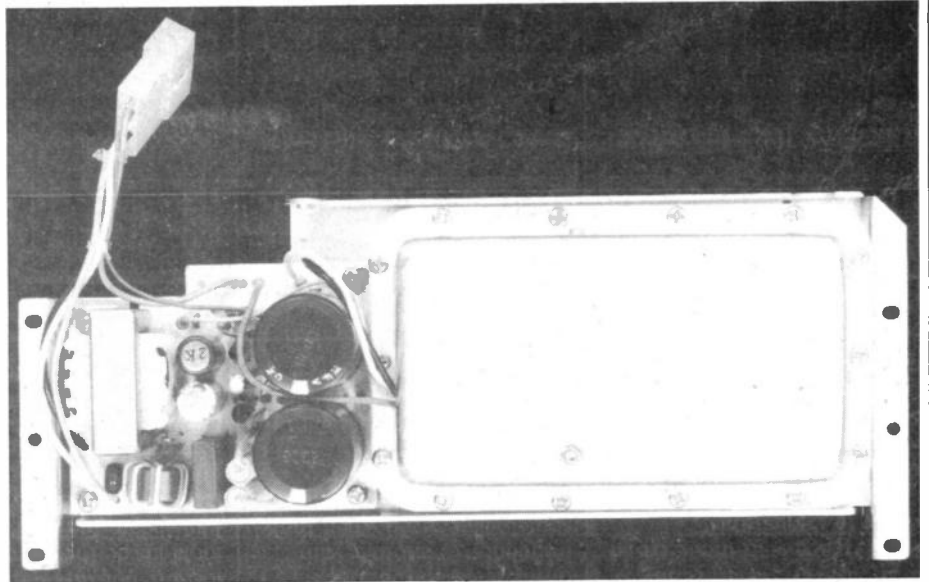

assured that the Icom microphone could do with changing.

We then tried some FM, and that worked out OK – the repeater access arrangements took a bit of getting used to and we cursed the manual "tone call" a couple of times as cumbersome. What happens is that the tuning speed button doubles as a tone burst switch, but it isn't automatic – you have to push the thing with your mit for about half a second to produce the 1750Hz Open Sesame. This was a bit boring, and if we bought a 251 we'd spend some time sussing out an auto-toneburst for it. Technical Bod did, in fact, but we didn't implement it since it would have meant attacking the innermost PCB inside the box and we didn't want Mr Thanet to beat us over the head when he got it back...

CW worked nicely, and tests with one of our locals suggested that the keying was delightfully clean and tidy, much better than yer average black box. We'd have liked a narrower CW filter, and we'd also have liked some sidetone – the 251 doesn't provide any, although it's easy enough to derive some. Presumably the manufacturers feel that SSB and FM are the main things that multimodes get used for so they stick the CW in as a bit of an afterthought to keep the cost down – it probably wouldn't be fair to kick them for it and they're things you can get round quite easily.

We spent a couple of days on and off, getting used to the 251E in its basic form and getting the feel for how it worked out. Then we couldn't restrain ourselves any longer, and it was time to plug in the Mutek-modded one and use it.

Oh wow, what a treat. The first impression was that in some funny way the receiver was deafer than the basic 251 – it seemed quieter somehow. But as soon as a signal came up, that impression went clean out of the window. The first signal we heard was a weak and watery guy up in Lancashire; conditions were quite flat at the time and there was the usual flutter and QSB but the signal-to-noise ratio seemed much better than on the first rig

*Power supply for the 251E. This is an AC supply built into the rig, and is a newly developed switching regulator system, providing a lightweight device and a high level of efficiency.*

and you just got the feeling that it was a lot more lively. We'd have given him about an S2 report on the Mutek rig. So we whipped the first one back and plugged the antenna in and you could immediately hear the difference – this time you really had to work for it, the signal was very much down in the noise and we were missing every third word. OK, he was workable but it would have been a struggle, whereas with Rig 2 it was all nice and simple.

This impression was reinforced as the evening went on and I felt that this 251 was even better than my own Mutek 221. Resolution No.1: bring it into the office tomorrow and try it. Which I did and it was by a whisker – and my 221 isn't exactly bad!

**The 144MHz Low Power Contest: "The results were remarkable"**

Anyhow, the next item of interest was the 144MHz Low Power Contest, and here again the results were remarkable. At one stage there was an S9 plus about a million dB local on 144.295MHz and another more than a little potent portable on a hill not a million miles away on 144.318 or thereabouts. Believe it or not, we worked G6LCL/P up in ZO square in between these two! It was hard going since he wasn't strong, but we made it – we couldn't quite believe it ourselves but we did. However, on Rig 1 (unmodded) there was just no way we would have known 'LCL was on the band, and this is very much the feeling I get with my 221 – it's the ability to work very close to strong signals without them causing the slightest problem. Rig 1 just didn't want to know, and the S meter registered a steady S4 or so all the way up and down the band. Intermod products, of

# ICOM IC-251E + MUTEK BOARD

course. Rig 2's S-meter, on the other hand, just sat at zero when there wasn't a signal and bounded up to S9 or whatever when there was.

By this stage Tech Dept was itching to give them the works, and reluctantly we handed 'em over. We had to hire some rather spiffing test gear for some of the measurements, but the results go something like this.

Basically, the Mutek board replaces the Icom front end amp and mixer with a proper changeover relay into a low-noise FET RF stage. This gets followed by something known as a "high-level" mixer, which in this case uses a ring of four diodes driven with a positively whopping amount of local oscillator injection, of the order of +7 or +8dBm. This is the chief reason for the ability to hear G6LCL/P amongst the locals! After that you get another nice amplifier stage and then a "roofing" filter which keeps any unwanted nasties from getting further down the IF chain and doing all sorts of no good. There's another amplifier after that to get the signal level right for the rest of the wireless.

**"The Mutek board replaces the Icom front end amp and mixer with a proper changeover relay into a low noise FET RF stage"**

Half the battle with diode mixers is making sure that they see the right impedances at certain points, and the Mutek board does this supremely well. In fact, the whole job is very purposefully engineered and a triumph of the RF designer's art.

As far as the figures go, the noise figure of Rig 1 panned out at just over 6dB, whereas the Muteked Rig 2 turned in a figure of just less than 2dB – it was extremely difficult to measure accurately and we'd say it's of the order of 1.7dB. This

couldn't be better because it means that the sensitivity of the rig is limited by the amount of external noise coming in from the solar system and whatnot. A preamp would do precisely *nothing* to improve it unless it was at the top of the mast and had just enough gain to overcome the loss in the feeder which you have to add to the receiver noise figure to get the overall system noise figure. To put it another way, you can hear the effect when you point our antenna at the setting sun! You simply couldn't use any more sensitivity. The image rejection on Rig 1 was -39dB, whereas on Rig 2 it was about -70dB; splendid, and no chance here of PMR or what-have-you getting in and spoiling things.

In signal handling, the Muteked rig was in a class of its own. The classical third-order intercept came out as a mighty +8dBm and the figure for "gain compression" (which defines the point at which a strong signal elsewhere in the band is going to affect the weak DX you're trying to listen to) was amazingly high. If you stuck in a level of -70dBm on 144.300MHz, which is pretty weak, and then smashed in another signal on 144.350MHz, you had to crank that one up no less than 110dB more in order to bring the gain of the receiver down by 3dB on the 144.300MHz signal. We didn't quite believe this and used two highly expensive Marconi generators and a number or precision attenuators and whatnot to measure it, but it really is so. Tech Dept hasn't yet recovered from the shock, or the bill... (You really are a brick short of a load, aren't you? What about my profitability? – MD).

We thought that with this order of performance we'd better have a good look at the synthesiser – synthesiser noise isn't usually a problem as such because it's masked by shortcomings in the front end but having got rid of *those* it was the next obvious step. The general PLL noise from the synth in the 251E was very low and in fact it was about 2dB quieter on Rig 1 than in Rig 2 – not that it matters. In fact the 251E has the quietest synth of any rig we've seen so far, and with such good performance from the front end that's just as well. It means that the synthesiser doesn't let the side down and gives a much better figure for reciprocal mixing than you usually find. It's extremely difficult to measure at this level and we're not absolutely sure of

our figures so we won't quote them as such – the performance is just extremely good and reciprocal mixing is very unlikely to prove a problem with this little lot.

The transmit side checked out fine, with both rigs turning in a third-order IM performance of -27dB below one tone of two at a level to give 10 watts pep. This is pretty good third-order performance, and the higher orders were just fine as well. The third harmonic was at -66dB, which is good, and carrier suppression on SSB clocked in at -60dB, which is superb. Same figures on both rigs, by the way. Other sprogs were in the noise floor of the analyser at about -75dB, so they ain't gonna worry man nor beast.

What's the final verdict? Well, we devoutly hope that you don't think either Thanet or Mutek are giving us a backhander for every rig they sell 'cos they're not, but this combination is far and away the best performance we've ever seen commercially available for 144MHz.

**"General PLL noise from the synthesiser has the quietest synth of any rig we've seen so far"**

For the keen weak-signal merchant, there's just no way we can see this order of performance ever being improved on, and indeed we can't see any real necessity – it really is a superb instrument. Leaving aside the odd niggles we've mentioned, the heart of the rig is very much in the right place and one thing is for sure – if you use one of these from a good site in a contest, you're going to be very hard indeed to beat.

We feel that the Icom 251E with the Mutek board will do for 144MHz DX work what the Audi Quattro does for car rallying, and as far as we're concerned it has to be the standard by which all 144MHz transceivers are judged from here on in. And isn't it nice that Britain leads the world in something for a change? We're just wondering what either Mr Icom or Mr Bartram are going to do for an encore...!

*The Mutek front end board for the 251E. Neat, well put together and it looks good from all angles.*

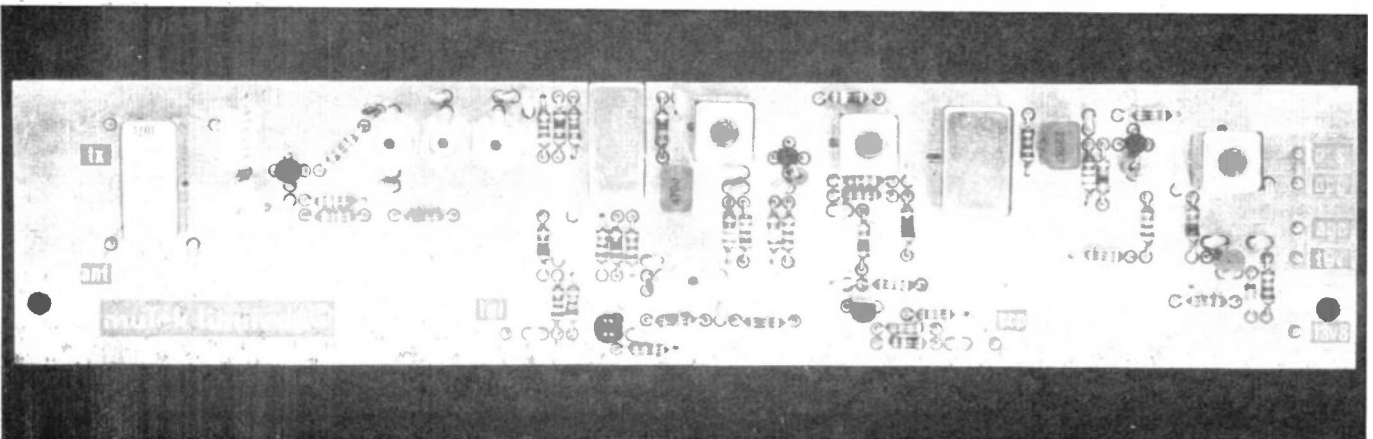

# NOT ONLY, BUT ALSO...

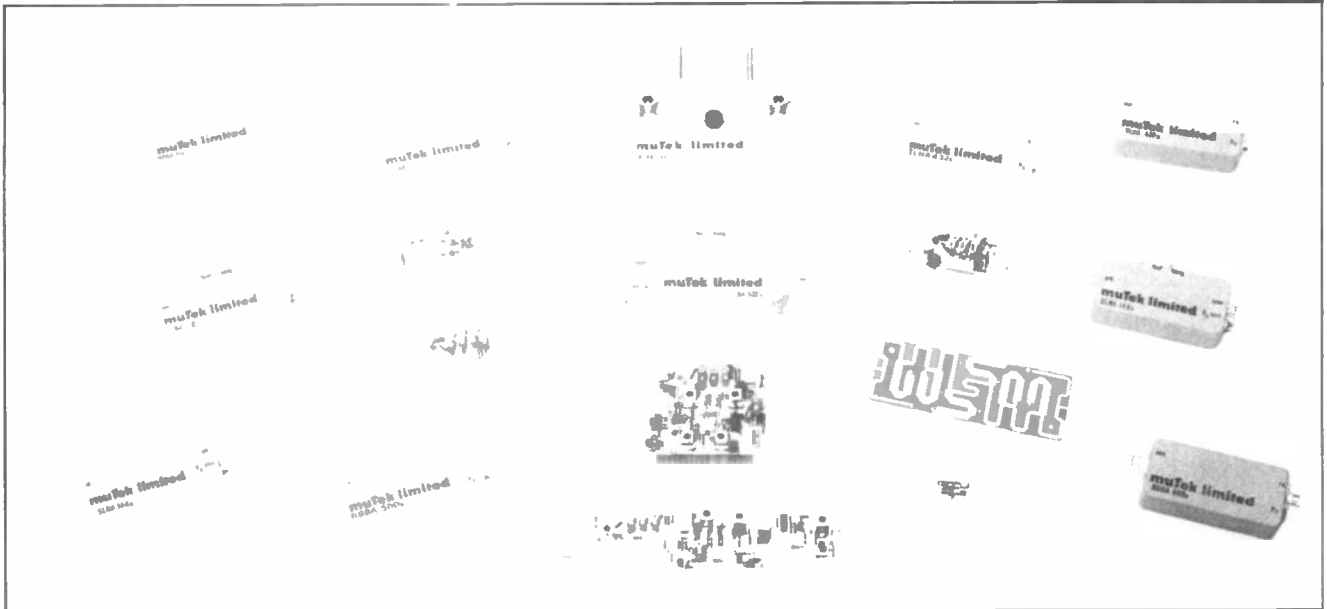

OK, so you know a bit about muTek limited's front-end boards for the IC251 and FT225. You may even have heard a little about our peramplifiers for all amateur vhf bands from 50 through to 1296MHz. But why should you buy our products rather than those of our competitors?

muTek products aren't cheap. They couldn't be. However they represent some of the best value for money around. The difference starts at the design stage with a thorough appraisal of both the systems requirements of our customers and the circuit design options open to us. We don't (like some of our competitors!) simply rush to the nearest amateur publication and rip-off a 'design' which looks as though it will do the job!

Once we've set our design objectives we then produce a design which is thoroughly analysed using various computer-aided approaches to determine whether it's even worth picking-up a soldering iron to try it in practice. If it is we usually will build a breadboard to check it through and then proceed to pcb design. We use a 'cut and strip' drafting machine to prepare our pc masters as this allows us to produce accurate microwave and other boards in prototype form 'in house' with greater accuracy than other techniques would allow. This is probably more important for our non-amateur radio business but perhaps it illustrates the care which we take in the production of amateur radio products. We've always felt that the manufacture of amateur radio products deserves at least as much involvement as our professional interests. Indeed, its more difficult to manufacture high quality

amateur radio gear within the price constraints without sacrificing quality!

The attention to detail in the design process is carried on to production. Some of the measurements which we make routinely are very difficult. Noise figure for instance is a parameter which many quote and very few can measure! We specialise in low noise amplifier design and we've spent many happy hours (and a lot of money) refining our measurements. Without a very great deal of care its really quite easy to have a 1 dB uncertainty even using apparently high quality test equipment. With sub-dB noise figures a reality on all bands up to 2.3GHz its clearly a nonsense to quote noise figures of this order if the uncertainties are greater than the figure being measured!

As an example of the care we take, our GFBA 144e masthead preamplifier not only sees our noise figure measurement system (which is based on a HP346B 0.01-18GHz noise source) but also an HP141 T/8555A/8552B 18GHz spectrum analyser system to check for broadband instabilities, and in conjunction with a high-level two-tone test source for intermodulation measurements. The filter is set-up separately with a Telonic sweeper and reflection bridges whilst the power handling capabilities are checked by dumping the output of a willing pair of 8874's via the amplifier into a 1.5kW Termaline!

We care a great deal about the quality of the products leaving our factory and have spent a great deal of time and money making sure that we can substantiate the claims we make. That's why you should buy muTek.

## THE RANGE

		Price£
SLNA 50s	50MHz low noise switched preamplifier using BF981	37.10
SLNA 70s	70MHz low noise switched preamplifier using 8F981	37.10
SLNA 70u	70MHz low noise unswitched preamplifier using 8F981	22.40
SLNA70ub	Unboxed version of SLNA 70u	13.70
SLNA 144s	144MHz low noise switched preamplifier using BF981 (0.9dB noise figure)	37.10
SLNA 144u	144MHz low noise unswitched preamplifier using BF981	22.40
SLNA 144ub	Unboxed version of SLNA 144u	13.70
SLNA 145sb	Transceiver optimised preamplifier with antenna c/o switching using BF981. Intended for the FT290R, but has many other applications	27.40
GFBA 144e	Ultra-high performance environmentally housed switched gasfet preamplifier using advanced negative feedback circuitry for superb dynamic performance. Supplied with ATCS 144s controller.	129.90
TLNA 432s	Very high performance bipolar transistor switched preamplifier for 430-440MHz using BFQ69 for 1.4dBm and 0dBm input intercept performance.	74.90
TLNA 432u	Unswitched boxed variant of TLNA 432s	29.00
TLNA 432ub	Unboxed TLNA 432u	20.40

All prices include 15%VAT

GLNA 432u	Series 432 MHz gasfet unswitched preamplifiers - please ring.	
BLNA 432ub	Sub-miniature 1.3dBm BFQ69 preamplifier	13.70
BLNA 1296ub	Noise matched NE64535 1.3GHz Ina	26.90
RPCB 144ub	Complete replacement front-end for the FT221 and FT225	71.00
RPCB 251ub	Complete replacement front-end for the IC211 and IC251	76.90
HDRA 95u-1	1.5dBm/8.5dB gain high dynamic range 88-108MHz preamplifier	32.90
HDRA 95u-2	11.5dB gain variant	32.90
BBBA 500u	20-500MHz broadband high dynamic range preamplifier	29.00
BBBA 860u	250-860MHz broadband low noise amplifier	22.60
XBPF 700ub	Microstripline band pass tvi filter	2.95
PPSU 012	12V (nominal) mains psu for HDRA95 & 888A860	6.90
CISA 001	'UHF'(f) to BNC(m) coaxial adaptor	1.60
ATCS 144s	Transmit receive changeover sequence and controller	22.60
Carriage/Postage Rates		
GFBA 144e		2.50
All other products above		1.20

## muTek limited

— the rf technology company



Bradworthy, Holsworthy, Devon EX22 7TU (0409 24) 543

# · E-TYPE ·

# · PROPAGATION ·

What is sporadic-E? When does it happen? And how  
can you make best use of it?

Julian Moss, B.Sc., G4ILO, explains all.

It was a hot, sunny afternoon in July, 1974. A newly-licensed radio amateur sat in his shack, drinking a cup of tea and idly tuning the 2-metre band. It was very quiet. Suddenly, he noticed a strong SSB signal. He switched on the BFO.

**"HG5AIR calling CQ DX. This is HG5AIR, the Radio Club of Bucharest Airport, calling CQ..."**

It must be 10 metre IF breakthrough, he thought, disconnecting the power to the 2-metre converter to check. The Hungarian station disappeared. When he reconnected the power, the HG5 was still there, still calling CQ!

So he must be on 2 metres! As if to confirm this, the Hungarian went back to an inaudible G8 station, mobile on the M6. Then he called CQ again. Hands shaking with excitement, the amateur selected a frequency close to the DX station and called him. But with only four crystal-controlled channels of FM, he was at a severe disadvantage, and though he called several times, he had no luck.

This was how G4ILO (then G8ILO) first experienced **sporadic-E propagation**. It convinced him that SSB was the mode to use if you wanted to work DX, and some sideband gear was soon acquired. But so elusive are sporadic-E openings, particularly to those who are normally at work during the day, that it was four years before G8ILO was once again in the shack, tuning the band, when a strong station with a thick foreign accent was heard calling CQ.

So what exactly is sporadic-E? Basically, it is long-distance propagation caused when clouds of ionised particles form at an altitude of about 110 miles up in the E-layer of the ionosphere, causing radio waves which hit them to be bent back to earth. The conditions which cause these clouds to form generally occur between mid-morning and late afternoon during the season May to August.

The signals are not reflected off these

ionised clouds, as you might think, but *refracted*. Some readers may remember from school physics how a beam of white light entering a glass prism is refracted into its different colours. Red light (the lowest frequency of visible light) is bent the most by the prism, while violet light (the highest frequency) is bent the least. Intermediate colours are bent by varying amounts so that the light leaving the prism is split up into all the colours of the spectrum.

**"A strongly ionised cloud will bend the signals through a sharper angle..."**

The same principle applies to radio waves in a sporadic-E cloud. Low frequencies are bent through a greater angle than high frequencies. The stronger the ionisation, the greater the bending of the waves. So a weakly ionised cloud may cause 10 metre and 90MHz FM Band 2 signals to be bent back to earth (Fig 1a), while a 144MHz signal is hardly affected, and passes through and out into space. A strongly ionised cloud (Fig 1b) will bend the signals through a sharper angle, so that they reach the ground nearer to the transmitter, while even a 144MHz signal is refracted back to earth.

The distance between the transmitter and the receiver of the refracted signal is called the skip distance. On HF, where refraction of signals by higher layers of the ionosphere cause longer distance propagation, sporadic-E type conditions are often referred to as 'short skip'. Keen sporadic-E watchers will monitor the 10 metre band, taking note of the locations of stations heard, knowing that the shorter the skip, the stronger the E-layer ionisation and the greater the chance of propagation extending to VHF.

Many VHF DXers also monitor Band 2 FM. Propagation must extend to 90MHz before it can reach 2 metres, although it is possible for DX to be coming in on Two when nothing is heard on Band 2, if the sporadic-E is from a direction where there are few FM broadcast stations. Eastern Europe, for example, tends to use the band 68-88MHz for FM broadcasting.

Because it requires a higher level of ionisation to achieve propagation at higher frequencies, sporadic-E openings are less frequent and of shorter duration on 2 metres than on the lower bands. During the season, there may be openings nearly every day on 10m, while at the other extreme, sporadic-E is probably non-existent at 70cm. The graph in Fig 2 shows the probability of propagation occurring at 90MHz for days throughout the season. The most likely time for an opening is around the second week in June, when there is about a 60% chance of DX being heard at some time during the day.

On 144MHz, openings are about one-fifth as likely to occur, which means, taking an average over the whole month, that there are likely to be no more than four openings on 2 metres during June. Since some 2 metre openings may last for only a few minutes, and since they usually occur between about mid-morning and late afternoon, it is easy to see why most people find them somewhat elusive.

So what is the attraction of this mode of propagation? On 2 metres, the shortest skip encountered is about 1200km (anything shorter than this is probably tropospheric propagation) while the maximum distance workable is something approaching 2400km. In other words, it is possible to work stations over distances which could normally only be accomplished using meteor-scatter. The map in Fig.3 illustrates the area workable from central England via sporadic-E; it covers Scandinavia, eastern Europe and western USSR, Italy, most of the Mediterranean, southern Spain, Portugal and north Africa.



**Fig 1: Refraction of radio signals by sporadic-E cloud.**

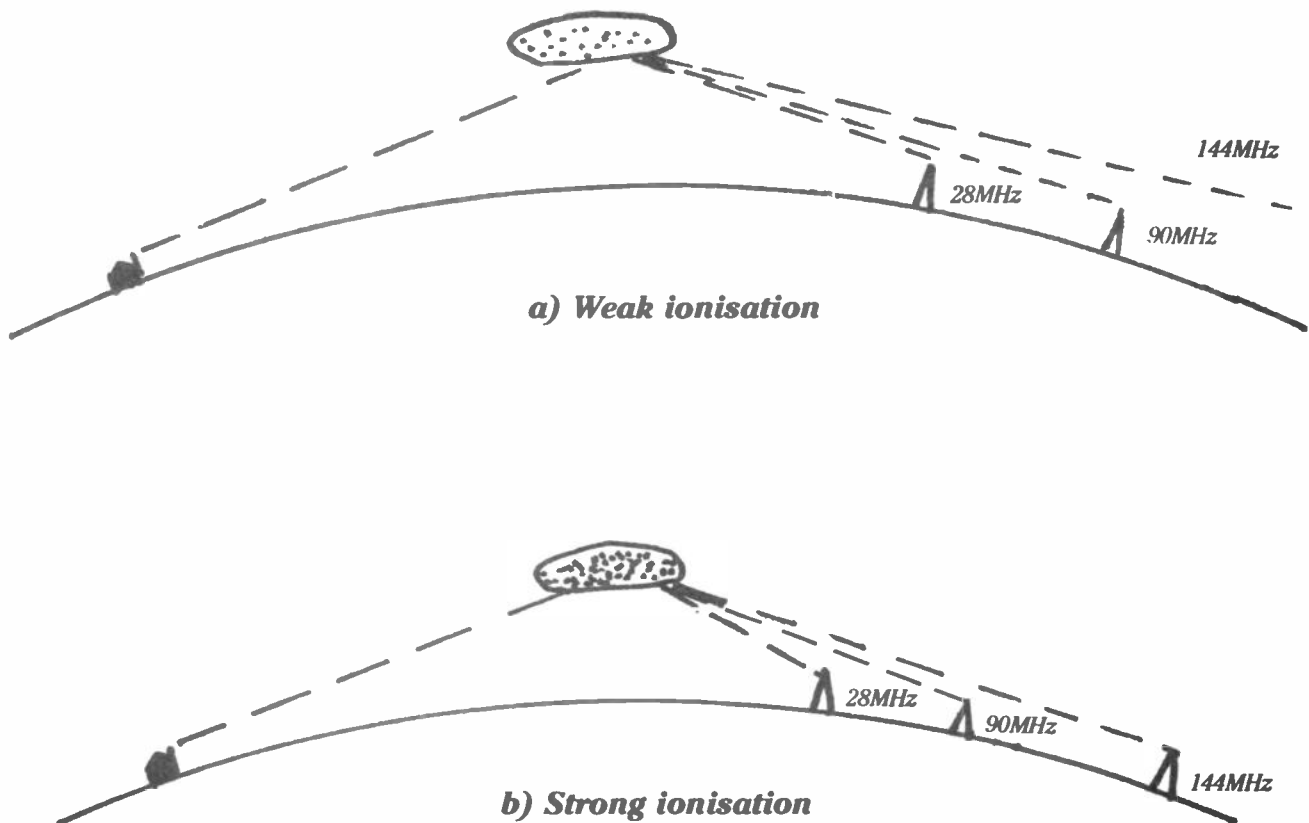

However, what is characteristic of sporadic-E propagation is the strength of the signals, particularly over the shorter distances. There is no searching for weak CW signals down in the noise. For many stations, the first warning that an opening is taking place has been when the local station they have been talking to is suddenly blotted out by someone jabbering away in a foreign language at S9 plus! And it is not uncommon for someone using a barefoot FT290 into a whip antenna to work into the Mediterranean area with good reports both ways.

Obviously, a major factor contributing

to success in making sporadic-E contacts is luck, particularly luck in being on the band at the right time. However, the level of interest now shown by amateurs in working DX on 2 metres is such that word of an opening soon spreads, and within a few minutes QRM levels can be very high indeed! Sporadic-E signals are subject to sudden, irregular fading, and it is quite common for an S9 station to suddenly vanish for good, as if his rig just blew up! So as well as luck, good operating technique aimed at completing the contact in as short a time as possible is very important.

The information exchanged should be

simple; callsign, signal report and QRA locator. Keep it short, don't repeat anything unnecessarily, give each item of information no more than twice, once in plain letters and once using standard phonetics. Do not make the common mistake of giving names, equipment details and so on; this simply wastes time, conditions may change at any moment, and the DX operator may have limited English and have trouble understanding you anyway. Remember also, in your excitement, not to speak too fast!

# · E-TYPE · PROPAGATION ·

Unless you have high power and a big antenna, it is probably not profitable to sit on one frequency calling CQ. Tuning the band will enable you to get a better picture of what DX is coming in, and you may be lucky and beat a pile-up by catching a DX station making his first CQ call. Pile-ups can become very heavy, and the DX station may well ask for you to call him a few kHz up or down in frequency, or he may tune a little either side of his transmit frequency anyway in an attempt to resolve something out of the cacophony of calling stations.

**“Low power can still produce good reports at distances of over 1000km, and this is equally true of FM, given a clear channel.”**

Rigs with multiple memories really come into their own during a sporadic-E opening. Frequencies on which a DX station has been heard, or where there is a large pile-up, can be memorised and then checked periodically, so that you can tune the band while awaiting your chance to call a station.

## DX on FM via E

Although the majority of sporadic-E contacts are on SSB or CW, there is no reason why DX cannot be worked via this mode of propagation using FM. As has already been mentioned, low power can still produce good reports at distances of over 1000km, and this is equally true of FM, given a clear channel.

FM operators tend to be less DX-minded than those on sideband, and it may be difficult to break into a QSO in a foreign language or even to catch the call signs, as the author found one summer when he heard a couple of Spanish-speaking stations on 145.00MHz. However, it is worth remembering that many of the countries within range of the UK via sporadic-E, particularly north Africa, have few high-power SSB stations on VHF, and so if propagation favours that particular direction then it is quite likely that the only activity will be found on FM.

Being in the shack at the time of an opening is the major difficulty for most amateurs, because the conditions are so unpredictable. A nationwide telephone warning net exists for keen DXers, but to become a member requires a large degree of dedication, and a guarantee that someone will always be available to answer the

phone, so that news of an opening is passed on to the next people in the chain. Groups of friends, or a radio club, could of course set up their own sporadic-E alert system, perhaps using a local repeater to warn those listening. This would be ideal for mobiles with multimode rigs in the car, who could then drive to a hill-top and be in an ideal position to work the DX.

In spite of recent advances in knowledge about the ionosphere, little is yet known about how sporadic-E is formed, and as a result, it is impossible to predict when openings will occur. Amateurs can assist research into this phenomena by reporting details of contacts made via sporadic-E. In fact, details of any DX heard, including non-amateur transmissions on other VHF bands, is equally useful, so this is an area where listeners may also make a contribution. Report sheets (Fig 4) are available from the Propagation Studies Committee of the RSGB, and these should be used so that the information is presented in a standard format. This information is ultimately sent to F8SH, who co-ordinates the data for the whole of IARU Region 1. It is hoped that eventually this information, in conjunction with other data, will help to find an explanation of what causes these mysterious sporadic-E clouds to form.

In the meantime, amateurs can look forward to another exciting season of sporadic-E DX. Good hunting!

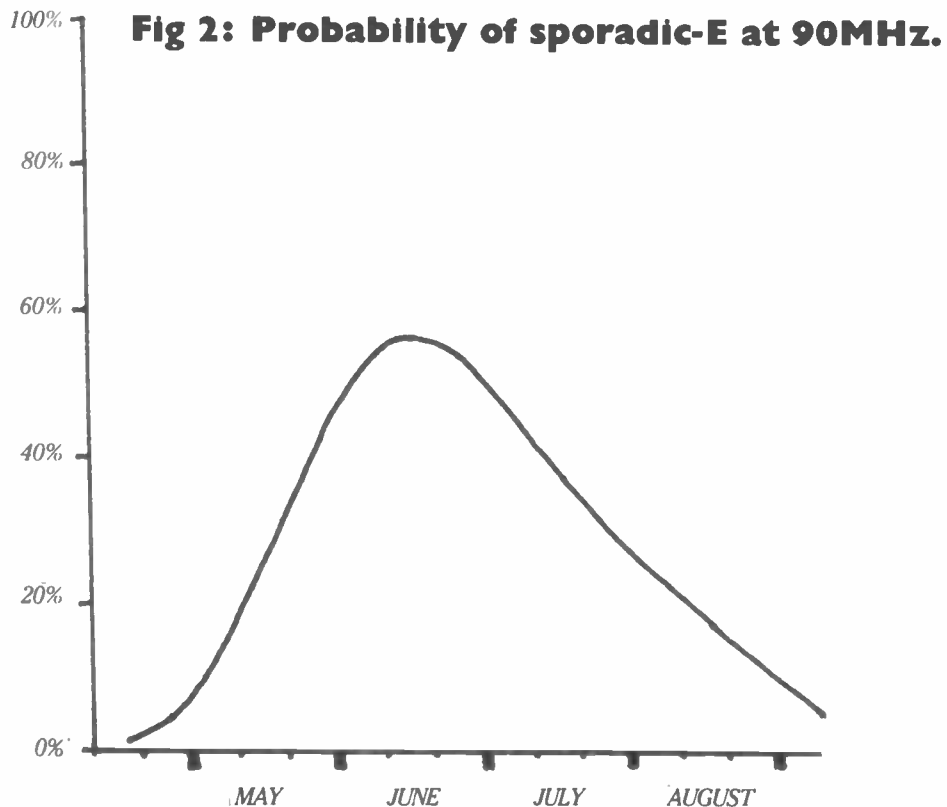



**Fig 3: Map showing the area workable via sporadic-E from the UK.**

As you can see, a large area is workable from the United Kingdom, with favourable sporadic-E conditions. Many of these countries (especially north Africa) have few high-power SSB stations on VHF, so the majority of the activity will be found on FM. On the other hand, as a rule, FM operators tend to be less DX-minded than those on SSB. Sporadic-E conditions are unpredictable in the extreme, although on the opposite page we provide a "probability scale" that shows July and August to be getting a fair share of the action.

### What causes sporadic-E - current theories

For many years it has been thought that sporadic-E is caused by a phenomena called 'wind shear'. Certain conditions in the upper atmosphere result in winds moving at high speed in different directions. Static electricity is generated where two winds meet, and this produces ionisation, which forms into clouds at a height of about 110km.

Like the high-altitude winds that cause them, these clouds move at a speed of about 100km/hour, generally drifting towards the Equator, with the result that propagation tends to favour one area only for a short time, and as some stations fade out others will fade in.

What puzzles geophysicists is what causes these wind shears to develop? It has been suggested that they are caused by violent thunderstorms, and statistical evidence does seem to show some relationship between storms and occurrences of sporadic-E, although no convincing explanation as to how storms could cause wind shears to occur has yet been found.

The writer has noticed that 2 metres has a characteristic sound to it when sporadic-E is about. The normally quiet band is buzzing with static, which could be the noise of distant storms, reflected back to earth by the abnormally high levels of ionisation.

# Than E.T.

## YOU'LL MEET THE MOST INTERESTING PEOPLE

### IC-720A



The main problem that the amateur of today has to deal with is deciding just which rig out of the many excellent products available he is going to choose. Technology is advancing at such a rapid rate that many cannot hope to keep up. Some go too far!

Perhaps one way of dealing with the problem is to look at just what each model offers in its basic form without having to lay out even more hard earned cash on "extras". The IC-720A scores very highly when looked at in this light. How many of its competitors have two VFOs as standard or a memory which can be recalled, even when on a different band to the one in use, and result in instant returning AND BANDCHANGING of the transceiver? How many include a really excellent general coverage receiver covering all the way from 100KHz to 30MHz (with provision to transmit there also if you have the correct licence)? How many need no tuning or loading whatsoever and take great care of your PA, should you have a rotten antenna, by cutting the power back to the safe level? How many have an automatic RIT which cancels itself when the main tuning dial is moved? How many will run full power out for long periods without getting hot enough to boil an egg? How many have band data output to automatically change bands on a solid state linear AND an automatic antenna tuner unit when you are able to add these to your station?

Well you will have to do quite a bit of hunting through the pages of this magazine to find anything to approach the IC-720A. It may be just a little more expensive than some of the others – but when you remember just how good it is, and of course the excellent reputation for keeping their secondhand value you will see why your choice will have to be an IC-720A!

### trap dipole £49.50.inc.

The MT-240X Multi-band trap dipole antenna (80m – 10m) is a superbly constructed antenna with its own Balun incorporated in the centre insulator with an SO239 connector. Separate elements of multi-stranded heavy duty copper wire are used for 80-40-15 and 20-10 Metres. Really one up on its competitors

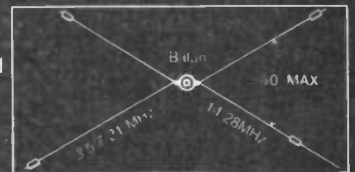

### IC-730



ICOM's answer to your HF mobile problems – the IC-730. This new 80m–10m, 8 band transceiver offers 100W output on SSB, AM and CW. Outstanding receiver performance is achieved by an up-conversion system using a high IF of 39MHz offering excellent image and IF interference rejection, high sensitivity and above all, wide dynamic range. Built in Pass Band Shift allows you to continuously adjust the centre frequency of the IF pass band virtually eliminating close channel interference. Dual VFO's with 10Hz, 100Hz and 1KHz steps allows effortless tuning and what's more a memory is provided for one channel per hand. Further convenience circuits are provided such as Noise Blanker, Vox, CW Monitor APC and SWR Detector to name a few. A built in Speech Processor boosts talk power on transmit and a switchable RF Pre-Amp is a boon on today's crowded bands. Full metering WWV reception and connections for transverter and linear control almost completes the IC-730's impressive facilities.

Thanet ICOM Thanet ICOM Thanet ICOM Thanet ICOM Thanet ICOM Thanet ICOM Thanet ICOM







# TWO MULTIMODE MOBILES

The TR9130 is the very latest multimode rig in a long line of two metre mobile transceivers, the earliest of which was the TS700. The 700G followed with minor improvements, and then the TR700S, partly redesigned, incorporating digital readout.

All these early Trio rigs had conventional VFOs, and tuned in 1MHz wide lumps. They all had 11 crystal-controlled positions as well as VFO, with FM, AM, upper and lower SSB and CW. All the units could be operated directly off 240v AC or 13v DC by using the appropriate power lead, and all had (usefully) a bevy of phono sockets and jacks on the rear for many interconnections with external equipment, including ALC input, a short on TX socket to operate relays, etc, etc.

The first Trio multimode rig designed as a new concept was the TR9000, introduced as a 13v DC mobile rig with optional accessories, including memory backup unit/controller and mains PSU. In the new concept, Trio abandoned the continuously tunable VFO for the stepped synthesiser, providing 25, 12.5 and 100Hz steps on FM, and 100Hz steps on SSB and CW. They also abandoned the AM facility, and the tuning knob rotated in well-defined click steps. The TR900 gave a nominal output of 10w FM and SSB and had quite good overall quality with a reasonably sharp IF on FM for 12.5kHz channelling.

Trio gained much experience in the expanding market world-wide in finding

Take two of the most popular Trio all-mode mobile transceivers available, wire them up to equipment capable of giving the most accurate readings, and decide, following extensive electronic and handling tests, which one is the better of the two. Here, Angus McKenzie, G3OSS, reviews the Trio TR-9500 and TR-9130.

out more about market requirements, and continued their policy of introducing different versions of each of the models for different markets, so that a unit purchased in Japan (or the States) might have to be very extensively modified in order to cope completely satisfactorily with Western Europe standards. The TR9130 was introduced as the result of all this market surveying, but some time before this Trio had introduced their first 70cm-only multimode rig, also operating on 13vdc.

To complete the picture, it is worth mentioning that two other important Trio rigs have been introduced in a number of successive versions, the TS770 followed by the TS780, both incorporating 2m and 70cm, being more like much-modernised versions of the old 700 series than bearing any resemblance at all to the 9000 series.

## TR9130 2m mobile multimode

**Facilities and operation:** This rig is primarily designed for mobile use, being supplied with a mounting bracket. It is capable of delivering at least 25w FM, SSB or CW into 50ohms. Frequency selection is either from a tuning knob rotating in click steps, from any of six memories, or sweeping/scanning.

Two FM positions are provided, FM1 having 25kHz steps and FM11 having 12.5kHz, or 1kHz steps, choice being made with the DS switch which appropriately alters the green fluorescent digital display resolution and the steps. On upper and lower SSB, and on CW, steps are switchable to 100Hz or 5kHz.

Buttons select memory write, noise blanker on/off, VFO A or B and RIT on/off, memory recall, scan start, scan stop, tone burst on/off and reverse repeater (spring-loaded for RX only). RF and AF receiver gain controls are complemented by a squelch control which usefully operates on SSB as well as FM. Switches select any of six memories (the sixth can have independent RX and TX frequencies on FM) repeater plus/minus 600kHz shift/simplex, and high or low power (as normally supplied the rig can be switched only to low power on FM and CW, SSB output PEP remaining unchanged). However, if R188 is cut at one end, which can be seen underneath the main chassis once you take off the bottom cover 1mm behind

connector J33, SSB max PEP is also reduced, which is extremely useful if you wish to use a transistorised linear amplifier and avoid overdriving it. The low power output preset is VR3, which is at the back of the rig underneath the top cover.

The receive incremental tuning (RIT) can alter frequency continuously from - to +800mHz nominal, which is most useful if somebody is halfway between steps. Scanning can be selected either by pressing the scan button on the rig (holding this in increases scanning rate), or by using the up and down buttons on the mic. Scanning continues automatically if the squelch control is turned sufficiently to cause squelch action and scanning stops when a station is found, but restarts when the station switches off. The scan stop button always reverts the rig to normal VFO or fixed memory channel operation.

**“For SSB you can operate a linear PTT line by interposing a small reed relay . . .”**

On the rear panel are sockets for interconnecting an 8ohm extension speaker and a Morse key (both 3.5mm jacks). An auxiliary socket provides interconnections for earth, ALC input, output 9vdc on TX and 8vdc when FM is selected, this socket being useful for operating external linears. For SSB, you can operate a linear PTT line by interposing a small reed relay on the 9v pin and earth, which will save the dreadful RF vox sensing hiccupping and dropping out syndrome. Lowe Electronics, the official importers, will be pleased to assist Trio users in further interface details.

**Subjective comments:** I purchased this rig in late 1982, having sold my old TR9000, and I am quite convinced that the 9130 showed ergonomic and technical improvements. Optional extras include a

memory backup/MOX operation unit and a mains PSU. Internal short term memory backup can be provided with a PP3 equivalent Nicad battery, a holder for which is included, together with fitting instructions in the manual. Backup requires 2mA incidentally.

At this point I must criticise the extremely vague instruction book supplied, which gives no idea of where to find pre-sets that so many users will want to adjust, including, for example, output power in the low power position, tone burst duration (it was rather short), and mic gain. A very comprehensive service book is available, at an additional cost, whereas most other manufacturers include much service information in the normal instruction book.

The transmit quality on SSB was generally considered quite reasonable, and no criticisms of poor quality were made by listeners. FM transmit quality was adequate, but a little lacking at HF, and also slightly coloured. On receive, as supplied and originally tested, the rig was thought

slightly insensitive on FM, and was a little disappointing on SSB, although an external pre-amp in a linear brought up sensitivity well.

Receive quality was very good on all modes, and particularly good was the ability to cope with 12.5kHz channels without adjacent channel interference, many now being used more and more in the London area to gain more channels. It was useful to have 25w barefoot, although a loud mouth is not much use without better ears! The choice of 100Hz and 5kHz steps on SSB was not adequate, and I would have preferred an additional 1kHz step function in this mode, although scanning was most effective in 1kHz steps, at 10kHz per sec.

Memory and FM scanning functions worked excellently, and the microphone was easy to use, the up and down buttons pipping when touched, or making a continuous tone when held down as a reminder. It was extremely useful to have two completely separate selectable VFOs, and

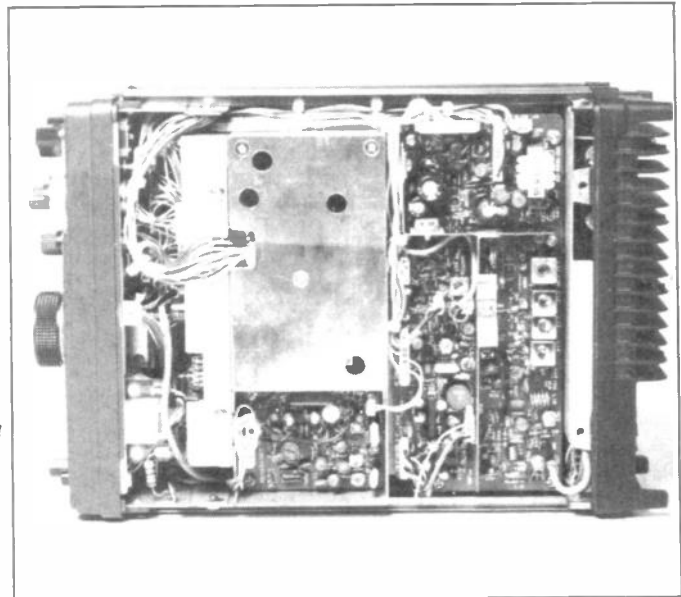

*Top left: the two wirelasses. Below: A close-up of the fascia of the TR9130 radio. Right: Topside of the Trio TR9130 looking jolly clever and complicated. And they call it wireless!!*



## TWO MULTIMODE MOBILES

I normally set one on the SSB calling channel, with the other on a local natter channel for FM. CW keying seemed satisfactory, and rather better than on my old 9000. A metal bar foot can be inserted into two holes underneath the rig to raise the front, thus improving the audio quality from the loudspeaker which is underneath. The antenna socket, incidentally, is an S0239 with a conventional thread.

**Lab results:** The receive sensitivity on FM was not good as delivered, but improved by 2dB after very careful alignment internally with much lab equipment being used. SSB sensitivity was disappointing, and could not be substantially improved. FM selectivity was excellent at 25kHz spacing and on one side of the adjacent channel, whilst the other side was just fairly good. SSB selectivity was excellent. RFIM measured very well, and much better than most other black boxes that I have checked on this band.

As usual with so many Japanese-designed black boxes, the S meter had a very narrow range, S1 on FM and SSB being only just under 1uV, whilst S9 was around 5uV. 2dB per S point is rather far from the original recommendation of around 5dB so many years ago. Audio distortion in the discriminator was rather high for 4kHz deviation, but we improved this by tweaking.

**“...working this rig quite hard for some months, not a single fault has developed, which is credit to Trio...”**

The distortion of the product detector though, was much better on SSB and CW, and the characteristics of the AGC quite well liked, although I would have preferred very much more IF gain on SSB. If you want to take matters seriously on SSB, you will undoubtedly need an external pre-amp, which will of course, increase the system gain, and bring up weak signals to similar audio levels as strong ones. The maximum audio output into 8ohms was quite adequate, and the built-in speaker was reasonably efficient, so a reasonable volume can be obtained under mobile conditions without distortion. It is worth noting that the current drawn on receive with squelch operative was rather high, so don't forget to turn the rig off, otherwise you will flatten the battery over a weekend.

On FM, the transmitter exceeded the specified minimum power with a good margin, low power being a fifth of high power. I cannot understand why the rig is normally supplied such that power cannot

be reduced on SSB, but the modification is simple. Well over 30w PEP output was available on SSB, which is a useful power for mobile working. Transmit frequencies were all just 200Hz high across the band, and the repeater shift was amazingly accurate. Harmonic outputs were at very low levels which should not disturb anybody. DC current drawn on TX showed reasonable efficiency on high power, but was of course, not good on low power, although this does not really matter unless you are working off a battery without the engine running. Using the new Marconi deviation meter, type 2305, I was a bit surprised that the FM deviation was very much on the high side, although in average use this maximum deviation is not reached, and no repeater has yet blown me a raspberry!

Power output was well maintained across the band. Despite the fact that I have been working this rig quite hard for some months, not a single fault has developed, which is a credit to Trio's reliability.

**Conclusions:** I have been currently using this machine with a Mirage B3016 transistorised linear amplifier which is similar to the model I reviewed last month, although it has lower intermodulation products, since a driver stage is omitted. The Mirage pre-amp did improve the 9130, particularly on SSB, and worked well with it.

I found the ergonomics excellent, and strong points which highly recommend it are the provision of 12.5kHz FM channelling and reverse repeater functions, and good scanning/memories, together with its high output power. I prefer it to the Yaesu FT480, although the latter has got some good points. The UK version of the TR9130 supplied by Lowe Electronics allows a short tone burst of 1750Hz at the beginning of each transmission when selected, whereas the European version, most annoyingly in my opinion, is a spring-loaded, non-latchable, push-to-burst button.

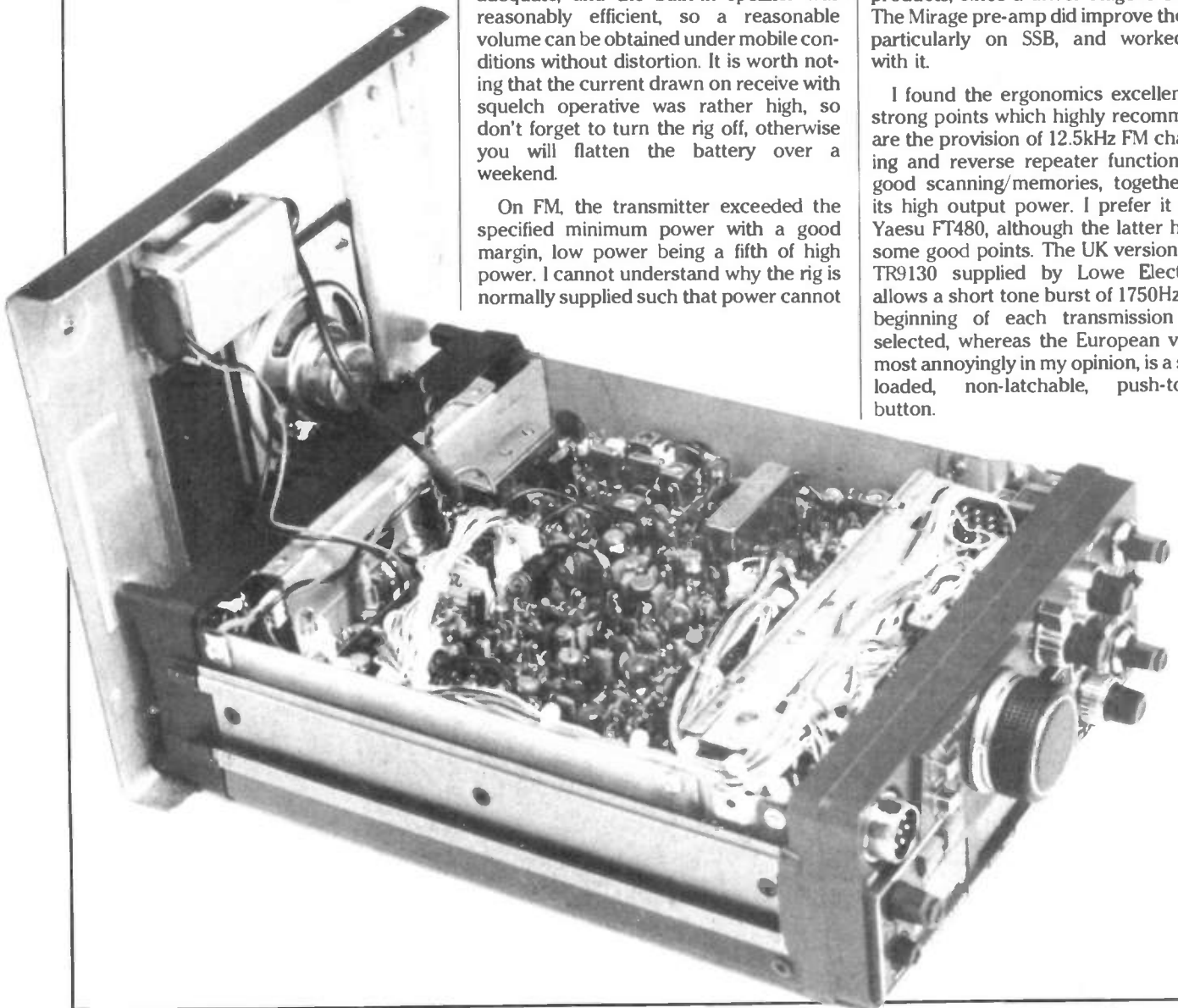





### Trio 9500 70cm mobile multimode

**Facilities and operation:** I have been very pleased to see an expansion in the use of 70cm FM in the London area in the last two months, with more and more of the new licencees choosing this band rather than 2m for their main operating. The TR9500 fills a need for a good multimode rig for the band that has a good selectivity and RFIM performance, together with good sensitivity.

Although it is almost the twin of the 2m TR9130, it bears a closer resemblance still to the old TR9000. It covers 430 to 439.9999MHz. FM1 is always in 25kHz steps, whilst FM2 is in 1 or 5kHz steps, selectable again by using the DS button. On SSB and CW 100Hz steps are provided, the tuning being in click steps as the knob is rotated. When DS is pushed in on SSB/CW, the receiver scans (approximately each second) a 10kHz section of the band, and clicking the tuning knob clicks up a 10kHz chunk, as on the TR9000.

All the other facilities are as on the TR9130, but there are a number of exceptions. The reverse repeater button, most unfortunately, is omitted, and replaced by a 1MHz step button, which allows the user to whizz up and down the band. There is no high/low output switch, which I think is a serious omission, and the squelch control works only on FM. The repeater shift switch, of course, selects 1.6MHz up or down on TX. Most annoyingly, in the position where the 9130 has an auxiliary socket, the 9500 is blanked off, making it awkward to interconnect a linear. There is thus no ALC input, let alone any external relay operation of any kind. However, Lowe Electronics, the official importers, helpfully supplied us with details of a simple modification which changed the PTT socket over to one which shorts on TX, and opens on RX, with the help of an internal reed relay.

*Left: Underside of the 9130, showing the battery pack attached to the lid. The thick wire (black) leading to the pack is a mod by G30SS for changing over the external equipment on transmit. Above: Fascia of the TR-9500. Right: Underside of the 9500.*

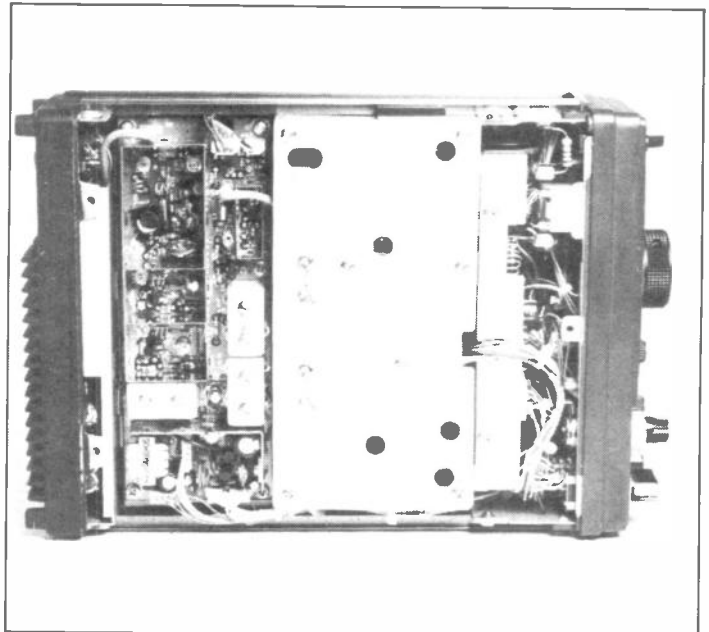

Memories one to five are completely normal, as is memory six on SSB/CW, but six can be set to retain separate RX and TX frequencies on FM by first putting in RX, when a beeping sound is heard until the TX frequency is inserted, which of course can be the same.

**Subjective comments:** In general operation I have much enjoyed using the 9500 mobile and fixed. Sensitivity seems reasonable on FM, and acceptable on SSB, although an external pre-amp does make an improvement. Selectivity has been excellent, and no interference occurred when the Ministry of Defence used some 12.5kHz off-set channels recently in the London area, which did cause a problem to some band users. As set up by the manufacturers, the 1750Hz tone burst was ludicrously short, and only two out of three repeaters opened up, and thus we had to dig inside and adjust VR102 to lengthen the tone burst. Several 9500 users have had the same problem.

VR102 can be reached by taking off the bottom cover, and releasing screws on the circuit board that is hinged at the back of the rig. On lifting up this board, the appropriate pot can be found and adjusted. VR101, incidentally, adjusts TB frequency, but this was very close as found. As with the 9130, the 9500 instructions were totally unhelpful as far as pre-set adjustments were concerned. Again, a service manual is available to special order, but why cannot Trio incorporate this into their normal manual? Only an external back up facility is available for the memory, unlike the TR9130, but memories are retained when the rig is connected to a 13v supply, but switched off, provided the supply is always live.

Modulation quality reports have always been good, and received audio was also of very good quality, with good AGC action, although I would have preferred rather more gain on SSB at RF. The lack of low power switching, I think, is quite a disad-

## TWO MULTIMODE MOBILES

vantage, and it is virtually impossible to attempt to listen to input of a repeater without much twisting, turning and button pushing, and this is most annoying.

One obviously does not want to clutter up memories with repeater inputs, and I am told that it is not an easy matter to put any reverse repeater modification into the circuitry. Scanning worked very well indeed, and I was surprised to find many strange frequencies out of the normal band area in use in the home counties. CW keying worked satisfactorily, but was tried only briefly.

I was impressed by the way the rig handled under mobile conditions, and for the first time I had a go at SSB mobile, using a Microwave Modules 432MHz 100w linear. Despite my breaking the rules by using a vertical whip for SSB, I remained in QSO in this mode with various stations all the way from Towcester in Northamptonshire to my home QTH in North London, much to the surprise of 70cm SSB enthusiasts. It makes me realise that there could be a good market for a 70cm horizontally polarised halo or Alford Slot antenna (please let me know if anyone makes either of these).

**Lab results:** Rather surprisingly, the RF sensitivity of the 9500 was actually 2dB

**“I was impressed with the way the rig handled under mobile conditions. . .”**

better on FM than on the 9130, as purchased. SSB sensitivity was also appreciably better, but by a bigger margin. The RFIM performance, whilst being inferior to the splendid performance of the 9130, was nevertheless adequate for 70cm, and I never encountered any trouble with it in this area subjectively.

Adjacent and alternate channel selectivity measured splendidly well. On FM the S meter was useful for indicating the presence of a medium or strong signal, if you wanted to keep the volume at minimum, but at 2dB per S point it could hardly serve any other purpose. SSB indications were only marginally better up to S9, but at least S9+20 did represent a useful RF increase, actually of 22dB (FM only increasing by 3dB!)

Audio distortion on FM was very low, but the product detector on SSB was not quite as clean as I might have expected. Adequate volume was given by the rig to its internal speaker, or to an external one for normal purposes, and there was plenty of gain in hand on the volume control. I am slightly concerned that the DC current

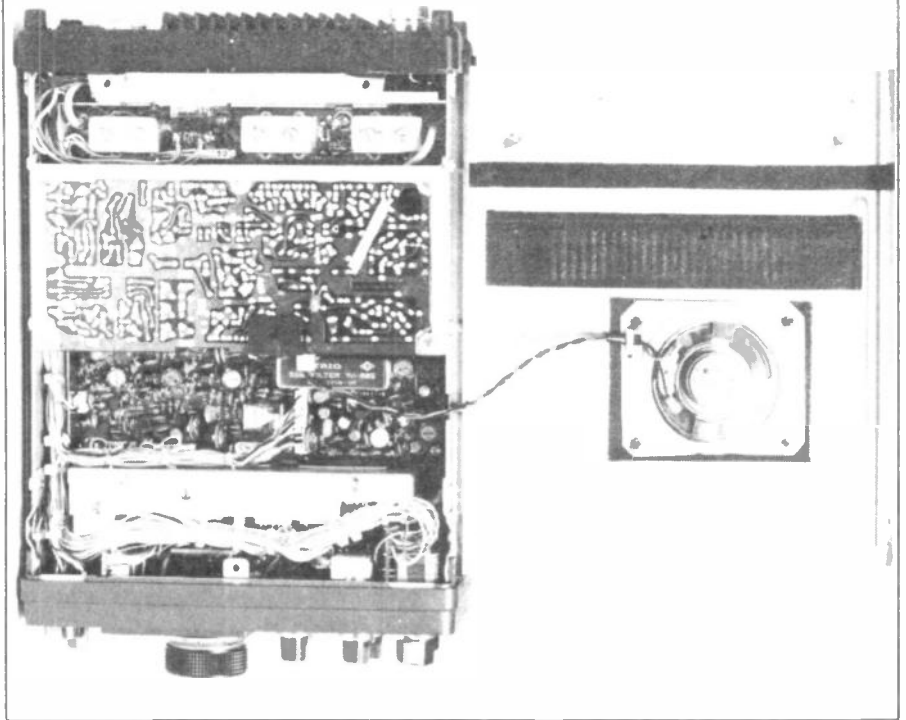

drawn on receive (FM squelched) was a little high again, and it will be even more important to avoid leaving the rig switched on by mistake in the car.

On TX, the FM output power was quite high, which is all to the good. Note, incidentally, the provision of an N-type socket for the aerial connection, which I strongly applaud, and which obviously helps both on TX and RX. The power on SSB was slightly less, higher than spec, but it can be cut down by internal adjustment if required, as can the FM power. The maximum current drawn on TX is rather high, and so the rig is rather inefficient, but this will only matter if you are running off accumulators for very long periods without a charging system being around.

Frequency accuracy, as transmitted, measured extremely well, but it was a little curious that below 435MHz, frequencies were marginally low, whereas they were very slightly high above that frequency. Repeater shift was extremely accurate. Second and third harmonic outputs of the main transmitted frequency were at very low levels indeed, which is most commendable, and I cannot believe that anybody could ever grumble. The maximum FM deviation was generally above 7kHz on speech peaks, as measured on our new Marconi peak reading meter, and this may need some adjustment. Once again the normal manual is useless here.

**Conclusions:** Whilst strongly recommending this rig, I think you will have to weigh up whether you might not be as happy with a 2m multimode with a Microwave Modules 2m/70cm transverter combined with a switching unit which could also incorporate extensive repeater shifts, which this rig does not have.

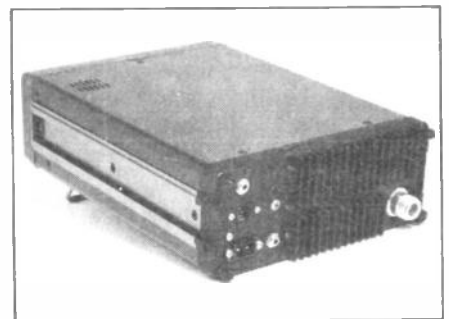

*Top: With the top taken off, the TR-9500 looks very neat, and straight forward for those with knowledge.*

*Above: Rear view of the same radio.*

The MM transverter combined with the 9130 for example, in low power, and with the resistor cut for SSB low power, will perform extremely well. You would be able to work simplex from 432MHz up to 435.6MHz using the repeater shift switches appropriately.

**“More of the 70cm band is being used around London.”**

However, more and more of the 70cm band is now being used around the UK, and particularly in the London area, and the obvious advantage of the TR9500 is that it covers the whole band. It is extremely useful to have completely independent rigs for 2m and 70cm, and it is fun to work cross band.

If you want a 70cm multimode now, then the 9500 is probably your best bet. It will of course work with the same accessories as are available for the 9130.

**Trio TR 9130 and TR 9500**  
**General. RFIM offsets for 2m 25.50kHz;**  
**for 70cm 50.100kHz.**  
**Deviation offsets for 2m 4kHz; for**  
**70cm 5kHz.**

**Frequencies. Deviation/bottom/mid/top of band for**  
**2m 144/145/145.975MHz; for 70cm 432/435/439MHz.**

<b>RX Measurements</b>	<b>TR9130</b>	<b>TR9500</b>
FM sensitivity bottom/mid/top of band (dBm)	-119.5/ -120.5/ -120.5	-121/ -123/ -123
SSB sensitivity middle of band (dBm)	-120.5	-125
FM selectivity adj; channel unwanted low/high (dB)	33.5/ 63.5	70.5/ 169.5
Alternate channel low/high (dB)	77.5/ 78.5	76/ 75.5
SSB bandwidth -3/-40/-60dB (kHz)	2.0/ 3.1/ 4.5	2.3/ 3.4/ 7.8
RFIM levels at each frequency for 12dB sinad (dBm) product	-43 each side	-57 each side
S meter FM for S1/S3/S5/S7/S9 +20 (dBm)	-109/-100/ -96/-94 -92/-87	-110/-103/ -100/-98/ -96/-93
As above, for SSB	-109/-104/ -100/-97/ -94/-85	-113/-110/ -107/-103/ -98/-76
Audio distortion for 125mW o/p FM (%)	4.5	1.5
As above for SSB	1.2	2.4
Audio o/p for 10% THD (w)	2.4	2.2
Current drawn when squelched on FM (mA)	430	550
<b>TX Measurements</b>		
FM power high/low (w)	28.7/5.7	14.1
SSB power (WPEP)	36	12.5
Frequency accuracy	200Hz high across band	+230Hz <435MHz/ -80Hz >435MHz
Repeater shift accuracy	Within 10Hz	Within 10Hz
Harmonic output 2nd/3rd (dBc)	-63/ -70	-65/ -70
Current drawn FM TX high/low (a)	5/ 2.5	3.5
FM deviation. Max seen/ max on speech (kHz)	8.0/ 8.0	7.6/ 7.4

**Measurements by Simon Roberts G8UQX and**  
**Angus McKenzie G3OSS.**

# DEWSBURY

# ELECTRONICS



## UHF ALL-MODE TRANSCEIVER

# TR 9500



The TR 9500 is a lightweight compact 70cm FM/USB/LSB/CW transceiver with advanced and convenient functions and many accessories at an affordable price.

The transceiver is designed for FM, SSB, and CW modes, utilizing a microcomputer which permits frequency selection in 100Hz, 1kHz, and 5kHz, 25kHz steps by means of two digital VFOs. The microcomputer also permits memory, scanning, searching, and other features.



SP 120 TR-9500 BO-9  
**£450 + carriage £5.00**

PS-20

The TR9130 is the new all mode VHF mobile or base station rig from Trio giving 25 watts output on 2 metres FM, USB, LSB and CW and now having a green LED display to make for easier mobile operation.

- 25 watts output on FM, SSB and CW.
- FM/USB/LSB/CW all mode operation.
- For added convenience in all modes of operation, the mode switch, in combination with the digital step (DS) switch, determines the size of the tuning step, and the number of digits displayed.

- Six memories. On FM, memories 1 through 5 for simplex or +600kHz offset, with the OFFSET switch. Memory 6 for non-standard offset. All six memories may be operated simplex, any mode.
- Memory scan. Scans memories in which data is stored. Stops on busy channels.
- Internal battery memory back-up. With Ni-Cad installed (not Trio supplied), memories will be retained approximately 24 hours, adequate for the typical move from base to mobile. A terminal is provided on the rear panel for connecting an external back-up supply.
- Automatic band scan. Scans within whole 1MHz segments (ie 144.0-144.999MHz), for improved scanning efficiency.
- Dual digital VFOs. Incorporates two built-in digital VFOs, selected through use of the A/B switch and individually tuned.
- Squelch circuit on all modes (FM/SSB/CW).
- Repeater reverse switch. For checking signals on the repeater input, on FM.
- CW semi break-in circuit with sidetone. Built-in, for convenience in CW operations.
- Digital display with green LEDs.
- Transmit offset switch for repeater shift
- High performance noise blanker.
- RIT (Receiver Incremental Tuning) circuit. Useful during SSB/CW operations.
- HI/LOW power switch. Select 25 or 5 watts RF output on FM or CW.
- A four-pin accessory terminal is provided for use with a linear amplifier or other accessory
- Includes quick release mobile mounting bracket and up/down microphone.



ISOPOLE 144  
**A.E.A ISOPOLE™  
2M AND 70cm  
VERTICAL  
ANTENNAS**

These antennas simply put your signal where you want it - on the horizon. Most other VHF verticals radiate at 10-15° above the horizontal but the Isopole's unique (aesthetically pleasing) decoupling cones stop any feeder radiation and ensure a proper 0° radiation pattern. All users report dramatic improvement over previous, similar sized, antennas they have used. One of the hottest selling antennas in the U.S.A.  
Isopole 144 £35.00 (£2.50 P&P & Insurance)  
Isopole 440 . . . . . £59.00 (£2.50 P&P & Insurance)

# TR TRIO 9130



TR9130 ALL MODE TRANSCEIVER £433 + car: £5.00

Access/Barclaycard accepted. Licenced credit broker

Dewsbury Electronics offer a full range of Trio Equipment always in stock. We are also stockists of DAIWA - WELTZ - DAVTREND - TASCOS TELEREADERS - MICROWAVE MODULES - ICS AMTOR - AEA PRODUCTS - DRAE

Dewsbury Electronics, 176 Lower High Street, Stourbridge, West Midlands.  
Telephone: Stourbridge (0384) 390063. After Hours: Kidderminster (0562) 851255

Closed Thursday



# Whatever Next?



FIND OUT WITH

## **Radio & Electronics World** THE COMPLETE ELECTRONICS MAGAZINE

Available at your Newsagent each and every month — price 85p

# HOW HAMS SHAPED RADIO HISTORY

David Lazell maintains that it was a couple of amateurs playing records and teaching others how to use their radio that started the great radio revolution

Sherlock Holmes' problems with Moriarty were child's play compared with today's electronic research.

Any day now, we should get a radio antiques show on TV, perhaps called 'Going For A Frequency' and featuring hot bottles, old-time oscillators and Great British Transformers. Wise old owls – of the ham fraternity – will be invited to identify each item and describe how it works (and *that* should make for extended viewing all right!).

The only problem with the programme format is the impending shortage of objects. As the USA's antique radio boom continues, shiploads of 1930s short-wave radios are likely to follow other national treasures across the Atlantic. If the government had any sense, it would appoint a Minister of State for Short-wave at once, preferably someone who knows his wavebands from his arm bands.

Meanwhile, more and more hams are playing Sherlock Holmes. In one sense, they always did. 'G.T.K.' for example, in his June 1932 feature, 'The Month on Short-Waves' asked a question which raises various unanswered questions: **"Talking of Yanks, by the way, what has happened to W3XAL? This time last month, he was playing havoc with the baby next door, but at the time of writing, he is anything but good, even on phones."**

How old was the baby next door – and what was *she* up to? Still, the Stationery Office provided literature for the 1930s ham fraternity. In 1934, you could buy, for

just one shilling, 'A Critical Survey on Present Knowledge'. Within a mere fifty-six pages, you could check on ways to keep 'transmitters dead on their right wavelengths'. But who wants a *dead* transmitter? Ironically, all the questions from way back are getting a new airing, especially as radio museums in the USA build up their collections and lecture programmes. Some of this work has already been reported in this magazine.

**"First mystery: Which was the first broadcast station in the USA?"**

Because radio in the USA grew up in a free enterprise (some would say free for all) setting, the fruits for the researcher can be very rewarding. Hams were the original pioneers of wireless, and added an impetus to the early development. Home-built sets preceded the first commercial models, and only in the mid 1920s did the domestic market get its appropriate exploitation. And here comes the first mystery; which was the first broadcast station in the USA? Hams took up the issue in the late 1960s. Research quoted in the official journal of the Antique Wireless Association (*The Old Timers Bulletin*, June 1969) suggested that the radio and general knowledge encyclopedias had got it wrong.

Pittsburgh, the sturdy industrial city in Pennsylvania, had acquired the title of

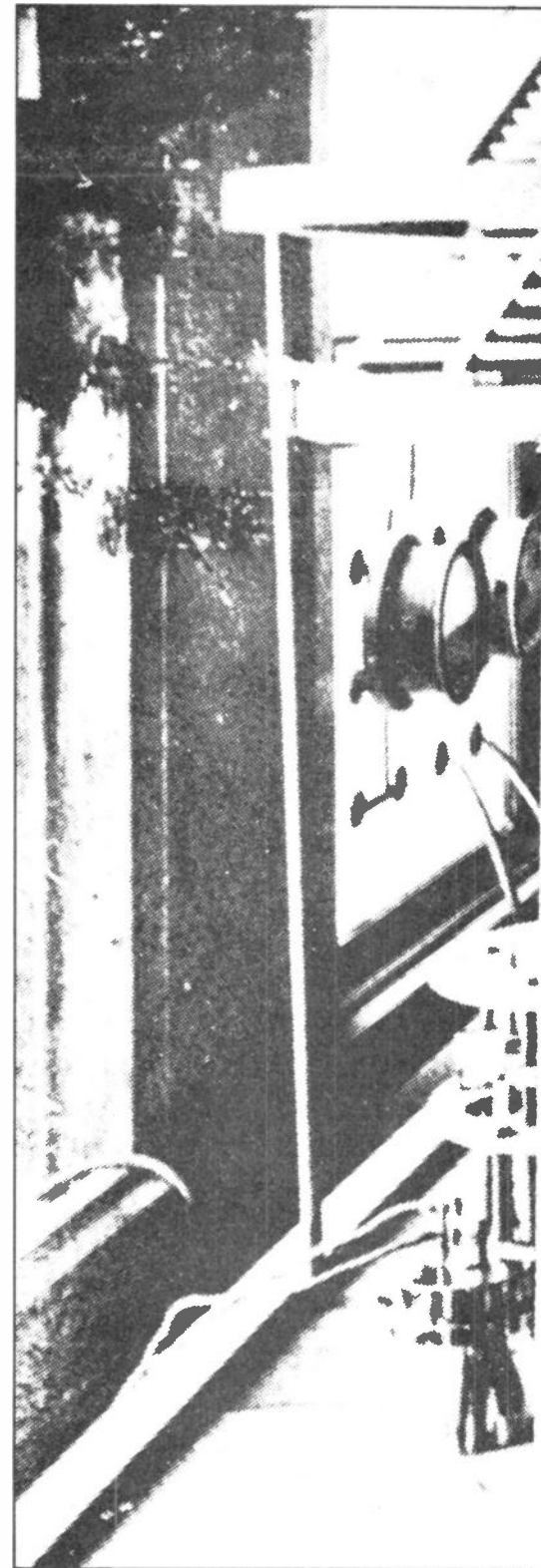

'first', since its local station, KDKA, went on the air in 1920. KDKA was a very enthusiastic, publicity-minded station; today, more than sixty years after KDKA went onto the air, Pittsburgh has one of the nation's most ambitious cable TV systems, with more than eighty channels and interactive facilities. Warner Amex Qube Cable TV follows in the footsteps of the KDKA pioneers – who had to work hard to create a radio audience. Yet the research, first published in *Pacific Telephone Magazine*, concluded that the kudos had been earned as long ago as 1909, by Charles Herrold, whose nickname of 'Professor' came from his initiative in telling young enthusiasts how to use radio.

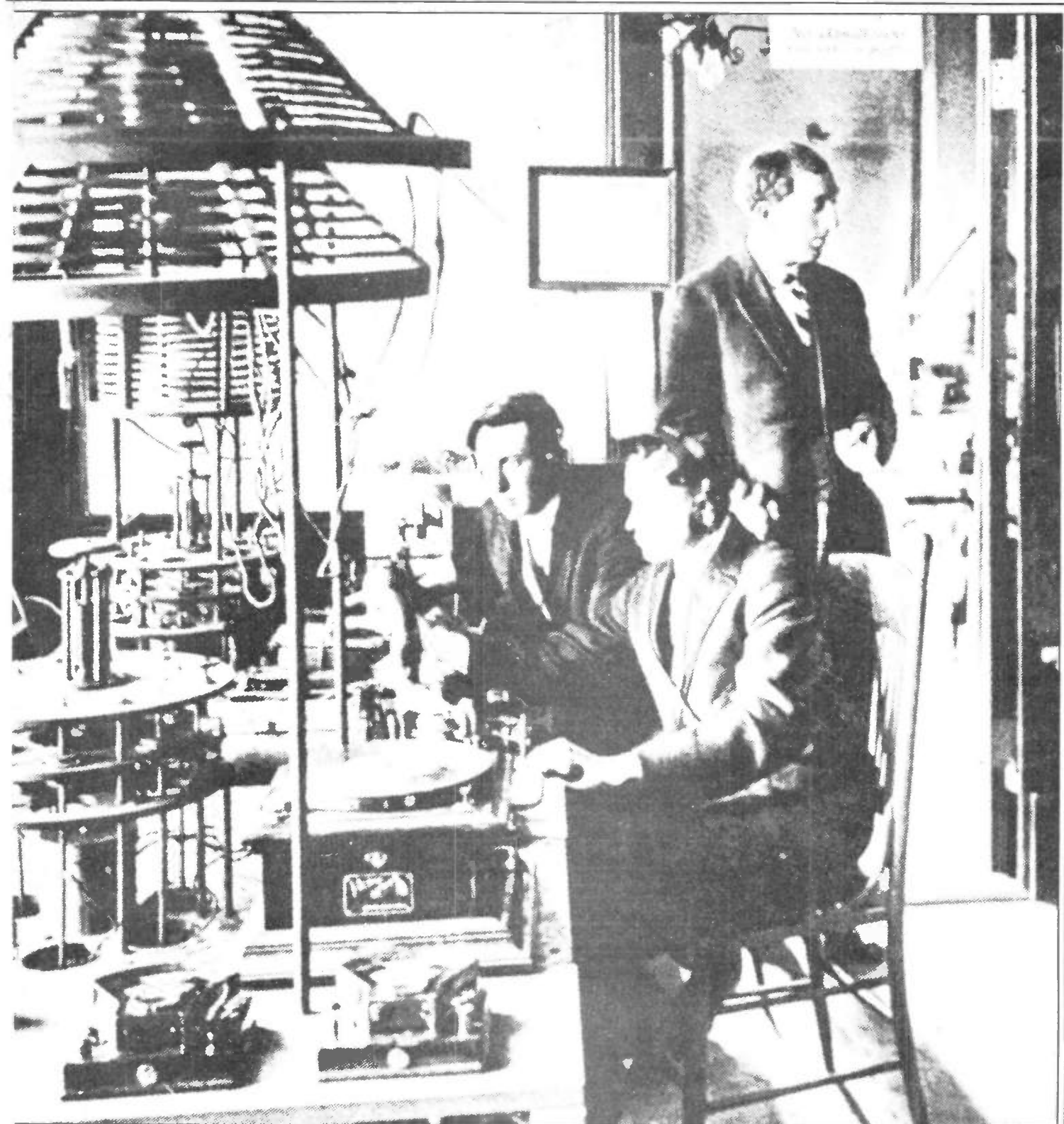

Professor Herrold's 'station' began as little more than an amateur 'net'. Some twelve or thirteen years later, the embryonic radio industry in Britain also realised the need to provide some kind of programming for would-be radio users. Back in 1909, however, broadcasting was no more than a remote possibility – though it would certainly have developed far earlier but for the advent of the second World War. The Marconi Company pioneered the techniques which are today perfected in MARISAT.

*A Marconi Year Book of Wireless Telegraphy* appeared annually to assist the growth of maritime wireless telegraphy.

Indeed, an American ham (Rex Matlack, W3EFX) completed some very useful research on an early Marconi Station in Tampa, Florida, for the publication of the Antique Wireless Association ('Station WPD, Tampa, Florida', *The Old Timers Bulletin*, June 1976) again confirming the ability of hams to root out the facts. Professor Herrold came onto the air on Wednesday evenings and although on paper it seemed that his signal would have an effective range of only a few miles, research indicates that he had enthusiastic listeners as far away as the Santa Clara Valley, some seventy miles from the station, in the Garden City Bank Building at San Jose, California.

*"Professor" Charles Herrold's assistants sitting at the table upon which is probably an arc transmitter. Herrold himself is in the doorway, standing. The picture, taken from the Old Timer's Bulletin, is dated at around 1920, although this is uncertain. Is this the first "broadcasting" station?*

# STATION WPD, TAMPA, FLORIDA

by Rex Matlack, W3EFX

In the 1913 Marconi Yearbook of Wireless Telegraphy, WPD, Tampa, Florida, is listed as a commercial station operating on a wave length of 600 meters. The day and night range was given in kilometers, of 800 day and 2300 night--approximately 450 and 1200 miles. In the 1914 Yearbook of Wireless Telegraphy, WPD is listed as controlled by the Marconi Company.

I have talked with a couple old time commercial operators in Tampa within the past few years, and they recalled that the original site of WPD was outside Tampa, in a location called at that time (1911) Palmetto Beach. This area is now the eastern boundary of the city.

The original installation consisted of two wooden masts with a four-wire inverted L antenna, being fed from a five KW Spark with an open gap. When transmitting, the spark could be heard several hundred feet from the open windows of the building. This installation was closed down when United States entered World War I in the spring of 1917, and some of the equipment was moved across the bay to St. Petersburg and operated, using the Navy call of NGL.

Approximately ten months after the Armistice was signed in 1919, WPD reopened back in Tampa inside one of Tampa Bay's large hotels, now the University of Tampa. The operating room was in one of the towering Moorish minarets of the hotel, with access by fire escape only. The goings and comings of the telegraph messenger boys at all hours of day and night, plus the whine of the motor generators and rotary spark, caused alarmed guests of the hotel to complain of these distractions. The equipment then being used was a 1916 two KW rotary spark with a Kilbourne and Clark receiver.

In the early Twenties the station was moved to its present site at 1330 McKay Street, which runs along the Tampa docks. It has continued to operate to the present, with the exception of World War 2. After the end of W. W. 2 the

station was re-established by George Warner, who owned and operated it until his death in 1939, when he was electrocuted while repairing a faulty transmitter.

His widow, Mrs. Clara Lee Warner, inherited the license and station, unique in that it shares with a Mobile, Alabama, station the distinction of being the only privately owned, licensed, maritime radiotelegraph station in the country. Other such services throughout the country are owned by RCA, MacKay, Tropical Radio or I. T. T. (WPD does maintain a working agreement with RCA in collecting bills).

Mrs. Warner, now Mrs. Wood, handled the financial part of the station until the end of 1973, leaving the technical aspects to Don Berger, her chief engineer. To my knowledge she was the only woman in the country who had the sole responsibility for running a commercial, radio, maritime telegraph station. (The station license is now in her son's name.)



Exterior view of station taken in April, 1976. Dock and cargo vessels are in rear and left of building. Note tower in rear.

The build  
of paint in r  
will testify.  
building con  
table, strain  
years' old e  
and outmode



Don Berger

WPD serv  
graph servi  
Tampa area  
tween local  
heading to o  
The agents l  
expect the v  
and what rep  
ships. Most  
range of 100  
sions the sta  
with ships i  
Pacific.

Typical entr  
DDOI 420 kc.  
"Send time c  
SEDN 8.0 mc.  
"Arrival tin  
SMOG 420 kc.  
"Position to

WPD QSL c  
used for  
erence ar  
sent to S

This article is taken directly from the Old Timer's Bulletin. Reproduced here with thanks



# HOW HAMS SHAPED RADIO HISTORY

The broadcasts included not only speech but 78rpm records, borrowed from a cooperative local dealer (whose name was mentioned on the air). In that sense, San Jose had, not only the first broadcast station, but the first DJ and the first radio commercial. His wife Sybil became America's first lady DJ— and the baby brought by the stork in 1913 was the first child to come onto the air. Professor Herrold's station had a fifteen watt output, but was sometimes able to boost this. San Jose saluted this pioneering family some years ago, when Professor G.B. Greb, of the San Jose State College undertook some research. Columbia University also undertook research here, interviewing some of those who listened in.

Following the end of the war, Professor Herrold's station was officially adopted by the Second Street Baptist Church in Pittsburgh, and designated KQW. Mrs Herrold had done a lot for the war effort, helping her husband to teach Morse to young radio students who later went 'over there'. San Francisco's lively radio station, KCBS, developed from these modest beginnings, but Herrold's contribution was really only brought to light through the initiative of Professor Greb (a real 'professor' please note!) and the interest of the American ham radio fraternity. The San Jose radio pioneer died in 1948, and his devotion to the cause is aptly reflected in a comment from a contemporary. Professor Herrold kept going, he reported, until 'the mike got too hot to continue'.

Amateurs were also instrumental in developing radio in Pittsburgh, where Frank Conrad, an engineer, played records and talked on the air on Saturday evenings. From this 1920 initiative developed the first commercial station, KDKA. Help came in the shape of a Mr H.P. Davis, Vice President of Westinghouse – and another visionary. He saw the potential of radio, and helped the ad hoc station to grow, though it held an amateur licence for operation before it received commercial station status.

It covered the 1920 presidential campaign and later got a lot of 'firsts' in broadcasting. But, for quite a time, the organisation of the station was a case of everyone pitching in to handle anything that came up. Broadcasting in the USA often grew from amateur short wave radio. On the prairies, for example, ham radio was a valuable business tool and also a way of keeping in touch with farmers many miles distant. Dr W.C. Hess (W6CXC) caught a flavour of those distant days in his chapter 'Pioneer Radio on the Prairie', printed in a 1971 Tab Title, *The Fascinating World of Radio Communications* (W. Foulsham, Slough).

ing has not enjoyed a coat many years, as the picture The operating room in the contains an ancient, sagging ing under the weight of quipment appearing shabby d.

There were two RCA high frequency transmitters: a Model 8039 and 8023 using four (4) 813's in push-pull parallel driven by 807. The 420 kc. set was homebrew with a pair of 833-As driven by 813's. Master oscillators were all in crystal ovens.

A Collins 51-J receiver was used on the higher frequencies with a WWII Navy RBM and a BC-348 on the lower frequencies. The antenna system consisted of dipoles (no beams) strung between (2) 50 year old masts.

The station may not be impressive in appearance but its operation under the guiding hand of Don Berger, W4CQC makes up for its limited facilities. Don's is a one-man operation: he maintains the building, the antennas, transmitters and receivers and is as well the Chief Radio Operator! In fact, he is the only operator except when another "ham" with a commercial ticket comes in occasionally to relieve him.

It was a pleasure to see Don casually operate both HF and LF sets simultaneously (3 receivers and 2 transmitters), type tfc on "mill", pour coffee and talk to his visitors -- all the same time -- so it would appear. To break up the long hours (there is no such thing as 8-hour day) his wife visits the station and helps with office routine.

Up to 1974 there was no air conditioning in the building and five cats presided over the primitive office and operating room. Today there is only one cat in the station, air conditioning has been installed, and major improvements are being contemplated.



W4CQC operating WPD

es as the only radio tele- ce for ships at sea in the providing information be- shipping agents and vessels r from the Port of Tampa. earn through WPD when to essels, what their cargo is airs may be needed to the communication is within a 0 miles although on occa- sion has handled traffic n the North Sea and mid-

ies in WPD log:

(German ship off Yucatan)  
f arrival to New Orleans"  
(Swedish ship, Cape Hatteras)  
e to owner in New Jersey"  
(Liberian vessel in Gulf)  
owner in New York City"

## Radio Station "WPD"

MUNICIPAL DOCK

MAIL ADDRESS: 1330 MCKAY ST.

TAMPA, FLORIDA 33602

AN INDEPENDENTLY OWNED RCA AFFILIATE

QTU: 1300 GMT til 2200 GMT DAILY 1800 WX

TFC LISTS: 1320 1520 1720 1920 GMT & 2120

500/420 Khz

4274 - 8473 - 6446 - 13051.5 - 17170.4 1Khz

NOTE: Tampa agents prefer WPD routing therefore please watch WPD lists four days before and after docking in the Tampa area AND WHILE AT ANCHOR.

Telephone 223-2762

73 Don Berger

# HOW HAMS SHAPED RADIO HISTORY

Station KG CX, in Vida, Montana, used a 7½ watt output generated by farming equipment. Like other hams getting into broadcasting, the originator of KG CX used a hand-wound gramophone and 78rpm records for his music programming. The infant commercial radio shared financial problems known to some hard pressed stations today; once, KG CX had to accept a rooster in payment for a commercial for a farm sale.

Local papers seemed to regard these new activities by hams as distinctly quaint though newsworthy, never realising that all too soon they would be in competition for the advertising budgets of local businessmen. In December 1924, *The New York Tribune* ran a feature on WDBX, a station built by a local amateur and run by a New York radio business. Operating originally with a five watt output on 233 metres, the station went on the air three nights a week with records, speech output and some attempts at live entertainment. One is impressed by the way that anyone could get into broadcasting. Max Jacobson, a former marine radio operator, helped to get WDBX on the air. Later a member of the Antique Wireless Association, his salute to 'New York's Smallest Station' appeared in *The Old Timers Bulletin* in March 1979.

In Britain, hams pursuing some of these US styles of communication would certainly have been branded as 'pirates' (perish the thought). Yet even in Britain, the development of broadcasting owed a lot to the ham fraternity, who championed the innovation. It was the hobby radio press, for example, that offered the best informed and most pointed criticism of the emerging bureaucracy at Broadcasting House. The issue of possible centralised control in London and the need to protect and develop regional broadcasting initiatives were both discussed in shortwave journals, in the early 1930s.

Lighter aspects of broadcasting were no less the subject of learned discourses. *The Wireless Constructor*, in June 1932, followed up readers' mail with an article on 'That Interval Signal' – a sound which suggested the arrival of the deathwatch beetle. In true Sherlock Holmes fashion, the writer tracked down the source of 'the dismal dooms'. It was, in fact, no more than a microphone situated above an electrically driven clock. "The slow, monotonous 'doomp, doomp, doomp' that you hear is the large second hand slowly striding its way round the dial," declared the writer.

Campaigning for brighter radio, the amateur asked a BBC boffin if something more cheerful might be applied to intervals. Cut down to size, the enthusiast 'was told that at present there was no mechanical gadget or gramophone record in preparation to take its place'. The comment symbolised the great difference between the US and the British attitude to hams. In America they were given carte blanche to try their hand at broadcasting. In Britain they were not allowed even to change the BBC's sonorous interval signal. But the hams *did* represent a very important moment in our radio history.

America might have had a field day with radio, but the US short-wavers were to be appalled at some of the consequences. Today's regrettable problems with those who abuse CB frequencies fade into insignificance compared with the chaos that developed in the USA during the 1920s – and from people who would have called themselves 'serious about radio'. The roaring 1920s represented an era of 'laissez-faire', in which government regulation was considered inappropriate for the well-being of capitalism. No wonder the US short wave magazines of the period began to have second thoughts above broadcasting. In all the cacophony, a few bright beacons shone, one being the WWV broadcasts initiated by NBC from the Washington radio laboratory in 1923.

**"Since the signals began, those in the east have been able to make precision calibrations of their own wave meters . . ."**

QST – probably the best known US short wave magazine of the time – noted in an editorial of October 1924: "Probably no radio station has ever rendered the American radio world so great a service as that of WWV in transmitting the standard wave signals. Before these signals began, both broadcasting and amateur waves were uncertain and often wave-meters disagreed violently. Since the signals began, those in the East have been able to make precision calibrations of their own wave meters and pass the information on into the West." This year, the WWV service celebrates its sixtieth anniversary, against a background of budget cutbacks for federal agencies and services. Another parallel with 1923 is the promise of new broadcasting services, including cable/satellite TV and a proposed Independent National Radio (INR) service by the end of this decade.

Could today's booming research into radio history reflect a feeling that the serious hobby interest groups may have to emphasise 'what radio is for'? Increasingly, the electronic media are being regarded as vehicles for mass advertising, in some cases to the detriment of variety in programming. Yet, as far as we know, few of Britain's independent local radio (ILR) stations have developed on-going links with the hobby radio/ham community.

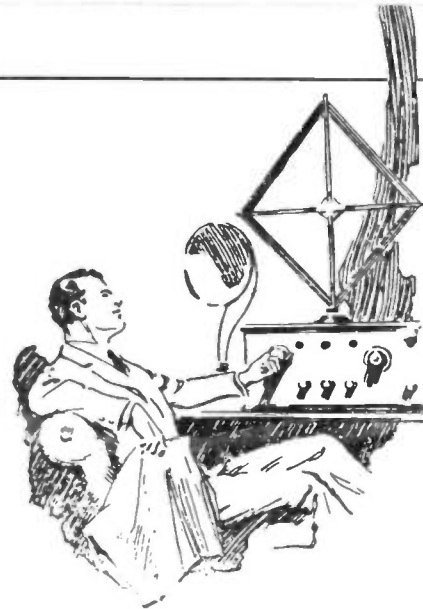

The story of the early 'hams in broadcasting' would make a fine history book – and it could appear one of these days. Publishers have been issuing literature celebrating radio here and in the USA. The more open – if somewhat chaotic – scene in the USA makes for more interesting reading. A new Dover title *Great Radio Personalities in Historic Photographs* by Anthony Slide (Constable, ISBN 0 486 24298 6, £6.40) captures the flavour of the era, and has a good introduction to American radio in its golden decade. Some of the photographs illustrate the equipment around at the time, like the fire extinguisher-shaped microphone used by crooner Gene Austin or the really ancient Columbia microphone used by pianist Nat Brusiloff. Olsen and Johnson – two of the craziest characters to hit radio, or movies – are portrayed with a battery of lollipop mikes and an old time telephone, whilst the late and great Basil Rathbone is seen in the studio shot as Sherlock Holmes.

And that, as they say, is where we came in. For the wonderful radio programmes and characters of the 1940s and 1950s – so well captured in this Dover paperback – might not have been there at all had it not been for the handful of radio hams who saw the potential of radio. The author of *Great Radio Personalities in Historic Photographs* rightly says, "The commercial development of radio is generally credited to H.P. Davis, Vice President of the Westinghouse Electric and Manufacturing Company, which opened the first regularly scheduled radio station in the United States, KDKA in East Pittsburgh, on November 2nd 1920." But it was a couple of hams playing records and teaching radio that really initiated the radio revolution.

Researching these great pioneers is a little like marching a long way behind giants. In these technologically amazing 1980s, these tributes from today's radio hobbyists to the old timers show that, despite all the rumours, hams really do have a heart.

\*See 'Antiques or Rubbish?' December 1982 issue.

# R.A.S. (NOTTINGHAM) G8UUS

Radio Amateur Supplies

Tel: 0602 280267



Visit your Local Emporium

Large Selection of New/Used Equipment on Show.

**AGENTS FOR:** F.D.K. AZDEN ICOM YAESU SOMMERKAMP FORTOP ATV

**ACCESSORIES:** Welz Range Microwave Modules. Adonis Mics. Mutek Pre-Amps. DRAE PSU and Wave Metre

**AERIALS:** Tonna, Halbar, New Diamond Range of Mobile Whips.

**PLUS OWN**

"Special" Q.R.P. GW5 HF 5 Band Beams.



JUST GIVE US A RING

3 Farndon Green, Wollaton Park, Off Ring Road between A52 (Derby Rd) & A609 (Ilkeston Rd).



## AMATEUR RADIO PRODUCTS

### POWER SUPPLIES



All fully protected, including over voltage crowbar circuit. Can you afford to buy a cheaper power supply?

4 Amp PSU	£30.75
	+ £1.50 carr
6 Amp PSU	£49.00
	+ £2.50 carr
12 Amp PSU	£74.00
	+ £2.50 carr
24 Amp PSU	£105.00
	£3.50 carr

### VHF WAVEMETER



The 'DRAE' morse tutor, a self contained unit for learning morse £49.00 + £1.00 carr

### MORSE TUTOR

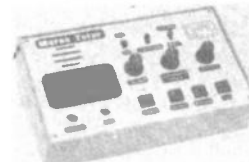

VHF Wavemeter designed to meet the Home Office requirements for amateur VHF operation. £27.50, Carr free.

### OTHER PRODUCTS

24v to 12v 6amp switch mode converter  
24v to 12v 10amp switch mode converter  
custom built linear end switch mode power supplies

Please phone for further details

ALL PRICES INCLUDE VAT  
ACCESS CARDS ACCEPTED

Davetrend Ltd.  
Sanderson Centre,  
Lees Lane,  
Gosport,  
Hants. PO12 3UL  
(07017) 20141

# DIGITALIS 83 HF TRANSCEIVER

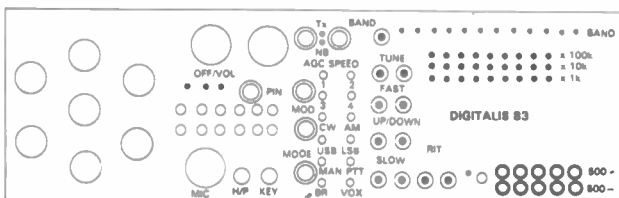

- ★ Price ready built £385.75
- ★ Price of Kit £255.00
- ★ Very advanced novel circuitry
- ★ No alignment problems
- ★ Dual Conversion
- ★ 10Khz 2nd if with variable filtering using active filters
- ★ 300Khz, 3Khz and 6Khz filters
- ★ Power input 40w, 20w and 10w
- ★ Very linear class B output stage
- ★ Real output power meter
- ★ 4 spread AGC
- ★ Very effective noise blanker
- ★ Morse aidetone
- ★ Push button function control and tuning
- ★ LED displays
- ★ Size 12" x 8" x 3"
- ★ Thyristor power supply for low weight
- ★ Works on any A.C. Voltage 100v-250v
- ★ Max power output 25w
- ★ Fully protected output stage with minimal power reduction when mismatched
- ★ All R.F. frequencies come from stable 5 Mhz crystal oscillator
- ★ 12 x 0.5 Mhz bands
- ★ Full fault finding guide with extra fault finding circuitry, included which lights up LED's or PCB's if everything is O.K.
- ★ 1 year money-back warranty

Please make cheques payable to:

N.J. Edwards, 17 Palace St, Norwich, Norfolk.  
Free Securicor delivery. State some times of delivery after 1 month waiting period.

# Get your RADIO AMATEURS

City & Guilds Qualifications with ICS  
In your own time—at your own pace

ICS, the world's leading home study specialists, offer a superb course for those wishing to obtain their City & Guilds Radio Amateurs qualifications. Prepared by experts, the course fully covers the syllabus of the examination, and you study step by step at your pace, in your own home, via the post.

### Personal Tuition

Throughout your course you have the expert and personal guidance of a fully qualified tutor, plus the ICS guarantee of tuition until successful.

### Other courses available

The ICS School of Electronics offer a comprehensive range of courses for most areas including: TV & Audio Servicing & Engineering, Radio Frequency, Electronic Engineering, Electrical Engineering, ... and many more.



Approved by CACC



Div National Education Corporation



Member of ABCC

### POST OR PHONE TODAY FOR FREE BOOKLET

Please send me your FREE School of Electronics Prospectus.

Subject of Interest \_\_\_\_\_

Name \_\_\_\_\_

Address \_\_\_\_\_



Dept J282  
ICS School of Electronics  
180 Stewarts Road  
London SW8 4UJ



01-622 9911  
(All Hours)

# • ASYMMETRICAL • • FED WIRES •

By John D. Heys, G3BDQ

The aerials to be discussed in this section although once very popular are now often disregarded and are actually dismissed by some of the pundits as 'aerials to be avoided!' Fortunately most amateurs love to experiment and many still successfully use these scorned radiators. The writer has so far in this series described only those wire aerials which he has actually used or personally evaluated and does not propose to deviate from this principle. Asymmetrically fed wires may not seem very brilliant to the theoretician but in practice they often prove to be most effective and occasionally little short of miraculous in their performance!

## The Windom aerial

The official house magazine of the ARRL which is called *QST* ran a feature by a Mr. L. Windom, W8GZ back in the September 1929 issue. At this point I must add that many modern writers have called him Mr. Windham, Wyndom or Whyndham, and once he was elevated to the rank of Colonel! *Windom* knew that a resonant wire has an impedance along its length ranging from as low as 50 and up to 5000 Ohms and that a single 14swg wire (at a height of from 10 to 30ft) normally has a characteristic impedance between 500 and 600 Ohms. He then suggested that the single wire could be connected to the resonant wire at a point which would make an exact match. His described antenna and a half wave resonant top and the single wire feeder joined it at approximately one sixteenth of a wavelength from the aerial centre. This concept of a single wire acting as a feed line may at first be difficult to understand, but it must really be considered as one part of a two wire feeder, the missing wire being represented by the 'earth image'.

A good earth is essential for the correct operation of Windom antennas, a point which may go towards explaining why some users have been disappointed with their performance. All twin wire feeders must have the wires reasonably close to each other in terms of wavelength if their equal and opposite RF fields are to cancel and prevent feed line radiation. Unfortunately, in the case of Windom aerials when they are used on the higher frequency bands

(14MHz and higher) the separation of feeder wire and the ground image is considerable and some feeder radiation must always occur. The writer has never found this to be a disadvantage for the RF was still being radiated and not getting lost in the system and it contributed to the 'all round' DX capability.

**“The concept of a single wire acting as a feed line may at first be difficult to understand . . .”**

Later experimenters soon discovered that 'Windom taps' could be put on to full wave aerials, and a formula to work out this new tap point was evolved. Most of the literature describing Windom aerials tends to be somewhat vague as to the correct feeder tap point. One article seen recently states just that the tap is made at a distance from the centre representing 14% of the top length. Another article gives the tap point at .067 of a wavelength from the centre.

To simplify the making of 'Chinese copies' of the classic Windom, a few minutes with a calculator have allowed the production of design tables for both the half wave and full wave versions on the five most used amateur bands. The dimensions are for wire aerials using end insulators; the wire being between 18 and 14swg. The tables show the tap distance from one end of the top, which is more convenient to work with than the off centre distance that is usually quoted.

The reader may wish to design Windom aerials for other bands or frequencies so the basic formula used for a half wave top is:

$$\text{Length (ft)} = \frac{468}{f \text{ (MHz)}}$$

$$\text{Tap distance FROM CENTRE} = \frac{66}{f \text{ (MHz)}}$$

in feet.

For full wave versions of the antenna the following must be used:

$$\text{Length (feet)} = \frac{960}{f \text{ (MHz)}}$$

$$\text{Tap distance FROM CENTRE} = \frac{170}{f \text{ (MHz)}}$$

in feet.

## Practical considerations

The usual objective which is to put up the aerial as high as possible and as far as possible from buildings, trees etc, of course still applies but a new factor to consider is the run of the single feed line down to the shack. The wire must come down from the top at a right angle and not deviate from its line for at least quarter of a wavelength. Then it may gently bend to run into the shack. All sharp angles and bends must be avoided and the usual care taken to insulate the entry point, remembering that the feeder has a relatively high impedance and will carry high RF voltages when transmitting with moderate power. Good conductive ground below a Windom is the ideal, but over dry calcareous soils an earth mat of buried wires or a counterpoise system is recommended.

### HALF WAVE WINDOM AERIALS

Length of top:	3.65MHz 128ft 2in	7.05MHz 66ft 4in	14.2MHz 32ft 11in	21.2MHz 22ft	28.4MHz 16ft 5in
Tap distance from one end:	46ft	23ft 10in	11ft 10½in	7ft 11in	5ft 10½in

### FULL WAVE WINDOM AERIALS

Length of top:	3.65MHz 263ft	7.05MHz 136ft 1in	14.2MHz 67ft 7in	21.2MHz 45ft 3in	28.4MHz 33ft 10in
Tap distance from one end:	85ft	44ft	21ft 10½in	14ft 7½in	11ft



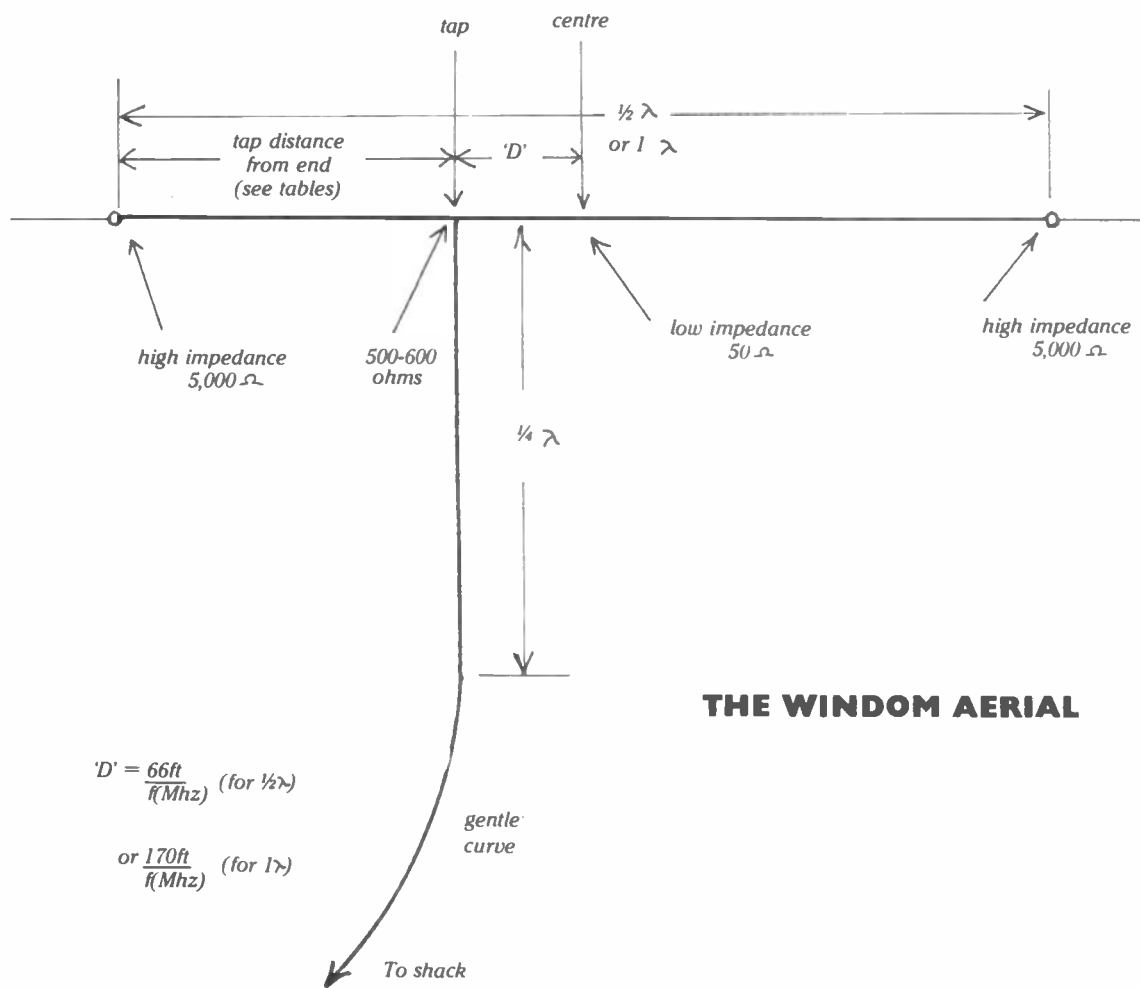

## THE WINDOM AERIAL

A Windom aerial should have a perfectly resonant top at the operating frequency and no standing waves along its feed line. If the tap point is not correct there will be mismatch and the feeder will then tend to behave like an end fed wire with the top as an extension. Although theoretically the feeder may be of any length the writer has always 'played it safe' and avoided obviously resonant feeder lengths such as a quarter wavelength or its multiples.

The tapping points shown in the tables are just starting points, and permanent connections should not be made until a 'neon test' has been made. A neon bulb will readily strike if put near a Windom feeder when more than about 20 watts of power is used, and it is an easy matter to fabricate a long and lightweight bamboo pole (12ft) to which the neon is taped at one end. With moderate power into the aerial the neon will strike when near or touching the feed line. If it is then (perhaps with the help of a step-ladder) run along about quarter wavelength of feeder at the lower end any

unwanted standing waves present will be indicated. If the tap is wrong the neon will not show a constant or near constant brilliance along the feeder but it will vary considerably and even fail to strike at high current points.

### Voltages too small to strike a neon bulb

A correctly placed tap will result in a 'flat' line, and it follows that if the lower quarter wave is in order the rest of the line will also be correct. This somewhat primitive test technique may also be used with non-resonant or 'flat' 300 Ohm ribbon lines to folded dipoles or other aerials. It cannot be used on 75 Ohm twin line for the voltages along it are too small to strike a neon bulb.

The first Windom used by the writer was during his first few months of operation after being licenced and when he lived in an attic room at the top of a sea-front boarding house. Each end of the 67 foot

Fig 1: The basic design of the Windom aerial with either a half wave or full wave top. For DX work the top should be at least a half wavelength above ground, and it is important that the feeder drops vertically for at least quarter wavelength.

top was tied to conveniently placed chimney pots and the single wire feeder actually ran along horizontally to the shack window. It was an easy matter to walk over the flat roof when checking with a neon; a roof which by the way was completely lead covered and perhaps acted as a fine 'virtual earth'!

### The VS1AA Multi-Band Windom

It was both a privilege and a pleasure to be a personal friend of the late Jim MacIntosh, GM3IAA, formerly VS1AA. Jim had a sister living in the writer's village, and whenever he was visiting her in East Sussex we always arranged to spend some time

## A New Look at Wire Aerials 4

together to talk about aerials, his life as a POW of the Japanese, his prowess at tennis (he was a former Singles Champion of Malaya and still playing at 80!) and the usual old-timer reminiscences. During the mid-1930s when then living in Kuala Lumpur Jim developed the concept of the Multiband Windom. This idea was really so simple that it is surprising no one else had thought up the idea.

If the tap point on a resonant wire (which may have a half wave or its even multiples) is made one third of the distance along the wire and if also the feeder wire is thinner than the wire used for the top there will be a good match on more than just one band. A VS1AA antenna cut as a half wave on 80m will work well on 40, 20 and 10 because these bands are even harmonics of the fundamental resonance. By making the feed wire thinner its natural impedance is raised and it then offers a good match on each band at the one third tap point. Suggested wire sizes are 14swg for the top and either 18 or 20swg for the feeder.

### Neons rule OK!

The writer once used stranded 7 x .07 wire for the top and a three strand plastic covered wire for the feedline and it worked out quite well. Jim MacIntosh used his VS1AA type aerials right up to the time of his death. He had a pair up at 50 feet at right angles to each other and they were cut as half waves on Top Band. With a genuine 10 watts of input he often worked Australia on that band; no mean achievement with any type of antenna. Jim's original article was published in the old *T & R Bulletin* (now called *RadCom*) in the November 1936 issue. The neon bulb test described earlier remains applicable for the VS1AA but it should be done for the band considered to be of most importance. The correct tap point for 80 metres for instance will not necessarily be so good on the other harmonically related bands and it may be preferable to set up the aerial for one of those other bands initially instead.

### Matching to the rig

Both the Windom and the VS1AA aerials have feed impedances within the middle range (500 to 600 Ohms) and will match into most commercially available ATUs. The home-brew ATUs suggested in an earlier article dealing with end fed wires will be quite suitable and yet another suggestion is to use the modified-Pi circuit illustrated here. It does not seem to be a Pi network at first glance, but if the aerial was connected to the top of the coil and the earth connection went to the junction of the two capacitors to replace it then it begins to make sense and is the normal Pi circuit.

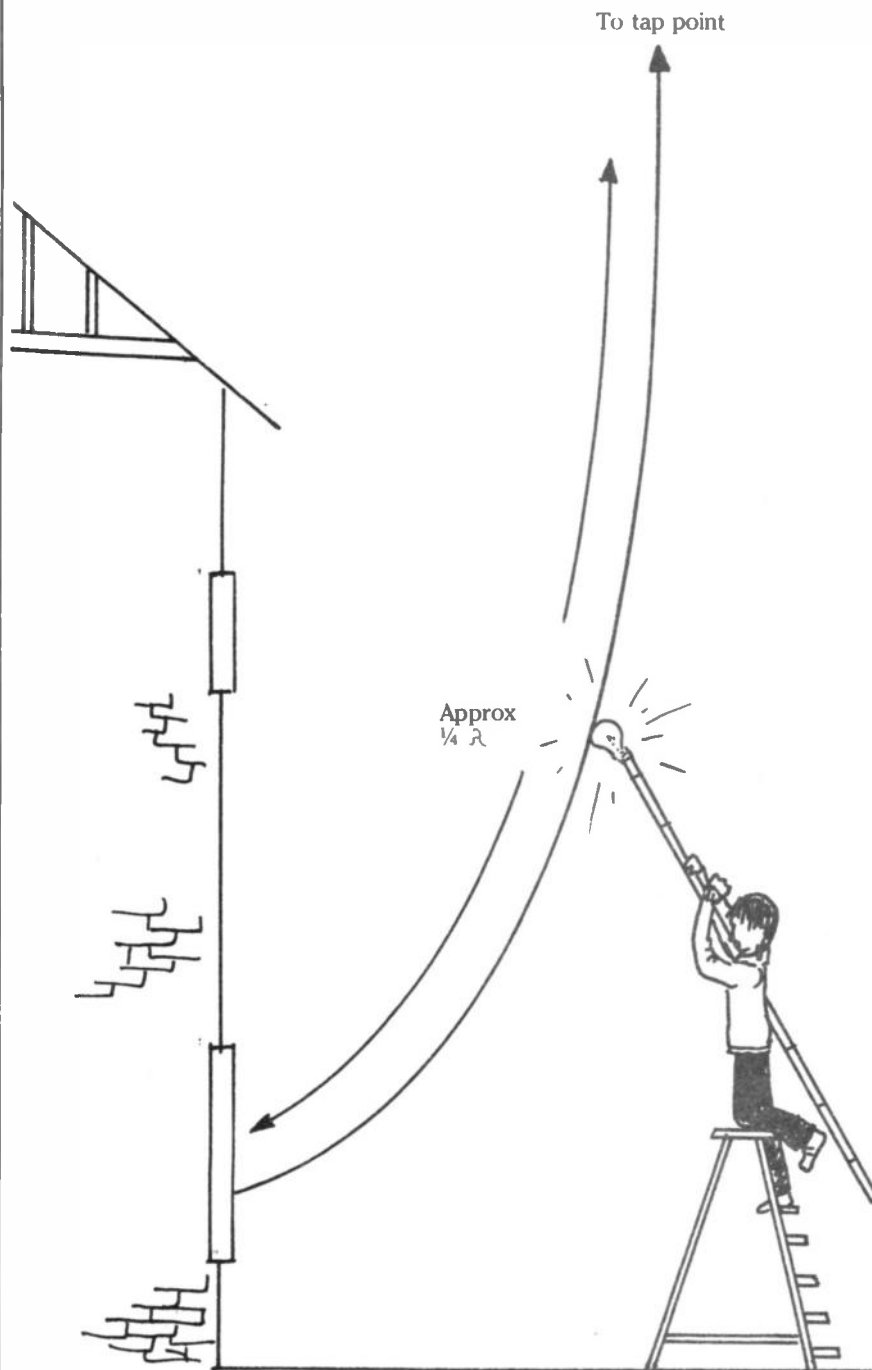

### THE NEON LAMP TEST FOR WINDOM AERIALS

Fig 2: A neon bulb taped to the end of a long pole is a useful device for checking that the feeders of Windom and VS1AA aerials are correctly tapped to the top of the aerial.

## A MODIFIED-PI ATU

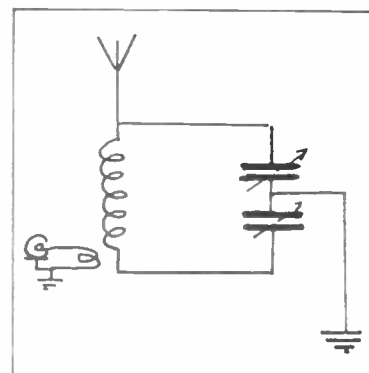
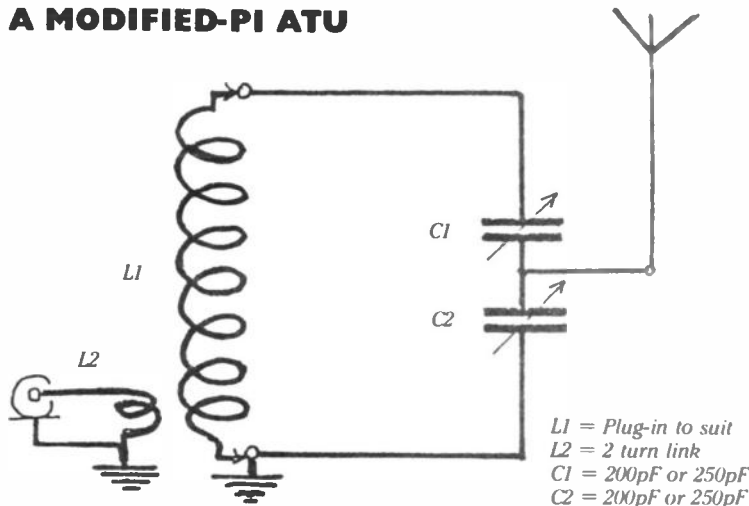

Conventional Pi coupler

The beauty of the modified-Pi is that by using two independent capacitors in series it allows an infinitely variable 'tap' down the coil as the proportion of the two capacitances varies. With equal capacitance the 'tap' is effectively half way down the coil. When the lower capacitor C2 is greater than C1 the tap is more 'earthy' and the impedance at the feed point is lowered. Both capacitors must be adjusted to maintain resonance and cannot be ganged to a common spindle. Their frames and spindles are also not at earth potential and must be insulated from the chassis or panel. A pair of 200 or 250pF variables are ideal in this circuit and the coil inductance for each band will be as suggested in the earlier article describing a simple parallel tuned circuit. The total capacitance in circuit for each band should give resonance with this capacitance in pFs being equal to the band in metres; ie 40pF on 7MHz or 40m. Plug-in coils are essential, for most attempts at switching can prove to be lossy and shorted coil turns must certainly be avoided.

### The G3BRD 'Special'

Another good friend of the writer is G3BRD (with whom he once shared a house many years ago) and with his permission I shall attempt to describe his off-centre feed antenna which is proving to be almost miraculous in its DX potential. This antenna has not been tried at the writer's QTH but I have seen the original, operated with it, and can testify as to its great performance. John, G3BRD developed the aerial when living in Canada operating as VE3BRG and he refined it for use on 14MHz when he returned to live in the UK.

### A top, one wavelength long on the operating frequency

It has a top one wavelength long on the operating frequency and a 75 Ohm coaxial feeder which is connected a quarter wavelength from one end at a current maxima

point. No balun is used and the mean aerial height is about 30 feet. Although simple in concept the actual setting up of the system demands some patience if it is to perform properly. The resonant top starts off about 68 feet long before testing and 'pruning' and it is broken by a small pyrex insulator 16ft 8in from one end; that end nearest the shack window. Across the insulator the coax is connected, which for the 100 watt output levels used by G3BRD need only be standard TV aerial type cable. End insulators are used and one end of the wire goes to a convenient pine tree. The other end goes over to a 20 foot pole fixed to the garage and the feeder drops straight down at right angles for about 16 feet to the shack window below. This feeder must drop vertically.

### "Each inch of the top at the far end raised the resonant frequency by about 100kHz."

With low power and an SWR meter in the feed line at the shack SWR readings are taken over the band. If as suggested the top is too long the best SWR will be at the LF end beyond. Considerable pruning next takes place but no wire is cut at this stage; the top is dropped and some excess wire is pulled through the insulator at the far end furthest from the feed point and wrapped around the top temporarily. By continuing this procedure the SWR will come down. G3BRD initially found that his SWR was much too high (more than 1:4) but pruning brought this down to 1:1.1 on 14.2MHz. He found that each inch of the top at the far end raised the aerial's resonant frequency by about 100kHz.

When finished the aerial was quite flat across the band and the SWR only went up to 1:2.1 at the band edges enabling SSB and CW operation. It is important that to begin with the top is longer than theory suggests and also that all pruning takes place at the far end away from the feed point.

Fig 3: The Modified-Pi ATU allows an almost perfect match to the 500-600 Ohm feed lines of Windom or VS1AA aerials. It is very similar to the standard Pi coupler circuit.

This off-set feed dipole has enabled John to work some fantastic DX and has left many stations with beams spluttering when he raises the rare ones before they do! He never uses more than 100 watts PEP and finds that the four lobed radiation pattern of a full wave antenna does him proud over the major land masses. A long list of prefixes would be needed to amplify the results gained from this antenna, but mouth watering items such as VK0, JT, 3B8, 3B9, KH6, C31 and etc. are just a sample. The reports received average S6-7 which is very good for a wire antenna at that power level.

Should the reader like an efficient mono-band aerial for 14MHz which does not need an ATU and the coffers do not run to the purchase of a tower and beam, the G3BRD is worthy of investigation. It is a real DX antenna, cheap, not too difficult to set up and ideal for the average garden.

### Other systems and things

Descriptions of aerials which use off-centre feed with 300 Ohm ribbon feeder may be found (eg the W9GJY and others) and DJ2KY has described a version which uses a 1:6 balun at the feed point and has 60 Ohm (where do you find this?) coax feeder. No description of these aerials given for they have not been seen or tested by the writer and no guarantee of their effectiveness can be offered.

Before leaving the topic of asymmetrical feed some mention must be made of the fact that they can be used as Marconi aerials and tuned against ground on the LF bands. Then the feeder acts as the radiator and the top becomes a top loading capacitance which contributes little to the radiation. The system then becomes a top loaded 'T' aerial and is vertically polarised; just the job for 160m DX!

A New Look at  
Wire Aerials 4

Fig 4. THE G3BRD 'SPECIAL' 14MHz DX AERIAL

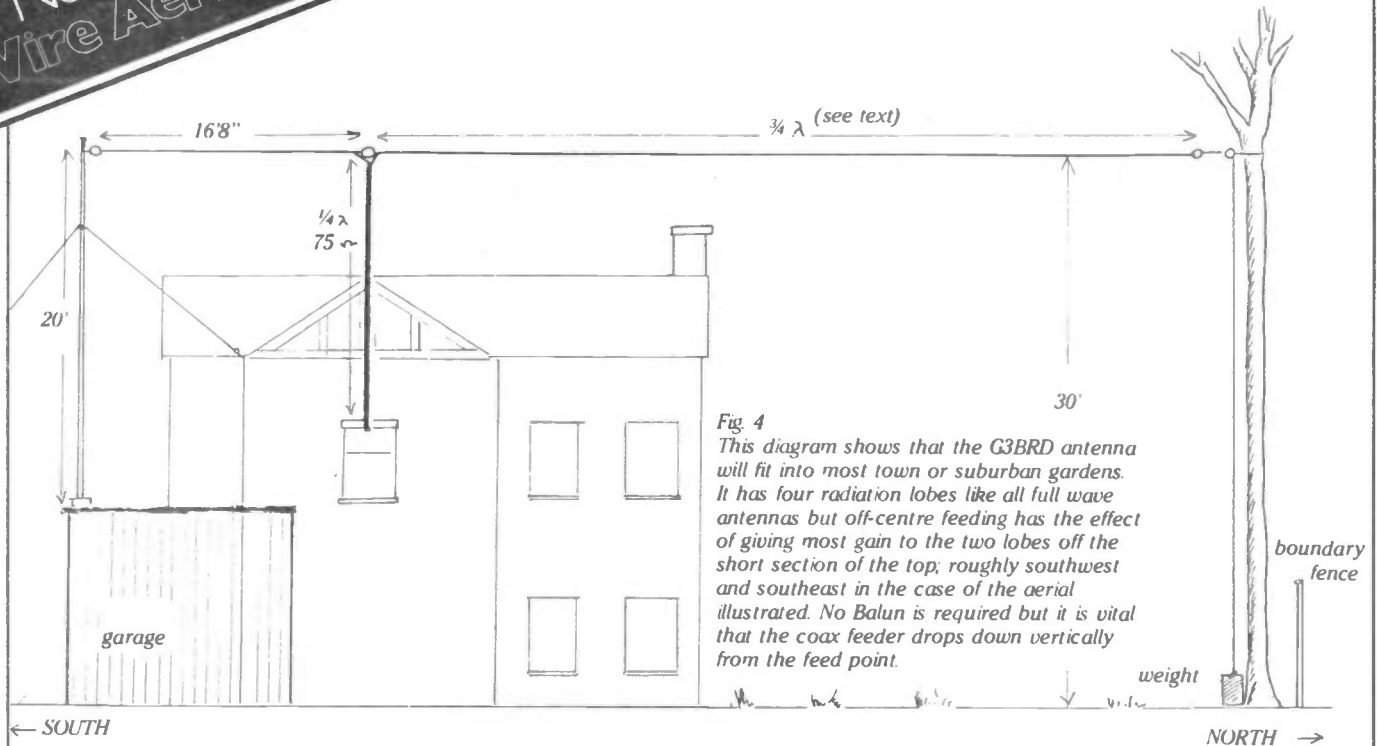

Fig 4  
This diagram shows that the G3BRD antenna will fit into most town or suburban gardens. It has four radiation lobes like all full wave antennas but off-centre feeding has the effect of giving most gain to the two lobes off the short section of the top, roughly southwest and southeast in the case of the aerial illustrated. No Balun is required but it is vital that the coax feeder drops down vertically from the feed point.

The G3BRD "Special" 14MHz DX aerial, as described in G3BDQ's article on the previous few pages. If readers have any questions regarding any of John Heys' drawings or advice, please write and we'll pass on any letters to John direct.

## HOTELECHOALPHALIMATANGOHOTEL!

Sitting at your radio all day and all night long? Never get out into the sunlight? You even control your antenna from a control on the shack wall? Oh dear, you're obviously not fit and healthy. What you need is good healthy food, some exercise, and some advice on how you can keep going for longer at the wireless!

Now all this useful and important information is in one monthly magazine.

Send the XYL out to buy it!

# HEALTH & FITNESS MAGAZINE

At your newsagents today.

The June issue contains a magnificent Home Health poster worthy of a place in any shack (sorry, kitchen) wall, containing all the information you need on vitamins, minerals, and in what foods you'll find them. It's a free poster.

AT YOUR NEWSAGENT NOW. ONLY 90P AND PACKED WITH EVERYTHING YOU WANT TO KNOW ABOUT KEEPING FIT AND HEALTHY.



A Goodhead Publication





Keep your copies of  
Amateur Radio  
in

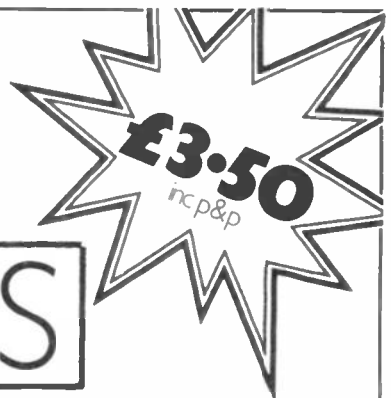

# BINDERS

New, strong with leather-style covering, each Amateur Radio binder can contain 12 copies. Embossed in silver to give your collection of Amateur Radio magazines a sophisticated quality, while keeping them clean, and forever on file for future reference.

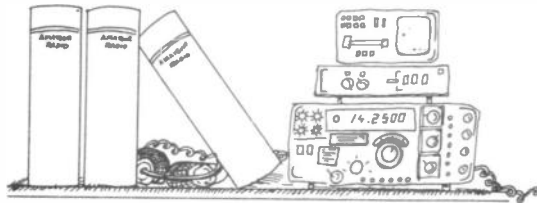

Amateur  
**RADIO**  
M·A·G·A·Z·I·N·E

To: Amateur Radio,  
27 Murdock Road, Bicester, Oxon.

Name .....

Address .....

Tel:.....  
Postal order, or cheque made out to Amateur Radio.

McMichael Amateur Radio Society

## MOBILE RALLY

Talk in S22 (GB2MRS)

Sunday 24th July at 11am  
Sefton Park, Bells Hill, Stoke Poges, Slough.

### AMATEUR RADIO EQUIPMENT IN THE SOUTH WEST



- |                              |                         |                           |
|------------------------------|-------------------------|---------------------------|
| FT1 - HF TX                  | FT708 - 70cm H/H        | IC2E - 2Metre H/H         |
| FT980 - HF TX                | FT230 - 2Metre 25W TX   | IC4E - 70cm H/H           |
| FT102 - HF TX                | FT730 - 70cm 10W TX     | IC25E - 2 Metre 25W TX    |
| FT101ZDFM - HF TX            | FT726R 2 metre/70CM B/S | IC45E - 70cm 10W TX       |
| FT707 - HF Mobile TX         | FRG7 - RX               | IC251E - 2M Multimode B/S |
| FT780R - 70cm TX             | FRG7700 - RX            | IC720 - HF TX             |
| FT480R - 2 Metre TX          |                         | IX730 - HF TX             |
| FT290R - 2 Meter TX          |                         | IC740 - HF TX             |
| FT790R - 70cm M/M H/H        |                         | ICRX70 - RX               |
| FT208 - 2 Metre Portable M/M |                         | IC290E - 2Metre 10W       |
|                              |                         | IC290H - 2Metre 25W       |

all models normally always in stock plus full range of accessories.  
Ancillary equipment by: Microwave Modules, Mutek, Drae, Datong, Hanson, Pecker, Tokyo Hypower, Himound, Shure.  
Aerials by: Jaybeam, T.E.T., Hygain, G. Whip.  
Tono - Tesco Telereaders  
also plugs, dummy loads, rotators, cables, valves etc., RSGB Publications.  
**REG. WARD & CO. LIMITED**  
GEORGE STREET, AXMINSTER, DEVON. EX13 5DP  
REG. G2BSW Telephone (0297) 33163 Rodney, G6LUJ

Amateur  
**RADIO**

on subscription

## TELECOM.

THE BEST IN AMATEUR RADIO

EQUIPMENT BY:  
YAESU MUNSEN  
SOMMERKAMK  
ICOM  
TRIO

DISTRIBUTORS OF:  
THANDAR PORTABLE  
TEST EQUIPMENT AND  
LEADER TEST INSTS.

COMPUTERS BY:  
ACORN 'ATOM'  
COMMODORE 'VIC-20'

AERIALS BY:  
CUSHCRAFT  
J-BEAM  
REVCO  
WESTERN

6 NEW ST, BARNSELY, SOUTH YORKS  
Phone: 0226 5031

# HOW TO RIG AERIAL

**A properly constructed aerial system can survive winds of over 100mph. If it is put up correctly, it will undoubtedly bend in gusty weather but no other damage should result. Ken Williams advises.**

Looking at many aerial systems installed by radio enthusiasts, one can only conclude that somewhere there must be a very hard working patron saint for aerials. Almost any old piece of wire or coax is used for guying without regard to strength or life expectancy. After every winter storm, stations disappear from the bands only to return a few days later with a weaker signal and an explanation of storm damaged aerials.

Yet there is no real reason why they should, for a properly constructed aerial system can survive winds of over 100mph, a speed at which major structural damage of buildings can be expected and to venture out carries the distinct risk of injury from flying roof tiles!

In this article there would be little point in discussing commercial masts and towers, for they are professionally designed to very high standards and come with careful installation instructions which, if followed, will ensure that until the wind reaches a velocity which will physically bend the mast, no other damage is likely.

Even the best commercial masts can come to grief, however, as the author knows to his cost. Some years ago, he was working on a hilltop radio station where, due to the aerodynamics of the surrounding terrain, if the wind was blowing onto the face of the hill, the base of the mast was in the lee whilst the top suffered an accelerated airflow. At times this could amount to three times the windspeed at the top compared with the base. The mast was a wooden lattice structure, 120 feet high with a base about 30 feet square. The legs were of Canadian Red Pine and about 18 inches square. The cross members were of proportionate size. One night, a deep depression over North West Scotland gave rise to very strong winds and during the early hours of the morning, without warning, the mast snapped off at the 25ft level. When daylight came, wreckage was found over a wide area, some over 500 yards from the base of the mast. An examination of the anemograph (wind speed) recording showed that at ground level the windspeed had peaked at 143mph - Force 17 - whilst the velocity at the top of the mast could only be guessed!

Such windspeeds are unknown over most parts of the country, even a mere 100mph being a once-in-a-lifetime event. However, if commercial towers are installed and maintained in accordance with the maker's instruction, they will come to no harm in any conditions which can be expected.

The type of radio mast which usually suffers wind damage is the free-standing pole in the garden, and the reason for this damage is almost always insufficient guys, inappropriate materials for guy wires or inadequate ground pickets. In the case of unguyed wooden masts the reason for failure is usually either insecure fitting or unsound timber.

If for some reason it is necessary to use an unguyed mast, this should be of timber which has been well impregnated with preservative, preferably being an ex-British Telecoms telegraph pole. Little can be said about the installation except that between 15% and 20% of the total length should be below ground level - more on soft ground.

## Guyed masts

These days, the guyed mast usually comprises approximately two-inch diameter steel or alloy tubing. The height may be anything up to 50 feet, but above that height larger diameter tubing would be preferred. If two or more lengths are required to reach the desired height, commercial couplers, such as manufactured by Jaybeam should be used. In the author's experience, for mast heights up to about 30 feet, only one set of guys is necessary at about the 25ft point, but if the mast is taller than this, the first set of guys needs to be at the 18 - 20ft mark with further sets every 10 - 12 ft with the top set some two or three feet below the top of the mast. Each set of guys may comprise of three or four guy wires, the former being adequate but the latter number sometimes being more convenient due to local conditions. The guy wires should be evenly spaced around the mast with the ground pickets spaced a minimum of a third of the mast height from the base. When three wires only are being used, their position should be such that one lies under the line of the aerial.



If a portable mast is required, lengths of 18swg alloy tubing, each 1/8 inch smaller diameter than the next, will be found to telescope neatly together for transport. So snug will be the fit between adjacent sections that no couplers are required. Provided that 12 - 18 inches overlap is allowed, matching holes with pins will provide adequate security of coupling. All guyed masts should be provided with a baseplate to prevent them sinking into the ground. This can conveniently consist of a 12 inch diameter steel plate with a short spike in the middle to prevent the mast being displaced.

## Guy wires

Many amateurs seem to think that any old piece of string, rope or wire is suitable for guying their pole and then show great surprise when some time later, in the way of inanimate objects, it comes crashing down with great precision across the greenhouse, your neighbour's wife's head or a passing police car - depending on which way the wind was blowing at the time. This can be prevented by the use of correct guying materials and ground pickets. For temporary masts like portable expeditions, field days etc., polypropylene rope is probably the most suitable. Rope sizes are quoted by circumference, so for this purpose one inch would normally be most convenient. This is about 3/8 inches in diameter, convenient to handle and doesn't tangle as easily as smaller diameters. This material is not, however, suitable for permanent installations for, after a period of time, the ultra-violet content of sunlight causes hardening and weakening.

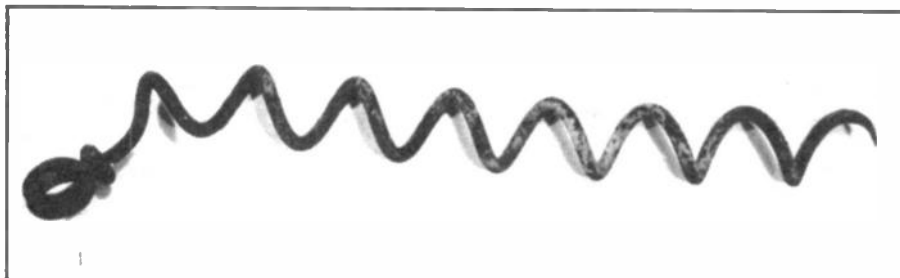

# MASTS

For permanent installations the stranded, galvanised iron wire available from most ironmongers is extremely suitable. This material is strong, can be easily and strongly whipped onto eyes, insulators etc, and is very resistant to corrosion. The author has several lengths of this which has been for over twenty years and is still perfectly servicable. One disadvantage of this material is that it is an electrical conductor and, should any guy be resonant at the frequency of operation, it will re-radiate the signal causing distortion of the radiation pattern and losses. This can be avoided by breaking each guy wire into non-resonant lengths by means of "egg" insulators. Galvanised iron guy wires should be cut to length prior to the erection of the aerial with each end being terminated with an "eye". Uncle Pythagoras will probably be the best help in calculating the lengths required... Final tensioning of the wires is achieved by fitting a turnbuckle between the end of the guy wire and the ground picket. Suitable fittings to attach the guy to the mast can be obtained from Jaybeam.

## Guy pickets

As the purpose of the guy pickets is to provide firm anchors for the guys, it follows that the security of the whole aerial system depends largely on their integrity. The two most suitable types of picket are either 4ft lengths of two inch angle iron or helical pickets made from half inch steel bar. Angle iron pickets should be driven into the ground at an angle of 30 degrees to the vertical, sloping away from the mast leaving only about six inches above the surface for attaching the guys. The inside of the "V" should face the mast so as to present maximum resistance to movement.

## Second picket about two feet behind

If it is not possible to drive the pickets sufficiently deep into the ground due to underground rock etc, the picket should be driven in as far as possible and then a second picket should be driven in about two feet behind. A strainer wire is fitted from the top of the first picket to a point near earth level on the second. The guy wire should be fitted to the first picket as near to ground level as possible. Provided that both pickets penetrate the ground to a depth of at least two feet, this system should prove perfectly adequate for masts up to about 50 feet. In soft earth a similar method should be used but in this case the ground penetration should be as much as possible.

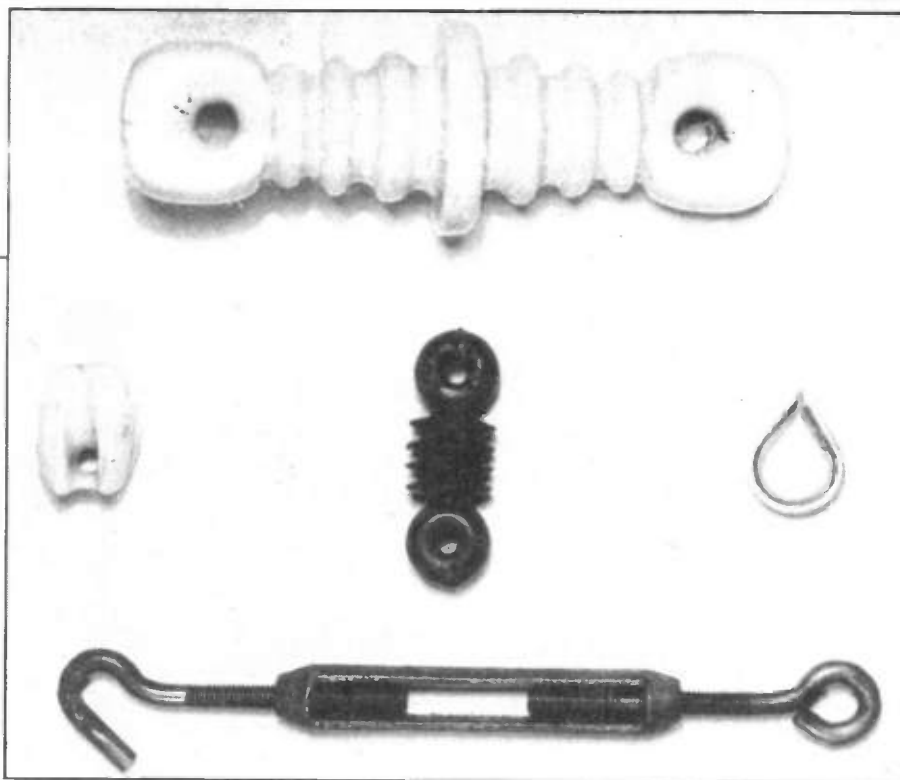

Far left: A helical ground picket. If this one looks a little rusty, it is not surprising for it has already seen more than 20 years' use. Left: An eye whipped onto a polypropylene rope using waxed string. Above: (top) an insulator for the QRO station! (centre) an egg insulator, nylon insulator, and an eye. (bottom) A turnbuckle. Here: How to guy a mast, using eggs, turnbuckles and guy pickets.

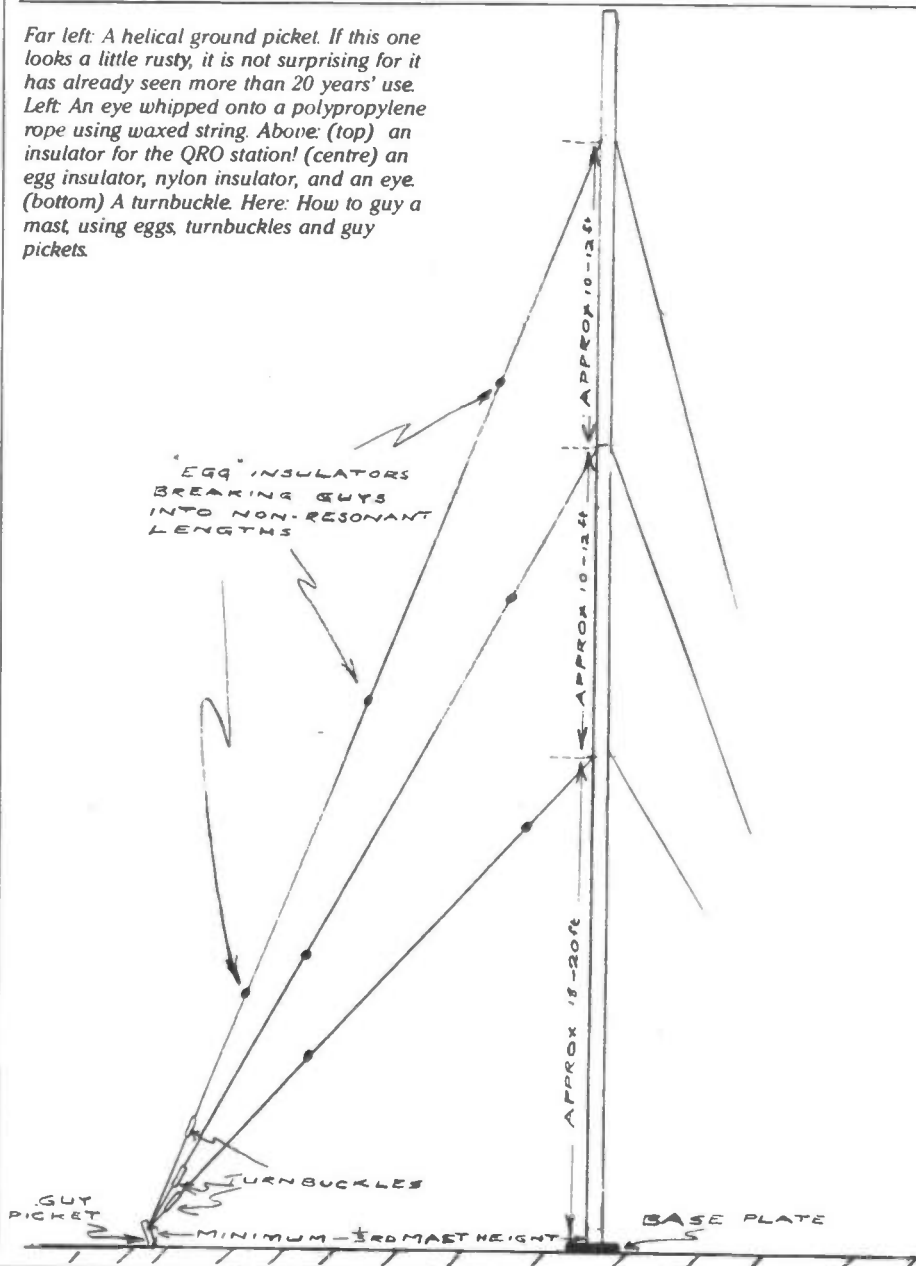

# HOW TO RIG AERIAL MASTS

By far the most secure pickets are those of the spiral variety. In appearance they resemble a giant corkscrew some six inches in diameter and four feet in length. Unfortunately I do not know of any commercial manufacturer but if you can find a blacksmith who learned his trade in the Royal Air Force, he will know exactly what you want for these were used for securing aircraft in windy weather. Show your blacksmith the photograph with this article and leave the rest to him. Spiral pickets are driven into the ground by inserting a crowbar through the top loop and just winding them into the earth. Once in, they cannot be dislodged by any upwards or sideways force but when needed elsewhere can be easily "unwound" from the ground. These pickets are also very suitable for soft ground.

## Splicing

Many amateurs seem to fight shy of splicing. Perhaps the words bring an image of working aloft on a square rigger rounding Cape Horn in a Force 12 gale. However, with stranded galvanised iron wire it is simple, quick, neat and extremely strong. Consider first splicing a wire onto an egg insulator.

Pass about 12 inches of stranded galvanised wire through the hole in the insulator and lay the free end parallel to the main length. Unravel a strand of wire from the

free end back to the eye and wind six to eight turns tightly around fixed and free ends. Any of the strand remaining should be laid parallel with the main and free wires. Unravel a second strand and with this wind a further six to eight turns close up to but in the opposite direction to the previous winding and again lay any spare parallel with the main and free wires. Repeat the process with each strand of the free end of the cable. Using this method it is not possible to secure the last strand but due to the stiffness of the galvanised iron wire, it will be found that if after the last winding, the ends are clipped off neatly, the winding will remain securely in place.

## Splicing two cables

Although not normally recommended, it is sometimes necessary to join two cables. For this operation, splay the strands of each cable for a distance of about six inches. Interweave the splayed ends together and bring the strands parallel with the main cables. Take one strand from one main cable and bind six to eight turns around the other main cable and strands parallel to it, laying any excess length parallel to the main cable. Repeat on the other side of the join. Take a second strand from adjacent to the first main cable and wind six to eight turns adjacent to but in the opposite direction to the previous

winding. Continue in a similar fashion to that described for fixing an insulator. Whilst it cannot be claimed that such a joint is as strong as an unjoined wire, nevertheless, in my experience I have never known such a joint fail.

## Erection of mast

The erection of the mast requires careful planning and preparation, otherwise not only will a great deal of effort be wasted, but damage could occur to the mast, to the aerial in the case of a beam, to property or even injury to you or your helpers.

There are two common methods of elevating a free-standing mast. Which is chosen will depend upon such factors as the amount of space available, the number of helpers available, the height of the mast and its headload. Particular consideration should be given to the loading especially when using light alloy poles, for it is due to this that most accidents occur. The author well remembers one field day when an attempt was being made to erect a 50ft alloy pole with a headload of two Tonna 16 element beams and a rotator. The base of the mast had been secured and a crowd of enthusiastic helpers attempted to push up the mast by hand. The mast bowed more and more until the midpoint was perhaps 15 – 20 feet above the ground whilst the antenna end had hardly moved.

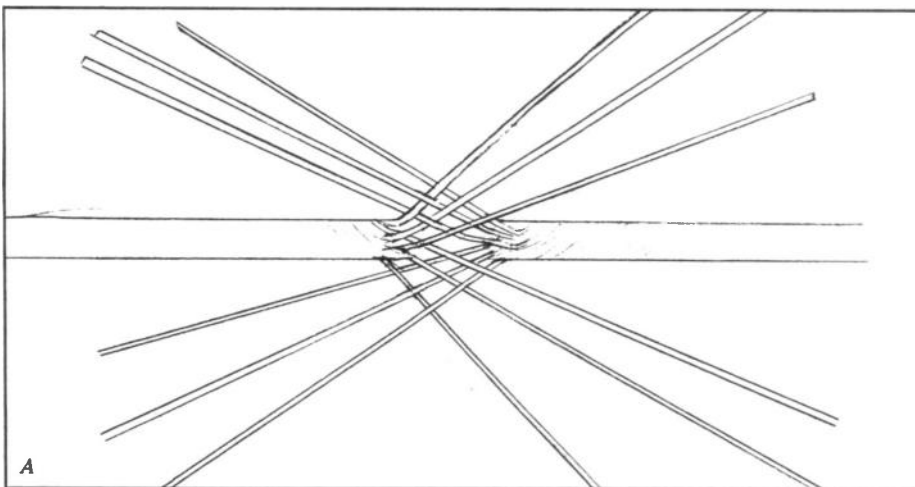

Left: Splicing two wire ropes in three stages. Mesh them as in the picture, then straighten the wires, finally completing each side as for splicing an eye.





Eventually the aerials started lifting but when they were some 20 feet above the ground, started wobbling, the mast started whipping about and then a coupler broke under the strain and the mast came crashing to the ground, wrecking the beams. Several hours and a lot of hard work later the station came on the air with a shortened mast and a small beam made from the remains of the two Tonnas. If correct techniques had been applied, the original system would have been erected within a few minutes.

The first essential in erecting any guyed mast is to make sure that the guy pickets are secure in the correct position, that the guy wires have been cut to the correct length and secured to the mast. Connect all guys except those to one picket and lay the mast such that the base is adjacent to where it will eventually stand and that it is in a line opposite to that of the unconnected guys. A picket should be driven into the ground adjacent to the baseplate and the base of the mast should be joined to the picket with a short (about 12 inches) of rope (not wire). The pole is then brought to the vertical position using either ladders or a gin pole (also called a falling derrick).

In the former case, the mast is gradually lifted into position by a number of helpers spaced along its length. As the pole is elevated beyond arms reach of the helpers, so they continue to support the pole with the help of one or more ladders until the vertical position is reached. At all times care should be taken to make sure that the mast remains as straight as possible and that no "bow" develops. This is of such importance that if at all possible one helper should be delegated to sole job of watching progress and giving appropriate instructions.

The second, and better, method is to use a gin pole. For this a further length of pole is required - preferably the same length as the distance from the base of the mast to the guy pickets. The unattached guys from the mast and three other ropes are attached to one end of the gin pole whilst the other end is fixed at right angles to the base of the mast. One of the three ropes attached to the gin pole is led in the direction of pull which will be towards the as yet unused picket and the other two are led to either side in order to hold the gin pole vertical and prevent it tilting to either

side during the lifting operation. A steady pull is then exerted on the centre rope as the gin pole is pulled towards the ground so that the mast is brought to the vertical position, supported throughout the lift by its own guys. A most important factor in this part of the operation is that the pull should be slow and smooth, for if it is not, the partially erected mast could develop a wobble which could easily get out of control and cause a catastrophe.

When the mast is vertical the gin pole should be resting on the ground and it only remains to transfer the guy wires to the picket, remove the gin pole and finally tension all the guy wires by means of the turnbuckles. Although these techniques may seem long and complicated when described in words, they are soon learned and never again will you have the slightest qualms about erecting any mast you may require. You will also be confident that there it will remain, defying the worst conditions that Mother Nature can offer.

*Right: Splicing a stranded wire rope onto an insulator using the unravelled strand method. Unravel one strand first, whilst the second strand is wound six-to-eight turns in the opposite direction.*

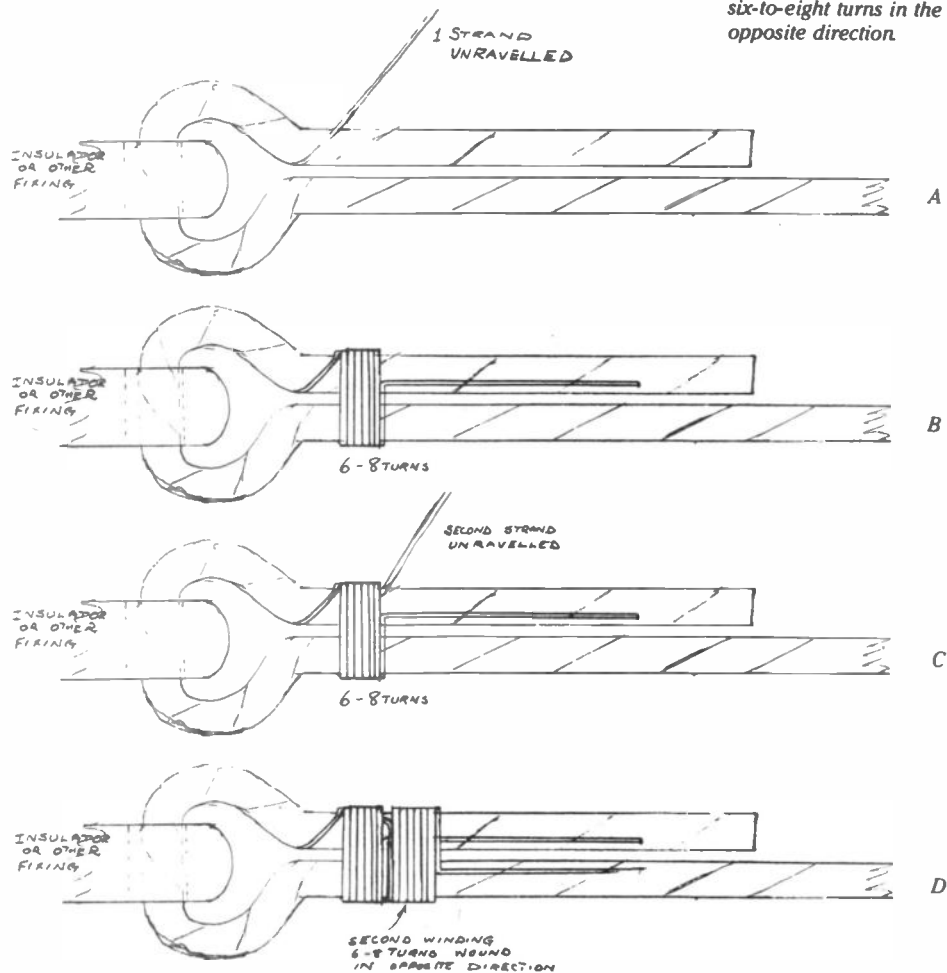

# HOW TO RIG AERIAL MASTS

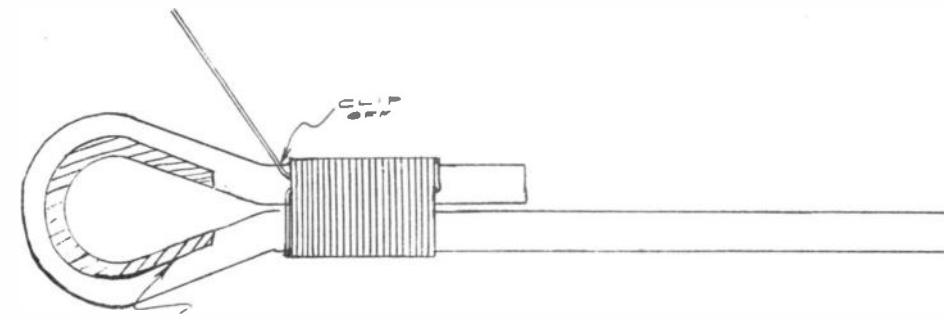
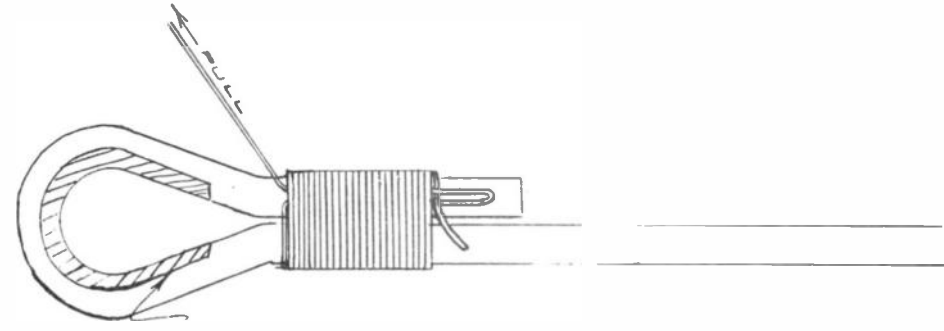
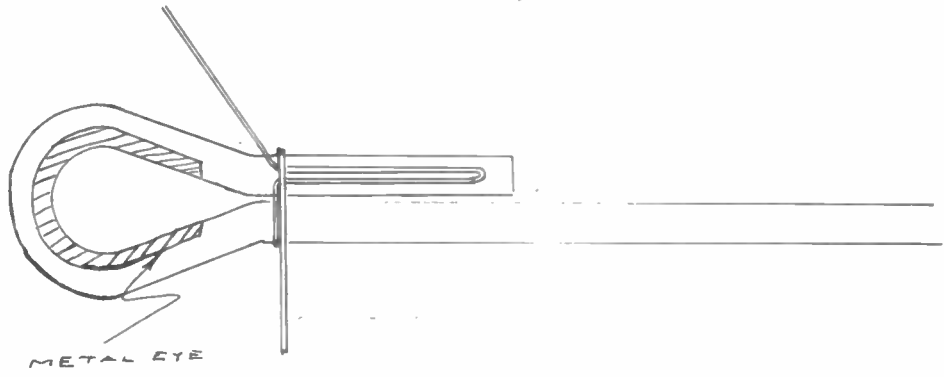
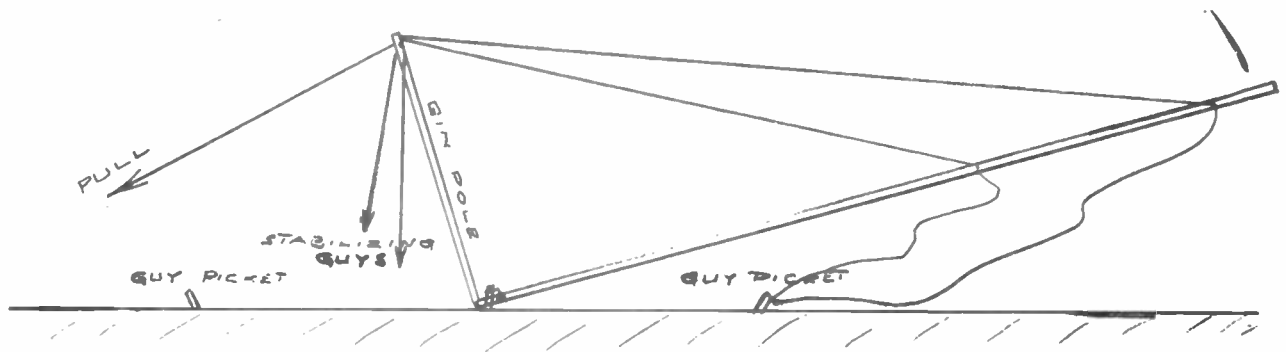
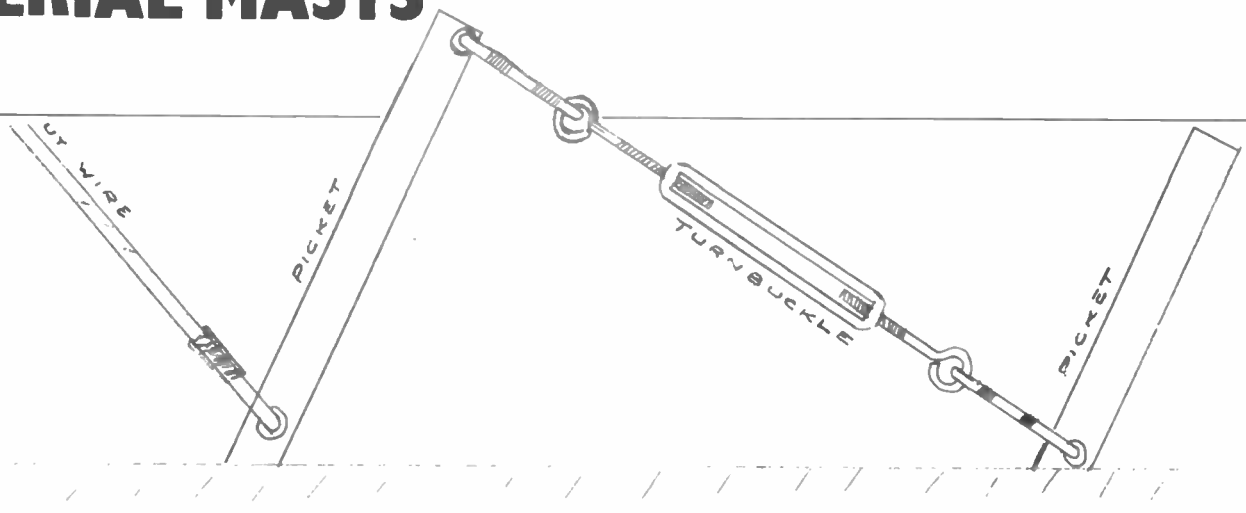

Top: Double picketing in soft or shallow earth. Above: This shows how to erect a mast using a gin pole (falling derrick) that's too heavy to lift by hand. Left: Whipping a rope (not wire) onto an eye, describing a waxed string system where the end result is both strong and long-lasting.

# ELECTRONIC BARGAIN SUPPLIES

## VERSATILE BENCH POWER SUPPLY UNITS

Contains high quality transformer made to exacting specifications giving one 40v output and one 20-0-20v output RMS. All outputs 3 amps. D.C. input 110/250v c/s. Bridge rectification. Contained on metal chassis with robust compact case size 7" x 5 1/2" x 4 1/2". Easily modified to give 40 or 60v output. Makes an ideal variable power supply. Normally cost around £60.00. OUR PRICE AS NEW with circuits £8.50. Carr.£3. 2 units for £20 carr. free.

COMPLETE VALVES LINE-UP REPLACEMENT SETS. For most communication receivers. Send SAE for quote.

MINIATURE MAINS TRANSFORMER. Mains input. Output 6-0-V. 250MA. 90p. P&P 35p. 2 for £2. post free. 10 for £8.75 post free.

FERITE RODS. 4" long. 5/16th diam. Packs of 10 £1.35. PP 50p. 10 packs (100 rods) £10. Carr. £2.50.

SCOOP PURCHASE PYE POCKET PHONE RECEIVERS. Type PF1 normal freq. 450Hz. Supplied in used condition less battery. £4.50 each. Carr. £1. 2 for £9. post free. 4 for £16 post free.

MINIATURE TRANSISTORISED BFO UNIT. Enables you to receive C.W. and S.S.B. transmission. Fully transistorised (tunable). Very compact. Fits anywhere. Single hole fixing. Brand new with fitting instructions. £8.95. PP 50p.

GENUINE AFV TANK HEADSETS AND MIKE. £3.50 per pair. PP.£1.50. 2 pairs £7.50 post free. All headphones fitted with ex ministry plug. Standard jack plugs available. 25p each. 2 for 40p. Headphone extension sockets available at 25p each. 2 for 40p. Impedance on first two items 600ohms. All headphones in good condition.

WE SELL VALVES OF ALL TYPES. Please send SAE for your requirements.

## THE GOVERNMENT SURPLUS WIRELESS EQUIPMENT HANDBOOK

Gives detailed information and circuit diagrams for British and American Government Surplus receivers, transmitters, test equipment etc. Also suggested modification details and improvements for surplus equipment. Incorporated is a surplus commercial cross reference valve and transformer guide. The standard reference work in this field ONLY £7.50 PP £1.50. No VAT on books.

PYE POCKET PHONE PF1 DATA AND INSTRUCTIONS. Contains circuit layouts, operating and modification details for amateur use etc. £1.50 post free.

New release of MODERN DYNAMIC MOVING COIL MICROPHONES. 200ohms impedance. Switch incorporated. With lead and DIN plug. Used but nice condition. 3 designs of case housing. Price one make our choice £2.00 plus 50p PP. Bargain offer all 3 mikes £4.50 PP £1.

GENUINE TRANSFORMER BARGAIN. Brand new Westool 15v, 1 amp transformers. Mains input £2.25 each. PP 60p. or 2 for £4.50 PP £1.

GENUINE EX GOVT COLLASABLE AERIALS. A fully adjustable highly efficient whip aerial in 5 sections. Length 1 1/2 metres Closed 300mm. Copper plated sections. As used on Ex Govt manpacks. Brand new in makers boxes £2.50 each. PP 75p. 2 for £5 post free.

HAVE YOU SEEN THE GREEN CAT 1,000's of new components radio, electronic, audio at unbelievably low prices. Send 50p for catalogue. (Refundable on purchase).

PLEASE ADD 15% VAT to all orders including carriage and PP.

*Myers Electronic Devices*

Dept. AR5 12/14 Harper Street, Leeds LS2 7EA.  
Tel. (0532) 452045. Retail premises at above address.  
(opposite Corals). 9 to 5 Mon to Sat. Sunday 10 to 1 by appointment. Govt. Surplus Items always in stock.

# WOOD & DOUGLAS

## Interested in Amateur TV?

*Did you miss the BATC Convention at the Post House, Leicester.*

*This is what we had to offer....*

LIVE DEMONSTRATIONS of practical FM TV systems at

1.3 GHz

2.3 GHz

10 GHz

using as the heart of the receive system our new product the VIDIF. The single pcb provides a complete 52MHz centre frequency wide band FM demodulator. A down converted rf video signal from any amateur or DBS source is limited, demodulated and converted to two standard IV video levels. This will drive a monitor directly or via our TVMOD 1 UHF modulator into a domestic TV set. The board gives an a.g.e. output to drive an '5' meter and provides an a.f.c. level for 'front end' stability. The module fits our new standard enclosure for total accessibility and screening.

All this for only £38.95 in kit form. Complementary modules are already underway for front end converters and low level exciters.

Our AM TV PRODUCTS were on offer in kit form and we extend this to AMATEUR RADIO readers until 31/7/83.

Any purchase of an ATV-1 or ATV-2 70cms video transmitter can take a 3W to 10W linear as part of the package.

If you are keen on constructing you can make an equivalent system from our standard kits. Typical package offer are:-

- |                     |        |
|---------------------|--------|
| 1) 500mW Transmit   | £30.00 |
| 2) 10W Transmit     | £50.00 |
| 3) 500mW Transceive | £50.00 |
| 4) 10W Transceive   | £70.00 |

Interested? Ring for further details, place your order by credit card too.

One other NEW PRODUCT worth mentioning is the 70PA5 GqAs MESFE pre-amp. This is designed for 70 cms operation and will give typically 1.5dB Noise Figure with an associated gain of 16dB. The kit sold very well at the Convention and is very straightforward to build. Have a go, its only £12.65 in kit form.

These offers and many new products are detailed in our new price list available on receipt of an A4 SAE to our Aldermaston Works.

Prices include VAT at the current rate. Please add 75p postage and handling to the total order. ATV-1 and ATV-2 orders should include £2.00 for postage and insurance. Please allow 28 days for delivery if not stock at time of ordering.

### MAIN AGENTS:

J. Birkett. LINCOLN 0522-20767

Darwen Electronics, LANCS 0254-771497

Wood & Douglas (Scandia) HB,  
SWEDEN 040-94-89-55

UNIT 13  
YOUNG INDUSTRIAL ESTATE  
ALDERMASTON  
READING RG7 4PQ.  
TELEPHONE: (07356) 5324.



# TALK TO THE WHOLE WORLD



Study now for the  
**RADIO AMATEUR'S EXAMINATION**  
We have had 40 years successful experience in training men and women for the G.P.O. Transmitting licence.

FREE R.A.E. brochure without obligation from:-

British National Radio & Electronics School  
READING, BERKS. RG1 1BR

Name .....

Address .....

BLOCK CAPS PLEASE

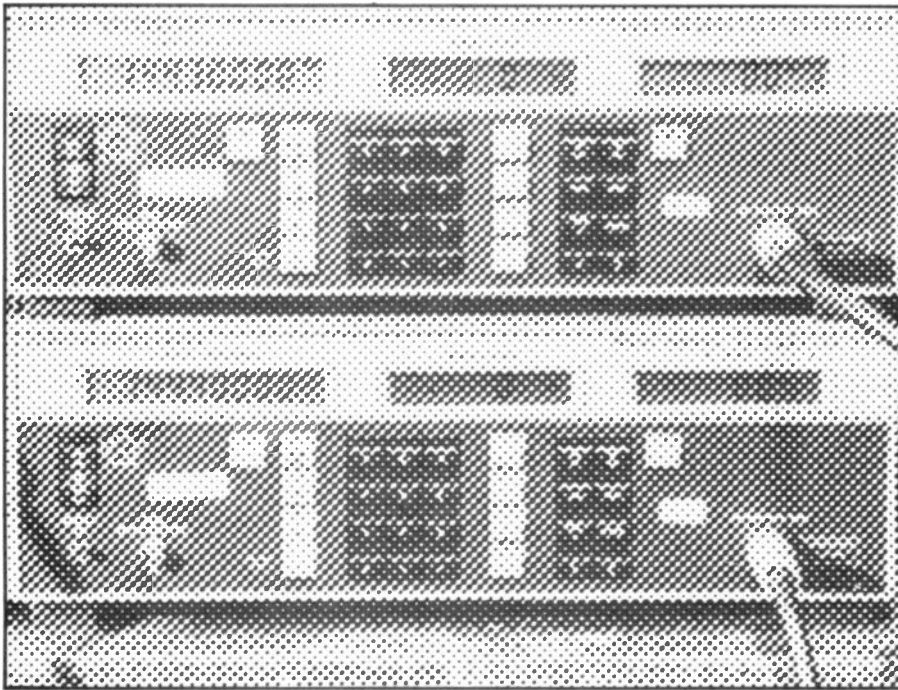

## From the lab to the shack

Angus McKenzie, G3OSS, continues his explanation of how amateur radio equipment is measured, bearing in mind the relevance of laboratory measurements. This month, G3OSS takes a look at more front end measurements, including radio frequency intermodulation distortion, reciprocal mixing, image response, and front end band width.

Last month I described the relevance of front end sensitivity to the frequency band in use. It should be noted that two receivers which have the same noise figure for their front end may have considerably different sensitivities, because of IF bandwidth and detector characteristic differences, whilst two receivers can have different noise figures but the same IF sensitivity.

The very good FM receiver having an excellent noise figure, as well as a good discriminator and limiter, may show little or no advantage when a preamp is put in front of it. A very good receiver having a good front end is extremely useful for comparing the qualities of different preamps.

Don't forget that a poor receiver may well show more improvement with just a fairly good pre-amp which has a high gain, than with a pre-amp that has a very long cable run which loses you several dBs at UHF. Then a high gain pre-amp with a 2dB noise figure may be noticeably superior to one with a 1dB noise figure, but have perhaps 10dB gain instead of 15dB.

### The dreaded RFIM

Now let's consider the effects of radio frequency intermodulation distortion, and the way that the performance of a system in this area deteriorates very significantly when pre-amps are used.

The easiest way to explain RFIM is to look at a well-known example, and then briefly check the mathematics to see how it has occurred. Just imagine that two stations are talking to one another on S21 (145.525MHz), and one is quite close to you. You decide to put a call out on S20 (145.5MHz), and whilst listening for a reply you notice two stations talking at once on your calling channel, apparently without any beat note. Maybe you don't realise that they are not on S20, one of them actually being on S21, whilst the other has popped up on S22 (145.55MHz). Two stations on S21 and S22, both being received strongly, will be generating radio frequency intermodulation products on both S20 and S23 (145.575MHz). The S20 and S23 products are 3rd order, and if a receiver is very bad indeed, you may also notice 5th order IM one channel further away still, ie on S19 and S24.

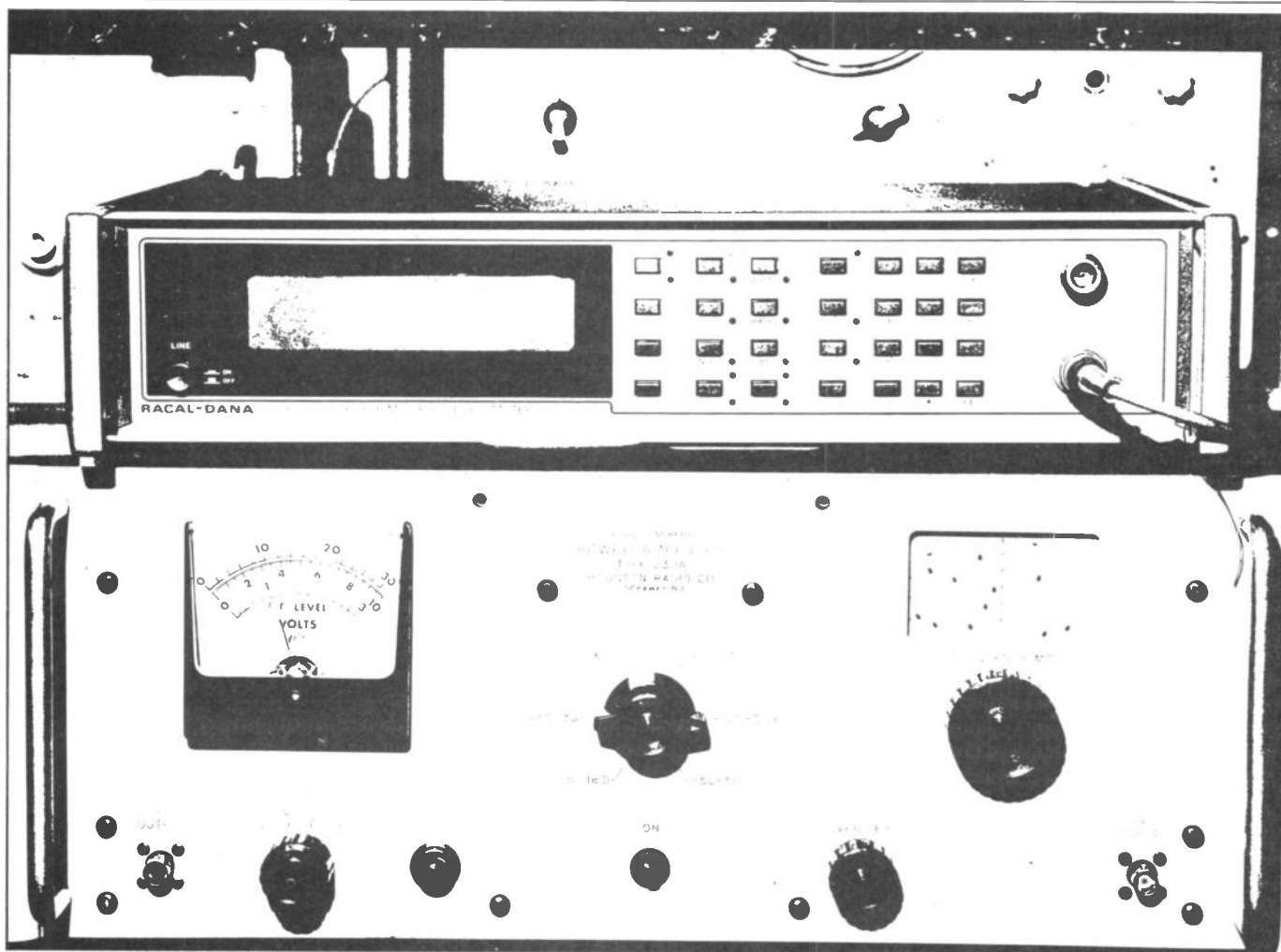

Equipment such as this is in great demand for testing electronic hi-fi, and radio units. Seen in the laboratory of G3OSS

You can work out easily where IM products are coming from, if you can find one of the two main products, plus one of the stations which are strong enough to be causing the problem. Listen carefully to the two signals apparently on the same channel, and then try to find one of them. Note the frequency difference between the IM products and the main transmission. The other causatory transmission is either half way between those two, or twice as far off frequency. Two frequencies, F1 and F2 will generate 3rd order products at  $(2F1 - F2)$ , and  $(2F2 - F1)$ . If you work it out you

will see how S20 and S23 resulted from S21 and S22. The poorer the IM performance of the receiver, the stronger will be the IM levels, and the weaker the signals will have to be to create audible products.

**“... dozens of stations coming in with very strong signals, perhaps during a contest...”**

Bad IM products can be far stronger than the station you want to receive.

Matters are particularly important with SSB, where there may be dozens of stations coming in with very strong signals perhaps during a contest, which may be generating a bevy of strong IM products. Even more annoying is when an exceptionally strong carrier is received outside, for example, the 2m amateur band, which can have a devastating effect on most average rigs, so let's have a look at what has been commonly called "the Euston Tower syndrome".

I do not want to quote precise frequencies or locations of actual transmissions which are causing amateurs in the London area a considerable headache, so let's look at some typical examples which will explain the syndrome.



## From the lab to the shack

Imagine an exceptionally strong silent carrier on 141.5MHz, receivable in the entire greater London area, then add to this, from another location, a very strong digital transmission on 143MHz which, say, was amplitude modulated for some strange reason, with a 10kHz sampling rate. This transmission would have sidebands at 10kHz intervals, and if the pulses were not rounded off as they should be, the sidebands would be very wide indeed. Within the average rig, the two separate transmissions at 141.5 and 143MHz would give a spurious IM product at 144.5MHz, together with strange noise humps at 10kHz intervals either side.

**“On a poor receiver all sorts of burbles and noise humps across the band which vary dependant upon where your antenna is pointing”**

Within perhaps an SSB receiver, these 10kHz sidebands could actually beat with the beacon GB3VHF (144.925MHz), and give you lots of little beacons at 10kHz spacings either side. Supposing you then add a few more strong carriers, some blank, and some with different forms of digital modulation, all below 144MHz, then you would be able to detect on a poor receiver all sorts of burbles and noise humps across the band, which vary dependent upon where your antenna is pointing. You find to your surprise that when you take the pre-amp out, either at mast head or on your shack bench, the problem almost disappears. You might blame the pre-amp, thinking it is causing trouble, whereas what is probably happening is that the wide response of the pre-amp is letting in all the rubbish with virtually no attenuation, and pushing your receiver far beyond the point where intermod becomes noticeable.

There are many locations in the Greater London area where 2m mobiles may have to close down because of these problems, one being very close to Warren Street station. It is understandable that the authorities claim that the problem is in the receiver, and quite frankly they are right. I suggest here that the majority of 2m rigs are nowhere near bomb proof enough, and it's partly because of this mania we have for having the best possible sensitivity.

It has been customary for people to talk rather glibly about the importance of the intercept point, and so here are a few words about it, together with a few common misconceptions; We can measure the ratio between two equal RF carriers being received, and the level of the 3rd order IM product generated in the receiver. Let us say that a particular level of each of the two carriers gives an IM product 60dB below their equivalent level on either side.

**“... people talk glibly about the importance of the intercept point... a few words about it”**

3rd order intermodulation, when introduced by one stage along, and in a conventional manner, increases at double the rate of the causatory carriers. For example, if we increase the levels of the two carriers from 100 $\mu$ V to 1mV, an increase of 20dB, then the IM products (3rd order) will increase by 40dB. Thus if we determine the point for the IM products at -60dB, then an increase of 30dB in input signals would have double the effect and give the equivalent of an equal IM product. This never actually occurs in practice in quite this way, but this level is termed the intercept point. Two carriers, each of 1 $\mu$ V, which give an S meter reading of a product which is equivalent to 1 $\mu$ V, would have an intercept point of 31.6mV, ie, 30dB up on 1mV, which is itself 60dB up on 1 $\mu$ V.

Unfortunately, the calculation of intercept point in this manner is not of much use, other than for giving a “number” which might impress the less-than-knowledgeable reader. The calculation is too often based on one measurement only, despite the fact that front end RFI, is caused by the mixer and all the stages before it. It is more useful, but much more difficult if one can obtain at least three

separate points giving, for example, 60dB, 50dB, and 40dB IM products. By plotting these on a graph, one can begin to see that they are almost certainly not on a straight line, and the real intercept point will in almost all circumstances actually be at a somewhat lower level than that arrived at from a single measurement.

In the lab, we first of all calibrate the S meter with the rig switched to the mode which is to be used for the measurements. Having determined the single tone inputs required for the different S meter readings, one can develop two tones of equal level, mix them in a hybrid transformer, then feed them through a calibrated attenuator, thence through a stabilising attenuator into the rig. By selecting the two signal generator frequencies appropriately, and tuning in the rig to the 3rd order product, one can lift the levels until the product hits S2, S6 and S9. By noting the degrees of attenuation which have to be taken out one can immediately calculate RFIM ratios.

The principle is the same whether you are looking at an HF or VHF rig. Some measurers like to look at the level at which the IM product adds, say, 3dB to the noise floor, using an RMS meter. The IP is then the same level as the noise floor, which can itself be independently verified from a single tone generator source. One must bear in mind the RF bandwidth of the system, as well as the IF bandwidth, since of course the frequency spacing between the two carriers must be considerably wider than the IF bandwidth at say -60dB, whilst normally being within the RF input circuitry bandwidth.

### Front-end bandwidth

The front end bandwidth of the receiver is controlled by the band pass characteristics of any tuned circuits, from the aerial input coil to the feed into the mixer. Sometimes the Q of the circuits can be quite high, and in some rigs helical or some other type of filter is employed, interdigital filters being used having very steep skirts for microwave applications. HF receivers will often have low pass and high pass filters which can be switched in and out with diodes to give the optimum pass band for any particular frequency region. The greater the selectivity before mixing, the fewer will be the spurious products developed at the mixer.

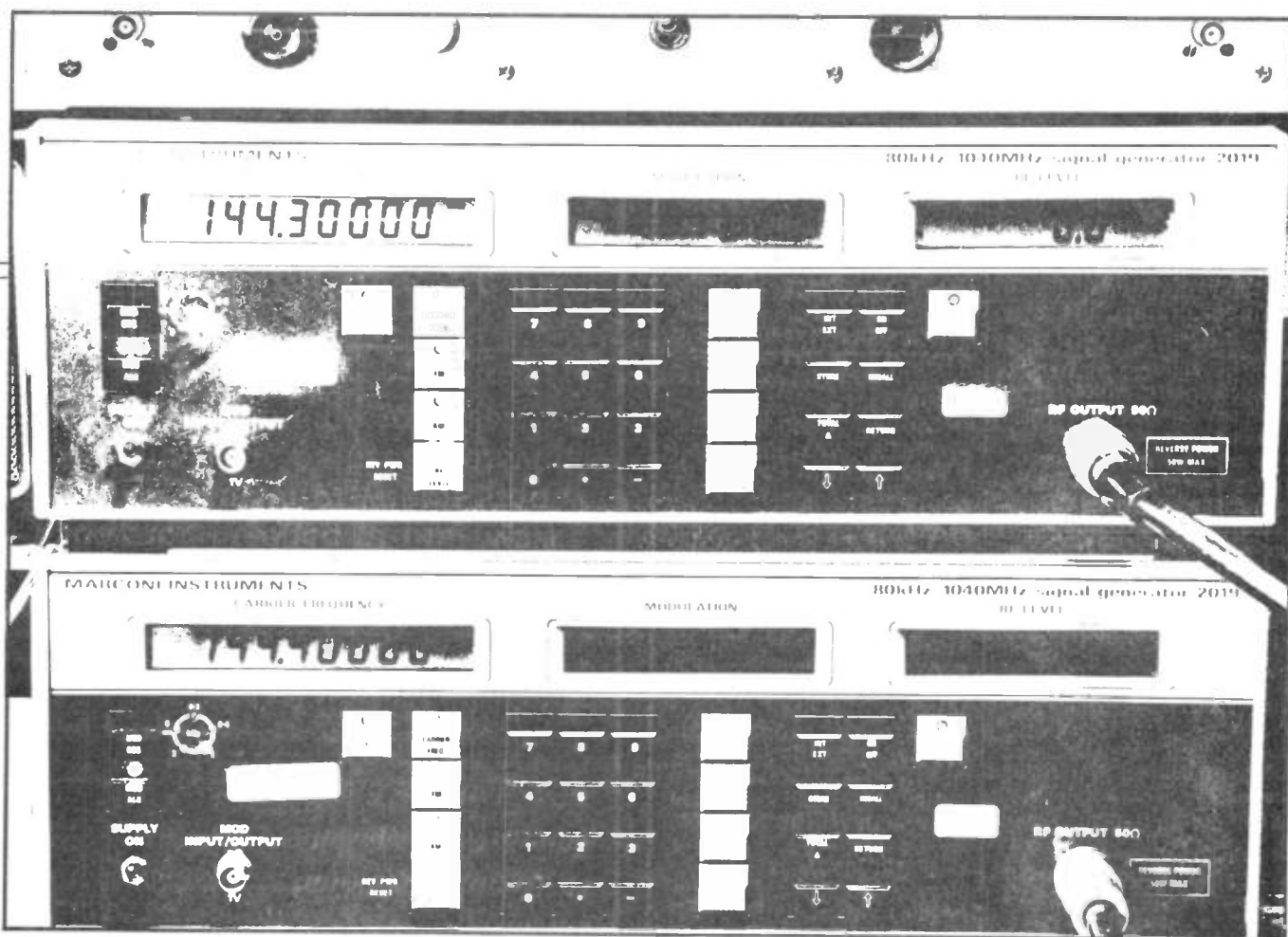

Just imagine you live quite close to Brookmans Park in London as in fact I do. Connecting an average long wire aerial to an average inexpensive short wave receiver will normally receive bad IM products all over top band. A steep high pass filter inserted, cutting steeply below 1.8MHz (Yaesu makes one of these), almost completely eliminates medium wave breakthrough. Unfortunately, high Q circuits in front of pre-amplifier stages can seriously affect input sensitivity, and so one can go too far in improving RF selectivity against sensitivity.

**“... one of the most difficult measurements and parameters is reciprocal mixing”**

Hand in hand with RF selectivity is one of the most difficult measurements and parameters, reciprocal mixing. Imagine you want to receive a very weak signal on 144.15MHz, in the presence of a signal 50kHz higher, of many millivolts. Even if this signal were itself completely clean, it would beat with the noise sidebands of the receiver's local oscillator to introduce IF

noise. Noise 50kHz off the local oscillator frequency perhaps generated as synthesiser noise, could be enough to be heard at the same sort of level as that of the weak station.

**“You would hear noise puffs underneath your wanted weak station - one must have an impeccably silent carrier”**

If the strong signal at 144.2MHz was a CW one, then you would hear noise puffs underneath your wanted weak station, which might make you think that the CW transmission was faulty, rather than the design of your receiver being poor. For testing reciprocal mixing, eg, the sideband noise of the receiver's local oscillator, one must have an impeccably silent carrier, preferably crystal-controlled, an order of magnitude quieter than any system likely to be measured against it. Despite the complexity of reciprocal noise, there can be no doubt that it is one of the most important factors in determining a receiver's dynamic range.

Image response problems abounded in the old valve receivers of yesteryear, such as the AR88, and the CR100. The first IF was 455kHz, and so the local oscillator could beat with input frequencies  $\pm 455$ kHz. At frequencies up to 15MHz or so, the front end selectivity was more than sufficient to give a good image ratio, but by the time you tuned up to 28MHz you would also be receiving a channel 910kHz away, at perhaps only 30dB down. This caused many problems when 28 to 30MHz was used as an IF for 2m converters in the old days.

Next month I shall look at image ratio and local oscillator problems in further detail, together with problems at intermediate frequency, and the measurement of various parameters.

# PROCEDURES • 3

Well, well – you remember that last time we were listening to our heroes having a contact, when disaster struck? G6ZZZ had been in the throes of a contact with GW4ABC in Swansea (apologies to the eventual owner of G6ZZZ, by the way – we didn't mean it personally, honest) when suddenly we hear:

**"Break, from G6YYYY"**

**"Hello, Fred, go ahead"**

**"Sorry to break in, Jim, but did you know you're something like plus and minus 14kHz with me? G6ZZZ from G6YYYY"**

**"Oh dear, hang on a sec..."**

Now I know we've been beefing a bit recently about the quality of signals but this isn't a devious way of moaning; it's nice to know what might be at the root of the problem, and we feel that many new licencees don't know quite what to do if someone comes along with a remark such as this. Equally, it might be nice to know what you're looking for if you're the one doing the complaining! So let's see what happens:

**"GW4ABC, this is G6ZZZ. I'm told by a local that I seem to have a problem, so if you don't mind I'll sign with you now and have a look at it. Many thanks for the contact and for the new square – hope to work you again soon. Golf Four Alfa Bravo Charlie, this is Golf Six Zulu Zulu Zulu signing and by for your final"**

**"OK, G6ZZZ from GW4ABC. Well, very nice to meet you for the first time and hope we'll meet up again soon. Golf Whisky Four Alfa Bravo Charlie off and clear with Golf Six Zulu Zulu Zulu, listening briefly this frequency and then closing down, bye bye"**

**"Cheers Mike, all the best – Golf Six Zulu Zulu Zulu clear with GW4ABC and continuing with G6YYYY"... short pause.**

Let's look at this. G6ZZZ wants to take a look at the problem so, instead of carrying on the contact with the Welsh station he signs off with him – they could have gone on to talk about whatever they wanted to, although with unstable signals and some difficulty with fading and so on it's unlikely that they would have held it for very much longer.

There are all sorts of styles of ending a contact on voice modes; the classic way is to say more or less what G6ZZZ did. In other words to include both the distant station's callsign and his own and then state that he was "signing". He then puts it back to GW4ABC for his "final", or final transmission. GW4ABC takes the chance to say his last words and then says that

## Basic operating procedures explained in traditional English, by Technical Editor Nigel Gresley, who continues this month with the next instalment of the adventures of Fred and Jim.

he's "off and clear" with G6ZZZ – this is a time-honoured ceremonial formula and many people these days just say "...GW4ABC clear with G6ZZZ..." In other words, however and whatever you say you've now ceased communication with the other guy, and the time at which you do so is what you put in the log.

So the usual sequence is whoever wants to get away first "signs" and passes the transmission back to his partner for his "final" – he then announces that he's "off and clear" or "clear" or whatever, leaving the man who signed first to announce his intentions.

This is where it gets interesting, and we've heard a lot of promising contacts go wrong over the years through fouling up this bit. Generally speaking, the man who made the initial CQ call keeps the frequency and the person who called him moves elsewhere – or, if you call someone you'd usually be the one to move when the QSO is complete. However, there are a couple of things to remember. A Welsh station in X-ray Lima isn't exactly commonly copied in Alfa Lima, and there might be several stations listening on the frequency and itching to try and work him. Now, remembering that it was he who called G6ZZZ, the normal course of events would be for him to move off the frequency and go someplace else, but in the event he knows he's rare-ish and says he'll "listen briefly this frequency". G6ZZZ also knows, or ought to, that the Welshman may well get called by others and so after his final transmission he doesn't continue straight away with G6YYYY but he leaves a couple of seconds' pause so that anyone local to him who would like to work Mike can give him a call and establish contact. Let's see what might happen:

**"GW4ABC, Golf Whisky Four Alfa Bravo Charlie, this is Golf Six X-ray Yankee Zulu, G6XYZ in Alfa Mike square calling and by."**

**G6XYZ from GW4ABC – roger roger, I copy you. I'll listen for you 10 up on 144.24, OK?"**

**"Call you 10 up, G6XYZ".**

So because G6ZZZ and G6YYYY are courteous enough to leave a little pause, some-

one else gets a chance to work the Welshman and set up a contact with him elsewhere in the band whilst the other two get on with their tests. GW4ABC said he was closing down, but he probably won't be averse to working AM square, or if he already has he won't mind exchanging reports with G6XYZ just to confirm the square for him.

So, thanks GW4ABC, you were a good chap, enjoy your wireless. He disappears from the story now, except to say that there's one other thing that might have happened when he and G6ZZZ had finished. Suppose that there was a really good east-west opening and GW4ABC had been 5 and 9 over a good area of Germany; he'd probably have been called by about a million DLs after he'd signed with G6ZZZ. In which case G6ZZZ would probably suggest to G6YYYY that they slide up the band a bit and leave him to it – actually, they'd slide up the band quite a long way if they were going to do any tests so as not to cause QRM to those taking part in the massive opening!

In other words, if you call CQ and some rarish DX comes back, there are times when you can't expect to keep the frequency even though you were there first. In fact, if you do work someone in that category I'd suggest moving away anyhow, especially if he isn't a strong signal, because Murphy's Law of DX-chasing on VHF says that one good way to lose the prize contact you've been trying to make for the last 20 years is to try changing frequency when signals are weak. The *only* exception is the calling frequency, and even if the DX is the rarest of the rare you'd better move off it as we discussed last time. Two reasons – you're monopolising it to the exclusion of everyone else who wants to use it, and some simpleton is bound to come up and call CQ just as the DX is passing your report and fading rapidly into the noise – net result, you lose him for good under another contact and sit muttering and cursing, and generally feeling murderous.

Back to the problem in sunny Sevenoaks.

**"G6ZZZ from G6YYYY – sorry about that but I thought you'd like to know, over"**

**"OK Fred, from G6ZZZ – no, I don't like using the amplifier when something's wrong, you never know who you're clobbering. Can you say what the problem is, go ahead"**

**"G6ZZZ from G6YYYY. Well, you're about S9 with me, I'm not really beaming your way and I don't think that's the sort of level where I'd begin to suspect the receiver, but when I tune round your signal I can hear all sorts of spitchy noises out to about 8kHz either side and then**

there are still a few whiskers and things out to about 15kHz either side. The audio sounds OK though, so I wonder whether something is amiss with the linear. I'll be happy to do some tests if you like, Jim. G6ZZZ from G6YYY"

"Thanks Fred, I'd appreciate that - G6YYY from G6ZZZ. Let me just check everything here. Hold on"

So G6YYY has said that G6ZZZ's signal isn't so strong that he'd expect his receiver to be caving in under the strain. Too many reports of wide signals have been given by chaps whose front-end is not far off bursting into flames under the strain and the IF filter is about to flash over due to the intense electric field. Not quite, but you get the drift! Equally, some signals *are* wide, so there's blame on both sides. It's important to know at what point your receiver is going to start telling fibs about signals and if you're not sure, try turning your beam away to cut down the signal from the guy who you think has a poor transmission. Try some tests with a local station who you trust one of these evenings when there's no DX to work and the band seems as though it's forgotten how to propagate more than about ten yards and note the results in the log. While you're at it, get him to check out your own signal for things like width, carrier suppression and any other ailments and enter the results in the log as well. We'll look at tests you need to do from time to time in accordance with the terms of the licence later on in the series, but those we've mentioned will give you the general idea and will also give you a baseline for future tests every now and then so you can see that everything's behaving more or less as it should.

### See you further down the electricity bill

Anyhow, let's keep earwiggling, or "reading the mail", as they say. Oh yes, talking about the things they say, things like "see you further down the log" at the end of a contact really are a bit cliched these days. If you must, try the one I heard the other day, "see you further down the electricity bill!"

"OK, this is G6ZZZ testing with G6YYY. I've just had a look, Fred, and the amplifier was a bit off tune and the screen current was going rather a lot positive. I've just set it up for half an amp on the anodes and re-loaded for more or less no reading on the screen meters with a carrier in, can you have a look round it now. I'll just count up to ten and back a few times . . ."

Which he proceeds to do.

" . . . nine, ten, G6ZZZ testing with G6YYY and listening"

"From G6YYY. Yes Jim, that's a lot better but there are still a few whiskers on speech peaks. Are you driving it a bit hard? Suggest you have a look at the grid meters when you talk it up a bit, over."

"OK. Aaaaalo, aaaaaaalo, one, two, three, G6ZZZ testing, aaaalo, Golf Six Zulu Zulu Zulu testing, aaaaaalo. Right, that ought to do it, I was seeing about a milliamp of grid current and that shouldn't have been there, should it. I've wound the drive down, is that any better? G6YYY from G6ZZZ."

"G6ZZZ from G6YYY. Yes Jim, that's a lot better, I lose you about 4kHz HF and about 5LF and you're completely gone at that. No, there shouldn't be any grid current at all in Class AB1, sounds as though you had the drive a bit high."

So G6ZZZ discovers that it's simply a matter of retuning and reloading and turning the drive down a bit, and then his amplifier is back to normal. The reason for the "aaaaaalo" bit is that the meter movements can't follow the speech peaks in Jim's voice and he could well be running into grid current and not notice it on normal speech, so he makes a sustained sound in order to see some sort of consistent reading.

The fact that he sees any grid current at all alerts him immediately to the problem because in Class AB1 you can't take the drive up that far - RF-type linears are usually run in Class AB1, and one definition of that class of use is not to drive the valve beyond the point that grid current gets drawn on a half-cycle. If you do, it won't be a linear any more! Equally, it is important that 4CX amplifiers get loaded with reference to screen current - you mustn't load and tune them for every last watt of RF out because if you do it certainly won't have enough loading and you'll be in for the proverbial "flat topping" - bad scene. Still, he said earlier that he was using an EHT transformer at least and not one of the Ogden Special voltage quadrupler things - Gordon Bennett! If you want to see how *not* to make an EHT supply, see Spam Radio Toady a couple of issues ago . . .

So, with G6ZZZ back on the path of righteousness, let's see what happens next.

"There was one other thing Jim, from G6YYY. I noticed a little bit of carrier as I tuned through the signal, I guess the carrier suppression needs a bit of a tweak, go ahead."

"G6YYY from G6ZZZ. Okay Fred, I'll have a go at that later on. Many thanks indeed for all your help. Wonder what you've been working today? Over."

So the tests are complete, and G6ZZZ may well note the fact in his log. Fred obviously detected a little carrier and told Jim about it. It isn't a major problem and it just means he'll have to get the manual out and find out where the carrier balance pot is. What he'll then do is listen on another receiver and switch to transmit with the mic un-plugged - he'll then tweak the pot for minimum S-meter deflection on the other RX.

# STARTING FROM SCRATCH

You'll note, by the way, that in all these contacts the amateurs haven't solemnly been giving their callsigns at the beginning and end of each over, as you might imagine ought to be the case. What you usually find is that people use their common sense a bit and identify reasonably frequently but not each and every time they press the PTT. As far as we know this is perfectly acceptable to the Powers That Be as being within the spirit, if not the precise letter, of the licence - if we get a narky letter from the Home Office we'll let you know, but the guiding rule seems to be a bit of discretion and common sense, as we said. You soon get a feel for the general usage.

### Don't go breaking into every contact

You'll note, by the way, that in all these want to leap in to a contact that's already in progress, and you will need to use your common about this. Obviously if you know both parties well it's fair enough but don't go breaking into each and every contact you hear because it does get up some people's noses and in a way you can't blame them! It's all a matter of experience, though, and you'll pick it up as you go along.

Let's leave it there for this time. Next month we'll look at the finer points of contest operating; let's just wrap it up for now by seeing what Jim and Fred do.

" . . . so I didn't really work anything new even though conditions were reasonable. Anyway, the new issue of *Amateur Radio* magazine has arrived and I want to see if they've mixed up any more formulas this month - actually it isn't a bad magazine and I'll take out a subscription if they keep it up. Many thanks for all your help, Fred, and I gather they're featuring us in this month's - wonder what they'll say? G6YYY, this is Golf Six Zulu Zulu Zulu signing, wishing you all the best and may hear you on later."

"OK, Jim, glad to help. Yes, hope they say nice things about our operating. May see you later on. Golf Six Zulu Zulu Zulu, Golf Six Yankee Yankee Yankee in Alfa Lima square beaming north-west off and clear, briefly listening and then closing down!"

"Cheers. Golf Six Zulu Zulu Zulu beaming west from sunny Seven-oaks clear and listening."

You never know - they *might* be called by someone exotic! See you next time.



# South Midlands

SMC YOUR SINGLE STOP SOURCE FOR RECEIVERS,

 FT 1 GENERAL COVERAGE £1450 inc



 FT 980 COMPUTER AIDED TRANSCEIVER £1215 inc



Free FT901R transverter frame with every FT902 LIST £195.00

 FT 902DM all bands all mode £885 inc



 FT 102 ALL MODE HF TRANSCEIVER £839 inc

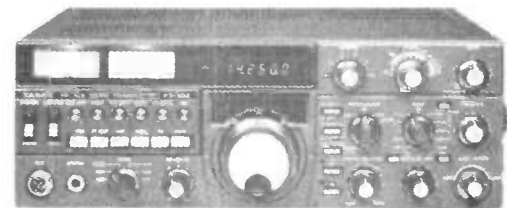

FREE FT707 transverter frame with every FT707 LIST £79.00

 FT 707 RUGGED HF MOBILE £515 inc

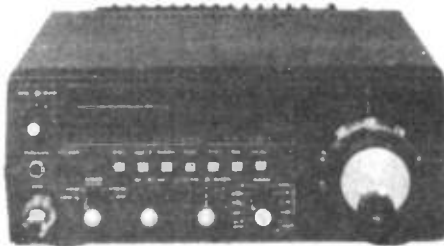

 FT 77 MOBILE TRANSCEIVER £515 inc



### COMPACT FM MOBILES for 2m or 70cm

 2m FT 230R £255 inc



70cm FT 730R £299 inc.

### MULTIMODE PORTABLES for 2m or 70cm

 2m FT 290R £285 inc  
70cm FT 790R £349 inc



 SMC FOR 2 YEAR YAESU GUARANTEE, FREE SECURICOR DELIVERY, FREE FINANCE.

**SMC SERVICE**  
Free Securicor delivery on major equipment.  
Access and Barclaycard over the phone.  
Biggest branch agent and dealer network.  
Securicor 'B' Service contract at £4.49.  
Biggest stockist of amateur equipment.

**FREE FINANCE**  
On many regular priced items SMC offers Free Finance (on invoice balances over £120).  
20% down and the balance over 6 months or  
50% down and the balance over a year.  
*You pay no more than the cash price!!*

**GUARANTEE**  
Importer warranty on Yaesu Musen products.  
Able staffed and equipped Service Department.  
Daily contact with the Yaesu Musen factory.  
Tens of thousands of spares and test equipment.  
Twenty-five years of professional experience.

S.M. HOUSE, RUMBRIDGE STREET, TOTTON, SOUTHAMPTON, SO4 4DP, ENGLAND,  
Tel: Totton (0703) 867333, Telex: 477351 SMCOMM G, Telegram: "Aerial" Southampton



# Communications Ltd

TRANSCEIVERS, ANTENNAS, TOWERS, MASTS, CABLES, ETC.



**Handhelds for 2m or 70cm**

2m FT 208R  
£199 inc

70cm FT 708R  
£229 inc

**FT726R MULTIMODE £699\* inc**

\*C/W 2m fitted. 70cm, 6m & HF modules optional

**FRG 7700 £355 inc**

7700 THE ONE WITH FM!  
MEMORY VERSION £399

**JRC COMMUNICATION RECEIVER:**

NRD 515, 100kHz-30MHz Coverage

### ANTENNAS VHF FIXED

<b>JAYBEAM</b>					
4Y/4M	Yagi 4 element	2.3M	7.8dB	29.90	2.20
LW5/2M	Yagi 5 element	1.6M	7.8dB	14.37	2.50
LW8/2M	Yagi 8 element	2.8M	9.5dB	17.82	2.50
LW10/2M	Yagi 10 element	3.55M	10.5dB	24.15	2.50
LW16/2M	Yagi 16 element	6.54M	13.4dB	35.07	3.20
14Y/2M	Yagi 14 element	5.34M	12.8dB	38.23	3.20
PBM10/2M	10 element Parabeam	3.93M	11.7dB	44.85	3.20
PBM14/2M	14 element Parabeam	5.95M	13.7dB	55.77	3.20
04/2M	Quad 4 element	1.5M	9.4dB	29.32	2.50
06/2M	Quad 6 element	2.5M	10.5dB	39.10	2.50
08/2M	Quad 8 element	3.54M	11.9dB	44.65	2.50
05/2M	Yagi 5 over 5 slot	1.6M	10.6dB	25.30	2.50
08/2M	Yagi 8 over 8 slot	2.8M	11.1dB	34.50	2.50
8XY/2M	Yagi 8 element crossed	1.7M	7.8dB	28.17	2.50
8XY/2M	Yagi 8 element crossed	2.8M	9.5dB	35.85	2.50
10XY/2M	Yagi 10 element crossed	3.6M	10.8dB	46.00	2.50
PBM18/70	18 element Parabeam	2.9M	13.5dB	32.20	2.50
PBM24/70	24 element Parabeam	4.5M	15.1dB	42.55	2.50
LW24/70	Yagi 24 element	5.1M	14.8dB	27.02	2.50
MBW28/70	28 element Multibeam	1.25M	11.5dB	21.27	2.50
MBM48/70	48 element Multibeam	1.83M	14.0dB	35.65	2.50
MBM58/70	88 element Multibeam	3.98M	16.3dB	48.87	2.50
8XY/70	Yagi 8 element crossed	1.5M	10.6dB	42.55	2.50
12XY/70	Yagi 12 element crossed	2.6M	12.8dB	52.90	2.50
CR2/23CM	Corner reflection	0.76M	13.5dB	40.25	2.50
<b>S.M.C.-H.S.</b>					
SMCGDX1	Discone 80-480MHz 3dB	3.3'		40.25	2.50
SMCGDX2	Discone 50-480MHz 3dB	6.2'		49.45	2.50
GDXA	Discone 100-440MHz 3dB			33.75	2.50
SMCVHF1	Discone 65-520MHz Rn only	5.0'		15.10	2.50
SMCGP23	Collinear 2M 3 x 1/4 wave 7.8dB	14.6'		39.85	2.50
SMCGP144W	Collinear 2M Multi 1/4 wave 8.5dB	10.2'		27.80	2.50
SMCGP2M	1/4 wave L/W ground plane 3.4dB	4.6'		18.00	2.50
SMCSQ144	2M Swivel Quad for vertical mounting			57.80	2.50
SMCGP432X	Collinear 70cm 3 x 1/4 wave 6.8dB	5.6'		29.50	2.50
SMC702V	Collinear 2.8dB 2M, 5.7dB 4M 70cm	3.6'		29.50	2.50
SMC2H86	6M HBSDV 2 Driven elements			19.95	2.50
SMCHS770	144/432 Duplexer 50W 30dB isolation			15.35	1.50

### ANTENNA ROTATORS

KRS0G	Kenpro, Elevator Meter cab ±90°	112.12	Free
9506	Channel Master, offset	80.21	Free
9502B	Channel Master, offset	56.92	Free
KR250	Kenpro, Ball type	54.91	Free
AR40	CDE Turn and Push control	90.85	Free
KR400RC	Kenpro Round meter 360°	114.94	Free
CD45	CDE 8 x 4cm meter readout	136.85	Free
KR600RC	Kenpro Round meter 360°	163.30	Free
Ham IV	CDE 8 x 4cm meter readout	258.75	Free
TXZ	CDE 8 x 4cm meter readout	327.75	Free
KR2000RC	Kenpro Heavy Duty round meter 360°	314.52	Free
<b>ROTATOR ACCESSORIES</b>			
9523	Support Bearing Upper type	15.81	2.50
KS050	Rotary Bearing Kenpro Takes 1 1/2" mast	13.74	2.50
KS065	Rotary Bearing Kenpro Takes 2" mast	20.12	2.50
KC038	Lower Mast Clamp for KR400, KR600	12.07	2.50
RCSW	5 Way For AR30 AR40 BT1 KR400RC	P/M	0.37
RCBW	8 Way For KR250-400/500/RCRC	P/M	0.51
RCBW	8 Way For CD45, Ham 4, TXZ, KR2000RC	P/M	0.55
Carriage on Rotator cable £1.80 up to 20 metres, over 20 metres £2.40			

### ANTENNAS HF FIXED

<b>HY GAIN</b>					
12AVD	Vertical 10, 15, 20	14.0H	50.80	2.75	
14AVD/WB	Vertical 10, 15, 20, 40	18.0H	64.40	2.75	
18AVT/WB	Vertical 10, 15, 20, 40, 80M	25.0H	113.85	2.75	
14RMQ	Roof mounting Kit 12AVD 14AVD & 18AVT		38.52	2.75	
18V	Vertical 10, 15, 20, 40, 80M	19.0H		38.52	2.75
103BA	3 Element Yagi 10 metres	17.0LE	8.0H	67.85	3.50
105BA	5 Element Yagi 10 metres	18.5LE	24.0H	155.25	3.95
155BA	5 Element Yagi 15 metres	23.0LE	12.0H	90.85	3.50
203BA	3 Element Yagi 20 metres	35.0LE	16.0H	178.25	4.90
204BA	4 Element Yagi 20 metres	36.5LE	26.0H	286.35	7.30
205BA	5 Element Yagi 20 metres	36.5LE	34.0H	396.75	9.40
402BA	2 Element Yagi 40 metres	43.0LE	16.0H	247.25	6.50
DB10/15A	2 Element Yagi 10-15M	23.0LE	13.0H	198.95	4.80
TH3JNR	3 Element Yagi 10-15-20M	24.2LE	12.0H	202.40	3.50
TH3MK3	2 Element Yagi 10-15-20M	27.3LE	8.0H	169.05	3.50
TH3MK3	3 Element Yagi 10-15-20M	27.0LE	14.0H	274.85	5.30
TH5DIX	"Thunderbird" 5 Element	31.0LE	18.0H	419.75	6.70
TH6DIX	"Thunderbird" 6 Element	31.1LE	24.0H	595.75	8.50
TH7DIX	"Thunderbird" 7 Element	31.0LE	20.7H	511.78	8.75
HYQUAD	2 Element Quad 10, 15, 20M	13.5TR	8.0H	354.20	8.00
18TD	Dipole Tape 10, 15, 20, 40, 80M		132	121.90	2.80
<b>JAYBEAM</b>					
VR3	Vertical 10-15-20M, DC Short	8.1h	13.5h	46.00	2.50
TB3	3 Element Yagi 10-15-20M	14.6TR	14.1H	189.75	5.40
<b>MINI BEAM</b>					
CA	Vertical Miniature 10-15-20M	8.1h	11.5h	59.00	2.50
H01	"Mini" Quad beam 10-15-20M	11.0LE	4.5H	139.00	4.00
<b>G 4MM MINI BEAM</b>					
	Mini Beam 10-15-20M			82.50	4.00
<b>SMC TRAPPED DIPOLE 10-80M 119° Potted Traps</b>					
SMCTD/HP	14SWG H/D cu traps 1000W PEP			43.41	2.50
SMCTD/P	Portable cu/terylene 75 caae			59.80	2.50
SMCHPT	High Power 7MMH 1000W Per Pair			15.52	1.80
<b>SMC-H.S. ANTENNA</b>					
SMCHFSV	Vertical 10, 15, 20, 40, 80M	15.7'		54.80	2.50
SMCHFSR	Radial lat loaded	6.5'-7.3'		34.80	2.50
SMCHFSVNB	Vertical 10-18-24M 1000W PEP	18.0H		51.35	2.50

### ANTENNAS VHF MOBILE

SMC20W	Element 144MHz 1/4 wave	0dB	2.30	1.50
SMC2NE	Element 144MHz 5/8 wave	3.0dB	6.90	1.80
SMC2VF	Element 144MHz 1/2 wave	3.0dB	11.50	1.80
SMC78F	Element 144MHz 7/8 wave	4.5dB	13.80	2.00
SMC78B	Element 144MHz 7/8 wave	4.5dB	13.80	2.00
SMC88F	Element 144MHz 8/8 wave	5.2dB	18.80	2.00
SMC258	Element 432MHz 2 x 5/8	5.5dB	12.65	1.80
SMC358	Element 432MHz 3 x 1/4	6.3dB	16.85	1.80
SMC70N2M	2M 2.7dB 70cm	5.1dB	16.85	1.80
SMCHS770	144/432 duplexer 50W 30dB isolation		15.35	1.50
SMCGCCA	Gutter clip 4 metres cable		9.95	1.80
SMCSOMM	Magnetic base l/w 4 metres cable		9.95	1.80

ALL PRICES INCLUDE VAT  
CARRIAGE PRICES MAINLAND ONLY

INSTANT HP, MAIN DISTRIBUTOR WARRANTY, CREDIT COVER.

<b>SOUTHAMPTON</b> SMC Ltd 36-38 Rumbridge St. Totton, Southampton Southampton (0703) 867333 9-5.30 Mon-Sat	<b>LEEOS</b> SMC (Leeds) 257 Otley Road Leeds 16, Yorkshire Leeds (0532) 782326 9-5.30 Mon-Sat	<b>CHESTERFIELD</b> SMC (Jack Twendy) Ltd 102 High St. New Whittington, Chesterfield Chesterfield (0246) 453340 9-5 Tues-Sat	<b>BUCKLEY</b> SMC (T.M.P.) Unit 27, Pinfold Lane Buckley, Clwyd Buckley (0244) 549563 9.30-5.30 Tues-Sat	<b>STOKE</b> SMC (Stoke) 76 High St. Talka Pitts, Stoke Kidsgrove (07816) 72644 9-5.30 Tues-Sat	<b>GRIMSBY</b> SMC (Grimsby) 247A Freeman St. Grimsby, Lincs Grimsby (0472) 59388 9.30-5.30 Mon-Sat	<b>JERSEY</b> SMC (Jersey) 1 Belmont Gardens St. Helier, Jersey (0534) 77067 10-7 Mon-Sat									
Edinburgh	Jack	GM8GEC	(031-657) 2430 Day (031-665) 2420 Eve	Bangor	Tandragee	John	GI3KDR	(0247) 55162	Mervyn	GI3WVY	(0762) 840656	Neeth	John	GW4FOI	(0639) 52374 Day (0639) 2942 Eve (03843) 72632
						Stourbridge	Andrew								

PASS THE  
R.A.E.

# THEORY & PRACTICE

First of all the answers to the questions posed at the end of last month's instalment. First off, we asked you what that voltage of a battery which caused three amps to flow in a resistance of 30 ohms – well, by Ohm's Law  $V$  equals  $I$  times  $R$  and this comes out to three times 30 which is 90 volts – it must have been one of those old layer-type batteries which powered valve portables years ago and we must admit that it wouldn't last very long if you asked it to supply three amps!

The second question asked the resistance of a piece of wire which permitted a current of two amps to flow when you connected a 10 volt power supply across it. Well, we know from the said law that  $R = V/I$  and in this case  $R$  equals 10 over two ohms – must be five ohms. Remember that the units involved are volts, amps and ohms, and you need to be careful not to mix them up.

Which is what the typesetters did with our Question three! We said that your mate who went to the rally had given you some unmarked batteries which, when he connected a resistance of 100ohms across them, produced a current of 0.09 amps – fine, fair enough, good stuff. We then airily went on to say that, since the amp was a bit big for radio-type use, your mate would probably have expressed this in milliamps, which are units of a thousandth of an amp. Fine, yes he probably would. However, we said that a current of 0.09amps would be the same as a current of 9 milliamps, which is baloney – 0.09 times 1000 is 90, not nine, and all we can say is that we're sorry we didn't spot it when we checked out the pages before bursting into print. Twits.

Anyway, just to make it clear, the amp is a bit more suitable for electrical engineering and solid-state amplifiers and the like than everyday radio, and you'll find the milli-amp (for which the symbol is mA) is commonly used – you just need to remember that it's a thousandth of an amp and you make the appropriate adjustment to Ohm's Law. One trick here is to remember that the resistance element needs to be kilohms instead of ohms.

Let's look at our Question three again; if we assume that we're sticking to 100ohms and 0.09amps, the formula for the battery volts will be  $I$  times  $R$ , which is 100 times 0.09, which is nine. So your friend had got

## Part 4

Theory and practice – two of the most important aspects of taking the RAE – must be learned if you're to get your callsign next time round. Nigel Gresley continues this theme, and this month discusses resistors, and those often-misunderstood words, series and parallel.

hold of some ordinary nine-volt transistor-type batteries. Let's say you'd known that the batteries were nine volts and that an unknown resistor caused a current of 30 milliamps to flow – well, we can use milliamps directly, remember, if we accept an answer for resistance in kilohms. In this case  $R = V/I$  and that's 9/30 kilohms, which is 0.3 kilohms or 300 ohms. Had the current been three miliamps, of course, the answer would have been three kilohms or 3,000 ohms.

So, on to Question four, and we asked in effect, what current would flow if you stuck a piece of wire with a resistance of 0.01 of an ohm across a car battery of 12 volts? Well, it'd be  $I = V/R$  and tht would come out to be 12/0.01 which is 1200 amps! Hmmm. That's an enormous amount of current but it'd be well within the capacity of a big 12 volt car battery for a very short period, and in fact it would be dangerously high. Why's that? As we'll see shortly, an electric current has a heating effect and a current of 1200 amps would have one hell of a heating effect in a thin piece of ordinary copper wire. It'd probably more or less explode – well, it's highly likely that it wouldn't last very long.

You might wonder why we asked such a seemingly stupid question. The idea was to show that very high currents can be made to flow if you're not careful, and indeed you should always take care with things like car batteries and high-current power supplies. The reason is that if you start short-circuiting them with pieces of stray wire, the said wire will get extremely hot and you may well get a very nasty burn. In fact,

when we worked in telephone exchanges for a living many moons ago, the rule was that when working on certain parts of it you weren't allowed to wear rings or watches or bracelets or whatever in case you managed to short circuit the exchange battery – since the latter in a medium-size exchange usually occupied a large room all to itself it could have supplied pretty well any current you could think of for a time.

Imagine that your watch, which gleams on your wrist with its nice stainless steel bracelet, has a resistance of 0.001 of an ohm and you end up with it across a 50 volt exchange battery – what current will flow? Answer? A lot, to wit 50,000 amps. You can rest assured that your watch wouldn't work too well after that, and you can also rest assured that your hand wouldn't – if it was still attached to your wrist, that is.

Anyway, enough of the gratuitous violence, this is a family mag and we ought to get on with it. Lets' now turn our attention to the strange and erudite words "series" and "parallel", which you'll find banded about in electronic circles rather a lot.

Before we do, though, it's worth talking about resistance in slightly more general terms. It might seem a bit of an abstract concept at the moment, but if you go into any self-respecting radio bits shop you'll find that you can buy components called **resistors** – these are small items which have a specific value of resistance, and they come in all sorts of values from 0.47 of an ohm right up to 3.3 million ohms, or three megohms if you like. There are even higher-value ones if you really need them. Now you might wonder why you need resistors at all. Well, they possess all sorts of useful properties in terms of deriving various voltages from fixed amounts of volts from a power supply and also they're what you need when it comes to things like matching. Anyway, don't worry too much about all that for now. You'll find that when we start getting into circuitry and things, it'll all start to emerge.

Let's imagine that we've taken a trip to our local friendly radio store and we've acquired a mixed bag of resistors – they'll look a bit like small cylinders with strange coloured bands on them. The coloured bands tell you what the **value** of the

## TYPICAL RESISTOR CODES

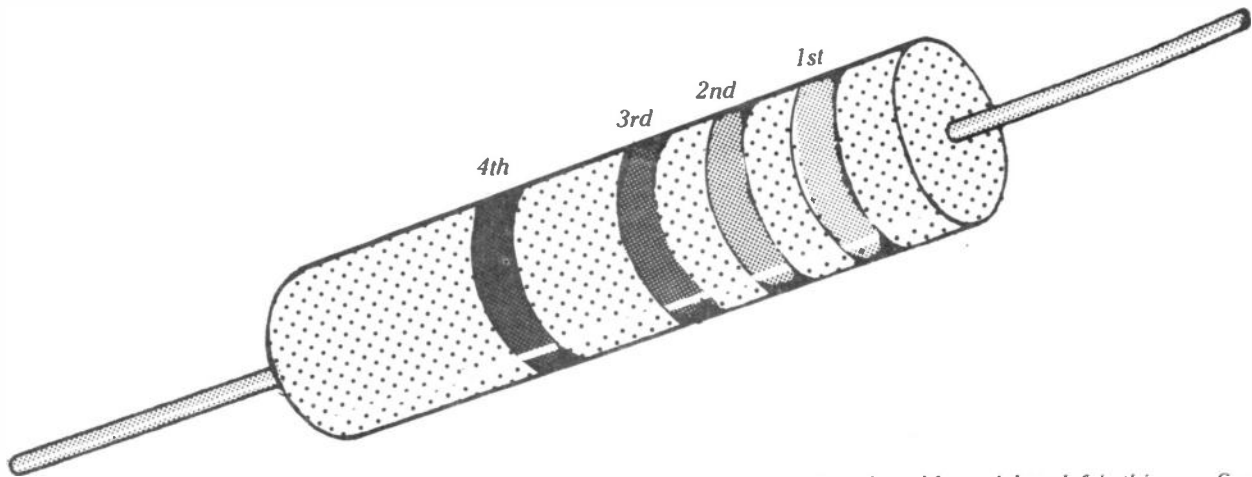

Bands are nearer to one end, and read from right to left in this case. See over page for explanations.

resistor is, or in other words how many ohms of resistance that particular component possesses, and we'll show you how to read the code shortly. Let's imagine that we take out of the packet two resistors which have a value of 1000 ohms each – in fact, from now on we'll refer to them as one kilohm (that means 1000 ohms – remember?) and, since the symbol for kilohms is a capital K, most of us just say "1K" in referring to a resistor of that value.

Just for fun, let's hook our 1K resistor across a power supply which is producing 10 volts – let's then measure (yes, yes, I *know* we haven't dealt with how you'd measure it yet, just pipe down you Clever Dicks at the back or you'll have to stand in the corner) the amount of current flowing in the circuit formed by the battery and the resistor. Now then, Ohm's Law at the ready, what do we find with our clever meter which we haven't discussed yet? Well, us chaps who've been following this article closely and with minute attention won't need a meter because they'll know that the current will be 10/1000 amps which is 0.01 amps or 10 milliamps. Actually, if we'd wanted we could have called it 10 volts divided by one kilohm and taken out the result in milliamps – see above. Either way, it comes out as 10mA, and the clever chappie with the meter will have to agree with you when he measures it.

Okay. Now then, just for a laugh, let's take the other 1K resistor and connect it sort of end-to-end with the other one so that they form a sort of chain of two resistors together. What do you feel might happen if we connect this combination across our 10 volt power supply? You might get a sort of feeling that since the current has now to flow through two lots of 1K together there might be rather less of it, and you'd be dead right. The clever man with the meter would be able to tell you instead of the 10mA we found with just 1K there's now only 5mA flowing around the circuit. Now we know from Ohm's Law that a current of 5mA and a voltage of 10 volts must imply a resistance of – what?  $R = V/I$ , so it must be 10/5 kilohms, and even the dum-dums at Bicester know that 10 divided

by five comes out to two. So our two 1K resistors connected end-to-end, or **in series** as it's known in electronics, look to all intents and purposes like one 2K resistor.

"Well" you might say, "I could have guessed all that, why make such a song-and-dance about it? It's just like the fairy

**“Connect two resistors in parallel, we'll end up with one resistor, half the value of the ones we used”**

lights at home". People do get it wrong, though, especially when we get into Phase Two of all this! Phase Two is what happens when, instead of connecting the resistors end-to-end we connect them sort of across each other – ie with the two wires emerging from each end of the resistor joined to the other two wires of the other resistor and a couple of handy bits of wire connected to the junction of each pair of wires. Let's do this with our pair of 1K resistors and stuff them across our 10 volt power supply as before.

What does Brain Box read on his natty meter? Interesting. It says 20 milliamps now, or in other words twice the current which flowed through the first resistor on its own. If we apply our old friend  $R = V/I$  we shall rapidly discover that the pair of 1K resistors (remember that 1K is the same as 1000 ohms) looks suspiciously like one resistor of half that value, ie 500 ohms. So we can safely deduce that if you connect two resistors in **parallel** (as this is known in the trade) we'll end up with one resistor whose value is apparently half of the ones we used. Actually, we need to be a bit careful because that's only true if both resistors are the same value – if they're not you'll need to apply a little formula but don't worry – we'll come to that in a minute.

So – what do we now know? Basically, that you can connect resistors in **series**

and **parallel** and you'll end up with an apparent resistance that's either the sum of the values or, certainly where the resistors are of equal value, half the value of one of them. Actually, this is a major discovery for all sorts of reasons which will emerge later on in the course, but for now it means that you can make up resistance values that you might not have had in one component and also you'll find that other things behave in the same way when you connect them in series and parallel. So it's all good stuff.

Let's now take a little look at some more formal ways of stating what we've discovered. If we use the usual symbol for resistance, which is R, we can say that the total value for resistors in series is  $R_1 + R_2 + R_3 + R_4 \dots$  etc, for however many resistors you like. It's straight addition, in other words; so 500 ohms, 1500 ohms, 220 ohms and 470 ohms in series produce a total value of 2690 ohms. For resistors in parallel, life gets a teensy bit more complicated because the formula goes  $1/R = 1/R_1 + 1/R_2 + 1/R_3 \dots$  etc.

In other words, you take the reciprocal of the resistances in the circuit or whatever, add them up and take the reciprocal of the answer. Sorry about that; let's take an example. Let's go back to our pair of 1K resistors in parallel, just to make it simpler first time round. Now if the R in the formula represents the eventual resistance we're trying to find and R1 and R2 are our pair of resistors, we know from the formula above that  $1/R = 1/1000 + 1/1000$ . You'll remember from school that adding fractions isn't too tricky, and we end up with one thousandth plus another thousandth being two thousandths or 2/1000. Cancelling in the usual way – dividing two into the top and bottom of the fraction – leaves us with 1/500. So if 1/R equals 1/500, it's easy to see that R is equal to 500.

Matters get a little hairier if we take the example we used for series resistors. If you remember, they were 500 ohms, 1500 ohms, 220 ohms and 470 ohms, so our formula goes  $1/R = 1/500 + 1/1500 + 1/220 + 1/470$ . Hmmm – it isn't exactly tricky but it's tedious! We must admit that at this point we get out the calculator because it

PASS THE  
R.A.E.

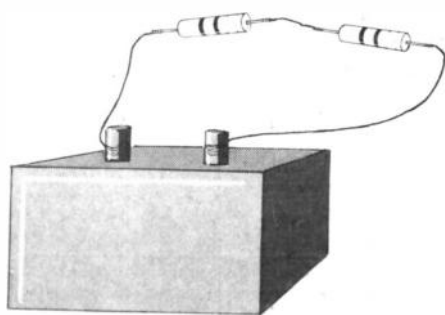
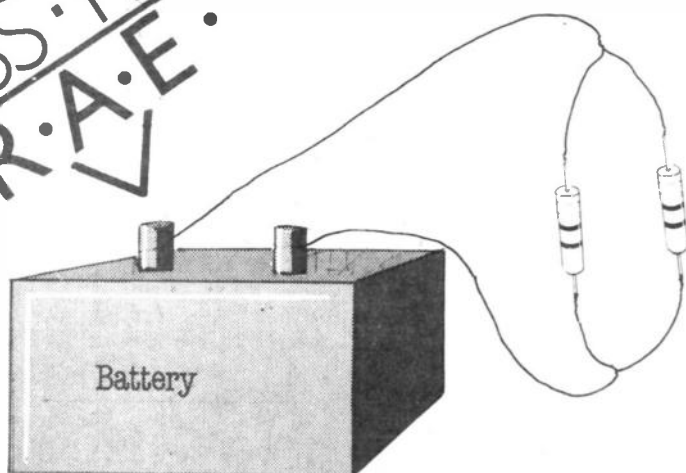

1st Band	
Black	0
Brown	1
Red	2
Orange	3
Yellow	4
Green	5
Blue	6
Violet	7
Grey	8
White	9

2nd Band	
Black	0
Brown	1
Red	2
Orange	3
Yellow	4
Green	5
Blue	6
Violet	7
Grey	8
White	9

3rd Band	
Silver	Divide by 100
Gold	.. .. 10
Black	Multiply by 1
Brown	.. .. 10
Red	.. .. 100
Orange	.. .. 1000
Yellow	.. .. 10,000
Green	.. .. 100,000
Blue	.. .. 1,000,000

4th Band Tolerance	
Red	± 2%
Gold	± 5%
Silver	± 10%
No Colour	± 20%

means otherwise that we have to fiddle about finding common denominators and such, and the yawns set in. Can we suggest that if you're going to do the RAE you invest in a small calculator which has a reciprocal key on it? They're only about a tanner these days, and for that kind of money you can get one with scientific functions like index notation, logs, trig functions and all manner of goodies that'll make your life ever so much easier in the long run. You'll find, for instance, that when we get to the topic of decibels and power levels it's a doddle if you have a little scientific calculator whereas it's a thundering nuisance if you have to fiddle about with log tables.

In this case, it takes us all of ten seconds to bang the numbers in and come up with the fact that the value of R will be a shade over 107 ohms – a little Sharp calculator costing £8.95 was all it took, and you can use them in the exam so it'll save you hours of spraining your brain.

Just to finish with for this time, let's take a look at something interesting about the series resistors – you remember, when we put the two 1K components across our 10 volt supply? Had we had another clever kind of meter, called a voltmeter, we could have measured the actual voltage across each resistor and we would have found that it was five volts. Interesting, huh? There wasn't a five volt supply anywhere within range and yet we've found a way of knocking the 10 volts down to five – could be useful. What happens here is that Ohm's Law has struck again. We can predict the potential difference in volts across each resistor by multiplying the current through it by the resistance in the

usual way ( $V = IR$ , yes?). We know that a current of 5mA flowed in the total circuit, and if we multiply that by our figure of 1000 ohms, which was the value of one of the resistors, we come up with a value of five volts. So there is five volts across the ends of each resistor, and they must add up to 10 volts since there are two resistors. Yes, that must be right because it's a 10 volt power supply!

**“We can predict the potential difference in volts across each resistor”**

So, a couple of fiendish questions which we'll answer next time:

1. You take it into your head to connect a 10K, a 5K and a 1K resistor in series and stick them across a 15 volt power supply which you happen to have. How much current will flow in the total circuit, and what will be the voltages across the individual resistors?
2. You find a resistor in the junk box which just might be right for a job you have in mind (it's Saturday night at midnight, there are no shops open and the contest starts at 1000 on the Sunday – without the right value resistor your monster linear which will surely win the contest for your group hands down is a non-starter and will have to be left at home). Your meter for measuring current is broken (you dropped it down the mountain during the last contest) and all you have is a voltmeter and a 24 volt power supply. So you discover that if you connect the unknown resistor in series with one whose value you know to be 8.2K

and apply the whole shooting match across the 24 volt supply, you measure a voltage of 15.25 volts across the said 8.2K. What is the value of the unknown resistor? Will it save the day? Will we keep selling magazines if we keep this up?

3. You have an important sked in half an hour and when you switch the rig on in order to let it warm up, there is an Awful Smell and everything stops. You whip the lid off and you notice that a resistor whose value was 1.8K has departed for another world – shock, horror, you can't find one in the junk box with which to replace it. You do, however, have any amount of resistors whose value is 4.7K, a 240 ohm and a 560 ohm in the box. Can you find the right combination to replace the 1.8K for now and get back on the air in time to work the rare QTH square or Heard Island or whatever before propagation fails or your sked partner gets bored waiting and QSYs?

Bite your nails until next time. See you soon!

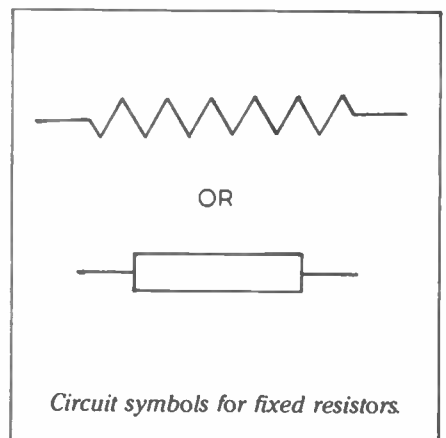

## International Q-code

- QRA** What is the name of your station? The name of my station is ...
- QRB** How far are you from my station? The distance between our station is ...
- QRC** Will you tell me my exact frequency (or that of...)? Your exact frequency (or that of...) is ... kHz (or MHz).
- QRH** Does my frequency vary? Your frequency varies.
- QRI** How is the tone of my transmission? The tone of your transmission is ...
- QRK** What is the intelligibility of my signals (or those of...)? The intelligibility of your signals (or those of...) is ...
- QRL** Are you busy? I am busy (or I am busy with...).
- QRN** Are you troubled by static? I am troubled by static.
- QRO** Shall I increase transmitter power? Increase transmitter power.
- QRP** Shall I decrease transmitter power? Decrease power.
- QRQ** Shall I send faster? Send faster (... words per minute).
- QRR** Are you ready for automatic operation. Send at ... words per minute.
- QRS** Shall I send more slowly? Send more slowly (... words per minute).
- QRT** Shall I stop sending? Stop sending.
- QRU** Have you anything for me? I have nothing for you.
- QRV** Are you ready? I am ready.
- QRW** Shall I inform ... that you are calling on ... kHz (or MHz). Please inform ... that I am calling him on ... kHz (or MHz).
- QRX** When will you call me again? I will call you again at ... hours (on ... kHz (or MHz)).
- QRY** What is my turn? Your turn is Number ...
- QRZ** Who is calling me? You are being called by ... (on ... kHz (or MHz)).
- QSA** What is the strength of my signals (or those of...)? The strength of your signals (or those of...) is ...
- QSB** Are my signals fading? Your signals are fading.
- QSD** Is my keying defective? Your keying is defective.
- QSI** I have been unable to break in on your transmission or Will you inform ... that I have been unable to break in on his transmission (on ... kHz (or MHz)).
- QSK** Can you hear me between your signals and if so can I break in on your transmission? I can hear you between my signals; break in on my transmission.
- QSL** Can you acknowledge receipt? I am acknowledging receipt.
- QSN** Did you hear me on ... kHz (or MHz)? I did hear you on ... kHz (or MHz).
- QSO** Can you communicate with ... direct (or by relay)? I can communicate with ... direct (or by relay through ...).
- QSP** Will you relay to ...? I will relay to ...
- QSR** Shall I repeat the call on the calling frequency? Repeat your call on the calling, frequency; did not hear you (or have interference).
- QSS** What working frequency will you use? I will use the working frequency ... kHz.
- QSU** Shall I send or reply on this frequency (or on ... kHz (or MHz)) (with emissions of class ...)? Send or reply on this frequency (or on ... kHz (or MHz)) (with emissions of class ...).
- QSV** Shall I send a series of Vs on this frequency (or ... kHz (or MHz))? Send a series of Vs on this frequency (or ... kHz (or MHz)).
- QSW** Will you send on this frequency (or on ... kHz (or MHz)) (with emissions of class ...)? I am going to send on this frequency (or on ... kHz (or MHz)) (with emissions of class ...).
- QSX** Will you listen to ... on ... kHz (or MHz)? I am listening to ... on ... kHz (or MHz).
- QSY** Shall I change to transmission on another frequency? Change to transmission on another frequency (or on ... kHz (or MHz)).
- QSZ** Shall I send each word or group more than once? Send each word or group twice (or ... times).
- QTH** What is your position in latitude and longitude? My position is ... latitude ... longitude.
- QTK** Can you communicate with my station by means of the Code? I am going to communicate with your station by means of the Code.
- QTR** What is the correct time? The correct time is ... hours.
- QTS** Will you send your call sign for tuning purposes or so that your frequency can be measured now (or at ... hours) on ... kHz (or MHz)? I will send my call sign for tuning purposes or so that my frequency may be measured now (or at ... hours) on ... kHz (or MHz).
- QTV** Shall I stand guard for you on the frequency of ... kHz (or MHz) (from ... to ... hours)? Stand guard for me on the frequency of ... kHz (or MHz) (from ... to ... hours).
- QTX** Will you keep your station open for further communication with me until further notice (or until ... hours)? I will keep my station open for further communication with you until further notice (or until ... hours).
- QUA** Have you news of ...? Here is news of ...
- QUM** May I resume normal working? Normal working may be resumed.

Frequency (MHz)	Call sign	QTH	Frequency (MHz)	Call sign	QTH	Frequency (MHz)	Call sign	QTH	Frequency (MHz)	Call sign	QTH
50.005	H44HIR	Solomon Is	144.157	EA3URE	AA12c	144.945	GB3GI	XO41j	432.910	GB3EM	ZN32b
50.010	ZS1STB	Still Bay	144.800	0H8VHF	MZ79h	144.945	SP3VHG	HL08j	432.925	SK6UHF	GR61a
50.020	GB3SIX	YN49f	144.810	ISOA	EA08a	144.950	SK1VHF	JR41d	432.930	OZ71GY	GP23c
50.030	ZS6PW	Pretoria	144.825	10A	GB12d	144.960	SK4MPI	HU46d	432.960	SK4UHF	HT55j
50.035	ZB2VHF	XW64g	144.830	9H1VHF	HV03f	144.965	GB3LER	ZU65f	432.970	GB3CTC	XK76d
50.039	FY7THF	Guyane	144.840	IT9G	GY67c	144.975	GB3ANG	YQ35c	432.975	SK5UHF	IU78d
50.055	PY2AA	Sao Paulo	144.850	DL0UB	GM47b	144.975	DL0SG	GJ77e	432.983	OZ2ALS	EP79c
50.088	VE1SIX	New Brunswick	144.855	LA5VHF	JD25e	144.980	SP2VHC	JO33e	432.984	HB9F	DG40c
50.498	5B4CY	QU51b	144.860	LA1VHF	ET13c	144.985	ON4VHF	CK23e	1,296.810	GB3NWK	AL51b
52.300	VK6RTV	Perth, WA	144.870	LA2VHF	FX43g	432.865	OZ2UHF	EP83h	1,296.830	GB3BPO	AM77j
52.320	VK6RTT	Carnarvon, WA	144.875	SK2VHF	JY69h	432.810	GB3WHA	AL71d	1,296.870	GB3AND	ZL63b
70.030	GB3CTC	XK76d	144.885	OY6VHF	WW76d	432.855	LA4UHF	JD25e	1,296.890	GB3DUN	ZL08e
70.040	GB3SX	AL71d	144.890	LA4VHF	CU47a	432.855	SK3UHF	IW40b	1,296.900	GB31OW	ZK34a
70.050	GB3SU	ZN61a	144.895	FX0THF	A146h	432.860	LA1UHF	FT05a	1,296.910	GB3CLE	YM48h
70.060	GB3ANG	YQ35c	144.897	EA3VHF	BB41c	432.865	OZ2UHF	EP83h	1,296.915	PA0QHN	CM53j
70.112	5B4CY	QU51b	144.900	OH6VHF	KW59f	432.870	FX4UHF	ZD52c	1,296.920	DB0VC	FO51j
70.120	ZB2VHF	XW64g	144.910	DL0PR	EO54c	432.880	LA3UHF	DS80b	1,296.925	SK6UHF	FR29g
144.130	ZS6DN	Pretoria	144.915	GB3CTC	XK76d	432.885	OY6UHF	WW76d	1,296.930	GB3MLE	ZN32b
144.138	LX0LX	DJ31b	144.920	SK7VHF	GP38c	432.890	GB3SUT	ZM31b	1,296.930	OZ71GY	GP23c
144.139	5B4CY	QU12b	144.925	GB3VHF	AL52j	432.890	LA4UHF	CT47c	1,296.975	PA0ZM	DM65h
144.145	ZB2VHF	XW64g	144.930	OZ71GY	GP23c	432.900	OH3UHF	LV39j	1,296.990	GB3EDN	YP04g



# HAM BYTE

## Computing and the radio amateur, with John Morris, G4ANB.

Second in our new series about computing and the amateur. In a way, it's a forum for the growing number of amateurs who use computers as an integral part of amateur radio. Readers' comments are welcome - simply address your letters to me, John Morris, G4ANB, and we'll see how things go. Meanwhile, I'll try and keep you up to date with things happening, and new developments in this exciting field.

If you haven't caught the bug yet, now looks like a good time to start playing with computers in the shack. Recent months have seen the introduction of several new models with impressively low prices, and many of them British made to boot. (Oh all right, put together in Britain from chips made in Taiwan for US manufacturers - but it's the thought that counts.)

Nice though these machines undoubtedly are, I have a complaint; there is hardly ever any decent documentation on the hardware. When I buy a rig I expect to get a circuit diagram, and instructions on how to get the back off, even if I can't make head or tail of what's in there when I do it. With a computer all I get is a software manual, almost entirely devoted to yet another description of Basic. If I am lucky I might get a memory map telling me roughly which bits of hardware are in the box, but rarely more.

**“... if I had not wandered inside, rearranged a few wires”**

Two machines in particular have caught my eye, the Dragon and the Oric. Now these are both very nice computers, and I have no criticism of them whatsoever - as computers. Yet they both have labels over the screws on the bottom, saying “break this and forget your guarantee, chum”, or words to that effect. Does anybody have an explanation for this? Has there been a spate of computers being returned for repair because little Jimmy decided to see what happened if he swapped all those little black things with legs around?

Certainly with my main (and very elderly) computer I could not do half of what I do do with it if I had not wandered inside,

rearranged a few wires, and reprogrammed a couple of EPROMS. Do the manufacturers want to make you buy their custom add-ons instead of building your own? Or am I just getting paranoid?

### Computer RTTY

The growth of computers in the shack has brought a massive upsurge of interest in RTTY (Radio TeleType). Ye honourable Editor was mumbling in his beer something about an RTTY special coming up in a few months or so, so I won't go into the details of what RTTY is, what terminal units are, and so on. What I will do is give some hints for anyone trying to make a computer pretend to be a teleprinter.

Writing an RTTY program really means going into machine code. With very few exceptions, Basic just is not fast enough (unless a special UART chip is used - I'll be talking about them another month). It is not difficult, and is actually an excellent project for learning about machine code programming.

The two frequencies in an RTTY signal are called “mark” (low) and “space” (high). For the computer it is convenient to say that “mark” is a logic 1, and “space” is a logic 0, and convince the terminal unit to produce these levels on reception of the appropriate frequencies. This choice of convention is quite arbitrary, and you can use the opposite if you want - but the rest of this section won't be much use to you if you do!

The basic waveform of a single RTTY character is shown in Figure 1. When idling, a “mark” (logic 1) is transmitted continually. For each character there is one and a half stop bits (always 1). The speed of an RTTY signal is given by the number of bits transmitted in each second. This value is called the “baud” rate.

RTTY code	Letters shift		Figures shift	
	Char	Hex	Char	Hex
12345	-----	----	----	----
00000	Null	00	Null	00
00001	T	54	5	35
00010	C. R.	0D	C. R.	0D
00011	0	4F	9	39
00100	Space	20	Space	20
00101	H	48	#	23
00110	N	4E	,	2C
00111	M	4D	.	2E
01000	L. F.	0A	L. F.	0A
01001	L	4C	)	29
01010	R	52	4	34
01011	G	47	@	40
01100	I	49	8	38
01101	P	50	0	30
01110	C	43	:	3A
01111	V	56	=	3D
10000	E	45	3	33
10001	Z	5A	+	2B
10010	D	44	A. B.	--
10011	B	42	?	3F
10100	S	53	'	27
10101	Y	59	6	36
10110	F	46	%	25
10111	X	58	/	2F
11000	A	41	-	2D
11001	W	57	2	32
11010	J	4A	Bell	07
11011	Figs	--	Figs	--
11100	U	55	7	37
11101	Q	51	1	31
11110	K	4B	(	28
11111	Lets	--	Lets	--

Table 1. RTTY to ASCII look-up table. Special characters:

Null: No action (idle).  
 C. R.: Carriage return.  
 L. F.: Line feed.  
 A. B.: Answer back.  
 Figs: Go to figures shift.  
 Lets: Go to letters shift.

```

5 REM Quick and dirty great circle distance/bearing calculator
10 DR = 3.14159265/180
20 INPUT "HOME LATITUDE NORTH (DEG)";N1: N1 = N1*DR
30 INPUT "HOME LONGITUDE WEST (DEG)";W1
40 INPUT " DX LATITUDE NORTH (DEG)";N2: N2 = N2*DR
50 INPUT " DX LONGITUDE WEST (DEG)";W2: W = (W1-W2)*DR
60 D = COS(N1)*COS(N2)*COS(W) + SIN(N1)*SIN(N2)
70 DX=ATN(SQR(1-D*D)/D)*6367 + 10001*(1-SGN(D))
80 C = SIN(N2) - D*SIN(N1): S = SIN(W)*COS(N1)*COS(N2)
90 TH = ATN(S/C)/DR + 90*(1-SGN(C)): IF TH<0 THEN TH = TH+360
100 PRINT " BEARING"; INT(TH+.5); " DEGREES"
110 PRINT "DISTANCE"; INT(DX); "KM": GOTO 40

```

For computers we can concentrate on the length of a single bit, or the period. The period, in milliseconds, is calculated by dividing 1,000 by the baud rate. This is important because at some stage you are going to have to write a short delay routine, which pauses for this period. Traditionally a period of 22mS has been used, giving a baud rate of 45.45. Increasingly a 20mS period (50 baud) is becoming popular. With computers even faster speeds can be used, although beyond a few hundred baud the frequency shift used by amateurs is too small. Other standard speeds are 75, 100, 150, 300, 600 and 1200 baud. Any program worth its salt will of course be able to handle any speed within reason.

### Curious Baudot

The code used on amateur RTTY has a very curious name. It is almost always referred to as: 'Well a lot of people call it Baudot but it is really Murray code though its official name is actually CCITT No. 2'. Fortunately, the computer doesn't give a damn what it's called, only what it looks like. What it looks like is shown in the table below. It is odd, in having two sets of characters, depending on what "shift" you are in.

The simplest algorithm for receiving RTTY runs something like this: Start with a register (or memory location) containing zero. When the start bit is detected wait for the first data bit. Put it into the bottom (low order) of the register. Wait again for the next bit. Shift the whole register left one place, and put the second bit into the just vacated bottom of the register. Do this several times, until all five bits have been read. The result will be a register containing

the character, built up bit by bit. From high to low order in the registers will be three zeroes, followed by the five data bits, from 1 to 5.

### Transmitted to ASCII for printing . . .

Now the character has been received it must be translated to ASCII for printing, and this depends on the shift. Add 32 to the register if figures shift is set. The register can then be used as an index to look up the ASCII character in a 64 byte long table, with the letters shift characters in the first 32 bytes, and the figures shift characters immediately after. Remember to check for "specials" such as line feed or carriage return before translating the character.

That is a quick run down of an RTTY receiving routine. Sending is very similar, only backwards. Of course there are all sorts of fiddly little details to sort out - but fettling these is half the fun of writing the program!

### Distances and bearings

This month's bijou programette is a "quick and dirty" great circle distance and bearing calculator. It is in Microsoft Basic, but there should be few problems setting it going on other machines. For the ZX81 the multiple statement lines will have to be split.

Its use is fairly obvious; type in your own latitude and longitude, and then the latitude and longitude of a distant station, and back come the great circle bearing and distance from you to there. Then you get the chance to type in the co-ordinates of

Program opposite page: How to make a computer pretend to be a teleprinter! If you want to write an RTTY program, you'll have to work out a machine code, but with very few exceptions, Basic is just not fast enough. Program above: This month's "bijou programette", as we put it in the text. Briefly, it is a quick and dirty great circle distance and bearing calculator. It's in Microsoft Basic, favoured by many computer amateurs. There should be few problems setting it going on various machines. Type in your own latitude and longitude, and then the same information for a distant station, and back come the great circle bearing and distance from you to there. QED. Diagram below: Basic waveform of a single RTTY character. The speed of an RTTY signal is given by the number of bits transmitted in each second, called the "baud" rate.

another distant station, and the whole thing is repeated until you get fed up and press the BREAK or STOP key, or whatever your computer has. For stations south of the equator or east of Greenwich the latitude or longitude respectively should be entered as negative.

### "Distances should be right to within half a percent or so."

I call it "quick and dirty" because it is trimmed down as far as practicable to run quickly and be simple to use, albeit at the expense of the last few decimal places in accuracy - which would mostly be superfluous anyway. The distances should be right to within half a percent or so, and the bearings rather better. Only the degrees parts of the latitudes and longitudes are used to save typing.

This will be fine for the HF bands, where distances are large and antenna beamwidths broad. For VHF and local working it might be a good idea to add a bit more to the input routines (lines 20-50) to set the minutes as well.

### Interesting calculations

Most of the program is quite straightforward. The interesting calculations all take place in lines 60-90. The station locations (converted from degrees to radians) go into this section in variable N1, N2 and W (the last being the difference between the two longitudes), and the distance and bearing come out in DX and TH respectively. You may like to pull this bit out for use in your own, more versatile distance and bearing calculator.

That's it for another month, so I'll say 73, or as my hexadecimal computer would put it, 49.

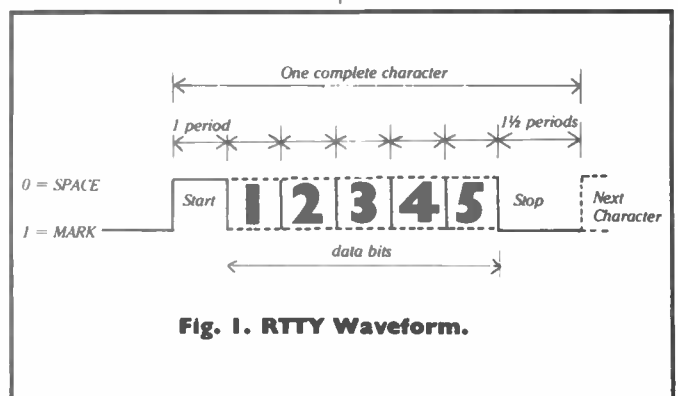

Fig. 1. RTTY Waveform.

# HAM BYTE

Many 6502-based machines use a 6522 VIA (Versatile Interface Adaptor) chip for input and output. This chip has lots of nice features, including a couple of bi-directional input-output ports, a pair of 16 bit counter/timers, and a shift register.

You may not have realised it, but if you have a 6502-based computer with a 6522 VIA (such as a PET or a BBC and many others) then you have nearly all you need for a programmable audio signal generator. All that has to be added is a simple program, such as the one shown here.

It uses timer-1 of the VIA in free running mode to produce a square wave on output PB7 of the 6522 (pin 17). This probably

```

5 REM A.F. Sig-gen for systems with a 6522 VIA. Output on PB7.
10 CK=7.5E5: REM Change to system clock frequency (Hertz).
20 VA=49088: REM Change to base address of the 6522 VIA.
30 POKE VA+2,255: POKE VA+11, 192: DL=VA+4: DH=VA+5: T=256
40 FH=INT(CK/2): FL=INT(FH/65535+1)
50 PRINT "Frequency range";FL;"to";FH;"Hz."
60 INPUT "Frequency (Hertz)";F: IF F>=FL AND F<=FH GOTO 80
70 PRINT "Frequency out of range.": GOTO 50
80 C=INT(FH/F+.5): H=INT(C/T): L=C-T*H: POKE DL,L: POKE DH,H
90 PRINT "Actual frequency =";FH/(T*H+INT(L)):"Hz": GOTO 60
  
```

emerges out of the computer box somewhere, and a bit of delving into the manual should tell you where. Sometimes it is used as the tape output, which is ideal.

Change the "7.5E5" in line 10 to the actual clock frequency of your computer and the "49088" in line 20 to the base address of the VIA (this is also the address of data port B). Consult the manual for details.

The program takes care of the rest. Tell it what frequency you want. It calculates and prints the nearest frequency it

can actually produce, and kicks the VIA off.

Be careful about what you attach to the VIA. Some sort of isolation should always be used, the bare minimum being a simple capacitor (about 0.1uF will do). The output is a square wave and full of harmonics, so whatever else you do please don't shove it straight into the microphone socket of a transmitter!

One point about using the VIA to generate tones in this way is that once it has been started it will carry on by itself,

*Due to lack of space, this program was left out of last month's issue. But we print it here, along with the accompanying text*

and the computer can wander off doing other program type things.

Signal generators have all sorts of uses in the shack, and a programmable one is quite handy - especially when it comes practically for free! I have recently found it very useful for providing accurate tones when setting up an RTTY system.

*"...and we can now keep our copies of Amateur Radio in special binders... I understand that back numbers are still available... I'm on my way to the newsagent to place a regular order... or perhaps I will take out a subscription... Yes I know it costs only £10.80 for 12 issues..."*

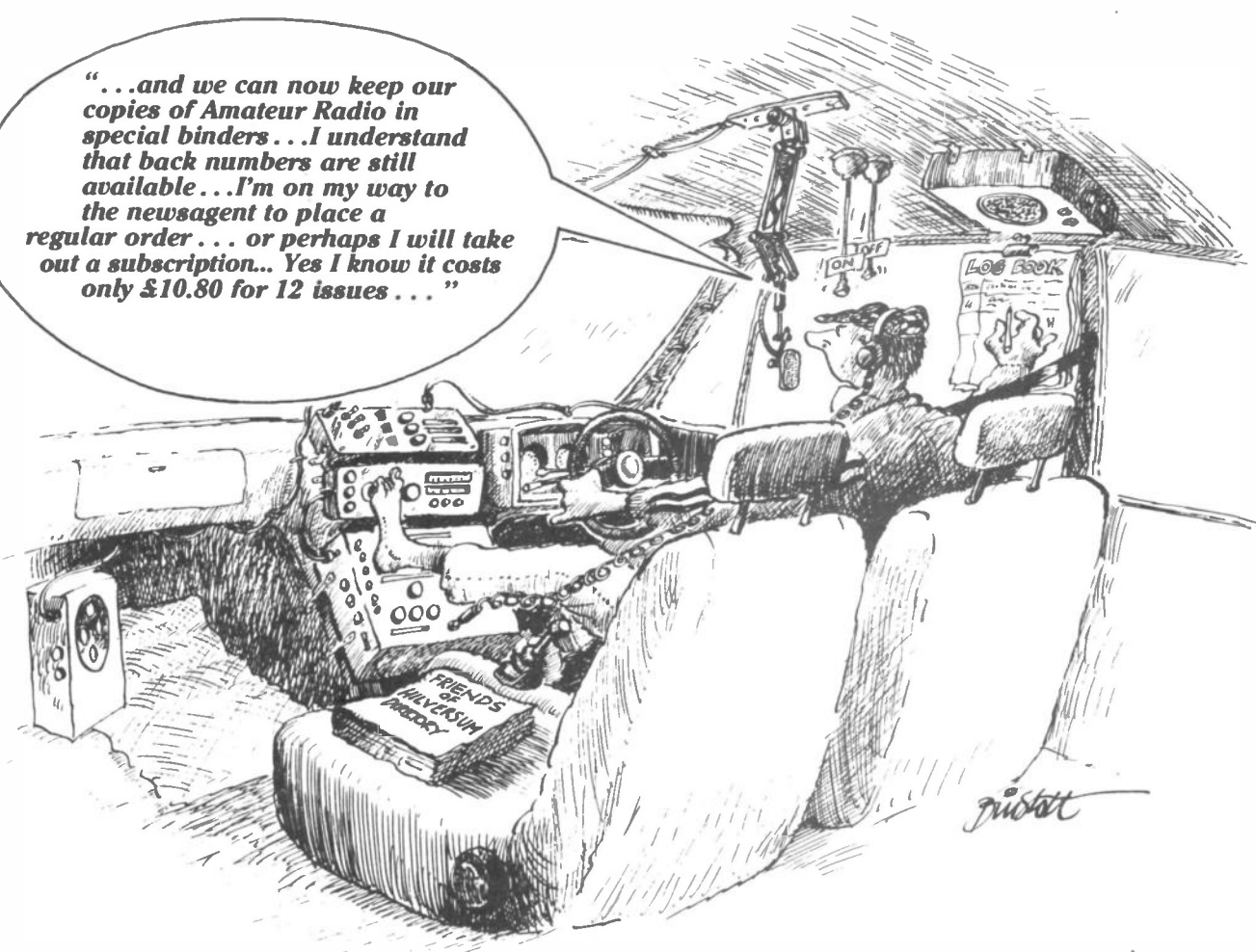

## Marconi Radio Society re-launches historic callsign

The callsign used to introduce Britain's first scheduled radio entertainment broadcast, 2MT, will be heard on the amateur bands this month after a 60-year break in transmissions.

Home Office approval has been granted to the use of the callsign G2MT by the Marconi Radio Society, a group formed recently by enthusiasts employed at the Stanmore headquarters of Marconi Space & Defence Systems and at other company sites in the locality. The callsign will be used at Stanmore for the first time at 1200 hours BST on Saturday 2nd July 1983 using equipment owned and operated by members. The frequencies used will depend on the prevailing propagation conditions but it is hoped to organise contacts with amateur radio clubs affiliated to the BBC and with similar groups within the GEC-Marconi organisation.

The founding of the Marconi Radio Society and its authorisation to use the historic callsign G2MT during 'World Communications Year' has been given support by Marconi Space & Defence Systems. As well as using the facilities at Stanmore, the society's Patron is General Sir Harry Tuzo and its President, Dr W. Bardo, Chairman and Technical Director respectively of MSDS.

Marconi's Wireless Telegraph Company Ltd was first granted an experimental licence in the Summer of 1920 to use the callsign to introduce news bulletins. This permission did not apparently extend to music, even in the accompanying role, and the licence was swiftly revoked following the broadcast of 'drama per musica' by a Danish tenor.

Following representations to the then Postmaster General by the Wireless Society of London (now the RSGB), the company was later authorised to recommence transmissions. And so, the first scheduled entertainment broadcast in the UK was transmitted on 700 metres from Writtle, near Chelmsford, on 14th February

# CLUB NEWS

1922 under the callsign 2MT ("Two-Emma-Tock"). The 'G' (for England) has now been added to accord with current practice. The licence restricted broadcasting to half an hour each Tuesday evening and the station was required to cease transmitting for three minutes in every ten. These frequent intervals were spent in checking to hear whether any complaints had been received.

The broadcasts provided amateurs with invaluable checking references and their content set the pattern for later public broadcasting programmes; for example, the first radio play was produced (Cyrano de Bergerac) and a rudimentary Childrens Hour was evolved before transmissions ceased in January 1923.

## Greater Peterborough AR Club

The club meets on the fourth Thursday of each month (during school terms) at Southfields Junior School, Stanground, at 7.30pm. The following are the dates June 23rd, July 21st, September 22nd, October 20th and November 24th. Events/meetings include the VHF Field Day in July, Special Event Station, computers, home-built transceiver, quiz/raffle, video evening and (possibly) a talk on satellite working. The club has a net on Mondays at 2000hrs clock time on 21.200MHz. Further details from Frank Brisley, G4NRJ, QTHR 27 Lady Lodge Drive, Orton Longueville, Peterborough, PE2 0ES.

## McMichael Mobile Rally

The McMichael Amateur Radio Society, in conjunction with the Burnham Beeches ARS, the Home Counties ATV Group and the Maidenhead and District ARC are staging a Mobile Rally at the McMichael Sports and Social Club, Bells Hill, Stoke Poges, Bucks. The date is Sunday 24th July, and the doors will open at 11am.

A large number of traders have been invited, displaying everything from black boxes through kits to surplus components. A fleamarket will be in operation for those with a boot-full of items to sell, and there are many other attractions, such as amateur TV demonstrations, an HF station, radio-controlled models, and a variety of displays and demonstrations. As this is now the only mobile rally in the Home Counties area, a large attendance is expected.

## RSGB Group East London

This group has been going through a revival. Recently, a new committee has been formed and a number of successful meetings held. Furthermore, the number of members has increased. Besides organising a series of lectures and social events, the club hopes to reopen their radio station. It meets every third Sunday in the month, and newcomers are welcome to their meeting place, Wanstead House, Wanstead, London, E.11. It's 100 yards behind Wanstead underground station, by the way.

Chairperson is Sheila Gabriel, G3HCQ, and Clive Ramsey, G8VZD, is the Secretary, at 01-539-7590.

## Bury Radio Society

On Tuesday, July 19th, this society holds a surplus equipment sale, while there is no meeting on July 5th and 12th because their usual meeting place, Mosses Community Centre, Cecil Street, Bury, Lancs, is closed.

In August, however, there's a fox hunt on the ninth, where members are invited to join the search for last year's winner, Roger, G6FUQ. Newcomers can contact the Secretary, Brian Tyldsley, G4TBT, 4 Colne Road, Burnley, Lancs, at the telephone number of Burnley 24254. Note Brian's new callsign.

## Cambridge and DAR Club

This old-established club caters for the interests of those keen on listening and licensed transmission and is open to one and all. Several members, both men and women, have their own transmitting licences and young (and old) beginners are particularly welcome. The club has its own HF and VHF transmitters, operating under the callsign G2XV.

Computer, amateur television transmission and satellite communications enthusiasts are also catered for. The club meets each Friday during term-time in the Visual Aids Room on the ground floor of the Coleridge Community College, Radekund Road (a turning off the well-known Coleridge Rd in the south part of the city of Cambridge) at about 7.30pm.

The current programme is (subject to amendment) as follows: 1st July - talk planned; 8th July - Informal Morse class, Operating club transmitters; 15th July - talk planned; 22nd July - Informal Morse class, Operating club transmitters.

For information about the club and its meetings contact Secretary Dave Leary, G8JKV, 9 Priory Avenue, Swavesey, Cambs., CB4 5RY, telephone: Swavesey 31120 or Publicity Officer, Dave Wilcock, G2FKS, telephone: Cottenham (0954) 50597.

**DODSON ON THE ROAD.** The second of a series of profiles of distributors who serve the amateur radio fraternity.

# DEALER PROFILE

**Arrows Electronics Ltd.**

**A company that obviously doesn't need a massive shopfront to generate business, Peter Clarke's "corner shop" not only specialises in Icom, Yaesu and Sommerkamp equipment, but deals in many other well-known makes of electronic radio gear. "In the next five years there will be a contraction in the trade...with a corresponding contraction of retail outlets. We do not intend to be amongst them," he says.**

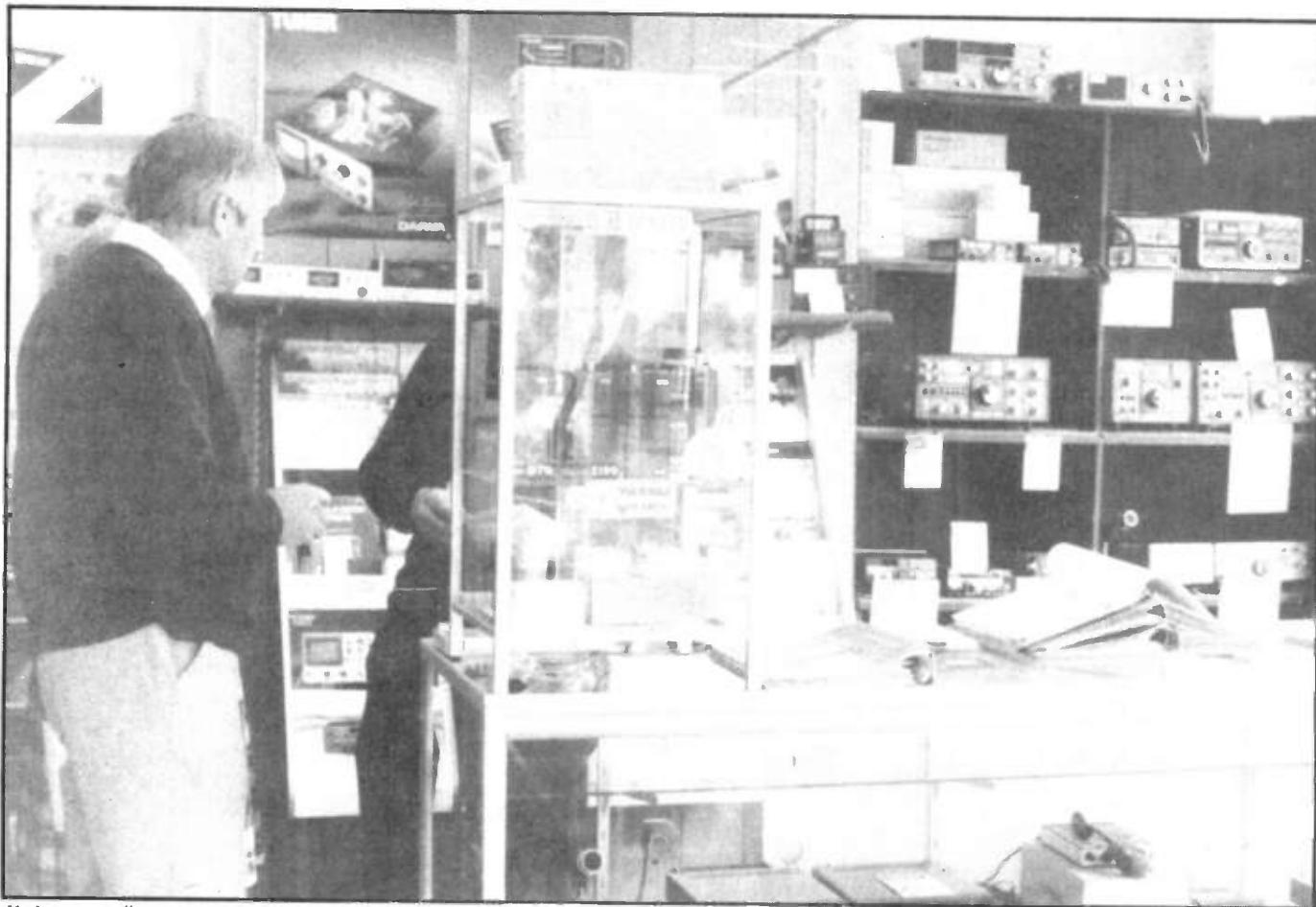

If the term "corner shop" conjures up a mental image of a cosy environment where sound advice goes free with the shopping – that's Arrow Electronics in one! In a quiet backwater, close by down-town Brentwood, Peter Clarke makes his living by guiding the innocent, assisting the skilled and supplying amateur radio equipment.

But if modest frontage and a limited sales-area give the impression of a limited operation, nothing could be further from the truth; the reputation and respect for Arrow extends far beyond the boundaries of Essex. And as proof of this, the day they opened the M25 to let the world circumnavigate London, Peter Clarke's till-takings doubled!

Although Clarke's interest in amateur radio dates back over 25 years to when he was first allocated his British callsign, G3LST, it was rejuvenated in 1976 whilst on holiday at Exeter when he found himself surrounded by amateur radio antennae. It was a busy centre for amateurs! He ended up with a 2m sideband rig – and the determination to get himself into the retail side of the game. Clarke had already been in the semiconductor business since 1965 and the company went public in 1973. From personal choice, he brought Arrow out of the group to commence trading again in 1976.

Not that the formative years of Arrow were easy. In an industry dominated by four major importers, Peter took advan-

tage of the termination of a marketing agreement concerning the firm of Sommerkamp. This had restricted the sale of their equipment in the United Kingdom. As a result of a large import order and a fantastic stand at a show in Leicester, the 'big four' saw fit to reconsider their earlier judgement with regard to dealing with the Peter Clarke organisation.

So, having established Arrow as a Yaesu Musen and Sommerkamp dealership, Clarke wanted to broaden the scope of his enterprise even further, and he approached Icom. Yet again, their initial response was to refuse on the grounds of geographical proximity – a hurdle Peter was able to overcome by looking abroad – successfully. "We were always well financed,



so the investment wasn't that much of a strain."

Without academic qualifications ("there aren't any in this business") Peter Clarke is the son of a timber merchant whose RAF trade as an airframe fitter took him to all parts of Britain. As a result, young Clarke attended many schools, including two in Scotland and several more in the Midlands and all points south, including Cardington where he was with Colin Cowdry. His 21st birthday he spent in Germany and a year later he was a lumberjack in Sweden. "That's the only qualification I've got - a member of the Wood Science Institute!" His linguistic abilities include Swedish, German, French and a smattering of Russian.

Clarke was introduced to amateur radio by no less a personage than Eddie Edwards (G8TL) who lived a stone's throw away from one of Peter's many schools. "Like many others, I started out just listening. Then I built myself a one-valve crystal-controlled transmitter, got a converted 1155 aircraft receiver and went into business on 160 metres CW with a big brass key!" Now as a "young old-timer" as Peter Clarke chooses to call himself, he hasn't the time to build equipment. "Anyway, you just can't get bits like RF components and the cost of building an aerial tuner would be exorbitant!"

Above all, Peter Clarke is a businessman, and behind the modest facade of his Coptfold Road premises is a suite of offices suitably equipped with the tools of modern commerce, including a computer and printing equipment. Running the organisation requires the full-time services of two secretaries, a dispatch clerk, Peter's wife Fay who is the Financial Director and his service technician Bob Body. Because the Clarke empire includes other enterprises, Peter employs the "almost full-time services" of an accountant. "Really, we're unaffected by the recession. We have enjoyed a very satisfying growth-rate over a number of years".

Like any good businessman, Peter keeps a cautious finger on the pulse of his industry. "The amateur radio market is at a peak at the moment, which will continue to be a profitable enterprise for a while. We intend to stay in the market. In the next five years, there will be a contraction in the trade with a corresponding contraction of retail outlets. We do not intend to be amongst them."

Expansion of the Arrow organisation has been similarly cautious, with only one addition of premises - in Glasgow. Up there, at 51 Highland Street, Phil McJimpie G6NHJ, his two able sons and an assistant will attend to the requirements of radio enthusiasts from the recently-opened shop. On the other hand, Peter does have a commission agent at 14 Carreg-Y-Gad Llanfair-P-G, Anglesey by the name of John Lewis, and a similar scheme is being set up at Leicester. If any further expansion of Arrow were to take place, it would be in South Wales and Southern England.

It is difficult to determine exactly where the division lies between Peter Clarke's business and pleasure activities - if indeed

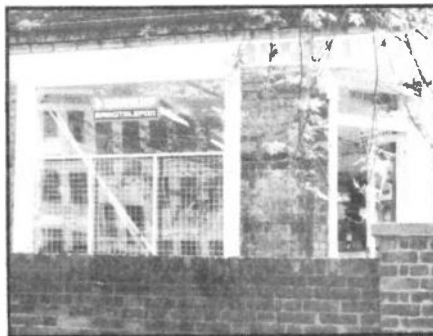
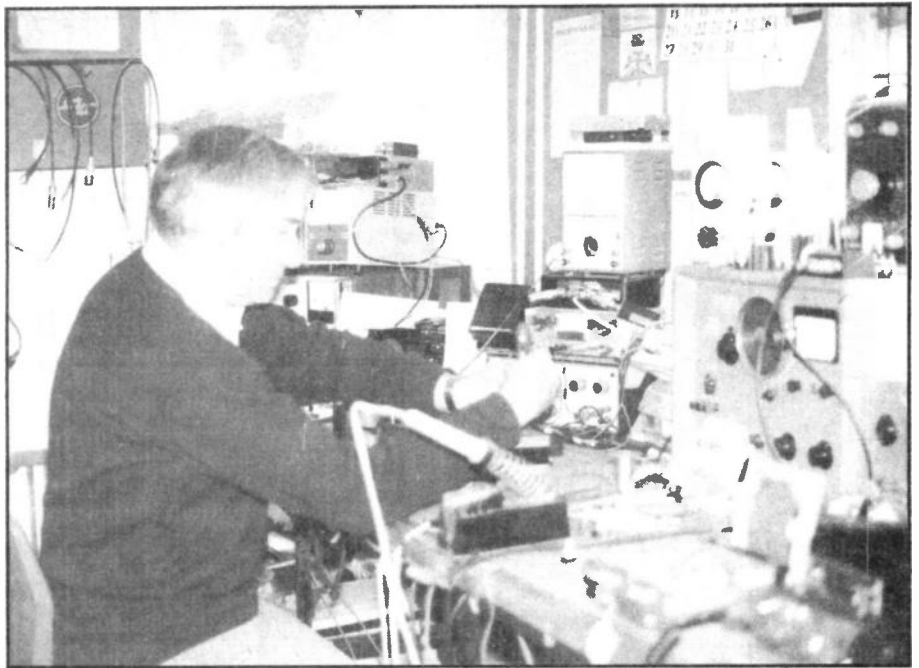

there is one! Even on his 30ft yacht 'Leisurely', which he berths in France, he is as concerned with the technical problems of marine radio as he is with seamanship. Many of his evenings are spent in giving talks to amateur radio and CB clubs. "CB was a right that the British public should have had years ago. It was the British government's procrastinations that caused all the problems of the enormous nets of illegal breakers. All this could have been avoided, but in the land of the brave, the home of the free, they don't really want anybody to have that much freedom!" But despite his agreement with the principles of citizens' band radio, Peter's company remained strictly within the law "in spite of the fact that we watched a lot of people make a lot of money by not doing so."

Arrow Electronics has fared extremely well with the steady hand of Peter Clarke at the helm. Quite apart from other business interests, and the big dealerships he fought long and hard to earn, he is a stockist for Diawa, Alinco, Vibroplex, Tet, Tonna, Halbar, G-Whip, Hi-Mound and others, including his own brand-name products.

Among the many topics concerning amateur radio that Peter discusses with clubs is the fact that "chatting to someone in the next county is only the tip of the iceberg. For that matter, so is talking to someone in South Africa." A proportion of Peter's enthusiasm is directed towards the high-technology possibilities of amateur radio - satellites, UHF, RTTY, fast (and



*Distinguished-looking Peter Clarke, head of the Arrow business that sells, modifies, repairs amateur radio equipment.*

slow) scan TV, colour, microwave or even solar power; all these are part of the exciting future of amateur radio for everybody.

Under the business hat of this slim, grey-haired 46-year-old lies a sincere concern for the best interests of the amateur radio enthusiast. "It's no good spending £1500 on a Yaesu Musem at a CB shop or an unauthorised dealer. If it went wrong he wouldn't know where to start to service it. If I have an agency, I must have the technical back-up and spares to go with it." Indeed, Arrow suspended dealing in one product because the firm concerned could not provide this facility.

If anything has made Peter Clarke a trifle uncompromising in his attitude, it has been because of the treatment he received at the hands of the barons in the upper echelons of the radio industry. Now, as a baron himself, he is determined to look after "those who favour us with their custom".

# THE INTERNATIONAL VHF-FM GUIDE

THE NEW EDITION YOU'VE BEEN ASKING FOR.

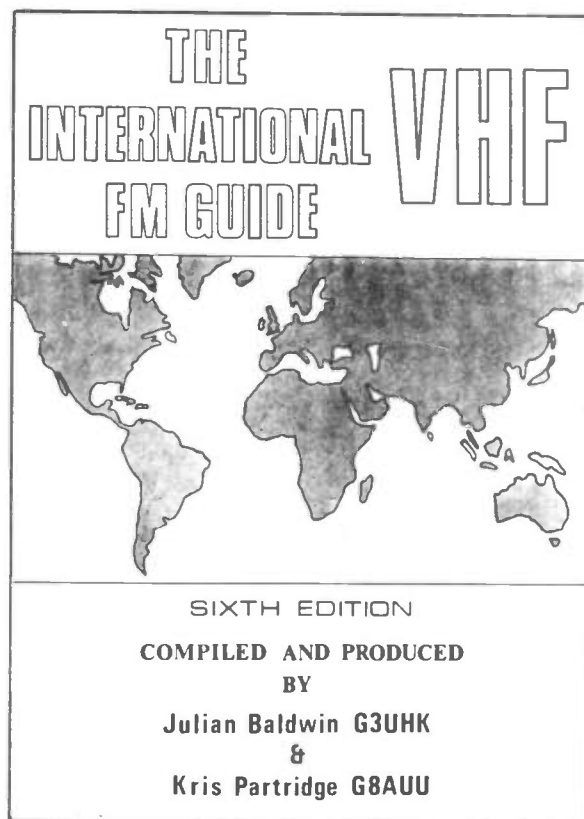

**£2**  
+30p p&p

**THE RADIO AMATEUR'S FOREMOST GUIDE  
TO REPEATERS AT HOME & ABROAD AND  
RECIPROCAL LICENSING FORMALITIES IN  
MOST POPULAR HOLIDAY DESTINATIONS.**

**COMPREHENSIVE COVERAGE OF 20 COUNTRIES.**

Maps showing repeater locations with keyed lists of channels, callsigns and brief details - Addresses, charges and formalities etc. to obtain a visitor's licence - Summarised information on a further 21 countries - A major 62 page supplement\* of detailed information about all active, and some planned, 2m U.K. repeaters, with coverage area maps and details of how to operate through each repeater - Beacon lists - Chart of FM channel frequencies - A description of the proposed new Locator System.

\* U.K. supplement not included in the 'Overseas' edition normally sold outside the U.K.

DOMESTIC EDITION £2.00 + 30p p&p      OVERSEAS EDITION £1.25 + 25p p&p to Europe.

Cheque/P.O. to J. Baldwin, 41 Castle Drive, Maidenhead, Berks. SL6 6DB

National Girobank Transfers to a/c 22 442 4009

# Classified Ads

● **TRANSISTOR** Diode tester with test leads. Brand new £27 carriage paid. R. Hayward, Sunnyfields, Lighthouse Road, St. Margarets Bay, Nr. Dover, Kent CT15 6EJ.

● **WANTED HRO** preferably in clean and serviceable condition. Ideally with range of general coverage and bandspread coils. Alternatively BC 342 (or BC 312) unmodified and in good condition. Telephone GW3FSW on Dyserth (0745) 570538.

● **YAESU FT20ZR**, charger, nicads, quarter wave, helical, power adaptor, crystals for S23, S17, S16, A5, R3 and Raynet. Also speaker/ Mic for attention. £80 ono. Tel: Romsey (Hants) 515246 Evenings.

● **G2DAF RECEIVER PARTS** required please. 898 dial variable capacitors for preselector and V.F.O. 455kc's IF cans. Aladin type full or part receiver chassis. Phone or write G4GIM QTHR (0905) 354727 TNX.

● **OFFERS WANTED:** Eddy-stone 670 Rx in working order, Leak TL25 and TL50 audio power amps working order 130 copies Practical Television, 118 copies Wireless World, 12 volumes Newnes R and T/V Servicing. QTY R and T/V radio books, good condition, dated 1943. Mr. E. Chapman, 12 Hobson Avenue, Dormanstown, Redcar, Cleveland, TS10 5PS.

● **WANTED:** Instruction book and circuit for Hewlett Packard vacuum tube voltmeter model 410B, copy will do. Stone, 16 Cromford road, Wirksworth, Derby. DE4 4FH.

● **YAESU FT1012** as new with mike, fan, manual. Original packing. £400. Phone Preston 35049.

● **FOR SALE RTTY** gear terminal teletype £65. Reader £7. 144MHz 40+W PA £28. IC4E 70 cms Portable Mint, very new with speaker microphone £189. All ono G6HKS. Need the money! Wisbech 584640.

● **WANTED** R.A.E. Home Course, will collect in Eastern Home Counties. Telephone 0279 54330 or write to Eric Coe, 15 Matching Lane, Bishops Stortford, Herts. CM23 2PP.

● **QSL CARDS WANTED** which show Concorde, TU 144 or Boeing 2707 swing wing planes. Also needed are Micky Mouse, Felix or any from VP8 Antarctica or foreign bases there. Fair prices paid. John Heys, G3BDQ, "Whitefriars", Friar's Hill, Guestling, near Hastings, TN35 4EP.

● **EXCHANGE** ICF 2001 and DX100L for Satellit 1400 or DX 302 or what have you. Telephone (0258) 53933.

● **FOR SALE:** Racla R17rx, MA 197B pre-selection unit, RA98 side band adaptor, Relevant Manuals. Good condition £250. Gordon L. Holdom, 229 Southwell Road West, Mansfield, Notts. Tel: (0623) 29289 (after 6.00 pm).

● **SALE** radio values 5B/254M (5) £3 each two for £5; 5763 (5) £2 the lot P/P 75p G35VO. 53 Maldon Road, Great Baddow, Essex. CM2 7DN. Telephone: Chelmsford (0245) 76129.

● **ICOM IC202S** with charger £110 ono. Microwave Associates Gunplexer transceiver 10GHz with PW dish cross coupler wavemeter £80 ono. Ring 0453-83-3411 or 0453-45461 evenings and weekends.

● **EXCHANGE:** Tandy TRS 80 16K. L2. computer with lower case, all manuals, and some software (needs monitor and cassette recorder) for YAESU FT208R portable. Tel 01-751 2262. G8AWV QTHR.

● **TRS 80 MICROCOMPUTER** 16K level 2, complete with power supply; visual display unit; cassette storage recorder; tapes; programming and instruction manuals. Cost £500. Sell 5350 or exchange transceiver or W.H.Y.? G3NQU, "Bonacre", St. Gennys, Bude, Cornwall.

**FREE ADS: Sell your radio equipment and spares for profit!**

## AMATEUR RADIO Classified Order Form

Name .....

Address .....

Tel: .....

To: Amateur Radio,  
Classified Dept,  
27 Murdock Road, Bicester, Oxon.

The Advertisement Manager reserves the right to alter, reject or suspend an advertisement without assigning any reason. Advertisements are accepted subject to approval of copy and to the right of the Advertisement Manager to alter, reject or cancel any order or part of order without explanation. The Proprietors are not liable for any loss from any cause whatever, nor do they accept liability for printers errors. The Advertisement shall indemnify the Publishers in respect of any claim, costs and expenses arising out of any libellous or malicious matter or untrue statement in any advertisement published for the advertisers, or any infringement of copyright, patent or design therein. The placing of any order will be deemed to be an acceptance of these conditions.

Don't forget – August issue of Amateur Radio appears on July 26th, 1983.

● **WANTED** urgently circuit and/or component valves of Eagle Products model K-110 RF power asnd SWR meter 53 and 75 ohms. R. Thurlow, G3WW, 2 Church Street, Wimbling ton, March, Cambs. Tel (0354) 740255.

● **FOR SALE** as new 3 element Hygain Yagi beam for 10 and 11 metre bands complete with Sky King rotator £55 ono. Tel Chris, Kidderminster 754388.

● **WANTED:** Handook/Manual for Eddystone 730/1A receiver. Graham hall, 14 Evington Parks Road, Leicester. Tel: Leicester (0533) 734902.

● **SANYO RP8880** general coverage Rx. F.M. L.W. M.W. S.W. (1.6-30 MHz). Double Conversion system. RF gain Antenna adj. 1MHz 100kHz, 10kHz XTAL marker, wide narrow selectivity. B.F.O. £100 or exchange for Sony ICF-2001. J. Graham, 8 Oaktree Drive, Ecclefechan, Dumfriesshire. Tel: 057-63-494.

● **WANTED** by complete novice. Multi-band receiver covering aircraft, public services etc. or information as to possible source of supply, new or s/h. R. G. Collett, 7 Norway Drive, Warden Hill, Cheltenham. (0242) 24259.

● **WANTED:** handbook or circuit diagram for Lafayette HE-30 general coverage receiver willing to buy or hire to copy. All expenses paid. Urgent need. John C. Bowditch, 21 East Wyld, Weymouth, DT4 ORP, Dorset. Tel: Weymouth 75353.

● **KENWOOD/TRIO TS820** £400 or near offer. Will accept 2 metre multi mode base TX/RX with cash adjustment Cavendish 2000A Spinet electronic organ. Best offer secures. Need the room SAE for further details. J. Peerless, 157 Fairmead Crescent, Edgeware, Middlesex. Tel: 01-958 6887.

● **SANWA** 3 channel radio control outfit. Dry cell. 3 servo's 2 sets of xtals. 27MHz AM. £30 ono. J. Smith, G6VAR. Phone 0594 34338.

● **FOR SALE** (owing to unforeseen circumstances) Icom's new receiver, the ICR70. Mint and in perfect order. Purchased five months ago. £400 cash. Details from Robinson. Telephone Bury St. Edmunds (0284) 61951.

● **SALE OR EXCHANGE** Halli-crafter S38D AM & CW receiver £25.00. Would exchange for good up down key. Or a morse reader. Mr D. Clifford, G6UFV, 160 Goldsworthy Way, Slough, Berks. SL1 6AY. Tel: Burnham 64567.

● **SCANNER** required, will pay up to £150 evenings. Up to 9pm. Colin on Eastbourne 0323 57769.

● **TRIO TR2400**, synthesised handheld 2m transceiver, case, nicads and charger. £130 ono. 13.8v PSU £10. Wanted: 2m, 25-30W linear amp. plus pre-amp. 6 or 8 element Yagi and Rotator. Tel. Luton (0582) 31 075.

● **ICOM 720A** complete station with PSU automatic ATU and matching speaker unit this unit has only been used for amateur bands and is a bargain at £1125 complete. Telephone Mike 01-641 1127 any evening.

● **FOR SALE** Drake TR4C RV4C AC4 noise blanker £350. Linear FL2100B £225 both as new approx 10hrs. use only. Catronics CT100 Terminal unit brand new plus Siemens T100. Buyer collects. Alec F. Ward 4 Boscome Ave, Grays, Essex. Tel: (0375) 70782.

● **FRDX 400** receiver 160-10m W.W.V. and C.B. plus 2m and 6m convertors AM,FM, SSB, CW filters matching speaker £140 ono. Tel: Kilmarnock (0563) 24009.

● **EXCHANGE** my communications receiver, Lowe SRX-30 (analogue) for Sinclair Spectrum computer or offers Tel: Leeds (0532) 703143.

● **FOR SALE** a 1917 to 1918 Field Telephone with a morse key, in case, good condition for age. Open to any reasonable offers. Mr. R. Lane, 36 Elan Close, Bettws, Newport Gwent. Tel: 272871.

● **WANTED** VFO 30G for use with TR2200GX also TX and RX crystals for TR2200GX on 144-850 (Simplex) and 145-200 (S8). Tel. Steve Buxton (G6NLU) (0602) Nottingham 878920.

● **AR88D** including 2M converter, handbook, spare valves, buyer collects £60. Tel: Colchester 71387.

● **WANTED:** Connecting plug 5 pin for Philips portable car radio type 90RP33515E also handbook for same. Harold Roberts, 31 Southampton House, Broadmere Ave., Havant, Hants PO9 5HZ. Tel: Havant 454720.

● **TRIO 2300** 2 metre portable complete with nicads, charger, carrying case, helocal aerial. Excellent condition. £115. Phone Worcester 53027.

● **YAESU FRG7** communications receiver 0.5 to 30MHz with manual. Mint condition. Prefer buyer inspects and collects or carriage and insurance extra. £120. Jim Blake Tel. Ross-on-Wye 63126.

● **YO90IP YAESU** Multiscope wanted. Good price offered. Will collect anywhere. Tel: 01-850 4848. G4NOW.

● **WANTED:** Manual for Rhode & Schwarz model ZWA or a good working unit. will pay cash. John Thomas, VE3BVX, 58 Albert St. N. Lindsay, Ontario, Canada K9V4J8.

● **WANTED** by keen collector: C1920-1929 crystal sets, valves, components, Celestion C14 cabinet speaker, Gecophone 2 valve receiver, magazines London Radio Circle Badges and certificates, C1939 Eddystone "All-World Two" receiver in good condition. N. Richardson G6RGR, 2 Edna Road, Maidstone, Kent ME14 2QJ

● **WILL EXCHANGE** YAESU FT-7B transceiver with YC-7B display unit both new and boxed plus YAESU FT401 DX transceiver in V.G.C. For any transceiver covering top band 160 metres please phone (0475) 706451.

● **RACAL RA17Mk2** receiver S.S.B adaptor codar pre-amp home brew A.T.U. All £325 B&H 642-16mm sound projector matching speaker all above mint condition. **WANTED:** T5700 FT225 RD part exchange. G4LW 3166 Trowbridge, Wilts.

● **WANTED:** For the Wireless Museum. Old radio books, magazines, catalogues, QSL-cards, callbooks, components, valves, any old knobs! Collection arranged. Details please to Hon Curater G3KPO, 34 Pellhurst Road, Ryde, I.O.W. (0983) 62513.

● **YAESU FT790R** portable multimode carrying case ni-cads charger mobile mount ten watt P.A. helical antenna £250 G4CGZ QTHR (01)-679 1378 after 6 p.m.

● **FOR SALE** Trio TS515 V.G.C. £225. YAESU FT101B as new plus G3LLL R. F. Clipper and two pair new Toshiba 6J56C tubes £350.

S. Stobbs, 78 Hershall Drive, Middlesborough, Cleavland. TS3 8NX. Tel: 2116855.

● **PYE** enclosed 19 inch rack cabinet. Approx 57 x 20½ x 18 inches. Suit repeater/beacon or similar project. Some blank panels. £30 ono. Wimborne (0202) 882269 G8CEZ QTHR.

Ant Products,  
All Saints Industrial Estate,  
Baghill Lane, Pontefract,  
West Yorkshire.  
Telephone 0977 700949

**AMATEUR ANTENNA**

Silver 70-70cms 16 dbd	
Gain Beam .....	£31.95
Tiger LY6 9 dbd	
2 Meter Beam .....	£12.95
Tiger LY8 11 dbd	
2 Meter Beam .....	£19.50
Tiger LY10 14 dbd	
2 Meter Beam .....	£32.95
TWO YEAR GUARANTEE ON ABOVE	
ZL 12 Mk 2 13 dbd	
Gain Beam Antenna .....	£32.95
ZL8 Mk 2 9 dbd	
Gain 5'-7" Long Boom .....	£19.95
ALL ABOVE HAVE STAINLESS STEEL PARASITIC ELEMENTS	
Norcone 512 Wide Band	
Discone Antenna .....	£25.95
Superior Amateur Radio Station Log	
Book .....	post paid: £3.00
Securicor Delivery Extra .....	£4.50

Send cheque or money order today, made payable to Ant Products or write enclosing S.A.E. for full details.

Professional 12-Band all mode ultra-sensitive SW/VHF/UHF Communications Receivers, VHF/UHF Scanners, Vega Short Wave Portables, Transceivers, Security Devices, Electronic Handbooks etc., etc., including our Professional 52-176MHz VHF pocketable receiver incorporating 40ch FM CB Monitor with Volume, Squelch etc. at only £13.95 post paid. Comprehensive range now available, see details (+25p full catalogue).  
**D. TAYLOR, 8 EMMERSON STREET, CROOK, CO. DURHAM. UK Tel: 0388 763323.**

**HAM HOLIDAY SRI LANKA**  
**WRITE TO SPANGLES TRAVELS,**  
**84 TEMPLERS ROAD,**  
**MOUNT LAVINIA. SRI LANKA.**  
**TELEPHONE 010 941 713437.**

**G2DYM AERIALS**  
**TRAP UNI-POLES OR TRAP DIPOLES**  
**DATA SHEETS LARGE SAE. AERIAL GUIDE 75p**  
Callers Welcome Tel 03986-215  
**G2DYM, UPLOWMAN, TIVERTON, DEVON**

**Amateur Equipment** bought and sold, cash waiting. Contact G3RCQ, Hornchurch 55733 evenings.

**List-A-Rig.** A service offered by G3RCQ Electronics to introduce buyers and sellers of used amateur equipment. Buying? It's free, just send an s.a.e. Selling/wanted? Send s.a.e. for details on how to join the fast-growing list. List-A-Rig is sent and updated daily; no waiting, no deadlines. — **List-A-Rig (AR)**, 65 Cecil Avenue, Hornchurch, Essex RM11 2NA.

● **DX 302** Digita HF communications receiver SSB AM CW. Three months old as new, original packaging. List £289 accept £165 or exchange HF equipment, test equipment or W.H.Y.? Telephone: Keith G4TDA Rugby (0788) 70363.

● **BRAND NEW** Icom IC740 one week old. £600. Unused, listed at £725. Also P.S.U IC-PSIS £75, Unused. Listed £115. Sell together £650. For more information ring (0293) 515711.

● **ATTRACTIVE** QSL cards ancient or modern are wanted by top British QSL collector. Antartic, Concorde, Heraldic and most topics are needed. Write to G3BDQ, 'Whitefriars', Friars Hill, Guestling, Hastings, TN35 4EP.

● **WANTED** QRP Tx/Rx CW/SSB or CW only. D. Douglas, GM4ELV, 3 Kirkfield Place, Arrochar, Strathclyde.

● **ICOM** I.C. 730 with power supply and mic all bands 80m to 10m £525. YAESU FT480R £285 G.3. I.W.C. Lilac Cottage, Moorhouses, New Bolingbroke, Boston. PE22 7JL Phone 0526-42918.

● **WANTED** Ex Army R209 receiver 6 volt or 12 volt versions. Details and price to: Jim Thomson, 2 Wilton Hill, Hawick. TD9-8BA. Roxburghshire, Scotland. Tel: 0450-75089.

● **COMPUTER FOR SALE.** TRs 80 level II 16K plus V.D.U. green display £150-00. Tel 05255 3300 after 1400hrs. Very good condition. T. O'neil, 10 Frenchman Close, Toddington, Beds. Tel: Toddington 3300.

● **EXCHANGE** Grundig Satellit 1400SL receiver, week old, for Panasonic R5-3100 DR 31 or any good receiver not Realistic. Grundig supplied original packing still guaranteed all leads and paper work brought for starting Dx'ing. I. Sear, 35 The Oval, Didcot, Oxon.

● **FOR SALE** Microwave Module MML 144/100S linear amplifier. Unwanted gift. Never been used. £110.00 plus Lowe SRX 30 receiver 500kcs to 30 megs £95.00. Purchaser collects or pays postage or would consider exchange for Trio 2300 IC2E or similar handheld transceiver. Tel: Southport 20003.

● **WANTED** YAESU FL 100 B transmitter and manual. R. Colvin, 46 Beechwood Ave, Woodley, Berks. RG5 3DG.

● **FOR SALE** YAESU FT101ZD Mk3 fitted fan. FM, hand mic and MD1B base mic. SP901 speaker FC707 ATU YH77 headphones. All two months old and boxed as new best offer secures or split. G. Wagstaff. (0279) 441994.

● **SWOP** CYBERNET Beta 1000 FM CB telephone mike Amstrad aerial with three mounts all excellent working condition for ZX81 computer with 16K ram pack or for an Amateur Band HF receiver. Mr. R. J. Twose, 8 Hawthorn Avenue, Headington, Oxford-OX3 9JG. Tel. Oxford 65156.

● **EDDYSTONE** 840A communications receiver. Good working condition will exchange for any 2 metre accessory of similar value or will sell on own. Tel. (0704) S/port 73435.

● **ICOM 720A PLUS** PS20 Psu £869.00 o.n.o. ICAT 500 auto ATU 1.8-30MHz £270.00 o.n.o. Mobile mount, headphones, base mike. Boxed mint condition £1,100 the lot. ICOM 701 1.8-30MHz, PS20 PSU boxed only used receive £475 o.n.o. Phone Crawley 510491 Evenings.

● **KW TRAP** Dipole 80/10 inc with balun 100ft coax £15 RA17 handbook £2. Ring G3LEX 01-481 1597 (evenings).

● **WANTED:** Instructions manual for AVO multimeter electronic type CT38 also service manual for Marconi signal generator type TF801A. All expenses paid. Mr. M. Nixon, 103 Patrick Street, Grimsby, South Humberside DN32 9PQ.

● **BADGES OF** callsigns in brilliant copper, lapel or tiepin mounted on solid brass badge pin 90p including delivery within 10 days. Griffith, 6 Stanway Close, Alkington, Middleton, Manchester. M24 1HP66CVW Tel. 061-643 6944.

● **PYE POCKET** phone's transmitter and receiver. Good condition, crystallised on RB10DY £25.00 for the pair. Telephone 0283 815295 after 7pm.

● **WANTED:** ICOM 202.5 5.5.B. portable, Telford TC.10 2m Tx. Phone Dan, Haverfordwest 6256. Evenings. GW6CCM.

● **FOR SALE** YAESU FT401 560-watt P.E.P input transceiver. Handbook. £245. Datong FL audio filter. Instructions. £65. SM71 low noise fet 70-CM preamp. £11 Telephone: 01-460 3852. G4ALV QTHR.

● **TR2200G** FITTED S10,13 18 to 23 plus R0 R1 R3 R5 twelve channels fully XTALD also spare XTALS for R6-7 and 58 CW nicads charger case boxed manual £100 o.v.n.o. Mr. R. Rixon, 4 Bartlet Close, Fareham, Hants. Tel. Fareham 238305.

● **TEKTRONIX 500** series test instruments SC502 15MHz dual trace oscilloscope FR502 11MHz function generator DC502 550 MHz frequency counter TM515 portable main frame. All as new £2795 Cardiff 731228 Evenings.

● **JAY BEAM** Trap vertical antenna 10-15-20m fitted ground planes. G. Milsted G35OF IGIA Gurney Court Road, St. Albans (0727) 59693. Only £30.00 for quick sale.

● **ORIC BBC** programs morse tutor £4.50 Locator gives distance, bearing, points handles lat/long. QRA, QTHL codes £4.50 BBC RTTY £5 Requires TU Texas TI99 distance £4 GBKMV QTHR Tel. 0438 54689.

● **TRIO JR 500 S** receiver preselector for Ham bands. Good working order £35 also Belcom AMR 217 B scanning monitor VHF-FM model with crystals for marine bands will take crystals for 2 metres £50 Ring 0435-612007

● **HY-GAIN 3 AM-FM** transceiver converted to 28.15-30.0 in 10 KHz steps. Repeater fitted. 10 watts output. Internal S.W.R. meter. £60. LC.L 2740 C.B. rig convertible. 10 metres with mod details £25. Telephone: Watford 24752.

# Amateur RADIO

## ... on subscription

Make sure of your copies of Amateur Radio. Order 12 issues for the basic price of £10.80 — no extra charges

Just complete the coupon and send it, with a cheque or postal order for £10.80 (£16.80 surface mail outside UK) to: Amateur Radio Subscriptions, 27 Murdock Road, Bicester, Oxon OX6 7RG.

Please send me Amateur Radio magazine for one year. I enclose a postal order/cheque made out to Goodhead Publications Ltd., in the sum of £10.80 (£16.80 surface mail outside UK). Please write clearly.

Name ..... Address .....

.....



● **CORDLESS RADIO TELEPHONE** new and unused. Cost £190 accept £120. Telephone answering machine G.P.O. approved also new and unused. Fully guaranteed. Cost £109 accept £72.50 (will send C.O.D.) 01-942 6412 anytime.

● **YAESU FRG 7000** general coverage receiver 200kHz-30MHz. Digital tuning. AM/SSB/CW A.C or 12v. Preset automatic recording facility. Mint condition little used £200 also Hygain 5 AM/SSB-TxR £45 requires attention. 19 Central Drive, Bramhall, Cheshire. Telephone 061-439 9637.

● **SONY STEREO MUSIC SYSTEM HP511A** excellent condition two solid teak 35W speakers. Wanted good communications receiver or TR2400. All replies answered. Securicor delivery. T. Waters, 42 Tregundy Road, Perran Porth, Cornwall.

● **SHARP MZ80-K** computer 48K. Software includes:- Basic extended, SP 259, plus Forth, Pascal, Machine code, word processor, 100 programme library, M/C games, £390; TRID 9R-59D receiver £70. All excellent condition. Tel. Tewkesbury 297579.

● **CYBERNET BETA 3000** as new £30. Cybemet Beta 1000 £20. Harvard 40ch hand held £30.00. All for £70 Mr. Morris, 22 Deans Walk, Gloucester. Tel: 0452 421920.

● **WANTED:** Eddystone side-wiper morse key - Tony G4KHT QTHR. Telephone Hull (04820) 852216.

● **HELP! WANTED** any information, circuit diagrams, service manuals, modifications for Jennen-Trio JR101 valve general coverage receiver H.F. about 15-20 years old Pete Stephens, 49 Kings Court, Bishops Stortford, Herts CM23 2AB thanks!

● **FOR SALE:** rotating multi element FM and TV aerial 14' long with control unit, tripod mast 14' high. Chimney fastening. Cost £300 perfect working order. Buyer collects. Offers. Tel: North Weald (Essex) 2576.

● **TRIO 2300** 2 metre portable complete with nicads, charge, carrying case, helical aerial. Excellent condition. £115. Phone Worcester 53027.

● **CORDLESS RADIO TELEPHONE** new and unused cost £190 accept £120. Telephone answering machine G.P.O. approved also new and unused fully guaranteed. Cost £109 accept £72 50. Will send C.O.D.) 01-942 6412.

● **SUPERSTAR 360 FM.** AM/FM/USB/LSB/KW/KC shift. Built in SWR meter, standard mike, plus turner. JM+ZU power mike. AS new and boxed £135.00. Tel: 01-958 6400 after 7pm.

● **RADIO SHACK DX 302** quartz synthesised digital world receiver 10kHz-30MHz. As new, superb DX'er. L.S.B. C.W. U.S.S.B. £175. An outstanding offer, genuine 12 volt-240v mobile marine base station. Mr. A. A. Bailey, 40 Salisbury Way, Salisbury, Wilts. Tel: Salisbury 22646.

● **FOR SALE:** Eddystone 358X receiver, coverage 40kHz-31MHz incorporating 300Hz crystal filter, with homebrew P.S.U., manual £35. Collection only please. Tel Cambridge (0223) 64352 after 6pm.

● **FRG7** with fine tuner, Joy-match A.T.U. Microwave Modules 2 metre converter for the above. £120 the lot. Buyer to collect. Gone G4. Tel: Berkhamstead (04427) 4059.

● **LINER 2 SSB** 144.10 to 144.3 with mobile mount and manual. Fitted pre-amp. Good condition £65 Delivered. Paul G3MWZ Tavistock (Devon) 0822 4595.

● **FOR SALE:** 5 band vertical trap antenna model 18AVT. 80, 40, 20, 15, 10 metre wave band with HS ground plane kit as new only 4 months old £80 ono Ring Worthing 691717.

● **WANTED URGENTLY:** MR-1000A (or similar) pocket 2M scanning receiver. Will pay carriage. All letters answered. Mark Cooper, 33 Park View, Royston, Barnsley, South Yorks. S71 4AA.

● **SALE OR EXCHANGE:** Rotel RVC 230 40 channel FM CB transceiver to Home Office specification. Plus Harrier SWR meter. Used once only. £50 or will exchange direct swop for Heathkit RA1 or Eddystone 888A with cash adjustment. Telephone (0272) 642101.

● **SWAP REALISTIC 2001** scanner for Morse Tutor or sale £70 or W.H.Y. Mr. C. G. Holloway G6UMM, 42 Oban Street, Poplar, London E14 0HZ. Tel: 01-987 2296.

● **WANTED** Admiralty SSB/RTTY converter for B40D Rx complete mounting tray, manual, connectors. For sale 2M receiver SR9 £35, new. R. L. Allen, 3 Oakfield Court, Reed Street, Oakfield, Ryde, Isle of Wight PO33 1EN.

● **RARE AUDIO AMP IC** Matsushita AN7140. Small quantity only. £5.00 each. Tel: (07356) 6087.

● **BADGES OF CALLSIGNS** in brilliant copper. Lapel or tiepin mounted on solid brass badge pin 90p including delivery within ten days. Griffiths 6 Stanway Close, Alkington Middleton, Manchester M24 1HP 66CVW. 061-643 6944.

# Advertisement List

<i>O.C.T. International</i> .....	2
<i>Datong Electronics</i> .....	5
<i>Mutek Ltd.</i> .....	19
<i>Thanet Electronics</i> .....	24/25
<i>Dewsbury Electronics</i> .....	32
<i>Davtrend Ltd.</i> .....	39
<i>International Correspondence School</i> .....	
	39
<i>N.J. Edwards</i> .....	39
<i>R.A.S. Nottingham</i> .....	39
<i>Telecom Barnsley</i> .....	45
<i>Reg Ward &amp; Co. Ltd</i> .....	45
<i>McMichael Ltd.</i> .....	45
<i>British National Radio &amp; Electronics School</i> .....	
	51
<i>Wood &amp; Douglas</i> .....	51
<i>Myers Electronic Devices</i> .....	51
<i>South Midlands Communications Limited</i> .....	
	58/59
<i>Spangles Travel</i> .....	72
<i>Ant Products</i> .....	72
<i>David L. Cole</i> .....	72
<i>R. Benham-Holman</i> .....	72
<i>Microwave Modules</i> .....	75
<i>021-Radio &amp; Electrical</i> .....	76

Now turn to page 71 for your opportunity to include a free private classified ad in the next issue of Amateur Radio!

It pays to advertise in  
**AMATEUR RADIO**



# MICROWAVE MODULES LTD

**QUALITY, ALWAYS AND GUARANTEED**



**MML144/30-LS**



**MML144/50-S**

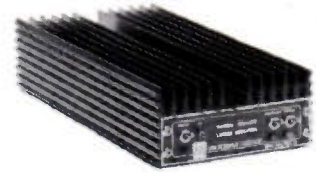

**MML144/100-S**

INPUT POWER	OUTPUT POWER (R.M.S.)	MODES OF OPERATION	PRODUCT	PREAMPLIFIER		POWER REQUIREMENTS	RF FOX	CONNECTORS
				GAIN	N.F.			
1 or 3W	30W	SSB	MML144/30-LS	12dB	<1.5dB	13.8V @ 4A	✓	SO239
10W	50W	FM	MML144/50-S			13.8V @ 6A	✓	SO239
10W	100W	AM	MML144/100-S			13.8V @ 12A	✓	SO239
1 or 3W	100W	CW	MML144/100-LS			13.8V @ 14A	✓	SO239

**PRICE (inc VAT)**

**MML144/30-LS :£69.95** (p+p £2.50)  
**MML144/50-S :£85.00** (p+p £2.50)  
**MML144/100-S :£139.95** (p+p £3.00)  
**MML144/100-LS :£159.95** (p+p £3.00)  
**MML432/30-L :£99.00** (p+p £3.00)  
**MML432/50 :£109.95** (p+p £3.00)  
**MML432/100 :£228.65** (p+p £4.00)

This advertisement represents a cross-section of our extensive range of linear power amplifiers, currently available for the 144 and 432MHz band.

We offer the widest choice of superb quality, British-made products, to suit virtually all transceivers, from hand-held to base station models, and provide guaranteed value for money.

**ALL OF OUR PRODUCTS ARE FULLY GUARANTEED FOR 12 MONTHS - INCLUDING PA TRANSISTORS.**

Although cheaper amplifiers have appeared on the market, we seriously advise the potential buyer to consider the following points:

- 1 Has the company manufacturing the product been in business since 1969?
  - 2 Is the product manufactured solely in the U.K.? If not what happens when you need service facilities?
  - 3 Does the amplifier you are considering have a "realistic" power output specification? Be sure to check if the power rating is RMS or PEP!
  - 4 Is the product fully guaranteed for 12 months - INCLUDING PA DEVICES?
- If the answer to any of these questions is No, then you should telephone us immediately for help.

INPUT POWER	OUTPUT POWER (R.M.S.)	MODES OF OPERATION	PRODUCT	PREAMPLIFIER		POWER REQUIREMENTS	RF FOX	CONNECTORS
				GAIN	N.F.			
1 or 3W	30W	SSB FM SSTV AM CW	MML432/30-L	12dB	<2dB	13.8V @ 6A	✓	INPUT BNC OUTPUT BNC
10W	50W		MML432/50	12dB	<2dB	13.8V @ 8A	✓	INPUT BNC OUTPUT N
10W	100W		MML432/100	—	—	13.8V @ 20A	✓	INPUT BNC OUTPUT N



**MML144/100-LS**



**MML432/30-L**



**MML432/100**

**OUR ENTIRE RANGE OF PRODUCTS WILL BE EXHIBITED AND ON SALE AT MOST OF THE 1983 MOBILE RALLIES BY OUR OWN SALES TEAM. COME AND TAKE A CLOSER LOOK**

ALL MICROWAVE MODULES PRODUCTS ARE FULLY GUARANTEED FOR 12 MONTHS (INCLUDING PA TRANSISTORS)



WELCOME

**MICROWAVE MODULES**  
 BROOKFIELD DRIVE, AINTREE, LIVERPOOL L9 7AN, ENGLAND  
 Telephone: 051-523 4011 Telex: 628608 MICRO G  
 CALLERS ARE WELCOME, PLEASE TELEPHONE FIRST

**HOURS:**  
 MONDAY-FRIDAY  
 9-12.30, 1-5.00



# PUMA

## The new power booster for your handheld.

Meet the new linear amplifier that extends the power and range of your handheld to performance of home transceiver quality.

---

**BIT 02 (left)**

144-148MHz · output 7-20W ·  
input 0.1-3W · weight 165g

RRP **£59.95**

---

**BIT 07 (similar)**

430-440MHz · output 4-15W ·  
input 0.1-3W · weight 185g

RRP **£79.95**

---

**BIT B (insert, far left)**

Gives 120-minute operation at  
10W or 600 minute at 1.5W

RRP **£64.95**

---

Below: **BIT B** power pack  
with case for use at home  
or outdoors – clips to belt!



*Ask for all details at your  
local amateur radio shop*

