

Amateur

# RADIO

90p

No.2

For all two-way radio enthusiasts



**Getting started**  
short wave listening

**VHF antennas**  
-special feature

**Two top rigs**  
on test

**Build a power/SWR meter**



**The Falklands:**  
how amateur radio  
helped Britain  
to victory

# Whatever your interests...

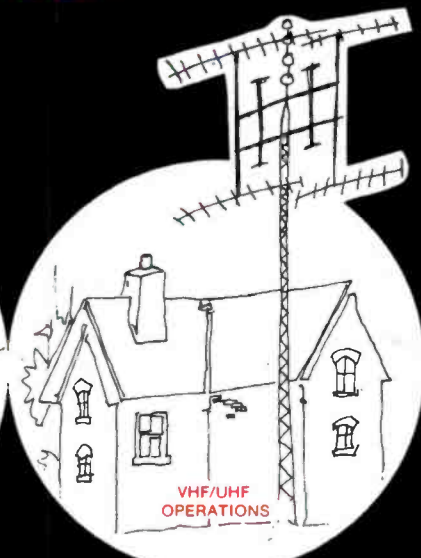
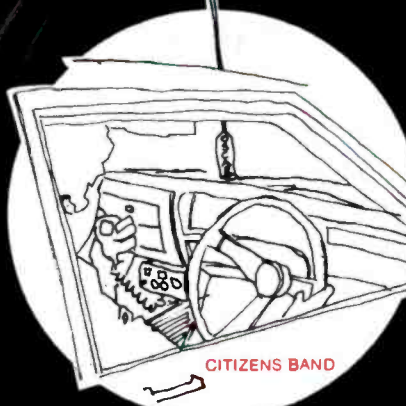

## we can help

**SMC** The Biggest Amateur Radio Distributor in Europe!

**Branches and Agents throughout the U.K.**

**S.M.C. (Jack Tweedy) Ltd.,**  
102, High Street,  
New Whittington, Chesterfield.  
Chesterfield (0246) 34982

**S.M.C. (Humberide)**  
247A, Freeman Street,  
Grimsby, Lincolnshire.  
Grimsby (0472) 59388

**S.M.C. (Stoke)**  
76, High Street,  
Talke Pits, Stoke.  
Kidsgrove (07816) 72644

**S.M.C. (Leeds)**  
257, Otley Road,  
Leeds 16, Yorkshire.  
Leeds (0532) 782326

**S.M.C. (T.M.P.)**  
Unit 27, Pinfold Lane,  
Buckley, Clwyd.  
Buckley (0244) 549563

U.K. Distributors for; YAESU MUSEN-KDK-HY GAIN- CDE-HANSEN



**SOUTH MIDLANDS COMMUNICATIONS LTD.**

S.M. House, Rumbridge Street, Totton, Southampton. SO4 4DS  
Telephone: (0703) 867333 (8 lines). Telex: 477351 SMCMM G. Telegrams: "Aerial" Southampton



# Amateur RADIO

## 5 Current comments

News and views from the world of the radio amateur. Written by the Editor. Plus, readers' letters.

## 7 On the straight and level

Gossip, things heard and things we shouldn't have heard, brought to you by the editorial staff who happen to be in the right place at the right time!



## 10 Falklands factor

It's a little known fact, but amateur radio had a lot to do with the British victory in the South Atlantic. Here, Chris Drake tells you how a few operators got in on the act, and how radio amateurs can help in times of emergency.

## 14 Meteoric messages

Bouncing your transmissions off the trails left by meteor showers can be tremendously satisfying. You get an insight into the field of astronomy too. Here's how to do it.

## 18 Shoptalk

New equipment, transceivers, antennas, along with prices, availability, specifications and pictures.

## 24 Starting from scratch

All about short wave listening. It's about the best way you can get into amateur radio — you don't need a licence, and the world's your hunting ground.

## 28 Long distance information

There are few things more worthwhile than talking with friends in far distant lands. What you should know before you make contact, and how to make the best of the available bands.

## 32 Radio prefixes

From Botswana (A2) to Trinidad and Tobago (9Y4), all the world's prefixes are listed. Yes, Bophutatswana is there too.

## 34 Don't interfere!

If your transmission is heard through next door's television set, it's not called interference — it's called breakthrough. Here's how to eliminate breakthrough, and deal with a potentially sensitive neighbour.

## 38 Feeders

Otherwise known as the cable linking the antenna with the receiver. All about co-ax, and connectors, and how to go about assembling them.

## 42 Beginner's guide

The semi-conductor — what it looks like, does, and a description of how they are made.

## 48 The myth exploders

Things you've believed for years, may not necessarily be true. Here, P. Dodson explains a few stories that somehow have become believable over the years.

## 50 Question of power

Which batteries are the best for the money? For your particular purposes? For longest life? Amateur Radio's special survey of batteries, for use in hand-helds among other places.



## 54 Major test — TS830

Amateur Radio puts the Trio TS830 through its paces, and decides whether £694 is a good price for this mainstation.

## 58 The licence

The cans and cant's of the Home Office Amateur Radio Licence.

## 60 Project: SWR/power meter

Step by step instructions — with pictures — on how to put together your own bridge with a Heathkit.

## 64 VHF antennas

Our Technical Editor discusses this popular range of aërials, the various types, and what they can and can't do for you.

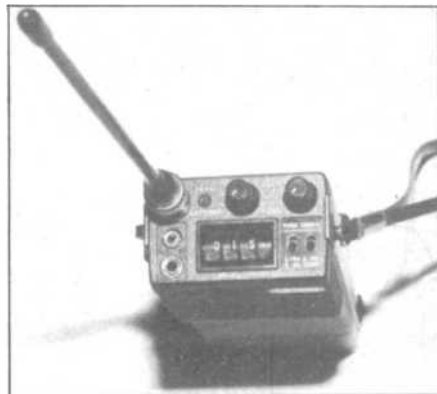

## 67 Major test — IC4/E

The Icom IC4/E tested by Amateur Radio's own team of experts. Full specs and pictures. You get a lot of hand-held for your £199.

## 70 The explained

Operational amplifiers — or op amps as they're better known. What they are, and how they work. The inexplicable explained.

Editor: Christopher Drake  
Technical Editor: Nigel Gresley  
Art Editor: Frank Brzeski  
Photographer: Tony Large  
Advertisement Manager: Linda Beviere  
Ad. Assistant: Rose Kirtland  
Production Co-ordinator: Kim Eeles  
Managing Director: Eric Rowe  
Published by Goodhead Publications Ltd,  
27 Murdock Road, Bicester, Oxon,  
England. Telephone: 08692 44517.  
Typesetting by Goodhead Press Ltd,  
Launton Road, Bicester, Oxon.  
Printing by Wiltshires Ltd, Bristol.  
Distributed by COMAG Ltd, Tavistock  
Road, West Drayton, Middlesex.  
© Goodhead Publications Ltd.

Whilst every effort is made to ensure the correct reproduction of advertisements, neither the Publishers nor their advertisement contractors accept any responsibility for errors in, or non-appearance of the final reproduction of advertisements.

Advertisements are accepted and reproduced on the understanding that the Publishers' "Conditions of Acceptance" apply in all cases. Copies of these conditions are also available from the Advertisement Offices.

All material printed in this magazine is the copyright of the Publishers and must not be reproduced in any form or affixed to as any part of any publication or advertising whatsoever without the written permission of the Publishers.

# THE MAGAZINE FOR THE ACTIVE RADIO ENTHUSIAST

If you're not content with just using an oriental 'black box' transceiver - without worrying too much about how it works, then R&EW is the magazine for you.

Our in-depth reviews of reveals the innermost thoughts of commercial equipment, and puts the spec. in perspective.

Updated and 'perfectly bound' reprints of most of our earlier projects are also available (as well as some of the back issues at £1 copy.)

Our projects feature transceiver add-ons that enable useful gains in performance to be realised at a fraction of the cost of ready-built equivalents. By building them yourself, you'll also learn a lot about the theory behind the theory and practise of circuit design.

All our projects are backed by our unique project pack service, that means all the components are available...and from a single source. No more hunting around for an unusual coil, or a "State of the art" semiconductor.

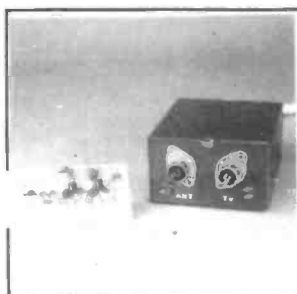

## MASTHEAD TV PREAMP

Featured in January '82

An ingenious design for a high gain, UHF TV preamplifier where power to the preamp is supplied via the coax cable, from a mains PSU at the base. A complete kit, including two cases (one for the preamp, one for the PSU)

Stock No. Price  
40-06200 (kit) £10.47

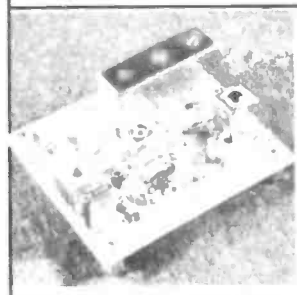

## 2m CONVERTER

Featured in October '81

A low noise 1445/6MHz to 28/9MHz converter, using a noise matched MOSFET RF stage, and 3 chamber helical filter for superb RF selectivity and freedom from spuri. Complete kit, high spec. crystal, case.

Stock No. Price  
40-01030 £16.67

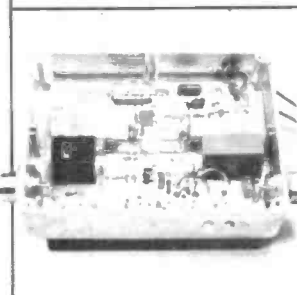

## 2m POWER AMP

Featured in June '82

A 25/25W, 10dB gain linear power amplifier for 2m handhelts and portable transceivers, available with or without a noise matched receiver preamp. Complete with die cast box, heatsink, etc.

Stock No. Price  
40-14421 (no preamp) £32.77  
40-14422 (inc preamp) £34.96

## 23cm CONVERTER

Featured in March '82

Is there life above 2m? Find out with this low noise, low cost introduction to microwaves. 2m or 10m outputs available. Supplied with stripline PCB, and all parts other than connectors. Xtal for 2m or 10m.

Stock no. Price  
40-23144 2m £19.45  
40-23028 10m £19.45

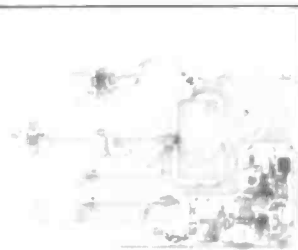

## 2m MONITOR RX (UOSAT)

Featured in May '82

A complete 2m/UOSAT receiver, with 6 Xtal channels, with AFC on 2 channels for tracking Doppler effects on Satellite signals. 0.15uV for 12dB SINAD. Complete RF/IF/AF kit. PSU optional.

Stock no. IF filter Price  
less PSU components...  
40-14404 SLFD12 £33.12  
40-14405 LFH12S £27.94  
with mains PSU...  
40-14406 SLFD12 £37.07  
40-14407 LFH12S £34.20

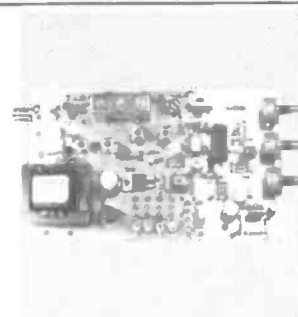

## 27MHz DEVIATION METER

Featured in October '81

Reads the mod level of NBFM signals in the range 27.6-28MHz, also use as a wideband monitor for CB. An ingenious approach for low cost & versatile test gear. Kit includes all parts shown, plus a moving coil meter.

Stock no. Price  
40-01040 £8.62

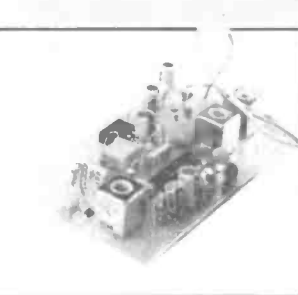

Prices inc 15% VAT: P&P is 50p per order.  
Please allow 21 days for delivery

Here are just few examples of projects from past issues....

R&EW is published on the first Thursday of the month.  
CHECK THE SHELVES OF YOUR NEWSAGENT NOW  
AND SEE WHAT'S IN THE LATEST ISSUE OF

## Radio & Electronics World

For enquiries, please quote Dept. AM1

Annual subscriptions (£12-UK), & details of back issues, project reprints etc., from:

Radio & Electronics World, 417a High Street, Brentwood, Essex CM14 4SG

Congratulations on your publication *Amateur Radio*. I was really impressed.

I take an RAE Class locally and will advise intending candidates to buy a copy if still available. *Amateur Radio* answers many of the questions I've been asked!  
R. B. McCartner,  
GM4BDJ,  
East Lothian.

I enjoyed what I believe is the first edition of *Amateur Radio*. It took a lot of reading, is worth the money, but can it keep it up?

I'm a lady just reached the middle years in life. I would love to get into amateur radio but I'm too "thick". I've got all the books you mentioned, and dozens you didn't! I'm a member of the RSGB, joined my local club and my works club, but I'm an introverted type, not a mixer, and all the radio stuff is double dutch to me. Maths? I've read umpteen times in different books magazines etc that it's simple, junior school stuff, but because I was involved in a bad road accident as a child — which has left me badly disabled — I lost a lot of schooling, and if I didn't like a subject (and I didn't like maths!!) I was not pressured into learning it. My teachers were too sympathetic. Now of course trying to teach myself basic algebra, etc it is not sinking in at all.

I can't go to evening classes any more because I now have

# Letters

These are just a few of the many letters and telephone calls we have received at Bicester; many thanks to all of you for the kind words, and interesting comments. Many of the ideas put forward are being acted upon.

an eye disease, and can't see to drive in the dark. So is there any hope for the likes of me? I've even tried to buy children's books on these subjects itself but most educational books are revision. I need to learn right from scratch.

I don't dare tell you my job, or you'd no doubt emigrate thinking you'd heard the ultimate. Anyway keep up the good mag, I buy all the rest but they are too highbrow for me. Mrs Frances Knight, Cheltenham, Glos.

May I compliment you on your magazine which will fill a gap between the magazine *Radio Communication* and commercial interests.

I teach students for the No. 765 examination and have done for 10 years. During the past two years the numbers have increased to the extent that I have had seven classes per

week, a total of about 120 students.

The Metropolitan Borough of Walsall demands no fee for tuition or the City of Guilds examination entry for unemployed, school boys and pensioners.

The multi-choice format calls for a specialised form of teaching, which I find acceptable as I am a full-time teacher in F.E. which uses objective testing, eg, C&G No. 224 Radio and TV. I set many of the examination questions for the City & Guilds.

It may be of interest to your readers to know that a new class for beginners is to run at Boldmere Centre, Sutton Coldfield, a district of Birmingham. The courses at Walsall College of Technology will start in September as usual.

A special short course for students who failed a part of the May examination will start at Barr Beacon Centre Aldridge, in Walsall. The object is revision

for the candidates to take the examination in December and provision is made for this to be taken at the Centre. This course lasts 10 weeks.

F. A. Fear,  
G8CVR,  
Walsall.

I am writing to congratulate you on an excellent magazine. I am a member of a CB D/Xing Club at the moment and I have been thinking about starting to study for the RAF but have had doubts about it because I heard so many stories about how difficult the exam was.

But having read your magazine I have decided to go ahead and try for my licence. I must say your magazine is providing a service that has been needed for a long time. Other radio magazines are very good but do not get down to the basics for the benefits of the beginner the way *Amateur Radio* does, so I would just like to say well done and continue with the good work.  
John McCurdie,  
Ayr.

Following your recent article about the RCA AR88, I wonder if any of your readers would be interested in buying the one I own; frequency range 540KC-32MC. One valve needs replacing. Suitable for repair or spares. Offers to: Mr A. Eadie, 109 Turquoise Terrace, Bellshill, Lanarkshire, Scotland. Tel: Bellshill 747054.

## Current comment

Welcome to the second edition of *Amateur Radio!* We hoped the first issue would cover the basics of what amateur radio is about but it sold so well and we received so many nice letters and telephone calls that asked: "When's the next one coming out?" we thought that this time we'd incorporate more of the ideas we had for the first one and simply hadn't got the space for.

A lot of people asked us to write about the problem of breakthrough and where they stood — so we did, and you'll find it on page 34. We also had a lot of letters from short wave listeners who wanted advice on how to get into it, so we've done that as well. There are articles on all sorts of topics to do with basic amateur radio, but you'll also find a couple of things for the man/woman who has a licence already and wants to go into things in a little more depth.

Amateur radio is in a very healthy state. The RAE results are hot off the press as we write this, and it seems that

somewhere around 6,000 people have passed — we're wondering how long it'll take the Home Office to issue everyone's licence! Interest in the hobby is increasing and many folk are coming into it via CB, so we're bearing them very much in mind — one or two people thought we were anti-CB but that isn't true at all. We have published a number of magazines in the CB field, and several people in the office here at Bicester enjoy CB as well as amateur radio.

Both have their place, and we're not saying for an instant that one is better than the other or that if you're interested in one, it somehow rules out your being interested in the other. Having said that, none of us think that 27MHz is a good choice of frequency for a CB service, on purely technical grounds. But don't confuse that with any anti-CB feeling.

In a sense, since we're all interested in amateur radio in one form or another, it's your magazine as much as ours and we need to know what you

want to see in it. Amateur radio is a very diverse hobby, and one thing we've noticed from your letters is that no two of you are interested in the same things. The guy who is interested in DX working, for example, isn't the same chap as the man who's an avid home brewer, so we want to offer something to both of them.

We don't feel that any of the established British magazines cover the amateur radio field very well, and we're arrogant enough (insane enough?) to think we can do better. We can — but we'll need your help so that we know we're doing it right and it's what you want to see. For those who want super-technical reviews, we are just setting up access to a large laboratory along with people who know how to use it. If you want columns of who's worked what — we can do that too. Tell us!

Anyway, as we said at the beginning, welcome to the second issue of *Amateur Radio* and we hope you enjoy it. Any bouquets, brickbats or used

notes should be sent to the Editor, Chris Drake, ie, me, at the Bicester address.

PS. To whet your appetite, in the next issue we'll look at how the FT1 and the TR7 stack up in words of one syllable, we're hoping to set up an interview with a Very Important Person at the Home Office to talk about amateur radio and licensing etc, and we'll also run small ads column. If we sell as many magazines as we did of the first issue, that ought to work well. After that, you tell us what you want and we'll try and do it.

Other possible features include a special on rallies, what you can get and at what prices; setting up a basic electronics workshop; and what the amateur can do in cases of sudden emergency.

Remember — if you have anything to sell, give away(?) or you want certain equipment or technical assistance, let us know in good time and we'll try and include your ads in the next issue. You'll find a classified ad form on page 71. Good luck.

Chris Drake

# EAST LONDON HAM STORE H. LEXTON LIMITED

01-558 0854 :: 556 1415

Telex: 8953609G

191 FRANCIS ROAD, LEYTON, LONDON EC10

## DRESSLER AMPLIFIERS

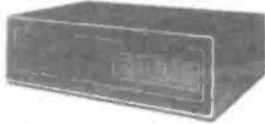

D70 70cm 200W FM, 400PEP	£495.00
D200C 2mtr 125W FM, 220W PEP	£285.00
D200 2mtr 300W FM, 600W PEP	£495.00
D200S 2mtr 400W FM, 1kW PEP	£600.00

## GAAS-FEG DRESSLER PRE-AMPS

VV 2 Gaas 150W	£40.00
VV200 Gaas 750W	£69.00
VV200 Gaas 1kW	£79.00
VV2 RPS	SO259
VV2 PPS "N"	
VV7 RPS SO259	
VV7 RPS N	



## ICOM

IC740 HF 100W	POA
IC720A HF 100W S/C	POA
IC730 HF 100W	£586.00
IC2KL linear	£839.00
IC2KLP5 PSU	£211.00
PS15 PSU	£99.00
PS20 PSU	£130.00
DT500 ATU	£299.00
RX70 Receiver	

## ICOM

IC2E 2mtr FM portable	£159.00
IC4E 70cm FM portable	£99.00
IC25G 2mtr 25W FM	£235.00
K290 2mtr 10W FM/SSB	£366.00
IC251 2mtr 10W FM/CW/SSB/Base	£495.00
IC451 70cm 10W FM/CW/SSB/Base	£630.00
IC490 70cm FM/SSB Mobile	£445.00
ICSP3 Speaker	£29.00
ICSM5 Mic	£29.00

## ICOM

Accessories	
ICLC1/2/3 Case	£4.25
ICWM9 Sp/Mic	£12.00
ICBP2 6v Pack	£29.50
ICBP3 9v Pack	£20.00
ICBP4 Empty	£6.95
ICBP5 12v Pack	£39.50
ICCP1 Charging Lead	£3.75
ICDC1 12v Car Pack	£9.75
LC8 Leather Case	£18.98

## YAESU

FT-One Gen Coverage TX/RX	£1,295.00
FT102 150W 10-mtr-160mtr	£690.00
FT707 100W 3.5-10mtr	POA
FP707 20A PSU	POA
FC707 ATU	POA
FT107m 9 band 100W	POA
FP107 PSU	POA
FT1012D 160-10mtr	POA
FT9020M 160-10mtr AM/FM	POA
SP901 Speaker	£30.00
FC902 ATU	£135.00
FL2100Z 1.2kW PEP Linear	£425.00
FC102 Speaker	POA
FC102 ATU	POA
FV162 VFO	POA

## YAESU

FT290T with mods	£245.00
FT480R 2mtr Mobile	£365.00
FT780R 70cm 7.6 Shift	£400.00
FT208 2mtr Portable	£195.00
FT708 70cm Portable	£205.00
FT230 2mtr FM Mobile	£220.00
FRG7700 Receiver	£295.00
FRG7700 Memory	£80.00
FRV7700A 118-150	£69.00
FRV7700B 50-60/118-150	£75.00
FRV7700C 140-170	£65.00
FRV7700D 70-80/118-150	£72.00
FRT7700 Aerial Tuner	£37.00
FRA7700 Active Antenna	£36.00
FF5 Filter	£9.95
MMB11 FT290 Car Mount	£22.00
NC11C Charger	£8.00

## TRIO KENWOOD

TS930 Gen Cov RX/TX	£995.00
TS830 100W HF	£650.00
TS530 100W HF	£475.00
TS130 100W HF	£495.00
TS9130 25W 2mtr FM/SSB	£390.00
TS7850 40W 2mtr FM	£300.00
TS7800 25W 2mtr FM	£245.00
TR2500 2mtr Portable	£200.00
TR7730 2mtr FM	£245.00
AT230	£110.00
SP230	£34.00
DM801 GDO	£60.00
R600 Receiver	£190.00
MORSE KEY	
Swedish Hand Made Key	£43.00
SONY	
ICF2001 Receiver	£140.00

## WELTZ

SP200 1.8-160MHz 20-200-1kW	£59.00
SP300 1.8-500MHz 20-200-1kW	£79.00
SP400 130-500MHz 5-20-150	£59.00
SP400 130-500MHz 5-20-150	£59.00
SP250 1.6-600MHz 20-200-2k	£43.00
SP15 1.8-160MHz 5-20-200	£29.95
CT150 150/400W Dummy load	£31.00
AC38 3.5-30MHz ATU	£59.00
SP10X 108-150MHz 20-200	£19.95

## DIAWA

DR7500R	£105.00
DR7500Z	£98.00
DR7500	£140.00
RM940 Mic, infra-red	£45.00
CN620A 1kW SWR	£52.81
CN1001 Auto ATU	£156.00
CN2002 2kW Auto ATU	£228.00
CN518 2.5kW ATU	£175.00

## DATONG

D70 Morse Tutor	£56.35
PCI Gen Cov Converter	£137.00
FL1 Agile Filter	£79.35
FL2 Active Filter	£89.70
SP Auto Clipper	£82.80
D75 Manual Clipper	£56.35
RFC Speech Clipper	£29.90
AD270 Indoor Active Ant	£47.15
AD370 Outdoor Active Ant	£64.40
RFA Wide Band Amp	£33.92

## MICROWAVE MODULES

MML144/30	£69.95
MML144/100LS	£159.95
MML144/100S	£139.95
MMC435/600	£27.90
MM2001	£189.00
MM4000	£269.00
MM4000KB	£299.00
MMT28/144	£109.95

## TONA

144 4 Ele	£13.00	432/440 21 Ele	£19.00
144 9 Ele	£16.00	432/435 21 Ele ATU	£27.00
144 9 Ele Crossed	£30.00	144/435 9-19 Ele	£31.00
144 9 Ele Portable	£30.00	144 19 Ele X	£30.00
144 16 Ele	£33.00	1296 23 Ele	£27.00
144 13 Ele Portable	£29.00		
435 19 Ele	£19.00	Phasing Harnesses	
430/440 19 Ele Crossed		and Telescopic Masts	

## JAYBEAM

TB3 HF 3 Band	£181.70	5XY 2M	
VR3 3 Band Vertical	£46.00	8XY 2M	
C52M Colinear	£47.72	10XY 2M	
5Y 2M 5 Ele Yagi	£12.00	Q4 2M	
8Y 2M 8 Ele Yagi	£15.50	Q6 2M	
10Y 2M 10 Ele Yagi	£33.00	Q8 2M	
P8M10 10E Parabeam	£39.50		
	MMB 48/70cm		
P8M14 14E Parabeam	£48.00		
	MMB 88/70cm		
	8XY 70cm		
	12XY 70cm		

## TET

HB33T	£189.00
HB34T	
HB34D	£202.00
HB35T	P.O.A.
HB35C	P.O.A.
SQ22 144	£55.00
SQ22DX 144x4	£90.00
SQ007 70cm	P.O.A.

## HOXIN

GP5 2mtr Colinear	
DX1 Discone	
HF5DX 5 Band Vertical	
HF5DX Veranda Vertical	
40-10mtr	£69.00

## MAXIMEL

Mk4000 RECEIVER	
70-87 9875Mc/s	
140-175 9875Mc/s	
+ 24h Clock	
12v operated	
£89.95	



## INSTANT HP FACILITY EASY PARKING

Open Mon-Fri 9.00-5.30. Sat 10.00-3.00

Easy Parking

Easy Access M1, M11, M2

# ON THE STRAIGHT AND LEVEL

Well, nothing momentous seems to have happened since the last issue apart from about 6,000 candidates passing the RAE and about to become licensed. Welcome to your new hobby, and let's hope you have a really enjoyable time in it whatever your interests turn out to be.

Remember that there's no need to decide you're going to concentrate on one facet or other at this stage and that there's a lot to be said for testing the water, as it were. Or should that be testing the volts? Or testing the mortar as you put up your new antenna...? Ouch. In future issues of *Amateur Radio* magazine, we promise to cut out the awful jokes, but leave in the good ones.

Amateur radio in July and August tends to take second place to things like family holidays, mowing the lawn, painting the house, etc, although it could just be the best time of the year for taking your antennas down and giving everything a good once-over.

One of our technical bods in the office was working on his car last week and he decided to use some silicon sealant for making sure all the muck and stuff on the winter roads didn't ruin reception on the broadcast radio in the car. He bought a big tube of it and splurged it all over the bottom of the antenna, where the co-ax runs into it. He was so taken with it that he's going to use it for his amateur antennas, particularly where the co-ax goes into the PL259 and on the base of his Ringo Ranger 144MHz collinear. He's going to screw the connector in and then cover the lot with this goo.

Sounds like a good idea to us — you can buy it as Silastic or TTV Sealant, and we understand that RS Components also do it under the stock number 555-558. It costs £2.25 for an enormous tube of the stuff, and it certainly sounds like a good idea for the winter.

Getting hold of components can put people off, because it's all very well to wake up with a brilliant idea for making something or other and then get thoroughly cheesed off 'cos you can't get the bits for the RS

## News and views from the world of the radio amateur, compiled by the staff of Amateur Radio.

Components won't supply to the private individual, unfortunately, but your local friendly dealer ought to have an account with them and should be pleased to order whatever bit you want.

You could try asking him to save you the catalogue when he gets a more up-to-date one. A new one comes out every quarter, and indeed we get ours about the same day as the phone bill! You could then have a browse through and see what's on offer.

However, the Maplin catalogue is probably the best source of goodies for most of us — in fact we tend to use them whenever we can because certain others can be very expensive for some unknown reason. With Maplin, you can ring them up and use your plastic glue-spreader to pay for what you want. In our experience, the goodies invariably arrive next day and we've never yet caught them out of stock.

Their nice thick catalogue costs the princely sum of one quid and you get it in all sorts of places like your local W. H. Smith, etc, and you can see what they'll do for you. We've always found them to be very good, joking apart, and they're not paying us anything for saying so, so we aren't biased! They're not even advertising in this magazine. Next time, perhaps...

Of course, the other nice thing about summer is the amateur rally scene. You'll always find all sorts of dealers selling all sorts of things from resistors to enormous ex-Ministry whatsits and they're great places to go for the real build-it-yourself fan. We didn't get our act together to go to Longleat, but the Woburn rally was really good and the weather was truly amazing. Apparently it hasn't rained at Woburn for years, and the RSGB man we spoke to said it had been a sell-out as far as traders were concerned.

There certainly were masses

of people, and some good things on sale — we bought an ex-Navy low voltage power supply which we intend to restore to life, use, and write about in a future issue of the magazine. It's good for 0-50V at (get this) 66 amps! We should be able to do some good transistor linear projects with that — now, let's see, should we get a three-phase mains supply into the building???

The last rally of the year is the Amateur Radio Retailers' Association bonanza at Leicester. For vaguely political reasons this got split into two rallies last year, but this year everything's back to normal — so maybe we'll see you at Leicester.

Any brickbats for our second issue? We've heard some moans about how long the RSGB take to deliver books but one of our orders took only a fortnight to come and, to be fair, they do state "please allow at least 28 days" in their small print. A bijou brickbat to whoever does the Headline News for telling us that the Longleat Rally was taking place next Sunday — fine, but we rang it the Tuesday after. Ah well. The clod of the month award has to go to a G3R station on our local repeater (in other words not a recent licensee, who could have been forgiven for it) who, during a recent tropo opening was heard to say: "Will the mobiles please QRT and let the DX through?" Now REALLY! Write out one hundred times: "Repeaters are for mobile and portable stations. I am not working DX if I use a repeater — I am working the same old repeater all the time. I do not expect a QSL from the DX I work via a repeater because I am not working it. I am a thick twit who ought to know better."

Changing the subject, we were wondering what to call this column; it's supposed to be general news and views from the amateur world and we were looking for a snappy high-tech name for it. It was going to be

Nelson's Column but (a) he couldn't write it anyway this time and (b) it would have been a bit of a cop-out. Any good ideas out there? Seriously though, we'd like to hear any odd items of local gossip, funny stories, whatever — if it's interesting to about 40,000 other amateurs we'll put it in.

Aren't some QSL cards boring? We had a batch through the other day for a DXpedition we did last year, and my oh my — some of them really let the side down a bit. Short wave listeners tend to complain that amateurs don't reply to their QSLs but looking at some of the SWL reports we got I'm not surprised. Most of them just told us we were S9 thirty miles from where the transmitter was.

Well, considering we were on one of the highest hills in Southern Scotland I'd have regarded it as an insult if we hadn't been! To make it worse, most of them didn't tell us any more than that we were S9 on this receiver and that antenna and that the listener's name and address was whatever it was, "please QSL txn".

An SWL report is potentially very useful to the amateur, probably more so on the HF bands than on VHF (where we were, incidentally) but it needs to contain something



### Information sheet

units: Entertainment Equipment and The Radio Amateur

Problem of Interference  
The Commission should give a Post Office copy of this pamphlet. Good Radio and Television sets for the radio to be used for a  
units: Entertainment Equipment and The Radio Amateur  
The Commission should give a Post Office copy of this pamphlet. Good Radio and Television sets for the radio to be used for a  
units: Entertainment Equipment and The Radio Amateur  
The Commission should give a Post Office copy of this pamphlet. Good Radio and Television sets for the radio to be used for a

enlightening to the man who gets it. It would have interested us, for instance, if we'd been calling CQ on a flat band and getting no replies, to know that we were being heard by stations in the Bristol area at the time, for instance..

Many cards aren't all that inspiring either. Obviously, well-printed cards cost a bomb but they don't need to be expensive as long as they're a bit — well — interesting. Maybe we ought to have a QSL card design competition and give the Art Editor something to do . . .

Don't get me wrong — I'd rather receive a QSL card than not, but if we're going to send them to each other let's try and make them a bit more meaningful. Fine if one's after them for DXCC or whatever, but, particularly for the SWL, we're beginning to feel that if there was a bit more useful info on the card, the listener would be that much more likely to get one back.

Try telling the amateur what his signal sounded like, whether there was too much compression, whether there were stations calling him who he couldn't hear, what the fading was like in Manchester (we know what it was like on the signals from the Bristol area, so it'd be interesting to know how it was from another part of the country in line with the path being worked), how strong the signal was compared with others from the same area, etc, etc. It's all good stuff, and helps the amateur no end.

### Shed a tear

Sad news from some of the old-time valve makers, folks — if you've never heard of the 807 and 813 you can skip this paragraph but those who have, prepare to shed a tear or two. RCA are apparently ceasing production of these old beasts, which is going to make them even more difficult to get. The 807 was a beam tetrode of the classic old school — incredibly rugged, reliable as old boots and beautiful to behold. The 813 was a real corker. If you had a bit of gear with an 813 in it, you really had got it together when I first came into the hobby in the fifties. It, too, was (is) a beam tetrode, with a whacking great big carbon anode, chunky pins and a general air of great promise about it. You only had to put one on the mantelpiece and look at it to get visions of kilowatts, huge antennas and transmitters with some real, well, essence about them.

I can't help feeling that one of the losses of the solid-state age is the sheer thrill you used to get from valves lighting up, big transformers humming and the *smell* of old-time gear. No,

we're not barmy, it was the wax and varnish and hot valves that did it, and some of us still miss it. Transistors are much more efficient and they don't need a generating station to run them but they haven't got the *character* of valves, have they?

Perhaps we ought to start a Valve Preservation Society column, with people dedicated to building immaculate Top Band transmitters with 807s and the black crackle front panel which was what every *real* transmitter had thirty years ago. Ah well . . .

Anyone got an old 813 we can mount on a wooden plinth and look at? It might look nice in reception here. Come to think of it, it's too good for that. We'll have a KT66 in reception and I'll keep the 813. For real valve buffs — did you know that KT stands for Kinkless Tetrode?

On that note, we'll leave it for now. 21MHz seems to be in quite good shape at the moment, so we'll fire up the office wireless and see what goes. Quite a change, actually, because the HF bands have been pretty sick for the past couple of weeks due to all sorts of weird and wonderful things happening on the Sun. 28MHz has been a real no-no for the past week or so, although we've been using it a lot for local nattering after dark, and it looks as though it's going to be the LF bands ruling OK for next year. Someone said we ought to put up a three-element quad for 3.5MHz on the roof of the office the other day — hmmm! Just as we were about to close for press, we started hearing some rumours about the loss of the 430 to 440MHz band to an odd-sounding military system.

We gather from the RSGB's *Headline News* that the rumours aren't true and that the Ministry of Defence have put some sort of mobile-type communications system into a small section of the 70 centimetre band. Listening around here at the office hasn't shown up any wierd-sounding signals on 432MHz, and we're wondering whether someone hasn't made a mountain out of a molehill.

We share many of our bands anyway, and from what little the MoD would tell us, it seems that their system won't cover more than about 500KHz of the band; this doesn't square with a report in the *Guardian* that we were about to lose the lot!

What seems much more important to us is, what the hell are the Ministry of Defence doing sticking an allegedly classified system into one of the most public bits of the radio spectrum? You can buy scanning receivers for 430-440MHz more or less anywhere, and the Home Office eventually told us that yes, 70 centimetres was a popular

The RSGB is  
NOT the  
governing body  
of amateur  
radio in this  
Country

Christopher Wake,  
Editor,  
Amateur Radio,  
27, MURDOCK ROAD,  
BICESTER,  
OXON

amateur band — with about 100 repeaters in it if we've reckoned them up properly. Popular seems about the right word.

But do the MoD know about such things? Do they know that there are other users of the band apart from amateurs even, such as the dreaded Syledis? Another thought that occurred to us is that amateurs are primary users of 70 centimetres in Europe and, when conditions are good enough (like about once a fortnight) they'll hear this MoD system quite well.

### Refused point blank

Rumour has it that the system is running a lot of power from some very choice sites, although MoD refused point blank to confirm or deny this, so no doubt there'll be a lot of eager ears on the Continent listening out for all sorts of intriguing signals and no-one'll be able to stop them.

Somehow we don't reckon the amateur part of this lot is all that important, since surely there's no technical problem sharing half a meg with the military — but couldn't they find some better frequencies to play with? And what's all this about the military having overall control over this part of the spectrum? We asked a friend of ours who spends all day with his head in the Radio Regulations and he didn't know anything about that — so how many other frequencies do they have "overall control" over?

Surely we should be told? Or do MoD own the entire troposphere by the grace of God? Watch this space.

LATE FLASH: We heard on the RSGB's GB2RS news broadcast the day before we sent off this amazing magazine to the printers that there had been some changes to the amateur licence — a couple of not-so-good things but some mighty good ones too. First off, we're to get the 18 and 24MHz bands from October 1 — there are some strings attached, like

We received the letter shown. It's unsigned, and came from Manchester. Posted on August 3, if anybody knows who might have sent it, please thank them for the information contained in the note. By the way, you might notice that the Editor's christian name should be spelled with an "h" . . .

horizontally polarised antennas, operating on a non-interference basis to other stations and a power limit of 10 watts. You can only use CW, and you can't use an antenna with a gain greater than zero dB with respect to a half-wave dipole. Sounds like the dipole is going to be the in antenna on these bands. The new bands are 18.068 to 18.168 and 24.89 to 24.99MHz, and we'll have an analysis of who is on them and what you can do with them in the next issue.

The RSGB have apparently also persuaded the Powers That Be to let a "very limited" number of Class A amateurs loose on 50-52MHz outside broadcasting hours — applications on a postcard to Keith Fisher, G3WSN at 7 Burlington Road, Swanage, Dorset. There's also a relaxation in the terms of greetings messages and four new microwave bands. Nice one, RSGB — good to see some positive things happening in the amateur world.

Only bad points are that apparently we're asked to "voluntarily desist" from using 431-432MHz in Central London. It's going to be allocated to PMR in the London area, and also that the sub-band 10.25 to 10.4GHz is going to have to be shared with some more primary users. This doesn't sound too bad to us, but we haven't had a look at all the implications yet.

So — worth holding the front page for, we thought!  
See you next time.



# ARROW

7 Coptfold Road, Brentwood, Essex CM14 4BN

Tel: 0277 226470 or 219435 Ansafone on 219435 Telex: 995801 (REF: A5)

Open 5 days a week. Closed Thurs.

ACCESS • VISA • INSTANT HP • TWO YEARS' WARRANTY  
• BEST TRADE-IN PRICES

Give us a ring  
Tel: 0277-226470 or  
219435

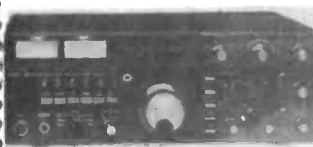

New FT102 HF all mode with superb specification. Details by return. Phone for a quotation: Also available new FC102 ATU & FV102DM VFOs SP102 speaker.

## FRG7700



FRG7700 Yaesu  
FRG7700 Sommerkamp with  
memory  
FR77700 Tuner  
FF5 Filter  
FRV7700A Converter  
FRV7700B Converter  
FRV7700C Converter  
FRV7700D Converter

## FT-ONE



Units now available with psu mod, IF unit & local unit mods. FM units, RAM units, etc etc. Extra filters from stock. Please phone for quotation.

## FT290R



Now with Auto tone burst (repeater mode only) and push to monitor repeater input. Plus FREE NCIIC charger! Nicads (2.2AH/10HR British made) Helical aerials cases.

## FT707



FT707 "WAYFARER" from stock with full range of accessories FC707 atu, FP707 psu, FV707DM VFO, MIC's YM35, YM36, extra filters, & FTV707 transverter frame + 2M/70cm/4M modules from stock.



## FT480R

— SOMMERKAMP  
ALL-MODE MOBILE  
144-148MHz

## FT101ZD



AM or FM models. Speakers, ATU's, fans, transverters, filters, widest range of stock. Please telephone for quotation.

## FT107



FT107 special offer. Ready fitted with internal power unit, digital memory & microphone.

## FT902DM



FT902DM. ATU's VFO's, extra units for FT902 series. Please ask.

## FT7B (shown with YC-7B)



Still a marvellous buy for that first rig. FT7B still available. PSU's & YC7B displays stocked.

Interest free finance on many major items available — its easy: Scheme "A" 20% deposit divide balance by 6 monthly payments or Scheme "B" 50% deposit balance divided by 12 monthly payments it costs you nothing in interest charges and that new rig/receiver/accessory can be yours now!! Phone for a written quote by return post.

### NEW LINES:

"TET" Antenna systems are the best mechanically we've seen. HF bearrs that go together in two hours & have excellent broadband characteristics. Price list & details by return.

"TONA" The famous F9FT range now ex stock at Brentwood & at the many shows we visit. Full price list & illustrated catalogue on request.

KENPRO rotators, DAIWA instruments, HOXIN mobile antennas now stocking . . .

WELZ Coaxial switches, dummy loads wattmeters of all types now stocking . . . Competitive prices on all Welz models.

Plus of course the fullest range of accessories, nicad packs, antennae, chargers, microphones, headphones. Please phone for full price list sent free with colour Yaesu brochure of that new rig you fancy. Yes — just phone 0277 219435 or 0277 226470 & we will send immediately a quote, price list, brochure, HP quotation.



"PHONE YOUR ORDER FOR TODAY'S DESPATCH. ALL WE NEED IS YOUR OR NUMBER, SMALL SPARES — PLUGS — AERIALS — PHONE FOR A QUOTE FOR THAT NEW RIG!"

OUR 1982 LIST & SHORT FORM CATALOGUE FREE OF CHARGE — SAE APPRECIATED

ALL-IN POLICY: ALL ADVERTISED PRICES INCLUDE TAX AND FREE DELIVERY (SECURICOR FOR RIGS)

# THE FALKLANDS FACTOR

THE SUNDAY TIMES, 25 JULY 1982

Simon Winchester

One important but hidden factor in Britain's South Atlantic victory was amateur radio. Here, Chris Drake outlines how a few brave men evaded the enemy to guide the land forces to Port Stanley.

The first issue of the magazine came out just as the Falklands war was about to resolve itself, and several people have asked us whether we could do an article about exactly what part amateur radio played in it. The short answer is that we can't, really, for two reasons.

One is that a lot of what happened is still classified and we'd be getting into all sorts of very heavy problems if we started digging at this moment in time. The other is that, quite simply, we don't want to queer the pitch. It stands to reason that if we, or anyone else, started shouting names and call signs everywhere, if there was any sort of recurrence of the problems in the Falklands it's a tanner to a bent penny that a potential enemy would know exactly where to look. Obviously it would be interesting to read about who exactly was involved, in the same way as it would be interesting to read about, say, where those interesting-looking antennas you tend to see in the countryside go to. The thing is that one has to be a bit responsible.

Having said all that, some things do seem to be clear about the involvement of amateurs in the Falklands war. Or should it be "battle?" One man, particularly, seems to have been up to his ears in it — a chap by the name of Reginald Silvey, VP8QE, who is an assistant keeper in the Imperial Lighthouse Service. He came to the Falklands ten years ago and apparently he's a 43-year-old throwback who saw no good reason for closing his station down when the Argentinians breezed in. He was using 21MHz for most of the time and speaking to several stations in the UK with an Atlas 210X; he was probably running about 100 watts to some sort of simple antenna. Reports in the papers didn't seem to register that 100 watts to a dipole on



In touch: (left) Reginald Silvey, the Phantom Voice of Radio Port Stanley

## The Phantom Voice Argentines never

Simon Winchester reports from F

THROUGHOUT the 73 days of the Argentine occupation of the Falklands, a secret daily radio link was maintained between Port Stanley and — improbable though it may sound — the resort of Bridlington-on-Sea, Yorkshire, via the good offices of one of the principal unsung heroes of the South Atlantic war.

Reginald Silvey, assistant keeper in the Imperial Lighthouse Service, can now be revealed as The Phantom Voice of Radio Port Stanley, The Man With The Plastic Shopping Bag, The Man The Argies Never Found.

Silvey, who came to the Falklands 10 years ago as junior keeper of the Cape Pembroke light, is a ruminative, taciturn bachelor of 43, whose main interests are fishing and ham radio. He set himself up on the islands — as he had done when he worked in the British Antarctic bases — as station Up 8 QE, broadcasting to whoever in the world would listen on 21.325 megahertz in the 15-metre band.

When the Argentine commandos stormed ashore on April 2, he saw, as if "no particular could close

a ham operator in Bridlington — Bob North, call-sign G4KHR — made firm contact with Silvey, whereupon someone, as yet unidentified, realised the value of retaining a link between the two operators for as long as possible.

"I realised by the Monday morning that Bob North had been taken over by the Ministry of Defence," Silvey says now. "He would come on each evening around 4 pm, saying: 'This is G4KHR, waiting for traffic from the South Atlantic. I could tell from his manner there was a ministry man breathing down his neck. I had to decide whether it was worth the risk, my talking to him any more. I thought about it a lot, and then decided I had to do my bit. So we would talk almost every day: I would pass on their questions and I would pass back answers."

Silvey is well known in Falklands as a ham operator. His equipment was listed in the Post Office register at Stanley, and it was only days before the Argentine occupation forces arrived at his front door to confiscate his unregistered gear. But he then managed to row an American paltry

The "Voice of Radio Port Stanley" — a certain Reg Silvey who, says reliable reports, kept the British informed of Argentinian movements on the Falkland Islands.





Bob North (G4KHR) who received Reg Silvey's transmissions at his Bridlington home. Whether Government officials were actually breathing down his neck, dictating questions to be asked of Reg, we don't know, and even if it were so, we suspect it would be subject to the Official Secrets Act! Note Bob's Yaesu antenna tuner and FT 101.



Mike Phipps

and, right, Bob North.

# ... the silenced

## ... Stanley

... it was so small neatly into a plastic bag. I was able to find from house to house without any of the noticing." Silvey excited, really, being able to hear England calling, and being able to explain it's difficult to explain if you're not mad on radio."

Silvey's mischievous enthusiasm was not limited merely to sending Argentine military secrets to Bridlington. He spent some weeks rigging up a transmitter to jam the Argentinian's two-metre local radio network, and, according to other islanders, caused havoc. "He would jam them for a while, and then stop jamming and start sending false messages to various army units. He had great fun. Best of all was that the Argies knew that someone in Stanley was doing it, but they could never find out who. It was great for our morale. We called him the Phantom Voice, a sort of Lord Haw-Haw in reverse."

Silvey, sadly, no longer has a paying job. The Cape Pembroke lighthouse—one of only two in the world still run by the once great Imperial Light House Service—is unworkable, surrounded by Argentine minefields. So the Phantom Voice is coming home by boat next week, and is already busily writing out cards to hand to those privileged few who heard his ghostly transmissions during the war. He is preparing, too, to meet in person for the first time the mysterious Bob North, and see what Bridlington-on-Sea looks like.

"Once in a while, they got so close that I got really nervous, and I did think about giving it up. They put the word around that they would do all sorts of nasty things if they ever found me. But it was so

21MHz would get into the UK perfectly well at the right time of day, and they thought it was a sort of fluke miracle that it worked at all. Which as we all know isn't so.

We gather that he kept regular skeds with one or two operators in the UK and that he'd come on for about five minutes at a time. That in itself must have been pretty risky because it isn't all that difficult to trace a transmitter which is on for that length of time, and reading between the lines we get the impression that he must have been operating from all sorts of different places. We've heard and read various stories about who he spoke to and how many Ministry of Defence people were breathing down various people's necks, but it doesn't really matter. Certainly VP8QE was a good signal in the UK most evenings, and there were no problems in copying him.

He wasn't the only one either. When we were listening, it seems that there were three or four regulars who were using a different callsign each day but talking to the same people. Our guess is that they had relatives in the UK and were keeping in touch; there probably wasn't anything heavily military in their messages.

Poor old Reg, though, is out of a job. The Cape Pembroke lighthouse is surrounded by an Argentinian minefield and is more or less unworkable, so he's coming back to the UK. Maybe we'll be able to speak to him and find out a bit more about what was happening down there in the Falklands.

MANY journalists and the general public seemed a little surprised that amateur signals could get from the Falklands to the UK with no apparent difficulty, on the relatively low powers in use. In fact, it's generally true that amateurs in general use far less power than a commercial user would consider possible. The Atlas 210X used by our friend in the lighthouse is a typical commercial radio for the HF bands, which runs about 100 watts PEP output on SSB and a bit less on CW — much the same power level, in fact, as the TS 830 reviewed in this issue — it wouldn't be in the least bit unusual

to receive signals sent with it in the UK, assuming that the band was open in that direction. During the Falklands conflict, in fact, the bands in use most of the time

were 21MHz and 14MHz, and most contacts which we know about took place in the early evening our time. Propagation on 21MHz would be the classic double-hop or chordal-hop mode, and provided that reasonable antennas were in use at both ends of the path one would expect quite good signal levels at that time of the year and at this stage of the sunspot cycle. In fact, the HF bands were not in the best of condition during the time of the Falklands affair, and a professional communicator forced to use the HF spectrum would probably have picked a somewhat lower frequency for a Falklands-UK link — the 18MHz band would probably have proved ideal if we had had access to it and if we could have run reasonable power on it! 14MHz would have worked quite well during the evening, and indeed did do on some evenings when VP8s were coming through into the UK; we heard one at a good steady S8 at about 7 o'clock our time, although here again HF conditions were erratic.

One interesting point would have been that the antennas in use at the Falklands end of the path were probably makeshift and, as such, may not have been very efficient; one imagines that random lengths of wire loaded up against earth in some way were used as clandestine antennas. Presumably one does not erect a three-element tribander if one is attempting to carry out clandestine radio operations! In all probability, therefore, the angle of radiation from the antennas in use would have been on the high side, and this may be another reason why signals on 21MHz were not, perhaps, as strong as might be expected given the equipment in use and the time of day. It may be also that lower power was used at the Falklands end in order to render detection that much less likely, although we remain a bit surprised (and very grateful) that our Falkland friends were not caught by the Argentinians. Direct-finding is not all that difficult, and the ground-wave would have been extremely strong if one was in the same town. A decrease in transmitter power would certainly have helped.

One final point which intrigued us a bit was why the Cable and Wireless people apparently had no HF back-up to their satellite antenna; the one which was demolished at an early stage in the proceedings? Possibly they did and no one mentioned it, but if they didn't they seem to us to have been a bit complacent. Satellite-type dishes don't exactly come cheap, whereas an HF antenna can cost peanuts as every amateur knows and it's easy to replace it if you have to. Moreover, a dish is far more vulnerable to attack in various forms whereas wire antennas are remarkably resilient to bombs, explosions and whatever. Memo to C & W — get yourself an amateur-type HF rig and a reel of cable and then you'll be able to talk to the outside world next time there's a problem! Mind you, maybe they had one and haven't told anybody, in which case our humble apologies.

Anyhow, let's all hope that amateur radio doesn't have to play a part in another affair like the Falklands crisis for a long time; there are better ways of getting publicity for the hobby than that, and it's sad that the only time Jo Public gets to hear about it is either when there's a crisis or when his TV and h-fi get knocked out by the amateur three doors away. Maybe we ought to start a positive publicity campaign for our hobby — how about it, RSGB?

# AMATEUR ELECTRONICS UK



Your number one source for **YAESU MUSEN**



**KEEP AHEAD  
WITH THE  
NEW FT-102!**



Once again YAESU lead the field with the exciting new FT-102 HF transceiver— no other manufacturer offers so many innovative features.

#### Better Dynamic Range

The extra high-level receiver front end uses 24 VDC for both RF amplifier and mixer circuits, allowing an extremely wide dynamic range for solid copy of the weak signals even in the weekend crowds. For ultra clear quality on strong signals or noisy bands the high voltage JFET RF amplifier can be simply bypassed via a front panel switch, boosting dynamic range beyond 100dB. A PLL system using six narrow band VCOs provides exceptionally clean local signals on all bands for both transmit and receive.

#### Total IF Flexibility

An extremely versatile IF Shift/Width system, using friction-linked concentric controls and a totally unique circuit design, gives the operator an infinite choice of bandwidths between 2.7kHz and 500Hz, which can then be tuned across the signal to the portion that provides the best copy sans QRM, even in a crowded band. A wide variety of crystal filters for fixed IF bandwidths are also available as options for both parallel and cascaded configurations. But that's not all; the 455kHz third IF also allows an extremely effective IF notch tunable across the selected passband to remove interfering carriers, while an independent audio peak filter can also be activated for single-signal CW reception.

#### New Noise Blanker

The new noise blanker design in the FT-102 enables front panel control of the blanking pulse

width, substantially increasing the number of types of noise interference that can be blanked, and vastly improving the utility of the noise blanker for all types of operation.

#### Commercial Quality Transmitter

The FT-102 represents significant strides in the advancement of amateur transmitter signal quality, introducing to amateur radio design concepts that have previously been restricted to top-of-the-line commercial transmitters; far above and beyond government standards in both freedom from distortion and purity of emissions.

#### Transmitter Audio Tailoring

The microphone amplifier circuit incorporates a tunable audio network which can be adjusted by the operator to tailor the transmitter response to his individual voice characteristics before the signal is applied to the superb internal RF speech processor.

#### IF Transmit Monitor

An extra product detector allows audio monitoring of the transmitter IF signal, which, along with the dual meters on the front panel, enables precise setting of the speech processor and transmit audio so that the operator knows exactly what signal is being put on the air in all modes. A new "peak hold" system is incorporated into the ALC metering circuit to further take the guesswork out of transmitter adjustment.

#### New Purity Standard

Three 6146B final tubes in a specifically configured circuit provide a freedom from IMD products and an overall purity of emission unattainable in two-tube and transistor designs, while a new DC fan motor gives whisper-quiet cooling as a standard feature. For the amateur who wants a truly professional quality signal, the answer is the Yaesu FT-102.

#### New VFO Design

Using a new IC module developed especially for Yaesu, the VFO in the FT-102 exhibits exceptional stability under all operating conditions.

### ANCILLARY EQUIPMENT

#### SP-102 EXTERNAL SPEAKER/AUDIO FILTER

The SP-102 features a large high-fidelity speaker with selectable low- and high-cut audio filters allowing twelve possible response curves. Headphones may also be connected to the SP-102 to take advantage of the filtering feature, which allows audio tailoring for each bandwidth and mode of operation to obtain optimum readability under a variety of conditions.

#### FC-102 1.2 KW ANTENNA COUPLER

#### FV-102DM SYNTHESIZED, SCANNING EXTERNAL VFO

### FT-101ZD Mk III



YAESU's FT-101ZD WITH FM is still rolling off the line as fast as YAESU can produce - thanks to its very comprehensive specification and competitive price. Incorporates notch filter, audio peak filter, variable IF bandwidth plus many other features.

### FT-ONE SUPER HF TRANSCEIVER



The ultimate in HF transceivers - the superb FT-ONE provides continuous RX coverage of 150KHz-30MHz plus all nine amateur bands (160 thru 10m). All-mode operation LSB, USB, CW, FSK, AM, \*FM · 10 VFO system · FULL break-in on CW · audio peak filter · notch filter · variable bandwidth and IF shift · keyboard scanning and entry · RX dynamic range over 95dB! and NO band switch!!!

\*OPTIONAL

### FT-902DM Competition grade HF transceiver

The HF transceiver with the pedigree for the man who

insists on only the best in conventional format. 160 thru 10 metres including WARC bands. All-mode capability, SSB, CW, AM, FSK and FM transmit and receive. Teamed with the FTV-901R transverter coverage extends to 144 & 430MHz.



### FT-707 All solid-state HF mobile transceiver



The definitive HF mobile rig, digital, variable IF bandwidth, 100watts PEP SSB. AM, CW (pictured here with 12 channel memory VFO). Latest bands.

## TET ANTENNA SYSTEMS

TET HF antennas are unique in that they employ dual driven elements with the following distinct advantages—

- Improved gain over conventional arrays.
- Broader bandwidth with lower SWR.
- Enhanced front to back ratio.
- Better matching into solid state transceivers without an A.T.U.
- High power handling capacity.

TET manufacture an exciting range of multi-element HF beams including superb monobanders plus HF verticals. Also there is a full range of VHF/UHF antennas most of which have multi-element drive or distinctive technical features.

Model	Description	Price incl. VAT	Carriage	Model	Description	Price incl. VAT	Carriage
HB10F2T	2 Ele. Mono Band Beams for 10 Meter Band	50.75	2.75	HB33SP	3 Ele. Tri Band Beams for 10/15/20 Meter Bands	189.23	4.60
HB10F3T	3 Ele. Mono Band Beams for 10 Meter Band	73.79	2.75	MV3BH	Vertical Antenna for 10/15/20 Meter Band	40.25	1.75
HB15F2T	2 Ele. Mono Band Beams for 15 Meter Band	57.21	2.75	MV4BH	Vertical Antenna for 10/15/20/40 Meter Band	49.50	1.75
HB15F3T	3 Ele. Mono Band Beams for 15 Meter Band	88.49	2.75	MV5BH	Vertical Antenna for 10/15/20/40/80 Meter Band	71.25	1.75
HB34D	4 Ele. Tri Band Beams for 10/15/20 Meter Band	202.69	5.87	MLA4	Loop Antenna for 10/15/40/80 Meter Band	105.60	2.10
HB23SP	2 Ele. Tri Band Beams for 10/15/20 Meter Band	128.80	2.60				

● Full range of VHF/UHF Beams now in stock — an S.A.E. for full details please

### YOUR LOCAL TET STOCKISTS

Amateur Radio Exchange, 373 Uxbridge Road, Acton, London W3  
 Amcomm Services, 194A Northolt Road, South Harrow, Middlesex  
 Bredhurst Electronics, High Street, Handcross, Haywards Heath, West Sussex RH17 6BW  
 Stephens James Ltd., 47 Warrington Road, Leigh, Lancs. WN7 3EA  
 Uppington Tele Radio, 12-14 Pennywell Road, Bristol BS5 0JT

### AGENTS

North West—Thanet Electronics Ltd. Gordon, G3LEQ, Knutsford (0565) 4040  
 Wales & West—Ross Clare, GW3NWS, Gwent (0633) 880 146  
 East Anglia—Amateur Electronics UK, East Anglia, Dr. T. Thirst (TIM) G4CTT, Norwich 0603 66189  
 North East—North East Amateur Radio, Darlington 0325 55969  
 Shropshire—Syd Poole G3IMP, Newport, Salop 0952 814275

**Amateur Electronics UK**  
**504-516 Alum Rock Road · Birmingham 8**  
**Telephone: 021-327 1497 or 021-327 6313**  
**Telex: 334312 PERLEC G**  
**Opening hours: 9.30 to 5.30 Tues. to Sat.**  
**continuous — CLOSED all day Monday.**

### THE ANTENNA WITH THE DIFFERENCE

HB33SP 3 element tri-band beam with dual drive for 14/21/28 MHz

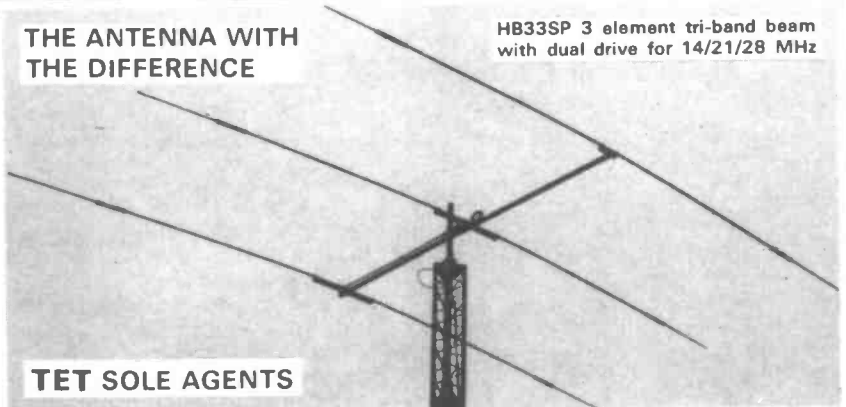

### TET SOLE AGENTS

### WHERE TO FIND US



# Meteoric messages

No, Ursids are not some form of disgusting disease. They're a meteor shower, and you can bounce your signals off the trails they leave behind. The arrival of meteor showers is awaited with enthusiasm by amateurs. With a top range of around 2,000 kilometres the possibilities are exciting. But it's a lot of hard work. Editor Chris Drake explains.

It sounds a bit odd, doesn't it? But let's take a look at one of the most interesting propagation modes there is on VHF and UHF and which is available to most well-equipped stations. It's meteor scatter, which is otherwise known as MS and boy, is it fun!

It's quite easy to work DX on the VHF and UHF bands — assuming you have a reasonable station and some good conditions to help you along a bit. VHF DX on "tropo", which is what most of us get up to when there's a spell of good conditions and you suddenly find that the normal range of your station is multiplied by six, is all very well and very rewarding, but after a while some VHF and UHF folk get to think they want to work farther than a few QRA Squares away. This is when thoughts tend to turn to MS propagation, and lips get licked in anticipation of lots of exotic stations suddenly appearing in the logbook and nice QSL cards on the wall.

Fine, but how to go about it? Well, first we ought to have a look at meteors themselves, especially since most of us tend to think of them as those pretty shooting stars that we see when we go for a walk with the lady in the countryside at night, nudge nudge.

## Bits of planets

A meteor is a piece of rock or metallic ore which can be anything from dust-particle size to a dirty great chunk of rocky stuff weighing about 50 pounds or so. They originate from somewhere in space and are bits of planets, asteroids and assorted debris from the Hitch-Hiker's Guide to the Galaxy. As Mother Earth whistles round in orbit every day, some meteors get "intercepted", as it were, and get captured by the earth's gravitational field. You tend to find that, although this happens every day to some extent, there are well-known periods of a few days or indeed a few weeks in some cases when there seem to be more meteors than usual. Good time to go for a walk, chaps, and forget all this radio nonsense for a while ... sorry, where was I? Oh yes.

These periods are called "showers" and there are about a dozen of them every year. They're given names which reflect those areas of the sky from which they appear to come, for example, we've just had a good shower which is called the Perseids, because the meteors seem to come from that area of the sky in which sits the constellation of Perseus.

Constellations, by the way, are groups of stars that in ancient mythology were supposed to make a shape of someone or something — the signs of the Zodiac are those most people know, such as Aries, Taurus, etc.

When a meteor comes within about 150 kilometres of Earth, they start to run into its atmosphere, and when they get about 100 kilometres out they start getting rather hot as the friction generated by their speed (they're doing a fair old lick) meeting more and more of the atmosphere heats them up somewhat. It's rather like the Space Shuttle at re-entry, only a meteor doesn't have all those tiles and things. By the time they get within about 80 kilometres of the Earth they're more or less frazzled (actually, the technical term is ionised) and the ionised trail they leave behind them is what MS people can use to "scatter" their radio signals from.

Now this is where the fun starts, because obviously ionised trails like this don't exactly last for ages; about a second or so is par for the course. There's no way you can have a two-way contact with another station in a second or so, so an MS contact is rather an intermittent affair. You need rather special operating procedures to make it work for you — in fact there's an international agreement on how to go about it.

In the vast majority of cases, the

## MAJOR METEOR SHOWERS

NAME OF SHOWER	DATES OCCUR	MAX STRENGTH
Quadrantids	1-5 Jan	3-4 Jan
April Lyrids	19-25 Apr	22 Apr
Eta Aquarids	1-12 May	5 May
Piscids	3-10 May	7 May
Nu Piscids	11-14 May	12 May
Arietids	30 May 18 June	8 June
Zeta Perseids	1-16 June	8 June
June Perseids	22-30 June	26 June
Nu Geminids	9-15 July	12 July
The Perseids	20 July 18 Aug	12 Aug
Taurids	10 Oct 5 Dec	1 Nov
Geminids	7-15 Dec	13-14 Dec
Ursids	17-24 Dec	22 Dec

contacts will be prearranged, although there are frequencies set aside for so-called "random-MS". This is OK if you're fairly advanced and really know the ropes, but certainly to begin with a prearranged contact or sked (which is short for schedule, in case you were wondering) is much the best way for the beginner. There's a "net" which takes place on the 20 metre band, on a frequency of 14.340MHz, and you'll find someone on it practically all the time — alternatively, you can always drop a quick note to the station you'd like to work. Obviously you'll have to do a bit of listening to get the idea of how MS works and really get the hang of it before you do either.

Our article is only the bare bones of it, and the last thing we're suggesting at this stage is that you drop a note to one of the top European MS folk and ask him for a sked; just like that! You'll need to do a bit of work beforehand to get to that stage, because, as we'll see you need a good station and, more importantly, to have all the procedures worked out to a T. The snag with MS operation is that one man who's got it wrong can really cause big problems for lots of people all at once, and if they've all got out of bed at 0300 to work a really rare one you won't be the most popular man on the band for many a long year.

Anyway, let's get back to how it works. The idea, basically, is that you take it in turns to transmit and receive at accurately timed periods (and I mean *accurate*, to the second) and you both keep at until you've both got the information over to each other. The periods are normally one minute for Morse (which is much the most common MS mode, by the way) and 15 seconds for SSB, and both stations have to exchange callsigns, reports and a final "R", which stands for Roger in order to show that everything's been copied. Most sked periods are arranged to take one or two hours (although don't think that all MS contacts take this length of time — we've heard of some which have taken eight minutes) and it's a matter of keeping going until you've got the job done.

Obviously ordinary hand-speed Morse won't do at all. Most MS stations who are seriously interested in the game use clever high-speed keyers which are pre-programmed with all the information and they use a multi-speed recorder to slow down the bursts they receive. Most skeds these days run at about 80 words per minute. You'll also find that most real MS-oriented stations use high power; real success requires at least a hundred Watts of RF output to a decent antenna system and the proverbial "red-hot" front end in the receiver department. This is likely to mean a good (quiet) pre-amp at the top of the mast.

### Bang on frequency

It's also important to make sure that both stations are on the same frequency — it's no use your transmitting oodles of power into a gigantic antenna system if you're three KHz away from the man you're trying to talk to. Remember that in MS operation you don't have a chance to set things up beforehand — you've both got to be bang on frequency independently of each other, and in practice this means being within plus or minus about 300Hz of each other. And on VHF that isn't easy; the only way to achieve it is to have some

sort of really good frequency standard available in the shack, such as a frequency counter with an ovened crystal as its fundamental stable source which you've checked against something like a standard frequency transmission before you start the sked. The reason is simply that if you're using Morse it's a matter of making the receiver's bandwidth as narrow as possible so as to maximise the signal-to-noise ratio. But narrow receiver bandwidths demand good frequency setting accuracy at the transmitter end otherwise the receiver will never know the transmitter was there. The other point is that if your sked is going to go on for an hour or more, the transmitter and receiver have both got to stay absolutely put as far as their frequencies go — it's not going to work if

halfway through the QSO you're not in each other's passband!

Okay, let's have a look at how a typical MS QSO might work. One other point before we go ahead is that the clock we're using will have to be good and, as we said, accurate to within one second. This normally means a quartz clock of some sort, which you've checked beforehand with TIM or the Greenwich pips or something. And finally, if several of your local mates are all having a go at MS, it'll have been wise of you to arrange that you all transmit and receive during the same period and that you're not all within 500Hz of each other. There seems to be a convention that stations in the UK always receive first, ie during the first period, which helps.

*This is the orbit of the Leonid meteor shower (a), shown in relation to the Earth (b), Mars (c), Jupiter (d), Saturn (e), and Uranus (f). This shower appears every year around November. The main stream appears every 33 years however, and the last time they appeared in 1966, the sight of 100,000 meteors per hour was amazing.*

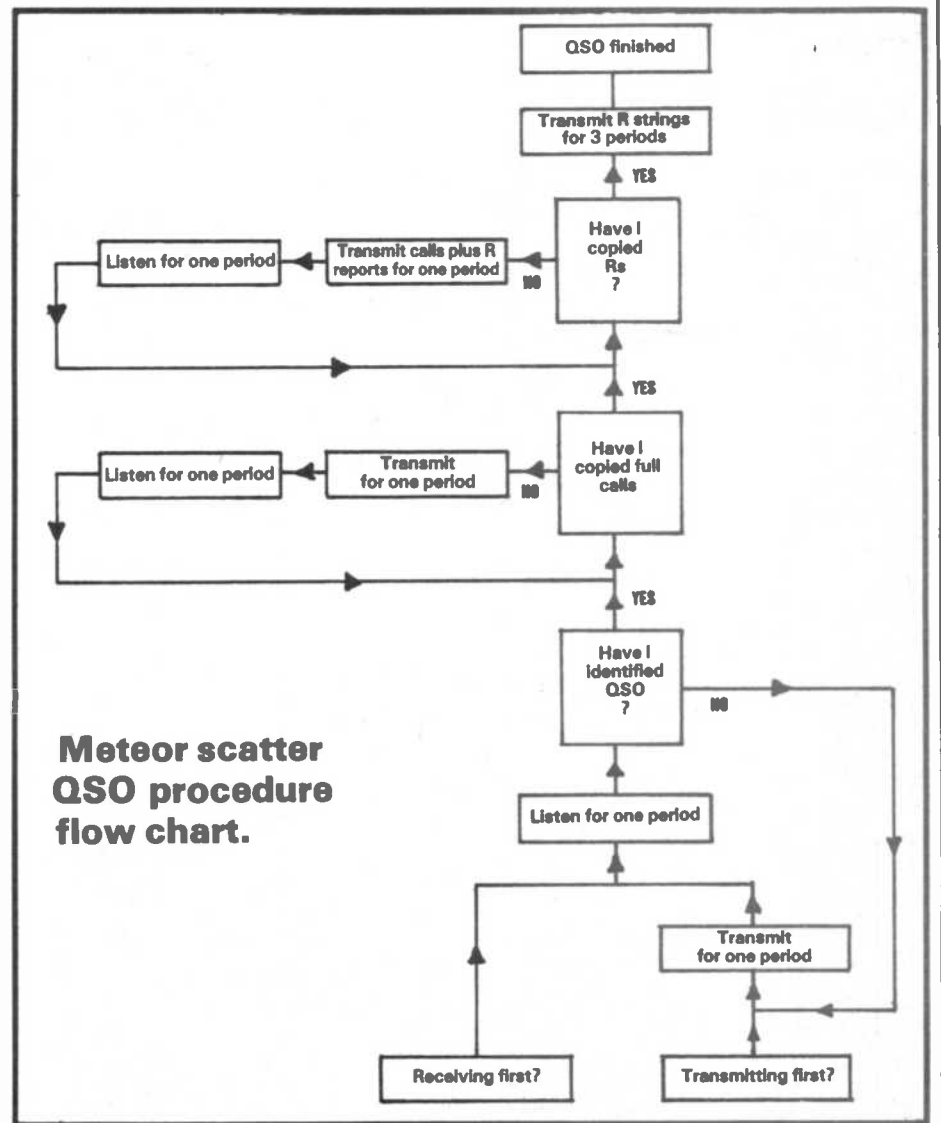
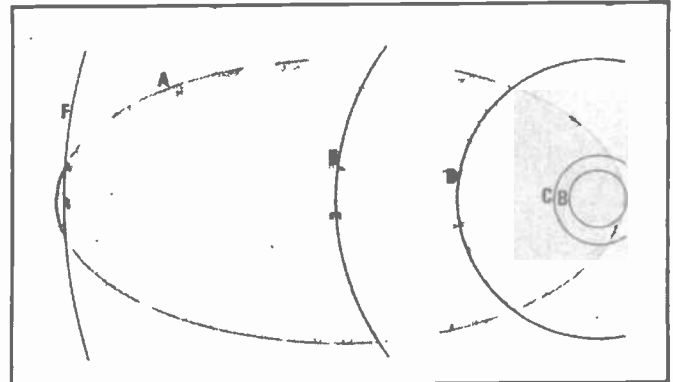

# Meteoric messages

So we'll assume that G4ZZZ has arranged a sked with YU1ZZZ in swinging Yugoslavia. In the usual way of MS skeds it'll take place at some unearthly hour and you'll have crawled out of bed cursing and wishing you'd taken up something civilised like rally cars or wrestling in mud or something. You switch on all the gear, light another fag, take a swig of your coffee and, when the second hand comes up you get listening for the duration of the period. Actually, if you're sensible you'll have switched the gear on hours ago, or at least the receiver part of it, so that it can all warm up and stabilise, and you'll also have done the frequency-checking bit.

So — YU1ZZZ will be calling you, in the format G4ZZZ YU1ZZZ G4ZZZ YU1ZZZ, etc, etc, for one minute if it's in Morse or 15 seconds if it's SSB. If you hear him, you'll give a report which is composed of two numbers — one will indicate the duration of the burst from which you got the information and the other is a measure of his signal strength. Heres a table:

First number (duration)

- 2 = bursts up to 5 seconds
- 3 = bursts of 5-20 seconds
- 4 = bursts of 20-120 seconds
- 5 = bursts longer than 120 seconds

Second number (signal strength)

- 6 = up to S3
- 7 = S4-S5

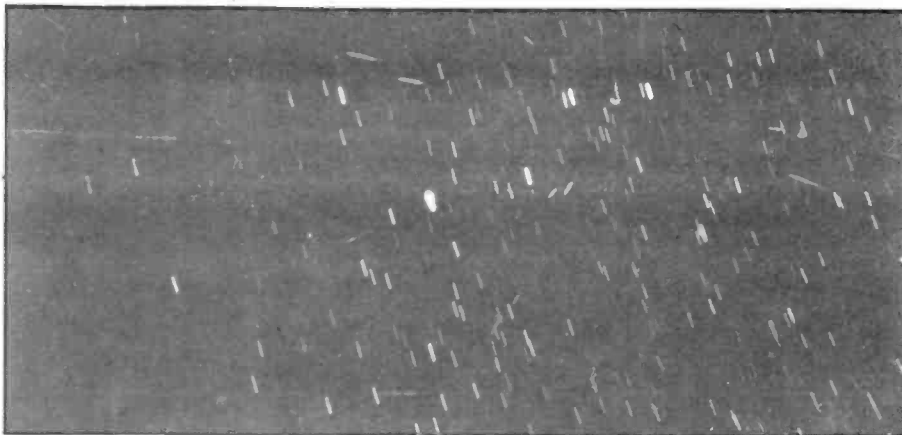

8 = S6-S7  
9 = S8 and stronger

You can only send a report if you either hear your own or the other man's callsign, and if you've heard something — let's say a burst of less than five seconds in which you just caught your callsign and it was about an S5 signal — you'd put your ciggy down and send:

**YU1ZZZ G4ZZZ 27 27 YU1ZZZ G4ZZZ 27 27 YU1ZZZ G4ZZZ 27 27**

You'd send that for the whole of your transmission period and then sit back to await events. Note here that whatever happens subsequently you *don't* change the report even if you get a huge burst from Yugoslavia which sets your preamp on fire and wakes up the dog — the report of 27 must stand for the whole of the contact.

Hopefully you'll receive a report on the

*It is generally thought that more than 20 million meteors enter the Earth's atmosphere every day. The majority though, are mere specks of space dust, and when they burn themselves out in the upper atmosphere, they are otherwise known as shooting stars. This picture is of the Leonid shower in 1966.*

next listening period. You probably won't, so it's back to the same old report as above. Remember, you must copy both callsigns (yours and his) the report and the final Rs for the QSO to be complete, so you just keep bashing away until you've got the first two done. As soon as either one of you copies both the callsign and the report, he can start sending the confirmation, the "R" bit. This means that all the letters and numbers have been correctly received. So after some time and effort you might get to hear:

## ADVICE AND HELP FOR BEGINNERS.

### FRG7700



Listen to the World — Our Mr Harry Leeming (G3LLL) who has been licenced since his teens and lectures on Amateur Radio at the local Tech. recommends the FRG 7700. It will do anything you are likely to ask and incorporates NBFM for listening to CB. OK for use with 2M Converter. SAE for leaflet. Price (Aug '82) £329 including VAT and delivery.

### HOLDINGS MODIFIED FT290 IS EVEN BETTER.

We add auto tone burst, and listen on input both switchable. Makes this the best fixed/portable/mobile, multimode on the market. Use with linear/preamp and RX out-performs more expensive rigs. Total price is still less and you get 10 memories and more power. FT290 basic £249 (phone re cost of mods) sorry we can only do rigs we sell. Mobile bracket £22.50, Speaker Mic £15, 1.8 AH nicads £18, Charger £8, Microwave linear. Securicor free with FT290 otherwise £4. Post £1.50. Now plus extra brightness!



FT101 EXPERTS. Many of our Improvements have been incorporated by Yaesu into design. Get your rig from FT101 experts. SEA for range of accessories. Securicor delivery.

FT101 VALVES. We still have NEC valves in original boxes. No longer made, other makes not recommended (some even oscillate on receive). NEC 12BY7A £3, NEC 3JS6C £13 matched pair (matched G.E. 6146B for 101Z, £17 pair), post 50p. SAE details.

SUPER CW FILTERS 250 HZ BANDWIDTH exact replacements for FT101 Mk 1-E, FT902, FT901, FT101ZD, TS520, TS820 £22 inc VAT. Post Paid.

MAKE YOUR ORIGINAL FT101 BETTER THAN FT101EI G3LLL RF CLIPPER. Over 1,000 sold in USA improves RX plus harmonic distortion-free speech processing — doesn't sound like a "one man pile-up". £35 inc VAT. Very easy to fit, for FT101 Mk 1-B, state which. DIY? P/C board wired and tested £25.

G3LLL DBM. Replaces first mixer on FT101 Mki-E, much quieter receiver, and doesn't "fall apart" on 40m after dark, £11.50, Mki-E. £12 FT101 Mki version.

LEGAL CB CRYSTALS FOR YAESU listen to legal CB frequency. FT101 Mki-E, 101Z or 902 — state which — -3.75 plus SAE, FM unit for FT101 Mki-E £35.

DATONG, YAESU, FDK, J/BEAM, ARRL, BOOKS, microwave modules, etc.

COUNT ON G3LLL AT HOLDINGS 9-digit Frequency Counter, 10MV 10MHz, 25MV 150MHz, 150MV 500MHz, ±.0005% (set spot-on against WWW etc), with mains unit input lead, post and VAT £99.90 ±.0001% £117. .0002% £110. FC841, 10HTz-50MHz reviewed August '81 PW, £52 inc output lead, mains unit, post and VAT.

STOP PRESS. New SOAR FC845 160MHz counter £69.90 with mains unit. SAE details.



### HOLDINGS PHOTO AUDIO CENTRE

39/41 Mincing Lane, Blackburn BB2 2AF.

Tel: (0254) 59595/6.

Access/B Card, Cheque. Closed Thursday.

FC-841

## Get your RADIO AMATEURS City & Guilds Qualifications with ICS

In your own time—at your own pace

ICS, the world's leading home study specialists, offer a superb course for those wishing to obtain their City & Guilds Radio Amateurs qualifications. Prepared by experts, the course fully covers the syllabus of the examination, and you study step by step at your pace, in your own home, via the post.

### Personal Tuition

Throughout your course you have the expert and personal guidance of a fully qualified tutor, *plus* the ICS guarantee of tuition until successful.

### Other courses available

The ICS School of Electronics offer a comprehensive range of courses for most areas including: TV & Audio Servicing & Engineering, Radio Frequency, Electronic Engineering, Electrical Engineering, ... and many more.



Approved by CACC



Div. National Education Corporation



Member of ABCC

### POST OR PHONE TODAY FOR FREE BOOKLET

Please send me your FREE School of Electronics Prospectus.

Subject of Interest \_\_\_\_\_

Name \_\_\_\_\_

Address \_\_\_\_\_

ICS Dept 282Y  
ICS School of Electronics  
160 Stewarts Road  
London SW8 4UJ



01-622 9911  
(All Hours)



G4ZZZ YU1ZZZ R27 R27 G4ZZZ R27 R27  
G4ZZZ YU1ZZZ R27 R27

In other words, Comrade Josip has copied all that is required. When you hear *that* coming back, you confirm during your next transmission period with a string of R's, thus:

RRRRRRRR G4ZZZ RRRRRRRR G4ZZZ  
RRRRRRRR G4ZZZ RRRRRRRR G4ZZZ

Insert your own callsign after every eighth R. On SSB the sound of a station chanting "roger, roger, roger, roger" may make you wonder what the hell he's doing. Well, now you know! He's probably just worked the rarest of the rare and is on the way to getting a super QSL on the wall.

As we've seen, the data is built up bit by bit as it comes through in little bursts. In some listening periods you might not hear a thing and neither might your partner; you might then get the lot in one long burst. MS is a very variable mode of working, and that's part of the fascination of it.

Using meteor scatter, who can you work? Most operation takes place on 144MHz, although 70MHz is a good band for it, or would be if more countries had it available. 432MHz is getting very dicey indeed and MS contacts, although possible, tend to be very hard work. The maximum range possible is just over 2000 kilometres, and that's assuming a good antenna with a low wave angle; this is about the same as Sporadic E contacts tend to work at.

There is a special part of the 144MHz band set up for MS use. You take a reference frequency of 144.100MHz for CW and 144.400MHz for SSB and then add one kHz if the last letter of your

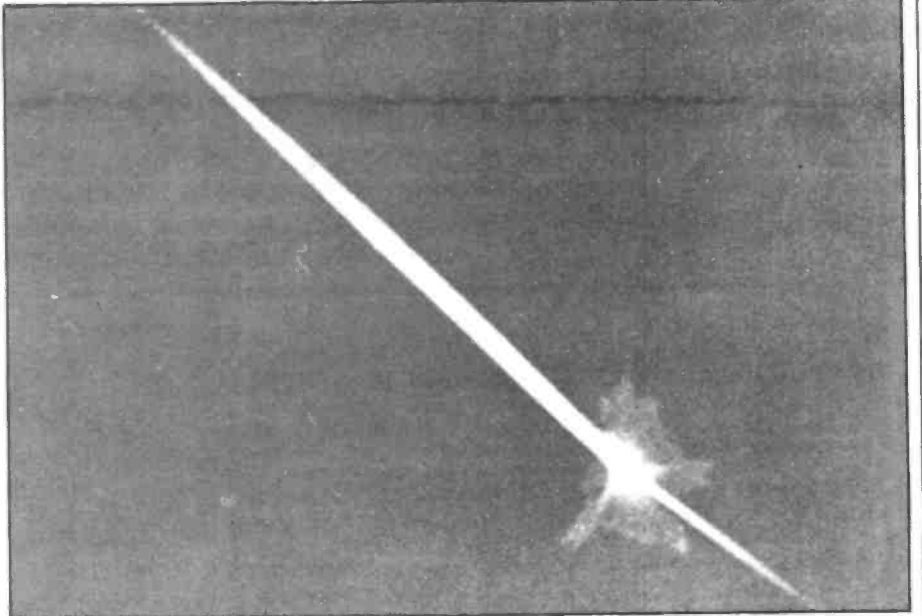

callsign is A, 2 kHz if it's B and so on up to 26kHz HF of the reference frequency if your callsign ends in Z. So if you were G4YZX, for instance, and you wanted to work on CW, you'd use a frequency of 144.100MHz plus 24kHz which is 144.124MHz. This system was originally meant for random MS use but many MS folk seem to use it for scheduled contacts. The idea is to spread everyone out a bit and reduce interference problems.

That's about it — we haven't the space to go into all the technicalities of memory keyers and tape machines so we hope

*It has been known for meteors (or shooting stars) to actually explode when entering the upper atmosphere. This one did in 1895, which made it one less in the late November Andromedid shower.*

we've whetted your appetite for this fascinating mode. Now all I need to do is to get the boss to agree that I don't have to come into the office the day after I got up at O-God-zero-zero for an MS sked! Seriously, we're thinking about setting up an MS station in the coming months, and we'll keep you posted as to how we're doing.

## TELECOM.

THE BEST IN AMATEUR RADIO

EQUIPMENT BY:  
YAESU MUNSEN  
SOMMERKAMK  
ICOM  
TRIO

DISTRIBUTORS OF:  
THANDAR PORTABLE  
TEST EQUIPMENT AND  
LEADER TEST INSTS.

COMPUTERS BY:  
ACORN 'ATOM'  
COMMODORE 'VIC-20'

AERIALS BY:  
CUSHCRAFT  
J-BEAM  
REVCO  
WESTERN

6 NEW ST, BARNSELY, SOUTH YORKS  
Phone: 0226 5031

## CHORDGATE LIMITED

(Dept AR)

Electronic Components, Equipment,  
Ex-Equipment, PCB's, Chassis, etc.

Retail shops at:

75 Faringdon Road, Swindon, Wilts.

Tel: (0793) 33877

and

21 Deptford Broadway, London SE8

Tel: 01-691 5106

WOOD & DOUGLAS



## RADIO KITS?

*Have you ever thought of building  
your own amateur transmitter?*

*Wouldn't you like to know what is  
under the lid of your transceiver?*

*Why not build your next pre-amp for  
a change?*

Wood & Douglas have had ten years of professional r.f. experience which has led in the past five years to the largest range of original design products for the radio amateur market in the UK. Our professional standards have led to only the best quality components being used on our compact miniature assemblies.

Our range offers kits or made-up modules for VHF and UHF transceivers, tonebursts, pre-amps, synthesisers etc. Each kit comes with a comprehensive set of notes that include circuit diagram, testing procedure, parts list and generally a twice full size layout. We do not offer the simple items external to the pcb such as a box or volume control which you probably already have. We give you the electronic heart of the equipment to an exacting well designed standard.

Full Details of our complete range are available on receipt of an A4 size SAE. Professional users should ask for our advanced design modules for OEM applications.

If you can solder you can build our products. If it doesn't work apart from being surprised we can offer a complete back-up/servicing facility for all the range.

TRY A KIT AND WE KNOW YOU WILL ENJOY IT  
9 HILLCREST, TADLEY, BASINGSTOKE, HANTS RG26  
6JB.

# SHOP TALK

Equipment available today. From hand-held radios to full blown bench equipment, there is enough to suit all tastes and requirements. Here is a selection of things available in the shops currently.

THE idea of this column is to take a look at various new products which are of interest to the radio amateur, with — we'll admit it — a bit of bias towards the man who wants to build his own. We could fill columns with details of all the new black boxes for the amateur, but we thought it better to concentrate on what's available to help you learn more about amateur radio and to make general improvements to your station rather than to delve into the latest black box — what else do we pay our reviewer for ??? Anyway, we'll kick off with what's almost a black box, or rather a range of black boxes, except that most of them aren't black and that there are literally hundreds of types. They fill a catalogue which comes from an outfit called West Hyde Developments, "the instrument case specialists" as they call themselves, and if you're after something nice to put your latest project in they're the people to get hold of. Basically, they aim to "provide a practical solution to every problem of electronic packaging" and this means everything from a snazzy case for your computer terminal, complete with screen and keyboard, to a small die-cast box for that little RF preamp you've just put together. On the way you'll find boxes for every type of project you can think up, including standard 19in rack panels and so on, and boxes with built-in heat sinks. These would be ideal for stabilised power supplies of one sort or another. They also do a range of knobs, handles, counter-type dials (just the thing for that VFO you had in mind) and what they call "front-panel

furniture" in the shape of fuseholders, LEDs, switches and jacks. To be quite honest, it made us look a bit ruefully at things we've built over the years and we've resolved to make all our projects *look* nice from now on. You can obtain the catalogue from West Hyde Developments Ltd, Unit 9, Park Street Industrial Estate, Aylesbury, or give 'em a ring on Aylesbury 20441, and you can even order with your credit card so there's no excuse whatsoever for not making your latest brainchild look good (said he, heart sinking at having to explain to the wife what all the extra lines on the Access statement mean — "no dear, it's just my front panel furniture, hem hem").

Right: West Hyde cabinets.

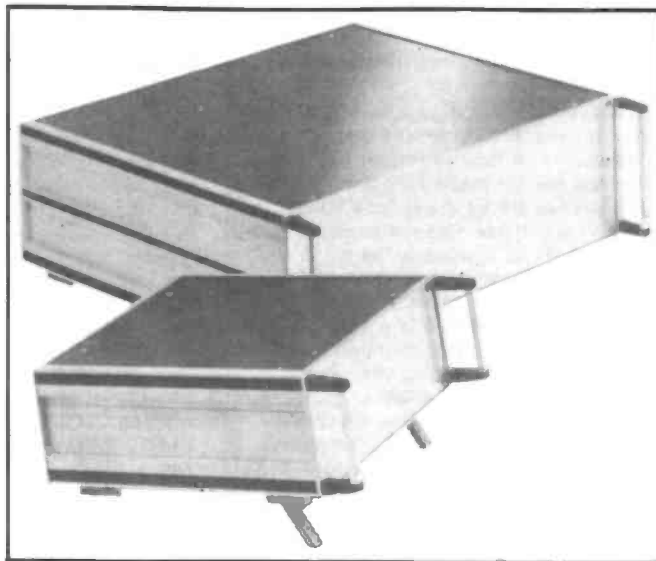

Above: Microwave Modules' 144MHz SSB transverter. Below: More West Hyde cabinets. See text.

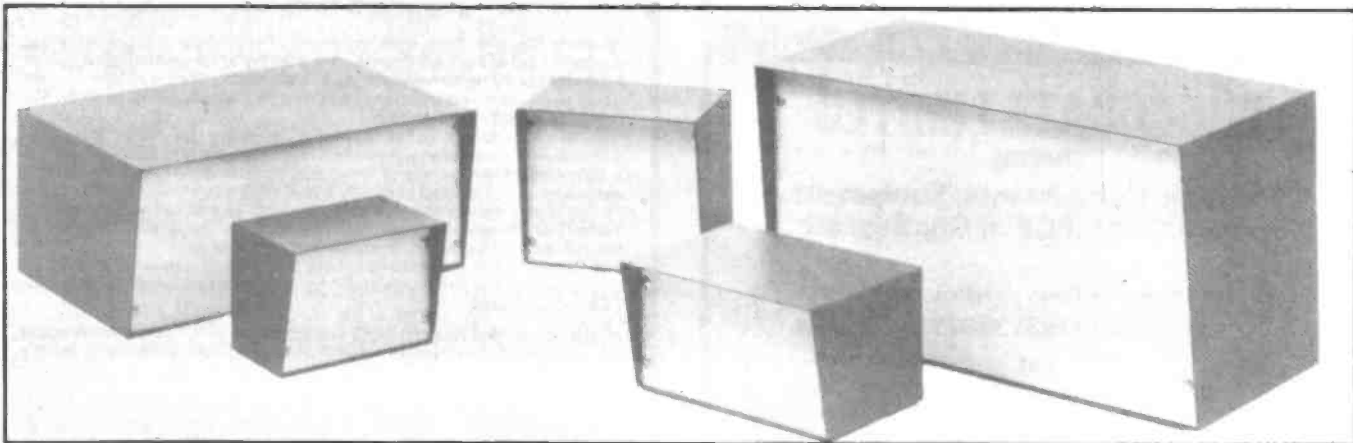

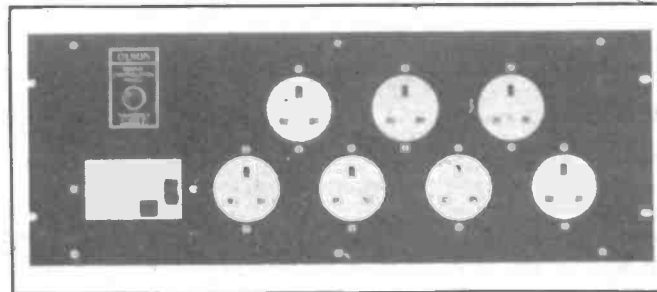
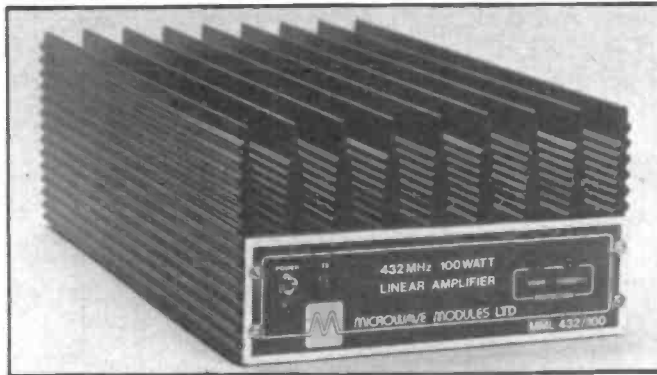
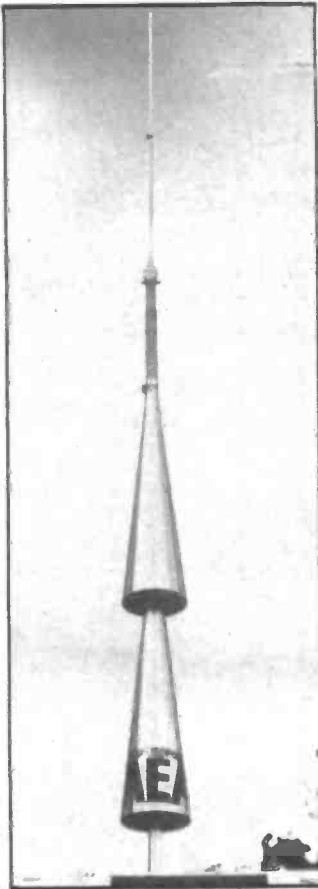

Left: The Isopole antenna. Top: MM's 100 watt amp. Above: Circuit breaker protected socket panel. Below: Wolf electric drill.



Now we know we said that we weren't going to go into the black-box regime much, but we have a soft spot for British manufacturers and we feel like giving them a plug or two. One company, Microwave Modules of Liverpool, have been around for years; they make various goodies which you can add on to your station and thus get more out of it. They've long been active in the "transverter" field, and almost everyone who owns an HF transceiver and who wants to get on to VHF or UHF uses a "Mickey Mouse" transverter to do it if they don't build their own. Microwave Modules can get you on to 70, 144 and 432MHz from 28MHz at an output level of about 10 watts, and they also do a range of transistorised linear amplifiers to boost the power somewhat. MM equipment is well put together and easy to interface with your rig, and you'll also find that they're very friendly if you run into problems of one sort or another — we had some dealings with them in the professional world a few years back (they're active in the pro field as well as the amateur one) and they struck us as knowing very much what they were about. They do all sorts of other things, and you can get a nice catalogue from them at Brookfield Drive, Aintree, Liverpool L9 7AN. You can telephone them on 051-523 4011 if you wish, and they'll be delighted to send you all sorts of data sheets and things — they also tend to frequent the major rallies, and we suspect they'll be at Leicester from October 7-9. It's nice to see a British outfit who know what they're doing — there's another of them, Datong Electronics up in Leeds, who make all sorts of clever devices to make the amateur's life easier. Rumour has it they've just brought out another of their clever receiver filters, and if it's as good as their last effort, the FL2, the queue will stretch round England.

"Facts about proper VHF vertical antenna design" was the title of a little book which arrived at the office just as we were about to close for press — it came from ICS Electronics Ltd, who are the UK representatives for Advanced Electronic Applications Inc of the USA. Basically, they market the so-called "Isopole" antenna, which is a state-of-the-art VHF vertical

# SHOP TALK

which claims to outperform every other sort. You can buy them for the 144 and 432MHz bands, for £29 and £45 respectively, and they certainly look interesting — we'd need to try one for ourselves before making any comments, but the theories they put forward in their little booklet look interesting and sound quite convincing. If you'd like to see a copy, try ICS Electronics at PO Box 2, Arundel, West Sussex, or ring 'em on 0243 65 590.

If you're going to build equipment, you'll need a soldering iron. One company who've been making them for years are GEC-Henley, and the "Solon" seems to be one of those trademarks that have been around since Marconi first started it all. You'll find their irons in all sorts of professional places, and indeed we've had one for many years ourselves. The laddie who built the HM-2141 for us used the 15 watt Solon for the job, and he reckoned that it was one of the best soldering irons he's ever used. You can buy them almost anywhere from electrical and DIY shops, and indeed there's a range of them which goes all the way from 15 watts to a whopping 240 watt beast which would come in handy for jobs like making anode lines from brass or copper on your next VHF linear. You can replace the bit when they wear out, and we gather they're cheap, so there's no excuse for bashing on with the same old clapped-out iron for years and years! As we said, all sorts of shops stock Solon irons, but if you'd like a look at their catalogue contact GEC-Henley at Crete Hall Road, Gravesend, Ken DA11 9DA or ring them on 0474 64466.

Sticking with tools for a while, you'll need the odd power tool if you're into making big chassis and things; the classic one to have is an electric drill, although you'll have to be careful not to let the wife see it otherwise you'll be up for all sorts of odd jobs round the house ("but surely you can put some kitchen shelves up for me, dear, if you can make all those clever things . . .") and that'll be that. Messrs. Wolf do a good range, and we've just acquired one for our workshop; we'll be reporting on what we're making in subsequent issues. Our one has an electronic variable-speed switch, and you can reverse it if you need to — believe it or not, that's extremely

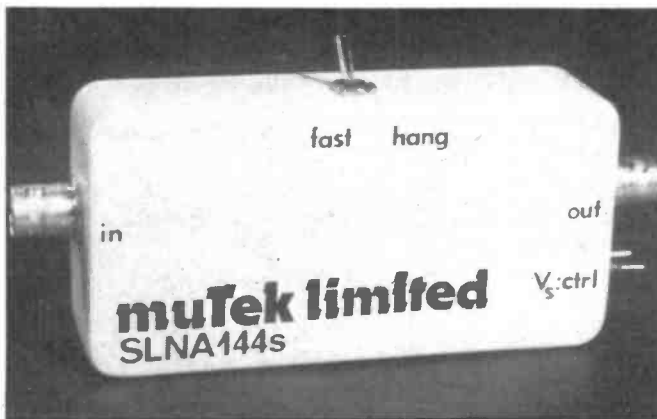
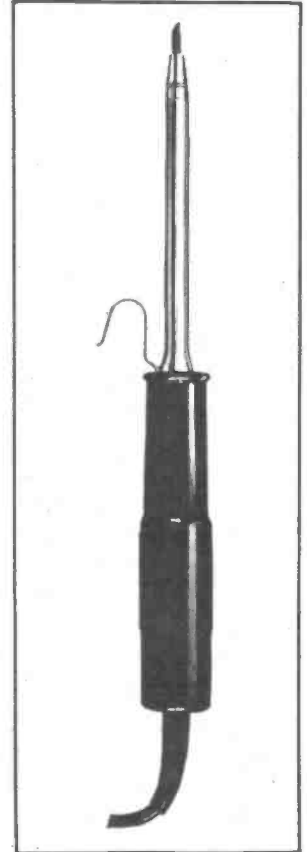
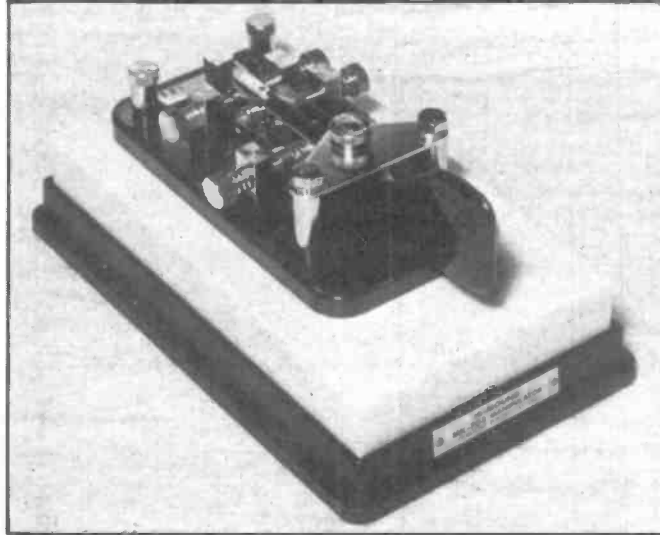

Top left: Hi-Mound Morse keyer. Above: GEC-Henley soldering iron. Left: Switchable low-noise 144MHz pre-amp from Mutek. Below: Oscilloscope from Electronic Hobbies.

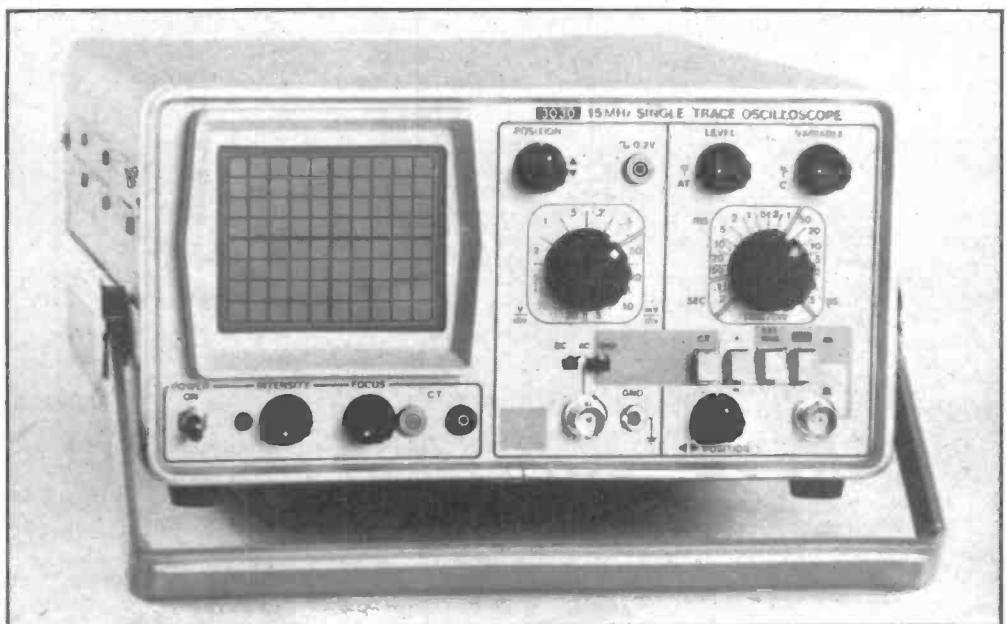

useful if you're making chassis and whatnot out of relatively soft ally and the drill keeps sticking. It'll even do the jobs which require a percussion action, but we'd better not say any more about that because that's meant for masonry and you'll find yourself doing all sorts of terrible jobs round the house if you let on that you've got a drill that'll bore holes in bricks and concrete.

Mind you, it should come in handy for when we want to put another UHF antenna on the chimney stack . . . and also if you want to fix 26 antenna sockets to the lounge wall. Seriously, it's a lovely tool and you can get a catalogue of all Wolf's nice things from Kango Wolf Power Tools Ltd, Hanger Lane, London W5 1DS. Telephone number is 01-998

2911 — if you can hear anyone through the noise of all that drilling!

Want an oscilloscope, mister? Well, we all do — come to that, we really do need a small one for the office shack, must look into that soon, can't keep borrowing the Technical Department's £3,700 monster otherwise they'll start moaning and complaining. Sorry, where were we? Oh yes, 'scopes. Well, good one's aren't ever cheap but Electronic Hobbies have just brought one out for £150 which caught our eye recently. It's basically a 15MHz bandwidth machine, single-trace only, with 18 sweep speeds from 200 ns to 200 ms per division and some nifty triggering and sync modes. It also, would you believe, has a built-in component tester — you can test active and passive components, in and out of circuit, and of course you see the results on the screen. Well where else would you see them, dum-dum?

This one, anyhow, is the Type 3030, and you can get details from Electronic Hobbies Ltd, 17 Roxwell Road, Chelmsford, Essex CM1 2LY. Telephone number for them is 0245 62149. Wonder whether they do a double-beam one? We tend to find we need a twin-beam scope most of the time, to be honest, but maybe that's because we weren't brought up properly or something.

Finally, a handy accessory for all those little gizmos you have in the shack which need a source of mains — you tend to find you have 16 plugs and two mains sockets, which is a great recipe for wailing and gnashing of teeth. Messrs Olson Electronics can help you, since they make 13 amp distribution units in all sizes from three to ten outlets — just the thing for the amateur shack. They come in bench units, wall-mounted units and portable units, and you can even get them with built-in earth-leakage circuit breakers for added safety. An ELCB is a very clever device which detects an imbalance between the currents in the line and neutral and trips out, so it can protect equipment and, more importantly, you in the event of a fault. So they're good things to have around, and indeed they're tending to crop up in domestic-type consumer units. Only snag is that they're still not cheap, but they're certainly a great thing as far as safety in the shack is concerned — we certainly believe in them. Anyhow, no doubt Olson Electronics will be pleased to tell you all about them if you drop a line to them at Factory No. 8, 5-7 Long Street, London E2 8HJ or ring them on 01-739 2343.

Datong are a very innovative British company who make all sorts of clever gadgets to improve the quality of your amateur life. The picture shows their AD370 active antenna (don't transmit with it, Brian, or there'll be a loud explosion . . .). This is for the listener who doesn't have the space for a mammoth erection in the back garden — er, well, you know what we mean.

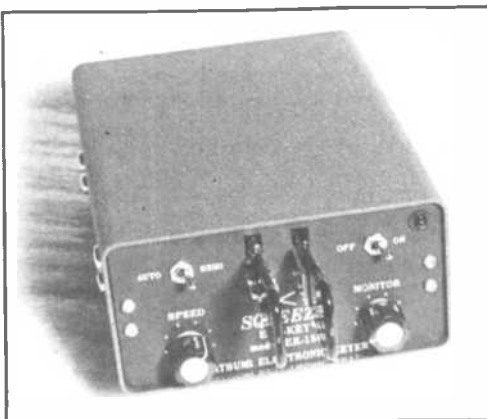
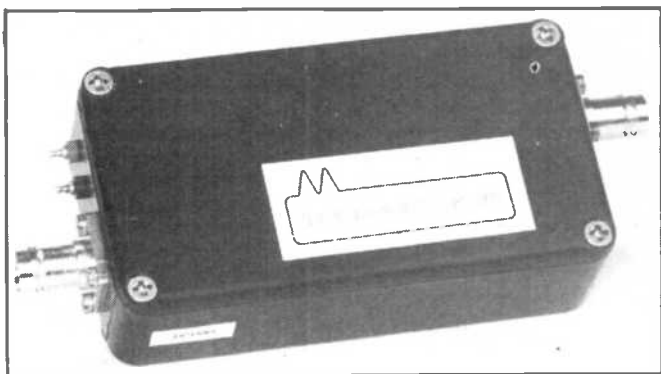

Top: 432-28MHz converter from MM. Centre left: Datong AD370 active antenna. Right: Katsumi iambic keyer. Left: Morse tutor.

# SHOP TALK

It's basically a small antenna with a low-noise high dynamic range amplifier tacked on the end, and it'll cover 200kHz to 100MHz. Katsumi make some nice keyers if you're into Morse, and we had a look at the new EK-150. It has twin paddles, so you can use what is known as iambic keying, and is delightful to use. Radio Shack in North London sell the whole range of Katsumi keyers, and many notable CW users use them.

Another innovative British company is Mutek which is run by Chris Bartram, G4DGU, down in Devon. They do some very well-engineered pre-amplifiers for the 144 and 432MHz bands, as well as a replacement "front-end" board for the Yaesu FT225 which turns an ordinary receiver into a very good one. Picture shows their switched low-noise 144MHz amplifier, the SLNA 144s, and it's a superb piece of kit. Mutek are at Holsworthy in Devon, or on 0409 24 543. Datong's Morse Tutor sells like hot cakes to those who want to learn Morse for their Class A licence. It generates random Morse at whatever speed and inter-character spacing you like, and it will send letters, numbers and a mixture of the two so that you can practice whatever you feel you need to before you take the trip to London or to your local friendly coastal radio station. Datong live in Leeds, and advertise in this magazine.

Microwave Modules do a natty little frequency counter; basically, it'll work up to 50MHz but you can buy what is known as a "prescaler" to use it all the way up to 500MHz and more. Just the thing for the VHF and UHF

man, and it's well made too. See elsewhere for the address of Microwave Modules. This isn't a new product by any means but people often ask us: "Where can I get a good cheap counter?" and this is the one we often suggest to them. Another of Microwave Modules' converters takes frequencies on the 432MHz band and translates them downwards to the 28MHz band so that you can listen to UHF on an HF receiver. If you want to do the same on transmit, MM also make a good range of "transverters". See the text.

A Hi-Mound manual Morse key is one of the family of keys which is known as "bugs" for some obscure reason — they generate the dashes manually but they also generate strings of dots by means of a clever mechanical arrangement. The classic bug key was the old Vibroplex, and the Hi-Mound is a modern variant on the same theme. Old-timers love them and modern amateurs like them too except that they often use Morse keyboards these days. Oh well!

Scanning receivers are very common these days. Basically, they are receivers with a wide tuning range which have a synthesiser as the main tuning element and which are controlled by a microprocessor. You tell the receiver the frequency limits you'd like to scan between and off it goes — it'll stop when it finds a signal. A well-known firm in this field is Bearcat, of the good ol' USA, and Bredhurst Electronics amongst others, sell them in the UK. The one in our pic is the SX200, and you can use it for the amateur 144MHz band as well as all sorts of other frequencies.

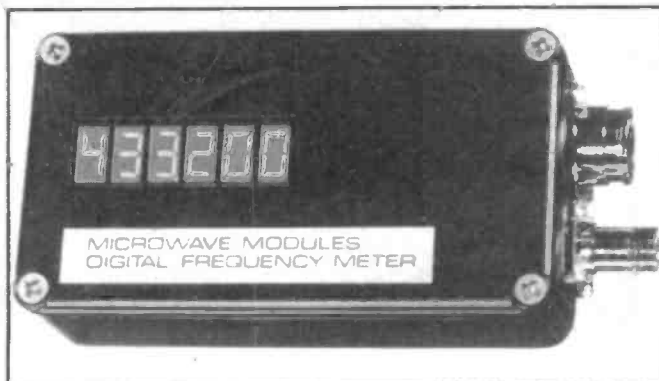

Microwave Modules' little digital frequency meter — good to 50MHz, and to 500MHz with an add-on prescaler from the same company.

## SOTA'S LINE OF LINEAR AMPLIFIERS

**Model No. SCL 144/30**    £50 + VAT  
RF drive 2/3 watts    RF output 20/30 watts  
Receiver pre amp independently controllable.

**Model No. SCL 144/40**    £60 + VAT  
RF drive 10 watts    RF output 40 watts  
Receiver pre amp independently controllable.

**Model No. SCL 144**    £80 + VAT  
RF input 10 watts    RF output 100 watts  
Receiver pre amp not applicable.

**Model No. SCL 144P**    £100 + VAT  
RF input 10 watts    RF output 100 watts  
Receiver pre amp independently controllable.

-----  
All linear amps have straight through facility.  
-----

All the above Models are designed for a nominal 12 volt supply. If AC mains operation is required, please see our Model SCL 144/PS as featured on page 26 of the February issue of Practical Wireless.

Sota Communication Systems also manufacture Receiver pre amps for 28 MHz and 144 MHz these being two versions one which operates as pre amp for installation internally in Transceivers and the other version which has an RF switching facility and is mounted in a neat aluminium case.

The above specifications are a brief outline to our Product Range please send an SAE or telephone for further information.

Trade and export enquiries welcome. We are Northern Representative for "VHF Communications" Magazines and Kits. Telephone credit card orders taken. Carriage or postage on all equipment.

**Please allow 10 days for delivery**

## Sota Communication Systems Ltd

22-26 Childwall Lane, Bowring Park  
Liverpool L14 6TX, England.

Tel: 051-480 5770    Telex: 628702 SOTA G

Hours 9am-6pm Monday to Friday  
9am-1pm Saturday

Radio Consultants, Suppliers and Manufacturers

**BARCLAYCARD    AMERICAN EXPRESS    ACCESS**

DO YOUR SHOPPING  
THE EASY WAY —  
THE BREDHURST WAY

TO ORDER ANY OF THE ITEMS LISTED BELOW, SIMPLY WRITE ENCLOSING A  
CHEQUE, OR PHONE AND QUOTE YOUR CREDIT CARD No.

# Bredhurst electronics

HIGH ST., HANDCROSS, W. SUSSEX O444 400786

## TRIO TRANSCEIVERS

	£	C&P
TS930S 9 band TX Gen Cov RX	1078.00	(—)
TS830S 160m-10m 9 bands	694.00	(—)
TS530S 160m-10m 9 bands	534.00	(—)
TS130S 8 band 12V dc 200W pcp	525.00	(—)
TS130V 8 band 12V dc 20W pcp	445.00	(—)
TR9130 2M 25W Multimode	395.00	(—)
TR9000 2M 10W Multimode	359.00	(—)
TR7800 2M 25W FM Mobile	257.00	(—)
TR7730 2M 25W FM Compact Mobile	247.00	(—)
TR2300 2M Portable (FM)	166.00	(—)
TR2500 2M Handheld (FM)	207.00	(—)
TR8400 70cm FM 10W	299.00	(—)
TR9500 70cm Multimode 10W	449.00	(—)

## YAESU TRANSCEIVERS



YAE SU FT 102 — £725

	£	C&P
FT1 9 band TX Gen Cov RX	1295.00	(—)
FT902DM 160-10m 9 band (+FM)	885.00	(—)
FT102 160-10m 9 band	725.00	(—)
FT707 8 band 12v dc 200W pcp	569.00	(—)
FT707S 8 band 12v dc 20W pcp	485.00	(—)
FT230R 2M 25W FM Mobile	239.00	(—)
FT208R 2M Handheld (FM)	209.00	(—)
FT290R 2M Portable Multimode	249.00	(—)
FT480R 2M Multimode Mobile	379.00	(—)
FT708R 70cm FM Handheld	219.00	(—)
FT780R 70cm Multimode Mobile	469.00	(—)

## ICOM TRANSCEIVERS

	£	C&P
IC740 8 band 12v dc Mobile (+FM)	699.00	(—)
IC720A 9 band TX Gen Cov RX	883.00	(—)
IC251E 2M base multimode	499.00	(—)
IC25E 2M 25W Mobile	239.00	(—)
IC290E 2M Multimode Mobile	366.00	(—)
IC2E 2M FM Handheld	159.00	(—)
IC4E 70cm FM Handheld	199.00	(—)

## FDK TRANSCEIVERS

	£	C&P
Multi 700EX 2M FM 25W Mobile	169.00	(—)
Multi 750E 2M Multimode Mobile Expander	289.00	(—)
750E 70cm Transverter for	199.00	(—)
PS750 230V ac 6amp psu	69.00	(2.00)

## RECEIVERS

	£	C&P
TRIO R600 Gen Cov HF Receiver	235.00	(—)
TRIO R1000 Gen Cov HF Receiver	297.00	(—)
YAESU FRG7 Gen Cov HF Receiver	199.00	(—)
YAESU FRG7700 Gen Cov HF Receiver	329.00	(—)
YAESU FRG7700M Gen Cov HF Receiver + Memories	409.00	(—)
ICOM RX70 New Gen Cov HF receiver	469.00	(—)
SX200N VHF-UHF Scanning Receiver	264.00	(—)
R517 Handheld Airband Receiver	49.50	(1.00)
ATC-720 Fully Synthesised Airband receiver	135.00	(—)

## MICROWAVE MODULES

	£	C&P
MMT144/28 2m Transverter for HF rig	109.95	(—)
MMT432/28S 70cm Transverter for HF rig	159.95	(—)
MMT432/144R 70cm Transverter for 2m rig	184.00	(—)
MMT70/28 4m Transverter for HF rig	119.95	(—)

MMT70/144 4m Transverter for 2m rig	119.95	(—)
MMT1296/144 23cm Transverter for 2m rig	184.00	(—)
MML144/30LS 2m 30W Linear Amo (1/3 1/P)	69.95	(—)
MML144/100LS 2m 100W Linear amp (1/3W 1/P)	159.95	(—)
MML144/40 2m 40W Linear Amp (10W 1/P)	77.00	(—)
MML144/100S 2m 100W Linear Amp (10W 1/P)	139.95	(—)
MML432/20 70cm 20W Linear Amp (3W 1/P)	77.00	(—)
MML432/50 70cm 50W Linear Amp (10W 1/P)	109.95	(—)
MML432/100 70cm 100W Linear Amp (10W 1/P)	228.64	(—)
MM2001 RTTY to TV Converter	189.00	(—)
MM4000 RTTY Transceiver	269.00	(—)
MMC50/28 6m Converter to HF rig	29.90	(—)
MMC70/28 4m Converter to HF rig	29.90	(—)
MMC144/28 2m Converter to HF rig	29.90	(—)
MMC432/28S 70cm Converter to HF rig	37.90	(—)
MMC432/144S 70cm Converter to 2m rig	37.90	(—)
MMC435/600 70cm ATV Converter	27.90	(—)
MMK1296/144 23cm Converter to 2m rig	69.95	(—)
MMD050/500 500MHz Dig Freq Meter	69.00	(—)
MMD600P 600MHz Prescaler	29.90	(—)
MMDP1 Frequency Counter Probe	14.90	(—)
MMA28 10m Preamp	16.95	(—)
MMA144V 2m RF Switched preamp	34.90	(—)
MMF144 2m Band Pass Filter	11.90	(—)
MMF432 70cm Band Pass Filter	11.90	(—)
MMS1 The Morse Talker	115.00	(—)

## DATONG PRODUCTS

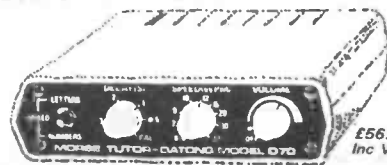

DATONG D70 MORSE TUTOR

£56.35  
Inc VAT

	£	C&P
PC1 Gen Cov Convtr HF on 2m rig	137.42	(—)
VLF Very Low Frequency Converter	29.90	(—)
FL1 Frequency Agile Audio Filter	79.35	(—)
FL2 Multimode Audio Filter	89.70	(—)
ASP/B Auto RF Speech Clip (Trio Plug)	82.80	(—)
ASP/A Auto RF Speech Clippers (Yaesu Plug)	82.80	(—)
D75 Manually con RF Speech Clipper	56.35	(—)
RFC/M RF Speech Clipper Module	29.90	(—)
D70 Morse Tutor	56.35	(—)
AD270 Indoor Active Dipole Antenna	47.15	(—)
AD370 Outdoor Active Dipole Antenna	64.40	(—)
MPU1 Mains Power Unit	6.90	(—)
MK Keyboard Morse Sender	137.42	(—)
RFA Broadband Preamp	33.95	(—)
Codecall Selective Calling Device (Link Prog)	32.20	(—)
(Switch Prog)	33.92	(—)

## DUMMY LOADS

	£	C&P
DL30 PL259 30W Max 150MHz	5.00	(0.50)
CT15A WELZ PL259 50W Max 450MHz	6.95	(0.75)
CT15N WELZ N connector 50W Max 450MHz	11.95	(0.75)
T100 SO239 100W Max 500MHz	22.95	(0.75)
T200 SO239 200W Max 500MHz	34.00	(1.00)
DL600 SO239 600W Max 350MHz	29.95	(1.50)
CT300 WELZ SO239 1KW Max 250MHz	42.95	(2.00)

## TELEREADERS (CW & RTTY)

	£	C&P
TASCO CWR 680	189.00	(—)
TONO 500	299.00	(—)

## WELZ SWR POWER METERS

	£	C&P
SP15 H.F/2M 200W	29.00	(0.75)
SP45 2M/70cm 100W	45.00	(0.75)
SP200 H.F/2M 1KW	59.00	(1.00)
SP300 H.F/2M/70cm	79.00	(1.00)
SP400 150W (N connectors)	59.00	(1.00)

## DAIWA SWR POWER METERS

	£	C&P
SW110A H.F/2M 200W	35.00	(—)
CN 620A H.F/2M Crosspointers 1KW	52.80	(—)
CN630 2M/70cm Crosspointers 200W	71.00	(—)

## OTHER SWR POWER METERS

	£	C&P
Model 110 H.F/2M Single Meter	11.50	(0.50)
YW/3 H.F/2M Twin Meter	11.50	(0.50)
T435N 2M/70cm (N connectors) Twin Mtrs	34.00	(1.00)

## HEADPHONES

	£	C&P
HS4 TRIO Economy	10.35	(1.00)
HS5 TRIO Deluxe	21.85	(1.00)
HS6 TRIO Lightweight	14.95	(1.00)
YH55 YAESU Standard	10.00	(0.75)
YH77 YAESU Lightweight	10.00	(0.75)

## COAXIAL SWITCHES

	£	C&P
2 way Toggle Switch (H.F/2M)	5.00	(0.50)
2 way Diecast — PL259 (500MHz)	10.00	(0.50)
2 way Diecast — N type (500MHz)	12.95	(0.50)
2 way WELZ CH20A (PL259)	15.95	(0.75)
2 way WELZ CH20N (N type)	27.95	(0.75)
5 way Western Rotary Switch H.F	13.50	(0.75)
3 way LAR Modules H.F	16.95	(1.00)

## DESK MICROPHONES

	£	C&P
Shure 444D Dual Impedance (SSB)	£39.00	(1.50)
Shure 450 Dual Impedance (FM)	53.00	(1.50)
Shure 526T Series II Power Microphone	46.00	(1.50)
Adonis AM303 Power Mic and Scan Buttons	29.00	(1.00)
Adonis AM503 Compression Mic and Scan Buttons	39.00	(1.00)

## MOBILE SAFETY MICROPHONE

	£	C&P
Adonis AM202S Clip-on	21.00	(—)
Adonis AM202 HD Head band and Scan Buttons	31.00	(—)
Adonis AM202F Swan Neck — Scan Buttons	33.00	(—)

## JAYBEAN ANTENNAS



Phone for details

## MORSE EQUIPMENT

	£	C&P
HK707 Up/Down Key	10.50	(0.50)
MK704 Squeeze Paddle	10.50	(0.50)
HK704 Deluxe Up/Down Key	16.95	(0.50)
EK121 Elbug	32.00	(0.75)
EKM1A Matching side tone monitor to EK121	10.95	(0.50)
EK150 Electronic Keyer	74.00	(—)
General Practice Oscillator	8.75	(0.50)
Datong D70 Morse Tutor	49.45	(—)
Microwave Modules MMS-1 Morse Talker	115.00	(—)
Datong MK Morse Keyboard	137.42	(—)



MAIL ORDER  
9-12.30, 1.30-5.30

Goods normally despatched  
within 24hrs. Allow 28 days max

All prices correct at time of going to press  
**BREDHURST ELECTRONICS**  
HIGH ST., HANDCROSS, W. SUSSEX. TEL: 0444  
400786

RETAIL CALLERS  
9-12, 1.30-5.30  
E&OE



TO ORDER ANY OF THE ABOVE ITEMS SIMPLY WRITE ENCLOSING A CHEQUE OR PHONE YOUR CREDIT CARD NUMBER

# STARTING FROM SCRATCH



## Listening into shortwave

You don't need a licence, and you'll hear anything from local signals to transmissions from the other side of the world. It's about the best way of beginning your association with amateur radio. And it needn't cost the earth, says Chris Drake.

Yes, yes, I *know* we had an article called "Getting Started" in the last issue of this magazine. John Nelson wrote it, and very well too. It's just that I thought I'd have a go while he isn't around, because we had a lot of letters after the last magazine from people who wanted to start right at the very beginning of the hobby as **Short Wave Listeners**.

Now as John said in the last issue (rumour has it he was trying to put up a 150-foot dish on the roof of his house and he's still up there trying to work out how the hell to get down) twenty years ago practically every amateur started life as a Short Wave Listener; that's to say, someone who *listened* on the high frequency, or short wave, bands. There are many types of radio traffic to be heard on the short waves apart from amateur. The international broadcasting services form a large part of what goes on, along with shipping, aircraft and all sorts of miscellaneous noises which belong to everything from radio beacons to Embassy-type traffic in all sorts of sneaky codes.

The "short waves" traditionally imply all that part of the radio spectrum between 3 and 30MHz, and what makes them so special is that they have much greater range than your long and medium wave

radio does. This is because, as we saw in the last issue, various reflecting layers that encircle the Earth have the property of reflecting signals on these sorts of frequencies and returning them back down to Mother Earth at a range which depends on various things like the frequency in use, the type of antenna used for the transmission and so on. If you're into geometry, you'll realise that to obtain the maximum range from a transmission launched from the surface of a sphere and reflected off a layer surrounding that sphere, the angle which the wave strikes the layer needs to be as shallow as possible.

This actually means that the departing wave needs to have been fired at a tangent to the sphere (remember they called it trigonometry at school). The angle at which a radio wave is launched is called the wave angle, and if it could be launched at a tangent to the Earth's surface it would be said to have a wave angle of 0°. Conversely, if you were to fire the wave vertically upwards, the wave angle would be 90°. If you become a keen DX chaser, one of the things you'll covet is an antenna which will give you as low a wave angle as possible. The only snag is that low wave angles are rather difficult to achieve in

practice and require quite elaborate antenna systems in order to approach anything like a really low angle of radiation (as you'll sometimes hear "wave angle" referred to on the wireless).

If you're the BBC you use a dirty great array of phased dipoles and reflectors which is one wavelength off the ground. If you remember that the wavelength corresponding to the 6MHz broadcast band is 41 metres, you'll soon twig why you can't miss the Beeb's station at Daventry if you pass it on the train!

However — we'd better get back to what you'll be able to achieve in your back garden. If you have thoughts of trying out the short waves, you'll need two basic things — a receiver of some sort and an antenna with which to provide it with signals. Let's discuss the receiver first.

The first point to make is that the short wave bands are crowded. The second point is that by a variant of Murphy's Law the signal you'll want to listen to will be (a) exceedingly weak and (b) right next door to another station which is almost causing your radio to leap off the table because it's so strong. These things being so, a short wave receiver worth the name is going to be somewhat more technically sophisticated than its domestic radio



cousin. It's going to require a bit more in the way of decent engineering in several areas. Let's look at some of them.

It'll need to have good **selectivity**, meaning that it must be able to resolve stations which may be only a short distance apart in terms of frequency, without running the two together. It will need good **sensitivity**, so as to be able to make some audible sense out of the weak signals without losing them in its internally generated noise. Lastly it'll require good **dynamic performance**. This means, approximately, an ability to resolve weak signals in the presence of much stronger ones on adjacent frequencies without making an unholy mess of itself. Unfortunately, this is a point that has to be watched very closely in this solid-state age. The valve receivers of yore had an inherently good strong signal performance because of the way in which valves work but, as we implied in the article on interference, the transistor and various of its solid-state brethren aren't in the same league as the valve in this area.

The reasons are a bit difficult to explain but it's true to say that a good average transistorised radio of today will in all probability have a rather inferior strong-signal performance to its valve ancestor. Good strong-signal performance with solid-state devices has only really come about during the last few years, with the advent of clever devices like the Schottky diode — but you'll still find that, particularly on frequencies such as the 6MHz broadcast band and the 7MHz amateur band, where signals at night can be excruciatingly strong, many transistor radios simply won't "cut the mustard", as the Americans say. They'll tend to go into various forms of overload and you'll hear lots of horrible noises and not a lot in the way of intelligible signals.

## Trying it out

This, incidentally, is why you'll often find an "attenuator" switch on the front panel of a modern middle-of-the-road receiver. It's the manufacturer's way of admitting that the receiver's strong signal performance isn't outstanding and that you'll need to use the attenuator sometimes in order to stop it overloading.

When you come to buy a short wave receiver, by the way, you can do an easy test on its signal handling abilities by connecting it up to a reasonable antenna and trying it out on either the 6MHz broadcast band or, rather better, the lower part of the 7MHz amateur band at about 10pm. You will discover a lot about your radio in a few seconds, because signals on 7MHz at that time of night tend to be coming from two sources — to wit, the amateurs who have every right to be there, and some broadcasting stations who haven't.

These latter, of whom the most notable example is Radio Tirana, use enormous power and antennas designed to put the best possible signal into Europe; their signals will be something like a hundred thousand times stronger than the loudest amateur on the band, unless you're right next door to one, and if the receiver you're using can copy the amateur signals with no real problems it's likely to be well worth having on the grounds of strong-signal performance. It may have other defects, which we'll come to later, but signal handling is very important and quite easy to establish.



*This SWL station (left and above) is advanced; the main receiver for the amateur bands is the superb Collins 75A4 and it's hooked into a microcomputer to decode RTTY and Morse signals. Various other receivers handle other bands, and the computer has frequency and station information stored in it. The owner has a Class B licence, actually, but he says he seldom uses it! He's been a listener for 31 years . . .*

What sort of receiver to get? Well, what *not* to get if you're serious about your SWLing is a domestic-type radio with some short-wave bands tacked on. Its performance under all the three headings we've mentioned is likely to be pretty dire and it won't be fit for much other than listening to strong broadcast stations during daylight hours. You'll find also that the amateur bands, because they don't cover much in terms of frequency range — the 40 metre band goes from 7 to 7.1MHz, for instance — tend to be packed into about half an inch of space each on the tuning dial. This doesn't make for good selectivity!

You'll probably also find that the bands seem to get very crowded as you go higher than about 8 or 9MHz. They aren't, but your radio will be tending to receive stations at two closely-spaced points on its dial if it isn't engineered with selectivity in mind. This little bother is known as "image interference", by the way, and is an inherent defect of simple short-wave radios of what is known as the superheterodyne or "superhet" type. Since almost every commercial radio ever built since the thirties is, or was, of this type, it's a common problem if the short-wave bands have been tacked on as a sort of afterthought.

In general, then, I'd forget the sort of thing you often see in windows in back-street shops, bristling with chrome plate, knobs and dials. They look impressive but they don't do the job very well.

Really you have three options. You can build one yourself, which is great fun but we don't really have the space to delve into how to do that here. You can buy something like the Trio R1000 or R600, or the Yaesu FRG7 or FRG7700, or indeed any radio of that ilk; they all do a good job and are very simple to use. The benefit of this approach is that radios of this type use a device called a frequency synthesiser, so you get continuous coverage of all the bands in 1MHz steps and a digital readout of the frequency you're tuned to. Or you can get hold of an old-type valve receiver such as the RCA

AR88 or the Marconi CR100. These can be bought for the proverbial song compared with the cost of a new transistor wireless, and they have two other main benefits; you'll learn an enormous amount about using a radio receiver, in rather the same way as you learn a lot about photography from starting with a manual camera, and you'll find that in general their performance is really very good. You will find that they tend to get somewhat less sensitive as you go higher in frequency, which is another of the little defects we mentioned a while ago; the AR88, for instance, is getting more than a bit deaf on the 28MHz band. However, you can always build a little preamplifier to help it along a bit; perhaps we'll persuade Mr Editor to publish a design in the next issue of the magazine if anyone's interested! Write in.

Anyhow, assuming you've obtained a receiver, what about the antenna? To start with, there's nothing like a length of wire down the garden. If you put it up as high as possible and make it as long as possible, this will do very nicely for getting the feel of the various bands. A refinement is to build a little Antenna Tuning Unit, which will match the antenna to the radio and allow it to transfer the maximum signal into the receiver's circuitry. You can then "peak" the received signals for maximum strength. Later on, you can try out antennas such as dipoles or verticles, and we delved into these a little in the last issue; in fact, if you engineer them well, in accordance with the usual rules, you'll be able to use them for transmission when you get your licence.

If you live in a place where external antennas of any sort are absolutely forbidden for one reason or another, don't lose heart. Try a connection to such things as the guttering of your house or, believe it or not, the bedsprings! As long as you use your common sense and don't connect the antenna input of your receiver to anything that looks as though it might be remotely connected to the mains supply, all sorts of unlikely things will act as some sort of antenna. And, without inciting anyone to break the terms of their tenancy agreements or lease or whatever, remember that thin wire is practically invisible if you're not looking for it. If you really have problems, a length of wire round the picture rail, or even an aerial system of some sort in the loft, will produce some signals for you.

As to what you'll hear, well, you could write a book. Remember that short wave propagation is influenced by all sorts of factors such as the time of year, the sunspot cycle, solar activity and so on. The first thing to establish is where the amateur bands are, and then to listen on them to build up an idea of what you will find and where at various times.

You'll find, for instance, that the 3.5MHz band in daylight will produce mostly local stations, whereas 14MHz in daylight will be chock-a-block with stations from various parts of the world. Bit by bit you'll build up your knowledge, and you'll also begin to get a feeling for what is rare DX and where you're likely to find it. All of which will stand you in good stead when you pass the RAE and get your licence.

That's about it. The rest is up to you and your receiver. You'll certainly discover that the high frequency bands are a fascinating part of the radio spectrum, though I doubt you'll ever get to enjoy Radio Tirana!

Get the most from your VHF equipment with a

# PACKER COMMUNICATIONS

## Antenna Tuning Unit



### IMPROVE YOUR VSWR!

We are often asked, "why an ATU at VHF?", well for exactly the same reasons that apply to HF.

- (1) Antennas are often anything but 50
- (2) Their VSWR is never constant across the band from CW, through SSB and FM, to satellites.
- (3) Many modern rigs have VSWR protection. Even a slight increase in VSWR can cause a dramatic reduction in output power.
- (4) Rotation of a beam can cause reflections from nearby objects. Many customers are experimenting with long wires and (AT145Z option) with Rhobics and Veels. Load up an ordinary car broadcast antenna if you have a vandalism problem.

USE FIXED OR MOBILE MATCHES 0 - 10/500Ω 500 Watts

AT-145 £22.85 SO-239 standard. N or BNC £23.75.  
 AT-432 £28.80 N-type standard. So-239 or BNC to order.  
 AT-70 £24.55 Any connector to order.  
 AT-145Z £29.45. SO-239 + terminals 50-10/500Ω (built in balun) and 50-100/2000Ω

Remember, you MUST have a wavemeter!

WM-2 130-300 MHz £22.45

WM-7 400-900 MHz £24.35

OLD STATION, CONISTON, CUMBRIA, LA21 8HQ

Access - Visa - American Express Cards.

## GAREX (G3ZV1)

# SX200-N

THE ULTIMATE SCANNER



COMPARE THESE FEATURES

- \* SPECIALLY DESIGNED FOR EUROPEAN MARKET
- \* MICROPROCESSOR CONTROLLED 32,000 CHANNELS
- \* AM AND FM ALL BANDS
- \* WIDER COVERAGE: 26.58, 5B-88, 108-180, 380-514MHz; includes 10m, 4m, 2m and 70cm Amateur Bands
- \* 5kHz and 12½kHz FREQUENCY INCREMENTS
- \* 16 MEMORY CHANNELS WITH DIRECT ACCESS
- \* 2-SPEED SCAN/SCAN DELAY CONTROL
- \* 2-SPEED SEARCH UP AND DOWN
- \* SEARCH BETWEEN PRESET LIMITS UP AND DOWN
- \* 3 SQUELCH MODES inc CARRIER AND AUDIO
- \* RELAY OUTPUT FOR Aux CONTROL
- \* INTERNAL SPEAKER
- \* EXTERNAL SPEAKER AND TAPE OUTPUTS
- \* LARGE GREEN DIGITRON DISPLAY BRIGHT/DIM
- \* AM-PM CLOCK DISPLAY
- \* 12V DC, 230V AC OPERATION
- \* 12 MONTH WARRANTY FACTORY-BACKED SPARES AND 'KNOW-HOW'

AND THE ALL-IMPORTANT PRE-DELIVERY CHECK BY GAREX, THE MAIN SERVICE AND SALES AGENTS. £264.50 inc VAT Delivered

\* NEW \* REVCON \* NEW \*

A new top quality 16-element, all British made, VHF/UHF broadband fixed station aerial from Revco. Ideally suited to SX200 and other VHF/UHF Receivers.

PRICE £24.95 inc

MAIN DISTRIBUTORS OF REVCO AERIALS & SPECIAL PRODUCTS

(trade enquiries welcome)

PRICES INCLUDE UK P&P and 15% VAT

## GAREX ELECTRONICS

7 NORVIC ROAD, MARSWORTH, TRING, HERTS HP23 4LS  
 Phone 0296 668684 (Callers by appointment only)

# WATERS & STANTON ELECTRONICS

18/20 MAIN ROAD, HOCKLEY, ESSEX. TEL (0702) 206835



£235 carriage £5

The FRG7700 is for the advanced listener or for the enthusiast who demands the best in short wave reception. The receiver covers the complete spectrum 200kHz to 30MHz with a highly accurate digital display. The receiver offers excellent sensitivity and selectivity and has separate detectors for AM, FM and SSB, plus switched bandwidth on AM. Other controls include automatic gain control, noise blanker, attenuator, squelch, rf gain control and clock with timer. There is also facilities for fitting an optional 12 channel memory unit. The receiver runs from 230v AC mains or 12v DC and there is an optional aerial tuner to go with it. And if you are interested in VHF, there is a complete range of specially designed converters to go with the receiver that covers the amateur, aircraft and marine bands, etc. Why not send today for our coloured brochure and get to know more about what the FRG7700 has to offer.

TRIO	
TS930 1.8-30MHz Tcvt. 230v AC 100w.....	£1.078
TS830 1.8-30MHz Tcvt. 230v AC 100w.....	£884
TS530 1.8-30MHz Tcvt. 230v AC 100w.....	£534
TS130S 3.5-30MHz Tcvt. 12v DC 100w.....	£525
TR9000 2M FM/SSB Tcvt. 12v DC 10w.....	£358
TR8130 2M FM/SSB Tcvt. 12v DC 25w.....	£395
TR7730 2M FM Tcvt. 12v DC 25w.....	£247
TR2500 2M FM handheld tcvr. 3w.....	£207

YAESU	
FT102 1.8-30MHz Tcvt. 230v AC 100w.....	£725
FT902 DM 1.8-30MHz Tcvt. 230v AC 100w.....	£885
FT101ZDFM 1.8-30MHz Tcvt. 230v AC 100w.....	£865
FL2100Z 1.8-30MHz 1kw amp. 230v AC.....	£425
FT480R 2m FM/SSB Tcvt. 12v DC 10w.....	£378
FT290 2m FM/SSB portable tcvr. 3w.....	£249
FT280R 2m FM handheld tcvr. 3w.....	£209
FT230R 2m FM mobile tcvr. 12v DC 10w.....	£239

WSE PRODUCTS	
W700EX 2m FM Tcvt. 12v DC 25w.....	£189
W750E 2m FM/SSB Tcvt. 12v DC 10w.....	£288
EXP430 UHF transverter for above.....	£199
P.11 2m FM handheld tcvr. 2w.....	£109
PCS3000 2m FM Tcvt. 12v DC 25w.....	£219
PCS300 2m FM handheld tcvr. 3w.....	£179
MX-2 2m SSB handheld tcvr. 200mw.....	£88
SPI0X Super power/swr meters 1.8-150MHz.....	£19.95

TRIO, YAESU, FDK, ICOM, AZDEN, WELZ, JAYBEAM, MICROWAVE, ETC  
 18-20 Main Road, Hockley, Essex. Tel: Southend (0702) 206835/204965  
 Open Monday-Saturday 9am-5.30pm. EC: Wednesday 1pm

E & OE

Many of you reading this publication will have just become interested in the hobby. Congratulations and welcome. You are embarking on a hobby that will bring you a lifetime of pleasure and bring you friends from all over the world. Whether you are interested in the technical side of the hobby or simply chatting to friends in other countries, Amateur Radio will provide a level of pleasure and friendship few other hobbies can match. I have personally been licensed for 22 years and can therefore give you the benefit of my vast experience. If you are a beginner please do not hesitate to contact me or one of my staff for good honest advice. My company is now enjoying its 10th successful year in amateur radio retailing and you may rest assured of a good deal from us. The lads in our service department are there to help you with any technical problems as well as giving speedy back-up service should any equipment require attention. Our lasses in the mail order department make sure that your goods go out the same day your order is received. On the ground floor we have the largest display of amateur radio equipment in the South East and full demonstration facilities. If you are some distance away from us we can offer an excellent mail order service. Either send us a cheque of telephone your order in quoting credit card number. If you can visit us then you will be very welcome to come and discuss your requirements. We are 5 miles from Southend on Sea. I look forward to hearing from you.

PS. Send SAE for copy of our latest catalogue.

*Peter Waters*

If you're a beginner just starting out in radio you'll be delighted with the performance that the R600 offers you. Considering the electronics that are packed into this receiver, the price is remarkably low. A few years ago this performance would have cost you twice as much. Full digital readout and really simple tuning in SSB signals makes this one of the few top receivers that the beginner should consider. With all the gloom and doom one hears about it in the news these days, why not put a pair of headphones on your head, plug them into the R600 and whisk yourself away into the wonderful world of wireless. Signals from the Australian outback or the flying doctor, radio amateur expeditions on some remote Pacific island, signals from Russian amateurs or young American novices, the latest World news before the BBC reports it, aircraft over the Atlantic, shipping distress frequencies; all this and much more is possible on this little receiver. So don't delay any further, send today for full details and introduce yourself to an exciting new hobby.



£319 carriage £5



# CATRONICS FOR TRIO

ALL TRIO EQUIPMENT PURCHASED FROM CATRONICS NOW CARRIES 2 YEAR GUARANTEE



## TS830S WITH NEW BANDS



**TS830S Brief Specification**  
 Frequency Range: 9 bands, 160m-10m  
 Modes: CW, USB, LSB  
 Final Power Input: 220 watts PEP (SSB)  
 180 watts DC (CW)  
 RX Sensitivity: 0-25µV at 10dB S/N  
 Catronics' Price: £694

## TS130S WITH NEW BANDS



**TS130S Brief Specification**  
 Frequency Range: 8 bands, 80m-10m  
 Modes: CW, USB, LSB  
 Final Power Input: ~200 watts PEP (SSB)  
 ~160 watts DC (CW)  
 RX Sensitivity: 0-25µV at 10dB S/N  
 Catronics' Price: £525  
 25W PEP version also available TS130V at £445

## NEW TR2500 2M SYNTHESIZED PORTABLE



**TR2500 Brief Specification**  
 Frequency Range: 144-146MHz  
 Mode: FM  
 RF Output Power: HI - 2.5W, LO - 0.3W  
 Sensitivity: 0-2µV for 12dB SINAD  
 Display: LCD (4 digit)  
 Memories: 10 built in  
 Scanning: Band or Memories  
 Catronics' Price: £207

## TR7730 2M COMPACT TRANSCEIVER



**TR7730 Brief Specification**  
 Frequency Range: 144-145-995MHz  
 RF Output Power: HI - 25W, LO - 5W  
 RX Sensitivity: 0-25µV for 12dB SINAD  
 Memories: 5 (scanning)  
 Autoscans: 5kHz or 25kHz  
 Repeater shift: +/- 600kHz  
 Microphone: 500Ω with UP/DOWN + PTT  
 Catronics' Price: £247

## TS530S BUILDING ON SUCCESS



**TS530S Brief Specification**  
 Frequency range: 9 bands, 160m-10m  
 Modes: CW, USB, LSB  
 Final Power Input: 220 watts PEP (SSB)  
 180 watts DC (CW)  
 Receive Sensitivity: 0-25µV at 10dB S/N  
 Catronics' Price: £534

## TR9000 2M COMPACT ALL MODE



**TR9000 Brief Specification**  
 Frequency Range: 144-146MHz  
 Modes: USB, LSB, FM, CW  
 RF Output Power: 10 watts  
 Sensitivity: SSB: CW 0-25µV for 10dB S/N  
 FM 0-25µV for 12dB SINAD  
 Frequency Control: Digital, phase locked VCO  
 Memories: 5 built in  
 Scanning: Auto 25/12-5kHz/100Hz  
 Catronics' Price: £359

## NEW TS780 ALL MODE 2M + 70CM



**TS780 Brief Specification**  
 Frequency Range: 144-146MHz  
 430-440MHz  
 Mode: SSB (USB, LSB), CW, FM  
 RF Output Power: 10 watts. Only for FM:  
 10W (HI) Approx. 1W (LOW)  
 Sensitivity: SSB: CW 0-2µV for 10dB  
 (S+N)  
 FM 1µV for 30dB (S+N)  
 20dB quieting (FM): Less than 0.4µV  
 Catronics' Price: £748

## TR8400 70cm FM SYNTHESISED MOBILE



**TR8400 Brief Specification**  
 Frequency Range: 430-439-975MHz  
 Channel Spacing: 25kHz  
 RF Output Power: 10W (HI) or 1W (LO)  
 RX Sensitivity: 0-4µV for 12dB SINAD  
 Memories: 5 (scanning)  
 Repeater shift: -1.6kHz  
 Catronics' Price: £299

## NEW R600 COMMUNICATIONS RECEIVER



**R600 Brief Specification**  
 Frequency Range: 150kHz-30MHz  
 Modes: AM, USB, LSB, CW  
 Sensitivity: <2MHz: 5µV  
 >2MHz: 0-5µV  
 for 10dB S+N on SSB  
 to 1kHz  
 Digital Readout:  
 Catronics' price: £235

Illustrated leaflets on all above products available. Prices include VAT and carriage.  
 Goods may now be ordered via PRESTEL: use MAILBOX account 016696701

We always have a good selection of used equipment in stock - ask for current list.

We are 300 yards from Wallington Railway Station (London Bridge or Victoria). Frequent buses from Croydon and Sutton. Three large car parks within 100 yards. Credit sale facilities available on all equipment. Credit cards accepted. Mail orders normally dealt with on day of receipt.

**CATRONICS LTD, DEPT 20, COMMUNICATIONS HOUSE**

20 WALLINGTON SQUARE, WALLINGTON, SURREY SM6 8RG. Tel: 01-669 6700.

Shop/showroom open Monday-Friday: 9.00-5.30, closed for lunch: 12.45-1.45. Saturdays: 9.00-12.45.

**EXPORT SALES WELCOME - PAY BY CREDIT CARD OR BANKERS CHEQUE**



Nearly everyone (well nearly everyone who's interested in radio) knows that DX is an old-time abbreviation for "distance". In everyday use on the bands however, you'll often hear people talking about the DX which they've worked. Does this mean that the distance their signals have travelled is what's important?

Well, some of the time it does, but "DX" implies a combination of how far away the man you worked is, and also how many of them there are on the band. For instance, from Great Britain it's easy enough to speak to stations in Australia and New Zealand, and you can't get stations farther away from us than that! Now it's always very pleasant to chat to Australian stations on 14MHz, for example, and at certain times of the year you can do it day after day without fail, with very strong signals both ways.

However, to speak to an Australian station on 3.5MHz, for instance is much more difficult; you'll need a fairly special antenna system and to be around at the right time of day. So an Australian station might be DX on one band and hardly at all on another.

Equally, there are plenty of Australian stations to go round, and one couldn't call them rare. However, there are plenty of places in the vicinity of Australia and New Zealand which either have very few amateurs living there or which don't have any resident hams at all. Papua, New Guinea, for instance, isn't far from Australia and if 14MHz is open to Australia

it's certainly going to be open to both places. The only thing is that there are very few amateurs on Papua and if you manage to work one (the prefix is P29, so a callsign you might hear could be P29JS, for example) you've just hooked a very nice piece of DX despite the fact that it's on a nice easy band. If you work Papua New Guinea on 3.5 MHz, well, you certainly don't need to be reading this!

### Special visit

Equally, if you take a place like Macquarie Island, which from the point of view of radio licences is part of Australia although it's counted as a separate country from the DX point of view, there are about three people on the entire island and none of them are amateurs. This means that in order for anyone in the world to add Macquarie Island to their list of the DX they've worked, someone has to go out there with some amateur equipment and "activate" the place.

The only slight problem is that many places which are counted as countries from the radio amateur's point of view are more or less impossible to get to. In the case of Macquarie, it needs special permission from the Australian Government and then there's the little matter of transportation. It lies several hundreds of miles from anywhere, so if you want to mount a "DXpedition", as it's called, you're going to have to charter some sort of seaborne way of getting you and your wireless to the place. So if you ever get to work

Macquarie Island at all, you're very lucky indeed because you'll get amateurs there once in a blue moon.

For many people, working DX of one sort or another — whether it's obscure islands in the Pacific or whether it's working vast distances on very unlikely bands — is the only true stuff of amateur radio. There are many awards for DX working, but the oldest and best-known of them all is called DXCC; this stands for DX Century Club and it's administered by the American Radio Relay League, which is the USA equivalent of the RSGB. You can obtain the basic award, which is a handsome certificate, for working one hundred separate countries out of a total possible of something like 360. You have to have had all your contacts confirmed, which means that you have to have received a QSL card for the contact with each country. All the cards have to be sent in for scrutiny and they have to be seen to be genuine — one of the reasons why DXCC is such a worthwhile award to go for is that everything is totally above-board. Any alterations, even on a QSL card will disqualify that contact for an award.

The basic hundred isn't too difficult to achieve — it's what happens after that that makes life interesting! Certainly the average amateur station these days shouldn't have too much trouble working a hundred different countries, but life gets rapidly more difficult after you've worked the easier ones because you'll find that practically every DX chaser in the world is after the same countries after a while and they'll inevitably be the countries which either don't have many resident amateurs



*How to chat with somebody in the Seychelles (although it might be a bit difficult at the moment, considering the recent military coup!) or in Australia. It's all a matter of planning, and knowing how to go about it. Here, Chris Drake tells you what's possible, and with what equipment.*

# LONG DISTA

or which don't have any at all and which need ten thousand dollars to get an expedition out to them. When they *do* get there, your next discovery will be that about half a million amateurs will be trying to work the same station as you are . . . which means you'll have to get pretty smart!

Very, very few stations have worked every country in the world (don't forget we're talking about "country" in a radio sense, not in a geographic or political one, by the way — although Revilla Gigedo is a separate country as far as DXCC is concerned, it's a very small island belonging to Mexico, if you're a geographer) and if you can get the extra stickers on your DXCC certificate certifying that you've worked 200, 250 or even 300 you're going to know an awful lot about DX-chasing on the HF bands by that stage! So let's have a look at how to go about it.

## Easy to get

When you get your receiver, you'll find that certain countries are extremely easy to hear. You'll get used to looking at the prefix list and remembering that a station signing JD-what's it is in Germany, for instance, or that W6-somebody or other is probably on from his five-thousand acre ranch somewhere in California. At first you'll have to consult the list a lot, and you'll quickly get a sense of what's rare and what isn't. Don't assume, by the way, that there's no DX to be heard coming from Europe. There aren't a lot of stations in Monaco, for instance, and you won't hear a 3A2 callsign every day of the week. By the same token, if you're a Class B licensee and you suddenly discover that 432MHz is full of Swiss stations you'll be well advised to snap 'em up because, as we said, DX is all relative. You may get quite bored with hearing Switzerland on 7MHz, say, but if you start hearing 'em on 432MHz you'd better get in there and get a QSL from HB9.

VHF and UHF DXing, to digress a moment, is in a class of its own because VHF and UHF propagate very differently from the HF bands. We'll take a closer look at it later.

So let's say you get to the stage of hearing, and maybe working, the easier countries where there's a lot of amateur activity and plenty to go round. You'll find it easy to speak to Finnish stations, for instance, but let's say you've noted from the prefix list and from your atlas (which every DXer should have, by the way) that the Aland Islands, just off the Finnish coast, are a separate country as far as DX is concerned. "OH" is the Finnish prefix, but OHO is that for the Alands, and indeed OJO is the prefix for the even rarer Market Reef, which is also not too far from Finland. How are you going to get these in your logbook?

With difficulty, basically! There are a few active amateurs in the Alands but not exactly hundreds — when one pops up he's likely to be very busy for an hour or two being called from practically everywhere where there's propagation on

the band he's on. So if you want a chance of working one, you'll need a reasonable antenna system and some good tactics to make sure that your signal gets picked out of the dozens and dozens who'll be calling him. As far as Market Reef goes — and many places like it — there aren't any amateurs at all and the only time you'll stand a chance of getting OJO in the log is when someone goes there. Information on who's going where is often published in the magazines — most amateur radio publications have a column about who has worked who, and who is going where — and there are also some specialist news-sheets which give detailed information.

One such is the *DX News Sheet*, which the RSGB puts out once a week. It gives a sort of table of who was where, when and on what frequency, and there are several American publications available which do the same. You'll find that some of the big DXpeditions publish details a long way in advance, and if you're a serious DX chaser you'll find that a little diary or chart on the shack wall will be very handy. If anyone's going to Market Reef, you'll need to know that so that you can be listening for them when they arrive and set up shop.

You will then find that working DX isn't

at all like having a cosy chat with your local mate or discussing things with an American for a half-hour "ragchew". DX work is fast and furious, and all there'll be time for is an exchange of callsigns and reports. The DX probably won't be calling CQ if he's that rare — he might have called CQ when he first came on the air but then it'll just be a case of him saying his callsign once followed by QRZ. QRZ is the Q-code for: "Who is calling me?", and that'll be your moment to speak your own callsign a couple of times and then listen. If he comes back to you, great. All you do is give him a signal report, and that's all he wants. He won't want your name, your location, the story of your life or the make of your transmitter — he'll get that off your QSL card, and you'll get the details from his. Just the report. You then wait for him to give you yours and then sign. Just like that. A DX contact shouldn't take more than about twenty seconds unless there's interference or signals aren't very strong, and it's very discourteous to make them any longer unless the DX station obviously wants to. Always play it the way he's playing it. That way everyone's happy.

If he doesn't come back to you, try again

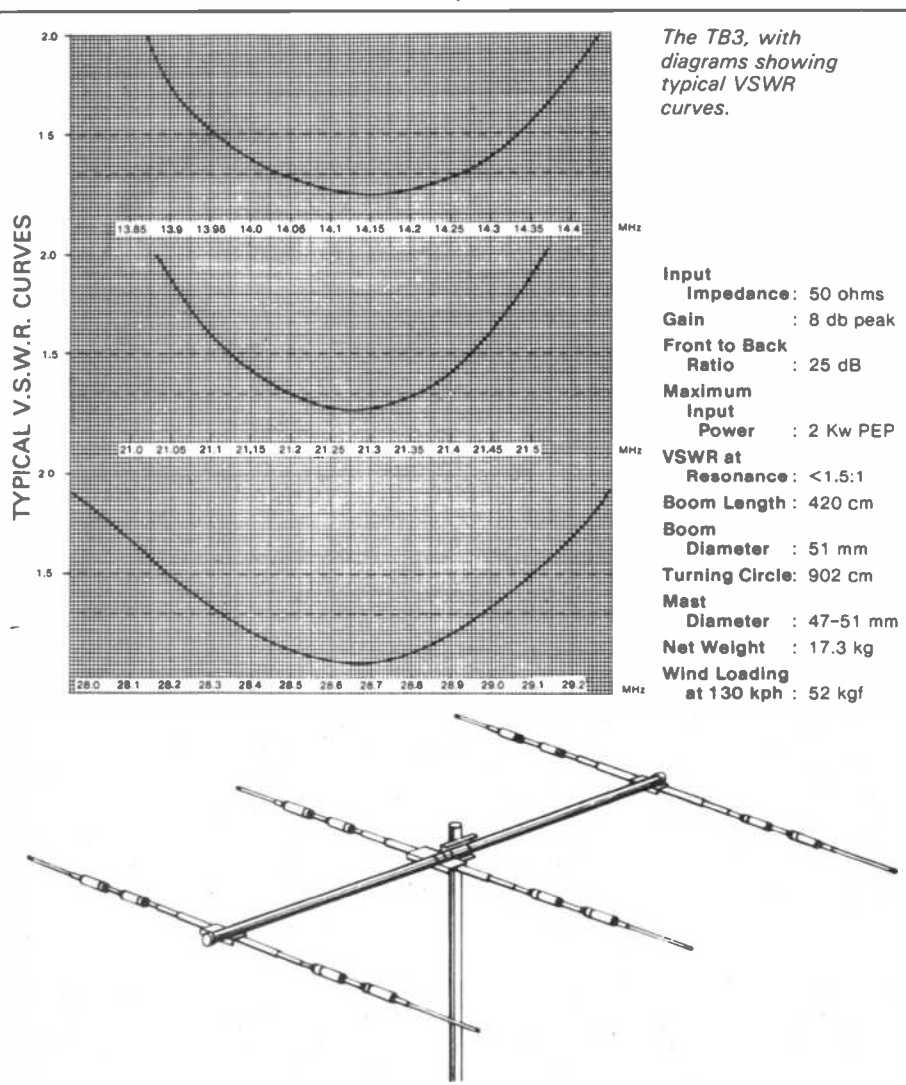

# NCE INFORM

— if still no joy, have a think. Listen to him and see what tactics he's using. He might be taking countries in some sort of order, for instance, or he might be listening for specific areas. You should have established this before you called him, actually, but if you come across a "pile-up", as it's called, you might put a couple of calls in before establishing how he's playing it. Unless propagation is about to quit on you, for instance, it's best to have a listen to a couple of his contacts and get a feel for what's going on. Then you can have a crack at making contact.

You may find that whatever you do, you're not being heard. Take heart — so are thousands of others! Remember that if the DX really is rare you're going to have to be a pretty special signal in order to stand out, and a bout of non-worked DX can be just the thing to inspire you to go out into the garden and improve the antenna system, or to build the big linear you've been threatening your mates with for the last six months. Whatever you do, don't be tempted to wind up the transmitter's audio gain and shout in the hope of squeezing every last watt out of it — you're far more likely to make the signal sound less rather than intelligible to the DX and he isn't going to bother to work someone he has to strain to copy when there are heaps of easier signals to work.

## Peaky speech

A couple of things will be useful, however. Basic SSB is somewhat inefficient at using the transmitter effectively because human speech is very "peaky" and the average power coming out of the transmitter will be quite low. A speech processor, which can be inserted between the microphone and the transmitter, can produce a considerable improvement if the final amplifier can cope with the extra work. Many commercial rigs have one built in and they're a good idea for DX work. The only thing is that it's very easy to mis-set them so that they work against you instead of for you. If you want to use any form of speech processing, make sure you know exactly what you're doing as far as setting it up is concerned and that you try it out on the air with a local before you unleash it on the ionosphere.

You may find that another VFO is useful because some DX stations prefer to work "split" — meaning that they transmit on one frequency and listen on another, or a group of others. This can make life much easier for the DX but unless your rig can cope with it you'll just have to sit there muttering, because the DX won't be listening on his own frequency and transceivers don't transmit on different frequencies from those they receive on, do they? If you feel you're going to be interested in DX working, make sure that you have the capacity to work "split" because Murphy's Law says that the DX you've been waiting for for the last thirty

years will be doing so even though you haven't heard anyone doing it for ages and ages.

The only problem with DX is the pile-up; it's only natural that some of them degenerate into all-out warfare, especially if the DX isn't very experienced, and that's just not a pretty sight. Some DX stations prefer to work according to "lists" in order to avoid the horrors of the pile-up, and in the right hands list operation can be useful especially if the DX is a bit weak or his English isn't too good. Basically, someone will be on a frequency at a certain time and

you'll call him to get your callsign on the list. The someone then passes the list to the DX station, and he'll proceed to call everyone on the list in order. In theory, it's good — the only snag is that some people who didn't get on the list sometimes try to squeeze a report out of the DX station and then the whole thing degenerates into a shambles as everyone thinks: "Well, if he can do it, so can I".

The other thing you'll really need to know a lot about is propagation. If, say, there's an expedition to Market Reef, you'll need to know what bands are likely to



*Top: A useful range of two metre linear amplifiers includes the above version, with input power of 10 watts and power requirement of 13.8v at 12 amps. Input modes are SSB, FM, AM and CW.*  
*Right: Three antennas from the Jaybeam catalogue, illustrating the various types you can use, along with their gains, polar limits, and other technical specifications.*

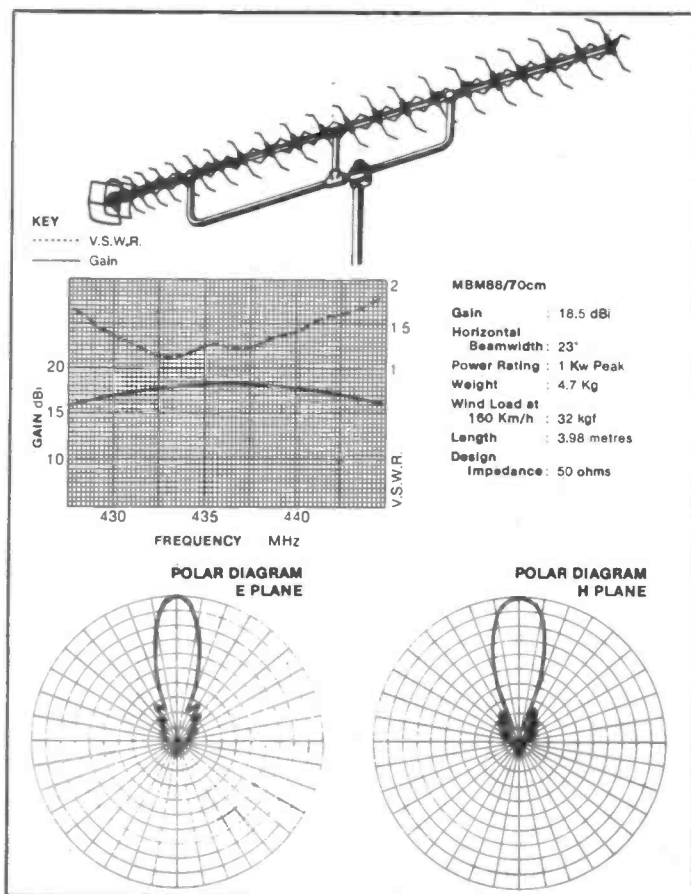

# NATION LONG

propagate to that neck of the woods and when the expedition will be on that band. In this example, at this time of the year you ought to manage them on 3.5, 7 and 14MHz, although not all at the same time of day. And if you're after what is called Five-Band DXCC — meaning a hundred countries on each band — you'll want to work them on every band. This is why it helps to be an insomniac if you're interested in DX chasing!

Just to round off, VHF and UHF DX is rather more dependent on propagation than its HF cousin. The bands can, and do, open up in all sorts of directions, and if you habitually don't work further than say, fifty miles from Birmingham, a station in Devon might be DX indeed even though he's in the same country. Many VHF DX chasers collect QTH or QRA squares, which John Nelson mentioned in the last magazine. You'll need a good antenna and a good site to do well on VHF and/or UHF, but for many it's the purest form of DX work there is, especially if it's done via the moon or from an aurora or meteor trails.

I think I'll stop now, because there's a station coming in from Thailand on the office HF rig and we haven't worked that yet — now then, which direction is that . . . ?

*The ultimate in long distance art? This beauty illustrates the front cover of the Randam Electronics catalogue, and it is a Tonna. This range of antennae is said to be one of the most popular in Britain.*

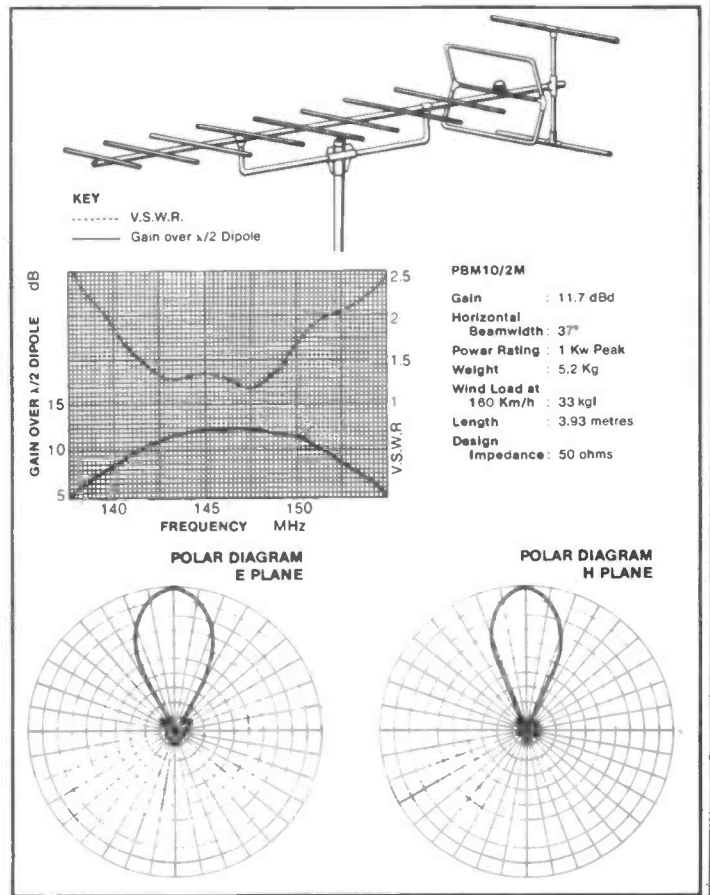
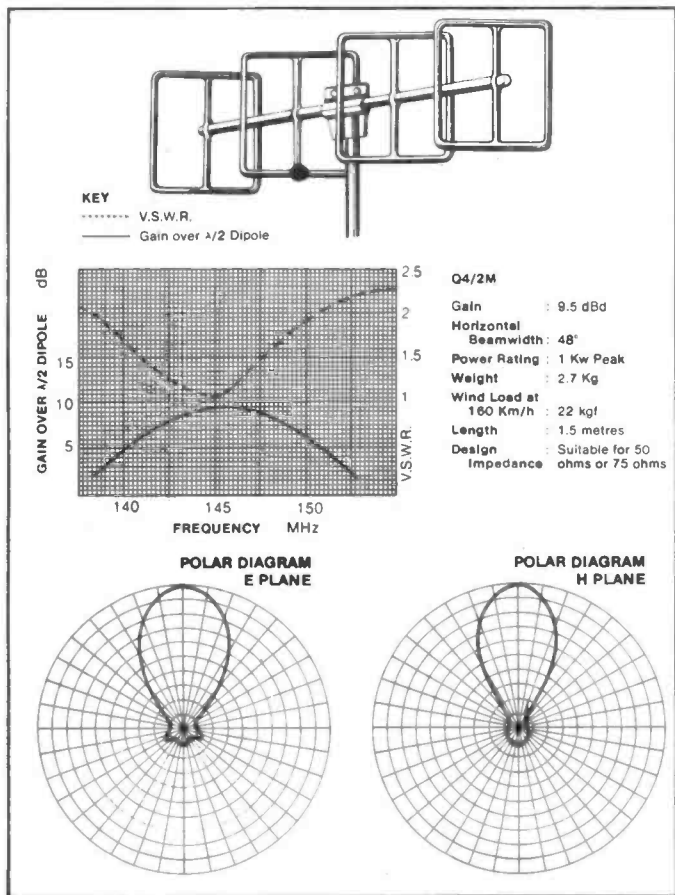
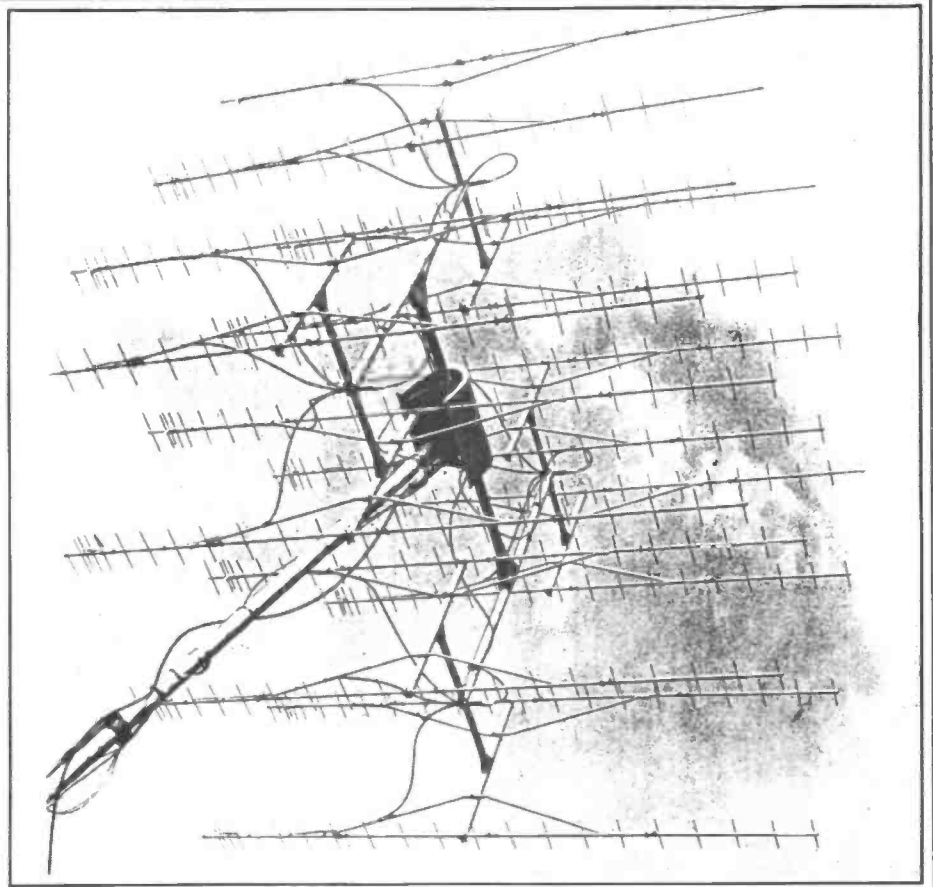

# LONG DISTANCE

# RADIO AMATEUR PREFIXES (INTERNATIONAL)

Eventually, you will get to know a number of these by heart. Keep this list handy by your transceiver.

<b>A2</b>	Botswana	<b>GI</b>	Northern Ireland	<b>OA</b>	Peru
<b>A35</b>	Tonga	<b>GJ</b>	Jersey	<b>OD</b>	Lebanon
<b>A4X</b>	Oman	<b>GM</b>	Scotland	<b>OE</b>	Austria
<b>A51</b>	Bhutan	<b>GU</b>	Guernsey, Alderney, Sark	<b>OF, OH</b>	Finland
<b>A6X</b>	United Arab Emirates	<b>GW</b>	Wales	<b>OH0</b>	Aaland Is
<b>A7X</b>	Qatar	<b>H44</b>	Solomon Is	<b>OH0M, OJ0</b>	Market Reef
<b>A9X</b>	Bahrein	<b>H5</b>	Bophutatswana	<b>OK, OL</b>	Czechoslovakia
<b>AA-AL</b>	See USA table	<b>HA, HG</b>	Hungary	<b>OM</b>	
<b>AP</b>	Pakistan	<b>HB4, 9</b>	Switzerland	<b>ON</b>	Belgium
<b>BL</b>	Tibet	<b>HE, HB0</b>	Liechtenstein	<b>OR4</b>	Antarctica (Belgium)
<b>BV</b>	Formosa (Taiwan)	<b>HC</b>	Ecuador	<b>OX</b>	Greenland
<b>BY</b>	China	<b>HC8</b>	Galapagos Is	<b>OY</b>	Faeroes
<b>C5</b>	Gambia	<b>HH</b>	Haiti	<b>OZ</b>	Denmark
<b>C6</b>	Bahamas	<b>HI</b>	Dominican Republic	<b>P29</b>	Papua New Guinea
<b>C9</b>	Mozambique	<b>HK</b>	Colombia	<b>PA, PE</b>	Holland
<b>C21</b>	Nauru	<b>HK0</b>	San Andres, Providencia, etc	<b>PI</b>	Holland (Special)
<b>C31</b>	Andorra	<b>HL, HM</b>	Korea	<b>PJ</b>	Dutch West Indies
<b>CE</b>	Chile	<b>HP, HO</b>	Panama	<b>PJ5</b>	St Eustatius
<b>CE9</b>	Antarctica (Chile)	<b>HR</b>	Honduras	<b>PJ6</b>	Saba
<b>CE0A</b>	Easter Island	<b>HS</b>	Thailand	<b>PJ7</b>	St Maarten
<b>CE0X</b>	San Felix Is	<b>HV</b>	Vatican City	<b>PP-PY</b>	Brazil
<b>CE0Z</b>	Juan Fernandex Is	<b>HZ</b>	Saudi Arabia	<b>PY0</b>	Fernando de Noronha, Trinidad and Vaz Is
<b>CM</b>	Cuba	<b>I, IA, IB</b>	Italy	<b>PZ</b>	Surinam
<b>CN</b>	Morocco	<b>IC, ID, IE,</b>		<b>RA-RZ</b>	USSR
<b>CO</b>	Cuba	<b>IF, IG, IH,</b>		<b>S2</b>	Bangladesh
<b>CP</b>	Bolivia	<b>IL, IP, IZ</b>		<b>S7</b>	Seychelles
<b>CR9</b>	Macau	<b>IS, IM</b>	Sardinia	<b>S8</b>	Transkei
<b>CT1.4</b>	Portugal	<b>IT</b>	Sicily	<b>S9</b>	Sao Thome, Principe
<b>CT2</b>	Azores	<b>J28</b>	Djibouti	<b>SL</b>	Sweden (Special)
<b>CT3</b>	Madeira	<b>J3</b>	Grenada	<b>SM, SK</b>	Sweden
<b>CX</b>	Uruguay	<b>J5</b>	Guinea-Bissau	<b>SP, SQ</b>	Poland
<b>D2</b>	Angola	<b>J6</b>	St Lucia	<b>ST</b>	Sudan
<b>D4</b>	Cape Verde Is	<b>J7</b>	Dominica	<b>SU</b>	Egypt
<b>D68</b>	State of the Comoros	<b>JA, JE, JF,</b>	Japan	<b>SV</b>	Greece
<b>DA, DB</b>	West Germany	<b>JG, JH, JI,</b>		<b>SV5</b>	Rhodes
<b>DC, DF,</b>		<b>JJ, JR</b>		<b>SV9</b>	Crete
<b>DJ, DK,</b>		<b>JD</b>	Bonin and Volcano Is (Minami Is, Ogasawara Is)	<b>SY</b>	Mt Athos
<b>DL</b>				<b>T2</b>	Tuvalu
<b>DU, DX</b>	Philippines			<b>T3K</b>	Kiribati
<b>EA</b>	Spain	<b>JT</b>	Mongolia	<b>T3L</b>	Line Is
<b>EA6</b>	Balearic Is	<b>JW</b>	Svalbard	<b>T3P</b>	Phoenix Is
<b>EA8</b>	Canary Is	<b>JX</b>	Jan Mayen	<b>TA</b>	Turkey
<b>EA9</b>	Spanish North Africa (Ceuta, Melilla)	<b>JY</b>	Jordan	<b>TF</b>	Iceland
<b>EI, EJ</b>	Eire	<b>K</b>	USA (for Districts see under "W")	<b>TG</b>	Guatemala
<b>EL</b>	Liberia	<b>KA-KZ</b>	See USA table	<b>TI</b>	Costa Rica
<b>EP</b>	Iran	<b>KB6*</b>	Baker, Howland Is	<b>TI9</b>	Cocos Is
<b>ET3</b>	Ethiopia	<b>KC4*</b>	Navassa Is, Antarctica	<b>TJ</b>	Cameroon
<b>F</b>	France	<b>KC6</b>	Caroline Is	<b>TL8</b>	Central African Republic
<b>FB8W</b>	Crozet Is	<b>KG4</b>	Guantanamo Bay	<b>TN8</b>	Congo Republic (formerly French Congo)
<b>FB8X</b>	Kerguelen Is	<b>KG6*</b>	Mariana Is, Marcus Is, Guam	<b>TR8</b>	Gabon Republic
<b>FB8Y</b>	Terre Adelle	<b>KH6*</b>	Hawaiian Is	<b>TT8</b>	Tchad Republic
<b>FB8Z</b>	Amsterdam Is, St Paul Is	<b>KJ6*</b>	Johnston Is	<b>TU2</b>	Ivory Coast
<b>FC</b>	Corsica	<b>KL7*</b>	Alaska	<b>TY</b>	Benin
<b>FG</b>	Guadeloupe	<b>KM6*</b>	Midway Is	<b>TZ</b>	Mali Republic
<b>FH8</b>	Mayotte Is	<b>KP6*</b>	Palmyra Group, Jarvis Is	<b>UA, UV,</b>	European Russian SFSR
<b>FK</b>	New Caledonia	<b>KS6*</b>	American Samoa	<b>UW, RA</b>	
<b>FM</b>	Martinique	<b>KV4*</b>	Virgin Is	<b>1,3,4,6</b>	
<b>FO</b>	French Oceania (eg Tahiti), Clipperton Is	<b>KW6*</b>	Wake Is	<b>UA2</b>	Kaliningradsk
<b>FP</b>	St Pierre and Miquelon Is	<b>KX6</b>	Marshall Is	<b>UA9, 0,</b>	Asiatic RSFSR
<b>FR</b>	Reunion Island, etc	<b>LA</b>	Norway	<b>UW9, UZ9</b>	
<b>FS7</b>	St Martin	<b>LB</b>	Norway (Special)	<b>UB5, UT5,</b>	Ukraine
<b>FW</b>	Wallis and Futuna Is	<b>LU</b>	Argentina	<b>UY5</b>	
<b>FY</b>	French Guiana, Inini	<b>LX</b>	Luxembourg	<b>UC2</b>	White Russia
<b>G</b>	England	<b>LZ</b>	Bulgaria	<b>UD6</b>	Azerbaijan
<b>GB</b>	United Kingdom (Exhibitions and Special Purposes)	<b>M1</b>	San Marino	<b>UF6</b>	Georgia
<b>GD</b>	Isle of Man	<b>N</b>	USA (for districts see under "W")	<b>UG6</b>	Armenia
		<b>NA-NZ</b>	See USA table	<b>UH8</b>	Turkoman
				<b>UI8</b>	Uzbek



UJ8	Tadzhiz	W3	Delaware, Maryland,	ZS4	Orange Free State
UK	Russian club stations (see p115)	W4	Pennsylvania (including District of Columbia)	ZS5	Natal (including Zululand)
UL7	Kazakh	W5	Alabama, Florida, Georgia, Kentucky, North Carolina, South Carolina, Tennessee, Virginia	ZS6	Transvaal
UM8	Kirghiz	W6	Arkansas, Louisiana, Mississippi, New Mexico, Oklahoma, Texas	1S	Spratty Is
UN1	Finno-Karelia	W7	California	3A2	Monaco
UO5	Moldavia	W8	Arizona, Idaho, Montana, Nevada, Oregon, Utah	3B6	Chagos Is
UP2	Lithuania	W9	Washington, Wyoming	3B7	Agalega and St Brandon
UQ2	Latvia	W0	Michigan, Ohio, West Virginia	3B8	Mauritius
UR2	Estonia	WA-WZ	Illinois, Indiana, Wisconsin	3B9	Rodriguez
VE, VO	Canada	XE, XF	Colorado, Iowa, Kansas, Minnesota, Missouri, Nebraska, North Dakota, South Dakota	3C	Equatorial Guinea
VE1	Maritime Provinces	XE4	See USA table	3D2	Fiji
VE2	Province of Quebec	XT2	Mexico	3D6	Swaziland
VE3	Province of Ontario	XU	Revilla Gigeo	3G3	Chile
VE4	Province of Manitoba	Y	Upper Volta	3V8	Tunisia
VE5	Province of Saskatchewan	YA	Kampuchea (Khmer, Cambodia)	3W8	Vietnam
VE6	Province of Alberta	YB, YC, YD	Vietnam	3X	Republic of Guinea
VE7	Province of British Columbia	YI	Laos	3Y	Bouvet Is
VY1	Yukon Territories	YJ	Burma	4M	Venezuela
VE8M-Z	NW Territories	YK	East Germany	4S7	Sri Lanka
VO1	Newfoundland	YN	Afghanistan	4U1ITU	ITU, Geneva
VO2	Labrador	YO	Indonesia	4W	Yemen (AR)
VK	Australia	YS	Iraq	4X, 4Z	Israel
VK0	Heard Is, McDonald Is, Macquarie Is	YU	New Hebrides	5A	Libya
VK1	Canberra	YV	Syria	5B4	Republic of Cyprus
VK2	New South Wales	YV0	Nicaragua	5H1	Zanzibar
VK3	Victoria	ZA	Roumania	5H3	Tanzania (except Zanzibar)
VK4	Queensland	ZB2	Salvador	5L	Liberia
VK5	South Australia	ZC4	Yugoslavia	5N	Nigeria
VK6	Western Australia	ZD7	Venezuela	5R8	Malagasy Republic
VK7	Tasmania	ZD8	Aves Is	5T5	Mauritania
VK8	Northern Territories	ZD9	Albania	5U7	Niger Republic
VK9	New Guinea, Norfolk Is, Papua, Cocos-Keeling and Admiralty Islands	ZE	Gibraltar	5V	Togo
VO	See under VE	ZF1	Cyprus (British assigned)	5W1	Western Samoa
VP1	Belize	ZK1	Cook Island	5X5	Uganda
VP2	Leeward Is, Windward Is	ZK2	Ascension Island	5Z4	Kenya
VP2A	Antigua and Barbuda	ZL, ZM	Tristan de Cunha, Gough Is	6D	Mexico
VP2E	Anguilla	ZL1	Zimbabwe (Rhodesia)	60	Somali Republic
VP2H	Anguilla	ZL2	Cayman Isles	6W8	Senegal Republic
VP2K	St Kitts and Nevis	ZL3	Cook Island	6Y	Jamaica
VP2M	Montserrat	ZL4	Niue	70	Yemen (PDR)
VP2S	St Vincent	ZL5	New Zealand, Chatham Is, Kermadec Is	7P8	Lesotho
VP2V	British Virgin Isles	ZM7	Auckland District	7Q	Malawi
VP5	Turks and Caicos Islands	ZP	Wellington District	7X	Algeria
VP8	Falkland Is, S Georgia, S Orkneys, Shetland Is, Sandwich Is, Grahamland	ZR, ZS	Canterbury District	7Z	Saudi Arabia
VP9	Bermuda	ZS1	Otago District	8F	Indonesia
VQ9	Chagos Is	ZS2	New Zealand Antarctica	8J1	Antarctica (also OR4, VK0, ZL5, VP8)
VR6	Pitcairn Is	ZS3	Tokelau Is	8P	Barbados
VS5	Brunei		Paraguay	8Q	Maldives
VS6	Hong Kong		Republic of South Africa, Prince Edward and Marion Is	8R	Guyana
VU2	India		Cape District	8Z4	Iraq/Saudi Arabia Neutral Zone
VU5	Andaman Is, Laccadive Is		Cape Province (excluding ZS1)	9A1	San Marino
W	United States of America (Note stations can now retain former call signs when moving districts) (see also KH6, KL7)		South West Africa	9G1	Ghana
W1	Connecticut, Maine, Massachusetts, New Hampshire, Rhode Island, Vermont			9H	Malta
W2	New Jersey, New York			9J2	Zambia

\*Former prefix still in use.

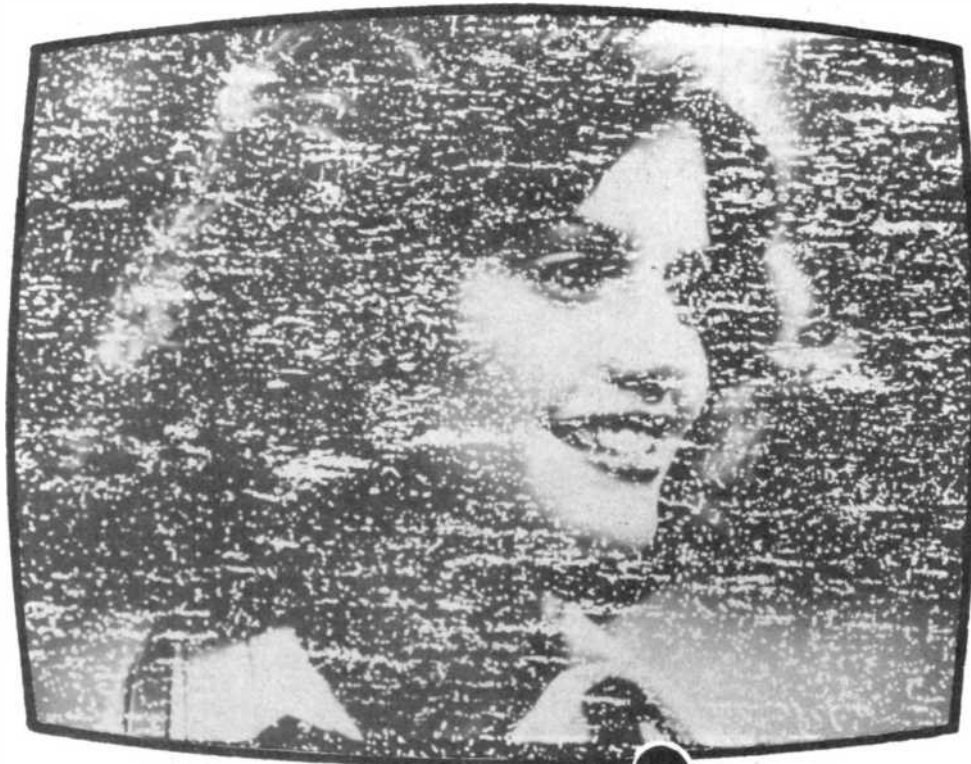

# DON'T INTERFERE...

One of the good things about amateur radio is that it isn't an aggressive hobby . . . unless, that is, your signal is causing havoc with next door's Blankety Blank! Here's how to (a) deal with your next door neighbour, and (b) how to cut down or eliminate the interference from your radio.

Chris Drake reports.

At least once in their life, practically every transmitting amateur will get a knock on the front door — or an irate telephone call — on the lines of "ere you. You're wiping out the cup final and you're coming through on my hi-fi. Knock it off, will you?" You then have to exercise a mixture of engineering know-how and diplomatic savvy that wouldn't be out of place at the United Nations.

So let's take look at how to handle this sort of situation and, while we're about it, we'll have a look at how to stop things like your neighbour's electric drill wiping out all the DX which is struggling through the noise on the HF bands.

The thing to remember about interference is that 95% of it won't be your fault. The trouble with the word "interference" is that it somehow suggests that you, the amateur, are transmitting on the same frequency as BBC2 or whatever and somehow deliberately causing mayhem to your neighbours. This, of course, isn't true. Try to use the word "breakthrough" when you're discussing it with the man

next door because it describes the problem more truthfully. Most of the time the problem is caused by inadequacies of one sort or another in the domestic TV set or hi-fi. Let's take a look at this in a bit more detail.

The first point is that the bands on which the amateur is licensed to transmit are not the same as the bands used by the BBC or the IBA; in terms of frequency, they're "miles" away. So it's not possible for the fundamental frequency of your transmitter to cause trouble. The "fundamental", by the way, means the output frequency of the transmitter; if you're tuned, say, to 144.300MHz, the "fundamental" frequency is 144.300MHz. The word is used to distinguish it from some other outputs which will always be there even though they may be very weak. All transmitters have them and if they're on a multiple of the fundamental they're called harmonics. Our 144.300 MHz transmitter will have a harmonic at 288.600MHz even if it's the best transmitter in the world.

It might be extremely weak in comparison with the fundamental but it'll

be there no matter what. In this particular case, where the harmonic is double the frequency of the fundamental, it's called the "second harmonic" which is a bit confusing. Theoretically it ought to be the first harmonic, but over the years the first harmonic coming out of a transmitter is called the second harmonic. Oh well. If you were to listen on a frequency of 432.9MHz, which is three times 144.3MHz, you'd also hear something; the third harmonic.

And so on. Now don't run away with the idea that your transmitter's up the creek because it's producing harmonics — every transmitter ever built does because it's in the nature of transmitters to do so. In a decent one they'll be very weak indeed and they'd be most unlikely to cause problems to your neighbour's TV set. However — there is a catch insofar as certain fault conditions in a transmitter can cause the harmonics to be almost as strong as the fundamental!

This is particularly true with transmitter final amplifiers which use transistors, and just occasionally the harmonic frequency

turns out to be the same as the frequency of the signal your neighbour is trying to listen to. For instance, let's suppose your neighbour is still into 405-line black-and-white TV. Maybe he's in some part of the country where UHF television still hasn't penetrated, or maybe he's a pensioner who can't afford anything better. Now Channel 3 of the 405-line television broadcast band uses frequencies of 53.25MHz for sound and 56.75MHz for vision. The 53.25MHz sound channel needn't worry us at this stage, but if you divide 56.75 by 2 you get 28.375.

Can you see the potential problem yet? A frequency of 28.375MHz is right in the middle of a busy bit of the 28MHz amateur band. It's just the sort of frequency that exotic DX from practically anywhere in the world is likely to appear on when that band is open. If your transmitter has any more than a tiny whiff of second harmonic coming out of it, your efforts at working the DX on 28.375MHz are likely to be accompanied by roars of rage from next door as the smiling face of Jan Leeming disappears in a whirl of lines and mess. The TV will hand in its dinner bucket in a big way, and you won't exactly be in line to win the Most Popular Man In Acacia Grove contest.

Now this situation isn't exactly common — in fact these days I'd say it was rare — but it's worth mentioning to see how the problem might be happening. It also leads us into the next aspect of the how-it-just-might-be-your-fault scenario, which is worth taking a quick look at.

Harmonics aren't the only things that transmitters produce in the way of outputs that we don't really want. Because a transmitter generates various frequencies inside itself in the process of producing the final output which is modulated in whatever way we desire, it's possible for the thing to produce outputs which are in some way related to these and which can fall in awkward spots. Let's take an example; suppose you decide to build yourself a simple 144MHz transmitter. You already have an HF band transceiver and you want to use this as the heart of the VHF rig. You might say to yourself: "Well, if I take an output at 28MHz from the HF rig and mix this with 116MHz from somewhere, that'll get me up on 144MHz. Should be no problem." Please understand this is only an example, by the way, and you'd need to have a bit of experience before you did this — it is a common way of getting on VHF with an HF rig, however.

So, you delve around in the junk box and in due course it's all sitting on the kitchen table. A few more hours and bingo! you've had your first contact. However — sure enough, there goes the telephone. "Oy! You're at it again!!"

The problem might arise because 28MHz and 116MHz might be producing outputs other than the one you wanted on 144MHz. I heard of one recently where the fourth harmonic of 116MHz, ie 464MHz, was mixing with the 28MHz output from the HF rig and producing a tiny amount of power on  $464 + 28 = 492\text{MHz}$ . This was wiping out about five television sets, since a frequency of 492MHz falls well into the UHF 625-line TV neck of the woods and it just happened to be the local channel!

Outputs such as this are known as "spurious" and there is a plural form of the noun deriving from it; because it sounds so odd, most amateurs simply refer to them as sprogs! If you hear someone talking about sprogs or sproggies, he hasn't gone

barmy — he's probably bemoaning his own, or someone else's, transmitter.

Here again, they're not exactly common. In fact, you might think at this stage that amateur radio is just too risky and that you're better off collecting stamps. Well, please don't because what we've just looked at are very much the worst cases. Harmonics can be cured very simply by a piece of kit called a "low-pass filter", which is just a device for removing frequencies higher than those you want; you can make one on the kitchen table in about half an hour. The RSGB do a very good book called *Television Interference Manual* which contains all you need to know about making filters, and I'd suggest that a low-pass filter is a good thing to have on the output of any amateur transmitter. Most of the time it won't be necessary, but as a precaution it's well worth the effort.

## Sproggies about!

Sprogs are a bit more difficult to deal with. Basically, commercial gear should be designed in such a way as to ensure that any spurious outputs will be much weaker than the fundamental and it's extremely rare to come across a case of TVI (as it's usually called) that's down to this sort of problem. If it's a home-brew job, life can be a bit more difficult; the best way here is to have a think about what could go wrong and then make sure you've designed in enough filters and so on to cope with it. Actually, you'll probably know what you're doing if you're at the stage of rolling your own, so we needn't dwell on that too much. The best way to detect spurious outputs from a transmitter is to use a piece of test gear called a spectrum analyser. These are common enough in industry although not many amateurs own one because they cost an arm and a leg. Someone in your local club may have access to one, and if you're at all worried about your transmitter the spectrum analyser will give you the answer in a few seconds flat.

However, as we've said, 95% of TVI and its relatives aren't caused by transmitter problems. So let's have a look at how they happen.

In the vast majority of cases, the reason that a television set gets clobbered by

amateur signals is the set itself. Obviously, it's supposed to respond to signals sent out by the TV transmitter and it's not supposed to take any notice of any others. In real life, however, what tends to happen is that the TV set maker wants to make his life easy and keep his profits high. He therefore tends to make the simplest set that will actually do the job. One area which suffers is the "front end", or the bit that takes the signals from the TV antenna and passes them down to the parts of the set that produce pictures and sound. When TV sets were full of valves it didn't matter so much, but one drawback of the semiconductor age is that it's a bit more difficult to make "front-ends" with transistors and they tend to be much more wide open to signals on other frequencies. So if you, the amateur, have your antenna on the roof or wandering down the garden, the amount of signal from it which reaches the TV antenna is quite likely to be more than the TV front-end can cope with; the net result is that when you come on and call CQ DX, the television has the electronic equivalent of a nervous breakdown and so does your neighbour.

Let me stress that it isn't your fault. If the setmaker had added four or five more components to the front end of his design, the TV would probably sit there quite happily even with you beaming kilowatts of UHF at it. You tend to find that Japanese televisions are made this way, perhaps because Japan is a crowded island with a lot of radio transmitters of one sort or another. Whatever the reason, I've never yet heard of Sony sets having this problem, for instance. A friend of mine used to have a small Sony colour set in the lounge of a minute London flat. It was about three feet from his amateur equipment, and indeed three indoor antennas carrying quite high power ran inside the same room. In three years operating on nine different bands, he never saw a flicker on that picture. Conversely, I have had several problems with sets belonging to neighbours, but they weren't Japanese!

British TV makers have a long way to go in the field of immunity from other radio signals. It wouldn't matter so much, but there are plenty of other users of the radio spectrum apart from amateurs.

*Typical low-pass filter.*

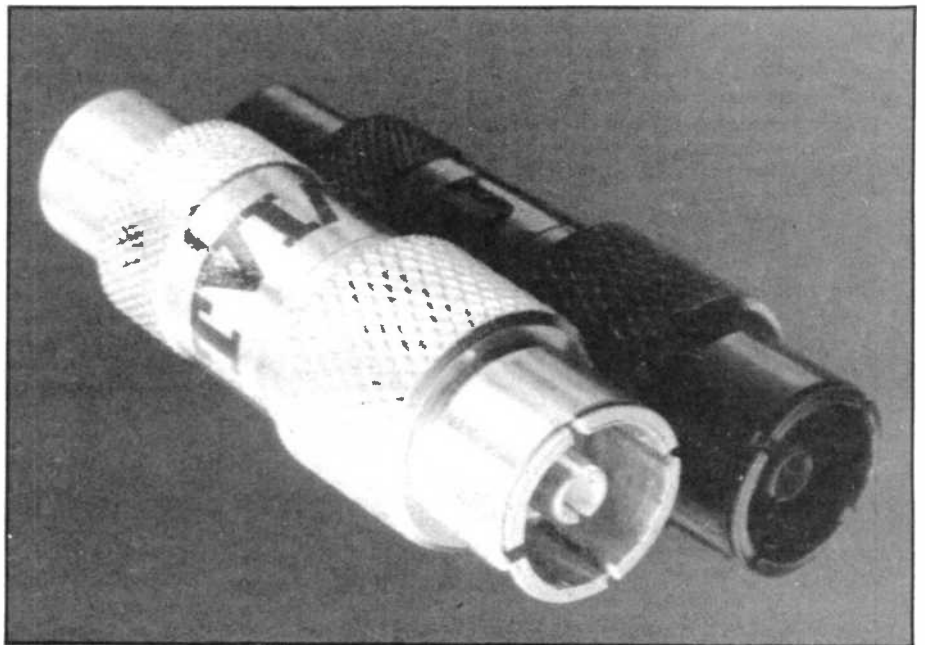

# DON'T INTERFERE...

Unfortunately, the poor old amateur, along with the CBer, gets the stick for the setmaker's shortcomings.

The other problem this brings with it is how to explain to your neighbour that his TV isn't adequate for the job? You are up against several problems here. One is psychological. People tend to feel rather invaded if they're sitting in their lounge watching television and it disappears in favour of you calling CQ DX. They also tend to feel something like "I paid £600 for this and it's the best there is, so don't tell me there's anything wrong with it, mate." In a sense there isn't anything wrong with it but in another sense there is insofar as if the design of it is deficient and it's got practically no ability to reject strong signals outside the TV bands it's not, perhaps, the best TV set in the world even if it does produce good pictures and pretty sounds.

The psychological problem is compounded if you offer to fit a filter to it, and this job is easy to do and is what the setmaker should have done in the first place. But the owner is probably going to feel, "Well, I don't want him messing about with my set. There's nothing wrong with it until he comes on with his transmitter, so it must be his fault, not mine." There is a subtle lack of logic in this way of thinking, but it's very common. People seem to get emotionally attached to the TV and rapidly lose any ability to think straight when it gets threatened!

Your job is to point out that your transmitter isn't *causing* the problem — it's *revealing* one that's always been there and would have appeared if any sort of transmitter came anywhere near it, whether it was an amateur, a taxi company, a garage using radio to talk to its breakdown truck or whoever. You then have to assess the reaction. You might offer to fit a filter to it if he seems amenable, and it's easy enough to do. Here again, the RSGB's *TVI Manual* will tell you exactly how to go about it.

However, it might not be the best line to take with your neighbour. You might do better to point him in the direction of the local Post Office and suggest that he fills in a form which makes a complaint about interference to broadcast reception. You can mention that part of his licence fee goes to maintain this service, which is operated by British Telecom, and that they should be able to help him. This will involve you to some extent, so we'll look at this in a minute.

The thing not to do is to give in and agree to stay off the air whenever he wants to watch television. If the diplomatic situation starts to deteriorate, don't let it degenerate into a slanging match on the lines of "I know my rights" etc, because you won't achieve anything and the next thing you know is that half the street will be signing petitions and things. Play it cool and stay courteous. And do remember the psychological angle. You can seldom reason with people when there's a TVI problem, and it doesn't usually help to get technical because the problem is essentially an emotional one. It's rather like trying to reason out why you're in love!

Be polite but don't meekly give up in the face of it. To some extent you have to be



prepared to try and strike a balance between living in peace with your neighbours and sticking up for what you know to be right. It *isn't* your fault, and the problem can be solved in a few minutes with a little goodwill. TVI problems are technically simple to solve, but psychologically they're anything but if you've got the wrong sort of neighbour.

The same is true, unfortunately, of another problem area — breakthrough into hi-fi systems, music centres and so on. Now it must be obvious to anyone that a hi-fi amplifier isn't designed as a radio receiver of any kind and that if it starts relaying your amateur-type signals there's a whopping problem somewhere. Technically, this sort of problem occurs because your radio signals get picked up on the speaker leads or the mains cable and find their way into the amplifier: they then get acted upon by the amp's circuitry to produce all sorts of funny effects, which can range from simply the sound of your voice to hums and whistles.

It's also quite common for electronic musical instruments to suffer in peculiar ways from radio waves; my friend used to run 400 watts on 144MHz from west London and it used to have rather a profound effect on the organ in the Methodist Church about half a mile away. When I heard about the problem, and persuaded a reluctant reverend gentleman that I could fix it, it took about 30 seconds flat to do so and the problems went away. I hope I still get to heaven . . .

Be that as it may, the problem is technically simple but it can be difficult in other ways. Hi-fi is one of those hobbies where people regard it as an extension of their souls; the equipment is often a lot more important than the music, and I often think that most hi-fi addicts don't go to concerts. Any threat to it, or any attempt to tell them that maybe the design isn't as good as it might be in the area of rejection

*The picture on page 34, and the one above, show television screen interference that could be caused by amateur radio activity. Or, rather, the televisions themselves aren't equipped to deal with breakthrough.*

of radio signals, seems to feel like a direct attack on the hi-fi enthusiast himself. Many of them seem to identify with it to an alarming degree. The snag, here again, is that as far as sound reproduction is concerned it may well be very good. However, it may be as wide open as the proverbial barn door to radio signals from practically anywhere.

Modern amplifiers in hi-fi systems and music centres are much more prone to RF breakthrough than their earlier brethren, for two main reasons. They use transistors and they also use a lot of what is known as feedback. This latter means that signals picked up on the speaker cables from the amplifier are much more prone to find their way back into the system and mess things up. That's putting it in a nutshell but it's true, more or less.

You can offer to fix it yourself, and it'll probably involve a couple of capacitors in strategic places. However, if the signal is being picked up inside the amp itself (transistor amplifiers are quite capable of detecting radio signals at VHF if the design doesn't keep them out) it's better not to try and solve the problem yourself unless you're on very good terms with your neighbour and he's a bit more rational than the majority of hi-fi buffs.

The best thing in these circumstances is to suggest that he writes to whoever made the amplifier and ask them for their views. He ought to present the letter to his local friendly hi-fi dealer and ask him to put it right. The only snag here is that, being human, the dealer will often try to say that it's all the amateur's fault. You may then be forced to have a few short sharp words with the service manager and tell him the

facts of electronic life. Point out to him that if an amplifier responds to radio signals there's something amiss with it. End of story.

The same problem, incidentally, can arise if there's a TVI problem and it's a rental set. Many dealers will say to the suffering neighbour: "Oh no, nothing we can do squire. You'll have to get the amateur to close down." Bunkum. If he says that, he's either incredibly technically incompetent or, more likely, lazy. Don't hesitate to tell him so. It's their responsibility to sort it out and, if the neighbour won't tell them, you'll have to.

Let's take a look at what British Telecom can do. If the neighbour fills in the Post Office form, you may well get a telephone call or a letter from the Radio Investigation people telling you what has happened. They may, depending on the circumstances, ask you to stay off the air during TV hours until they can do some tests. What then happens is that they will come round and look at both your amateur installation and the offending TV set. They'll then do some tests to establish the circumstances under which the problem arises.

What happens next depends on what they find. They can say to the neighbour that his installation is not of a reasonable standard, for example he's using a set-top antenna in a TV fringe area, and that they won't take any action until his installation has been improved. If it's breakthrough due to strong signals, they'll try some filters which often cure the TVI and which they will charge for.

If the neighbour accepts that, well and good. There are times when you might consider paying the few pounds yourself, for example if it's an elderly neighbour on a pension or something like that, but I wouldn't pay for the filters out of some misplaced sense of guilt. As we've seen, it really is the neighbour's set which is responsible, and it wouldn't seem right to pay for solving the problem unless the circumstances were a bit special.

Do co-operate with the men from BT. They have a hell of a difficult job and it helps if you've done all the right things such as used low-pass filters. You'll also find that a well-kept logbook will be handy because it sometimes happens that it isn't your transmitter that's causing the aggro but something completely different. It'll make the BT's life easier if you can show them the log kept in accordance with the licence.

They won't be impressed by your not operating in accordance with the terms of your licence in such areas as the amount of power you run, and they're not stupid either. If you've got the biggest linear this side of Daventry sitting under the table in the lounge and wired to a three-phase supply, *don't* waste their time telling them stories about only running 400 watts out. Leave that sort of nonsense to the pirates. The amateur licence is worth a bit more respect than that.

However the tests turn out, you might find that you are restricted in some way for a period — usually 28 days — so that the neighbour can get his dealer or whoever to carry out the modifications or additions that the BT people have suggested.

Whatever they say, do it, it's for a good reason and it's in your own interests — you can always get on with building something for a month instead of yacking on the air if the worst comes to the worst and you'll be able to go back on at the end of the period anyway. Sometimes they'll ask you not to beam in certain directions, or not use more than a certain amount of power on certain bands at certain times. Just grit your teeth and do what they've asked. Then, if the neighbour hasn't got the work done, that's entirely his affair. You've done your bit.

One thing BT won't touch, by the way, is hi-fi or music centres or whatever. They take the view that these things are not designed as radio receivers and that it's a matter for the dealers or the manufacturer if they suffer from RF breakthrough. Which is more or less the view we've discussed in this article. It's a pity the hi-fi magazines don't get down to addressing this particular problem instead of wittering on about some of the awful garbage they do.

Sometimes, of course, you get some really nasty problems which often crop up when the matter wasn't handled well at the very beginning. Also, you occasionally get some TVI cases that aren't easy to fix from the technical point of view. In these cases, RSGB members can avail themselves of the help of the Interference Committee. This group has an enormous amount of experience and knowledge to draw upon, and in its time has solved some real stinkers. If you're an RSGB member and you've got a real horror of a problem, don't hesitate to drop the Society a line. At the very least, trouble shared is trouble halved, and you'll generally find that the Committee can fix it if all else fails. The RSGB also do a very nifty information sheet which you can present to your bolshie neighbour and suggest he reads. It's available for the asking if you're a member, and it can help the situation.

Well, that's a look at the interference

problem from the point of view of the transmitting amateur. As we've seen, it's not technically difficult to fix most cases of TVI and breakthrough but there's often a fair amount of psychological difficulty on the way. The main thing, above all else, is to keep your cool. Don't start a war and don't let it escalate if you do start one!

Just to finish with, what happens if your neighbour is a DIY fanatic, for instance, and his electric drill wipes out your HF receiver? Or, come to that, if your own electrical gear of one sort or another does the same? If it's your own equipment, you can have a go at suppressing it with chokes and capacitors in strategic places, or you can fit a filter to the mains lead of the rig (be CAREFUL) if the interference is getting in that way.

Any of the textbooks, such as the RSGB *Radio Communication Handbook*, will show you how. If it's electrical equipment belonging to the neighbour, it all depends how friendly he is. Unfortunately, the amateur service isn't protected against this kind of interference, so you can't fill in the form at the Post Office and hope they'll come along and do something. However, if whatever it is is also affecting your television or radio reception, you are entitled to ask them to have a look; if it clears up your amateur wireless that's an added bonus.

One problem area, by the way, is the rise of the home computer. Some of these can radiate hash all over the HF bands, and if it's your own you may have a fine old time trying to suppress it. If it's your neighbour's, you have a real problem and I don't envy you one little bit. Your best hope is to get your antenna as far away from the offending beast as possible and hope for the best.

That's it really. Let's hope you don't get struck down by the TVI virus, but if you do let's hope it's not too much of a problem. It shouldn't be.



"10-10 till we do it again"

# FEEDERS:

Briefly, it's another word for the cable and connectors that join up the antenna to receiver. Great care has to be taken to make sure all joints are perfect in order to get the optimum performance from your equipment. Read on and learn how to make co-ax connections, and much, much more! By our Technical Editor.

No, this isn't about what to eat before you go on the air, or a learned report about the radio amateur's diet. The feeder is the way you get the power from the rig to the antenna. It's important because, whether you're into Top Band or 1296MHz, how you feed the power to the antenna has a lot of bearing on how well you'll get out, how well you'll hear other people on the same band and even how happy in its work your transmitter is.

We'll neglect bands above 1296MHz for the purposes of this article because you're getting into the realm of microwaves at that stage and feeding a microwave antenna needs rather different techniques from those you'll be using on the lower bands.

You might say to yourself: "What's so special about getting power from the rig to the antenna? If ordinary cable is good enough for ordinary electricity, what's all the fuss about?" In a word, two things: the frequency of the power you're trying to transfer from the rig to the antenna, which is a good deal higher than the frequency the electrical authority uses to transmit power from the power station to Acacia Grove, and a little thing called impedance. Let's have a bash at impedance first, since it'll come in useful in other areas of radio and, in a way, the frequency angle ties in with it.

What's impedance? Well, that's quite a big question, but the answer goes something like this: one of the basic things about radio — or, come to that, anything to do with electricity — is enshrined in something called Ohm's Law. Mr Ohm discovered, many years ago, that the current which flows in an electrical circuit is directly proportional to the potential difference — ie the amount of volts — across the circuit. Or, to put it another way, if you double the voltage across a given resistance, you double the current flowing in that resistance.

Potential difference, as we've said, is measured in volts; you can say, if you like, that there's a potential difference of 9 volts between the two terminals of a battery which has "9 VOLTS" written somewhere on it, assuming that the battery isn't five years old and as flat as a pancake. If it is, the potential difference between its terminals is likely to be about half a volt if you're lucky, and zilch if you're not. Current is measured in amps, which is a shortening of the name of a gentleman called Ampere (say it in a thick French accent) and I've often wondered why we don't call them omps instead of amps. However . . .

If you wish, you can write a little equation which goes  $V = I \times R$ . Now,  $V$  is the potential difference in volts and  $I$  is the current which flows, measured in amps. The  $R$  bit is the amount of resistance in the circuit, which, commemorating Mr Ohm, is

measured in ohms. The definition of one ohm of resistance is that amount of resistance which allows one amp of current to flow when there is one volt of potential difference across it.

To make it clear, let's try an example. Suppose we take the 9 volt battery and get hold of an ordinary radio-type resistor of a value of 1000 ohms. Let us then connect the resistor across the battery. How much current will flow through it? Well, Ohm's law says that  $V = I \times R$ ; if you turn the formula round a bit,  $I$  turns out to be equal to  $V$  divided by  $R$ . In our case, that's 9 divided by 1000 which is 0.009 amps. Actually you'll find that in radio you're not often dealing with amps because they're rather large units; the common unit of current is the milliamp, which is just one-thousandth of an amp. 0.009 amps is 9 milliamperes, or 9 mA as it's usually written.

## Want to use AC?

So — that's a very quick look at Ohm's Law. Don't worry, we'll get to impedance in a sec! Just to see if you've twigged it, what happens if you get hold of another 9 volt battery and hook that up so that there's now 18 volts across our 1000 ohm resistor? If your answer isn't 18 mA, I don't want to know!

Now, all this is all very well if you're dealing with batteries and other sources of direct current. If, however, you wish to use any form of alternating current, such as the mains supply or the output of a radio transmitter, things become a teensy bit more complicated. Not so much if you're dealing with resistors, I hasten to add, but there are two very important types of electronic component whose effects in a circuit are dependent on frequency. These are inductors and capacitors and if both leave you cold, don't worry about it for now — you'll get round to exactly how they do their stuff later on, and I'm only mentioning them now so that we can see how the idea of impedance works.

Now the theory of AC circuits could fill this entire magazine so we'll have to skip lightly over whole reams of it. Suffice it to say for now that although the resistance of a resistor doesn't change if you apply AC of some frequency or other to it, the apparent resistance of a capacitor or an inductor changes with frequency. A capacitor, by the way, won't allow any current to flow if you connect a battery across it — it doesn't possess any DC resistance, if you like — whereas an inductor will; the reasons don't matter for now but it's worth bearing those things in mind for later on.

Just to make life easy let's take the case of the inductor. Now almost any coil of wire is an inductor. That's to say it possesses a property called inductance, which is extremely handy for the radio

engineer but doesn't bother us at this stage. The element in an electric fire, for example, is an inductor. Now if you were to measure the resistance of a typical electric fire element with a meter designed to do such things, like the ordinary "multimeter", for instance, you'd discover that it has a fairly low resistance. Or, to bring the example a bit nearer home, the primary winding on the average rig-type mains transformer, which is an inductor, also has a low-ish DC resistance — I've just measured mine and it's about 100 ohms.

Now you might say to yourself: "Hmm, the mains supply is 240 volts and the resistance is 100 ohms, so the current in it will be 240 divided by 100 which is 2.4 amps? But it's only a 13amp socket. Come to think of it, there's only a 5amp fuse in the plug — how come the fuse doesn't blow when I switch on?"

Well, remember we said that as far as an inductor is concerned, the DC resistance is one thing but it'll also have some properties which vary with frequency. The *apparent* resistance of the primary winding of your mains transformer will be a good deal more when it's connected to the mains because the mains supply isn't DC but it's alternating at 50 times a second — hence the 50Hz bit you find on equipment data plates and so on. The name for this resistance as far as AC is concerned is reactance, and the word means resistance as far as alternating current is concerned. In an inductor of a given type, the reactance goes up as the frequency increases. The primary of our mains transformer will have a DC resistance of about 100 ohms but at 50Hz its "reactance" will be nearer 1000 ohms. If you were to pump AC of a higher frequency into it you'd find that its reactance would also increase. In fact, a capacitor works the other way about — its reactance *decreases* with frequency, and it's the way these two behave that makes radio possible.

## Impedance info

So we now know about resistance and its cousin reactance. "Impedance" (which is where we came in) is the name given to the combination of resistance and reactance in a given circuit. If you like, you can say it's the ratio of voltage to current as far as AC is concerned. Technically, that's only true if you're talking about something called a sine wave, which is an AC wave of one frequency only, but we'll be dealing with sine waves most of the time so we can let that pass. If you have a combination of resistors, capacitors, inductors and whatever else you fancy, the "impedance" of the circuit which they formed would just be the apparent resistance it presented to AC of whatever

frequency you had in mind. Note here, by the way, that it might well have a different impedance at, say, 100kHz from what it'll have at 100MHz — this is often exactly what you want to happen, as you'll see later in your studies.

So, let's get back to our feeders. Before we do that though, take a look at the instruction book for your wireless. You'll very probably find that the output impedance of your transmitter, and indeed the input impedance of your receiver, is 50 ohms.

This is a handy piece of information because if you wish to transfer power anywhere in an AC circuit you have to obey a few little rules; your transmitter, the feeder and the antenna form an AC circuit, of course, since it's AC you want to use in the form of RF output from the transmitter.

Now the "little rule" that we need to bear in mind at this stage is that if you wish to transfer power in an AC circuit, the impedance of the generator (your transmitter in this case) must match the impedance of the load (viz. the antenna). Furthermore, the "characteristic impedance" of the "transmission line" which connects them must be the same as both. A "transmission line" in this case is a fancy way of describing the cable which connects the rig to the antenna. The theory of transmission lines is jolly interesting but a bit hard going and needn't detain us here.

Now I know it seems a bit weird to think of a piece of cable as having a characteristic impedance but please don't let it bother you. All you need to know is that, for example, if your wireless has an output (or input if it's a receiver) impedance of 50 ohms, the antenna will also have to have an impedance of 50 ohms. Also, whatever type of cable (the transmission line) you use will have to have a characteristic impedance of 50 ohms. If you do all these things you will satisfy what the textbooks call "the conditions for optimum power transfer" — in other words, your rig will be happy because it's seeing the right "load impedance" and all the power it generates will find its way to the antenna with no problems.

In the last edition of this magazine, we talked a bit about such things as standing wave ratio, or SWR. If you remember, this is bound up with what happens if the load

impedance isn't the same as the generator impedance. In a perfect world, antennas would always have an impedance to match the generator, which is your transmitter, and there'd never be any problems — however, life isn't like that and most of the time your antenna will look like anything but 50 ohms! This in itself doesn't matter a damn, as we discussed in the earlier article; what does matter is that the transmitter always sees a load which it is happy with.

This is easy enough to do by means of an Antenna Tuning Unit, at least on the HF bands. At VHF And UHF, you generally won't need to worry if you're using a commercially-made antenna because most of them look like 50 ohms, more or less, wherever you happen to be in the band and you can forget about matching and all the rest of it.

## Cables and connectors

All you will need to decide is what sort of feeder to use, and in the vast majority of cases on these bands it'll be coaxial cable of one type or another. "Co-ax", as it's generally referred to, habitually comes in two characteristic impedances, which are 50 ohms and 75 ohms. The 75 ohm isn't much used in amateur radio these days and 50 ohm is more or less standard for most things. For an average VHF or UHF station the stuff to get is usually known as UR67 or RG8U. It's about 3/16 in diameter and quite stiff. Whatever you do, don't try bending it round tight curves, and treat it with some care. You'll find that it has an "inner" core which is insulated with thick polythene from an outer braid of copper, and one of your first chores will be to connect one end to the appropriate connector to suit the output of your rig.

This is always a tiresome procedure, since there are two sorts of connector commonly used and they're both fiddly to fit. The common one for 144MHz is an abomination called a PL259, and if I ever meet the man who invented it I'd roast him over a slow fire. They're not all that good electrically, and they're also impossible to fit neatly unless you've done nothing else for forty years. Personally I won't have them in the house, and if I get some gear which uses them (the socket for them is

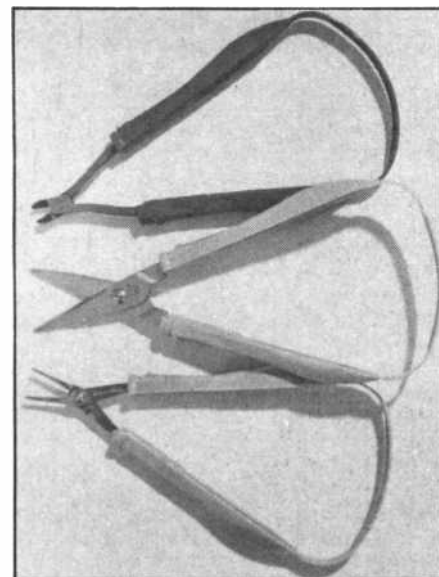

*Ideal for stripping cables and single wire leads, the Easi-Grip from Electronic Hobbies Ltd, costs £3.25 plus postage and packing and VAT. Note the self-opening handles, and there is a variety of cutting and gripping blades. The firm are at 17 Roxwell Road, Chelmsford, Essex.*

known as an SO239, by the way) I replace them with what are known as "N-type" connectors. Good-quality ones, such as you can get from companies such as Greenpar, are much easier to fit than the evil PL259 and are better in other ways too. If you're using smaller diameter coax for other purposes, the best connectors I know are the BNC series.

The N-type, although still a bit of a pain to fit, is a whole lot nicer than the PL259, and in fact you shouldn't really use PL259s at 144MHz although everyone does. Certainly, for the 432MHz band the N-type is really obligatory. One other nasty thing about PL259s is that some of them have inferior insulation and are even worse than usual at 144MHz.

I'm not going to describe how to fit them here since I suspect my way of doing it is a bit "non-standard" and the manufacturer might loose off an Exowrit at me! The usual textbooks will show you the proper procedure, which admittedly works just fine if you have a sharp knife and some decent side-cutters.

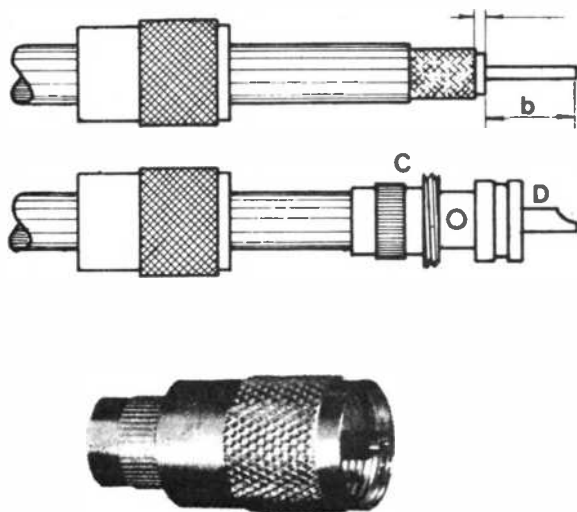

*The most popular (or should it be common?) connector in use is probably the PL259. Available in several forms, this one is the easiest to work with. The drawings illustrate how to assemble such a beast and you'll require, needless to say, a soldering iron to join the braid and inner cable to their respective points, although make sure you don't melt or mis-shape the cable sheath.*

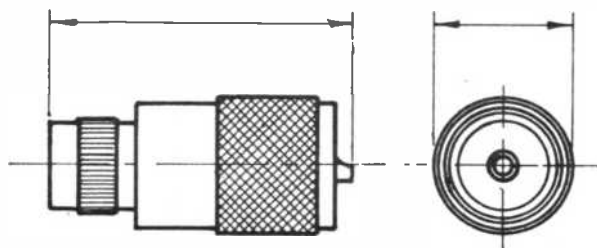

# FEEDERS:

If you want the ultimate in terms of good cable (ie that doesn't lose either power from the transmitter or the weak signals coming back from the antenna on "receive") you can get some really low-loss coaxial from manufacturers such as Andrews. Coax such as LDF-4 or Heliac is well worth having if (a) you can afford it, (b) you can get it, (c) you can get the proper connectors for it and (d) if you don't mind the fact that it's practically rigid. It's almost essential if you want good performance on bands such as 1296MHz because ordinary UR67 or RG8U is getting more than a bit lossy at that sort of frequency if you've got anything like a long run of it.

Remember that if, for instance, the loss of the cable you're using at the frequency you're using it is 3dB, that means that half your transmitter power is going to disappear before it gets to the antenna. If you've just spent ages getting 400 watts out on 144MHz it's a bit galling to realise that only 200 watts reaches the antenna and gets radiated.

On the HF bands you have another option, which is to use so-called "open-wire" feeder. This isn't at all like co-ax and you can even make it yourself. In fact, there's a lot to be said for it at HF, where antenna impedances are likely to vary all over the place according to frequency and sundry other things like how high off the ground the antenna is. Open-wire feeder is more tolerant of high-power high-SWR conditions than co-ax is and you won't lose so much in transit, as it were. Admittedly it isn't so convenient as co-ax and it looks a bit more unsightly but for the reasons we've mentioned, plus a few others which there isn't really the space to delve into, it's A Good Thing for HF antennas.

Normally it's meant to have an impedance of about 300 ohms, which means that you need an Antenna Tuning Unit at the transmitter end so as to match the transmitter into the feeder, and you'll also need to design the antenna with open-wire feeder in mind. However, since this is no problem — and indeed some HF antennas look about 300 ohms anyhow — it doesn't really affect the situation.

So — the choice comes down to either coaxial cable or open-wire feeder for HF antennas and there's not much choice at all for VHF and UHF antennas. If you feel you'd like to go into the theory a bit more, and it's certainly very interesting, try the *ARRL Antenna Book* or *HF Antennas for All Locations*. Both are available from the RSGB and are very good indeed. Then, all you have to do is practice putting the connectors on to co-ax cables. It shouldn't take you more than about 40 years to get the knack . . .!

A little appendix for the eggheads! The symbol for resistance is R, as we've seen, and its units are ohms. The symbol for reactance is X and that for impedance is Z. As we've seen, both of these are also measured in ohms. The relationship between impedance, resistance and reactance is given by the formula:

$$Z = \sqrt{R^2 + X^2}$$

You can't just add resistance and reactance because they're slightly different sorts of units. You'll need to

bring in a mathematical "operator" which is known as *j* and which is the square root of minus one. So if you see an impedance expressed as, for instance,  $R + jX$ , don't worry about it!

*BNC connectors are also in common use. Follow this guide to assembly and you shouldn't go far wrong, but bear in mind that some dimensions could vary so modify your work as you go.*

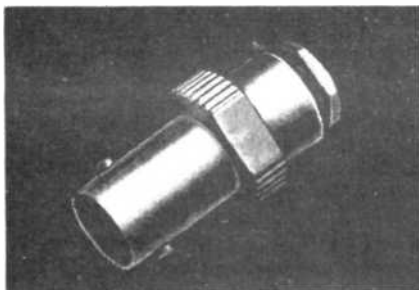

Above left: BNC 1/5 jack, with a NATO stock number of 5935-99-940-1089!

Above: BNC BN 1/5 plug, and on the left, an alternative panel-mounting jack with bolt holes.





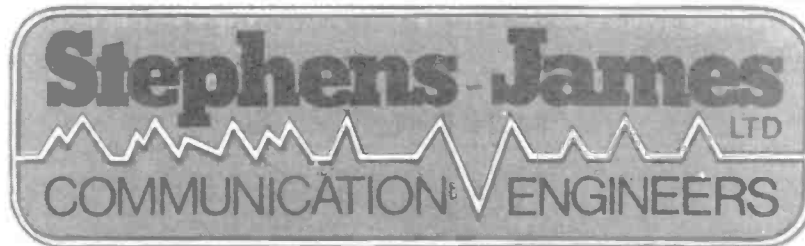

# COMMUNICATIONS CENTRE OF THE NORTH WEST

We stock a wide range of communications equipment for the beginner and licensed operator.

Full demonstration facilities for all equipment available on the premises. We are open Mon-Sat. No parking problems at any time.

Equipment supplied to cater for SWL's, Aircraft Band, Marine Band, VHF, UHF. All accessories stocked including aluminium tubing, clamps, etc and full range of antennae.

A SAE will bring you our up to date range of secondhand equipment or 50p for full details.

HP, Access and Barclaycard facilities.

47 Warrington Road, Leigh, WN7 3EA. Tel: (0942) 676790.

## AKD Blackline Series

★ TELECOMMS ★  
EXCLUSIVE  
UK DISTRIBUTORS

### High Quality Signal Boosters

#### SIGNAL BOOSTER (CBPA 1)

Hear more stations, boosts incoming signals by up to 6 times.

£14.37

#### CB VAMPIRE (CBA 1)

Eliminate the worst effects of adjacent channel interference (bleed-over).

£14.37



CB VAMPIRE (CBA 1)

*The answer to better reception*

#### CAR RADIO FM BOOSTER (PA1)

Greatly improves the reception of VHF FM car radios (mono or stereo).

£10.92

All prices include VAT & Post/Packing Available from most good quality CB/Amateur Radio Retailers or direct from Telecomms

### High Quality TVI Filters

#### TUNED NOTCH FILTER (TNF11)



#### TVI FILTERS

##### HIGH PASS FILTERS (HPF1)

If your television is troubled by interference from CB, amateur radio, emergency services etc., this filter with its built-in braid breaker will solve the problem. It requires no power and it provides 70dB of rejection at HF (independently checked).

£6.32

**TUNED NOTCH FILTER (TNF11)**  
This individually tuned filter provides notch on inner and braid. It is supplied ex-stock with a centre frequency of either 27.5 Mhz, 145 Mhz, 21 Mhz, 28 Mhz, or 14 Mhz.

£7.50

**BB1 Braid Breaker only, 1:1 ratio transformer**

£6.32

AS SUPPLIED TO  
BRITISH TELECOM

**SAME DAY DESPATCH  
ON OUR HOTLINE  
0705 662145**

Simply phone — quoting Barclay or Access number for immediate despatch of items listed. Send £1 for our full lists and colour brochure and receive a £2 voucher against your first purchase.



TELECOMMS

189 LONDON ROAD, NORTH END  
**PORTSMOUTH (0705) 662145**

TELEX: 869107 TELCOM G

**2 year  
guarantee**

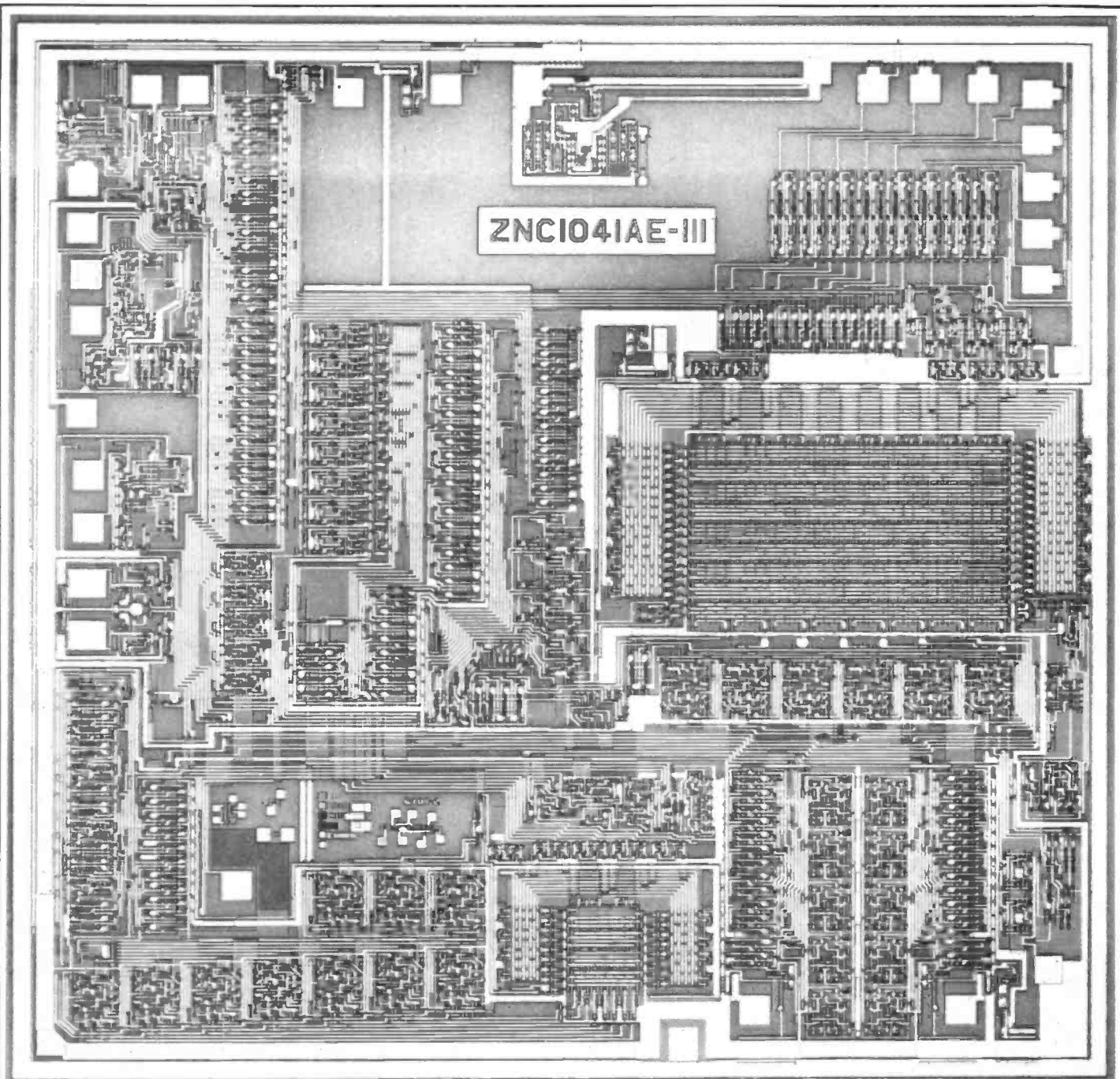

# THE CHIP SHOP

Otherwise known as semiconductors, chips can do many and wondrous things, including amplify a small signal into a bigger one.

Semiconductors are, in a way, partway between a conductor and an insulator. This in-between material can be made to do all kinds of interesting things . . . Interested? Then read on.

Does the word transistor sound like something faintly rude? Does thyristor sound like something even ruder? Let's take a look at some of the ways of making electronic circuits work with some of these strange-sounding devices.

In the beginning, of course, the ruler of the electronic roost was the valve. This assembly of wire and metal in a glass envelope was the mainstay of electronic circuitry right from the early twenties until the sixties or thereabouts, and in some ways and in some applications you still can't beat valves unless you're prepared to spend a bomb on exotic components.

High-power transmitters, for instance, still use valves almost exclusively and why not? They're very rugged and insensitive to overloads of one sort or another and they're very easy to work with. If you want to run the legal limit on the amateur bands, it's a thousand-to-one that the final stage of the amplifier will have valves in it. However, in the last ten or fifteen years the valve has been displaced by semiconductors of one sort or another, and it's this huge family which we'll be looking at.

The thing about a valve, and the thing that made it such a giant step forward when it was invented, is the fact that it could be made to amplify — in other words, to take a small signal and turn it into a larger replica of the same. Not only did this make it possible to amplify signals but it meant that you could have such circuitry as oscillations and electronic switches.

Electronics never really looked back from then on. Indeed, as an amplifier of really powerful signals there still isn't a real rival to the valve. However, the disadvantages of it were size, the fact that you needed high voltages (that is, relatively high compared with the tens of volts you need for semiconductors) and also the relative inefficiency of it. Valves require a heater inside them to make them work, and it's an interesting thought that the heater alone of an ordinary domestic TV-type receiver valve consumed far more power than an entire transistor radio does today.

---

## Vast size

---

The size bit is important, too. If you take the ordinary electronic calculator of today and remove the back, you'll see two or three unimpressive-looking black things inside it with lots of little legs sticking out of them. These are what are called "integrated circuits" and if you wanted to build even a simple electronic calculator using valves to replace them, you'd probably take up most of your house and the garden with it. The integrated circuits in your calculator are a good deal smaller than the socket into which you would plug a valve, and yet you would need thousands of valves to duplicate their functions. It makes you think . . .

The semiconductor age could, actually, be said to have begun before the valve era, believe it or not. If you remember the "cat's whisker" of the early crystal sets, you may be surprised to know that this was the earliest of all semiconductors!

This is because you could say that the important thing about semiconductors is the "junctions". Now unfortunately, unlike the valve, the physics of semiconductors are very difficult to explain without going into about 94 pages of formulae every time you want to explain something, so what

follows is drastically simplified (why didn't the Editor ask me to explain how valves worked? I could have saved myself the bottle of Aspirins and the ice-pack). If you think back to basic school-type electricity, you'll recall that most materials are either conductors or insulators — meaning that they either conduct electricity or they don't. The copper wire in an electric cable is a conductor. The plastic sheathing around it is an insulator.

There is, however, a small group of materials which don't really fall into either class, and whose properties in the conduction/insulation stakes can be drastically modified by messing about with their atomic structure. These are called **semiconductors**, and, to put it in a nutshell, they have all kinds of interesting properties. The most interesting is, as we said above, the fact that you can tinker about with them in such a way as to change various electrical properties to your own advantage; this is called **doping**.

Suppose you take very pure silicon — which starts life as sand on the beach and ends up as a highly refined chemical element, and add minute quantities of other exotic elements to it, such as, for example, antimony or arsenic and so on. Cutting out about a million pages of esoteric physics, you can end up with two different sorts of silicon, which are known as n-type and p-type.

Now then. The interesting bit is that, by combining n-type and p-type silicon and applying various voltages to the different parts of the combination (which is known as **biasing**, by the way) you end up with various interesting properties. If you simply take p-type and n-type silicon and stick 'em together (not that you're supposed to take this literally, by the way, since we're talking about events on a molecular scale. You can't go into your local friendly dealer and ask for one lump of each sort) you end up with something called a **diode**. A diode has the property of being able to pass current one way and not the other, and you'll find them all over the place in electronics. The precise reason it has this property isn't easy to explain in a few words but it's bound up with the n-type and the p-type silicon and what happens at the junction between them.

Which is why I said earlier that the important thing about semiconductors is the junctions; the junctions between the different types of silicon or whatever it happens to be. Silicon isn't the only semiconductor material but it's far and away the most common. If you wish to make a transistor, for instance, you require two of one sort and one of the other, or, in other words, two bits of n-type and one of p-type. Put 'em together, bias to taste and you've got the equivalent to the valve.

Why is it equivalent? Because it will amplify. It will do the same job as the valve in a radically different way. The valve requires lots of volts, whereas the transistor does very nicely on 9 volt batteries, for instance, and it's also a good deal smaller.

Just to get back to the cat's whisker (I bet you thought I'd forgotten!) the reason it worked was that the whisker itself and the slice of galena or whatever formed a semiconducting junction which acted just like the diode we've described above. You can duplicate Grand-dad's crystal set with modern components and an ordinary semiconductor diode and have a lot of fun with it. Actually, the cat's whisker wasn't a very good diode, and one imagines that

Grand-dad would have given a lot for its modern equivalent.

The transistor, then, incorporates three "areas", if you like of doped silicon; you'll find that the majority of transistors are described as "pnp" or "npn" devices, and this refers to the order in which the types of silicon used in their manufacture is put together. It also implies the polarity of the transistor. The pnp type needs a negative voltage on one of its electrodes, which is called the collector, whilst the npn type needs a positive voltage on the same electrode.

"Electrode", by the way, is just another name for the point at which you apply voltages and take signals into and out of the device. Just as there are three slices of silicon in a transistor, there are three electrodes. These are called the **emitter**, the **base** and the **collector**, and they are analogous to the three bits of silicon. The centre letter in "npn" or "pnp" describes the polarity of the collector of the transistor (in an npn type, it's p for positive) which helps you remember which way round it has to go.

---

## Diode means "two"

---

The diode, which is made of one piece of n-type and one piece of p-type, has, to no-one's great surprise, two electrodes. These are referred to as the **anode** and the **cathode**, and in order for the diode to conduct, the anode has to be more positive than the cathode. The word "diode" is partly derived from the Greek word meaning two and implies what we've just said, that it contains two electrodes. The transistor gets its name from an amalgam of the words *Transfer Resistor*, and it was so christened by the gentlemen who invented it just over 30 years ago.

This type of transistor is known as a **bipolar transistor** because it uses both polarities of electrical current in its operation. Another type of transistor which is often found in amateur-type electronics is called the "fet", which stands for **Field-Effect Transistor**. This device also uses n-type silicon in its construction but it's put together in a rather different way and its electrodes have different names. The bit of a fet corresponding to the emitter of a bipolar transistor is called the **source**, whilst the base becomes the **gate** and the collector is known as the **drain**.

The fet works in roughly the same way as the bipolar transistor but some of its electrical characteristics are very different.

It has very different uses, particularly in the front-ends of high-performance receivers and as electronic switches. A version of it, called the "gasfet", is used for very low-noise amplification of UHF and microwave signals. It gets its name from the fact that it isn't made of silicon but uses a compound called gallium arsenide in its structure.

Since the chemical symbol for this stuff is GaAs, it's become known as **GaAsFET**, or "gasfet". You'll come across other variants of it, and indeed several sorts of fet. A **MOSFET** is a **Metal Oxide Semiconductor Field-Effect Transistor**, which is a bog-standard fet; a **JUGFET** is a **Junction Gate** ditto, which is a different sort of fet but which works on the same principle, and a **MESFET** is a **Metal Semiconductor fet**. **MESFET** is a family term for the sort of device exemplified by a gasfet. Quite clear so far? No? Oh well, read it again — it'll stick eventually!

Right — what's next? There are several

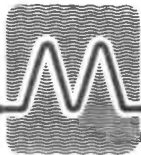

# MICROWAVE MODULES LTD

## WELCOME . . . .

### TO THE WORLD OF AMATEUR RADIO

**Q. WHO ARE WE?**

**A.** WE ARE MICROWAVE MODULES LTD, FORMED IN 1969, A WHOLLY INDEPENDENT BRITISH COMPANY, LOCATED IN LIVERPOOL, MANUFACTURING QUALITY PRODUCTS TO PROFESSIONAL STANDARDS SOLELY FOR THE AMATEUR MARKET.

**Q. WHAT DO WE MANUFACTURE?**

- A.**
  - HF, VHF AND UHF LINEAR POWER AMPLIFIERS UP TO 200 WATTS
  - FREQUENCY CONVERTERS AND TRANSVERTERS UP TO 13cm
  - AMATEUR TELEVISION TX AND RX EQUIPMENT FOR 435 MHz
  - RECEIVE PREAMPLIFIERS FOR HF, VHF and UHF
  - RTTY RECEIVE and TRANSCIVE CONVERTERS
  - MORSE TUTORS WITH SYNTHESISED SPEECH RESPONSE
  - MORSE KEYBOARD
  - FREQUENCY COUNTER, PRESCALER and PROBE ACCESSORIES

**Q. HOW CAN I FIND OUT MORE ABOUT THESE PRODUCTS**

**A.** SEND 40p IN STAMPS TO THE ADDRESS BELOW AND WE WILL DESPATCH A COPY OF OUR LATEST 24 PAGE CATALOGUE BY RETURN OF POST ALSO, WE EXHIBIT AT MOST OF THE MOBILE RALLIES HELD THROUGHOUT THE UK, SO WHY NOT COME ALONG AND TAKE A CLOSER LOOK AT OUR RANGE OF PRODUCTS

IT WOULD BE IMPOSSIBLE TO DETAIL EACH OF OUR TOP QUALITY PRODUCTS HERE. BUT WE HAVE TAKEN THIS OPPORTUNITY OF OUTLINING SEVERAL ITEMS FROM OUR RANGE. THIS WILL ILLUSTRATE THE VAST EXTENT OF OUR TECHNICAL RESOURCES AND MANUFACTURING CAPABILITY TO THE MANY NEWCOMERS INTERESTED IN THE FASCINATING WORLD OF AMATEUR RADIO.

**MMS1**



Price: £115 inc VAT (D+D £2.50)

**THE MORSETALKER**  
Speech synthesised Morse Tutor, 2-20 wpm, variable group lengths, ideal for amateur, Post Office and Maritime Exams.

**MTV435**



Price: £149 inc VAT (D+D £2.50)

**435MHz 20 WATT ATV TRANSMITTER**  
Two channel, two video inputs, internal aerial changeover switching internal waveform test generator

**MML28/100-S**

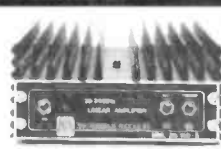

Price: £129.95 inc VAT (D+D £3)

**28MHz 100 WATT LINEAR AMP & RECEIVE PREAMP**  
Suitable for 10 Watt transceivers, RF Vox, switchable PA and preamp

**MMC144/28**

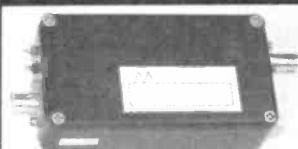

Price: £29.90 inc VAT (P+P £1)

**2 METRE CONVERTER**  
For use with 28-30MHz receivers to allow reception of the ever popular 2 metre band

**MMC435/600**



Price: £27.90 inc VAT (D+D £1)

**435MHz ATV RECEIVE CONVERTER**  
Suitable for UHF TV receivers - CH35  
Gain: 25dB Noise figure: 1.9dB  
Fully compatible with our MTV435TX.

**MML144/30-LS**



Price: £69.95 inc VAT (P+P £2.50)

**144MHz 30 WATT LINEAR AMP & RECEIVE PREAMP**  
Switchable input, 1 or 3 Watts, suitable for use with rigs such as C58, FT290-R, TR2300 etc

**MM2001**



Price: £189 inc VAT (P+P £2.50)

**RTTY TO TV CONVERTER**  
Suitable for 45.5, 50, 75, 100 baud RTTY 110, 300, 600, 1200 baud ASC with printer output facility.

**MMA144V**



Price: £34.90 inc VAT (D+D £1)

**144MHz RF SWITCHED LOW NOISE PREAMPLIFIER**  
Noise figure: 1.3dB max  
100 Watts through power capability  
Utilises 3SK88 MOSFET

**MML144/100-S**



Price: £139.95 inc VAT (P+P £3)

**144MHz 100 WATT LINEAR AMP & RECEIVE PREAMP**  
Suitable for 10 Watt transceivers, RF Vox, switchable PA and preamp

**MMD050/500**



Price: £75 inc VAT (P+P £1)

**500MHz DIGITAL FREQUENCY METER**  
Two ranges: 0.45-50MHz, 50-500MHz  
6 digit resolution, highly compact, 12v DC operation

**MMT144/28**

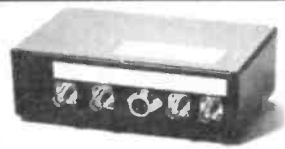

Price: £109.95 inc VAT (P+P £2.50)

**2 METRE LINEAR TRANSVERTER**  
For use with 10 metre transceiver  
10 Watts RF output, low-noise receive converter, 12v DC operation

**MML144/100-LS**



Price: £159.95 inc VAT (P+P £3)

**144MHz 100 WATT LINEAR AMP & RECEIVE PREAMP**  
Switchable input, 1 or 3 Watts, suitable for use with rigs such as C58, FT290-R, TR2300 etc

**ALL MICROWAVE MODULES PRODUCTS ARE FULLY GUARANTEED FOR 12 MONTHS (INCLUDING PA TRANSISTORS)**



WELCOME

## MICROWAVE MODULES

BROOKFIELD DRIVE, AINTREE, LIVERPOOL L9 7AN, ENGLAND

Telephone: 051-523 4011 Telex: 628608 MICRO G

CALLERS ARE WELCOME, PLEASE TELEPHONE FIRST

HOURS:  
MONDAY-FRIDAY  
9-12.30, 1-5.00

# THE CHIP SHOP

other sorts of diode apart from the bog-standard rectifier-type which we've discussed. One of them is called the Zener diode, after the man who discovered it, and it's very commonly found in equipment as a method of stabilising a particular voltage. You buy them according to their "Zener voltage", or the voltage you want them to stabilise.

Let's say you have a 9 volt battery which is a power source for some equipment but that part of the circuitry of the aforesaid equipment is very sensitive to the voltage applied to it. Now batteries don't give the same voltage throughout their lives, and this could cause you a problem. However, if you designed that bit of the circuit to work well off, say, 6 volts, you could use a 6 volt Zener diode to make sure that, whatever the battery voltage, it always had 6 volts on it. Mind you, if the battery got really old and its output fell below 6 volts, the Zener diode wouldn't be able to help you . . . needless to say.

Another variety of diode is the varicap. This is short for variable capacitance, and it works as follows. We said above the junction between different types of silicon was where it all happens; well, one of the properties of a "p-n junction" is that it displays a capacitance between the two parts of itself which varies according to the voltage applied across the junction. All diodes (or, come to that, all p-n junctions in all semiconductors) have this capacitance, but a varicap is specially treated at the doping stage in order to make it as marked as possible. This in turn means that you end up with a capacitor whose capacitance is variable according to the voltage across it — this can be very useful in tuned circuits where you want an easy means of changing the resonant frequency electronically.

Varicap diodes are also handy things to have around if you want to build an FM transmitter, since if you have the varicap as part of the tuned circuit of the transmitter's oscillator stage you can apply audio from the microphone to it and vary the capacitance directly with the audio frequency wave form. Hey presto — instant FM. Actually it isn't *true* FM in most cases but a variant of it known as phase modulation. Don't let this bother you for more than about a milli-second, however, because 99 per cent of the FM you hear on the amateur bands is PM and no-one's bothered. The difference between them is a bit theoretical in the practical world.

Bashing rapidly on, however, there's an interesting device which is a sort of controllable diode insofar as you can switch it on when you want. It's called a thyristor, and it actually contains four bits of silicon in a p-n-p-n arrangement. You'll also hear it described as an SCR, which stands for silicon controlled rectifier.

Either way, it has three electrodes. Like the diode there's an anode and a cathode but there's a third which is called the gate. Basically, you can make the anode as much positive of the cathode as you want (within reason — don't blow it up!) but it won't conduct or "turn on" until you apply a small positive voltage to the gate. It will then turn on in no time flat, and you can't turn it off again until you make the anode

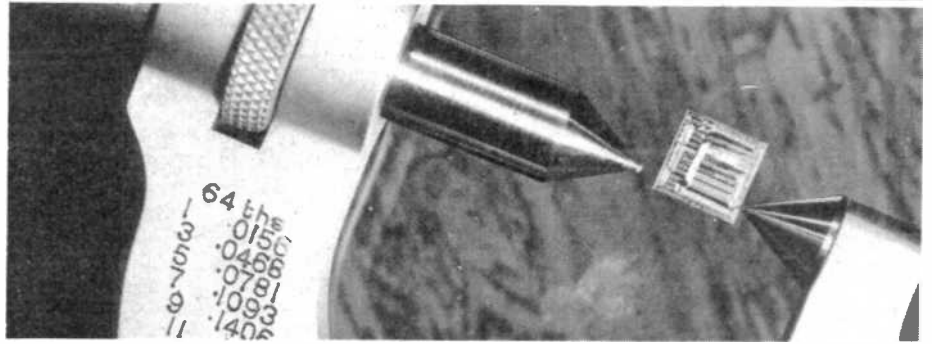

*This is a Ferranti semiconductor, shown within the jaws of a micrometer. A typical microprocessor slice (3in) contains 94 complete chips, each a quarter-inch square. Each one contains over 9,000 individual components so that the slice contains a total of 850,000 components.*

more or less equal in potential to the cathode. That's condensing whole manuals into two sentences, but it is more or less how it works. It is extremely useful for various forms of power control — your electric drill speed controller, for instance, probably contains either a thyristor or its cousin, the triac. And it's often found in power supply units as a "crowbar".

The idea of a crowbar is to short-circuit the power supply and hence blow its fuses in the event of a fault condition of one sort or another.

Beauty of the thyristor in this application is that it's such a high-speed device that it will remove volts from vulnerable semiconductors downstream before they've had a chance to decide whether or not they're going to blow up. Whole books have been written about thyristors, and they really are interesting devices if you're into power control in various forms.

**The prototype of the Ferranti Mark 1 Star computer, developed in conjunction with Manchester University in 1950, was one of the world's first commercial computers. It used 4,000 thermionic valves, 100,000 soldered joints, six miles of wire, consumed 27kW of power, needed air conditioning, and took up the space needed by an average dining room!**

**Nowadays, equipment needed to carry out similar work is contained in a quarter inch square chip containing 9,000 components, eight feet of aluminium connections, and its computing power is about 100 times that of the Mark 1 Star, operating at only five milliwatts of electrical power — about five million times less than the Mark 1 Star.**

The triac is like a thristor except that you can also tell it when to turn off — you don't have to take the anode volts away or whatever as you do with a thyristor — which makes it very handy for all sorts of AC applications. "Triac", for your information, is an acronym of "Triode AC switch", which is more or less what it is. "Thyristor" is derived from the Greek word for a door, "thyra". Presumably because you can open and close it however you wish, unlike the diode.

There are other members of the thyristor family too, such as the SCS (Silicon Controlled Switch) and the UJT. UJT stands for Unijunction Transistor, and, although it's called a transistor, it always seems to me to be more like a thyristor. It has two bases and an emitter, and it will turn on when the voltage on the emitter reaches a certain proportion of the voltage on one of the bases with respect to the

other. The UJT is very useful for things like timing circuits and triggering circuits for thyristors, and deserves to be better known than it is.

These are some of the semiconductor family. However, it's possible to go one stage further and to manufacture several devices on the same slice of silicon, and indeed out of the same slice. You can then package them up as matched devices. The next stage up from this is the "integrated circuit", which we mentioned at the beginning of the article. The IC is what has caused the revolution in electronics over the last 10 years or so.

If you design a circuit and then scale it down in size until it can all be fabricated on one silicon "wafer", that's an integrated circuit. They tended in the early days to be quite simple circuit "building blocks" such as the so-called operational amplifier or "op-amp" which is commonly found in all sorts of miscellaneous circuits. You can treat an op-amp as a sort of "gain block" whose parameters you can define to suit the application you're using it for. There's also a whole family of devices which have what are known as "logic" functions. Now to go into all these would take an article on its own; suffice it to say for now that what is known as TTL, which stands for Transistor Transistor Logic, is an important part of many electronic devices. One family, the 74-series, has been around for years and will probably stay around for some more.

Another important family of integrated circuits is based on what is known as CMOS technology. CMOS stands for Complementary Metal-Oxide Semiconductor, and its outstanding virtue is that its power consumption is incredibly low. Your pocket calculator uses CMOS technology, and it will run for ages on a small mercury battery.

The form of integrated circuit which is practically a household word is the "micro", or microprocessor. This is basically a computer on a chip, and one is tending to find them everywhere from amateur radios to door bells. All clever stuff, and it all seems a far cry from the early valves of the 20s.

Of course, one beauty of being an amateur is that you can use anything from valves to microprocessors in your projects. Me? I have a hankering to use both in one!

Anyway, that's a very quick tour round the world of the semiconductor. Now, what does MESFET stand for? You've forgotten? Go to the beginning of the article and start again.

# The professional

## IC-Rx70, The very latest from Icom! £469.



The New Rx 70 receiver from Icom is designed to provide a really stunning performance at a price not much greater than its inferior competitors.

It covers all modes (when the FM option is included), uses 2 CPU – driven VFO's for split frequency working, has 3 IF frequencies – 70MHz, 9MHz and 455KHz and a dynamic range of 100dB.

Other features are:-

Input switchable through a pre-amplifier, direct or via an attenuator.

Selectable tuning steps of 1KHz, 100Hz or 10Hz.

Adjustable IF bandwidth in 3 steps (455KHz)

Noise limiter. Switchable AGC. Tunable notch filter.

Squelch on all modes. RIT. Tone control.

Tuning LED for FM (discriminator centre indicator)

Recorder output. Dimmer control.

Separate antenna sockets for LW-MW with automatic switching.

Large front mounted loudspeaker - 5.8W output.

Frequency stability 1st hour  $\pm 250\text{Hz}$ , thereafter  $\pm 50\text{Hz}$ , sensitivity

-SSB/CW/RTTY better than  $0.32\mu\text{V}$  for 12 dB  $\frac{S+N}{N}$ .

Am -  $0.5\mu\text{V}$ , FM better than 0.32 for 12 dB Sinad.

Built in mains supply - DC optional.

Size 286mm x 110mm x 276mm - weight 7.4Kg.

## IC-25E, The Tiny Tiger £239.inc.



Amazingly small, yet very sensitive.

Two VFO's, five memories.

priority channel, full duplex and reverse, LED S-meter, 25KHz or 5KHz step tuning. Same multi-scanning functions as the 290 from mic or front panel. All in all the best 2M FM mobile ICOM have ever made.

Remember we also stock Yaesu, Jaybeam, Datong, Welz G-Whip, Western, TAL, Bearcat, RSGB Publications.

Agents (phone first - all evenings and weekends only, except Scotland).

Scotland - Jack GM8 GEC (031 665 2420)

Midlands - Tony G8AVH (021 32 - 2305)

North West - Gordon G3LEQ (0565 4040 Ansafone available)

## Introducing the NEW IC-740. £699.



This latest transceiver contains all the most asked-for features, in the most advanced solidstate HF base station on the amateur market...performing to the delight of the most discerning operator.

Study the front panel controls of the ICOM IC-740. You will see that it has all of the functions to give maximum versatility to tailor the receiver and transmitter performance to each individual operator's requirements.

Features of the IC-740 receiver include a very effective variable width and continuously adjustable noise blanker, continuously adjustable speed AGC, adjustable IF shift and variable passband tuning built in. In addition, an adjustable notch filter for maximum receiver performance, along with switchable receiver preamp, and a selection of SSB and CW filters. Squelch on SSB Receive and all mode capability, including optional FM mode. Split frequency operation with two built-in VFO's for the serious DX'er.

The IC-740 allows maximum transmit flexibility with front panel adjustment of VOX gain and VOX delay along with ICOM's unique synthesized three speed tuning system and rock solid stability with electronic frequency lock. Maximum versatility with 2 VFO's built in as standard, plus 9 memories of frequency selection, one per band, including the new WARC bands.

With 10 independent receiver and 6 transmitter front panel adjustments, the IC-740 operator has full control of his station's operation requirements.

See and operate the versatile and full featured IC-740 at your authorized ICOM dealer.

### Options include:

- FM Module
- Marker Module
- Electronic Keyer
- 2 - 9MHz IF Filters for CW
- 3 - 455MHz Filters for CW
- Internal AC Power Supply

### Accessories.

- SM5 Desk Microphone
- UP/DWN Microphone
- Linear Amplifier
- Autobandswitching Mobile Antenna
- Headphones
- External Speaker
- Memory Backup Supply
- Automatic Antenna Tuner

Ask about the new range of CUE DEE antennas, the winners in recent tests!

Thanet ICOM Thanet ICOM Thanet ICOM Thanet ICOM Thanet ICOM Thanet ICOM

# double act

Thanet ICOM  
Thanet ICOM

The World's most popular portables  
IC-2E £159. IC4E £199.inc.

and now the marine version  
IC-M12 £199+VAT.



Nearly everybody has an IC-2E, the most popular amateur transceiver in the world, now there is the 70cm version which is every bit as good and takes the same accessories.

**Fully synthesized** – Covering 144-145.995 in 400 5KHz steps. (430-439.99 4E). **Power output** – 1.5W. **BNC antenna** output socket. **Send/Battery indicator**. **Frequency selection** – by thumbwheel switches, indicating the frequency. 5KHz switch-adds 5KHz to the indicated frequency. **Duplex Simplex switch** – gives simplex or plus 600KHz or minus 600KHz transmit (1.6MHz and listen input on 4E). **Hi-Low switch** – 1.5W or 150mW. **External microphone jack**. **External speaker jack**.

The IC-4E is revolutionising 70cm!

## Multimode Mobiles

IC-290E £366. IC-490E £445.inc.



290E-144-146 MHz/490E-430-440 MHz. 10 W RF output on SSB, CW and FM. Standard and non-standard repeater shifts. 5 memories and priority channel.

Memory scan and band scan, controlled at front panel or microphone. Two VFO's. LED S-meter. 25KHz and 1KHz on FM – 1KHz and 100KHz tuning steps on SSB. Instant listen for repeaters.

IC-720A Possibly the best  
choice in HF. £883.inc.



One way of keeping up with rapidly advancing technology is to look at what the IC-720A offers in it's BASIC form. How many of it's competitors have two VFO's as standard, or a memory which can be recalled, even when on a different band to the one in use, and result in instant retuning AND BANDCHANGING of the transceiver? How many include really excellent general coverage receiver covering all the way from 100KHz to 30MHz? How many need no tuning or loading whatsoever? and take care of your PA, should you have a rotten antenna. How many have an automatic RIT which cancels itself when the main tuning dial is moved? How many will run full power out for long periods without overheating? How many have band data output to automatically change bands on a solid state linear AND an automatic antenna tuner unit?

The IC-720A may be just a little more expensive than some, but it's better than most! Make your choice an IC-720A.

IC-PS15 Mains PSU £99.

## Tono RTTY and CW computers

7000E £500. 9000E £650.inc.



The TONO range of communication computers take a lot of beating when it comes to trying to read RTTY and CW in the noise. Others don't always quite make it!

Check the many facilities offered before you buy – especially look at the 9000E which also throws in a Word Processor. Previous ads have told you quite a lot about these products – but why not call us for further information and a brochure?

IC-730 The best for mobile or  
economy base station £586.inc.



ICOM's answer to your HF mobile problems – the IC-730. This new 80m–10m, 8 band transceiver offers 100W output on SSB, AM and CW. Outstanding receiver performance is achieved by an up-conversion system using a high IF of 39MHz offering excellent image and IF interference rejection, high sensitivity and above all, wide dynamic range. Built in Pass Band Shift allows you to continuously adjust the centre frequency of the IF pass band virtually eliminating close channel interference. Dual VFO's with 10Hz, 100Hz and 1kHz steps allows effortless tuning and what's more a memory is provided for one channel per band. Further convenience circuits are provided such as Noise Blanker, Vox, CW Monitor APC and SWR Detector to name a few. A built in Speech Processor boosts talk power on transmit and a switchable RF Pre-Amp is a boon on today's crowded bands.

## Great base stations

IC-251 £499. IC-451 £569.inc.



ICOM produce a perfect trio in the UHF base station range, ranging from 6 Meters through 2 Meters to 70 cms. Unfortunately you are not able to benefit from the 6m product in this country, but you CAN own the IC-251E for your 2 Meter station and the 451E for 70 cms. Mains or 12 volt supply. SSB, CW and FM.

Thanet ICOM  
Thanet ICOM  
Thanet ICOM  
Thanet ICOM  
Thanet ICOM

Thanet Electronics  
143 Reculver Road, Heme Bay, Kent.  
Tel: 02273 63859  
Trade enquiries welcome.



# THE MYTH EXPLODERS

Every hobby, profession, trade and religion has its fair share of believable myths. These misconceptions are also to be seen in amateur radio. By Peter Dodson.

Like any other hobby, amateur radio has its fair share of old wives' tales, myths and sheer misunderstandings. We thought we'd have a go at some of the more common ones and try and clear up the misunderstandings which surround them. Now read on . . .

1. "My SWR is 2 to 1; my mate up the road has got his down to 1.5 to 1 and he gets out better than me."

The SWR (or to give its full wording, the standing wave ratio) is just a measure of how good a match the antenna is to the transmission line which feeds it, and how good a match the latter is to your rig's output impedance.

If you have a high SWR, which in the real world implies anything more than about 3 to 1, your rig may not be able to deliver its maximum power into the antenna, especially if it's a modern solid state one because the rig's protection circuitry will try to protect the final amplifier from damage. It isn't that you lose power because of the SWR itself — the high SWR may well cause your rig to throttle back a bit but there's a subtle difference.

The fact that power is reflected back down the line doesn't mean that it's lost somewhere — after all where could it go? Besides which, an SWR of 2 to 1 isn't worth losing sleep about. If it's any higher, there's likely to be a fault somewhere in the system but all that means is a possibility of problems with the transmitter itself. It's best to sort it out, but by itself an SWR of 2 to 1 or thereabouts will make no difference whatsoever to the field strength from the system — which is what counts when it comes to getting out!

2. "I've got one of those solid state no-tune broadband rigs. I don't need to tune anything up; I can use any antenna I want on whatever band I like."

Provided you don't mind having to fit new PA transistors in the final amplifier every day or so, that's fine. The fact is that the final amplifier of your rig might not need to have tuning or loading controls but unless your antenna is decidedly unusual (and probably highly expensive) you'll need to have some form of antenna tuning unit in order to match the antenna system to the transmitter. As we said above, the transmitter needs to see a low SWR; the problem is that the SWR on most amateur antennas will change with frequency, particularly on the lower frequency bands, and even if you tune everything up nicely on, say, 3.66MHz, you'll certainly have to

re-tune the antenna if you move 50kHz down the band.

It's quite easy to make a broadband final amplifier, just as the manufacturer says, but that isn't the whole story; a broadband antenna is a very different kettle of fish and, in amateur terms, very difficult to do. In other words you're very likely to need an ATU for HF band operation, whether or not you have a broadband final amplifier in your rig. The ATU will also help the receiver along a bit because it'll keep strong out-of-band signals out of the front end.

3. "Transistors are much better than valves."

For some things, yes. In a receiver there's no real reason to use valves these days except that it's a lot easier to make a simple valve front-end which has good signal-handling properties than a simple transistor ditto. If you enjoy DIY there's still a lot to be said for valves because they're easy to use and very tolerant of overloads. As John Nelson said in the last issue, the transistor is the fastest fuse on three legs known to mankind!

Also, there's no real substitute for the final output stage of a transmitter; many commercial rigs use transistors, but transistor amplifiers running any sort of power are not for the novice. That may change when VMOS becomes more common; VMOS stands for Vertical Metal-Oxide Semiconductor and is a fairly new form of transistor for high power work. Some of the newer hi-fi amplifiers are using them, and they are useable for transmitters. For lots of watts with ease, you still can't beat a bottle!

4. "I'm running a dipole on 7MHz firing east-west, so signals from the north aren't too good."

It must be very high off the ground then! For a dipole to display any directional properties at all it needs to be at least one wavelength off the ground and the wavelength of a 7 MHz dipole is about forty metres or 120 feet. In other words, for your dipole to be at all directional it needs to be about 120 feet above the ground, which isn't exactly easy to achieve. The same is true even moreso for the 3.5MHz band, where a dipole would need to be 240ft off the deck to give it any directivity at all. So next time you hear someone running a dipole on the LF bands and talking about its directivity, you can smile quietly to yourself.

Any average antenna on top band, 3.5 and 7MHz is going to be omnidirectional

for all practical purposes. It's a good thing to get it as high as you can, however, because the higher it is the lower its angle of radiation will be and you'll work more in the way of DX with it.

5. "What's the point of learning Morse these days? SSB is just as good." Well, it all depends. Morse is very good at getting information through when all else fails and you'll often find that there are times when you just can't quite get the information you want with SSB and going on to the key will let you copy the other station quite comfortably.

The only thing is, your receiver needs the right filters to take advantage of this, and many commercial rigs use the same filter for Morse and SSB — this throws away a lot of the advantage. If you're interested in winking out the weak ones, do get hold of a receiver with really good CW filtering and try it; you'll see the difference very quickly. If you're into VHF and UHF DX-ing, Morse is very useful indeed, strange though it may seem. You will often find that a DX SSB signal is weak and noisy, and the fading is coming at awkward times — go to CW and you'll work with no problems.

Meteor scatter work and auroral openings really require Morse to work at all well. SSB during an aurora is very hard work, since the speech gets very chopped about by Doppler shift within the auroral curtain and becomes almost unintelligible. Morse, however, is quite readable as bursts of keyed noise.

So don't turn up your nose at Morse — if you're after real DX on any band, Morse is one of your most potent weapons. Much rare DX uses only CW as well, so if you're going to make DXCC you'll need it. Old fashioned it may be, but it's still an extremely effective form of communication.

6. "My callsign at the moment is G6ZZZ pedestrian mobile."

Often heard, and not true. There's no such category in the licence as pedestrian mobile — the three suffixes you can use are /P, meaning Portable, /M which means you're Mobile and /A, which says that you're at an Alternative location to that specified in the licence. If you're walking down the road with your hand-held you're /P and you announce yourself as "G6ZZZ Portable". Same if you're riding down the road on your bike, actually, because the rig isn't connected to a power source on the bike; if you had it fixed to the dynamo in some way you'd become G6ZZZ Mobile.

If you're sitting in your country cottage



where you have an HF rig and an antenna strung in the trees, you'd be G4ZZZ Stroke A, or G4ZZZ Alternative. But pedestrian mobile you ain't, ever!

7. "I've just got my G4 and I'm going to run an end-fed long wire for the HF bands. I can use the mains earth, can't I? After all, earth is earth, isn't it?"

This was the gist of a half-hour telephone call we had in the Amateur Radio offices the other day, and our technical people had a hard time trying to convince a new G4 that it was asking for trouble! The problem is that the earth you need to use with a long-wire needs to be a bit better than a mains-type earth, which is for electrical safety only.

It needs to have the shortest possible lead and to have the greatest possible amount of metal in the ground; a mains earth usually wanders round the building and ends up on a water pipe or something. It's not anything like good enough for radio purposes, and the other problem is that using the mains earth is a great way to cause all sorts of breakthrough problems into TV and hi-fi. The mains earth will probably present quite a high impedance to radio signals, and they'll find their way into all sorts of unlikely places.

The mains earth wire can even act to re-radiate signals, which can cause all sorts of problems. We know of a case where someone tried to use a mains earth with a 3.5MHz end-fed half-wave, and all the metal work of the transmitter became "hot" with RF — net result was that every time our man pressed the Morse key, he got a shock and all the pilot lights on the linear glowed even though it wasn't switched on at the time . . .

A good thick wire from the shack to as much metal as you can get in the ground is the way to do it. One of the guys in the office has an old cold-water tank which he took out of his house recently — he says he's going to bury it under the lawn when his wife's away for the weekend! Joking apart, that would be a perfectly good thing to do, and if he does it he should be a good signal on the LF bands.

8. "I want to get into amateur radio but I can't afford it. It looks as though it'll cost me at least £1,000 to get on the air." Well, if you want to do it that way it can, but you can build your own and it could cost you anything between a few quid and nothing, depending on how well-stocked your junk box is. Don't overlook the possibilities of a QRP, or low-power, transmitter using Morse, along with a simple receiver of the "direct-conversion" type — see any of the textbooks.

Antennas can cost next to nothing if you make them yourself from wire; we know someone who puts out a very good signal on 432MHz using an antenna made from reclaimed coat hangers from the dry cleaners, and you can do great things with old TV antennas. With the rise of the integrated circuit, there's never been a better time for the home brewer than now. Don't fall into the trap of thinking that amateur radio is all about commercial rigs because it's not. The best fun in amateur radio comes from making it yourself.

For the next issue of the magazine, we're thinking of showing how to talk to America for £20; we'd have had it in this issue but someone in the office dropped one of the valves and we haven't

scrounged another one yet! Note the word "scrounge". You'll find that the best amateurs are born scroungers when it comes to electronic bits and bobs, and we've seen some amazing rigs in our time which cost the builder precisely £0.0p. Buying a commercial rig is fine if you can afford it, but don't think it's the only way into amateur radio because nothing could be further from the truth.

Well, that's a quick look at some of the myths of amateur radio. If you'd like us to explode any more for you, just write to us and we'll ask our resident technical geniuses (or is it genii?) to do so. Come to that, we're going to start a technical and non-technical letters page in the next issue, so if you want to ask something, tell us something or merely sound off about something at S9 + 40, give us a blast.



## THE **microdot** CWSRTTY COMMUNICATIONS TERMINAL

### STANDARD FEATURES INCLUDE

- \* Integral high resolution video monitor.
- \* Professional keyboard with many special functions.
- \* Real-time clock (constantly displayed).
- \* Transmit and receive both CW (morse) and RTTY (teleprinter).
- \* Users call sign programmed in.
- \* Receive CW speed tracking and display.
- \* Self checking facility.
- \* Char. by char. or 'page' transmission modes.
- \* Stylish two tone metal cabinet.

### OTHER OPTIONAL FEATURES

- \* Printer interface board (Centronics compatible).
- \* On-board 40 column printer (12V).
- \* External 80 column printer (SEIKOSHA GP100A).

**£381.74** inc carriage (Standard unit cost — VAT not included).

*Forget all those messy wires, the MICRODOT now offers a totally integrated communications system.*

Write for full details to:

**POLEMARK LTD**

Lower Gower Road, Royston, Herts SG8 8EA  
Tel: Royston (0763) 47874



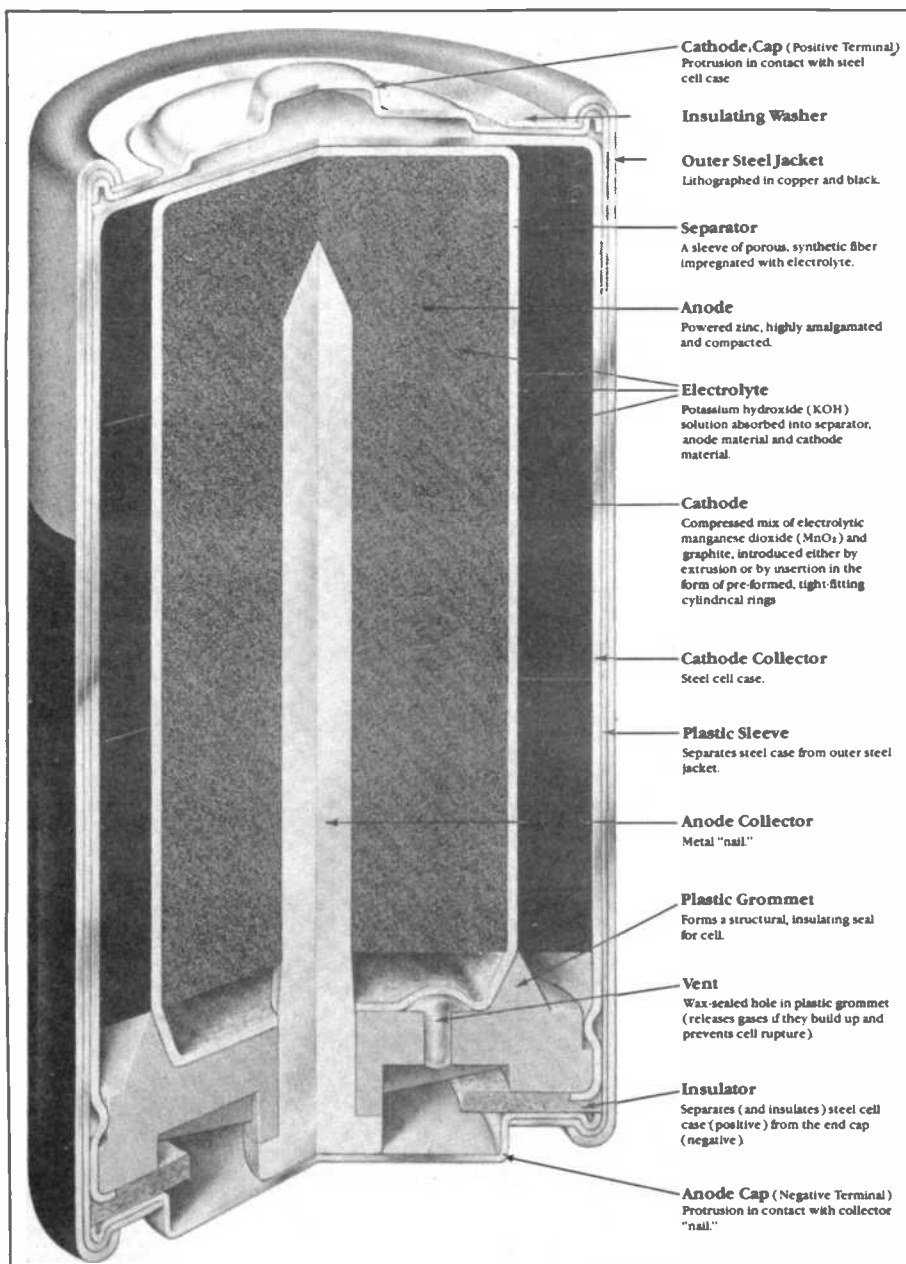

# The quest for power

*Well, in a small way. Here, Amateur Radio describes what dry cell batteries are all about, and how they apply to users of hand helds and other equipment. There's more to that little battery you've bought down the road, than you think!*

You might think it seems strange to devote a whole article to batteries. After all, apart from your hand-held, the amateur station doesn't use many of them. However, with the way integrated circuitry is going, various sorts of batteries are available and using the right one for the job can often save you money and lead to extra life for gear which uses batteries.

So we thought we'd have a look at what the battery makers have been up to in the last few years and see which is best for particular applications. We'd like to acknowledge the help of Duracell (previously known as Mallory) and the Ever Ready Company of Great Britain, who gave us enough technical data to start our own battery manufacturing plant, let alone write this article!

Basically, batteries fall into two sorts — primary and secondary. Primary cells are the ordinary batteries you buy in the shop and put in your torch, calculator, flashgun or whatever, whereas secondary cells are rechargeable — things like the battery in your car and the type of battery usually referred to as a "nicad" fall into this category.

Note we said "cell" instead of "battery" — this is because the cell is the basic element in which the specific chemical reaction which produces electricity from the particular sort you're using takes place. A "battery" consists of one or more cells. For instance, something like the common battery for transistor radio which is known as a PP9 produces nine volts. It's made up of six cells which produce 1.5 volts each, linked together to produce nine volts. The sort of thing you put in your camera, for instance, or the ordinary HP2 you put in a torch (actually you might put two or three of the latter in) is a "cell" because there's only the single unit in it. Both the PP9 and the HP2, incidentally, are the examples of the same sort of battery and their basic element is known as a Leclanche cell. Mr Leclanche invented it in 1866 and it's been going strong ever since. Well, at least the idea has . . . the original battery went flat some time ago!

The Leclanche in all its various forms is probably the most common type of battery. In the amateur world you'll often come across three sorts — the so-called "layer" battery such as the PP3, PP9 and so on, which produce nine volts, the SP battery, which is a 1.5 volt unit found in everything from electric torches and, probably more often used, the HP or PP types. These are the same physical size and weight as the basic SP battery but offer better performance in rigs such as the Icom IC202 SSB transceiver. This takes the HP7 size, and you'll find that because HP types have been designed to give their best performance in equipment which takes comparatively heavy currents and doesn't like it when the volts get a bit low, the HP7 would be a good choice for this sort of application. The PP equivalent, which is the R6PP, costs 24½ pence as opposed to the 16½ pence of the HP7 but our tests with an IC202 suggested that

*Above illustration:*

*Alkaline manganese cell. Made of more expensive materials than the zinc carbon version, this battery has an anode (not part of the container housing) of zinc powder. The basic cathode material is called electrolytic manganese dioxide which has greater content of oxygen which in turn means increased reactivity and the cell capacity is extended.*

you got almost double the life with the more expensive battery.

Tests like this have to be interpreted with care, however. The life you'll get from a battery depends very much on what current you take out of it and for how long at a time, and in the basic Leclanche type the quantity of electricity you'll get out of it depends on its physical size, the rate at which you discharge it, the period of time per day for which you use it, the point at which the equipment doesn't like the lower voltage you get from the battery as it discharges (which is known technically as the "voltage endpoint", by the way), the temperature, the length of time that the battery sat on the shop shelf before you bought it and, lastly, how good the manufacturer is at making batteries!

A battery — any battery — is quite a complex device, and you can draw all sorts of graphs to see which is best for any particular application; if you really want to have a close look, Ever Ready do a very good little booklet called "Modern Portable Electricity". It's available for free and is extremely interesting.

However, to sum up the Leclanche type, a few general ideas might go something like this. If you're thinking of using a nine volt type for a particular application, remember that they come in one basic type but in a variety of sizes. Roughly speaking, the bigger the battery the more current it'll supply for longer. The PP9 type is recommended for a current drain of anywhere between five and 50 milliamps, and obviously it'll last longer at lower currents. In contrast, the little PP3 isn't recommended for applications which require more than about 10 milliamps.

## Amateur batteries

As far as the 1.5 volt Leclanche type is concerned, the choice is the HP and PP types in most applications you'll come across in the amateur world — quite a lot of portable gear uses the HP7 size, and the HP7 and the R6PP, which is the slightly improved and later type, are both excellent for the job. The "bog-standard" SP type isn't made in size seven, as it were, so the choice is just these two — well, for the Leclanche types anyway, as we'll see shortly. For a very rough comparison of the service lives, have a look at our diagrams.

However, let's move on and take a look at some more types of battery. A more modern version of the basic Leclanche is called the manganese-alkaline cell or, to give it its full title, the "Alkaline Manganese Dioxide — Zinc System". It differs from the Leclanche type which we've been looking at (which is sometimes known as the zinc-carbon type, by the way, from its basic materials) mainly in the "electrolyte" it uses. The electrolyte, roughly, is the stuff that makes the battery work; in the manganese-alkaline battery you'll find a chemical called potassium hydroxide, as opposed to various sorts of chlorides in the older type. As you can see from the diagram, the manganese-alkaline battery is constructed "inside out" in comparison with the zinc-carbon type.

Anyhow, enough of the clever chemistry, how well does the thing work? The most common make of manganese-alkaline batteries seems to be the black-and-gold Duracell which you see advertised on the television, although various other

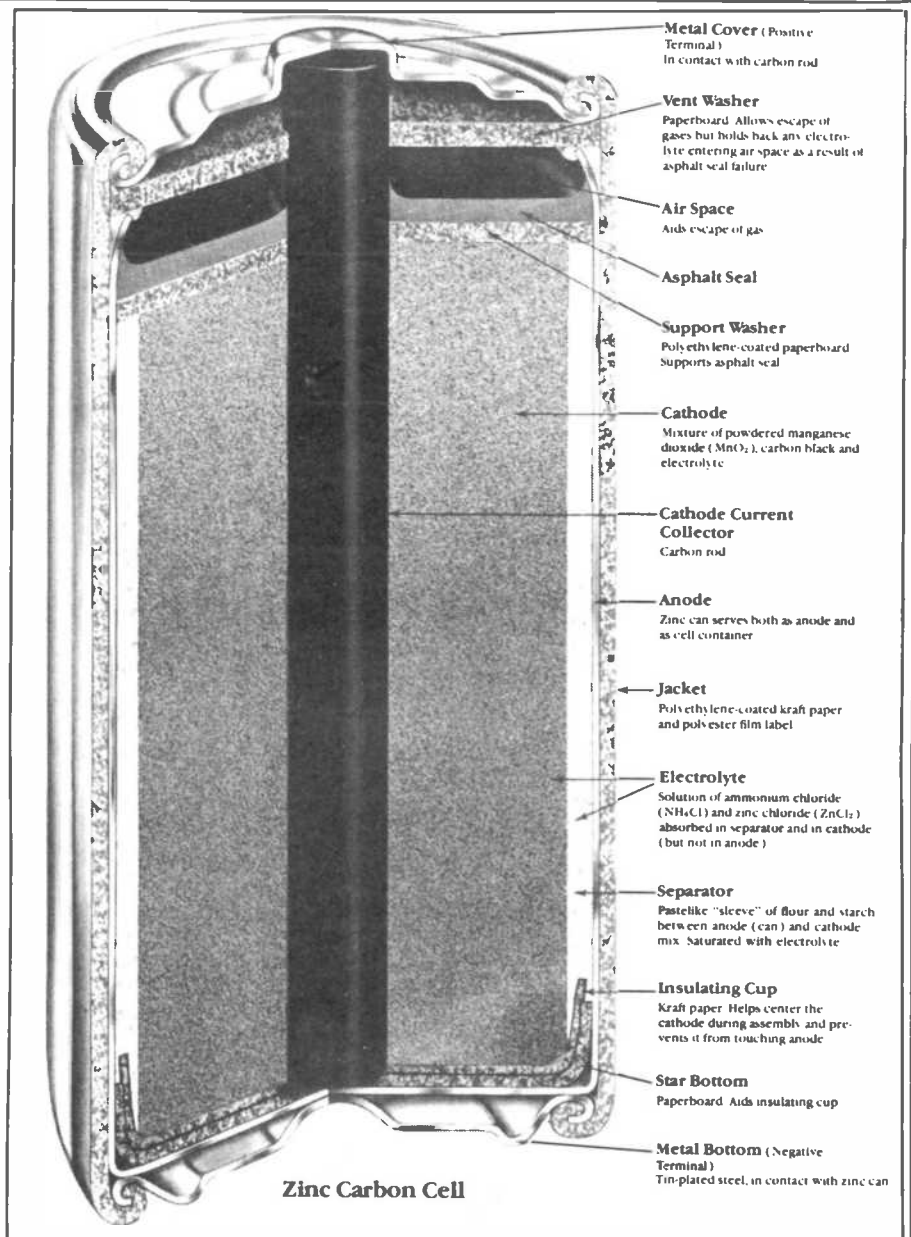

Zinc Carbon Cell

manufacturers including Ever Ready do them. They aren't made in an equivalent to the "layer" type of nine volt battery; all the manganese-alkaline types are 1.5 volt cells and they're equivalent in size to the HP7s and HP11s we discussed a while ago.

So what's the odds? the manganese-alkaline battery is a high-capacity device. Because of its construction it has a low "internal resistance", which is what causes the voltage of a battery to fall when you put a load on it. The zinc-carbon type has a rather higher internal resistance than a manganese-alkaline equivalent, and in practical terms this means that the latter works very well if you're asking it to supply a high current for a continuous period.

The "high current" bit is the clue to where you'd use the manganese-alkaline in place of the ordinary type. If we take our HP7, as used in the hand-held Icom IC4E, we'll find that the manganese-alkaline equivalent is the MN1500. Now according to the data sheet for the MN1500, on a load of 10 ohms for one hour per day — which is a reasonable approximation to a hand-held radio — it'll give 14.5 hours of useable life, as opposed to 3.8 hours for an HP7 and 4.5 hours for the R6PP. However, under conditions of low or intermittent

*Zinc carbon cell. The housing that contains the materials is made of zinc and it functions as the anode as well. Here, the manufacturers say that cheapness is a prime objective.*

current drain, the HP or PP series make better economic sense because the MN1500 will cost about 45 pence as opposed to 16½ or 24½ pence. So, to sum up, the manganese-alkaline is great when you need a lot of power, relatively speaking, from a small battery, but there's no point in using them for a piece of test gear you use for five minutes every fortnight because the storage life is similar for both types and you'll work out that batteries cost more than they need under these conditions.

We'll come on to other possibilities for this size of battery later, but let's look now at the "mercury" cell. This tends to crop up more for things like hearing aids and camera meters than in amateur radio, but you'll find one used in some rigs for things like memory back-up. They look something like pyjama buttons, and they're sometimes called "button cells" for this very reason.

The basic voltage for both types of battery we've discussed so far is 1.5 volts, and because of the internal resistance of the said batteries, this will fall gently from

this figure until the battery is exhausted. However, the first thing about the mercury cell is that its basic voltage is a bit lower (at 1.35 volts) and also that because of the way it's made its internal resistance doesn't increase slowly with age as the other sorts do but remains much the same until the battery's practically dead. This means that the working voltage is very stable, and indeed one good use for a memory cell is if you've just built something like a meter which requires a known source of volts to calibrate it. Mercury cells when new seem to produce 1.35 volts plus or minus nothing at all, so they're very handy for a good source of known voltage. You can use a mercury cell either continuously or intermittently and it just goes on nicely without losing any output. Since they don't work in the same way as the two types we've looked at, they don't need a rest period either, so they're very useful for things like clocks.

However, they aren't meant for high-current work — it is not considered kind to ask them to supply more than a milliamp or so. They also don't mind high temperatures, and indeed have been used for a few hours at 90°C; they're unruffled by temperatures up to 55°C in everyday use. However, they aren't very good below freezing. The types we discussed previously, by the way, are rather better, so if you want to operate at the North Pole or in the tropics you'd do well to remember that the manganese-alkaline battery doesn't mind anything between -20°C and 55°C.

### Stable voltage

Another "button cell" is the silver-oxide type. Its performance is similar to that of the mercury cell except that its nominal voltage is higher at 1.55 volts, and you'll find it's used in the same sort of places as you'll find the mercury cell. The silver-oxide type, however, is more suitable for high discharge rates and "pulse" discharges such as you'll sometimes find in clock and logic circuitry; the internal resistance is low and the voltage tends to remain stable throughout its life.

There are one or two other "primary" cell types but they're not yet of much concern to the radio amateur. What about the "secondary" cells? The most common one you'll come across is the nickel-cadmium type, usually referred to as the "nicad". Today's type is completely sealed and comes in a wide variety of sizes. Electrically, the cell voltage is more or less constant throughout their discharge cycle and they don't need rest periods. They have a very low internal resistance and are very good in applications where a continuous high rate of discharge is required, for instance in a hand-held FM transceiver. Obviously they are much more expensive than the ordinary cells but with proper treatment they will last for many hundreds of charge and discharge cycles. They'll operate over a very wide temperature range of about -40 to 60°C, and in fact their capacity is greatest at room temperature or a bit over.

*Mercury button cell. Used widely in hearing aids, digital watches, photographic equipment and calculators. Cathode material here is mercuric oxide which has a good oxygen content.*

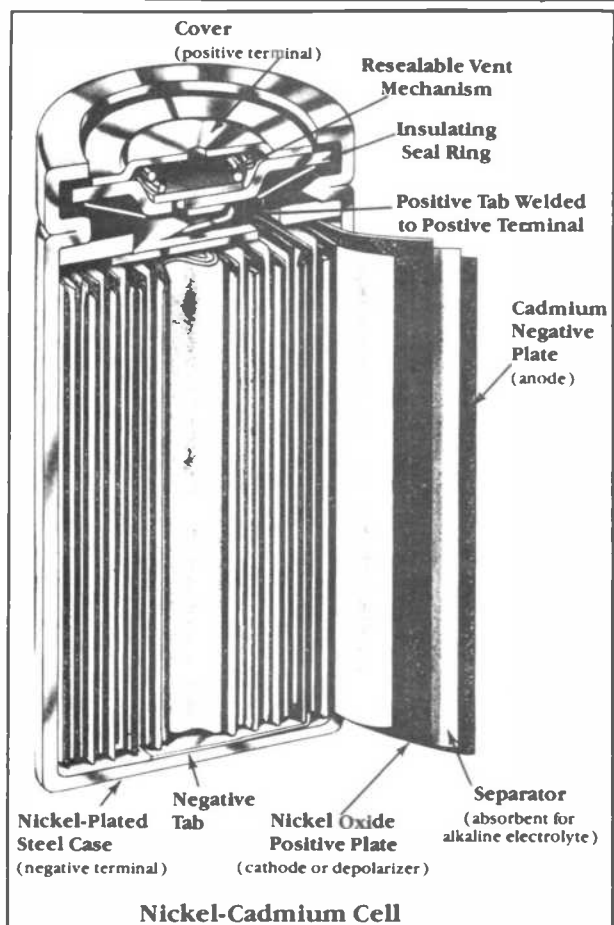
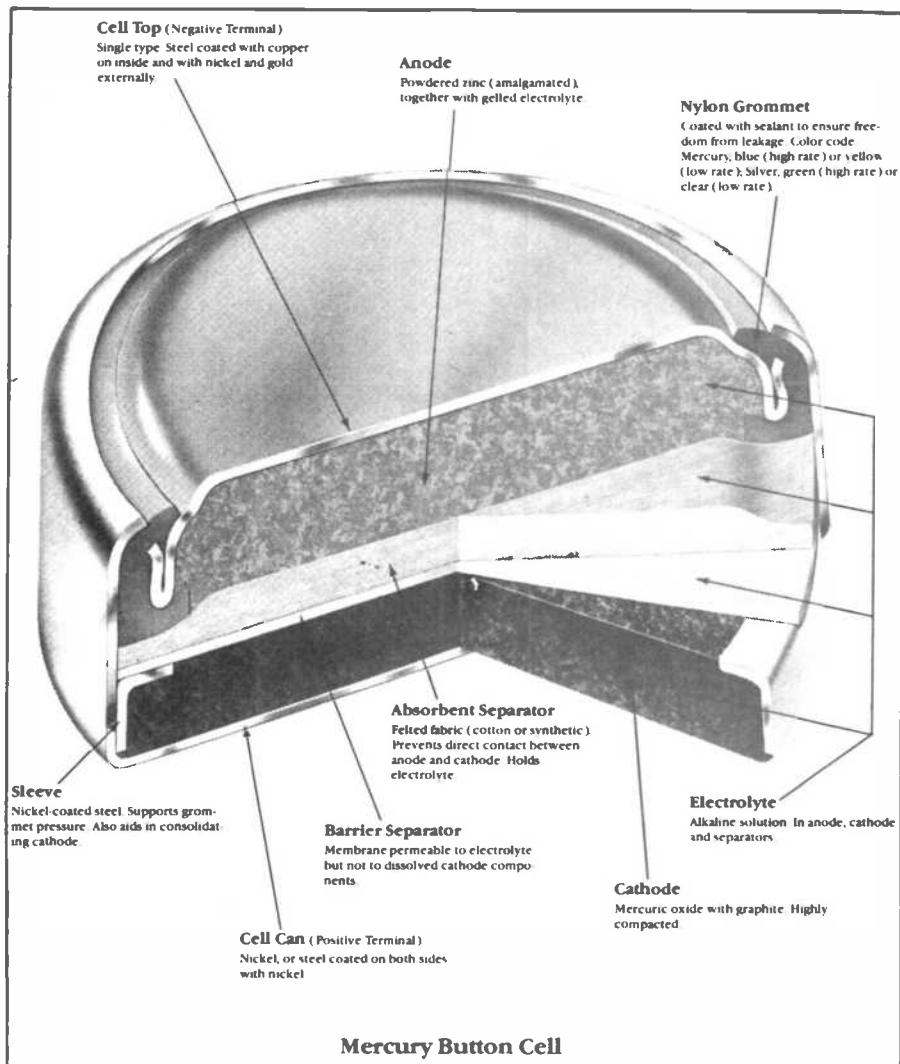

As far as charging nicads goes, you can use very simple circuitry. The only thing is that the current should either be more or less constant or limited to a known and safe value. You can't charge them as though they were a car battery, ie stick a constant voltage across them, because in those circumstances they can draw enormous currents because of their low internal resistance and kaboom! And an exploding nicad is not funny, so if you're thinking about building your own charger, do take care.

You'll find that most commercial chargers take about 14 hours to bring a nicad from fully discharged to fully charged, and this is because they use what is known as the "C/10 rate". You can express the nominal capacity of a nicad (remember, capacity is the measure of how much electricity the battery can provide — it's normally expressed in ampere hours) as the amount of amp hours you get when the cell is discharged at such a rate as to bring it to an end point of one volt in five hours. This rate of discharge is called the five-hour rate and is expressed as C/5. So the C/10 rate would be equivalent to the amount of current which, when taken out of the battery, would bring it to one volt in ten hours — you use the same value of current for charging it up. There are so-called "rapid chargers" but they need to be used with very great care and only when the battery is fully discharged.

Nicads are very good for portable transmitters and so on — they are a much more economical way of obtaining portable power than primary cells of any sort. The only snag we've found with nicads is forgetting to put them on charge the day before we need them!

HP7/R6HP



1.5V  
IEC R6

SECTIONAL PROFILE

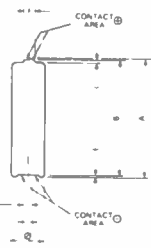

AL DIMENSIONS IN MILLIMETRES					
DIMENSIONS	IEC		EVER READY		UNIT
	MAX	TYP	MAX	TYP	
A	50.5	—	50.5	—	mm
B	—	49	—	49	mm
C	—	7	—	7	mm
D	—	0.5	—	0.5	mm
E	—	4.2	—	4.2	mm
F	—	14.5	—	14.5	mm
G	—	13.5	—	13.5	mm

nominal open circuit voltage	1.5V
maximum open circuit voltage	1.725V
nominal mass	1.5g
nominal volume	8.7ml
recommended storage conditions	20° ± 5°C max
max temp	80% RH

TYPICAL SERVICE LIFE AT 20°C

Applications	Test conditions	Standard	Typical service life		
			Initial	2 yr at 20°C	
hearing aids	3000 hr 12hr/d	10 0 3V	IEC	2.2hr	1.8hr
transistor radios	750 hr 4hr/d	10 0 3V	IEC	5.4hr	4.9hr
calculators	150 hr 20min/d	10 0 3V	IEC	10hr	9hr
tape recorders*	100 hr 1hr/d	10 0 3V	IEC	3.8hr	3.4hr
portable lighting	50 hr 5min/d	10 0 3V	IEC	3.8hr	3.4hr
conv cameras	3.90 hr 5min/d	10 0 3V	IEC	1.5hr	1.3hr
portable lighting	3.90 hr 5min/d	10 0 3V	IEC	2.6hr	2.3hr
radio & teletransmitters	3.90 hr 5min/d	10 0 3V	IEC	2.2hr	2.0hr

\*includes cassette recorders

Data sheet for the Ever Ready HP7/R6HP. Note the typical service life figures.

One word of warning. There's recently been a fair amount of debate in amateur circles about whether or not you can recharge primary cells, and various amateurs have claimed great success with their own patent recharging methods. However, the two major battery manufacturers we spoke to both reckoned that this was a really bad idea. Ever Ready said that their tests had shown that, even under carefully controlled conditions, you couldn't get any useful amount of charge into any type of primary cell and that in fact you can get a dangerous build-up of gas pressure within the cell.



A lot of Duracell batteries . . .

They say that "charging of primary cell systems should not be attempted under any circumstances" and certainly from looking at the chemistry of what goes on that seems quite reasonable. One other rule is don't, for goodness' sake, ever throw a battery on to any sort of fire. When you've finished with it, always put it in the dustbin. Don't be tempted to chuck it on the garden bonfire because some batteries will explode with an almighty bang if you do.

Well, that's a quick look round the world of portable power — there's certainly more to those little cylinders than you think!

THE  CENTRE

10 MERTON PARK PARADE,  
KINGSTON ROAD,  
LONDON SW19  
(Opp JUNCTION OF MERTON HALL ROAD)

TEL: 543 5150

ACCESS BARCLAYCARD  
BOWMAKER FINANCE

NEW AND SECOND HAND EQUIPMENT  
ALL FULLY GUARANTEED

ICOM — YAESU — TRIO — STANDARD  
FDK — AZDEN — JAYBEAM — FDK  
Full range of SMC — Jaybeam and T.A.R  
Antennas always available.

All your requirements for Poles — Lashing  
Kits — Rotators — Cables etc.

2 METRE SLIM JIM £7.00  
2 METRE HB9-CV BEAM £8.50

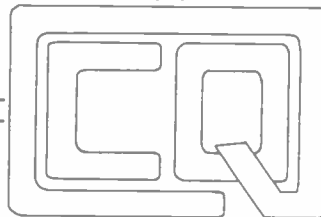

CITIZENS BAND RADIO

We are stockists for:

SMC — MURA — CAL COMM  
TURNER — COMMTRON — MAXCOMM  
AVANTI — K40 — TAGRA — HY GAIN  
HAVARD — HMP — HIRSTCHMAN

Call in and see the latest rig

THE INTERCEPTOR TC-300

Large selection of Antennas — Power Mikes —  
Meters — Pre Amps — Burners — PSU — etc.  
We are the sole CB stockist of the Adonis Mobile Mike.

Why not telephone or drop in for a chat about your gear. Copious amounts of tea and coffee always available plus friendly sensible advice.

We are always seeking secondhand equipment to purchase or part exchange, faulty or working. Try us first (or last perhaps), we think you will be pleasantly surprised. We also offer a tried and tested sale or return service, we will sell your equipment on a 10% commission basis, you affix your own price ticket.

UPSIDE DOWN

WE ARE TURNING SECOND HAND PRICES

# TRIO TS-830

Three new bands and extra facilities are  
"a lot of radio for your money"  
By our Technical Editor

AS we said in the review of the Icom IC-4E elsewhere in this magazine, we're still in two (only two?) minds about how best to do our reviews. We feel we have a duty to discuss the equipment we review as honestly as possible bearing in mind what it's intended to do, and from the point of view of the average amateur who is going to buy the thing. So when we decided to review an upper-middle class radio such as the Trio TS-830, there was a bit of head-scratching in the office. Should we bombard everyone with spectrum analyser traces, IF filter plots and the like, or should we just say whether or not we think it's a good rig. We've decided, as a first effort, to evaluate it in the middle of the extremes, rather as we have done with the IC-4E, although obviously the TS-830 is rather more complicated.

## Good reputation

So — what about the TS-830? We thought we'd like to review it because it's the sort of radio you might buy if you were coming to the hobby and had enough of the folding stuff available to invest in a good piece of gear which would last you a long time and which will do the job. The TS-830 is made by Trio — Japanese, of course — and is the lineal descendant of the popular TS-820 with the addition of the three new bands which the amateurs obtained at the World Administrative Radio

Conference in 1979 (three cheers for the RSGB) and one or two extra odds and ends. In terms of facilities it's the Volvo of HF transceivers; in terms of price it's somewhere about the same. Trio equipment has had a good reputation for reliability for a long time now, and you often hear people on the air who've had a TS-520 (another popular Trio model) for years and years. Just to digress a bit, Japanese equipment in general seems to be extremely well put together from the reliability point of view — we don't know of the Japanese equivalent of a "Friday car" and we've only ever come across one instance in about the last five years of a Japanese rig being faulty when bought. Trio equipment is, as we've said, highly regarded by amateurs, and the TS-830 itself is the second-in-line from the top-of-the-line TS-930.

So we were smacking our lips when Mr Securicor brought the big packet into the office, and it was unpacked with great expectations. It was well protected in about three layers of cardboard and some expanded polystyrene, and there was a natty polythene dust cover-cum-packing material stretched over it. When we got our strength together to get it out of the box (it weighs about 30 pounds, so the carrying handle on the side is a great benefit) and put it on the editorial table, the first impression was of a good-looking radio with a well laid-out front panel and an

air of nice design about it.

The first job, of course, was to sit down and have a thorough read of the instruction book. We don't subscribe to the "if all else fails read the instructions" school of thought, because a transceiver is a fairly complicated animal and it is possible to cause damage if you haven't got the operation of it sorted out. This applies particularly to the transmitter side of things. The TS-830 uses a pair of valves in its final amplifier, driven by another one actually, so there are three of those splendid glass devices in the transmitter. Now valves are several times more rugged than transistors, but you can still inflict various nasties on the power amplifier stage if you don't tune it up correctly, for instance. Since it uses valves, the TS-830 has tuning and loading controls for the final amplifier stage, unlike its cousins which use transistors and which have "broadband" output stages. As we've discussed elsewhere in these pages, this isn't a disadvantage since broadband transistor final amplifiers aren't the whole story, and you'll find in practice — as we were to — that a valve final amplifier will cope with various forms of mismatching as far as the antenna is concerned rather better than the solid-state equivalent. It's swings and roundabouts really — you're 99 per cent certain to need an ATU anyway, even with a broadband output stage, and the extra two controls don't



really make a significant difference in practice. The only point is that you need to follow the instructions carefully so that you don't knock hours off the life of the valves when tuning up.

The handbook goes into it all very well, and we found that in practice tuning up became second nature. The handbook in general is very well done, with comprehensive instructions and all sorts of helpful operating hints thrown into it.

There's no trace of the strange "Japanese-English" which used to afflict handbooks from the Orient until relatively recently, and there are clear explanations of what goes where and which control does what. The section on maintenance and troubleshooting is good enough for basic maintenance although it isn't a workshop manual — here again, we'd hesitate to do major work on equipment such as this without access to some pretty decent test gear. The main distributors, who are Lowe Electronics up at Matlock, have an excellent reputation for servicing, and have a hundred thousand quids-worth of test gear for fixing Trio equipment — from what we hear they're very good at it and offer a pretty quick turnaround if your rig has gone horribly sick on you. There's a full circuit diagram right at the back of the handbook and, in common with every Japanese circuit diagram we've ever seen, you'll need a good magnifying glass to get much out of it! Mind you, this one is better than some others we've seen . . . We liked the block diagram a lot, and our technical bod spent a good half-hour poring over it whilst warming-up the test gear for his torture tests later on.

### Get the feel

So — before we let him loose on it, it was time to connect the TS-830 up to our tri-band antenna and have a listen round 15 metres to get the feel of the receiver side. The main tuning was a delight; it felt very smooth and stable, and it was no surprise to find some nice precision mechanical work in that side of things. As far as the receiver side is concerned, the TS-830 has all the usual controls — RF gain, RF attenuator, S-meter, etc — but what makes this rig an absolute delight from the handling point of view are some features that you don't find on all receivers by any means. We'll take them in the order in which we found them.

The first nice thing was the noise blanker. The idea of a noise blanker is to help the operator copy signals through interference which comes from such things as car ignition systems, faulty electrical equipment and the dreaded Russian "Woodpecker" over-the-horizon radar system which sometimes makes life extremely difficult on 14MHz. Several rigs have some form of this, but that in the TS-830 is a rather superior sort which has a variable threshold. This means that you can set up the precise amount of noise blanking that you need without losing too much of the signal, and we found in practice that it worked very well indeed. If it was wound all the way in, we found that the Woodpecker completely disappeared, which is no mean feat — no other rig we've tried can do that. The only slight thing here was that our technical wizard reported that the intermodulation performance of the receiver (that's a concept which describes how well it handles weak signals in the presence of strong ones, to simplify about 50 pages

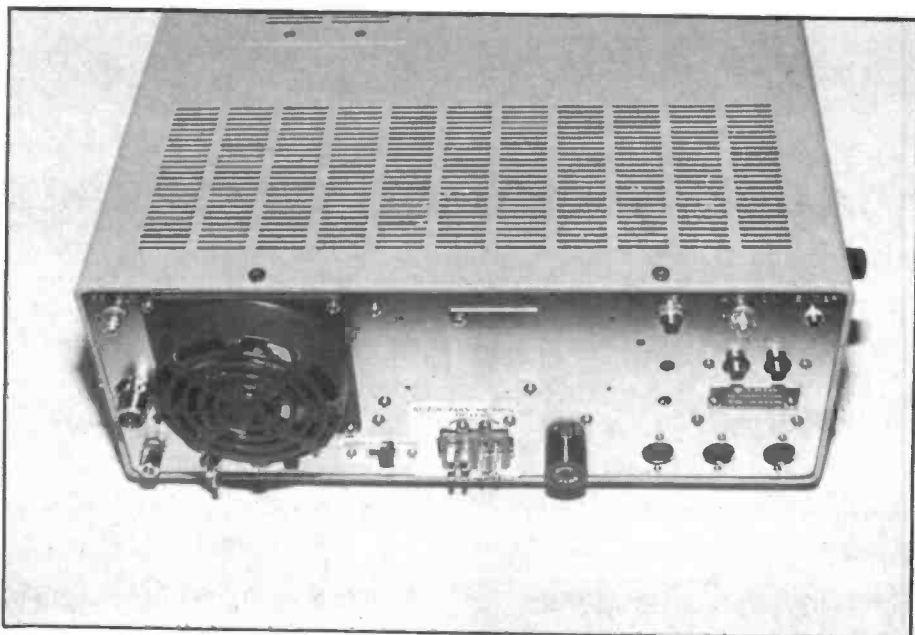
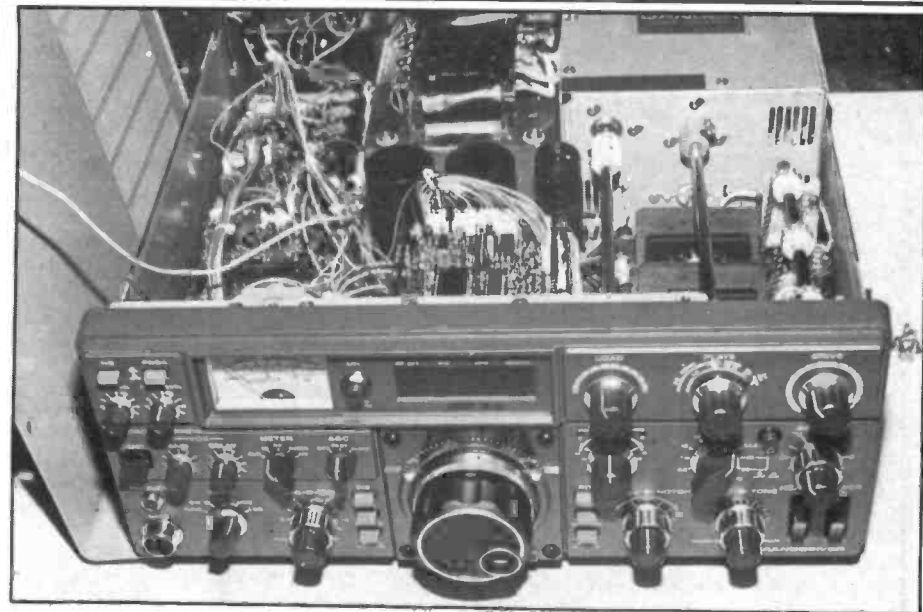

into two lines) was a bit worse with the noise blanker all the way in, but you'll find that most rigs suffer from rather degraded intermod. performance when the noise blanker is switched on because of the way it works. Since on most rigs you can't vary the blanking threshold you're stuck with it, but we discovered that the noise blanker barely affected the IM performance until it was almost fully wound up. We liked Trio's blanking circuitry — it's quite complex but it works very well indeed, so the devout 14MHz DX chaser will do well with this rig. While we're on the subject of signal handling, we evaluated the TS-830 on 7MHz, since this is the band you're most likely to need a good front-end on. The "third-order intercept" on the review sample came out as +1 dbm; if that doesn't mean a thing to you, don't worry about it! In the real world of radio waves, it's a reasonable performance; it's not super-outstanding but in practice it's very adequate to do the job. You tend to have to use rather exotic devices to get a really good front-end on any receiver, and in some ways it's more important that a VHF and UHF receiver has a high third-order intercept point than an HF machine. So we were quite happy with the TS-830's

*Top: the innards of the TS-830. Above: a look at the rear, showing the PA cooling fan and the plethora (disgusting!) of connectors.*

performance. We appreciated the S-meter calibration as well; it was a good deal more linear than several rigs we've seen and a reading of S9 on the review sample required exactly 50 microvolts on the 7MHz band.

The filtering arrangements are what make the TS-830 outstanding on receive, however. As well as both an IF shift control and a facility to adjust the IF bandwidth — which is doing the job properly, in our opinion, unlike some rigs which simply have a passband tune control — there's a notch filter for removing whistles from those idiots who will insist on tuning up 1KHz away from the frequency you've been on for the last half-hour. This works well, and we measured the depth of the null on ours as a whopping 40 dB down. This means that you could reduce the amplitude of an interfering tone by about 6S points! From an S9 signal to an S3 is extremely good, and in using the TS-830 on 7MHz during the daytime we found it extremely easy to use the notch control to zap the interfering

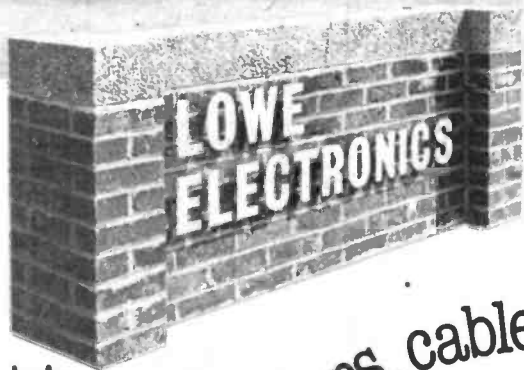

hf, vhf and uhf transceivers. aerials. rotators. cable. receivers. meters. etc.  
 for the best in amateur radio contact us.



#### The company

Founded almost twenty years ago by an individualist who placed emphasis on fair trading, good products and service to the customers before and after the sale. Now grown into the most successful amateur radio retail dealers in the country, with Headquarters in Derbyshire and new branches opening in major cities. Lowe Electronics endeavour to carry on the original concepts of its founder.

#### The products

We only deal in the best, and there is no doubt in our minds that the best in amateur radio comes from the Trio company. As sole distributors for the Trio range, we have built up a sure knowledge that Trio products represent the very finest engineering, coupled with a sensible programme of innovative design for the thinking radio amateur.

Coupled to the Trio range, the other products which we sell are all chosen on the basis of providing only the best for our customers.

From aerial plugs to complete stations, you buy with confidence from Lowe.

#### The people

Totally dedicated to serving you in the tradition of our founder, the staff combine knowledge of the products, a desire to help, and a real sense of humour in all their respective functions.

More a family than a company, anyone who has visited us will tell you of the real welcome you receive at Matlock from its members.

The technical backup is, of course, second to none. A continuous investment programme ensures that the workshop facilities are kept right up to date and each engineer is carefully selected by our Technical Director so as to ensure specialist knowledge available to you, the customer.

When only the best will do — Trio from Lowe.

CHESTERFIELD ROAD, MATLOCK, DERBYSHIRE, DE45LE. 0629 2817, 2430, 4057



# TRIO TS-830

nitwit who was tuning up. A little LED comes on to remind you that it's in circuit.

We could write heaps of words about the receive side of the TS-830, but there isn't the space — suffice it to say that we were highly impressed with it and, unlike some rigs, it *felt* nice to use. We found that it took about two hours to get the feel of the beast and sort out what the filters and so on could do for us, and we worked just over 80 stations with it during the review period. The best DX, by the way was an 8P6 on 7MHz and TYA11 in Benin (what an odd callsign he has — the story goes that the authorities thought he was applying for a commercial licence instead of an amateur one, and issued him with that distinctly odd callsign. He's perfectly legal, and pretty rare), as well as miscellaneous VKs and ZLs. One gotaway was an XT2 — grrr. Ah well — it wasn't the rig's fault, we just couldn't crack the pile-up before having to go to work!

So — how about the transmitter? First off, we measured the output power on all the bands, and it came out at between 110 and 120 watts when switched to CW. This, of course, is more than you're allowed in this mode, but you can use the "carrier" control on the rig to set it up to the magic figure of 20 dBW (or 100 watts in ordinary language). On Top Band, indeed, you're supposed to use 9 dBW, or 8 watts, and you can indeed set up the legal level very nicely with the carrier pot. It's important to stick to the rules on Top Band, since it's shared with all sorts of other services and we don't want to cause problems for signals which might be a little bit more important than the fact that your mate is S9 plus 20 with you and that it's a nice day in Bridlington or whatever. Various coastal and maritime stations use Top Band, and indeed they're the primary users, so always play the game and don't run more power than you're licensed for — it could just be someone's life you're messing about with.

## The harmonics

Anyhow — our next step was to have a look at harmonics and other odds and ends which transmitters can produce. Our TS-830 was pretty sanitary on all bands bar 18MHz, and the reason for that is bound up with the design of the set. The final intermediate frequency in the TS-830, as it is in several other rigs, is around 9MHz and you can't really get good rejection of the second harmonic of it. We measured the spurious output on this band at -43 dB, which our king of the test gear thought wasn't too bad under the circumstances, and when he saw the circuit initially there was much head-shaking and dire prophecies of terrible things on 18MHz but it wasn't so. The part of the circuit in question is called the "balanced modulator" and Mr Trio seems to have done his homework all right. One suspects that when we get the 18MHz band the power limit will be pretty low anyway, so there'll be microwatts coming out as a spurious. (We're getting it from October 1 — Ed.)

Anyhow, back to the salt mine. The classic test for an SSB transmitter is known as a "two-tone" test (something

tells me we'll have to do an article on what all these things mean) and we applied said test to our TS-830. Basically, this test tells you something about how linear the final amplifier stages are, and you often find that a valve PA stage is rather better than a transistor one. The Trio was no exception, and its intermod. performance on a two-tone test was really good. It's rather interesting that the RSGB's magazine, *Radio Communication*, reviewed the TS-830 a couple of months ago, and they found that the transmitter's performance under two-tone conditions got markedly worse after an extended period. We didn't find this at all with our one, and the figures on the analyser stayed pretty much the same throughout the transmitter tests. We also got rather more power from our sample at the same intermod. level so we imagine that there was something a bit odd about the one they tested. Their man Peter Hart, certainly knows what he's doing — don't get us wrong — so we think that the one the RSGB reviewed was something of a rogue. It must be the London air!

## Good audio

Anyway, enough of the figures — how did it perform on the air? Very well we found, and everyone we asked told us that the audio sounded very good and that the transmission was extremely clean and narrow. A "narrow" SSB signal implies good intermod. performance in the PA (please don't confuse this with the intermod. performance of the receive side, by the way — it's a rather different use of the term, although it means almost the same insofar as both are to do with the linearity of whatever stage it happens to be), and it also means that you don't cause trouble to your fellows on the band. The speech processor worked well, and we found that all the DX we worked preferred the signal with the processor in and that all the locals on 80 metres with S9+ signals preferred it out. Which is just about what you'd expect. We found ours very easy to

load and tune up — here again, the RSGB found their one a bit odd in tuning up on the HF bands but ours was no problem at all, so we'd guess that something was amiss in the PA of their one.

## Verdict

So what's the overall verdict? You can have one for £694, and you certainly get a lot of radio for your money. The filtering arrangements on the receiver are second to none except professional receivers costing about ten times more, and they work extremely well; in fact, we'd much rather have a rig like this than some which cost twice as much because you don't get a receiver which performs twice as well for the bread. The TS-830 spends the money where it matters — there isn't a superfluous control on the front panel, and it does all the things an HF transceiver should do very well indeed. By absolute standards, the receiver's front-end performance could bear some improvement — you tend to find that you have to switch the attenuator in on 7MHz rather a lot — but in fairness we didn't come anywhere near losing any signals because of that! It's always interesting to compare what you measure in the lab. with what you actually find when you use the wireless, and we feel that nice handling and a feeling that the rig will do anything we ask of it is worth several dbm in the "third-order intercept" stakes! The nicest compliment we can think of for the TS-830 is that we'd like one ourselves — which certainly isn't the case with many rigs we've used in the last few years.

*A good look at what's inside the grey box (did we say Volvo? Should have been Mercedes . . .) of the TS-830. The PA compartment is at top right, and the mains transformer on the left of that. The main smoothing capacitors for the HT rails sit below.*

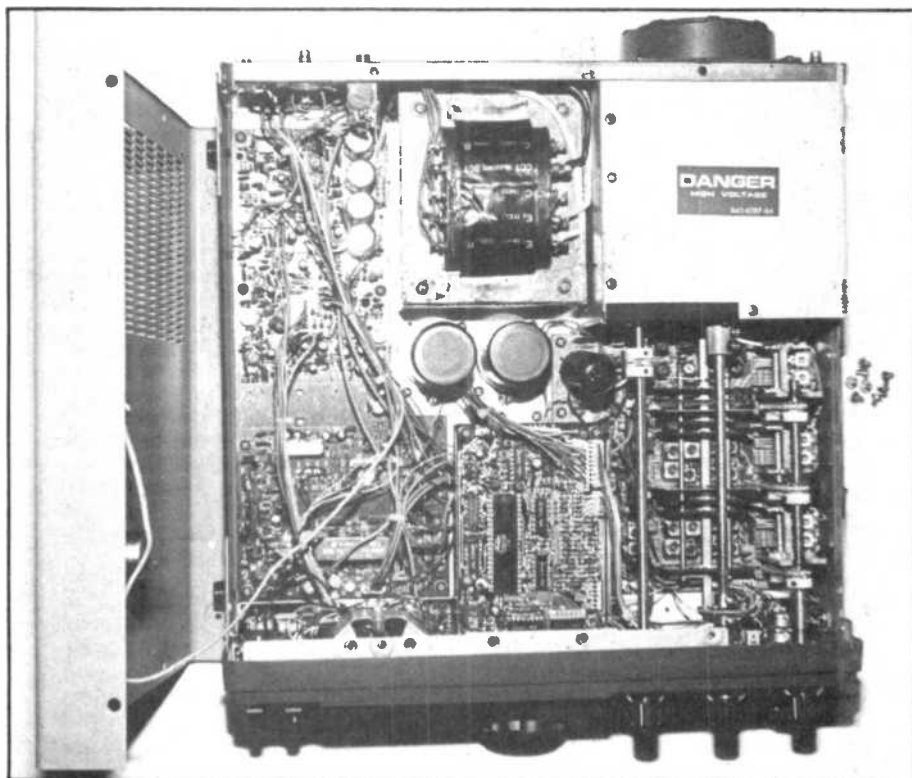

# THE AMATEUR

... what you can and can't do, what about.

From what we hear on the air, and from some letters we had following the last (and first!) issue of the magazine, it seems that there are a few misconceptions about exactly what the amateur licence allows you to do. By way of trying to clarify some of them, we offer an analysis of the amateur's licence as we see it — we stress, however, that this isn't official and that we're open to correction (no, adjustment . . .) if we're wrong!

The licence falls into two parts; the licence itself and the schedule. The first page of the licence says that one may establish in the United Kingdom an amateur sending and receiving station for wireless telegraphy; "telegraphy" in this context doesn't only mean Morse, of course, but all other modes (mentioned later on in the schedule). The station may be established at the address written on the licence, which is normally your home address or your normal place of residence, or at a variety of others which we'll come to in a minute.

If you're operating from the "main address" you use your callsign as written on top of the licence, eg G6ZZZ. Two other "addresses" you might want to operate from are "temporary premises" or "alternative premises" and amateurs sometimes get these mixed up. "Temporary premises" or "temporary location" might be, say, a friend's house or a holiday cottage or indeed the top of a hill in a contest. If it's the friend's house, etc, you use the callsign "Stroke A", eg G6ZZZ/A, and the licence states that you must send the address of it every fifteen minutes or at the beginning and end of every contact you have.

We've never in our lives heard an amateur who is "Stroke A" doing it, and according to the licence we must do this — presumably so that if we were causing interference to other services we could be asked to close down. The same is true if you're up on top of the hill in a contest, except that in this case you sign "Stroke P" instead of "Stroke A", eg G6ZZZ/P. Most of us say "G6ZZZ portable".

The difference between temporary premises (/A) and temporary location (/P) seems to us to be whether the station is being run from a mains supply in a house or a generator up on top of a hill, although if we were using a hand-portable in our friend's lounge we suspect we'd sign Stroke A. Perhaps it's simply whether or not you're surrounded by four walls or not that make the difference between /A and /P.

There are also "alternative premises" which, confusingly, are nothing to do with "Stroke A". In this case, provided you

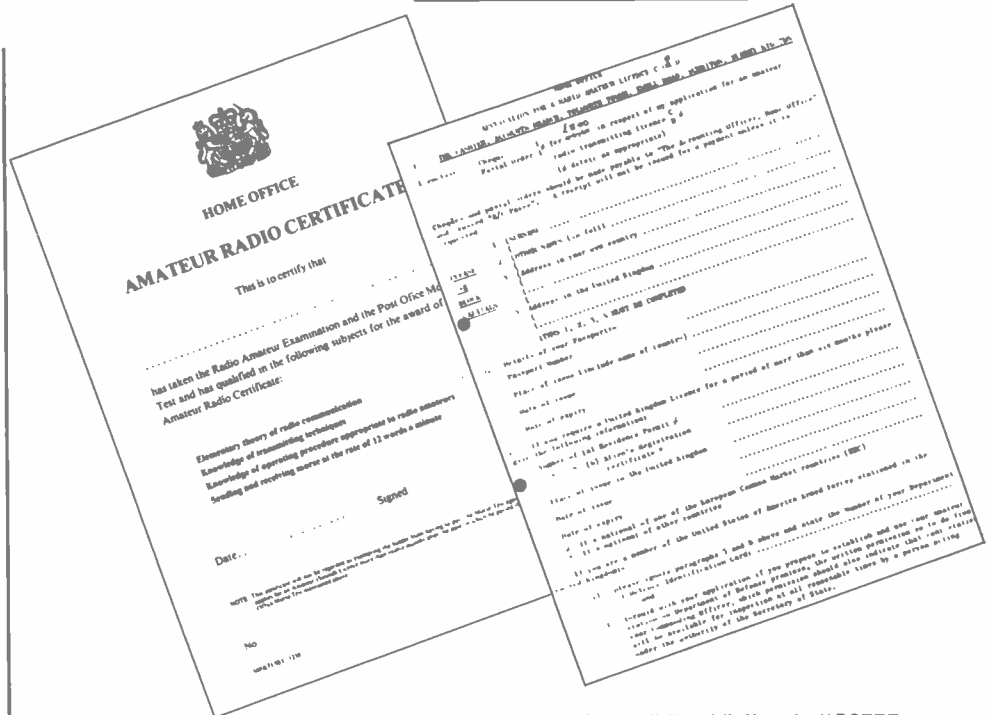

notify the General Manager of the Post Office Telephone Area in which you propose to run the station at least seven days before you want to start, and also tell him when you've finished your stint there, you don't have to use any suffix at all. A case where you might use this facility could be if your station was registered at your home address but you were at college in another part of the country for six weeks or so at a time. You could notify the local General Manager of the telephone area and just use G6ZZZ or whatever it was in the usual way. Here again, presumably this is so that any interference complaints can be traced to the source.

## Going portable

You must not operate Stroke A or Stroke P for more than four consecutive weeks from the same place, by the way, so if you were going to college, for instance, it'd be a good idea to notify the man that you were going to operate from "alternative premises."

It then says that you may establish the station in any vehicle or vessel but not on the sea or within any estuary, dock or harbour. In other words, you can use your rig in whatever form of road transport you like and also in something like a narrow-boat on a canal or a pleasure cruiser bowling down the Thames on a nice day. In both cases you sign "Stroke M", which

most of us call "mobile" as in "G6ZZZ mobile". It seems you can't establish your station on a cross-channel ferry, for instance, or on the hovercraft going between Portsmouth and the Isle of Wight, which is fair enough. It says later on that you can't use your station in an aircraft or a public transport vehicle, so this rules out chatting to your mates from the top of a London bus or from a train — actually, it would also eliminate the cross-channel ferry and the hovercraft come to think of it, even if they weren't on the sea, because they're public transport as well.

All of which is fair enough, and common sense when you think about it. One man in the office is a keen glider pilot, and he laments the fact that there isn't a facility for using a hand-portable in his glider. You can in some countries but in the UK it's not allowed because of the possibilities of interference to aircraft radios and so on.

So, having sorted that lot out, what can you talk about? The licence says "matters of a personal nature in which the Licencee, or the person with whom he is in communication, has been directly concerned" — this is part of using the station "... as part of the self-training of the Licencee in communication by wireless telegraphy". This is the best part of the licence because it's what amateur radio is by doing it.

It goes on to say that "no message which is grossly offensive or of an indecent or obscene character shall be sent", which

# LICENCE...

from where, to whom, with what, and  
By Peter Dodson.

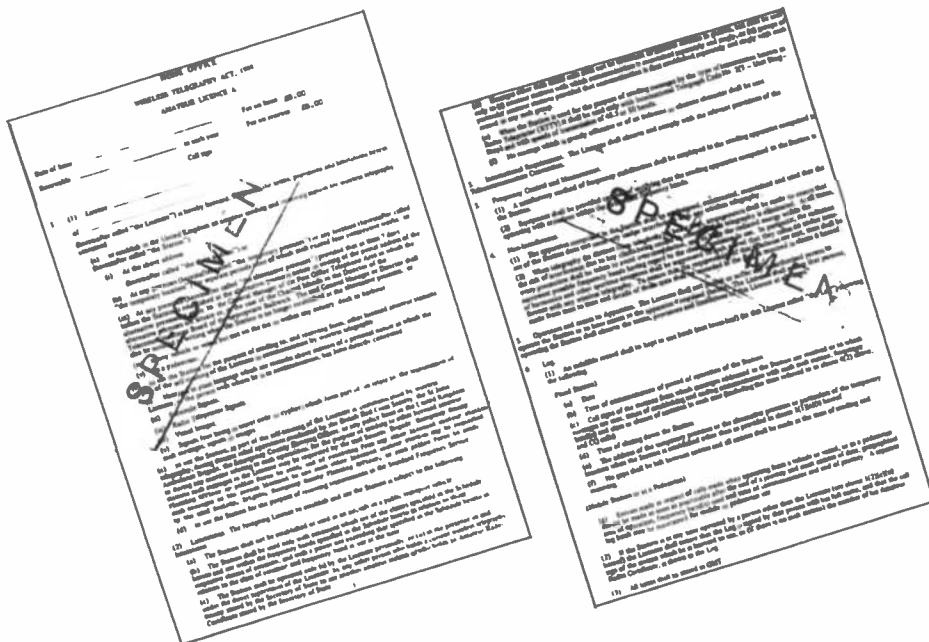

is self-explanatory, and also that "nothing in this Licence shall be deemed to authorise the use of the station for business, advertisement or propaganda purposes . . . or on behalf of . . . any social, political, religious or commercial organisation."

In other words, you must not use amateur radio as any sort of extension of your business, or discuss anything which could sound like advertising. We tend to interpret that by not mentioning, for instance, the names of dealers on the air — we would tend to say, for instance, "a dealer in Matlock" rather than "Lowe Electronics". May be that's unnecessary but that's what we have to do.

The "matters of a personal nature" seems to mean more or less anything; most amateurs seem to use their common sense and don't go into how charming their girlfriend is on the air, for instance! The words we've just quoted above seem to rule out religion and politics and that's probably just as well: somehow the amateur airwaves don't seem the right place to start an argument with someone about the merits and demerits of the Liberal-SDP Alliance, for instance.

The traditions of amateur radio have been established for a long time, and most amateurs play it as though half a million others are listening to them, which is fine; if you want to have extremist arguments, go down the pub and have them, seems to be the moral of that one.

Most of the rest of this part of the

licence is clear enough — there are one or two things implicit in it, however, that we can have a look at. Class B licencees can't use Morse or bands below 144MHz from their own stations; however, as we read it, there's nothing to stop a Class B licencee going round to his Class A friend's house and using his station on all bands and with Morse if he wishes. He would have to use the Class A man's callsign and, in accordance with Clause 6 (2), he must sign the logbook at the Class A station with his name and his Class B callsign, on the lines of "station operated by Fred Bloggs, G6ZZZ on 1 January 1985". This could be a very good way of getting experience on the HF bands and also some Morse practice for real; it's a facility that isn't used enough, it seems to us.

## Crossband?

A Class B licencee can work "cross-band" on the bands he's licenced to use; in other words, G6ZZZ could talk to G4YYY on 144MHz and listen to him on 432MHz. However, he can't, as we see it, talk to him on 144MHz and listen to him on, say, 3.5MHz or 70MHz because a Class B licencee isn't licenced to use those bands. This isn't specifically stated in the licence, but the spirit of it seems to us to be that you "use" the bands you're licenced for only, in the sense that you only receive on them as well as transmit on them. Having said that, of course, Class B

licencees can and do use 29MHz as the downlink band from some amateur satellites, so this is a bit of a grey area.

We've heard one or two local stations going crossband to CB operators on 27MHz, and this doesn't seem to be on to us at all. Clause 1b clearly states "to use the station for the purpose of sending to, and receiving from, other licenced amateur stations", and CB users aren't licenced amateur stations. It seems to us that the only stations you can talk to are genuine amateurs — in other words, you're in breach of the terms of your licence if you talk to pirates or to CBers on 27MHz crossband. Which is fair enough. You wouldn't go crossband to any other radio station, so we can't see why amateur/CB crossband is any different.

So, that's our brief look at the licence. The schedule is more or less self-explanatory except that power is measured in dBW which might be a slightly unfamiliar unit to some. You won't find it in the RAE, for instance! Since it refers to a power level at the antenna, also, you could presumably have a very large linear amplifier to make up for feeder losses on VHF and UHF — if you had 6dB feeder loss on 432MHz, for instance, presumably you could quite legally have a linear amplifier producing 1.6kW of RF output to produce the 400 watt (or 26dBW) level at the antenna. Or do the Home Office mean 26dBW at the input to the antenna, ie the feeder itself? It isn't clear to us, but maybe we've missed something. We have written to the Home Office to ask them, but we hadn't received a reply by press time so we'll have to leave you in suspense. . .

There it is. The amateur licence in the UK is really quite unrestrictive — there's no restriction on your antenna, for instance, and provided you stick to the terms and the spirit of it you can have an enormous amount of fun. One last tip is that, if you're mobile, it's a nice idea to carry a copy of the front page of it around with you. It isn't so bad now but before CB was legalised, staff members were stopped no less than seven times by police who wanted to know what the antennas all over the car were! The police were no problem and didn't hassle us at all — once we showed them the licence and the driving licence they soon got the idea, and in fact one of them turned out to be a keen short wave listener himself.

It's a pity that the licence itself isn't a bit more official-looking, because we've heard of a few cases where the police thought it was a forgery — however, with the legalisation of CB they haven't stopped any of us in the office for a long time now. It won't hurt a bit to carry a copy of the first page, with your name, address and callsign on it, just in case anyone does want to know what it's all about.

Right — speak to you on the air!

# Build a VHF dual wattmeter

Heathkit are an old and much-respected name in the electronic kit world; building from a kit, which contains everything down to the last nut and bolt, can be a fascinating halfway house between buying a commercial piece of equipment and building from scratch.

We thought we'd take a look at a typical piece of Heathkit equipment that a novice might like to assemble, and we gave it to a "typical enthusiast" to build and try out. Here's what he made of it.

Since I spend part of my working day assembling electronic equipment for a leading electronics company, I was intrigued to have a go at a Heathkit project, which in this case turned out to be a 50-175 MHz power meter.

It is somewhat different from the run-of-the-mill power meter-cum-SWR bridge in that it not only reads continuous power, such as you would get from an FM transmitter, but it has a "peak-reading" function, so as to be able to measure peak envelope power from an SSB transmitter. In the UK it would be useful for the 70 and 144MHz bands, and of course a 50MHz band if one is ever allocated, and has two ranges which read up to 30 watts and 300 watts respectively.

Since the UK licence specifies a maximum power of 400 watts on SSB (peak-envelope power, of course, not DC input!) it's a slight drawback that one cannot use the Heathkit unit to be certain that one is not inadvertently exceeding the licenced output power on SSB. However, many amateurs are quite happy to use less than 400 watts on 144MHz, and of course the power limit on the 70MHz band is lower anyway.

The wattmeter incorporates an SWR measuring circuit, and one can either read reflected power directly in watts, as on a professional power meter such as the Bird series, or it may be read in terms of standing wave ratio. A slightly unusual feature is that the unit incorporates a remote sensor into which the input from the transmitter and the output to the antenna plug in. This can either be part of the unit itself or sited up to four feet away from it, with the output from the sensor head taken to the instrument via a five-way cable.

This feature could be useful if the transmitter was sited away from the main operating position, and would avoid running coax at longer lengths than one might otherwise want to. Since the leads from and to the remote sensor head are well decoupled with respect to RF, there would seem to be no reason why the cable could not be extended if necessary, although this would mean breaking a seal on the sensor head, which, it says, would void the guarantee. Presumably, this is because the sensor head itself is calibrated at the factory so that one does not have to set the unit up against a professional

Build it yourself. It is a combined power meter and SWR bridge, and it does both rather well. Designed primarily for the radio amateur, the Heathkit HM-2141 measures both forward and reflected power for frequencies between 50 and 175MHz.

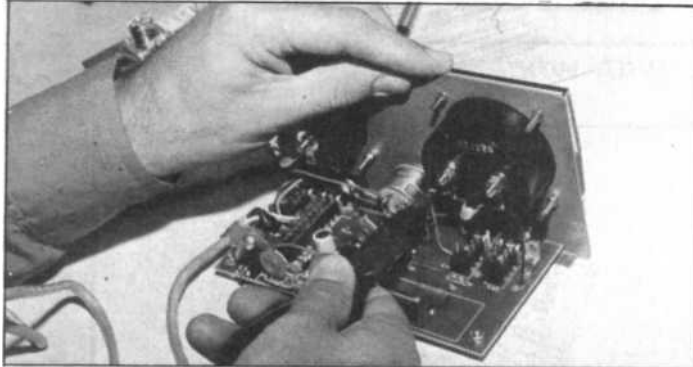

drawn circuit diagram which even told you which way the preset potentiometer on the circuit board had to turn, and a large sheet which gave instructions on how to solder and how to read colour codes on capacitors and resistors. Having been doing both for about 30 years, I thought I didn't have to read it, but it was very well done. It made all the right points about soldering and how to recognise good solder joints as distinct from bad ones, with some nice illustrations.

So, having bashed my way through the paperwork, I laid out all the bits and got stuck in. Heathkit used a "step-by-step"

power meter of known accuracy; this is a boon, and is typical of the thoughtful and thorough approach I was to find in the unit.

The HM-2141 arrived in a small box, which greeted me at home after a particularly difficult day trying to sort out why £40,000 worth of exotic test equipment which was due for delivery next week wasn't doing what it was supposed to, so I didn't feel like getting the soldering iron out! However, after tea, I opened the box and laid out all the bits on the kitchen table. My first impression was the comprehensiveness of it all; every single bit, down to the last little lockwasher, was there, and the quality of the metalwork forming the front panel and cabinet was definitely a cut above the usual simple power meter/SWR bridge.

The meter movements looked good too — the scaling was easy to read, and an inspection of the meter movements themselves showed that they were of much better quality than usual. Meters are odd things, and meters which cost the same in the shops are often very different from one another in terms of manufacturing accuracy. The movements even had little spring clips across the terminals to short them out and hence protect them during transit — that's another bit of attention to detail which augured well.

So all in all, I couldn't resist it. Heathkit supply an enormous amount of paperwork with the kit; the assembly instructions themselves, another book of pictorial diagrams for every stage in construction, a complete parts list, an extremely well-

assembly method, and there's a little space left for you to tick off when you've done it. The first job was to mount all the components on to the printed circuit board; the latter was well made and, rather surprisingly, made of glass fibre rather than the cheapest SRBP you often find in electronic circuitry for the amateur and domestic market. SRBP, which stands for Synthetic Resin-Bonded Paper, is adequate for some things, but you won't find it in professional equipment, and in the case of equipment such as the HM-2142 which is meant for portable as much as fixed-station use and likely to find itself in the field, as it were, on a contest, the strength and insulation resistance of glass fibre is most welcome. The top of the board was clearly marked with all the component identifications, and the various holes for wires to be soldered into were also labelled to tie in with the instructions.

I really didn't see how I could go wrong! There were small pictures and drawings of where everything had to go, and it was just like a slightly superior jigsaw puzzle. You didn't even need to know, or refer to, the colour code for resistors because they were all spelt out for you in the text, and arrows pointed to the locations on the PCB where they had to go. Since the PCB itself has the component identifications marked on it, you could cross-check these with the numbers on the instruction book and that was that. When I got to the top of page 14, for example, the step said "R19: 15k (brown-green-orange)" with an arrow showing where R19 was located on the PCB with respect to the other components.

## Soldering technique

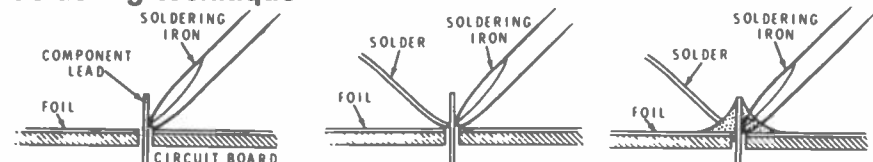

1. Place the soldering iron tip against both the lead and the circuit board foil. Heat both for 2 or 3 seconds.

2. Then apply solder to the other side of the connection. **IMPORTANT:** Let the heated lead and the circuit board foil melt the solder.

3. As the solder begins to melt, allow it to flow around the connection. Then remove the solder and the iron and let the connection cool.

Another nice touch was that if the instructions called for a 3in wire, for example, you didn't have to get up and find a ruler. Heathkit even provide you with a scale on the appropriate page so that you can measure wire lengths without wasting time.

The PCB was finished in about an hour, after a stop for some photographs and a cup of coffee or two, and it was then time for the "circuit board checkout". Having got a feeling for Heathkit's scrupulous accuracy as far as component quantities were concerned — there were the right number of resistors, diodes, nuts and bolts and so on — I was initially a little disturbed to discover that I had two small capacitors left over and I spent about five minutes looking all over the PCB for where they ought to go. I couldn't see anything, so I thought they'd just slipped in a couple of extra ones in case, but it seemed out of character for the manufacturers and I fretted a bit until the penny dropped a little later. They were for connecting across the meters to decouple them from the RF point of view, and it said as much quite clearly on page 22. I resolved to trust Mr Heathkit from then on, and awarded myself the Gumby Prize for Idiocy.

Still on the subject of the PCB, the underside, or track side, was nicely coated so that all that was exposed were the points which were for soldering. Another bonus point. I did go a little further than the instructions insofar as I defluxed all the solder joints with Arklone before the next stage of the assembly, for two reasons: it's standard procedure in the professional world anyhow, and I couldn't kick the habit.

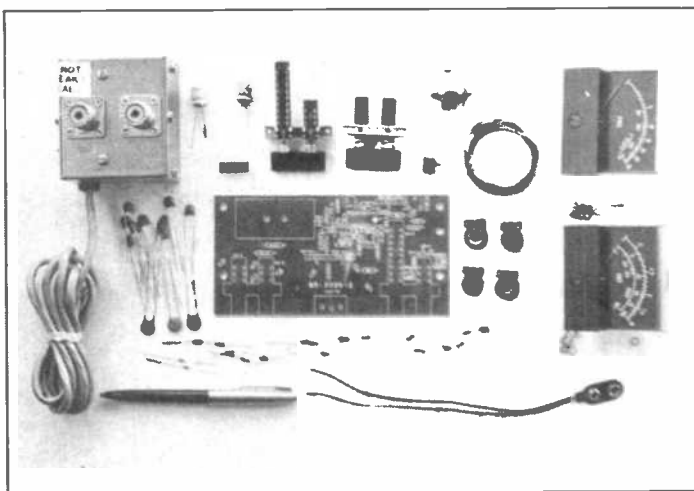

The internals of our Heathkit VHF dual wattmeter laid out on a clean table. Included in the kit is the casing, comprehensive how-to-do-it manual (42 pages) plus the necessary nuts, bolts and screws in see-through bags.

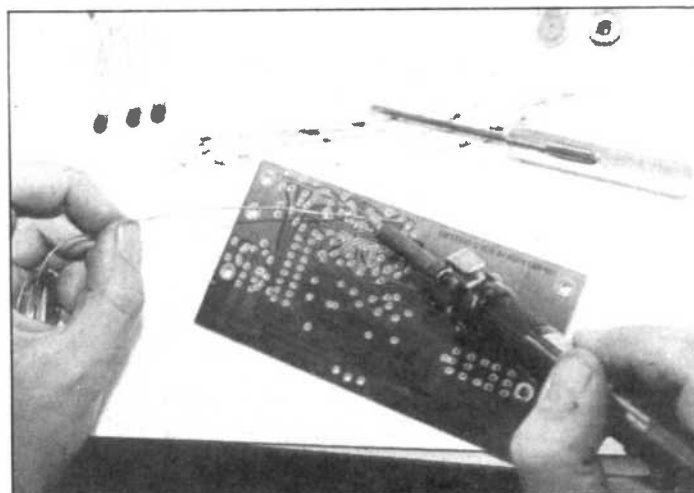

After sorting everything into neat divisions, we finally get to the ceremonial soldering on of the first component, a diode, to the printed circuit board. Note that a diode will not work if it's installed backwards. They are clearly marked with coloured bands.

### Connecting a diode

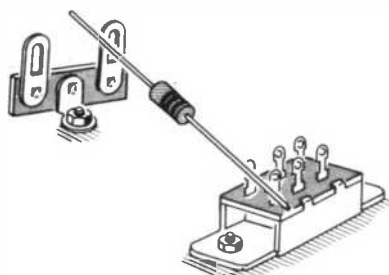

1. Cut the leads to the proper length.

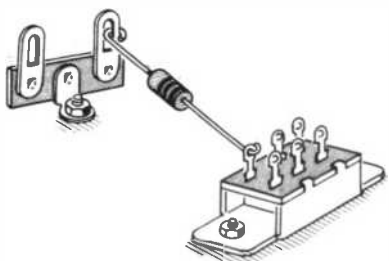

2. Fasten the lead ends.

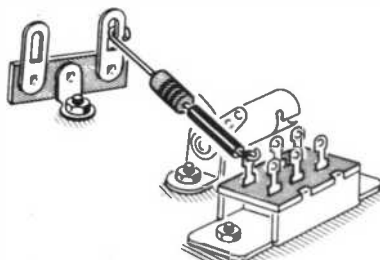

NOTE: Use sleeving when it is called for to provide insulation.

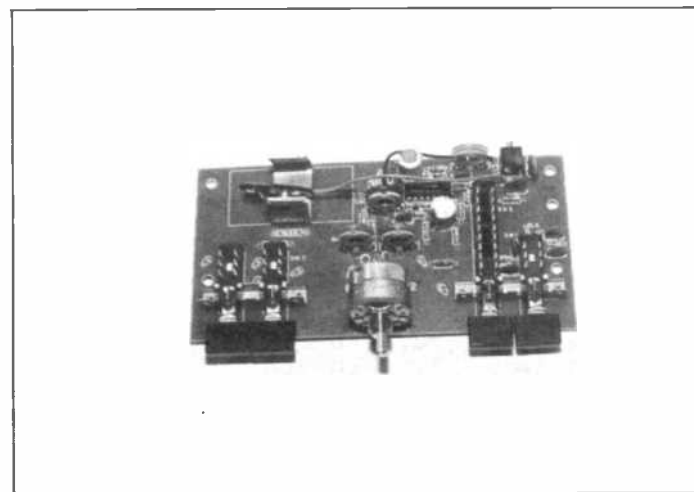

The completed PCB. Trim off any excess lead lengths as you go. Note the neatness of the arrangement. When soldering, don't melt or burn the insulation. Also, keep the soldered joints neat, smooth and shiny. A bad joint could cause problems later.

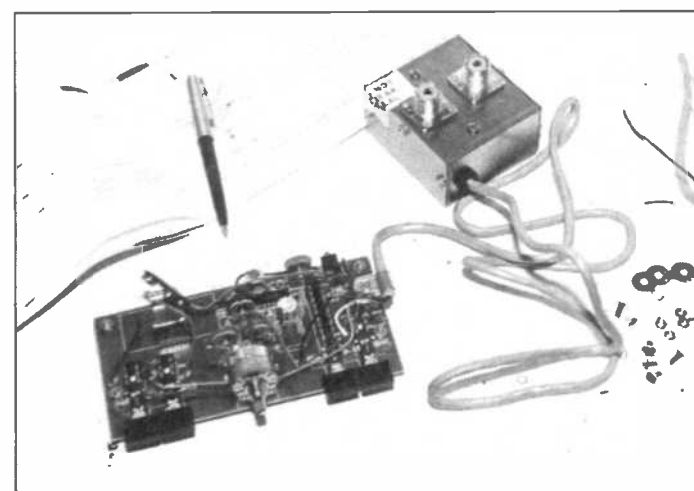

Finished PCB with remote sensor attached via 5-wire cable of the correct length. Check out the circuit board for unsoldered or poor connections, leads that could touch each other, proper installation of capacitors, ic, and of course, the diodes!

# Build a VHF dual wattmeter

The solder itself was rather more "fluxy" than the Savbit I often use and there was quite a lot of flux around the joints. Over a period of time this can change the performance of equipment because it attracts dust, which can form a high resistance path to somewhere it shouldn't, and also it isn't a perfect insulator anyway. So it's good to remove it.

Anyhow, the next job was the mechanical assembly, and here again the instructions were clear and easy to follow. There are well-drawn pictures in the manual and one can even double-check that the correct nuts and bolts are being used in the right place. The only slight problem I found was that, being of American origin, the manual uses terminology such as a "6-32" nut and a No 6 lockwasher instead of the more usual British BA series. However, the manual made things extremely simple, and in the event a 6 BA nut-runner seem to fit a 6-32 nut perfectly well. I suppose that, since we're all metric now, we'll all have to learn exactly what the M series nuts and bolts are. We still work with BA hardware at my place of work, although we're scheduled to change next year. Presumably then, we'll all be talking about an M6 bolt instead of a 6 BA one!

Having completed the mechanical assembly, it was time for the tests and adjustments. Here again, these were very easy, and I'm proud to say that my HM-2141 worked first time. Calibration consisted of setting preset potentiometers for zeroing the meter movements and for equalising PEP and average power readings, and took about five minutes with the aid of the 144MHz multimode transceiver in the shack and a dummy load. That done, I thought I'd use it for an hour or so before bed, just to see how it felt in service.

A couple of local QSOs later, I was impressed. I didn't have any means of checking the accuracy of the power meter in the shack but the figures it was coming up with looked about right, with 14 watts average power on FM from the FT-225 and 24 watts PEP on SSB. In use, it was very easy and I was pleased with it.

Just to round off, I took it to work next day and compared it against a professional power meter in the shape of the Bird "RF Analyst". This is an extremely good unit, and I'd love one in the shack, but at about a thousand dollars it isn't really on; our unit was recalibrated recently and is within about 0.4 per cent accuracy.

On 144MHz into a 50ohm dummy load, the HM-2141 was within six per cent of the Bird on its 30 watt range, and indeed consistently read some four per cent low except at the 30 watt level itself, when it became six per cent low.

On the 300 watt range, or at least up to 260 watts which was all we could muster, it read within three per cent of the Bird all the way, which is an extremely good performance for a simple power meter using uncomplicated circuitry.

This, of course, was into a dummy load, which must have (or should have) displayed a consistently low SWR. I did intend to have a look at the accuracy of

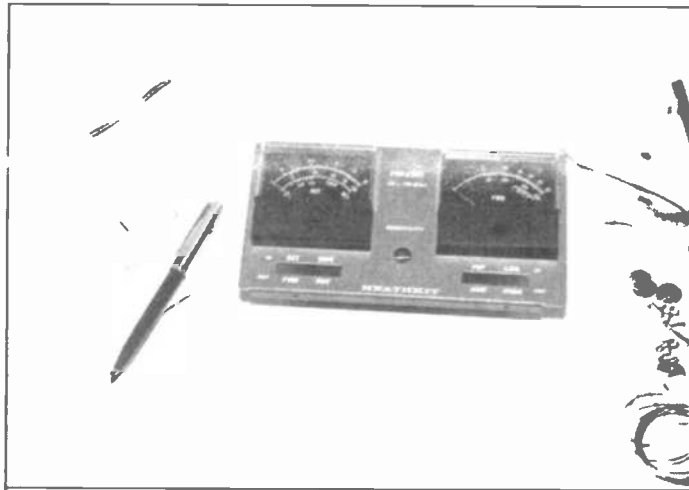

Now to the front panel, and here the two meters have been fixed into position (note the instructions) with eight small nuts. Take care not to scratch the panel and meters by placing a cloth on the table. Don't pinch any wires between the PCB and panel.

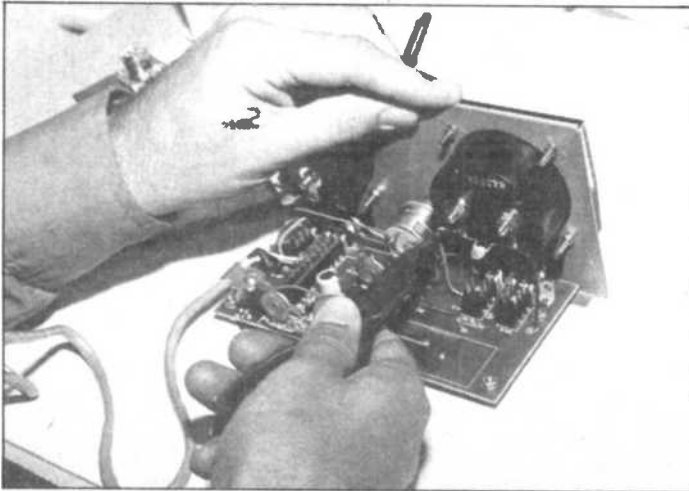

The front panel bolted to the PCB, and here the wires have been soldered between the meter and switches. Pointed nose pliers are being used to make a tidy job of the wiring. At this stage you'll need a battery and the required type is a nine-volt.

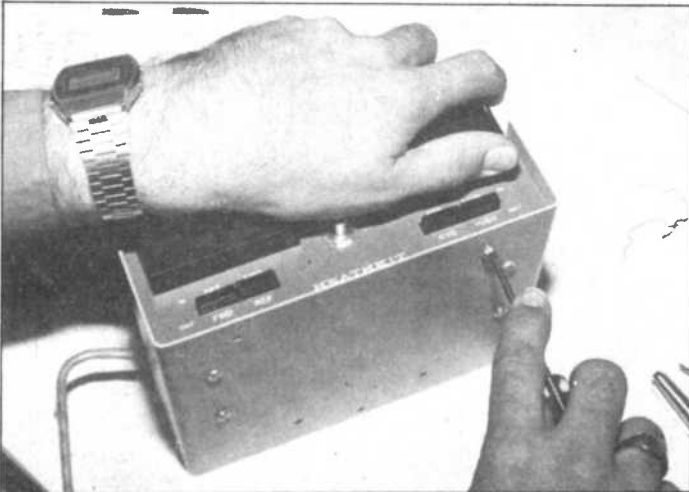

Getting towards the end now, and here the front panel is bolted to the bottom of the cabinet. Again, make sure no wires are caught between the various components, and coil the sensor cable and push it into the cabinet at the side of the sensor assembly.

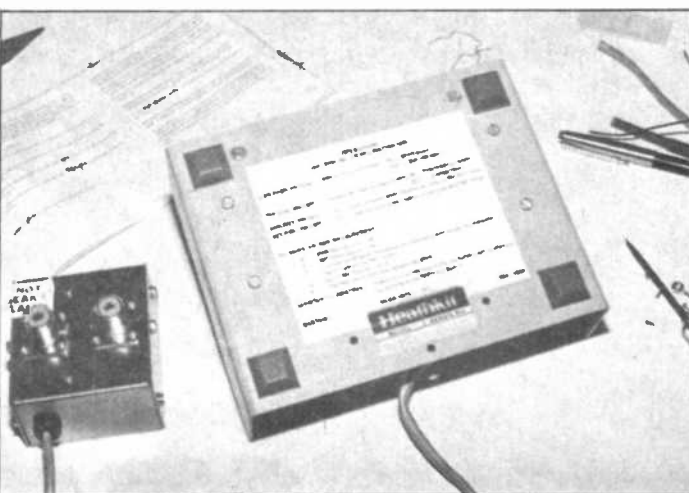

No, they're not bits from a bar of chocolate! They are the feet which simply push onto the base of the cabinet. By the way, you also have to stick the instructions and serial number to the base yourself. No mollycoddling by the manufacturers!

Rear of the HM-2141 with the remote sensor bolted into place. The completed unit weighs around four pounds, and is 7½in wide, by 4½in high, by 6¾in deep, just so you can design it into your existing array of equipment.

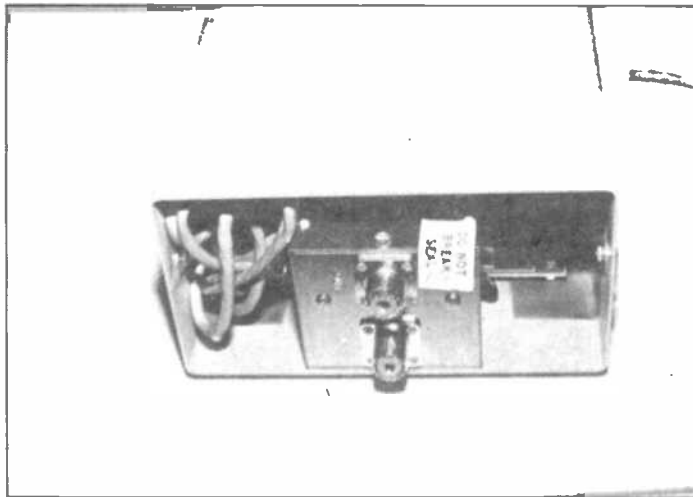

Finished, apart from the checking procedures. The knob here is being pushed onto the sensitivity control unit. The Heath manual recommends a number of checks and tests, and a troubleshooting chart with probable cures for various problems is provided.

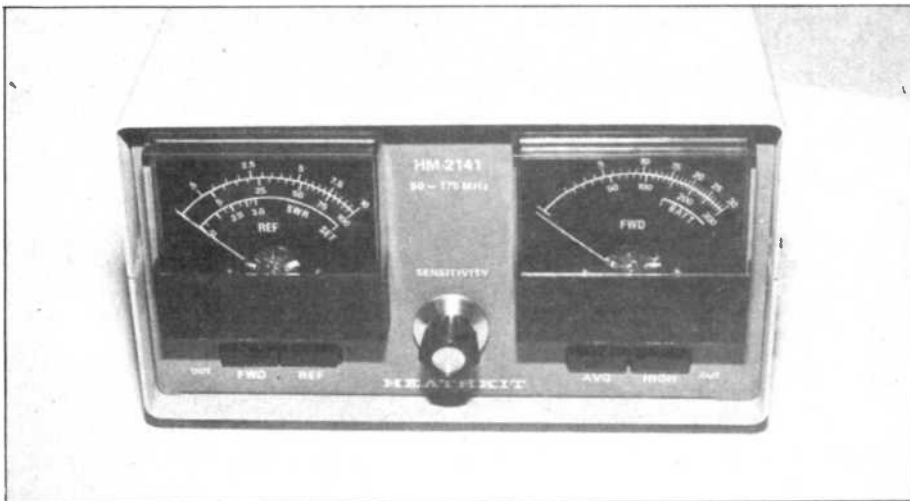
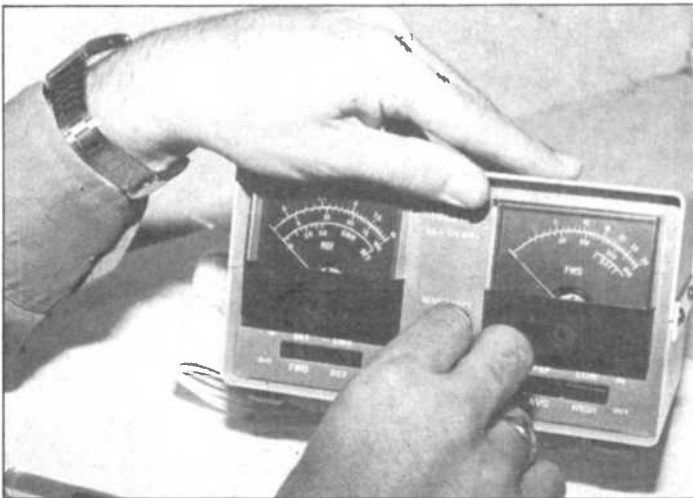

2. Hold the resistor as shown and bend the leads straight down with long-nose pliers to fit the hole spacing on the circuit board.

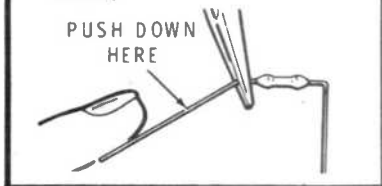

3. Push the leads through the holes at the proper location on the circuit board. The end with color bands may be positioned either way.

4. Press the resistor against the circuit board. Then bend the leads outward slightly to hold the resistor in place.

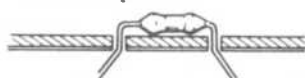

the Heathkit meter from the power point of view into an SWR which was different from unity — ie more typical of a real transmitter working into a real antenna — but there wasn't time in the end to do that. Theoretically, this type of power meter can give erroneous readings if a high SWR is present on the transmission line and it would have been interesting to have had a close look.

All I could do in the time was to compare the HM-2141 and the Bird when using the FT-225 into a mobile whip with an SWR of about 1.8 to 1; both of them agreed that the SWR was 1.8 to 1, which was a good start, and the power readings were much the same in that the HM-2141 read about four per cent lower than the Bird.

Overall then, the HM-2141 was impressive. It looks good in the shack and, as I said at the beginning, it's definitely a cut above its Japanese equivalent in the shops. The components were of good quality and the circuit design itself looked good, using a quad op-amp as the heart of the electronics in a simple and elegant way. Accuracy, certainly under the conditions in which I tested it, seemed perfectly adequate. Measurement of RF power and SWR is not particularly easy at the best of times, and the HM-2141 would be a good addition to the average amateur shack.

It's a pity that it can only be used on two bands in the UK and that the power limit on one of them is higher than the highest meter range. Given that the HM-2141 costs £88, which is a good deal of money, one has to ask oneself whether it is worth it.

It all depends how you look at it. Certainly one could obtain a commercial power meter and SWR bridge for a good deal less than £88, although it wouldn't be able to read PEP on SSB signals (according to the licence you're supposed to do this with an oscilloscope, anyway). It is a quality product, especially if it's well made, and there is excellent after-sales service in case you've made a mistake. I tend to feel that although £88 is expensive on the face of it, you're also getting an opportunity to see how electronic equipment is made in the most painless way and for the novice that's almost priceless.

There's also the fact that there's a little bit of you in it — the feeling of "I made that myself" is a good one, and the corollary is that after you've finished the HM-2141, you'll have a good idea of how a power meter and SWR bridge works, you'll know how to build a PCB and install it into a piece of equipment and you'll be used to what components look like and how to identify them. It all adds to your store of knowledge, and if you ever get round to building your own from the ground up, you'll have a good background from which to work. I feel that this makes the Heathkit approach worth the extra cost, and to some extent, you're paying for the quality. Good metalwork, well-written instruction manuals and silk-screened glass fibre PCBs don't come cheap, but there again, quality doesn't, does it?

Certainly the HM-2141 gets top marks for quality and ease of building. Nine out of ten for usefulness (since you can't measure 400 watts PEP with it) and somewhere between 6/10 and 9/10 for price, depending on whether you class it as a power meter pure and simple or part of your education. If I were a novice I'd certainly love to build something from a kit such as this.

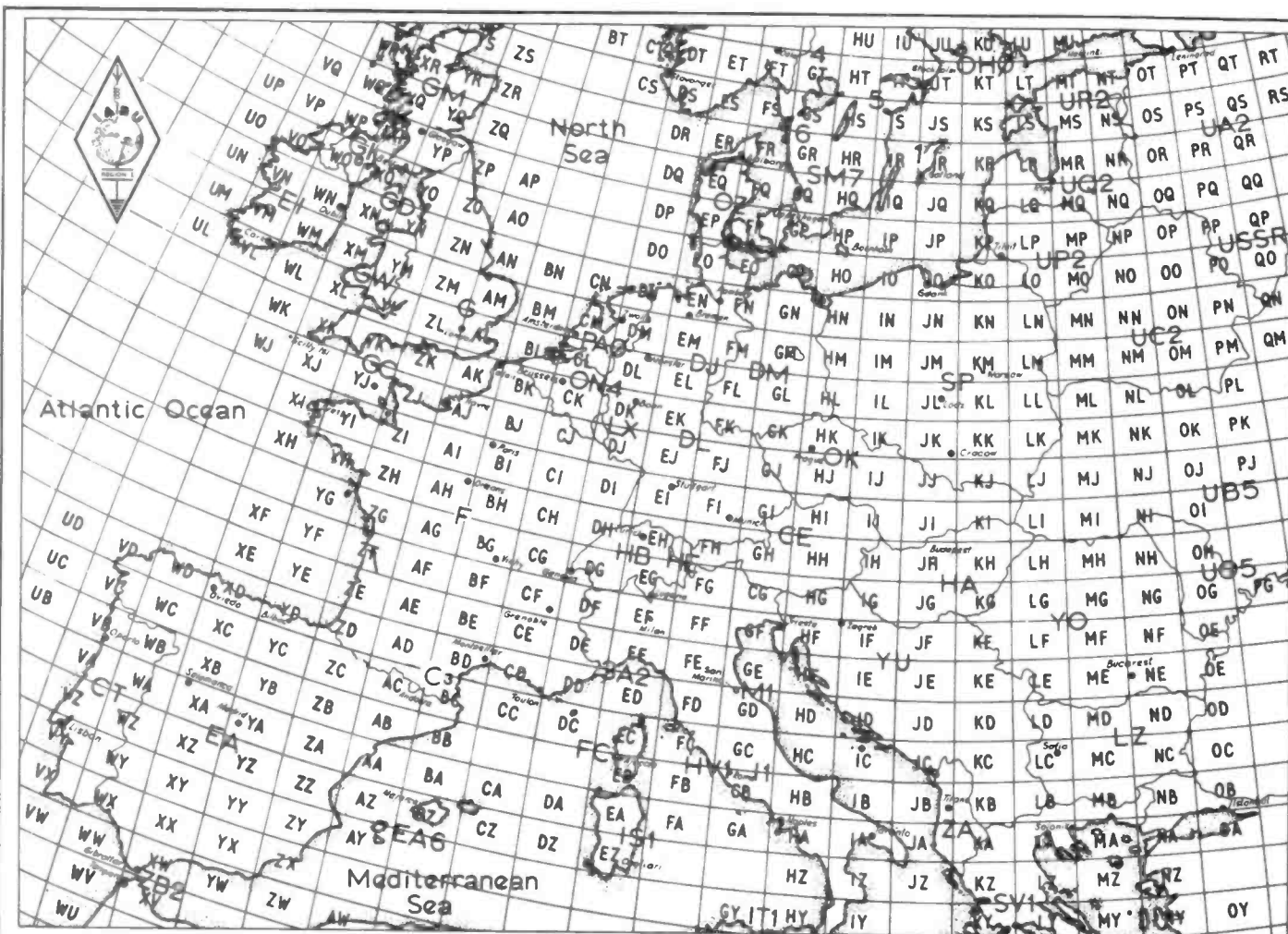

# VHF ANTENNAS

*On VHF the aerial is the most important component in your set-up, so here's how to make sure you have the right equipment for the job. By Peter Dodson.*

Or, if you prefer, antennae. Many new licencees come into amateur radio with a "Class B" licence. That's to say — one which permits them to operate on bands of 144MHz and above. This being so, it seems worthwhile spending some time looking at what is arguably the most important part of the station, which is the antenna.

You might think that the most important part of the station isn't the antenna at all but the transmitter and the receiver. Certainly to judge from the prices you're likely to pay for commercial equipment for the VHF and UHF bands, you could be excused for thinking that this might be the case. However, a little thinking about the situation might make you think otherwise!

The antenna is the thing that ultimately launches your dulcet tones in one form or another in the general direction of the DX, and also receives the signals aimed at you by the station you're attempting to make contact with. Now the nature of VHF and UHF is such that the amount of signal you get out and indeed receive back is a function much more of the antenna than of anything else. Let's assume that you have the full legal limit of power available to you

*Above: The IARU QTH square map for VHF and UHF users. Right: a vertical dipole over "radials" — this configuration is known as a ground plane,*

*Below: a halo antenna which gives you omnidirectional coverage from a horizontally polarised antenna.*

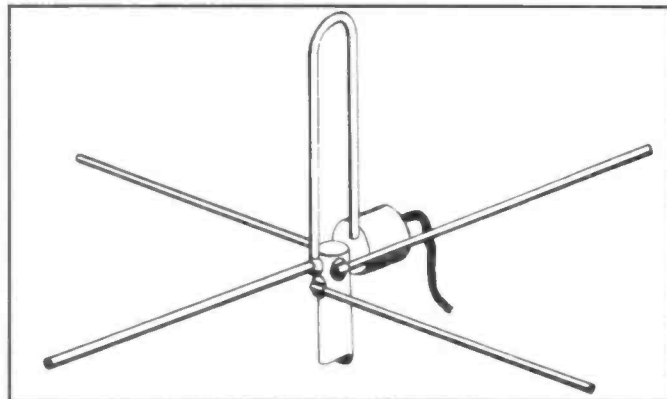

and that you also have a good receiving system, and let's pretend that you have come on to VHF from the HF bands and you're not all that familiar with the mechanics of the situation. Let us suppose that you connect your rig to a dipole in the roof, more or less as you might do on the HF bands.

For the sake of a bit more work, you're throwing away a good deal of the potential of your station. If you put 400 watts into a dipole, your effective radiated power will

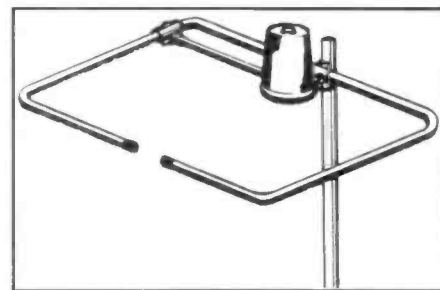



be 400 watts, more or less. Now you could achieve 400 watts of effective radiated power by running the average commercial VHF rig of about 15-20 watts output into an antenna with 13dB gain (don't worry about what that means for the moment — we'll see it in a minute or two). An antenna with 13dB gain would be a hell of a lot cheaper than a 400 watt linear amplifier, and you'd also have the advantage of 13dB gain for free on receive.

This means that if I was running 400 watts into a dipole and you were running 15 or 20 watts into an antenna with 13dB gain, you'd work an awful lot more stations on VHF than I would! "But, but" I hear you say "hold on a minute. What's all this about a 13dB gain antenna? What's a dB anyway — a dog biscuit? How the hell can an antenna have gain anyway?"

OK chaps, hold on there and we'll get to it. Let's have a look at the dreaded dB for a start — you'll come across it all the time in radio, so we may as well bite the bullet and take a prod at it now.

Decibels are hell. Well, actually, they're very useful if you've got them sussed. A "decibel" is actually one-tenth of a Bel, and that word derives from Alexander Graham Bell. He required some means of expressing levels of voltage, current and power with respect to each other or, in other words, the ratio of one to the other. He did it by taking the logarithm of one power with respect to the other, but the resultant unit — the Bel — is a bit big for everyday use and the decibel, or dB, is universally used. When power is under consideration, such as it might be if we wished to relate one power level to another, the appropriate formula is:

$$N = 10 \log_{10} (P2/P1)$$

P1 is the reference level and P2 is the power output. N is the ratio in dB.

Um, let's take that again, with an example. Suppose we have an amplifier with an output of 2 watts and we decide to increase this to 5 watts. Suppose further that some clever Dick wants to know what that increase is in dB. Gritting our teeth, let's apply the formula. It will be  $10 \log_{10} (5/2)$ , which is  $10 \log_{10} 2.5$ . Digging out our log tables from school days (or, if you're a Great Brain with a clever calculator, pressing the appropriate buttons) this comes out to 3.979 according to me, which is near enough 4. So if I were chatting to someone on the air I'd say it was an increase of 4dB.

I think that's all we need to know for now, he said, hastily skipping over half a million other emerging and interesting facts about decibels. What it means as far as this article about VHF antennas is concerned is that the ratio of one power to another can be expressed as so many decibels, either up or down on the reference. If we take the example of the antenna mentioned above, its gain was 13dB up on a dipole; in English, this means that the effective radiated power emerging from the end of it was 13dB greater than the same amount of power emerging from the end of our dipole. Or, to put it yet another way, if you put 10 watts into the dipole, you'll get 10 watts effective radiated power. If, however, you put 10 watts into your 13dB gain antenna, you'll get an output level of 13dB more than 10 watts. What's that in watts? I wish you hadn't asked. From the formula, we know that  $13 = 10 \log_{10} P2/10$ , and I never was any good at rearranging formulae!

Let's save hours of strain by looking it up in the sort of handy table that most of

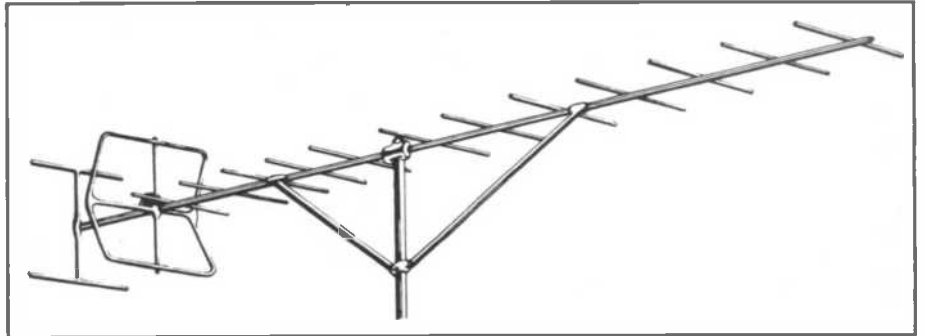
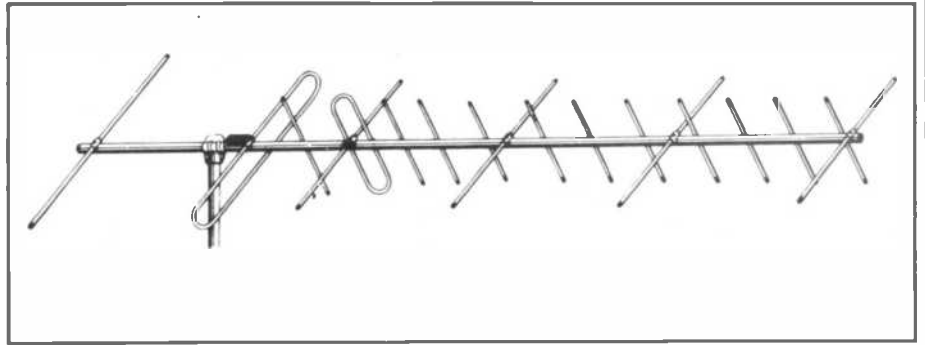

Top: A combined 144 and 432MHz Yagi, great for satellites and DX work. Above: the venerable 14-element Parabeam, which is still one of the very best 144MHz antennas for DX working. Right: a four-element 144MHz Yagi.

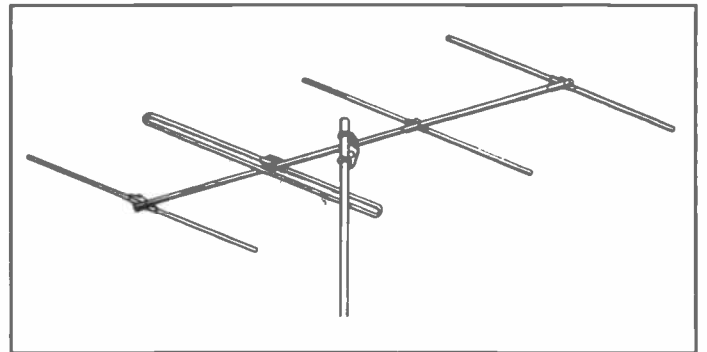

the textbooks contain. Heaving a sigh of relief we discover that it's 200 watts. Stand up the man who said "antilog" and go to the back of the class. If you wish to bandy dB around on the air, I'd suggest that you either bone up on the subject and buy some log tables or, alternatively, do what I do and remember a few simple rules. Rule 1 is that most textbooks contain a table of power ratios in dB. Rule 2 is that doubling the power increases it by 3dB, and rule 3 is that increasing it 10 times is a 10dB increase. Since it's logarithmic, it follows that increasing the power by 100 times implies 20dB, by 1000 times implies 30dB and so on. So when the spec sheet tells you that the carrier suppression of your rig is 50dB below 100 watts, how much power is there in the carrier? Well?

Come on, Bloggs, I haven't got all day. It's, er, let me just think, erm, well of course, it's 100,000 times less than 100 watts, that's erm, 0.001 watts. One thousandth of a watt, or, if you prefer, 1 milliwatt.

Quite simple really. Actually, dB are very useful despite our sending them up a bit. It's just a bit difficult to grasp the concept straight off unless you're a Cambridge Double First.

Getting hastily back to our VHF antennas, the next question is how an antenna could have gain. Well, the short answer is that it has gain relative to something, and that something is a type of reference antenna known as a dipole. Now if you saw the first edition of this august publication, you'll know that a dipole is a basic antenna that radiates in a sort of

figure-of-eight pattern; it's commonly used on the HF bands, for instance. The way in which an antenna could be said to have gain is by concentrating the power into a much narrower beam which is very directional instead of sending it out to the four winds, and this is where the concept of "effective radiated power" comes in. It simply means the apparent power which an observer would measure in the most favourable place relative to the antenna. Obviously the most favourable place for a high-gain antenna would be in the eye of the beam, as it were, since one rule of science is that you don't get something for nothing and the higher the gain of the antenna the narrower its beam is going to be.

In fact, the reputable antenna manufacturers quote the gain of the antennas in units called "dBd" which simply means dB relative to a dipole. Other manufacturers will specify it in units known as "dBi", which implies units relative to an isotropic source. Yes, I know we haven't explained that yet. "Isotropic" means radiating equally well in all directions, and there ain't such an animal as an isotropic antenna. A dipole isn't isotropic because, in theory at any rate, it doesn't radiate at all off its ends. You can actually say that a dipole has a gain of about 2dBi if you want, although it's of not the slightest practical significance. However, it obviously sounds better to say that an antenna has a gain of 15dB rather than 13dB if the antenna maker actually means dBi instead of dBd! If the spec sheet refers to a gain of so many dB, being cynical I tend to think he means dBi and

# VHF ANTENNAS

mentally knock about 2dB off the figure. However, if he says it's so many dBd I'll believe him!

Actually, just to round off this section, measuring antenna gain is very difficult to do without good facilities and the right sort of test gear. It's always worth trying to find comparative reviews made at the same antenna measuring facility if you can; they take place every now and then, and the results often upset a few appreciators!

So — that's what we mean by antenna gain, and it's important at VHF and UHF for several reasons. One is, of course, that your transmitter power gets increased in terms of Effective Radiated Power (which is usually written ERP, by the way, and sometimes spoken that way on the air. If you hear someone talking about "erp", don't necessarily assume he's just finished his supper) by the amount of the antenna gain. As we so painfully found out a while back, 10 watts into a 13dB gain antenna implies 200 watts ERP, which all helps your signal strength at the distant end. Also, in electronic terms, gain tends to mean an increase in noise somewhere along the line. However, 13dB of noise-free gain is well worth having at VHF and UHF. To obtain it by electronic means, such as a pre-amplifier with 13dB of gain, would worsen the noise performance of the system and also probably make the receiver side of the rig more prone to various overloading phenomena when the local signals are very strong.

## Full legal whack

One other point which we might as well mention is that if you run the full legal whack into an antenna with 13dB gain, you're producing an ERP of around 8000 watts, or 8kW. That's a lot of power whichever way you look at it, and it's only fair to say that your local TV and radio sets aren't going to like it one little bit.

There's a chapter on interference elsewhere in this magazine, and you may well find you need to read it if you start running stacks of power on VHF and UHF. Don't let me dissuade you for one minute, but TVI can be a problem at that sort of power level and it's only right to admit it. 13dB is a reasonable figure for a 144MHz Yagi with any pretensions to breeding, and it's easily possible to get more than that, especially on 432MHz where antennas are smaller for the same gain and it's still easy to generate 400 watts.

Probably 15dBd is the average sort of gain for a really good antenna for use at these frequencies, but you can get still more by combining two or more. This process is known as "stacking", if you have them vertical with respect to one another, and "baying" if they're horizontal, and in theory adding each new one will give you 3dB — doubling the ERP — remember? In practice it's difficult to achieve more than 2dB more gain for various reasons, but there are people that combine 4 or even 8 antennas to get as much gain as possible. You might also like to bear in mind that each time you double the height of a VHF or UHF antenna you get 6dB increase in ERP, or at least you do according to the textbooks. I'm not sure I believe it in the average urban amateur

location, but it is indisputably true that it pays to get VHF and UHF antennas as high as possible.

This is also why VHF addicts tend to move house so that they're living on the highest point for miles around. You'll hear much muttering about "take-off" on the VHF and UHF bands, and this doesn't mean that all Class B licencees are also aviation enthusiasts. Take-off in the radio sense means the path that the radio waves take after they get emitted from the end of the antenna on the way to the distant station. If someone is overheard to say that old so-and-so has a superb take-off to the north, he means that there isn't much between so-and-so's antenna and the horizon and thus the radio waves don't get deflected by hills, buildings and whatnot. This is important on VHF and UHF because of the much shorter waves, in comparison with wavelengths at HF, and the fact that the "wave angle", or the angle at which

the waves depart from the antenna, is much nearer horizontal at the higher frequencies and with the sorts of antennas which we've been discussing.

In other words, if you live at the bottom of a Welsh valley you're not going to win any VHF contests. You'd be better off going on the LF bands and work all the DX. This also explains, incidentally, why so many groups depart for the Welsh hills for VHF and UHF contests. The better the take-off, the stronger the signals at the other end and the longer the distances which you can work — thus, the better the chances of winning the contest.

Anyway, that should be enough to be going on with. All you have to do now is sort out how to get your two 19-element 144MHz antennas up on the chimney without bringing the brickwork crashing down! Perhaps we ought to have an article about that some time . . .

*Right: "Crossed Yagi" from the Tonna range.*

*Below: A Tonna "long Yagi" which is well regarded and comparatively lightweight. Next diagram down: a portable 144MHz antenna, dead easy to assemble and (bottom) Tonna's version of the two-band Yagi antenna.*

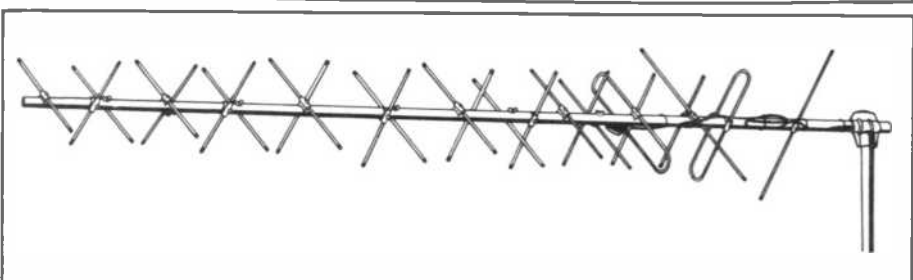
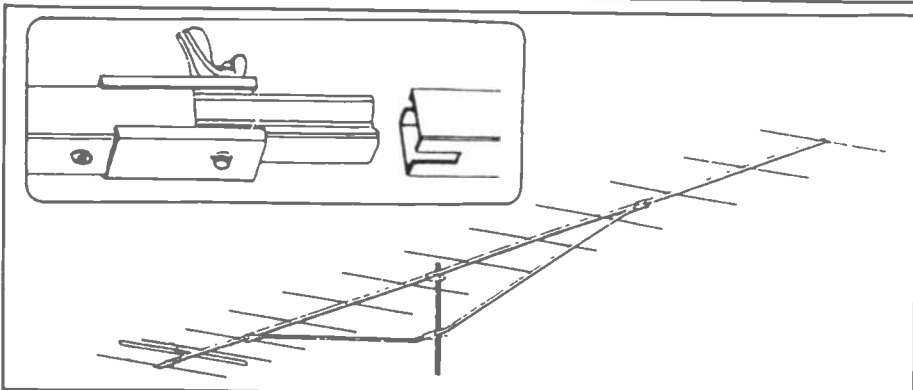
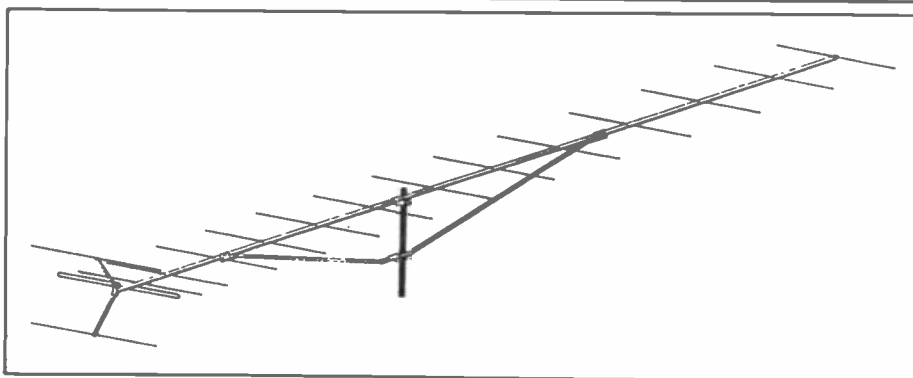
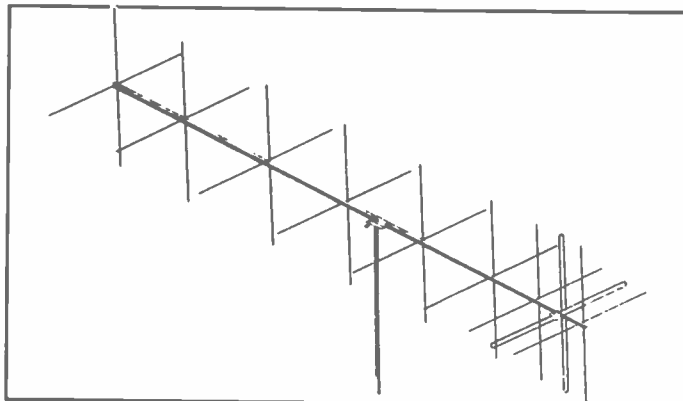

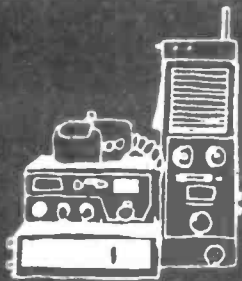

## SOUND ANALYSIS

The IC-4E is a hand-portable 432MHz FM transceiver from the well-known amateur equipment manufacturers Icom of Japan. They have a reputation for innovative, well-made designs and it was with great anticipation that we decided to get hold of one for review.

Reviews of amateur equipment are difficult things to do well because different amateurs want to know different things. The more technically-minded will want to know esoteric things like the two-tone dynamic range and the Minimum Discernible Signal level of the receiver and what the third-order transmitter products are like. The novice, on the other hand, wants to know whether it's easy to use and good value for money; he probably doesn't want to know the fine technical detail of how the PLL synthesiser works, but he will want to know whether he can talk to his mate via the local repeater with it.

While we're on this subject, perhaps you, the readers, might like to tell us what you want to know about the gear — come to that, we'd like to hear from you about what gear you'd like us to review!

For this issue, we thought we'd do a simple "user review" which concentrates on how well the equipment does the job it's meant to do and how easy it is to use. We've taken some measurements of the essential things, but we haven't bothered with the front-end's third-order intercept point, for instance, because you can get by without that. We've aimed to help you make an evaluation of your own about whether the equipment is for you and will do what you have in mind; tell us what you think.

### 2000 channels?

So — back to the IC-4E. As we said, it's a small FM hand-held transceiver which runs about 1 watt output. What makes it interesting is that, like several of the newer generation of hand-portable equipment, it contains a synthesiser which can produce any frequency from 430.000MHz to 439.995MHz in 5kHz steps. The specification calls this "2000 channels", although this is a bit misleading insofar as by "channels" in the amateur world one usually means the "simplex" or "repeater" channels which are at 25kHz spacing in both the 144 and 432MHz bands. Also, of course, there is a bandplan in the UK, as in most other countries, and you wouldn't be very popular if you used an FM rig on the SSB calling frequency even though you can dial it up easily enough. Many people seem to feel that they have a licence and that they can transmit where they like, which in a sense is perfectly true; however, the point about the bandplan is that if we all stick to it we can all enjoy the part of the hobby we want to without making life difficult for our colleagues.

# ICOM IC4E

This 432MHz hand-held transceiver will do virtually anything you ask. Test report by Nigel Gresley



If you want to natter with your neighbour on FM, there's a part of the band set aside for that. Equally, if you want to work the DX on SSB, there's a slice of the band set aside for that too. The two modes don't mix very well so let's keep them in the parts of the band they're meant to be in, OK?

Anyway, you can dial up any of the 2,000 frequencies available on the IC-4E with three little thumbwheels on the top of the rig. It's a tiny piece of gear, by the way, of which fully one-third is taken up by the battery pack! Technology has changed so much that if you'd had access to a time-warp and showed today's IC-4E to an amateur of ten years ago you'd probably have been burned at the stake

*The push-to-talk (PTT) switch is on the hidden side, and both the mike and speaker are in the front panel. Using a nickel cadmium rechargeable power pack which is polarity protected, the IC4E weighs 470g including antenna.*

... the idea of a fully synthesised hand-portable would have seemed outrageous then. Today, the IC-4E sits comfortably in the palm of your hand. Complete with its clip for sitting on your belt or in your top pocket, it tipped our office scales at 472 grammes and measured 117 by 65 by 35 millimetres without the battery pack. Sliding the latter on to the bottom of the rig added another 49 millimetres to its

length. The flexible antenna which came with it looks like a quarter-wave on 432MHz and terminates in a BNC plug — this means that you can either use the antenna or plug in an external antenna of some sort.

Our first impression, having taken it out of the packet and put it all together, was of a solidly constructed little radio which fitted into our somewhat mucky palm with no problem (we'd been working on a rally car for our sister magazine, *Rally Sport!*) and felt promising. The first step was to get the battery charged, because the rig comes as standard with the IC-BP3 battery pack which contains rechargeable ni-cads — so we got out the little charger that comes with the IC-4E and plugged in. Or rather, we wanted to but couldn't straight away because it comes with the adaptor to suit the American-type flat-blade mains outlet on the charger body to a British two-pin socket but . . . we don't have any two-pin sockets in the office, do we? Someone was hastily despatched to go and buy a razor adaptor from the supermarket down the road — we were then on line. In other words, you'll need either a two-pin socket or a razor adaptor to use your IC-4E with the BP-3 battery pack. This isn't a criticism because the charger's made that way. Just a word of warning.

### 15 hour charging

The handbook (which is extremely comprehensive, by the way, and not at all afflicted with Japanese-English, like some) suggested a fifteen-hour charge for the new batteries, so there was plenty of time to read the instructions and get familiar with the circuit before going on the air. The circuitry looks pretty standard, with plenty of low-pass and bandpass filtering where it mattered and some nice touches in various places. There are 43 transistors, two FETs and half-a-dozen integrated circuits doing their stuff — frequency generation is by courtesy of a digital phase-locked loop synthesiser and the final output is switchable between high and low power.

With the BP-3 battery pack, which comes as standard, the high power is supposed to be 1.5 watts and the low power 150 milliwatts — in fact, ours produced exactly 150 milliwatts on low power and just over 1.8 watts when switched on to high power.

You can get other power sources for the IC-4E, however, which is a nice touch — the BP-4 causes the high power to fall to 1 watt and consequently lasts longer. Conversely, the BP-5 provides a QRO 2.3 watts. These two use six and nine AA type ni-cads respectively, and each has 400mAh capacity. We didn't test either of these, but friends with IC-4Es who own them tell us that they work well and give them about a day's average operating apiece.

There's also a battery case available in case you don't like ni-cads and want to use ordinary dry batteries of one sort or another (see our article in this issue for the reasons why you should use alkaline types for this sort of application).

Coming back to the handbook, we thought it was good; one of the nice things about the handbooks with Icom equipment is that there's plenty of servicing information in the shape of voltage tables, board layouts, a good description of the circuitry and a block diagram. It isn't a full workshop manual by any means, and you'd need some good test gear and nimble

fingers to work on a rig of this size, but it helps.

So — while the batteries were charging, we got ourselves familiar with the controls. They're all on the top and the back of the rig and looked obvious enough to us — volume and squelch were the standard rotary controls, and you push the volume control knob downwards in order to bring up a 1750Hz toneburst to access your local repeater. This also puts the rig into transmit, by the way, so don't do what we did and try to press the PTT and the volume control knob downwards simultaneously . . . it isn't necessary and you'll probably either tie your fingers in knots or drop the rig.

Thanet Electronics, who kindly loaned it to us, will be pleased to hear that we didn't drop it, by the way — we tied our fingers in knots instead, before we found the knack. Ah well — when in doubt, read the instructions. . . ! Actually, we had the same problem next day when we couldn't get into the repeater for love or money — until, that is, we remembered the wicked little switch on the back labelled SIMP-DUP. Simplex or duplex, in other words, and you talk to a repeater on one frequency and listen to it on another, don't you? We found that it was easy to forget whether you were a SIMP or a DUP and consequently we sometimes found that we couldn't talk to whoever we wanted to talk to — finger trouble, we agree, but it would be nice to be prodded in some way and told whether you were in one mode or the other. Better still, tie in the shift to repeater channels only. That's difficult to do, though, and you'd lose flexibility, so on balance it's probably better as it is and we'll just have to remember whether we're SIMPS or DUPS.

It'd be nice, too, if the toneburst did its thing automatically when you were switched to duplex, although here again different repeaters in different places need different burst lengths so although you have to do it all manually you've always got the flexibility. We used a repeater in Germany last month that needed no less than a 2½ second toneburst, and we could have done with the IC-4E then because you get the burst as long as you press the knob down. With the rig I was using you didn't have the option — it was half-a-second take-it-or-leave-it and I had to leave

it until someone else came up. Also, of course, most UHF repeaters in the UK are "carrier re-accessed" which means that you only need the toneburst to bring them up from cold, as it were — asking for automatic toneburst just for that is a bit off!

We'd all be reduced to button-pushers if it was all automatic, now, wouldn't we? Icom have, on balance, got it right even though you need to think a bit. That German repeater needed a tone every time, by the way — it was a nuisance. Can all UHF repeaters please have carrier re-access?

Anyway, all you need to remember is that in order to work via a repeater you dial up the repeater input frequency on the thumbwheels and switch to DUP on the back of the rig. A quick burst of tone should bring it up, and you're away. We had it sorted out quite quickly, and it was all very easy to use.

The other controls on the top were the synthesiser thumbwheels. Reading from the left, these select MHz, 100kHz and 10kHz so that if, for instance, you wanted to transmit on 434.8MHz, they'd read 485. Should you need the odd 5kHz, for example when working on the repeater or simplex channels, you can increase the transmit frequency by 5kHz with the "+5kHz" switch on the right of the thumbwheels — so if you wanted 434.885MHz the thumbwheels would say 485 and you'd slide the "+5kHz" switch upwards. Very nice and simple; here again, you have to remember your repeater frequencies, for instance, and add on the extra 5kHz if you need it.

### On-off control

The main on-off switch is to the right of the 5kHz shift and indeed on the extreme right of the top panel. It slid away from you to turn on the rig. The only small criticism of both of these switches, incidentally, is that they're very tiny and if you're not as young as you were (what, me? No, mate, my fingers are as nimble as ever. Well, almost. I suppose I am getting a bit older. Mature, that's the word, mature) they're a little bit fiddly. It's also quite easy to leave the rig switched on, as we did overnight once — it would have been nice to have a tiny LED, say, just to show that the power was on. You have an LED to show that you're transmitting, by the way,

*With the front panel off, you can see the sophisticated internals. Those long pill-looking things towards the lower section are the tone burst and LO crystals. In the dead centre is the ICI MC3357 IF circuit ic.*

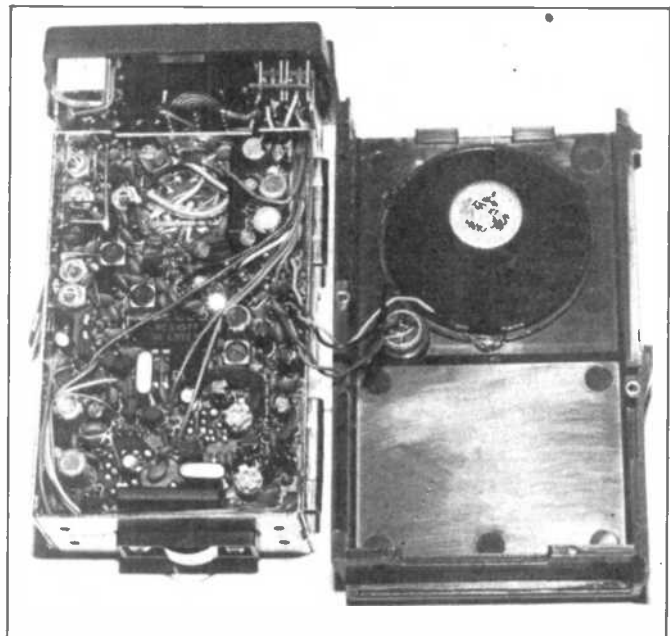



between the volume control and the antenna socket; I suppose that even a small LED takes too much current out of the battery pack to allow it being left on all the time.

There's a jack for an external microphone and also one for an external speaker or earpiece — both are on the top panel, just below the antenna socket. You can buy a very nice hand microphone-cum-earpiece for the IC-4E, and indeed it was very pleasant wandering round the Derby Rally recently chatting to a couple of our friends via the IC-4E and its little hand mike.

Coming on to the back of the rig, there are three tiny slide switches. One selects high or low transmitter power, one selects either simplex or duplex operation and the other is marked MONI-NOR. This is a "reverse repeater" facility whereby the rig interchanges the transmit and receive frequencies when switched into duplex mode — the idea if it is that if, say, you're working your mate on the repeater and you want to listen on the repeater input in order to find out whether you can hear him direct and thus work him simplex, you simply go to MONI and you're listening on the input without twiddling thumbwheels like crazy and taking the skin off your fingers. It's always good practice to work simplex if you can and leave the repeater for those who can't, and this switch is very useful for that.

### No problems

So how did the IC-4E shape up in day-to-day operating? Very well indeed, basically. For local nattering at rallies and to friends coming into the office, etc, we rarely used anything other than the low-power position so as to prolong battery life, and it would usually keep going all day long without needing a recharge. We bought the battery case and kept a set of alkaline cells in it for emergency use but we only needed to use it a couple of times; once was when we had been using the rig all day and then needed talk-in to somewhere in Wolverhampton. If you've ever driven round the one-way system at Wolverhampton you can guess the rest — suffice it to say it took about half-an-hour to find the place *even with directions!* The IC-4E came into its own that day all right.

We found that it worked well into a beam antenna too. On one occasion, night conditions on 432MHz were up a bit and we worked some stations in South Yorkshire from Bicester on the 1.8 watts — we worked one who was also running an IC-4E and signals were about S6 both ways. The receiver seemed very good indeed, and when we did some lab tests we discovered a sensitivity of 0.9 microvolts for 20dB SINAD. This is a good performance, as is the fact that the automatic noise figure measuring equipment we "borrowed" measured a

noise figure of just over 3dB. The only spurious response we found in the receiver was the image 43.6MHz away and this was 76dB down.

The transmitter was extremely clean — we thought we'd misadjusted the spectrum analyser at first, because all we found was the second harmonic at about 80dB down and practically nothing else! This is very good indeed, and shows that Mr Icom has got the filtering very well arranged. Deviation measured plus or minus 7kHz, which is a bit on the high side and indeed would get chopped by a few repeaters; there's an internal pot. to set it up, however, and we soon set it for something more reasonable in about two seconds flat. We measured a couple of other IC-4Es belonging to friends and they were more or less spot on the plus and minus 5kHz of the specification, so maybe ours was an odd sample. Either way, it's a pretty trivial thing.

Other than that, everything measured very well. We did have a look at a few esoteric things like the third-order intercept point of the front-end and if you're interested it came out to be — 2dB. This isn't a bad figure for this type of radio, and doesn't matter in practice at all; if you'd like to know all about these clever things, write and tell us and we'll delve into it. If you don't, fine.

So — what did we make of the IC-4E overall? We liked it very much indeed, for all kinds of things — the performance of the receiver, the nice audio it produced on transmit, the general ease of use and the fact that you get a lot of rig for your money. Messrs. Thanet will supply you with an IC-4E for £199 should you so desire, and we must say at this point that they're very good people to deal with down there — their after-sales service is extremely good, apparently, and they know how to fix the stuff they sell. Which helps — because even the best equipment goes wrong, and with the complexity of some modern amateur equipment it's sometimes necessary to give in gracefully and let the dealer have a crack at it. That's a nice idea for an article — shall we do a survey and find out what you think of "amateur" dealers?

The only thing about the IC-4E concerns the way in which you select the frequency, and it's a problem common to all makes of small hand-portables which contain a synthesiser. The two methods in vogue at the moment are keyboards, such as the Trio radios have, and thumbwheels, as per the IC-4E. If you know what channel you want to listen on, there's no problem with either — but if you're generally tuning the band to see what's about, you'll generally find that the rig with keypad entry of frequency is easier — not, we hasten to say, because of anything to do with the keypad but because it's easier to interface some form of scanning circuitry with it such that you can tell the rig to scan the band between limits you enter and also tell it to stop on a signal. You can't really do this with thumbwheel input to a synthesiser, and you're down to manual tuning — which can become very laborious after a while. As usual, it all depends what you want.

### Reliable too

We find that with a hand-held like the IC-4E and its relatives, we're generally either using repeaters or communicating with someone on a frequency which we've arranged beforehand (on the lines of: "Well, when I get to the rally I'll give you a call on SU10 and if I don't hear you I'll sit on the frequency until you come up".)

We have a 144MHz scanning FM transceiver in the office, and we find that the scanning function is used 99 per cent of the time for casual listening around — so maybe it depends what you want to use the rig for. We find the IC-4E extremely good at the things we want to use a hand-held for; we don't, in other words, find ourselves saying: "Oh I wish it had a scanning function" or something. One magazine criticised it by saying that it was impossible to use it mobile at night — well, maybe it is but we don't think it's really intended for that sort of use.

As a hand-held, lightweight, versatile UHF FM radio, the IC-4E is very good — it will do everything you could ask and, from what we've heard on the grapevine, they're very reliable too.

*The IC4E's control functions, clockwise from centre top: squelch control, volume and tone call switch, power and 5KHz shift switches, 10KHz, 100KHz, and 1MHz thumbwheels, external speaker jack, external mike jack, antenna, and transmit battery indicator.*

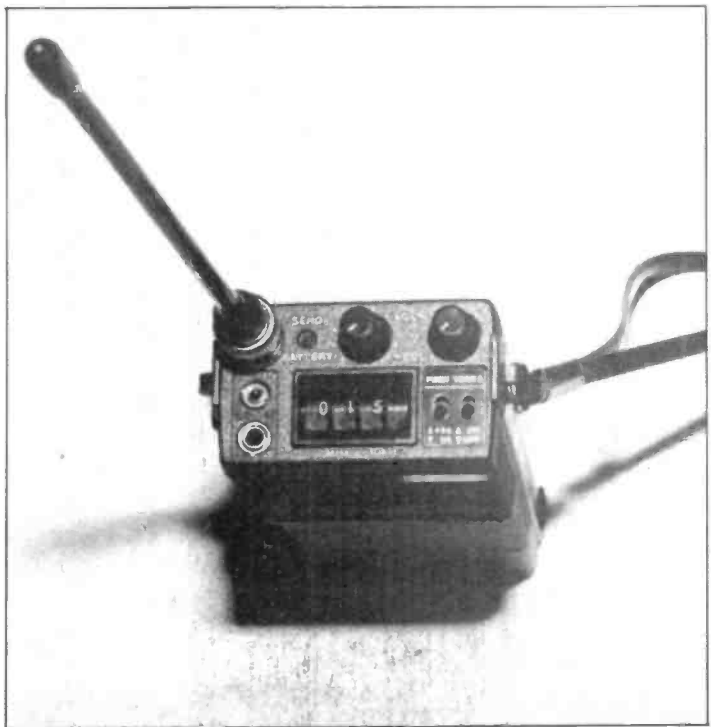

# The unexplainable explained: op-amp

“... if you want to make some form of audio speech processor, for instance, an op-amp is very handy to have around.”

The op-amp is a ubiquitous feature of modern electronics. You find them everywhere from peak-reading wattmeters (see our project this month) to complex industrial control circuitry. Whole books have been written about the op-amp, so we're certainly not going to go into it in any detail. All we'll do is have a peek at it and identify something about how it works.

Its name is a contraction of Operational Amplifier, and that refers to a device used by analogue computer engineers in the sixties. Basically, they were using feedback to change the properties of an amplifier in such a way as to make it capable of mathematical operations. Hence the word "operational".

Now feedback is a big subject and we can't go into it in any depth because there isn't the space for it if we're ever going to get round to the op-amp itself. Basically, it's possible to modify the performance of any amplifier by taking a bit of the signal from its output and feeding it back to the input in such a way as to change some parameter of the amplifier. You can change its frequency response, its gain or its linearity, for instance — the latter is what the hi-fi magazines are talking about when they refer to amplifiers with negative feedback.

Now then. If we take the bog-standard op-amp, which is these days a tiny integrated circuit with about eight pins coming out of it, we can visualise it first of all as a "gain block" or, if you wish, a device for giving us an enormous amount of gain. You'll see that apart from the supply connections, there are two inputs and an output; don't worry about the fact that there are two inputs, we'll see why in a second. In other words, the usual sort of amplifier, whether it's your hi-fi or your microphone preamp — an input and an output.

If you add the bare minimum of components to your op-amp (a device called the 741 is the classic, and it costs about 30p in the shops) and use it as an amplifier without any feedback from output to input, it'll have a very high "gain". This is called the open-loop gain, in fact, and it's of little practical use. However, let's have a look at the two inputs.

They're called inverting and non-inverting, and all that means is if you apply a signal to the inverting input, the phase of the output signal will be reversed with respect to it. In other words, if the signal you apply to the inverting input is negative-going, the output is positive-going. Conversely, the non-inverting input doesn't change the phase of the signal at the output; if you apply a negative-going signal

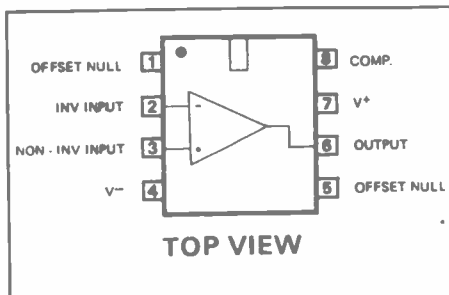
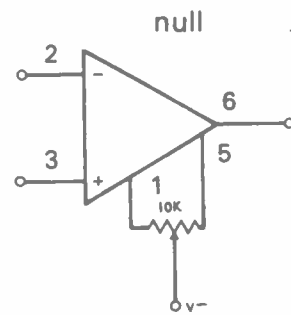
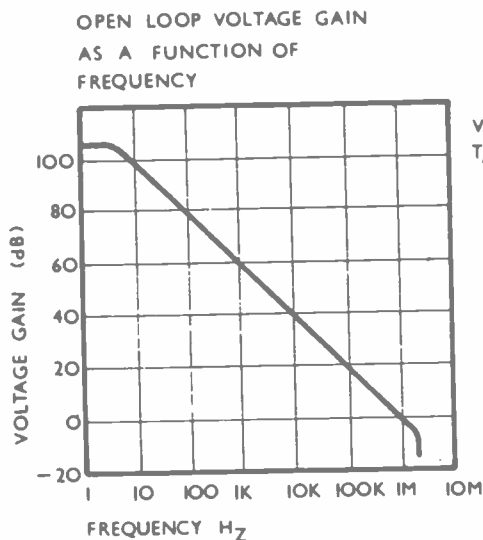

Top: a plot of the open-loop gain of a 741 op-amp as a function of frequency; not that you'll need it every day! Above: the connections, or "pinouts" of a 741. Right: a high-power op-amp, which can be mounted on a heatsink.

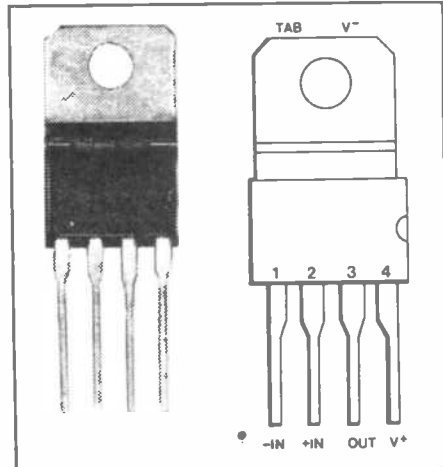

to the non-inverting input, the output will also be negative-going.

Still with us? Right, then. If you have one input to apply your signal to and another input into which you can stuff some feedback, you're in a good position to make the amplifier do all sorts of clever things. We have here in the office a book called *Operational Amplifiers*, and there are 406 pages devoted to making the op-amp do everything but climb up the wall, so we can't go into it much here. However, if you'd like to try some circuits, we've thrown in a few ideas for you.

If you want to do anything with audio-frequency signals, the op-amp is for you. It's not really any use at RF, but you'll find that if you want to make some form of audio speech processor, for instance, an op-amp is very handy to have around. The

reason is simply that you can define the gain you want, the frequency response you'd like to suit your voice and microphone simply with a few resistors and capacitors.

If you want any "gain block" for use in anything from power supplies to preamps, here again the op-amp is a very handy device because all you need is the integrated circuit itself and a handful of other components. In fact this is typical of the trend in electronics today wherein the designer who is faced with a requirement for any of the devices we've mentioned won't bother sitting down and designing a whole circuit based on discrete components — he'll reach for an op-amp and specify the parameters he wants simply by changing the values of a few external components.

This "building block" approach is getting more and more common, and there's a lot to be said for it. If you have a look at the circuits we've included, you'll see that they all use an op-amp and a few external components to do very different jobs. Don't worry about how they all work for now, since all we're trying to do is grasp the general principles of the device.

If you decide to play about with op-amps, here are some tips; a pair of PP9-type batteries are a good power supply, since you'll find quite often that you need what is known as a "split-rail" supply with op-amp circuitry. "Split-rail" simply means that you join the two batteries in series and use the junction itself as the earth line — the supply rails are the +9, 0 and -9 volts.

The well-known 741 is probably the best op-amp to play about with, since it's very cheap and pretty well indestructible in our experience. Early op-amps were a lot more fragile than the newer devices, so you don't have to be quite so careful with them. Incidentally, the 741 isn't a CMOS device, so you don't need elaborate precautions when you handle it.

So, go ahead and play with a few circuits. If you'd like to know more, there are a couple of books we'd suggest you read. One is called *IC OP-AMP Cookbook* and the other is *Design of Op-amp Circuits, with experiments*. Both are very readable, and we shamelessly admit to having used umpteen of their circuits for our own projects. You can get them from the RSGB or from any reasonably good electronic-type bookshop. Perhaps one of these days we'll have a little competition for the most unusual circuit using an op-amp.

### VOLTAGE REGULATOR

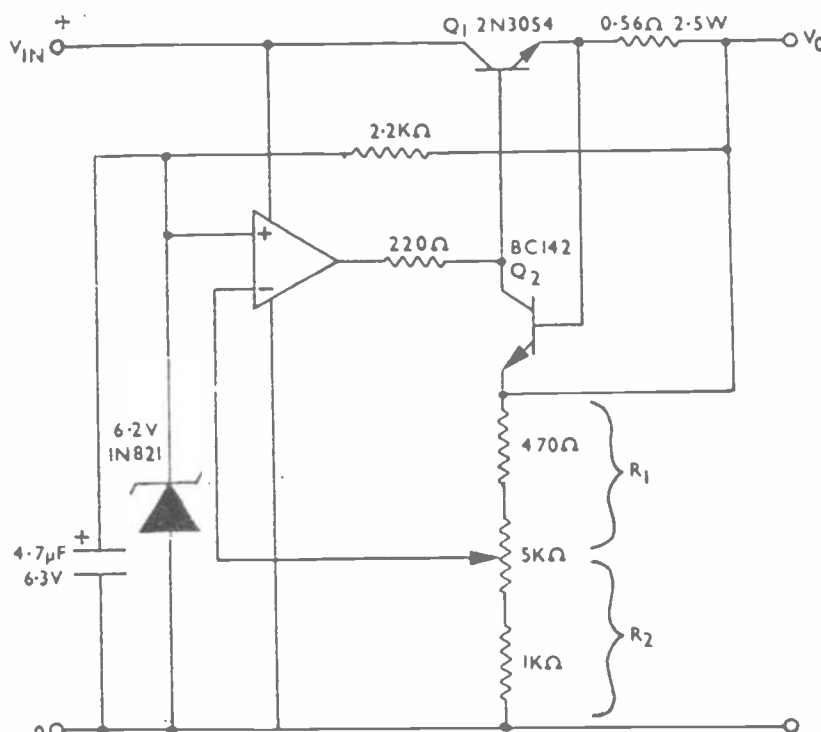

\* $Q_1$  SHOULD BE FITTED TO A 2:1 c/w HEATSINK (401-403) FOR MAXIMUM DISIPATION.

Above: a voltage regulator circuit using an op-amp, which you can build. It'll do the same job as the clever three-terminal devices you can buy.

**FREE ADS: Sell your radio equipment and spares for profit!**

## AMATEUR RADIO Classified Order Form

Copy Deadline for Advertisements:  
November 18, 1982

The Advertisement Manager reserves the right to alter, reject or suspend an advertisement without assigning any reason. Advertisements are accepted subject to approval of copy and to the right of the Advertisement Manager to alter, reject or cancel any order or part of order without explanation. The Proprietors are not liable for any loss from any cause whatever, nor do they accept liability for printers errors. The Advertisement shall indemnify the Publishers in respect of any claim, costs and expenses arising out of any libellous or malicious matter or untrue statement in any advertisement published for the advertisers, or any infringement of copyright, patent or design therein. The placing of any order will be deemed to be an acceptance of these conditions.

Name.....

Address.....

.....

Tel:.....

To: Amateur Radio,  
Classified Dept,  
27 Murdock Road, Bicester, Oxon.

**Don't forget — the next issue of Amateur Radio appears  
on December 9th!**

# COME TO RADIO SHACK!



DRAKE

TR-7A



COLLINS

KWM-380

FOR  
THE BEST



BEARCAT-BC 2020



TRIO

IN AMATEUR RADIO



**RADIO SHACK LTD**

188 BROADHURST GARDENS,  
LONDON NW6 3AY

*(Just around the corner from West Hampstead Station on the Jubilee Line)*  
Giro Account No. 588 7151 Telephone 01-624 7174 Telex: 23718

S.A.E.



ACCESS  
MAIL ORDER

**Photo Acoustics Ltd**  
MICRO COMMUNICATIONS DIVISION

BARCLAYCARD  
MAIL ORDER

**NOW ON SHOW  
ONE BIG HAPPY FAMILY**



TRIO TS-930S



TRIO TS-830S



TRIO TS-530S

IF YOU WOULD LIKE TO TRY ONE OF THESE SUPERB PIECES OF EQUIPMENT COME ALONG AND SEE US. WE ARE JUST OFF THE MOTORWAY AT JUNCTION 14.

Authorised Stockists for: **TRIO  
YAESU  
ICOM  
FDK**

We also stock: **JAYBEAM ANTENNAS  
G-WHIP ANTENNAS  
MICROWAVE MODULES  
HALBAR AERIALS**



24 HOUR ANSWERPHONE - CREDIT CHARGE - PART EXCHANGE  
58 HIGH STREET, NEWPORT PAGNELL, BUCKS.  
TEL: 0908 610625





## 2 METER HIGH POWER LINEAR AMPLIFIER

Designed and manufactured by us specially for the FT290R multimode transceiver or any other model with an output of 2 to 3 watts  
Minimum of 80 watts output with 2 j watts drive (13.8v D.C. supply). Suitable for FM and SSB. Fully RF switched or can be used via transceivers PTT line. Separate led's to show "power" "SSB" "on air", straight through operation when switched "OFF". Quiescent current 300 mA max. with no drive when cold. Finished to high industrial standards with professional grade PCB. SO239 sockets fitted as standard. Colour storm grey and matt black. Size 105 x 78 x 210mm. Reverse polarity protected. Receive pre-amp NOT fitted as we found this degrades the noise figure and increases cross modulation problems, better to fit a higher gain transistor in the receiver front end such as the 3SK88. PRICE ONLY £98.00.

### SIGNAL GENERATORS:

MARCONI TF14H/45 10kHz to 72MHz AM only superb generator in first class condition fully checked and in working order. £70.00  
MARCONI TF8010/85 10MHz to 480MHz AM only with output for frequency counter, output 0.1uV to 1 V mint condition. £125.00  
RACAL communications receiver RA117E rack mounting in ex condition and working, with, manual. £275.00

"Signal generators and Rascal receiver to be collected by arrangement."  
FM ADAPTER for the popular FT101 up to "E" model only, adds FM mode to the FT101 without fitting any boards inside, free standing unit with only one wire to solder across the clarifier control, just plugs into existing sockets on the back of FT101 still the best available ONLY £70.00  
RECEIVER PRE-AMP PCB for 27 30MHz 25db gain (adjustable) 1db nf. ready built on board 40 x 60mm ideal for fitting inside receiver. £8.00.

3SK88 DUAL-GATE MOSFET up grade the RF stage of your VHF 2 Mtr transceiver with this superb device, 26db gain with only 1 db noise @ 150MHz. will fit directly in place of most mosfets. PRICE ONLY £1.20 or two for £2.20. Data sheet supplied.  
3SK87 DUAL-GATE MOSFET same device but with approx 3db more gain, same price as 3SK88

MOSFETS - 3SK60 similar to 3N204 80p, 3SK51 smir to 40673 85p, 3SK45 50p, 8FR84 60p, FET'S 2N3819 35p, TIS88A 40p.

VHF RF POWER 2N6083 30 watt out @ 175MHz for 8 watt drive, 12v-FM SSB with data sheet only £8.50.

PT4236A sm. (BLY34) 75p, 2N3866 75p, BFW16A 75p, 2N2631 sm 12N3553i 80p.  
HF RF POWER 2N5070 SSB 24v 25watt out @ 30MHz 15db gain £5.00, 2SC1307 9db gain 12v, 25w SSB, 15w AM. £3.00, 2SC1909 13db gain 5w AM 12w SSB 12v, 30MHz. £2.00 all with data sheet.

FILM TRIMMERS 2-25pf 10mm dia. 15p ea. 10 for 80p, 10pf 7mm sq. 10p ea. 2-18pf 9mm sq. 18p ea. 2-32pf 10mm dia. 15p ea.

CERAMIC TRIMMERS 2-9pf 7mm dia. 15p ea. 3-9pf and 10-40pf 10mm dia. tab end type 15p ea. miniature 1-5pf 2 pin PCB mount 10p ea.

CERAMIC COMPRESSION 10-40pf and 10-80pf both types 12p ea.

BOLT-IN TYPE FEEDTHROUGH CAPACITORS 1000pf 500vw req's 4.3mm hole specially made due to demand but limited supply, 40p each.

SOLDER-IN FEEDTHROUGH CAPACITORS 1000pf 500vw req's 3mm hole 10 for 25p.

SOLDER-IN FEEDTHROUGH INSULATORS req's 4.3mm hole, 100 for 70p.

100 CERAMIC DISC CAPACITORS mixed values from 1pf to 470pf DK for the VHF/UHF constructor £1.50 per bag.

100 ELECTROLYTIC CAPACITORS all transistor types mixed values 1mfd to 1000mfd £2.00 per bag.

250 j watt RESISTORS vertical pre-formed type all with long leads good range mixed values £1.50 per bag.

MOTOROLA CAR CASSETTE PLAYERS (Warranty returns and NOT working) 6 watts per channel, simple faults mainly audio IC's blown, supplied with circuit, models available but our choice 401, 615, etc. Sorry but once purchased we cannot accept these back for refund but we do guarantee that these are complete ONLY £6.75.

CRYSTAL FILTERS  
ITT 024DE 10 7MHz + 31KHz @ 3db for 12KHz channel spacing, 910 ohm imp. New £6.00.

Cathodons BP4133 for SSB lower sideband only, 10 7MHz 200 ohm imp. New only £5.00.

MOTOROLA CAR RADIO PCB'S 2 kilo box of mixed damaged and good boards we wish to clear out stores of vast quantity hence the low price. A gold mine of spares for the service engineer. PRICE £3.50 plus £1.50 p/p. 4 kilo box £5.00 plus £2.00 p/p.

Terms of business - Cash with order, please add 60p for post and packing.

MAIL ORDER ONLY OR CALLERS BY APPOINTMENT

**AH ELECTRONICS**

20 Barby Lane, Hillmorton, Rugby, Warwickshire.

Tel: Rugby (0788) 76473 & 71066

# TALK TO THE WHOLE WORLD



..... and discover a new one for yourself. If you're experienced or even a beginner our skilled preparation will enable you to obtain a G.P.O. Licence.

British National Radio & Electronics School, Reading, Berks. RG1 1BR

FREE brochure without obligation from:-

British National Radio & Electronics School  
READING, BERKS. RG1 1BR

Name .....

Address .....

AM/9/816

BLOCK CAPS PLEASE

**R.A.S. (NOTTINGHAM)**

G8UUS

Radio Amateur Supplies

Tel: 0602 280267

Visit your Local Emporium  
Large Selection of New/Used Equipment  
on Show.

AGENTS FOR:

F.D.K.

AZDEN

ICOM

YAESU

SOMMERKAMP

FORTOP ATV

ACCESSORIES:

Welz Range

Microwave Modules.

Adonis Mics.

Mutek Pre-Amps.

Packer Communications.

AERIALS: Tonna, Halbar, R.A.I.C. 5/8 & 7/8  
Mobile Whips.

**PLUS OWN**

"Special" Q.R.P. H.F. 3 & 5 Band Beams.



USUAL CREDIT FACILITIES



VISA

3 Farndon Green, Wollaton Park, Off  
Ring Road between A52 (Derby Rd) &  
A609 (Ilkeston Rd).

# PCBs FOR PRACTICAL WIRELESS PROJECTS

WR068 AF SPEECH PROCESSOR	£2.68
WR067 WIDE BAND RF PRE-AMP	£1.05
WR073 NIMBUS TRANSCEIVER	£5.50
WAD634 BEGINNERS 2 METRE CONVERTER	£1.38
WAD927 SWR WARNING INDICATOR	£1.40
WR121 HF CONVERTER	£2.40
WK103 70cm-2m CONVERTER	£3.70
WR140, WR141, WR142 3 BAND SHORT WAVE CONVERTER	£5.40 per set
WR131 AUDIBLE FIELD STRENGTH METRE	£2.50

Full range of RS components available

Please phone for quote

Allow 14 days for delivery

Please note our new address:

**C. BOWES ELECTRONIC LTD**

28 Stockport Road, Cheadle, Cheshire

Tel: 061 491 1644 ext 5

PLEASE SEND CASH WITH ORDER



VISA

# Amateur RADIO

Dear Readers . . .

Help us to help you. Due to the excellent response to the first issue of Amateur Radio Magazine, we have decided to go ahead with a second one — well of course, now you know that. But we are planning Amateur Radio magazine's future and would appreciate some comments, and advice, from you, our readers.

Please answer the questions below, and return the completed page (or a copy of it) to: The Editor, Amateur Radio, 27 Murdock Road, Bicester, Oxon. There's a modest (but free) gift to the reader whose form is pulled out of the proverbial hat first.

Name (Mr/Mrs/Miss/Ms).....

Address .....

Callsign (if any).....Age.....

Married/single (delete)

Trade/profession.....

Amateur radio equipment used.....

Other hobbies.....

1. How long have you been interested in amateur radio?.....

2. Date of passing Home Office test?.....

3. Or, when do you expect to pass the test?.....

4. How did you become interested in amateur radio? (from CB, a friend etc?).....

5. What other magazines do you read?.....

6. What are your specialist interests in radio?.....

7. What would you like to see in future issues of Amateur Radio magazine.....

8. Would you take out a subscription to Amateur Radio? Yes/No

When you have completed the form, please send it to: The Editor, Amateur Radio, 27 Murdock Road, Bicester, Oxon.

## Advertisement List

- 2 South Midlands
- 4 Radio and Electronics World
- 6 H. Lexton Ltd
- 9 Arrow
- 12/13 Amateur Electronics UK
- 16 Holdings Photo Audio Centre
- 16 ICS School of Electronics
- 17 Telecom
- 17 Chordgate Ltd
- 17 Wood & Douglas
- 22 Sota Communications Systems Ltd
- 23 Bredhurst Electronics
- 26 Packer Communications
- 26 Garex Electronics
- 26 Waters & Stanton Electronics
- 27 Catronics
- 41 Stephen James
- 41 Telecomms
- 44 Microwave Modules
- 46/47 Thanet
- 49 Polemark
- 53 CQ Centre
- 56 Lowe Electronics
- 72 Radio Shack Ltd
- 72 Photo Acoustics Ltd
- 73 AJH Electronics
- 73 RAS (Nottingham)
- 73 C. Bowes Electronics Ltd
- 73 B.N.R.E.S.
- 75 Bi-Pak
- 76 OCT

Now turn to page 71 for your opportunity to include a free private classified ad in the next issue of Amateur Radio!

It pays to advertise in  
**AMATEUR RADIO**

# BI-PAK BARGAINS

## TRIACS — PLASTIC

4 AMP - 400v - T0202 - TAG 1360  
 1 OFF 10 OFF 50 OFF 100 OFF  
 40p £3.75 £17.50 £30.00  
 8 AMP 400v - T0220 - TAG 425  
 60p £5.75 £27.50 £50.00

## SLIDER POTENTIOMETERS

Plastic 40mm Travel Mono  
 SX63 5 x 470 ohms £1.50 SX67 5 x 47k Ohm  
 SX64 5 x 1k Ohm £1.50 SX68 5 x 47k Ohm  
 SX65 5 x 27k Ohm £1.50 SX69 5 x 100k Ohm  
 SX66 5 x 77k Ohm £1.50 SX70 5 x 1 meg Ohm

**ALL AT 50p PER PAK**

**SX40** 250 Silicon Diodes-Switching like IN4148 DO-35. 45v 75mA. All good-uncoded. Worth double our price. **£1.25**  
 250 Silicon Diodes-General Purpose, like DA200/202, BAX13/16. Uncoded. 30-100v 200mA DO-7. **£1.25**

**SX44** 10 5ASCR's T064. 3 x 50v. 3 x 100v. 2 x 200v. 2 x 400v. Super value less than 1/2 price. **£1**  
**SX45** 10 5ASCR's T066. 2 x 50v. 2 x 100v. 4 x 200v. 2 x 400v. All coded. Brand new, a give away at all. **£1**

## MINIATURE TOOLS FOR HOBBYISTS

**MINIATURE ROUND NOSE SIDE CUTTERS** - insulated handles 4 1/8 inch length Order No Y043. **£1.25 each**

**MINIATURE LONG NOSE PLIERS** - insulated handles 5 1/8 inch length Order No Y044. **£1.25 each**

**MINIATURE BEND NOSE PLIERS** - insulated handles 5 1/8 inch length Order No Y045. **£1.25 each**

**MINIATURE END NIPPERS** - insulated handles 4 1/8 inch length Order No Y046. **£1.25 each**

**MINIATURE SNIP NOSE PLIERS** with side cutter and serrated jaws - insulated handles 5 1/8 inch length. Order No Y047. **£1.25 each**

**ALL WITH INSULATED HANDLES**

**FLEXEY DRIVER**  
 A flexible shaft screwdriver for those awkward to get at screws. Overall length 8 1/8 inch. Order No FS-1 Flat blade 4mm FS-2 Cross point no 1 **£1.75 each**

**GRIP DRIVER**  
 Binch long screwdriver with spring loaded grip on end to hold screws in position while reaching into those difficult places. Order No SD-1 Flat blade 4mm SD-2 Cross point no 0 **95p each**

**INEXPENSIVE TOOLS OF IMMENSE VALUE**  
 Combined wire stripper, cutter, crimper incl 25 ass't terminals for crimping Order No WS2. Our low price **£1.20 each**

**BA NUT DRIVER SET**  
 Set of 5 BA spanner shafts plus universal handle in roll-up wallet. Sizes OBA 2-4-6-8BA Order no. T192 **£2.75 set**

**NEON SCREWDRIVER**  
 7 1/8 inch blade order no. NS1 **£0.85p each**  
 5 1/8 inch blade order no. NS2 **£0.50p each**

**Guarantee**  
 Satisfaction or your money back has always been BI-PAK'S GUARANTEE and it still is. All these Sale items are in stock in quantity and we will despatch the same day as your order is received.

## EXPERIMENTOR BOXES - ALUMINIUM - PLASTIC ALUMINIUM BOXES

Made with Bright Aluminium folded construction with deep lid and screws

SIZE	L	W	H	Order No.	Price
5 1/4	2 1/4	1 1/2	159	<b>83p</b>	
4	2 1/4	1 1/2	161	<b>83p</b>	
4	2 1/2	2	163	<b>83p</b>	
3	2	1	164	<b>87p</b>	
8	6	3	166	<b>£1.08</b>	
6	4	2	167	<b>£1.12</b>	

All measurements for boxes are shown in inches. L = Length, W = Width, H = Height

## Plastic Boxes

Coloured black. Close fitting. Flanged Lid, fixing screws into brass bushes.

SIZE	L	W	H	Order No.	Price
4	2	1	141	<b>£1.00</b>	
4	2 1/2	1 1/2	143	<b>£1.30</b>	
6	3 1/2	2	144	<b>£1.60</b>	

Plastic as above but with aluminium top panel

4	2 1/4	1	146	<b>£1.40</b>
---	-------	---	-----	--------------

Plastic sloping front

5 1/2	4 1/4	2 1/4	to slope	
to			to	
1 1/2			148	<b>£2.14</b>

## IC SOCKETS

**The lowest price ever.**  
 The more you buy the cheaper they come!

Pin	10 off	50 off	100 off
8 pin	85p	£3.50	£8.00
14 pin	90p	£3.75	£8.50
18 pin	95p	£4.00	£7.00

## VOLTAGE REGULATORS

**T0220**

	Positive +	Negative +
	7805 - 50p	7905 - 55p
	7812 - 50p	7912 - 55p
	7815 - 50p	7915 - 55p
	7824 - 50p	7924 - 55p

## BI-PAK'S OPTO 83 SPECIAL

A selection of Large & Small size LED's in Red, Green, Yellow and Clear, plus shaped devices of different types. 7 Segment displays, photo transistors, emitters and detectors. Types like MEL11, FPT100 etc. Plus Cadmium Cell ORP12 and germ. photo transistor OCP71.

O/N0 SX574  
 Valued - Normal Retail £12.00  
 Our Price **£5.00**

## SEMICONDUCTORS FROM AROUND THE WORLD

**100** A Collection of Transistors, Diodes, Rectifiers, Bridges, SCR's, Triacs. IC's both Logic and Linear plus Opto's all of which are current everyday usable devices.

Guaranteed Value over £10 at Normal Retail Price

**£4.00**

Data etc. in every pak. Order No. SX56

## MW398 NI-CAD CHARGER

Universal Ni-Cad battery charger. All plastic case with lift up lid. Charge/Test switch. LED indicators at each of the live charging points.

Charges -	Power -
PP3 (9V)	220-240V AC
U12 (1.5V penlite)	Dims -
U11 (1.5V "C")	210 x 100 x 50mm
U2 (1.5V "D")	<b>£6.95</b>

## POWER SUPPLY OUR PRICE £3.25

Power supply fits directly into 13 amp socket. Fused for safety. Polarity reversing socket. Voltage switch. Lead with multi plug. Input - 240V AC 50HZ Output - 3, 4, 5, 6, 7, 5, 9 & 12V DC Rating - 300ma MW88

## 1 Amp SILICON RECTIFIERS

Glass Type similar IN4000 SERIES IN4001-IN4004 50 - 500v - uncod. J - you select for VLTS ALL perfect devices - NO dud's Min 50v 50 for **£1.00** - worth double ORDER NO. SX76

Silicon General Purpose NPN Transistors T0-18 Case Lock In leads - coded CV7644 Similar to BC147 - BC107 - ZT89 ALL NEW! VCE 70v IC500mA Hfe 75-250 50 off 100 off 500 off 1000 off PRICE **£2.00 £3.80 £17.50 £30.00**

Silicon General Purpose PNP Transistors T0-5 Case Lock In leads coded CV9507 similar 2N2905A to BFX30 VCE 60 IC 600mA Min Hfe 50 ALL NEW! 50 off 100 off 500 off 1000 off PRICE **£2.50 £4.00 £19.00 £35.00**

## Silicon NPN 'L' Type Transistors

T0-92 Plastic centre collector Like BC182L - 183L - 184L VCBO 45 VCEO 30 IC 200mA Hfe 100-400 ALL perfect devices - uncoded ORDER AS SX183L 50 off 100 off 500 off 1000 off **£1.50 £2.50 £10.00 £17.00**

**PNP SILICON TRANSISTORS:**  
 Similar ZTX500 - ZTX214 - E-Line VCED 40 VCBO 35 IC 300mA Hfe 50-400 Brand New - Uncoded - Perfect Devices 50 off 100 off 500 off 1000 off **£2.00 £3.50 £15.00 £25.00**

## DIGITAL VOLT METER MODULE

3 x 7 segment displays Basic Circuit 0-2v± instructions provided to extend voltage & current ranges Operating voltage 9-12v Typ Power Consumption 50mA D/N0 SX99 Once only price **£9.95**

## ELECTRONIC SIREN 12v DC

Red plastic case with adjustable frequency trimmer. Emits high pitched warning siren of varying pitch - 100 cycles per minute. Dims - 90mm (dia) 60mm (depth) Power - 12v DC **Our Price: £5.50**

## 8 Bit MICROPROCESSOR

National INS8080AN 40 Pin DIL N Channel Silicon GATE MOS TECHNOLOGY As used in Nationals 8080 Micro Computer Family Instruction Cycle Time 2µs Supplied with functional Block Diagram BRAND NEW - NOT seconds or reclaims 100% perfect ORDER NO. SX8080 Normal Sell price £4.50 each **Our BI-PAK Special Price £2.00** SD HURRY - LIMITED STOCKS

40 Pin IC Socket to fit SX8080 Offer price ORDER NO. 1609 **30p**

## MULTITESTERS

30,000 opv Including test leads and case. AC volts - 0.25-10-25-100-250-500-1,000. DC volts - 0-0.25-1-2.5-10-25-100-250-1,000. DC current - 0-50µa 0-5ma-50ma 0-12amps. Resistance - 0-6K ohms-70K ohms-6meg ohms-60meg ohms. Decibels - -20db to plus 56db. Short test: Internal buzzer. Dims - 160 x 110 x 50mm.

O/No. 1315. OUR PRICE **ONLY £24.75**

1,000 opv Including test leads & Battery. AC volts - 0-15-150-500-1,000. DC volts - 0-15-150-500-1,000. DC currents - 0-1ma-150ma. Resistance - 0-2.5 K ohms 100 K ohms. Dims - 90 x 61 x 30mm

O/No. 1322. OUR PRICE **£6.50 ONLY**

## BI-PAK'S COMPLETELY NEW CATALOGUE

Completely re-designed. Full of the type of components you require, plus some very interesting ones you will soon be using and of course, the largest range of semiconductors for the Amateur and Professional you could hope to find. There are no wasted pages of useless information so often included in catalogues published nowadays. Just solid facts i.e. price, description and individual features of what we have available. But remember, Bi-Pak's policy has always been to sell quality components at competitive prices and **THAT WE STILL DO.**

BI-PAK'S COMPLETELY NEW CATALOGUE now available to you. You will be amazed how much you can save when you shop for Electronic Components with a Bi-Pak Catalogue. Have one by you all the time - it pays to buy BI-PAK.

To receive your copy send **75p** plus 25p p&p.

# BI-PAK

Send your orders to Dept. BI-PAK PO BOX 6 WARE HERTS. SHOP AT 3 BALDOCK ST WARE HERTS. TERMS: CASH WITH ORDER, SAME DAY DESPATCH ACCESS. BARCLAYCARD ALSO ACCEPTED. TEL (0920) 3182. CRO 388 7006. ADD 15% VAT AND 75p PER ORDER POSTAGE AND PACKING.



Use your credit card. Ring us on Ware 3182 NOW and get your order even faster. Goods normally sent 2nd Class Mail. Remember you must add VAT at 15% to your order. Total. Postage add 50p per total order.



# BREMI

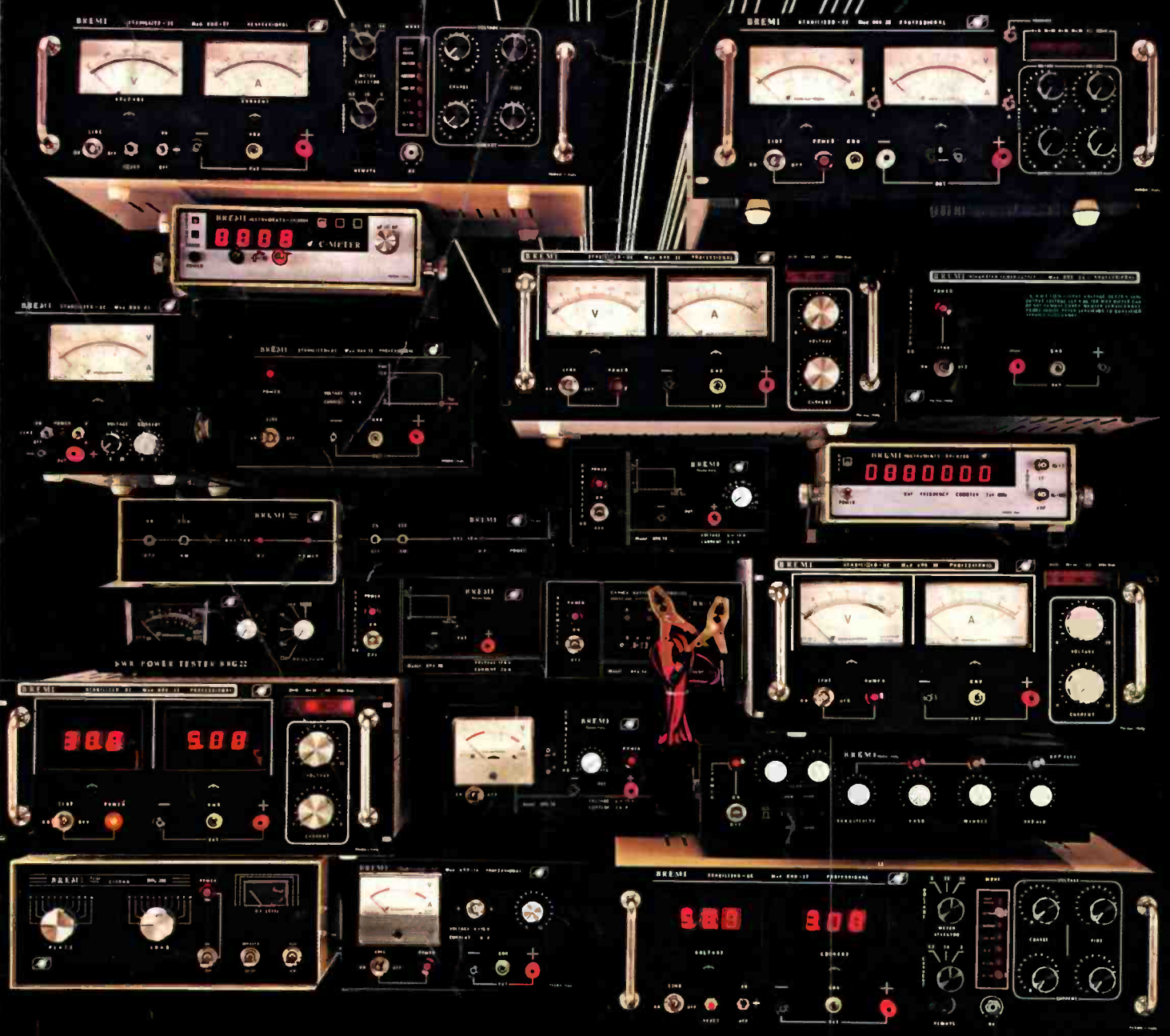

**OCT**  
#1 in Electronics and Communications

For more information:  
Ask at your nearest electronics stockist  
01-808 5656/(0476) 76928

CB TRADE ASSOCIATION  
**CiBTA**  
MEMBER