

1938

# LAMPHOUSE ANNUAL

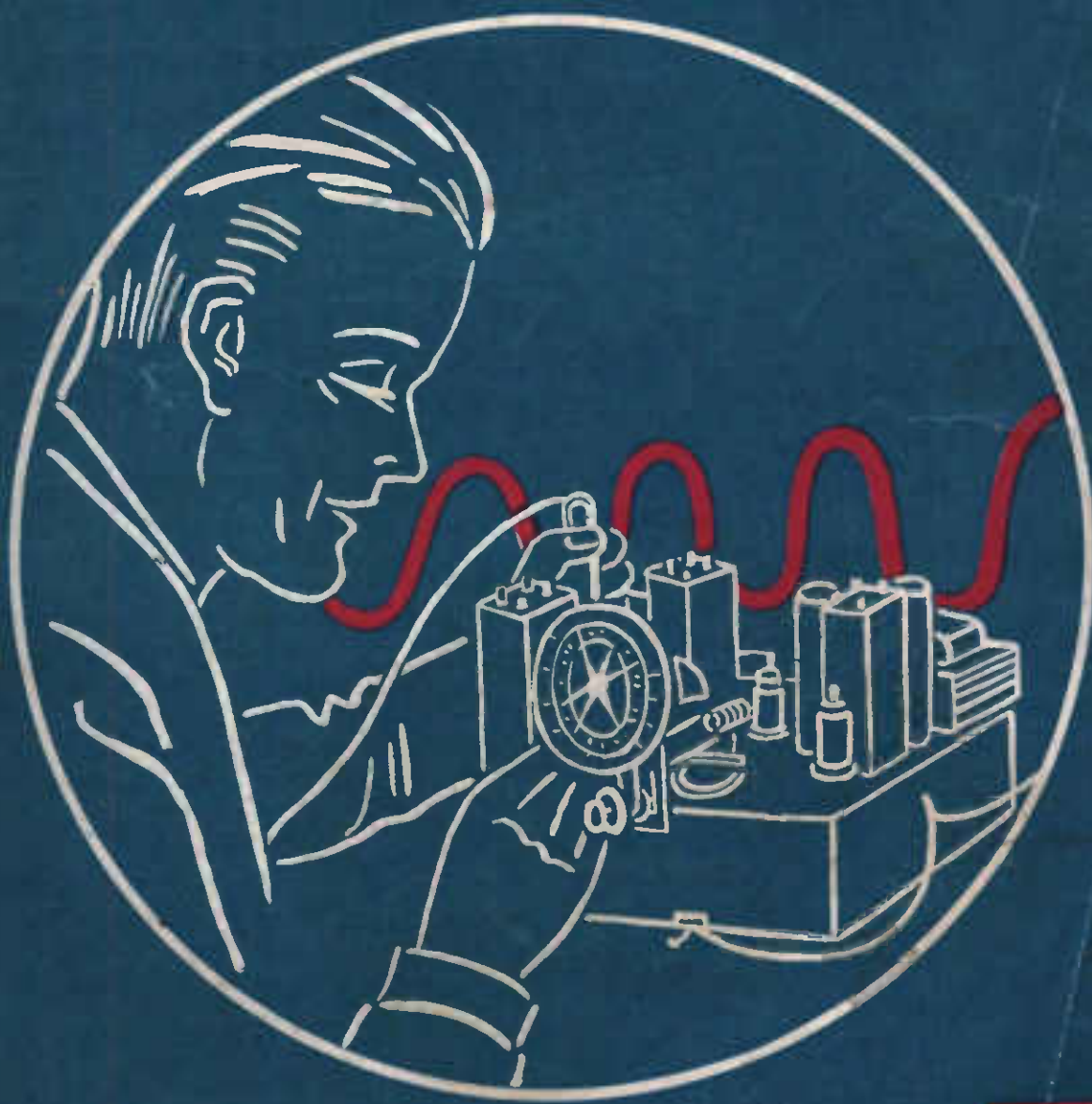

6<sup>p</sup>  
PER COPY

R.C.S. EDGELIT DUAL-WAVE DIAL. (K)



A high quality Dial, designed for those who require a first-class article at a reasonable price.

It features the new dual-colour lighting system, the short-wave portion being orange and the broadcast green. Colour changing is operated by the wave-change switch.

A new method of friction-drive gives powerful action, free from backlash and slip and ensuring ease of tuning on short-wave.

Broadcast section is calibrated in K.C., also main N.Z. and Australian stations. Short-wave in meters with principal stations.

Calibrated for clockwise condensers and fitted with double grub screws to obtain positive grip on condenser shaft.

Escutcheon of brown bakelite, and solid glass face. Supplied with mounting screws and spacers.

New Switch (K)

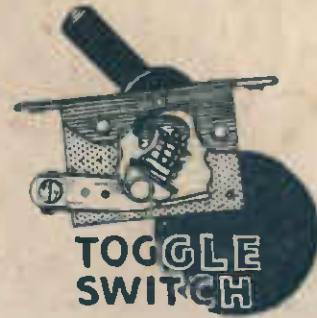

Switches as used on Vacuum Cleaners and other appliances. Flush mounting.

Cat. No. ES460 ..... Each 2/6

MOUNTING HOLE FOR ESCUTCHEON—7 1/2 in. x 4 1/2 in. ....  
 DIAL PROJECTS BEHIND PANEL—2 in. ....  
 OVERALL DIMENSIONS—9 1/2 in. x 6 1/2 in. ....  
 RATIO—8-1 .....  
 SHAFT—3/8 in. ....

Cat. No. ED614—  
 29/6  
 EACH

# L.B.P.

## WHAT EVER'S THAT?

Ah! That's got you guessing! Well! L.B.P. is the name given to a brand new idea originated by the *Lamphouse* which enables you to obtain the goods you want from the "Radiogram" or "*Lamphouse Catalogue*" and pay for them in a wonderfully convenient and easy manner. Space does not allow a fuller explanation, but if you are interested write and ask for our leaflet about L.B.P.

## Just on 6,000 RADIOGRAMS Monthly Proves Its POPULARITY!



The consistent growth of the "RADIOGRAM" circulation is proof positive of its usefulness to Radio Amateurs, Experimenters, Servicemen and Radio Owners. Almost every mail brings us letters of appreciation from pleased subscribers. Every month the "RADIOGRAM" brings you the latest and best news regarding everything radio and electrical. Circuits appear regularly for both Electrical and Battery Sets, from small LOCAL receivers to powerful SUPERHETS. Articles of general interest include hints about better reception, better performance, aerials, static reduction, jokes, etc., etc. A Beginner's Page in each issue is proving wonderfully helpful. And all this for the modest subscription of 3/- a year. The next issue is worth the money alone.

Send your subscription NOW. The 3/- also entitles you to membership of the HOBBIES' CLUB, club badge, registration, and other benefits. Address your letter to Editor, "Radiogram," 27 Manners Street, Wellington.

### You Can't Afford to Miss It!

Mail All Orders to the "Electric Lamp House" 27 MANNERS ST WELLINGTON



# Hello Everybody

## 1938 Lamphouse Annual



**"THANKS A MILLION!"** Yes, many, many thanks for all the letters and telegrams which flowed in when last year's Annual was published, and the proof of the pudding is in the eating, within two months we were busy preparing a second Edition! Need we say more?

And just as our Annual proved more popular than ever, so did our goods and services. Every month of 1937 was a record month for sales.

During 1938 we have no hesitation in preparing for larger sales than ever before, because we know that the values we offer are better than ever before. We know that our old customers will come back again and again, because they know the value of the Lamphouse unconditional money-back guarantee, which reads:—

**"Any goods that are in any way unsuitable may be returned within seven days (from receipt), and your money will be refunded in full."**

**The Electric Lamp House Ltd.**  
Manners Street - Wellington, C.1



<b>A</b> Accumulators	32, 48, 77
Adaptors, Electrical	21
Aerial Equipment	44 to 47
Aerial Series Condensers	57
Aeritrols	51
Air Cells	48
Akros Flex	24
Alligator Clips	60
Anchoring Strips	77
Angle Brackets	70, 77
Appliance Cords	29
Appliance Plugs	22
Appliance Terminals	29
Arrestors, Lightning	45
Attachment Switch Conversion	13
Audio Transformers	55, 79, 80-122

<b>B</b> Banana Plugs	78
Batteries, Accumulators	32, 48, 77
Batteries, "A," "B" & "C,"	48, 49, 122
Batteries, Torch	25
Battery Cables	81
Battery Clips	60
Battery Chargers	50
Battery Eliminators	50
Battery Sets, Radio	39, 40, 42, 43
Battery Tester	66, 69
Beaters, Electric	14, 18
Bed Warmers	13
Beehive Insulators	44
Bells and Bell Material	20, 76
Bevels	38
Blocks, Transposition	45
Blocks, Wood	23
Boards, Terminals	78
Boilers, Water	16
Bolts, Nuts and Washers	77
Books	58, 72
Bowl Buttons	30
Bowl Fittings	19
Braces (Carpenters')	37
Brackets, Angle	70, 77
Brackets, Lamp	15, 22, 60, 61
Buckles, Klipsits	24
Bulbs, Tungar	50
Bumpers, Tack	77
Bushes, Insulating	77
Button Insulators	44
Buttons, Bowl	30
Buttons, Horn	36
Buzzers, Electric	20

<b>C</b> Cabinets, Radio	52
Cable Ignition	33
Cables, V.I.R.	24
Cables, Battery	81
Cables, Motor Car	33
Cahtyre Flex	24
Camping Lamp, Motorists	36
Cans, Coil and Valves	75
Ceiling Plates	30
Ceiling Roses	23
Ceiling Switches	23
Celluloid Cement	77
Cells, Dry	48, 49
Chain	30
Chargers, Wind	47
Chargers, Battery	50
Chatterton's Compound	77
Chokes	52, 55, 112
Cleaners, Electric	16, 17
Cleats, Aerial	45
Clips Battery	60
Clips, Earth	46
Clips, FahstocK	78
Clips, Grid Screen	77
Clips, Voltage Divider	72
Clocks, Electric	8
Coil Feet	77
Coil Former	63
Coils, Radio	53, 54, 55, 60
Coil Shields	75
Coils, Medical	12
Coils, Speaker Transformer	80
Coils, Violet Ray	30
Compound, Chatterton's	77

## INDEX

Condenser Couplings	57, 62
Condenser Extension Shafts	58
Condensers, Radio	56, 57, 58, 122
Condensers, Violet Ray	30
Connecting Wire	81
Connectors, Aerial	45
Connectors, Banana Plugs	78
Connectors, Wire	20, 70, 77, 78
Contact Studs	76
Cooker Elements	29
Cookers, Breakfast	12
Coppered Staples	46
Cords, Appliance	29
Cords, Ceiling Switch	23
Cords, Headphones	60
Cords, Lighting Extension	11
Cord, Speaker	74, 81
Cord Switches	23
Couplings, Condensers	57, 62
Crystal Sets and Parts	59, 60
Curlers, Hair	12
Cycle Cyclometers	35
Cycle Dynamo Outfit	34, 35
Cycle Horns	32, 35
Cycle Lamps	35
Cycle Mascots	32, 35
Cycle Mirrors	32

<b>D</b> D.C.C. Wire	81
Detecolites	66
Detectors, Crystal	59
Dial Bracket Fittings	60, 61
Dial Knobs	60, 62
Dial Lamps	81
Dials	60, 61, 62
Diaphragms for Phones	60
Dividers, Voltage	72
Doublet Aerials	47
Drills	37
Dry Cells	48, 49
Dryers, Hair	12
D.S.C. Wire	81
Dynamo Outfit, Cycle	34, 35

<b>E</b> Ear Caps for Phones	60
Ear Pads	60
Earth Clips	46
Earth Tubes	46
Earth Wires	46
Egg Insulators	44
Electrical Adaptors	21
Electric Bells and Buzzers	20
Electric Cleaners	16, 17
Electric Clocks	8
Electric Cookers	12
Electric Fans	14
Electric Gas Lighters	11
Electric Irons	9, 11, 13, 17
Electric Jugs	12
Electric Kettles	16
Electric Lamps	17, 27, 28, 31, 81
Electric Mixers	14, 18
Electric Motors	11, 30
Electric Radiators	15
Electric Razors	8, 18
Electric Switches	23
Electric Toasters	9
Electric Torches	25, 26, 27
Electric Urns	12
Electrodes, Violet Ray	30
Electrolytic Condensers	56
Elements, Electric	29
Eliminators, Aerial	46, 47
Eliminators, Battery	50
Enamelled Wire	44, 81
Escutcheons, Magic Eye	60, 62
Extension Cords, Lighting	11
Extension Speakers	73, 74
Eyes, Galvanised	45

<b>F</b> FahstocK Clips	78
Fans, Electric	14
Feed Thru Insulators	44
Feet, Coil	77
Filament Transformers	55, 60
Filters, Aerial	47

Filters, Line	46
Filters, Motor	51
Fires, Electric	15
Fittings, Bowl	19
Fixed Condensers	56, 57
Flanges	30
Flexible Wires	20, 24, 33, 81
Floats, Hydrometer	69
Formers, Coil	63
Fuse Holders	71
Fuses, Kettle	29
Fuses, Radio	71
Fuses, Range	23
Fuse Wire	23

<b>G</b> Galleries (Lamp Shade)	30
Gas Lighters	11
Generator Outfits, Cycle	34, 35
Generators, Telephone	77
Glass Insulators	44
Gramophone Motors	71
Gramophone Pickups	71
Gravity Hooks	30
Grinders	37
Grommets, Rubber	77
Guide Arms, Insulated	44
Gauges, Marking	38

<b>H</b> Hack Saw Frames	36
Hair Curlers	12
Hair Dryers	12
Handlamp, Inspection	17, 33
Handles, Iron	29
Headphones, Spares	60
Headphones	59
Health Lamp	10
Heating Flex	24
High Tension Batteries	48, 49, 122
Holders, Fuse	71
Holders, Lamp	21, 33, 71
Holders, Shade	22, 30
Hooks, Galvanised	45
Hooks, Gravity	30
Horn Buttons	36
Horns, Cycle	32, 35
Hot Plates	12, 16
Hydrometers	69

<b>I</b> Ignition Cable	33
Immersion Heaters	16
Indoor Aerials	44, 47, 51
Inspection Handlamps	17, 33
Insulated Aerial Wire	44
Insulated Guide Arms	44
Insulated Screw Eyes	22
Insulated Staples	46
Insulating Panels	71
Insulating Tape	23
Insulating Washers	77
Insulators	44
Interference Units	51
Intermediate Frequency Trans-	54, 55
formers	54, 55
Iron Elements	29
Iron Handles	29
Irons, Electric	9, 11, 13, 17
Irons, Soldering	36, 76

<b>J</b> Jacks, Phone and Tip	63
Jug Elements	29
Jugs, Electric	12

<b>K</b> Kettle Elements	29
Kettles, Electric	16
Keys, Morse	63
Kit Sets	84 to 128
Kits, Tool	112
Klipsit Buckles	24
Knife Switches	45, 46
Knight Vacuum Cleaners	16, 17
Knobs, Dial	60, 62

<b>L</b> Lamp Brackets	15, 22, 60, 61
Lamps, Camping, Motorists	36
Lampholders	21, 33
Lampholders, Dial	60, 61
Lamp Inspection, Hand	17



# INDEX

	Page
Lamp Locks	30
Lamps, Cycle	34, 35
Lamps, Dial	81
Lamps, Electric	17, 27, 28, 31, 81
Lamps, Health	10
Lamp Shades	7, 16, 19, 30
Lamps, Motor Car	31
Lamp Sockets, Motor Car	33
Lamps, Table	6, 11, 13, 18
Lamps, Torch	28
Lead-in Tubes	45
Lead-in Wire	44
Lead-ins, Flexible	45
Levels	36
Lighters, Gas	11
Lightning Arrestors	45
Line Filters	46
Lissen Valves	83
Locks, Lamp	30
Loud Speakers	73, 74, 79
Lugs, Soldering	78
<b>M</b> Magic Eye Escutcheons	60, 62
Marking Gauges	38
Mascots, Cycle	32, 35
Massage Vibrators	11
Masts, Aerial	45
Medical Coils	12
Medical Handlamps	10
Meters	64, 65, 66, 67, 68, 69
Meter Shunts	65, 67
Meter Spares	68
Microphones	71
Microphone Transformers	79
Mirrors, Cycle	32
Morse Keys	63
Morse Practice Sets	63
Motor Car Aerials	47
Motor Car Batteries	32
Motor Car Lamps	31
Motor Car Lamp Sockets	33
Motor Car Radio	39
Motor Car Switches	33, 35, 36
Motor Car Terminals	33
Motor Car Wires	33
Motor Cycle Batteries	32
Motorists' Camp Lamp	36
Motor Filters	51
Motshavers	8
Motors, Gramophone	71
Motors, Electric	11, 30
<b>N</b> Nail-it Insulators	44
Needles, Pick-up	41
Nippers	38
Nipples	30
No-Mast Aerials	46
Nuts	77
<b>O</b> Oscillators	67, 68
Osram Valves	82
<b>P</b> Padding Condensers	57
Pads, Ear	60
Panels, Ebonite	71
Pear Pushes (Bell)	20
Percolator Elements	29
Phone Jacks	63
Phone Plugs	70
Phones, Head	59
Pick-up Needles	41
Pick-ups, Gramophone	71
Planes	38
Plates, Aerial-Earth	45
Pliers	38
Plugs, Appliance	22, 70
Plugs, Banana	78
Plugs, Phones	70
Plugs, Spark	33
Plugs, Speaker	70
Plugs, Wall	22, 70
Plugs, Wander	78
Potentiometers	70, 85
Power Plants	50
Power Transformers	55, 80
Preset Condensers	58
Prods, Test	66
Pulleys, Galvanised	45

Punches	36, 80
Push-back Wire	81
Pushes, Bell	20, 76
<b>R</b> Radiator Elements	29
Radiators, Electric	15
Radio Cabinets	52
Radio Sets	39, 40, 41, 42, 43
Radio Switches	74, 76
Radiotron Valves	82
Radio Tuners	51
Range Elements	29
Raytheon Valves	82
Razor, Electric	8, 18
Razor Blade Sharpener	18
Red and Black Flex	81
Resistance Wire	24
Resistors	67, 70, 72
Rheostats	72
Rods, Threaded	72
Rope, Aerial	45
Resin Core Solder	76
Rubber Grommets	77
Rules	38
<b>S</b> Saw Sets	38
Scout Practice Sets	63
Screen Grid Clips	77
Screen Lead-in Wire	44
Screw Drivers	36, 37, 38
Screw Eyes, Insulated	22
Screened Tubing	81
Screws and Nuts	77
Sets, Radio	39, 40, 41, 42, 43
Shade Holders	22, 30
Shades, Lamp	7, 16, 19, 30
Sharpex Stropper	18
Shell Insulators	44
Shields, Coil and Valve	75
Shunts, Meter	65
Silk, Speaker	81
Snips	38
Sockets, Valve	75
Soldering Irons and Material	36, 76
Soldering Lugs	78
Spade Terminals	78
Spaghetti Tubing	81
Spark Plugs	33
Spark Plug Suppressors	72
Spark Plug Tester	32
Spanners	38
Speaker Cabinets	52
Speaker Cord	74, 81
Speaker Cord Tips	78
Speaker Plugs	70
Speakers	73, 74, 79
Speaker Silk	81
Speaker Transformers	55, 80
Sprayers, Vacuum Cleaner	14
Spring Aerials	47
Springs, Aerial	45
Squares	38
Staples	46
Stay Wire	45
Step-down Transformers	55
Strainers, Wire	45
Strips, Terminal	77, 78
Studs, Contact	76
Suppressors	51, 72
Surprise Packets	41
Switch Arms	76
Switch Conversion Attachment	13
Switch Cords	23
Switches, Electric	23
Switches, Knife	45, 46
Switches, Motor-car	33, 35, 36
Switches, Radio	45, 74, 76
<b>T</b> Table Lamps	6, 11, 13, 18
Tack Bumpers	77
Tack Lifters	38
Tape, Insulating	23
Telephone Generators	77
Telephones	13
Telephones, Head	59
Terminal Boards	77, 78

Terminals, Appliance	29
Terminals, Motor Car	33
Terminals, Radio	77, 78
Terminal Strips	77, 78
Tester, Spark Plug	32
Tester, Valve	65, 66
Testing Equipment	64, 65, 66, 67, 68, 69
Test Prods	66
Threaded Rods	72
Tilters, Shade	22
Tinsnips	38
Tip Jacks	63
Tips, Speaker Cord	78
Toaster Elements	29
Toasters, Electric	17
Tool Kits	112
Tools	36, 37, 38
Torch Batteries	25
Torches, Electric	24, 25, 26
Torch Lamps	28
Transformers, Audio	55, 79, 80, 122
Transformers, Bell	20
Transformers, Filament	55, 80
Transformers, I.F.	54, 55
Transformers, Power	55, 80
Transformers, Speaker	55, 80
Transformers, Stepdown	55, 79
Transmitters (Telephone)	71
Transmitting Condensers	58
Transposition Blocks	45
Tubes, Earth	46
Tubes, Former	63
Tubes, Lead-in	45
Tubes (Valves)	82, 83
Tubing, Metallic Screened	81
Tubing, Spaghetti	81
Tuners, Radio	51
Tungar Bulbs	50
<b>U</b> Urns	12
<b>V</b> Vacuum Cleaners, Knight 16	17
Vacuum Cleaner Spares	14, 30
Vacuum Cleaner Sprayer	14
Valve Pins and Sockets	78
Valves	82, 83
Valve Shields	75
Valve Sockets	75
Valve Testers	65, 66
Variable Condensers	57, 58
Vibrators, Massage	11
Vibrators, Radio	50
Vibrator Transformers	79
Violet Ray Machines	6
Violet Ray Spares	30
Voltage Divider Clips	72
Voltage Dividers	72
Voltage Reducers	79
<b>W</b> Wall Plugs	22, 72
Wander Plugs	78
Warmers, Bed	13
Washers	77
Washers, Insulating	77
Water Boilers	16
Wave Traps	51
Wind Chargers	47
Wire, Aerial	44
Wire, Bell	20
Wire, Connecting	81
Wire Connectors	20, 70, 77
Wire, D.C.C.	81
Wire, D.S.C.	81
Wire, Enamelled	44, 81
Wire, Flexible	20, 24, 33, 81
Wire Fuse	23
Wire, Lead-in	44
Wire, Push-back	81
Wire, Screened	33, 81
Wires, Motor Car	33
Wires, Resistance	24
Wire, Stay	45
Wire Strainers	45
Wire, Tinned Earth	46
Wire V.I.R.	24
Wood Blocks	23
Wrenches	38

## GENERAL INFORMATION

**TERMS OF BUSINESS.**— Our terms are cash with order. We buy for cash and sell for cash, that's why our prices are lower. If it is desired we will hold any monies of regular customers in a deposit account for future purchases, otherwise any balance due will be returned with the goods.

**HOW TO ORDER.**— Order forms are always available for your convenience. It is only necessary to quote the catalogue number and short description when ordering, such as "EA 123—Accumulator."

**CATALOGUE NUMBERS.**— The first letter (E) of the number is for our reference, and alters with each price list or advertisement published. The balance of the catalogue number will always remain the same for the same article.

**FREIGHT.**— We pay freight on all retail orders over £1 value. Please include sufficient cash for postage on small orders.

**GUARANTEE.**— Any goods that prove in any way unsuitable may be returned within seven days and your money will be refunded in full.

**REFERENCE.**— Our Bankers are the National Bank of New Zealand, Ltd., Courtenay Place, Wellington.

**COMPLAINTS.** Please specially address all letters containing complaints, etc., to "The Director."

**RETURNS.**— Should it be necessary to return goods, always put in a slip of paper with your name and address. When returning goods for credit or exchange, state invoice number in covering letter to ensure prompt attention.

**TELEGRAMS.**— Address telegrams to "Lamphouse," Wellington.

**POSTAL ADDRESS.**— All orders and general correspondence should be addressed to—

## THE ELECTRIC LAMP HOUSE LTD.

MANNERS STREET . . . . . WELLINGTON, C.1

**DELIVERY.**— We endeavour to maintain a same day dispatch service. This is not always possible as at times goods have to be specially procured, and at times exceptional rushes take place. It is very seldom, however, that an order is held for more than one day after receipt.

**A SUGGESTION.**— As it is much easier for us to make a refund along with your receipt than for you to get stamps or postal notes to remit a small balance that may be left owing when your receipt is sent, would it not save you inconvenience if you were always to send ample cash to allow for freight, etc.? We will refund the difference, or place it to your credit, according to your instructions. Do as hundreds of our customers do, send a blank cheque, which we will fill in when we have totalled your order. You can write across the top of the cheque "Not to exceed £5"—or £10, or £20, as the case may be.

**REMITTANCES.**— Enclose cheque, pound note, postal note, or money order to the full amount of your order. If you send coin or bank notes, be sure to register the letter. Make cheques and postal notes payable to The Electric Lamp House, Ltd., and keep numbers for reference.



# WHERE IS IT?

*How to find the Goods or Circuit you require*

**INDEX.** On pages two and three you will find a complete index of all goods listed in the Catalogue portion of this book. A moment's glance at the index will save you looking through over 2000 items.

## CATALOGUE ARRANGEMENT

The catalogue portion of this book has been divided up into 5 divisions, viz.:

- 1 Electrical Appliances, Fittings, Table Lamps, etc.—pages 6-19.
- 2 Electrical Accessories: Adaptors, Switches, Lamps, etc.—pages 20-30.
- 3 Motor-car Accessories and Tools—pages 31-38.
- 4 Radio Sets—pages 39-43.
- 5 Radio Accessories—pages 44-83.

(Always refer to Index Pages 2 and 3 when looking for an article.)

Where possible, kindred items of the above sections are grouped; for instance: Aerial Equipment will be found on pages 44-47. All testing equipment such as Meters, Instruments, Hydrometers, etc., see pages 64-69.

## CONTENTS

CATALOGUE INDEX—  
Pages 2 and 3

CATALOGUE .. Pages 1 to 83

T.R.F. Tuning Unit .....	84
Morse Code Oscillator ....	85
Economy Three Receiver ..	86
All-wave Double Forty-Nine	87
Crystal Sets .....	89
Joining Wires .....	90
R.C.S. D.W. Five .....	91
1938 Dual Six .....	92
Improved Hiker's One ....	94
Hiker's 49 Amplifier .....	96
"Wireless Weekly" Wave Trap .....	97
Connecting Extra Speakers	97
New Year Battery Five ...	98
Aerials .....	100
Power Pack for S.W. Sets ..	101
Pentagrid Four .....	102

Amplifiers for Battery Sets	104
B-less Oneder .....	105
Simplex Single .....	106
3-5 Battery Set .....	107
Battery Skysweeper .....	108
Short-wave Converter ....	110
Wave Trap .....	112
Add-a-Valve .....	113
All-Wave Duplex Single ...	114
Simple Crystal Set .....	115
Swing Amplifier .....	116
Popular Skysweeper .....	118
All Star Two .....	120
Home Volume Amplifier ...	122
Auto Receiver .....	123
Vibrator Unit .....	125
Pentagrid 7 .....	126
Ironclad Skysweeper .....	126
Straight Super Five .....	127

Mail All Orders to the "Electric Lamp House" 27 MANNERS ST WELLINGTON



### Try it at Our Expense!

Send for one NOW! Try it out for seven days, and if at the end of that time you can honestly say you have not benefited, return the machine to us in the same condition as when received, and we will refund your money in full, including return postage. That's what WE think of Helios Violet Ray.

SPARE ELECTRODES AND PARTS ALWAYS AVAILABLE.

(D)

## HELIOS VIOLET RAY IS ABSOLUTELY SAFE!

It can be handled as easily as a toy and can be attached by anyone, however inexperienced, to any electric-light installation that may be handy. The working is as simple as possible, and the amount of current used extremely small.

### Our Guarantee Protects You!

There's absolutely nothing to stop you proving to your own satisfaction, in your own home, the value of Violet Ray. Every HELIOS VIOLET RAY MACHINE is unconditionally guaranteed for 12 months. Should, by any chance, a defect show up during that period, we will repair it or replace it free of all charge.



As fully explained in the instruction booklet—High-frequency in its many uses is incomparable for generally strengthening the nerves and mental functions. It builds up and nourishes the muscles and blood, destroys all unhealthy foreign and infectious matter, and is a physiological stimulus for the whole body system.

The doctors who seriously treat a great many patients say that high-frequency currents give unexpected success. It is possible to help cases of nerve weakness, and neuropathics have been strengthened by a moderate use of high-frequency rays. Dilation of the heart caused through nerve strain may be cured by this method. Heart diseases of various kinds and hardening of arteries are improved.

### Health Comes FIRST!

Are you ill, suffering, nervous? Are you tortured by rheumatism, gout, or asthma? Do you feel worn-out, fagged, anaemic? Are you troubled by corpulency or signs of age?

If, so, then give a trial to the high-frequency current, which is a dispenser of new strength and new life, a healer and a rejuvenator.

To thousands upon thousands it has already brought relief, healing, recovery, new courage to face life.

Why should it not help you, too?

In elegant case, all ready for use, with FIVE ELECTRODES.

COMPLETE, as illustrated for ..... £4/19/6

Cat. No. EE128 ..... £6

Also 9 Electrode Model ..... £6

Cat. No. EE129 ..... £6

PARTICULARS ON APPLICATION

The "HELIOS" VIOLET RAY MACHINE *builds*

**BODILY HEALTH AND STRENGTH**



# THE LAMPHOUSE CATALOGUE

1938

1938



Modern Chromium Stand, coloured feet and spacers. Stand with fittings and shade.

- Cat. No. EF708 ..... **£1/8/6**
- Stand, without shade.  
Cat. No. EF708A ..... **£1**
- Shade only.  
Cat. No. EF754 ..... **8/6**



Modern Stand. Chromium finish, colour relief. Stand with fittings and shade.

- Cat. No. EF706 ..... **£1/8/6**
- Stand, without shade.  
Cat. No. EF706A ..... **19/-**
- Shade only.  
Cat. No. EF752 ..... **9/6**



Black marble column with white relief and mottle marble base. Chromium fittings. Complete.

- Cat. No. EF704 ..... **£1/12/6**
- Stand without shade.  
Cat. No. EF704A ..... **£1/10/-**
- Shade only.  
Cat. No. EF750 ..... **2/6**



Modern marble stand, complete with fittings and shade.

- Cat. No. EF707—  
**£1/7/6**
- Stand, without shade.  
Cat. No. EF707A—  
**£1/5/-**
- Shade only.  
Cat. No. EF753—  
**2/6**

(D)  
NOTE.—Shades can be supplied in different colours. All Shades are interchangeable with the various types of stands.

## PIANO LAMP

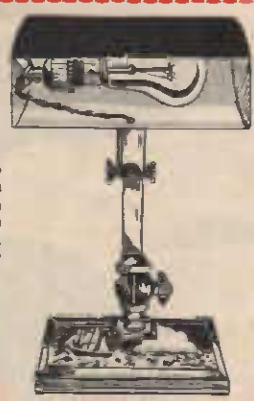

Adjustable Piano Lamp, with heavy base. Can be stood on the top of piano, with reflector hanging down. Chromium finish, reflector lacquered grey inside. Price, complete with flex and fittings, without lamp bulb.

- Cat. No. EF701 ..... Each **17/6**



White marble stand, slightly mottled. Chromium fittings. Complete with flex, shade, etc.

- Cat. No. EF705—  
**£1/4/-**

- Stand, without shade.  
Cat. No. EF705A ..... **£1**
- Shade only.  
Cat. No. EF751 ..... **4/-**

**WESTINGHOUSE  
Electric Clocks (D)**

**JUST PLUG IN AND FORGET.  
Correct Time is Yours Always.**

**Method of Operation.**—In these Westinghouse electric clocks the synchronous motor carries the time train and automatically winds the spring that operates the sounding mechanism. The slip spring, a patented and exclusive feature automatically wound by the motor, is infallible in action and positive in operation.

In summarising the advantages of these clocks we find:—

- 1—Low wattage consumption means less operating cost, less heat, less noise, and long life.
- 2—Slow speed motor means long life and quiet operation.
- 3—Ample power prevents stoppages from line surges.
- 4—No contacts, no buzzers, no dual motors.
- 5—Ample provision for lubrication means long life and less noise.



**RIGEL TIMEPIECE.**

Modern design. Metal case in choice of red, green, ivory or black finish. Height 8 1/2 in. Width 6 1/2 in. Depth 2 in. Two-tone dial, 4 in. wide and 5 in. high. Front set.

Cat. No. EE455 ..... Each **52/6**



**NORTH STAR ALARM.**

Sturdy, small-proportioned Alarm Clock. Heavy cast-metal case finished in crinkled ivory. Height 4 1/2 inches. Width 3 1/2 inches. Patented bell alarm different from ordinary buzzer.

Cat. No. EE459 ..... Each **51/-**



**ARIEL ALARM.**

Clever octagonal design. Solid brass case finished in ivory with polished brass trim. Heavy die-cast base. Height 4 1/2 in. Width 3 3/4 in. Patented bell alarm different from ordinary buzzer.

Cat. No. EE458 ..... Each **47/6**

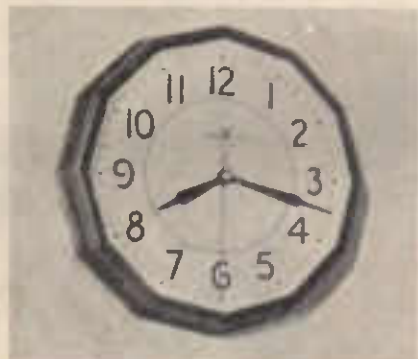

**POLARIS TIMEPIECE.**

Exceptionally legible. Solid mahogany case. Width 14 in. Depth 2 1/2 in. 12 in. dial. Front set; sweep second hand.

Cat. No. EE456 ..... Each **105/-**



**ANDREA MOTOR-CAR RADIOS**  
See page 39.

**New!**

**A PERFECT DRY SHAVE IN TWO  
TO FOUR MINUTES EASILY!**

**MOTOSHAVER**

No blades, no lather, saves time, never needs sharpening, cannot cut yourself, shaves clean, improves the skin.

You shave as fast as you like. The cutter is driven with an extra fast motor, and you have TWO cutting surfaces working at once.

**OUTSHAVES ANY COMPETITOR AT ANY PRICE.**

After a year of laboratory research and development . . . after most thorough testing in practical use . . . MOTO-SHAVER announces a revolutionary new head, which outshaves any electric shaver at any price.

It provides TWO cutting surfaces, which shave simultaneously, giving a faster, cleaner shave without the slightest pull or irritation. **DUAL-HEAD MOTO-SHAVER** means a better **FIRST** shave for the beginner and much less practice to master its use. To the seasoned dry shaver it brings a new perfection in close, clean, rapid shaving.



**DUAL-HEAD MOTOSHAVER** is self-cleaning, self-sharpening—free from all bother. It has the **EXTRA STRONG, EXTRA FAST MOTOR** which the actual experience of thousands of users has proved unsurpassed in efficiency and durability. The motor that will last a lifetime!

**BEST SHAVEN FOR WOMEN**—Enables them to shave under arms and on limbs with ease. Does not enlarge pores or produce bristly regrowth. Absolutely will not cut the skin.

(Passed by the New Zealand Public Works Department.)

**LONGEST GUARANTEE.** — Warranted free from factory defects for 18 months—the longest guarantee, so far as we know, offered by any electric shaver manufacturer. Remember, **MOTOSHAVER INC.** is one of the pioneer manufacturers of electric shavers, and has a record for making its guarantees good.

**DUAL-HEAD MOTOSHAVER** makes an ideal Christmas gift. Women prefer it because it is a welcome gift for husband, father, son or brother, and one **WHICH THEY CAN ALSO USE THEMSELVES.**

Suitable for 230-volt A.C. current supply only.

Cat. No. EE275 .... (D) **115/-** each



# BRITISH "MONARCH" The King of ELECTRICAL APPLIANCES

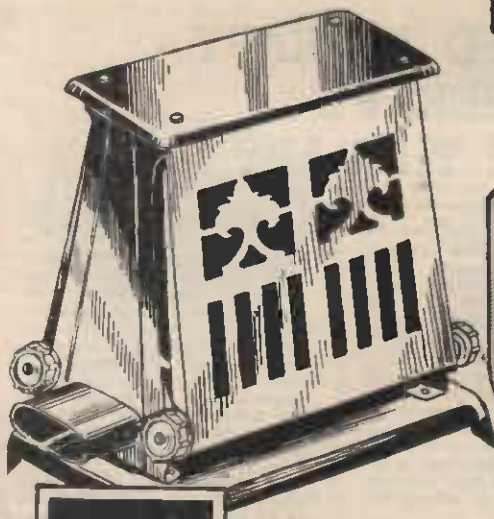

**19/6**

**MONARCH TOASTER. (G)**

You will be proud to own this Toaster. Finished in highly polished nickel-plate. Has turnover feature. Just lower the side and the bread is automatically turned over. Element designed so that the bread toasts quickly and evenly. Supplied complete with cord, etc., ready for use.

Cat. No. EE750 ... **19/6**  
Each

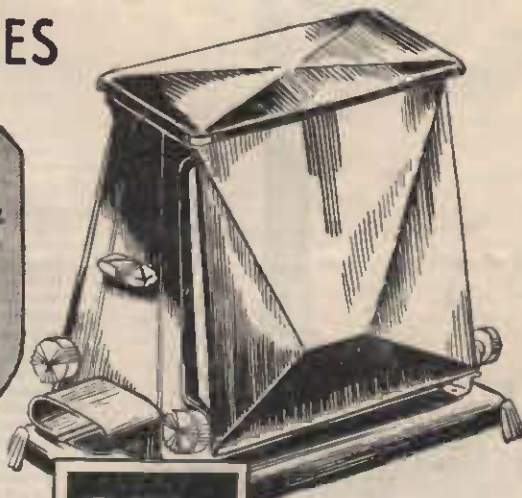

**27/6**

**MONARCH DE LUXE TOASTER. (G)**

An appliance of beauty and utility. Lowering the side automatically turns the toast. Toasts evenly and quickly. Supplied complete.

Cat. No. EE751 ... **27/6**  
Each

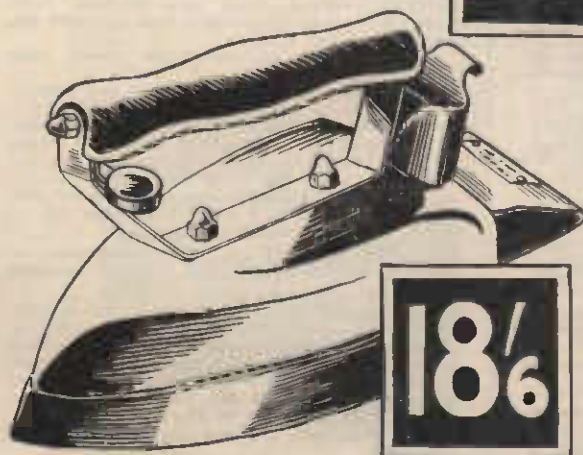

**18/6**

**MONARCH ELECTRIC IRON. (G)**

Although priced within the reach of all, this Iron will compare very favourably with the much higher priced lines. Easy to hold without strain. Thumb rest. Element clear mica and highest grade resistance wire. Stand at back. Beautifully finished.

Weight 6 lbs., 2 years guarantee. Supplied complete ready for use.

Cat. No. EE710 ... **18/6**  
Each

**ALL  
MONARCH APPLIANCES  
Are Guaranteed for Twelve  
Months.**

**LAMPHOUSE GUARANTEE**  
Any goods that prove in any way unsuitable may be returned within seven days, and your money will be refunded in full.



THE "MONARCH" Sun Lamp heals by Infra-red, Chrome and Radiant Heat all acute conditions of injury, pain and inflammation. THE "MONARCH" Radiating Hand Lamp consists of a highly polished nicked brass parabolic mirror, with a black polished protective ring (for the protection of the skin against heat), and black polished wooden handle. It includes a 7ft. connecting cord with the necessary contacts, and three natural coloured glass special lamp globes—red, white and blue.

THE "MONARCH" Hand Lamp does not require any knowledge of electricity to operate. It simply plugs into the wall plug or light socket, and the lamp is ready for operation. There is no danger when using this lamp.

In the past, light-ray treatment has been confined to hospitals, doctors, and to expensive special treatment. The Monarch Sun Lamp now brings this treatment into your own home. With this simple hand lamp it is possible to employ light therapy (as the best authentic healing agent) without great difficulty or expensive apparatus, as has been required in the past. On account of the high parabolic form of the metal reflector, the rays of light and heat are strongly concentrated, and with little loss reflected in great intensity upon the affected part.

# MONARCH

## Rheotherm Medical Hand-Lamp

(G)

Treatment by  
**INFRA-RED THERAPY**  
**HEAT THERAPY**  
**CHROME THERAPY**

THE MONARCH SUN LAMP is designed to combine Heat Therapy with its concomitant Infra-red Therapy and Chrome Therapy. Any reliable medical dictionary will explain these terms with elaboration, but as this is not a treatise on the subject, we simply enumerate the diseases and tabulate the recommended duration of treatment.

INFRA-RED THERAPY is the treatment of disease by infra-red rays, an invisible emanation. Infra-red rays have a greater power of tissue penetration than Ultra Violet Rays and, therefore, are invaluable in effecting a deep, enduring hyperaemia. Locally infra-red rays promote increased circulation by the dilation of the blood vessels, and stasis is effectively overcome.

HEAT TREATMENT is the treatment of disease by the suitable application of heat to the part affected. Radiant-heat embraces all instruments which give out a bright light as well as heat; in other words, soars amongst visible and invisible infra-red rays. One of the most outstanding forms of heat generators which are of practical medical value are Radiant Heat Lamps. Some of the medical uses to which the heat can be put are:—

- (1) Dilation of superficial vessels and glands.
- (2) Removal of venous stasis and promotion of normal circulation.
- (3) Bactericidal on superficial treatments, and as a practical result of these you—
  - (a) Get relief from pain.
  - (b) Restoration of functional activity both in the skin and in the deeper glands.

CHROME-THERAPY is the treatment of diseases by filtered light, using coloured screens.

In accordance with the nature of the malady and the desired therapeutic result, either a blue, red or white incandescent lamp of natural glass is used. The colouring of these lamps is actually in the glass itself, as artificial staining would not affect the desired therapeutic action. The colouring of the bulbs filters out certain rays not required for the particular treatment.

The "MONARCH" Sun Lamp diminishes the sensibility to pain and relieves congestion with remarkable speed. Because of these powers, the lamp is most valuable for treatment of joint injuries, and pains of an arthritic or rheumatic origin. This power to relieve pain quickly is also important in the treatment of non-articular manifestations of rheumatism, in cellulitis, torticollis, lumbago and tarsalgia.

The "MONARCH" Sun Lamp also produces excellent effects in all types of neuritis cases.

Cat. No. EE75—

**39/6**

With full instructions



### FOR TREATMENT OF

Rheumatism - Arthritis - Lumbago - Neuralgia  
 Neuritis - Sciatica - Rheumatoid Diseases  
 Digestive Disorders and Gastric Irritabilities  
 Neurasthenia - Insomnia - Catharral Sinus  
 Abdominal Pains - Sprains - Pleurisy  
 Skin Diseases of all kinds - Open Wounds  
 Cuts, etc. - Eczema



LOW VOLTAGE MOTORS. (G)

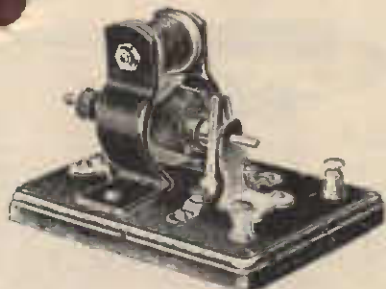

Low voltage Electric Motors. Work from 2-6 volt battery. For driving mechanical models, toys, etc.  
Cat. No. EE499 ..... Each **4/11**

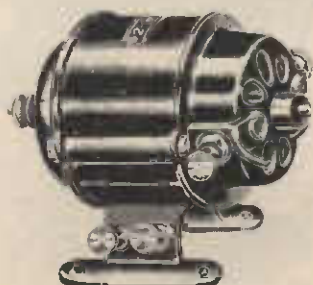

This motor is of sturdier construction and is completely shielded. Excellent for models, etc. Cat. No. EE500 ... Each **12/6**

STAR ELECTRIC MASSAGE VIBRATOR. (G)

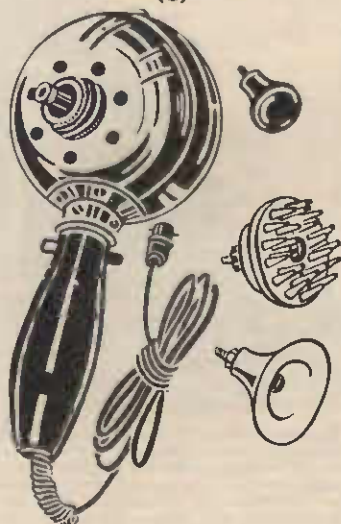

The Star Massage Vibrator is safe to use by the most inexperienced and unequalled for home massage without the necessity of a professional masseur. It promotes the proper and steady circulation of the blood and reinvigorates the nervous system.

Absolute simplicity, no directions necessary. Operates without any expert knowledge. Supplied complete with three applicators, flexible cord and lampholder adaptor; push-bar switch fitted. Each of the three applicators has a different use according to individual requirements. For delicate, light, medium and general massage. Hard applicator for body; spiked applicator for scalp; flat cup applicator for face and eyes.  
Cat. No. EE79 ..... Each **19/6**

SAVE YOUR EYES. (G)



This Sun-Shine Adjustable Reading Lamp will clamp on the bed-rail, and both the stand and shade can be adjusted so that the light is put just where it is wanted and avoids all eye strain. Complete with switch, adaptor, and 9 ft. of flexible cord. Assorted colours.  
Cat. No. EE47 ..... **10/9**  
(Lamp Bulb extra.)

LIGHTING EXTENSION CORDS. (K)

Read in Comfort!

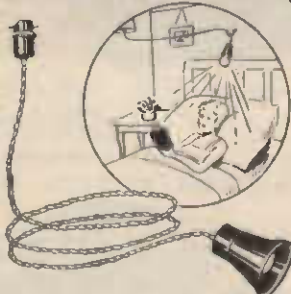

For taking the light where you want it Ten feet long, and supplied with an insulated shockproof lampholder. Extra long lengths can be made up at 4d. yard extra.  
Cat. No. EE51 ..... **3/-**  
Cat. No. EE52 ..... **4/9**  
(with switch holder)

HOTPOINT ELECTRIC IRONS. (D)



Hotpoint IRON

Genuine Hotpoint Electric Irons, complete with Plug and Cord.  
Cat. No.  
EE700—Hotpoint Utility ..... **27/6** each  
Electric Irons  
EE701—Hotpoint De Luxe ..... **35/-** each  
Electric Irons  
EE702—Hotpoint Super Automatic Electric Irons ..... **59/6** ea.  
EE703—Hotpoint Automatic Electric Irons ..... **45/-** each

GAS LIGHTERS. (G)

"Matchless" Electric GAS LIGHTER



Simply hold over the gas and push the switch on the bottom of the lighter. The filament glows red and the gas lights. Use ordinary Bijou 2-cell torch battery, which lasts four to six months, and can be replaced at the cost of 6d. An excellent line which will save you thousands of boxes of matches.  
Cat. No. EE38 ..... Each **2/6**  
Spare tips.  
Cat. No. EE43 ..... Each **1/-**

CLAMP LAMPS. (D)

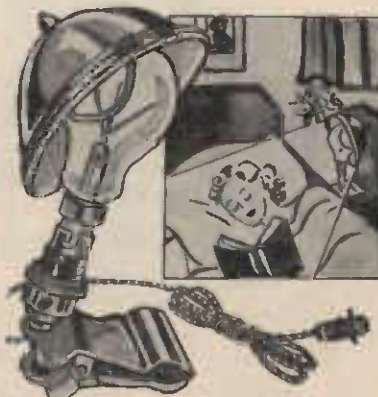

A great job! And only 5/6. Plated Lamps, clips on to the bed rail, table, book case, etc. Adjustable reflector throws light just where you want it. Switch enables Lamp to be turned on and off. Supplied complete with 6ft. of flex and bayonet adaptor, but not lamp.  
Cat. No. EE65 ..... Each **5/6**

UTILITY DESK LAMP. (D)



A standard flexible arm reading lamp, 12in. goose-neck, heavy cast iron base. Large size reflector, with switch lamp socket. The flexible arm bends as required, putting the light just where it is wanted. Supplied with cord and lamp.  
Cat. No. EE45 ..... **12/6**  
Each  
Extra cord, 4<sup>d</sup>. yard (additional).



NEW! BETTER! (G)



Cat. No. EE34 ..... **19/6** each

The last word in Efficient ELECTRIC JUGS. Beautifully glazed earthenware, in modern colour effects, with very reliable element. Boils 3 pints in about 7 minutes. Complete with plug and cord.

TWO SHAPES AVAILABLE

BOTH **19/6** EACH



Cat. No. EE35 ..... **19/6** Each

SUPREME HAIR DRIERS. (D)



Supreme Hair Driers are moulded in beautifully finished bakelite. They are British made, the fan being driven by a solidly constructed and trouble-free motor. A heating element is incorporated and a switch provided so that hot or cold air can be obtained at will. As a quick and efficient means of drying the hair, these electrical hair driers are ideal.

Cat. No. EE15 ..... **49/6** each

Spare Heating Element for above **3/6**  
Cat. No. EE14 ..... Each

THE NIPPY COOKER. (D)

Guaranteed All-British.

With this useful device, a kettle or other vessel can be kept at the boil, and at one and the same time (with no extra current consumption) fish, bacon, chops, cutlets, etc., can be grilled. Crisp toast, evenly brown, can be quickly made. No flue or outlet is required, and the Griller-Boiler can be used anywhere, even on the meal table, by connecting to any lampholder or plug connection. Current consumption is 650 watts per hour; thus all the advantage of Electric Cooking can be obtained at a very low cost. No time is wasted in waiting for griller to heat up. Simply switch on and the cooker is in full operation. With the Nippy Combination Cooker and Heater it will be realised that all the heat is available, grilling proceeding at the same time as boiling on the top.



Illustration shows the "NIPPY" in use as a boiler and griller.

Cat. No. EE6 ..... **39/6**

SPEEDEE HOTPLATE. (G)



A new type 1,000-watt Hotplate, supplied complete with cord. 230 volt, 1,000 watt. Open porcelain type element. **12/6** ea.  
Cat. No. EE156 .....

"SPEEDEE" UNBREAKABLE ELECTRIC JUGS. (G)



Made of metal with hard-baked enamel finish; perfectly safe and cannot break. Very quick boiling. Price complete with plug and cord.  
Cat. No. EE33 ..... Each **21/6**

WESTINGHOUSE HAIR CURLERS.



DE LUXE CURLING IRON.

Extra large barrel. Switch mounted in handle. Five-foot flexible cord. Insulated button on handle of tong prevents burnt thumb. Black handle. 20 watts; barrel, 3in dia. x 6 1/2 in. long.

Cat. No. EE80 ..... **15/9**  
Each

MEDICAL COILS. (D)



Medical Coil, mounted on neat brown bakelite base. Works from 1 1/2 to 3 volt dry batteries. Has high speed trembler, make and break contact, which ensures a steady soothing current, the strength of which can be regulated from mild to powerful. Supplied complete with handles.

Cat. No. EE67 ..... **12/6** each

DE LUXE MEDICAL COIL. (D)



Specification: Polished case, fall-down front, containing powerful coil with regulating tube. The coil has a two-way switch which enables the operator to use one or two batteries as required. The batteries are fitted in the compartment at the back of the cabinet. Including two Lissen Dry Cells, and round plate, button and crimped brush electrode. Size 7 1/2 x 7 1/4 x 6in.

Cat. No. EE68 **£3/15/-** complete

ELECTRIC URNS.

Prices on Application.





**WESTINGHOUSE ADJUST-O-MATIC IRON. (D)**

This Westinghouse development is aptly called "the easiest iron to use." It embodies those many features introduced by Westinghouse to make a more perfect iron. From its tapered point to its convenient heel rest, every part has been designed with but one thought in mind—easier ironing for the woman who uses it. When you've finished your first ironing with it, you'll find how true this is! And then you'll agree with the thousands of women who say, "I never knew how easy ironing could be until I got my Westinghouse Adjust-o-matic."

**Six Reasons Why the Adjust-o-matic is the Easiest Iron to Use.**

**Finger-tip Control:** A convenient lever sets this iron for any heat you want—you iron every fabric with your iron set at just the right temperature for that kind of cloth.

**Automatic Control:** Keeps the heat just where it is set. The iron can never get too hot nor too cold.

**Chrome Finish:** Actual tests show that chrome finish makes the iron 30 per cent. easier to move along the cloth. And this lustrous long-wearing finish resists tarnishing, stays bright and shining.



**Bevelled Base:** Notice how the base of this iron is flared up, so that you can always see the edge without bending over your work. An ironing convenience originated by Westinghouse.

**Tapered Point:** The point of the Westinghouse Adjust-o-matic is carefully tapered to make it easy for you to get around buttons, under frills and ruffles and into hard-to-iron places.

**Perfect Balance:** When you lift one of these new irons, you'll realise at once that it has the proper "feel" for easy ironing. Perfect balance is an important feature of its design. Weight 6 lbs. **44/6** each  
Cat. No. EE27

**DUPLEX WALL TELEPHONES. (G)**



Time and labour saving devices are the keynote of success to-day. This is recommended in all branches of business and everyday life. To fulfil the increasing demands of an inexpensive communication this telephone has been designed for any place in factories, offices, etc., where instant communication is a convenience. This telephone provides the easiest, simplest communication between two points. All insulated parts are impregnated with paraffin. They will operate efficiently up to 100ft., signals being clear and loud. No special knowledge is required to install them. They require two dry batteries, No. 6 type, at each 'phone and the necessary length of wire. Cases are of heavy gauge steel. Packed in attractive display box with 100ft. wire, staples and complete instructions for installing.  
Cat. No. ET142 **45/-** per pair

Batteries for above (extra).

Cat. No. EB187 **2/9** each

**PLUGS FOR APPLIANCES.**

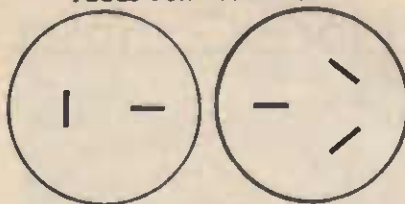

Tee Type.

3-Pin Type.



Parallel Type.

All appliances are quoted complete in every respect, even to plug tops. When ordering it is advisable to put in your order the type of plug required. The types of plugs in general use in New Zealand are shown in the accompanying diagram.

The third wire on the 3-pin plug is the earth wire, and the correct wire to connect to earth is the white one on the appliance. When wishing to use a light socket as the source of power supply (not advised, as this is against the electrical regulations) an adaptor is used instead of the plug top.

**SERVEX CLAMP LAMPS. (G)**

Table Lamps which will stand on the table or clamp on the bed. Will tilt and bend so as to put the light just where it is wanted. Supplied complete with cord, but without lamp bulb. Rubber protection so clamp cannot harm furniture.

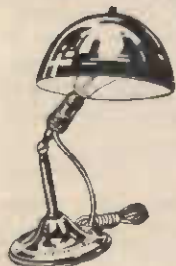

Cat. No. EE62 — De Luxe Lamp with chromium plated shade.

**22/6** each



Cat. No. EE63—Bronze or Silver finish. **19/6** each



Cat. No. EE64—In various Duco pastel colours. **15/6** each

**PEAR SWITCH CONVERSION ATTACHMENT. (G)**

**Read in Bed!**

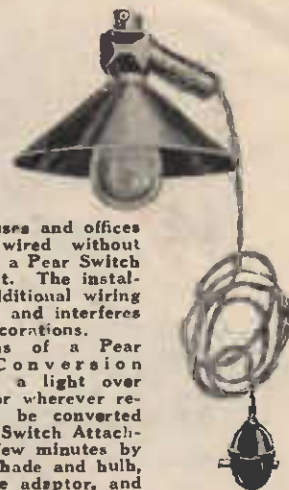

Many houses and offices have been wired without provision of a Pear Switch near to light. The installation of additional wiring is expensive and interferes with the decorations.

By means of a Pear Switch Conversion Attachment, a light over bed, desk, or wherever required can be converted into a Pear Switch Attachment in a few minutes by taking off shade and bulb, inserting the adaptor, and replacing shade and bulb in the adaptor holder.



The luxury of reading in bed without the necessity of getting up to switch off at door, is one of the many advantages which this attachment will provide. **Outfit** is complete with Adaptor, 6ft. Twin Art. Silk Flexible Cord and Pear Switch ready for immediate use. **5/6** each  
Cat. No. EG130

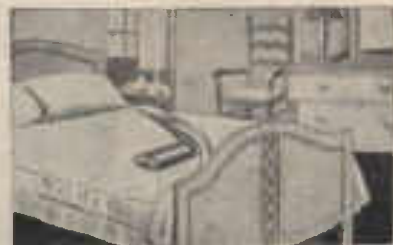

**THE OXFORD BED WARMER. (D)**

This new electrical device dispenses with the old-fashioned hot-water bottle. To heat it you simply connect it to the power supply and leave it for six minutes. It is then disconnected, and will retain a comfortable heat under the bed clothes for about six hours. May be taken in your motor car to add comfort to travelling, or to the pictures as a foot warmer. Inexpensive to run and, of course, invaluable in the sick room. Costs about 1d. per week for current.

Cat. No. EE66 **8/6** each



## More Compact More Beautiful

and with  
Heat-Resisting Glass Bowls

New Attractive  
Design

Features that make  
UNIVERSAL MIXERS

The Housewife's Greatest  
Helper.

## New UNIVERSAL Mixer-Beater and Beverage Blender (D)

The ideal gift for Wife, Sweetheart or Mother—a UNIVERSAL mixer-Beater that will help with dozens of tiresome tasks—it beats eggs, mixes batters, whips cream, stirs beverages and mashes potatoes. Easy to clean and use, there are no complicated adjustments. Powerful, quiet, air-cooled three-speed motor, is portable for convenient use over stove or anywhere else without the stand and in either large or small pans or bowls. Beaters and motor tilt back out of the way and batter drips back into bowl. Large bowl fits into revolving turn-table and is turned by the mixing action of the beaters.

Two French Ivory Heat Resisting Glass Bowls—  
one-quart capacity and three-quart capacity.

Chromium Plated Beaters, which are easily and simply attached  
or removed by spring lock.

Finished in Ivory Enamel. Ebonized Handle.

Base has rubber feet which prevent marring of polished surfaces.

Six foot rubber covered cord. Operates on either A.C. or D.C. current.

Cat. No. EE139 ..

**£7**

These additional attach-  
ments can also be sup-  
plied:—

(1) Juice Extractor. The  
electrically operated juicer  
coaxes the last drop of  
juice from all citrus fruits.  
It is fast, easy to operate,  
easy to clean.

Cat. No. EE140 **£1/5/-**

(2) Slicer, Shredder and  
Grater Attachments, elec-  
trically operated. One cut-  
ter for slicing potatoes,  
apples, beets, carrots and  
onions. Slices 2lbs. of  
potatoes in a minute, and  
slices them with perfect  
evenness. And a cutter,  
for shredding cabbage,  
pineapple, and other fruits  
and vegetables for soups,  
salads and garnishes. Also  
a cutter for grating cocoa-  
nut, sweet potatoes and  
horse-radish.

NOTE.—To operate this  
attachment it is necessary  
to have the Juice Extrac-  
tor.

Cat. No. EE141 **£1/5/-**



**TILT BACK MOTOR**  
Bowls and Beaters  
easily removed—batter  
drips back into bowls.  
Three-speed Motor.

### PORTABLE

May be used over  
stove or elsewhere  
and in any bowl or  
pan.

### SEPARATE BEATERS

Easily attached or  
detached by simple  
spring lock. Chromium  
plated.

### KNIGHT PAINT AND DISINFECTANT SPRAYER. (D)



Has been designed for use with Electric  
Cleaners which are provided with a blowing  
end. It is connected through the flexible  
hosepipe to the blowing end of the cleaner,  
and can be adjusted to fit any size of pipe  
up to 1 1/2 ins. diameter.

The sprayer is constructed from cast alu-  
minium, highly polished, and is equipped  
with a fine nozzle for paint spraying, and  
another with a larger hole in for spraying  
disinfectants, etc., where it is desired to  
dispense the liquid over a wide area. The  
point tube and nozzle being in a straight  
line are easily cleared. Instructions sup-  
plied with each sprayer.

Cat. No. EE239 ..... Each **31/6**

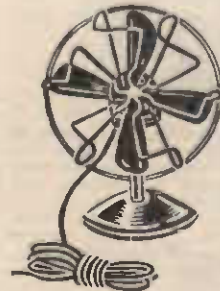

### COOL ELECTRIC FANS. (G)

Which can be used  
on table or hung on  
the wall. Well ven-  
tilated motor. Wire  
guard over fan  
blades. Finished in  
coloured enamel.  
Diameter of fan  
7 1/2 in. Diameter of  
base, 4 1/2 in. Over all  
height, 10 in.

Cat. No. EE119—

**27/6**

### G. E. C. ELECTRIC FANS (Made in England)

#### TABLE AND BRACKET FANS. (D)

These Fans are designed to give maxi-  
mum air displacement for minimum current  
consumption. They are fitted with a swivel  
and trunion movement which permits the  
direction of the air disturbance to be alter-  
ed quickly and easily. The adjustable base  
allows the fan to be used either as a table  
or bracket fan. Speed regulators are  
provided giving two speed variations and an  
"off" position on 10-in. fans and three speed  
variations and an "off" position on 12 and  
16 inch fans. The standard finish is black  
enamel and oxidised copper.

#### TABLE AND BRACKET (Alternating Current).

Cat. No.	Each
EV106—10in. Universal Fixed	<b>£3/3/6</b>
EV115—10in. AC Oscillating	<b>£4/19/-</b>
EV121 12in. Induction Fixed	<b>£4/5/-</b>
EV137 — 12in. Induction Oscillating	<b>£6/7/-</b>
EV129 — 16in. Induction Fixed	<b>£5/2/3</b>
EV145 — 16in. Induction Oscillating	<b>£7/4/-</b>

#### CEILING (LARGE SWEEP TYPE)

EV227 — 44in. Kingsway Junior	<b>£8/15/-</b>
Extra for Speed Regulator	19/6
EV217—56in. Kingsway	<b>£11/3/-</b>
Extra for Speed Regulator	11/8/-



BRITISH BOWL FIRE. (D)



The challenger bowl fire. This model represents the finest value for the money it is possible to obtain in electric bowl fires. 10in. solid copper bowl, hammered finish, mounted by means of an adjustable support on cast iron base. Back of bowl is finished in Florentine bronze. Base and support black enamel. Each fire is supplied complete with a standard plug-in type element, wire guard and two yards of flexible cord. British.  
Cat. No. EE301 . . . . . Each **14/-**

MORPHY-RICHARDS FIRE.



SENIOR SERIES. (D)

Scientific design, a carefully chosen colour range, and due regard for the strictest requirements of the electrical authorities combine to make the Morphy-Richards "Senior" reflector fire one of the most popular ever introduced in England.

CHROME REFLECTOR.

Height, 10in.; width, 17½in.; depth, 7in.  
Cat. No. EE309—1000 watts . . . **40/-**

Cat. No. EE310—Twinbeam, 1000 watts + 1000 watts . . . . . Each **56/-**

Cat. No. EE313—Twinbeam, 1500 + 1500 watts . . . . . Each **69/-**

**SPEEDEE**

**ELECTRIC RADIATORS**  
Are available from the  
**LAMPHOUSE.**

Write for Price List.

MORPHY-RICHARDS FIRES.



TUBULAR SERIES. (D)

Here is a new range of reflector fires to satisfy the most exacting demands of the moderns. The scientifically designed parabolic chrome reflector is mounted on a substantial frame of chromium plated tube forming both base and carrying handle.

The "Twinbeam" Models, which are designed on the "distributed heat-beam" principle, are supplied with a switch, enabling one or both of the heating elements to be used at will. Six feet of best quality 3-core flex is supplied with each fire. The exclusive Morphy-Richards Safety features are, of course, incorporated.

On all "Twinbeam" Models a switch is provided to cut out one bar. To conform to I.E.E. regulation the second bar is controlled from the wall socket.

Cat. No. EE311—Twinbeam **£3/1/-**  
1000 watts.

Cat. No. EE312—Twinbeam **£4/2/-**  
1000 + 1000 watts.



JUNIOR SERIES. (D)

This Radiator is very efficient in performance and neat in appearance, and eminently suitable for use in living-room, bedroom, or dining-room. In addition an ingenious wall shoe is supplied which allows the fire to be fixed on the wall out of reach, in such places as nursery, bedroom, etc.

CHROME REFLECTOR.

Height, 11in.; width, 13½in.; depth, 5½in.  
Supplied complete with 6ft. of 3-core flex.  
Cat. No. EE307—750 watt . . . . . Each **35/6**

Cat. No. EE308 Twinbeam, 750 watt + 750 watt. **45/-**

BRITISH-NATIONAL FIRES.



"STOCKWELL"—1000 WATT. (D)

The British Fire is the outcome of exhaustive consideration as to the requirements of the great mass of electricity users, and its introduction is made possible only by the use of the most up-to-date equipment and carefully planned mass production methods. Light in weight, for use in moving from room to room, very reliable, the fire bar employed being precisely similar to those fitted to our most expensive designs, and of the utmost utility, a special feature being the provision of a trivet effect over the fire-bars which, in combination with the carrying-handle, allows the fire to be laid back for boiling a kettle, toasting or similar cooking operations. Consumption one unit per hour.  
Cat. No. EE304 . . . . . each **19/6**



"STOCKWELL"—2000 WATT. (D)

Precisely as Cat. No. EE304, but arranged with two Standard Fire Bars, having a full-on consumption of two units per hour, reducible by the switch provided to one unit per hour, being suitable for the heating of rooms of average size up to 16ft. x 14ft.  
Cat. No. EE305 . . . . . each **35/-**

BAKELITE LAMP BRACKETS. (G)

**WALL BRACKET**

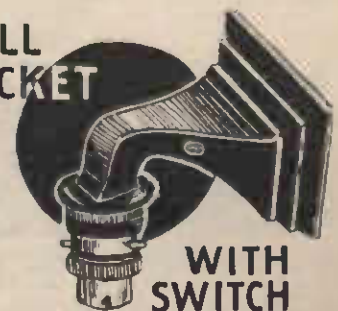

**WITH SWITCH**

Handsome Bakelite Wall Bracket with Lampholder. Projects overall 3½ inches.

Cat. No. EG250—With plain Lamp Holder . . . . . Each **3/-**

Cat. No. EG251—With Switch Lamp Holder. . . . . Each **5/3**



**ELECTRIC CLEANER. (K)**

Electric cleaning is now within the reach of every home. The "Knight" is a thoroughly efficient, high-grade cleaner—a marvel of beauty, simplicity, and SAFETY—you get it at about half the usual cost because of our modern buying and selling policy.

We import direct from the Factory in England, so as to cut out all intermediate charges and profits. We are proud of this Cleaner, and the fact that we can sell it at only £7/10/-, because we know of similar makes of cleaners that sell for nearly twice as much.



**COMPLETE EQUIPMENT INCLUDES:—**

7in. Oval Brush; 8in. Nozzle; "Nosis Parker"; Curved and Straight Extension Tubes; 5ft. 6in. Covered Flexible Metallic Hose; 15ft. Flexible Heavily Braided Cord, with plug and switch connections.

**ONLY £7/10/- CASH**

**HOMES CLEANER WITH LESS LABOUR.**

No pushing, pulling, or lifting of heavy furniture, no stooping, no climbing, straining, or back-breaking beating, no taking down of draperies or curtains if you own a "KNIGHT" ELECTRIC CLEANER.

And the home will be cleaner, freer from dust. The enormous suction power of the "Knight" extracts every particle of dust, grit, fluff, animal hairs, etc., from carpets, upholstered furniture, book cases, stairs, cupboards, etc.

Don't be a slave—let the "Knight" do the work. Send for one to-day. Can be used both on AC or DC 230-volt supply.

**TRY IT AT OUR RISK!**

Let us send you a "KNIGHT" ELECTRIC CLEANER—try it out in your own home, and if you are not satisfied in every way, we will refund your money in full, including return delivery charges. Our guarantee is your assurance of fullest protection. You can't lose.  
Cat. No. EE200 ..... **£7/10/-**

**"SPEEDEE" ELECTRIC HOT PLATE. (G)**



"Speedee" reliable Hot Plate with two-heat switch that makes for economical working which is a feature that appeals. Of rugged construction and is suitable for both industrial

or domestic use.

Cat. No. EE155 ..... Each **29/6**

**SWAN ELECTRIC KETTLES. (D)**



Of course, we would not offer any other than a British Kettle. Made of heavy aluminium, Swan Kettles are fast-boiling and of pleasing finish, which is easy to keep clean. Reliable element, which is guaranteed for 12 months. Supplied complete with 6 feet of the best asbestos-covered cord.

Cat. No.	Each
EE8—2-pint, 700 watt .....	<b>38/-</b>
EE9—3-pint, 1000 watt .....	<b>49/-</b>
EE10—4-pint, 1500 watt .....	<b>57/-</b>
EE11—6-pint, 2000 watt .....	<b>61/6</b>
EE7—3-pint Kitchen Model Automatic .....	<b>35/-</b>

All the above models are supplied complete with special safety fuse device.  
Cat. No. EE604—Spare Fuses for above **6D.**  
Each **6**

**SUN-UP ELECTRIC KETTLES. (D)**



Sun-up Kettles hold 3 pints and are made of cast aluminium and not ordinary spun metal, which is of much inferior quality and cheaper to manufacture. The element is in the kettle itself and not in a false bottom. It has been proven under test that where the element is in a false bottom 40 per cent. of the heat is wasted. The element is enclosed in copper tubing, guaranteed for 12 months. British. Supplied complete with two yards cord and plug.

Cat. No. EE13 ..... each **36/-**

**"SPEEDEE" IMMERSION HEATERS. (G)**

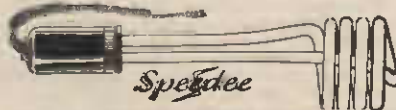

Here's the de luxe Immersion Heater. Very fast, safe, dependable and economical. A genuine "Speedee" product. Made in New Zealand. Will give you lasting satisfaction. Immersion Heaters can be used in any vessel containing water, either glass, porcelain, aluminium or other metal.

Cat. No. EE22—1000-watt	Each <b>9/6</b>
Cat. No. EE23—1500-watt	Each <b>15/6</b>

*Boils 1 pint in about 2½ minutes*

**BRITISH WATER BOILER. (G)**

The greatest boon to the housewife for years. These Immersion Heaters are the quickest means of bringing water to be boil.



Place the boiler in any vessel containing water or other liquid, and in a few minutes you can make the tea, feed the baby, or wash the dishes. Very economical and can be used from any wall plug.



**LOOK AT THE PRICE**—No better value offer in New Zealand.

Supplied complete with Plug and Cord.

Cat. No. EE21—750 watt ...	Each <b>5/6</b>
Cat. No. EE41—1000 watt ..	Each <b>7/6</b>

**SAVE YOUR EYES. (D)**



Green and White Opal Shades will save you eye-strain. Green outside, white inside. Dimensions 5½in. x 5in. To be used over desks, for writing, etc.  
Cat. No. EF600 ..... Each **6/6**



Here is another pattern of slightly different shape. Dimensions 5½in. x 4½in.  
Cat. No. EF601 ..... Each **6/6**



HANDLAMPS, INSPECTION. (G)



For Garage and Workshop!

Inspection Handlamps are invaluable in the workshop or garage. The light can be taken to just where it is wanted. Bakelite handle—strong wire frame to protect the lamp. Fitted with bakelite shockproof lampholder. British. **8/6** each  
Cat. No. EE36

GARAGE HANDLAMP. (G)



Golton Hand Lamp for garage use, etc. Strongly constructed to strict Home Office requirements; shockproof heavy wire guards. Cat. No. EE37 **12/6**

DECORATION SETS. (D)

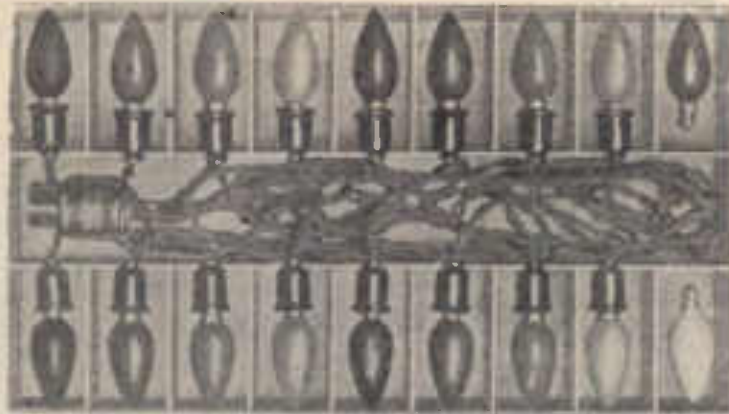

These Decoration Sets comprise 16 Insulated Lamp Holders, each with 16-volt Miniature Screw Lamps in assorted colours sprayed on clear glass. All completely wired and in box, with two extra lamps and with flexible cord and bakelite lamp holder adaptor. Ready to fit in electric light socket. Just the thing for dances, parties, Christmas trees and shop window decorations. Can be used anywhere where an inexpensive form of decoration is required. Cat. No. EL111—Complete **7/6** each Set as above. Cat. No. EL112 — Spare **9D.** each Lamps.

SPECIAL VOLTAGES

100 VOLT APPLIANCES.

All appliances quoted are for the 240 volt supply, which is practically standard throughout New Zealand.

Many appliances can also be supplied for the few towns that have a 100-volt supply.

32 and 100 Volt KNIGHT VACUUM CLEANERS. (K)

These famous Cleaners are now available for 32 and 100 volt supply.

Cat. No. EE201—32-volt **£8/10/-**

Cat. No. EE202—100-volt **£8/10/-**

Westinghouse Adjust-o-matic STREAMLINE IRON (D)

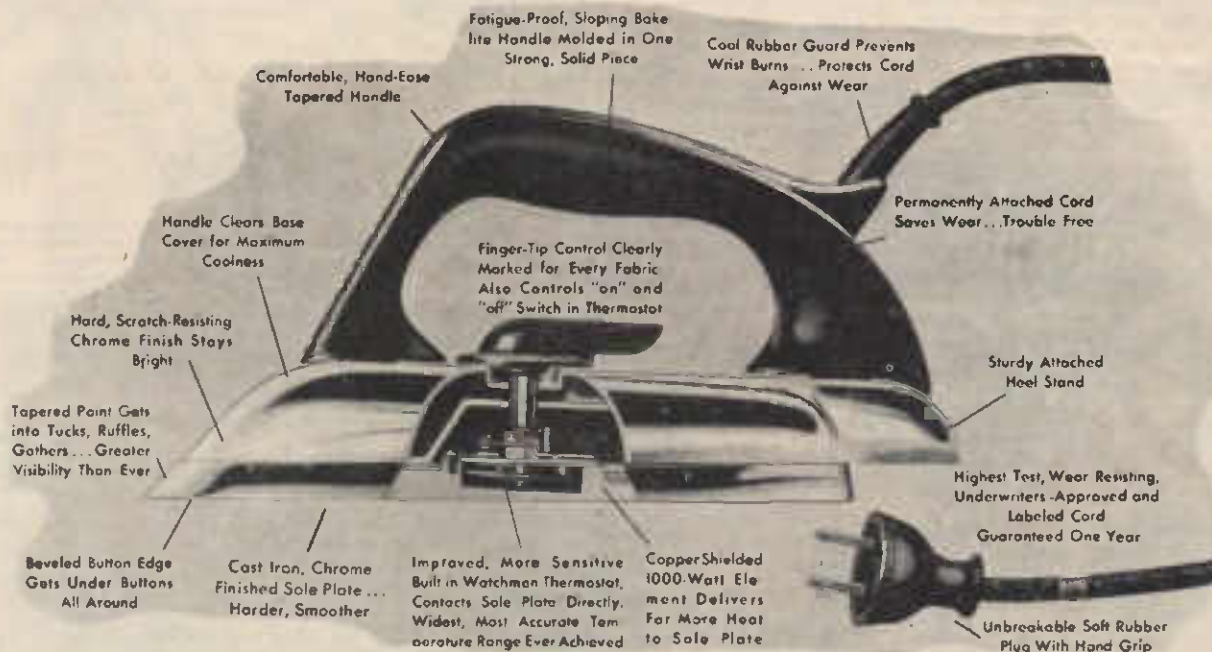

Smart streamline design—wide temperature range with positive, accurate Spencer disc thermostat heat control—new type base and heating element providing faster heat recovery and more even heat distribution—heat concentrated in the base where it belongs, providing a cooler top and handle—mirror-like chrome ironing surface that is almost self-gliding—one-piece Bakelite "Fatigue-proof"

sloping handle insulated from the cover for extra coolness—lighter weight, only 4 pounds... all these features make this the best-looking, fastest and most convenient and finest quality iron ever produced. The cord is permanently attached to the iron handle, and made with highest quality, extra long-wearing covering.

Cat. No. EE711 **63/-**



THE LATEST IN ELECTRIC SHAVERS.  
RAZOLETTE. (G)

No power supply needed. The Razor has its self-contained battery in the handle. Battery drives a powerful motor which swings the blade 3000 times a minute. The Razolette ensures a fast smooth shave in all circumstances, specially suitable for tough beards. Can be used by ladies and youths without lathering. The battery is standard size 2-cell bijou, and lasts 2 to 3 months according to use.

Cat. No. EE276 ..... Each **35/-**

LAMPHOUSE GUARANTEE.

Try out any article purchased from the Lamphouse for 7 days. If, at the end of that time, you are not well pleased with your purchase, return it and we will refund your money in full.

**EEDEE Electric MIXER & BEATER**



EEDEE MIXER. (D)

Just the thing for Mother—for whipping cream, beating eggs, mixing drinks, etc., a hundred and one kitchen jobs can be done with this mixer. (Unsuitable for heavy cake mix.) Portable, plugs in to any power point or light socket. Shockproof, having no exposed metal parts.

Cat. No. EE142 ..... **25/-**

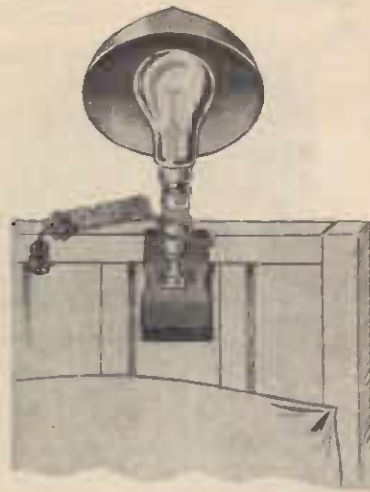

CLIPIT LAMP. (D)

Held with spring, clip attached and shade. Ideal for kitchen, bedroom, desk, etc. Bronze finish. Complete with flex, without lamp bulb.

Cat. No. EF702 ..... **4/11**

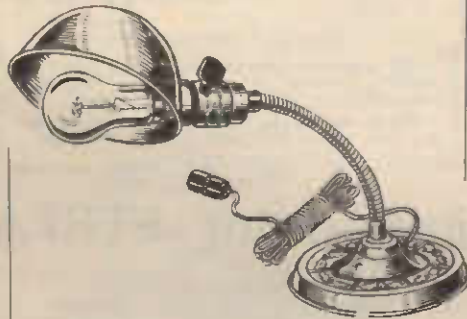

FLEXIBLE DESK LAMP. (D)

Chromium-finish, complete with fittings and cord. Without bulb.

Cat. No. EF700 ..... **15/-**

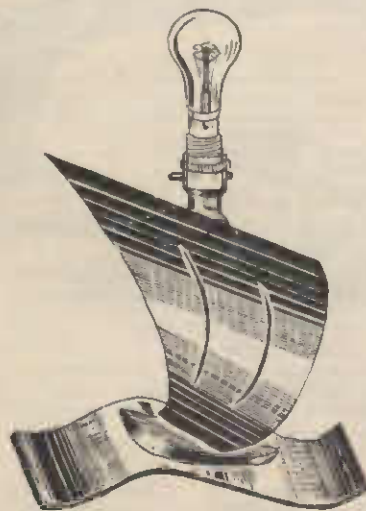

FUTURISTIC STAND. (D)

Chromium, complete with fittings and flex, but without lamp bulb.

Cat. No. EF703 ..... **17/6**



**“PIFCO” SHARPEX**

(Solution of the Razor Blade Problem).

Pifco Sharpex guarantees an incomparable clean shave, and one blade now lasts 12 months. Pifco Sharpex supersedes every other kind of razor blade sharpener. It is simple, speedy and thorough. No complicated parts, nothing to get out of order, wear or break. It will put a keen edge on any Gillette type of blade instantly. Sharpex saves literally pounds in razor blades and ensures regular, smooth and easy shaves.

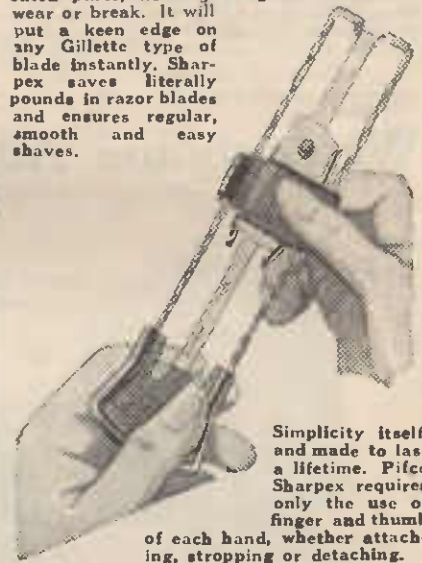

Simplicity itself, and made to last a lifetime. Pifco Sharpex requires only the use of finger and thumb of each hand, whether attaching, stropping or detaching.

Construction and Description:

The carriage holding two stropping rollers runs along two spiral guides. The blade is easily attached or slipped on to the centre band, and the carriage is then run up and down the guides to their full extent, and the stropping rollers revolve at a high speed along the shaving edges of the blade. Running the carriage upwards one roller stropps the top edge of one side of the blade, and the other roller the under edge of the other side of the blade, and vice versa on the return action of the carriage.

To obtain most perfect results the use of a little paste on the rollers, and vaseline on spiral guides is strongly recommended. Suitable for all blades of the new and old Gillette pattern.

Cat. No. EU200—Pifco Sharpex Stropper ..... Each **3/11 (G)**

Cat. No. EU201—Pifco Stropping Paste ..... Per tin **8D. (G)**



# THE HOME BEAUTIFUL

(D)

There's no place like home, but one of these bowl fittings will brighten up the best of homes. All prices are quoted complete with oxidised copper fittings similar to those illustrated with Catalogue No. EF300.

Semi indirect lighting such as obtained from the use of these fittings is ideal because it eliminates practically all shadows and at the same time it protects the eyes from the strain of sharp light beams by making an even diffusion of the light.

This glassware is British made and the finish is satin opal. All fittings illustrated are white.



Cat. No. EF300—12in. diameter. Complete with fittings, as illustrated. Price **22/6**



Cat. No. EF301—14in. diameter Price, complete **32/6**



Cat. No. EF302—12in. diameter Price, complete **22/6**

### BOWL FITTINGS.

Prices of all Bowl Fittings are quoted complete with oxidised chains; chromium fittings and chain can be supplied at an extra charge of 4/-.



Cat. No. EF305—14in. diameter Price, complete **32/6**

Cat. No. EF306—Complete set of chain fittings without bowl (O.C. Finish) **7/6**

Cat. No. EF307—Ditto (Chrome) **11/6**



Cat. No. EF303—12in. diameter Price, complete **22/6**



Cat. No. EF304—12in. diameter Price, complete **22/6**

Mail All Orders to the "Electric Lamp House" 27 MANNERS S WELLINGTON

# ELECTRICAL ACCESSORIES

## HIGH QUALITY ELECTRIC BELLS, ETC. (G)



Round. Sheep. Church

For those requiring something a little better in the way of Electric Bells, etc. All these Bells and Buzzers have external adjusting screws. Double coil, cased in attractive bakelite. The various gongs give a different tone, so that several bells can be used in the same office, etc., and the tone will indicate which one is ringing.

Cat. No.	Each
EG315—3in. Round Gong Bell	4/9
EG316—3in. Sheep Bell	6/-
EG317—3in. Church Bell	5/6
EG318—High Quality Buzzers	4/-

## BAKELITE BUZZER. (G)

An attractively finished article with high, pleasing note. British. Operates from 3 to 6 volts or from transformer. Size 3 1/2 x 2 1/4 x 1 1/4.

Cat. No. EG312—  
2/9 each  
32/- dozen



## BAKELITE BELL. (G)

A British made bell of moulded walnut bakelite. Good contacts. 2 1/2-inch gong. Operates on 3 to 6 volts.

Cat. No. EG301—  
2/11 each  
32/4 dozen



## METAL CASED BUZZER. (G)

A midget buzzer. Black enamelled finish. High note. Metal cased.

Cat. No. EG313—  
2/- each  
22/- dozen



## BELL PUSHES. (G)

Cat. No. EG324—Round Bakelite Bell Pushes.

8d. Each  
7/8 dozen



In White Bakelite  
Cat. No. EG333 ..... Each 1/3

## "CUBIST" BELL PUSH. (G)

A new type of Bell Push of exceptionally attractive appearance suitable for inside or outside use. Moulded Bakelite. Size 2 1/2 x 2 1/2.

Cat. No. EG326—  
1/- Each  
11/4 Doz.



## DOOR BELL PUSH. (G)

Flush mounting barrel type Bell Pushes.

Cat. No. EG325—  
Each 1/3  
13/8 dozen



## BAKELITE PEAR PUSHES. (G)

Bell Pear Push for cord suspension. Attractively finished in moulded bakelite. The plunger is of polished bone.

Cat. No. EG330 ..... Each 1/3  
EG331—Rosettes for above .. Each 1/-



## BELL STAPLES. (K)

Insulated staples for tacking up bell wire.  
Cat. No. ES118 ..... 3d. doz.; 9d. pkt. 50

## BELL PUSH. (G)

Bell Push incorporates name plate. Useful, attractive bakelite push, for use in flats, with space for name card and glazed covering.

Cat. No. EG332 ..... 1/6 Each



## BELL TRANSFORMERS. (G)

Bell Transformers for 230-volt supply. Output 3 5/8 volts. Moulded into an attractive bakelite case. British.

Cat. No. EG337 ..... Each 6/11



## BELL FLEX. (G)

Twia Twisted Bell Flex (7/012); Art. silk covered. For Bell Pear Pushes, etc. British.  
Cat. No. EW117 ..... per yard 3d.

## BELL WIRE. (K)

Bell Wire, best British quality, insulated with rubber and double cotton covered. Paraffined over-all.

Cat. No.	Each
EW111—1/22 (100ft. coils) ....	1/10
EW113—1/22 (100 yd. coils) ....	5/3
EW112—1/20 (100ft. coils) ....	2/6
EW114—1/20 (100yd. coils) ....	7/3
EW115—2/20, Twin 100ft. ....	5/-
Cat. No.	Per yard
EW113A—1/22 .....	1d.
EW114A—1/20 .....	1d.
EW115A—2/20 .....	2d.

## CONNECTORS FOR A.C. LEADS. (K)



Two-piece Cord Connectors (parallel pin) for joining mains flex.  
Cat. No. EG21—  
1/3 Each

Ditto—Polarised type  
Cat. No. EG20 ..... Each 1/3  
14/- dozen



Two-piece Connectors similar to above, but for tee-pin plugs. British.  
Cat. No. EG22 ..... Each 3/6  
40/- dozen

## CORD CONNECTORS (3-Wire). (G)



Twopiece Cord Connectors for joining three-wire cord. Moulded in bakelite.  
Cat. No. EG23—Complete Each 4/6  
51/- dozen

## CONNECTORS FOR A.C. MAINS. (K)



This Two-piece Connector gets over the difficulty of joining two power leads, etc. Made of best bakelite, they are strong and easy to pull apart.  
Cat. No. FG24 ..... complete 1/9  
Three-pin Flat Cord Connector similar to above. Handy for special jobs. Heavy size.  
Cat. No. EG25 ..... Each 2/6

## CONNECTORS—2-WIRE BLOCK. (K)

Porcelain Insulated Connector for joining twin wires, etc.  
Cat. No. EG28—  
3d. Each  
2/9 dozen





TWO-LIGHT ADAPTORS. (K)



New type two-light adaptor.  
Cat. No. EG5 ..... Each **1/6**  
Dozen **16/-**

TWO-LIGHT ADAPTORS. (D)

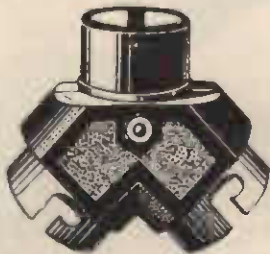

Two-light Bakelite Adaptors .....  
Cat. No. EG4 ..... Each **11D.**  
Dozen **10/9**

**Light Where You Want It!**



TWO-LIGHT ADAPTORS. (G)

Enables an extension to be taken from a lampholder. Provided with a switch so that the centre light can be switched off and leave the extension going.  
Cat. No. EG7 ..... Each **2/11**  
33/- dozen

THREE-LIGHT ADAPTORS. (K)

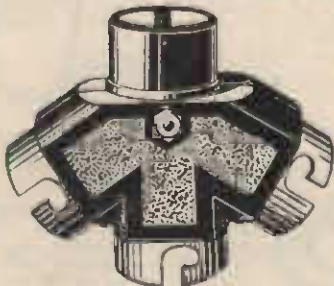

This special Three-light Adaptor is most useful for demonstrating purposes, etc. Three lights or leads can be used at the one time.  
Cat. No. EG6 ..... Each **1/9**

ADAPTORS. (D)



British Bakelite Adaptors. For fitting on end of extension cord for plugging into an electric lamp socket.  
Cat. No. EG1 ..... Each **3D.**

ADAPTORS, MINIATURE. (K)

To fit miniature lampholders. Standard motor-car size.

Cat. No. EG3—Single contact. Each **8D.**

Cat. No. EG2—Double contact. Each **8D.**

CONVERSION ADAPTORS. (D)

Sometimes it is found desirable to put a lamp or other appliance with a bayonet cap attachment, into a screw socket—or vice versa.

These Adaptors overcome this difficulty.

Cat. No. EG14—BC to ES Adaptors. Each **2/-**

Cat. No. EG15—ES to BC Adaptors. Each **2/-**

LAMP HOLDERS. (G)

Lamp Holders for electric light. O.C. finish cordgrip.

Cat. No. EG58—  
1/- each

10/- dozen

O.C. finish with fin. thread.

Cat. No. EG59 Each **1/-**

O.C. finish with fin. thread.

Cat. No. EG60 Each **1/3**



BATTEN HOLDERS. (G)

Batten Type Lamp Holders, for screwing down on wood base.

Cat. No. EG62—  
1/- each



SWITCH LAMP HOLDERS. (G)

Cordgrip Lamp Holders, with push bar switch.

Cat. No. EG66 ..... Each **2/9**

Holders, with push bar switch, and fin. thread, for table lamps, etc.

Cat. No. EG67 ..... Each **2/9**

EG57—Chrome finish ..... **3/3** each



SWITCH BATTEN HOLDER. (G)

Holders with push bar switch, batten type for screwing down on wood base.

Cat. No. EG68—  
2/9 each



LAMP HOLDERS. (G)

Angle Batten type.

Cat. No. EG65—  
1/3 ea., 13/6 doz.



Lampholders, fin. Brass Conduit thread.

Cat. No. EG61—  
1/- each, 10/- doz.



INSULATED BATTEN HOLDER. (G)

Batten type Insulated Holders with skirt.

EG54—  
13/9 doz. 1/3 each



HOLDERS—INSULATED. (G)

Insulated (bakelite) Lamp Holders are used in bathrooms, kitchens, etc.

Cordgrip, with skirt.  
Cat. No. EG50 Each **1/-**  
11/4 doz.



HOLDERS—INSULATED. (G)

Insulated (bakelite) Lamp Holder, with push bar switch and skirt.

Cat. No. EG52 Each **3/-**  
34/- dozen



INSULATED ANGLE BATTEN HOLDER. (G)

An all insulated Holder with an angle back plate. Handy for walls, etc.  
Cat. No. EG55—

2/3 Each



INSULATED PUSH BAR SWITCH BATTEN HOLDERS. (G)

Cat. No. EG69—  
3/- Each





**SCREW LAMP HOLDERS. (G)**  
 Cord grip Lamp Holders for Edison screw type lamps.  
 Cat. No. EG63— 20/- doz. Each **1/9**  
 As above, but to fit Rin. thread.  
 Cat. No. EG64— 20/- doz. Each **1/9**

**HOLDERS—MINIATURE. (G)**

Miniature Lamp Holders, double contact. Fit standard size motor car lamps.  
 Cordgrip Miniature Lamp Holders.  
 Cat. No. EG70— 13/6 dozen. **1/3** each



Batten Miniature Lamp Holders.  
 Cat. No. EG71 13/6 dozen. Each **1/3**

**MINIATURE LAMP HOLDER. (K)**

For torch or fuse lamps. Well made out of moulded brown bakelite.  
 Cat. No. ES222 5/6 doz. Ea. **6D.**



**MINIATURE BRACKETS. (K)**



Miniature Brackets, length 1 1/2 in. over-all. Fitted with lamp holder to take torch screw lamp.  
 Cat. No. EG76 1/- Each

**WALL PLUG CAPS ONLY. (G)**



2-Pin Parallel Pin Type  
 Cat. No. EG84 ..... **3D.** Each  
 2-Pin Parallel Type (Polarised).  
 Cat. No. EG87 ..... **4D.** Each  
 2-Pin "T" Type.  
 Cat. No. EG85 ..... **4D.** Each  
 3-Pin Type.  
 Cat. No. EG86 ..... **4D.** Each

**HEAVY TYPE BRITISH-MADE PLUG CAPS. (G)**



For those who require a lasting job.  
 Two (T) Pin.  
 Cat. No. EG96 ..... **1/6** Each  
 3-Pin Ditto.  
 Cat. No. EG97 ..... **1/6** Each

**Side Entry 3-PIN PLUGS. (G)**

Moulded in two pieces. Connecting screws completely covered.  
 Cat. No. EG88 **9D.** Each  
 8/- doz.

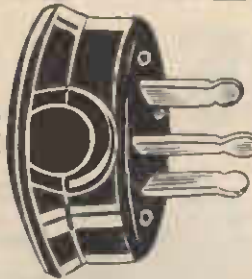

**PARALLEL PIN GRIP TYPE PLUG CAPS. (G)**

Cat. No. EG83 **5D.** Each



**PLUG CUBE, (K)**



Triple Plug Cube, with parallel pins. Enables 3 separate leads to be taken from one point.  
 Cat. No. EG102— 9/6 doz. Each **10D.**

**PLUGS, DOUBLE THREE-PIN. (G)**

A useful plug where it is desired to take two leads from one three-pin socket. The plug illustrated is fitted to the appliance or radio cord. A standard 3-pin plug cap can then be inserted into the top of it.



Cat. No. EG100 **3/3** Each

**WALL PLUGS AND BASES. (G)**



Parallel Pin Plugs and Bases  
 Cat. No. EG90 **1/6** Each  
 T-Pin Plug and Base.  
 Cat. No. EG91 **1/6** Each  
 3-Pin Plugs and Bases.  
 Cat. No. EG92 **1/6** Each

**PLUG BASE ONLY. (G)**

Parallel Wall Base.  
 Cat. No. EG93 ..... **1/3** Each  
 T-Pin Ditto. .... **1/3** Each  
 Cat. No. EG94 ..... **1/3** Each  
 3-Pin Ditto. .... **1/3** Each  
 Cat. No. EG95

**SIDE ENTRY PLUGS. (G)**



Side Entry Electric Iron or Appliance Plugs.  
 Cat. No. EG108: **10D.** Each | 9/- doz.  
 Ditto, with earth terminal.  
 Cat. No. EG109: **1/1** Each | 11/8 doz.

**BETTER APPLIANCE PLUGS. (K)**

**SWITCH APPLIANCE PLUGS. (K)**

These plugs will fit practically all makes of appliances. Used in many of the leading vacuum cleaners, such as the "KNIGHT." Push bar switch allows current to be turned off at will.



Cat. No. EG111— **3/6** Each

**DE LUXE IRON PLUGS. (K)**



Many people require a better plug than the usual cheap grade supplied with irons, etc. This British plug will fit practically all makes. Made of best bakelite, has entrance coming out at an angle so as to keep the cord away.

Cat. No. EG110 ..... **2/3** Each

**APPLIANCE PLUGS. (K)**



Made of bakelite. Strong type that will fit practically all makes of electric irons and other appliances.  
 Cat. No. EG106 **9D.** ea. 8/6 dozen.

Similar to the above, but with earth connection for use with 3-wire cord.  
 Cat. No. EG107 **1/-** 10/6 doz. Ea.

**SHADE HOLDER. (K)**

Shade Holders for table lamps. Oxidised finish. Hinged in the centre so that the shade can be tilted.



Cat. No. EG36, **1/3** Ea.

Similar to the above, but chrome plated.  
 Cat. No. EG37 **1/6** Ea.

**INSULATED SCREW EYES. (K)**



The wiring regulations state that all flexible cords running along walls, ceilings, must be supported by an insulated screw eye every 12 inches. Well, here they are:—  
 Cat. No. EG139— **1D.** each  
**11D.** doz. **10/6** gross



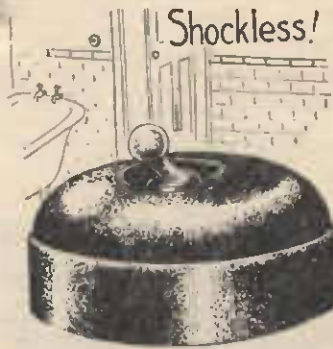

**SWITCHES—INSULATED ELECTRIC. (K)**

All-insulated Switch for use in bathrooms, kitchens, and near telephones, etc. British made.

- Cat. No. EG119—5 amp. .... Each **1/-**  
11/6 dozen
- Cat. No. EG122—5 amp. .... Each **1/3**  
All white.
- Cat. No. EG120—10 amp. ... Each **3/-**
- Cat. No. EG121—5 amp., 2-way ... Each **1/9**

**SUPER QUALITY SWITCHES. (K)**

- Genuine Crabtree Insulated Switches.
- Cat. No. EG123—5 amp., 1-way, ... Each **1/6**
- Cat. No. EG129—10 amp. ... Each **4/6**

**SWITCHES, ELECTRIC. (G)**

British Switches. Metal covers. Ox. copper.



- Cat. No. EG125—5 amp. **1/6** et.
- Cat. No. EG126—10 amp. **3/-** ea.

**MINIATURE SWITCHES. (K)**

Similar to above, but miniature for radio and motor-cars. Nickel-plated.

- Cat. No. EG118 ..... **1/3**

**EGG CORD SWITCH. (K)**

Switch (230 volt, 2 amp.) for hanging on end of cord. Handy for sick rooms, etc. British. Made of brown bakelite.



- Cat. No. EG134 ..... Each **1/9**

**WOOD BLOCKS. (K)**

Round and rectangular Wood Blocks for mounting switches, ceiling plates, etc. Carefully made and well finished. Recessed.



- Cat. No. EG79—3 1/2 in. round ..... Each **3D.**
- EG80—6 x 3 rectangular ..... **7D.**
- EG81—9 x 3 rectangular ..... **9D.**
- EG82—6 x 6 square ..... **1/6**

**SWITCH OF THE FUTURE**



**THE NEW MORSOM! (G)**

A neat and extremely efficient Switch of modern design and perfect construction. Very positive make and break action. Electrically perfect. A product of Sperryn. Size of base 2 1/2 in.

- Brown (Cat. No. EG127) ..... **1/8**
- Blocks (Cat. No. EG128) ..... **9D.**

**CEILING SWITCHES. (G)**

Switch for fitting on the ceiling. Supplied complete with cord.



- Cat. No. EG114— **3/6** each

**CORDS FOR CEILING SWITCHES. (K)**

Spare Cords for Ceiling Switches.

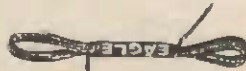

- Cat. No. EG116 **6D.** ea.

**SWITCHES, CORD. (K)**



For through connection. Made of bakelite. This is a useful switch for fitting on the cords of vacuum cleaners, appliances, etc. Cat. No. EG131 ..... **2/-** Each  
22/- dozen.

**LAMPHOUSE GUARANTEE.**

Try out any article purchased from the Lamphouse for 7 days. If, at the end of that time, you are not well pleased with your purchase, return it and we will refund your money in full.

**FUSES, ELECTRIC RANGE. (G)**

Screw Type Fuses are used on nearly all makes of electric ranges and other electrical appliances.



- Cat. No. EG40—5-amp. **4D.** each
- 3/4** doz.
- Cat. No. EG41—10-amp.
- EG42—15-amp.
- EG43—20-amp.

- ALL
- Each **4D.**
- Dozen **3/4**

**MEND YOUR FUSE. (G)**

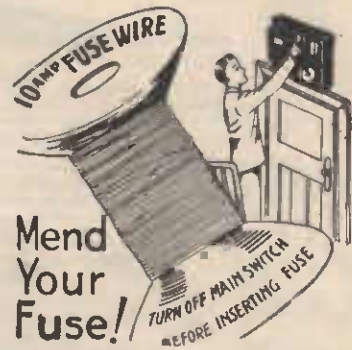

**Mend Your Fuse!**

Have a packet of each size of this Wire handy. You never know when you will have to renew your fuse.

- Cat. No. EG46—5-amp. size **2D.** Each
- Cat. No. EG47—10-amp. size **2D.** Each

**BLACK INSULATING TAPE. (G)**



**Has Many Uses!**

Has many uses, such as binding hockey sticks, axes, etc., besides being an excellent means of insulating. 2oz. rolls.

- Cat. No. ES237 ..... **3D.** a roll
- Cat. No. ES238—8oz., rolls **11D.** each

**CEILING ROSES. (K)**



Bakelite Ceiling Roses for electric light pendants.

- Cat. No. EG32 ..... Each **10D.** Dozen **9/6**
- Ditto, in attractive white bakelite.
- Cat. No. EG33 ..... Each **1/-** Dozen **11/6**

**GOLTON'S**  
**AKROS**  
 REGISTERED  
**FLEXIBLE CORD**  
 British Pat. No. 381,038  
 Attractive appearance.  
 Conductors rubber insulated to sectional shape to form a **Non-Kinking, Shock-proof and durable circular twin flexible** without any internal textile padding  
 The ideal flexible cord for All Mains Radio Units, and Portable Appliances.

600 meg. Grade 23/.0076. **AKROS FLEX. (G)**  
 Cat. No. EW88 **6**<sup>D</sup>. yard; **23/6** 50-yd. coil

**RESISTANCE WIRES. (D)**

The following Chromel "A" Resistance Wires have become the standard Resistance Alloy for hard service jobs: Electric Ranges, Radiators, Irons, and for all appliances with a temperature above a bright red heat, where the element is exposed to the air. Supplied in approximately 1lb. reels, or cut to the desired length.

Cat. No.	B. & S. Wire Gauge.	Ohms Per ft.	Feet Per lb.	Price Per lb.	Price for 12ft.
Cat. No. EW89	21	.802	430	<b>26/6</b>	<b>10<sup>D</sup></b>
Cat. No. EW90	24	1.61	565	<b>32/6</b>	<b>9<sup>D</sup></b>
Cat. No. EW91	25	2.03	1090	<b>34/-</b>	<b>9<sup>D</sup></b>
Cat. No. EW92	26	2.57	1380	<b>36/6</b>	<b>8<sup>D</sup></b>
Cat. No. EW93	27	3.23	1730	<b>39/-</b>	<b>7<sup>D</sup></b>
Cat. No. EW94—Ribbon	1/32 X.0031	5.58	3000	<b>94/-</b>	<b>1/-</b>

**WIRES AND CABLES**  
**FLEX for EXTENSIONS**

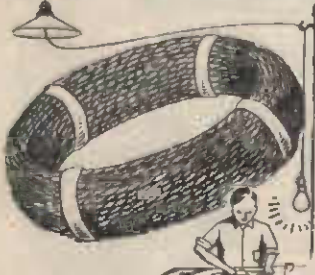

For 230-volt supply. Handy for extending lights, etc. 23/.0076. (G)  
 Cat. No. EW70 ..... **4**<sup>D</sup>. yard  
 12/8 coil (50 yards)

**WIRE, V.I.R. CABLE. (D)**

Cat. No.	Yard
EW77—1/.044 (1/18), 15/- 100 yds.	<b>3<sup>D</sup></b>
EW78—7/.029 (7/21), 30/- 100 yds.	<b>5<sup>D</sup></b>
EW79—3/.036 (3/20), 26/- 100 yds.	<b>4<sup>D</sup></b>
EW80—7/.036 (7/20), 50/- 100 yards.	<b>7<sup>D</sup></b>

**SILK-COVERED FLEX. (K)**



Thin Silk-covered Flex, 14/0076, laid flat and braided all over. Handy for wiring table lamps, etc., which have too small a hole for ordinary flex.  
 Cat. No. EW118 ..... **4**<sup>D</sup>. yard

**WIRES, CABTYRE FLEX. (G)**

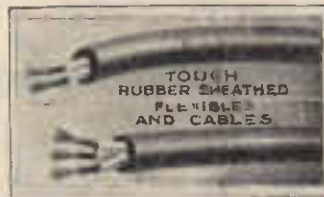

Heavy rubber-covered Circular Flex for extensions in workshop. Flexible. 11/.012.

Cat. No. EW71—2-wire ..... **7 1/2**<sup>D</sup>. yard  
 Cat. No. EW72—3-wire ..... **9**<sup>D</sup>. yard

**WIRES, HEATING (ELECTRICAL). (G)**

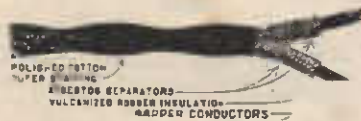

23/.0076 Rubber-insulated Asbestos-covered, heating flexible. Covered over all with a glazed cotton braid. Used for toaster and other appliance cords

Cat. No. EW73—2-wire ..... **7 1/2**<sup>D</sup>. yard  
 Cat. No. EW74—3-wire ..... **9**<sup>D</sup>. yard

(WIRES FOR RADIO—See page 81.)  
 (AUTO—See page 33.)

**TORCHES. (G)**

These Torches are made by the famous British factory in Hong Kong. All are well constructed, the body being made of thick brass and well electroplated. The reflectors are silver plated and with a special focusing device. Will throw a beam of light for a long distance. When the head is removed any of these torches can be used as an electric candle.



Cat. No. ET813—300ft. range focusing model with normal head, takes standard 2-cell battery. Each **2/6**



Cat. No. ET814—Two-cell model as above, but with large head, 450ft. focus—**3/3**<sup>D</sup> fine range. Each

Cat. No. ET815—Three-cell focusing model with large head, 750ft. range. Each **4/6**

Cat. No. ET816—Five-cell focussing torch with 1000ft. range and large head. Each **7/11**



A Small Torch with a Big Light!

**FOUNTAIN PEN TORCH. (G)**

No larger than a pen. Just clips into the vest pocket. Nickel-plated finish. Supplied complete with battery and bulb.  
 Cat. No. ET803 ..... **1/3** each



**BUCKLES**

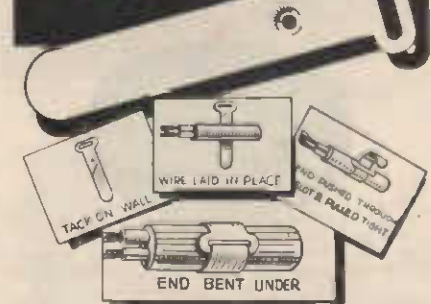

**KLIPSIT BUCKLES. (K)**  
 Cat. No. ES130—Cards of 12 ... **5**<sup>D</sup>. card  
 4/4 doz. cards



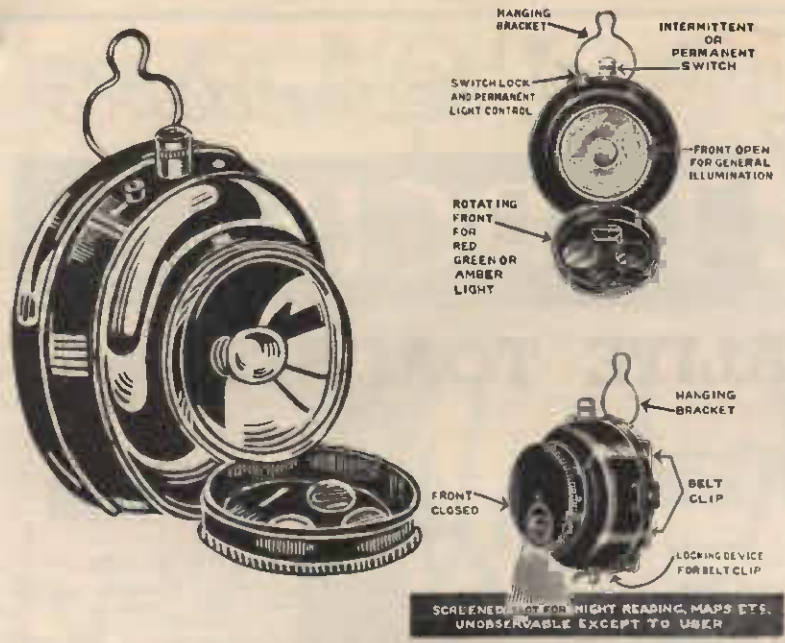

**PORTABLE COMBINATION LAMP. (D)**

Combination Table, Wall and Hanging Lamp, all black finish, fitted with hanger for attachment to buttons or tent poles, etc. Suitable for Railwaymen, Police and Scout use. Complete with standard size, 3-cell pocket lamp battery and globe. **7/6**  
 Cat. No. ET915

**SMALL TORCHES FOR THE HANDBAG OR POCKET. (G)**

For those not requiring a large torch, these low-priced torches will give years of service. Foreign manufacture.

**BAKELITE 2-CELL TORCH.**

Uses standard Bijou batteries. Supplied complete with batteries and bulb. Length overall 4 1/2 in. Diameter 1 1/2 in.  
 Cat. No. ET826 Each **1/3**

**SPARE BATTERIES.**

Obtainable everywhere.  
 Cat. No. EB303 Each **6D.**

**METAL TORCH.**

Similar to above. Reliable switch. Nickel finished. Uses standard Bijou batteries. Dimensions 4 1/2 in. x 1 in.  
 Cat. No. ET827 Each **1/3**

**SMALLEST FOCUSING TORCH MADE.**

Takes standard Bijou batteries. Size of head 1 1/2 in., length 4 1/2 in., complete with battery and bulb.  
 Cat. No. ET828 Each **1/6**

**SMALL SIZE FOCUS TORCH.**

Nickel plated. Takes standard 2-cell baby battery. Size 5 1/2 in. x 2 in. head. Supplied complete with battery and bulb.  
 Cat. No. ET830 Each **2/6**



**BAKELITE TORCH.**

Size 5 1/2 in. x 1 1/2 in. Takes standard 2-cell battery. Throws broad beam. Supplied complete with battery and bulb.  
 Cat. No. ET829 Each **2/-**

**USALITE—NEW AND NOVEL PENLIGHT. (G)**



Solid brass case in handsome modern ribbed design. Reading house numbers and letter box names, locating keyholes and light switches, scanning programmes in theatres, finding articles under seats, and for use by doctors and nurses for mouth inspection.  
 Cat. No. ET825— **3/-** each complete

**NEW PIFCO TORCHES. (K)**



Bijou Torch, with 1 1/2-inch lens. Elegant polygon body, chrome-plated throughout. Length 4 1/2 inches. Complete with battery and bulb. Empire make.  
 Cat. No. ET817 **1/6** each

**TORCH BATTERIES. (K)**



Vidor Torch Batteries. British made. Stocks arrive each month so as to ensure that you only get new first-class fresh stocks.

- Standard Size Vidor Torch Cells. **4 1/2 D.**  
 Cat. No. EB301 ..... Each
- Baby Torch Unit Cells. **4 1/2 D.**  
 Cat. No. EB302 ..... Each
- Bijou 2-Cell Torch Batteries (Standard 3-Cell Flat) **6 D.**  
 Cat. No. EB303 ..... Each
- Standard 3-cell Flat Pocket Lamp Batteries. **6 D.**  
 Cat. No. EB304 ..... Each
- Pen Torch Batteries (2-cell) **6 D.**  
 Cat. No. EB305 ..... Each
- Twin 2-cell Cycle Batteries **1/-**  
 Cat. No. EB306 ..... Each

**GNOME 3-CELL FLAT BATTERIES. (K)**

For special Torches. Dimensions 2 1/2 in. x 2 in. x 3/4 in. **9 D.** each  
 Cat. No. EB307

**COLUMBIA TORCH BATTERIES. (G)**

Standard size Columbia Torch Cells. **6 D.** each  
 Cat. No. EB315—

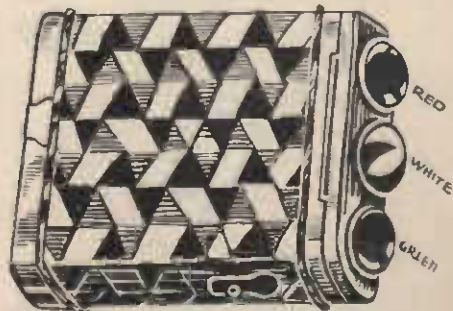
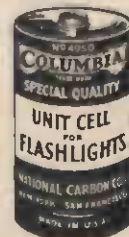

**RAILWAY TORCH. (G)**

Pocket Lamp Torch—metal case—red, white, or green light by just pushing lens across lamp. Takes standard 3-cell flat battery. Price complete with lamp and battery.  
 Cat. No. ET914 **3/6**

*Flashing Value* *In dependable*  
**TORCH Cases**

GUARANTEED NICKEL  
 FLASHLIGHT.  
 RELIABLE SWITCH.

**USALITE TORCHES** (G)

EQUIPPED WITH  
 MAZDA BULBS.  
 MADE IN U.S.A.



Small Torch, Broad Beam.  
 Cat. No. ET818  
 Complete **4/6** each



Small Torch, focussing spotlight,  
 300 ft. range  
 Cat. No. ET819  
 Complete **4/6** each



**LONG RANGE FOCUS TORCHES.**  
 Very popular with hunters and fishermen and general outdoor use, where powerful light is needed. Will focus broad spreadlights or long penetrating beams.  
 3-Cell Focus Torch, 800 ft. range **8/6** each complete  
 Cat. No. ET822



Focus Spotlight 2-Cell Torch, 300 feet range.  
 Cat. No. ET821  
 Complete **4/9** each



Regular 2-Cell Torch, broad beam  
 Cat. No. ET820  
 Complete **4/9** each

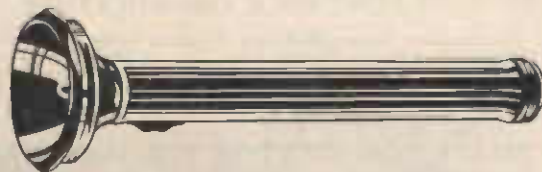

5-Cell Focus Torch, 1800ft. range **11/6** each complete  
 Cat. No. ET823



**2,500 Ft. Range**

8-Cell Focus Torch, 2500ft. range. The longest Torch and longest range Torch ever imported into N.Z. **17/6** each complete  
 Cat. No. ET824



**Pifco Lighthouse Lamp (G)**

For Hall, Cloakroom, Bathroom, Bedroom, Lavatory, etc.

Pifco Lighthouse Lamp is a modern electric night lamp, beautifully designed, extremely well made in brass and handsomely finished in chrome plate. The satin frosted glass globe gives a soft light and pleasing effect. Hanger incorporated so that it can be suspended if required, and is always handy for any purpose. Lever action switch. Uses two baby unit cell batteries and 2.5 volt bulb. Dimensions: Height overall, 5 1/2 in. Width overall, 3 1/2 in. Complete with battery and bulb. **5/-**  
 Cat. No. ET913

**Pifco Electric Owlite Lamp (G)**

Owlite is the new Pifco Electric Night Lamp combining brilliant lighting results with attractive appearance. The Owl is of figured satin frosted glass, and when lit is very effective. Hanger incorporated so that it can be suspended or carried with ease. Lever action switch. Handsomely finished in chrome plate. Uses two baby unit cell batteries and 2.5 volt bulb. Dimensions: Height overall, 5 1/2 in.; diameter of base, 3 1/2 in. Complete **5/-**  
 Cat. No. ET912





# There's a RIGHT Lamp For Every Purpose! (D)

This page has been prepared to enable you to choose your electric lamps wisely. Instead of buying "just a lamp," buy the RIGHT Lamp for the particular use, and you'll buy greater efficiency plus utmost economy. . .



**OSRAM Standard Vacuum CLEAR BULB**

This is the ideal lamp for halls, landings, passages, etc., where a low intensity light is required.

- Cat. No. EL201—15 watt, 1/11 each
- Cat. No. EL202—25 watt, 1/11 each
- Cat. No. EL203—60 watt . . 2/- each

**OSRAM Gas-filled CLEAR BULB.**



This type of lamp is universally used for the kitchen, bathroom and for use in factories, stores and shop windows—it might be termed the "general purpose" lamp.

- | Cat. No.              | Each |
|-----------------------|------|
| EL205—40 w. . . . .   | 1/11 |
| EL206—60 w. . . . .   | 2/-  |
| EL207—75 w. . . . .   | 2/11 |
| EL208—100 w. . . . .  | 4/-  |
| EL209—150 w. . . . .  | 6/6  |
| EL210—200 w. . . . .  | 9/-  |
| EL211—300 w. . . . .  | 12/6 |
| EL212—500 w. . . . .  | 18/- |
| EL213—1000 w. . . . . | 29/- |
| EL214—1500 w. . . . . | 40/6 |



**OSRAM TURN-DOWN LAMPS**

These lamps can be dimmed by simply pulling a cord connection on the top of the lamp.

- Has two filaments—one dim, the other bright. Just the lamp for over the child's cot, the sick bed, or for front halls, etc. . . . .
- Cat. No. EL259 . . . . . 5/5 each



**OSRAM GAS-FILLED DAYLIGHT**

These lamps have a special "blue" glass which filters out all red and yellow beams, and provides the nearest approach to daylight so far obtainable. Essential for colour matching in shops and warehouses, and also for window display.

- | Cat. No.                            | Each  |
|-------------------------------------|-------|
| EL229—40 w. BC or ES cap . . . . .  | 2/5   |
| EL230—60 w. BC or ES cap . . . . .  | 2/7   |
| EL231—75 w. BC or ES cap . . . . .  | 3/8   |
| EL232—100 w. BC or ES cap . . . . . | 5/-   |
| EL233—150 w. BC or ES cap . . . . . | 8/2   |
| EL234—200 w. BC or ES cap . . . . . | 10/11 |
| EL235—300 w. GES cap . . . . .      | 15/6  |
| EL236—500 w. GES cap . . . . .      | 21/6  |



**OSRAM Gas-filled OPAL**

Pure opal glass lamps which give a soft white light. Particularly desirable for sewing, reading, "swotting," etc., where the worker is liable to suffer from eye-strain.

- | Cat. No.             | Each  |
|----------------------|-------|
| EL221 40 w. . . . .  | 2/2   |
| EL222—60 w. . . . .  | 2/3   |
| EL223—75 w. . . . .  | 3/3   |
| EL224—100 w. . . . . | 4/8   |
| EL225—150 w. . . . . | 7/6   |
| EL226—200 w. . . . . | 10/5  |
| EL227—300 w. . . . . | 14/5  |
| EL228—500 w. . . . . | 19/11 |

**OSRAM Gas-filled PEARL**



Just like the lamp above except that the inside of the glass is frosted just sufficiently to keep sharp light beams from the eyes, without impairing the efficiency of the light. Ideal for "close work" in offices or where work under artificial light is constant.

- | Cat. No.             | Each |
|----------------------|------|
| EL215—40 w. . . . .  | 1/11 |
| EL216—60 w. . . . .  | 2/-  |
| EL217—75 w. . . . .  | 2/11 |
| EL218—100 w. . . . . | 4/-  |
| EL219—150 w. . . . . | 6/6  |
| EL220—200 w. . . . . | 10/6 |

**VACUUM TYPE SPRAYED COLOURS.**

These are used for special displays, electric signs, and also for home decoration. We have them in pear shape, in red, blue, green, orange, white, yellow.

- | Cat. No.                    | Each |
|-----------------------------|------|
| EL239—40 watts . . . . .    | 2/2  |
| EL240—60 watts . . . . .    | 2/3  |
| EL241—Small pilot . . . . . | 2/2  |

Vacuum type, as above, but natural coloured glass. Colours: Red, blue, green, amber. . . . .

- | Cat. No.                 | Each |
|--------------------------|------|
| EL242—40 watts . . . . . | 3/-  |
| EL243 60 watts . . . . . | 3/-  |

Gas-filled (3-watt), natural coloured lamps. Colours: Red, blue, green, amber. . . . .

- | Cat. No.                  | Each |
|---------------------------|------|
| EL244—40 watts . . . . .  | 4/1  |
| EL245—60 watts . . . . .  | 4/11 |
| EL246—75 watts . . . . .  | 5/5  |
| EL247—100 watts . . . . . | 7/8  |

**LAMPS—PHOTOGRAPHIC. (D)**  
**THE DUO PHOTO LAMP.**

Special Lamps for darkroom use. This type has two filaments, one an ordinary lighting filament, the other gives a coloured glow like an ordinary photo lamp; by simply pulling a cord at the side of the lamp you switch over the filaments.

- Cat. No. EL260—Opal White and Yellow (for printing and developing) Each **12/1**  
 Cat. No. EL261—Opal White and Red (for developing plates and films) Each **12/1**



**OSRAM PILOT LAMPS. (D)**

This Lamp is ideal for bathroom, halls, landings, and in fact every place where a small light is required for long periods. It only consumes 15 watts, and is therefore very economical. Cat. No. EL204 ..... **1/11** each



**OSRAM ROUGH SERVICE LAMPS. (D)**

Vacuum type Lamps with specially reinforced filaments for places where ordinary lamps have a short life owing to excessive vibration.

- Cat. No. EL237—40 watts, ES or BC base. **2/2** each  
 Cat. No. EL238—60 watt, ES or BC base. **2/3** each

**LAMPS—CARBON FILAMENT. (D)**

Carbon filament are now very seldom used for lighting, but are still in use as resistances (approx. 1 c.p. equals 4 watts).

- Cat. No. EL255—8 c.p. .... **2/5** each  
 Cat. No. EL256—16 c.p. .... **2/5** each  
 Cat. No. EL257—25 c.p. .... **3/1** each  
 Cat. No. EL258—50 c.p. .... **5/-** each

**LAMPS—CANDELABRUM. (D)**

Fitted with candle tube ready for use; with candle fittings. Cat. No. EL267—25 watts .. **6/-** each

**LAMPS—CANDLE. (D)**

For chandeliers, wall brackets, candle fittings, etc. When ordering, state type of base required.

- Cat. No. EL265—Plain flame, 25 watts. Each **3/3**  
 Cat. No. EL266—Twisted flame, 25 watts. Each **3/3**



**OSGLIM NEON LAMPS.**  
Voltage 200-250.

Type	Watts	Cap	Price
Nightlight	5	BC	4/9
Letter or Figure	5	BC	4/9
Dwarf Indicator	0.5	SBC	3/11
Dwarf Indicator	0.5	BC	4/4
Cross Shaped Electrodes	5	BC	10/3

**EXCITER LAMPS.**

Volts.	Watts.	Light Centre.	Price.
8	32	50 mm.	5/7
8	32	56 mm.	5/7
8.5	32	56 mm.	5/7
10	50	48.5 mm.	5/7
10	75	50 mm.	6/9

Caps Asst.

**LAMPS—FLASHOLITE. (D)**

This type is used for electric signs and for advertising effects, etc. A flasher inside the top of the lamp switches the lamp on and off approximately every 20 seconds. Available both in clear and sprayed coloured (Red, White, Blue, Orange, Yellow, Flame, Green).

- Cat. No. EL253—Clear ..... **5/5** each  
 Cat. No. EL254—Coloured .. **6/1** each

**LAMPS—SPECIAL ROUND BULB. (D)**

These are used in American type candle fittings, etc. Frosted.

- Cat. No. EL249—25 watts, B.C. base .... Each **2/10**  
 EL250—40 watts, B.C. base .... **2/10**  
 EL251—25 watts, E.S. base .... **2/10**  
 EL252—40 watts, E.S. base .... **2/10**

**PROJECTION LAMPS. (D)**

Type	Volts	Watts	Cap	Price
Class A1 Tubular for Vertical Burning	30, 50 100-110 200-260	100	ES	14/3
		250	ES	25/-
		500	ES or GES	36/6
		600	GES	41/9
		900	GES	57/3
Class A2 Round Bulb for Vertical Burning	100-115 and 500 200-260	100	ES	14/3
		250	ES	24/9
		500	ES, GES	35/9
		1000	GES	57/-
Class A3 Round Bulb for Horizontal Burning	100-110 and 500 200-260	100	ES	14/3
		250	ES	24/9
		500	ES, GES	35/9
Class B Round Flood-light	100-130 and 250 200-260	100	ES	14/3
		250	ES	24/9
		500	GES	35/9
		1000	GES	57/-

**OSRAM TURN-DOWN LAMPS. (D)**

Just what you want for the sick room, kiddies' room, front halls, etc. Pull the cord and you dim the light—pull the other and it's brilliant again.

- Cat. No. EL259 .. **5/5**  
Each



**LAMP CAPS.**

- BC = Standard Bayonet Cap.  
 ES = Standard Screw Cap.  
 GES = Goliath Screw Cap.  
 SBC = Small Bayonet Cap.

**SPARE LAMPS FOR "MONARCH" SUN LAMPS. (D)**

Special carbon filament lamps with screw base, as used for the famous "Monarch" Health-giving Sun Lamps. Clear. 230 volt.

- Cat. No. EL600 ..... **4/6** each  
 Red Natural Glass Ditto **6/6** each  
 Cat. No. EL601 ..... **6/6** each  
 Blue Natural Glass Ditto. **6/6** each  
 Cat. No. EL602

**LAMPS FOR LIGHTING PLANTS. (D)**

Of course the Lamphouse have them. Volt Lamps with standard bayonet caps available in the following sizes: 10w., 15w., 25w., and 40w., and 12-volt Lamps in the same sizes are all listed at the **2/4** same price. Each

Other special voltages are also available, such as 32v., 50v., 60v., and 100v.

**IF IT'S LAMPS**  
**Send to the LAMPHOUSE.**



**TORCH LAMPS. (K)**

Standard Types.  
Best Quality.

- Cat. No. EL100—1.25 volts ..... Each **10<sup>D</sup>**  
 EL101—2.5 volts ..... **6<sup>D</sup>**  
 EL102—3.5 volts ..... **6<sup>D</sup>**  
 EL103—4 volts ..... **10<sup>D</sup>**  
 EL105—Focus, 2.5 volts ..... **6<sup>D</sup>**  
 EL106—Focus, 3.5 volts ..... **6<sup>D</sup>**  
 EL109—Focus, 6 volts ..... **1/-**  
 EL115—8v., Lamp for Cycle Lamp, etc. **1/-**  
 EL137—9.6 volt (for 8-cell Torches) **1/9**

Tubular Radio Panel Lamps—See page 81.

**SPECIAL TYPES. (K)**



(German)

- Cat. No. Voltage. Type. Each  
 EL130—2.5, Bull's-eye ..... **10<sup>D</sup>**  
 EL131—3.5, Bull's-eye ..... **10<sup>D</sup>**  
 EL132—2.5, 2 Opal ..... **9<sup>D</sup>**  
 EL133—3.5, 2 Opal ..... **9<sup>D</sup>**  
 EL134—2.5 Solid Crystal ..... **10<sup>D</sup>**  
 EL135—3.5, Solid Crystal ..... **10<sup>D</sup>**  
 EL136—6.0, Silk frosted (for Cycle Generators, etc.) **1/3**

**LAMPS FOR CYCLE GENERATORS. (K)**

These Lamps are specially constructed to be used for Cycle Generators giving the wattage output indicated on the lamp.

- Cat. No. EL116—6 volt, .25 amp. Generator Lamps Each **1/3**  
 EL117—.35 amp. Ditto ..... **1/3**  
 EL118—.50 amp. Ditto ..... **1/3**

Radio Panel Lamps—See page 81.



# RADIATOR ELEMENTS (D)



### SPARE FIRE BARS FOR RADIATORS.

- 1000 watt, 10 1/2 in. between centres of mounting holes. Over all width of bar, 3 1/2 in.
- |   |                |     |
|---|----------------|-----|
| Cat. No. EE519  | Each           | 9/6 |
| Speedee Fire Bars. Small 1kw. 7 1/2 in. long.                   | Cat. No. EE531 | 7/6 |
| Large 1kw. Ditto, 9 in. long.                                   | Cat. No. EE532 | 8/6 |
| Round Porcelain Bars, with Spiral Elements; 1kw; 9 1/2 in. long | Cat. No. EE533 | 9/6 |

### RADIATOR ELEMENTS—SPIRAL WINDINGS. (K)

- Spiral Element Windings for re-winding Radiator Elements, etc. Made of best British resistance wire.
- |                           |      |  |
|---------------------------|------|--|
| Cat. No.                  | Each |  |
| EE509—230 Volt, 600 Watt  | 1/9  |  |
| EE510—230 Volt, 750 Watt  | 2/-  |  |
| EE511—230 Volt, 1000 Watt | 2/3  |  |

### MORPHY RICHARDS RADIATOR ELEMENTS. (D)

- |                     |      |     |
|---------------------|------|-----|
| 750-watt Round Bars | Each | 6/- |
| Ditto, 1000-watts   |      | 7/- |
| Cat. No. EE521      |      |     |



RADIATOR ELEMENTS. (G)

Plug-in type Radiator Elements, will fit "Magnet" and other British and Continental Radiators. 750 watts.

- |                 |     |      |
|-----------------|-----|------|
| Cat. No. EE502— | 6/6 | Each |
|-----------------|-----|------|



RADIATOR ELEMENTS. (G)

Here is a replacement Radiator Element of the standard screw-in pattern. Many people like to make up their own radiators.

- |                 |     |      |
|-----------------|-----|------|
| Cat. No. EE501— | 5/- | Each |
|-----------------|-----|------|

### RANGE ELEMENTS. (D)

- Electric Range Hot Plates.—Elements that will fit all makes of ranges. Speedee to fit any make of range, 8 in. to 1 1/2 in. diameter. 1750 watts.
- |  |      |
|--|------|
| Cat. No. EE550                             | 35/- |
| Ditto, 6 in. to 8 in. diameter, 900 watts. |      |
| Cat. No. EE551                             | 29/- |

### NIPPY COOKER ELEMENTS. (D)

- Complete Porcelain and Elements for Nippy Cookers.
- |                |      |      |
|----------------|------|------|
| Cat. No. EE527 | Each | 16/6 |
|----------------|------|------|

### APPLIANCE TERMINALS. (K)



Plated Appliance Terminals, for fitting in the back of electric irons, etc. Supplied complete with two nuts, mica and metal washers.

Cat. No. EE400	6D.	each
----------------	-----	------



Flat Pin Terminals, as above.

Cat. No. EE401	6D.	each
----------------	-----	------

### SWAN KETTLE SPARES. (D)

- |                                      |      |  |
|--------------------------------------|------|--|
| Cat. No.                             | Each |  |
| EE600—2-pint, 700-watt elements      | 18/- |  |
| EE601—3-pt., 1000-watt elements      | 19/6 |  |
| EE602—4-pt., 1500-watt elements      | 22/6 |  |
| EE603—6-pt., 2000-watt elements      | 22/6 |  |
| EE604—Spare fusible capsules         | 6D.  |  |
| EE605—Spare Plugs                    | 7/-  |  |
| EE606—Spare Plugs, with 3-core flex. | 11/6 |  |
| EE607—Washers                        | 2D.  |  |

### SUN-UP KETTLE ELEMENTS. (D)

Spare Elements for Sun-up Kettles; 230 volt.

Cat. No. EE530	Each	9/6
----------------	------	-----

### ELECTRIC IRON ELEMENTS. (D)

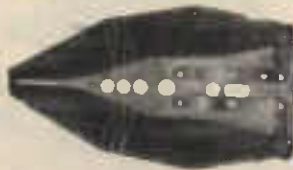

The Element in the iron is the part that does all the work and practically the only part that goes wrong. These Elements are specially constructed for long service, and will fit all standard makes of irons.

- |          |     |      |      |       |
|----------|-----|------|------|-------|
| Cat. No. | 2/6 | Each | 29/4 | Dozen |
| EE508    |     |      |      |       |

### APPLIANCE CORDS. (D)

Cords for electrical appliances, irons, toasters, jugs, etc., etc. Fitted with "Fitall" type appliance plug on one end and a wall plug on the other end.

(See diagram on page 13 for different types.)



- |                                    |     |  |
|------------------------------------|-----|--|
| Cat. No.                           |     |  |
| EE800—Cord with 2-pin parallel cap | 3/9 |  |
| EE801—With 2-pin tee cap           | 3/9 |  |
| EE803—With 3-pin cap               | 4/- |  |
| EE802—With lamp socket adaptor     | 3/7 |  |

(Note.—The above are fitted with 6 feet best cord. Extra long cords can be supplied. Add 9d. for each extra yard required.)

# ELEMENTS FOR APPLIANCES

### SPECIAL ELEMENTS. (G)

Besides the "Fit-all" Elements listed elsewhere, we can supply the following special Elements:—

### IRON ELEMENTS.

- |          |  |       |
|----------|--|-------|
| Cat. No. |  | Price |
| EY1      | Hotpoint Travelling Type, single voltage | 8/-   |
| EY2      | Premier Ditto                            | 6/-   |
| EY3      | Universal Ditto                          | 6/-   |
| EY4      | Hotpoint Travelling Type, 100-230 volts  | 13/6  |
| EY5      | Premier Ditto                            | 13/6  |
| EY6      | Universal Ditto                          | 13/6  |
| EY7      | Magnet Tailors', single heat             | 13/6  |
| EY8      | Hotpoint Ditto                           | 13/6  |
| EY9      | Hotpoint Tailors', three heat            | 18/-  |
| EY10     | Magnet Ditto                             | 18/-  |

### TOASTER ELEMENTS.

- |          |                        |       |
|----------|------------------------|-------|
| Cat. No. | Make of Toaster.       | Price |
| EY11     | Waratah                | 6/9   |
| EY12     | Hotpoint D22           | 6/9   |
| EY13     | Hotpoint T9            | 6/9   |
| EY14     | Magnet                 | 6/9   |
| EY15     | Universal E944         | 6/9   |
| EY16     | Universal E9312        | 6/9   |
| EY17     | Westinghouse           | 6/9   |
| EY18     | Hecla                  | 6/9   |
| EY19     | Star-Rite              | 6/9   |
| EY20     | Toastmaster Commercial | 6/9   |
| EY21     | Double Action Centre   | 6/9   |
| EY22     | Double Action Outer    | 6/9   |
| EY23     | Creda Swing-gate       | 6/9   |
| EY24     | Creda Two-strip        | 6/9   |

### KETTLE ELEMENTS.

Two, Three, and Four Pint.

- |          |                 |       |
|----------|-----------------|-------|
| Cat. No. | Make of Kettle. | Price |
| EY25     | Magnet          | 8/3   |
| EY26     | Ideal           | 8/3   |
| EY27     | Diamond         | 8/3   |

### KETTLE STRIPS.

Two, Three, and Four Pint.

- |          |        |                 |
|----------|--------|-----------------|
| Cat. No. | Make.  | Price per strip |
| EY28     | Hecla  | 4/6             |
| EY29     | Creda  | 4/6             |
| EY30     | Excell | 4/6             |
| EY31     | Revo   | 4/6             |

### PERCOLATOR ELEMENTS.

- |          |           |       |
|----------|-----------|-------|
| Cat. No. | Make.     | Price |
| EY32     | Universal | 4/6   |
| EY33     | Hecla     | 4/6   |

Any odd sized Elements can be made to sample.

### ELECTRIC JUG ELEMENTS. (G)

Spiral Windings for Electric Jugs. 230 volt.

- |          |     |
|----------|-----|
| Cat. No. | 1/6 |
| EE514    |     |

Porcelain Bobbins for Jug Elements.

- |          |     |
|----------|-----|
| Cat. No. | 1/6 |
| EE515    |     |

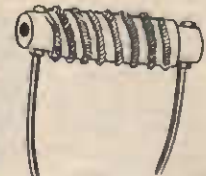

- |                            |      |
|----------------------------|------|
| Winding on Bobbin—Complete | 3/6  |
| Cat. No. EE513             | Each |

### SPEEDEE JUG ELEMENTS. (D)

- |                             |      |
|-----------------------------|------|
| For Speedee Enamelled Jugs. | 9/6  |
| Cat. No. EE516              | Each |

### ELECTRIC IRON HANDLES. (D)

- Wooden handles for electric irons—will fit practically all makes.
- |                |     |      |
|----------------|-----|------|
| Cat. No. EE405 | 1/6 | each |
|----------------|-----|------|

**SPARES AND EXTRA ATTACHMENTS FOR KNIGHT ELECTRIC CLEANERS (G)**

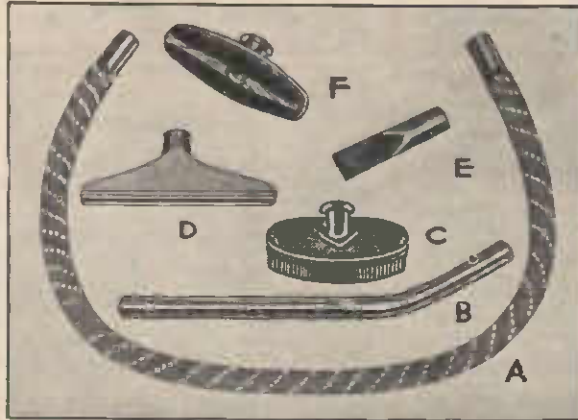

- A.—Flexible Hosepipes ..... Each **15/-**  
Cat. No. EE230
- B.—Bent Extension Tubes ..... Each **6/9**  
Cat. No. EE231
- C.—Oval Brushes ..... Each **6/-**  
Cat. No. EE232
- D.—Long Aluminium Nozzles ..... Each **6/-**  
Cat. No. EE233
- E.—Fibre Nozzles ..... Each **3/-**  
Cat. No. EE234
- F.—Floor Polishing Nozzles, fitted with two pads. It can be fitted to the tube in the same way as the other nozzles, and used in conjunction with the "Knight" Cleaner for polishing floors.  
Cat. No. EE235 ..... Each **13/6**
- Spare 230 V. Armatures ..... Each **45/-**  
Cat. No. EE236
- Field Coils ..... Each **10/6**  
Cat. No. EE237
- Carbon Brushes ..... Each **1/3**  
Cat. No. EE238
- Straight Tubes ..... Each **5/-**  
Cat. No. EE240
- Spare Bags ..... Each **6/6**  
Cat. No. EE241
- Spare Brush Caps ..... Each **1/3**  
Cat. No. EE242

**LAMPLOCKS. (D)**

- Lamplocks which prevent lamps being stolen or removed from their sockets, only persons with key being able to exchange lamps.
- Cat. No. EG400—Lamplocks ..... Each **1/9**
  - EG401—Keys for Lamplocks ..... Each **1/6**

**GALLERIES FOR LAMP-SHADES. (G)**

- All the following have a standard 1 1/2 in. hole for fitting on to standard size Lampholder.
- Brown Bakelite Moulded Gallery, 2 1/2 in. Cat. No. EF350—**9D.** each
  - Ditto, 3 1/2 in. ..... Each **1/4**  
Cat. No. EF351
  - Ditto, 4 1/2 in. ..... Each **1/6**  
Cat. No. EF352
  - Metal Galleries as above. Oxidised copper finish. 2 1/2 in. ..... Each **9D.**  
Cat. No. EF353
  - Ditto, 3 1/2 in. ..... Each **1/4**  
Cat. No. EF354
  - Ditto, 4 1/2 in. ..... Each **3/11**  
Cat. No. EF355
  - 6 in., with Canopy ..... Each **7/6**  
Cat. No. EF356



**FLANGES. (G)**

Cat. No. EG206—**6D.**

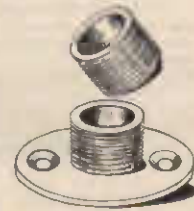

**NIPPLES. (G)**

Threaded Brass Tube for making table lamps, etc. Fit standard 3/4 in. lampholders.

Cat. No. EG200—**3D.** Each



**CHAIN SETS. (D)**

- Complete Chain Set for hanging bowl fittings. Consists of deep canopy with three hooks, three lengths of chain, each 36 in. long, three oxidised gravity hooks.
- Cat. No. EF306 ..... Each **7/6**
  - Chrome Ditto ..... Each **11/6**  
Cat. No. EF307

**DEEP CANOPY.**

- Has three hooks for hanging bowl fittings, etc. Deep enough to fit right over the ceiling rose, thus saving the expense and trouble of removing the ceiling rose and block to fit a special connecting block. Oxidised copper finished.
- Cat. No. EF310 ..... Each **2/6**
  - Ditto, Chrome finish ..... Each **3/6**  
Cat. No. EF311

**CHAIN.**

- For hanging bowl fittings, etc. 1 in. link, oxidised copper finish.
- Cat. No. EF315 ..... per yard **1/3**
  - Ditto, chrome finish ..... per yard **2/1**  
Cat. No. EF316

**GRAVITY HOOKS.**

- For hanging on the lip of bowl fittings. Oxidised copper finished.
- Cat. No. EF320 ..... Each **5D.**
  - Ditto, Chrome finish ..... Each **9D.**  
Cat. No. EF321

**BOWL BUTTONS.**

- Oxidised.  
Cat. No. EF325 ..... Each **5D.**

**SPARES FOR VIOLET RAYS. (D)**

Cat. No. EE253—Surface Electrodes (A) ..... Each **2/6**

EE254—Condenser Electrodes (B) ..... Each **6/6**

EE255—Nape and Neck Electrodes for external treatment. (C) ..... **5/6**

EE252—Comb Electrodes (D) ..... Each **3/6**

EE256—Spinal Electrodes. (E) ..... **5/6**

EE257—Massage Roller Electrodes. (F) ..... **10/6**

EE259—Nerve Brush (G) ..... **4/6**

EE260—Brush Electrode, for care of the hair, massage of head and body. (H) ..... **19/6**

EE258—Ozone Inhaler, with spray. (I) ..... **16/6**

EE261—Special Foot Electrode, for deductive treatment for nervousness, diseases of the heart or head, or for diseases needing deductive treatment. (J) ..... **21/-**

Cat. No. EE250—High Voltage Condensers ..... Each **6/6**

Cat. No. EE251—H.F. Coils ..... Each **9/6**

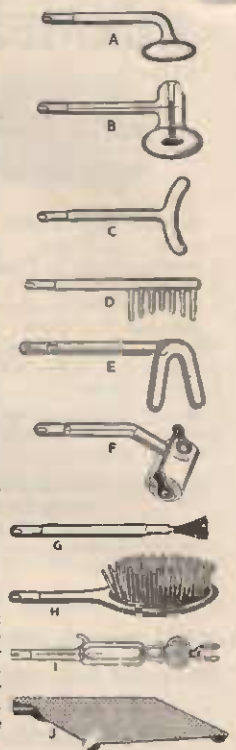

**1-HORSE POWER MOTOR. (D)**



Handy Motor for saw benches, pumps, drills, and dozens of other jobs around the house. Manufactured by Brown, Brock and Meyers, U.S.A. Speed 1440 r.p.m. Size 7 in. x 6 in. Base, 6 1/2 in. high. Weight 28 lb.  
Cat. No. EM650 ..... **£4/12/6**

**CLAMP-ON SHADES. (D)**

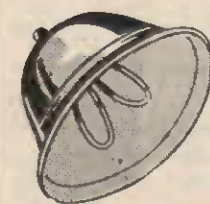

Spare Shades for Clamp-on Table Lamps. Available in various colours. Metal shade is 6 1/2 in. in diameter, and is provided with a clip so that the shade will clamp on to the lamp bulb.  
Cat. No. EE48—**3/-** each



# AUTO—CYCLE—TOOL SECTION

## PHILIPS

### MOTOR CAR LAMPS

(H)

We can supply Lamps for any type of car, and if you are in doubt about the type to order, state name of car, year of model, and position of lamps in car. We will do the rest.

#### 6 8 VOLT SINGLE CONTACT SINGLE FILAMENT LAMPS.

Cat. No.	Candle Power.	Wattage.	Location.	Price.
EL300	6	5	Tail	1/1
EL301	6	5	Side	1/1
EL302	15	12	Stop	1/9
EL303	21	20	Head	1/9
EL304	32	25	Head	1/9
EL305	50	35	Head	1/9

#### 6/8 VOLT DOUBLE CONTACT SINGLE FILAMENT LAMPS.

Cat. No.	Candle Power.	Wattage.	Location.	Price.
EL306	6	5	Tail	1/1
EL307	6	5	Side	1/1
EL308	15	12	Stop	1/9
EL309	21	20	Head	1/9
EL310	32	25	Head	1/9
EL311	50	35	Head	1/9

#### 12/16 VOLT SINGLE FILAMENT SINGLE CONTACT LAMPS.

Cat. No.	Candle Power.	Wattage.	Location.	Price.
EL312	6	5	Tail	1/4
EL313	6	5	Side	1/4
EL314	15	12	Stop	2/3
EL315	21	20	Head	2/3
EL316	32	25	Head	2/3
EL317	50	35	Head	2/3

#### 12/16 VOLT SINGLE FILAMENT DOUBLE CONTACT LAMPS.

Cat. No.	Candle Power.	Wattage.	Location.	Price.
EL313A	6	5	Tail	1/4
EL314A	6	5	Side	1/4
EL315A	15	12	Stop	2/3
EL316A	21	20	Head	2/3
EL317A	32	25	Head	2/3
EL318	50	35	Head	2/3

#### 6 8 VOLT DOUBLE FILAMENT HEAD LAMPS WITH STANDARD DOUBLE CONTACT CAP.

Cat. No.	Candle Power.	Equivalent Wattage.	Price.
EL319	21/3 (Ford)	20/3	2/-
EL320	32/6	25/5	2/-
EL321	21/21	20/20	2/6
EL322	32/32	25/25	2/6
EL323	50/50	35/35	2/6
EL324	21/21 (Duplo)	20/20	3/6
EL325	32/32 (Duplo)	25/25	3/6
EL326	50/50 (Duplo)	35/35	3/6

#### 12/16 VOLT DOUBLE FILAMENT HEAD-LAMP WITH STANDARD DOUBLE CONTACT CAP.

Cat. No.	Candle Power.	Equivalent Wattage.	Price.
EL327	21/3	20/3	2/8
EL328	32/6	25/5	2/8
EL329	21/21	20/20	3/5
EL330	32/32	25/25	3/5
EL331	50/50	35/35	3/5
EL332	21/21 (Duplo)	20/20	3/11
EL333	32/32 (Duplo)	25/25	3/11
EL334	50/50 (Duplo)	35/35	3/11



- A—Ignition Indicator Min. Screw.
- B—Trafficator.
- C—Ignition Indicator Min. Bayonet Cap.

#### 6/8 VOLT LAMPS WITH SPECIAL CAPS.

Cat. No.	Location.	Wattage.	Cap. Price
EL347—	Head	25/20	835 3/2
EL348—	Head	25/25	835 3/2
EL349—	Head	35/35	835 3/2
EL350—*	Head	25/25 Prefocus	836 4/-
EL351—*	Head	35/35 Prefocus	836 4/-

\* Super Duplolum 1936 American Cars.

Cat. No.	Location.	Wattage.	Cap. Price
EL352—	Side	5 Tubular	Bosch 2/-
EL353—	Head	20	SC853 1/9
EL354—	Head	20	DC943 1/9
EL355—	Head	25	SC863 2/7
EL356—	Side	5	SC847 2/-
EL357—	Head	20	SC863 2/7
EL358—	Head	25	SC863 2/7
EL359—	Head	35	SC863 2/7
EL360—	Head	35	SC848 2/7
EL361—	Head	35	DC943 2/7
EL362—	Head	25	SC853 1/9
EL363—	Head	25	DC943 1/9
EL364—	Head	35	SC943 1/9
EL365—	Head	35	DC943 1/9
EL366—	Head	25/25 (Duplo)	864 4/4
EL367—	Head	35/35 (Duplo)	864 4/4
EL368—	Head	35/35 (Duplo)	946 4/4
EL369—	Head	35/35 (Duplo)	943 3/11

NOTE.—Lamps with Prefocus Cap No. 835—Chevs., Hudsons, Oldsmobiles, Terraplanes, Chryslers, Nash, etc. 1935 Models, 1936 Models Cap 836 Super-duplolum.

- Lamps with Cap 863—Recent Model Fiats.
- Lamps with Cap 848—Old Model Fiats.
- Lamps with Cap 946—Old Model Fiats.
- Lamps with Cap 847—Fiat.
- Lamps with Cap 864—All Lucas Graves Systems.
- Details of Special Caps on application.
- EXTRAS—Satin frosted  
List Price plus 10%
- Selectiva (Cadmium Yellow)  
List Price plus 20%

#### SPECIAL INTERIOR LAMPS, ETC., 6/8 VOLTS.

Cat. No.	Location.	Size. M.M.	Cap.	Price.
EL335—	Trafficator	38 x 71	Tubular 2-cap	1/6
EL336—	Festoon	43 x 15	Tubular 2-cap	1/6
EL337—	Festoon	32 x 15	Tubular 2-cap	1/6
EL338—	Ignition Indicator	—	Min. Screw	1/1
EL339—	Ignition Indicator	—	Min. B.C.	1/1
EL340—	Dash Board Dial	—	Min. B.C.	1/1

#### SPECIAL INTERIOR LAMPS, ETC., 12/16 VOLTS.

Cat. No.	Location.	Size. M.M.	Cap.	Price.
EL341—	Trafficator	38 x 71	Tubular 2-cap	1/8
EL342—	Festoon	43 x 15	Tubular 2-cap	1/8
EL343—	Festoon	32 x 15	Tubular 2-cap	1/8
EL344—	Ignition Indicator	—	Min. Screw	1/2
EL345—	Ignition Indicator	—	Min. B.C.	1/2
EL346—	Dash Board Dial	—	Min. B.C.	1/4

#### Motor Car Lamps!

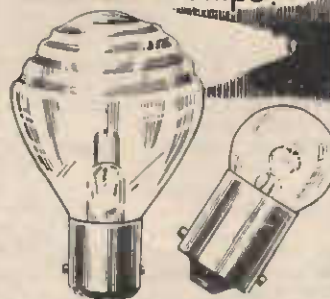

#### 12/16 VOLT LAMPS WITH SPECIAL CAPS.

Cat. No.	Location.	Wattage.	Cap. Price
EL370—	Head	25/20	835 4/1
EL371—	Head	25/25	835 4/1
EL372—	Head	35/35	835 4/1
EL373—	Head	25/25 Prefocus	836 4/8
EL374—*	Head	35/35 Prefocus	836 4/8
* Super Duplolum 1936 American Cars.			
EL375—	Side	5 Tubular	Flat or Bosch 2/-
EL376—	Head	20	SC853 2/3
EL377—	Head	20	DC943 2/3
EL378—	Head	25	SC863 2/8
EL379—	Side	5	SC847 2/-
EL380—	Head	20	SC863 2/8
EL381—	Head	25	SC863 2/8
EL382—	Head	35	SC863 2/8
EL383—	Head	35	SC848 2/3
EL384—	Head	35	DC943 2/3
EL385—	Head	25	SC853 2/3
EL386—	Head	25	DC943 2/3
EL387—	Head	35	SC853 2/3
EL388—	Head	35	SC943 2/3
EL389—	Head	25/25 (Duplo)	864 5/2
EL390—	Head	35/35 (Duplo)	864 5/2
EL391—	Head	35/35 (Duplo)	946 5/2
EL392—	Head	35/35 (Duplo)	943 3/11

NOTE.—Lamps with Prefocus Cap. No. 835—Chevs., Hudsons, Oldsmobiles, Terraplanes, Chryslers, Nash, etc., 1935 Models, 1936 Models Cap 836 Super-duplolum.

- Lamps with Cap 863—Recent Model Fiats.
- Lamps with Cap 848—Old Model Fiats.
- Lamps with Cap 946—Old Model Fiats.
- Lamps with Cap 847—Fiat.
- Lamps with Cap 864—All Lucas Graves Systems.
- Details of Special Caps on application.
- EXTRAS—Satin frosted  
List Price plus 10%
- Selectiva (Cadmium Yellow)  
List Price plus 20%

**OXFORD MOTOR-CAR BATTERIES. (G)**



Eighteen months unconditional guarantee. Solidly built H.D. leak-proof batteries. Thick plates built in N.Z. for N.Z. conditions.

Thick Plates—Carefully Sealed Cells—Long Life Guaranteed.

Cat. No.	Type	Width	Length	Height	Price
EA40	6-volt, 9-plate.	7in.	7in.	9in.	55/-
EA41	6-volt, 11-plate. English.	7in.	7 1/2in.	9in.	59/-
EA42	6-volt, 11-plate. Squat.	7in.	7 1/2in.	7 1/2in.	59/-
EA43	6-volt, 13-plate.	7in.	9 1/2in.	9in.	62/-
EA44	6-volt, 13-plate. Squat.	7in.	9 1/2in.	7 1/2in.	62/-
EA45	6-volt, 15-plate.	7in.	10 1/2in.	9in.	68/-
EA46	6-volt, 15-plate. Squat.	7in.	10 1/2in.	7 1/2in.	68/-
EA47	6-volt, 17-plate.	7in.	11 1/2in.	9in.	80/-
EA48	6-volt, 17-plate. Squat.	7in.	11 1/2in.	7 1/2in.	80/-
EA49	6-volt, 19-plate.	7in.	12 1/2in.	9in.	92/-
EA50	12-volt, 7-plate.	7in.	11 1/2in.	9in.	86/-
EA51	12-volt, 9-plate.	7in.	12 1/2in.	9in.	92/-
EA52	12-volt, 11-plate.	7in.	14 1/2in.	9in.	115/-
EA53	12-volt, 11-plate. Squat.	7in.	14 1/2in.	7 1/2in.	115/-
EA54	6-v., 7-plate. Motor Cycle.	3 1/2in.	4 1/2in.	6 1/2in.	35/-



"PIP PIP" HORN. (L)

British. Size 7 1/2in., universal screw clip. Plated, rubber bulb with screw-off ferule. Cat. No. ET907 ..... Each **1/6**

**THE "BLUE TIT" FLYING BIRD MASCOT. (K)**

Of metal-finish Blue Enamel. For handle bar fitting. When the cycle is in motion the wings move as in flight. Very lucky.

Cat. No. ET902. Each **1/11**

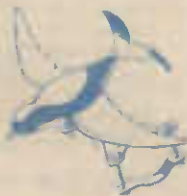

**"GOLSTONE" IGNITION CABLE ASSEMBLY KIT. (K)**

Registered Design No. 793780.

A useful Ignition Kit, indispensable to the Garage. The Ignition Cable is supplied with a range of easy fitting terminal ends to suit almost any make of British, American or Continental Car.

To make up replacement ignition leads is the work of a minute or two with this outfit. Cut cable to length required, slip over coloured distinctive sleeve supplied, and attach ignition terminal.

The Kit includes a strong box (Registered design), containing a drum of 100 feet of 7 mm. H.T. Cable, with a fixed compartment storing a variety of 7 dozen Ignition Terminals, indicating Coloured Sleeves, and everything essential for the rapid assembly of replacement ignition cables.

Outfit includes:—	List Price.
100 feet "Golstone" H.T. Ignition Cable multi-rubber sheathed (tested at 20,000 volts) on Drum 7 mm.	£1/1/-
Cat. No.	
ET56—12 Distributor Lead Terminals	1/6
ET51—24 Ignition Terminals	2/4
ET1001—12 Ignition Terminals	9d.
ET58—12 Ignition Terminals	1/6
ET55—12 Ignition Terminals	9d.
ET1002—12 Ignition Terminals	2/6
48 Indicating vari-coloured slide-on varnished sleeves	2/6
Strong container with fixed compartment	FREE

TOTAL ..... **£1/12/7**



This Cable can be drawn out of aperture in carton in lengths as required, thus preventing waste or damage.

**COMPLETE KIT. (K)**

List Price Individual Parts—32/7 **22/6**  
Cat. No. EW200 ..... Each



**CYCLISTS' MIRRORS. (K)**

British. Oblong mirror. Size 3 1/2in. x 1 1/2in. Black finish, with nickel mounts. Adjustable clip. For cycles, motor cycles, motor cars, etc. Cat. No. ET908 ..... Each **1/11**

**SPARK PLUG TESTERS. (K)**

For testing Spark Plugs and making sure your cylinders are firing correctly. Ensure smooth running of your car, and make power by keeping a check on your spark plugs. Anyone can use them.

A Special PENCIL for MOTORISTS!

Why ?



A smart efficient propelling pencil that is much more than a pencil to the motorist. It's job is that of spark plug testing. You simply apply the pencil point to the spark plug terminals and an even intermittent glow in the NEON window of the pencil indicates correct adjustment. Get one and KNOW the condition of your plugs at all times Only **3/6** Each  
Cat. No. EM255 ..... Each

**MOTOR CAR RADIOS**

Page 39

**MOTOR CAR AERIALS**

Page 47

You will never know starting trouble if you charge your battery with an

**A T L A S .**

See page 50.



**"FIT & FORGET"**  
(C)

**K.L.G.**  
**SPARKING**  
**PLUGS**



**MICA PLUGS OR MICA WITH SHROUDS.**

("M" in Type No. = Shroud.)

Type No.: K1, KM1, K2, KM2, K7, 843, S1, 669, 669LR. Thread: 18 m/m metric.

Type No.: KAM3, KAM4, 669J. Thread 3/16 in. S.A.E.

Type No.: L777, 831. Thread: 14 m/m metric.

Each **5/-**

Type No.: KSM6 (18 m/m), LKS5 (14 m/m)

Each **6/-**

**PLUGS WITH PLATINUM POINT ELECTRODES.**

Type No.: PK1, PK2, P843. Thread: 18 m/m metric.

Type No.: PKA3, PKA4. Thread: 3/16 in. S.A.E.

Type No.: P721B, P831. Thread: 14 m/m metric.

Each **6/-**

**CORUNDITE PLUGS.**

Type No.: F30X, F50X, F60X. Thread: 14 m/m metric.

Each **4/6**

(N.B.—18 m/m Models, etc., arriving shortly.)

State make and model of Car or Cycle, and we will do the rest.

**THE FASTEST SPARKING PLUG IN THE WORLD**

Leaflet with full particulars on request.

**MOTOR CAR CABLES (K)**

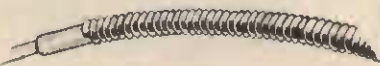

Aluminium Armoured Cables. Standard flexible conductors, 23/0076. Insulated vulcanised rubber protected with impregnated yarn and bright aluminium armoured. Current capacity 4 amps. 100ft. reels.

Cat. No. EW201 ..... 2 D. foot; 14/3 reel



Ditto; twin ..... 4 D. foot; 26/6 reel  
Cat. No. EW202 ..... 4



Rubber-covered Ignition Cable. Super quality multiple layers of high grade rubber, 7 mm.; 100ft. reels. 2 D. foot; 14/- reel  
Cat. No. EW203 ..... 2



Single Conductor, Glossy Varnished Electric Celluloid Flexible Cable. This attractive cable withstands severe conditions. Standard conductor insulated vulcanised rubber, braided strong yarn and multiple cellulose, bright full glossy varnished, oil and heat resisting. 100ft. reels.

Cat. No. EW204—2.75 mm. ... 2 1/2 D. foot; 15/- reel

EW205—4 mm. .... 3 D. foot; 17/3 reel

EW206—7 mm. .... 3 D. foot; 21/- reel



Twin Celluloid Varnish Cable, as described above. 4 D. foot; 26/3 reel  
Cat. No. EW207 ..... 4



Metal-screened Ignition Cable for suppressing electrical interferences. For use on cars and aeroplanes fitted with radio. It is of super grade and complies with severe regulations. Tested at 22,000 volts after being immersed in water. Approx. outside diameter 7.5 mm.; 100ft. reels.

Cat. No. EW208 ..... 8 D. foot; 54/- reel



Motor Car Lamp Cord (Twin Lighting Flex). Stranded copper conductors insulated with high grade vulcanised rubber. Each conductor braided glass cotton, then twin twisted. 14/36. Colour: Black with red tracer. 100ft. reels.

Cat. No. EW209 ..... 1 1/2 D. foot; 7/6 reel

**MOTOR CAR HIGH AND LOW TENSION TERMINALS. (K)**

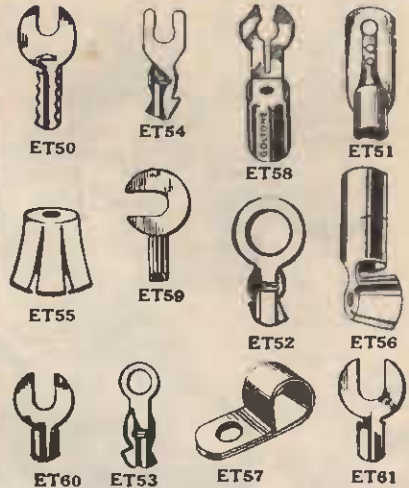

Cat. No.	Price per dozen.	Price per box (100)
ET50	9d.	4/6
ET51	1/2	7/6
ET52	10d.	5/3
ET53	9d.	4/6
ET54	9d.	4/6
ET55	9d.	4/6
ET56	1/6	10/6
ET57	4/6	32/-
ET58	1/6	10/-
ET59	9d.	4/6
ET60	7d.	3/-
ET61	9d.	4/6

(Illustrations are approximately half-size.)

**ADAPTORS, MINIATURE. (K)**

These are similar to EG1, but fit miniature lamp holders. They are standard size for use on motor cars.

Cat. No. EG2—Double contact ... 8 D.  
EG3—Single contact ... 8 D.



**MOTOR CAR LAMP SOCKETS. (G)**

American type Lamp Sockets for Motor Car Lamp Extensions, etc., etc.

Cat. No. EG72—Single contact 1/- each

Cat. No. EG73—Double contact 1/- each

(Also see page 21.)

**MINIATURE SWITCHES. (K)**



Here's a handy little switch suitable for radio and motor car work. Positive action. Nicely finished (nickel plated). British made.

Cat. No. EG118 **1/3**

**MINIATURE LAMP GUARD. (G)**



Lamp Guards of this type are very useful when used in conjunction with our Voltage Reducer, type ET622, as they protect the lamp from damage. A double contact holder is provided so that any double contact car lamp may be fitted.

Cat. No. EE130 ..... Each **5/6**



# “ESMA” GENERATOR CYCLE LAMPS *and* FITTINGS

(G)

The Senior Service Dynamo Head Lamp is our 1938 contribution to bringing De Luxe cycle lighting within the reach of all.

**THE  
BIG  
FELLOW**

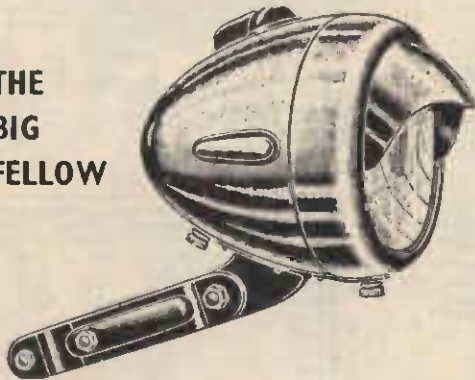

Beautifully designed, chromium-plated finish, with deep set, silver-plated reflector providing a wide and powerful beam of light. Torpedo shape with control and sidelight. 4-way switch. Battery for standing operation. **20/-**  
Cat. No. ET869

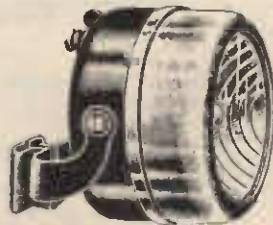

**THE WONDER HEAD LAMP**—Although low priced, this Head Lamp retains many advantages which the other head lamps offer. Throws a powerful beam of light over a long distance. Sturdily constructed and will give trouble-free service for years. Has battery for emergency lighting. **6/-**  
Cat. No. ET868



**THE PREMIER HEAD LAMP**—All chromium plated, 4-way switch, 2 bulbs, provides a brilliant beam of light. Obstacles are visible at a great distance, and steady road illumination assured. Built to give reliable and dependable service. 4½-volt standard battery provides a light when not riding. **16/6**  
Cat. No. ET872

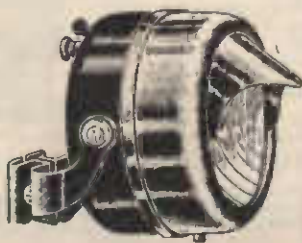

**NIGHTLITE HEAD LAMP** — Another powerful Head Lamp with Chrome trim. Has 4½-volt battery for emergency lighting. **8/-**  
Cat. No. ET867

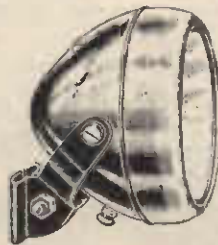

**JUNIOR HEAD LAMP**—An efficient Head Lamp that has been built for long service. Heavy gauge metal body. Black japanned. **7/6**  
Cat. No. ET870  
Chromium-plated. **9/6**  
Cat. No. ET871



**DE LUXE DYNAMO**—Chrome plated. Output, 6 volt, 0.5 amp., 3 watt. Exclusive design. Chromium plated finish and waterproof. A really first-class job in every respect. **17/-**  
Cat. No. ET866



**DYNAMO** — Perfectly balanced Dynamo. Brackets brass with chrome finish. Neck black japanned. Output 6 volt, 0.3 amp., 1.8 watt. Suitable for any of the head lamps above. **12/6**  
Cat. No. ET865



**REAR LIGHT**—Chromium-plated. Complete with bulb and cable. **3/-**  
Cat. No. ET873

## “ESMA” GENERATOR CYCLE LAMPS.

For your convenience we are listing Generator Head Lamps and Tail Lamps separately. You can then make up your Generator Set to suit your needs and pocket. All the Lamps are interchangeable with the Generators listed.



**PIFCO SAFETY CYCLE LAMP. (G)**



The big feature of this Pifco Cycle Lamp is the nickel-plated hood and tell-tale glass window with unique cut channel, so that the rider and traffic get a beam of light from three extra directions. The hood increases the beam of light for the cycle rider. Special switch incorporated.

Incomparable for utility, merit and value. Black finish, fixed bracket. British.  
Cat. No. ET841 ..... **4/9** each  
Spare Batteries—Cat. No. EB306 **1/-** ea.

**PIFCO JUNIOR CYCLE LAMP. (G)**



A popular electric Head Lamp. Strong and solid construction, using a standard 3-Cell Battery. Gives off a fine bright light of good range and width of beam. Finished black. Equipped with patent three-finger triangular and positive action switch. Fixed cycle

bracket for quick fixing. Plated reflector. British.  
Cat. No. ET840 ..... Each **3/3**

**PIFCO ELECTRIC CYCLE HORN. (G)**

Pifco Electric Cycle Horns add to safety and speed. Under every condition of weather will give unfailing service. Robustly built and easy to fix. Outfit comprises: horn with cables, battery container, and switch attachment ready for use. Use 3-cell flat pocket battery. Horn and battery container fit directly under the handle bars. British.

Cat. No. ET850 ..... **9/6** complete

**VOLMAG DYNAMO CYCLE LAMPS. (D)**

A well made British Dynamo Cycle Lamp.

Fits the front forks of the cycle, ensuring a bright light under all conditions. Weight approx. 9 ozs. Silver plated lamp reflector is 2 1/2 in. diameter.

Cat. No. ET858—

**12/6** each

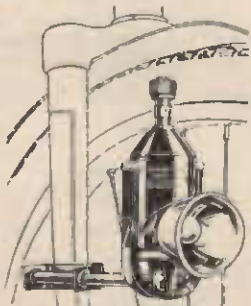

**LAMPHOUSE GUARANTEE!**

Any goods not considered completely satisfactory can be returned **WITHIN 7 DAYS** and the purchase price will be refunded without a quibble.

**BRITISH-MADE REAR LAMP. (K)**

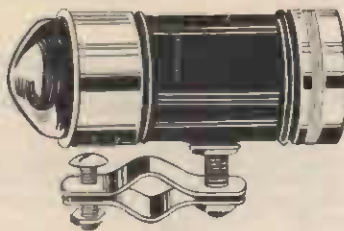

Black finish, with plated mounts. Clip especially designed to fit oval, D, and round stays. Unbreakable red projector. Designed to project red light to the rear and sides. Fitted with low consumption bulb and complete with battery. Uses standard size single torch cell.

Cat. No. ET900 ..... Each **2/-**

**PIFCO DE LUXE CYCLE LAMP. (G)**

This powerful Pifco Headlamp has its imitations, but has not been equalled. Special dim-bright switch. A powerful 90ft. beam of anti-dazzle light for dark road touring, and by switching the light is reduced for town riding, and battery consumption reduced.

Power supplied by two standard 3-cell pocket lamp batteries. Body finished matt black with chromium-plated fittings. British.

Cat. No. ET842—  
**10/6** ea



**CYCLE ACCESSORIES**

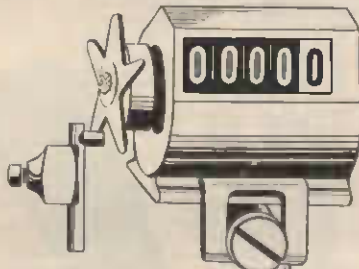

**CYCOMETERS. (K)**

Reliable and accurate Cyclometers for checking your mileage. Cat. No.

ET903—For 28in. wheels ... Each **7/6**

ET904—For 26in. wheels .. Each **7/6**

ET905—Strikers for above .... **6D.** Each

**DYNAMO TAIL LAMPS. (K)**



Tail lamps for use from dynamo or battery. Chromium plated with 1 1/2 in. faceted red glass. Supplied with 50in. cable with terminal clips. Lamp bulb extra. **3/6** ea.  
Cat. No. ET901 .....

**ENGINE PROPELLOR MASCOT. (K)**



British made. All metal plated. Finished with coloured propeller blades and screw clip for handle-bar fitting. .... **1/3**  
Cat. No. ET906 .....

**HYDROMETERS. (K)**

Eagle glass tube type, with non-sticking float. Test your own batteries.

Cat. No. EM300 .. **2/11**

SPARE FLOATS  
Cat. No. EM301 ... **1/-**



**MIDGET BALL HYDROMETERS. (K)**

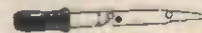

These are accurate, and the acid is tested by means of three coloured balls. The condition of the accumulator is shown instantly by the way the three balls of different specific gravities and colours sink or float, indicating fully charged, half charged, and discharged. (British.)

Cat. No. EM302 .... **1/3**  
Each

**STRONG N.P. ON-OFF SWITCHES. (K)**

Can be supplied with or without mounting brackets.

Cat. No. ES437 **1/9**



With mounting brackets  
Cat. No. ES436 ..... **2/6**



For Garage and Workshop!

INSPECTION HANDLAMPS are invaluable in the workshop or garage. The light can be taken to just where it is wanted. Wood handle—strong wire frame to protect the lamp. Fitted with bakelite shockproof lampholder. British. (G) **8/6**  
Cat. No. EE36 ..... Each

**MOTORISTS' CAMPING LAMP. (K)**

A handy lamp for hanging in a tent, etc. Fitted with standard double contact motor car lamp holder. With twin wire leads for joining to your car battery or your dash board.



Cat. No. EE131— **5/6** each

**AUTO SWITCH. (K)**

Useful switch for dashboard mounting, all insulated. Trafficator type. Has 3 positions, such as: Bright, Dim and Off. Reliable job, with good solid contacts. Diameter 1 1/2 in.



Cat. No. ES440 ..... Each **3/6**

**TWIN SWITCH. (K)**



All insulated. The two switches are of the on-off type and work independently from each other. Size 1 1/2 x 2 1/2 in. Cat. No. ES439 ..... Price **3/-**

**HORN BUTTON. (K)**



With mounting brackets for cycles or motor bikes. Nickel-plated finish. Cat. No. ES438 ..... Price **2/-**

**GOOD TOOLS for GOOD WORKMEN**

(D)

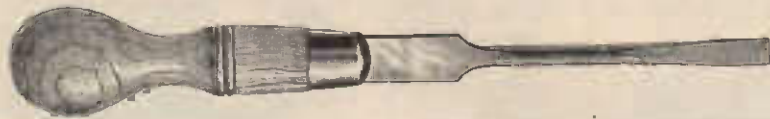

Whether for home or tradesmen's use, these SHEFFIELD-MADE SCREWDRIVERS will give complete satisfaction. Beechwood oval handle. Steel cut ferrule.

- Cat. No. EU112—2in. blade ..... **1/-**
- Cat. No. EU113—4in. blade ..... **1/3**
- Cat. No. EU114—6in. blade ..... **1/6**
- Cat. No. EU115—8in. blade ..... **2/3**
- Cat. No. EU116—12in. blade ..... **3/3**

**UTILITY TOOL SET. (D)**

Set comprises Hammer, Gimlet, large and small Screwdriver, Reamer or Countersinking Tool and Scriber. Hammer head fits on hammer by well-cut thread. Others fit screw by set-screw on the side of the handle. All bits are housed in the hollow handle, which is made of wood. Length of handle, 6 1/2 in. Length of bits, 2 1/2 in. Length of hammer head, 3 1/2 in.



**6 in 1 TOOL SET**

The handiest tool in the world. Every home, store, office and workshop should have one. As a hammer alone it's worth the money. All parts of good quality. Cat. No. EU118 ..... Each **2/6**

**THE PERFECT SCREW-DRIVER. (D)**

A strong Screwdriver for all purposes. Steel shaft right through the handle.

- Cat. No. EU123—4in. .... **5D.**
- EU124—6in. .... **10D.**
- EU125—8in. .... **1/2**
- EU126—10in. .... **2/6**
- EU127—12in. .... **3/6**



**TOOL SET. (D)**



Best German steel. Five Tools, as illustrated. Two Centre Punches, two Nail Punches and Cold Chisel. Cat. No. EU119 ..... per set **2/-**

**HACK-SAW FRAMES. (D)**



Steel Frame Adjustable Hack Saw frames. Pistol grip. Wood handle. Cat. No. EU79 ..... **3/3**

**RADIO SCREWDRIVERS. (K)**



Insulated handle Screwdrivers. Best steel, fine points, moulded handle that remains fast. Cat. No. EU109 ..... **9D.** each 8 G dozen.

**METAL SPIRIT LEVELS. (D)**



Cast-iron bodies, best spirit tube, brass plate. Warranted absolutely true. 6in. long. Cat. No. EU77 ..... Each **1/3**

**SOLDERING IRONS. (G)**

Non-Electric.

Soldering Irons, British made.

- Cat. No. EU80— Small model **1/-**
- Cat. No. EU81— Large model **1/6**

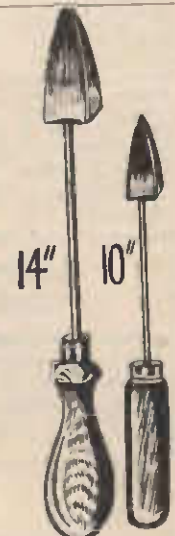



# QUALITY TOOLS LAMPHOUSE PRICED (D)

## BREAST DRILL

A heavily constructed drill, 17in. high, with 2-speed gears, operated by detachable handle, which is fitted to the desired gear shaft.

Takes round shank drills up to 1-in. Chuck is 3-jaw type ensuring certain grip at all times. Gears are totally enclosed, being fitted with removable cover for inspection and oiling—breastplate removable for carrying. Stove Black enamel finish.

Cat. No. EU131—  
**32/-**



## HAND DRILLS

A one speed double gear drill, taking round shank drills up to 3/8 in. Steel chuck fitted with three spring type jaws. Has fixed side knob and detachable handle. Metal parts black and red enamelled with polished wooden handle and side knob. Length overall 12in.

Cat. No. EU133—  
**12/6**

## SMALL HAND DRILL.

A lighter pattern similar to above, having single gear drive. Takes drills up to 1/2in. Length overall 8 1/2in.

Cat. No. EU132—  
**4/11**



## SMALL BENCH GRINDER.

A lighter pattern grinder, having 3in. dia. wheel, 7/8in. thick. Finished in red enamel. An excellent machine for light work. Fits up to 1in. bench.

Cat. No. EU135—  
**6/6**



## BENCH DRILL

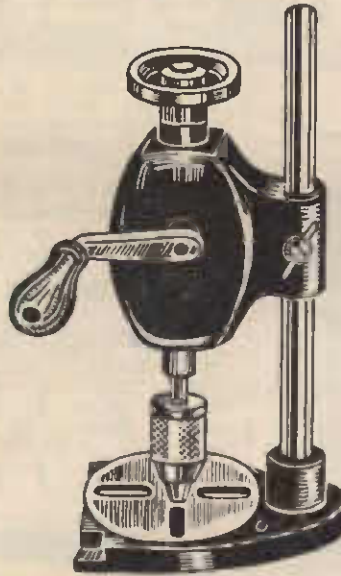

14-in. high with ball bearings, taking round shank drills up to 3/8in. Three jaw steel chuck. Automatic feed and thrust. Maximum distance from chuck to table 4in. Table size 3in. x 3 1/2in. Distance from chuck to pillar, 2in. Finished in Red and Black enamel. A first class tool in every respect.

Cat. No. EU134 ..... **35/6**

## LARGE BENCH GRINDER



A really fine machine, having 6in. dia. wheel 1in. thick. Machine cut gears. Blue enamelled finish. Fits up to 1 1/2in. bench.

Cat. No. EU136 ..... **21/-**

## PLAIN BRACE



Forged steel body, octagon mouthpiece, spring jaws, 8in. sweep, 14in. long. Polished wood handle and ball. Bright steel bar. Plain bearings.  
Cat. No. EU129 ..... **3/9**

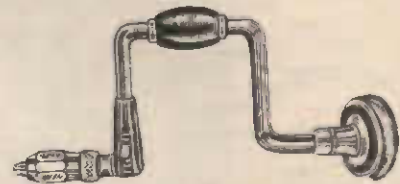

**SPECIAL VALUE RATCHET BRACE.** High quality Ratchet Brace that would cost double this price elsewhere. Takes any size bits, and has polished hardwood head and handle. Has octagon mouthpiece and spring jaws. 10in. sweep, 14in. long. Ball bearing, nickel plated. You will find many uses for tools of this kind round the home, for making minor repairs.  
Cat. No. EU130 ..... **8/9**

## SPIRAL RATCHET SCREWDRIVER.

Those who have frequent use for a screwdriver will find the Spiral Ratchet Screwdriver much speedier and more convenient than the ordinary driver. Has an improved spiral action for driving or withdrawing screws. Right and left hand movements, and a device for making it rigid. Tempered steel, perfectly cut spiral groove with one groove deeper than the other to prevent wear. Has spring in handle for quick return. Total length 12 ins., weight 6 oza.  
Cat. No. EU137 ..... **12/6**



## RATCHET SCREWDRIVERS.

This line of screwdrivers have forged steel blade, mahogany finish handle, and left or right ratchet as well as fixed operation.

Cat. No. EU138—2-in. blade ... each **8D.**

Cat. No. EU139 — 6in. blade .. each **10D.**



**THE LAMPHOUSE GUARANTEE PROTECTS YOU!**

**TOOLS FOR THE HANDYMAN (D)**



5 1/2 in. Modiate **PLIERS**—Polished.  
Cat. No. EU69 ... Each **1/8**



5 1/2 in. **RADIO PLIERS**—1st Grade insulated checkered handle. Rated 3,000 volts. Long round nose. Cutting edge. 5 in. overall.  
Cat. No. EU52 ... Each **3/9**



5 1/2 in. **RADIO PLIERS**—Insulated handle, long nose, cutting edge.  
Cat. No. EU51 ... Each **1/3**



8 in. Extra Long Nose **Radio and Telephone Pliers**. Very handy for awkward places. Insulated handle. Cutting edge.  
Cat. No. EU53 ... Each **2/3**



7 in. Insulated **Combination Pliers**—Powerful and useful  
Cat. No. EU57 **2/11**



Lever Cutting **NIPPERS**—Black with polished head.  
Cat. No. EU64—6-inch ... Each **2/6**  
Cat. No. EU65—8-inch ... Each **3/11**

**ALL-METAL SLIDING BEVEL (D)**



Made in Sheffield, accurately machined and glazed. Blade 6 in. long. Useful Tool.  
Cat. EU78 ... Each **1/3**

**SPANNERS. (G)**

These are made from tempered steel, and contain ten spanners in one. Fit all nuts from 0 B.A. to 9 B.A. Useful for all engineers, radiotricians, and electricians.  
Cat. No. EU1 ... Each **1/6**



6 1/2 in. Morills Type **Saw-Setting Pliers**. Polished finish.  
Cat. No. EU67 ... Each **4/6**



5 1/2 in. **SIDE CUTTING NIP PERS**—Bright finish.  
Cat. No. EU55 ... Each **1/6**



5 1/2 in. **SIDE CUTTING NIP PERS**—1st Grade, insulated checkered handles. Rated 3,000 volts.  
Cat. No. EU54 ... Each **4/9**



7 in. **SIDE CUTTING NIP PERS**—Finish Black. Powerful type for cutting steel wire.  
Cat. No. EU56 ... Each **3/11**



8 in. **Combination Pliers**—Fine polished metal handle with checkered grip.  
Cat. No. EU58 ... Each **2/11**

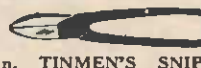

8 in. **TINMEN'S SNIPS**—Light quality, black with bright blades with rivet.  
Cat. No. EU70 ... Each **1/9**



9 1/2 in. **GARDEN SHEARS**—Forged from steel, bright finish. Checkered handles. With lock, screw and nut.  
Cat. No. EU74 ... Each **2/6**



**TINMEN'S SNIPS**—English pattern, broad finish, with secret spring. Black handles, bright blades. Screw and nut. Leatherlock.  
Cat. No. EU71—2/11  
Size 8 in. Each **2/11**  
Cat. No. EU72—3/11  
Size 10 in. Each **3/11**  
Cat. No. EU73—5/3  
Size 12 in. Each **5/3**



7 1/2 in. **MOTOR PLIERS**—  
Cat. No. EU66 ... Each **3/11**



Footprint Type **PIPE WRENCHES**—  
Cat. No. EU61—1/11  
7 in. Each **1/11**  
Cat. No. EU62—3/3  
9 in. Each **3/3**  
Cat. No. EU63—4/11  
12 in. Each **4/11**



9 in. Patent **WRENCHES**—With revolving adjuster. Superior quality.  
Cat. No. EU60 ... Each **4/3**



8 in. **Revolving Leather Punching Pliers**—With 6 different size punches. Polished.  
Cat. No. EU68 ... Each **3/11**



7 in. High Voltage **Combination Pliers**—Rubber handle, with hand guard. Rated 12,000 volts.  
Cat. No. EU59 ... Each **6/6**

**MARKING GAUGES. (D)**



Made in England, therefore reliable. Will give lasting service and satisfaction.  
Cat. No. EU90 ... Each **2/6**

**TACK LIFTERS. (D)**

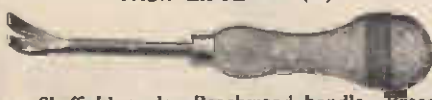

Sheffield made. Beechwood handle. Press hoop, 4 1/2 in. Bright blade.  
Cat. No. EU95 ... Each **1/3**

**FLEXIBLE STEEL RULES. (G)**



Rule rolls up into small round bakelite case. 1 1/2 in. diameter. Rule releases when centre button is pressed. 8 in. wide, 39 in. long. Marked in 1/32nds for the first 2 inches, and 1/16 in. for the balance. Also marked in centimetres.

Cat. No. EU120 ... **11 D.** each

Similar to the above, but of a larger type. Case of bakelite, 2 in. diameter. Ruler releases when button is pressed. Rule is 8 in. wide, and 0-78 in. long, the first 2 in. being marked in 1/32nds and the balance in 1/16 in.; also marked in centimetres.



Cat. No. EU121 ... **1/3** each



De Luxe type **Steel Spring Rule**. Contained in Nickel-plated Case, 2 in. in diameter. Rule released by pulling end; when centre button is pressed rule rolls back into case. 8 in. wide. Marked from 0-78 in. in 1/16 in., the first 2 in. being calibrated in 1/32nds. Also marked in centimetres, 0-200 c.m.  
Cat. No. EU122 ... **3/-** each

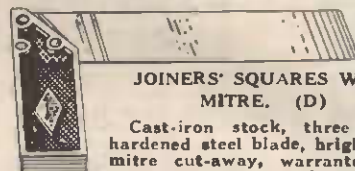

**JOINERS' SQUARES WITH MITRE. (D)**

Cast-iron stock, three rivets, hardened steel blade, bright, with mitre cut-away, warranted true and accurate. Sheffield make, 6 in.  
Cat. No. EU75 ... **1/6** each

**SMALL IRON BLOCK PLANE. (D)**



100% British. 5 1/2 in. long, with best crucible steel blade (1 1/2 in. wide). Black enamelled stove finish, 5 1/2 in. long.  
Cat. No. EU76 ... Each **2/6**

**POCKET RADIO SCREW-DRIVERS. (K)**

Hellogen Screwdrivers for the radio man. Handy size; made of best steel; complete with cover and clip for fitting into pocket.  
Cat. No. EU101 ... **1/-** each



**(G)**  
Screwdrivers, thin blade, coloured wood handle. An attractive line. One dozen on card.  
Cat. No. EU102 ... **6 D.** each 5/9 dozen

**RADIO SCREWDRIVERS. (K)**



Insulated handle Screwdrivers. Box steel, fine points, moulded handle that remains fast.  
Cat. No. EU109 ... **9 D.** each; 8/6 dozen



# Andrea Radio

**ANDREA 6-VALVE  
DUAL-WAVE (K)  
Battery 6-volt Model  
£31/10/-**

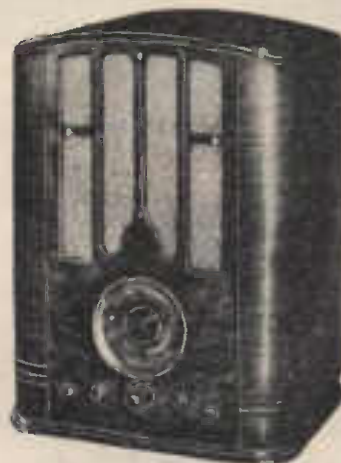

Hand-rubbed piano finish cabinet of beautifully matched American Walnut, 20½ in. high, 15½ in. wide, and 11 in. deep.

6 NEW TYPE OCTAL BASE TUBES, ONE-HALF USUAL BATTERY DRAIN—8 tube performance—short and medium waves 17.8 to 52 and 195 to 580 metres (520 to 1550 K.C.—5800 to 16,800 K.C.)—operates from one 6-volt storage battery—NO B or C BATTERIES REQUIRED, BUILT-IN SELF-RECTIFYING POWER SUPPLY—8 in. AL-NI-CO permanent magnet dynamic speaker—3-gang low minimum condenser—tunable R.F. stage on all wave bands—470 KC Hi-Q I. F. system—two-speed tuning (12 to 1—60 to 1 ratio)—5 in. illuminated etched on metal dial, calibrated in MC and METRES on short wave band, KC and METRES on medium wave band—triple automatic anti-fading control—continuous variable tone control—diode detector—gramophone connection—Remote speaker connection—Complete shielding from back door pick-up—TROPIC-PROOF (all H.F. parts impregnated) — AC RECEIVER OUTPUT—SUPER-SENSITIVITY on all WAVE BANDS — RUSTPROOF cadmium plated chassis 8½ in. high, 13½ in. wide, 10½ in. deep. TUBES USED: 2-6S7G, 1-6D8G, 1-6T7G, 1-6L5G, 1-6K6G.

Cat. No. ER903 ..... **£31/10/-**

**POWERFUL — NOISELESS — SUPPRESSORLESS  
LOWER BATTERY DRAIN**

**ANDREA 7-TUBE  
AUTO RADIO (K)**

**£22/10/-**

7 Tubes—Superheterodyne Circuit—Wave Range 1600-540 K.C. (188 to 555 Metres)—Hi-Q 175 K. C. I. F. system—Hi-Gain Antenna circuit—6 in. Dustproof Dynamic Speaker—Anti-fading control—Built-in noise suppressor—Continuous tone control—Steering post remote control—Illuminated Airplane Dial—Cushion mounted 3-gang condenser—Improved plug-in type vibrator—Single unit one hole mounting—3 watts output—Crackle finished cabinet in rich brown, trimmed with Chromium plated speaker grill—Dimensions 8½ in. wide, 7½ in. high, 7½ in. deep. Tubes used: 1-6A7, 2-6D6, 1-6H6, 1-75, 1-84, 1-41.

Cat. No. ER713 ..... **£22/10/-**

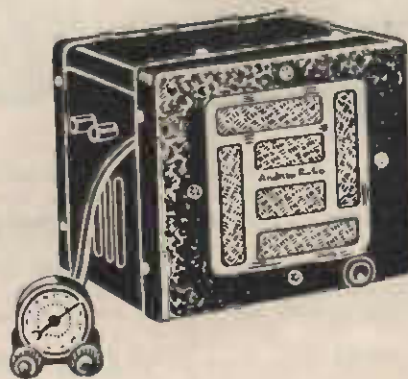

Hand-rubbed piano finish American Walnut cabinet of excellent proportion and design, with beautifully contrasted mahogany stripe running vertically through front and top. 10in. high, 16½in wide, 7in. deep. CONTAINS 6-TUBE AC Chassis D6S. short and medium wave bands, 6½in. El. Dy. Speaker.

6 tubes—equivalent 7.

Tapped for 120, 150, 220, 250 volts, 50/60 cycles.

17.8 to 53, 187 to 571 (16.8 to 5.6 MC, 1600 to 525 KC).

Superheterodyne Circuit.

470 KC HiQ I. F. system.

2 Double tuned sectionalised I.F. Transformers.

10 Tuned Circuits.

Shock Mounted Bar Type Gang Condenser.

6½in. Electro Dynamic Speaker.

Phono Connection

Short-wave De-Fluttering Filter.

BEAM POWER Class "A" Output.

Dual Automatic Anti-Fading Control.

Diode Detection.

Built-in Line Noise Filter.

TROPIC-PROOFED—all parts impregnated.

ILLUMINATED DIAL: 5½in x 3½in.

MICROMETER TUNING 18.5 to 1 ratio.

INDICATING KNOBS

TUBES USED: 6A7, 78, 76, 77, 6V6G, 80.

Chassis Dimensions: 7½in. high, 13in. wide, 6½in. deep.

Cat. No. ER714 ..... £22/10/-

## ANDREA 6-VALVE DUAL WAVE ELECTRIC £22/10/-



## ANDREA 5-VALVE BROADCAST Electric RECEIVER £12/10/- (K)

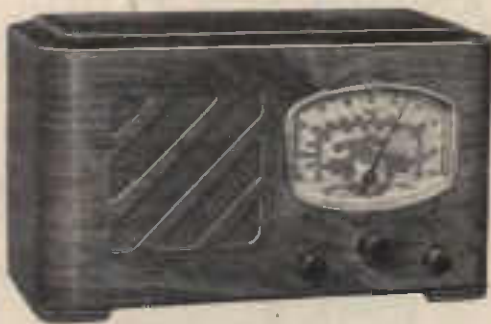

This Model, newly developed, meets the universal demand for a HIGH QUALITY Radio Receiver PRICED WITHIN THE MEANS OF THE SMALL WAGE-EARNER!

The tone quality, selectivity and sensitivity of this carefully constructed five-tube superheterodyne, compare favourably with many larger and more expensive sets.

Cat. No. ER904 ..... £12/10/-

### CABINET—

Selected American Walnut.

Hand-rubbed piano finish.

Artistically proportioned.

8½in. high, 14½in. wide, 6½in. deep.

### CHASSIS—

Rustproof cadmium plated.

All parts weather and "tropic" proofed.

Dimensions: 12in. long, 5½in. deep, 7½in. high.

### CIRCUIT—

Superheterodyne.

8 Tuned Circuits.

Dual automatic volume control.

Diode detection.

470 K.C. I.F. system.

2 double tuned Litz wound transformers I.F.

### BAND COVERAGE—

535 to 1720 KC (560 to 174.5 metres).

2050 to 7000 K.C. (42.9 to 140 metres).

### DIAL—

Full visioned illuminated dial 5½in. x 3½in.

Buffed gold bezel—glass front.

Scale calibrated in metres and K.C.

Extra easy logging scale.

Vernier tuning drive 12 to 1 ratio.

### SELECTIVITY—10 K.C.

SENSITIVITY—Within noise level.

SPEAKER—Electro Dynamic.

TUBES—6A7, 6D6, 75, 41, 80.

POWER SUPPLY—Alternating Current.

110 to 130 volts, 210 to 250 volts, 50/60 cycles.

ANDREA QUALITY THROUGHOUT.



**A  
YEAR AHEAD!**  
THE  
*Burndept*  
*All-Wave*  
BATTERY RECEIVER!



**TRY IT AT  
OUR RISK**

VIDOR MODEL. (K)

**Seven Reasons Why  
You Will Be Well  
Pleased With  
"BURNDEPT"**

We tried and tested, on all points, 30 different Battery Receivers of English and American manufacturers, and we decided on the "BURNDEPT" for the following reasons:—

- 1—Sensitivity. Although of only three valves, the set will give a performance equal to many 4 or 5 valve sets.
- 2—The fact that the set only uses three valves makes it most economical to run.
- 3—The tone is excellent.
- 4—It is entirely of British manufacture.
- 5—It is easy to operate and tune.
- 6—It is an All-Wave set, whereas most sets offered in New Zealand are Dual-wave only.
- 7—As far as we are aware, there is no other battery set on the New Zealand market that can touch the "Burndept" for price.

FOUR-BAND TUNING FROM:

Short Wave (1) ...	13.5 — 48.5 metres
Short Wave (2) ...	75 — 210 metres
Medium Wave .....	200 — 350 metres
Long Wave .....	900 — 1,200 metres

AND A NEW FEATURE IN A BATTERY RECEIVER!

Simply by pressing the switch knob, the scale of this new "Burndept" can be flooded-lit while tuning, and can then be switched off for greater economy.

ONLY

**£14/10/-**

**Complete With  
Batteries**

Cat. No. ER900

RESULTS THAT COUNT!

Although it is but a few weeks since we first offered this Radio to the public, we have already received testimonials from various parts of the Dominion, enthusiastically expressing satisfaction and pleasant surprise at the marvellous performance of this set.

Call or send for a "Burndept" Receiver to-day! Try it out in your own home for SEVEN DAYS. If, at the end of that time, you are not fully satisfied in every way with its performance, return it and we will refund your money in full, including return delivery charges!

The 1938 Burndept All-Wave Band-Pass Receiver has an aristocratic pedigree dating from the infancy of Radio. As far back as 1922 Burndept were making receivers of the all-wave lengths, and this early pioneering is evident in the superiority of Burndept receivers of to-day! Programmes are easily received on the two short-wave bands, are really entertaining, and provide real enjoyment for listeners. Of particular interest is the fact that this Burndept Receiver tunes as low as 13.5 metres, making possible the reception of stations NOT receivable on other so-called all-wave receivers. This receiver provides excellent and trouble-free reproduction from all New Zealand and Australian stations, on the broadcast band and all main world stations on short waves. In a walnut cabinet that could quite possibly contain a receiver costing twice as much.

PICK-UP NEEDLES. (K)

**"HEROLD"  
PICK-UP-NEEDLES**

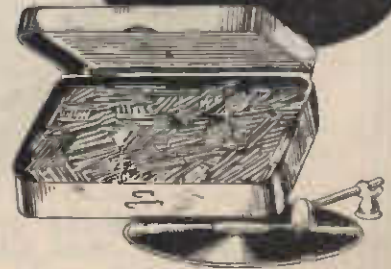

Steel Gramophone Needles, gold plated. Specially prepared for pick-up work. Also excellent for ordinary gramophones. 200 in box.  
Cat. No. EP250 ..... Box **1/6**



**Only 5/-**  
(B)

No. 12 Surprise Packet may not be as big as it looks in this picture, but it's the big value that counts.

Constructors, amateurs, experimenters, etc., Big Bargain Packets, containing a collection of useful radio parts.

Trust the Lamphouse with 5/-. You will not be disappointed. Money refunded in full if you if you are not more than pleased with your bargain. Limited quantity. Order early.

Cat. No. ES12 ..... Price **5/-**

Postage 6d.



# ENSIGN (K) RADIO

*The Sensation of a Decade*

Listen to "ENSIGN" RADIO for two minutes, and MARVEL! You'll hardly believe it's radio, because, for the first time, you'll be listening to REAL REPRODUCTION—just as if the actual studio performance was taking place in your very home.

*Distinctly Modern and exclusively designed cabinets of sturdy construction and beautifully finished, housing chassis embodying every worth-while and up-to-the-minute engineering improvement. This assures the proud owners of these receivers performance of outstanding merit, the clarity and richness of tone being unsurpassed. A comparison of any one of these receivers with the best competitive offerings will make apparent the reasons for their reputation.*



Model J6—6-Valve DUAL-WAVE MANTEL, using the identical chassis as 6-Valve Dual-wave Console Model, and giving the same smooth operation and trouble-free performance.  
Cat. No. ER850 ..... £24

Model JN7—Cabinet fitted with Battery Type 5-VALVE DUAL-WAVE VIBRATOR CHASSIS. The ideal Set for the country listener on account of the low "A" Battery consumption. (Requires no "B" Batteries.) Equipped with 8in. Speaker and full-size Aeroplane Dial.

Cat. No. ER856 ..... £28



**NEW PUSH BUTTON ELECTRIC TUNING.**

The operation is both fast and positive, and the accuracy of selection is such that automatic frequency control of the receiver to overcome selection discrepancies, is unnecessary and, in fact, undesirable.

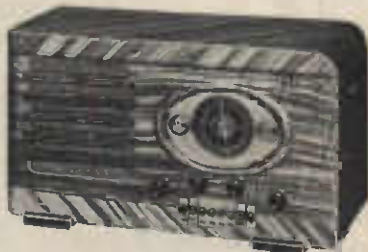

7-VALVE ALL-WAVE STREAM-LINE MANTEL—With push button tuning and with 8in. speaker.

Cat. No. ER857 .. £37/10/-

*Specially Designed, with high safety factors to give dependable operation even under unusual service and climatic conditions, the manufacturers of these high-grade, modern-type, low-cost radio receivers employ only trained personnel and the best of equipment; this together with their belief of the indisputable fact that:*

*"There is no substitute for precise manufacturing and high quality"*

*is what makes this range of receiving sets compare so favourably with the best competitive offerings.*



# ENSIGN RADIO *The Sensation of a Decade!*



Model G1—7-VALVE ALL-WAVE CONSOLE. Incorporating latest circuit—Metal Valves—Cathode Ray Magic Eye Station Selector—Colour Band Micrometer Dial—Visible Tone and Volume Control Tuning. De Luxe chromium-plated Chassis, Iron Core Intermediate Transformers, and supplied with 10in. Operadio Dynamic Speaker.

Cat. No. ER853 .. £39/10/-

[K]



7-VALVE ALL-WAVE G1 CONSOLE—With push button tuning.

Cat. No. ER858 .. £45/10/-



Model JN5 — 6-VALVE DUAL-WAVE CONSOLE.. Incorporating advanced Superheterodyne Circuit, latest type Valves, Colour Band Dial—Visible Tone and Volume Indicators—Colour Wave change Switch—Cadmium-plated Chassis, and equipped with Operadio Dynamic Speaker.

Cat. No. ER851 ..... £29



Model F1—7-VALVE ALL-WAVE MANTEL, using the same beautifully constructed chromium-plated chassis as in the Console Model, and capable of bringing to your fireside world-wide programmes for your entertainment and enjoyment.

Cat. No. ER852 .. £32/10/-



New Model—DUAL-WAVE, DUAL-PURPOSE, A.C. VIBRATOR TYPE PORTABLE RECEIVER, operating from 230-volt A.C. supply or from 6-volt A battery (No B battery required). Change is made by simply touching a switch. Ideal for beach or week-end cottages, boats, launches or motor-cars, and for districts where the power is to be shortly installed. 6-valve.

Cat. No. ER855 .. £31/10/-



Equally dependable low-priced Model F2—5-VALVE BROADCAST MANTEL MODEL, using Modern Superheterodyne Circuit and employing latest types Valves, 4-in. Aeroplane Dial and 8in. Operadio Speaker Design and performance place this Set definitely apart from ordinary mantel type broadcast receivers.

Cat. No. ER854 .. £17/10/-

# RADIO SECTION

## AERIAL WIRE, PLAIN COPPER. (K)



Only best British pure copper wire supplied.  
 Cat. No. EA251—3/22, 100ft. .... 1/9  
 Cat. No. EA252—7/22, 100ft. .... 3/6  
 Cat. No. EA253—7/20, 100ft. .... 6/3  
 Cat. No. EA254—7/22, 50ft. .... 1/11

## AERIAL WIRE, ENAMELLED. (K)

Enamelled aerial wire will last longer than the plain copper, as the enamel covering protects the wire from corrosion. The enamel also acts as an insulation.  
 Cat. No. EA255—7/22, 100ft. coils **5/6**

## SCREENED LEAD-IN WIRE. (K)

Effective in reducing static noises caused by electrical devices, etc. 50ft. coils.  
 Cat. No. EA261 ..... **8/-** each  
 6d. yard

## SHIELDED LEAD-IN. (K)

Heavy shielded wire for lead-ins or for shielded earth wire, core 3/22 copper wire, well insulated and covered with metal braid. Total diameter approximately 6.5 mm. As used in most shielded aerial systems.  
 Cat. No. EA273 ..... **10<sup>D</sup>** yard

## SINGLE 14SWG ENAMELLED COPPER WIRE. (K)

For doublet aerials, etc. 2lbs. equals approximately 100ft.  
 Cat. No. EA265 ..... **3/-** lb.

## AERIAL WIRE—INSULATED—LEKRIT. (K)



11-strand conductors with a strong compounded insulation which is waterproof. Suitable for both indoor and outdoor use.

Cat. No. EA266—25ft. coils **1/4** each  
 15/- doz.  
 Cat. No. EA269—50ft. coils **2/3** each  
 26/- doz.  
 Cat. No. EA270—75ft. coils **3/3** each  
 37/6 doz  
 Cat. No. EA271—100ft. coils **4/3** each  
 49/- doz.

## FLEXIBLE LEAD-IN WIRE. (K)

Specially manufactured for lead-ins. Made very flexible so that it will not be affected by constant swaying. Consists of 30 strands copper wire, each .010. Heavily insulated with vulcanised rubber. Diameter 4 m/m.  
 Cat. No. EA260 ..... per yard **3<sup>D</sup>**  
 7/6 for 100ft.; 33/- for 500ft. coil.



## COUNTERPOISE AERIAL WIRE. (K)

Hard drawn bare Copper Wire, 12 S.W.G., for use with counterpoise aerials, etc. 1lb. approx. 30ft.  
 Cat. No. EA263 ..... **1/6** lb.

## AERIAL WIRE, INDOOR. (K)

Art. silk covered in various colours. Stranded, very flexible. Suitable for putting around picture rails, etc. Also used for making frame aerials.  
 Cat. No. EA262—100ft. coils **3/3**  
 Each **3/3**  
 36/6 doz.



## INSULATORS, EGG. (K)

Egg Insulators are almost universally used in N.Z. To secure good results you should put two or three on each end of the aerial.  
 Cat. No. EA312 ..... Each **1<sup>D</sup>**  
 9d. dozen; 6/- gross.



## INSULATORS, GLASS. (K)

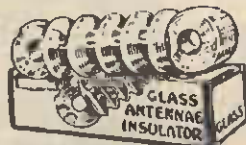

Glass Insulators, used where a really good job is to be made of insulating your aerial. Length 3 1/2 in.  
 Cat. No. EA313 ..... Each **6<sup>D</sup>**  
 5/9 doz.; 60/- gross.

## SHELL INSULATORS. (K)

Useful and popular Aerial Insulators  
 Cat. No. EA324—1 1/2 in. x 1 1/2 in. .... 2d. each  
 Cat. No. EA325—2 1/2 in. x 2 in. .... 4d. each



## AERO INSULATORS. (K)

Special Low Loss Insulator. Porcelain. Size 2 1/2 in. x 2 1/2 in.  
 Cat. No. EA326 ..... Each **6<sup>D</sup>**

## BEEHIVE STAND-OFF INSULATORS. (K)

Made of best quality glazed porcelain. For anchoring wires to walls or for mounting transmitting coils. 2 1/2 in. base.  
 Cat. No. EA307 ..... Each **1/1**



## BUTTON INSULATORS. (K)



For running wires along walls, etc. Always handy to have a few in your radio chest. Prices are without screws.

Cat. No. EA349—Size 7-16 x 7-16 ..... Each 1d.  
 EA350—Size 9-16 x 9-16 ..... Each 1d.  
 EA351—Size 11-16 x 11-16 ..... Each 1d.  
 EA352—Size 1 x 1 ..... Each 1d.  
 EA353—Size 1 1/2 x 1 1/2 ..... Each 2d.

## MIDGET STAND-OFF INSULATORS. (K)

Useful for transmitters, etc. Nickel-plated fittings.



Cat. No. EA306— **6<sup>D</sup>** each

## FEED-THROUGH INSULATORS. (K)

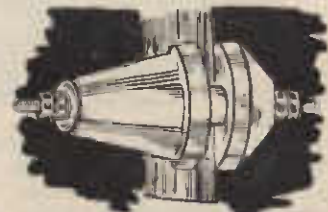

An Insulator in two sections with cork spacing washer for feeding through panels, etc. Length 1 in. overall diameter 1 in., conductor 1 1/2 in. long, with nuts on each end  
 Cat. No. EA311 ..... **9<sup>D</sup>** each

## "NAIL-IT" INSULATORS. (K)



Used for taking wires along outside walls, etc. Made in two pieces, and when nailed up grip the wire and make a neat and efficient job.

Cat. No. EA310— **4<sup>D</sup>** each

## INSULATED GUIDE ARMS. (K)

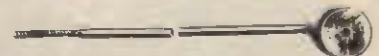

Used for insulating lead-in wire from spouting, eaves, etc., the lead-in wire passing through a hole in the insulator, which is attached to a 6 in. iron rod. A coach screw thread on the end of the rod enables it to be screwed directly into the wood.

Cat. No. EA301 ..... **10<sup>D</sup>** each

## LONG GUIDE ARMS. (K)

Similar to the above, but of heavy construction and 12 in. arm, **1/3** each  
 Cat. No. EA302 .....

## "EMILY" GUIDE ARMS. (K)

Are similar to the above, but of a much lighter construction.

Cat. No. EA303—3 in. over-all. Each **4<sup>D</sup>**  
 Cat. No. EA304—7 in. over-all. Each **8<sup>D</sup>**  
 Cat. No. EA305—12 in. over-all. Each **9<sup>D</sup>**



**PULLEYS GALVANISED. (K)**

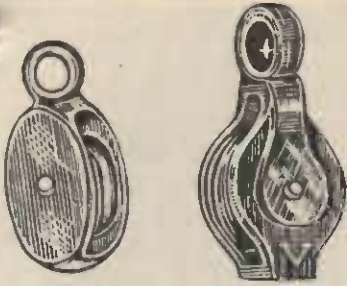

EA412

EA413

1in. galvanised pulleys for halyards, etc.  
Cat. No. EA412 ..... 6<sup>d</sup>. each, 5/9 dozen

**NON-JAM PULLEYS. (K)**

These pulleys are specially constructed so that the guy wire cannot jam. Heavily galvanised.  
Cat. No. EA413— 1/2 each; 13/- doz.

**AERIAL OUTFIT PARCEL. (K)**

Special assortment of good aerial equipment. Contains:—  
1 Coil (100ft.) 7/22 aerial wire.  
1 9in. Lead-in Tube.  
6 Egg Insulators.  
1 Lissen Lightning Arrestor  
2 Nail-It Insulators.  
10yds. Special Lead-in Wire.  
1 doz. Insulated Staples.  
1 Galvanised Pulley.  
Cat. No. EA287, 11/6 complete parcel

**LEADS-IN, EBONITE. (K)**



Lead-ins are used for putting through the wall. Consists of brass rod insulated with ebonite. With a nut and washer on each end. Diameter 1/4in.  
Cat. No. EA401—Ebonite Lead-in, 7<sup>d</sup>. each 6in. long. 6/6 doz.  
Cat. No. EA402—Ebonite Lead-in, 9<sup>d</sup>. each 9in. long. 8/6 doz.  
Cat. No. EA403—Ebonite Lead-in, 1/- ea 12in. long. 11/9 doz.

**LEADS-IN, EBONITE. (K)**



This is a better type, with wing-nuts on each end. 1/4in. diameter, 9in. long.  
Cat. No. EA404 ..... 1/3 each 13/6 doz.

**LEADS-IN, FLEXIBLE WINDOW. (K)**

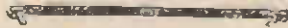

This type is flexible and can be fitted under windows, etc., when it is not desired to bore a hole through the wall.  
Cat. No. EA405 ..... 6<sup>d</sup>. Each 5/6 doz.

**PORCELAIN LEAD-IN TUBES. (K)**



These are hollow porcelain tubes for leading in a wire through the wall of the house, etc. We prefer this type of lead-in, as it does away with the necessity of extra joints. The lead-in wire can be brought in without getting wet and avoids joints that sooner or later become troublesome. The end is bent to keep out the rain.  
Cat. No. EA406 ..... 1/- each

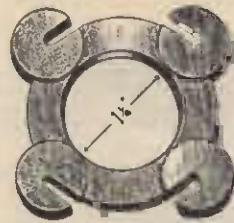

**TRANSPPOSITION BLOCKS. (K)**

As used in double aerial systems for transposing lead-in wire.

Cat. No. EA315  
For set of 8 4/6



Best Quality FLEXIBLE Galvanised Steel  
**AERIAL STAY WIRE**

This wire has been made quite flexible without foregoing any of its great strain strength.

Cat. No. EA259—60ft. coils .. Each 1/3  
14/6 doz.; 164/- gross



**AERIAL EARTH PLATES. (K)**

Eliminate unsightly wires to your set, having them concealed in the wall. Beautiful bakelite plate. Has attractive and neat appearance.

Cat. No. EA431— 2/6 each

**LISSEN LIGHTNING ARRESTORS. (K)**

(Approved by the Fire Underwriters)  
To make your aerial system comply with the Fire Underwriters' regulations, a lightning arrestor must be fitted to all installations. The arrestor must be fitted on the outside of the building containing the receiver, it being usual to place it just where the lead-in wire enters the house.

This Lissen Lightning Arrestor is small in size, easy to instal, and gives you full protection. Instructions for installing sent with every Lissen Arrestor.

Cat. No. EA426 ..... 1/9 each 20/- doz.

**HELIOGEN LIGHTNING ARRESTORS. (K)**

(Approved by the Fire Underwriters.)  
Here is a de luxe approved Lightning Arrestor which is not only efficient in every respect, but will give an enhanced appearance to your aerial system. Supplied complete with fixing bracket as illustrated.

Cat. No. EA427 3/6  
Each

**LIGHTNING ARRESTORS. (K)**

Small type Eagle Arrestors.

Cat. No. EA428— 10<sup>d</sup>. each; 9/6 dozen

**AERIAL CLEATS. (K)**



Galvanised iron cleats for securing halyard ropes.  
Cat. No. EA414— 4<sup>d</sup>. Each

**AERIAL ROPE. (K)**



Manufactured from best hemp and specially prepared so that it will withstand the weather over long periods. 60ft. hanks.  
Cat. No. EA424 ..... 2/6 Each

**AERIAL CONNECTORS. (K)**

Specially designed for connecting the lead-in wire to the aerial to do away with soldering. When clamped on, the two wires make a perfect joint.

Cat. No. EA425— 4<sup>d</sup>. ea. 3/9 doz.



**AERIAL SPRINGS. (K)**



Consist of a strong steel spring with an insulator on each end. Used for taking up the sway of masts or trees, etc., to prevent the aerial from breaking.  
Cat. No. EA423— 20/- doz. 1/9 each

**STRAINERS, WIRE. (K)**

Galvanised iron wire strainers for tightening stay wires, &c.

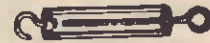

Cat. No. EA415 ..... 1/3 Each

**GALVANISED HOOKS AND EYES. (K)**

For screwing into wood to hold aerials, stay wires, etc.



Cat. No. EA410—Galvanised Hooks, 2 1/2in. .... 2<sup>d</sup>. Each



Cat. No. EA411—Galvanised Screw Eyes; 2 1/2in. 2<sup>d</sup>. Each

**AERIAL MASTS. (K)**

30 Feet Steel Masts. British manufacture. Supplied in three sections, which are telescopic. Made throughout of British steel close joint tubing. All fittings are included, together with stranded steel galvanised wire

Cat. No. EA432— 32/- each



**CHEAP AERIAL SWITCHES. (K)**

Aerial - Earth Knife Switch, porcelain base (Foreign)  
A real bargain at—

5<sup>d</sup>. each (K)  
Cat. No. EA478 ..





INSULATED STAPLES. (K)

Makes a Neat Job!

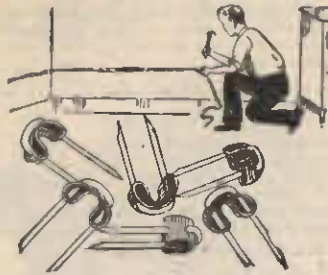

Insulated Staples are used by all who wish to make a neat job. The fibre insulation in these staples protects the wire and guards against loss of signal strength. British made. Coloured. 50 staples in a packet.

Cat. No. ES118 3D. doz., 9D. packet  
Or 7/6 per dozen packets

Competition quality Insulated Staples. Grey colour. 100 Staples in packet.

Cat. No. ES117 6D. pkt.; 5/6 doz. pkts.

STAPLES. (K)

Copper Staples (not insulated), for fastening earth wires, etc.

Cat. No. ES119—

1/6 lb. 2D. dozen



KNIFE SWITCHES. (K)

Single Pole Double Throw Aerial Earth Switches. Bakelite base. 8D. each  
Cat. No. ES490 .... 7/6 doz.

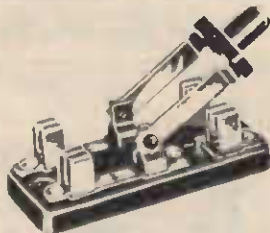

Double Pole Double Throw Knife Switches on bakelite base. 1/6  
Cat. No. ES491 — 17/6 doz. Each



HEAVY KNIFE SWITCH. (K)

A Single Pole Double Throw Knife Switch with heavy blade and solid contacts. Specially designed for transmitters, etc. Mounted on slate base. 3/6 each  
Cat. No. ES492 .....

EARTH TUBES. (K)

Coppered Earth Tube. When hammered into the ground will make a good earth connection. Provided with screw for attaching earth wire. 27in. long.

Cat. No. EA433 .. 2/6 each



EARTH CLIPS. (K)

Light adjustable pattern. Has a number of holes so that screw can be shifted. Fits practically all sizes of pipes.



Cat. No. EA434— 3 D. each  
2/6 doz.

CLAMPTITE. (K)

Special Earth Clip, easily fitted, the 3 points make a sure contact.



Cat. No. EA435— 6D. each  
5/6 doz.

EARTH CLAMPS. (K)

Heavy brass type, N.Z. made. Will secure a good permanent earth on a water pipe, etc.

Cat. No. EA436 — 1/2in. water pipe size (will fit pipes up to 1in. outside diameter). 7D. each

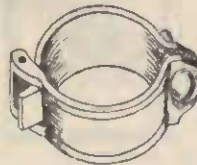

Cat. No. EA437 — 1/2in. water pipe size (will fit pipes up to 1in. outside diameter). 9D. each

Cat. No. EA438—1in. water pipe size (will fit pipe up to 1 1/2in. outside diameter). 10D. ea.

WIRE, TINNED EARTH. (Z)



7/029 Bare Tinned Copper Earth Wire. 4/6 100ft.  
Cat. No. EA264 .....  
14/- coil (7 lbs.)

AERIAL ELIMINATORS. (K)



Muter Compo. Aerial Eliminators. These are claimed by the manufacturers to be superior to an outdoor aerial. On test we find that while they do not give quite so much volume as an outdoor aerial, the reduction in static and interference is considerable. Selectivity is also improved. They can therefore be recommended for people not wanting to put up an outdoor aerial, for demonstration purposes, and in places where static and interference are particularly severe. 3/- each  
Cat. No. EA286 .....

"NO-MAST." THE WORLD'S BEST AERIAL. (K)

Patent No. 337866.

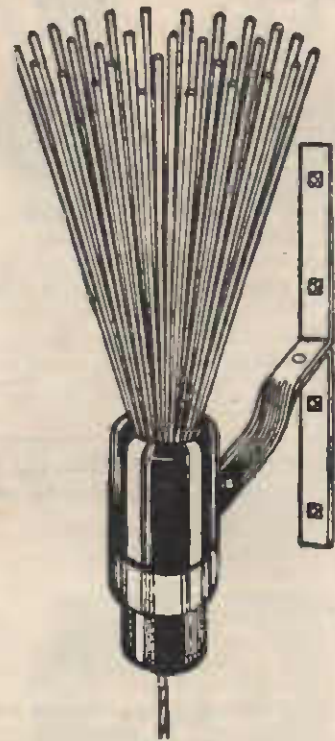

No Mast. No unsightly pole required. Enables you to tune in stations never heard before on your set. Increases volume of all stations and reduces overlap and interference. Neat and unobtrusive, yet the last word in aerial efficiency.

Until the introduction of the "No-Mast" Aerial there was no satisfactory alternative to the ugly, cumbersome and troublesome aerial pole—difficult and expensive to erect, awkward to maintain, and an eyesore to the locality. The "No-Mast" enables everyone, even flat-dwellers, to obtain an unobtrusive outdoor aerial at minimum cost and inconvenience of erection, yet giving the maximum efficiency.

Designed by experts on the latest scientific principles, the "No-Mast" Aerial has received the unqualified approval of the world's best-known radio authorities. It is the choice of many leaders of the industry, including B.B.C. officials, and also at Windsor Castle, where the leaden roofs make satisfactory reception difficult.

The cost of the "No-Mast" Aerial is definitely less than that of erecting a pole aerial. It can be erected in 20 minutes by anyone who can knock in six nails, and once fixed cannot be blown down. Complete with fittings. 17/6

Cat. No. EA294 .....  
Postage 1/- extra.

LEKMEK LINE FILTER. (K)



Designed for use with electrically operated radio receivers. Simply fits between the receiver and the wall plug. It will definitely stop all man-made static entering through the AC mains. 19/6 each  
Cat. No. EA297 .....

(See inside front cover.)





**THE MOTO-WHIP—STREAMLINE AUTO AERIAL. (K)**

The I.C.A. Moto-whip is a novel adjustable auto, antenna that can be adjusted for both city and country driving. The sturdy construction of the Moto-whip makes it a most desirable antenna that can be used on any type car. Streamline design offers a minimum of wind resistance. Beautiful triple-plated chrome finish. Permanent, lasting, efficient. Important features that make the Moto-whip a fast selling aerial:—

Beautiful triple-plated chrome finish matches fittings of all cars.

Easily installed.

Snap clip adjustable for country or city reception.

Can be used on any type car.

No drilling on top of car.

Furnished complete with lead-in cable.

Full length of Moto-whip—62in.

The Moto-whip antenna is equipped with all necessary hardware and lead-in cables, individually packed.

Individually packed.

Cat. No. EA290 ..... **16/-**

**I.C.A. POLETENNA. AUTO AERIAL. (K)**

The ideal Aerial for long distance reception. Works on broadcast receivers or all-wave receivers. Attached in a few minutes.

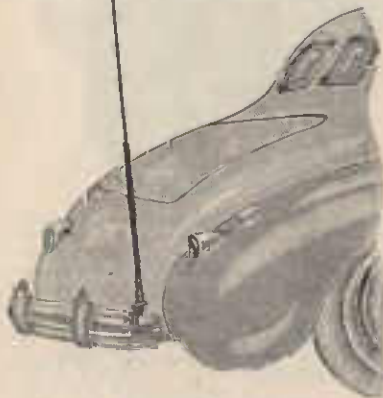

The new POLETENNA is a telescopic type of antenna extending to a maximum height of 8ft. when open. This collapsible metal type of antenna provides increased signal pick-up, especially in locations away from broadcasting stations.

Will fit any make of car regardless of whether it is a new streamline turret-top, coupe, or roadster, or old-type cars, regardless of make.

Mounts quickly and easily on the bumper support—no drilling necessary. Can be collapsed when not in use.

The POLETENNA is also practical for transmission and can be tuned for 5 to 10 metre operation.

Effectively finished in Black Duco Parkered Polish Finish, the POLETENNA comes completely assembled with insulated, sturdy mounting brackets.

Cat. No. EA291 ..... **19/6 (K)**



**BEAUTIFUL EAGLET, TWIN-FLOW—THE ANTENNA BEAUTIFUL— IN PERFORMANCE! APPEARANCE! DESIGN! (K)**

I.C.A. now presents a truly new motor-car antenna in this EAGLET TWIN-FLOW, utilising the doublet system which is an established principle of noise cancellation. The components and symmetry of design are such as to enhance the beauty of any car upon which it is installed. The Eaglet is designed to work on both short-wave and broadcast bands. The Eaglet Twin-flow contains the following important features:—

Beautiful, lasting triple-chromium plated finish.

Doublet system of noise cancellation. No drilling on top of car.

Effective vacuum cup and plates ensure quick and permanent installation. Doublet aerial mounts on beautiful chrome-finished ornamental insulators. (Insulator's design shows an eagle in flight.)

Adapted to the contour of all streamline cars.

Not affected by rain, snow or ice.

Can be used on coaches, sedans, or coupes.

Minimises static and wheel noises.

Attractively priced.

Cat. No. EA289 ..... **30/-**

**And Now— A NEW AERIAL ELIMINATOR (K)**



This new and improved scientific device replaces outdoor and indoor aerials with startling efficiency. The Insultenna is a very compact unit, measuring only 5in. x 2½in. x 1in., which can be installed anywhere. Thousands of users report freedom from interference and man-made static, often unbearable with old-type aerials. The Insultenna is not a light socket aerial and has no connection with the electric current line—eliminating any possibility of A.C. hum. No lightning arrester required.

Cat. No. EA288 ..... Price **13/6**

**LEKMEK AERIAL FILTERS. (K)**

Recommended for all broadcast band sets. Checks man-made static and electrical interference picked up through the aerial. The Lekmek Aerial Filter is designed for the purpose of reducing noise and interference which is adjacent to the receiver. Comprises two transformers, and 50ft. of screened interference-proof lead-in cable...

Cat. No. EA299 ..... **35/-** each

Cat. No. EA300—Ditto with 100ft. cable. **45/-** each

**LEKMEK DOUBLET AERIAL SYSTEMS. (K)**

Specially suited for dual-wave sets, short-wave sets, and short-wave converters. Consists of a complete doublet aerial system in kit form and incorporates a Lekmek aerial cable interference eliminator. No wiring or assembling necessary. It has all been done at the Lekmek laboratories. Includes everything necessary except the ropes and supports, and only needs to be erected. Full instructions and a clear diagram is provided with each outfit. Ideal for city, suburban and country users, as it successfully combats all interference from trams, trains, neon signs, electric motors, refrigerators, vacuum cleaners, noises from passing cars and all other types of man-made static. In many cases reception has been improved more than 50 per cent.

Cat. No. EA298 ..... **47/6**

(See inside front cover.)



**INDOOR AERIAL!**

**INDOOR AERIAL. (K)**

An indoor spring type aerial that will stretch out to about 12 feet across an ordinary room, and still remain in its spiral form.

Cat. No. EA285 ..... **1/6** each

**KEEP YOUR BATTERIES FULL OF POWER WITH THE FREE WIND! (D)**

Gone are the expense and inconvenience of run-down Radio Batteries from the moment you instal a

**DE LUXE WINCHARGER**



From then on, all your power cost will be the adding of distilled water to your battery when necessary. The WINCHARGER airbrake governor eliminates vibrations, bluttering, and damage from strong winds. Equipped with special condenser to dampen generator interference in radio. Charging rate can be altered to suit charging condition.

**COMPLETE AS ILLUSTRATED.**

With Ampmeter and Cut-out Panel.

Cat. No. EA200—

**£14/10/-**

Each

Length of Propellor, 6ft.

Height of Metal Stand, 6ft.



**LISSEN 2v50amp ACCUMULATOR**

(K)



2 volt 50 amp. hour (actual) Accumulators. There are no separators, the plates being kept in position by ribs moulded inside the glass container, the result being a highly efficient cell, having low internal resistance. Size 4 1/2 in. x 5 1/2 in. x 7 1/2 in.

Glass cell.  
Cat. No. EA124—  
**27/6**  
Each

**LISSEN GLASS CELL. (K)**

Two plate type, with thick massive plates. Will hold up for a long time when used at low discharge rates, and will retain their charge for long periods. Thick glass containers. Ready for use when acid is added, but best results will be obtained by charging before putting into service.

LOOK AT THESE PRICES!

- Cat. No. EA121—2-volt 10/20 amp. Size 2 3/4 x 2 1/4 x 5 1/2 ..... **5/6** each  
Cat. No. EA122—2-volt 20/45 amp. Size 3 1/2 x 3 1/2 x 7 1/2 ..... **9/6** each



**GREAT NEWS FOR BATTERY SET OWNERS. (K)**



**EVER READY AIR CELLS. NO RECHARGING!**

At last the country's biggest Radio problem is solved. A new Ever Ready Air Cell means improved performance, and does away for ever with the trouble and cost of battery charging. The Ever Ready Air Cell gives a minimum of 1000 hours service whether used continuously or at infrequent intervals over a lengthy period; it delivers constant voltage and prevents valve "burn outs" due to too high a voltage. Can be used as an "A" battery, for any battery set where the maximum "A" drain does not exceed .65 of an ampere. Write for further literature dealing with this wonderful Air Cell. **55/-**  
Cat. No. EB189

**HEAVY DUTY C BATTERIES. (K)**

Berec 15-volt, tapped every 1 1/2 volts. Cat. No. EB192 ..... Each **6/6**

**LISSEN FOR PORTABLES. (K)**



This Accumulator is constructed so that the plates remain immersed in acid both in carrying and operating positions. Reinforced moulded containers with special insulated terminals. Unspillable. Celluloid case.

Cat. No. EA123—2-volt 20 amp. (actual). Size 4 5/16 x 2 7/16 x 4 1/16. Each **29/6**

**BEREC 45-VOLT "B" BATTERIES. (K)**



This Battery is of standard size and is a special export model manufactured by the Ever-Ready Company of Great Britain. Being of generous capacity they will out-last most other standard 45-volt types. They have the added advantage of being tapped every three volts, thus assuring that modern battery valves requiring special voltages are supplied with the exact voltage to enable them to give maximum efficiency.

Cat. No. EB191—Berec 45-volt "B" Batteries ..... Each **16/6**

**OXFORD RADIO BATTERIES. (G)**



Heavy duty, solidly constructed leak-proof Batteries that deliver maximum power. Thick plates, carefully sealed cells; built for long, enduring, trouble-free service. With radio type terminals. 18 months unconditional guarantee.

- Cat. No. EA20—2-volt, 110 amp.; 3 1/2 x 7 1/2 x 9 1/2 ..... Each **27/-**  
EA21—2-volt, 130-amp.; 3 1/2 x 7 1/2 x 9 1/2 ..... **29/-**  
EA22—2-volt, 150-amp.; 4 1/2 x 7 x 9 1/2 ..... **33/-**  
EA23—6-volt, 110-amp.; 7 x 9 1/2 x 9 1/2 ..... **62/-**  
EA24—6-volt, 140 amp., Type for Vibration, 7 x 11 1/2 x 9 1/2 ..... **80/-**  
EA25—6-volt, 150 amp., Type for Vibration, 7 x 11 1/2 x 9 1/2 ..... **85/-**  
EA26—6-volt, 170 amp., Type for Vibration, 7 x 12 1/2 x 9 1/2 ..... **90/-**



**FULL O'POWER RADIO H.T. BATTERIES. (K)**

"Full O'Power" Batteries are genuinely made in England by Siemens Bros. & Co., Ltd., of Woolwich, England.

- Description. Each  
Cat No. EB173—60 volts. Popular (V1) **12/9**  
EB174—100 volts. Popular (V2) **21/-**  
EB175—60 volts. Power (V4) **22/6**  
EB176—45 volts. Power (V5) **17/-**  
EB177—45 volts. Super **£1/8/6**  
EB178—60 volts. Special (H1) **13/6**  
EB179—108 volts. Special **£1/2/-** (H2)  
EB180—120 volts. Special **£1/4/6** (H3)

**GRID BIAS OR "C" BATTERIES. (K)**

- Cat No. EB181—4 1/2 volts ..... Each **3/-**  
EB182—9 volts ..... **2/3**  
EB183—16 1/2 volts ..... **4/3**  
EB184—18 volts ..... **4/6**

**GENERAL PURPOSES OR "A" BATTERIES (G)**

- Cat. No. EB185—1 1/2 volts. Round ..... Each **2/9**  
EB186—6 volt in metal case ..... **16/-**

**COLUMBIA RADIO BATTERIES. (K)**



Columbia Radio Batteries need no introduction to New Zealand Radio fans. They continue to assure you greater clarity, volume and distance. Always specify Columbia for longest life and most power per shilling.

- Cat. No. EB168—Columbia 45 volt (4772) Standard upright battery. Each **19/6**  
EB170—Heavy Duty Layerbilt (4486), 45 volts **30/-**

Cat. No. EB172—4 1/2 volt C Battery. **3/-**



**COLUMBIA DRY CELL. (G)**

Cat. No. EB187—1 1/2 volt No. 6 Type Cell. **2/9**



**WORLD  
RECORD**

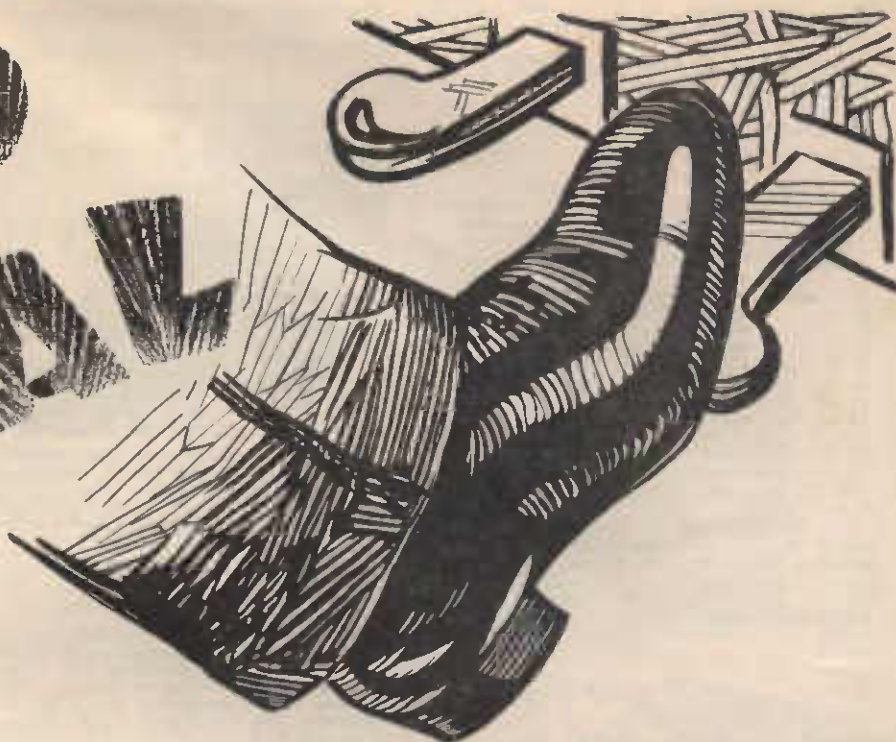

The Battery with  
A  
THOUSAND  
LIVES!



**AND AT ONCE YOUR SET  
DEMANDS A BIG INCREASE IN  
CURRENT FROM YOUR BATTERY**

(K)

**VIDOR 120V. B AND C BATTERIES.**  
Size 8 1/2 in. x 6 1/2 in. x 3 in. If the bias section is not required connect HT — plug to CB—9v. Voltage is then 120v. If, however, CB is used the "B" voltage available is still 111 volts. Bias battery tapped every 1 1/2 volts. "B" battery tapped 27, 39, 51, 63, 75, 87, 99 and 111 volts.  
Cat. No. EB7 ..... **18/6**

**VIDOR 120V. H.D. BATTERIES.**  
Size 10 1/2 in. x 6 1/2 in. x 6 1/2 in. Weight 17 1/2 lbs. Tapped 15, 30, 45, 60, 75, 90, 105 and 120 volts.  
Cat. No. EB6 ..... **29/-**

**VIDOR No. 6 TYPE 1 1/2V. Cells.**  
For bells, radio, etc. Size 6 in. high. 2 1/2 in. diam. Weight 1 lb. 13 oz.  
Cat. No. EB30 ..... **2/3**

**VIDOR 60V. 6M.A. BATTERIES**  
(Light Duty)  
Size 9 1/2 in. x 3 1/2 in. x 3 1/2 in. Weight 3 1/2 lbs. Tapped at 18, 30, 36, 42, 48, 54, and 60 volts.  
Cat. No. EB2 ..... Each **9/-**

**VIDOR 100V. 6M.A. BATTERIES.**  
Size 10 1/2 in. x 5 1/2 in. x 3 1/2 in. Weight, 6 1/2 lbs. Tapped at 37, 46, 55, 64, 73, 82, 91 and 100 volts.  
Cat. No. EB4 ..... Each **13/9**

**VIDOR 120V., 6M.A. BATTERIES**  
(Light Duty)  
Size 12 in. x 5 in. x 3 1/2 in. Weight 7 1/2 lbs. Tapped at 24 volts and every 9 volts thereafter.  
Cat. No. EB5 ..... Each **16/-**

**VIDOR 60V. BATTERIES**  
(Heavy Duty)  
Size 10 1/2 in. x 6 1/2 in. x 3 1/2 in. Weight 9 1/2 lbs. Tapped at 15, 30, 45 and 60 volts.  
Cat. No. EB6 ..... Each **14/6**



**VIDOR 45V. STANDARD BATTERIES.**  
Size 8 in. x 2 1/2 in. x 7 in. Weight 6 1/2 lbs. Tapped 22 1/2 v., 45v.  
Cat. No. EB1 ..... **12/6**



**VIDOR 9V. "C" BATTERIES.**  
Size 5 in. x 4 in. x 3 1/2 in. Weight 11 ozs. Every 1 1/2 volts.  
Cat. No. EB20 ..... Each **1/9**

**VIDOR 16V. "C" BATTERIES.**  
Size 9 1/2 in. x 3 1/2 in. x 2 in. Weight 1 lb. 3 ozs. Tapped every 1 1/2 volts.  
Cat. No. EB21 ..... Each **3/3**

Mail All Orders to the "Electric Lamp House" 27 MANNERS ST WELLINGTON

THE PERFECTED VIBRATOR—

# It's RADIOKES!

Dual-Unit for Use with EVERY Battery Set.

**Q** The Radiokes Vibrator is particularly easy to instal. One cable only is provided, and this cable is totally shielded and wired to a 5-pin plug in such a way that the switch on the receiver also controls the vibrator. This also acts as a safety measure to prevent the vibrator unit from being operated without load.

The days of Vibrator experimenting are over—Radiokes announce the PERFECTED VIBRATOR—absolutely fool-proof in installation, marvellously economical in operation and 100 per cent. satisfactory and reliable in service.

The Radiokes Vibrator is designed to supply "B" voltage up to 150 volts, with a maximum current rating of 40 m.a. The power transformer and filter choke have a 60 m.a. rating. Completely assembled on a cadmium-plated chassis, and the whole enclosed in an attractive black crystalline case.



The main Vibrator unit is for sets already designed for vibrator operation, but with the addition of the Special Voltage Divider Unit, the Radiokes Vibrator can be used with ANY BATTERY RECEIVER without any difficult alterations.

Think of the money you save in replacements—order this Radiokes Vibrator to-day—instal it yourself—full instruction with each unit. Remember—it suits EVERY battery receiver—is shielded INSIDE and so eliminates "hash" and is silent in operation (you'll be surprised how quiet it is on short-wave)—fitted with extra heavy power equipment to stand overload—small in size, neat in appearance.

(K)

RADIOKES VIBRATOR UNIT £6/6/-  
Cat. No. EA186 ..... (K)

VOLTAGE DIVIDER UNIT ..... 15/-  
Cat. No. EA197 .....

SPARE BULBS FOR TUNGAR CHARGERS.  
(D)

Cat. No. EA189—2 amp. .... 25/-

Cat. No. EA190—6 amp. .... 59/-

PORTABLE POWER PLANTS. (D)  
WITHIN THE REACH OF EVERYBODY.



NOW!

"PIONEER" now furnishes this remarkable plant at amazing low prices. Now you can have plenty of current for lights, motors, radios, battery charging, etc.—and you don't have to be a master mechanic to do it.

6 VOLTS, 200 WATTS,  
PUSH BUTTON STARTING,  
BATTERY IGNITION. (D)

The complete unit is easily moved about and is sturdily built for long life under heavy duty service. Easy to operate. For installation where engines of this type are satisfactory, the "PIONEER" L.B. Plants have no equal.

Cat. No. EA199 ..... £22/10/-

WRITE FOR LEAFLET.

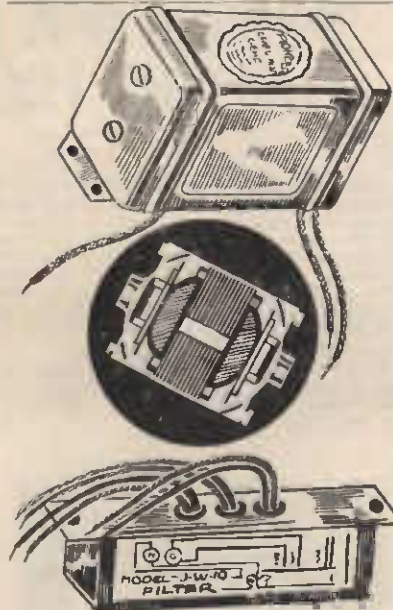

PIONEER GEN-E-MOTORS. (K)

"B" Battery Eliminators, driven from a 6-volt "A" Battery. Where "A" batteries can be easily charged, this method of obtaining the "B" supply for battery sets is most satisfactory and economical.

NO OILING IS NECESSARY!

INSTAL IT—AND FORGET IT!

This new unit measures 4in. x 5½in., and as a matter of convenience the filter system is now contained in a separate metal housing measuring 5½in. x 1½in. x 1½in.

This arrangement is far more convenient as far as installation practice is concerned, as it allows the Gene-E-Motor to be connected in a much smaller space.

The filter unit is complete with a circuit diagram on the side of the metal can.

Cat. No. EA192—6v., D.C. Input 1.1 drain, output 140v., 25 mils. £5

Cat. No. EA193 — 6v. D.C. Input 1.65 drain, output 180v., 30 mils. £5 each

Cat. No. EA194—Type "JW" Filters. For any type Pioneer Gen-E-Motors. Each—£1/15/-

## ATLAS



England

"ATLAS" TRICKLE CHARGER. (D)

Consists of Stepdown Transformer and permanent metal Rectifier, suitably mounted in a strong well-finished sheet steel fire-proof case. Will charge two, four and six volt accumulators on approximately half an amp. It may be left permanently connected to the accumulator but should be switched off from the mains when the receiving set is actually in use.

Cat. No. EA183 ..... Each 25/-

FOR CAR  
or  
RADIO.

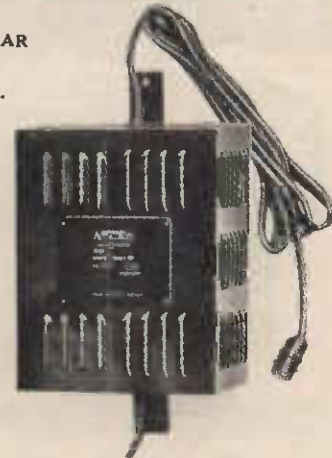

"ATLAS" ENGLISH BATTERY CHARGER. (D)

Designed for 6 or 12 volt batteries. Provision has also been made for charging 2v. accumulators, thus making the Charger universal for all types of car batteries and radio accumulators. The charging rates are as follows:—2 volts at 1 amp.; 6 volts at 2 amps.; 12 volts at 1 amp. Incorporates metal rectifier. Prices include all cables, plugs, etc. Just plug into your light socket and charge your batteries.

Owners of auto. radio sets who would like their sets in constant use, sometimes find they cannot have their switch turned on all the time, as the drain on their battery is too severe, and the next morning they are unable to start their car.

The "ATLAS" Battery Charger overcomes this difficulty. Simply plug it in overnight, and in the morning your battery is fully charged, full of pep and ready for another day's programme.

Cat. No. EA184 ..... Each 79/6

De Luxe Model, with moving iron amp-meter. Cat. No. EA185 ..... 95/-



# AIDS TO BETTER RECEPTION

## 5 GOOD REASONS WHY YOU WILL WANT AN "AERITROL"

(K)

FOR MARVELLOUSLY IMPROVED RECEPTION

1. It will separate interfering stations.
2. It will reduce noise level and interference.
3. It will increase volume of weak stations.
4. It will eliminate outdoor and indoor aeriels. Acting as a perfect aerial eliminator.
5. It controls volume from powerful local stations.

Installed in a Few Minutes, Without Tools!

A safe scientific device which uses no electricity and costs nothing to run, and works on all types of receivers, old or new, battery or electric. Increases volume equivalent to adding an extra valve. Strong metal case, in crackle finish. Full directions with each.

Price only **27/6**

CAT No. EA1



Try It At Our Risk.

Send for an "AERITROL" to-day, try it in your own home for 7 days. If at the end of that time you are not thoroughly satisfied with it return it, and we will return your money in full.

### ICA 3-IN-1 RADIO TUNER. (K)

Antenna Tuner.  
Wave Trap.  
Aerial Eliminator.



Carefully designed and engineered. Consists of a highly efficient L.C. Circuit tuning over the entire broadcast band. It functions as either an antenna tuner, wave trap, or Aerial Eliminator, depending upon the manner of its connection to the radio set. A valuable adjunct to the radio receiver, greatly enhancing radio performance. Operates on any make or model of radio set.

As an Antenna Tuner, it will improve the reception of weak stations. As a Wave trap, it will separate interfering stations and improve selectivity. As an Aerial Eliminator, it makes unnecessary the outdoor aerial. Can be installed by anyone within a few minutes.

Cat. No. EC294—Complete with Instructions. **3/11**

### R.C.S. WAVE TRAP. (K)

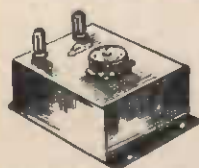

The R.C.S. Wave Trap is connected in series with the aerial terminal of the set, and will effectively eliminate heterodyne whistles and cross modulation and interference.

Cat. No. EF503 ..... **18/6**

### R.C.S. HEAVY DUTY MOTOR FILTER. (K)

This filter eliminates all noises which occur by reason of feed-back from power mains, and also electrical disturbances caused by such things as electric motors, refrigerators, elevators, high tension lines, violet ray plants, etc., and it has a carrying capacity of 5 amps. It is made specially for use with motors of the heavy duty type, such as used in factories, etc. **37/6**



Heavy Duty Motor

### R.C.S. FRACTIONAL H.P. MOTOR FILTER (K)

This filter eliminates all noises which occur by reason of feed-back from power mains, and also electrical disturbances caused by such things as electric motors, refrigerators, elevators, high tension lines, violet ray plants, etc. It connects between the offending motor and the power. **13/6**

### LEKMEK LINE FILTER. (K)

For eliminating man-made noises and electrical interference coming over the A.C. mains. Filter fits between set and power point. Also particularly successful in D.C. areas and on ships with D.C. generators.

Cat. No. EA297 ..... **19/6**

### GOLSTONE RADIO INTERFERENCE SUPPRESSOR UNIT. (K)



Size, approx. 4 1/2 in. x 1 1/2 in. Tested at 2500 volts.

This Suppressor Unit is fixed in the flexible cord of small appliances which cause interference in nearby radio sets, and it should be placed as close as possible to the appliance.

It effectively stops electrical interference from all manner of domestic electrical apparatus such as vacuum cleaners, sewing machines, motor mixers, etc., and can be used in every case where it is not possible to incorporate a filtering arrangement in the motor-case of the appliance.

The Condensers are impervious to heat and moisture. The case is of high-grade bakelite material with cord grips for attaching to the flexible conductor. It is equally successful on A.C. or D.C. circuits up to 250 volts at 10 amps.

Cat. No. EF504 ..... **8/6**

THE "NEVADA" CONSOLE CABINET. (D)



American figured walnut front, with walnut ends, splayed front. Inside measurements of chassis compartment 20 $\frac{1}{2}$ in. x 12in. x 10 $\frac{1}{2}$ in. high. Overall: 38in. high, 22in. wide, 14in. deep. Highly polished.  
Cat. No. EC178 ..... Each **129/6**

THE "SOUTHBRIDGE" MANTEL CABINET. (D)

Walnut front, birch ends, inside measurements 13in. x 10in. x 9in. to bottom of speaker fret. Overall: 18 $\frac{1}{2}$ in. x 13 $\frac{1}{2}$ in. x 10 $\frac{1}{2}$ in. deep. Highly polished.



Cat. No. EC176 ..... Each **39/6**

"BURNIAC" SPEAKER CABINETS. (D)

Walnut finish. Provision to take either 6in. or 8in. Speakers. Has felt feet to protect furniture. Size 11 $\frac{1}{2}$ in. x 11 $\frac{1}{2}$ in. x 7in.

Cat. No. EC179—  
**27/6** Ea.



THE ARAWA CABINET. (D)

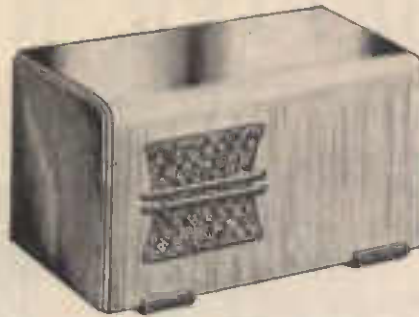

Inside measurements 20 $\frac{1}{2}$  x 9 x 11. Nicely finished, polished walnut.  
Cat. No. EC180 ..... **32/6**

THE "CAMBRIDGE" MANTEL CABINET. (D)



American figured walnut fronts and walnut ends. Inside measurements 15 $\frac{1}{2}$ in. x 12in. x 11in. high to bottom of speaker fret. Overall: 21in. x 15 $\frac{1}{2}$ in. x 10 $\frac{1}{2}$ in. deep. Highly polished.  
Cat. No. EC177 ..... Each **52/6**

LISSEN DISC TYPE H.F. CHOKE. (K)



A Choke of the highest quality in a new and compact form. The choke will function perfectly in any circuit and can be used for anode feed or reaction circuits, H.F. stoppers and, in fact, any use to which H. F. chokes can be applied. The choke may be mounted on the baseboard of a receiver or to the metal screening without fear of the windings coming into contact with the metal. The choke itself can be removed from its case by undoing the centre screw, and it can then be mounted direct to the wiring of the receiver.  
Cat. No. EC41 ..... Each **1/6**

R.C.S. R.F. CHOKE—HONEYCOMB TYPE. (K)



This type of choke is wound with double silk wire. It is of single hole mounting type, with solder lugs attached so as to facilitate wiring.  
Cat. No. EC43—30 M.H. Each **1/6**



LEKMEK R.F. CHOKE. (K)  
Duo-lateral Windings.  
Impregnated.  
Cat. No. EC48  
Price **1/9**

LEKMEK POWER FILTER CHOKES. (K)

Manufacturers' types for below panel mounting, layer wound, impregnated and baked.  
Cat. No. EC122—30 Henry 100 ma.  
3 $\frac{1}{2}$ in. x 2 $\frac{1}{2}$ in. x 2 $\frac{1}{2}$ in. **11/3**



R.C.S. FILTER CHOKES. (K)

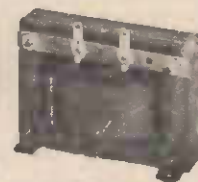

We can thoroughly recommend these Chokes for the elimination of hum from a filter circuit. A large core area is provided with a low resistance and high inductance winding. The air gap on these Chokes is scientifically adjusted on the latest type of choke testing apparatus, and it remains cool when carrying the rated current.

EC130—30 H., 100 M.A. .... **10/-**  
EC131—30 H., 50 M.A. .... **9/3**  
EC132—30 H., 150 M.A. .... **18/6**  
EC133—30 H., 200 M.A. .... **26/6**

LISSEN ALL WAVE CHOKE. (K)

Lissen Astatic H.F. Choke, specially designed for all-wave sets (as used in the famous Lissen All-Wave Four). **5/6** ea.  
Cat. No. EC49

R.C.S. H.F. CHOKES. (K)



These are slot wound on five groove formers with a total of 1200 turns, and are of the manufacturers' type fitted with pins for soldering direct to the plate contact of the socket.  
Cat. No. EC42 ..... Each **11/-**

VIBRATOR HIGH TENSION CHOKE. (K)

This Choke is similar in appearance to the R.C.S. Audio Transformer. The H.T. Choke for a Vibrator Unit requires special treatment in designing and engineering. Its core and winding are properly balanced to suit the exacting conditions for effectively filtering a vibrator. **13/6**  
Cat. No. EC50

VIBRATOR TUNED R.F. CHOKE. (K)

This Choke is specially wound for the elimination of noise from the Vibrator and is vacuum impregnated. **3/9**  
Cat. No. EC51



THESE NEWLY DEVELOPED

# R.C.S. COILS (K)

Will make your  
DUAL-WAVE RECEIVER A SUPER SET.

As any constructor knows, the coils are really the heart of any set, so that if you want your Dual-Wave Receiver to be absolutely "A1 at Loyds" use only these new R.C.S. products.

## R.C.S. TUNING COILS.

Aerial, R.F., and Oscillator specially wound on high-grade grooved formers with isolantite type base; both broadcast and short wave coils have trimmers for stable adjustment (very critical on short waves) and are enclosed in the one can, which is large and definitely non-damping and designed for rigid mounting. All leads are colour coded with strongly soldered connections.

- AERIAL Cat. EC382 **11/6**
- RF Cat. EC383 **11/6**
- OSCILLATOR Cat. EC384 **11/6**



## R.C.S. High Gain Special IRON CORE INTERMEDIATES

Are extremely sensitive and designed for high fidelity results. Isolantite type base, with extra strong leads colour coded.

- Cat. No. **9/9**
- EC314



R.C.S. DUAL-WAVE COIL KIT.

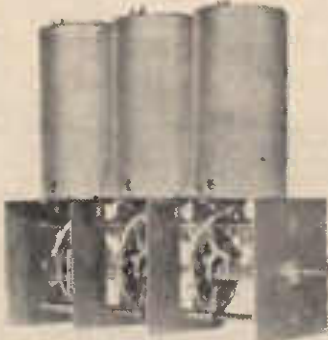

Comprises Aerial, R.F., and Oscillator Coils, as illustrated, with wave change switch and broadcast padders, completely wired and assembled on a rugged steel bracket for quick mounting. Each bank is effectively shielded with the minimum of metal surrounding switch and wires, allowing extremely short leads and thus giving the maximum efficiency. All leads are colour coded.

- Cat. No. EC385 **£3/10/-**
- Complete Kit with two special high-gain intermediate transformers. **£4/9/6**
- Cat. No. EC385A

## OXFORD T.R.F. COILS. (K)

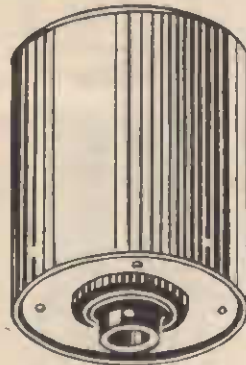

The Oxford T.R.F. Coils are made on new principles. They are wound on Dalton ring fixing coil formers. This method has many advantages over the old bolt and nut method of fixing. To fix an unshielded coil to a chassis you simply have one hole, put in the former and screw up the fixing ring—ever so much simpler than using bolts and nuts which are so awkward to tighten up. Another advantage is that if you require to remove the coil for examination all you do is to unscrew the ring and lift out the coil. All coils are wound to match .00035 Condensers, special coils can be supplied on request.

- Cat. No. EC304—Aerial Coils, unshielded .. **2/6**
- EC305—RF Coils, unshielded ..... **2/6**
- EC306—RF Coils (with reaction) .. **3/-**

The shielded coils have even a greater advantage, as the shield base and former are fixed by the ring in one operation. The coil cover is simply attached to the base by a half turn. The accessibility of this method of fixing is at once obvious.

- Cat. No. EC307—Aerial Coils, shielded .... Each **3/9**
- EC308—RF Coils, shielded ..... **3/9**
- EC309—RF (with reaction) ..... **4/3**

Dalton Formers can be supplied without windings as follows:—  
EF52—Dalton Coil Formers, 1 1/2 in. 9D. diam.

## RADIOKES TUNING COILS. (K)

Type BCS. Litz-wound coils in two PI sections, similar to BC2, but housed in small square can. Shield can: 1 1/2 in. x 1 1/2 in. x 2 1/2 in. Mounting centres: 1 5/16 in.

- BCS Aerial Coil Cat. No. EC392 ..... **7/6**
- BCS R.F. Coil Cat. No. EC393 ..... **7/6**
- BCS Oscillator Coil Cat. No. EC394 ..... **7/6**

Type BIC. Litz-wound iron core coils, wound on high-efficiency Sirufer cores. The most efficient coil made, with amazing sensitivity and selectivity. Can is same as BCS.

- BIC Aerial Coil Cat. No. EC395 ..... **12/9**
- BIC R.F. Coil Cat. No. EC396 ..... **12/9**
- BIC Oscillator Coil Cat. No. EC397 ..... **12/9**

Type DIC. Dual wave iron core coils, using new Sirufer cores, complete with Isolantite trimmers in top of can. 18-50 and 200-550 metres—for 465 k.c. only. Shield can: 2 1/2 in. diameter, 4 in. high. Mounting centres: 2 1/2 in.

- DIC Aerial Coil Cat. No. EC398 ..... **21/-**
- DIC R.F. Coil Cat. No. EC399 ..... **21/-**
- DIC Oscillator Coil Cat. No. EC400 ..... **21/-**

## SHORT-WAVE COIL UNIT. (K)

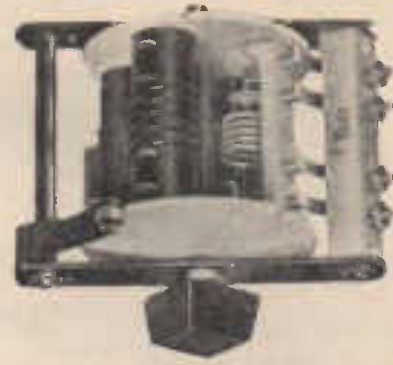

LISSEN HI Q4 range Rotary Coil Unit. Designed to ensure minimum losses. Four bands from 4.8 to 91 metres can be selected by a turn of the knob, while the positive contact of plug-in coils is retained. The insulating material is of low-loss ceramic. Switch contacts are solid nickel and self cleaning. **25/6**  
Cat. No. EC403

## RADIOKES TWA-3 TRI-WAVE COIL BOX. (K)

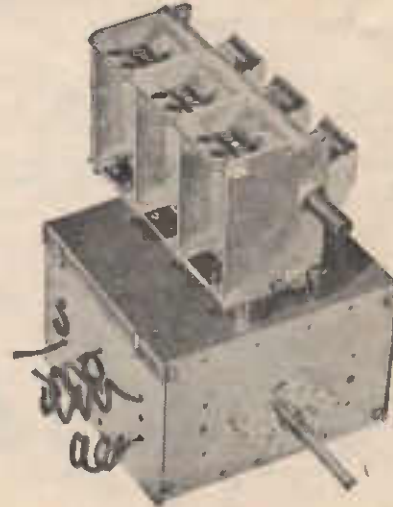

Type TWA-3 Coil Assembly is of greatly improved type. Briefly, the unit has been built in three sections, the first section housing aerial coils, the second R.F. coils, and the third oscillator coils. Complete and most effective brass shielding between each section gives complete stability with a minimum of loss due to close coil shields.

Broadcast coils are of the new iron core type, Litz wound, giving unequalled sensitivity and selectivity. The TWA-3 assembly covers an unusually wide frequency range, from 11 to 80 metres on short wave and the usual broadcast band, 200-550 metres. The use of Type AD-465 or AF-465 I.F. transformers completes a coil kit which definitely has no equal.

- TWA-3 Coil Assembly, complete with gang condenser. **£6/17/6**
- Cat. No. EC388

## IRON CORED COILS. (K)

Pep up your set. Use RCS Iron Cored Coils. These Coils will give you more gain and better selectivity. RCS Coils use SIRUFER Iron Cores. Supplied complete with shield.

- Cat. No. EC377—RCS Iron Cored Aerial Coils ..... Each **9/9**
- Cat. No. EC378—Ditto R.F. Coils ..... Each **9/9**

R.C.S. 4/5 VALVE DUAL-WAVE BOX. (K)



The R.C.S. Dual-wave Box contains both the Short-wave and Broadcast Coils, Switch, and necessary trimming Condensers. The box is single-hole mounting.

Cat. No. EC376 ..... 48/6  
(I.F.s. Extra.)

**LEKMEK**  
**QUALITY**

LEKMEK SUPERFINE COIL KIT. (K)  
Type 356R (2A7)

This Coil Kit is as used in the now famous "£50 Prize Winner." It can be used by all wishing to build a high-class broadcast receiver with the best possible coil kit.

Wave-band 200-550 metres, 186KC circuit, 1 R.F., 1st Dect., I.F.; 2nd Dect., followed by single or push-pull output.



CONTENTS.

- 1 Aerial Coil.
  - 1 R.F. Coil.
  - 1 Oscillator Coil.
  - 2 High-gain 186 KC Litz Wound Inter-mediate.
  - 1 3-gang Condenser,
  - 1 Padder.
  - Circuit Diagrams and Instructions.
- Cat. No. EC2008 ..... £5/5/-

RCS MIDGET LITZ WOUND BROADCAST COILS. (K)

These Midget Aerial, R.F. and Oscillator Coils are, due to their small size (1 1/4 in. x 1 1/4 in.), ideal for mantel, portable or car radio. The coils are sensitive and selective and are the latest product from our laboratory. You can't go wrong in wiring up—no colour or number code needed as our new design mounting panel is embossed showing identical letters at connecting points with those in "Wireless Weekly" diagrams.

- Cat. No. EC410—Aerial Coils ..... 5/6
- Cat. No. EC411—R.F. Coils ..... 5/6
- Cat. No. EC412—Oscillator Coils .. 5/6

R.C.S. T.R.F. COILS. (K)

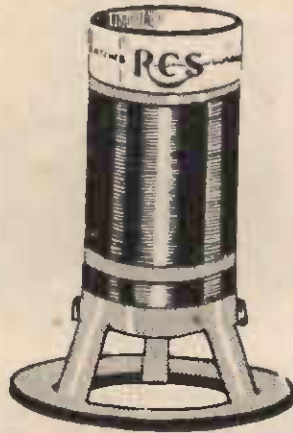

- |  |      |
|--|------|
| Cat. No.                                 | Each |
| EC356—Aerial Coils .....                 | 2/3  |
| EC357—RF Coils .....                     | 2/3  |
| EC358—RF with Reaction .....             | 2/6  |
| EC359—Aerial Coil with Shield ...        | 3/3  |
| EC360—RF Coil with Shield ....           | 3/3  |
| EC361—RF Coil with Reaction with Shield. | 3/6  |

R.C.S. ISOLANTITE I.F. TRANSFORMERS. (K)



R.C.S. Intermediate Transformers of the Isolantite base type have exceptionally high gain, due to the special impregnation of the coils and the entire elimination of the steel supports, and to the very low loss base.

- Cat. No. EC312—460 K.C. Each 6/3
- Cat. No. EC313—175 K.C. Each 6/9

BAKELITE BASE I.F. TRANSFORMERS. (K)



R.C.S. Intermediate Transformers of the bakelite base type have exceptionally high gain, due to the special impregnation of the coils and the entire elimination of the steel supports. The coils

are supported on a special support which is part of the trimmer plates themselves.

- Cat. No. EC310—460 K.C. Each 5/6
- Cat. No. EC311—175 K.C. .. Each 6/-

RCS MIDGET SQUARE TYPE IRON CORE. (K)

This square Midget I.F. is just as sensitive and selective as its larger brother, and was specially designed for the car radio described in this issue. It is ideal for use in any receiver where space is very limited. Size: 3 1/4 in. high x 1 1/4 in. square. 460 K.C.

- Cat. No. EC315 ..... Each 10/-
- RCS MIDGET OR CAR RADIO COIL KIT. (K)
- Consists of 3-Type, H.C. 51 coils, 2-type I.F.84 iron cored I.F.'s, complete with special padder and circuit data.
- Cat. No. EC409 ..... 40/-

LEKMEK SUPERFINE COIL KIT. ((K))

As the basis of a high-grade elect. broadcast receiver this coil kit will be hard to beat. Made in accordance with Lekmek's usual high quality standard, but supplied at a price only a little in advance of the cheapest coil kits. Can be used in either electric or battery sets using such oscillator valves as 2A7, 6A7, 1A6, 1C6, etc.

Circuit: 1st Dect., I.F. (458 KC), 2nd Dect., followed by either single or push-pull output.



CONTENTS.

- 1 Aerial Coil (shielded).
  - 1 Oscillator Coil (shielded).
  - 2 IF Transformers (Litz wound).
  - 1 2-gang Condenser with floating rubber mounts and screws.
  - 1 Padder.
  - Circuit Diagrams and Instructions.
- Cat. No. EC2005 ..... £2/17/6

WORLD-WIDE S.W. CONVERTER COIL KIT. (K)



R.C.S. Coil Kit contains special periodic aerial coil, together with the shunt resistor, an oscillator coil and special coupling chokes.

- Cat. No. EC379 ..... Each 10/6

WHAT PEOPLE THINK ABOUT "THE SKYSWEEPER."

(See page 118.)

Invercargill, 18/6/37.  
I received the "Skysweeper 4 Kit Set" in good order and condition and have to thank you for your excellent attention to my order. I built up the Set and was amazed at its performance, 26 stations being logged on the first night.—C.H.W.

Auckland, 18/9/37.  
"Was pleasantly surprised to have the "Skysweeper Kit" arrive here this morning (before the invoice). On opening up and checking up found everything O.K., including 6E5 valve, which I propose to use as a leakage tester. Really did not expect the goods so soon under the L.B.P."—W.B.

North Walroa, 11/9/37.  
Last night on my old 'Skysweeper' I had dozens of stations. I still find the Muter Aerial Eliminator superior to an ordinary out-door aerial."—H.U.

Waimauku, 22/9/37.  
"Thank you for the tools forwarded by you to me. They are of higher quality than I expected."—R.B.K.



# EXCELRAD PRODUCTS

(K)

## MADE IN NEW ZEALAND

### EXCELRAD COILS.

The following are details of Excelrad Coils for 1938/9. The Coils are grouped into Coil Kits for various kinds of circuits, but individual coils can be supplied separately. Circuit diagrams using the various Coil Kits will be released shortly and published in the "N.Z. Radiogram" (monthly).

For 5-valve Broadcast Sets using a 3-gang Condenser, Band Pass Input.

Cat. No. (Type)	Price
EN8 (R95)—Aerial Coil	6/-
EN9 (R96)—Band Pass Coil (capacity coupled)	6/-
EN10 (R94)—Oscillator Coil	6/-
EN11 (8B3)—Coil Kit, as above, with matched condenser	35/-

For 5-valve Broadcast, using 2-gang Condenser, Coils for mounting underneath the Chassis.

Cat. No. (Type)	Price
EN12 (F100)—Aerial Coil	8/-
EN13 (R101)—Oscillator Coil	5/-
EN14 (5B2)—Coil Kit, as above, with matched condenser	23/6

For 5-valve Dual-wave, using 3-gang Condenser, (Band Pass Input)

Cat. No. (Type)	Price
EN15 (R97)—Aerial Coil	9/-
EN9 (R96)—Band Pass (capacity coupled)	6/-
EN17 (R91)—Oscillator Coil	9/-
EN18 (5D3)—Coil Kit, as above, with matched Condenser	41/-

For 5-valve Dual-wave, using 2-gang Condenser.

Cat. No. (Type)	Price
EN12 (F100)—Aerial Broadcast Coil	8/-
EN20 (R84)—Aerial Short-wave Coil	4/-
EN13 (R101)—Broadcast Oscillator Coil	5/-
EN22 (R85)—Short-wave Oscillator Coil	4/-
EN23 (5D2)—Coil Kit, as above	31/6

For 6-valve Broadcast with RF Stage, using 3-gang Condenser.

Cat. No. (Type)	Price
EN24 (R102)—Aerial Coil	6/-
EN25 (R103)—R.F. Coil	6/-
EN26 (R104)—Oscillator Coil	6/-
EN27 (6B)—Coil Kit, as above, with matched condenser	35/-

For 6-valve Dual-wave, with RF stage, using 3-gang Condenser.

Cat. No. (Type)	Price
EN28 (126)—Aerial Broadcast (550-1550 KC), and standard short-wave (6-16.5 MC)	9/-
EN39 (127)—R.F. Coil Broadcast and Short-wave	9/-
EN40 (190)—Oscillator Coil, broadcast and short-wave	10/-
EN130 (6D)—Coil Kit, as above, with matched condenser	45/-

For 6-valve All-wave, with RF stage, using 3-gang Condenser.

Cat. No. (Type)	Price
EN41 (R78)—Aerial Coil, broadcast (550-1550 KC) and standard short-wave band (6-18 KC)	9/-
EN42 (R81)—Aerial Coil, Medium short-wave (2-6 MC)	6/-
EN43 (R79)—R.F. Coil, Broadcast and standard short-wave	9/-

EN44 (R82)—R.F. Coil, Medium short-wave	6/-
EN45 (R80)—Oscillator Coil, Broadcast and standard short-wave	9/-
EN50 (R83)—Oscillator Coil, Medium short-wave	6/-
EN51 (6A)—Coil Kit, as above, with matched condenser	62/-

### EXCELRAD PRODUCTS.

Particulars of the 1938 range of Excelrad Transformers, Coils, etc., have just been released. Prices for some of the lines have not yet come to hand, but will be supplied on request.

(Excelrad Type Numbers are in Brackets.)

### EXCELRAD INTERMEDIATE FREQUENCY TRANSFORMERS.

Cat. No. (Type)	Price
EN52 (7A)—456 Mixer Plate Grid	14/-
EN53 (7B)—456 KC Plate to diode	14/-
The above two types are high-gain, Litz-wound Transformers, and are recommended for use with all R.F. Kits.	
Cat. No. (Type)	Price
EN54 (24)—256 KC	9/-
EN55 (21)—175 KC	9/-
EN56 (29A)—456 KC, similar to 7A, but lower gain	12/-
EN57 (29B)—456 KC, similar to 7B, but lower gain	12/-
EN58 (25A)—456 K.C., similar to 29A, but lower gain. Air core	10/-
EN59 (25B)—456 KC, similar to 29B, but lower gain. Air core	10/-

### MISCELLANEOUS COILS.

Cat. No. (Type)	Each
EN60 (111)—Aerial Coil, Low impedance	6/-
EN68 (115)—Band Pass Coil, Inductively coupled	9/-
EN69 (112)—R.F. Coil, Low impedance	6/-
EN70 (139)—Oscillator Coil, Broadcast (175 KC)	6/-
EN71 (116)—S.W. Converter Coil	15/-

### EXCELRAD POWER TRANSFORMERS.

Cat. No. (Type)	Each
EN72 (343)—Vertical type for four or five valve with single 42 output. H.T. 350 v., 50 m.a. Fil. 5 v.-2 a., 6.3 v.-1 a.	24/-
EN73 (373)—Vertical type for 5 or 6 valve Sets, with single 42 output. H.T. 350 v.-70 m.a. Fil. 5 v.-2 a., 6.3 v.-2 a.	27/-
EN74 (T57)—Same as above, but for horizontal mounting	27/-
EN75 (TL18)—Same as T57, but with 240 v. H.T.	27/-
EN76 (T56)—Vertical type for 7 or 8 valve Sets, for single 42 output. H.T. 350 v.-80 m.a. Fil. 5 v.-2 a., 6.3 v.-3 a.	30/-
EN77 (423)—Vertical type for push-pull output H.T. 350 v.-125 m.a. Fil. 5 v.-2 a., 6.3 v.-5 a., 6.3 v.-3 a.	36/-
EN78 (225)—2.5 v., 3 amps. Filament Transformer	15/-
EN79 (240)—4 v., 2 amp. Filament Transformer	15/-
EN80 (263)—6.3 v. 2 amp. Filament Transformer	15/-

### SPECIAL TRANSFORMERS.

(Prices on request.)

Cat. No. (Type)	
EN94 (110)—60-watt stepdown Transformer for 230 v., 110 v.	
EN95 (T47)—Power Transformer for 10-watt Amplifier. H.T. 230 v. 180 m.a. Filaments 5 v.-3 a., 6.3 v.-3 a.	
EN96 (TL52)—High-tension Transformer for 30-watt Amplifier. H.T. only. 500 + 500 v. Tapped at 375 + 375 v.	
EN97 (TL53)—Filaments only, 2 x 5 v.-3 a., 6.3 v.-4 a.	
EN98 (TL47)—For Speaker field supply. 40 watts. 200 v.-200 m.a. Fil. 5 v.-3 a., for 5Z3.	

### AUDIO TRANSFORMERS.

Cat. No. (Type)	Each
EN99 (81)—General purpose ratio 1:3	12/-
EN100 (82)—Push-pull input, ratio 1:3	15/-
EN101 (83)—Push-pull input for 19 valve class B	15/-
EN102 (84)—Coupling between 56 valve and push-pull 45's. Class A.B.	19/6
EN103 (91)—Output Transformer from single output penthode to average speaker of 4 ohms coil impedance	12/-
EN104 (92)—Push-pull from output pentodes to average speaker of 4 ohms coil impedance	15/-
EN105 (95)—Output from single 45 to 4 ohms speaker	12/-
EN106 (96)—Universal output Transformer from any modern output stage, single or push-pull pentodes or triodes into speakers from 1-10 ohms voice-coil impedance	18/-
EN107 (TL49)—Output Transformer for 2 x 6L6 in class A. Secondary tapped at 500, 200, 50, 25, 15, 8, 5, and 2.5 ohms. Price on request	
EN108 (TL39)—Output Transformer for 2 x 6L6 in Class A.B.1. Secondary tapped at 500, 200, 100, 50, 25, 16, 8, 5, and 2.5 ohms. Price on request	

### CHOKES.

Cat. No. (Type)	Each
EN109 (C350)—R.F. Choke Broadcast	1/9
EN118 (C350S)—R.F. Choke Short-wave	2/6
EN119 (62)—600 Henry 1 m.a. Audio Choke for coupling purposes. D.C. resistance 3000 ohms	18/-
EN120 (61)—20 Henrys 50 m.a. Filter Chokes for general use. D.C. resistance 420 ohms	12/-
EN121 (71)—30 Henrys 100 m.a. Filter Choke for general use. D.C. resistance 260 ohms	24/-
EN122 (72)—8 Henrys 150 m.a. Filter Choke for general use. D.C. resistance 150 ohms	24/-
EN123 (TL30)—Filter Choke, 8 Henrys 200 m.a. D.C. resistance 75 ohms	30/-

### TRANSFORMERS AND CHOKES FOR VIBRATOR POWER SUPPLY.

(Prices on request.)

Cat. No. (Type)	
EN124 (T.6)—Transformer for use with 6 v. Synchronous Vibrator to give 130 v. D.C. at 25 m.a.	
EN125 (T.5)—Same as above, but delivers 150 v. at 25 m.a.	
EN126 (Z13)—Filament Filter Choke.	
EN127 (61)—High Tension Filter Choke.	
EN128 (RC3)—R.F. Filter Unit for Vibrator Transformer low voltage supply.	
EN129 (RC1)—R.F. Filter Choke for high tension.	

# T.C.C.

## CONDENSERS



T.C.C. ELECTROLYTIC CONDENSERS. (K)

- Wet Type—Aluminium Cased.
- |              |      |
|--------------|------|
| Cat. No.     | Each |
| EC550—4 MFD  | 4/-  |
| EC551—8 MFD  | 4/-  |
| EC552—16 MFD | 7/6  |
- Dry Type in Cardboard Containers.  
500 volts D.C. peak working.
- |               |      |
|---------------|------|
| EC560—4 MFD   | 4/-  |
| EC561—4X4 MFD | 6/6  |
| EC562—8 MFD   | 4/-  |
| EC563—8X8 MFD | 10/- |
- Tubular Type—Dry.
- |                      |     |
|----------------------|-----|
| EC570—12 volt 50 MFD | 3/- |
| EC571—25 volt 25 MFD | 3/- |
| EC572—50 volt 10 MFD | 3/- |

### T.C.C. TUBULAR CONDENSERS. (P)

Non-Inductive Condensers with wire ends. 350 volts. (Working).

Cat. No.	Each
EC659—.0001 MFD	10d.
EC660—.0002 MFD	10d.
EC661—.00025 MFD	10d.
EC662—.0003 MFD	10d.
EC663—.0005 MFD	10d.
EC664—.001 MFD	10d.
EC665—.002 MFD	10d.
EC666—.003 MFD	10d.
EC667—.004 MFD	10d.
EC668—.005 MFD	10d.
EC669—.006 MFD	10d.
EC670—.01 MFD	10d.
EC671—.02 MFD	10d.
EC672—.03 MFD	10d.
EC673—.05 MFD	10d.
EC674—.1 MFD	1/-
EC676—.25 MFD	1/3
EC677—.5 MFD	1/8
EC678—1 MFD	2/6



### T.C.C. MICA CONDENSERS. (P)

TCC Type M Mica Fixed Condensers.

Cat. No.	Each
EC692—.00005	10d.
EC679—.0001	10d.
EC680—.0002	10d.
EC681—.0003	10d.
EC682—.0005	1/2
EC683—.001	1/3
EC684—.002	1/6
EC685—.003	1/6
EC686—.005	2/-
EC687—.006	2/3
EC688—.01	2/6

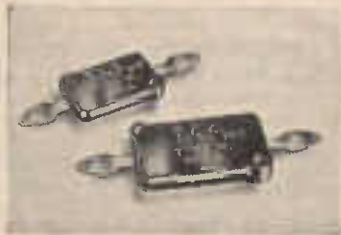



**MIDGET CONDENSERS. (K)**  
**STAR MIDGET CONDENSERS.**

A very popular low-priced midget variable condenser for builders, experimenters and laboratories.

The 100-mfd. is ideally adapted for tuning short-wave coil kits and other coils of that nature.

Single hole mounting. Shaft 1/16 in. diameter. Mounting bushing is 5-16 in. diameter. Size 1 1/8-1 1/2 in. wide by 1 1/2 in. high.



Cat. No.	Max. Cap. Mmfd.	Min. Cap. Mmfd.	Plates	List Price
EC820	10	3	2	2/-
EC821	15	3	2	2/3
EC822	25	3.5	4	2/6
EC823	35	4	5	2/9
EC824	50	4	7	3/3
EC825	70	5	9	4/-
EC826	100	6	14	4/6

**M.C. MIDGET CONDENSERS.**

Ceramic insulation reduces dielectric losses to a minimum, and assures maximum and uniform efficiency under all conditions of temperature and humidity. Non-corrosive soldered brass plates eliminate vibration and effect lowest series resistance. Provision is made for both single hole panel mounting and base mounting. Used for ultra short-wave and short-wave tuning, broadcast tuning.

Shafts are 1/16 in. diameter and extend 5-16 beyond the rear frame to facilitate ganging. Standard condensers include stops and are made to increase capacity by clockwise rotation. Individually tested for breakdown on 500v. A.C.

Type No.	Plates	Min. Cap.	Max. Cap.	List Price
EC827	3	3	20	7/-
EC828	5	4	35	7/6
EC829	7	5	50	8/-
EC830	11	6	80	8/6
EC831	14	6	100	9/-

**DOUBLE SPACED M.C. CONDENSERS.**

The double spaced condensers have the same characteristics and the same constructional features as the standard M.C. Ideal for use in transmitters. Provide the same operating advantages outlined in description of M.C. condensers.

No.	Stator Plates	Rotor Plates	Max. Cap.	Min. Cap.	List Price
EC832	2	1	54	3	7/-
EC833	3	2	8	3	7/6

**CONDENSERS, MIDGET. (K)**

Air spaced Midget Condensers. Prices without knobs.

Cat. No. EC859—13-plate .0005 **2/-** each

Cat. No. EC860—23-plate .0001 **3/-** each



**COIL TRIMMER CONDENSER. (K)**

This R.C.S. Coil Trimmer is ideal for fitting on the top of the coils, and measures approx. 1 3/16 in. in diameter. Moving plates made of German silver, Cat. No. EC891 **1/4** Each



**COIL OR GANG TRIMMERS. (K)**

R.C.S. Coil or Gang Trimmers are fitted on top of the gang or across a coil, and measure 1/2 in. x 1/2 in. wide, and consist of two German silver plates mounted on a porcelain base, with a minimum capacity of about 10mmf and a maximum of about 100 mmf. Cat. No. EC890 **10D.** Each



**R.C.S. ISOLANTITE PADDERS. (K)**

These Padders are of a special high grade type, and are made in various capacities, varying from 4 mmfs. to 2000 mmfs., and they are ideal for trimmers on short-wave coils. The moving plate is made of heavy gauge spring German silver, and the capacity will not vary with temperature or humidity. Cat. No. EC950—460 K.C. **1/6** each



Cat. No. EC951—175 K.C. **2/-** each

**LISSEN MINIATURE PRECISION VARIABLE CONDENSER. (K)**



Suitable for both tuning and reaction circuits, these Lissen Variable Condensers are designed particularly for home constructed receivers, and where space is a major consideration, the condenser projecting only 1/2 in. behind the panel.

It can be mounted by normal one-hole fixing to any panel or may be entirely insulated from a metal panel by use of the bakelite end plate and two screws.

EC878 supplied complete with graduated bakelite tuning knob; others with suitable knob. The 1/2 in. spindle will fit any standard dial or drum control.

Cat. No. EC878—0005	<b>3/6</b> each
Cat. No. EC879—0003	<b>3/6</b> each
Cat. No. EC877—0001	<b>3/6</b> each

**NEW TYPE OF SOLID DIELECTRIC CONDENSERS. (K)**



With black highly polished Tertinax outside plates. Central fixing, small initial capacity. Smooth working rotor. Useful for all types of reaction and tuning condensers.

Cat. No. EC801—0005	<b>2/6</b>
Cat. No. EC802—00025	<b>2/6</b>
Cat. No. EC803—0001	<b>2/6</b>
Cat. No. EC800—00025 (Differential)	<b>3/6</b>

**TELSEN AERIAL SERIES CONDENSERS. (K)**

This Condenser provides an ideal selectivity and volume control. The maximum capacity is .0003 mfd., and has an extremely low minimum capacity. The switch arm is attached to the spindle, whereby the Condenser is short-circuited at its maximum position, giving a straight-through aerial connection when desired. This results in a wide range of control. Supplied complete with knob. Cat. No. EC883 **3/6** each



**CONDENSER COUPLER. (K)**  
Extension piece for ganging Condensers, with 1/16 in. shaft. Cat. No. EC868 **6D.** each

**CONDENSER COUPLING. (K)**

Condenser Coupling used for ganging two single condensers. Cat. No. EC901: **1/-** each



**CONCOURSE TUBULAR CONDENSERS. (N)**



Concourse Tubular Condensers can be used in all circuits requiring a high voltage non-inductive Condenser.

600 VOLT D.C. WORKING NON-INDUCTIVE.

Cat. No. EC643—.1	<b>9D.</b> each
8/3 dozen.	
Cat. No. EC644—.25	<b>1/1</b> each
12/6 dozen.	
Cat. No. EC645—.5	<b>1/3</b> each
14/3 dozen.	

**CLEARING LINES.**

**STANDARD TELEPHONES BLOCK TYPE CONDENSERS. (K)**

Cat. No. EX370—.1	<b>6D.</b> each, 4/6 doz.
Cat. No. EX371—.25	<b>6D.</b> each, 4/6 doz.
Cat. No. EC372—.05	<b>6D.</b> each, 4/6 doz.
Cat. No. EX373—.5	<b>6D.</b> each, 4/6 doz.



**FIXED CONDENSERS. (K)**



Limited stocks only.

Cat. No. EX352—Telsen Mansbridge type .04	<b>6D.</b>
EX355—S.T.C. Tubular type .001	<b>4D.</b>
EX356—S.T.C. Tubular Type .003	<b>4D.</b>
EX359—S.T.C. Tubular Type .0035	<b>4D.</b>
EX360—S.T.C. Tubular Type .0005	<b>4D.</b>



**.0005 TRANSMITTING CONDENSER. (K)**

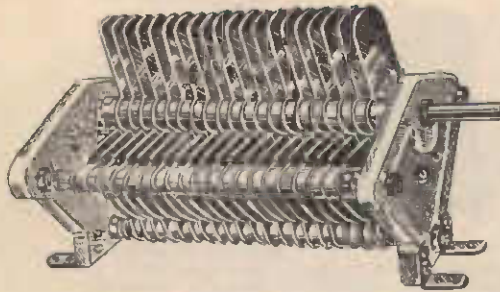

An excellent Condenser for plate circuits of high-power amplifiers, being of very sturdy construction, and having high insulation properties. Vanes are of pressed aluminium, and are double spaced. End plates manufactured from first grade ceramic material. Has removable insulated shaft, the length of which can be adjusted to suit individual requirements. Fitted with brackets for chassis mounting. Positive contact to moving vanes by means of twin spring wiper contacts. Dimensions (overall): 9in. long, 5in. high (vanes open), 5 1/2 in. wide, 43 plates. Weight: 3lb.; shaft diameter, 1/2 in.

Cat. No. EC806 ..... **50/-**

**.0001 TRANSMITTING CONDENSER. (K)**

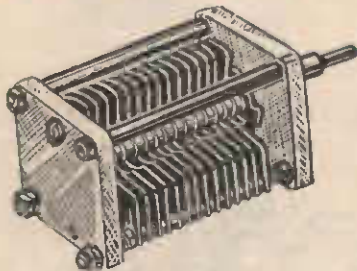

A high efficiency ceramic insulated, double spaced Condenser, being both small in physical size and robust in construction. Ideal for grid circuits of high power stages, coupling Condensers, plate Condensers in low-power transmitters, etc. Panel mounting. Dimensions (overall): 3 1/2 in. long, 2in. square, 1/2 in. shaft. Weight, 10 ozs.

Cat. No. EC807 ..... **9/6**

**.0001 MIDGET CONDENSER. (K)**

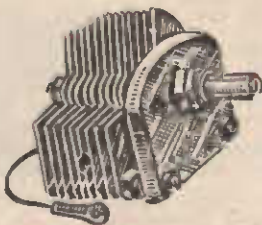

A 17-plate single-spaced Condenser, mounted on isolantite panel. Useful for short-wave receivers, crystal and self-controlled oscillators, etc. Plates are made of brass. Panel mounting. Shaft, 1/2 in. Dimensions: Height 2in. (plates open), width 2in., length 1 1/2 in. Weight, 4ozs.

Cat. No. EC808 ..... **5/-**

**1938 RADIO GUIDE. (B)**

A very popular Radio Annual containing descriptions of over twenty complete Sets of all types, as well as much other useful and interesting Radio Information, Tables, etc.

Cat. No. EB704 ..... Each **2/6**

**LISSEN HI Q LOW-LOSS CONDENSERS. (K)**



Special low-loss Condensers with a minimum capacity of 5 micro-micro-farads. Absolutely noiseless in action even at 5 metres. Ceramic end-piece. Capacity 160 mmfd.

Cat. No. EC897 ..... **12/6**

**CONDENSERS, SHORT-WAVE. (K)**

This model is specially designed in every detail for short-wave work. No current is carried by the bearings, and a special screened pig-tail connection to rotor is used. The minimum capacity is very small and the maximum is true to rating. Such insulating material as is used is carefully placed and proportioned so as to reduce H.F. losses. The frame has been designed to avoid as far as possible closed loop effects. British.

Cat. No. EC895—.0001 ..... **8/6** each

Cat. No. EC896—.00015.... **8/6** each

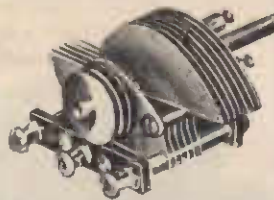

**SINGLE GANG CONDENSERS. (K)**

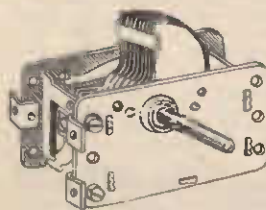

A neat Variable Condenser of modern design. Air spaced.

Capacity .00035  
Cat. No. EC919—**5/6** each

Capacity .0005. An ideal job for all types of circuits. Crystal sets and wave-traps where it is desired to make a first-class job. Of rugged construction. 1/2 in. shaft.

Cat. No. EC918 ..... Each **5/11**

**J.B. TWIN GANG CONDENSERS. (K)**

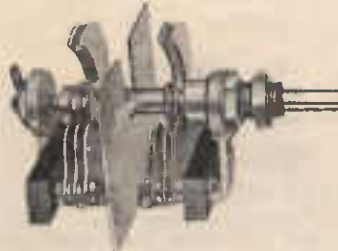

Specially produced for ultra short-wave work. Have a very low minimum capacity. Low losses and non-microphonic. May be employed for tuning or band spreading two tuned circuits or for trimming the pre-selectors of superhet receivers.

Cat. No. EC924—Capacity 45 MMF. **8/6** Each

**GANGED CONDENSERS. (K)**  
RCC Precision Tuning Condensers.

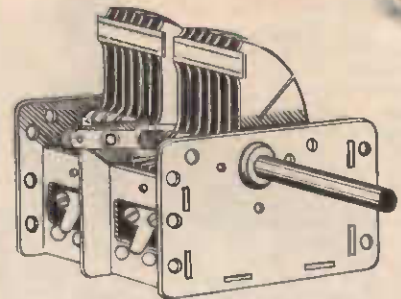

RCC Precision Tuning Condensers are actually precision built, rugged and compact. Because of the mechanical construction, the electrical characteristics are constant and do not vary. Constancy of electrical value is attained through the carefully designed one-piece frame and the use of a special brass shaft housed in a ball-bearing race.

Cat. No. EC920—2-gang .00035 **10/6**

Cat. No. EC921—3-gang .00035 **15/6**

Cat. No. EC922—4-gang .00035 **18/6**

Cat. No. EC923—2-gang .00015 **12/6**  
Special Short-wave type.

**SMALL SIZE TWO-GANG TUNING CONDENSER. (K)**

Capacity .00035. Overall dimensions 2 1/4 x 1 1/2 x 2 1/2 ins. 1/2 in. shaft. Ball bearing mounting.

Cat. No. EC925 ..... **10/6**

**STROMBERG CARLSON GANGED CONDENSERS. (K)**

These Condensers are of Australian manufacture, ruggedly constructed. Most Australian Coil Kits are designed to work with S.G. "G" Condensers. Capacity .000385.

Cat. No. EC926—2-gang .. Price **10/6**

Cat. No. EC927—3-gang .. Price **15/6**

**PRE-SET CONDENSERS. (K)**

The very low minimum capacity of these Pre-set Condensers gives a wide range of selectivity adjustment when used in the aerial circuit. They are substantially made, easily adjusted and provided with a locking ring. High insulation and low loss.



Cat. No. EC850—.002 mfd to .00025 mfd.

Cat. No. EC851—.001mfd to .0002 mfd.

Cat. No. EC852—.0003 mfd to .000025 mfd.

Cat. No. EC853—.0001 mfd. to .000005 mfd.

All **2/-** each

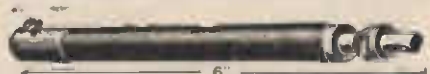

**EXTENSION SHAFTS FOR CONDENSERS. (K)**

Tuning Condensers in short-wave receivers should often be placed some distance from the panel to minimise hand capacity effects. These extension shafts will fit all makes of condensers having 1/2 in. dia. shafts. Fitted with 1/2 in. shaft for knob or dial, and complete with panel bush. Nickel-plated finish. 4in. long.

Cat. No. EC869 ..... Each **2/-**



**SIRIS FIXED DETECTORS. (K)**



This Detector requires no attention after being placed in the crystal set. Very sensitive and will remain active for a long period. The crystal has been set and tested at the factory.  
Cat. No. EC252 ..... **2/6** each

**S'INEL DORMEL DETECTORS. (K)**



This Detector has a perikon combination and gives excellent results. The crystal can be adjusted by withdrawing the knob, turning to the right and gently letting it go back on the crystal. Never try to adjust the crystal without first pulling out the knob.  
Cat. No. EC253 ..... **2/6** each

**PLUG-IN DETECTORS. (K)**

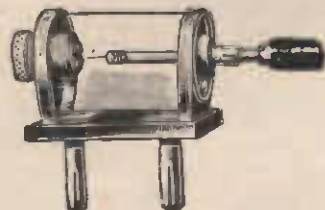

Sensitive Plug-in Type Detectors, with Banana Type Pins.  
Cat. No. EC261 ..... **2/6** each

**CRYSTALS, HERTZITE. (K)**



Hertzite Crystals, packed in boxes, complete with tweezers and catswhiskers. British.  
Cat. No. EC268 ..... **9D.** each

**CRYSTALS, UNITED. (K)**

Packed in tin boxes and complete with catswhisker. Very sensitive. British made.  
Cat. No. EC270 ..... **1/3**

**NEUTRON CRYSTALS. (K)**

Packed in tin boxes  
Cat. No. EC271 ..... **1/-**

**SYLVEREX CRYSTALS. (K)**



United Crystals are packed in glass tubes.  
Cat. No. EC269 ..... **3D.** each

**DETECTORS—ORMOND GLASS-ENCLOSED. (K)**



A really good Detector of the cats-whisker type. Nickel-plated fittings. Screw terminals. Glass enclosed. Mounted on ebonite base. Complete with sensitive crystal.  
Cat. No. EC256 ..... **2/6** each  
Cat. No. EC257—Spare Glasses **9D.** each for above.

**DETECTORS—RED DIAMOND. (K)**



Red Diamond Detectors are the semi-permanent type. Can be adjusted by moving the plunger. Sensitive, and give good results.  
Cat. No. EC254 ..... **3/-** each  
Cat. No. EC255—Spare Crystals for Red Diamond Detectors. **1/6** pr.

**DETECTORS. (K)**

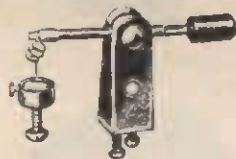

Set of Nickel-plated Detector Parts, including Arm, Crystal Cup and Cats-whisker  
Cat. No. EC258: **1/-** each

**CRYSTAL CUPS. (K)**

Spare Crystal Cups for above.  
Cat. No. EC259 ..... **3D.** each

**U- CRYSTAL DETECTORS. (K)**



Sensitive Fixed Crystal, complete with mounting clips. (Foreign.)  
Cat. No. EC262 ..... Only **1/-** each

**CRYSTAL SET.**



Moulded in bakelite case and supplied complete with plug-in coil and sensitive plug-in detector.  
Cat. No. EC290 ..... **8/6** each (K)  
Cat. No. EC291—Spare Coils complete with Banana Plug Type Pins. **1/9** each (K)  
Cat. No. EC261—Spare Plug-in Detectors with Banana Plug Type Pins **2/6** each (K)

**A DANDY CRYSTAL SET. (K)**



A new type of Low-Loss inexpensive Crystal Set for sensitive reception. Has a specially developed adjustable crystal and an adjustable slider tuning coil. All that is necessary to operate the Crystal Set is to connect up the aerial and ground and attach the headphones and it is ready to function. Complete with crystal and cat's whisker.  
Cat. No. EC292 ..... **6/11**

**BRANDES MATCHED HEADPHONES. (K)**

A scientifically made set of headphones designed for those demanding a superior article. They are full size, yet are unusually comfortable to wear. Shells are of polished aluminium. Adjustable. Web-covered flexible steel head band. Complete with cord.



Cat. No. EC283 ..... **17/6** pair

**LIGHT WEIGHT HEADPHONES. (K)**



These 'phones are extremely light. They are of German manufacture, with bakelite Ear Pieces that fit comfortably. Although low in price, and of light construction, they are very sensitive and give excellent results. 4,000 ohms.  
Cat. No. EC280 ..... **7/6** pair

**FROST 'PHONES. (K)**

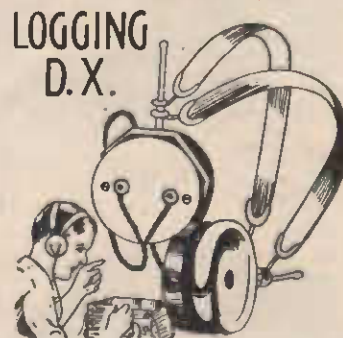

Frost 'Phones satisfy the exacting demands of those wishing to obtain extremely sensitive instruments. Light in weight, comfortable to wear and easily adjustable. All materials used are of the very highest quality, and these 'phones are made in a plant which for over thirty-five years has manufactured high-grade telephone equipment. These 'phones may be depended upon to give perfect satisfaction. Shells are of polished aluminium with black composition caps.  
Cat. No. EC281 ..... **15/-**

**EAR PADS. (K)**

Crepe Rubber Ear Pads for putting over the ear caps of headphones. Makes a wonderful difference to your ears.

Cat. No. EC282—  
**1/6** pair



**CORDS, HEADPHONE. (K)**

Cat. No. EC202—Headphone Cords, 4 lugs one end, 2 tips the other. 5ft. **1/6**

Cat. No. EC203—Headphone Cords, with tips both ends. 5ft. Each **1/9**

**COILS—CRYSTAL SET. (K)**

Coils for Crystal Sets. Consist of 70 turns, 24-gauge D.C.C. Wire on 3in. diam. bakelite former. Tapped every tenth turn. Cat. No. EC266 ..... Each **3/-**

**SPARES FOR HEADPHONES. (K)**

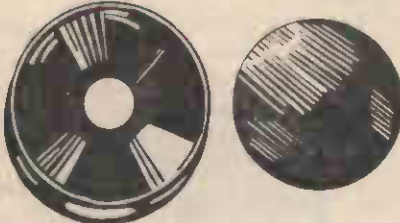

Spare Ear Caps for Frost Phones. Cat. No. EC286 ..... Each **2/-**  
Spare Diaphragm for Frost Phones. Cat. No. EC287 ..... Each **1/-**  
Spare Caps for Brandes Phones. Cat. No. EC288 ..... Each **2/6**  
Spare Diaphragm for Brandes Phones. Cat. No. EC289 ..... Each **1/-**

**UNIVERSAL BATTERY CLIPS. (K)**



British made, these Clips have good strong springs that make a sure contact. Three sizes available.

Cat. No. EC20—5/10 amp. .... Each **3D.**  
EC21—10/25 amp. .... **5D.**  
EC22—50 amp. .... **9D.**

**INSULATED (CROCODILE CLIPS. (K)**



New type of Crocodile Clip. Useful for servicemen, experimenters, etc., when dealing with high voltages. Wire passes through insulator to grip sleeve and screw. Nickel-plated. Red and black insulated.

Cat. No. EC18 ..... **7 1/2D.** each

**ALIGATOR CLIP**



**CLIPS. (K)**

Here's a Handy Clip for coil and battery connections. The strong spring ensures a good connection.

EC19 ..... **3D.** each **2/6** dozen

**INSTRUMENT KNOB**



(K)  
Special value Bar Knob for 1in. shafts. Cat. No. ED309—  
**8D.** each

**INSTRUMENT KNOBS (K)**

2 1/2in. diam. Black Knob for 1/2in. shafts only. A Precision job. Fixed with two grub screws.

Cat. No. ED23—  
**3/9**



**METAL MAGIC EYE ESCUTCHEONS. (K)**

Total diameter 2 1/2 x 1 1/2. Finished Florentine bronze. Cat. No. ES228:  
**1/6**



**POINTER, KNOB AND DIAL. (K)**

A direct control comprising satin finished aluminium dial engraved 0-10 degrees, with elegant shaped bakelite pointer bar knob, which is 1 1/2in. long, and has white line in centre of pointer for easy reading. For 1in. spindles only. Diameter of dial 1 1/2in. Cat. No. ED21 ..... **1/8**



**KNOBS ONLY—As above.** **10D.**  
Cat. No. ED340 .....



**RUBY WINDOW BRACKET FITTING. (K)**

An inexpensive accessory, comprising nickel-plated bezel with ruby lens and bulb-holder. Fixed by 3 screws provided. Takes all M.E.S. bulbs.

Cat. No. ED501—  
Each **2/6**

**CURSOR KNOB AND DIAL. (K)**

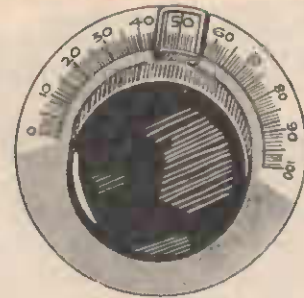

3in. diameter, satin finished, back plate No. 0-100 in black lettering. Knob is black finished. 2in. dia. and for 1/2in. shaft only. Has cursor with window which fits on shaft, etc. Cat. No. ED24 ..... **3/6**

**UTILITY SHORT-WAVE DIAL. (K)**



A British Dial for front of panel mounting. Ratio 100 to 1. Frictional drive guaranteed free from backlash. The open scale is surveyed by live-end cursor. Real hair-line, which enables accurate readings to be taken.

One of these dials will mean just the difference between receiving certain stations and not receiving them. Cat. No. ED64 ..... **12/-** each

**EFFCO DISC DIAL. (K)**

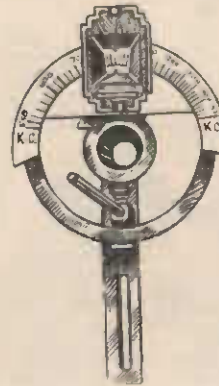

Diameter of scale 3in. Calibrated in kilocycles to suit clockwise Condensers. Back of panel mounting. Height overall 4 1/2in. Fitted with dial light and bulb. Window type escutcheon. Cat. No. ED65—  
Price **4/6**

**POINTER, KNOB AND DIAL. (K)**

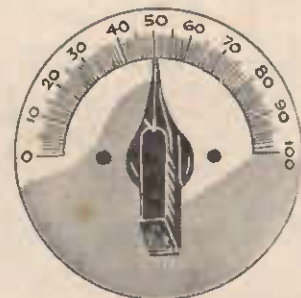

Consists of aluminium satin finished, back plate 3in. diameter, and engraved with 0-100 degrees in black lettering. The bar knob gives a direct control and is 2 1/2in. long, with white line up centre of the point.

Cat. No. ED22 ..... **2/-**

**SPARE BAR KNOBS—As above** **1/3**  
Cat. No. ED341 .....



**EFFCO BAND SPREAD DIAL. (K)**

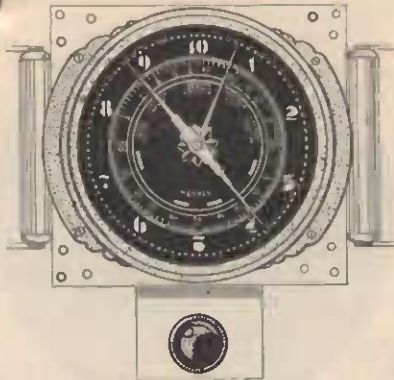

Dual-wave Band Spread Tuning Unit. This is a modern dial supplied with three glasses and giving a three-colour effect. Colour changes are operated on Short-wave Switch. Size approximately 6in. diameter. Main ratio 16 to 1, second-hand ratio 8 to 1. These new Edgelit Dials enhance the appearance of the cabinet, and are up to date in every respect.  
Cat. No. ED89 ..... Each **32/6**

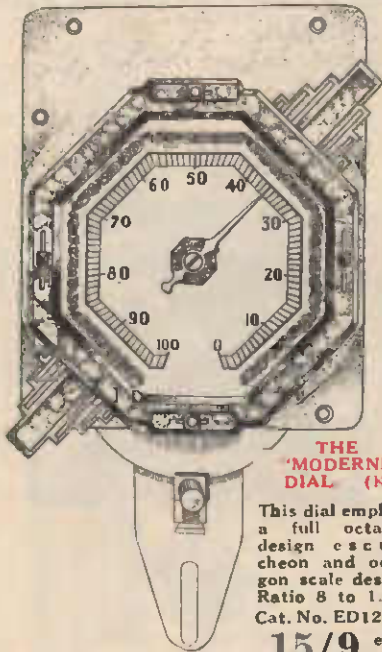

**THE "MODERNE" DIAL. (K)**

This dial employs a full octagon design escutcheon and octagon scale design. Ratio 8 to 1.  
Cat. No. ED121:  
**15/9** each

**1.B. SPECIAL SHORT WAVE DIAL. (K)**



Special Slow Motion Model for Short Wave work. Two ratios, 8 to 1, and about 120 to 1. Finely engraved scale in 200 divisions. Divisions 4 1/2 in. wide, 5 1/2 in. high. 1 in. in depth behind panel.  
Cat. No. ED86 ..... **9/6**

**LAMP HOLDERS FOR DIALS. (K)**



A skeleton type Lamp Holder which fits the standard type torch bulb. Used for illuminating dials.

Cat. No. ED502 **4** D. ea.



Fits standard screw torch or panel bulbs. Adjustable brackets with 3/16 in. long slot for screw mounting.

Cat. No. ED503 **6** D. ea.

5/3 dozen.



Ditto with clip style bracket, made to clip over condenser, etc.

Cat. No. ED504 **6** D. ea.

5/3 dozen.

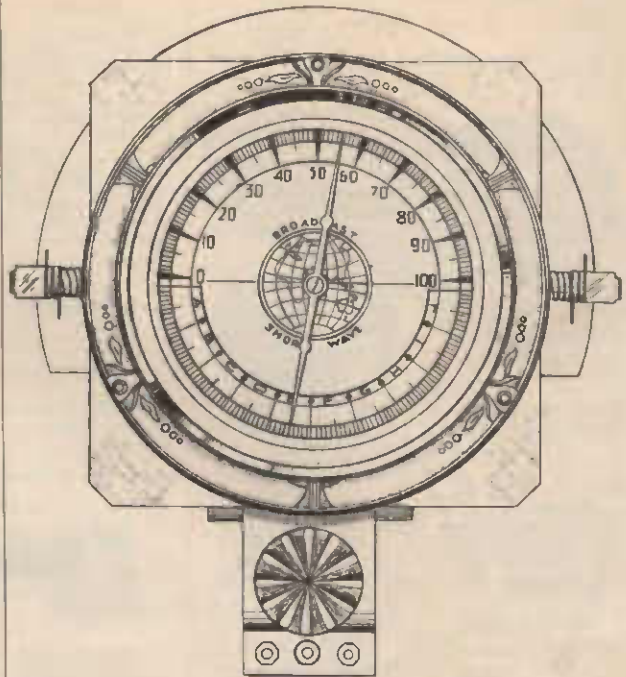

**THE "WORLD" DIAL. (K)**

Very popular design. A dial that will set off any cabinet. Exceedingly smooth and travelling through 180deg. Scale divided into two sections for broadcast and short wave.

Cat. No. ED120 ..... **16/3** each

**NEW RADIOKES DIALS. (K)**

This Dial is extremely attractive, featuring three colour lighting in red, green, and orange, and should prove immensely popular. It can be supplied in three different types: — Dual-wave Broadcast, or Tri-wave. It is of oval shape and supplied complete with attractive escutcheon.

Cat. No. Each

ED91—Broadcast Dial **27/6**

ED92—Dual-wave Ditto **28/6**

ED93—Tri-wave Dial **30/-**

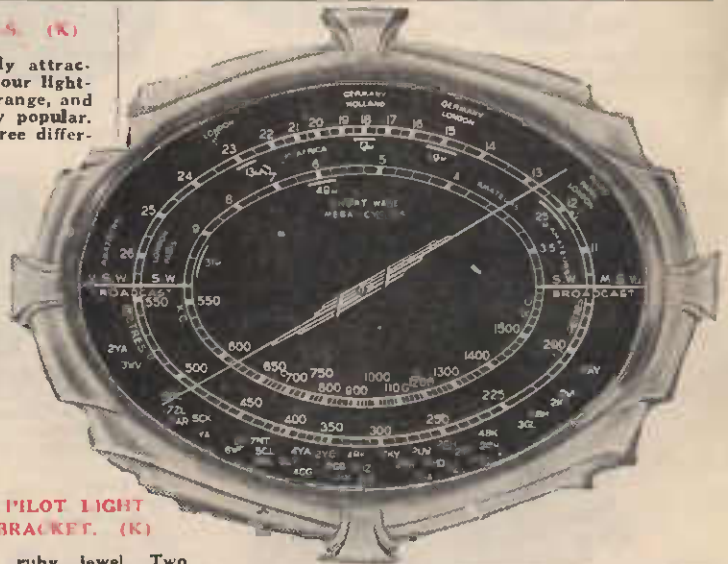

**"PILOT LIGHT BRACKET. (K)**



Red ruby jewel. Two lugs insulated from bracket. Jewel fits into 7/16 in. panel hole.  
Cat. No. ED500—

**1/9** each

**NEW DIAL.—LISSEN HI-Q DECIMAL DIAL AND SLOW-MOTION DRIVE. (K)**

A slow-motion drive for ultra short and short-wave work with an entirely new type of dial divided into 1,000 divisions. The dial is divided into 10 divisions for approximate tuning by the small pointer, and each division is subdivided by the large pointer into a further 100 divisions, so that accurate calibration is possible by decimal reading. The reduction of the drive is about 25 to 1, while special spring gears eliminate all trace of backlash. Complete with condenser-fixing bracket.

Cat. No. ED61 ..... **19/6**





**KNOBS (K)**

The Knobs illustrated are new designs on bakelite, with hole for 1/4 in. shaft. Best make, with brass inset.



Mahogany round Knob. 3/4 in. diam. Cat. No. ED301— 5D. each, 4/6 doz.  
Ditto—1 in. diam. Cat. No. ED302— 5D. each, 4/6 doz.

Round Knob, with chromium plated inset, 3/4 in. diameter. Cat. No. ED307— 7D. each, 6/- doz.



Ditto, 1 in. diameter. Cat. No. ED308 9D.

Cat. No. ED310—



Indicator Knob. 6D. each



Cat. No. ED311— Pointer Knob. 6D. each



Large Hexagon. Cat. No. ED312— 7D. each



Small Flare. Cat. No. ED313— 6D. each



Arrow Indicating Knob. Cat. No. ED316— 8D. each



Small Hexagon. Cat. No. ED314— 6D. each



Large Flare. Cat. No. ED315— 7D. each



Squat Knob. Cat. No. ED318— 6D. each



Square Knob. Cat. No. ED319— 6D. each



Cylinder Knob. Cat. No. ED317— 6D. each

**BAKELITE POINTER KNOBS. (K)**

Ideal Knobs for analyser, test equipment, 5 metre for all types of transceivers, and electrical and radio test equipment. Hole for 1/4 in. diam. shafts. Black finish with engraved white line through centre of pointer.



Cat. No. ED340—2 1/2 in. .... 10D. each  
Cat. No. ED341—1 1/2 in. .... 1/3 each

**LEVER KNOBS. (K)**

Moulded brown bakelite Lever Knobs. Over-all length, 1/2 in.



Cat. No. ED25— 4D.



Ditto—2 in. Cat. No. ED26— 7D.

**DIALS, PLAIN. (K)**



Cat. No. ED18— 2 in. dials 10D.  
Cat. No. ED19— 3 in. dials. Each 1/-  
Cat. No. ED20— 4 in. dials. Each 1/6

**"MAGIC EYE" ESCUTCHEONS. (K)**



Moulded in beautifully finished bakelite, it will finish off any radio cabinet. Made for use with "Magic Eye" Tuning Indicator. Size overall 4 1/4 in. x 1 1/4 in. Cat. No. ES225 ..... Each 1/3

**DIALS, ORMOND. (K)**



A very efficient type of slow motion dial, having a geared action. The frame is constructed of best quality bakelite of great strength, highly polished. Both fast and slow motion are provided. The former, by giving driving knob a cant towards central knob and throwing drive out of gear, enables central bush knob to manipulate the condenser spindle direct. Slow motion is obtained by pressing driving knob into original position and operating in the usual manner. The aluminium dial is in direct connection with the heel screw. Terminal is provided for separately earthing the dial. The latter may then be used as an anti-capacity earthing shield. Ratio approximately 10 to 1. Cat. No. ED63 ..... 4/6

**RADIOKES AERO DIALS. (K)**



Radiokes Colour Vision Aero Dial, marked in K.C. and numbers. Cat. No. ED124 ..... 15/-  
Radiokes Standard Aero Dial. Cat. No. ED125 ..... each 12/6

**EDGELIT AERO JUNIOR. (K)**

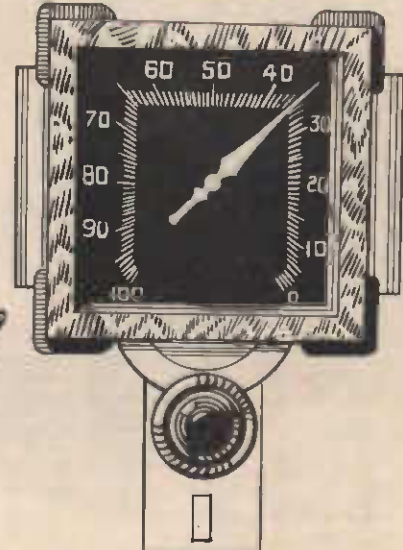

Ideally suited for Mantel Sets. Cat. No. ED90 ..... Each 17/-

**BAKELITE VERNIER DIAL. (K)**

Ratio 10-1. Easy action with standard 1/4 in. shaft. Supplied complete with knob. Diameter 3 in.

Cat. No. ED62— 3/+



**REDUCERS FOR CONDENSER DIALS. (K)**

Enables Condensers with 1/4 in. shaft to be used with dials that have 3/8 in. hole. Cat. No. ES224 ..... each 4D.



**FORMER. (K)**

This Former Tube for coil winding has very high insulating properties, the surface being made of pure bakelite. Made in England by Lissen Ltd.



- Cat. No. EF79— $\frac{3}{4}$ in. diam. 6in. lengths 7D. Each
- Cat. No. EF80 — 1in. dia., 6in. lengths. Each 7D.
- Cat. No. EF81 — 1 $\frac{1}{2}$ in. dia., 6in. lengths. Each 9D.
- Cat. No. EF82—1 $\frac{1}{2}$ in. dia., 4in. lengths (valve base size) Each 7D.
- Cat. No. EF83 — 1 $\frac{1}{2}$ in. dia., 6in. lengths (valve base size) Each 10D.
- Cat. No. EF84 — 1 $\frac{1}{2}$ in. dia., 12in. lengths (valve base size) Each 1/6
- Cat. No. EF85 — 1 $\frac{1}{2}$ in. dia., 6in. lengths. Each 1/1
- Cat. No. EF86 — 2in. dia., 6in. lengths. Each 1/3
- Cat. No. EF87 — 2 $\frac{1}{2}$ in. dia., 6in. lengths. Each 1/6
- Cat. No. EF88 — 3in. dia., 5in. lengths. Each 1/9

**FORMERS—MARQUIS, TRIPOD. (K)**

Standard sizes permit the adoption of uniform size shields..

Available in 1in. and 1 $\frac{1}{2}$ in. diameter with provision for 2in. winding space.

Cat. No. EF32—1in. diameter. 11D. each

Cat. No. EF33—1 $\frac{1}{2}$ in. diameter. 1/1 each



**PEERLESS COIL FORMERS. (K)**

Eight-ribbed Bakelite Former. Plug-in type; ideal for short-wave sets. The handle shown makes for easy insertion and withdrawal of the coils. The top (handle) screws off, facilitating wiring. Supplied in Red, Green or Black.

Cat. No. EF53—4-pin each 1/6

Cat. No. EF54—5-pin each 1/6

Cat. No. EF55—6-pin each 1/6



**DALTON COIL FORMER. (K)**

An advance in coil formers. Dalton Formers are fixed by means of a ring. All you do is to drill a hole in the chassis, plug in the former, screw up the ring, and the coil is fixed in place. No screws or brackets are necessary. Diameter 1 $\frac{1}{2}$ in. 9D. each

Cat. No. EF52— Shields for Dalton Formers 1/3 ea.



**HIGH FREQUENCY FORMER. (K)**

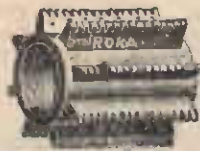

CALIT Super High Frequency, for winding special high frequency coils where it is absolutely essential there are no losses. Formers are already grooved and provided with holes to take the wire. Wiring diameter 11-16in.; length over all 1 $\frac{1}{2}$ in. Over all diameter 1 $\frac{1}{2}$ in. 8 ribs. Cat. No. EF60 2/6



Smaller size ditto for chokes, etc. Winding diameter 7-16in. Over all diameter  $\frac{3}{4}$ in. Over all length 1 $\frac{1}{2}$ in. 4 ribs. Cat. No. EF61 1/3

**TWIN TIP JACK UNITS. (K)**



A strong spring firmly makes contact to any tip inserted within its grip. Mounted on bakelite strip. Metal parts are nickel-plated. Jacks fit any standard 'phone tip. Cat. No. EJ8 7D. Each

Moulded Tip Jack, on right.

Cat. No. EJ9 2/3 Each



Useful Insulated Tip Jack.

Cat. No. EJ5—3D. each

**TIP JACKS. (K)**



Nickel-plated Tip Jacks. Strong contact springs make good contact with any standard size phone or speaker tip. Cat. No. EJ6 3D. Each

Similar to above but provided with a coloured disc (red or black), of insulating material. Cat. No. EJ7 4D. Each

**JACKS. (K)**



A small Jack which projects only one inch behind the panel. Will fit all standard size phone plugs; good contacts; bakelite insulation. Single Circuit. Cat. No. EJ2 1/9



Similar to the above. This useful Jack contacts its two pins together when a plug is withdrawn, thus maintaining the circuit. Useful for telephones and loud speakers, etc. Cat. No. EJ3—Single closed circuit 2/9 Each

**MORSE PRACTICE SET. (K)**



Ideal for all who wish to learn the Morse Code. Invaluable instructional unit for budding Radio Operators, Telegraph Operators, Sailors, etc. Adopted by the Boy Scouts of America as their National Signal Set. Consists of combination Morse Key and Buzzer. Three-position switch enables three different effects to be obtained. First position operates buzzer with sound exactly as heard by radio operators. Second position flashes signal lamps as used by ships, etc. Third position gives telegraph sounder effect for P.O. and Railway students, etc. Operates from two standard sizes, self-contained torch batteries.

The signaller is pocket size and the bulb and guard can be removed for carrying. The International Morse Code, in a new, easily read style, is mounted on an etched metal plate directly in front of the operator. The stroke of the key is adjustable.

Spring clips are provided for connecting to an additional set. When properly connected, either set can be operated and messages sent or received, signals being received by either the self-contained lamp or buzzer. Instruments finished in black and nickel. Cat. No. EH103 13/6 each

**MORSE KEY. (K)**

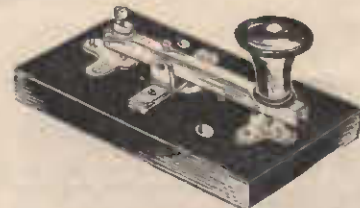

A good instrument with nickelled fittings and highly finished base. Cat. No. EH102 9/3 each

**KEYS. (K)**



Heavy brass arm, terminals and fittings. Heavy nickel-plated brass arm, terminals and fittings. Mounted on polished wood base. P.O. pattern. Cat. No. EH101 17/6 Each

**PRACTICE KEYS. (K)**



Light type for practising the Morse Code. Cat. No. EH105 4/3 each

# PALEC METERS



ACTUAL SIZE (5 in.)

## 5 in. MODEL.

Diameter across flange, 4.75 in.  
Diameter across body, 4.125 in.  
Scale length (single range), 4.5 in.  
Angle of arc, 95 degrees.

This high-grade line of Meters (5 in. class) is of the protected dial type, and is particularly suitable for bench and panel mounting.

The convex face of the highly polished bakelite case is symmetrically curved. This feature adds considerably to the instrument's appearance and at the same time enables the movement to be raised high enough, with respect to the dial, for a straight through needle of minimum weight to be fitted.

The long, clearly marked scale, in conjunction with the knife-edge pointer, reduces parallax errors to a minimum.

No flange screws are required for mounting. This is accomplished by means of the special back bracket provided.

Cat. No. EM423 ..... **£3/10/-**

## 3 in. MODEL.

Diameter across flange, 3.5 in.  
Approximate scale length, 2.5 in.  
Diameter across body, 2.75 in.  
Angle of arc, 100 degrees.

Fitted with the standard PALEC movement, this instrument can be relied upon not only for a high degree of precision, but also for its ability to withstand severe overloads.

It is housed in a polished bakelite case, and it fitted with knife-edge pointer and aluminium dial.

Cat. No. EM410 ..... **£2/12/6**

(D)

ACCURACY WITHIN 1%

The solid Cobalt Steel Magnet is magnetised and artificially aged, and can be relied upon never to vary or drop, even over a period of years.

This is a very important point, which is often overlooked in several lower grade imported Meters.

The seamless aluminium former is machine layer wound, even on the ultra sensitive micrometers, which require to be wound with enamel copper as fine as 48 SWG.

**MAGNETIC SHUNT.**—A correcting magnetic shunt is fitted across the pole pieces. This enables a ready adjustment to any degree of full accuracy.

**HUMIDITY EFFECTS.**—The movement is treated to withstand humidity effects. All metal parts, such as pole pieces, core, and magnet, are cadmium-plated as a protection against rust.

**TEMPERATURE COMPENSATION** is an added feature in PALEC Meters.

MICROAMMETERS D.C.			VOLTMETERS D.C.		
	Model 3in.	Model 5in.	(200 Ohms. per volt.)	Model 3in.	Model 5in.
	£ s. d.	£ s. d.	£ s. d.	£ s. d.	£ s. d.
0-100	4 2 6	5 5 0	0-2.5	2 12 6	3 15 0
50-0-50	4 7 6	5 8 9	2.5-0-2.5	2 15 0	3 18 9
0-250	3 8 6	4 10 0	0-5	2 12 6	3 15 0
250-0-250	3 5 0	4 7 6	0-10	2 12 6	3 15 0
0-500	2 17 6	3 18 9	10-0-10	2 15 0	3 18 9
<b>MILLIAMMETERS D.C.</b>			0-25	2 14 0	3 17 6
0-1*	2 12 6	3 10 0	0-50	2 14 0	3 17 6
0-5	2 12 6	3 10 0	0-100	2 15 0	3 18 9
0-10	2 12 6	3 10 0	0-250	2 17 6	4 0 0
0-50	2 12 6	3 10 0	0-500	3 0 0	4 2 6
0-100	2 12 6	3 10 0	(1000 Ohms. per volt.)		
0-500	2 12 6	3 10 0	0-50	2 13 6	3 19 6
0-1000	2 12 6	3 10 0	0-250	3 7 6	4 10 0
*Supplied with universal scale, unless otherwise ordered.			0-50-250	3 10 0	4 12 0
<b>AMMETERS D.C.</b>			0-500	4 2 6	5 5 0
0-1	2 12 6	3 15 0	0-100-500	4 10 0	5 12 6
1-0-1	2 15 0	3 18 9	<b>VOLTMETERS A.C., Rectifier Type.</b>		
0-2.5	2 12 6	3 15 0	Any of the above ranges listed under D.C. Voltmeters can be supplied fitted with a Westinghouse copper oxide rectifier (type MBS1 or MBS5). Additional cost, including installing, 45/-.		
0-5	2 12 6	3 15 0	<b>D.C. OHMMETERS.</b>		
5-0-5	2 15 0	3 18 9	0-500-5,000-50,000 5 5 0		
0-10	2 12 6	3 15 0	<b>THERMO-COUPLE AMMETERS.</b>		
0-25	2 15 0	3 18 9	0-1	5 2 6	5 15 0
0-50	3 7 6	4 10 0	0-2.5	5 2 6	5 15 0
0-100	3 10 0	4 12 6	0-5	5 2 6	5 15 0
0-250	3 15 0	4 15 0	0-10	5 2 6	5 15 0

Note the more popular sizes of the above. Meters are available from stock. Any meter can be supplied within 10 days from receipt of order.

**ACCURACY.**—The high standard of accuracy guaranteed on PALEC Meters is as follows: On D.C. Voltmeters and Milliammeters, the LIMIT OF ERROR OVER THE EFFECTIVE RANGE (AT 20 DEGREES C.) is within ONE PER CENT. OF THE MAXIMUM SCALE VALUE. Other types, 2 per cent.



## "PALEC" Engineer's Multi-Purpose Meter (D) Model "CM"



The Model CM Multitester is intended primarily for workshop or laboratory use. Numerous valuable ranges and tests are available to enable the Radio or Sound Engineer to cope with all problems connected with the servicing of Radio and Audio Apparatus.

### SPECIFICATIONS.

**METER:** Is fitted with a large 5in. type Meter (1,000 ohms per volt) with prominent easily read scales.

**ACCURACY:** The accuracy of same is unusually high (see Meter Page.)

**DESIGN:** Embodies a selective circuit of foolproof operation.

**CONSTRUCTION:** Has external eye appeal and is an instrument job throughout.

**RANGES: D.C. VOLTS—10-25-100-250-1,000. A.C. AND OUTPUT VOLTS (read on linear scale)—10-25-100-250-1,000.**

**DECIBELS—10-15 and 10 to 35 db. (Reference 6 mw. across 500 ohms.) D.C. MILLIAMPS—1-10-25-100-250.**

**A.V.C. MEASUREMENTS:**—An advanced feature is the ability to read D.C. potentials up to 25 volts without drawing any current from the load resistor (the equivalent of infinite ohms per volt).

**OHMS—0 - 2,000 - 20,000 - 200,000 - 1,000,000; battery operated. MEGOHMS—0-10 megohms. INSULATION TEST at 250 volts D.C. CAPACITY—,001-10 m.f.d. INDUCTANCE—0-10,000 Henrys. IMPEDANCE (at 50 c.p.s.)—0-1,000,000 ohms. ELECTROLYTIC CONDENSERS—Applies a Good-Bad leakage test to all types of electrolytic condensers and also measures capacity of same.**

**POWER SUPPLY.**—A built-in power pack operated from 200-250 volt A.C. line, supplies the necessary D.C. and A.C. voltages for a number of the above tests.

Model "CM" complete with leads and instructions in leatherette lidded case, size 8in. x 9in. x 7in.; weight, 12lbs. **£16/17/6**  
Cat. No. EM376

Model "CMS" (as illustrated), complete as above, plus Analyser Selector and extra large tool compartment. Overall size, 15½in. x 9in. x 7in.; weight, 17lbs. **£20/12/6**  
Cat. No. EM380

## PALEC Portable Valve Testers (D)



### Model "PV"

#### A.C. PORTABLE VALVE TESTER

This instrument is supplied in a compact and portable leatherette lidded case, measuring 8in. x 9in. x 7in. Its range and operation is the same as the Counter Type MV.

Is fitted with the 3in. type Meter with "Replace"—"Good" scale.

Will test on the direct reading dial, Battery, Auto, and if necessary A.C. type valves. Will also check for shorts and leakages. Two ranges of external volts, 0-7-70 volts, are provided for Battery checking; also range of external Ohms.

(Illustrated above.)

Cat. No. EM407 ..... **£14/5/-**

### MILLIAMP SHUNTS (D)

Cat. No.	Each	Cat. No.	Each
EM417—0/10 Milli-amps	4/-	EM420—0/50 Milli-amps.	4/-
EM418—0/20 Milli-amps.	4/-	EM421—0/100 Milli-amps.	4/-
EM419—0/30 Milli-amps.	4/-	EM422—0/200 Milli-amps.	4/-

# The PALEC COMBINED VALVE AND CIRCUIT TESTER

All Your Tests in One Case.

See Next Page For Particulars.

# PALEC

## A. C. Valve Tester (D) Model "MV" Counter Type



This fine looking instrument is intended for use as an aid to valve sales in stores and radio accessory shops. The circuit is of advanced design and applies a form of emission test which follows along similar lines to that recommended by the R.M.A.

**TESTS ALL VALVES**—Is designed for Australian conditions and will test all types of standard radio valves.

**HANDSOME APPEARANCE**—Will attract attention and inspire the confidence of the customer.

**MICRO LEAK TEST**—Will instantly detect leaky element Valves by means of a special Neon short test. NOTE: This test is made on a heated Valve.

**SERVICE**—Is designed and constructed to cope with future releases, and will give profitable service for many years to come. NOTE: Calibration figures of new types are supplied from time to time.

**METER**—Incorporates our large 5in. type Meter with prominent "Replace"—"Good" scale.

The Model "MV" is housed in a crystalline finished steel cabinet with sloping front panel. The over-all measurements are 19in. x 11in. x 12in. It is operated from a 200-250 volt A.C. supply. The procedure necessary to test a Valve for "merit" is simplicity itself, requiring only five operations, viz.: (1) A check of the line voltage by pressing a button; (2) the selection of the filament voltage; (3 and 4) the positioning of the selector and range controls from the figures shown on the Chart; and (5) the pressing of a button for the required reading on the Meter.

Cat. No. EM406 ..... **£17/10/-**

# PALEC

## Complete Valve & Circuit Tester Model "VCT"

(D)



### COMPLETE VALVE AND CIRCUIT ANALYSIS

The insistent demand for a complete Valve and Circuit Tester as one Unit was responsible for the design and production of the remarkably advanced and compact Model "VCT." This instrument is crowded with new and useful features and will enable the Radio Mechanic to check and test every component in a radio chassis — VALVES included.

### Specifications and Features:—

**VALVE TESTING**—Shows the condition of all types of Valves on the Good-Bad Scale as well as applying a Neon test for element leakage.

**LOW OHMS**—A range of low ohms, reading from a tenth of an ohm (ten ohms half scale) is provided for coil, contact, and dry joint checks. Three other ranges supply measurements up to 10 megohms.

**ELECTROLYTIC CONDENSERS**—All types of Electrolytic Condensers can be tested and checked on a Good-Bad scale.

**PAPER CONDENSERS**—Paper and Mica Condensers tested for open circuited connections and leakage by the Neon flash method.

**MA's** in four ranges to 250MA, D.C. VOLTS in four ranges to 1,000 volts, A.C. and Output VOLTS in four ranges to 1,000 volts.

Other points of interest are: 5in. type Meter with linear scale for A.C. readings, and VALVE RECTIFICATION for A.C. and Output measurements.

The latter is a new development and enables the maximum of unvarying accuracy plus freedom from the effects of accidental overload. All of the above plus QUICK AND SIMPLE OPERATION, attractive appearance, sound construction, accuracy, and compact size (11in. x 11in. x 6in.) makes this instrument unique.

Price, Model "VCT" (A.C. operated)  
Cat. No. EM388 ..... **£19/10/-**

### DETECTO-LITE. (K)

Every experimenter and serviceman should have a "Detecto-lite."

1. Will test any current from 110 v to 550 v., and will indicate the voltage.
2. Will tell instantly whether A.C. or D.C. current.
3. Will indicate the number of cycles.
4. Will detect live and earth wires.
5. Will give a temporary pilot light on any electrical apparatus.



Cat. No. EM252 ..... **11/6** each

### CHARGE AND DISCHARGE AMMETERS. (K)

For your Car. Made by Hoyt. Range 20/0/20 amperes. 3in. deep, diameter face 1 1/2in., flange 3in. For Ford and other cars.  
Cat. No. EM99 ..... **5/6**

### TEST PRODS. (K)

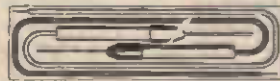

Test Prods (Red and Black), complete with flexible cable. Invaluable to servicemen and experimenters.  
Cat. No. EM254 ..... **3/-** pair

### BATTERY TESTER. (K)

Callipers with attached torch lampholder for testing torch batteries and bulbs.

Cat. No. EM251—Ea. **6D.**



### PIFCO TESTING PRODS. (K)



Pifco Patent Spring-loaded Red and Black Extension Test Prods. The points are not exposed until pressed. An easy method of testing contacts in the most remote parts of a receiver and a very useful addition to any testing instrument. Length of each prod 5in. Supplied complete with 18in. long rubber-covered cables. British.  
Cat. No. EM253 ..... per pair **5/9**

### LAMPHOUSE GUARANTEE.

"Any goods that are in any way unsuitable may be returned within seven days (from receipt) and your money will be refunded in full."



# PALEC OSCILLATOR

A FINER OSCILLATOR—  
AT A LOWER PRICE.  
MODEL D.R.

A soundly designed and constructed Oscillator is the radio man's most valuable test instrument.

**DIRECT READING DIAL** (Vernier Drive).—  
Calibrated to read simultaneously kilocycles and metres. Five ranges from 150 K.C.-16 000 K.C. (2000-19 metres).

**CONSTANT IMPEDANCE ATTENUATION** (Pad Type).

Each arm of the ten step network is individually shielded. The whole unit in turn is triple shielded, resulting in positive attenuation of the generated signal at all frequencies.

The above is a unique feature in a low-priced oscillator and enables one to make many reliable tests.

Other features are variable modulation 0-100 per cent.; a separate audio output 0-2 volts at 400 c.p.s.; a pilot light to ensure long battery life; a tapped dummy antenna for Int B. C. and S. W. bands.

The instrument is of attractive appearance and is supplied complete with valves (2), batteries and full instructions detailing Lining Up Procedure on all types of sets.

Cat. No. EM399—  
(D) £13/3/-



# PALEC VOLT-OHM-MILLIAMMETER MODEL "M5"

"The Palec" Model M5 is a reliable and an accurate multirange instrument equipped with our large 5in. type meter.

RANGES:ff—D.C. Volts, 10-100-500-1,000 (at 1,000 ohms per volt). Ma's, 1-10-50-100. Ohms, 0-2,000-20,000-200,000-2,000,000.

The latter range is obtained by connecting an external 45-volt battery to the terminals provided. The instrument is supplied in a well fitted leatherette case complete with test prods.

Cat. No. EM385 £7/10/-

### ANALYSER SELECTOR.

A special Analyser Selector which is easily fitted into the removable lid of Model M5 (see illustration) can be supplied. This Unit enables voltage and current readings to be readily taken at all points of American or Octal type Valves, without removing the chassis from the cabinet.

M5 Multi-range Meter, with Analyser Unit.  
Cat. No. EM387 £10/15/-



### PALEC UNIVERSAL METER. (D)

(Illustrated on page 64.)

Here is something you have been waiting for. An accurate Moving Coil and D.C. Meter that will make practically all tests. Shunts and Resistors can be purchased separately.

The Palec Moving Coil d'Arsonval Type Panel Meters represent a distinct advance on the standard of instruments available at a moderate price.

Although only recently made available to the general trade, they have been supplied in quantity to State and Federal Government Departments.

The very sensitive and critical parts of this instrument, such as springs, jewels and pivots are imported direct from Switzerland, while a unique feature is the Cobalt steel magnet which is specially manufactured by a well-known German firm.

These Meters are both accurate and sturdy. We guarantee them to withstand a 5,000 per cent. overload test repeated 100 times without upsetting the zero or accuracy. We further guarantee a full scale deflection inaccuracy of no more than plus or minus 1 per cent.

Palec Universal Meter.—Consisting of standard 0 to 1 milliamp with universal dial.

Cat. No. Each  
EM410—3in. £2/12/6  
EM423—5in. £3/10/-

NOTE.—Resistors and Shunts for the above instrument are extra. The Palec wire-wound bobbin type Resistors are non-inductively wound with DSC Eureka Wire, and can be relied upon to be within 1 per cent. of its rated value.

EM411—10,000 ohm 5/3  
EM412—50,000 ohm 6/3  
EM413—100,000 ohm 9/-  
EM414—250,000 ohm 16/6  
EM415—500,000 ohm 26/6

The standard bank of Resistors total of 500,000 ohm with tapings for 10, 50, 100, 250, 500 volts.

Cat. No. EM416 Each 35/-  
For Shunts see page 65.

### HERE IS THE NEW GEM METAL TUBE ADAPTOR. (D)

Tests All Metal Tubes.



This adaptor enables you to check all types of metal tubes in any tube checker. No jumper leads, external connections or trick setups necessary. Simply use the Adaptor in the type 36 tube socket of your tube tester for all tests. Has proper resistors as recommended by metal tube engineers to individually test each section of 6H6 double diode with protection to both tubes and instruments.

Two toggle switches provided—one for checking each plate of the 5Y3, 5Z4, 6A8 and 6N7 types, and the other for testing five volt tubes in the 36 basic test socket. Supplied with cap lead to contact new small size metal tube caps and stud to take regular control grid clip of present tube checker.

Checks octal based tubes, glass as well as metal, including 5Y3, 5Z4, 6A8, 6A8-G, 6B6, 6C5, 6C5-G, 6D5, 6D5-G, 6F5, 6F5-G, 6F6, 6F6-G, 6H6, 6H6-G, 6J7, 6J7-G, 6K7, 6K7-G, 6L7, 6L7-G, 6N7, and 6N7-G. Face of Adaptor carries an etched direction plate and bottom has complete detailed instructions and reading chart 3in. dia., 2 1/2in. high  
Cat. No. EM225 45/-

**"PIFCO" DE LUXE ROTAMETER. (K)**

Moving Coil Precision Instrument.  
Made in England.  
Indispensable to the Radio Engineer and  
Service Man.  
500 ohms per volt Resistance. Total  
Resistance 200,000 ohms.

The  
Sherlock Holmes  
of Radio



**RANGES:**

- 0.5 volts.
- 0.20 volts.
- 0.100 volts.
- 0-400 volts.
- 0-10 M.A.
- 0.50 M.A.
- 0-250 M.A.
- Filament and  
Resistance Test.

The Pifco Moving Coil Rotameter has eight different Dials capable of making over one hundred different tests—from the ONE INSTRUMENT. There are no external shunts or multipliers and no calculations of any kind are necessary. One set of connections only to be made and each test is available on its own different dial by a turn of the Rotameter, which is marked with range required. The Rotameter system makes the instrument more convenient and more practical than all other multi-range instruments because its simple switch movement enables tests to be made with greater speed and without the possibility of damage to the meter through wrong connections, as is possible with other instruments.



**SPECIFICATION:** Highly sensitive movement, moving on sapphire jewels. Knife-edged pointer. Zero adjuster. Black bakelite case. 22in. long rubber-covered cables. Dimensions: Height overall, 5 1/2in. Width 3 1/8in. Depth, 2 1/2in. Weight, 19 1/2 ozs.  
Pifco De Luxe Rotameter, with cables and fitted in vel-lined strongly made morocco style case.  
Cat. No. EM107 ..... **70/-**

**N.Z. RADIOGRAM.**

Published monthly. Full of interesting radio items, circuits, etc., etc. Only 3/- for a year's subscriptions, including postage.

**PIFCO**

**ROTAMETER. (K)**

One Needle Pointer. Eight Separate Dials.  
An English invention, made in England over one hundred tests.

- RANGES:**
- 0-8 volts.
  - 0-30 volts.
  - 0-250 volts.
  - Battery Test.
  - 0-20 M.A.
  - 0-100 M.A.
  - 0-250 M.A.
  - Filament and  
Resistance Test.

Nine separate meters all in one.

Incorporates the unique Rotameter principle. Every test can be made without a single change of connection. A turn of the INDICATOR and the required DIAL appears. A safety fuse is incorporated as a safeguard against damage by careless handling. The BATTERY TEST registers the voltage of the three Radiometer Cells fitted inside.



Black Bakelite case. Octagonal INDICATOR. Supplied with two 22in. long rubber-covered cables. Valves tested by plugging into holder on meter top. (English base only.)

Dimensions: Height overall, 4 9/16in. Width, 3 5/16in. Depth, 1 5/16in. Weight, 12 ozs.  
Cat. No.

- EM105—PIFCO ROTAMETER complete with cables. **47/6**
- EM106—Morocco Style Case for Rotameter. **6/6**
- EM117—Renewal Dry Cells ..... **4<sup>d</sup>**
- EM104—Spare Fuses ..... Each **10<sup>d</sup>**

**TEST YOUR BATTERIES. (K)**



Telsen Double Range Voltmeter in neat bakelite case. Every battery owner should have one of these useful meters. Ranges 0 to 9 and 0 to 180 volts. **9/6** each  
Cat. No. EM101



**DEALERS! SERVICE MEN! EXPERIMENTERS!**

Here it is! Just Released!

**PALEC 12 (D.C.) RANGE METER. (D)**

The latest PALEC triumph—a MULTI-RANGE METER incorporating the PALEC 5in. 0/1 M.A. Meter—with universal dial. Scales very clear. Easy to operate and definitely accurate on all scales. Provision is made so that a rectifier can be incorporated to give A.C. readings. Outside dimensions of case, 9 1/2in. x 9 1/2in. x 5in.  
Range Volts ..... 0/10/50/250/500  
Milli-Amps ..... 0/1/10/50/100  
Ohms ..... 0/2,000/20,000/2,000,000  
Cat. No. EM385 ..... **£7/10/-**

**R.C.S. MODULATED SERVICE OSCILLATOR. (B)**

This instrument is individually calibrated in five positions on a Standard Signal Generator, and measuring only 6 x 5 x 9in. high. The R.C.S. Oscillator will align any make or type of Radio Receiver, Intermediate Transformers, etc., as accurately as any instrument costing ten times the price. Operating on a power of 45 volts D.C. and 2 volts A.C. or D.C. Three coils are supplied, 175 K.C. (red), 460 K.C. (green), and Broadcast (brown), and the whole is completely shielded and finished with a special crackle finish. Full instructions are supplied with each Oscillator.  
Service Oscillator.  
Cat. No. EM321 ..... **£4/5/-**



**SPARES FOR PIFCO MOVING COIL METERS. (D)**

- COMPLETE MOVEMENTS ..... **25/-**
- Cat. No. EM150
- JEWELS IN SETTING ..... **1/9**
- Cat. No. EM151
- PIVOTS ..... **3/-**
- Cat. No. EM152
- MOVING COILS—With springs ..... **10/-**
- Cat. No. EM153
- HAIR SPRINGS ..... **1/-**
- Cat. No. EM154
- MOVEMENTS WITH MAGNETS ..... **27/6**
- Cat. No. EM155
- POINTERS ..... **3/4**
- Cat. No. EM156



SHERLOCK HOLMES SAYS..

*"Don't guess at the trouble TEST WITH PIFCO RADIOMETER"*



(K)



Pifco goes straight to the heart of the trouble, testing sets and components with equal ease and speed. Any radio set can be tested, either A.C. or D.C. Mains or Battery operated. Solidly constructed with fine bakelite case, the Pifco Radiometer has readings for high and low voltage, milli-amperes, ohms, continuity test, etc.

The "ALL-IN-ONE" RADIOMETER for A.C. or D.C.—For testing electric or battery radio sets. Anybody can trace faults with this wonder instrument. Finished in black bakelite. Size of dial 1 3/4 in. by 3/4 in., complete with leads.

Cat. No. EM103 ... (K) **21/-**

**ROTAMETERS and RADIOMETERS**  
PIFCO ON THE SPOT WILL TRACE YOUR TROUBLES LIKE A SHOT

**Hydrometers (K)**



A full-sized Hydrometer, robust make. Length 12in. Air-tight ribbed rubber bulb. Octagon nozzle which prevents the instrument from rolling. Beaded float included that does not adhere to side of glass barrel when testing.

Cat. No. EM300 Each **2/11**



Cat. No. EM301— Spare float for above. **1/- each**

**MIDGET BALL HYDROMETERS. (K)**



These are accurate, and the acid is tested by means of three coloured balls. The condition of the accumulator is shown instantly by the way the three balls of different specific gravities and colours sink or float, indicating fully charged, half charged, and discharged. (British.)

Cat. No. EM302 ..... Each **1/3**

**You CAN be Well!**  
Prove it by High Frequency Treatments with the  
**VIOLET RAY MACHINE**  
Full Particulars from -  
The Electric LAMPHOUSE LTD  
21, Manners St., Wellington

**"ACCURITE" METERS. (K)**



These Meters have been made to our specifications. Known as the CN type, they are of the moving coil pattern, and are for D.C. only. Scale diameter, 2in. Overall diameter, 2 3/4 in. Contained in moulded bakelite cases with highly polished nickel plated facings. These meters are dead-beat, accurate and durable.

**METERS, "ACCURITE." Moving Coil.**

Cat. No.	Each
EM1—0/1 Milli-Amps. ....	<b>37/6</b>
EM2—0/5 Milli-Amps. ....	<b>37/6</b>
EM3—0/10 Milli-Amps. ....	<b>37/6</b>
EM4—0/20 Milli-Amps. ....	<b>37/6</b>
EM5—0/30 Milli-Amps. ....	<b>37/6</b>
EM7—0/100 Milli-Amps. ....	<b>37/6</b>
EM8—0/200 Milli-Amps. ....	<b>37/6</b>

**Double reading type C.N. Milli-amp.**

EM102—0/1 and 0/100 M.A. ...	<b>47/6</b>
EM11—0/400 Volts .....	<b>42/6</b>
EM12—0/1 Amp. ....	<b>37/6</b>
EM13—0/5 Amp. ....	<b>37/6</b>
EM14—0/10 Amp. ....	<b>37/6</b>
EM15—0/20 Amp. ....	<b>37/6</b>

**"ACCURITE" A.C. METERS. (K)**



"Accurite" Type P.E.F. Meters are of the moving iron type. 2 3/4 in. diameter. Quite reliable and will work on both A.C. and D.C.

Cat. No.	Each
EM16—0/20 M.A. ....	<b>15/6</b>
EM17—0/30 M.A. ....	<b>15/6</b>
EM18—0/50 M.A. ....	<b>15/6</b>
EM19—0/100 M.A. ....	<b>15/6</b>
EM20—0/5 Volts .....	<b>15/6</b>
EM21—0/120 Volts .....	<b>15/6</b>

**THE MICROHM (REGD.)**

**WIRE-WOUND POTENTIOMETER. (K)**

A precision component incorporating the latest developments of potentiometer design. Standard shafts are 1/16 in. diameter and 1 1/2 in. long.

The following exclusive features make the Microhm Wire-wound Potentiometers the best available.

1—A staggered contact ensures an absolute minimum of jump between turns on the resistance strip, and provides an exceptionally even variation of the resistance from half-turn to half-turn.

2—A specially hardened nickel silver spring maintains an even tension during the rotation of the contact.

3—Only the highest quality nichrome wire has been used, expertly wound on rag fibre and finished with cellulose adhesive, which gives a "nearly perfect" resistance strip.

4—Two nickel silver pressure plates ensure efficient electrical connection and smooth mechanical movement.

5—An attractive bakelite case with pressed metal dustproof cover complete the Microhm Potentiometer.

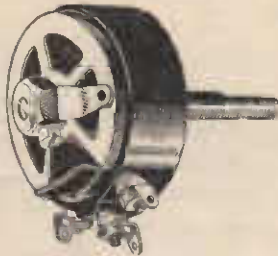

Cat. No.	Each
EP30—400 ohm	3/6
EP31—1000 ohm	3/6
EP32—2500 ohm	3/6
EP33—5000 ohm	3/6
EP34—10,000 ohm	3/6
EP35—15,000 ohm	3/6
EP36—20,000 ohm	3/6

**POTENTIOMETERS, CARBON. (K)**



Chicago carbon type employs a full wiping contact between the movable contact member and the hard smooth commutation element.

Cat. No. EP49—10,000 ohm	3/3 each
Cat. No. EP50—25,000 ohm	3/3 each
Cat. No. EP51—50,000 ohm	3/3 each
Cat. No. EP52—100,000 ohm	3/3 each
Cat. No. EP53—250,000 ohm	3/3 each
Cat. No. EP54—500,000 ohm	3/3 each
Cat. No. EP55—1 meg.	3/3 each

**LISSEN 50,000 OHM WIRE-WOUND POTENTIOMETER. (K)**

Cat. No. EP77	Each 5/6
---------------	----------

**POTENTIOMETERS, WITH SWITCH. (K)**



(Chicago Potentiometer with switch)

Cat. No.	Each
EP48—10,000 ohm wirewound	4/9
EP60—25,000 ohm, carbon	4/9
EP61—50,000 ohm, carbon	4/9
EP62—100,000 ohm, carbon	4/9
EP63—250,000 ohm, carbon	4/9
EP64—500,000 ohm, carbon	4/9

**PLUGS—SPEAKER. (K)**

Made of bakelite. For use with moving coil speakers, etc. Moulded in two threaded pieces and made to ensure perfect contact in standard type valve sockets. Ample internal space permits easy wiring. The knurled grip on the full exterior makes for easy insertion and withdrawal.



Cat. No.	Each
EP252—4-pin	8D.
EP253—5-pin	8D.
EP254—6-pin	9D.
EP255—7-pin	10D.

**DALTON POWER PLUG. (K)**



Mounted on back of chassis by means of ring lock device. This power plug enables the set to be completely disconnected from the power supply. Greatly facilitates the installation and disconnection of the receiver.

Cat. No. EP259	Each 1/9
----------------	----------

**SHIELDED CABLE PLUGS. (K)**

Plugs:

A metal capped plug with moulded male or female section—securely held in by spring ring—unbreakable and designed for use on all radio sets—amplifiers, test equipment, etc.



Cat. No. EP300—4-prong	All
Cat. No. EP301—5-prong	2/3
Cat. No. EP302—6-prong	Each

Sockets:

Cat. No. EP310—4-hole	
Cat. No. EP311—5-hole	
Cat. No. EP312—6-hole	

All 2/3 each



**PLUG, 'PHONE. (K)**



An inexpensive 'phone plug. The tips are held by spring contacts. The advantage is that the cords can be removed very quickly. Cat. No. EP265 ..... Each 1/-

**PLUG, 'PHONE. (K)**

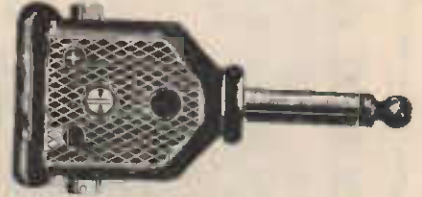

This is a well-made 'Phone Plug. The speaker tips are held by a small set screw in each side. This ensures a good contact at all times. Cat. No. EP266 ..... 1/6 each

**PHONE PLUGS. (K)**



A good Phone Plug at a low price. (Foreign). Cat. No. EP267 ..... 9D. each

**MINIATURE WALL PLUG AND SOCKET. (K)**



Handy for speaker extension, etc. Cat. No. EP256—8D. complete

**BRACKETS. (K)**

ANGLE BRACKETS—Useful for many purposes such as mounting components, panels, etc. 1/2 in. x 1/2 in. Cat. No. ES211 ..... 2D. each

1 1/2 in. x 1 1/2 in. Cat. No. ES210 3D. each

1 1/2 in. x 1 1/2 in. Ditto— Cat. No. ES209 3D. each

2 1/2 in. x 2 1/2 in. Ditto— Cat. No. ES208 4D. each

3 1/2 in. x 4 1/2 in. Aluminium Cat. No. ES207— 10D. each

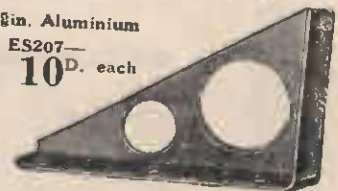



**COSMOCORD GRAMO CHASSIS. (G)**



This unit is the result of years of research work and manufacturing. The motor is absolutely constant in its speed, due to a specially designed governor, and has plenty of reserve power. Running of motor is practically inaudible. Speed Regulator, 74-82 r.p.m. 12in. De Luxe Turntable double action, fully automatic switch, with micrometer adjustment. Balanced tone. Cosmochord pick-up, with swivel head for easy needle changing. Screen-pick-up lead, pick-up rest, needle cup with slotted cap, volume control. All mounted on bakelite unit plate. Template for fitting and instructions are supplied.

Cat. No. EP210 ..... **£5/10/-**

**COSMOCORD PICK-UP HEAD. (K)**



Pick-up head which will fit the tone arm of practically all makes of gramophones. Good tone, low noise level. Weight on record, approx. 4 ozs.

Cat. No. EP203 ..... **11/6** each

**GRAMOPHONE MOTORS. (G)**



"Undy" Gramophone Motors, complete with turntable. Can be used either on 110 or 230 volt A.C. supply. Well constructed job, perfectly balanced. Speed control.

Cat. No. EM604 ..... **58/6** each

**COSMOCORD PICK-UPS. (K)**

The introduction of this Pick-up marks a great step forward in design. Completely moulded in bakelite of pleasing brown finish. Will give a perfectly uniform frequency response and has self-contained volume control in the base. Ea. **32/6**

Cat. No. EP202



Cat. No. EX921—Short type, as illustrated. **3/6**

**COSMOCORD Model 176 GRAMOPHONE PICK-UP. (K)**



Combines high volume with correct bass compensation and is suitable for practically every type of radio receiver. It is particularly noted for its full, rich tone, and its extremely pleasant rendering of both vocal and instrumental records. Supplied complete with arm, volume control, and 3ft. of silk-braided connecting lead.

Cat. No. EP205 ..... **36/6**

**"HAMS"—SPECIALLY FOR YOU! (K)**

Special purchase of used P. and T. TELEPHONE TRANSMITTERS, in good order. Make excellent "Mikes." Long type.

Cat. No. EX920 ..... **3/6** each

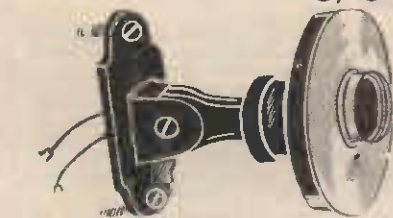

Cat. No. EX921—Short type, as illustrated. **3/6**

The Morphy Richards tone balanced record reproducer is introduced as a direct result of the persistent demand for an instrument of outstanding quality at a singularly reasonable price. The designer—a sound engineer of many years' experience—justly claims with great satisfaction and no little pride, that the Morphy-Richards Pick-up functions perfectly under widely varying conditions and can be relied on to give many years of satisfactory and trouble-free service.

Complete unit as illustrated with twin connecting leads; with built-in 50,000 ohms volume control.  
Cat. No. EP204 ..... **27/6** (K)  
Only



**CONNECTICUT TABLE MICROPHONES. (K)**

Furnished with a large sensitive single-button microphone and four-pin spring suspension. This microphone is 14 inches high, with pressed steel base, input transformer, on and off toggle switch, and cord. Nicely finished in black and green crackle with nickel trim. Two dry cells, No. 6 type, or one 4 1/2 volt "C" battery are required to furnish the current for the microphone. Packed in attractive display boxes with complete instructions for connecting and operating.



Cat. No. EM502 ..... **39/6**  
Each

**CONNECTICUT STAR MICROPHONES. (K)**

Here's a useful microphone of pleasing design, durable construction. Large diaphragm with single carbon button. Connects directly to detector tube. Microphone may be left permanently connected and programme cut in "on" at any time by means of button mounted in front of case. No batteries required. Made in U.S.A.



Cat. No. EM501 ..... **8/6**  
Each

**PANELS**

**PANELS—BLACK INSULATING. (G)**

These Panels are British and made of the very best quality insulating material. Highly polished on one side. Mechanically strong, but yet quite easy to cut and drill. 3-16in. thick.

Cat. No.	Each
EP1—9in. x 7in.	<b>3/6</b>
EP2—12in. x 7in.	<b>3/9</b>
EP3—15in. x 7in.	<b>5/9</b>
EP4—18in. x 7in.	<b>6/3</b>
EP5—21in. x 7in.	<b>6/6</b>
EP6—24in. x 7in.	<b>7/6</b>

**FUSES. (K)**

These Fuses screw into a holder like torch bulbs, but they will burn out and save your valve filaments should you make a wrong connection. 60 M.A.



Cat. No. ES221—**9D.** Each

**FUSE HOLDERS. (K)**

for Fuse Bulbs.  
Bakelite Holders  
Cat. No. ES222—**6D.** Each



**5/6** Dozen

## STANDARD RESISTOR COLOUR CODE

In the R.M.A. (American) standard coding, ten colours are assigned to the figures as shown in the following table:—

Figure.	Colour.	Figure.	Colour.
0	Black	5	Green
1	Brown	6	Blue
2	Red	7	Violet
3	Orange	8	Grey
4	Yellow	9	White

The body of the Resistor is coloured to represent the first figure of the resistance value. One end of the resistor is coloured to represent the second figure. A band or dot of colour, representing the number of ciphers following the first two figures, is located within the body colour.

### EXAMPLES:

Ohms.	Body.	End.	Dot.	Ohms.	Body.	End.	Dot.
100	Brown	Black	Brown	15,000	Brown	Green	Orange
150	Brown	Green	Brown	20,000	Red	Black	Orange
200	Red	Black	Brown	25,000	Red	Green	Orange
250	Red	Green	Brown	30,000	Orange	Black	Orange
300	Orange	Black	Brown	40,000	Yellow	Black	Orange
350	Orange	Green	Brown	50,000	Green	Black	Orange
400	Yellow	Black	Brown	60,000	Blue	Black	Orange
450	Yellow	Green	Brown	75,000	Violet	Green	Orange
500	Green	Black	Brown	100,000	Brown	Black	Yellow
750	Violet	Green	Brown	150,000	Brown	Green	Yellow
1,000	Brown	Black	Red	200,000	Red	Black	Yellow
2,000	Red	Black	Red	250,000	Red	Green	Yellow
3,000	Orange	Black	Red	300,000	Orange	Black	Yellow
4,000	Yellow	Black	Red	500,000	Green	Black	Yellow
5,000	Green	Black	Red	750,000	Violet	Green	Yellow
6,000	Blue	Black	Red	1,000,000	Brown	Black	Green
10,000	Brown	Black	Orange	2,000,000	Red	Black	Green



**SPEER COLOUR CODED RESISTORS. (K)**  
Conservatively rated at 1 Watt. They will stand up to 50 per cent. over load without injury. Colour coded to the R.M.A. standard. They are accurate to within 5 per cent. of stated values, which remain constant whether in use or in stock. Perfectly noiseless and completely free from hand capacity effects.

Cat. No.	Ohms.
ER210	100
ER211	200
ER212	250
ER213	300
ER214	400
ER215	500
ER216	750
ER182	1,000
ER183	2,000
ER184	3,000
ER185	4,000
ER186	5,000
ER187	7,500
ER188	10,000
ER189	15,000
ER190	20,000
ER191	25,000
ER192	30,000
ER193	50,000
ER194	75,000
ER195	100,000
ER196	150,000
ER197	200,000
ER198	250,000
ER199	300,000
ER200	500,000
ER201	1 megohm
ER202	2 megohm
ER203	3 megohm
ER204	4 megohm
ER205	5 megohm
ER206	6 megohm
ER207	7 megohm
ER208	8 megohm
ER209	10 megohm

ALL  
**6D. EACH**  
**4/6 DOZEN**

### MOTOR RADIO SUPPRESSORS. (K)



Distributor type. **1/9** each  
Cat. No. ER227  
Spark Plug Type (top illustration). A sturdy unit which meets the most exacting demands for spark plug suppression.  
Cat. No. ER226 ..... Each **1/9**

### "ACCURITE" RESISTORS. (K) (Wire Wound.)

These Resistors are rated at 100 M.A. and can be used in all circuits calling for a robust resistor of substantial carrying capacity.



Cat. No.	Value	Rating	Price
ER32	10 ohm centre-tapped	100 M.A.	6D. EACH
ER33	20 ohm centre-tapped		
ER31	50 ohm centre-tapped		
ER34	75 ohm centre-tapped		
ER35	100 ohm centre-tapped		
ER36	150 ohm		
ER37	200 ohm		
ER38	250 ohm		
ER39	300 ohm		
ER40	350 ohm		
ER41	400 ohm	100 M.A.	8D.
ER42	420 ohm		
ER43	450 ohm		
ER44	500 ohm		
ER45	750 ohm		
ER46	1000 ohm	50 M.A.	1/- EACH
ER49	1200 ohm		
ER47	1500 ohm		
ER48	2000 ohm		
ER50	3000 ohm		

### R.C.S. VOLTAGE DIVIDER (Heavy Duty) 50 M.A. (K)



These are wound on tubing 3in. in diameter, and the highest grade nichrome wire is used in their winding. The current capacity is 50 M/A. The contact clips are of a special flat type, which, while making perfect contact, do not damage the wire, as with the indented clips. The total length of the 15,000 ohm Divider is 5in., and has two clips. The 25,000 ohm Divider has three clips and is 7 1/2in. long.

Cat. No. ER82	15,000 ohms	2/10
Cat. No. ER83	25,000 ohms	3/9

### R.C.S. STANDARD VOLTAGE DIVIDERS.

Cat. No. ER84	15,000 ohms	1/9
Cat. No. ER85	25,000 ohms	2/3
Cat. No. ER86	Spare Clip for Voltage Dividers	2D. each

### RHEOSTATS. (K)

Radiokes Wire-wound, 30 ohm	3/9
Cat. No. ER503	

### HELIOGEN WIRE-WOUND 5-WATT RESISTORS. (K)

Wound on Porcelain Tube, size 2 1/2 x 19-32. Nickel plated clips. Capacity 5 watts.



Cat. No.	Value	Price
ER218	2,500 ohm	2/6
ER219	5,000 ohm	2/9
ER220	10,000 ohm	3/-
ER221	15,000 ohm	3/6
ER222	25,000 ohm	4/-
ER223	50,000 ohm	4/6
ER224	100,000 ohm	5/-
ER225	200,000 ohm	7/6

### SPARE VOLTAGE DIVIDER CLIPS. (K)

Supplied complete with nut and washer, ready for fitting.



Cat. No. ER88	Each	2D.
---------------	------	-----

### RHEOSTATS. (K)

20 ohm. Crossley Rheostats. Well constructed and wire wound. Because they are not the latest type they are offered for—



Cat. No. EX3	Each	1/-
Cat. No. EX137	6 ohm. ditto	6D. each

### RODS, THREADED—BRASS (K)

Threaded Rod is useful for many odd jobs. 12in. lengths.

Cat. No. ES218	6BA	5D. each
Cat. No. ES219	4BA	5D. each
Cat. No. ES220	2BA	6D. each

### 1938 RADIO CALL BOOK. (B)

This publication is absolutely essential if you are to enjoy your radio. It contains the official list of all New Zealand and Oversea Broadcast and Short-wave Radio Stations, together with all pertinent details, and is always thoroughly up to date. Get your copy without delay.

Cat. No. EB708	Price	1/-
----------------	-------	-----



**AMPLION SPEAKERS.**

Improvements in cone manufacturing have enabled consistency of characteristics to be maintained in production.

Raw cones are tested for such characteristics as mass and fundamental resonance frequency between definite production limits, and finished loudspeakers are tested individually for fundamental and cone resonances.

By a new process the cone-paper is "waterproofed" during fabrication.

Improvements in design have resulted in extension of low frequency response, reduction of harmonic distortion, improved transient response and control of fundamental and cone resonance.

In the 8in. and 10in. loudspeakers the peak in the response curve due to fundamental resonance occurs at 80 cycles per second and is from 4 to 5 decibels lower than in previous models.

The peak is also considerably broader than in previous speakers and the result is a gradually rising response characteristic from 200 to 70-80 cycles per second. This causes an extension of bass response down to 40-50 cycles per second, an absence of "boom," a reduction of harmonic distortion due to non-linearity, an increased intelligibility of speech and naturalness of musical reproduction.

**AMPLION PERMANENT MAGNET SPEAKERS. (K)**

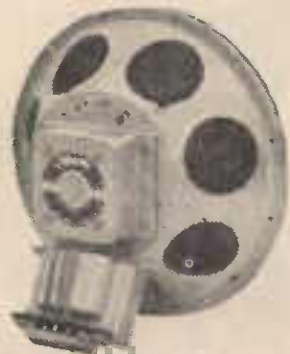

**MODEL "K"**

A 5in. Permanent Magnet Dynamic Speaker with built-in Darwin Alni-Magnet, otherwise similar to "M" type. Fitted with 10in. leads and mounting bracket.

Cat. No. ES808 ..... **£1/12/6**

**MODEL "G"**

A 6½in. Permanent-Magnet Dynamic Speaker particularly suitable for auto receivers. Transformers for single output only, 14in. leads and mounting bracket.

Cat. No. ES809 ..... **£1/17/6**

**MODEL "O1"**

An 8in. Permanent-Magnet Dynamic Speaker with over size Type "TA" Transformer. Fitted with entirely new cone giving splendid frequency response.

Cat. No. ES810 ..... **£2/7/6**

**MODEL "O5x." (K)**

A 10in. Permanent-Magnet Dynamic Speaker employing a high fidelity corrugated cone and over size or "TA" type of Transformer. Frequency response similar to the "S" type.

Cat. No. ES811 ..... **£3/15/-**

**CABINETS for above Speakers. 27/6**  
See page 52. Each (Extra)

**WRIGHT DE COSTER UNIVERSAL ELECTRO-DYNAMIC SPEAKERS. 3½-WATT TYPE. (K)**

Wright de Coster provides a Universal Speaker with special field and special transformers. It has a universal field which furnish the following:—2500, 2200, 1800, 1800 tapped at 300, 1500, 1000 and 700 ohms, furnished with universal transformer, dust and rust proof, voice coil impedance, 5.3 ohms at 400 cycles.

Cat. No. ES813—10in. .... **50/-**

Cat. No. ES814—12in. .... **70/-**

**AMPLION ELECTRO-MAGNET TYPES. (K)**



**MODEL "M"**

5in. Electro-Magnet Speaker with "TG" type Transformer. Transformer has been remodelled to increase output at lower frequencies. For single output only. Fitted with 10in. leads.

Cat. No. ES799 ..... **£1/7/6**

**MODEL "F"**

6½in. Electro-Magnet Speaker with "TG" type Transformer. A fundamental resonance frequency is maintained between 120-140 cycles per second to provide high fidelity and good bass response. For single output only. Fitted with 20in. cord.

Cat. No. ES800 ..... **£1/10/-**



**MODEL "Q"**

An 8in. Electro-Magnet Speaker with "TA" type Transformer. Improvements in cone construction have resulted in an extension of low frequency response and reduction of harmonic distortion. Fitted with 23in. cord and plug.

Cat. No. ES801 ..... **£1/15/-**

**MODEL "S"**

A 10in. Electro-Magnet de luxe Speaker with over size Transformer fitted with new high fidelity corrugated cone. Response of 80 cycles is equal to about 400 cycles. Fitted with 23in. cord and plug.

Cat. No. ES802 ..... **£2/15/-**

**MODEL S.A. (K)**

Robust 10in. Dynamic Speaker, fitted with new Multi-impedance Transformer, specially designed for 6L6 type of valves.

Cat. No. ES798 ..... Price **£3/10/-**

**LISSEN PERMANENT MAGNET MOVING COIL SPEAKERS. (K)**

The Ideal Speaker for Battery Sets.

An altogether outstanding Speaker, with a performance equalling that of much larger instruments, and certainly out of all proportion to its compact size and modest price. It is almost impossible to adequately describe the performance of this new Lissen Permanent Magnet Moving Coil Loud Speaker, and every home constructor and serviceman interested in this type should try this Lissen Model out.

Each Loud Speaker carries an output transformer securely fixed to the chassis. The transformer is supplied with four terminals, to which the leads from the receiver can be easily secured. Each terminal is identified by a coloured disc.

Perhaps one of the most remarkable features about this Speaker is its sensitiveness, for although it will handle tremendous output without a sign of distortion, weak distant signals are reproduced without trouble.

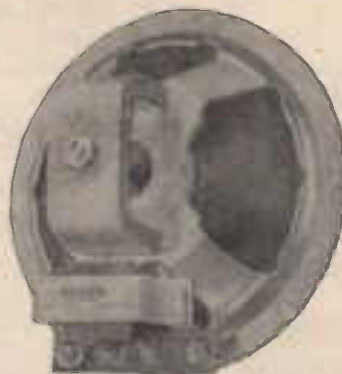

Cat. No. ES757 ..... **39/6** each

Spare Tapped Transformers for Lissen Speakers. **12/6**

Cat. No. ET704 ..... **12/6**



**ADD AN EXTRA SPEAKER (K)**

Enjoy the programmes in bed, or in another room. An excellent 3-in. high impedance magnetic speaker, in handsome black bakelite cabinet as illustrated, 5½in. wide, 6½in. high, by 2½in. deep. Easily attached to any set. Fully enclosed with insulated back cover for protection against dust, dirt, etc. Has "on" and "off" switch controlling each individual speaker. Supplied with clips for extension cord or wire connections. High impedance of speaker windings ensures excellent reproduction without affecting tonal quality of the radio set. Ideal for hospitals, schools, restaurants, etc. With instructions for connecting.

Cat. No. ES750, and only ..... **29/6**

**ORDERING SPEAKERS. (K)**

When buying a Speaker it is important that it is equipped with the correct transformer to match the output transformer in your set. Do not fail to state the type of output valve you are using. One advantage of Amplion is that spares are always available. Prices are as follows:—

ES820—Spare Field Coils ..... **13/-**

ES821—Spare Cones and Voice Coils ..... **13/-**

ES822—Spare Transformers ..... **12/9**

*Make every room  
a Reception  
Room*

WITH THE NEW

**LISSEN**



**EXTENSION SPEAKER (K)**

- PERMANENT MAGNET SPEAKER WITH 6in. CONE.
- ATTRACTIVE CABINET, 9in. HIGH x 12in. WIDE x 6in. DEEP. IN DARK BROWN WOOD WITH CREAM ESCUTCHEON.

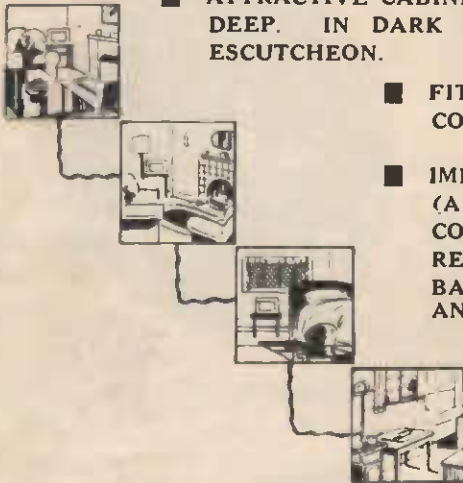

- FITTED WITH 5000 OHMS VOLUME CONTROL.

- IMPEDANCE OF SPEAKER (APPROX. 20,000 OHMS) PERMITS CONNECTION TO ALL TYPES OF RECEIVERS, WHETHER MAINS OR BATTERY, HAVING HIGH IMPEDANCE OUTPUT.

Cat. No. ES749 .....

**35/-**

**WRIGHT DE COSTER.**

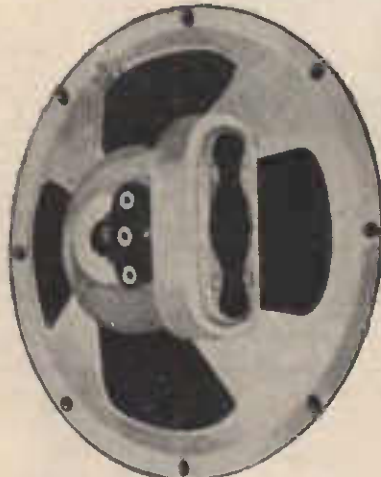

Hyflux Magnetic Speaker. (K)

Ideal for battery sets, extension speakers, P.A. systems, etc., etc. Built to the high quality standard of "Wright de Coster." 6in. diameter.

- Cat. No. ES759—7000 ohm (for most single output valves). Each **22/6**
- Cat. No. ES760—10,000 ohm. (for valves in push pull) Each **22/6**
- Cat. No. ES761—750 ohms. Each **22/6**
- Each Cabinet for the above speaker. **27/6**
- See page 52. Each (Extra)

**JENSEN HIGH FIDELITY SPEAKER. (K)**  
Model A12.

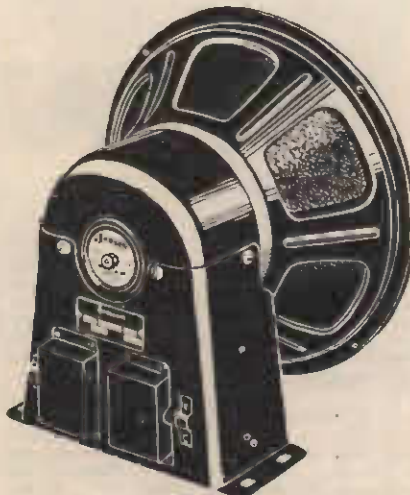

The High Fidelity model provides a practical solution to the problem of single speaker equipment in receivers which are to be "Audibly" better than the usual set. 12in. diameter and 1 1/2in. voice coil. Will handle 10 watts continuously and a peak of 15 watts. Voice coil has an impedance of 8 ohms at 400 CPS. This speaker can be used anywhere it is required to have perfect reproduction.

Cat. No. ES766 ..... **£10**

**SAXON 12-in. SPEAKERS. (K)**



Real life-like tone from these whopper 12-inch Speakers offered while present stocks last. Field 2,500 ohms. Supplied complete with input transformer for single penthode.

Cat. No. ES812 ..... Each **35/-**



**SELECTOR SWITCHES (K)**

The I.C.A. Selector Switches for changing wavelengths. Excellent for analysers, tube testers, and for general radio laboratory use or for use as rotary toggle switches. 3in. Single Hole Mounting. Single gang. Supplied in various positions. Made of laminated bakelite. The springs are of sturdy phosphor bronze for positive contact. The shaft extension is 1/2in. dia. x 2 1/4in. long.

- Cat. No. ES500—SPDT ..... **3/9**
- ES501—DPDT ..... **4/6**
- ES502—3PDT ..... **5/-**
- ES503—4PDT ..... **6/-**
- ES504—5PDT ..... **7/-**
- ES505—6PDT ..... **7/6**

**JENSEN 12X SPEAKER. (K)**

A new Jensen model Speaker. Embodies high fidelity design in a reasonably priced speaker. Specification: New Curvilinear cone, high efficiency, exceptional power handling capacity, voice coil impedance 5.5 ohms. Supplied complete with input transformer. (State valves used). Diameter 12in. Made in U.S.A. **£5/10/-**

Cat. No. ES767 .....

**CORDS, SPEAKER. (K)**



- Cat. No. EC197—6ft. Speaker Cords, lugs one end, tips the other. **1/6**
- EC198—10ft. Speaker Extension Cords, tips both ends. **1/9**
- EC196—Connector ..... Extra **1/-**
- EW100—4-wire Speaker Cable—yard **8D.**



R.C.S. MIDGET COIL CAN. (K)

Midget Coil Can, measuring 2 1/2 x 2 1/2 in diameter, and was specially designed for R.C.S. Coils wound on 1 1/2 in. formers, so as to give complete band coverage.



Cat. No. ES907—  
10<sup>D</sup>. Each

R.C.S. 2-PIECE COIL CAN. (K)

Two pieces, one used for the can, the other being the base, which is punched with a 1 1/2 in. hole in the centre for leads, and three special holes to suit the Marquis Former, on which most R.C.S. Coils are wound. With a 1 1/2 in. diameter former coil, it is important that the coil can be of the correct height and diameter for complete coverage of the band.



Cat. No. ES909 ..... Each 1/2

VALVE SHIELDS. (K)



ES901 ES903 ES902

Valve Shields for modern receivers. All supplied with Cap and Base.

Cat. No. ES901. This is the usual 58 type shield ..... Each 1/3

Cat. No. ES902—A new type of shield for modern sets. Parallel sides. The advantage of this type is their neat appearance and the fact that they take slightly less room on the chassis than other types. .... Each 1/3

Cat. No. ES903—Known as the 24 type. Now used mainly in connection with battery type screen grid valves. .... Each 1/3

COIL SHIELDS. (K)



Aluminum Coil Shields.

Cat. No. ES904—Size 4 x 2 1/2 in. .... Each 1/—  
Cat. No. ES905—Size 3 x 2 1/2 in. .... Each 1/—



GOAT VALVE SHIELDS. (K)

Goat form fitting Valve Shields. Complete with base clips.

Cat. No. ES910— 6<sup>D</sup>.  
Each

EBY LOW LOSS SOCKETS. (G)

Eby Low Loss Isolantite Sockets, as the name implies, are made of the highest quality of ceramic material, which is well known as high quality insulation for ultra high frequency circuit use. The exposed upper surface of the socket is glazed to resist moisture absorption or dust accumulation, the underside being unglazed.



Special contacts are used, which are made of highest grade Phosphor Bronze obtainable, which is hot tinned. The socket is adapted for mounting on chassis at 1 11/16 in. or 1 27/32 in. centres.

Cat. No. ES654—4 prongs ..... 3/—  
Cat. No. ES655—5 prongs ..... 3/—  
Cat. No. ES656—6 prongs ..... 3/3  
Cat. No. ES657—7 prongs ..... 3/3

EBY WAFER SOCKETS. (K)

Ruggedly constructed. Certain connection with three points contacting each of the valve pins. Standard mounting centres.



Cat. No. ES631—4-pin ..... 5<sup>D</sup>. each  
4/3 doz. ....  
Cat. No. ES632—5-pin ..... 5<sup>D</sup>. each  
4/6 doz. ....  
Cat. No. ES633—6-pin ..... 5<sup>D</sup>. each  
4/9 doz. ....  
Cat. No. ES634—7-pin ..... 5<sup>D</sup>. each  
4/9 doz. ....  
Cat. No. ES635—8-pin ..... 6<sup>D</sup>. each  
5/6 doz. ....  
Cat. No. ES636—7-pin Sockets ..... 6<sup>D</sup>. each  
for 59 Valves, etc.

SOCKETS—MARQUIS. (K)

Described by the manufacturers as "The Ultimate in Valve Sockets." Can be fitted to chassis or sub-panel. Fitted with contacts each in separate moulded pockets, having four parallel contacts positively pressing on each valve pin, thus ensuring enhanced grip and better point conductivity. The use of only one screw in assembly dispenses with numerous eyelets and short circuits are obviated by absence of loose metal parts to catch on chassis wiring. The location ring makes for easy insertion of valves.

Cat. No. ES601—4-pin ..... 1/3 each  
Cat. No. ES602—5-pin ..... 1/3 each  
Cat. No. ES603—6-pin ..... 1/3 each  
Cat. No. ES604—7-pin (large) 1/3 each

P. TYPE VALVE SOCKETS. (K)

Valve Sockets for Philips, Mullard and other English type valves, fitted with the P. type base.  
Cat. No. ES653 ..... 1/— each

AMPHENOL MOULDED BAKELITE SOCKETS. (K)



A new type of Socket that will be welcomed by all radio fans and service-men. The slotted mounting holes enable this socket to be used as a replacement for standard sockets, having mounting holes from 1 1/2 to 2 inches between mounting centres. The contacts make a firm grasp of the tube prongs. Easy to wire.

Cat. No. ES614—4-pin .....  
Cat. No. ES615—5-pin ..... 8<sup>D</sup>.  
Cat. No. ES616—6-pin .....  
Cat. No. ES617—7-pin small .....  
Cat. No. ES618—7-pin; large ..... EACH  
Cat. No. ES619—8-pin .....

SOCKETS—

Baseboard Mounting (K)

For American base valves. Made of bakelite with screw terminals. Special spring contacts ensure a good connection.



Cat. No. ES605—4-pin (U.X.) 1/3 each  
Cat. No. ES606—5-pin (U.Y.) 1/3 each

WAFER TYPE VALVE SOCKETS. (K)

For 4-pin English-base valves.

Cat. No. ES640— 9<sup>D</sup>. each  
5-pin Ditto.  
Cat. No. ES641— 9<sup>D</sup>. each



BASEBOARD MOUNTING VALVE-HOLDERS (K)

(For English Base Valves Only)

Cat. No. ES612—4-pin ..... 1/2  
Cat. No. ES611—5-pin ..... 1/6

COMPOSITE SOCKETS. (D)



For Valve Testers, etc., etc. Something entirely new. A silver-plated laminated contact that floats in a moulded pocket and cannot get jammed. Life tests exceed one million seven hundred and fifty thousand perfect contacts without failure. Mounting centres, 1 19/36 inches; diameter of body, 1 3/16 inches; 4-5-6 composite socket takes four, five, or six pin valves.

Cat. No. ES652 ..... 3/6 each  
7-7 Sockets take both types of seven-pin valves.  
Cat. No. ES650 ..... 3/6 each

Eight Contact Octal Sockets take all types Metal Valves, with Octal Base. 3/— each  
Cat. No. ES651 .....

SPEAKER SILK. (K)

A fabric specially woven for use behind the speaker opening frets in a cabinet. Just woven loosely enough to permit free air movement.

Cat. No. ES65—12 in. x 12 in. .... Each 1/3  
ES66—16 in. x 16 in. .... 2/3

**GOLSTONE  
SOLDERING  
IRONS. (D)**



Cat. No. ES400 ..... Price **7/6** Each

Small Electric Soldering Irons for radio men and all small work. Made in England.



Resin Core Solder is recommended for the home constructor. It looks like wire and is filled with a resin preparation which eliminates the necessity of using flux or spirits of salts, etc.

**Instructions for Using:**

1. The joints to be soldered should be thoroughly cleaned and free from acid or grease. On plated parts (nickel or chromium) the "plate" should be filed away where the joint is to be made.
2. Heat the soldering iron (preferably in a gas flame) just enough to melt the solder. "Tin" the copper bit by first filing lightly and then rubbing with the cored solder until coated. The area of this "coat" should extend about half-an-inch from the tip of the bit and completely round it.
3. Heat again for working, but not to red heat.
4. Apply the hit and the cored solder to the work, rubbing the bit well down to transmit the heat. It is important that the bit, cored solder and joint should come into contact simultaneously.

There is no necessity to clean the joints after soldering: the ratio of the flux to the solder is such as to obviate this.

(K)

Cat. No. ES411 — Small reel, **6<sup>D</sup>** each about 3½ feet.  
Cat. No. ES413—1 lb. reel .. **4/6** each



**BELL SWITCHES.  
(K)**

Bell type Push Switch for making momentary contact which is required for testing apparatus, etc.

Cat. No. ES481— **1/-** each

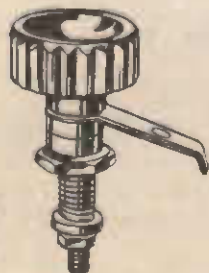

**SWITCH ARMS.  
(K)**

A sturdily built Switch Arm with laminated copper contact arm.

Cat. No. ES472— **10<sup>D</sup>** each

Nickel-plated contact studs for above.

Cat. No. ET39— **1/3** dozen

**SOLON ELECTRIC  
SOLDERING IRONS.  
(D)**

**Improved Bit.** — The Bit is of tinned copper of oval section allowing work to be done in a narrow space. It is designed to provide the maximum amount of heat at the working end with a minimum of heat loss due to radiation as the heating element is totally enclosed in the bit.

**Constant Heat.**—Four minutes to heat up and the "Empire" Model SOLON is ready for continuous use if required.

**Flexible Lead.** — Six feet of Tough Rubber-Sheathed 3-core Flex.

Cat. No. ES401—Solon Domestic or Radio Soldering **15/-**

Cat. No. ES402—Spare Elements for above. **5/-**

Cat. No. ES403—Spare Bits ..... **3/-**

Cat. No. ES404 — Heavy Duty (1 lb.) Soldering Irons. **37/6**

Cat. No. ES405 — Heavy Duty (2 lbs.) Soldering Irons. **65/-**



**SOLDER 50/50. (K)**

Full size sticks.

Cat. No. ES418 ..... **2/-** each

**SOLDERING PASTE. (K)**

Oxford Soldering Paste, 1 oz. tins.

Cat. No. ES419 ..... **4<sup>D</sup>** each

**RADIO SWITCH. (K)**

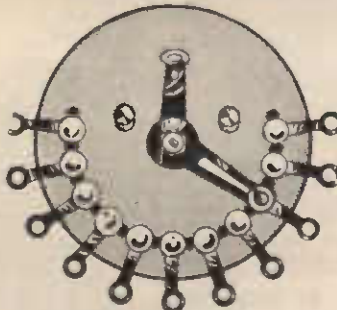

11 Contact Rotary Switch, lighter in construction than the above. Supplied without knob.

Cat. No. ES471 ..... each **1/6**

**TWO-BANK DUAL-WAVE SWITCHES. (K)**

Each bank has 9 contacts in sets of 3, and has 3 positions. Lengths of projecting shafts 2½in., diameter of shaft 1in.

Cat. No. ES510—2-gang ..... **8/-**

Cat. No. ES511—3-gang ..... **11/6**

**TOGGLE SWITCHES. (K)**



Quick make and break for A.C. mains use. Will handle currents up to 250 volts with perfect reliability. On-and-off toggle switch. Rating 250 volt, 3 amp.

Cat. No. ES451 ..... Each **1/3**

Double pole on-off Toggle Switches. Cat. No. ES452 ..... Each **1/9**

Single pole change-over Toggle Switches (S.P.D.T.) Cat. No. ES453 ..... Each **1/9**

Double pole change over Toggle Switches (D.P.D.T.) Cat. No. ES455 ..... Each **2/9**



**LISSEN S.P. PUSH  
PULL SWITCHES.  
(K)**

On-Off type. The heavy springs will retain their tension in spite of prolonged and rigorous use.

Cat. No. ES480— **1/6** each

**ROTARY RADIO SWITCHES. (K)**

Rated 230 volt, 2 amp. These are the rotating type of switches and are supplied with 1in. shaft, so that a knob can be fitted to match the other controls on the set. One hole fixing. Switch mounted in hermetically sealed cases perfectly reliable contact durable construction.

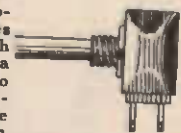

Cat. No. ES460—Single pole on-off ..... Each **2/3**

ES461—Double pole on-off ..... **2/6**

ES462—Single pole change-over .. **2/6**

ES464—Double pole change-over .. **3/9**

**S.P. ON-OFF  
SWITCHES.  
(K)**

For low tension flush mounting with neat moulded plate.

Cat. No. ES482— **1/6** each



**10-POINT ROTATING SWITCHES. (K)**

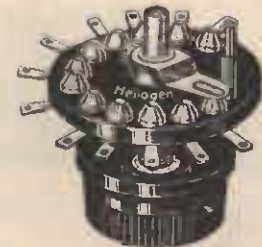

A 10-Point Rotating Switch for use on testing apparatus, crystal sets or any other outfit requiring a multi-contact switch arm. Made of moulded bakelite with solid studs and connecting lugs. Supplied complete with knob.

Cat. No. ES470 ..... **2/6**



**PORCELAIN**

**BUSHES. (K)**

For leading wires through metal.  $\frac{1}{2}$ in. hole. Supplied complete with galvanized screw-on washer.

Cat. No. ES241—  
4<sup>D</sup>. Each

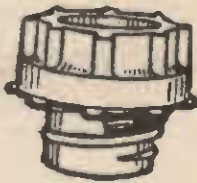

**BUSHES. (K)**

Bushes made of coloured insulating material, with metal nut for fixing, used for insulating wires through metal panels, etc.

Cat. No. ES239— $\frac{1}{2}$ in. diam. 3<sup>D</sup>. each, 2/9 doz.  
ES240— $\frac{1}{4}$ in. diam. 3<sup>D</sup>. each, 2/9 doz.



**BUSHING WASHERS. (K)**

Used in pairs, one plain, one embossed to insulate switches, volume control, condensers, etc. Black proofed fibre. High insulating qualities. Total diameter  $\frac{1}{2}$ in. Hole diameter  $\frac{1}{8}$ in.



Cat. No. ES228 . . . . Two pairs for 3<sup>D</sup>.

**RUBBER GROMMETS. (K)**

Made of good quality black vulcanised rubber. For fitting in holes from chassis, etc., to insulate and protect cables. To fit  $\frac{1}{2}$ in. hole. Inside diameter  $\frac{1}{8}$ in.



Cat. No. ES243 . . . . 2<sup>D</sup>. each 1/9 doz., 18/- gross.  
Ditto to fit  $\frac{1}{4}$ in. hole. Inside diameter  $\frac{1}{8}$ in.



Cat. No. ES244 . . . . 2<sup>D</sup>. each 1/10 doz., 19/- gross.

**RUBBER TACK BUMPERS. (K)**

For feet of Radio Sets and other articles. Tack is moulded in the rubber. Diameter  $\frac{1}{2}$ in. Height of rubber  $\frac{1}{4}$ in.



Cat. No. ES250 . . . . 1<sup>D</sup>. each 11d. doz., 10/6 gross.

**INSULATING WASHERS. (K)**

Insulating Washers for insulating potentiometers and other components from metal panels, etc.  $\frac{1}{2}$ in. dia. x  $\frac{1}{2}$ in. dia. hole x 1-16in. thick.



Cat. No. ES232—  
4<sup>D</sup>. Dozen 2/10 gross

Cat. No. ES233—Ditto,  $\frac{1}{4}$ in. x  $\frac{1}{2}$ in. x 1-16in. 4<sup>D</sup>. dozen 3/3 gross

**CONNECTORS—SINGLE. (K)**

Small nickel-plated Connector. Size  $\frac{1}{2}$ in. x  $\frac{1}{2}$ in.

Cat. No. EC194—  
2<sup>D</sup>. each



**CONNECTORS. (K)**

Useful single wire Connectors. Insulated. Cat. No. EC192—ea. 3<sup>D</sup>.

Ditto, double wire. Cat. No. EC193—ea. 4<sup>D</sup>.



**CLIPS, SCREEN GRID. (K)**

For attaching leads to the top of screen grid valves, etc.

Cat. No. EC23—  
1<sup>D</sup>. each 9<sup>D</sup>. doz.  
6/6 gross



Cat. No. EC24—Screen Grid Clips for metal valves . . . . . each 1<sup>D</sup>.

**METAL TUBE GRID CAP ADAPTOR. (D)**

Permits making grip cap connection on metal valves without additional wiring. Plugs into regular grid clip. Clip end fits metal tube grid caps. Very useful for tube checkers, set analysers, metal tube replacement adaptors, etc.



Cat. No. EM224 . . . . . 1/6 each

**R.C.S. COIL MOUNTING FEET. (K)**

Ideal for Coil Mounting.

Cat. No. ES212, ea. 1<sup>D</sup>.  
9d. doz.



**CELLULOID CEMENT. (K)**

Cat. No. ES217—1oz. bottle of cement for joining celluloid . . . . . Each 1/3

**INSULATING MATERIAL. (D)**

Chatterton's Compound (In 4oz. sticks).  
Cat. No. ES270 . . . . . 6/- lb.

**FOR EXPERIMENTERS. (K)**



Here's a line that will appeal to experimenters. You can have a lot of fun with these P. & T. Telephone Generators. They are worth the price for the four large, powerful magnets alone. 2/6 each

Cat. No. EX454 . . . . . 2/6  
(Postage 1/6 extra)

**TERMINAL**

Low-priced Terminal with insulated top for Crystal Sets, Wave Traps, etc.  
Cat. No. ET9 2<sup>D</sup>.  
1/6 dozen.



**BIG BATTERY BARGAIN. (D)**

6 volt 85 amp. Radio or Car Accumulators. Plenty of pep, and what a bargain!  
Cat. No. EA170 . . . . . Each 39/6

**SCREWS WITH NUTS (K)**

2BA—.185in. outside diameter.  
4BA—.142in. outside diameter.  
6BA—.110in. outside diameter.

These screws, nuts and washers are brass, highly nickel-plated, and must not be confused with cheap iron screws.

Screws and Nuts, Counter-sunk Head.

Cat. No.	Size.	Dozen.	Gross.
ET411	— $\frac{1}{4}$ x 2BA	10 <sup>D</sup> .	9/6
ET412	— $\frac{1}{2}$ x 2BA	11 <sup>D</sup> .	10/9
ET413	—1 x 2BA	1/2	13/-
ET414	— $\frac{1}{4}$ x 4BA	7 <sup>D</sup> .	6/4
ET415	— $\frac{1}{2}$ x 4BA	8 <sup>D</sup> .	7/6
ET416	—1 x 4BA	9 <sup>D</sup> .	8/3
ET417	— $\frac{1}{2}$ x 4BA	1/-	11/-
ET418	— $\frac{1}{4}$ x 6BA	6 <sup>D</sup> .	5/6
ET419	— $\frac{1}{2}$ x 6BA	6 <sup>D</sup> .	5/8
ET420	—1 x 6BA	7 <sup>D</sup> .	6/8

**SCREWS AND NUTS, ROUND HEAD.**

Cat. No.	Size	Dozen.	Gross.
ET421	— $\frac{1}{4}$ x 2BA	11 <sup>D</sup> .	10/6
EB422	— $\frac{1}{2}$ x 2BA	1/-	10/9
ET423	—1 x 2BA	1/3	14/-
ET424	— $\frac{1}{4}$ x 4BA	7 <sup>D</sup> .	6/6
ET425	— $\frac{1}{2}$ x 4BA	9 <sup>D</sup> .	8/6
ET426	—1 x 4BA	10 <sup>D</sup> .	9/3
ET427	— $\frac{1}{2}$ x 4BA	1/-	11/-
ET428	— $\frac{1}{4}$ x 6BA	6 <sup>D</sup> .	5/6
ET429	— $\frac{1}{2}$ x 6BA	6 <sup>D</sup> .	5/8
ET430	—1 x 6BA	8 <sup>D</sup> .	7/4

**Spare Nuts.**

Cat. No.	Size.	Dozen.	Gross.
ET431	—2BA	3 <sup>D</sup> .	2/10
ET432	—4BA	3 <sup>D</sup> .	2/10
ET433	—6BA	3 <sup>D</sup> .	2/10

**Washers.**

Cat. No.	Size.	Dozen.	Gross.
ET434	—2BA	2 <sup>D</sup> .	1/10
ET435	—4BA	2 <sup>D</sup> .	1/10
ET436	—6BA	2 <sup>D</sup> .	1/10

**ANCHORING STRIPS. (K)**



Used for supporting condensers, resistors, etc., above earth or chassis. Fixed by bolt through centre hole. . . . . Each 2<sup>D</sup>.  
Cat. No. ET34 . . . . . Each 2<sup>D</sup>.

**SOLDERING LUGS. (K)**

6 B.A. Tinned Soldering Lugs.  
Cat. No. ET12 2D. doz.  
1/6 gross

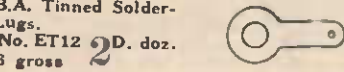

4 B.A. Tinned Soldering Lugs.  
Cat. No. ET13 2D. doz.  
1/6 gross

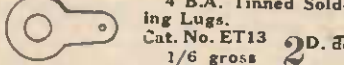

2 B.A. Tinned Soldering Lugs  
Cat. No. ET14 2D. doz.  
2/3 gross

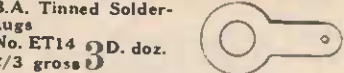

Open Type Soldering Lugs.  
Cat. No. ET15 2D. doz.  
2/4 gross

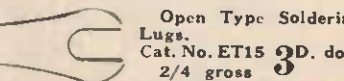

Special Spade Lugs. Large.  
Cat. No. ET16— 4D. doz.  
3/4 gross

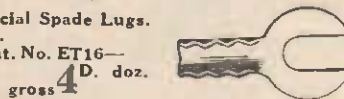

SMALL SPADE LUGS. (K)  
Cat. No. ET17 2D. doz.  
2/8 gross

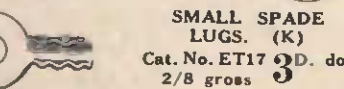

RING TYPE LUGS.  
Cat. No. ET18 2D. doz.  
2/8 gross

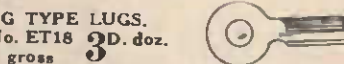

4 B.A. Double Ended Soldering Lugs. (tinned).  
Cat. No. ET7 3D. dozen

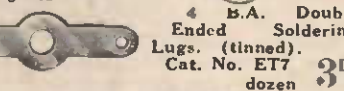

Cat. No. ET1—Large Brass Battery Terminal Spades . . . per dozen **10D.**

With eyelet. Cat. No. ET42 . . . 4D. doz.  
3/3 gross



**SPADE ANCHOR LUGS. (K)**

Steel cadmium plated for mounting coils, condensers, shield cans, etc. 6/32 thread. Hole in flat portion fits 9/64in. diameter eyelets and 6/32 screws. Cat. No. ET40 . . . 1D. each  
10d. doz., 9/- gross.



**SOLDERING LUG ASSORTMENTS. (K)**

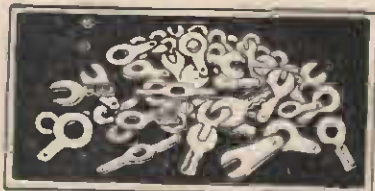

A useful collection of 100 items of assorted Spade End and Cable Lugs. Suitable for the serviceman and experimenter. Cat. No. ET46 . . . the lot **2/-**

A miscellaneous selection of 72 items of various types of Soldering Tags and Lugs. Cat. No. ET47 . . . the lot **1/2**

Serviceman's selection of Lugs, Spade Ends, Insulating Washers, etc. 500 assorted pieces. Cat. No. ET45 . . . **10/-**

Auto Electricians' assortment Cable Ends, etc., for motor car wiring, 144 assorted pieces. Cat. No. ET44 . . . **7/6**

**TERMINALS. (K)**



4 B.A. nickel-plated terminals with hole. Complete with nuts and washers. Cat. No. ET2 . . . 3D. ea.  
2/6 dozen

Nickel-plated binding posts complete with nut washer. Cat. No. ET3 . . . 3D. ea.  
2/6 dozen

Wood screw pattern, with hole. Nickel plated. Cat. No. ET4— 3D. each



**DALTON TERMINALS. (K)**

Insulated type supplied in either red or black. Spring grip makes easy connection or disconnection. Special design so that when fitted they are insulated from metal chassis. Cat. No. ET10 . . . 4D. ea.



**TERMINALS — INSULATED SPADES. (K)**

Insulated Spade Terminals are useful for easy connection of wires under terminals, etc. Colours: Red and Black. Cat. No. ET8 2D.  
1/10 doz. ea.



**TERMINALS, WANDER PLUGS. (K)**

Pin Type Wander Plugs. Have a screw on side for fixing wire. Cat. No. ET6 . . . (1/10 doz.) 2D. each

Cat. No. ET6 . . . (1/10 doz.) 2D. each

**TERMINALS—BANANA PLUGS AND SOCKETS. (K)**

Banana Plugs and Sockets have all sorts of uses, such as for aerial and earth connections, coil tapping, battery connections, etc. Assorted colours.

Cat. No. ET22—Banana Plugs and Sockets . . . Each 4D.  
Cat. No. ET23—Banana Plugs only . . . Each 2D.  
Cat. No. ET24—Sockets for above (all metal) . . . Each 2D.  
Cat. No. ET30—Sockets with insulating collar (red or black) Each . . . 3D.

**BANANA PLUGS. (K)**

Extra long type Banana Plugs. Cat. No. ET25, each 6D.

**BANANA PLUG CONNECTOR. (K)**

A useful Single Wire Connector that has a socket for the standard size Banana Plug. Cat. No. ET27, Each 3D.



**TERMINAL STRIPS. (K)**

Plain Bakelite Terminal Strips. For mounting terminals, etc. Size 6in. long, 1in. wide. Cat. No. ET35 . . . Each 6D.

**FAHNSTOCK CLIPS. (K)**

N.P. on spring brass. Size 4in. x 1in. Cat. No. ET41 2D. ea.  
1/10 doz.



**VALVE PINS AND SOCKETS. (K)**



N.P. Valve Pins, complete with nut and washer. Cat. No. ET19 . . . (1/8 dozen) 2D. each

N.P. flush mounting Valve Pin Sockets, with nuts. Cat. No. ET20, each 2D.



N.P. Upright Type Valve Pin Sockets, complete with nut and washers. Brass. Cat. No. ET21 . . . (1/8 dozen) 2D. each

**SPEAKER CORD TIPS. (K)**



Nickel-plated tips for speaker and 'phone cords. Cat. No. ET28 (10d. doz.) 1D. ea.

**SOLDERLESS 'PHONE TIPS. (K)**



A 'Phone Tip that does not need any solder. Especially constructed so that the wire makes a good connection without the use of solder. Cat. No. ET29 . . . each 3D.

**FREQUENTITE TERMINAL BLOCKS. (K)**



Consists of two terminals fitted with lugs and mounted on Frequentite base. Can be mounted directly on chassis without fear of shorting. Terminals are red and black. Ideal for short-wave receivers and for high frequency work. Cat. No. ET33 . . . 1/9 each

for short-wave receivers and for high frequency work. Cat. No. ET33 . . . 1/9 each

**TERMINAL STRIPS. NEW IMPROVED TYPE. (K)**

Eby Terminal Strips are equipped with the new type lug shown in the illustration at right. A stamped thread consisting of six or more turns insures lasting contact without the slightest danger of stripping the screw loose.



Cat No. ET70—2 Terminals . . . . . 10D.  
Price 1/1  
Cat. No. ET69—3 Terminals . . . . . 1/6  
Price 1/9  
Cat. No. ET71—4 Terminals . . . . . 2/3  
Price 2/3  
Cat. No. ET72—6 Terminals . . . . .  
Price  
Cat. No. ET73—8 Terminals . . . . .

**TERMINAL BOARDS. (K)**

Bakelite Terminal Boards for neat assembling of Resistors and Condensers. Lugs are eyeletted on to the bakelite. Mounting holes provided.

Cat. No. ET36—With 8 pairs of Lugs . . . . . Each 1/3  
ET37—With 12 pairs of Lugs . . . . . 1/9  
ET38—With 18 pairs of Lugs . . . . . 2/3





**HALLDORSEN AUDIO TRANSFORMER. (K)**



Replacement Audio Transformer. Insulated type. Special small size for replacement working. Mounting centres 2 5-16. Core size 8in x 8in. Weight 10oz. Ratio 3 1/2 to 1. Cat. No. ET603—**8/6** Each

**HALLDORSEN PUSH-PULL CLASS "B" TRANSFORMERS. (K)**

Ratio 1-1, mounting centres 3 9-16in. Core 1in. x 1in. Over-all dimensions, 2 1/2 x 4 x 2 1/2. Cat. No. ET608 **17/6**  
Lighter type. Ratio 1-1. Mounting centres 2 13-16in. Core 1/2in. x 1/2in. Over-all dimensions 2 x 3 3/4 x 1 1/2. Weight 1 lb. Cat. No. ET609 **12/-** Each

**PUSH-PULL INPUT TRANSFORMER. (K) CLASS "A"**

Push-pull Input Transformers, 1 1/2 to 1 ratio. Unshielded replacement type, mounting centres 2 5-16in. Weight 10 ozs. Core size 8in. x 8in. Cat. No. ET610 **9/3** Each

**COMBINATION OUTPUT TRANSFORMER. (K)**

Combination Tube Output Transformer. This is rather a sensational job, and what has been needed by dealers and servicemen for a long time. It is not just an output transformer with a tapped secondary, but is made up of definitely matched impedance combinations carefully worked out. Instructions supplied with each transformer give the accurate combination for each of the principal power tubes to match the Voice Coils in general use. This for both single and push-pull operation. Medium size core 1/2in. x 1/2in. Core mounting centres 2 13-16. Weight 1lb. Cat. No. ET613 **10/6** Each

**LISSEN TOREX TRANSFORMERS. (K)**

A small Transformer, but a giant in performance. The core is made of silicon steel the recognised material for all high grade transformers. The windings are accurately wound with the best quality copper wire. This is an entirely British-made transformer; the only inexpensive transformer sold with a curve—a curve which is practically straight from 100-7000 cycles, covering the most useful range of audible frequencies. In handsome brown moulded case, hermetically sealed against atmospheric changes. Ratio 3-1. Cat. No. ET601 **8/9**



**AMPLION'S NEW MULTI-IMPEDANCE TRANSFORMER. (K)**

A good Transformer is primarily dependent on its iron and copper content. The T.S. Multi-Impedance Transformer weighs 33 ounces.

The Transformer will safely carry up to 80 m/a.

It is fitted with 12 lugs, numbered 1 to 8, and lettered VC and FC. Impedances can be obtained by connecting the various lugs as follows:—

- Terminals:
- 1—5—8 :— 12,000 ohms centre tap.
  - 2—5—7 :— 7,000 ohms centre tap.
  - 3—5—6 :— 5,000 ohms centre tap.
  - 1—8 :— 12,000 ohms single output.
  - 2—7 :— 7,000 ohms single output.
  - 1—4 :— 2,500 ohms single output.
  - 3—6 :— 5,000 ohms single output.

Cat. No. ET709 **30/-**

**AMPLION SPEAKER TRANSFORMERS. (K)**

For Q. and R. Type Speakers.

- All **13/9** Each
- ET705—Single Penthode
  - ET706—Push-Pull Penthode
  - ET707—Single Triode
  - ET708—Push-Pull Triode

**LISSEN TRANSFORMERS. (K)**

Lissen Tapped Speaker Transformers. Suitable for use on practically all P.M. and other speakers. Cat. No. ET704 **12/6**

**TELSEN L.F. TRANSFORMERS. (K)**

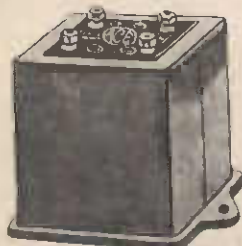

The Telsen is eminently suitable for receivers where highest efficiency is required at a low cost and where space is limited. Its characteristics will bear comparison with that of any other transformer.

Cat. No. ET604—Ratio 5-1 **8/6**

**VIBRATOR POWER TRANSFORMER. (K)**

The R.C.S. Power Transformer for Vibrator Units is contained in a new bakelite case. It is designed to supply correct voltages and current for the receiver, and the finest grade materials procurable are used in their construction. They are given individual tests during manufacture, as well as a rigid test and inspection before shipment. Cat. No. ET614 **16/6**

**MICROPHONE TRANSFORMER. (K)**

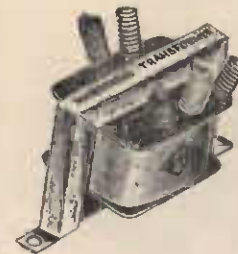

A coupling transformer. Ratio 1-35 with C.T. 10 ohm primary. 1-70 ratio thus being obtainable. Two microphones in Push-Pull can be used. Primary currents (max.) 25 MA for 1-70 ratio. For push-pull connections 65 MA max. Cat. No. ET600 **8/6** each

**HALLDORSEN STEP-DOWN TRANSFORMER. (K)**

Step-down Transformers, 240 volt to 110 volt. Useful for using 110 volt Radio Sets and other appliances from the 230 volt mains.

Cat. No. ET620—160 watt **45/-** Each

Cat. No. ET621—80 watt **29/6** Each



**VOLTAGE REDUCER, SINGLE OUTLET. (G)**

Measuring 6 x 4 1/2 x 3 ins., this reducer supplies 6 volts 5 amps. from the 240-volt light or power. A 2-pin plug outlet is provided.

Cat. No. ET622—**23/-** Each



**LISSEN Q.P.P. AUDIO TRANSFORMER. (K)**

Specially designed for Q.P.P. output circuits. Cat. No. ET607 **18/9** Each

**JENSEN SPEAKERS. (K)**

Moving Coil Speaker which represents the latest word in speaker design. All electrical connections are thoroughly covered and the field coils are wound with the heaviest possible gauge of wire. Supplied complete with 18in. cord (plug extra).

Cat. No. ES762—5in. **20/-**

Cat. No. ES763—6in. **22/6**

Cat. No. ES764—8in. **27/6**

**FERRANTI CLASS B. PUSH-PULL TRANSFORMERS. (K)**

Type No.	AUDIO DRIVER TYPES.		OUTPUT TYPES.		
	A.F. 15c EN568	A.F. 17c. EN569	O.P.M. 15c. EN570	O.P.M. 16c. EN571	O.P.M. 17c. EN572
Cat. No.	40/-	24/-	40/-	40/-	40/-
Price	1/1	1/1	1/1, 1.6/1 and 2.7/1	15/1, 22.5/1 & 45/1	1.6/1 and 23/1
Ratio	62/27	18/12	35/5.5	35/5.5	29/4.5
Primary Inductance Henries	0/10	0/6	0/50	0/50	0/50
For D.C. Milliamps	700	230	110, half winding	110, half winding	125, half winding
Primary D.C. Resistances in ohms	80	120	Total Resistance.	Total Resistance.	Total Resistance.
Secondary D.C. Resistances in ohms each half			1/1 162	15/1 1	1.6/1 160
			1.6/1 103	22.5/1 0.56	23/1 0.74
			2.7/1 59.2	45/1 0.45	
Maximum Power Handling Capacity in Watts	8	5	10	10	6
Normal Efficiency per cent.	90	90	90	90	90

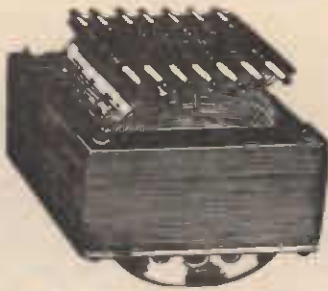

# R.C.S. Power Transformers

(K)

Guaranteed for twelve months. Ratings are very conservative. R.C.S. Transformers have a tapped primary for 220-40-60 volts. They function with low voltage drop low temperature rise and have high insulation which is imperative for efficient working.

PARTICULARS OF R.C.S. POWER TRANSFORMERS.

2.5 Volts		6.3 Volts	
Cat. No. ET650—60 mil. Filament Windings: 2.5v., C.T., 5 amp. 5v., 2 amp.	14/9	Cat. No. ET655—60 mil. Filament Windings: 6.3v., C.T., 3 amp. 5v., 3 amp.	14/9
Cat. No. ET651 80 mil. Filament Windings: 2.5v., C.T., 3 amp. 2.5v., C.T., 8 amp. 5v., 3 amp.	16/9	Cat. No. ET656—80 mil. Filament Windings: 6.3v., 3 amp. 6.3v., C.T., 3 amp. 5v., 3 amp.	16/9
Cat. No. ET652—100 mil. Filament Windings: 2.5v., C.T., 3 amp. 2.5v., C.T., 8 amp. 5v., 3 amp.	18/-	Cat. No. ET657—100 mil. Filament Windings: 6.3v., C.T., 3 amp. 6.3v., C.T., 3 amp. 5v., 3 amp.	18/-
Cat. No. ET653—125 mil. Filament Windings: 2.5v., C.T., 5 amp. 2.5v., C.T., 10 amp. 5v., 3 amp.	26/-	Cat. No. ET658—125 mil. Filament Windings: 6.3v., C.T., 3 amp. 6.3v., C.T., 3 amp. 5v., 3 amp.	26/-
Cat. No. ET654—150 mil. Filament Windings: 2.5v., C.T., 8 amp. 2.5v., C.T., 10 amp. 5v., 3 amp.	39/6	Cat. No. ET659—150 mil. Filament Windings: 6.3v., C.T., 3 amp. 6.3v., 5 amp. 5v., 3 amp.	39/6

RADIOKES AUDIO TRANSFORMER. (K)

Cat. No.	Type No.	Application.	Suitable Valves.	Price.
ET550	AF-3	"A" class single coupling transformer.	Match triode types 56, 76, 30, 55, 85, 6C6, etc.	20/-
ET551	AF-3C	"A" class push-pull trans.	Match triode types 56, 76, 30, 55, 85, 6C6, etc.	21/-
ET552	AF1	High impedance audio choke 230 henries.	Matches plate resistance pentode valves such as 6C6, 57, 6J7, etc.	18/6
ET553	AFB	"B" class input transformer.	Suitable for battery valves, typical combination 30 and 19 or B240. Also suits 49's, etc.	18/6
ET554	AFAB	Class "AB"	Using Pentode output valve as a triode driving pentodes in "AB" class. Typical combination 2A5 (triode) and two 2A5's ("AE"), or 42 driver and two 42's output.	28/6

FILAMENT TRANSFORMERS, R.C.S. (K)



These Filament Transformers are the Midget type, and have a carrying capacity of 7 watts, and can be procured in any secondary voltage. The primary winding is for 240 volts and have been flash-tested between

windings and earth at 1,000 volts. These Transformers are ideal for use when English and American valves are used in the same set. Stock types are as under:—

Cat. No.	Each
ET710—240 volts Primary, 7 watts 4 volts 1 amp. Secondary	9/9
ET711—240 volts Primary, 7 watts 2.5 volts 2 amps Secondary	9/9
ET712—240 volts Primary, 7 watts 6 volts .75 amp. Secondary	9/9
ET713—240 volts Primary, 18 watts 6 volts 3 amps. Secondary	9/9

R.C.S. SPEAKER TRANSFORMERS. (K)



The primaries are of specially matched impedance, and can be supplied, centre tapped, for push-pull. The secondaries are wound for both low and high impedance voice coils, and if the coils are required

for replacement we would advise the quoting of the type of speaker that they are required for.

Cat. No.	Each
ET700—Single 245 or Triode	10/-
ET701—Push-pull, 245 or Triode	10/6
ET702—Single Pentode	10/-
ET703—Push-pull Pentode	10/6

R.C.S. SPEAKER REPLACEMENT TRANSFORMER COILS. (K)

Cat. No.	Each
ET696—Single Triode	5/9
ET697—Single Pentode	5/9
ET698—Push-pull Triode	6/3
ET699—Push-pull Pentode	6/3



"B" CLASS AUDIO TRANSFORMER. (K)

R.C.S. "B" Class Radio Transformers have been improved in design and are now supplied in handsome bakelite cases. The special pie windings are vacuum impregnated, assuring freedom from electrolysis. Only high grade specially coated steel laminations are used. This R.C.S. product is unsurpassed for use in battery operated receivers.

"B" Class Audio Cat. No. ET560	16/6
-----------------------------------	------

CLASS "A" PUSH-PULL TRANSFORMERS. (K)

R.C.S. High Grade Audio Transformer, ratio 3:1 to 1.  
Cat. No. ET561  
Each 15/6



R.C.S. AUDIO TRANSFORMER. (K)  
Class A, 3:1 to 1 Audio Transformer of first grade make.  
Cat. No. ET562 ..... Each 15/-



WIRES, ENAMELLED. (K)



Only the Best British Wires stocked.  
Prices per Reel.

S.W.G.		1lb. Reels.		1lb. Reels.	
Cat. No.	Price	Cat. No.	Price	Cat. No.	Price
16—EW1	1/-	EW34	3/4		
18—EW2	1/-	EW35	3/4		
20—EW3	1/-	EW36	3/4		
22—EW4	1/2	EW37	3/6		
24—EW5	1/3	EW38	3/10		
26—EW6	1/3	EW39	4/-		
28—EW7	1/6	EW40	4/3		
30—EW8	1/6	EW41	4/8		
32—EW9	1/8	EW42	5/-		
34—EW10	1/8	EW43	5/3		
36—EW11	1/9	EW44	5/6		
38—EW12	1/9	EW45	5/9		
40—EW13	2/3	EW46	5/10		



WIRES, D.C.C. (K)

1lb. Reels.		1lb. Reels.	
Cat. No.	Price	Cat. No.	Price
16—EW14	1/-	EW47	3/2
18—EW15	1/1	EW48	3/4
20—EW16	1/2	EW49	3/10
22—EW17	1/4	EW50	4/-
24—EW18	1/4	EW51	4/8
26—EW19	1/7	EW52	5/10
28—EW20	1/8	EW53	6/2
30—EW21	1/11	EW54	7/5
32—EW22	2/6	EW55	8/7
34—EW23	3/3	EW56	11/8
36—EW24	4/-	EW57	14/9

WIRES—DSC.

20—EW25	1/6		
22—EW26	1/8	EW58	6/-
24—EW27	1/11	EW59	7/9
26—EW28	2/2	EW60	8/3
28—EW29	2/6	EW61	9/6
30—EW30	2/9	EW62	10/6
32—EW31	3/-	EW63	11/6
34—EW32	3/3	EW64	12/6
36—EW33	3/9	EW65	14/6

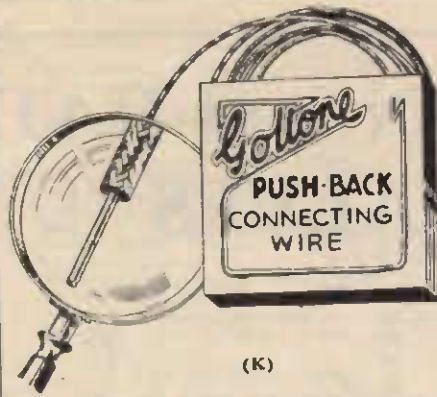

(K)

A time-saving connecting wire of high insulation. To bare, simply push back the insulation to the space required. Tinned copper conductors.

Cat. No. EW150 ..... 10ft. coil 6<sup>D</sup>.

Red and Black Extension Cord

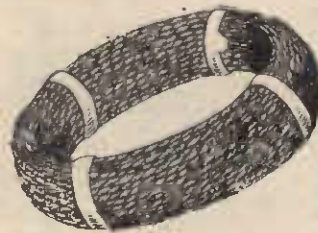

RED AND BLACK EXTENSION CORD. (K)

This red and black flex can be used for all sorts of purposes. Especially recommended for speaker extensions, etc.

Cat. No. EW69 ..... per yard 3<sup>D</sup>.

2/6 dozen per coil, 72 yds., 13/6

CONNECTING WIRE



WIRE, THIN SINGLE FLEX. (K)

14/0076 Flexible Wire. Insulated with a covering of vulcanised rubber. Assorted colours. Handy for temporary connections, etc. Cat. No. EW68 ..... yard 2<sup>D</sup>.

1/6 doz, yards, 4/3 coil (50 yds.)

HENLEY PUSH-BACK WIRE. (K)

Cat. No. EW151—25ft. coils, 1/18 single ... Price

Each 1/-

EW152—25ft. coils, 1/20 single ... 10<sup>D</sup>.

Each 10<sup>D</sup>.

EW153—25 ft. coils, 7/.0124, 11<sup>D</sup>.

strand-4 Each 11<sup>D</sup>.

EW154—300ft. coils, 1/18 single 11/6

2d. vari! coil 9/6

EW155—300ft. coils, 1/20 single 9/6

2d. vard coil 10/6

EW156—300ft. coil, 7/.0124 10/6

stranded. 2d. yard coil 10/6

POWER CABLES and ELECTRIC WIRES—

See page 24

MOTOR CAR WIRES and CABLES—

See page 33

METALLIC SCREENED TUBING. (K)

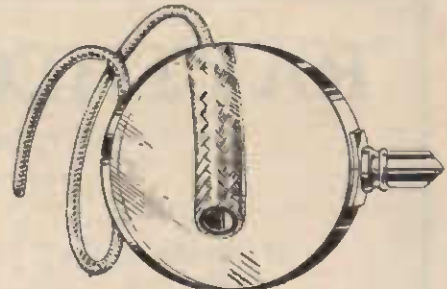

In many modern A.C. circuits it is essential to screen grid and plate leads to prevent pick-up on these leads. This tubing is made for this special purpose. Summed up it is flexible, insulating and screening. Supplied in 36in. lengths.

Cat. No. ES86 ..... 1/-

BATTERY AND SPEAKER CABLES. (K)



Cat. No. EW100—4-wire Battery Cable ..... Yard 8<sup>D</sup>.

EW101—5-wire Battery Cable. ... 9<sup>D</sup>.

EW102—7-wire Battery Cable. 1/-

SPAGHETTI TUBING. (K)

Spaghetti Tubing is used for slipping over bare wires as an insulation to prevent short circuits, etc. Assorted colours.

Cat. No. ES81—36in. lengths, 1 Mil. .... Each 3<sup>D</sup>.

ES82—36in. lengths, 2 Mil. .... 3<sup>D</sup>.

ES83—36in. lengths, 3 Mil. .... 4<sup>D</sup>.

ES84—36in. lengths, 4 Mil. .... 4<sup>D</sup>.

ES85—36in. lengths, 6 Mil. .... 6<sup>D</sup>.

PANEL LAMPS. (K)



Genuine Westinghouse Radio Panel Lamps. Tubular type.

Cat. No. EL119—2 volt, .05 amp. (special low consumption for battery sets) ..... 1/3 Each

Cat. No. EL120—2.5 volt ..... 12/9 Dozen

Cat. No. EL121—3.8 volt ..... 97/6 per 100

Cat. No. EL123—6 volt, with small bayonet base ..... 97/6 per 100

Cat. No. EL107—Lectra (Foreign), 2.5 volt 1/- each

Cat. No. EL110—Ditto. 1/- each 3.5 volt.

Cat. No. EL108—Ditto. 1/- each 6 volt.

Torch Lamps are listed on page 28.



Twin Flat Extension Cord for speakers, etc. etc. Two conductors, each 14/36 S.W.G. insulated with vulcanised rubber. Laid flat. Attractive overall braid in red and black glazed cotton.

Cat. No. EW87— 4<sup>D</sup>. yard or 6/6 25yd. drum. (K)

# RAYTHEON and RADIOTRON VALVES (D)

STANDARD GLASS VALVES.		Type No.	Price	GLASS, METAL OR OCTAL GLASS VALVES.	
Type No.	Price			Type No.	Price
01A	5/-	36	9/-	OZ4G	10/6
1A4	12/-	37	6/6	1C7G	12/9
1A6	11/-	38	8/-	1D5G	12/6
1B4/951	13/-	39/44	9/-	1D7G	12/6
1B5/25S	9/6	41	8/-	1E5G	12/-
1C4	13/-	42	8/6	1E7G	18/-
1C6	11/6	43	8/6	1F5G	12/-
1D4	13/-	45	6/-	1F7G	13/6
1F4	12/-	46	9/-	1G5G	13/-
1F6	12/-	47	9/-	1H4G	7/6
1K4	13/-	48	19/6	1H6G	12/-
1K6	13/-	49	9/-	1J6G	9/6
1V	8/-	50	19/6	5U4G	9/-
2A3	11/6	52	17/6	5V4G	12/6
2A5	8/-	53	10/6	5W4G	7/-
2A6	8/-	55	9/-	5X4G	9/-
2A7	10/6	56	6/-	5Y3G	6/-
2B7	10/6	57	8/6	5Y4G	6/-
2E5	12/-	58	8/6	6A5G	14/6
5Z3	8/-	59	11/-	6A8G	10/6
6A3	13/-	71A	6/-	6B4G	13/-
6A4/LA	11/-	75	8/6	6B6G	10/-
6A6	11/6	76	6/-	6B8G	11/6
6A7	10/-	77	9/-	6C5G	8/6
6AB5	12/6	78	9/-	6C8G	12/6
6B5	13/6	79	10/6	6D8G	12/9
6B7	11/-	80	5/6	6F5G	9/-
6B7S	13/-	81	17/6	6F6G	9/-
6C6	9/-	82	7/6	6H6G	8/6
6D6	9/-	83	8/-	6J5G	8/-
6E5	12/-	83V	13/6	6J7G	9/6
6E6	13/-	84/6Z4	9/-	6K5G	9/6
6F7	12/6	85	9/-	6K6G	9/-
6G5/6H5	12/-	89	9/-	6K7G	9/6
6J5	9/-	X99	9/6	6L5G	11/6
6N5	12/-	950	15/-	6L6G	15/6
6U5	12/-	BR	17/6	6L7G	11/-
6T5	12/-	ALL METAL VALVES.		6N6G	14/-
12A5	15/-	OZ4	11/6	6N7G	11/-
12A7	13/6	5T4	16/-	6P7G	16/-
12Z3	8/6	5W4	8/6	6Q6/6T7G	12/-
25Z5	8/-	5Z4	11/-	6Q7G	9/6
10	19/6	6A8	12/6	6R7G	10/-
12A	7/-	6B8	13/6	6S7G	11/9
15	15/6	6C5	8/6	6U7G	9/-
19	9/-	6F5	10/6	6V6G	10/-
20	11/-	6F6	10/6	6V7G	10/-
22	12/6	6H6	9/-	6X5G	10/6
24A	8/6	6J7	10/6	6Y6G	15/-
26	5/-	6K7	10/6	6Y7G	12/-
27	6/-	6L6	16/6	6Z7G	12/-
30	6/-	6L7	12/-	25A6G	10/6
31	6/-	6N7	12/-	25A7G	14/-
32	11/-	6Q7	11/-	25B6G	10/9
33	9/-	6R7	12/-	25L6G	10/-
34	10/6	6X5	12/-	25Z6G	9/6
35/51	9/-	25A6	13/-		
		25L6	12/6		
		25Z6	11/6		

Only The Best—RAYTHEON and RADIOTRON

SEND 1d. STAMP FOR POSTAGE ON FREE VALVE CHART.



# PHILIPS

**PHILIPS VALVES. (G)**

**METAL CLAD.**

6.3 volt AC Series. "P" base.

EF8—Silentode H.F. pre-amp.	11/-
EH2—Hexode Mixer	13/-
EBF1—Duo Diode Penthode	11/-
EK2—OCTODE (self neutralised)	13/-
EF5—RF Penthode (variable Mu)	11/-
EBC3—Duo-Diode Triode	11/-
EF6—RF Penthode	11/-
EL2—Power Penthode	11/-
EL3—Power Penthode (High Mu)	11/-
EBL1—Duo Diode Output Penthode	13/-
EZ2—Full-Wave Vacuum Rectifier	9/-
EZ3—Full-Wave Vacuum Rectifier	9/-
EM1—Magic Star	12/-

**METAL CLAD SUPER SERIES.**

4-volt A.C. "P" base.

AH1—Hexode	13/-
AB2—Duo Diode	9/-
ABC1—Duo Diode Triode	11/-
AC2—Triode, Oscillator, Amplifier	11/-
AF3—HF Penthode (variable Mu)	11/-
AF7—HF Penthode	11/-
AK2—OCTODE Frequency Changer	13/-
AL2—Power Penthode	11/-
AL3—Power Penthode (High Mu)	11/-
AZ1—Full Wave Rectifier (direct heating)	9/-
AZ3—Full Wave Rectifier	9/-

**METAL CLAD SUPER SERIES.**

4-volt A.C.

(With ordinary standard English or American base.)

AB1—Duo Diode	9/-
AF2—HF Penthode (variable Mu)	11/-
AK1—OCTODE Frequency Changer	13/-
E443H—Power Penthode (direct heating)	12/-
E444—Diode Tetrode	12/6
E446—HF Penthode	12/-
E447—HF Penthode (variable Mu)	12/-
E454—Duo Diode Triode	11/-
E463—Power Penthode	10/6
1561—Full Wave Rectifier	10/-
1805—Full Wave Rectifier	11/8

See Separate List for Prices of American Types.

**METAL CLAD SUPER SERIES.**

200 MA. AC-DC. "P" base.

CB1—Duo Diode	9/6
CB2—Duo Diode	9/6
CBC1—Duo Diode Triode	12/-
CC2—Triode; Oscillator, Amplifier	12/-
CF3—HF Penthode (variable Mu)	12/-
CF7 HF Penthode	12/-
CK1—OCTODE Frequency Changer	13/-
CL2—Power Penthode	12/-
C1—Barretter (resistance lamp)	11/-
CY2—Full Wave Rectifier	9/6
FZ1—Full Wave Rectifier	9/-

**METAL CLAD SUPER SERIES.**

2-volt Battery.

(With universal "P" base.)

KBC1—Duo Diode Triode	12/-
KC3—Triode, Amplifier, Driver	10/8
KF3—HF Penthode (variable Mu)	12/-
KF4—HF Penthode	12/-
KK2—OCTODE Frequency Changer	13/6
KDD1—Twin Triode Output (Class B)	12/6
KL4—Power Penthode	12/6

(With Standard American Base.)

KBC1—Duo Diode Triode	12/-
KF1—HF Penthode	12/-
KF2—HF Penthode (variable Mu)	12/-
KK2—OCTODE Frequency Changer	13/6
B217—Triode, Amplifier Driver	9/3
B240—Twin Triode (Class B)	12/6
C243N—Power Penthode	14/-
B262—S/g RF Amplifier Detector	11/-

**STANDARD AC TYPES.**

4-volt.

B443—Power Penthode	15/-
C443 Power Penthode	15/-
E406—Power Triode	14/6
E408N—High Power Triode	27/6
E409—Triode Amplifier	12/-
E415—Triode Detector Amplifier	12/-
E424—Special Detector Amplifier	12/-
E438—High Gain Detector Amplifier	12/-
E442—S/g Amplifier	12/6
E442S—S/g Detector LF Amplifier	12/6
E443N—Power Penthode	16/-
E452T—S/g Amplifier	12/-
E445—S/g Amplifier (variable Mu)	12/6
E499—Special High Gain Detector	12/6
F443—High Power Penthode	39/6
506—Full Wave Rectifier	11/-

**STANDARD DC TYPES.**

(The first figure represents filament volts.)

A409 General Purpose Triode	12/6
A415—Triode Detector Amplifier	12/6
A425—Triode Amplifier	12/6
A442—S/g Amplifier	15/-
A609—General Purpose Triode	12/6
A615—Triode Detector Amplifier	12/6
A642—S/g Amplifier	15/-
B405—Power Triode	13/-
B406—Power Triode	13/-
B409—Power Triode	13/-
B605—Power Triode	13/-
C603—(171a) Power Triode	8/-

**STANDARD RECTIFIERS**

(For Philips Apparatus.)

328—For 327 Charger	15/-
373—For 372 Eliminator	15/-
451—For 450 and 1453 Chargers	15/-
506—For 3002, 3003, 3009 Eliminators	11/-
1002—For 1001 Charger	19/3
1010—For 1009 and 1013 Chargers	29/9
1018—For 1017 Trickle Charger	15/-
1561—Full Wave Rectifier	10/-
3006—For 3003 Eliminator	9/-

**RESISTANCE LAMPS**

(For Philips Apparatus.)

329—For 327 Charger	6/9
452—For 450 Charger	6/9
1003—For 1001 Charger	6/9
1011—For 1009 Charger	13/3
1457—For 1453 Charger	6/9

Technical information on any of the above valves will be supplied on application.

**OSRAM VALVES. (K)**

2-VOLT BATTERY RANGE.

S28	17/6	HD22	12/-
S24	15/-	L21	13/9
VS24	15/-	LP2	13/9
VP21	15/-	P2	18/-
X21	20/-	KT2*	15/-
HL2	10/-	QP21	22/-
HL210	13/9	B21	20/-

\*KT2 replaces PT2.

**MANUFACTURERS' VALVES. (K)**

At times it is possible for us to buy surplus manufacturers' stocks of valves, etc., at a big saving. Every valve is guaranteed brand new and to give a first-class test. Makes at time of writing in stock are: Sonotron, Hytron, Sylvania.

	Each		Each
201A	4/-	47 (247)	6/11
171	4/9	50 (250)	17/6
24A (224)	6/11	55	7/6
26 (226)	4/-	56	4/11
27 (227)	4/11	57	6/6
30 (230)	4/11	58	6/6
31 (231)	4/11	80 (280)	3/11
32 (232)	8/11	81	15/11
35 (235)	6/11	99	8/3
45 (245)	4/-	2A5	6/3
59	9/4		

**H.M.V. VALVES. (K)**

Retail Price

MPT4—Plain and Cat.	12/-
MS4B—Plain, Metal and Cat.	14/-
U12—Plain	8/-
MH4—Plain, Metal, Cat.	13/-
VMS4B—Plain, Metal, Cat.	12/-
MS4 Plain, Metal	12/6
MHI4 Plain	12/-
PX4 Plain	12/-
S23 Plain, Metal	12/-
HL2 Metal	7/6
PT2 Plain	10/-
VS2 Metal	16/-
MHD4—Metal	12/-
MU12—Plain	11/-
MU14—Plain	12/-
MX40—Plain, Metal	14/6
VDSB—Metal	16/-
VDS—Metal	15/6
DH—Metal	11/-
DPT—Plain	15/-
DSB—Plain, Metal	15/-
X21—Metal	15/-
VS24—Plain, Metal	11/-
HD21—Metal	12/-
QP21—Plain	17/6
U14—Plain	9/-
MSP4—Metal	14/6
VMP4G—Metal	10/6
D41—Metal	7/6
X41—Metal	13/6
N41—Plain	11/6
PX25—Plain	18/-
VMP4K—Metal	12/-
VMS4—Plain, Metal	11/6

**LISSEN VALVES. (K)**

Full technical details on request. These Valves can be supplied with English type bases only.

Type	Each	Type	Each
H2	8/6	P220	12/6
HL2	8/6	L2D	17/6
L2	8/6	AVC2	27/6
SG2V	19/6	PX240	15/-
SG215	19/6	PT225	19/6
PT2A	19/6	B2	15/-

**VALVE ORDERS.**

When ordering Philips or Mullard Valves it is important to make sure you get the right type of base. State type of base you require on your order. The diagrams below will be helpful to you.

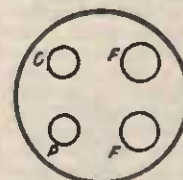

Cap G.

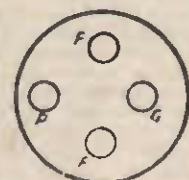

Cap A.

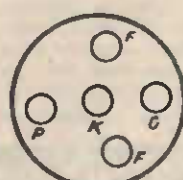

Cap O.

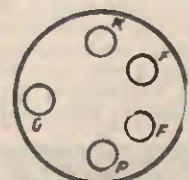

Cap N.







lear. The "cold" end of the pick-up is, of course, still connected to its terminal, and the chassis of the tuner, being connected to the chassis of the amplifier, provides the return when the radio is used.

In order to get the .125 resistor, which is not always easy to obtain, we connected two .25 meg. resistors in parallel. All the resistors may be of 1 watt capacity.

The voltages for the tuner are obtained from the amplifier. The filament terminals of the tuner valves are connected together in the normal manner, and are connected to the 6.3 volt winding which supplies the valves in the amplifier—as a rule this main winding will have ample capacity to take care of all the valves, as the drain is not much more than 2 amps. The high tension of 250 volts or so is also obtained from the amplifier and the B minus terminal of the tuner is connected to the chassis of the amplifier, which of course is in turn connected to the B minus of the amplifier itself.

We suggest that connection is made by mounting a four-pin valve socket at the back of the amplifier, and connecting its respective terminal to the corresponding points in the amplifier, which will give these voltages.

When completed, all that remains is to line up the tuner. This is done by loosening off the trimmers about half way, and lining them so that a station in the centre of the band is received to correspond with the dial markings. The others should then be found to correspond reasonably accurately all round the dial. It is a simple process of adjusting the trimmer until the station is received loudest for each trimmer setting.

It should not be necessary to use a very large aerial with the tuner—in fact, one too large will tend to broaden tuning too much, although probably increasing signal strength. About 30ft. of aerial should be enough.

The dial lamps should be 6 volt types, and connected to the filament terminals of one of the valve sockets.

Any suitable 6 volt valves may be used. The R.F. amplifiers may be 6K7, 6D6, or 6U7C, and the detector 6J7, 6D6, or 6J7C. Should it be necessary to use 2.5 volt valves, use a 57 detector, and 58 for the R.F. amplifiers. The results will be the same in each case.

3/5 KIT—See page 107.

Kaikoura.

The 3/5 Kit Set is now going fine and the owner is very pleased with it. The Little Wonder Set is also going fine.—V.W.L.

Feilding. 12/9/37.

"I have got my 3/5 Kit going with good volume on all YA stations. I am very pleased with the set now, and can say it has the volume of any 5-valve set."—W.H.G.

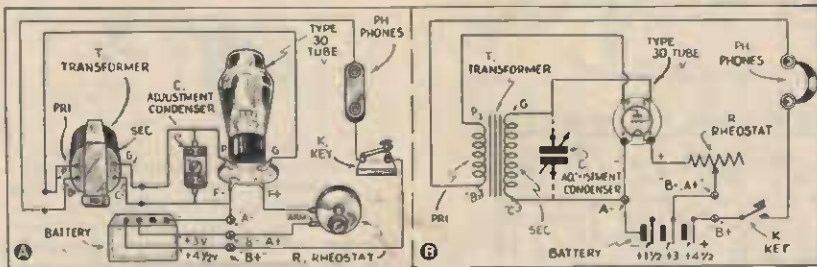

MORSE CODE OSCILLATOR CIRCUIT.

## MORSE CODE OSCILLATOR

The Morse Code is one of the first things to learn if you have ambitions to become a radio operator or amateur transmitter. The short-wave fan will also get much more fun from his set if he can understand dot dash messages flashing all over the world. The code oscillator is illustrated in both wiring schematic diagrams.

### CONSTRUCTION.

Mount the transformer, valve socket, condenser, and rheostat on the 6 x 6 recessed block, screw in the terminals for the battery, phones, etc., and wire the oscillator in accordance with the diagrams. Varying the condenser will alter the pitch of the notes. An oscillator of this nature is the best way to learn the code, as it gives you the same note as you will hear when you start deciphering real signals.

### PARTS LIST. (K)

- 1 6 x 6 Base Block
- 1 Audio Transformer
- 1 Valve Socket
- 1 Pre-set Condenser
- 7 Terminals
- 1 30 Valve
- 1 Rheostat

Complete Kit of Parts, as listed above. Cat. No. EK20 ..... **20/-**

### EXTRAS (not included in above)

- 1 4½-volt C Battery ..... 3/-
- 1 pair Phones ..... 7/6, 15/- or 17/6
- 1 Morse Key ..... 4/3, 9/3 or 17/6

## AIR-CELL PENTAGRID. (K)

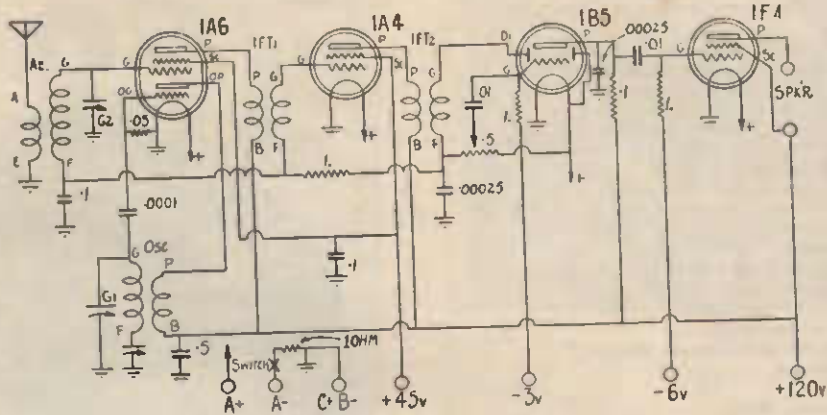

Here is a circuit of the Air-Cell Pentagrid, a 4-valve broadcast battery set. This is remarkable for its low battery consumption. The total drain from the "A" battery is only .3 of an amp., and the set is built for use from an Air-Cell which will give about 2,000 hours' life. The drain from the "B" battery is also very low. Full details of the set were given in the "Wireless Weekly," October 8th, 1937. A copy of this issue will be given with each Kit Set.

(K)

R.C.S. Coil Kit for Air-Cell Pentagrid Four. Cat. No. EC415 ..... **44/-**

Complete Kit of Parts for R.C.S. Air-Cell Pentagrid Four, without valves, battery, or speaker.

Cat. No. EK14 ..... **£6/10/-**

BRITISH

## MONARCH

(G)

### ELECTRICAL APPLIANCES

A Crowning Achievement in Quality and Value!

### TOASTER. (G)

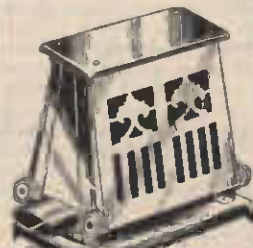

One you will be proud to own. Finished in highly polished nickel-plate. Has a turnover feature. Just lower the side and the bread is automatically turned over. Element designed so that the bread toasts quickly and evenly. Supplied complete with cord, etc., ready for use.

**19/6**

Cat. No. EE750 ..... **19/6**

### LAMPHOUSE GUARANTEE.

If for any reason whatever you are not fully satisfied with any goods purchased from the LAMPHOUSE, return them within 7 days and we will refund your money without question.



**ECONOMY THREE PARTS LIST.**  
(K)

- 1 Economy Three Aerial Coil.
- 1 23-plate Reaction Condenser.
- 1 .00035 Tuning Condenser.
- 1 RF Choke.
- 1 60 MA Power Transformer.
- 2 8 Mfd. Electrolytic Condenser.
- 3 Valve Sockets.
- 1 Valve Socket for Speaker.
- 1 400 ohm. W.W. Resistor.
- 1 50,000 ohm. 1-watt Resistor.
- 1 5 meg. 1-watt Resistor.
- 2 1/2-meg. 1-watt Resistor.
- 1 1/2-meg. 1-watt Resistor.
- 1 .00025 Condenser.
- 2 .01 Condenser.
- 1 15,000 ohm. Voltage Divider.
- 1 Chassis.
- 1 Dial.
- 1 Valve Shield.
- 3 Valves, 80, 53, 2A5.
- Sundries, including wiring wires, lugs, bolts and nuts, and sundry hardware.
- 1 6in. Speaker.

Complete KIT OF PARTS, including valves and speaker. **£4/19/6**

Cat. No. EK21 .....

NOTE—Only complete sets of parts as above will be supplied at this special price.

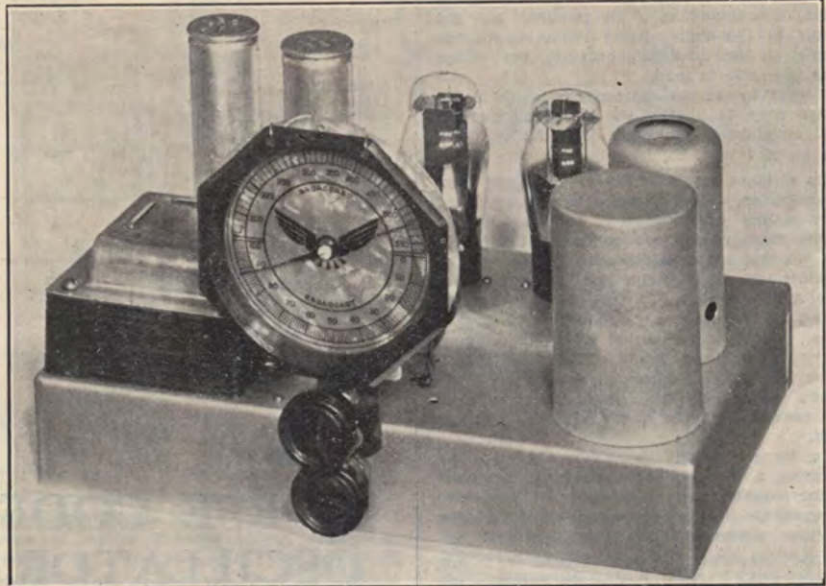

# ECONOMY Three RECEIVER

UNDER-CHASSIS WIRING DIAGRAM  
is on page 88.

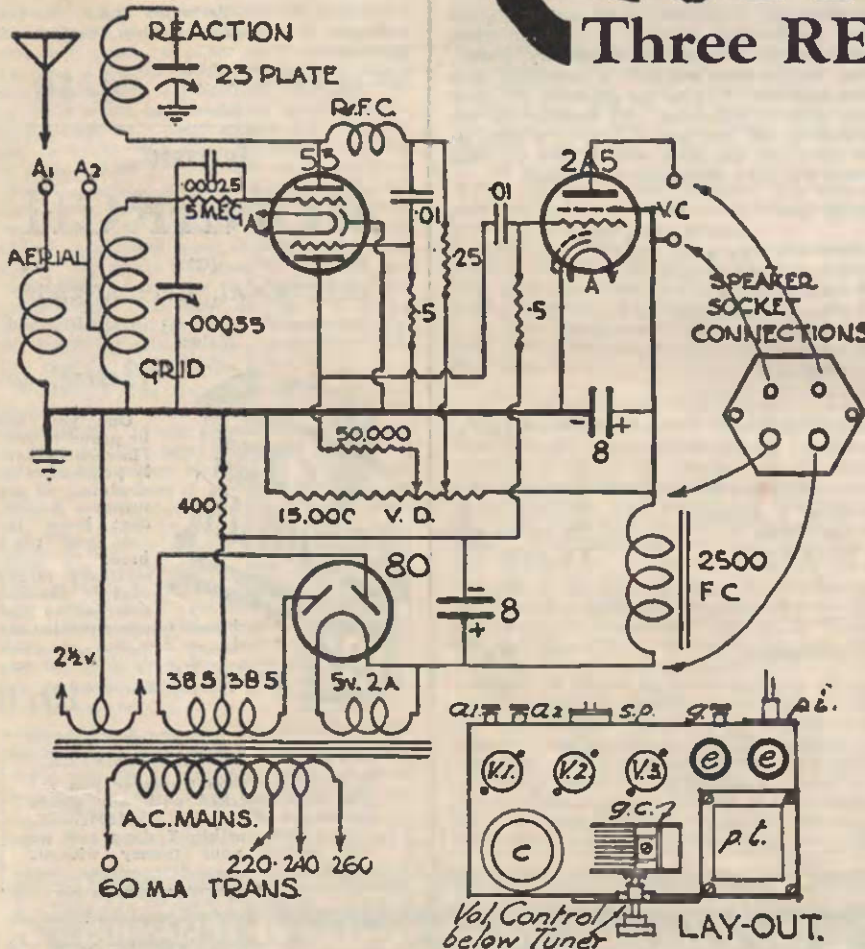

The Economy Three has been designed for constructors who want a set for local station reception. There are plenty of listeners who are satisfied with programmes from their several local stations, and to whom DX means nothing—this set will suit these folk admirably.

The tone is excellent—quite as good as many five and six valves commercial sets; the construction is simple and the upkeep low.

Although this set is described as a local receiver, constructors in the country away from the powerful broadcast stations should have no difficulty in logging all the main VA stations and several Aussies.

The layout and construction follows usual practice, and from the diagrams given here no difficulty should be experienced in completing the set. There are no other instructions available than those given in this Annual, so if you do not think you can build the set from the diagrams do not attempt it without help.

**SIMPLE TESTING.**

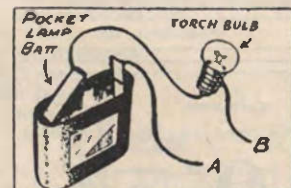

Probably the simplest of all testing instruments. Easily made. Test prods can be fitted to the leads A and B.

With it anyone can conduct numerous tests. In use this simple device forms an excellent tester of contacts and terminal connections, and of low resistance metallic paths such as are provided by loudspeaker connecting cords, battery leads, and so on.

Vol Control below Tuner LAY-OUT.





# All Wave Double "Forty Nine"

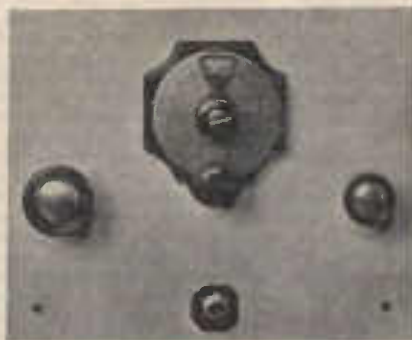

This set is the second of the "49 Family" which we have described, the first, "The Hiker's One," being put on the market in 1937. It met with amazing success and is still one of the "best sellers." This two-valve all-wave model is a little more advanced, and, with plug-in coils, covers from 20 to 500 metres. On test, no difficulty was experienced in receiving Daventry, Zeesen, Paris, Sydney, and Melbourne on short wave, as well as amateurs on the 80-metre band at good headphone strength, whilst the "locals", on broadcast, successfully operated a speaker.

### CONSTRUCTION.

Commence by mounting all the components on the chassis and panel as shown in the illustration. The audio transformer is mounted so that the correct terminals come opposite the holes marked G, CB, HT and P on the under-chassis diagram. Do not as yet attach the panel to the chassis, but you can solder the leads to C1, C2 and C3, leaving them long enough to connect to their respective destinations under the chassis. Also wire the moving plates of C1 (which are insulated from the panel by means of two of the insulating washers provided) to the fixed plates of C2. The moving plates of C2 and C3 are also connected, the lead from these being left long enough to pass through the chassis to earth. The aerial series condenser should have the outside rotor plate bent in a little, so that when the plates are fully enmeshed it will touch the stator plate, thus shorting itself out. Turning now to the chassis, wire up the components as shown in the diagrams. Always try to do your wiring from the schematic diagram, not the under-chassis diagram. Note particularly the connections to the coil socket. If a two-volt accumulator is to be used in place of the two only 1½ v. dry cells for the "A" supply the

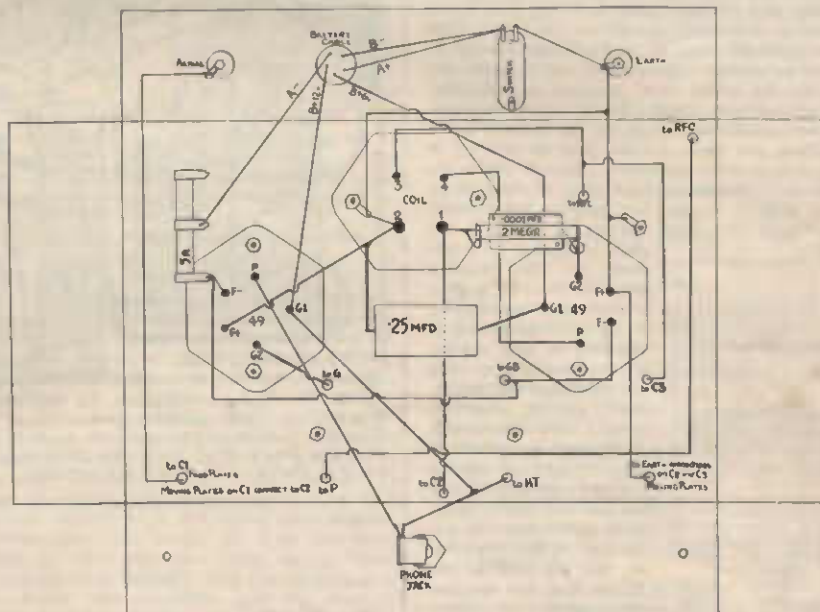

UNDER CHASSIS WIRING.

A negative resistor (5 ohms) will not be required, the A lead being taken direct to the valve socket. If you are unable to obtain a 5 ohm. resistor, you can use a centre-tapped 10 ohm one, connections being taken from one end and the centre tap. You can now attach the panel and phone jack, which must be insulated from the chassis with two insulating washers. As you are wiring in the battery cable, make a note of the colours and their battery connections, such as "Red A," etc.

### THE COILS.

These are close wound on 1½ in. former with 1 in. spacings between the grid and reaction coils. All coils must be wound in a clockwise direction and connected to the correct base pins. See Coil Connection Illustration. Gauge 26 DGC is used for the short-wave coils and gauge 32 or 34 enamel for the broadcast coils. If heavier wire is used for the BC coils difficulty will be experienced in getting all the turns on the former. On the BC coils, the reaction is wound over the grid coil at the bottom end, being separated by a piece of paper wrapped round the grid coil and gummed in position. The large reaction coils are necessary because of the low "B" supply.

### COIL DETAILS.

	Grid Coil.	Reaction Coil.
20 meter band .....	5	6
40 meter band .....	10	9
80 meter band .....	22	14
160 meter band .....	45	21
165 to 220 meters ...	165	30
210 to 350 meters ...	210	38

### OPERATION.

Having connected up the batteries, aerial and earth, plug in the phones and switch on the set. The reaction condenser (C3) should only be in sufficient to produce a faint rushing noise in the phones. The aerial condenser (C1) is used on the broadcast coils to obtain greater selectivity, and the short wave coils to remove blind spots and ensure smooth oscillation over all the wave-lengths. If the set oscillates uncontrollably, it will be necessary to remove

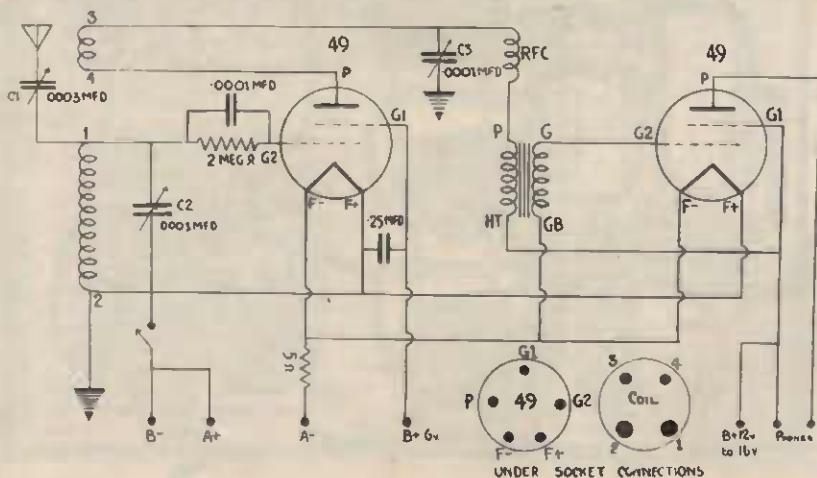

CIRCUIT.

UNDER SOCKET CONNECTIONS

some of the turns, one at a time, from the reaction coil. On the short-wave coils, only remove turns if moving the reaction coil further away from the grid coils does not produce the desired result. In tuning, turn the tuning condenser (C2) slowly and listen for station whistles. When a station is located, the whistle will change its note as the receiver is tuned over and past the station. When such a whistle is heard, tune till it is lowest in note and decrease the reaction condenser. The whistle will either get a little higher or lower, but re-tune as reaction is being adjusted until oscillation just stops. The station will now be heard clearly on music or speech. Do not allow the set to remain oscillating on a phone station. This will cause trouble with your neighbours. If the set goes out of oscillation with a loud howl, reducing the "B" voltages will remedy the complaint. When the "feel" of the tuning and reaction coils is found, the aerial coupling condenser should be adjusted. This will probably require further adjustments to both C2 and C3. The smaller the capacity left in C1, the better local stations can be separated, but with a slight loss in signal strength. Should oscillation not be strong enough, either increase the turns on the reaction coil or, in the case of short-wave coils, move it nearer the grid coil. Remember, the valve is most sensitive when it is just not oscillating for phone and when it is just starting to oscillate for code stations. In a set such as this, using only a low B supply, it will help considerably if the 12-volt tapping is adjusted for best results, usually between 9 volts (to control fierce oscillation) and 16 volts (to assist weak oscillation). It is also sometimes of great benefit to remove the earth connection from the set for short waves. With a little practice proficiency in the operation of this set will be obtained, and the operator well repaid. In conclusion, do not have your aerial too long, particularly on short waves, 75 feet being the maximum length for aerial and lead-in combined.

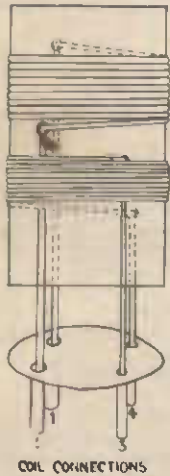

COIL CONNECTIONS

**PARTS REQUIRED.**

- 1 Midget 13-plate Condenser (C1)
  - 2 Midget 23-plate Condensers (C2 and C3)
  - 1 Vernier Dial
  - 2 Knobs
  - 1 Goltone Choke
  - 1 Choke
  - 1 Audio Transformer
  - 1 On-Off Switch
  - 1 2-meg. Resistor
  - 1 10 ohm C.T. Resistor
  - 1 .0001 Mica Condenser
  - 1 .25 Tubular Condenser
  - 1 4-pin Valve Socket
  - 2 5-pin Valve Socket
  - 1 Phone Jack
  - 1 Phone Plug.
  - 2 No. 49 Tubes
- Sundries, including terminals, bushing washers, bush, battery cable, bolts, connecting and coil wire
- Complete Kit of Parts, as above, without valves
- |                    |      |
|--------------------|------|
| Cat. No. EK25      | 57/- |
| Ditto, with valves | 70/- |
| Cat. No. EK26      |      |

**EXTRAS.**

- 1 16-volt C Battery ..... 3/3
- 1 pair Phones ..... 7/6, 15/- or 17/6
- 2 1½-volt Dry Cells ..... 2/6 each

BACK OF CHASSIS: INSIDE VIEW

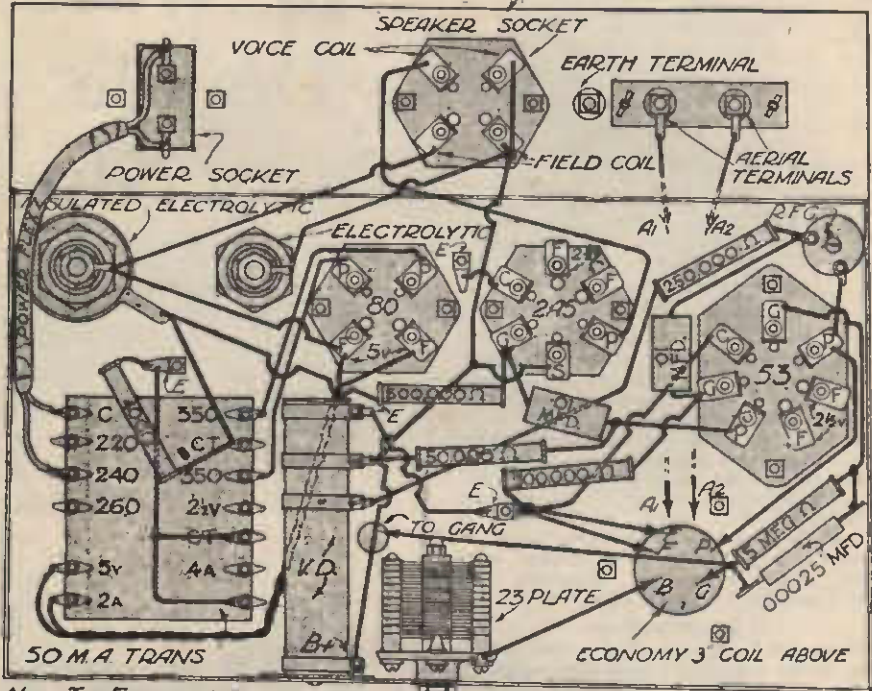

NOTE: THE FILAMENT WIRING TO THE 2A5 & 63 VALVES HAS BEEN OMITTED HERE. CONNECT UP THE 2½V. AA LUGS ON TRANSFORMER TO THE 'F' LUGS ON THE TWO VALVES. TWIST THE WIRES TOGETHER.

CONNECT THE AERIAL TERMINALS TO LUGS A1 & A2 ON COIL. AS INDICATED BY DOTTED ARROWS  
Ω = OHMS

UNDER CHASSIS WIRING OF ECONOMY RECEIVER. See page 86.

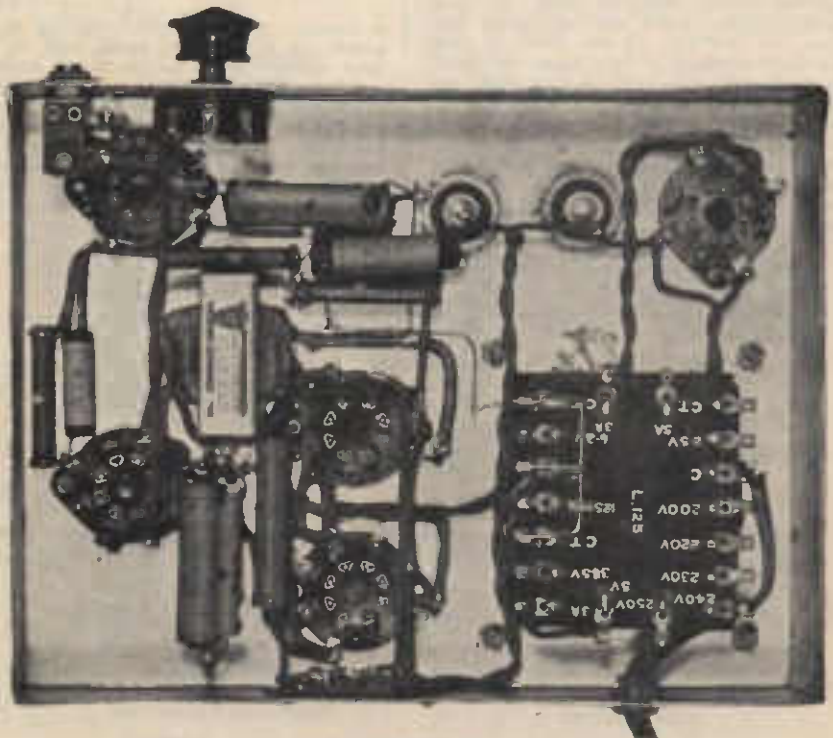

UNDER CHASSIS PHOTO OF HOME AMPLIFIER. See page 122.



# How to Build



("Wireless Weekly.")

In every home, whether a "real" radio set is installed or not, there is room for a crystal set or two. The boy can listen to a thriller on the crystal set without disturbing the household, his sister can use one under her pillow so that she is crooned to sleep by Bing Crosby. You can easily build such a set for yourself at the cost of a few shillings. Here are the instructions:

The simplest of all radio receivers is the crystal set. In the early days of radio crystal sets were particularly popular, mainly because they were so simple, and also because, in the days when radio was so expensive, the crystal set could be built for less money.

The crystal set is quite a good one for the small boy to build as his first radio set. With it he will be able to get a practical demonstration of many fundamental radio principles, and, at the same time, have a good deal of fun.

It is not good policy to use a crystal set farther than about 30 miles from a strong station. There is no amplification in such a set, and the only energy available is that picked up by the aerial itself. At 15 miles the energy as a rule is getting pretty small for the average station, and conditions would therefore tend to become difficult. However, by the use of good high aerials, country people have often achieved some most remarkable reception over long distances with crystal receivers. Such cases are the exception.

### AERIAL AND EARTH.

The aerial and earth should be something better than a length of wire round the picture rail. An outside aerial should always be used with a crystal set for best results. Do not make it too long in case interference troubles become too annoying—the longer the aerial the less selective it tends to make the set. We would suggest about 60ft. to 80ft. long and as high as possible.

### PARTS LIST.

- 1 Baseboard, wooden, about 6in. x 6in. x 1/4in.
- 1 Bakelite front panel, 6in. x 6in. x 1/4in.
- 1 Tuning Condenser, .00035 or .0005 mfd.
- 1 Knob for same.
- 1 Crystal Detector.
- 1 Coil Former.
- 50 feet of 24 gauge d.c.c. wire.
- 10 feet of hook-up wire.
- 4 Terminals.
- 1 pair headphones.

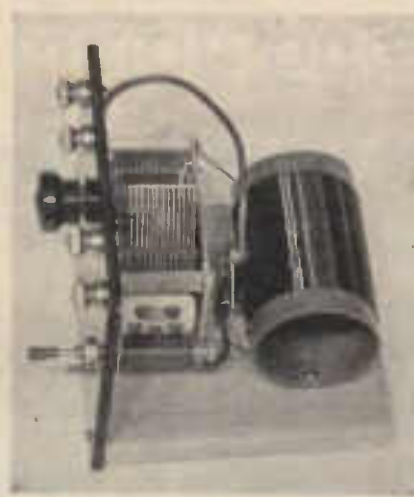

The earth may be a kerosene tin buried in the ground (or one could use a nearby water-pipe and an earthing clip for it. See that the aerial is well insulated to prevent losses in pick-up.

There is very little to the construction of the receiver itself. The main component to worry about is the tuning coil, and there is very little worry to it. The gauge and type of wire we suggest is 24-gauge double-cotton covered. Actually the wire is not a very important factor within limits, and may be anything between gauges 20 and 26, either d.c.c., enamelled, or silk-covered.

The total number of turns to wind on is 60. If a couple of holes are pierced at the beginning and end of the wiring, and the ends of the wire threaded through them, you will be able to anchor them quite firmly, and thus prevent the coil from unravelling when finished.

When you have wound on 15 of the turns twist the wire into tight little loop to make a tapping, and continue with the remainder of the turns. Make another such tap after 30 turns have been wound, and a third tap at 45 turns. When the coil is finished the insulation is scraped from these loops so that the aerial clip can make contact with the bare wire underneath.

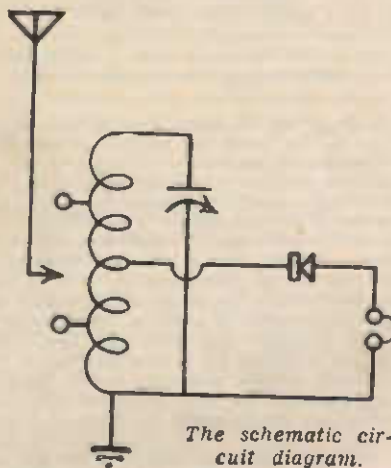

Leave about 6 inches of wire at the ends of the coil for connecting it into the circuit.

The base-board as shown in our pictures can be made of wood. The front panel may also be of wood or bakelite or other insulating material.

The coil may be mounted to the base-board by lying it on its side and tapping a couple

of tacks through the eardboard into the wood to keep it in place.

Immediately in front of the coil is the tuning condenser. A condenser of .00035 would probably be suitable, although it would not have such a wide tuning range as the .0005 type.

### WIRING UP.

In wiring up the set, the earth terminal of the set is connected to the terminal of the condenser which connects with the moving plates. The nearest end of the tuning coil is also connected to the earth terminal. The other end of the coil is connected to the fixed plates of the condenser. The 30th turn tapping, which is actually the centre of the coil, is connected to the cup containing the crystal. The other terminal of the crystal detector unit is connected to one of the headphone terminals. The other headphone terminal is connected to the earth terminal of the moving condenser plates (which is really the same thing). A wire connected to the aerial terminal has a clip fastened to its free end, so that it can be connected to either of the two vacant tapings.

This completes the construction of the receiver.

(K)  
COMPLETE KIT OF PARTS 13/-  
Cat. No. EK30 .....  
\*Phones extra.

### OPERATION.

To operate the receiver, the aerial clip is fixed to the tapping furthest from the earthed end of the coil. Set the dial or pointer about the centre of the scale where you are pretty certain to be roughly tuned to a station. Now carefully adjust the crystal, moving the condenser control to and fro on each adjustment until you can tune in a station. Tune in a good strong signal and adjust the catwhisker until you get the best results.

If you find bad interference, clip the aerial to the other tapping, which will reduce volume all round, but probably improve the selectivity considerably.

### HEADPHONES.

The limited application and low cost of the crystal set do not encourage one to spend much money on the headphones, and there are quite cheap 'phones available which will do the job very well. However, the better the 'phones, naturally, the better the reception will be in tone and volume. Therefore, if you have the opportunity to get a good pair of 'phones, by all means do so. Either 2000 ohms, or 4000 ohms. 'phones would be suitable, but 2000 ohms. should be regarded as the lowest possible rating.

### TWO MORE CRYSTAL SET CIRCUITS.

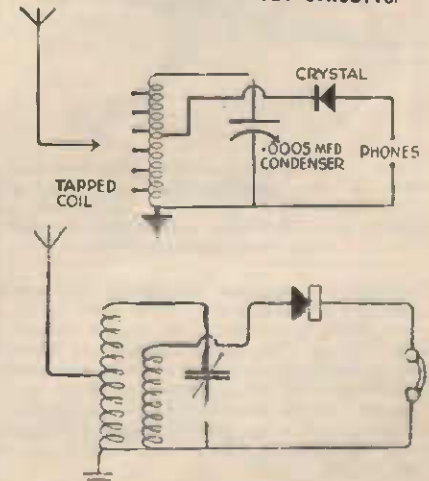

# Concerning Joining Wires

(Abridged from article which appeared in "Popular Wireless.")

## WIRELESS JOINTS.

The subject of wire joints and their making is not perhaps as important as it was a few years ago, when radio soldering operations were much more extensively carried out than they are at present. And consequently, the present-day constructor has to some extent lost the knack—for a knack it is and nothing else—of making wire joints in a manner which combines neatness with strength. Of course, so far as actual electrical efficiency goes, the soldered joint is infinitely better than any of the older spliced, twisted or intertwined joint, no matter how neatly and correctly they may have been made. But the fact remains that a soldered joint is not always a strong one, and that, in many instances, it is very desirable to splice up two pieces of wire which have to be connected together before soldering them.

It is, therefore, with the aim of giving the constructor a little extra information on the subject of wire-joint making that we have summed up the information contained in this article. Let us deal with the joints which are generally made in the aerial and earth systems of a receiving installation, for it is in the construction of these systems that a good method of jointing two or more wires proves the most effective. With stranded aerial wires of the usual 7/22 variety the effecting of a good strong joint is comparatively simple, as will be evident from a glance at the diagrams Fig. 1 (a) and (b). Here we see the making of a download joint from the aerial wire. The strands of

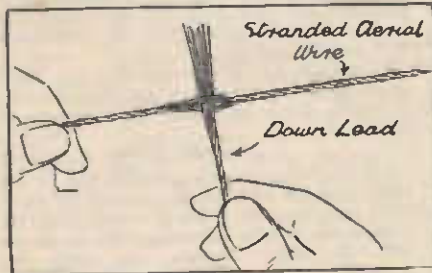

Fig. 1a.—Where stranded aerial wire is used this method of making a joint has many points in its favour.

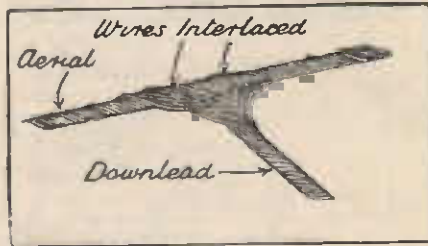

Fig. 1b. The final operation in making the Fig. 1a joint is to interlace the strands as shown here. Soldering is necessary to ensure good electrical conductivity.

wire are first separated and cleaned, after which they are smeared with a little soldering flux, and finally interlaced in the manner shown in the diagram. The joint should then be tightened with the aid of a pair of pliers, and finally the whole area of the joint should be fairly heavily, but at the same time neatly soldered. Such a joint in an aerial system will certainly last for the lifetime of the aerial, and it will be electrically efficient.

If single wire is used for any portion of the aerial earth system of the receiving installation, any necessary joint in it may be effected in the manner shown in Fig. 2. Here the two

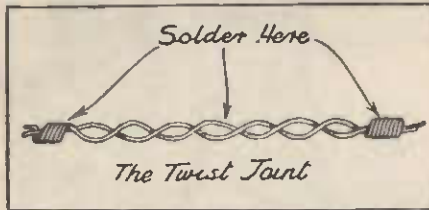

Fig. 2.—The two wires are loosely twisted together for a few turns, and then the last inch or so of free wire is tightly twisted round the second wire.

wires are loosely twisted together for a few turns, and the last inch or so of free wire is tightly twisted round the second wire, these latter turns being tightened by the aid of pliers. Such a joint should be neatly soldered at the places shown in the diagram. It is not necessary to solder over the whole area of this type of joint. This joint is technically known as the "twist joint."

Another useful form of joint for special purposes is the "Britannia Joint." As will be seen from the diagram, Fig. 3, which illustrates

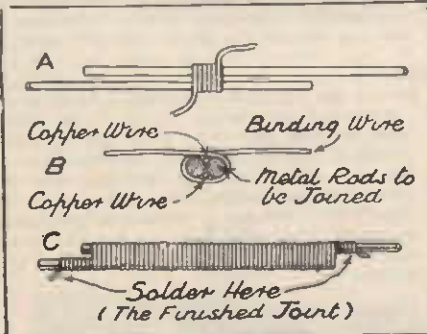

Fig. 3. The Britannia joint is applicable to metal rods or two stout conductors.

the joint, the Britannia Joint is only applicable for the connecting together of two stout conductors or metal rods. In order to effect a joint of this nature, lay the rods together so that they overlap a few inches. Next take a foot or two of 20's bare copper wire, and, using the middle of this, begin to bind up the two rods in the manner shown at A in the diagram, Fig. 3. After having made about six turns of binding wire, slip a few pieces of thin copper wire under the turns in order to enable them to attain a greater grip on the two rods. This method is brought out at B in the diagram, Fig. 3, which presents a section of the Britannia Joint, showing the small lengths of wire which have been slipped under the turns of binding wire.

Finally continue the binding of the two rods until all the binding wire has been used up. Finish the joint by soldering the binding wire at both ends, after tightening up the whole structure with pliers. If the joint is to have high electrical efficiency it must also be soldered in a few places along its length.

Another method of making a T-joint in stranded wire is shown in the diagram, Fig. 4. The

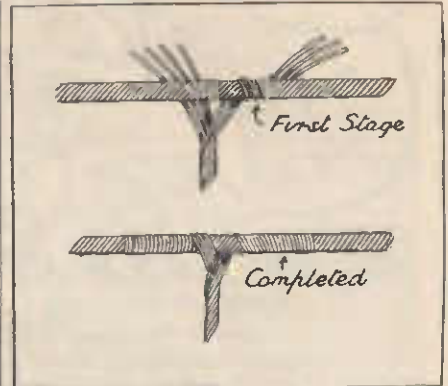

Fig. 4.—An alternative to the Fig. 1 method of making a "T" joint. It is a good one to adopt in those cases where it is difficult to separate the strands interlacing.

Joint is no more effective than the neater one illustrated at Fig. 1, but, nevertheless, this type of T-joint is of use when it is either difficult or impossible to separate the strands of wire in order to adopt the method of interlacing the wire strands.

Fig. 5 illustrates the making of what is known as the "Married" joint. Joints of this nature are especially suitable for connecting up two

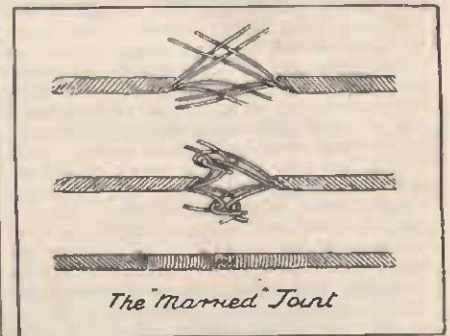

FIG. 5.

or three-stranded wires. The diagram is practically self-explanatory. It will be seen that each strand of wire is tightly wound round the others. A pair of pliers is finally used for tightening the joint. Here again, of course, if electrical efficiency of the highest order is demanded, one or two areas of the joint must be well soldered.

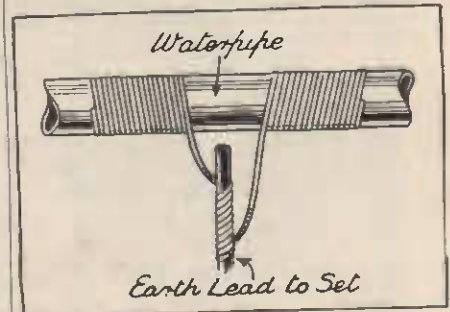

FIG. 6.



A good method of making an effective temporary connection of an earth lead to a water-pipe or metal rod buried in the earth is the one illustrated at Fig. 6. Here again the construction of the joint is self-explanatory, and therefore it does not require further elaboration. It should be borne in mind, however, that the majority of earth connections rapidly corrode, and, therefore, if they are required for permanent use, the soldering iron must invariably be brought into efficient operation.

Sometimes in experimental work it is necessary to make temporary connections between two nearby leads. Terminals may not always be convenient or even provided. Fig. 7 illustrates one way of doing this. Of course, whenever possible all joints and wire connections in

manner. The above method, however, carefully applied, is most useful for joining strips or sheets of lead or tinfoil. It is also of use in the installation of copper-strip aeri-als. A lap-

ped joint, carefully made, is extremely strong, and if a little solder is neatly applied to the joined surfaces, a connection of the highest electrical efficiency will result.

# R.C.S. STANDARD

## 4-5 VALVE

# DUAL-WAVE

## "Cir-Kit"

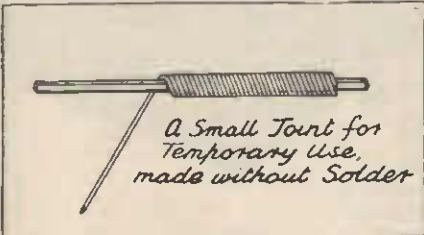

*A Small Joint for Temporary Use, made without Solder*

Fig. 7.—A connection of this type will often serve where a temporary joint for experimental work has to be made.

a set should be well soldered. After all, the practice of soldering is not difficult, and for electrical efficiency a simply soldered joint must necessarily be far better than the most elaborately twisted-together joint.

One point which some amateur constructors might do well to note is the making of a soldered T-joint, which is illustrated in Fig. 8. In the top diagram we have the method by which a T-joint in square-sectioned wire or strip should not be made. Such a joint may, of course, be electrically efficient but nevertheless it does not possess much strength. T-joints of this nature are much better made in the way indicated in the lower diagram. Here it will be seen that the two wires or strips are soldered together for a distance of about half an inch.

**A USEFUL JOINT.**

One of the most useful joints for strip conductors is that which is known as the "seamed" or "lapped" joint. The ends of the metal strips which are to be connected are turned over for a distance of about half an inch. These turnovers are then inserted into each other. The joint is then laid down upon a flat surface, and the area is subjected to a thorough hammering in order to compress the joined surfaces of the strip conductors together. Finally, the joint is finished off by means of the application of solder around the edges of the joined strips.

This method applies only to thin metal strips or sheets, of a thickness up to about a tenth of an inch. Thicker sheets than these usually have to be riveted and soldered in the ordinary

*A Joint Soldered in this position is Weak*



*By banding one Wire and then Soldering, the Joint made is perfectly strong.*

FIG. 8.

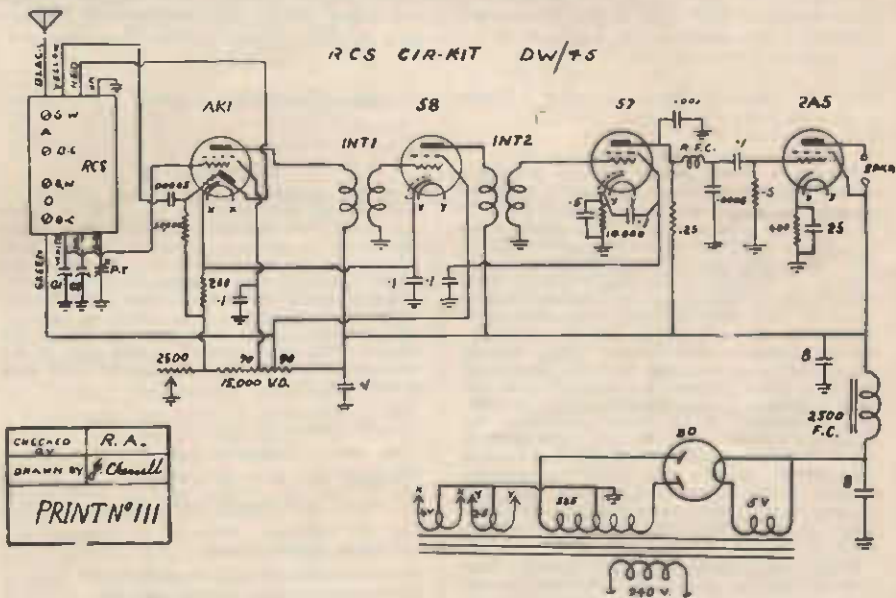

CHECKED BY	R. A.
DRAWN BY	J. Chiswell
PRINT N° III	

**5-VALVE DUAL-WAVE KIT FOR £7/15/-.**

For those requiring an inexpensive yet extremely efficient five-valve dual-wave kit set, the R.C.S. "Cir-Kit" will fill the bill.

The usual R.C.S. quality has been maintained throughout. Excellent reception of the main N.Z. and Australian stations is obtained on the broadcast band, while in favourable localities the Americans come in with a bang. On the short-wave band (19-50 metres), London, Paris, Berlin, etc., will be heard with good speaker strength. Each "Cir-Kit" is supplied with blue print circuit diagram and full size lay-out wiring diagram. Constructors are recommended to purchase the complete "Cir-Kit," but the dual-wave box is available separately if desired.

**PRICES. (K)**

- Cat. No. EK356—Complete "Cir-Kit" set of parts ..... £7/15/-
- Cat. No. EK357—As above, but with Raytheon Valves and Jonsen 8in. Moving Coil Speaker ..... £10/12/6
- Cat. No. EC376—Dual-Wave Coil Box only. ..... £2/8/6

**KIT, only**  
**£7'15'/-**

**HERE'S A USEFUL PAIR OF (D)**

**7in. PLIERS, WITH INSULATED HANDLES—**

Cat. No. EU57 ..... **2/11**



# 1938 DUAL SIX



"WIRELESS WEEKLY" CIRCUIT.

This Dual-wave Receiver is sensitive and selective and at the same time of good tonal quality. The cost of a Kit of Parts is comparatively cheap, and any experienced person will have no difficulty in building a set in his spare time. New-comers to Radio construction are not advised to attempt to build sets of this nature unless they can get someone to advise and help.

NOTE.—Kit of Parts do not contain any other instructions than those given in this article.

Here is a circuit for an effective receiver, a circuit suitable for either a straight broadcast receiver or for a dual-wave receiver. But it is also something more, it is a circuit which was designed from theoretical considerations, and then built from standard components, and were then assembled on the kitchen table. Even as you, gentle reader, might assemble them on your kitchen table. Immediately on completion the loud-speaker was fitted and the chassis connected to the power, and it brought in stations from near and far with tonal quality and power seldom attained in even the most expensive factory-built receivers. Without any adjustment at all, both short-wave and broadcast tuning was sufficiently accurate to allow truly excellent reception. The receiver was placed side by side with a commercial receiver listing at over £40, and in every way it was found that the sensitivity and selectivity of the kitchen-table model equalled that attained by the other.

Later, the alignment of the circuits was checked, and it was found that only a half turn on the padder adjustment was necessary to bring every circuit into proper resonance. Maybe, we happened to be very lucky, but that is the true story of how this receiver worked out in practice, and any handy man who follows our instructions should be able to get the same satisfaction.

#### THE POWER OUTPUT.

The normal power output of a 6A3 or 2A3 valve is only about  $\frac{1}{2}$  watts, which is about the same as the rating given for the pentodes usually found in commercial receivers. But don't let that rating fool you.

Actually by the time the distortion content amounts to the same as the distortion present when the pentode is delivering its rated power output, the 6A3 will be turning the loud-speaker inside out (and the neighbours will be throwing stones on your roof).

#### THE DUAL-WAVE UNIT.

The dual-wave unit is supplied in a form which allows quick mounting in the base, which is supplied with all holes cut, and the switching is all built into the unit. In practice, this means that the dual-wave model is just as easy, in fact slightly easier to build than a straight broadcast superhet. Some readers appear to have gained an impression that a dual-wave receiver is more difficult to build than a broadcast set, but we proved to ourselves in no uncertain way that this is quite wrong. A good dual-waver is just as easy to build and not at all difficult to get into proper alignment.

#### CONSTRUCTION.

In the assembly of the original receiver we adopted the safe policy of trying to fit every component into position with as short a length of wiring as possible. This is a very good plan and is a sure way to satisfaction. Long wires running about the base are always a possible source of feed-back, and when attached to tuning circuits often result in capacity effects which upset the normal tuning of the circuit. The total amount of wire used in the original receiver did not amount to more than a few feet.

#### PARTS LIST.

- 1 Base, size 14 x 10 x  $\frac{3}{4}$ .
- 1 Power transformer, 385v. 80m., 6.3 and 5v.
- 1 Filter Choke, 100ma.
- 1 Dual-wave coil kit, complete with gang, intermediates, padder, etc.
- 1 Suitable dial.
- 3 8-mfd. electrolytic filter condensers.
- 1 25-mfd. electrolytic tubular condensers.
- 2 .0001-mfd. mica condensers.
- 1 .001-mfd. mica condenser.
- 1 .04 mica condenser.
- 6 .1-mfd. tubular condensers.
- 2 .5-mfd. tubular condensers.
- 1 450-ohm 100 ma. wire-wound resistor.
- 1 2500 ohm, 25ma., wire-wound resistor.
- 1 15,000-ohm voltage divider.
- 2 1-meg. 1-watt resistors.
- 3 5-meg. 1-watt resistors.
- 1 .25 meg. 1-watt resistor.
- 1 .1 meg. 1-watt resistor.
- 1 50,000-meg. 1-watt resistor.
- 1 20,000-meg. 1-watt resistor.
- 1 1000-ohm potentiometer.
- 1 .5-megohm potentiometer.
- Sockets—3 4-pin, 2 small 7-pin, 2 6-pin
- 4-Valve Cans.
- Sundry hardware, screws, wire, mounting posts, etc.
- Valves—2 6D6, 1 6A7, 1 6B7, 1 6A3, 1 80.
- Speaker—1000 ohms field coil, 2500-ohm load impedance.

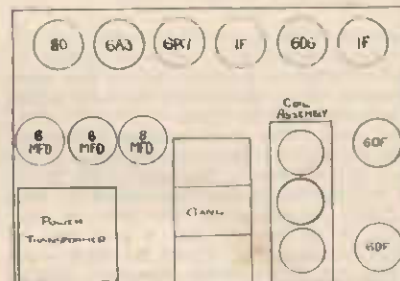

CHASSIS LAYOUT.

#### ASSEMBLY.

On opening up your parcel of parts it is not a bad plan to heat up your soldering iron and proceed to "tin" the terminal lugs of all the components, scraping the terminals with the side of a hacksaw blade first to make sure that the solder gets a good grip of the metal. Carrying out this precaution makes it far more likely that your finished set will have noiseless joints. As regards assembly, the first step is to get the sockets and valve can bases mounted, making sure that the filament pins are around in the direction indicated by the wiring diagram.

Then the power transformer can be mounted and the heaters wired up, the filter condenser fitted and wired, and the choke mounted and wired.

Then the coil unit goes into place and is connected, next the intermediates and their connection, and then the minor components can go into place, each mounting close into position. A couple of single mounting terminal strips are handy, especially for the F wire from the first intermediate, and for a main h.t. terminal up at the r.f. end of the set.

#### MOUNTING ELECTROS.

The electrolytic condensers are assumed to be the type which have the can as the negative side, and the first two filters need to be mounted so that the cans are insulated from the base. This can be done quite readily with the special mounting washers which are supplied with these condensers on request. Two terminal lugs should be obtained from the



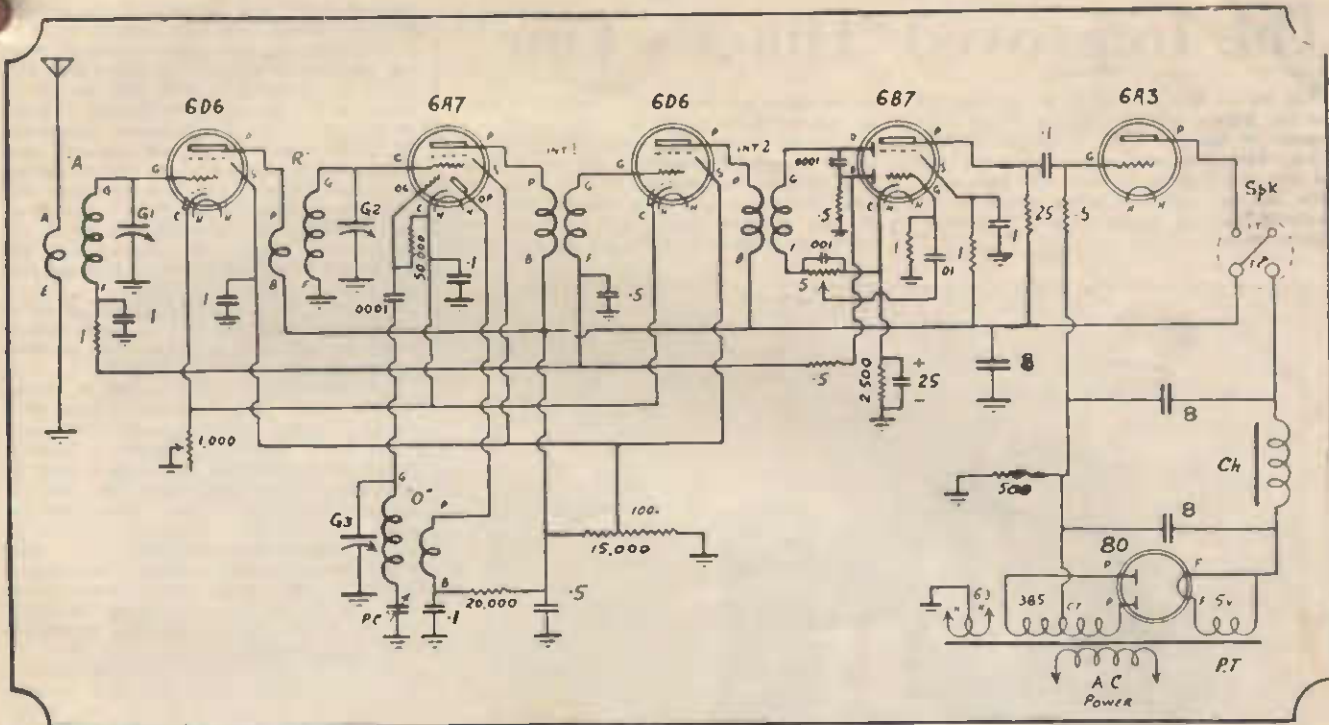

CIRCUIT—1938 DUAL SIX.

second condenser, and these can be arranged so that the grid-leak of the 6A3 mounts directly to this lug.

**THE EARTH RETURNS.**

A most important feature of the construction of a dual-wave chassis is to get efficient earth returns. Run earth wires from the earth lugs on the gang directly back to the coil unit in each case, and also connect up every earthing lug on the base with heavy-gauge copper wire, using several pieces, if necessary, and connecting around in loops, so that every earth return will be as short as possible. It will be found that the coil kit will have an earth wire running around it, and by-passes which are actually in the tuning circuit, such as those going to the F leads, are best connected direct to this earth wire.

The use of the metal of the base as the earth return is not sufficient, even if an aluminium base is used. Be sure to fit adequate earthing wires.

**SHIELDING WIRES.**

The shielding of wires is sometimes necessary to avoid hum troubles, but the shielding of wires to avoid instability is usually a complete failure, and we strongly advise the builder to avoid any shielding of wires. In the original receiver there was no shielding at all, and hum was only just detectable when the set was not tuned to any station and when the volume control was fully advanced. The last trace of this hum could be removed by shielding the three wires running to the volume control and the lead to the cap of the 6B7 valve, but this was not considered worth-while.

Shielding of the plate leads from the intermediates and such wires is sometimes carried out by the over-zealous set builder, but is nearly always a complete failure, resulting in the circuits failing to resonate on account of the capacity effects introduced. Avoid shielding wires.

**THE AERIAL LEAD.**

It is not good practice to feed the aerial lead in back through the wiring of the first

detector and the intermediate amplifier, as it is a possible source of feedback trouble. It is far better to use a lead-in running straight through a hole drilled in the end of the base near to the aerial coil.

**THE SENSITIVITY CONTROL.**

A potentiometer with a resistance of 1000 ohms or 2500 ohms is used as a sensitivity or stability control. It controls the basic bias on the r.f. amplifier, pentagrid converter and intermediate amplifier, and is adjusted to give the best all-round performance of the set. The control is brought through to the back of the base and on completion of the set the whole resistance is left in circuit and then advanced slowly until the set bursts into oscillation or chokes up. Then it is set back a fraction of a turn from this point and left at this setting until further notice. In practice it may be found that after a month's service or so the control may be re-adjusted to give maximum performance. The control results in maximum performance being obtained from every set, and ensures stability. It is also invaluable when the alignment process is being carried out.

**ALIGNMENT.**

To check over the alignment of the set the specially calibrated dial should be fitted so that the needle is on the end of the scale when the condenser is fully meshed. The screws clamping the dial to the shaft of the tuning condenser are then tightened.

The automatic volume control is then put out of action by soldering a short piece of wire to short-circuit the .5 mfd. condenser, which is attached to the F lead of the first intermediate transformer.

Then the set is tuned to any station down around 22B's place on the dial, the volume being regulated by the sensitivity control to keep it at a whisper. Then a small screw-driver is applied to the trimmer in the top of the oscillator coil can, and a fraction of a turn tried to see which screw controls the broadcast tuning. Having found the right screw,

it is adjusted whilst the dial is rotated until the station tuned comes in at its proper setting of the dial. Then the trimmers in the r.f. and aerial coils, are also adjusted to give best results, whilst the pointer is indicating the station on the dial. Then swing up to 2YA or other station at that end of the dial and apply the screw-driver to the padder adjusting screw, adjusting until best result is obtained from this station with the dial pointer in correct position.

Similar procedure is used to get correct alignment on the short-wave stations, and these will be found to come into alignment even easier than those for the broadcast, since there is no adjustment provided for a padding on the short-wave band.

Then the a.v.c. control is released by cutting the wire which short-circuits the a.v.c. voltage.

**COMPLETE KIT OF PARTS FOR 1938 DUAL-WAVE SET (K)**

Including  
**DE LUXE R.C.S. COIL KIT.**  
Cat. No. EK1 ..... **£9/12/6**

Ditto, with Valves and 8in. Speaker.  
Cat. No. EK2 ..... **£13/18/6**

R.C.S. Coil Kit for 1938 Dual Six.  
Consists of Aerial RF and Oscillator Coils with wave change switch and BC padders. Completely assembled on a rugged steel bracket. **70/-**  
Cat. No. EC407 ..... Each  
R.C.S. Iron-cored 1F transformers.  
Cat. No. EC314 ..... Each **9/9**

**USE R.C.S. COILS FOR BETTER RESULTS!**

# The Improved "Hiker's One"

The Hiker's One Set, which we described in our last Annual, proved to be one of the most popular of our Kit Sets. Hundreds of these little "Battery Misers" are in use every day all over New Zealand, in cities and bush countries and in backblocks where power is not available, and the average battery receiver expensive to run.

of the set, mark these clips from left to right as follows:—B + 9v. — B + 1½v. — E — A+ — A — E — A. Screw down the valve socket behind the condenser, the two filament pins being at the back of the set. Now the coil. It is essential that a neat job be made of this, otherwise tuning will be erratic and oscillation awkward to avoid. All three windings

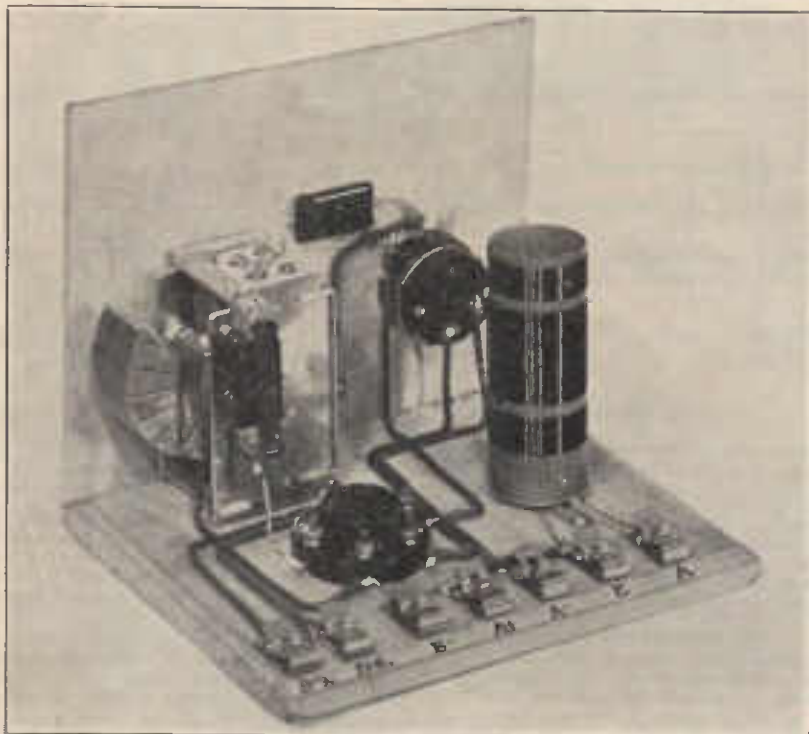

THE IMPROVED "HIKER'S ONE."

It was originally described to run off torch cells, and the components used were such as to cut down the weight as much as possible. The set was then used by hikers, trampers, and others, who have carried their Hiker's One from one end of New Zealand to the other.

We recommend using the batteries listed for more satisfactory operation and life-lasting economy. In country districts (away from powerful "local" stations) reception of all the main New Zealand stations and many Australian can be had in the evenings, whilst your nearest YA station will come in during daylight even in summer; and all this without the need of a large and expensive B battery.

**CONSTRUCTION.**

We advise you to purchase your kit complete—odd used parts DO NOT give efficient operation. First, screw the panel to the baseboard. Then slide the condenser up to the panel and mark the position for the hole to take the shaft. Now mark another hole on the opposite side of the panel in the same relative position for the potentiometer. Make both of these holes large enough to take the threaded bush on the condenser and potentiometer. You can now mount these two, fastening to the panel by means of the nuts—then mount the two terminals for the phones, making sure that the one nearest the tuning condenser does not touch the condenser frame. This finishes the panel. Next mount the seven fahenstock clips along the back of the baseboard by means of the ¼ in. wood screws provided. Looking at the back

MUST be in the same direction and spaced ¼ in. apart. Make a small hole ¼ in. away from one end of the former and pass the wire through this twice, looping it the first time and leaving about 5 in. to connect up to the A clip on the set afterwards. Wind on closely and neatly 35 turns, finishing the end off by passing the wire through two small holes in the former spaced about ¼ in. apart, and leaving about 5 in. wire for connecting up; ¼ in. below this winding make two more small holes and commence the next

winding of 100 turns, finishing off the same at the first winding. The third winding is put on in the same way ¼ in. below the second winding, and has 40 turns. You should have now about ¼ in. former left below this winding, to which the coil feet are now attached. Do not mount the coil yet, but commence the wiring. All joints should be soldered—and not with liquid solder or spirits flux—use resin core solder for a good electrical joint and make sure that parts to be soldered are CLEAN, preferably sand-papered clean. The following wiring list will be found helpful. All wires should be laid flat on the board and be short. Neatness here will count a lot.

Wire from the A— clip to one side of switch on potentiometer. Wire from other side of switch on pot. to F— (next to A) on valve socket.

Wire from centre contact on pot. to nearest phone terminal. Wire from top of third winding on coil, also to centre contact on pot.

One side of .0001 mica condenser—to frame of tuning condenser—(the coil should now be mounted)— and the other side also to centre contact of pot. Wire other phone terminal to clip marked B+ 9v. Wire G on valve socket to clip marked B+ 1½v. Wire from tuning condenser frame to remaining F terminal on valve socket and on to clip marked B—, and on to A+, and thence on to E. Bottom of first coil and bottom of second coil also to clip marked E.

Bottom of third coil to A on valve socket. Wire from left lug on pot., also to A on valve socket. Note that right lug on pot. is not used. Top of first coil to clip marked A. Top of second coil to fixed plate terminal on tuning condenser.

Place resistor and remaining .0001 condenser side by side, and twist together the pigtails of these and run the soldering iron along them. Connect one side of this combination to CAT on valve socket.

Connect other side to fixed plate terminal on tuning condenser.

The wiring is now finished, all but the checking. It is important to carefully check the wiring, as a mistake might mean burning out the valve. Put the knobs on the two shafts protruding from the front of the panel, and connect the phones to the phone terminals. Now connect the aerial (which must be a good one), and the earth (which also must be good) to the clips marked A and E respectively.

Clip A — goes to side terminal or wire on No. 6 cell.

Clip A+ goes to the centre terminal on No. 6 cell.

Clip B — goes to the —9 socket on the C battery.

Clip B + 1½ goes to the — 7½ socket on the C battery.

Clip B + 9v. goes to the + socket on the C. Battery.

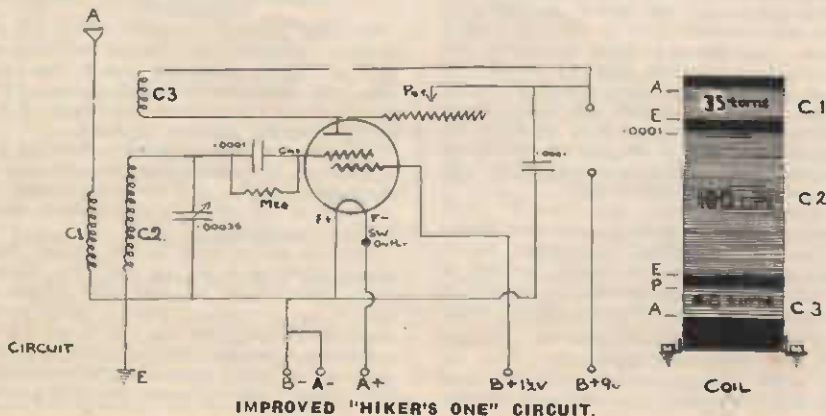



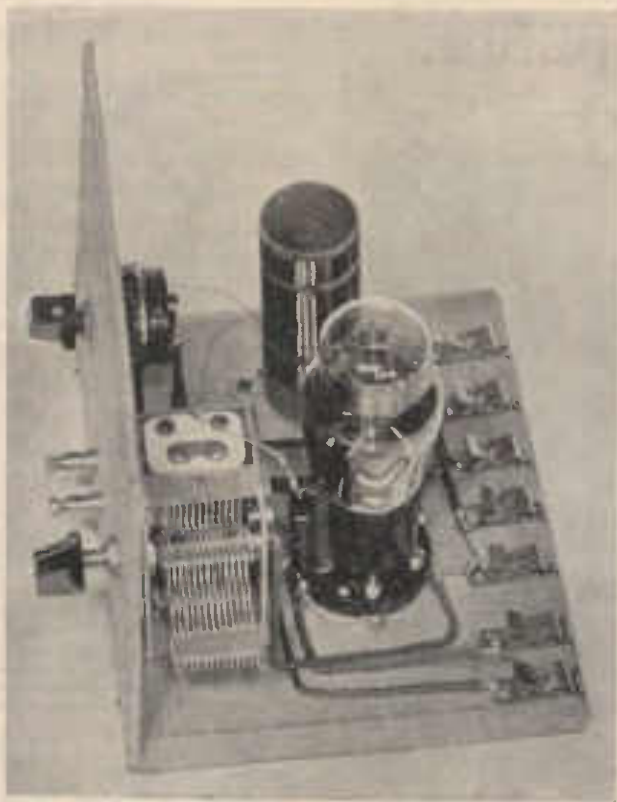

VIEW FROM ANOTHER ANGLE.

The last three connections might seem wrong, but you must remember a C battery is usually used for giving negative bias to valves, and consequently marked with one + socket and tapped - sockets. Actually the - 9 socket gives us - 0v.; the - 7½ socket gives us + 1½v., and the +0v. socket gives us + 9v. In operation it might be found necessary to increase B + 1½ to 3v., or 4½v., to obtain satisfactory oscillation. If this is so move the connection from - 7½v. socket to - 5 or - 4½ sockets.

**OPERATION.**

Turn the volume control clockwise until a plop is heard in the phones. This plop indicates oscillation. Now rotate the tuning condenser until a whistle is heard. Turn back the volume control until the whistle just disappears. Slight retuning will now bring in your station. The set is most sensitive at the point just before oscillation begins, but stations are more easily located just past the oscillation point. If desired, the baseboard and panel could be stained—before assembling, of course. In conclusion, let us wish you 365 days and nights of good reception, with all the other Radio listeners on their "Hiker's Ones."

**PARTS LIST IMPROVED "HIKER'S ONE."**

- 2 .0001 Mica Fixed Condenser.
  - 1 1-meg. Carbon Resistor.
  - 1 .00035 Tuning Condenser.
  - 1 ½-meg. Potentiometer, with switch.
  - 7 Fahnestock Clips.
  - 2 Terminals.
  - 1 5-pin baseboard type Valve Socket.
  - 1 1½in. Coil Former.
  - 1 oz. (approx.) gauge 32 Enamelled Copper Wire.
  - 2 Coil Feet.
  - 1 Type 49 Valve (Raytheon-Radiotron).
  - 9 6BA x ½in. R.H. Screws.
  - 5 6BA x ½in. R.H. Screws.
  - 2 6BA x ½in. Bolts with Nuts, R.H.
  - 1 Coil Hook-up Wire.
  - 1 Baseboard.
  - 1 Panel.
  - 2 Pointer Knobs.
- BATTERIES.**
- 1 1½v. Columbia, No. 6 Cell.
  - 1 9v. C Battery.
  - 3 Wander Plugs for above.

Dunedin, N.W.1, 15/10/37.

"I built the 'HIKER'S ONE' over the weekend from the instructions in the Catalogue and obtained wonderful results, getting all the main New Zealand and Australian stations."—A.T.S.

Nelson, 11/10/37.

"A number of my friends have heard the 'HIKER'S ONE,' and think it is marvellous, so I am trying to persuade them to get one.

"I have had J.O.A.K., Tokio, Japan, twice now about R6, besides about 8 Australian and 9 New Zealanders were on speaker and good strength.

E.M., Rahoh 2036.

**The Hiker's One**

(K)

This is the circuit of the original "Hiker's One," which was described in the 1937 Lamphouse Annual. Anyone preferring to make up this circuit can still obtain Kits of Parts as follows:—

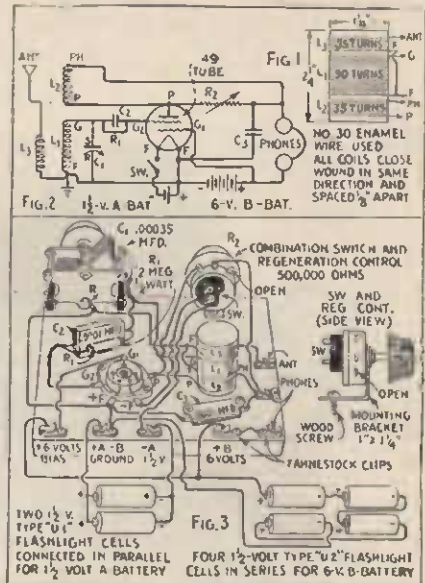

- |  |      |
|--|------|
| Cat. No.   | Each |
| EK585—Complete Kit of Parts, without batteries                         | 25/- |
| EK585A—Complete Kit of Parts, with torch batteries                     | 28/- |
| EK585B—Complete Kit of Parts, with 9-volt battery and 1½-volt dry cell | 29/6 |

**What Users Say!**

Pukehou, Hawkes Bay, 21/10/37.

"I wish to congratulate you on designing a set like the 'HIKER'S ONE.' I have built up the set and am more than pleased with its performance. I have logged 27 stations so far, 6 of these being Australian stations. I wish also to thank you for the prompt attention which my last order was shown."—D.R.P.

14/9/37.

"The 'HIKER'S ONE' purchased from you some time ago is going wonderful. It is a great little set."—E.W.W.

Te Kauwhata, 13/9/37.

"I think the 'HIKER'S ONE' is a wonderful little set, as I have logged 17 Australian stations on it."—J.S.

Frankton Junction.

"Dear Sir,—I am very satisfied with the 'HIKER'S ONE' set I bought a few weeks ago, and can recommend it as a set well worth making. So far I have received fourteen N.Z. stations and four Australian stations. I have increased the plate voltage to 15 volts. The goods arrived in good condition."—D.F.

R.D., Te Kauwhata.

"I received the 'HIKER'S ONE' on Friday and am more than pleased with it. I have an aerial about 50 feet long running above the ceiling and about two feet below an iron roof. So far I have received about twelve stations at good strength, including 4YA and 2YC. 1YA is too loud to listen to at full volume."—C.S.

**BUY A COMPLETE KIT FOR THE IMPROVED "HIKER'S ONE"**

(K)

COMPLETE KIT—With batteries.  
Cat. No. EK28 ..... **33/-**

COMPLETE KIT—Without batteries  
Cat. No. EK29 ..... **28/6**

# Hikers' "49" Amplifier.

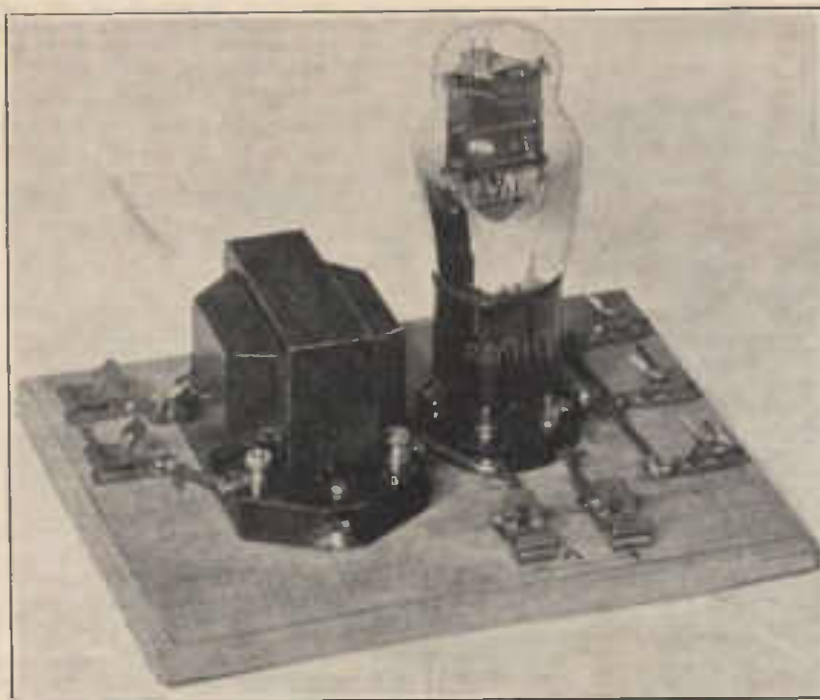

Here is a one-tube amplifier which can be used to pep up the volume from your "Hiker's One" or Crystal Set. It uses the 49 type tube in a space-charge circuit operating on 1½-volt "A" supply, and only 15 volts "B" supply, and will operate a small sensitive magnetic speaker if you have a "local" station close handy.

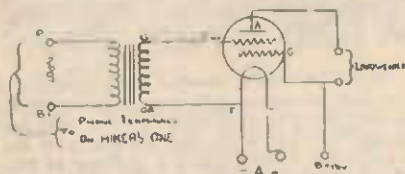

First of all, mount the components in position as shown in the (diagram) (picture). The two input clips on the left of the baseboard are wired to the HT+ and P terminals on the transformer respectively. Another wire connects transformer terminal G to lug marked CAT on the valve base. Then connect terminal F or GB to filament (F) lug on valve base, which is next to CAT lug, and carry the wire on to A- clip on baseboard. A+ clip goes to the other filament lug on valve socket. G lug goes to one speaker clip on baseboard, and the wire then carries on to the clip marked B+15 volts. The last wire connects the other loud-speaker clip to valve lug marked A or P.

There are one or two points to note regarding the operation of this amplifier. When connecting up to the "Hiker's One" make sure that the input terminal which is wired to HT+ or B+ on the transformer connects to the phone terminal on the "Hiker's" which is connected to the +B terminal on that set. The other input clip, which is wired to the P terminal on the transformer connects to the other phone terminal which you will notice is wired to the coil and centre contact on the potentiometer.

Connect A- and A+ clips to A- and A+ clips on the Hiker's One. Let us remind you here that it will be necessary to disconnect the

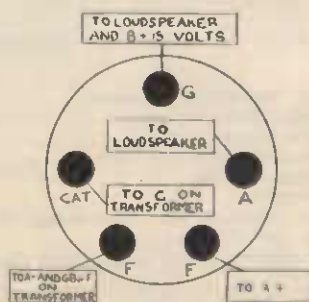

A- lead when the set is not in use as the switch on the Hiker's only controls the current to its own valve. No clip is provided for B-, as this will be an external connection to B+ on Hiker's, i.e., if a separate 6 to 9 volt battery is used, its + goes to clip marked B+15 volts and its - goes to B+ on the Hiker's. If a single 15-volt battery is to be used to supply both sets, a lead is taken from this battery's 15-volt tap to B+15 clip on amplifier. When used in conjunction with a crystal set, the input terminals are connected to the phone terminals on the crystal set and the "B" battery - lead is then connected to the A+ on amplifier.

## PARTS FOR HIKER'S AMPLIFIER. (K)

- Baseboard
- 7 Fahnestock Clips.
- 15-pin Baseboard Valve Base.
- 1 Audio Transformer.
- 7 ½ in. x 6BA Wood Screws.
- 2 ½ in. x 6BA Wood Screws.
- 2 ½ in. x 6BA Wood Screws.
- 18 in. Hook-up Wire.
- 49 Valve.

## RESISTANCES.

To obtain special values Resistances can be connected together in series or parallel as follows:—

Connected in series:—

$$\text{Total Resistance} = r_1 + r_2 + r_3$$



Resistors in Series.

Connected in parallel:—

$$\text{Total Resistance} = \frac{1}{\frac{1}{r_1} + \frac{1}{r_2} + \frac{1}{r_3}} \text{ etc.}$$

or

for two values only.

$$\text{Total Resistance} = \frac{r_1 \times r_2}{r_1 + r_2}$$

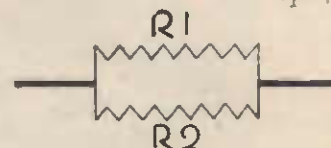

Resistors in Parallel.

Example 1.—A 1,000 ohm resistor is connected in series with a 2,000 ohm resistor. What is the total resistance?

Resistors in series = R + R, then the total resistance is 3,000 ohms.

Example 2.—A 1,000 ohm resistor is connected in parallel with a 2,000 ohm resistor.

What is the resultant resistance?

$$\text{Resistance in parallel} = \frac{R \times R}{R + R}$$

$$= \frac{1,000 \times 2,000}{1,000 + 2,000}$$

$$= \frac{2,000,000}{3,000}$$

Therefore the total resistance is 666.666 ohms.

Napier, 24/8/37.

I am very pleased with the performance of the "Hiker's One." The following are the results: 1YA, 4YA, 2ZP, 2ZB, 2YC, 3YA, 2ZH, 2ZL. The latter three I received on good speaker strength. Could any Rahob give me any reason why I cannot receive 2YA, Wellington. I have also received 2GF, Sydney. It came in as loud as some of the N.Z. stations.

Rahob No. 2349.

## LAMPHOUSE GUARANTEE.

"Any goods that are in any way unsuitable may be returned within seven days (from receipt) and your money will be refunded in full."

COMPLETE KIT OF PARTS — Without batteries.  
Cat. No. EK31 ..... **20/-**



# How to Build the "WIRELESS WEEKLY" WAVETRAP

There are many instances in which simple sets are being operated near to a strong station, in which case this strong station takes up more than its fair share of the tuning dial. Often the "spread" of the station may be so bad that as much as half the tuning dial is just swamped with the strong signal.

Under such circumstances, it is obvious that reception of stations near this strong local would be unsatisfactory, because they would be accompanied with a strong background from the heavy signal.

Under such circumstances, it is a comparatively easy matter to make up a simple little device which will greatly reduce and generally eliminate this interference. It is called a "wave-trap" because, when installed, it forms a trap-circuit for any signals near the frequency to which it is tuned.

A common fallacy which is often held about a wave-trap is that it makes a receiver more selective. Such is not the case. The selectivity of the set is not affected at all by the wave-trap. What the wave-trap can do is to practically remove a strong station from the dial altogether, so that it will not swamp out other stations near it.

The wave-trap is connected in series with the lead-in wire to the set. In other words, instead of connecting the lead-in to the aerial terminal of the set, it is connected to the tapping we have shown on the wave-trap coil. Then the terminal marked "to set" on the wave-trap is connected to the aerial terminal of the set instead.

The wave-trap can be built in a little box, and left permanently installed. It would be a good idea, if the interfering station is very close, to enclose the trap in a metal box, so as to prevent any direct pick-up by the trap-coil, which would spoil its efficiency.

### CONSTRUCTION.

It is very easy to make a wave-trap. Use a .0005 air-spaced condenser for best results.

The coil can be wound in a few minutes. We suggest making it 2½ inches in diameter, and using 55 turns altogether of 22 enamelled wire.

From one end of the coil make about four taps each 5 turns, so that you can use the one which gives most effective results. The connections to be made are only about four in number, and are shown in our diagram.

### USING THE TRAP.

The method of procedure is as follows:—Connect the trap as directed above, and swing its condenser until the plates are out of mesh. Now tune in to the station which is causing all the bother. Leaving this station tuned in, rotate the wave-trap condenser until you reach a spot where signals will either fade out altogether, or else reach a very low volume. Leave the trap tuned to this spot, and proceed to tune in the stations you desire. You will find that the strong station will no longer interfere with your reception.

Unfortunately, it is not always possible to remove the strong station without also affecting the reception of stations a few degrees on each side of it. This is because the trap is not razor-sharp in tuning, but generally, as in the case of local stations, they are well enough spaced out for the trap not to interfere with reception when tuned to one of them.

### THE TAPPINGS.

It will be found that the trap is most effective when using the highest or 20-turn tapping, but

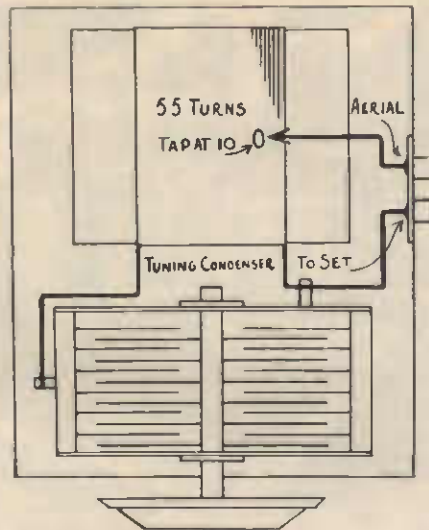

In this position the trap will affect the largest section of the dial. Moving the aerial connection down to the lower-value tappings will sharpen the trap tuning a good deal, but make it less effective in action. The advantage of the tappings is that you can select the one which gives the best results in any particular case. It is quite a good idea to tap the coil every 5 turns, so that you can have a large number of settings to choose from. If the aerial is clipped to the top end of the coil, so that all the turns are in the circuit, the trap will be very effective in action, but will probably affect reception over a good portion of the dial.

When reception of the strong station is desired, the trap condenser may be swung fully out of mesh, or alternatively, a switch could be included which short-circuits the coil altogether when the trap is not wanted.

The wave-trap will be found of great value for small one, two, or three valve sets, either A.C. or battery, where the initial selectivity is not very high. In the case of bigger sets, it is also useful if located very near a local station, which sometimes will place an annoying background on the carriers of other stations. Amateur transmitters also find the trap valuable should their transmissions unfortunately cause interference with broadcast sets, as sometimes unavoidably happens.

Only one trap at a time can be used—it is not practicable to connect, for instance, two traps in series to deal with two stations. If the locality is so unfortunate that more than one station has a swamping effect, the only remedy is a better receiver.

### PARTS LIST—WAVE-TRAP.

- 1 .0005 Air Spaced Variable Condenser.
- 2 Terminals.
- Bakelite Panel
- Base Board
- Sundries.
- Coil Wire.
- Wiring.
- Coil Former.
- Dial.

## COMPLETE KIT OF PARTS for "WIRELESS WEEKLY" WAVETRAP:

(K)

Cat. No. EK27 . . . . . 13/-

## CONNECTING EXTRA SPEAKER

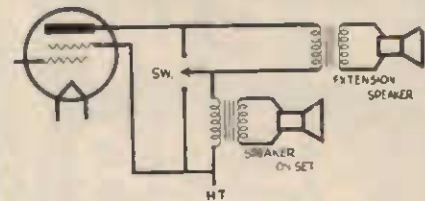

The above illustration shows the method of connecting an extra Speaker to an A.C. Set. The two-way switch shown allows either or both Speakers to be used at will.

### PARTS REQUIRED. (K)

- 1—A.C. S.P.O.T. Toggle Switch.
- Cat. No. ES453 . . . . . 1/9
- 1 Lissen P.M. Speaker
- Cat. No. ES757 . . . . . 39/6

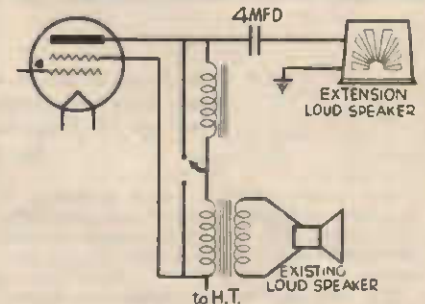

This illustration shows the method of connecting additional speakers of the magnetic type without input transformer.

### PARTS REQUIRED. (K)

- 1—A.C. S.P.O.T. Switch.
- Cat. No. ES453 . . . . . 1/9
- 1—30 Henry 100 M.A. Choke.
- Cat. No. EC122 . . . . . 11/3
- 1—4 mfd. Condenser
- Cat. No. EC560 . . . . . 4/-
- 1—Lissen Extension Speaker.
- Cat. No. ES749 . . . . . 35/-

## ABOUT THE BATTERY SKY SWEEPER.

(See page 108.)

Taupo, 17/3/37.

"The machine operates well and entirely to the owner's satisfaction, and out-performs his 6-tube Set, both for sensitivity and quality." These are his own words.—E.W.

Hastings, 20/3/37.

"I am the satisfied owner of a Sky Sweeper Battery 4 I purchased from the 'Lamphouse' last year."—J.H.

Wairarua Bay, 18/6/37.

### REFERENCE BATTERY SKY SWEEPER 4.

I am very pleased with the Sky Sweeper 4 I purchased off you. It is all you say and more.—W.F.N.

Pahiataua, 21/9/37.

"Just a note to let you know I received the "BATTERY SKY SWEEPER" KIT O.K., and it has surpassed all expectations. Enclosed please find further order for speaker and batteries for same.—L.A.

P.S.—Will send you further information on set's performance at a later date."—L.A.



We designed this 5-valve dual-waver to give its excellent performance with less battery drain than any similar receiver. It uses the latest type of economy valves, and makes a great set for long-distance daylight reception. It sets the pace for 1938 battery receivers.

By JOHN MOYLE (abridged from Wireless Weekly.)

Battery set design is always a matter of balancing performance against economy. The best battery set of a given type is the one which gives the best performance on the least battery drain.

This new receiver, the New Year Battery Five, does just this. To our knowledge, no dual-wave five-valve battery set has so far been released which calls for a smaller overall battery consumption. And as we really need five valves to get really good short-wave results, we could say, therefore, that it is the most economical dual-wave battery set one could construct.

It uses a converter valve which will give the best performance on short waves, even at the expense of more battery drain. Such a valve is the well-known 1C6, which accounts for an extra .06 amps. of filament current.

The R.F. and I.F. amplifiers as well as the second detector valve, may all be .06 types. Thus we have three valves drawing .06 amps. each, the converter valve drawing .12 amps., and the output valve, of the 1F4 type, drawing

another .12 amps. The total, therefore, is .42 amps. We do not think this total can be reduced, even if we were to sacrifice results. It is just about the irreducible minimum. It may be obtained from a 2-volt accumulator, and at the same time it is well within the limits of an Air-cell.

THE CIRCUIT.

First, however, we shall have something to say about the circuit in general.

The five valves are used as follows:—R.F. amplification followed by the frequency converter. Then comes a stage of I.F. amplification at 465 kc. The second detector is of the duo-diode-pentode type, resistance coupled to a pentode output valve.

It is almost superfluous to dwell on the value of the R.F. stage in a set of this type. It is an excellent thing to have on the broadcast band, and even more valuable on the short waves. Its extra amplification results in better signal strength, and a much better signal-to-noise ratio, which is the same thing as saying that the background noise of the set will be less. The tendency to second-spotting is also less with the R.F. stage, and this makes tuning easier than it is with a set having no R.F. amplifier.

A single I.F. stage is deemed sufficient and using high-gain intermediate coils such as are obtainable nowadays, there is plenty of amplification to be had.

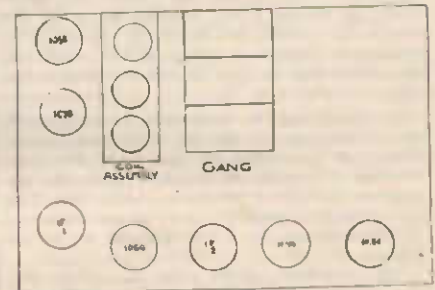

SHOWS POSITION OF COMPONENTS ABOVE CHASSIS.

The second detector is a duo-diode-pentode. One diode is used for detection, and the other for A.V.C. The pentode section of the valve is used as an audio amplifier, and it excites the output valve.

Of course, the 1A4, 1C6, 1F6, and 1F4 could be used in this set with the same results as with the newer valves we have quoted. Should it be necessary, the 1A4 valves could be replaced with 1C4's and 1F6 with a 1K6, and the 1F4 with the 1D4, the only difference being a much higher filament drain for the same performance.

OPERATING VOLTAGES.

Now a word about operating voltages. These, of course, are tied up with the valve types used, and we have been able to make them very simple.

The 1D5G is a valve rated to operate with 3 volts minimum bias at 67½ volts on the screens. However, we have found that the same results can be obtained by running these valves at zero bias, and reducing the screen voltage to 45 volts. We found in practice that this reduced the B battery drain somewhat in addition. Actually, the valves never quite reach the zero bias condition, because there is generally some signal being received, and, if no signal, some background noise. Because the valves are connected to an A.V.C. circuit, this means that they always have some bias, however small. Consequently, we are not troubled with oscillation on either short waves or broadcast band. Similarly, we have found that by running the converter valve with the same

PARTS LIST.

- 1 Chassis, 16 x 10 x 3.
- 1 Dual-wave tuning coil assembly.
- 2 465 kc. intermediates.
- 1 Tuning dial to suit coils.
- 1 3-gang tuning condenser to suit coils.
- 1 Battery switch.
- 1 .5 meg. volume control.
- 4 .1 mfds. tubular condensers.
- 2 .01 mfds. mica condensers.
- 3 .0001 mfds. tubular condensers.
- 1 .5 mfds. tubular condenser.
- 5 1 meg. resistors.
- 1 .25 meg. resistor.
- 1 .1 meg. resistor.
- 1 50,000 ohms resistor.
- Sockets—5 Octal, 1 4-pin, 1 5-pin.
- Valves—2 1D5G, 1 1C7G, 1 1F7G, 1 1F5G, or equivalents.
- Batteries—3 45-volt H.. B Batteries.
- 1 6-volt C Battery.
- 1 2-volt accumulator or aircell.
- Speaker—Permagnetic type matched for pentode.
- 3 Valve cans, battery plug, hook-up wire, nuts and bolts, 2 terminals, battery cable.
- 4 Knobs, etc.

NEW YEAR BATTERY FIVE. (K)

Complets Set of Parts, including R.C.S. Coil Assembly for New Year Battery Five.

Cat. No. EK3 ..... £7/10/-

Ditto, with valves and P.M. speaker.

Cat. No. EK4 ..... £12/10/-  
Batteries extra.

R.C.S. Coil Kit for New Year Battery Five.

Cat. No. EC408 ..... £3/10/-

R.C.S. Iron-cored I.F. Transformers.

Cat. No. EC314 ..... Each 9/9



5 volts on the screen, and 125 volts on the oscillator plate, and zero bias, we get all the sensitivity we want with very reasonable B battery drain. As the three valves all use the same screen voltage, connections are simplified by tying all three screens together and running them to the 45 volt tapping on the B batteries. Experiment on both bands failed to produce any noticeable improvement in results when using other operating conditions, and we have arranged the circuit using the operating conditions given above.

We had intended to simplify the circuit by using a simple A.V.C. circuit, which runs the grid returns to the hot end of the diode load resistor—in this case, also the volume control. However, in practice, we found better sensitivity on the short waves by using one of the diodes for A.V.C., picking up the voltage from the plate of the I.F. amplifier. This method requires a couple more components, but it is still pretty simple, and appears to be the better of the two methods in practice.

Incidentally, there is no harm in the constructor experimenting with the A.V.C. connections, if he feels inclined, by returning the 1 meg. A.V.C. load to 1.5 volts, and increasing the screen to 67½ volts. However, we doubt whether any improvement will be noticed, and, if any, not enough to justify the higher "B" drain which will result.

The connections to the 1F7G are straightforward. The screen voltage is obtained through a dropping resistor from the full high tension. With this valve it does not matter which diode is used for detection or for A.V.C., as they are both arranged at the same leg of the filament. It is probably more convenient to use the diode nearest the I.F. transformer for detection.

The output pentode, the 1F5G (and also the 1F4), as we have said, needs only .12 amps. filament current. However, for the same bias (4.5 volts) as the 1D4, which takes .24 amps., it will require about 3 mills. more B battery current. But we are able to take more liberties with the bias of this valve than we can with the 1D4, owing to its characteristics, and, consequently, by using a 6 volts bias, the B battery drain will be about the same as with the 1D4, and the volume and quality appear to be very little altered. Thus, we advise this valve operated in this manner as the most economical output arrangement of them all. Should the 1D4 be used, the bias at 135 volts should be 4.5 volts.

We found with our set, a B battery drain of 11 mills. when tuned to a strong local station, and about 16 mills. with no signal. Within a millamp. or two either way, these figures should hold good for any set built to this design, and must be regarded as being very satisfactory.

The sensitivity on the broadcast band still remained excellent, with only 22½ volts on the screen, and the B battery drain was, of course, even lower. However, this voltage is not enough for full sensitivity on short waves.

#### THINGS TO TRY.

We would mention, while on the matter of operating conditions, one or two points the constructor might feel like trying. The first is Inverse Feed-back. We have shown here the circuit for this, and we found it made quite a difference in improving the general tone. It certainly does give a better all-round balance. At the same time we found that sensitivity was slightly reduced with the Inverse Feed-back connection, and decided, therefore, to make it an alternative connection. It is very simple to make the change in connection and needs only two resistors. The builder may please himself whether he leaves it connected or not.

The second circuit is designed to prevent overloading of the set on very strong local stations. In the country, of course, this effect may not be nearly as noticeable as it is in the city. It might be found that on a very

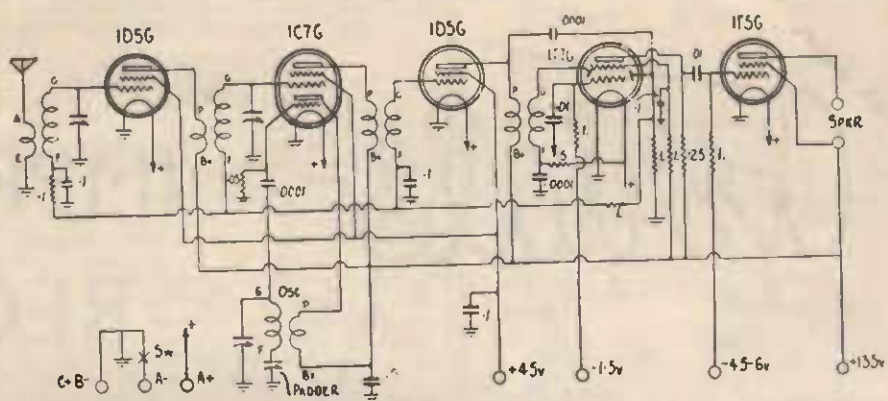

NEW YEAR BATTERY FIVE CIRCUIT.

strong signal, the set gives clear results on a short piece of wire,, and tends to block up and distort when a long aerial is used.

Should this be so, matters are considerably improved by feeding the screen of the I.F. amplifier through a resistor straight from high tension, by-passing with a condenser as shown in our diagram. There will be no difference in general performance other than this, and we mention it so that the constructor may try it out if he is troubled with overloading on strong signals.

The intermediates should be of the high-gain type, and no doubt will be supplied with the tuning coils themselves.

There is plenty of room on the chassis, as will be seen. The blank space to the left is unavoidable if symmetry is desired, because the tuning section must take up a fixed space on the chassis. However, we generally house the bias battery above the chassis, where it can be secured with a clip, and will therefore be well out of the way, and handy to its connecting leads which come up from below. The other components are all standard types, and any good quality resistors and condensers may be employed.

We did not find it necessary to shield the 1F7G, although there is no harm in doing this. Also, we did not find it necessary to run shielded leads to the volume control and 1F7G grid, although here again there is no harm in doing so.

If there should be any trace of instability or motorboating with the volume control wide open, it can generally be stopped by wiring a .1 meg. resistor between the "F" of the intermediate secondary and the volume control, with an extra .0001 mica condenser by-passing the junction of the two.

#### LOUDSPEAKER.

It is important to use a good loudspeaker with the set, in order to get the best sensitivity, and also the best tone. It will, of course, be a permagnetic type, and should be matched for a pentode output valve. We have used the standard type four-pin socket for speaker connections.

For batteries, heavy duty types should be used. The bias battery should be one on which there is a 6-volt tapping, not forgetting one also at 1.5 volts.

The filaments may be supplied with current either from an accumulator, or from an air-cell. The former will need recharging at intervals, according to its capacity, and the air-cell should run about nine months without attention.

If the Air-cell is used, a resistor must be included in one of the battery leads, to reduce the voltage to the amount required for satisfactory operation. Using the valves mentioned, it will require a resistor of .73 ohms. This resistor may be wired under the chassis between the switch and the chassis, or included anywhere in one of the battery leads. It

doesn't matter very much where it is placed, but its value should be as accurate as possible.

#### GETTING THINGS STARTED.

Assuming the the set is wired correctly, and that all the connections have been carefully checked, connect the A battery leads to the set, and note whether the valve filaments show a dull glow when the set is switched on. If they do not, have a good look round to see where you have gone wrong in the connections. If you get the A battery connection right there is no possibility of putting the B batteries through the filaments by mistake!

Next connect up the B batteries and switch on again. It is a good idea to include a small fuse-lamp in series with the B minus lead while making initial tests, so that an accidental short circuit won't do more than blow the fuse-lamp. Have two or three of these on hand for a start.

Assuming nothing out of the way happens, and none of the valves show disconcerting tendencies to get red-hot or anything like that, unscrew the padder about two turns and loosen the trimmers for the broadcast section of the set fairly well off. Each can will have two trimmers at the top one for broadcast and one for short waves.

Now tune into a station near the bottom of the dial, say, 2ZB, and adjust the oscillator trimmer until this station comes in at its right spot on the dial. Now adjust the other trimmers until the station is received at maximum strength. Swing up to a station round about 2YA or higher, and without touching the trimmers, adjust the padding condenser, until 2YA or whatever station is concerned, is tuned in at its right spot. If all is well, this should also be the spot at which the station is best received.

Now go back to a fairly weak station well down on the other end of the dial, and make a final careful check on the trimming condensers. Don't touch the padder while doing this.

The procedure on short waves is much the same, except that there is no padder to worry about. The oscillator trimmer is left about half unscrewed, and the other two trimmers adjusted until by checking on a station or just the noise level, you can tell they are peaking. By altering the adjustment of the oscillator trimmer, and bringing the others into line, the various 16, 19, 25 metre stations, etc., can be brought in at their right spots on the dial.

It is permissible when everything else has been satisfactorily adjusted, to check on the intermediate trimmers to make sure that they are lined up correctly. The only one likely to need much movement is the trimmer across the secondary of I.F. Trans. No. 2. This might need up to half-a-turn—the others only a fraction of movement. In any case, mark the original position of the cut in the screwhead, so that you can find the original adjustment again if you desire.



## THAT WILL IMPROVE RECEPTION!

No matter which way you look at it, your set cannot give you its best results unless you have a decent aerial.

A set with a good aerial will give much more pleasure and satisfaction than when it is used with an odd piece of wire in place of an aerial.

For best all-round radio reception on short-waves as well as long, under average conditions, nothing will produce appreciably better results than the standard single-wire aerial, provided it is properly installed. However, in locations where electrical interference is so bad as to prevent proper reception of short-wave stations, it may become necessary to employ a special type of aerial that tends to reduce the pick-up of man-made static.

### L AERIAL.

Height is more important than length in the horizontal part of the wire, though the length of the latter should not be cut down too much if the set is an all-waver. Forty-five feet or thereabouts is a good length to use.

If possible, the wire should be in one piece right from the far insulator through the lead-in, to the aerial terminal of the set. If you have any joints they must be soldered, and should also be covered with insulating tape or a protective covering.

Broken strands in stranded wire, loosely twisted points in the wire, such as at an insulator, or any point where two parts of the wire can rub together, are to be avoided, as they may cause clicks and other noises in reception.

When insulators are used, two small ones "in series" will stand the weather longer without cleaning than one.

Steel halyards, while being acceptable because they are strong and do not stretch, are

not desirable. They may introduce noises and can conduct interference of the "man-made" static type to the aerial.

For the same reason both the aerial and the down-lead should be kept a couple of feet or so away from metal gutter, pipes, and so on. Also they should not run too near to brick walls or slate roofs even. When these get wet they can become quite passable conductors.

Lastly there is the question of waving in the wind. On short waves this can alter the tuning sufficiently to cause fading, or even to make the reception of weak stations impossible. An anchoring stay, such as that shown, can keep the down-lead away from the side of the house as well as prevent it from moving in a strong wind.

This type of aerial is known as the inverted "L" type, and is the most suitable kind. A "T" aerial, in which the down-lead is taken from the middle is all right, provided the down-lead really does come from the middle. The trouble is that it should be the electrical middle, which does not always exactly coincide with the physical middle.

### "ANTI-NOISE" AERIALS.

The fitting-up efficiently of one of the numerous anti-noise aerials now on the market, of the all-wave or broadcast wave type, is not a difficult matter provided the important considerations receive due attention. To appreciate fully what these important considerations are, and therefore to treat them properly, it is necessary to have some idea of how these special aerials work.

First of all it must be appreciated that the horizontal or higher part of the average aerial picks up the greater proportion of the signal energy, while the down-lead, or lower part of the aerial picks up the greater part of the

interfering currents. So, provided we can stop man-made interference from reaching the lead-in we can be fairly sure to overcome man-made static. The use of screened lead-in wire prevents noise pick-up by the lead-in, and in some cases is quite effective in overcoming the trouble. To be really effective, however, the shielding should be earthed at both ends, and in the case of a long lead-in it should also be earthed in the centre. It may be found that, owing to the shielding running parallel to the lead-in proper, there is a loss of signal strength. To overcome this there has been designed special filter systems (such as Lekmek). These consist of a length of screened lead-in wire which has a special matching transformer on each end. These transformers prevent the signal losses mentioned above.

It must be borne in mind that as the lead-in will no longer be able to pick up signals (or noises) the signal strength may be reduced; but, as our main consideration is the signal strength to noise level ratio, the net result is better listening volume. In the event of signal strength being reduced too much it may be necessary to increase the length of the flat top of the aerial.

### SHORT-WAVE AERIALS.

Is a special aerial required for short-wave? It's a question often asked these days, and is answered in a practical and interesting way in this article.

Short-wave reception is becoming more and more popular both with special short-wave and dual-wavers, and the question of a suitable aerial is a very important one to the owners of these sets, so we are going to try and deal with this matter in a non-technical manner.

The numerous special aerials on the market have many advantages, but it is possible to get good short-wave reception from a single-wire aerial, and if you can erect this type of aerial and it will work well on the short waves, you will find it will give you good results on broadcast also.

It must be borne in mind that, due to the higher frequencies in use, losses on short-waves take place easier and consequently more care in erection is needed. The points at which care should be taken are illustrated.

### DOUBLE DOUBLETS.

The ideal aerial for use in areas where man-made interference is bad is what is known as the double doublet. The system really consists of two distinct aerials which are controlled by a switch and special matching transformer. As with other types of noise reducing aerials it is essential to get the flat top at least 20 to 30 feet away from or above any possible source of interference radiation. The double doublet uses a twisted lead-in cable which balances out any interference picked up on the lead-in. Double doublets are sold already assembled and ready for erection. They are moderately priced at 47/6.

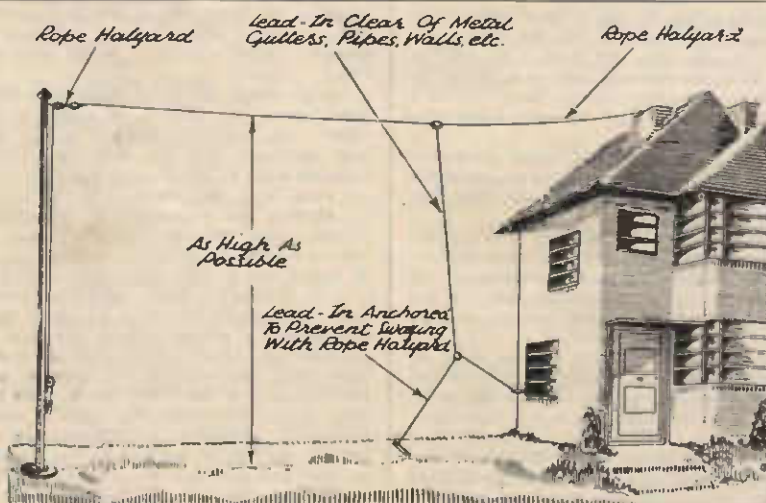



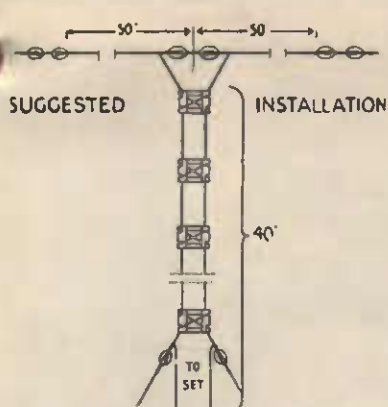

A DOUBLET AERIAL.

THE NO-MAST AERIAL.  
(See page 46.)

This is a new type of aerial and has many good points, the chief of which is the ease of installing. It can be fitted on to the side of a building or on the top of a pole. It takes up very little room, and so is especially suitable for the use of flat dwellers and in crowded city areas. As it can be easily put up and taken

down it is also ideal for people shifting from place to place. Like all other aerials, the higher it is erected the better the results.

INDOOR AERIALS.

These usually consist of a wire round the picture rail of the room or wires strung up in the rafters. Good results can sometimes be obtained with an aerial of this sort, but as a general rule a good outdoor aerial is far better.

LINE FILTERS.

Besides being picked up by the aerial system, man-made static can also come over the A.C. power mains.

We must now decide whether the man-made static, which is proving so troublesome, is being picked up by the aerial or is coming over the power lines or both. A good test is to tune the set to a point where the noise is particularly bad and turn the volume control well up. Now remove the aerial wire and attach it to the earth terminal, but do not remove the earth wire. The effect will be to reduce the noise level, but if the man-made static continues to be very severe you will at once know that at least portion of the interference is coming over the A.C. power mains, and you will at least need a Lekmek line filter before you can overcome the trouble. On the other hand, if the noise is entirely eliminated you will know that the noise is being picked up by the aerial and some form of noise-reducing aerial will be required.

Power Pack for Short Wave Sets

Many short wave circuits described in the monthly magazines require a separate Pack for their power supply. While some short wave sets may work on an ordinary power pack, it is usually found necessary for a special pack that is properly filtered so as to obviate any possible chance of hum arising from the power supply.

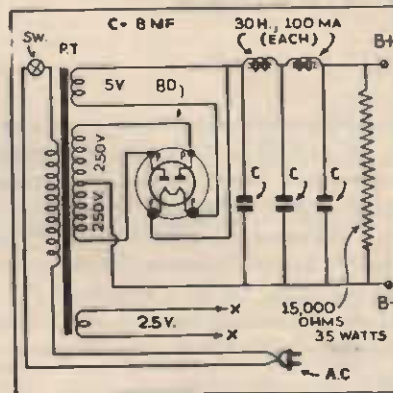

The Circuit Diagram given will be found suitable for all types of sets, and has sufficient filtering to make it humless. The voltage divider can be adjusted so that the different voltages required can be obtained.

PARTS FOR THE SHORT-WAVE PACK. (K).

- 1—Power Transformer 80 m/a. .... 16/9
- 3—8 mfd. Electrolytics ..... Lot 12/-
- 2—30 Henry 100 m/a. Chokes ..... Lot £1/2/6
- 1—15,000 ohm. Voltage Divider ..... 2/10
- 2—Valve Sockets ..... Lot 10d.
- 1—Chassis Base ..... 4/6
- Sundries, including Wire, Flex and Bush, etc., ..... 3/-

SPECIAL OFFER. (K).

Complete Kit of Parts for making Short Wave Power Pack, as described above.  
Cat. No. EK352 ..... £2/4/6  
(State whether 2.5 or 6.3 Volt Filament Valves are to be used.)

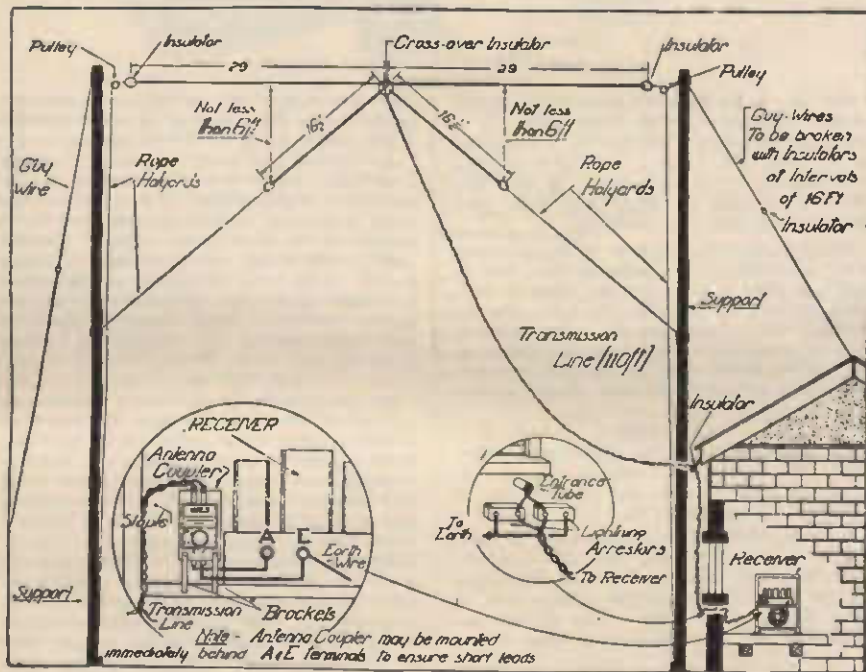

FOR DUAL-WAVE and SHORT-WAVE SETS,  
and SHORT-WAVE CONVERTORS (K)

A complete Double-Doublet Aerial System in kit form, incorporating the Lekmek Antenna Coupler interference eliminator. No wiring or assembling is necessary. It has all been done by Lekmek Engineers. Includes everything necessary except the supports and rope. Only requires slinging to the supports. A clear diagram is provided for your guidance.

IDEAL FOR CITY, SUBURBAN and COUNTRY USE, as it will combat interference from trams, trains, Neon signs, electric motors, refrigerators, vacuum cleaners, noise from passing cars and all other types of man-made static.

Cat. No. EA298

47'6

A MONARCH

A LOVELY IRON. (G)



Although priced within the reach of all, this Iron will compare favourably with the much higher priced lines. Easy to hold without strain. Thumb rest. Element clear mica and highest grade resistance wire. Stand at hack. Beautifully finished. Weight 6 lbs., two years' guarantee. Supplied complete, ready for use.

Cat. No. EE710 ..... 18/6

# PENTAGRID FOUR

Thousands of Pentagrid Fours are operating all over New Zealand and Australia. Our readers have supplied the evidence that this set has been, in its several versions, the most popular of all "Wireless Weekly" battery receivers. Here we present the latest "W.W." Pentagrid Four—still simple, straightforward and economical—and a better performer than ever.

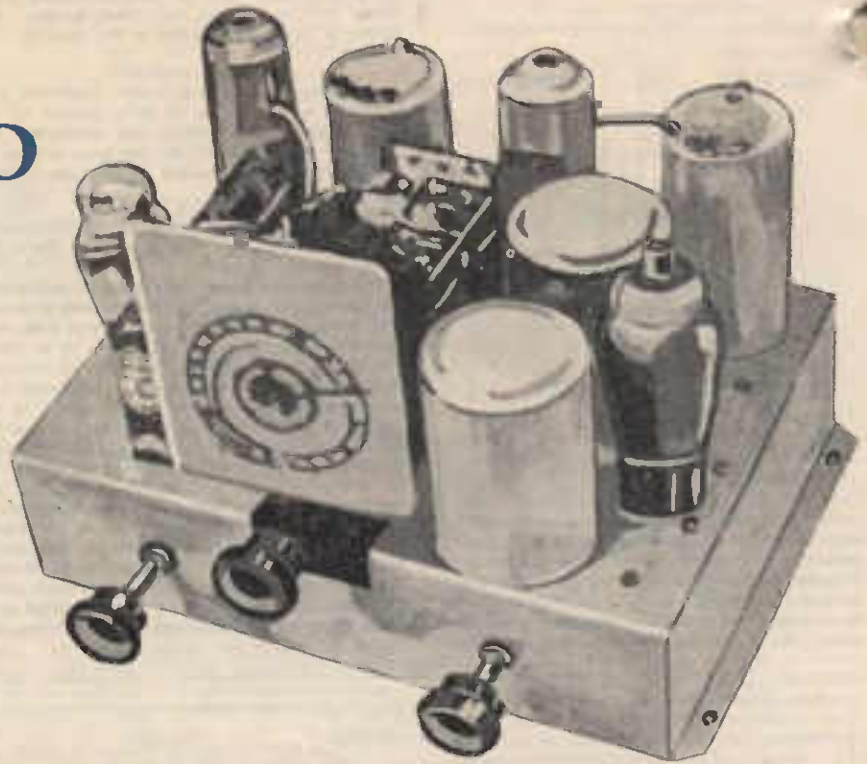

The "Wireless Weekly" range of Pentagrid receivers is probably the most famous among Australian battery sets. Originating in 1934, just three years ago, they commenced with the Pentagrid 4—still the simplest 4-valve battery set ever described. As time went on and U.S. Pentagrid sets "went over" others were produced—the A.V.C. Pentagrid Four, the Dual-wave Pentagrid Four, the Pentagrid Six, and the De Luxe Pentagrid Six—built before the days of diode-triode valves. Then followed the Dual-wave Pentagrid Six, which so many of our readers in the country are using.

The name Pentagrid refers, of course, to the use of the pentagrid converter type of valve used as the mixer valve.

The set to be described here is the latest of the Pentagrids—for broadcast work. It is the most satisfactory solution to the problem of the man who wants a small and inexpensive receiver, which costs little to run, and which is sensitive enough to give him good daylight and night-time reception.

Naturally, having only four valves, it is not quite a six-valver in performance. But it comes as close to it as one can expect a four-valve set ever to come close to a six. We are confident that it will give the fullest satisfaction to every owner, and keep him happy in its modest requirements in battery consumption. It is wonderful just what this set can do.

and also obtain the extra gain which the pentode gives when used as an audio amplifier. The output valve is a 1D4 pentode.

As will be seen from the circuit, "Inverse Feed-back" is used in conjunction with the output valve and the 1K6. This circuit has the effect of lowering the harmonic distortion which follows in the wake of the ordinary pentode, and allowing better effective output with less battery drain. The alterations to the circuit are small, and really consist of two extra resistors which are shown across the input to the loudspeaker in the circuit and wiring diagrams.

#### CIRCUIT POINTERS.

Now we come to a few matters dealing with the circuit which call for some comment. It will be noted that the voltage for the oscillator plate and the screen of the KK2 are shown as obtained from resistors connected across to the high tension. This is done for two reasons. One is to avoid having more leads to the batteries than are necessary, and the other is that, as the batteries drop in voltage, there is a better chance of maintaining these somewhat critical voltages in proportion to the plate voltage, than there otherwise would be. It is, however, quite permissible to run leads

#### PARTS LIST.

##### "W.W." PENTAGRID FOUR.

- 1 Base, 11½ x 9 x 3.
- 1 2-gang Condenser.
- 1 Tuning Dial to suit.
- 1 465kc. Superhet Coil Kit for KK2 (aerial coil, r.f. coil, 2 intermediates).
- 1 Battery Switch.
- 1.5 meg. Volume Control.
- 5 .1 mfd. Tubular Condensers.
- 2 .01 mfd. Tubular Condensers.
- 3 .0001 mfd. Mica Condensers.
- 4 1 meg. Resistors.
- 1 .25 meg. Resistor.
- 2 .1 meg. Resistors.
- 1 50,000 ohm. Resistor.
- 1 25,000 ohm. Resistor.
- 1 11,000 ohm. Resistor.
- 1 "P" type Socket (or 7-pin), 1 6-pin, 2 5-pin, 2 4-pin.
- Valves—KK2, 1C4, 1K6, 1D4 or C243N or PM22a.
- Batteries—3 45-volt H.D. B Batteries, 1 6-volt C Battery, 1 2-volt Accumulator, or Air-cell.
- Speaker—Permagnetic, matched for pentode.
- 3 Valve Cans, Battery Plug, Hook-up Wire, 2 terminals, Nuts and Bolts, etc.

#### THE CIRCUIT.

The first valve in the set is the Ootode KK2, which operates as the frequency changer. It is a very efficient valve, and we have used it in former Pentagrids.

A single stage of I.F. amplification is used, the IF amplifier being 1C4 RF pentode. This feeds into the 1K6, which is interesting because it is also a pentode with a pair of diode plates. The result is that we can get diode detection and A.V.C. using these diodes,

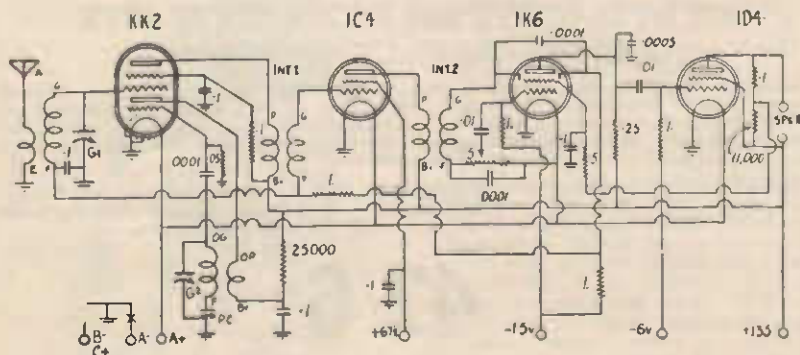



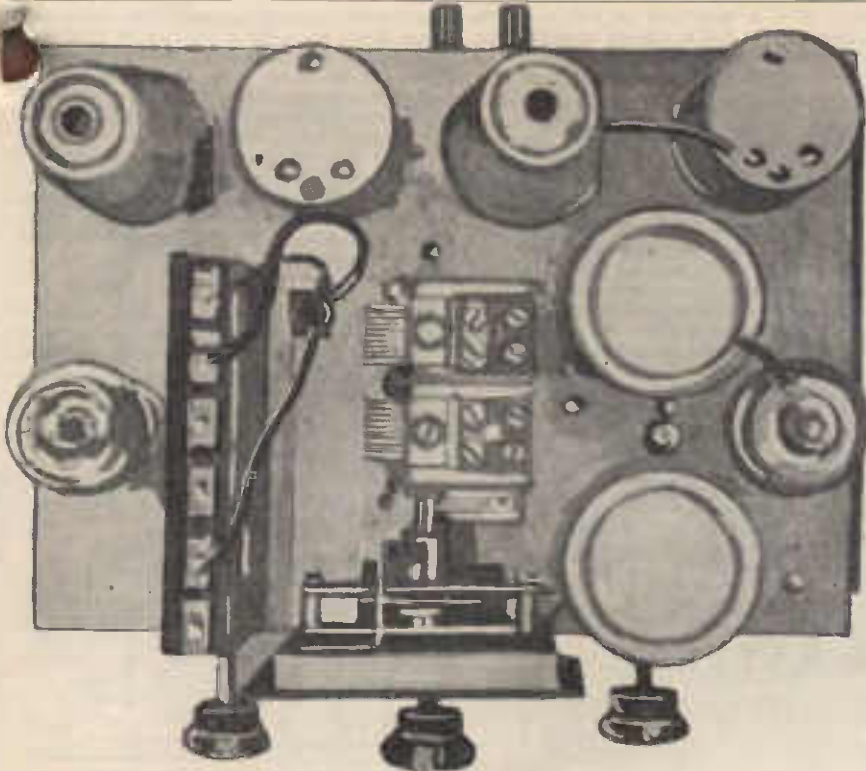

BIRD'S-EYE DRAWING OF CHASSIS.

for these points direct to the batteries should the constructor care to do so, and save a few components. In the case of the KK2, the makers advise up to 135 volts for the oscillator plate, and 45 volts for the screen. Slightly better sensitivity may be obtained by running the screen volts at 60 volts.

There is nothing much to be said about the 104 I.F. amplifier. Both the KK2 and the 104 are zero bias valves—in other words, they do not need a standing negative bias under any conditions. The A.V.C. line therefore does not return to the C battery, and need not do so except in special cases where intermediate oscillation might be present, due to rather high gain, or a bit too much gain throughout the set. As a rule, a standing bias of 1½ volts, obtained by running the A.V.C. load resistor to the bias battery, will decrease the gain, but improve stability should this be in doubt. Operating properly, the bias is not generally required.

The 1K6, being a pentode amplifier, has, of course, a screen as well as a plate. The screen is fed from the high tension tapping through a .5 meg. resistor, by-passed with a .1 mfd. condenser. The plate resistor is .25 megs., making the most of the high gain allowed by the 1K6. Note that the plate of this valve is by-passed with .0005 mfd. as a precaution against unwanted R.F. currents in the output circuit.

The feedback coupling from the output valve to the 1K6 is via a pair of resistors across the output of the valve. The values are standard, .1 megs. and 11,000 ohms, and to the junction of these is connected the plate resistor for the 1K6. There is nothing more or less to it than that. The output valve, under the inverse feedback conditions, is biased back to 6 volts. This in itself allows a saving in battery drain, and is one reason why the set draws so little current.

**CONSTRUCTION.**

When mounting the gang make sure that the dial will fit snugly before making fixtures—it is very annoying to find that the dial can't be fitted without removing the gang condenser after all the wiring has been completed.

We have shown the C battery on the chassis, as with other Pentagrids. It can, of course, be included at the bottom of the cabinet with the other batteries, but we have always found it more convenient to place it on the chassis out of the way, and thus reduce the number of leads out the back, which often tend to become confusing.

After mounting all the coils, valve sockets, etc., the wiring should be commenced, keeping an eye on our point-to-point diagram if necessary. There is nothing much to the wiring—just a straightforward connecting up of points with insulated hook-up wire. Where a lead in the circuit is to be connected to earth, it may be soldered to a lug firmly screwed under a nut on the chassis. In our set you will notice

- W. W. PENTAGRID FOUR. (K)**  
**R.C.S. COIL KIT for W.W. Pentagrid Four**  
 comprises—  
 1 Aerial Coil with Shield  
 1 KK2 Oscillator Coil and Shield  
 1 Special Padder.  
 1 Low Gain Iron-cored Intermediate  
 1 High Gain Iron-cored Intermediate.

- Cat. No. EC413 ..... **44/-**  
 Complete Kit of Parts for Pentagrid Four, without valves, speaker or batteries.  
 Cat. No. EK15 ..... **£4/19/6**  
 Complete Kit of Parts, with valves and P.M. Speaker. Batteries extra.  
 Cat. No. EK16 ..... **£9/4/6**

a network of heavy gauge tinned copper wire connecting all such points together, and the whole to the earth terminal. This is to guard against a poor earth at one point on the chassis, and also to prevent eddy current losses which might occur, particularly with a steel chassis.

Note that the leads to and from the volume control are encased in copper braid, which is earthed, and forms an effective shield and precaution against audio feedback. Insulated wire ready braided can be bought for this purpose, and only about one foot is needed.

Note that the batteries and the speaker both make contact through valve sockets and plugs at the rear of the chassis. It is a good idea to see that these have a different number of pins, to avoid confusion. Thus the speaker should have four pins and the battery plug five pins. Now you cannot plug the speaker in the battery socket by mistake.

**BATTERIES.**

We advise that this set be operated at all times from 135 volts, such as would be supplied by heavy duty batteries. This voltage will ensure maximum efficiency as well as maximum output. Should it be necessary to work the set from 90 volts, performance will suffer somewhat, mainly by a drop in output. The bias will have to be reduced probably to 3 volts on the output pentode, and, incidentally, the battery consumption will drop considerably. Battery figures are given elsewhere in this article.

The bias battery is a 6-volt type, or possibly a 9-volt battery tapped at 6 volts, should

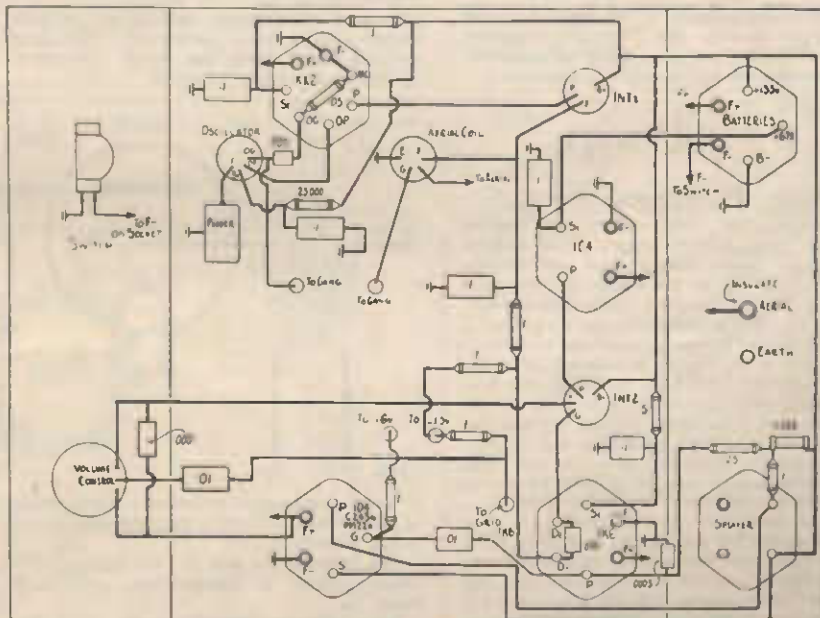

WIRING DIAGRAM.

a straight 6-volt battery be unobtainable. A 4.5-volt battery could be used, with slightly better quality, but the advantage of the feedback circuit in giving output with lower drain would not be realized.

The A battery for the set may be either a 2-volt accumulator of whatever size is most convenient (say, between 30 and 60 a.h.), or it may be one of the new air-cells, which need no recharging, and run over 1000 hours at practically constant voltage.

If an air-cell is used, a resistance of .5 ohm to carry .5 amp. must be included in series with the negative lead to the air-cell. Save for the occasional addition of tap water, the air-cell needs no attention until worn out.

**ADJUSTMENT.**

Assuming that the set has been correctly assembled, and is ready for work, connect up the batteries. Connect the A battery first and make sure that the filaments are alight (they will glow dimly) before connecting the B bat-

teries. It is a good idea to include in the negative lead to the B battery a small torch globe to act as a fuse. Should a short circuit occur it will burn out before the valves.

Having connected the batteries and received some kind of life from the set, slacken the padder about 3 turns, and the gang trimmers nearly all out. Now tune to a station low on the dial, such as 2ZB, and see if you can line the aerial trimmer (rear trimmer) until you find the spot where the station is loudest.

Now turn to the top of the dial, and tune in a station up there, such as 2YA, keep rocking the dial across the station, and adjust the padder until it also is received at best strength. Now return to the lower end of the dial, and retune for fine results on a weak but steady station. All being well, these instructions should be sufficient to get the set going.

It is permissible to reline the intermediate trimmers with a wooden screw-driver, to see that they are peaked properly. Do not touch

the padder or gang trimmers while doing this, and mark the original position of the intermediate trimmers so that you can return them if necessary. The trimmer across the secondary of the second I.F.T. is probably the one which will need the most adjustment, as it is damped by the diode circuit of the valve. If any but this trimmer needs more than a fractional adjustment, suspect something wrong, and return it to its first position, to check over the set again. Remember that if you lose the intermediate adjustment, you will probably have to send these back to the factory to be re-lined.

Use this set with a good aerial, although don't make it too long. Height is far more important. A good ground is also essential. An old kerosene tin punched full of holes sides and bottom, filled with ashes, and buried in deep soil, is an excellent earth. Solder a heavy wire to the can first, of course, and keep the spot damp.

## AMPLIFIER FOR BATTERY SETS

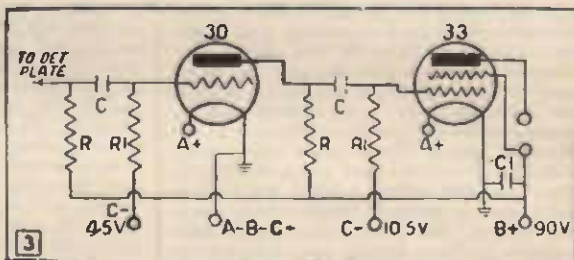
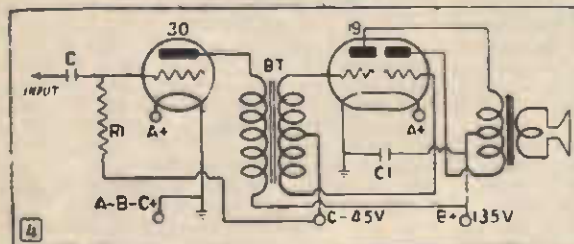
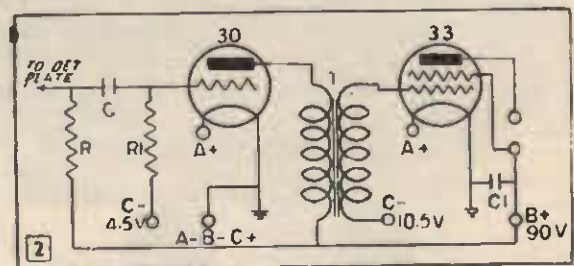
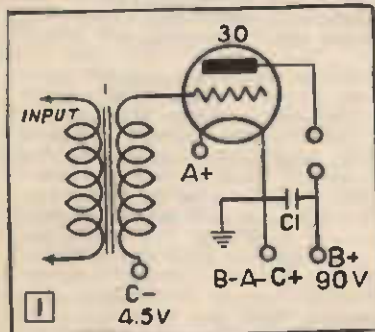

1. A Single Valve Amplifier suitable for connecting to a crystal or small valve set to increase its volume.

2.—Resistance coupled in the first stage and transformer coupled, this Two-Valve Amplifier uses a Pentode, and is capable of providing ample volume for any moderate sized room.

3.—Two-Valve Amplifier, with both stages resistance coupled. Excellent tone can be obtained from this Amplifier, although the volume will be slightly less than 2.

4.—Class B Amplifier will deliver excellent volume suitable for all home uses. When building this circuit parts and circuit arrangement should be exactly as specified.

Cat. No.	Price
ET560—Class "B" Audio Transformers, 16/6	
(C) EC671—.02 Tubular Condenser	10d.
(C1) EC677—.5 Ditto	1/8
(R) ER195—100,000 ohm 1 watt Resistor	6d.
(R1) ER200—500,000 ohm Ditto	6d.
(T) ET601—Lissen Torex Audio Transformer	
	8/9 each

## CLASS "B" For Battery Sets

By altering the audio end of their set to Class "B" amplification, owners of old battery sets can get much stronger tone and volume. Proceed according to the circuit as follows:—First, examine the existing audio transformers. Usually the first transformer has a ratio of 5 to 1, while the second transformer is 3 to 1, and if this is so, replace the former with the latter, discarding the 5 to 1. Should the first transformer have a ratio of 3 to 1, or if you have only one transformer in your set and the ratio is 3 to 1, you can leave them just as they are connected. You also leave in your first audio valve socket, and this is used for the 30 valve, which constitutes the driver stage.

Now fix your class "B" transformer as close to this socket as practicable, and then fix a six-pin socket for the type 19 valve. You are now ready to wire up in accordance with the diagram. Check wiring carefully before connecting batteries. Bear in mind that the valves used require only 2 volts for the filaments, and

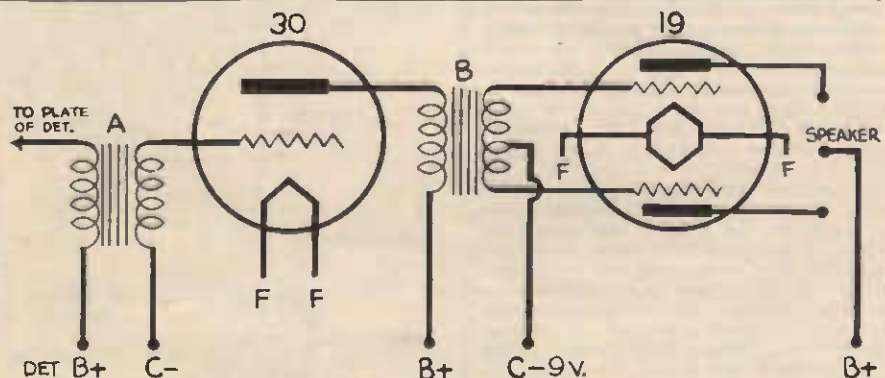

It will be necessary to insert a fixed resistor in the filament circuit if you are using a 4 or 6 volt battery.

This amplifier can also be used for amplifying crystal sets or as a gramophone amplifier for home use.

The speaker recommended is the Lissen P.M. Moving Coil type (Cat. No. E6757, 89/6), which,

combined with the "B" amplifier, will give you tone and punch equal to most modern electric models.

**PARTS REQUIRED.**

1 Class "B" Output Transformer, RCS	16/6
1 Type 30 Valve	6/-
1 Type 19 Valve	9/-
1 6-pin Socket	5d.



# The B-less One-der

Following the remarkable success of the HIKER'S ONE, our Technical Department have pleasure in now submitting particulars of the "B" Less One. This set can actually be used without a "B" battery, and excellent results have been obtained with just a 2-volt "A" battery. Particulars of the battery connections, etc., are given later in this article.

It must be pointed out, however, that with a "B" battery of even 1½ to 3 volts much better results will be obtained.

This is a most interesting circuit as the "B" voltage can be varied from nil to 45 volts.

This little receiver is rather unusual in that it utilizes the 1E7G valve, which is a twin pentode (Detector and Audio Amplifier) and can be successfully operated over quite long distances without any "B" potential. Naturally greater volume and more sensitivity are to be had when a "B" voltage from only 1½ volts to the usual 45 volts is applied.

### PARTS REQUIRED B-LESS ONE-DER. (K)

- 1 500,000 ohm Potentiometer with switch
  - 1 .0005 Tuning Condenser.
  - 1 2 megohm Resistor.
  - 1 .1 mfd Tubular Condenser.
  - 2 .001 mfd. Mica Condensers.
  - 1 .0001 mfd Mica Condenser.
  - 1 3 to 1 Audio Transformer.
  - 1 R.F. Choke.
  - 8 Wood Screw Pattern Terminals.
  - 1 Octal Socket—Baseboard Type.
  - 3 Mounting Brackets.
  - 1 Special Bracket.
  - 2 Knobs.
- 3in. x 1½in. Coil Former; Gauge 30 Enamel Wire; 6in. x 7in. x ½in. Baseboard; 3in. x ½in. x 6 BA Nuts and Bolts; Wood Screws.  
Coil Connecting Wire; 1 1E7G Valve.

Complete Kit of Parts, as above  
Cat. No. EK13.

**30/-**

### CONSTRUCTION.

The lay-out diagram clearly shows the positions of the various components which are mounted on a 6in. x 7in. baseboard. The .1 mfd condenser shown in the top left-hand corner is mounted upright, which accounts for its unusual position.

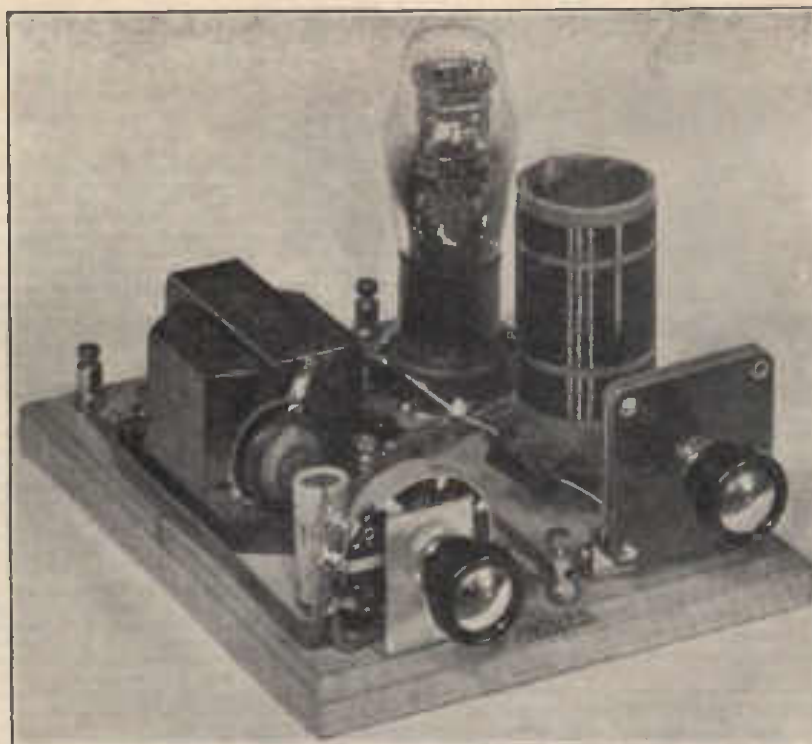

The coils are all close wound and spaced ½in. apart, all turns being in the same direction. Start by winding L1 first, close to the top of the former so as to allow sufficient room at the other end for the mounting bracket. When fitting the bracket, make sure it does not come in contact with L3. The start and finish ends of each coil are anchored by passing the wire through two small holes in the former. Be sure and leave the ends long enough to reach their various connecting points. The tuning condenser is of the solid dielectric type and is mounted by two brackets. The large bracket supplied is used to mount the .5 meg. potentiometer which controls regeneration and volume. This pot. has a switch mounted on the back of it, which is wired in between the A + B - terminal and socket 7 on the valve base, and is used to turn off the set. In both diagrams, the valve socket contacts are numbered from the key in an anti-clockwise direction, which is correct when viewed from the top. After the wiring has been completed, check carefully before connecting up the batteries.

### OPERATION.

The A Battery can be 1½ volts, although 2 volts is really necessary to get the best out of the 1E7G. If two dry batteries are used (i.e., 3 volts), a rheostat should be connected in the A + lead. When used without a B battery, terminals A + B - and B + 1 and B + 2 are connected together. With 1½ volt to 3-volt B supply—terminals B + 1 and B + 2 are joined in one lead to the + of the B battery. When using 4½-volt B; + 3 volts is applied to B + 1 and + 4½ volts to B + 2. With higher B voltages, half the total voltage is applied at B + 1, that is 8 volts to B + 1

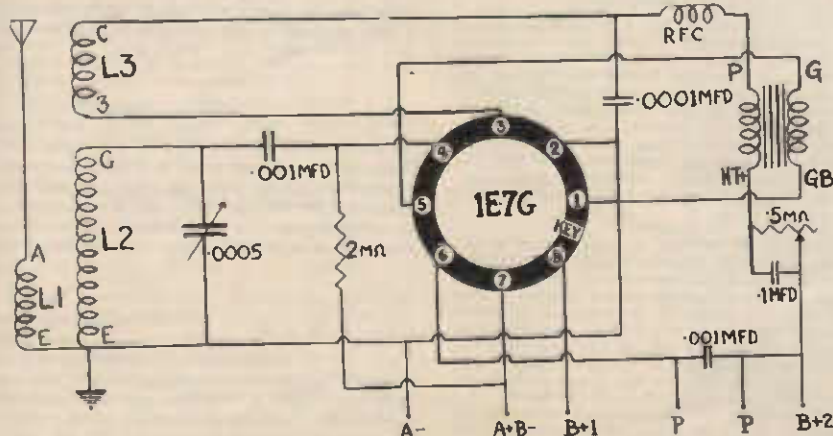

CIRCUIT DIAGRAM.

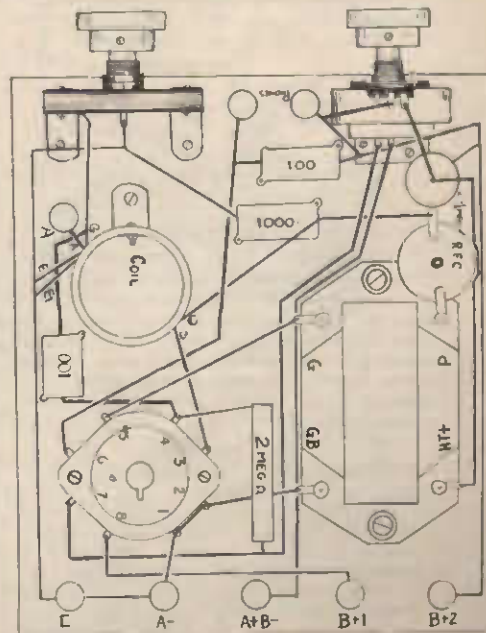

WIRING DIAGRAM.

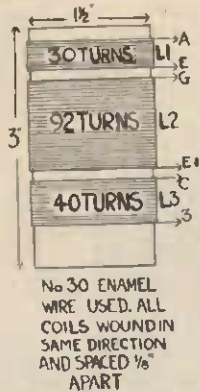

with 16 volts to B + 2 and 22 1/2 volts to B + 1 with 45 volts to B + 2. If you live in the same town as your nearest Broadcast Station, loud speaker reception will be possible when using anything over 16 volts B supply and a good aerial and earth. With this receiver, as with all small sets, a good aerial is a great asset, and a good earth essential. If you are close to a powerful station, or two or more stations, greater selectivity can be had by placing a .0003 mfd variable condenser in the aerial lead. If on the other hand, selectivity is of no importance, slightly increased volume is obtainable by connecting the aerial direct on to G on L2.

**IMPROVES RECEPTION OUT OF SIGHT.**

Make this new and better Wave Trap and get the most out of your radio. It is simply connected between the aerial and the set. To operate, turn the set to the station which is causing interference. Now turn the knobs on the Wave Trap until that station fades out or is greatly reduced in volume. Without again touching the Wave Trap you can tune the set to any station required. Care must be used when tuning the Trap as the tuning is very fine, and the strength of one station will be reduced at one point on the dial only.

This Wave Trap can also be used as an Aerial Trimmer to increase the volume of weak distant stations. Leave the Wave Trap connected as above. Now tune in the weak station on the set to its maximum volume. By carefully adjusting the controls of the

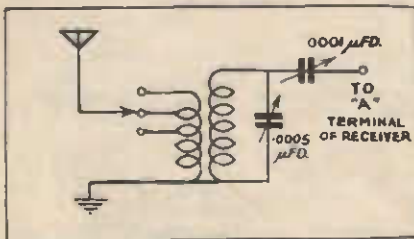

*This selectivity unit sharpens up tuning considerably, without cutting down signal strength.*

Wave Trap a point will be found where the aerial is "tuned," the result being greatly increased signal strength from that distant station. Tuning the aerial in this manner often increases signal strength as much as adding another valve.

**PARTS REQUIRED.**

	s.	d.
1 .0005 Solid Dielectric Lissen Condenser ..	3	6
1 .0001 Variable Condenser ..	3	0
1 6 x 7 Ebonite Panel ..	2	0
2 Terminals ..	0	6
1 Baseboard ..	1	0
Sundries, including Coil Former, Coil Wire, Wiring Wire ..	2	0
1 Ormond Vernier Dial ..	4	6
<b>Total ..</b>	<b>16</b>	<b>6</b>

# THE SIMPLEX SINGLE

Many readers have asked for a simple One Valve Battery Receiver, capable of supplying good headphone strength on all the local stations. An aperiodically coupled aerial is used. This consists of a small aerial winding, as shown in the circuit diagram. The effect of this winding is to make the set more selective, but at a loss of sensitivity. Constructors who are not troubled with powerful broadcast stations can dispense with this extra winding and connect the aerial terminal direct to tappings on the Coil L2.

**THE COIL.**

Use a piece of 3in. Coil Former and 26 S.W.G. D.C.C. wire.

Commence winding the reaction coil about half an inch from the bottom of the former, and lay on 20 turns, leaving about 6 to 8 inches of wire on each end of the winding to allow the leads to be taken direct to their respective points in the circuit.

The grid winding requires 48 turns, and should be started about a quarter of an inch away from the reaction coil.

The aerial coil consists of 15 turns, and is wound about a quarter of an inch above the grid winding. Should the aerial be coupled directly to the grid winding, this latter coil is not necessary, and tappings should be made at the 5th, 10th and 15th turns on the grid coil. All coils are wound in the same direction.

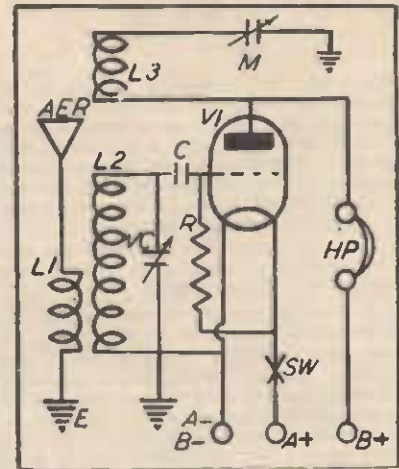

**SIMPLEX-ONE CIRCUIT.**

to one of the terminals on the socket mounted on the rear side of the chassis. Two other terminals on the socket are connected together, and serve the places of the other headphone terminal and the "B" positive battery connection.

Another lead is taken from one of the terminals on the socket to one side of the battery switch, the other side of this switch is taken to the positive filament on the terminal of the valve socket. The remaining terminal on the valve socket V1 is soldered to the two remaining terminals on the socket mounted at the rear of the chassis, and act as the "A" and "B" negative battery connections.

**OPERATION.**

When the batteries, aerial and earth leads are connected to their respective points, switch on the receiver and rotate the dial of VC until signals are heard. For best results, the reaction should be adjusted until the receiver is just on the verge of oscillation.

This one valve receiver should provide hours of amusement to the novice who is interested in radio, and provided the directions given in this article are followed, he should be able to tune in all the local "A" and "B" class stations and many of the amateur stations at good headphone strength.

Clifton House,  
Seacliff, Otago, 26/10/37.

**I.C.A. TUNER.**

"It was certainly well worth while spending a few shillings to cut out outside interference. Am well pleased with it."—J.W.L.

Seacliffe, Otago, 18/10/37.

"The I.C.A. Radio Tuner, FC294, has made reception much better and cut out some outside interference, a dynamo in a workshop close at hand may have been the cause. I took the outside aerial off, found the wave trap brought in stations just as well, tuned into the Empire station at Daventry, and was very clear at R.7."—J.W.L.

Wakefield, 9/8/37.

"Just a note of appreciation to you. The I.C.A. Aerial Tuner which I bought of you is giving wonderful results on my 5-valve set. I have now logged in numerous new stations, and I think the Tuner is a wonderful little gadget. I would not be without it on my set now. Thanking you.—P.L.B.

**LIST OF PARTS. (K)**

C.—.0003 Condenser .....	10d.
M.—.0001 Reaction Condensers .....	3/6
Knob for same .....	5d.
R.—2 meg. Resistor .....	6d.
SW—Lissen P.P. Switch .....	1/6
VC—Tuning Condenser, .00035 .....	5/11
Valve Socket .....	1/-
Ormond Vernier Dial .....	4/6
Type 30 Raytheon Valve .....	6/-
Sundries, including Baseboard, Panel, Former Coil Wire, Terminals, Wiring Wire, Screws, Lugs, Brackets for Coil, etc ..	3/6

**COMPLETE KITS.**

Complete Kit of Parts without Valve	
Cat. No. EK621 .....	21/9
Complete Kit of Parts with Valve.	
Cat. No. EK622 .....	27/-

**BATTERIES EXTRA.**

1—2-volt 10/20 amp. Lissen Accumulator .....	each 5/6
1—60-volt Light Outy "B" Battery, 9/-	

Note.—Two 1 1/2 volt Dry Cells connected in series will do quite well for an "A" Battery, but if these are used, a 30 ohm Rheostat should be inserted in place of the Switch S.W. 30 ohm Rheostat .. 3/.

**MOUNT COMPONENTS.**

With the standard kit a wooden baseboard and ebonite panel are supplied but constructors can use an aluminium chassis if they wish. Mount all components before commencing the wiring. Mount tuning condenser in the centre of the panel, then fix the switch, and .0001 reaction condenser, one on each side of the tuning condenser. Mount coil and valve socket on the baseboard. Screw the four terminals into the back of the baseboard, marking one "aerial," another "earth," and the other two "phones."

**WIRING.**

Little difficulty should be experienced in following the circuit diagram. Only three battery wires are needed, the negative terminals of both A and B Batteries being joined together. The start of L2 winding is soldered to the fixed plates of VC and to one side of the fixed condenser, C. The other side of this condenser, C, is fastened to one end of the grid leak, R, and to the grid terminal on the valve socket, V1. The other end of L2 is taken to earth. The beginning of the reaction coil, L3, is soldered to the fixed plates of the reaction condenser, M, whilst the other end of this winding is connected to the plate terminal on V1, and



# The "3-5" AN OUTSTANDING BATTERY 3-VALVE SET

It is with a feeling of somewhat justifiable pride that the writer of this article presents "The Three-Five." Although he has designed and constructed a great many previous sets it is no exaggeration to say that he has yet to see a battery three-valver to equal this for volume or quality. Indeed the volume is such as is usually associated with a five-valve, and on any station worth hearing is not incomparable to an A.C. set. Look over the circuit diagram and the reason for this splendid performance will immediately be apparent. The first tube is a 34 high-mu variable bias RF Pentode, giving tremendous signal lift; the next is a 19 combined detector and first audio,

volts; and C +, to earth. The rheostat has been included so that the filament can be run from two dry cells without damage. This also acts as a switch to turn off the set. Important: See that lead marked A + connects to the positive of the battery.

**TESTING.**—Having completed the wiring, plugged in valves, fuse, hooked up batteries, and satisfied yourself that all is in order, there only remains to line up the gang. This is done in the usual way. Set both trimmers half way out and tune in 4VA. Adjust reaction and the sensitivity control for best results, then go to work upon the trimmers, adjusting first the

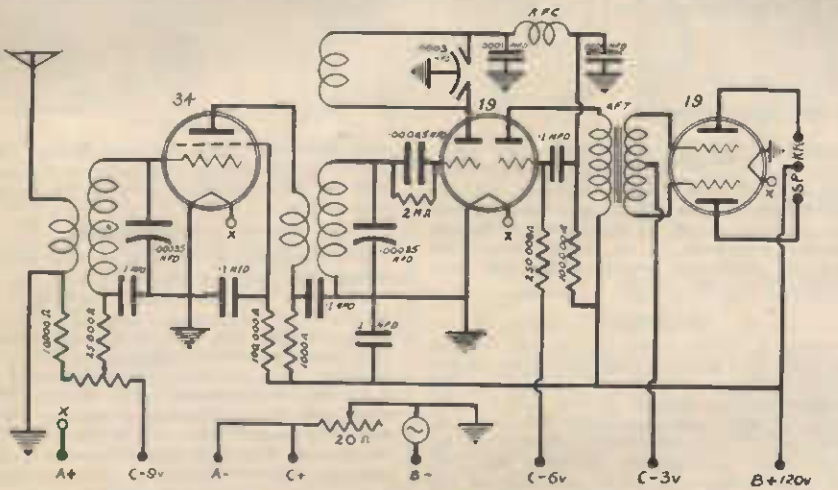
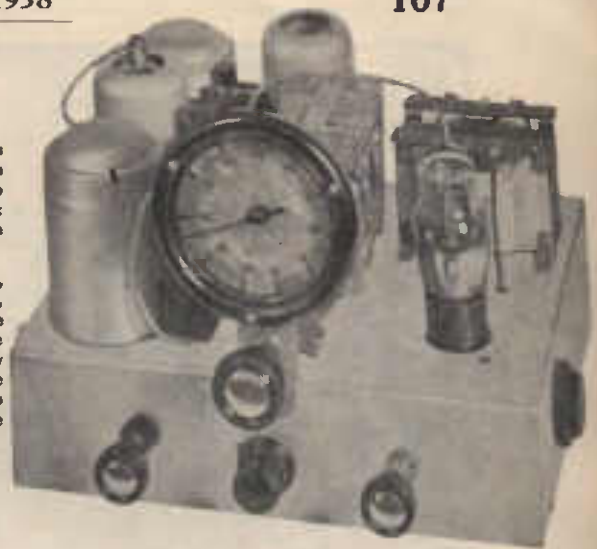

driving into a second 19, a "B Class" output stage, giving a further tremendous gain, and providing a power output and quality never before secured from a battery three. If space would allow, one could write pages upon the set's actual performance during the brief test given it. Forty-nine stations picked up from 7 p.m. to 11.30 p.m. However, if you are looking for a really outstanding battery set, why not build it up and try it out for yourself? You won't be disappointed. With a little practice in handling the controls, the above log could no doubt be easily improved upon.

**BUILDING THE SET.**—The first thing is to secure the whole of the parts. A complete list will be found elsewhere. A word of warning here. These parts have been carefully selected. Any old part of any old make will NOT do for this circuit. If you have not got the goods specified on hand you are strongly advised to purchase the lot as a kitset; you will then be assured of getting the identical items as used by the pilot-author. The aerial terminal is insulated from the chassis, while that of the earth is mounted directly upon it.

**COMPLETING THE SET.**—In connection with the push-pull stage one point which should be noted is that the two grid leads should be the same length. Measure the length required from the transformer to the valve socket and cut both leads exactly this length.

Battery connections are all supplied from a four-wire cable brought in through the back of the chassis. A - and the lead to C + both go to the terminal on the rheostat shown; A + goes to the appropriate filament lug of the detector valve; B - to the fuse holder; and B + to the speaker plug socket. 120 to 135 volts "B" are required, and a 9-volt "C" battery. "C" tappings are: - RF - 9 volt; transformer CT, - 3 volts; first audio, - 6

volts; and C +, to earth. The rheostat has been included so that the filament can be run from two dry cells without damage. This also acts as a switch to turn off the set. Important: See that lead marked A + connects to the positive of the battery.

RF, then the Detector, and rocking the dial pointer back and forth across the station until results are optimum.

Of course, with this set, as with any other, a good aerial and earth plus a little experience, are essential for real DX.

### LIST OF PARTS FOR THREE-FIVE BATTERY SET.

- 1 "Three-Five" Chassis, 10in. x 8in. x 2½in.
- 1 Aerial and 1 RF w/reaction, coils.
- 1 2-gang Condenser. 1 Aero Dial.
- 1 .0003 Differential Condenser.
- 1 50,000 ohm Wire-wound Potentiometer.
- 1 20-ohm Rheostat. 2 Valve Cans.
- 2 6-pin and 2 4-pin Valve Sockets.
- 1 Class B Push-pull Transformer.
- 7 1 watt Resistors: 2 100,000 ohm; 1 2 meg.; 1 25,000; 1 250,000; 1 1000; and 1 10,000 ohm.
- 7 Tubular Condensers: 4 .1 mfd.; 1 1 mfd.; 2 .0001 mfd.; and 1 Midget Mica .00025 mfd.
- Miscellaneous:—1 60 mil fuse and holder; 1 Switch; 1 SG clip; 2 2.5 volt dial bulbs; 4 wander plugs; A and E terminals; coil hook-up wire; nuts and bolts; 5ft 4-wire battery cable; 2 brackets.
- Valves:—2 19, 1 34, Raytheon.

### COMPLETE KIT OF PARTS FOR THE "THREE-FIVE." (K) (Including Valves).

- Cat. No. EK588 ..... £4/17/6
- Lissen Permanent Magnet Speaker—
- Cat. No. ES757 ..... £1/19/6
- Batteries recommended (extra): 2-volt 70 amp. Accumulators; 3 HD 45-volt "B" Batteries or 2 60-volt HD; and 1 2-volt Lissen "C" Battery.

BIRD'S-EYE VIEW OF THE "THREE-FIVE" SET.

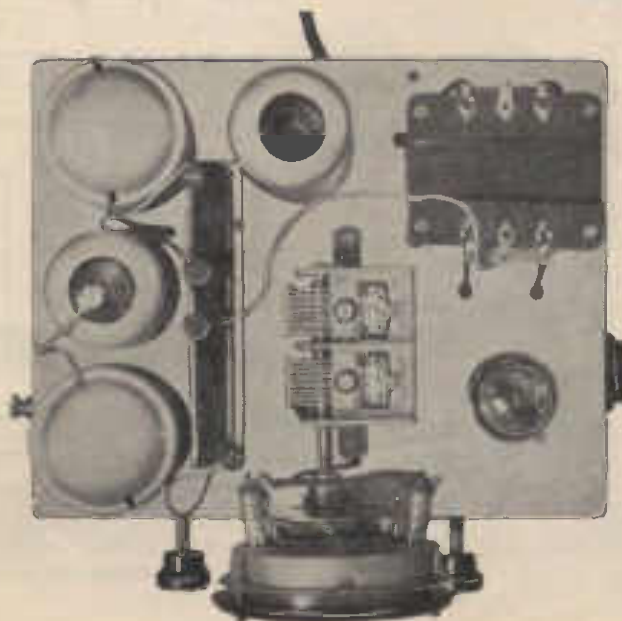

# The BATTERY Skysweeper



**A MODERATELY PRICED 4-VALVE T.R.F. KIT. HIGH GAIN, LOW BATTERY CONSUMPTION.**

A four-valve up-to-date battery set which has been designed with the following in view. Low first cost, low battery consumption, good quality reception from main N.Z. and Australian stations.

Our series of "Sky-Sweeper" Sets runs back to 1932, and each year's set has proved more popular than its forerunner. A glance at the circuit indicates that it is of conventional T.R.F. design and nothing out of the ordinary, but even so it took several months to perfect the circuit, and make it ready for publication. An added condenser here or a resistance of different value somewhere else make all the difference to the final performance of the completed job.

To obtain good sensitivity and therefore distance getting abilities, a leaky grid throttle controlled detector is used. On test all main New Zealand and Australian stations were logged with ease, and many "B" Class Australian stations were also received at good speaker strength. At 11 p.m. a Japanese station was logged. The above results were obtained in

Wellington City, and our activities were somewhat handicapped by electrical interference, proximity of steel framed buildings, etc. In favourable localities with a good aerial system no difficulty should be experienced in logging several Americans, so as regards range, the Battery Skysweeper should satisfy the most ardent D.X. fan.

**SELECTIVITY.**

Being a T.R.F. circuit the set is not so selective as a superhet., but this is not of any real importance as most listeners who operate battery sets are situated at least half a dozen miles or more from a powerful broadcast station and at that distance no difficulty will be experienced in separating stations. On test 3YA was brought in, while 2YA was on the air, and as the set was tested within half a mile from 2YA's aerial, the set is selective enough for all ordinary listeners' needs.

**TONE AND OUTPUT.**

While wishing to keep first cost as low as possible we did not wish to sacrifice the quality of the output and therefore a Phillips 2 volt Pentode was decided on as the output valve. Provided the set is used with a reasonably

good aerial the output will compare more than favourably with many commercial sets costing two and three times as much as the Battery Skysweeper.

**BATTERY CONSUMPTION.**

In the selection of valves to be used battery consumption was an important item, for no matter how well the receiver performed the set would not be favourably received unless the battery upkeep was low. After experimenting with every possible combination of valves the following were decided on: 32 Raytheon, 34 Raytheon, 30 Raytheon, C243N Phillips. The drain from the "B" battery at 120 volts varies between 5 and 8 mls, and is therefore very low indeed. The total filament current is only just over one-third of an amp., .38 to be exact.

**CONSTRUCTION.**

There are no snags or pitfalls in building Skysweeper Sets, as all tricky construction and unnecessary frills are eliminated when the sets are designed and constructors who have had previous set building experience will have no difficulty in following the circuit diagram, photographs, etc. The following points will make it easier for those who are not as advanced.

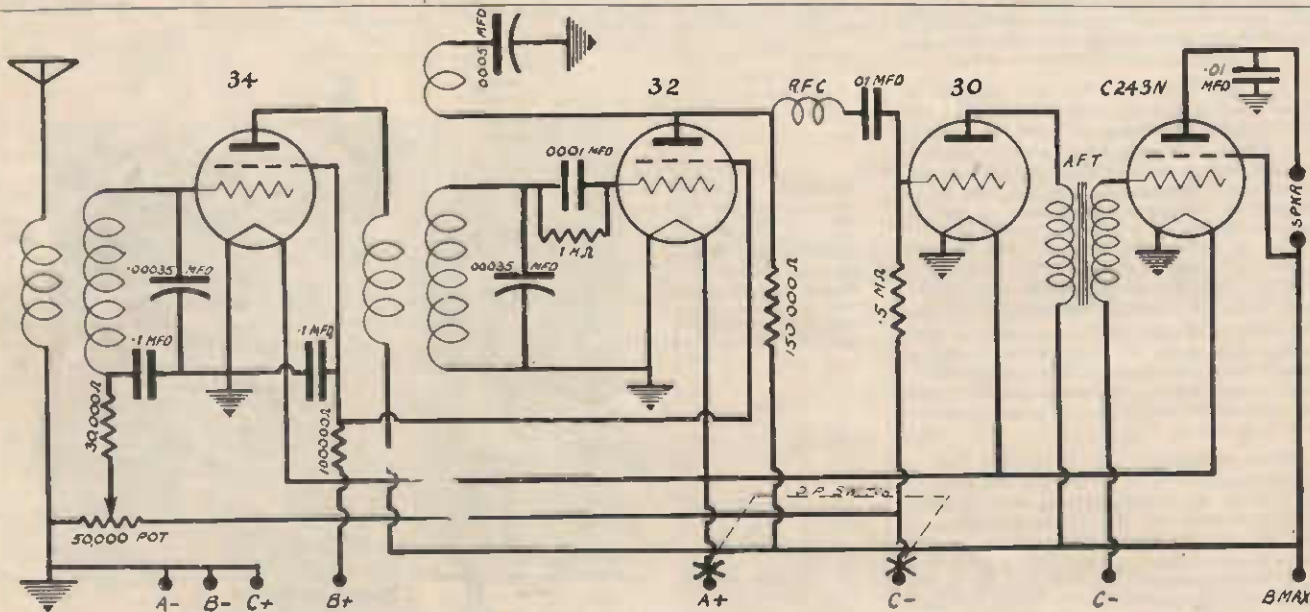

BATTERY SKY SWEEPER CIRCUIT.



**LIST OF PARTS (BATTERY SKYSWEEPER).**

	s.	d.
1 Chassis	7	6
1 2-Gang Condenser	9	6
1 Aero Dial Radiokes	12	6
2 Oxford Coils (unshielded) 1Aer. 1RF with Rea.	5	6
4 4-Pin Sockets and 1 6-pin	2	1
1 .0003 Reaction Condenser	2	6
1 50T Carbon Pot	2	9
1 D.P.D.T. Switch (Toggle)	2	6
1 Torex Audio Transformer	8	9
5 Speer Resistors (1 watt)	2	6
5 Tubular Condensers.. 2-1mfd. 2-.01mfd and 1-.0001 mfd	3	6
1 R.C.S., R.F. Choke	1	2
3 Knobs	1	3
2 Dial Lights	2	0
3 Feet, 7-wire Battery Cable	1	0
Sundries	2	6
<b>VALVES.</b>		
1 32 Raytheon	11	0
1 34 Raytheon	10	6
1 30 Raytheon	6	0
1 C243N Phillips	14	0

**ACCESSORIES.**

1 P.M. Speaker, Lissen (with 4-pin plug and cable)	39	6
1 2-Volt Accumulator, Lissen 50 amp.	26	6
3 45-Volt Bereo B Batteries	49	6
1 9-volt C Battery	1	9

**SPECIAL OFFERS FOR COMPLETE KITS. (K)**

- Complete kit of parts without valves or accessories.  
Cat. No. EK559 ..... 65/—
  - Complete kit of parts with valves.  
Cat. No. EK560 ..... 103/—
- Both of the above kits are quoted without speaker. Speaker recommended is the Lissen Permanent Magnet moving coil type, which can be supplied at 39/6 extra.
- Complete kit of parts with valves, speaker and all batteries as specified.  
Cat. No. EK561 ..... £12/18/-

**CHASSIS BUILT AND TESTED READY FOR USE.**

- Chassis only, Cat. No. EK562 ..... £4/5/-  
 Chassis with Valves, Cat. No. EK563 .. £6/3/-  
 Chassis with Valves and Speaker.  
 Cat. No. EK564 ..... £8/2/6  
 Chassis with Valves, Speaker and Batteries.  
 Cat. No. EK565 ..... £13/16/-  
 Any of the above can be supplied in nice mantle model cabinets at extra cost of 39/6.

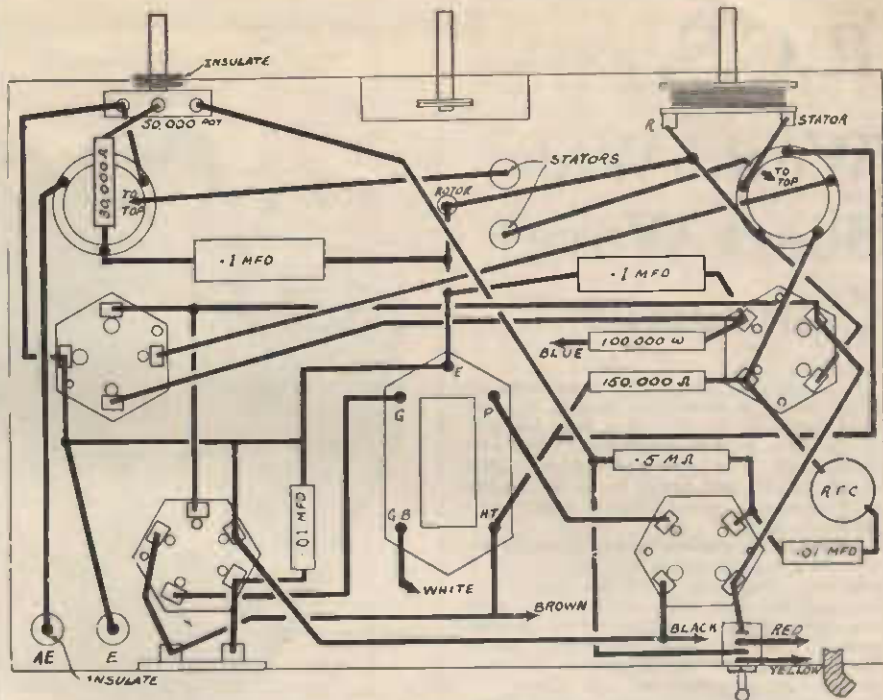

**UNDER CHASSIS WIRING.**

**MOUNT ALL COMPONENTS FIRST.**

Make this a golden rule when constructing a set. All components should be mounted in position before an attempt is made to start with the actual wiring. Care should be taken to see that the potentiometer is insulated from the chassis base by means of the insulating washers provided in the kit. Reference to the photograph will show you the correct position of the components and looking towards the front of the chassis they are as follows. Aerial coil on left, 34RF valve immediately behind this coil. Detector coil on right of chassis with 32 valve behind coil. A little to the left of this valve is the 30 audio valve, and to the right of the 34RF valve is the C243N output valve. Bolt the audio transformer under the chassis between the C243 and the 30 valve. The condenser is placed on the top centre of the chassis.

**WIRING.**

By carefully comparing the wiring diagram with the circuit diagram no difficulty should be experienced, but make as neat a job as possible, making sure that all joints are electrically as well as mechanically perfect. When wiring in the battery switch make sure that the C — lead to the potentiometer is connected to the switch.

**COIL CONNECTIONS.**

The coil connections are standard, but the illustration of the windings should be of assistance to new chums.

**CHECK CAREFULLY.**

With the wiring completed check up the wiring carefully from both diagrams; it is a good plan to mark each wire on the circuit diagram

(Continued on page 122.)

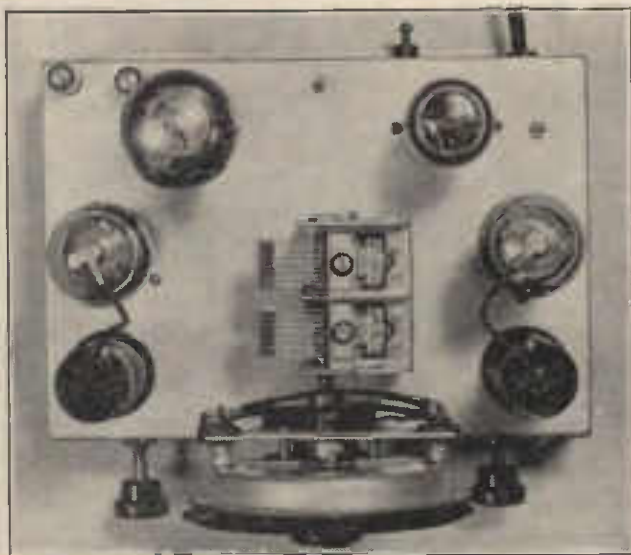

**BIRD'S EYE VIEW.**

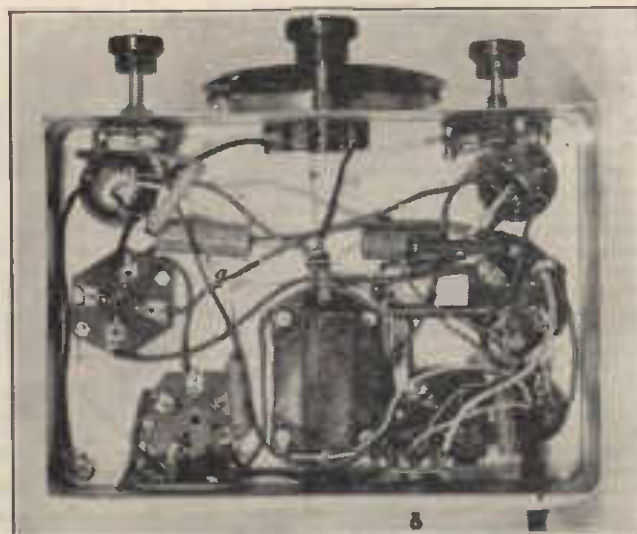

**WORM'S EYE VIEW.**

# R.C.S. World-Wide Short Wave Converter

It is now only about three years since the public began to take some interest in short-wave reception. In that short time the thrill of listening to the international short-wave broadcasters has so captured the imagination of the listener that to-day no set is regarded as truly modern unless there is a short-wave section to it.

Unfortunately, there are plenty of people who have very good broadcast sets only a year or two old. These are often too good to be scrapped in favour of a new receiver, which may not measure up to their owners' personal ideas of tone, etc. They have grown used to their old sets, and don't want to see them go under any circumstances.

It is for such people that short-wave converters are designed. They allow them to enjoy the same interest and entertainment from the overseas stations as are obtainable with dual-wave receivers.

We have described several converters in the past, each one with its own good features. Naturally, the art of making anything improves as times goes on, and the art of making converters is no exception. The converter to be described in this article is the cheapest, the simplest, and possesses a performance equal to that of any we have featured to date.

The home-builder is particularly interested in converters because they are so easy to make, and so fascinating to use. We have always found the greatest interest taken in every converter we have described. We are confident this one will easily outstrip the others, because, so far as we can see, it represents as nearly as possible the ideal converter.

### ITS FEATURES.

Let us run through the features which make it so attractive. In the first place, it has only one tuning condenser. All other converters to date, it will be remembered, have used a double gang condenser. This has been necessary in order to tune both the aerial secondary and the oscillator coil.

A glance at the circuit will show that there is no tuned coil in the valve's grid circuit at all! Instead, there is seen a plain coil, with a 500 ohms resistor wired across it.

This comprises the aerial impedance, specially designed to give the maximum of effect over the full band. It is found that in practice, where there is no R.F. stage in a dual-wave receiver or converter, the aerial circuit is very broadly tuned, and has little selectivity or gain on its own account. To obtain what advantage we can from tuning the stage we need an extra gang, carefully matched coil, and padder condenser, or aerial manual trimmer. In short, we go to quite a bit of trouble, and proportionate expense, to get something which doesn't seem to have a great deal of advantage to offer.

Therefore, we design an untuned stage to take the place of this aerial coil, and, in practice, we cannot tell any difference between a converter which does tune this first circuit, and our latest job, which doesn't. If there is

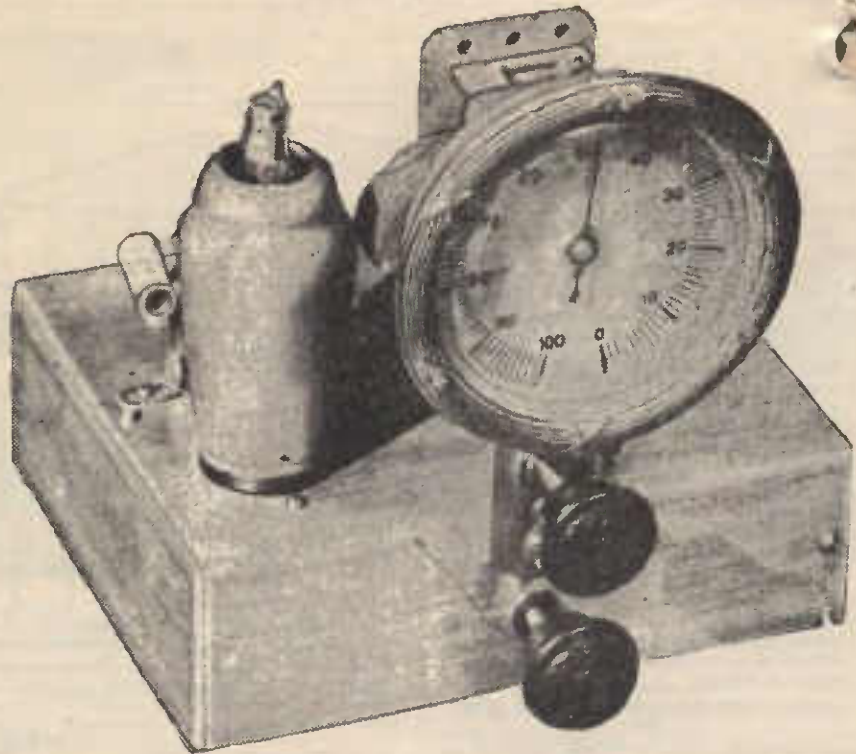

Only one control—the tuning dial. We present the simplest and most efficient of all short-wave converters, which has the added advantage of single dial control. (Described "Wireless Weekly.")

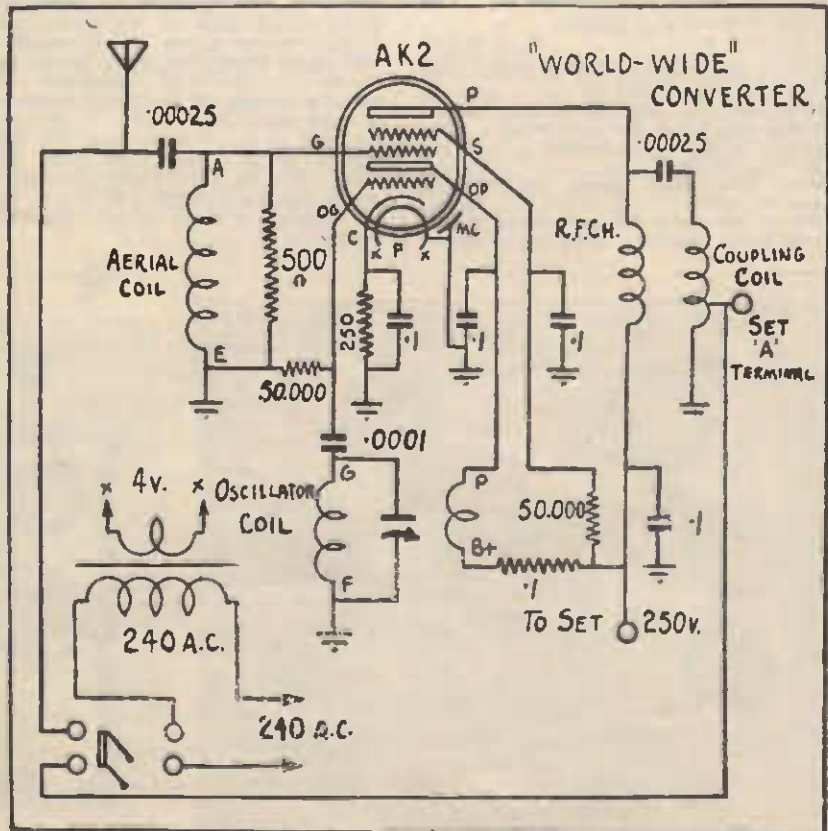

RCS CONVERTER CIRCUIT.



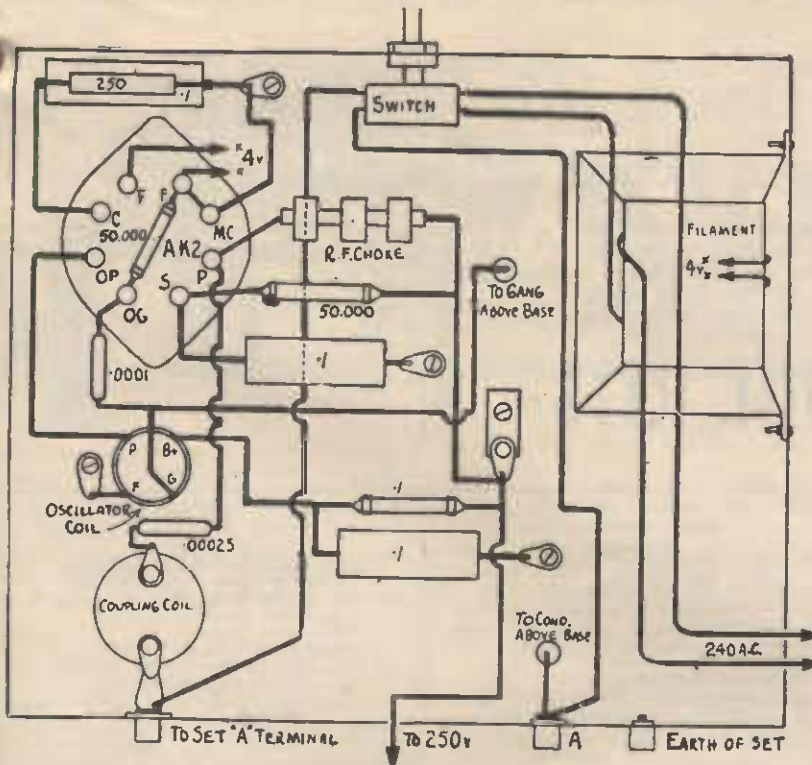

a difference, it doesn't matter for our purpose. We can play all the stations we want, and which we are likely to hear, with plenty of volume, and have the great advantage of only one control—a tuning dial.

**LIST OF PARTS REQUIRED.**

- 1 Base, 5in. x 7in. x 2in.
- 1 Single gang Tuning Condenser.
- 1 Special Coil Kit and Coupling Coil.
- 1 R.F. Choke.
- 1 Tuning Dial.
- 1 4-volt Filament Transformer.
- 2 50,000 ohm Resistors.
- 1 .1 meg. Resistor.
- 1 250 ohm Wire-wound Resistor.
- 2 .00025 Mica Condensers.
- 1 .0001 Mica Condenser.
- 4 .1 mfd. Tubular Condensers.
- 1 AK2 and Valve Socket.
- 3 Terminals, Nuts and Bolts, Hook-up Wire, etc.
- 1 Double Pole Switch.

**SIMPLE CONSTRUCTION.**

The construction of the converter is also made so simple by reducing the circuit to its present form. A glance at the circuit and the diagrams will show that the number of components has been reduced to a minimum, and the possibility of confusion among different coil leads, etc., entirely eliminated. The job of wiring up the bits and pieces is as easy as falling off a log!

Other features of the set include an "on-off" switch, which, when the converter is not in use, automatically connects the aerial straight through to the set without any need for changing leads about each time the converter is to be used. The switch used has the mains wired to one set of contacts, the other two being wired, one to the aerial terminal of the converter, and the other to its own output terminal. This is the only knob to worry about, and, as we could hardly leave the converter running all the time, it is essential, and cannot be termed as a control.

**CONSTRUCTION.**

Coming now to the construction of the converter, we obtain our base, 6 x 7 x 2 inches in size—it may be either steel or aluminium. As a matter of fact, we could have fitted all the gear to a much smaller base, but there would be nothing gained by doing so, and probably difficulties in getting all the parts nicely in place.

The position of the valve socket may be gauged from the wiring diagrams, and, of course, is not at all critical. Behind it are mounted two coils. The aerial coil, with its resistor, is mounted on top of the chassis, and immediately below it, using the same little bolts as hold the top coil in place, comes the oscillator coil. Behind the coils comes the little coupling coil for connection to the set.

The filament transformer is mounted on the other side of the chassis, being bolted to the side. The filament switch is mounted on the front of the chassis immediately below the dial itself.

**CONNECTING THE CONVERTER.**

Now we come to the matter of connecting the converter. The first step is to connect the earth terminal of the broadcast receiver to the earth terminal of the converter. Next, the H.T. wire coming through the rubber insulation grommet at the back of the converter is connected to the radio set at a point having the full high tension applied. For instance, this could be the "hot" end of the voltage divider, which is to be found in most sets. If there is no voltage divider, make the connection to the screen terminal of the output valve, assuming that, as in about 90 per cent. of cases, the set uses an output pentode. This connection should be soldered, as it is permanent, and need not be removed once it is made.

See that the earth connection between the two chassis is made before the H.T. connection; otherwise, should the set be turned on before the earth connection is in place, it would be possible to get a "bite" by touching the two chassis. The correct procedure when connecting is to have the receiver turned off altogether.

**SUPERSEDING ALL PREVIOUS DESIGNS. (K)**

The astounding efficiency of this new short-wave converter is exemplified by editorial comment in "Wireless Weekly" recently, which said: "After thorough tests we can vouch for its performance, and heartily recommend it as superseding all previous designs."

**R.C.S. RADIO WORLD-WIDE CONVERTER**—The complete R.C.S. Kit for this remarkable little converter comprises a periodic aerial coupler, with resistor, oscillator coil, and R.F. choke.

Cat. No. EC378 ..... **10/6**

Special Single Gang Condenser. Cat. No. EC919 ..... Each **5/6**

**R.C.S. CIRKIT SET** includes everything required to completely assemble the World-Wide Converter except the valve. So simple is this Kit to assemble, and so complete is the detailed instructions, that the merest novice could complete it in an evening and have plenty of time to tune in foreign stations. No intricate lining up is necessary. R.C.S. Cirkit Set, complete with all wire, nuts, bolts, etc., **£3/19/6**

Complete with Philips AK1 Valve—Cat. No. EK34A ..... **£4/17/-**

The next step is to remove the aerial connection from the set's aerial terminal, and connect it to the aerial terminal of the converter. Finally, the output terminal of the converter is connected with the aerial terminal of the set, from which the aerial itself has just been removed.

That is all there is to the connecting, and the converter is ready for use on plugging the main leads into a power socket. It can be wired to the same plug as serves the radio set.

When operating the converter, turn the broadcast dial to some spot between 2YA and 1YA where there is no station. It is not critical, but unless this same broadcast setting is used each time the calibrations of the converter will also alter each time it is used. Having adjusted the broadcast set, proceed to turn the converter dial, controlling the volume from the set itself. Short-wave signals will roll in from everywhere.

It will be noticed that all signals are tuned in two spots on the converter. This is quite normal, and it appears even on dual-wave sets with an R.F. stage. You will soon get into the habit of tuning in to the lowest spot on the dial where the stations are heard. A pencil mark on the dial will enable you always to find the short-wave stations, not forgetting to keep the broadcasting set tuned also to the same spot each time the converter is in use.

**THE BROADCAST SET.**

Any good broadcast set will be suitable for this converter, and it need not be a superhet. As long as the set has enough sensitivity to tune in Australian stations at good volume, it should be possible to get excellent results from short-wave stations. Any station which has any strength at all will be an easy mark for this great little converter.

**MAKES ANY SET A RADIO-GRAM. (K)**

Pick-up head which will fit the tone-arm of practically all makes of gramophones. Good tone, low noise level. Weight on record, Approx. 4 ozs.

Cat. No. EP203

**11/6**



# Make Sure of a Good Job by using the Correct Tools!

Radio work is daily becoming more complicated, and the necessity for efficient workmanship more and more necessary. The right tool for the job may save you many a laborious and aggravating check-over because some faulty connection refuses to work. Make your work easier and better. Get one of these—

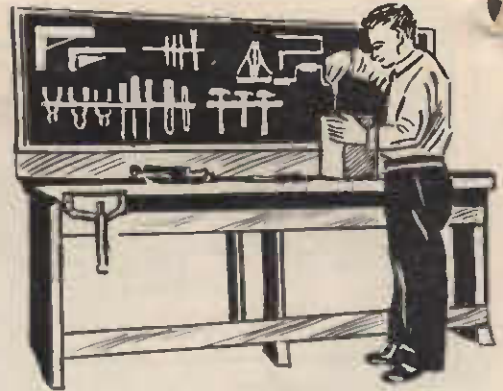

## RADIOMAN'S TOOL KITS (B)

<p><b>TOOL KIT NO. 1.</b> Contents. 1 Pair HU55 Side Cutters. 1 Pair Long Nose Pliers. 1 Pair HU57 Combination Pliers. 1 Pair HU109 Radio Screwdriver. Listed individually 6/5. Order Tool Kit 1. Cat. No. EU250 .... <b>5/6</b></p>	<p><b>TOOL KIT NO. 2.</b> Contents. 1—HU55 Side Cutters. 1—HU51 Radio Pliers. 1—HU53 Extra Long Pliers. 1—HU57 Combination Pliers. 1—HU75 Square. 1—HU77 Level 1—HU78 Bevel. 1—HU102 Screwdriver. 1—HU109 Screwdriver. Listed individually at 13/2. Order Tool Kit No. 2. Cat. No. EU251 .... <b>11/-</b></p>	<p><b>TOOL KIT NO. 3.</b> Contents. <b>A De Luxe Set of Finest Quality.</b> 1—HU54 Side Cutters. 1—HU52 Radio Pliers. 1—HU58 Combination Pliers. 1—HU71 Snip. 1—HU64 Nippers. 1—HU101 Screwdriver. 1—HU109 Screwdriver. Listed individually at 18/7. Order Tool Kit No. 3. Cat. No. EU252 .... <b>15/-</b></p>
--	---	--



### TO IMPROVE SELECTIVITY WAVE TRAP.

We make no excuses for repeating this circuit which was published in our last catalogue. It was a success right from the start and dozens of letters have been received telling us of the wonderful difference this little wave trap makes.

Should your set be too broad in tuning, that is, receiving two or more stations at the same time, or unable to receive a station owing to a powerful local station, the difficulty can be overcome by installing a Wave Trap.

Anyone without radio knowledge can make one.

#### WAVE TRAP PARTS REQUIRED. (K)

- 1 Alligator Clip.
  - 1 .0005 Condenser and dial.
  - 2 Terminals.
  - 1 Piece Former, coil wire, panel, baseboard, connecting wire, screws, etc.
- Cat. No. EK301 ..... 7/6  
Coil ready-wound. Cat. No. EG402 ..... 2/6
- The Wave Trap can be also supplied already assembled (without cabinet).  
Cat. No. EK303 ..... 10/6

#### WINDING THE COIL.

Bore a hole about 1/4 in. from one end of the former, thread the coil wire through and wind

on about sixty turns. At about every 8th or 10th turn make a small loop (or tap). The condenser is mounted on the panel and the coil on the baseboard.

#### WIRING.

The two ends of the coil are connected to the condenser as shown in the illustration. Secure the clip to a short piece of flexible wire the other end of which goes to the input terminal. The other terminal is connected to the end of the coil as shown.

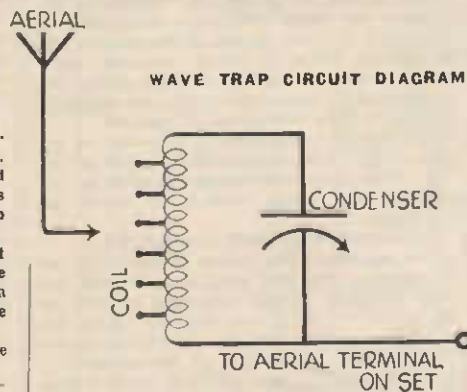

#### OPERATION.

It is very simple to fit to the set, the aerial being connected to one terminal on the Wave Trap, and the other terminal of the Wave Trap connected to the aerial terminal on the set. To operate, you tune the set to the station that is causing interference, then rotate the dial of the Wave Trap, and at one point it will be found that the unwanted station will almost completely disappear.

By trying the Clip on the different tappings, you can determine which is most suitable for your location and aerial.

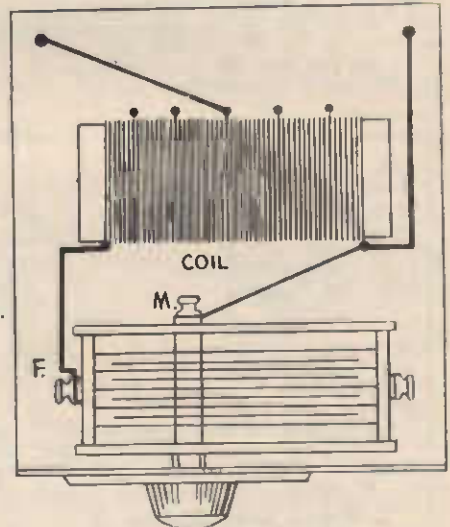

Illustration shows Coil and Condenser Connections.

Leaving the Wave Trap, the Receiver can now be tuned to any other station desired.

#### HOW TO STRENGTHEN WEAK STATIONS.

This useful device can be used as an Aerial Trimmer, leaving the connections exactly the same as for use as the Wave Trap.

Tune the set to a weak station, then tune the Wave Trap to a point where it is found that the signals will be greatly increased. The final adjustment of the Receiver's controls may now be necessary.

The difference in reception is sometimes remarkable, and an efficient Aerial trimmer is in many cases quite as effective in increasing signal strength as adding another valve, and it is well worth trying.





**THE ADD-A-VALVE.**

How to add an extra valve (tuned radio frequency stage) to any receiver at low cost and minimum trouble. The Add-a-Valve will extend the range and increase the selectivity of any set.

One of the most common questions we are asked is: How can I increase the range of my set? or How can I add another valve to my set?

To add another valve in the ordinary way usually involves considerable expense, and in most cases, pulling the set to pieces and rebuilding it, a task that many constructors are unwilling to undertake, especially if their sets are giving moderately good results.

However it is generally felt that if the set has a little more "pull" many more stations could be received and many stations that can just be heard could be brought in at good listening strength.

For a long time we have felt that some simple attachment could be supplied to fill this definite need, and with that in mind the Add-A-Valve has been designed. It is entirely independent from the set, so that in the unlikely event of it not being a success on any particular set it can be removed and no harm done. On the other hand, with practically all sets, it will prove a definite boon, and many stations that were previously weak or inaudible will be brought in at good volume.

On test the Add-A-Valve worked equally well on both T.R.F. and superhet sets. Although designed to improve distance reception, we found selectivity was also improved remarkably.

To the radio constructor the Add-A-Valve will present no difficulties, but we would not advise the absolute novice to attempt it. However, read the following instructions, study the circuit

diagram, and you can then judge for yourself whether you are able to build for yourself the "Add-A-Valve."

The filament voltage of the valve to be used will be decided by your set; if it uses 2.5 volt valves you will use a 57, but for sets using 6.3 volt valves a 6C6 will be required. Should you not wish to take the filament supply from the transformer in your set a separate filament transformer can be used.

The "Add-A-Valve" is completely assembled by the constructor into a shielded metal box.

**CONSTRUCTION.**

Mount all components, including valve socket, condenser, dial, terminals, bush, etc., on to the metal chassis base before you start wiring.

**WIRING.**

1. Connect a pair of twisted flexible wires to the filament terminals on the valve socket, push them through the bush, and leave sufficient wire to connect to filament points on your set.

2. Solder the 30 ohm C.T. Resistor across the filament terminals of the valve socket. The centre tap of the resistor is earthed to the chassis.

3. Connect 250 ohm resistor and .01MFD condenser to cathode; the other end of both of these parts are connected to earth.

4. From screen grid terminal on valve socket connect a .01 condenser and a 20,000 ohm resistor to earth and a 25,000 ohm resistor to blank lug on coil.

5. To the plate terminal on valve socket is connected a 25,000 ohm resistor, which also goes to blank lug on coil. A .01 condenser also connects to the plate terminal. The other end of this condenser is connected to a piece of flexible wire, which when the "Add-A-Valve" is attached to your set, connects to the aerial terminal.

6. Another flexible wire is connected to blank lug on coil and left ready to be attached to the set.

7. Connect aerial terminal on coil to aerial terminal on "Add-A-Valve."

8. Earth bottom of primary and secondary windings of coil, which completes the under-chassis wiring.

**ABOVE-CHASSIS WIRING.**

There are only two connections above chassis.

1. From coil to fixed plates on variable condenser.

2. From fixed plates of variable condenser to screen grid clip on valve.

**CONNECTION TO SET.**

Having completed the wiring and checked your work both from the above instructions and from the circuit diagram, you may connect the "Add-A-Valve" to your set. There should be four wires coming out of the bush from the "Add-A-Valve." The two filament leads are connected to the R.F. filaments on the set. The wire from the plate is connected to the aerial terminal on set. The remaining wire is connected to the HT plus at any point where maximum voltage is obtainable such as screen of output valve, or voltage divider, etc., etc. The earth terminal on the "Add-A-Valve" can

**"ADD-A-VALVE" PARTS LIST. (K)**

	s.	d.
1 .00035 Variable Condenser	5	11
1 Oxford Add-A-Valve Coil	3	6
1 Vernier Dial	4	6
2 25,000 ohm Resistors	1	0
1 20,000 ohm Resistor	0	6
1 250 ohm Resistor	0	6
1 20 ohm C.T. Resistor	0	6
1 57 Valve	8	6
1 Chassis and Metal Box	7	6
Sundries, including Terminals, Bush, Bolts and Nuts, Wire, Lugs, S.C. Clip, etc.	Lot 2	3

Cat. No. EK555—Complete Kit of Parts without valve ..... 27/-  
 Cat. No. EK556—Complete Kit of Parts with Raytheon Valve ..... 34/-

be connected to the earth terminal of the set. The aerial is connected to the aerial terminal of the "Add-A-Valve."

**OPERATION.**

Tune in a station in the usual manner on the set to maximum volume (of course, select a weak station). Now slowly rotate dial on the "Add-A-Valve," and at one point volume will increase considerably. To obtain maximum volume it may be desirable to adjust the receiver slightly. To the keen experimenter the "Add-A-Valve" will not only increase the range of his set, but will also open up new fields for his experimenting, and after all there's more fun and knowledge in improving our reception by our own work and experiments. In conclusion we must state that the "Add-A-Valve" is an efficient and inexpensive unit, which will improve the reception from many sets out of all proportion to the cost, and exceed the expectations of many constructors.

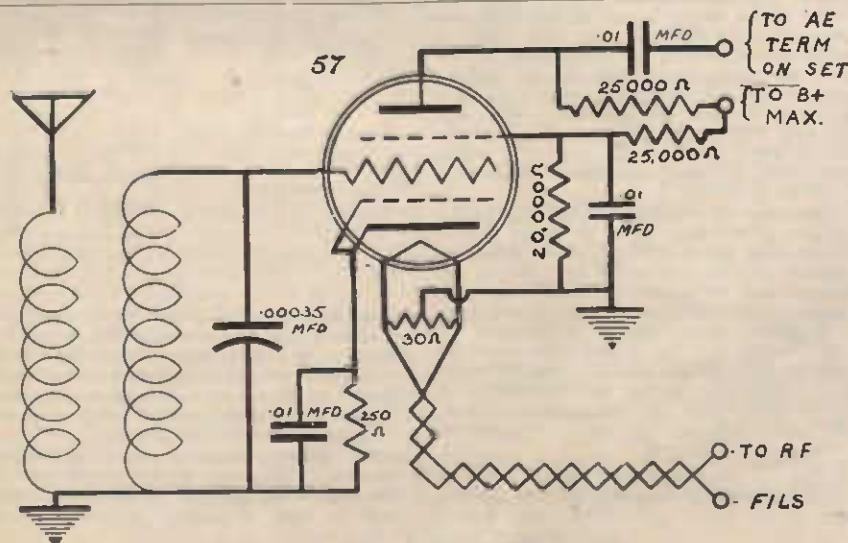

THE ADD-A-VALVE CIRCUIT.



Front View.

# The ALL WAVE DUPLIX SINGLE

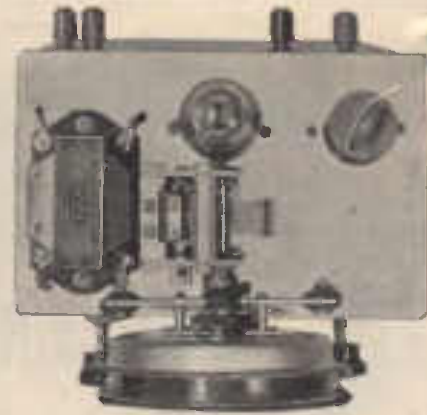

Bird's-eye View.

Here is a short article dealing with the construction of a single-valve all-wave receiver, which can be built for a very reasonable cost, yet will give the most remarkable results for a set of its size.

(A "WIRELESS WEEKLY" CIRCUIT.)

Build this wonderful little two-in-one valve set! It packs a marvellous punch, and costs only three pounds! Just as efficient on short waves as on the broadcast band. And, in good localities, will even work a loud-speaker!

This tiny receiver will go straight to the hearts—and the pockets—of hundreds of our readers. It has just about all the things they have been asking for in a set of this type, and at the same time it costs little to build, and is absurdly economical to operate.

It works just as well on the short waves as it does on the broadcast band, and for a head phone receiver, we have never worked with anything of its size which came anywhere near its results.

Perhaps the best way to introduce it would be to make a list of the things that make us so enthusiastic.

As far as the circuit goes, it is more or less standard. There is nothing in it which has not been tried and proved. Most of the features of this set are contained in the application of ideas destined to iron out the snags which in the past have handicapped a single-valve set which tried to be everything at once.

## 1. THE CIRCUIT.

The circuit is built round the 19-type valve. This is a 2-volt valve originally built for B class amplification in battery sets. Actually, it is two valves in the one envelope, both being triodes with a high amplification factor. Although the two sections were meant to work in push-pull, there is no reason at all why they should not be regarded as two separate valves, and wired accordingly. This is just what we have done. Each section of the 19 has its own filament, grid and plate. One we use as a triode detector with reaction, and the other as an audio amplifier. So that, although there is only one valve in the set, actually it is a genuine double-purpose type, and actually works as two valves. Transformer coupling is used between the two sections to get the utmost gain.

It will be noticed, by comparing the front view picture of the set and the circuit diagram that there is an extra control which is not shown in the circuit. This is merely an aerial series condenser, which is connected in the aerial lead. In country districts, this condenser will not be necessary, but it helps tuning and selectivity near local stations, and assists reaction control on short-waves.

## 2. REACTION CONTROL.

One of the things to watch when using reaction is to see that the control has the least possible effect on tuning. The ordinary reaction condenser circuit is very good, but, particularly

on short waves, affects the tuning quite a bit. We have used a different method, by employing a reaction winding, untuned, and varying the plate voltage on the detector to give us control. This is a much better idea. The effect of reaction is much more constant, and tuning is hardly affected at all, even on short waves. There is only one thing to watch and that is that there are not too many turns on the reaction coil. This would make the valve oscillate before there was enough plate voltage for best gain. We suggest using as few turns as possible on the coil, and if our coil winding data is followed everything should be fine. About 40 volts should be on the detector plate before oscillation. Control will be found very smooth in operation.

## 3.—TUNING CONDENSER.

We have used a full-sized gang condenser, the same capacity as used in the ordinary broadcast sets. We did this so that the broadcast band would be covered without changing coils as would be necessary with a smaller capacity.

On the short waves, the large gang will make tuning very sharp, and so we have provided a vernier control in the shape of a small 3-plate midget condenser wired across the main gang. We even pulled one of the plates out, leaving one moving and one fixed plate, which gives even finer tuning control. This control overcomes the disadvantage of the large condenser for short waves, and allows easy tuning anywhere on the dial.

One of our surprises was to find that only one coil was needed to tune from about 16 to 50 metres, exactly as marked out on the dual wave dial, as designed for an ordinary dualwave set. Over the full range, there was plenty of reaction and excellent results were obtained from the 19 metre overseas stations, the 20 metre amateurs, the 35 and 31 metres short-wave stations, and also the amateurs again on 40 metres.

Naturally, the efficiency of the set was not as good at 40 metres as at 19 metres, because of the high tuning capacity, so we wound up another coil which started off at 40 metres, and covered also the 80 metre amateur band with about half its capacity. At the same time, it is perfectly practicable to use the first coil over the full short-wave range, just as in the case of a big set and the advantage of having the wave-lengths marked on the dial is, of course, considerable to the average listener. For best results over the 40 metre band, the second coil can be used.

## 4.—PERFORMANCE.

We are most enthusiastic about the performance of the set. In the first place, it is a

real winner on the short waves. The overseas 19 metre stations were loud enough in the evenings to be heard with the phones on the table, as were many of the 20 metre amateurs. The same was true on the 25, 31 and 40 metre bands. Many of the weaker stations were heard by a little careful searching, the smooth reaction being a great help in this regard. For reception of Morse signals, the set was found to be wonderfully quiet and flexible.

On the broadcast band, we were able to receive quite good results on a loud-speaker. Many people who will build this set will have an old-type horn speaker somewhere, which experience has shown them to be sensitive. We have one at home, and heard a political speech clearly in every part of the house. By judicious selection of aerial lengths, we could separate all the local stations, and in the country there should be dozens of stations waiting to be picked up. Naturally, we intend this set to be used primarily with headphones, although on strong stations it is possible to get worthwhile results on a speaker, even of the permagnetic type. But don't worry about a loud-speaker unless you have at least one very strong local, and, in any case, rely on headphones for most of your listening.

## COIL WINDING DATA.

Wave-length:  
16-50 40 up B'cast

Aerial:

3 5 15

Grid:

5 15 100

Reaction:

5 7 25

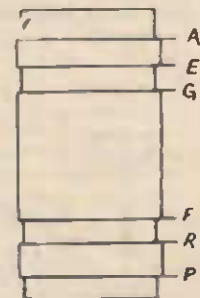

All windings close wound turns, with three-sixteenths gap between reaction and earthed end of grid winding, and a similar gap between grid end of secondary and start of aerial coil. S.W. coils—26 S.W.G., with d.s.c. or d.c.c. wire. Broadcast coil wound, with 32 S.W.G. enamelled wire. All formers' 1 1/4 in. diameter.

We found it handy to mount the gang on four 1/4 in. by 1/4 in. bolts, so that the dial mechanism could clear the front of the chassis. Don't drill the holes to support the condenser until



... you have made sure of their position by trial and error.

Now screw down the transformer and the valve sockets.

Our transformer has terminals, so we brought the connecting wires through holes in the chassis.

The wiring is so simple that even the novice should have no trouble with it. Note that the grid condenser is wired so that it mounts directly from the valve socket grid terminal to the grid terminal of the coil socket. If your valve sockets are of a different make, don't let that worry you. Ours just happened to be that way.

Incidentally, the 19 has a 6-pin socket. There are two filament terminals, the plate and grid pins for each section being arranged in pairs, and in that order on each side.

**5.—BATTERY CONSUMPTION.**

While the loud speaker was booming forth, we picked up a meter and measured the plate current. Exactly three milliamps! The total high tension we were using was 120 volts from light duty batteries. For average use with head-phones, we suggest 90 volts as the best voltage, although 135 would be better if signals were reckoned loud enough to work a speaker. The minimum should be 60 volts if good volume and adequate reaction are desired. We have, however, obtained quite good results on 45 volts. Below 60 volts, the set would probably work best without the bias battery. A bias of 1½ volts we found to be plenty.

The A battery current is .24 amps at 2 volts, and is most satisfactorily obtained from a small accumulator.

The 1.5 volt torch cell used for bias can be seen mounted under the base. See that the metal can does not connect to the chassis.

So much for the set and its features. It's an ideal little job for the lad who wants to build himself his first set, for it will get him short wave stations as well as broadcast, and is so cheap and economical. If he should live in the country, so much the better. Where expense must be considered, plenty of people could wish for nothing better in a small set. It has possibilities as a small portable set, and, in fact, will fill the bill wherever a little set is required.

A five-pin socket is used for battery connection at the rear of the chassis. There are also four terminals mounted there—two for phones and two for aerial and earth. Only the earth terminal should be connected to the chassis—the others must be insulated.

**WINDING THE COILS.**

In all cases, the bottom winding is the reaction. It starts at the plate pin of the former, and ends at the pin connecting to B plus 67½ volts. The next is the grid winding commencing with the earthed end and ending with that connected to Grid. Lastly comes the aerial coil, commencing with the end connected to aerial, and finishing also to the pin which is earthed. Thus, there are two ends connected to the earthed pin. Incidentally, the pins are hollow, and after holes have been drilled in the former through which to pass the wire, insulation is stripped, and the ends passed through the hollow pins. A drop of solder holds them in place, and the excess wire is snipped off. Make sure the pins are afterwards cleaned of any flux which would spoil contact.

There is little danger of failure with the set as it is so simple. Failure to obtain oscillation is generally due to reversed connection of the reaction coil, or too close coupling between the aerial and grid coils. Too large an aerial can also make oscillation difficult. Although 67½ volts is applied to the end of the regeneration control, rarely will it be necessary to use this full voltage to obtain oscillation.

We are confident that this little set will be a great success.

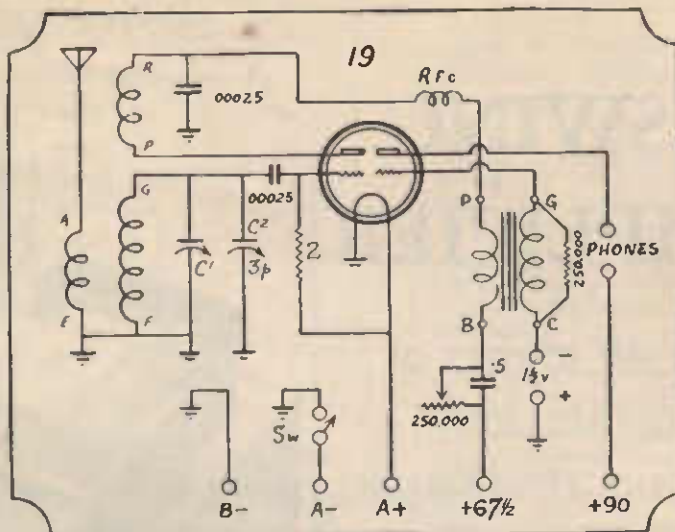

The circuit diagram. C1 is the main timing condenser, an ordinary single-gang of .00035, .000385, or .0005 mfd. capacity.

**AERIALS AND EARTHS.**

A good aerial should be used with this receiver, height being more important than length. Too long an aerial is not desirable for short waves, as it tends to load up the grid circuit and make oscillation difficult. About 75ft. or so should be ample, strung up as high as possible.

A good earth is also particularly important with a battery set. Our favourite earth is a kerosene tin punched full of holes (particularly the bottom), filled with ashes, and buried about a foot below the surface. The earth wire is soldered to this in several places. Throw a bucket of water over the spot occasionally. A piece of pipe reaching down into the ashes will make sure that the water actually reaches the can.

**LIST OF PARTS FOR DUPLEX SINGLE. (K)**

1 Metal Chassis Base	6/6
1 Aero Dial	12/6
1 Single Gang Condenser	5/11
1 3-plate Midget Condenser	2/6
1 Lissen Audio Transformer	8/6
1 250,000 ohm Carbon Potentiometer	2/9
1 2 megohm Resistor	6d.
1 .25 meg. Resistor	6d.
2 .00025 Mica Condensers	1/8 lot
1 1.5 mfd. Tubular Condenser	1/3
1 R.F. Choke, Lekmek	1/9
1 Filament Switch, Rotary type	2/3
3 Valve Sockets	1/3 lot
4 Knobs	1/8 lot
3 Coil Formers	4/6 lot
Sundries: Including Coil Winding Wire, Lugs, Bolts and Nuts, etc., etc. 4/6 lot	
1 19 Valve	9/-
Kit of Parts without Valve	<b>£2/16/6</b>
Cat. No. EK667	

Kit of Parts with Valve  
Cat. No. EK668

**£3/3/-**

**ACCESSORIES.**

- 2 45-volt Light Duty Batteries or 100-volt L.D. Battery.
- 1 2-volt Accumulator.
- 1 1½ - volt Torch Cell for Bias.
- 1 pair Headphones.

**SIMPLE CRYSTAL SET**

**PARTS LIST. (K)**

- 1 I.C.A. Tuner  
Cat. No. EC294 ..... 3/11 each
- 1 Ormond Crystal Detector  
Cat. No. EC256 ..... 2/6 each
- 1 Piece of Wood.

Break into the radio game. You can make a real good crystal set out of this tuner and detector. Just connect them up as shown in the diagram. Nothing more simple has been devised for the newcomer to radio.

**INSTRUCTIONS.**

The I.C.A. Tuner and Detector are screwed down upon a small baseboard to form a convenient mounting. For the aerial a regular broadcast aerial may be used provided it is a long outdoor one. If not, a good outdoor wire, about 100 feet long, high and clear of surrounding objects and well-insulated, should be erected. An insulated lead-in is attached to one end of the aerial (preferably soldered) and run down to the crystal set. Here it is attached to spring A (see diagram). For earth, connect a wire to a convenient water pipe or other earth. Use a good clamp to ensure good contact. Connect earth wire to spring B, connect ear-phones to A on tuner and one side of detector. Connect other side of detector to B, and the crystal set is ready for use. To tune in stations slide ball on tuner back and forth. If no station is heard, adjust catwhisker spring of crystal detector lightly on surface of crystal until a sensitive spot is found. Then slide the ball on the tuner again until a station is tuned in.

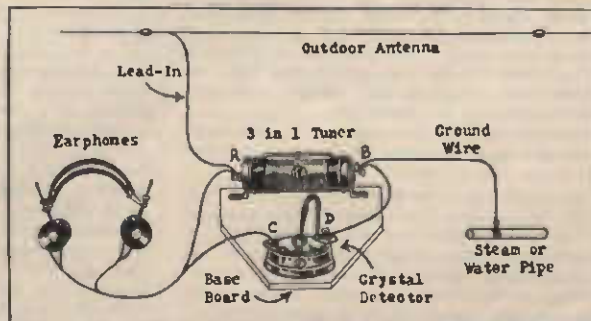

Connections of a Simple Crystal Set.

# A SWING AMPLIFIER

For all lovers of  
True Music—  
Swing or Classic

(Abridged from "Wireless Weekly.")

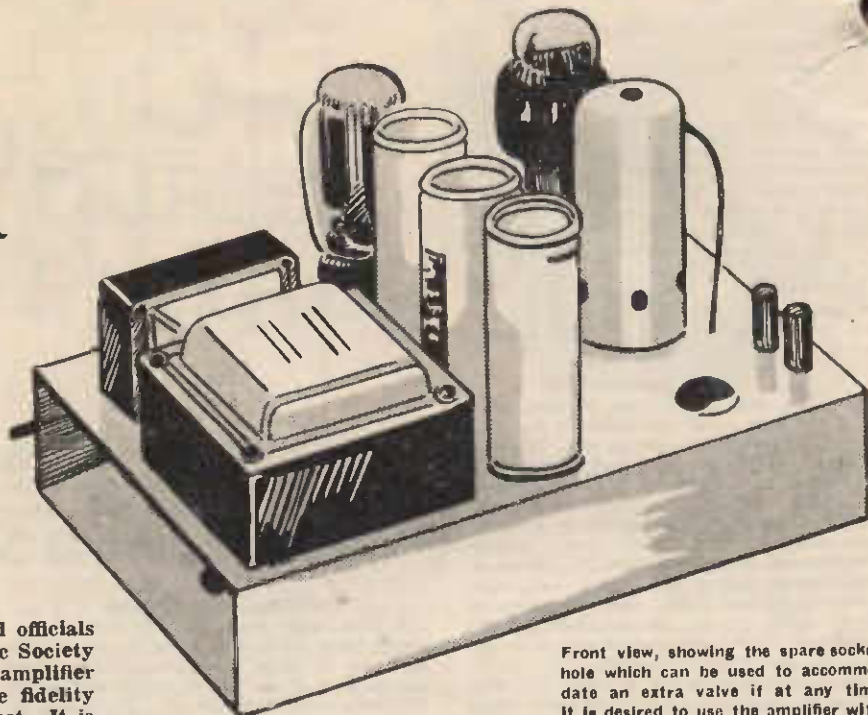

Front view, showing the spare socket hole which can be used to accommodate an extra valve if at any time it is desired to use the amplifier with a microphone for voice reinforcement work.

At the request of prominent members and officials of the Swing Club and the Recorded Music Society our Technical Editor has produced this amplifier as the most effective way of getting true fidelity of reproduction from recordings at low cost. It is a remarkable job in many ways.

It was only after attending a recent meeting of the Sydney Swing Club that we realised the need for a technical article on the construction of a simple but effective amplifier. At the Swing Club we found that hundreds were present to listen to recordings of famous overseas swing bands, and when we made enquiries amongst members we found that few appeared to appreciate that they could enjoy these recordings in their own homes by installing an amplifier at a total cost well under £10. Some said that they had ordinary radio sets at home with pick-ups attached; a few even boasted the ownership of radio-gramophone combination sets, but it was very evident that few of these equipments gave reproduction of the kind that can be obtained even with a simple amplifier which is designed to get as much as possible from the recordings.

In fact, few realise just how much there is in a record which can be brought out if the amplifier is designed to be capable of handling everything that the pick-up can give it.

For a start we tried out the experimental amplifier, from which this amplifier is evolved, on Stan Bourne, whose Ginger Jar Band broadcasts through 2GB and 2UW. Stan is a keen member of the Swing Club and a swing enthusiast right in to the bone. Stan came over to the laboratory on a Sunday morning to play over a few records, and was soon engrossed in picking out the harmonies in the recordings and the instruments which he had never previously heard from these recordings when he had played them on his own radiogramophone, although until he heard our amplifier Stan had thought his own was perfection.

Stan listened and listened, and it must have been 2.30 that afternoon when he went home for lunch!

And so it has been with everybody who had heard the amplifier—they have simply implored us to run an article on the construction of the amplifier to be published with their solid recommendation to everyone who likes music, whether it be swing or classic. From records you can get music which is miles ahead of anything which comes out of an ordinary radio set or gramophone.

## FUNDAMENTAL FACTS.

To get down to facts—in order to reproduce records properly you need first of all a turntable to turn the records, which can be an electric motor or a spring one, or the turntable in an old-style gramophone. All that is necessary is to have a device to turn the record at 78 revolutions per minute and maintain this speed, irrespective of the dragging of the pick-up.

The next thing is this pick-up, and many are the types and styles of pick-ups available on the market.

Next in the chain is the amplifier itself, and it is this item which we are so fully detailing, an amplifier which can be built by any handy man at a cost of about £5. The original amplifier was built in an evening. You, too, can build a job with exactly the same performance in your spare time. Probably the job will take you from six to eight hours, but it's pleasant and interesting work. Of course, if you really felt that you wouldn't be game to try your hand at building the amplifier, you will have no difficulty in finding a radio dealer who will gladly assemble one for you for a guinea or so.

On account of the wide difference in prices we have gone into the position very thoroughly, and tested dozens of different speakers, with the result that we have no hesitation in recommending the medium-price speakers between 55/- and £7/10/-.

## THE Baffle.

It is necessary to baffle the speaker. The most effective way to do this is to mount the speaker on a piece of plywood or celotex about a yard square, and with a suitable circular hole cut in the middle. With the speaker mounted on a baffle of this kind it is possible to get a reasonable response of low notes. The main difficulty is that this type of baffle board tends to be a little unsightly, and few are the wives who are tolerant enough to permit such a baffle to repose in the parlour. Yet cabinets, no matter how heavily constructed, tend to have their own particular resonance characteristics, which affect the quality of the reproduction.

## ROOM ACOUSTICS.

The next problem is the acoustic properties of the room, although these are seldom serious enough to be really considerable, a little experimenting often pays good dividends with improved reproduction. It is most important to have the speaker across a corner or mounted out in the room somewhere, but not close up to a flat wall; otherwise there will be reflections from the back. In a big room it is generally found that there is an apparent improvement in the brilliance of the reproduction when the amplifier is turned up to fairly loud volume. To attain the same brilliance at low volumes it is necessary to operate the amplifier in a smaller room, or in some one which does not contain a soft carpet, curtains, cushions and other sound-absorbent materials.

## MOUNTING ELECTROLYTICS.

The mounting of the electrolytic filter condensers calls for some care. There are three of 8 microfarad condensers. There is a central terminal lug, which is the positive side, and the can is the negative side. In the case of one of the condensers the negative side is earthed, and so this condenser is mounted so that the can makes metallic contact to the base, but the other two have the negative side running to the centre-tapping of the power transformer's high-voltage winding, and so the cans have to be mounted in the mounting washers which are provided with the condensers, so that the cans are insulated from the base. The cans of the condensers are arranged to make contact to the terminal washers also provided, and it is to these terminals that the wiring is soldered. The 500 ohm bias resistor is mounted directly between the terminal washers of the second and third electrolytics.

## POLARITY.

The polarity of the electrolytic condensers is most important. In the case of the filter condensers this is fully covered in the above explanation, but there remains the high-capacity by-pass condenser, a tubular type of electrolytic with a capacity rating of 25 microfarads and a peak voltage rating of 25 to 40 volts. This condenser must be connected so that the red



# CIRCUIT SWING AMPLIFIER

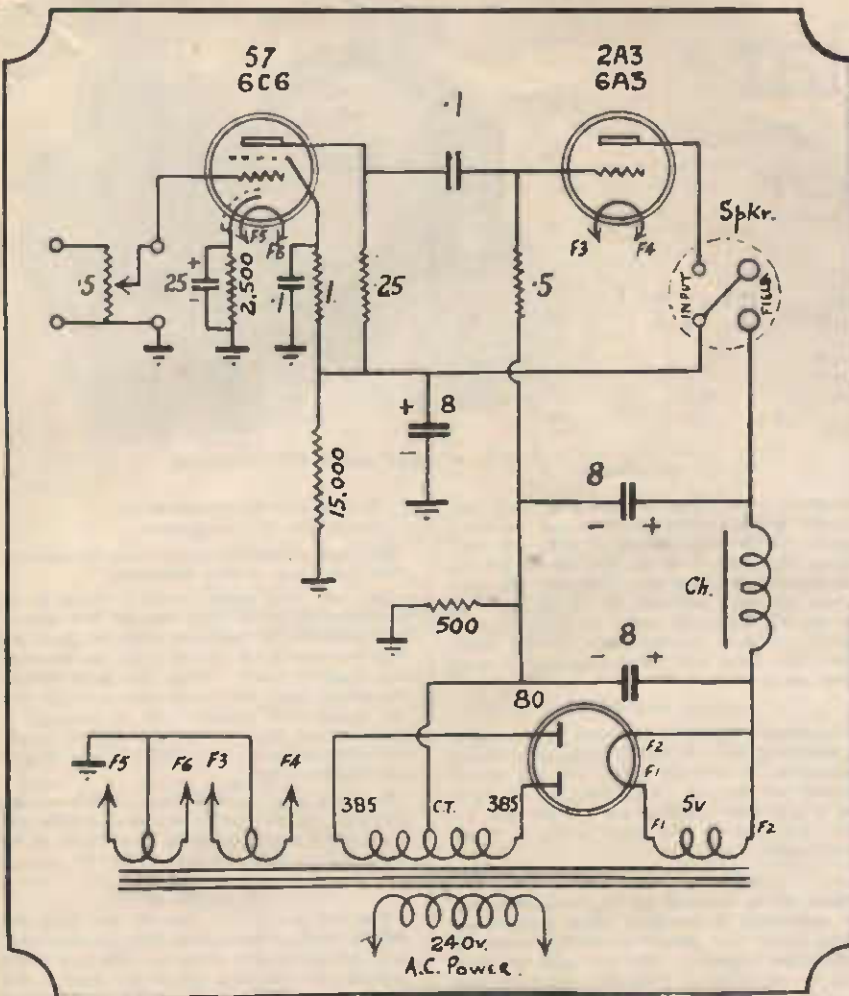

Circuit showing also the correct method of fitting a volume control if one is not already embodied in the pick-up.

(positive) end is to the cathode of the first valve, and the negative end is to earth. Incorrect connection of this condenser will mean that the amplifier will be quite unsatisfactory, with bad distortion resulting, so watch it!

### INPUT TERMINALS.

The input to the amplifier is between the grid (cap) of the first valve and earth.

If you are using a pick-up with an inbuilt volume control you will have two wires, and run one to the cap of the valve and the other to a terminal mounted directly in the metal of the base.

If you want to embody a volume control in the amplifier, then you will have to fit it according to our circuit diagram, but the value of the resistance of the control will vary according to the type of pick-up used. For crystal pick-ups the half-meg type is necessary, but for ordinary magnetic type pick-ups a value of 50,000 ohms will be preferable.

In the original amplifier we have two terminals, one earthed and the other mounted so that it is insulated from the base, and with a wire running straight up to a suitable clip to fit the cap of the valve. It will also be noticed that we have shielded the first valve inside a suitable valve can. This is by no means essential, but is good practice and gives a neater appearance.

### THE VOLTAGE DIVIDER.

The voltage divider is fitted, although it really serves little purpose. If at any time the amplifier is to be used with a tuner or with a pre-amplifier, the divider may be needed, anyway, but in the present amplifier its only purpose is to keep a small load on the high tension to stabilise it and prevent peak voltages, and to ensure adequate field coil energising for the loud-speaker. The clips on the divider are not used, and there are no connections required to them except at the ends. One end going to the main h.t. line and the other end being "earthed."

### GRID-LEAKS.

The half-megohm resistor in the grid circuit of the 2A3 is used to return the grid to a negative voltage to ensure correct bias, and the value specified is the highest value which is recommended for use with a valve, such as the 2A3. The use of a higher resistance in this position gives greater gain and better tonal quality, allowing a fuller reproduction of the very low bass. On this account, some enthusiasts prefer to use a 1 megohm or even a 2 megohm resistor in this position, and so far we have not heard of any valves giving unsatisfactory service on this account. In some cases, however, especially if the high tension voltage is a little higher than normal, there is a chance that trouble may result, taking the

### LIST OF PARTS FOR "SWING" AMPLIFIER.

- 1 Metal Chassis Base (already drilled), 12 x 7½ x 2½ 8/-
  - 1 RCS Power Transformer, 100 MA, with 6.3 volt filament windings 18/-
  - 1 100MA RCS Filter Choke 9/-
  - 3 8MFD Electrolytic Condensers 12/- the lot
  - 1 25MFD Ditto 3/-
  - 2 .1MFD Tubular Condensers 1/6 lot
  - 1 1-watt Grid Leak, 250,000 ohms 6d.
  - 1 Ditto 5,000 ohms 6d.
  - 1 1 megohm Ditto 6d.
  - 1 Wire wound Resistor, 2,500 ohms at 25 MA 1/6
  - 1 Ditto 500 ohms at 100MA 6d.
  - 1 15,000 ohms Voltage Divider 1/9
  - 3 4-pin Valve Sockets 1/3 lot
  - 1 6-pin Valve Socket 5d.
  - 1 Valve Can 1/3
- SUNDRIES—**  
Including 2 Terminals, Solder Lugs, Wiring Wire, Screws, etc. 2/6 lot
- 1 6C6 Valve 9/-
  - 1 6A3 Valve 16/9
  - 1 80 Valve 5/6

### (K)

- Complete Kit of Parts without Valves Catalogue No. EK669 £3/2/-
- Complete Kit of Parts with Valves Cat. No. EK670 £4/10/-

Speakers to obtain maximum tone from this Amplifier—it is essential that a high quality Speaker is used. The following are the prices of various types of speakers:—

- AMPLION 8in. 35/-
- AMPLION 10in. 55/-
- AMPLION 12in., Hi Fidelity, £7/10/-

form of the output valve over-heating, drawing more than normal plate current, with distortion in the reproduction, and the valve soon losing its emission and requiring replacement. All of which is supposition, as we have never actually heard of such trouble occurring in practice.

### ECONOMISING.

As we know from experience there are always those who want to cut down a bit on our instructions. Sometimes this is a great success, but sometimes a failure.

Let us consider some points first about the turntable. If you have a good reliable spring motor on hand it should be quite O.K. Generally speaking a spring motor has plenty of torque and its biggest drawback is having to wind it up by hand.

### VOLTAGES.

For those who have a suitable meter we give a few of the voltage checks which should be made to make sure that everything is in order.

First, the a.c. filament voltages should be checked and they should be within 10 per cent. of ratings, 6.3 volts for the 6C6 or 6A3.

High tension voltages, read in respect to earth should be 250 at the top of the voltage divider. Although not true readings the plate and screen voltages of the first valve can be read with a 500 volt scale on a 1000 ohm per volt meter. The screen should show between 40 and 50, and the plate between 50 and 60. Watching the polarity of the meter the bias on the output valve can be read across the 500 ohm resistor, and should be exactly 40 volts. Distortion due to overloading can be checked at this point by watching the meter needle. It should not show any variation of more than a volt or two on loud passages.

# The Popular Skysweeper

A Powerful 4-valve T.R.F. Electric Receiver.



THE COMPLETED CHASSIS.

Characterised by the usual neatness, simplicity, and ease of construction of the series, the Popular version of the Sky Sweeper Four makes its bow.

In designing the various Sky Sweepers over the past five years we have endeavoured to supply sets that give good tone and are sensitive enough to bring in all the main N.Z. and Australian Stations. The success of the various Sky Sweepers has well repaid us for the trouble we have gone to in experimenting with the different models.

While bearing in mind that satisfactory reception must be one of the primary considerations we have also to consider that a set of this nature must be low cost and simple to build.

In the popular Sky Sweeper now described fully, we have all the most desirable features. We have used glass valves in place of metal valves used last year, without losing quality or strength of reception, but in doing so have decreased your cost considerably.

The set is fully described and illustrated, and as there are no constructional snags, it is most suitable for a beginner.

One big advantage of a T.R.F. Circuit for home construction is that the lining up is comparatively simple, and can be done by anyone who can follow the instructions given.

On test the Popular Sky Sweeper brought in all the main N.Z. stations at good speaker

strength. Four Australian stations were also brought in at speaker strength and definitely logged. There were dozens of N.Z. and Australian "B" stations on the air, but we did not have time to log each one. However, the tests carried out were sufficient for us to say that the set will definitely bring in all main Australian and N.Z. stations under normal conditions. The tests were carried out with a short inside aerial.

#### BUYING THE PARTS.

We strongly advise constructors to start right by obtaining the full kit of parts as specified. Makeshifts, or inferior parts, are not recommended for this set. They may be all right, but if you take the risk you are spoiling the whole job, and for the small saving it is not worth while.

#### MAKING THE START.

Start off by marking all the components and get everything in position; before commencing wiring follow the circuit and wiring diagrams, noting the following. For the sake of clearance in the drawing, filament wires have been omitted.

Take a pair of twisted wires from the 6v. tappings on the transformer to the filament of the 6C6, 606, and 42, marked X in the diagram. The 230v. 3-core flex has also been omitted.

This is connected as follows:—

White wire to ground (i.e., to chassis).

Red wire to C on transformer.  
Black wire to 240v. tapping.

The rest of the wiring can now be proceeded with, according to the diagrams.

The only other special point to watch in the whole job is to see that the left side electrolytic condenser is insulated from the base, and that the dial lights do not short on the arms that support them. When you have finished the wiring, check every wire very carefully, then the valves and speaker can be plugged in. Now connect the set to the 230-volt supply, carefully watching the 80 valve to see that no blue flashes occur.

Should a blue flash be seen, switch off immediately, as this indicates a short circuit, and you should carefully check over again to see where this is occurring and remove it.

#### TRIMMING UP.

You now proceed to line up the gang condenser, which is best done with the set tuned to a station in the centre of the dial. Each trimmer on the gang should be rotated very slowly to bring the station up to maximum volume. When the trimmers have been set, do not move them again on any other part of the dial, as this would upset the lining process.

Your Sky Sweeper is now in working order, and you will be really surprised at the mellow tone, which can be varied to suit individual taste by the tone control on the left.

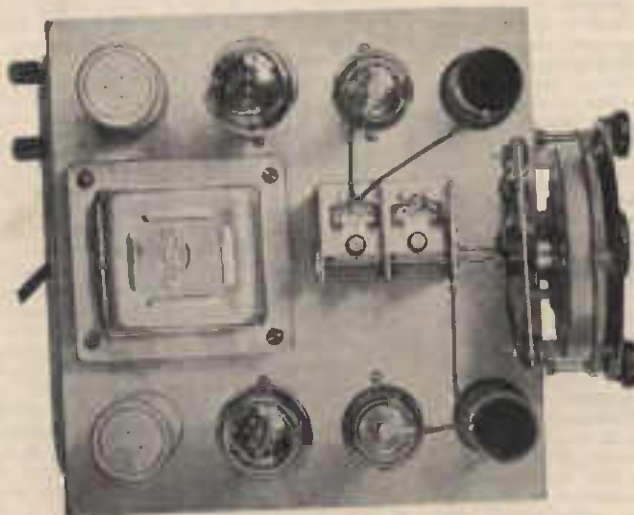

BIRD'S EYE VIEW.

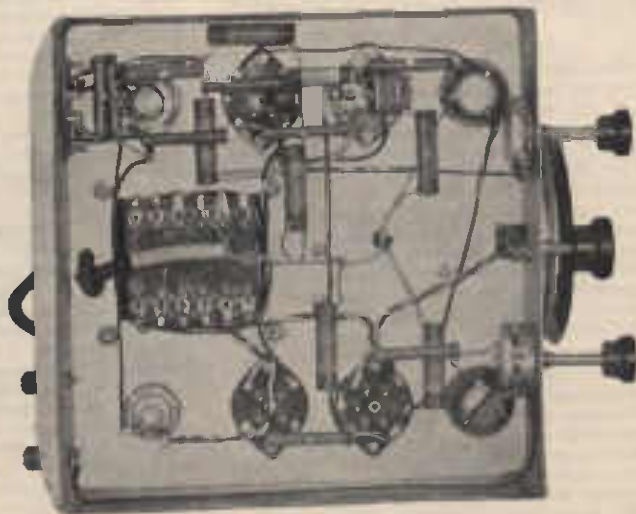

WORM'S EYE VIEW.



electricity is good, but, of course, the set is so sharp as a Superhet. The Popular Sky Sweeper is a receiver that you will be proud to own and to demonstrate to your friends, and, what is more, a receiver built by your own hands will give you more joy and entertainment than it is possible to get from any factory-made machine.

**POPULAR SKY SWEEPER CIRCUIT.**

As a further refinement a 100,000 ohm 1-watt Resistor may be placed between the screen of the 6C6 and 6D6 valves and earth.

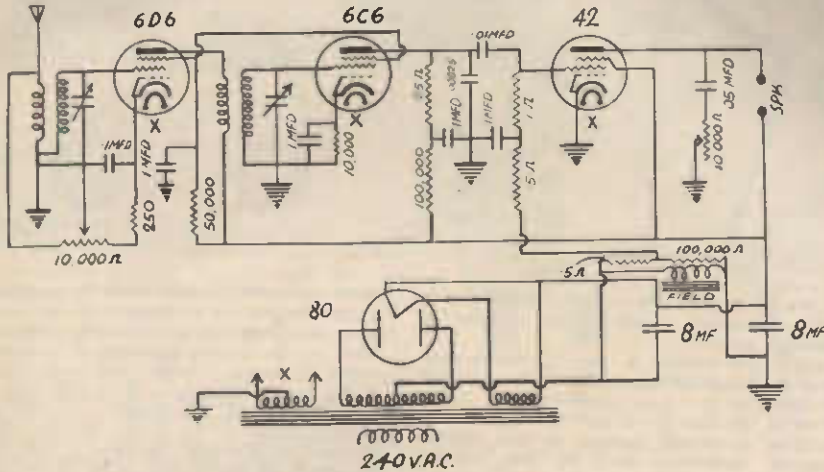

POPULAR SKY SWEEPER CIRCUIT.

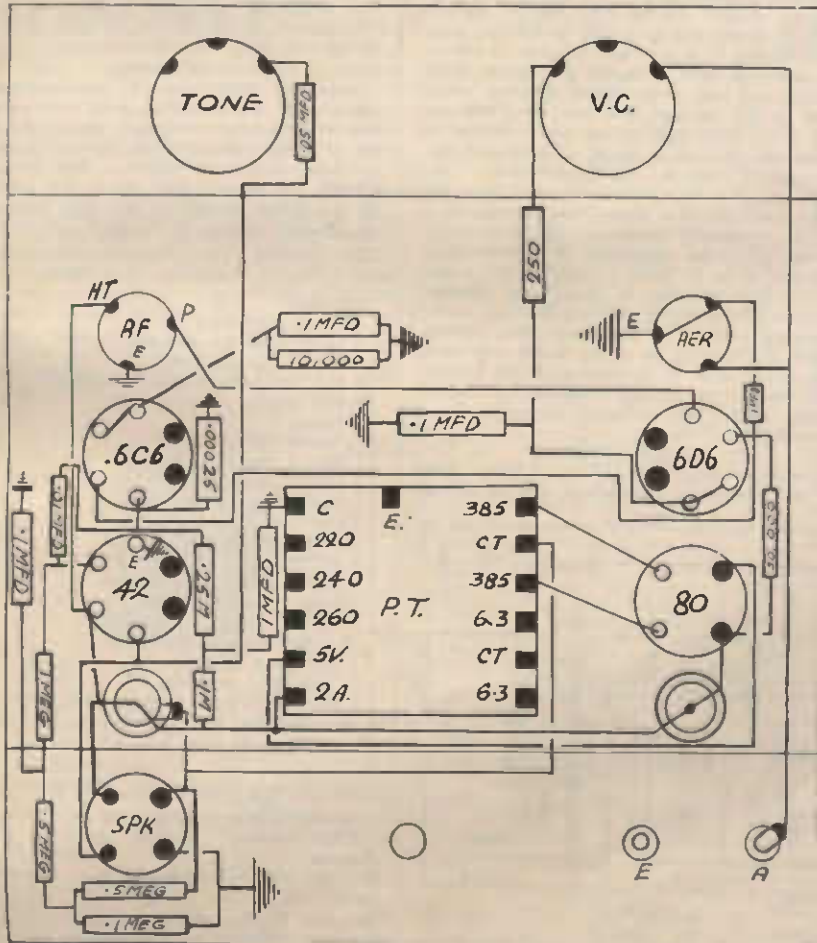

POPULAR SKY SWEEPER UNDER CHASSIS WIRING.

**POPULAR SKY SWEEPER. (K)**

**Parts List.**

- |                                   |                              |
|-----------------------------------|------------------------------|
| 1 Oxford Aerial Coil, Unshielded. | 5 .1 mfd. Tubular ditto.     |
| 1 Oxford R.F. Ditto.              | 1 .01 ditto.                 |
| 5 Valve Sockets.                  | 1 .05 ditto.                 |
| 1 Chassis.                        | 1 .00025 ditto.              |
| 1 Dial.                           | 9 Assorted 1-watt Resistors. |
| 1 2-Gang Condenser.               | 2 10 000 ohm Potentiometers. |
| 1 Power Transformer.              | 1 Set Raytheon Valves.       |
| 2 8-mfd. Electrolytic Condensers. | 1 Amplion 8in. Speaker.      |

Sundries, including Knobs, Power Flex, Bush, Terminals, Bolts and Nuts, Wire, Lugs, etc., etc.

**COMPLETE KIT OF PARTS**

Without Valves or Speaker.

Cat. No. EK599 ..... **£4**

Ditto, With Valves and Speaker.  
CAT. No. EK600 **£6/19/6**

Ditto, as embled and tested, with Valves and Speaker.  
Cat. No. EK605 .. **£8/5/**

**STANDARD COIL.**

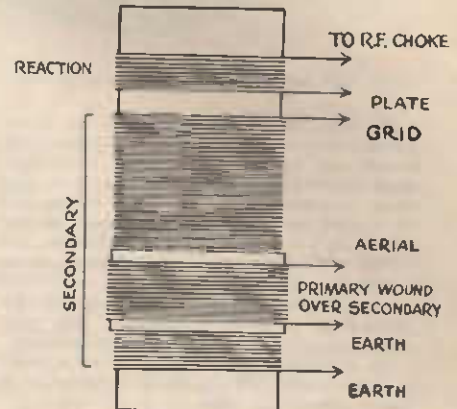

Illustration shows usual windings of a R.F. Coil. Reaction on top. Secondary below. Primary wound over secondary.

**HEAL DISEASE WITH LIGHT RAYS!**

**"MONARCH."**

Here's the famous Radiating SUNLAMP, a simple, safe and economical way of employing LIGHT THERAPY (as the best authenticated healing agent). It is a hand lamp that promotes strongly concentrated rays of light and heat upon the affected part. Relieves pain in the case of Neuralgia, Gout, Rheumatism, all nerve complaints, skin diseases, discharging eczema and open wounds.



Complete with fittings and instructions.

Cat. No. EE75 .. **39/6 (G)**

(See page 10 for further particulars.)

**SHADE HOLDERS. (K)**

For table lamps. Strong oxidised frames, hinged in centre so that shade can be tilted.

Cat. No. EG36: **1/3** Each

Ditto, chrome finish.

Cat. No. EG37: **1/6** each

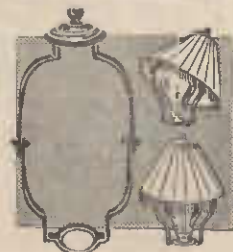

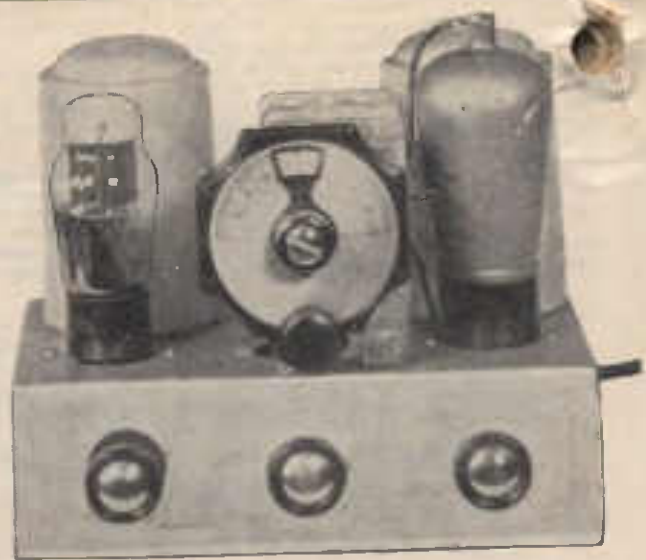

(Designed and Described by D. Sutherland.)

The main advantages of this set are its extreme sensitivity, economical running costs, low initial cost and surprising power. The complete set will cost about 75/., and if a good aerial and earth system is used, the set will be capable of giving quite good loud speaker results of an evening. With headphones, the volume from most stations will have to be turned down, and in most localities no trouble should be experienced in receiving the YA stations in daylight. Australian and even American stations can also be well received.

The A drain is .44 amps, while the B drain is about 4 mills. Thus a set of batteries would last a considerable time.

**THE CIRCUIT.**

As will be seen from the circuit diagram, a Kf1 Philips Valve is used as R.F. amplifier, and a type 19 as leaky grid detector and 1st audio amplifier. A Kf2 valve can be used in the place of the Kf1 specified, with slightly better results, but the B drain of this valve is greater than that of the Kf1. The Kf1 will probably suit most constructors, and if light duty batteries are used, it is just as well to keep the B drain under 6 mills.

A 2-gang .00035 condenser is used to tune the coils and a .0001 variable condenser inserted in the aerial lead enables smooth reaction to be obtained, and helps to sharpen up tuning, which is always inclined to be rather broad in T.R.F.'s. The plate supply of the Kf1 is through an R.F. choke, the primary of the R.F. coil, and thence to the cap on top

of the valve. This valve is spray shielded, and this is connected to one of the pins, so no shield is needed.

Leaky grid detector is used, as this method gives greater sensitivity. Reaction is controlled by means of a .1 meg. potentiometer. The B + 90 to 135 lead to the potentiometer should be tried at various tapings to give smooth reaction. Something about 100 volts will be found to be generally suitable.

If the rheostat breaks contact in the "off" position, a single pole on-off switch, as shown in the circuit, will be O.K., but if there is still A current flowing to the valves even when the rheostat is in the "off" position, it will be necessary to have a double pole single throw switch, one side of the switch breaking the A lead to the rheostat, and the other breaking the B + max. lead to the set. Failure to break this lead would result in continuous battery drain through the potentiometer. The .0001 and .0005 fixed condensers must be of the mica type, and if a deeper tone is required, a .01 or .02 tubular condenser can be connected across the phone terminals. If a 2-volt accumulator is to be used in place of the 2 only 1½-volt dry batteries to supply the filament voltages to the valves, then the rheostat can be dispensed with. In this case, the switch, which will have to be of the double pole type, can be mounted in the centre of the chassis, and the midget 23-plate condenser on the extreme right, thus keeping everything symmetrical.

**CONSTRUCTION.**

The construction is really very simple. First of all, mount all components, the lay-out of

which will clearly be seen from the photograph of the receiver. It is advisable to run a bare earth wire from the earth terminal round the inside of the chassis, anchoring it at various points by means of solder lugs under several of the nuts and bolts used in fastening the components on to the chassis. All earth connections shown in the circuit diagram should be made to this wire, including a lead from the wipers on the moving plates of the gang condenser. Before connecting up the batteries, check over all wiring—a fault might easily ruin your valves. Do not forget to note the various colours used in the battery cable for different voltages as you wire them up.

**OPERATION.**

When the construction has been completed, connect up the batteries, aerial and earth, plug in valves, connect plate cap of Kf1 to top of valve, and switch on the set. Tune in a station about the centre of the dial, and keeping the volume low, rotate the trimmer on the aerial section of the gang condenser for greatest volume, at the same time rooking

**PARTS LIST FOR "ALL STAR."**

- 1 Chassis.
- 1 2-gang Condenser, .00035.
- 1 23-plate Midget Condenser, .0001.
- 1 Aerial Coil and Shield.
- 1 R.F. Coil with reaction and shield.
- 1 R.F. Choke.
- 3 Knobs.
- 1 Vernier Dial.
- 1 20-ohm Rheostat.
- 1 100,000 ohm Carbon Potentiometer.
- 2 6-pin Valve Sockets.
- 1 yard 5-wire Battery Cable
- 1 On-Off Switch.
- 1 100,000 ohm Carbon Resistor.
- 1 250,000 ohm Carbon Resistor.
- 1 3-meg. Carbon Resistor.
- 1 .01 mf. Tubular Condenser.
- 3 .5 mfd. Tubular Condenser.
- 1 .0001 Mica Condenser.
- 1 .0005 Mica Condenser.
- 1 Philips Kf1 and 1 Raytheon 19 Valves.
- Miscellaneous—Bushes, terminals, bolts and nuts, wiring wire, S.G., clip, lugs.

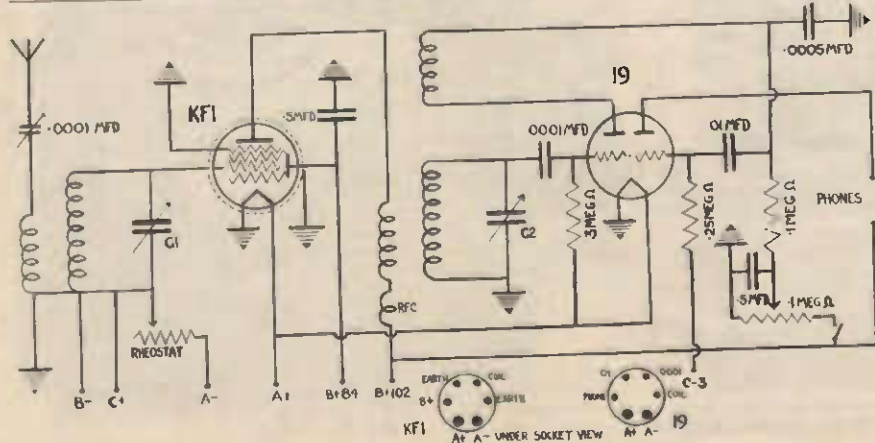

**SPECIAL KIT PRICES (K) ALL STAR TWO.**

- Cat. No. EK635—Complete kit of parts as listed above, without valves **£2/14/-**
- Cat. No. EK636—Ditto, with valves **£3/13/-**
- Cat. No. EK637—Complete Kit as above, with Valves, Phones and Batteries **£5/15/-**



... dial backwards and forwards for correct dial setting. Do the same with the other trimmer, and then set the aerial series condenser for best results. Now check over the trimmer as before to give the best results. The trimmers should not be touched again, but the aerial series condenser can be adjusted as required to suit local and station conditions.

As the results obtained by a set of this type depend largely on the aerial and earth system, particular attention should be paid to this part. An aerial as high as possible, and about 120 ft. long, including lead-in, will give best results. Do not increase the aerial length beyond 150 feet, as tuning will be too broad.

## IMPROVE YOUR RECEPTION

We receive dozens of enquiries every day on the many different phases of radio sets and circuits, but there are two questions that are asked more than all the others put together. They are: (1) How can I make my set more selective? and (2) How can I increase my volume?

An improvement on all types of sets can be made by placing a variable condenser in the aerial circuit. Many old-time sets included a condenser of this nature as part of the standard equipment, but the tendency nowadays is to reduce the number of knobs as much as possible, but if we do not mind twisting an extra knob better reception is yours. The condenser is simply placed in the aerial lead—that is, the aerial is joined to one terminal on the condenser. The other condenser terminal is connected to the aerial terminal on the set. The condenser tunes the aerial, and it will be found that at a certain setting the sensitivity of the set is increased, while at another setting the selectivity is improved (with a slight loss of volume).

The condenser can either be connected in the aerial lead-in outside of the set or on the panel of the set itself. The Telsen people make a special condenser for this purpose, and a shorting switch is incorporated so that at its maximum position a straight-through connection is given. Constructors of sets would be well advised to connect a condenser of this type in any set they build. It is well worth the small outlay, and after all it's a very cheap experiment.



Telsen Aerial Series Condensers (K)—  
Cat. No. EC883 ..... 3/6

## UTILITY DESK LAMP. (D)

A standard flexible arm Reading Lamp, 12in. gooseneck, heavy cast-iron base. Large size reflector, arm bends as required, putting the light just where it is wanted. Supplied with 6ft. cord and lamp.  
Cat. No. EE45 .. 12/6

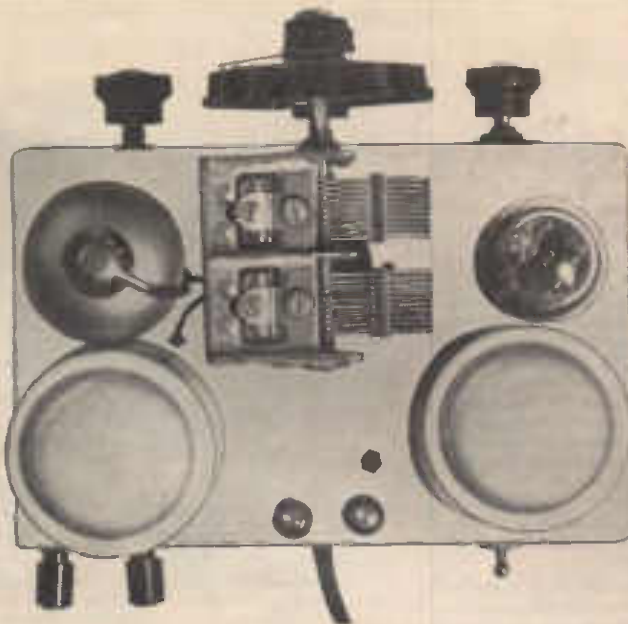
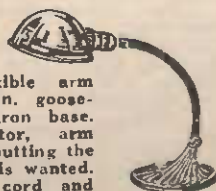

BIRDSEYE VIEW—ALL STAR TWO.

## ★ STAR ADVANTAGES

- ★ Simplicity of Construction.
- ★ Easy to Use.
- ★ Low Battery Consumption.
- ★ Distance Getting.
- ★ Low Initial Cost.
- ★ Compact.
- ★ All Standard Components.

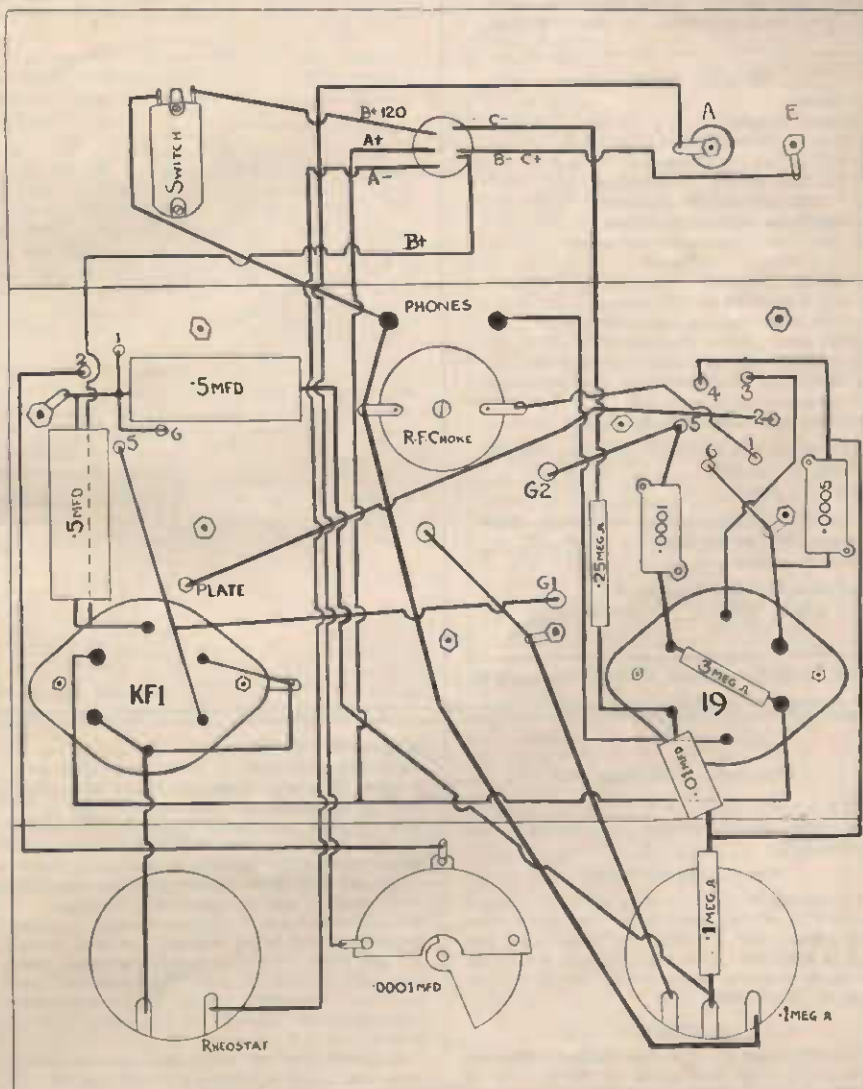

WIRING ALL STAR TWO.

# “Home Volume” Amplifier

This Amplifier is described for the benefit of the home constructor, who has need for an amplifier of this nature. While primarily intended for use in the home, it has plenty of volume for small dance halls, etc. The construction is simple and the cost low.

This Amplifier is designed for use in small dance halls, public address, etc. The circuit is designed to give a power output of approximately 8 watts, and its neatness and compact size will appeal to many.

A pentode with triode connections is resistance coupled to a 6C5 also as a triode amplifier, which in turn is transformer coupled to a pair of 6F6 pentodes in push-pull.

If a microphone is to be used, or if there is not sufficient gain from the pick-up, it may be boosted by connecting the pick-up or microphone to the primary side of an audio transformer and connecting the secondary winding to the pick-up terminals on the amplifier.



THE CHASSIS.

**LIST OF PARTS. (K)**

- 1 Chassis
- 4 Octal Sockets
- 1 1/2-meg. Potentiometer
- 1 P.P. Input Transformer
- 1 150 m.a. Power Transformer
- 2 8 mfd. Electrolyte Condenser
- 2 3000 ohm Carbon Resistors
- 1 300 ohm Wire-wound Condenser
- 1 .01 Tubular Condenser
- 2 10 mfd. Electrolytic Condensers
- 1 50T ohm Carbon Resistor
- 1 500T ohm Carbon Resistor
- 1 25T ohm Carbon Resistor
- 1 6J7, 1 x 6C5, 1 x 5Z4, 2 x 6F6
- 2 Terminals, power flex grid clip, push-back, nuts and bolts
- Speaker—1000 ohm P.P. Pentodes

Complete Kit of Parts as above, without valves or speaker. **£4/5/-**  
Cat. No. EK23

Complete Kit of Parts as above, with valves, without speaker. **£6/5/-**  
Cat. No. EK24

Suitable Ampillon Speakers—  
8-inch **35/-** 10-inch **55/-**

Photo of Under Chassis Wiring. See page 88.

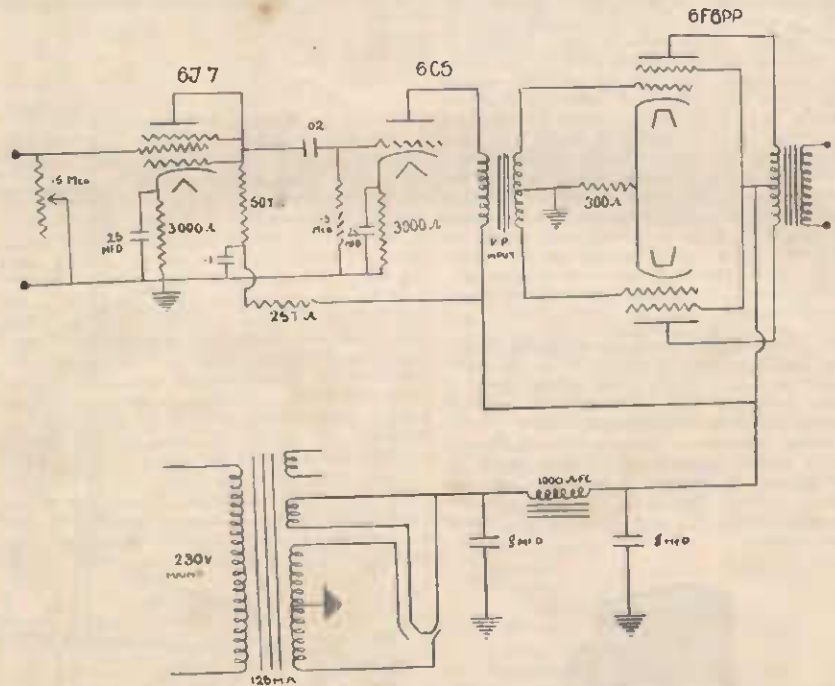

CIRCUIT HOME VOLUME AMPLIFIER.

## THE BATTERY SKY SWEEPER

(Concluded from page 109.)

with a coloured pencil as it is put into position. This plan should disclose a misplaced wire immediately.

### FINAL ADJUSTMENTS.

To line up the set tune to a station about the middle of the dial, the weaker the better, and adjust each trimmer until maximum volume is obtained. Once the trimmers have been adjusted correctly there should be no further need to touch them.

### BATTERIES.

The set being of very low battery consumption could very well work off light duty B batteries, but for ultimate economy and for efficiency we have chosen 3 45-volt standard size Barac batteries as our high tension supply. This size of battery is not only admirably

suitable for the Skysweeper, but also has an additional advantage of being tapped at every 3 volts. The advantage of this is that it allows us to adjust both the detector and screen grid voltages until smooth reaction is obtained and this is one of the secrets of success with regenerative detectors, and why our 4-valve set will give better distance reception than most 5 and 6 valve sets. Of course, if you already have B batteries with standard tappings there is no reason why you should not use them. Users of tapped batteries, however, will be able to experiment with the voltages until maximum results are obtained. The other batteries required are a 2 volt A battery and 9 volt C battery.

In conclusion, we state without hesitation, that the Battery Skysweeper will uphold the goodwill of the Skysweeper range of kits and provided you use good quality parts as specified the set will give you satisfactory results for many years.

## LISSEN KITS

Special Replacement Parts for Lissen ALL-WAVE FOUR KITS. (K)

- Lissen 2 x .1 Mansbridge Condenser Blocks. Each **4/6**
- Cat. No. EC647
- Lissen Astatic H.F. Chokes .. **5/6**
- Cat. No. EC49
- Lissen Hypernik Transformer for Q.P.P. Circuits. Each **18/9**
- Cat. No. ET607
- Complete Spare Volume Controls (Potentiometer and Condenser) **16/6**
- Cat. No. EP85

### BATTERIES.

We have specially imported Batteries as recommended by the Manufacturers for the Lissen All-Wave Four. Each set consists of 3 45-volt Barac "B" Batteries and 1 Heavy Duty "C" Battery (15 volts).

Cat. No. EB193 ..... Set **52/6**



# THE AUTO RECEIVER

Here are the details of a receiver which can be used in a car, operating entirely from a vibrator unit taking current from the ignition system of the car. At the end of the trip the set can be lifted from the car and used in the home when plugged into the special all-electric power pack which is also described.

(From "Wireless Weekly.")

Many of the followers of our technical articles have written to ask for full details of the construction of a receiver suitable for motor-car reception.

## POWER SUPPLY.

The set is especially designed to operate from the power supply unit, which is fully detailed on page 124.

It is also a simple matter to make up an a.c. power pack for the set, so that it can be used with the vibrator unit when installed in the car and then taken out of the car at the end of the trip and used in the home as an ordinary all-electric receiver.

## CIRCUIT.

The circuit has been specially designed to give the type of performance which is required in a car set, extreme sensitivity with low noise level, together with considerably more power output than is normally obtained from a battery-operated receiver.

The sensitivity has been obtained by using an r.f. stage ahead of the first detector, and by using an intermediate frequency of 175 kc. The power output has been obtained by using a two-stage audio end, finishing off with a 79 class B twin valve in the final stage. The high audio gain is also desirable, and offers no difficulties in a case like this.

## NOT FOR THE NOVICE.

We have never been very keen about recommending amateur set builders to try conclusions with a car receiver. The power unit was a very difficult problem and the suppression of noise from the ignition was another. Experience with this set has proved to us that the job is really not as difficult as it might be, and we feel sure that if the average advanced experimenter follows out the instructions carefully, he will be sure of success, but we still have doubts about the novice. We strongly advise him to start with something simpler.

By this, however, we do not mean a simpler car set. If the car has a set at all, then this is the circuit. The use of small two-valve sets in cars is seldom satisfactory, as there is insufficient pick-up from the aerial.

The use of battery type valves is also not quite satisfactory as the filaments will not stand up to the vibration of the car and the fluctuation of the voltages supplied by the car battery.

Directly heated valves also tend to feed noise into the set from the battery circuit, which is also connected to the ignition circuit. It will be seen that the indirectly-heated type of 6.3 volt valves are essential for satisfaction.

## PACKING IT UP.

The construction of the receiver is slightly more difficult than usual, because the components have to be packed up into a small space, as in most cases the room in the car is valuable, and the set has to be small enough to tuck away under the dash, without interfering with the knee space.

Fortunately, there are special coils available in small cans, those in the square cans being best to arrange to make the most of a small space.

All the other components are also available in small-sized units, but even so, they need a bit more care in assembly than is usual with a bigger set.

## THE LOUD-SPEAKER.

For the car set a small permanent speaker is used, the one in the original receiver being a four-inch model. The speaker needs to be capable of handling a fairly solid power output of the 79 in class B amplification, which in the case of this receiver amounts to about 5 watts. A few years ago it would have been very difficult to find a small permanent speaker which would serve the purpose satisfactorily.

An energised speaker could be used, but the drain on the car battery would be about an ampere, and nothing would be gained. We strongly recommend the permanent model mentioned.

## STOPPING NOISE.

Getting rid of interference noise is not as difficult as might be imagined, but only when the most thorough screening is carried out.

The set must be encased in a metal box, even the loud-speaker opening being covered with a grille made up of copper gauze, soldered to the can. All leads from the set must be thoroughly shielded, those running to the power supply unit being especially important. In this case one of the wires will be at earth potential, but to avoid any chance of picking up noise it becomes necessary to shield even this wire, the wire inside being earthed at both ends, and the shielding braid also at both ends.

The vibrator unit must also mount inside a metal can, efficiently earthed to the frame of the car. Provided that the leads from vibrator

## LIST OF PARTS.

### CAR RADIO SET

- 1 Chassis, 7in. x 10 $\frac{1}{2}$ in. x 2in.
- 1 3-gang Condenser.
- 1 4in. Permag. Speaker.
- 4 6-pin Sockets.
- 1 7-pin Socket.
- 1 5-pin Socket.
- 6 Valve Cans.
- 3 Midget Coils (Aer. R.F. and Osc., 460 kc.).
- 1 460 K.C. Padder.
- 2 I.F. Transformers.
- 1 Audio Transformer, Class B.
- 5 S.G. Clips.
- 1 Combined Volume Control and Switch.
- 8 .1 Tubular Condensers.
- 2 25 mfd. Condensers.
- 1 .0001 Mica Condenser.
- 1 .00025 Mica Condenser.
- 1 .0005 Mica Condenser.
- 2 .01 Mica Condensers.
- 2 2500 ohm. W.W. Resistors.
- 1 150 ohm. W.W. Resistor.
- 1 250-ohm W.W. Resistor.
- 3 .5 meg. Carbon Resistors.
- 1 .25 meg. Carbon Resistors.
- 1 50,000 ohm. Resistor.
- 1 25,000-ohm Resistor.
- 1 20,000 ohm. Resistor.
- Sundry Hardware, Wire Terminals, etc.

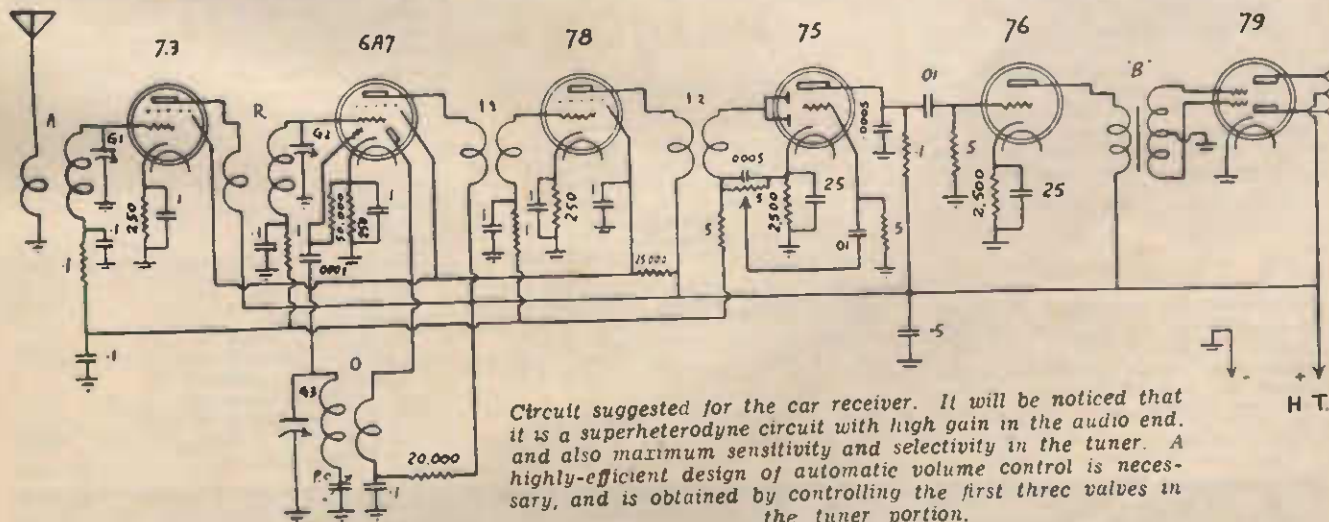

to set are well-shielded, it is often a good scheme to keep the vibrator at a distance of two or three feet from the set.

**FITTING SUPPRESSORS.**

There are many sources of ignition noise, and these vary with every individual installation, so that it is not really safe to give any definite advice. For an example we may take a modern American car, the latest Pontiac Six. In this case it was found desirable to fit a heavy-current filter choke in the A plus lead, a special choke for this purpose being readily available. It needs to be wound with wire capable of carrying 10 amperes. On the battery side of this choke a by-pass of .5 mfd. was fitted. On the generator a special interference condenser (metal encased) was fitted, with the can and one side earthed and the other side connected to the positive terminal of the generator's output.

A similar condenser was fitted at the distributor from the low tension input to earth, and this wire was encased in a shield. The main high tension lead from coil to the centre of the distributor was also shielded in copper braid, the shielding being earthed at both ends.

Special spark plug suppressors (available quite cheaply) were fitted to each sparking plug and also in the main h.t. lead to the distributor cap, although we doubt if these were absolutely necessary. The finished job, with a well-shielded lead-in from a topper aerial resulted in complete freedom from interference noise, even on distant stations.

**CONTROLS.**

The set can be operated by a small dial mounted directly to the outside of the box or by one of the extension units available. The best system to use will depend on the particular installation.

The control units to mount on the steering column are quite satisfactory and are readily available in a couple of different brands at reasonable prices.

**A.C. POWER UNIT.**

The power unit consists of a small power transformer, suitable filter system to take out hum, and is built on to a small base, with a plug similar to the plug on the vibrator unit.

This can be arranged by using a valve socket for the unit, with a 4-pin plug for the set, the filament pins being used for the 6.3 volts for the heaters and the plate pin for high tension, and the grip pin for earth.

While not essential, it is good practice to use a voltage divider across the high tension output of the a.c. unit, as shown in the diagram. This will limit the peak voltage if the unit is switched on without the set being connected, and will also serve to discharge the filter condensers under such circumstances, not that this is really important in the case of electrolytics, as they have quite a big leakage resistance even when in perfect condition. The resistance of the voltage divider is not important and 15,000 or 25,000 ohms are suitable resistances.

**R.C.S. CAR RADIO KIT SET. (K)**

As many of the components in the car radio are special, we are providing a complete set of parts, including Rola Loud Speaker, to make it easy to obtain and certain everything fits. All the components necessary are included excepting valves, cabinet, and vibrator unit, which is separate.

Cat. No. EK9 ..... £10/17/6

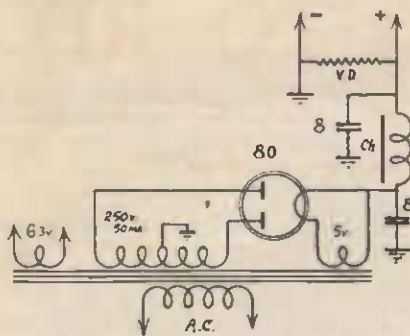

CIRCUIT OF A.C. POWER PACK.

**PARTS LIST—A.C. PACK. (K)**

- 1 Chassis
- 1 Midget Power Transformer, 6.3v. 2 amps.
- 1 Choke, 30H, 100M/A.
- 2 8-Mfd. Electro-Condensers.
- 4 Push Terminals.
- 9 feet Power Flex.
- 1 Rubber Grommet.
- 1 4-pin Socket.

Complete Kit of Parts, as above. Cat. No. EK11 ..... Each 45/-

**CAR RADIO FOUNDATION KIT. (K)**

Some constructors will prefer to purchase the main components, and for them we have the Foundation Kit which comprises: The Chassis, Coil Kit, complete with padder, special valve sockets and valve shields, and tuning Condenser.

Cat. No. EK10 ..... £4/13/6

**MIDGET OR CAR RADIO COIL KIT. (K)**

Consists of Aerial, R.F. and Oscil. Coils, and two small iron-cored I.F.'s, complete with special padder and circuit data.

Cat. No. EC409 ..... 40/-

**AUTO RADIO**

**ORDER YOUR REQUIREMENTS FROM THIS LIST:—**

Complete Car Radio Kit, with valves. Cat. No. EK32 ..... (K) £12/2/6

**EXTRAS.**  
Metal Case for above Cat. No. EK33 ..... (B) £1/2/6

Steering Column Control. Cat. No. EK36 ..... (D) £2/16/6

Kit of Parts for A.C. Power Pack Cat. No. EK11 ..... (K) £2/10/-

Kit of Parts for Vibrator Power Pack. Cat. No. EK12 ..... (K) £5/10/-

**A Vibrator Power Supply**

Radio broadcasting is now being fully recognised as a service as well as an entertainment, and many people have made radio such a part of their lives that they miss it very much unless constantly in touch with a receiver.

For example, it is the thing these days to have your car equipped with a radio receiver, and the car set is invaluable in many ways. Many a hen-pecked husband listens in to the description of the racing broadcasts when he takes the family for a picnic on Saturday afternoon.

But the value of a radio receiver in the car is a long story, and for the moment we are more interested in the technical details, and especially interested in the technical details of the vibrator type of power-supply unit which has made the all-electric car receiver a possibility.

By all-electric we mean a radio receiver which requires no batteries, and draws its complete power supply from the starting and ignition system of the car.

**THE HIGH-TENSION UNIT.**

This article and circuit is published in order to show the type of power unit required to supply high tension for a car set from the car's battery. The problem is rather different from the one presented when we want a power supply unit for a dual-wave type of vibrator set with directly-heated valves or a combination of directly and indirectly-heated types.

The main difference is in the matter of filtering the supplied power, and also in the filtering of the low tension circuits and the filament circuits of the set.

**THE VIBRATOR.**

The heart of the high-tension unit is the vibrator, a delicate arrangement of springs and contacts, which is supplied inside a sealed aluminium case, with pins at the bottom so that it can be plugged into a special type of socket like a valve socket, but with five contacts arranged in a form with three pins on one side and two on the other.

**THE FUNDAMENTALS.**

The basic operation of the unit is something like this—the six-volt direct current from the accumulator is broken up by the action of the vibrator into intermittent or pulsating d.c., and this is then supplied to the primary of the power transformer and operates in very much the same way as alternating current. The power transformer steps up this voltage to alternating current at a couple of hundred volts,

**LIST OF PARTS REQUIRED.**

- Base, size 6 x 7 x 2.
- Case, size 6½ x 7½ x 6.
- 1 Special power transformer.
- 1 Special filter choke.
- 1 Special r.f. choke.
- 1 Vibrator, with socket.
- 1 Electrolytic condenser unit, 12 and 4 mfd.
- 2 .5 mfd tubular condensers.
- 2 .004 mfd. mica condensers.
- 1 200 ohm centre-tapped resistor.
- Sundry hardware, screws, lugs, wires, copper braid, shielding, etc.



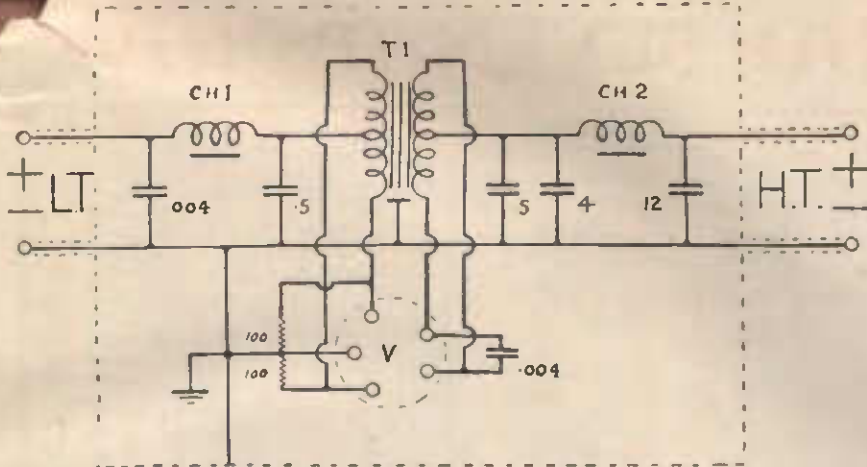

CIRCUIT VIBRATOR UNIT.

and this alternating current from the secondary of the power transformer is fed back into the vibrator unit for rectification, the rectified current then being filtered by a choke and condenser system to become the direct-current, high-tension supply for the set.

**SPECIAL COMPONENTS.**

The vibrator unit calls for several special components, which are not normally stocked by radio dealers. The two chokes are not ordinary filter chokes and the power transformer is also a special job. Fortunately, we have been able to make arrangements with the R.C.S. factory to supply these units, and they will, therefore, be ready for delivery by the time this article appears in print.

**SHIELDING.**

The important thing about the vibrator unit is the shielding, and the plan we suggest is to build the outfit on to a conventional base, about six inches by seven inches, and a couple of inches deep, and then fit it into a metal box about six inches deep and then place a plate across the bottom, so that the whole unit is totally enclosed.

Shielding is also necessary for the wires leading from and to the unit and the shielding must be effectively earthed to the frame of the car, as is the box containing the unit and also the negative lead. It seems to be ridiculous to have the negative wire earthed at both ends, then surrounded by braided copper shielding, which is also earthed, but that appears to be the way to ensure an entire absence of interference noise.

**ASSEMBLY.**

The socket connections are easy to follow, as it does not matter which is which of the outside terminals in the case of each set, the centre terminal on the three-terminal side being earthed. Right at the socket the 200 ohm centre-tapped resistor is fitted, with the centre-tapping earthed and the ends connected to the outside terminals, which in turn are connected to the outside ends of the power transformer primary.

The power transformer windings are also colour coded to show correct connections.

Matamata, 30/8/37.

"I do not now how to thank you for the Wave Trap I bought of you. It is a miracle. I tested it through that heavy gale, and I got good reception from most of the stations, and here is very bleak and heavy winds."—J.M.

**VIBRATOR UNIT PRICES.**

**R.C.S. VIBRATOR KIT SET. (K)**

Consists of a complete set of parts including vibrator to build a H.T. unit suitable for the Car Radio.

Cat. No. EK12 ..... £5/10/-

**R.C.S. VIBRATOR HIGH TENSION CHOKE. (K)**

This Choke is similar in appearance to our Audio Transformer. The H.T. Choke for a Vibrator Unit requires special treatment in designing and engineering. Its core and winding are properly balanced to suit the exacting conditions for effectively filtering a vibrator.

Cat. No. EC50 ..... Each 13/6

**R.C.S. VIBRATOR POWER TRANSFORMER. (K)**

The R.C.S. Power Transformer for Vibrator units is also contained in our new bakelite case. It is designed to supply correct voltages and current for the receiver, and the finest grade materials procurable are used in their construction. They are given individual tests during manufacture, as well as a rigid test and inspection before shipment.

Cat. No. ET614 ..... Each 16/6

**THE ADD-A-VALVE—See page 113.**

Wananiwal, 26/5/37.

Some time ago I built one of your Add-a-Valve Kits, and find that it works splendidly. It makes a set much more sensitive and selective, and I can pick up stations that could not be picked up without it. RAHOB 2540.

\* \* \*

Ngaruawahia.

Just a line to let you know that the Add-a-Valve is going O.K. on the broadcast band. Before I could just hear Dunedin in the middle of the day. Now I can get it at overloading volume. (Signed) B.A.

\* \* \*

Westport.

**REFERENCE ADD-A-VALVE.**

The articles I have purchased from your firm have been very successful, especially the Add-a-Valve. R.W.

**BURNDIPT BATTERY SETS.**

See page 41.

**GOING GREAT GUNS.**

"I received the 'BURNDIPT' All-wave Battery Set in good order, and I am very pleased with the set." F.R. (Wanganui).

\* \* \*

"It is now a week since I received the 'BURNDIPT' Receiver, and it is working up to expectations, and I am quite satisfied with same." G.D. (Taupo).

\* \* \*

"Referring to the 'BURNDIPT' All-wave Battery Receiver recently purchased from you, I have pleasure in advising you that the set is operating extremely well, in spite of only three valves." E.D.C. (Kalkohe).

\* \* \*

**"BURNDIPT THREE-VALVER"**

Putaruru, 27/10/37.

"The set is giving far better results than I thought possible for a three-valve. Everyone here seems interested, and I think you will get some orders from this district. I have already had Daventry and Berlin on short wave at quite good volume. As soon as my accumulator has been charged expect to do even better." H.S.

\* \* \*

Taupo, 18/11/37.

"It is just two months since I received the Burndipt All-wave Receiver. This machine has been in use on an average of six hours a day and has given every satisfaction, and from my point of view is very economical to run.

It brings in the foreign stations at good speaker strength.

Will you please forward a 'B' battery for the Burndipt set?" G.D.

\* \* \*

Kalkohe, 12/10/37.

"Burndipt' Receiver is remarkably efficient." E.D.C.

\* \* \*

**Ro VIOLET RAY MACHINE.**

Thames, 9/10/37.

"I am pleased to say that both Mrs. B and I have found benefit in way of relief from use of the machine. Slightly, of course, but nevertheless marked improvement. In spite of the fact that we are restricted with the use of it between the hours of 9 and 10 o'clock in the morning." J.A.B.

\* \* \*

Wyndham, 7/6/37.

I am well pleased with the Paec Oscillator. J.P.

\* \* \*

Via Nelson, 12/10/37.

"I wish to acknowledge receipt of the 'Paec' Multimeter, and to express my appreciation of its good value. This instrument is absolutely indispensable to every serviceman and bona-fide experimenter.

The Lissen Transportable also proves to be first-class value. So pleased am I with the machine that I am ordering another, as per enclosed order form." J.P.B.

# PENTAGRID SEVEN (Battery)

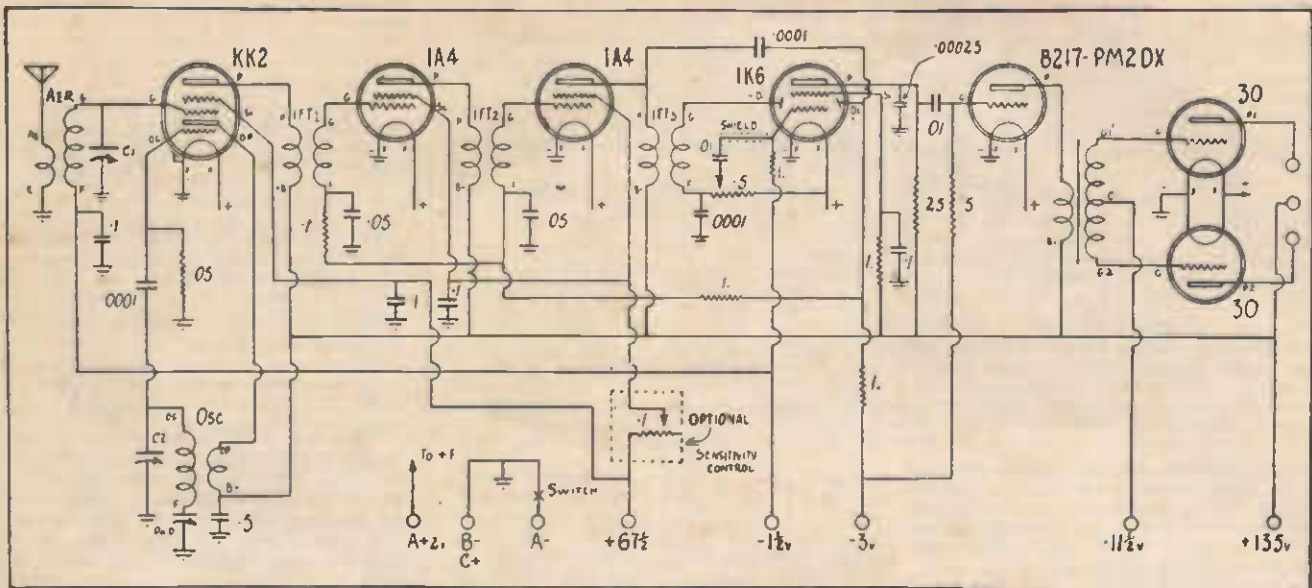

Here is the circuit of a very powerful 7-Valve Dual-Wave Battery Receiver. While every effort has been made to obtain best possible tone and sensitivity, battery consumption has not been lost sight of, and for such a powerful set the battery drain is very low indeed. The drain from the "A" battery is only .59 amp., which means that you will get about 1100 hours' life from a single Air-cell. On an accumulator rated at 60 a.h., it will give you a theoretical run on one charge of 100 hours, which will vary according to the condition of the battery.

### THE B BATTERY.

Consumption varies from 9 to 15 mls. This, too, is therefore very economical for a powerful set of this kind.

### LIST OF PARTS REQUIRED.

- Chassis, 15in. x 10in. x 3 1/2in.
- 1 Coil Kit (tuning box, 3 intermediates, low-gain, and padding condenser for broadcast).
- 1 2-gang Condenser to suit coils.
- 1 Tuning Dial, to suit coils.
- 3 Valve Cans.
- 1 .5 meg. Potentiometer.
- 1 Battery Switch.
- 4 1-meg. Resistors.
- 1 .5-meg. Resistor.
- 1 .25-meg. Resistor.
- 1 .1-meg. Resistor.
- 1 .05-meg. Resistor.
- 1 .5-mfd. Tubular Condenser.
- 2 .05-mfd. Tubular Condensers.
- 3 .1-mfd. Tubular Condensers.
- 1 .00025-mfd. Mica Condensers.
- 3 .0001-mfd. Mica Condensers.
- 2 .01-mfd. Mica Condensers.
- 1 B class Audio Transformer (battery type).
- Sockets: 1 "P" type, 5 4-pin, 1 6-pin, 1 5-pin.
- Valves: KK2, 2 1A4, 1K6, PM2X or B217, 2 30.
- Batteries: 3 45-volt H.D. B Batteries; 15-volt Battery.
- 1 Air-cell (or 2-volt Accumulator).
- Hook-up Wire, 5-pin Battery Plug and Cable, Valve Clips, 3 Knobs, 2 Terminals, Nuts and Bolts, etc.
- Speaker: Permagnetic for "B" class output.

### PRICES OF KITS. (K)

#### R.C.S. COIL KIT. (K)

R.C.S. Pentagrid 7-coil Kit includes the now famous R.C.S. dual-wave coil box, 3 iron-cored IFS and padder. Clearly coloured coded wires are simplicity itself to connect. The astounding efficiency of this kit will more than satisfy you.

Cat. No. EC962 .... Price **£3/19/6**

#### R.C.S. FOUNDATION KIT. (K)

Comprises chassis, coil kit and IFS as above, latest type of two-glass edgellit dial, padder, and Stromberg Condenser to suit.

Cat. No. EK17 ..... **£6/19/6**

Complete Kit of Parts for Pentagrid Seven, without valves, batteries or speaker.

Cat. No. EK18 ..... Price **£9/5/-**

Ditto, with valves and permanent magnet moving-coil speaker.

Cat. No. EK19 ..... Price **£14/9/6**

NOTE.—This set was fully described in "Wireless Weekly," July 30th, 1937. Constructors who cannot build from the circuit diagram should not attempt to build it, as full constructional details are not available.

## IRONCLAD SKY-SWEEPER

One of the high-lights of the 1936 season. Four-valve T.R.F. set, using metal valves. Good speaker reception from all main New Zealand and Australian stations. "Radiogram" with full particulars will be sent on receipt of three penny stamps.

Complete set of parts as above—

Cat. No. EK412 ..... **85/- (K)**

Ditto, with Raytheon Metal Valves and Jensen 6in. Moving Coil Speaker—

Cat. No. EK413 ..... **£7/14/6 (K)**

Ditto, with 8in. Speaker—

Cat. No. EK414 ..... **£7/19/6 (K)**

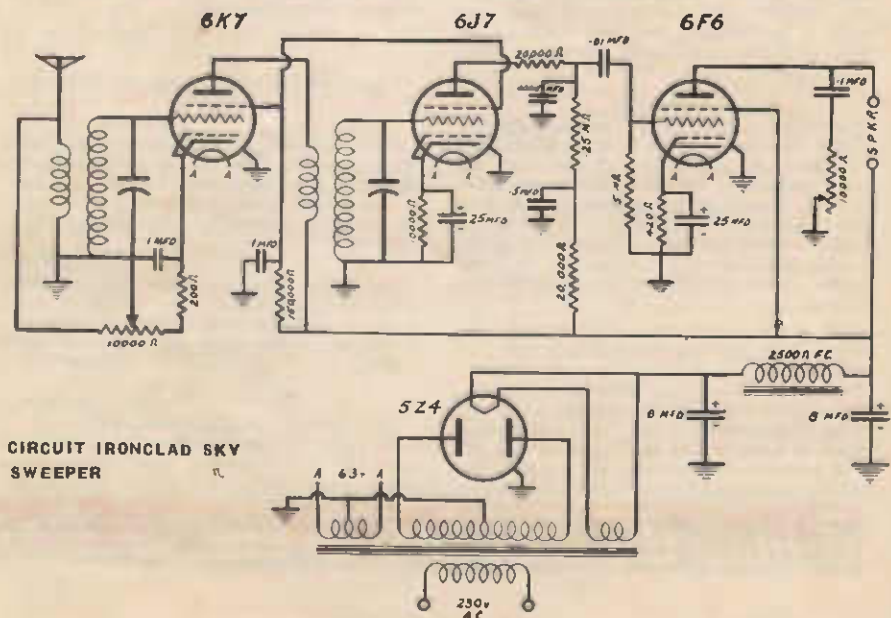

CIRCUIT IRONCLAD SKY SWEEPER



# STRAIGHT SUPER-HET. FIVE



STRAIGHT FIVE.



BIRD'S EYE VIEW.

The reason for the name "Straight Five" is that in this set all "bends," snags, etc., have been eliminated. We considered that there were still plenty of people who wanted a STRAIGHT-out broadcast set at a reasonable price. In designing this set we have therefore eliminated all fancy touches such as short-waves, metal valves, expensive dials, A.V.C., iron-cored coils, etc., all of which are very nice if you have the inclination for them and the cash to pay for them.

Now let us see what we have left. We have a 5-valve super-kit set of conventional design, glass valves (which will equal, if not better, results from metal ones). Selective enough for all but the most fastidious. Our set will bring in all the usual Australian and N.Z. stations at good speaker room strength, and is of good tone. For its price it is, in our opinion, a marvel of good value. Good quality parts are used throughout.

The Superhet Five Circuit is of excellent design, cheap to build, easy to construct, and when air-tested gave excellent performance on distant reception.

The tube line-up is as follows: A 6A7 1st det. and oec., followed by a 6D6 high gain IF stage at 460 K.C., this frequency being chosen to give better inter-channel selectivity and extra freedom from double spot tuning. Next follows a 6C6 2nd det., which is resistance capacity coupled to a 42 type Penthode power tube.

In building this set great care should be taken to mount all components as shown in the diagrams. The filament pins on the tube sockets should face in the direction shown in the diagram.

Remember when fixing the sockets of the 6A7, 6D6 and 6C6 tubes to mount the bases of the goat shields. Care also should be taken to see that the aerial terminal is insulated from the chassis. When mounting the filter condensers, see that one of them is insulated from the chassis and that the other is making good contact with the metal chassis, this being achieved by scraping the paint away from around the hole in which it is mounted. It is advisable to attach two pieces of push-back

wire to the two-gang condenser before mounting and also to earth the gang to the chassis. Wiring up the set should present no difficulties if the lay-out diagram is carefully studied before the wiring is commenced. First take in two pieces of wire and solder to the 5V. 2-Amp. lugs on the transformer panel and then connect these to the filament pins of the rectifier socket, two more wires should be taken to the plates of the rectifier socket from the 385V. 50M.A. solder lugs on the panel. The filaments of the remaining tubes are supplied from one 6.3V. winding, and the dial lights can be connected to the other winding, the 6.3V. C.T. and one side of the other 6.3V. winding earthed. The remaining wiring is quite straightforward. The most logical way to complete this is to commence at the aerial terminal and wire the

aerial coil, the 6A7 tube socket, then the first IF trans., and so on until all the wiring is completed. When wiring up the speaker socket the plate terminal should be wired to the plate terminal of the 42 tube, the screen terminal to the grid terminal, and the filament terminals one to be earthed and the other to be connected to the H.T.C.F.T., which also connects to the insulated side of the electro. The power flex should be connected to the lugs marked "C" and "240 volts." The grid clips fitted, the knobs fitted, the tubes plugged in and the cans fitted over them and the spk. plugged in. When all this has been done the set wiring should be given a thorough check over to make sure that no mistakes have been made.

The aerial and earth leads should now be connected, and the set made ready to be switched

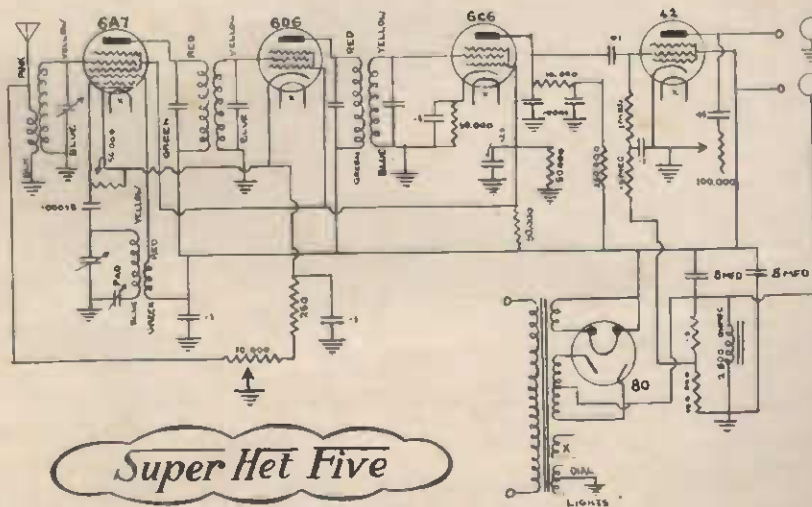

CIRCUIT DIAGRAM.

Mail All Orders to the "Electric Lamp House" 27 MANNERS ST. WELLINGTON

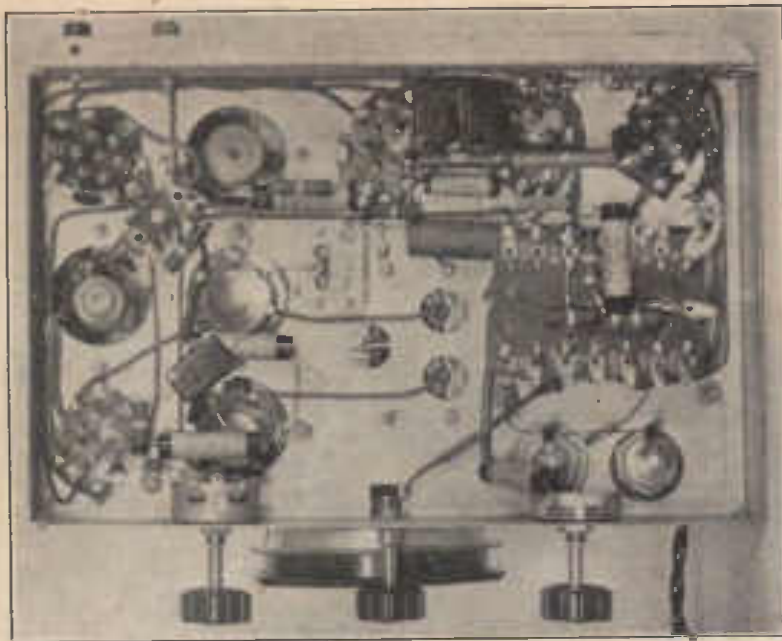

WORM'S EYE VIEW.

on. Be careful when switching on to note if there are any flashes or blue glows in the 80 rectifier. If there should be, switch off immediately and examine the set for any short circuits in the H.T. wiring. If, however, the filaments show a dull red glow and the other tubes light up, everything may be taken to be in order.

Next comes the more difficult task of aligning the set. This is best carried out by first setting the trimmers on the gang about half way out, and the same with the paddler. Next advance the volume control full on and rotate the dial until it reaches about 1400 K.C. Now

adjust the trimmers for best results, and as the volume rises turn the volume control back in order that slight differences in volume may be detected.

When best results have been obtained, swing the dial over to 600 K.C. reading and adjust the paddler, at the same time gently rocking the dial backward and forward to gain the maximum amount of volume. The whole process should now be repeated once again—the alignment is then completed. Though strictly speaking the IF trimmers should not be interfered with unless a signal generator is on hand, there is no reason why a slight adjustment

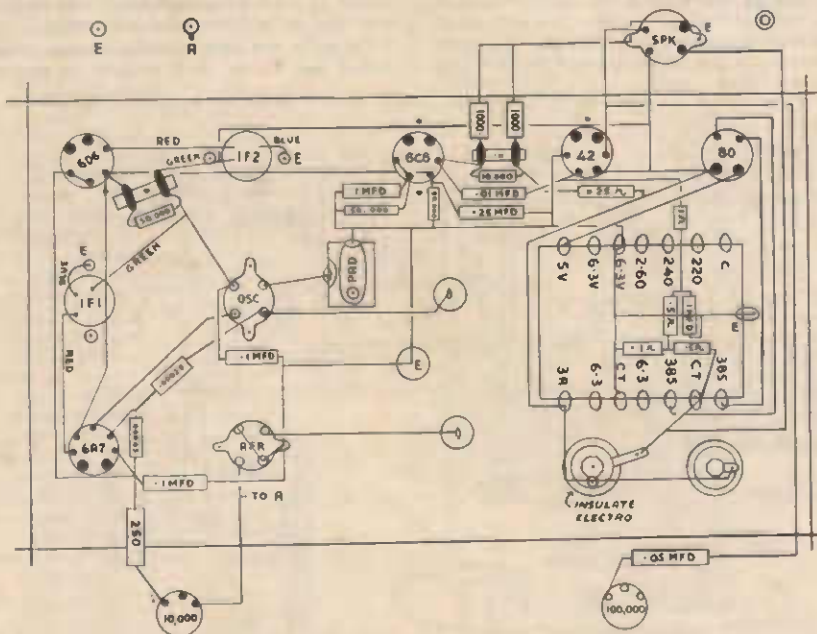

WIRING DIAGRAM.

should not be attempted to ensure maximum gain.

With the set tuned accurately to a station, say 4YA, and the volume turned well down, the trimmers tuning the secondary of the first IF transformer can be rotated carefully in both directions to see if any increase in volume results. It is advisable to note the original setting of the trimmer so that it may be returned to its factory setting. After this adjustment the remaining trimmers can be adjusted in turn, leaving them at their maximum volume.

**PARTS LIST.**

- 1 Chassis
- 1 Radiolux D Type Dial
- 1 R.C.S. 60 m.a. Power Transformer
- 1 2-gang Condenser
- 1 R.C.S. Coil Kit
- 3 Goat Shields
- 3 Grid Clips
- 2 Dial Lights
- 3 6-pin Tube Sockets
- 2 4-pin Tube Sockets
- 1 7-pin Tube Sockets
- 1 80 Type Tube
- 1 42 Type Tube
- 1 6C6 Type Tube
- 1 6D6 Type Tube
- 1 6A7 Type Tube
- 3 Knobs
- 1 10,000 ohm Potentiometer, W.W.
- 1 100,000 ohm Potentiometer.
- 2 yds. Heating Flex
- 2 in. Rubber Grummit
- 2 2-lug Connecting Strips
- 2 8 mfd. Condensers
- 4 .1 m.f.d. Condensers
- 1 .25 m.f.d. Condensers
- 2 .0001 m.f.d. Mica Condensers
- 1 .05 m.f.d. Condenser
- 1 .05 m.f.d. Condenser
- 1 .00025 m.f.d. Condenser
- 1 1 meg. Resistor
- 2 .5 meg. Resistors
- 1 .25 meg. Resistor
- 1 .1 meg. Resistor
- 4 50,000 meg. Resistor
- 1 250 ohm Resistor
- 1 10,000 ohm Resistor
- 1 Coil Push-back
- 6 Solder Lugs
- 8 5/32 W. Nuts (Whitworth T.)
- 2 Aerial and Earth Terminals
- 1 doz. 1/4 in. 4 B.A. Nuts and Bolts
- 3 1/2 in. 4 B.A. Nuts and Bolts
- 2 1/2 in. 6 B.A. Nuts and Bolts

**KITS. (K)**

- R.C.S. Coil Kit for 5-valve Straight Super, including I.F.S. **22/6**
- Cat. No. EC414
- Complete Kit of Parts, including valves and moving coil, speaker. **£7/10/-**
- Cat. No. EK38
- Ditto, without valves and speaker.
- Cat. No. EK39 **£5/10/-**

Mail All Orders to the "Electric Lamp House" 27 MANNERS ST WELLINGTON





Enjoy clearer overseas and local programmes without interference. Get more stations, get stronger reception—eliminate static with one of these—

## THE "TRAFFIC COPS" OF RADIO

(K)



**LEKMEK**  
LINE FILTER—  
ENDS  
ELECTRICAL  
INTERFERENCE!

No more power line noises if you use this. Designed for use with all electrical receivers. It will definitely overcome all extraneous noises except those entering the set via the aerial system.

Cat. No. EA297 .. 19/6

Particularly effective in D.C. areas and on ships with D.C. supply.

**LEKMEK**  
AERIAL FILTER—  
CHECKS NOISES  
TRANSMITTED  
THROUGH  
AERIAL

Designed for the purpose of reducing noise and interference picked up on the regular aerial of a Radio Receiver when the source of such noise and interference is adjacent to the Receiver. It comprises two special Filtering Transformers (one illustrated) and 50 feet Waterproof, Interference-proof Lead-in Cable.

Cat. No. EA299 .. 35/-

Cat. No. EA300 .. 45/-  
With 100ft. cable



## LEKMEK PRECISION MATCHED Double-Doublet Aerial System

FOR DUAL-WAVE & SHORT-WAVE SETS, & SHORT-WAVE CONVERTORS.

A complete Double-Doublet Aerial System in kit form, incorporating the Lekmek Antenna Coupler interference eliminator. No wiring or assembly is necessary. It has all been done by Lekmek Engineers. Includes everything necessary except the supports and rope. Only requires slinging to the supports. A clear diagram is provided for your guidance.

IDEAL FOR CITY, SUBURBAN and COUNTRY USE, as it will combat interference from trams, trains, Neon signs, electric motors, refrigerators, vacuum cleaners, noise from passing cars and all other types of man-made static.

# 47/6

Cat. No. EA298

Mail All Orders to the "Electric Lamp House" 27 MANNERS ST. WELLINGTON

ONLY  
**£7.10.0**  
 CASH



## ELECTRIC CLEANER

Electric cleaning is now within the reach of every home. The KNIGHT is a high-grade job—a marvel of beauty, simplicity, and SAFETY—yet you get it at ABOUT HALF THE USUAL COST because of the modern buying and selling policy of the Lamp House.

### TRY IT AT OUR RISK

Send for one, try it out in your own home, and if you are not satisfied in every way we will refund your money in full, including return postage.

Complete Equipment includes:—  
 7in. OVAL BRUSH; 8½in. NOZZLE; "NOSIE PARKER"; Curved and Straight EXTENSION TUBES; 5ft. 6in. Covered Flexible METALLIC HOSE; 15ft. Flexible Heavily Braided CORD, with plug and switch connections.

FULL  
 SIZE

FULLY  
 EQUIPPED

FULLY  
 GUARANTEED

Sent Freight Free to your door on Receipt of Cash. Money refunded if you are not delighted with your "KNIGHT"



# Electric Lamphouse Ltd.

NEW ZEALANDS RADIO AND ELECTRICAL HOUSE

POSTAL ADDRESS: 11 Manners Street, Wellington, C.I.

TELEGRAMS AND CABLES: Lamphouse, Wellington.

TELEPHONE: 43-015 (2 Lines).



## 5% SPECIAL DISCOUNT ORDER FORM

5% SPECIAL DISCOUNT (1/- in the £)

This Annual cost you 2/- and it actually cost us 4/6 to prepare and publish. This is the first year the price of the Annual has been increased since 1939, during which time costs have trebled.

Now then, to let you get your money cost back and to enable us to get more orders we are making a Special Offer of 5% discount. The more you order the more you save but remember that this discount applies to your First Order Only and must be on this Special Order Form or accompanied by this Form.

Take advantage of this offer and save 1/- in every £ spent.

Cat. No.	Brief Description of Goods	Price

**FREIGHT.**—We pay freight on all retail orders over £2 value. Please include sufficient cash for postage on small orders.

**GUARANTEE.**—Any goods that prove in any way unsuitable may be returned undamaged within seven days from receipt and your money will be refunded in full.

**REMITTANCES.**—Enclose cheque, pound notes, postal note, or money order to the full amount of your order. If you send coin or bank notes, be sure to register the latter. Make cheques and postal notes payable to the Electric Lamphouse, Ltd., and keep numbers for reference.

### A SUGGESTION

As it is much easier for us to make a refund along with your receipt than for you to get stamps or postal notes to remit a small balance that may be left owing when your receipt is sent, would it not save you inconvenience if you were always to send ample cash to allow for freight, etc.? We will refund the difference, or place it to your credit, according to your instructions.

Please Forward the Goods Listed Above immediately:

Name

Address

(Write Clearly in Block Letters.)

ENCLOSED	/	/	Forward	Per	POST
			"	"	RAIL
In Payment of Above.			"	"	

If there is not sufficient space on this form, attach a list of goods on writing paper.