

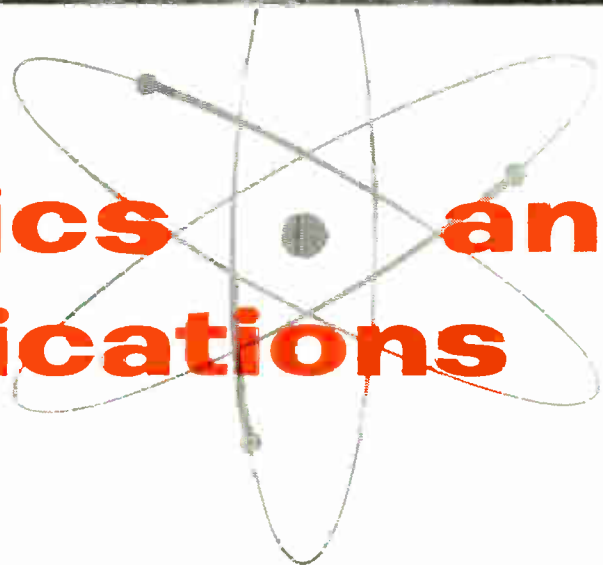

*Mechanical hands encapsulate Cobalt 60
(description page 5)*

electronics and communications



an age publication

APRIL 1959

1211C
OEL
CRC
EPA

MR F W PREZIOSI
8 EASTGATE CRES
SCARBOROUGH ONT

DIGITAL VOLTMETER, \$825

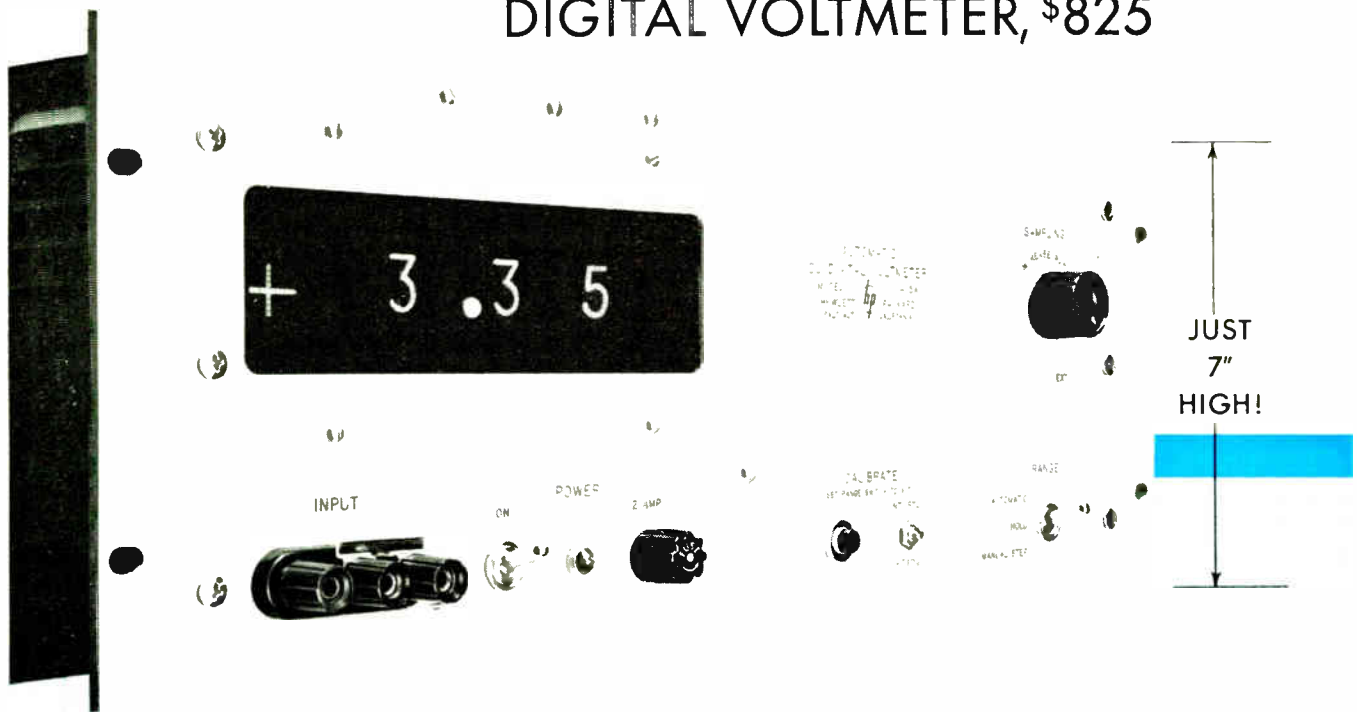

Automatic range and polarity selection. Just apply the probe and read voltage directly!

hp 405AR DC DIGITAL VOLTMETER is a completely new instrument providing, literally, "touch-and-read" voltage measurements between 1 and 1,000 volts. *Range, even polarity, are automatically selected.* Readout is in-line, in bright, steady numerals. *New, novel circuitry provides a stability of readings virtually eliminating jitter in the last digit. This reduces operator fatigue and avoids uncertainty.*

Special features include a floating input, electronic analog-to-digital conversion, digital recorder output and front-panel "hold" control permitting manual positioning of decimal. Voltage sampling rate is variable from 1 reading every 5 seconds to 5 per second; or can be controlled externally by a 20 v positive pulse.

BRIEF SPECIFICATIONS

Range: 0.001 to 999 v dc; 4 ranges.
Presentation: 3 significant figures, polarity indicator
Accuracy: $\pm 0.2\%$ full scale ± 1 count
Ranging time: $\frac{1}{2}$ sec to 2 sec
Input impedance: 11 megohms to dc, all ranges
Response time: Less than 1 sec
AC rejection: 3 db at 0.7 cps; min. 50 db at 60 cps
Price: \$825.00

Data subject to change without notice. Price f.o.b. factory.



HEWLETT-PACKARD COMPANY

Represented in Canada by:

ATLAS INSTRUMENT CORPORATION, LTD.

106-525 Seymour St., Vancouver, MU. 3-5848
72 Princess St., Winnipeg, WH. 3-8707
50 Wingold Ave., Toronto, RU. 1-6174

For complete details check No. 21 on handy card, page 41

→
at →
Canadian
Marconi
→

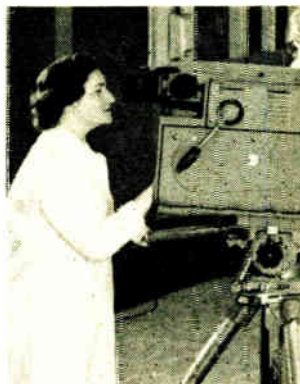

*factory tested
and sealed*

Before they leave the factory, all Marconi Image Orthicons undergo extremely critical testing.



*studio conditions
duplicated*

Acceptance tests are conducted when the tubes arrive in Canada. Marconi has built a special lab where the image orthicons are tested under Canadian studio conditions.

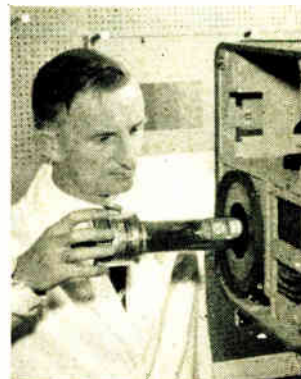

fast warranty

This special testing lab enables Marconi to offer immediate warranty adjustment when required.

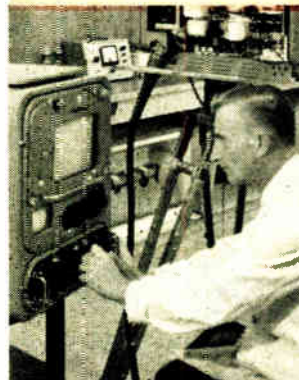

"total" testing

An extensive series of tests check every detail. Once it has passed these tests, the camera tube is shipped to the studio, sealed and protected by the Marconi guarantee.



*visiting
studio personnel*

Studio engineers and technicians are invited to inspect and make use of these facilities.

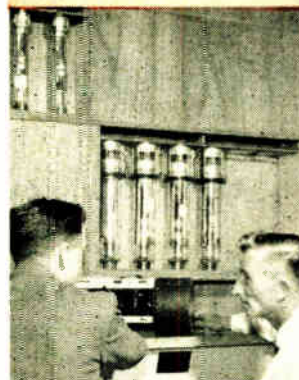

tests vary

Each of the six types of image orthicons undergoes its own special tests. To test each tube thoroughly takes 30 to 50 minutes.

the only complete
Image Orthicon
testing lab
in Canada

ELECTRONIC TUBE AND COMPONENTS DIVISION

CANADIAN **Marconi** COMPANY

830 BAYVIEW AVENUE • TORONTO, ONTARIO

BRANCHES: Vancouver • Winnipeg • Ottawa • Montreal
Halifax • St. John's, Nfld.

For complete details check No. 10 on handy card, page 41

ELECTRONICS AND COMMUNICATIONS. April, 1959



Silicon Rectifier... ... **1N2078**

NEW Tung-Sol 1N2078 designed and made for simple, speedy TV replacement!

Tung-Sol's new 1N2078 diffused junction silicon rectifier possesses distinct advantages the service industry will welcome. Optimum physical and electrical characteristics combine to make 1N2078 convenient to handle and install, and assure your TV and radio service customers the high-grade performance they want and appreciate.

Small size, easy to install. Tung-Sol's 1N2078 is smaller than most semiconductor devices, at no sacrifice in efficiency. Long

flexible leads can be quickly soldered to existing connections with no additional hardware. This is especially suited to printed circuitry.

Long life. Negligible voltage drop that remains stable over lengthy operation promotes long life. 1N2078 virtually unaffected by high current surges . . . maintains high B+ over full-length operation.

Special Insulated case. Special case insulates against chassis shorts to further ease replacement. Also, 1N2078 dissipates its own heat . . . needs no heat sink . . . yet never requires derating. Only leads get hot.

You can replace any other device and, in some cases, rectifier tubes, with the new, high-quality Tung-Sol 1N2078. For complete information . . . to stock up, contact your distributor or: Tung-Sol Electric Inc., Newark 4, New Jersey.

In Canada: ALPHA ARACON RADIO CO., LTD., Toronto, Ont.

1N2078 Maximum ratings (100°C) capacitive load:
(Similar types available with Peak Inverse Voltages ranging from 50 up to 500)

Peak Inverse Voltage	400 Volts
Continuous D. C. Reverse Working Voltage . . .	400 Volts
Average D. C. Output Current	500 mAdc
Peak Recurrent Forward Current	5 Amps.
½ Cycle Surge Current	30 Amps.
Full Load Voltage Drop @ 25°C	1.1 Volts
RMS Input Voltage	130 Volts
Minimum Series Resistance (for capacitive filter)	5 ohms, 10 watt



For complete details check No. 38 on handy card, page 41

Electronics and Communications



an age publication

Canada's pioneer journal in the field of electronics and communications engineering

Thomas W. Lazenby, editor
R. C. Poulter, P.Eng., associate editor
D. K. Trowell, editorial assistant
William Bowers, art editor
Guido Milanesio, photo editor

H. E. Dallyn, advertising manager
Arthur Dixon, assistant advertising manager
Nevill A. Campling, production manager
Paul A. Irwin, circulation manager

Norman G. McHardy, president
L. R. Kingsland, vice-pres. and sec. treas.
Clifford A. Sparks, business manager

Published by
AGE PUBLICATIONS LIMITED
450 Alliance Avenue, Toronto 9, Ont.
Telephone ROger 2-7225

publishers of
Wine/Beer/Spirits
Restaurants and Institutions
Automatic Heating/Plumbing/Air Conditioning
Air Age

MONTREAL
Keith Edgar
116 Flandre St.
(Preville)
St. Lambert, Que.
Telephone: OR. 1-2020

WEST COAST
Dillenbeck-Galavan, Inc.
266 S. Alexandria Ave.
Los Angeles 4, Calif.

U.K. AND EUROPEAN REPRESENTATIVE
Norman F. Keenan
47 Manchester Street
London, W. 1, England

Subscription Rates:
Canada, U.S.A. and U.K. Possessions \$5.00 a year
Foreign \$10.00 a year

Member Canadian Circulations Audit Board

by Post Office Dept., Ottawa
Authorized as second class mail



PRINTED IN CANADA

60

contents

APRIL 1959 Vol. 7, No. 4

- 16** Computerized process control
A system specifically designed to meet control problems
- 20** Scan conversion equipment provides brighter radar displays
Two-gun cathode ray tube transforms and prepares basic radar information
- 22** Continuing standardization linked with electronics progress
One "standardization oriented" employee is company's best investment by Vincent de P. Goubeau
- 24** Television from sound waves
Camera creates image from sound waves instead of from light waves
- 29** Photographic registration of measured service telephone calls
Monthly readings photographed for billing tabulation purposes

departments

- 11** EIA Report
- 12** CRTPB Newsletter
- 14** Business Briefs and Trends
- 31** New Products
- 35** News Report
- 50** Editorial

COVER STORY

Cancer victims in France and New Zealand will receive the benefit of this radioactive Cobalt 60. Peering through lead glass 36 inches thick into the "hot cell", a technician uses "mechanical hands" to encapsulate the radioactive pellets of Cobalt 60.

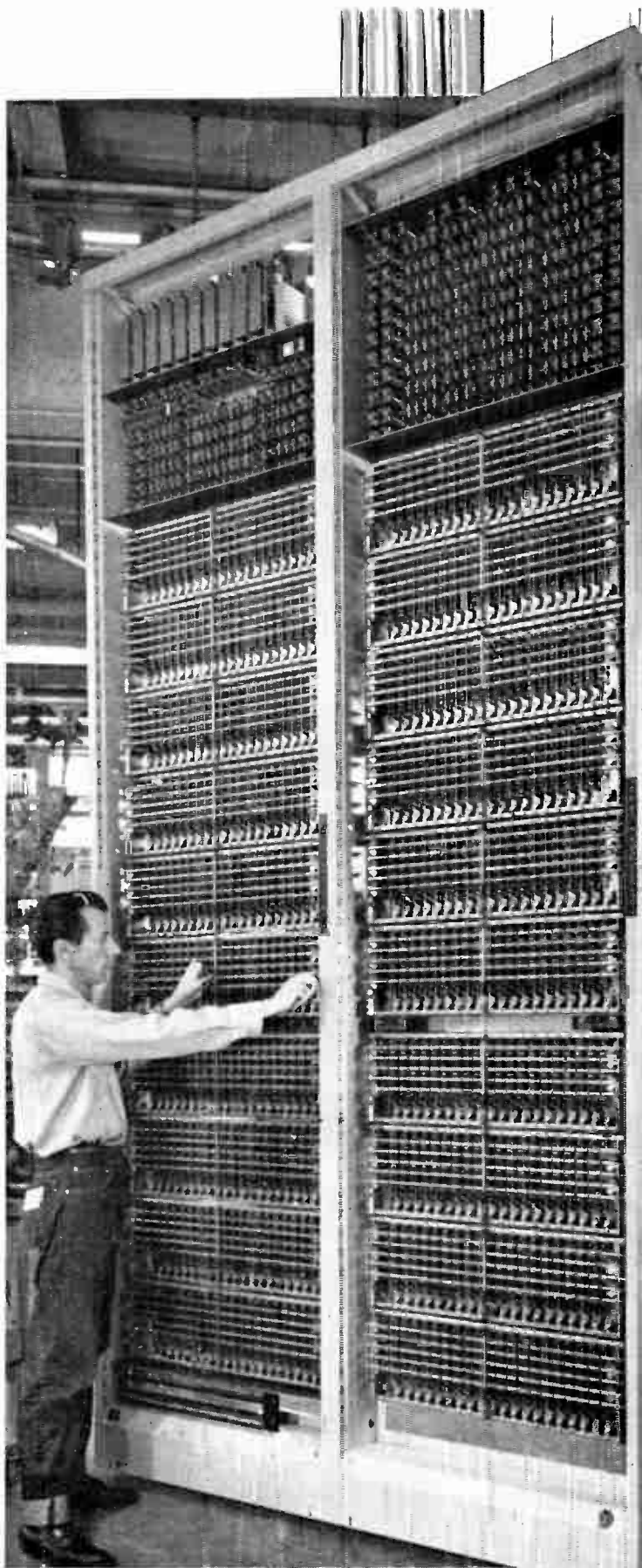

The shortest time between two points

Behind every telephone conversation there is a multiplicity of intricate and fascinating pieces of equipment. Much of this is large in size but many of the component pieces are extremely small and of delicate design. Northern Electric leads in the field of Communications. They are ever alert to the latest developments in Communication Equipment.

Northern Electric designs and manufactures a large proportion of Canada's telephones and its related complex equipment. Their extensive and long experience in telephone communication coupled with their modern manufacturing facilities are at your command. Branches are strategically located across Canada to serve your needs.

Northern Electric

SERVES YOU BEST



2059-1

For complete details check No. 29 on handy card, page 41



an age publication

Electronics and Communications

Canada's pioneer journal in the field of electronics and communications engineering

Thomas W. Lazenby, editor
R. C. Poulter, P.Eng., associate editor
D. K. Trowell, editorial assistant
William Bowers, art editor
Guido Milanesio, photo editor

H. E. Dallyn, advertising manager
Arthur Dixon, assistant advertising manager
Nevill A. Campling, production manager
Paul A. Irwin, circulation manager

Norman G. McHardy, president
L. R. Kingsland, vice-pres. and sec. treas.
Clifford A. Sparks, business manager

Published by
AGE PUBLICATIONS LIMITED
450 Alliance Avenue, Toronto 9, Ont.
Telephone ROger 2-7225

publishers of
Wine/Beer/Spirits
Restaurants and Institutions
Automatic Heating/Plumbing/Air Conditioning
Air Age

MONTREAL
Keith Edgar
116 Flandre St.
(Preville)
St. Lambert, Que.
Telephone: OR. 1-2020

WEST COAST
Dillenbeck-Galavan, Inc.
266 S. Alexandria Ave.
Los Angeles 4, Calif.

U.K. AND EUROPEAN REPRESENTATIVE
Norman F. Keenan
47 Manchester Street
London, W. 1, England

Subscription Rates:
Canada, U.S.A. and U.K. Possessions \$5.00 a year
Foreign \$10.00 a year

Member Canadian Circulations Audit Board

by Post Office Dept., Ottawa
Authorized as second class mail



PRINTED IN CANADA



contents

APRIL 1959 Vol. 7, No. 4

- 16 **Computerized process control**
A system specifically designed to meet control problems
- 20 **Scan conversion equipment provides brighter radar displays**
Two-gun cathode ray tube transforms and prepares basic radar information
- 22 **Continuing standardization linked with electronics progress**
One "standardization oriented" employee is company's best investment by Vincent de P. Goubeau
- 24 **Television from sound waves**
Camera creates image from sound waves instead of from light waves
- 29 **Photographic registration of measured service telephone calls**
Monthly readings photographed for billing tabulation purposes

departments

- 11 **EIA Report**
- 12 **C RTPB Newsletter**
- 14 **Business Briefs and Trends**
- 31 **New Products**
- 35 **News Report**
- 50 **Editorial**

COVER STORY

Cancer victims in France and New Zealand will receive the benefit of this radioactive Cobalt 60. Peering through lead glass 36 inches thick into the "hot cell", a technician uses "mechanical hands" to encapsulate the radioactive pellets of Cobalt 60.

THE NATIONAL SCENE

TEN-TO-ONE THE Copper Clad Laminate YOU WANT IS HERE!

From these ten basic PHENOLITE® Grades, you can select the base material, resin, properties and price to fit your present printed circuit need.

If your problem is finding a suitable cold-punch material, try samples of XXXP-470-1. It's designed for use in automated production equipment. If you are looking for higher heat resistance, check Grades G-10 and G-11.

Out of National's research laboratories come new advances every day. See your National Representative about new products and applications. He can keep you posted on the full line of PHENOLITE Laminated Plastic, Vulcanized Fibre and National Nylon for electronic applications across-the-board. In the meantime, write for our new "PHENOLITE Copper Clad Data" folder. Address Dept. 0-5.

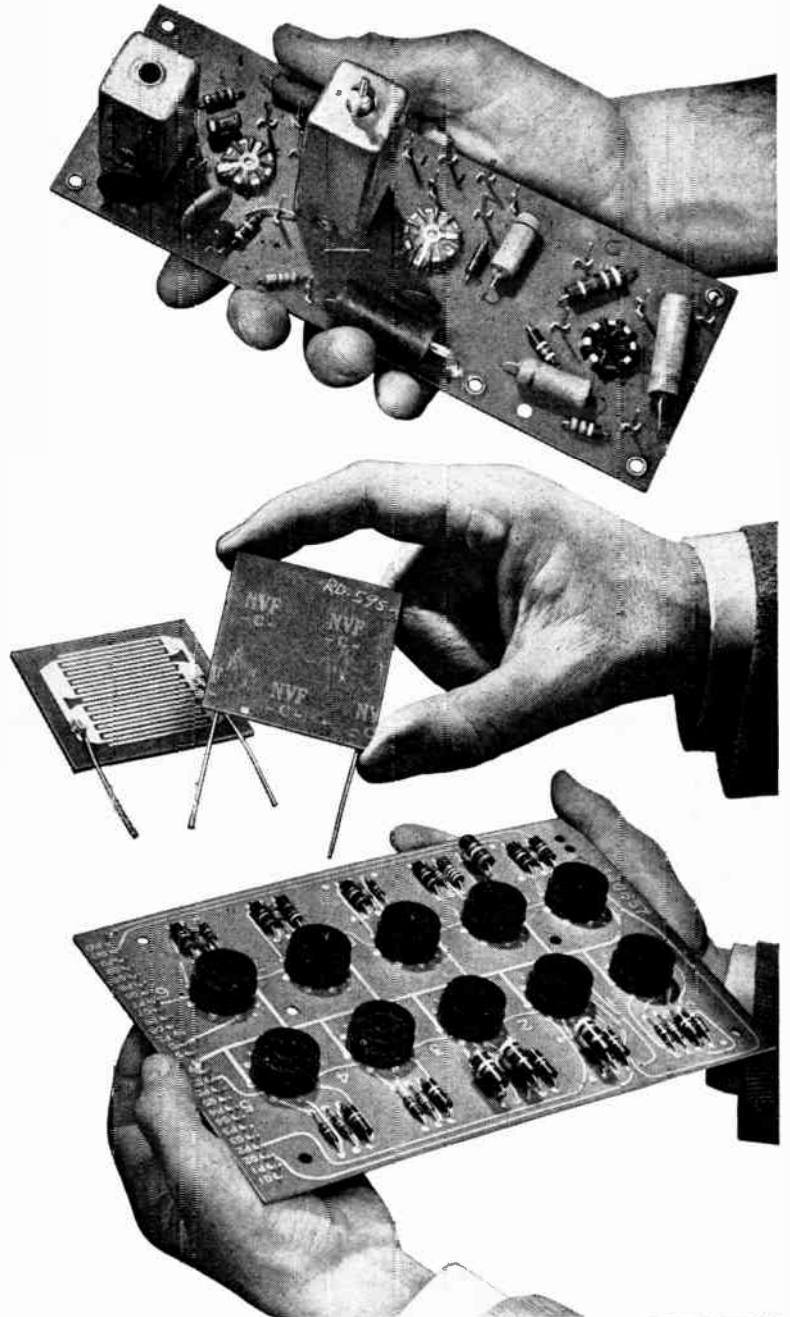

NATIONAL

FIBRE COMPANY OF CANADA, LTD.

Atlantic & Hanna Aves., Toronto • 1411 Crescent St., Montreal

TYPICAL TEST VALUES ON COPPER CLAD PHENOLITE

GRADE	PROPERTIES OF BASE MATERIAL					COPPER CLAD PROPERTIES			RELATIVE COST Based on XXXP on Arbitrary Scale of 1 1/4" Thk. 1 Oz. Copper 1 Side	
	Dielectric Constant	Dissipation Factor	Moisture Absorption	Flexural Strength	Maximum Operating Temperature	Copper Bond Strength		Hot Solder Resistance		Surface Resistance
						Pounds to Pull 1" Strip				
						1 Oz	2 Oz			
P-214-B-1	5.3	.040	2.20	18,000	250	8	11	> 10 @ 475°F	100,000	.81
XXP-209-G-1	4.6	.037	1.30	17,000	250	8	11	> 10 @ 475°F	200,000	.92
XXP-239-1 PHENOCLAD	4.2	.035	0.67	15,500	250	8	11	> 10 @ 475°F	200,000	.92
XXXP-219-C-1	4.5	.030	0.70	15,500	250	8	11	> 10 @ 475°F	500,000-1,000,000	1.00
XXXP-455-1	4.0	.026	0.55	23,500	250	8	11	> 10 @ 475°F	1,000,000-1,500,000	1.00
XXXP-470-1	3.7	.027	0.48	14,000	250	8	11	> 10 @ 475°F	300,000-500,000	1.00
N-1-852-1	3.3	.030	0.20	16,000	165	8	11	> 10 @ 450°F	2,000,000	2.69
G-5-813-1	6.8	.018	1.00	55,000	300	8	11	—	—	2.98
G-10-865-1	5.2	.012	0.13	60,000	250	10	15	> 30 @ 500°F	1,500,000-2,000,000	3.49
G-11-861-1	4.9	.015	0.17	60,000	300	10	15	> 30 @ 500°F	2,000,000	3.55

For complete details check No. 27 on handy card, page 41

The Rogers 6BQ5 Pentode for High Quality Amplifiers and Receivers Produced in volume in Canada, under Rogers High Quality Control Standards, the Rogers 6BQ5 has won acceptance by Equipment Manufacturers in Canada and abroad. It is a 12 watt dissipation pentode which provides high peak power of up to 17 watts output with very low distortion (4%).

The Rogers 6BQ5 (the world famous EL84) has been designed for two prime applications—as a sound output tube in high fidelity amplifiers and high quality television receivers; as a vertical output tube where special factory tests ensure good linearity and high zero-bias plate knee current.

Rogers wide range of receiving tubes are finding more applications in all types of electronic equipment. For high performance and greater reliability specify Rogers tubes.

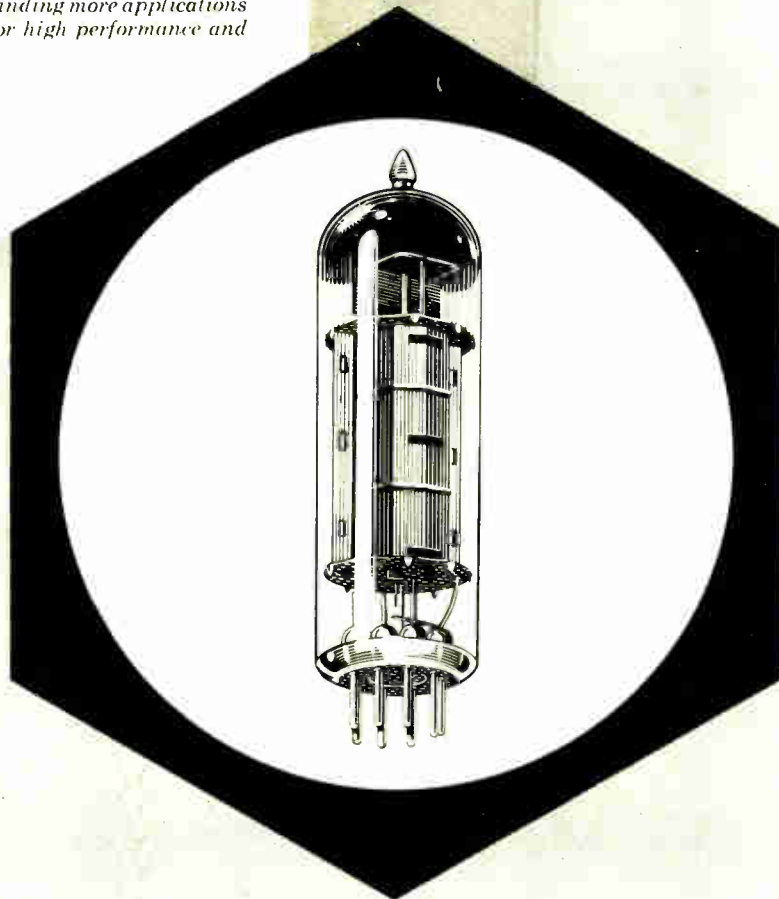

ROGERS

electronic tubes & components

A DIVISION OF PHILIPS ELECTRONICS INDUSTRIES LTD.

116 VAN

TORONTO, ONTARIO / BRANCHES: MONTREAL, WINNIPEG, VANCOUVER

★

...s Independent Electronic Parts Distributors

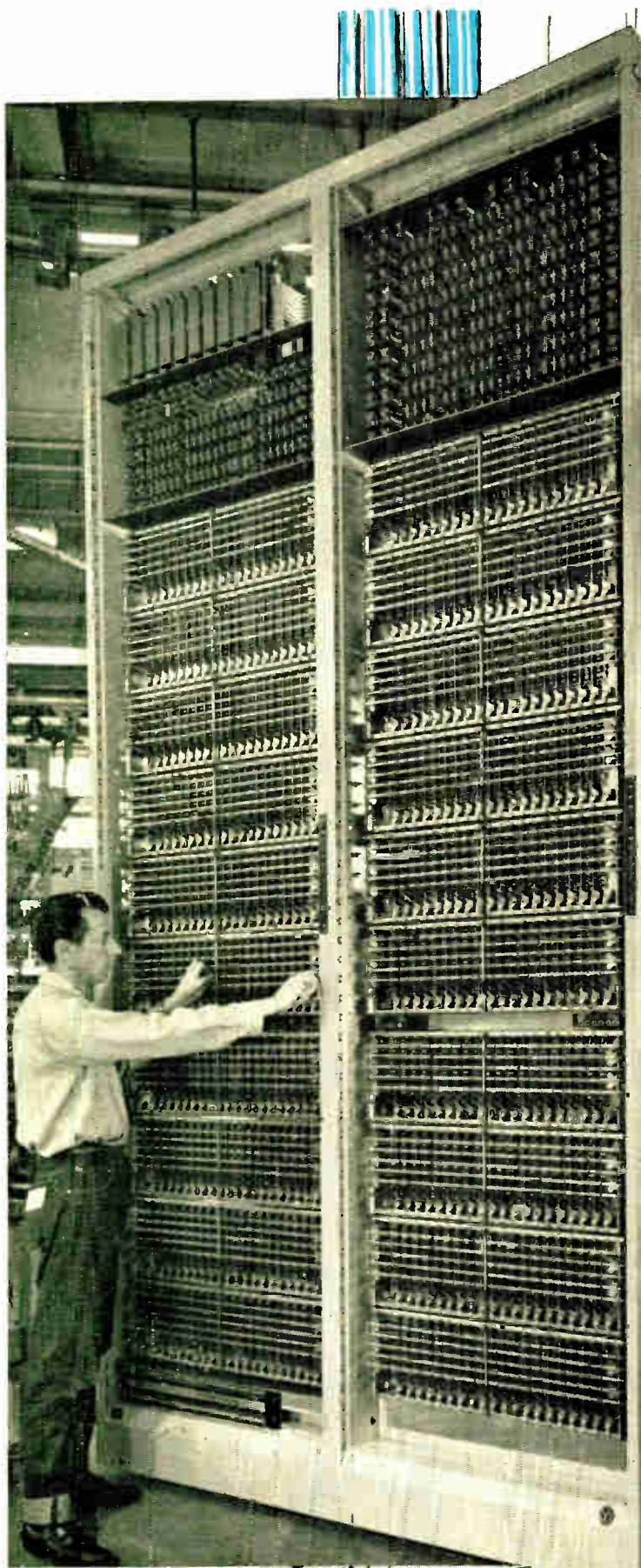

The shortest time between two points

Behind every telephone conversation there is a multiplicity of intricate and fascinating pieces of equipment. Much of this is large in size but many of the component pieces are extremely small and of delicate design. Northern Electric leads in the field of Communications. They are ever alert to the latest developments in Communication Equipment.

Northern Electric designs and manufactures a large proportion of Canada's telephones and its related complex equipment. Their extensive and long experience in telephone communication coupled with their modern manufacturing facilities are at your command. Branches are strategically located across Canada to serve your needs.

Northern Electric
SERVES YOU BEST



2059-1

For complete details check No. 22

100 CPS X-Y RECORDING

with immediate
readout

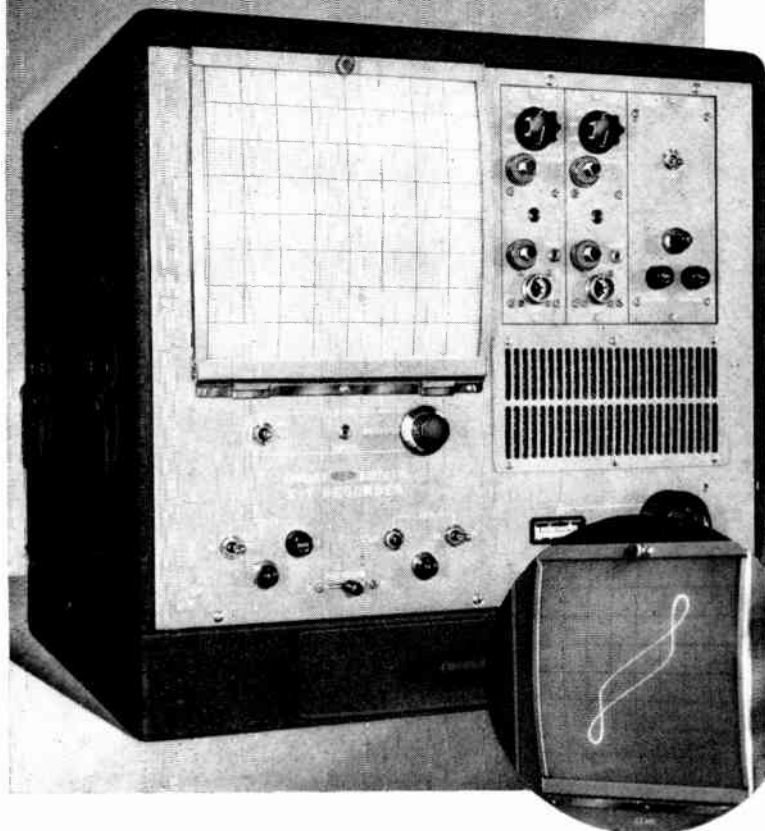

THE NEW SANBORN MODEL 670 OPTICAL X-Y RECORDER HAS

- 1% linearity
- frequency response 3 db down at 130 cps independent of amplitude
- writing speeds to 2500 in./sec.
- 8" x 8" direct print paper chart
- trace monitoring on phosphorescent screen

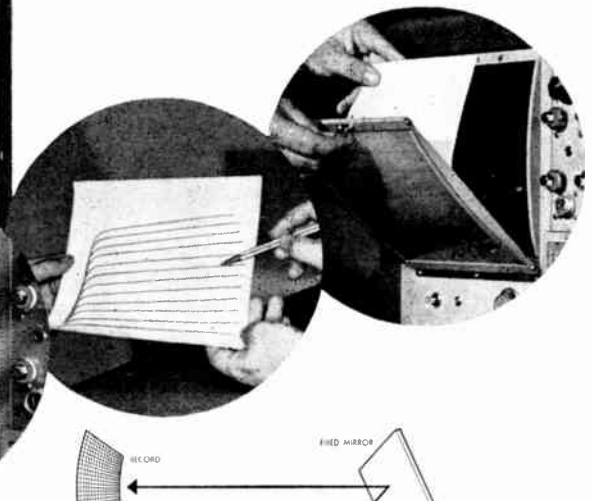

X-Y RECORDING never before possible with electro-mechanical instruments can now be done with the new Sanborn Model 670 X-Y Recorder. Direct writing on ultraviolet-sensitive recording paper by a beam deflected by optical galvanometers makes possible the combination of fast writing speed and 130 cps frequency response not found in any other X-Y recorder. Transistor characteristics, acceleration and vibration of mechanical parts and events of similar short duration can be recorded with linearity of 1% of full-scale and at trace speeds as fast as 2500 inches per second. Square wave response exhibits no greater than 1.2% overshoot at any amplitude; sensitivities as high as 62.5 uv. inch (depending on preamplifier used).

PLOTS OCCUPY AN 8" x 8" RECORDING AREA and can be previewed or monitored on the instrument's phosphorescent screen. An Axis Record switch to print X and Y axes on the record, and a Beam Intensity Control to assure maximum trace clarity, are among the front panel controls provided. An 8" x 8" sheet of the ultraviolet-sensitive chart paper (stored in drawer at base of cabinet) is easily placed on the back of the hinged screen. Brief post exposure in normal room light is the only developing process.

OPTIONAL INTERCHANGEABLE PREAMPLIFIERS for each axis presently include the Model 850-1300B DC Coupling and Model 850-1200 Phase Sensitive Demodulator; a Carrier Preamplifier, High Gain Preamplifier and a time base generator are now in development. Driver Amplifiers are compact,

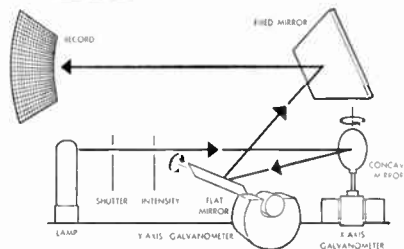

fully transistorized plug-in units with single-ended input and output. Galvanometers are low resistance, low voltage units of rugged, enclosed construction; sensitivity and damping are independent of coil temperature. Accessible, unitized circuitry also extends to the power supplies—a front-panel plug-in for both preamplifiers and a second supply for both driver amplifiers. A built-in blower provides constant, forced filtered air cooling. The Recorder can be rack mounted in 15 3/4" of panel space, or housed in its own 20" x 20" x 21 1/4" optional portable cabinet.

Ask your local Sanborn Sales-Engineering Representative for complete information on the Model 670 X-Y Recorder, or write the Industrial Division in Waltham, Mass.

SANBORN COMPANY

INDUSTRIAL DIVISION
175 WYMAN STREET, WALTHAM 54, MASS.

For complete details check No. 34 on handy card, page 34

AVAILABLE NOW

The new **MODEL '270'**

A custom instrument
in the *Simpson*
"260" tradition



- Increased accuracy
- Human engineered scales
- Movement overload protection - and a host of other attractive features for discriminating users.

For those who for years have valued the reliability and versatility of the Simpson "260", the Custom-Engineered Model 270 offers a multitude of new features for applications calling for a higher order of accuracy, with no sacrifice in the qualities which have made the "260" famous the world over.

Ranges and scale layouts have been designed for maximum readability with an anti-parallax mirror and knife edge pointer. Precision components and calibration techniques assure accuracies down to $\pm 1.25\%$ on most of the D.C. ranges, with similar accuracy improvements on other ranges. In addition, the operating manual specifies accuracies on

all ranges for a variety of operating conditions, frequency correction curves and a host of useful information.

To conserve this high order of accuracy, a circuit fuse and meter current-limiting diode guard against accidental overload, over and above that provided for in the choice of rugged and generously rated components.

Truly a Custom-Engineered Instrument to suit the present day trend to greater precision in measurement.

Write for further details
Price - \$62.50, Sales Tax Included

The Canadian-made Simpson 260 will continue to be available
Price: \$54.50

Bach-Simpson

LIMITED

1255 Brydges St.

London

IN U.S.A.—SIMPSON ELECTRIC COMPANY, 5200 W. KINZIE STREET, CHICAGO 44, ILL.

J-9331

For complete details check No. 7 on handy card, page 41

EIA Report

By Basil Jackson, A.R.Ae.S., Tech. M.C.A.I.

Prime Contractors Committee Adopt Terms of Reference

The Prime Contractors Electronic Materials and Components Committee of the Electronics Division of EIA, at a meeting recently in Toronto, adopted its terms of reference. Under the "Mode Of Operation" the Committee will, under its terms of reference, formulate its agenda from subjects submitted to it from the members of EIA or from any EIA committee, and also from military, civil, or Government agencies.

By the adoption of its terms of reference, the Prime Contractors Committee should do much in alleviating any difficulty which might arise in the interpretation of Government procedures.

Radio Frequency Spectrum Recommendations

Special meetings have been held during the past month by the various engineering committees of the Electronics Division to discuss their recommendations for radio frequency allocations. These will be co-ordinated and reviewed at a special meeting of the committee of all the engineering chairmen of the Division before submission to the Canadian Radio Technical Planning Board as EIA's recommendations to the CCIR and ITU conferences which take place in Los Angeles, California and Geneva, Switzerland this year.

Sound Equipment Specification

The Sound Equipment Committee of the Electronics Division met recently in Toronto to discuss the possibility of formulating a specification on sound equipment for installation in auditoriums and other buildings. The chairman of this committee, Mr. R. H. Tanner, had met with representatives of the Association of Consulting Engineers of Canada, the Association of Professional Engineers of Ontario, and the Specification Writers Association of Canada, to discuss this possibility.

The Committee decided to proceed with the preparation of a trial specification on sound system amplifiers dealing with the performance, mechanical features, methods of tests, and minimum standards.

U.S. Electronics Industry Fifth Largest Manufacturing Group

The electronics industry in the United States, during 1958, further entrenched its position as the fifth largest manufacturing group in the United States. During 1958 some 1,500 equipment and major assemblers, 2,400 component manufacturers, and 700 producers of switches, wire and other electronic hardware established a new aggregate sales record of 7.9 billion dollars. This amounts to a total industry figure of 13.3 billion dollars when distribution, servicing and broadcasting revenues are added.

An interesting point of the upward climb of the U.S. electronics industry is that military electronic equipment during 1958 accounted for 4.1 billion dollars' worth of the total 7.9 billion dollars of the industry — an increase of 200 million dollars from 1957. The value of equipment sold to industrial users was up 80 million dollars over 1957, reaching a total of 1.38 billion. Sales of replacement parts, tubes and semi-conductors declined from 900 million to 860 million while factory sales of consumer products such as television, radio, phonographs and other electronic household goods totalled 1.6 billion dollars during 1958. This represents a 100 million dollar drop from 1957. Employment in the United States electronics industry is currently at 700,000 persons of which nearly 100,000 are engineers.

Transformer Engineering Sub-Committee Consider New Specification

At a recent meeting the Transformer Engineering Sub-Committee of the Components Engineering Committee considered the preparation of a new specification to deal with power transformers for radio and television receivers. The Sub-Committee has already compiled a specification dealing with audio transformers for radio and television receivers and has circulated a questionnaire throughout the industry for the industry's comments and thoughts on the requirements for a power transformer specification. A Task Force was set up to consider these views of the various manufacturers and transformer users as stated in the returned questionnaires.

Newsletter

Canadian Radio Technical Planning Board

WHO'S WHO IN THE PLANNING BOARD

No. 13 — Western Canada Telecommunications Council

The Western Canada Telecommunications Council was incorporated in May 1957. Because the Canadian Radio Technical Planning Board is concerned mainly with the technical aspect of radio frequency use it had become apparent on the West Coast for many years that there existed a need for an organization to deal with the frequently occurring problems relating to economics and regulations in telecommunications. It is the main object of the Telecommunications Council to consider problems locally between its various member groups and then to present Ottawa with a unanimous request wherever possible. This avoids the previous procedure where various users of telecommunications went directly to Ottawa, either on their own or through their members of parliament, and this procedure generally gave an unsatisfactory approach as far as the Department of Transport was concerned.

Membership of the Western Canada Telecommunications Council is well balanced between manufacturers, suppliers and users. The Council concerns itself with economic, licensing, regulatory and technical matters. While representations are made by the Council direct to Ottawa, a close working liaison is always maintained with the Canadian Radio Technical Planning Board, particularly in connection with matters of a technical nature.

Suggestions Wanted on Compatible Stereo Systems

The first meeting of the Stereophonic Standard Sub-Committee of the Broadcast Committee of the Planning Board was held on March 12 in Toronto. Mr. A. Jamroz was appointed chairman and Mr. D. H. Johnston secretary.

After discussion of the various known systems of stereo broadcasting it was decided that the aim of the Sub-Committee was to produce standards for compatible stereophonic broadcasting systems for AM, FM and TV. To achieve this aim the Sub-Committee will conduct a technical study, investigate problems arising from this study, and then devise standards from the results. For this purpose the Sub-Committee will be pleased to receive suggestions and comments from any interested party for consideration. All communications on this subject should be addressed to Mr. D. H. Johnston, Secretary of the Stereophonic Standard Sub-Committee, c/o Canadian Radio Technical Planning Board, 200 St. Clair Avenue West, Toronto 7, Ontario.

At the recent meeting of the Stereophonic Sub-Committee the establishment of the National Stereophonic Radio Committee in the United States was discussed and it was generally agreed that the Sub-Committee's activities should parallel those in the United States after the consideration and study of Canadian aspects of stereophonic broadcasting.

Recent CRTPB Meetings

At a recent meeting of the Executive Committee the General Co-ordinator, Mr. R. A. Hackbusch, reported on discussions of the Ottawa meeting of all CRTPB committee chairmen with representatives of the Department of Transport. This meeting had been held to discuss the broad principles concerned with DOT Radio Specification No. 103, the Planning Board participation in the forthcoming CCIR and ITU meetings, and the general problems and conflicts concerning allocation of radio frequencies. The organization chart of the CRTPB was discussed and it was hoped to have this finalized in a very short time.

The Microwave Task Force on Communication System Parameters met in Toronto on April 7. At the meeting a short demonstration was presented designed to give the Committee members an appreciation of the effect of various amounts of noise on telephone circuits. The parameters on communication systems were discussed in detail.

The Amortization Committee of the Planning Board met at the CRTPB Conference Room in Toronto on March 18 to establish a recommended amortization policy applicable to non-type-approved equipment under DOT Specification No. 116 entitled "Specification for Fixed Radio Station Telephone and Telegraph Transmitters Operating in the 1.6 Mc/s to 20.0 Mc/s Band With Power Outputs Not Exceeding 500 Watts".

DOT Commissions Ground Approach Control System at Gander

A ground control approach system, installed as an additional safety factor for air operations, has been commissioned at Gander, Newfoundland, by the Department of Transport. This system augments the already extensive establishment of radio aids to air navigation serving traffic at this airport.

The new system was put to the test shortly after it was installed. A Trans-Canada Airlines aircraft was forced to make a landing in blizzard conditions. The aircraft had just taken off from Gander when the captain, noting that one engine was not operating properly, turned back to the airport. Despite the bad conditions, the aircraft was brought down safely.

Canadian Radio Technical Planning Board
200 St. Clair Avenue West, Toronto 7, Ontario

F. H. R. POUNSETT, President; C. J. BRIDGLAND, Vice-President; R. A. HACKBUSCH, General Co-ordinator;
R. C. POULTER, Director of Public Relations; F. W. RADCLIFFE, Secretary-Treasurer

HIGH TEMPERATURE POWER RESISTORS

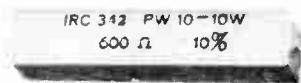

TYPES

PW-5 5 WATTS **PW-7** 7 WATTS **PW-10** 10 WATTS **PW-20** 20 WATTS

5 - 10% Tolerances
With Axial Leads

Properly Identified in Ohms, Tolerance & Rating

These high quality easily installed, high temperature, power resistors are low in cost.

MANUFACTURED & STOCKED IN CANADA

Write for Bulletins P2C & P4A

INTERNATIONAL RESISTANCE CO. LTD.

349 CARLAW AVE. TORONTO 8, ONT.

SALES OFFICES:

Radiovision Sales Ltd. 492 Somerset St. West 5890 Monkland Ave.
325 Tenth Ave. West Ottawa Montreal
Calgary, Alta. Ont. Que.

For complete details check No. 22 on handy card, page 41

"PLUS" VALUE NEW PRODUCTS

UNIVERSAL MINIATURE WAVEGUIDE SWITCHES

Designed to provide rapid switching of signals from any one of three positions to either of the remaining two positions.

Compact size makes these switches ideal for applications requiring minimum size and space.



Xs BAND SIZE:
Airtron Part No. 72605.

XL BAND SIZE:
Airtron Part No. 72610.

- Frequency Range: 8500 to 9600 mc/sec.
- Maximum VSWR: 1.10.
- Minimum Isolation: 40 db.
- Maximum Switching Time: .25 sec for 240° operation. .15 sec for 120° operation.
- Operating Current: 3.0 amperes maximum at 28 V.D.C. nominal.

Write for Bulletin 2320

Airtron CANADA LIMITED

300 CAMPBELL AVE., TORONTO

For complete details check No. 2 on handy card, page 41



NEW
CATALOG
ES59
AVAILABLE

Contains Complete Information on SENSITIVE SWITCHES

Including:

- SNAP ACTION
- SUB-MINIATURE
- SUB-SUB MINIATURE
- LIGHTED PUSH BUTTON
- DIE CAST ENCLOSED
- HERMETICALLY SEALED TYPES

All switch types available in a variety of contact arrangements.

Write today for your copy

RENFREW ELECTRIC CO. LIMITED

349 CARLAW AVENUE • TORONTO 8, ONTARIO

For complete details check No. 31 on handy card, page 41

"PLUS" VALUE NEW PRODUCTS



BLUE RIBBON AND MICRO-RIBBON

MINIATURE RACK & PANEL CONNECTORS



26 SERIES



57 SERIES

Constructed of blue diallyl phthalate dielectrics, gold plated "ribbon"-like contacts these AMPHENOL Rack and Panel connectors provide reliable, quick connection for plug-in sub-assemblies.

- Positive Contact 100% of the Time
- Self Aligning Self Wiping Contacts
- No Mating Problems Due to Bent Pins

Up to 32 Contacts in standard size and as many as 50 in new Micro-Ribbon versions.

Stocked by your local Distributor.

Write for Catalogue R2



CANADA LIMITED

300 CAMPBELL AVENUE
TORONTO 9 - ONTARIO

For complete details check No. 3 on handy card, page 41



DEPENDABLE POWER



LISTER AIR COOLED DIESEL ENGINES

In every field, Lister engines have proven themselves—setting a high standard of reliability and economy for industry and utilities. They are particularly suited to use in generating assemblies—for continuous running without attention.

Among their varied uses, Lister engines are in use for pumping and construction machinery, generating sets and marine propulsion. Parts and service are available throughout Canada.

Lister HA air cooled range. Direct injection for cold starting and greater economy. 10 BHP per cylinder continuous rating. 1800 RPM. Designed for working under the most varied conditions.

Write us for your free copy of Bulletins LD, SL and HA which describe, in detail, the Lister air-cooled range of Diesel engines 3½—30 BHP. Indicate application.

Lister-Blackstone engines 3½—1400 BHP.

CANADIAN LISTER-BLACKSTONE LIMITED

1921 Eglinton Ave. E., Scarborough, Toronto 13, Ont.

VANCOUVER

MONTREAL

In the U.S: Lister-Blackstone, Inc., 42-32 21st Street, Long Island City 1, N.Y.

For complete details check No. 9 on handy card, page 41

THE **Bendix**® ELECTRON TUBE YOU NEED IS HERE!

GROUP I—RECEIVING TUBES

HY-G-200®

EIA Type No.	JAN Type No.	PROTO-TYPE	BENDIX Type No.	DESCRIPTION
5838		6X5	TE-3	RECTIFIER. Full-wave
5839	5839	6X5	TE-2	RECTIFIER. Full-wave
5852	5852	6X5	TE-5	RECTIFIER. Full-wave
5992	5992	6V6	TE-8	AMPLIFIER. Beam power
5993	5993	6X4	TE-10	RECTIFIER
6106	6106	5Y3	TE-22	RECTIFIER
6385		2C51/5670	TE-21	MINIATURE TWIN TRIODE
6486		6AS6	TE-11	MINIATURE PENTODE
6582		6AK5	TE-35	MINIATURE PENTODE

HY-G-300®

(Reliable, hard glass, ceramic spacers, 300°C Bulb Temperature Rating)

6080WB		6AS7	TE-46	TWIN TRIODE
6082A		6082	TE-55	TWIN TRIODE
6094	6094	6AQ5/6005/6095	TE-18	MINIATURE AMPLIFIER
6384	6384	6AR6/6098	TE-27	AMPLIFIER Beam power
6486A		6AS6	TE-43	MINIATURE RF PENTODE
6582A		6AK5	TE-44	MINIATURE RF PENTODE
6754		412A	TE-36	RECTIFIER. Full-wave
6851		5751	TE-42	MINIATURE TWIN TRIODE
6853		5Y3	TE-45	BANTAM RECTIFIER. Full-wave
6854		2C51/5670	TE-47	MINIATURE TWIN TRIODE
6877		½ 6080	TE-48	MINIATURE TRIODE
6889		Top Cap 6384	TE-52	AMPLIFIER. Beam power
6900		5687	TE-54	MINIATURE TWIN TRIODE

COMPUTER TUBES

6888		7AK7	TE-40	GATED PENTODE
------	--	------	-------	---------------

GROUP II—MICROWAVE TUBES

EIA Type No.	JAN Type No.	BAND	BENDIX Type No.	DESCRIPTION
2K50	2K50	K	TE-4	REFLEX KLYSTRON
6116	6116	X	TE-62	REFLEX KLYSTRON
6541		K	TE-30	REFLEX KLYSTRON
6584		C	TE-38	REFLEX KLYSTRON
		Ka	TE-37	REFLEX KLYSTRON
		Ka	TE-53	REFLEX KLYSTRON
6845	6845 (US Navy)	X	TE-59	REFLEX KLYSTRON
6940		X	TE-58	REFLEX KLYSTRON
		K	TE-60	REFLEX KLYSTRON
		X	TE-61	REFLEX KLYSTRON
		V	TE-67	BACKWARD-WAVE OSCILLATOR
		C	RXB-103401	TRAVELLING-WAVE TUBE AMPLIFIER
		V	TE-66	BACKWARD-WAVE OSCILLATOR

GROUP III—GAS AND SPECIAL TUBES

SPECIAL PURPOSE GAS TUBES

EIA Type No.	JAN Type No.	BENDIX Type No.	DESCRIPTION
5643	5643	TD-17	SUBMINIATURE XENON THYRATRON (MIL SPEC)
5643		TD-37	SUBMINIATURE XENON THYRATRON (COMMERCIAL SPEC)
5947		TT-2	TEMPERATURE LIMITED DIODE
5960		TD-1	COLD CATHODE DISCHARGE
		TD-45	COLD CATHODE DISCHARGE
		TD-28	COLD CATHODE TETRODE THYRATRON
6142		TD-9A	GAS DIODE VOLTAGE REGULATOR
		TD-19	GAS DIODE VOLTAGE REGULATOR
6144		TT-1	NOISE DIODE
6352		TT-29	SUBMINIATURE TEMP LIMITED DUAL-DIODE
6361		TD-25	SINGLE CONVECTRON
5845		TT-30	MINIATURE TEMPERATURE-LIMITED DIODE

GROUP IV—GAS NOISE SOURCE TUBES

Frequency Range KMC	Band	Waveguide Number	Bendix Type Number	EIA Type Number	Mount Type	Recommended Mode of Operation	Anode Current MA	Tube Drop Volts	Excess Noise Ratio DB
1.12-1.70	L	RG-69/U	TD-21	6881	90°H	D.C.	250	65	15.2
			TD-29	7101	90°H	A.C. & D.C.	250	130	18.0
2.6-3.95	S	RG-48/U	TD-12	6358	10°E	D.C.	250	80	15.2
			TD-22	6782	90°H	A.C. & D.C.	250	45	15.2
3.30-4.90	S	WR-229	TD-24	6852	10°E	A.C. & D.C.	250	65	15.2
3.95-5.85	C	RG-49/U	TD-10	6356	10°E	D.C.	250	70	15.2
5.85-8.20	X	RG-50/U	TD-10	6356	10°E	D.C.	250	70	15.2
8.20-12.40	X	RG-52/U	TD-11	6357	10°E	D.C.	200	75	15.2
			TD-23	6882	10°E	D.C.	200	115	18.0
12.4-18.00	KU	RG-91/U	TD-18	6684	10°E	D.C.	200	70	15.2
18.0-26.5	K	RG-53/U	TD-13	6359	10°E	D.C.	200	65	15.2

GROUP V—SPARK GAPS

Type No.	DC Break-down KV	Initial Pulse Break-down KV	Repetitive Pulse Break-down KV	Watts Maximum Dissipation	Peak Discharge Watt-Second	Fault Surge Current Amps	Isotope Stabilization	Initial Equipment Usage	Configuration
TG-25	0.400			3	2		Yes	Safety	1
TG-26	0.75			5	2	1000	Yes	Safety	2
TG-27	1.0			5	5	1000	Yes	Safety	2
TG-30	2.0	3.0	2.7	5	14	2000	Yes	Safety	2
TG-34	5.0	8.5	5.5	5	19	3000	Yes	Safety	2
TG-37	10.0	20.0	15.0	5	22	4000	Yes	Safety	2
TG-56	20.0	23.0		7.5	30	5000	Yes	Safety	4
TG-60	50.0			7.5	50	6000	Yes	Safety	4

Many other models of Bendix gas noise source and spark gap tubes besides those shown here are available. There is also a HY-G-500 line of metal ceramic receiving tubes. For a completely up-to-date list, write

COMPUTING DEVICES OF CANADA LIMITED

Head Office: P.O. Box 508, Ottawa, Ontario
 Western Office: 712 8th Avenue, S.W., Calgary, Alberta
 Toronto Office: 164 Eglinton Ave. E., Toronto, Ontario

5806



COMPUTING DEVICES OF CANADA LIMITED
 P.O. BOX 508 • OTTAWA • CANADA

For complete details check No. 11 on handy card, page 41

As processes become more involved and their management more complex, a clear need has arisen for complementing human operators with advanced monitoring and control techniques and devices.

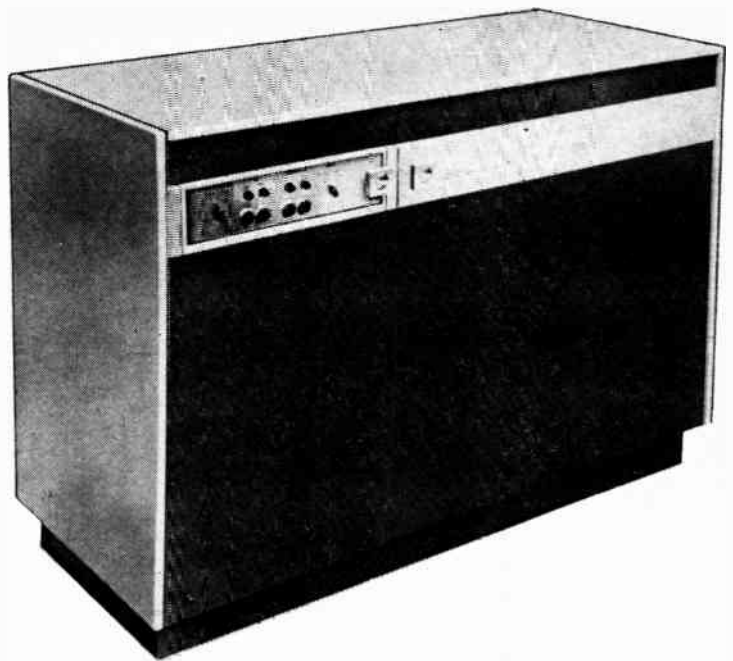

Fig 1 — Compact cabinet houses programming, computing and prime data processing elements of new process control system. To arrive at control decisions to optimize a process, information from monitoring instrumentation, complemented by fixed data and similar information from operating personnel, is processed by the computer.

Computerized process control

In attempting to optimize process control, the key to success is the matching of data processing with the time-control requirements. The vast amounts of data reflecting variations in the process must be collected, analyzed and displayed to permit control decisions to be made in time to effect corrective and optimizing action.

When large numbers of variables with rapidly changing values are involved, the factor of time is especially important. Time lost in the preparation suitable for making decisions results in very large losses in quality, reliability, efficiency and safety.

The real advantage of computerized process control is that it permits control decisions to be made at rates which match the time constants of the process and system involved. It is impossible to optimize a multi-variable process with control decisions which are effected after the variables have exceeded the allowable limits.

The time factors involved vary from process to process, and each process control situation requires control elements custom tailored to particular specifications.

Cognizance of the wide variety of control problems and the diverse operations involved dictated the design of the Libratrol-500 as a highly flexible and versatile process control system with adaptability to existing and "in design" industrial processing systems. The computer, which forms the basic portion of the control system, was developed to cope with the large number of variables, needs for intermittent information storage, and rapid computation common to the majority of process problems. Complementing the computer is the wide range of input-output equipment which creates a logical control system without excessive instrumentation.

These provisions in the Libratrol-500 for adaptability to a wide variety of process control requirements are

the result of applying the systems engineering approach to the problems of process control. Systems engineering recognizes the need for designing every element of a complex system in terms of its contribution to the final output, and with due regard for the inter-relationship of each particular element with the other elements of the system.

To be most effective in contributing to the system output, each element of the system must be ideally compatible with the other elements. To insure that process efficiency would not be affected by computer or control system characteristics, the Libratrol-500 was designed to contribute to overall system performance while complementing an extensive range of compatible process elements.

The action of this new process control system extends from the data sensing and gathering devices, through the data processing and computing modes, to the final decision making and controls actuation. The extent of the system's activity in any one of the above areas is, of course, dependent on the requirements of the process involved.

The basic "building block"

Basic building block of the process control system is a highly reliable electronic digital computer designed specifically for the computation and control requirements peculiar to process control. The computer operating on input information supplied by the process instrumentation performs the computations, logic manipulation, and decision making operations required to effect the control actions. Computer operation is serial, single address, fixed binary point, with internally stored program.

Inputs to the computer are derived from standard process instrumentation and may be in the form of voltages from analog instruments, signals from digitiz-

ing transducers, and fixed data and similar information from the process operating personnel.

Operating in the binary numerical system, the computer requires information in digitized binary form. Suitable conversion units for the various data sources perform the translation.

Input rate of the computer is 200 data words of 31 bit length per second. Inputs to the system are scanned and conditioned on command from the internal stored program regulating the computer functions. The program directing the computation and control system operations is stored in the computer and can be modified to incorporate desired operating functions.

Capabilities of the arithmetic unit include add and subtract times of two milliseconds minimum, multiplication or division times of 15 milliseconds minimum.

The magnetic drum storage unit has a capacity of 4,096 words.

Outputs from the computer may be in the form of voltages to actuate control elements, digital data for presentation to operating personnel, or punched tape for further data processing operations.

Power requirements for the computer only are 115 volt, 60 cycle single phase, at 13 amperes. Instrumentation, conversion, actuating, and other complementary equipment for specific applications require additional power.

Modes of operation

The new system operates in one of three modes. In its basic mode of operation, data processing, it monitors the "on-stream" process, compiles the various data, performs the required computations, and presents the information to the process operator. All subsequent evaluations and decisions are the responsibility of the operator. In addition, specific information which is vital to accounting and management is tabulated by the system.

Computer-directed control is the second mode of operation. Here, the equipment is used to calculate, on

the basis of data monitored by the instrumentation and information and logic stored in the computer, what the optimum set-points in the process should be to realize maximum efficiency, maximum output, or to reach a desired operating state in the minimum time. This information presented to the operator permits him to alter the process controls in keeping with the optimizing criteria and additional factors which the computer may not take into account. Again, besides effecting optimum control of the process, the equipment provides information of value to management regarding the overall operation.

In those processes where the relationships between the primary variables and the secondary process characteristics are firm enough to establish automatic operating criteria, the apparatus is used in its third mode of operation: automatic control of the process. With the control loop closed through the system, instantaneous regulation of the process is accomplished by conventional feedback controllers with the computer carrying out the automatic trimming operations by monitoring set-points and changing them as calculations indicate the necessity.

These three modes of operation of the process control system are indicative of the capabilities of the system to handle the wide range of process control problems. Its ability to grow with the development and expansion of the process is proper insurance against obsolescence. The versatility of the system and the ease with which it can be adapted to specific control problems guarantees its ability to incorporate new control elements as they are developed.

Open hearth installation utilizes basic mode

Optimizing an open hearth installation in a steel plant requires more than just the optimization of each separate heat with regard to quality and time involved. Since furnace operation and maintenance is one of the prime cost factors, optimization implies that the entire operation must be considered with maximum utilization of the furnace as the prime objective.

Each batch or heat of steel is produced according to a fixed schedule of furnace operations. As the heat is finished and the furnace tapped, the furnace must be prepared for the next heat. Above all, the furnace must be maintained at

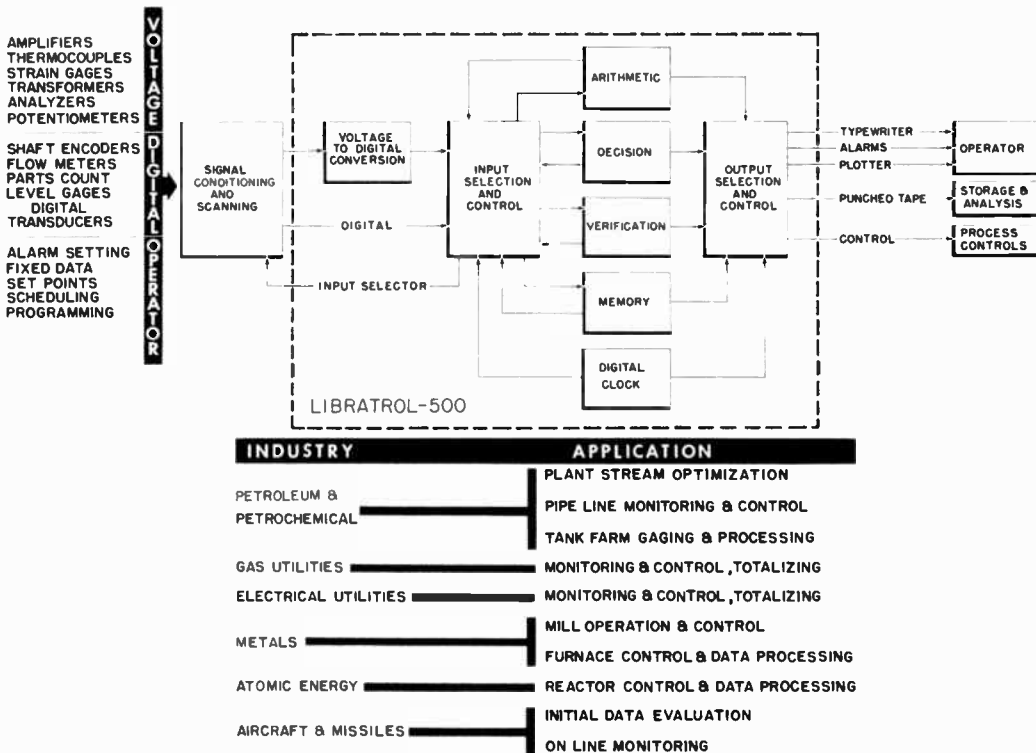

FIG 2 - LIBRATROL-500 PROCESS CONTROL SYSTEM

Extensive capabilities of process control system are shown in this general block diagram. System monitors wide range of monitoring instrumentation to obtain data with which to compute control action necessary to optimize process.

temperature, both to avoid costly re-heating and to avoid the damage due to cooling.

Optimization of the open hearth operation requires, then, that schedules be established on the basis of production requirements and in accordance with the criteria of minimum time between furnace heats. The Libratrol-500 process control system installed in an open hearth operation provides the monitoring and data processing necessary to accurately investigate the basic nature of open hearth operation and establish optimum scheduling programs. Each furnace is monitored with regard to time history of operation and fuel flow. As each heat is started the computer begins to record the fuel consumption and time involved in each step of the steel producing process. A typical heat program is: start charge — end charge — hot metal — end hot metal — end lime boil — tap.

The periods between tap and start of the next heat are referred to as make-up time. In normal operation specific time intervals are allotted to this make-up period. Any extension of the make-up period is credited to delay time.

Each type of steel produced in the open hearth has a specific time program with various steps which vary in time duration. The problem then is to arrange the scheduling of these various heats with regard to the specific furnace used and with regard to order of occurrence.

Figure 3 is a schematic of the open hearth installation showing the system in its basic mode of operation. Each furnace in the installation is continuously monitored for fuel consumption and time history of opera-

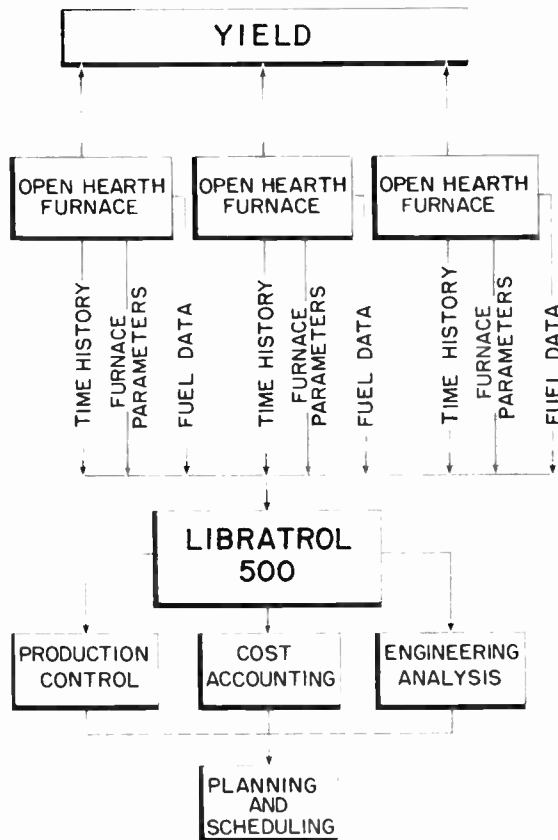

FIG 3-OPEN HEARTH STEEL FACILITY

Furnace time-histories of operation sequence, furnace parameters such as temperature, pressure, and combustion analysis plus fuel consumption are monitored by process control system in this open hearth installation.

tion sequence and furnace parameters such as temperature, pressure, and combustion analysis. Furnace operators indicate the status of the furnace and the point in the heat cycle by pushing the appropriate data insert button on the operating panel stationed at the furnace.

Data from each furnace on the line is compiled and processed by the computer and presented in typed form. The tabulations indicate the condition and performance of each furnace and the corresponding fuel consumption. Immediate indication of unscheduled delays in furnace operation is made to both operator and shop superintendent.

The tabulated data reviewed by the production control, engineering, and cost accounting departments gives valuable insight into the basic nature of open hearth process control. Examination of the time histories and the fuel usage histories provides the information upon which future scheduling can be planned to make maximum utilization of the facility.

Gas system calls for computer-directed control

Costs of public utilities are largely dependent on the efficient control of demand to avoid peaks which result in higher rates from the supplier. To accomplish this, the supply and distribution systems must be constantly monitored to prevent the occurrence of peak loads above the acceptable rate level. Gas distribution systems present particularly severe control problems in that the calculation required to determine the actual gas flow from pressure, temperature, and specific gravity information are rather involved and very time consuming.

Figure 4 is a block diagram of a gas distribution system utilizing the system in the computer-directed control mode of operation. Supply and distribution lines are continuously sampled for pressure, temperature, and specific gravity information. These data are converted to gas flow measurements by the computer which presents the information as gas demand and supply.

A program retained in the computer establishes the operating conditions of the system with regard to the allowable demand and determines if the system is approaching an unsatisfactory demand condition. If the demand exceeds a level set by the rate schedule, the computer alerts the control supervisor who then

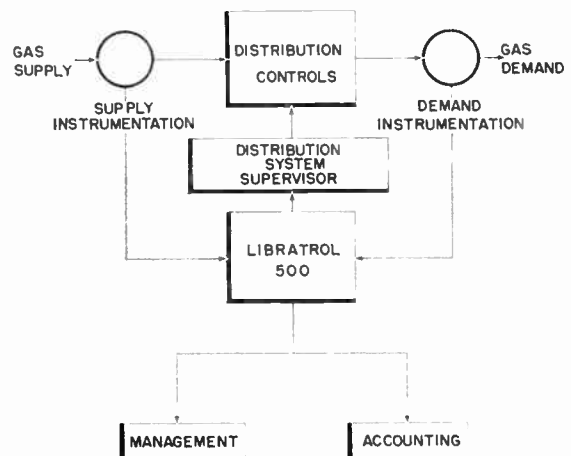

FIG 4-GAS DISTRIBUTION SYSTEM

Gas distribution system scans supply and distribution lines for pressure, temperature, specific gravity and flow data.

takes appropriate re-distribution measures to avoid exceeding the allowable level.

In addition to the functions of directing the distribution system, the equipment also provides the cost accounting department with the total gas demand and supply figures for a given time period.

By continuous monitoring of the distribution system and providing operating personnel with accurate real-time evaluation of the status of the system, the Libratrol-500 increases the operating efficiency of the gas distribution system and insures that the utility operates with maximum rate benefits to its customers.

Chemical process requires real-time, closed-loop control

True optimization of continuous chemical processes can only be obtained when the control system can respond to process conditions within the time base of the process. If control system response lags, the occurrence of variations in process conditions, due to time delays in discovering, analyzing, and taking action to correct undesirable conditions, will seriously affect the output, quality, and efficiency of the process.

In general, the prime cause of time lags in correcting adverse conditions is the delay in preparing and analyzing the data which represents the operating status of the process. Chemical processes with the many diverse stages of operation, various material inputs, and multi-stage outputs are especially subject to these delays because of the vast amount of data involved, and the complex nature of the computations required for thorough analysis of the conditions.

Correction of these conditions requires that the process characteristics be continuously monitored, that these characteristics be interpreted in terms of process performance, and that the interpretation be related directly to control of process parameters within time intervals short enough to effect efficient corrective action.

The major difficulty in effecting this control of a continuous process is the large amount of data which must be processed to determine the status of the operation. Manual reduction and interpretation of these data to the point that control decisions can be made and manual actuation of the control mechanisms accomplished are impossible within the time interval required in continuous processes.

Fully automatic control of the process using this process control system is the solution to the problem of matching the data processing and control action to the time characteristics of the process. Figure 5 is a block diagram of a typical chemical processing operation with the equipment installed to fulfil the complete automatic control requirements.

Process characteristics, which include specific chemical properties of the input materials and the final and intermediate products and physical conditions such as pressure, volume, and temperature existing at key points in the process, are continuously monitored by

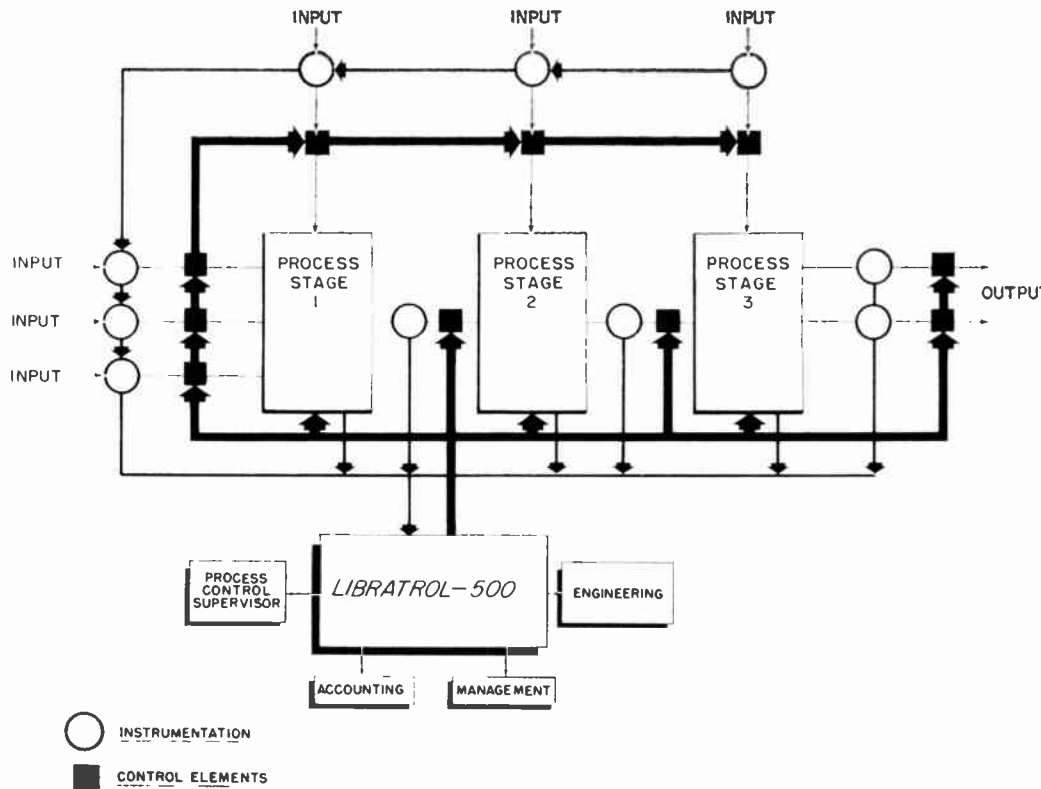

FIG. 5—CHEMICAL PROCESSING SYSTEM

Process control system monitors chemical and physical parameters of the process. It interprets data in terms of process status and performance, and optimizes production by actuating control elements.

sensing and analyzing equipment. This information is converted to digital form and fed to the digital computer. Here programs stored in the computer process the data and interpret the results in terms of system control requirements. Output signals from the computer alert the operating personnel to the process status and simultaneously effect the required control action.

This continuous monitoring and adjustment of process conditions in accordance with optimization criteria programmed in the computer provides marked improvement in productivity, product quality, and operating efficiency.

Naturally, the extent to which these improvements are accomplished depends on the degree to which the relationships between process parameters and process performance are known. However, whatever the level of analytical knowledge of the process performance, valuable contributions to optimizing the process can be made by application of this new process control system. In fact, the solution to the basic problem of determining the effects of the variations in process can be greatly accelerated. Pilot plant studies and even short run analyses of the process can be made under the control of the Libratrol-500. By programming the system to introduce variations in the process parameters, and to monitor the effects of these variations on the process, it is possible to determine the inter-parameter relationships and establish the optimizing criteria.

Versatility and adaptability

Success of this process control system is based on its adaptability to the wide range of processes requiring computer control aid, and its versatility in these applications of handling the many facets of process control. These advantages are the result of extensive development work undertaken by the manufacturers to produce a system specifically designed to meet the control problems common to all processes and with the flexibility required to make it adaptable to the specific problems of particular processes.

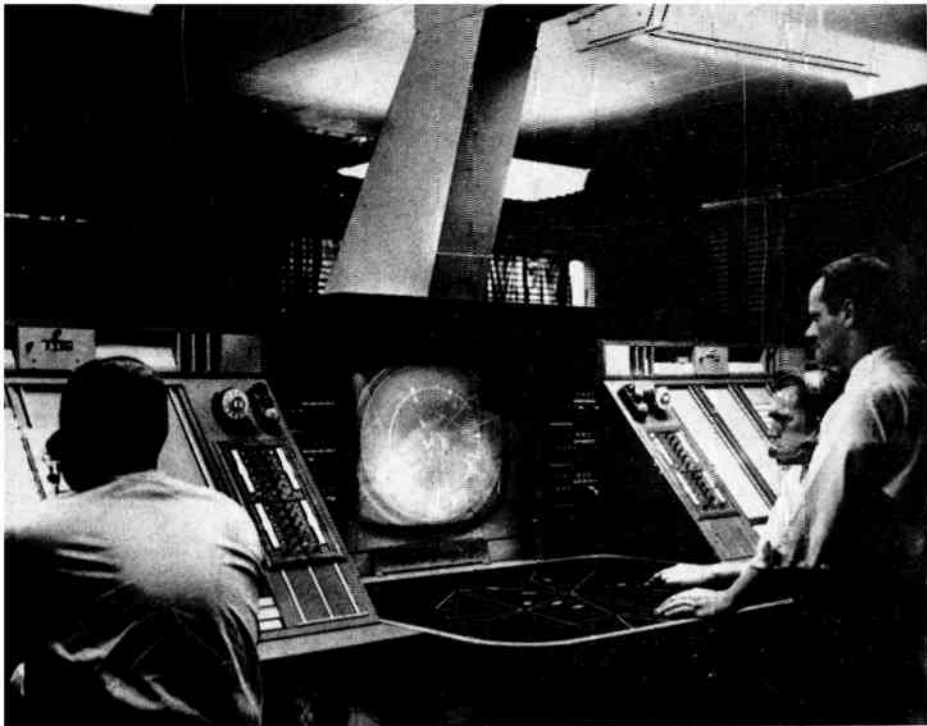

Superimposed panoramic radar display (SPANRAD) combines radar display and operations board image on same TV picture tube. Overhead box contains vidicon TV pickup for obtaining image of board. Scan conversion permits daylight viewing of transformed radar information on conventional TV receiver.

A new two-gun cathode ray tube capable of transforming and preparing basic radar information for a variety of types of display permits

Scan conversion equipment to supply brighter radar displays

Radar traffic controllers will direct aircraft from well lighted rooms instead of from semi-darkness with new equipment that converts radar information to a brighter and more flexible daylight television type of display for air traffic control purposes.

The Civil Aeronautics Administration, U.S. Department of Commerce has ordered 13 TI 440 scan converter units for this purpose.

Installation of the TI 440 equipment will be made at CAA operated air route traffic control centers and airport traffic control towers to be selected when delivery of the first equipment is made in approximately 60 days.

Features of the 440, other than successfully solving for the first time the old air traffic control problem of providing for bright displays of basic radar information, is the ability of the equipment to retain radar targets on

the display for up to 30 minutes and to show a trailing blip indicating previous positions of the target. The trailing blip has the advantage of keeping the controller continuously aware of the direction of the aircraft he is "working" and thus making it easier to detect possible collision courses. Both the target retention and the trailing blip may be controlled to suit local conditions giving great flexibility of use to the radar equipment.

Heart of the 440 scan converter is a two gun cathode ray tube made in France by Compagnie Generale de Telegraphie sans Fil of Paris. This tube takes the basic radar information and transforms it and prepares it for a variety of types of display.

The CAA initially will run radar data through the 440 equipment and display it on 20-inch horizontal television monitors. However, the converted radar information is readily adaptable to other types of



The INTEC Video Transformation Tube, TMA-403X, is extremely versatile, providing for fine grain signal resolution, a broad dynamic range of signal amplitudes and a signal remanence that is broadly controllable in time.

display and may be projected on huge screens if desired.

Until the present all CAA long range radar information for air traffic control has been displayed on the only equipment available, old World War II surplus military horizontal scopes that have not met the need due to low light levels plus the difficulty in maintaining them.

The CAA already has three TI 440 scan converters at its Technical Development Center at Indianapolis where they have been under evaluation since last spring.

Technical description — scan conversion

Scan conversion equipment takes conventional radar information and converts it into a composite television signal permitting direct viewing on a conventional TV receiver. The advantages of a scan converter over the conventional PPI radar display are the following:

The controllable video transformation tube retains target information that allows the operator to see the past track of the aircraft and also predicts its future position (memory characteristic).

A bright display is obtained that permits viewing in full daylight (conventional radar displays normally require a darkened room for viewing).

A wide variety of relatively inexpensive studio TV equipment is locally available for use with the scan conversion equipment.

It provides higher resolution than the PPI (no blooming of target echoes or sweep trace).

The transformed radar picture may be easily transmitted from one control center to another by means of conventional microwave equipment or coaxial cable.

Video transformation tube TMA-403X provides a controllable link between the radar and television circuits. The TMA-403X employs two axial opposed guns in a single cathode ray tube. One gun writes radar information with its electron beam on an internal target membrane. The other gun reads TV information from the target membrane. It is a semi-conductor type storage tube in which the two guns are in a physical arrangement that allows instantaneous transformation of video signals from one coordinate system to another (polar to rectangular) through simultaneous and non-synchronous scanning of both sides of the target membrane.

At the center of the TMA-403X tube is a target collector group. The group consists of a collector which we refer to as C_1 , a correction ring which we refer to as C_2 , and a target membrane which is similar in operation to a mosaic screen.

The reading gun charges one surface of the target

membrane to approximately the potential of collector C_1 . A thin aluminum film on the other surface of the target membrane is attached to a metal ring at the output of the target, which is at ground potential. Due to the proximity of these members, C_1 is held at a safe potential to prevent breakdown of target insulation.

The correction ring is used to reduce the level of the parasitic shading signal. This signal appears in camera tubes having a secondary emission greater than 1. The voltage of C_2 is approximately equal to that of C_1 . The exact value is determined experimentally for each installation.

The output signal, in the order of a millivolt for a load impedance of 2,000 ohms, provides a maximum useful current of 0.5 microamperes. It is possible to read the output signal of the target group from 15 seconds to over two minutes before erasure of written information; this, however, is a function of the operating point of the tube. Storage is controlled by the voltage applied to the collector, the writing-beam current, and the reading-beam current. The target is erased by reversing the voltage relationship between the target membrane and the collector.

For its writing function the scan converter requires radar trigger, synchro information from the radar antenna and radar video information. The trigger is used internally to develop the radar sweep and range marks. The antenna synchro information is used to develop the antenna rotation and angle marks information. The radar video is presented without modification. The results of these operations are applied in standard PPI form as a charge pattern on the memory surface of the TMA-403X video transformation tube.

The read-out is accomplished in the following manner:

A master synchronizing generator, locked to the 60-cycle line frequency, develops the television timing signals for the horizontal and vertical triggers, horizontal and vertical blanking, and horizontal and vertical unblanking of the video transformation tube.

The reading beam of the tube is deflected in television raster form by the above-mentioned signals. TV video information is thereby generated at the target membrane of the video transformation tube. This information is collected and mixed with the necessary synchronizing and unblanking information to produce a composite TV signal.

In control room operation, scan conversion equipment will facilitate less fatiguing observation of displays and help to solve the increasingly complex air traffic problem.

The scan converter has been used in conjunction with CPN, ASR and FPS series of radars.

Diagram of two-gun cathode ray tube.

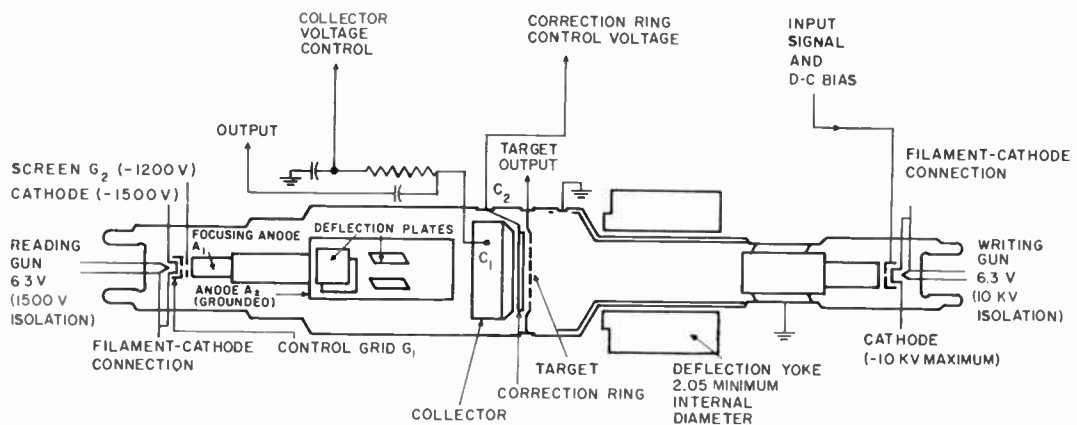

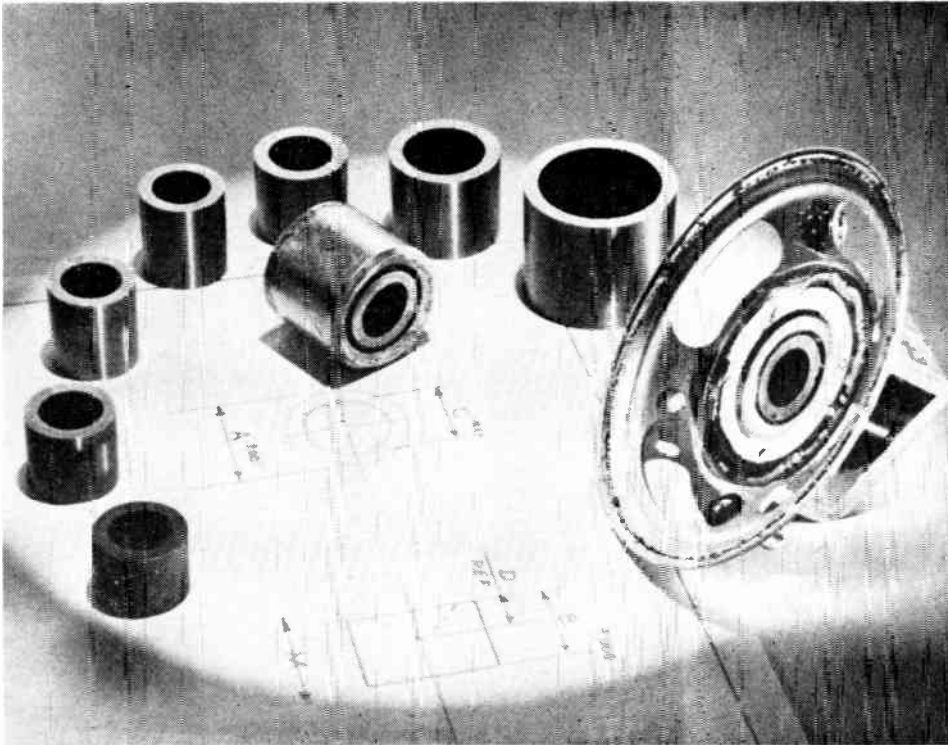

Standardization by Thomas and Skinner Inc., manufacturers of permanent magnets, has resulted in the production of a complete range of magnets that meets the needs of more than sixty per cent of all loudspeakers and transceiver applications.

Every company needs at least one "standardization oriented" individual to dig, question, analyze, reveal, and act upon opportunities. His salary can be your best investment.

Continuing standardization linked with electronics progress

by Vincent de P. Goubeau *

The title of a recent trade paper article stated that a certain industry, "Doesn't Buy Half as Well as it Knows How." The article pointed out that \$20 million of the industry's purchasing dollars goes down the drain annually because of major purchases of non-standard items.

Standardization is a little like virtue. You can't simply approve of it and practice it only on Sunday. Inevitably a little sinning begins to creep in and pretty soon the backsliding becomes general and substantial. You have to keep working at it.

The same holds true in standardization. In industry, two little sins are standpatism and complacency over things as they are. Unchecked, they can very soon add

up to the more significant sins of inefficiency and operating losses. However good its intentions, there isn't a business represented here that isn't subject to this form of failing. By the same token, there isn't one that doesn't stand to gain considerably by a continuing and realistic review of its standardizing efforts.

Key to effective standardization

The key word to effective standardization is "continuing". We operate on this basis in the Radio Corporation of America and throughout the electronics industry. We have learned that you cannot take an occasional look at standardization and expect to achieve anything solid and enduring. Standardization is a full-time basic industrial function whose activities

* Vice-president, Materials, Radio Corporation of America, Camden, N.J.

affect the performance of every other operating function of the business.

Concentrating on some specifics of this word, "continuing", it is pointed out that in the American Standards Association, the Electronic Industries Association, RCA, and in other associations and companies, standards are limited to a maximum five-year life. Many standards fall before the tide of progress in less than that time. Those that survive the five-year period are subject to critical review before they are continued as is or in revised form.

These are vitally important policy decisions. They require continuous effort by the standards experts on the industry level and, above all, on the company level where it is often necessary to act long before a standard can be cancelled or modified nationally.

A substantial contract received some years ago by RCA raised this very point. It concerned the use of the customer's standard items throughout the equipment which we were manufacturing.

As a result of national standardization, the customer's standards were generally identical with those current in RCA. This helped to speed the contract through development and product design, and to facilitate production. But in one area not then covered by national standards — insulated wire and cable — the customer's standards still included a type of hook-up wire that had long since been discarded by RCA. At one time it had been one of the best wires available, but since then it had become obsolete. It was twice as expensive as its modern counterpart, and difficult to strip, clean, and tin. Very tactfully, our standardizing division brought the matter to the attention of the customer and the new wire was promptly approved.

This incident is cited as an example of the need for

standardization to keep abreast of all phases of production and to adjust accordingly. Failure to eliminate items that have been topped by new and better products is what eats up purchasing and production dollars and weakens a company's profit position.

Effect on processes and products

The effects of standardization are felt not only in current industry developments; they have a definite impact on the industrial process and its products. Throughout a wide cross section of industry, executive thinking today is focussed on electronic data processing systems. Many of the larger companies have purchased or rented installations. Thousands of smaller concerns are waiting for the day when such equipment will come within the range of their more limited budgets. This day is close at hand as a result of major technological breakthroughs in which standardization has served as a silent partner. This partnership began in development and design. It continued in the engineering phase where standardization hastened the construction of parts for prototypes, thus further reducing time and cost expended in the period between the development of the idea and construction of the working model. It carried on through the production stages.

Only one year ago, for example, a typical electronic data processing system contained thousands of electron tubes. It required an elaborate, high capacity air-conditioning installation to carry off the heat generated by the tubes. The RCA 501 electronic data processing system, now in production, is about one-third the size of a less versatile system of a year ago. A look behind its standard doors and inside its standardized cabinets, however, might give the impression that it is not electronic because the standard electron tubes usually associated with such equipment are missing.

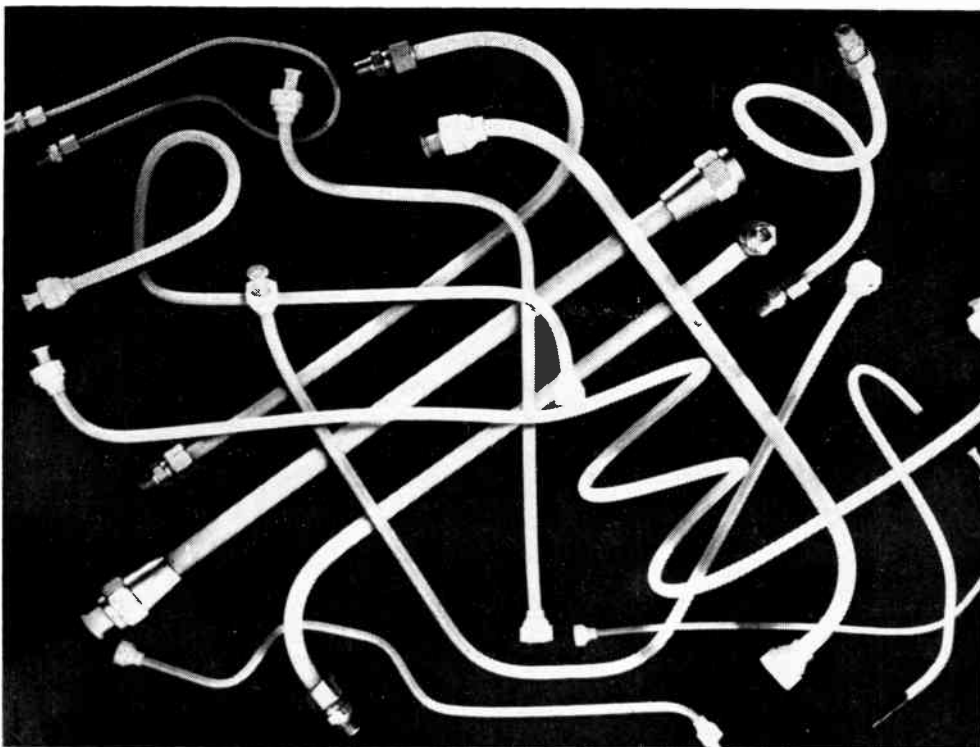

Another example of standardization is the volume production of prefabricated assemblies which substantially reduce costs of tubing manufacture at Polypenco Inc., Reading, Pa. Refined methods of mass production reduce handling time per unit in the manufacture of Nylaflo tubing, a flexible polyamide tubing for use in hydraulic, lubrication, pneumatic, instrumentation, oil, chemical and beverage lines.

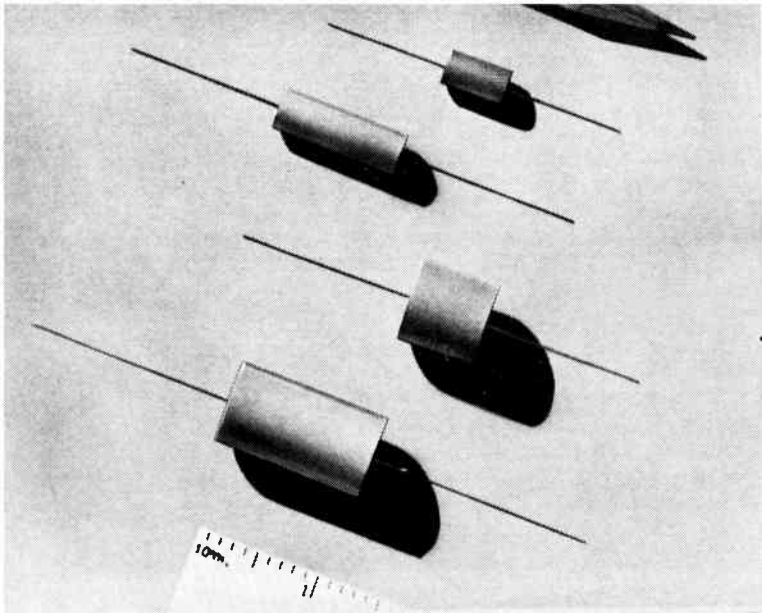

A new line of Zener reference "strings" manufactured by the Hoffman Electronic Corporation, Evanston, Ill., and designed specifically for an extremely low amount of voltage change over a wide temperature range eliminates the necessity for designing a special product each time an application arises.

Insofar as computer trends are concerned, the electron tube, an indispensable standard for many years, is being displaced by the tiny and more reliable transistor. With the elimination of thousands of tubes, a major source of troublesome heat problems also has been removed. As a result, air-conditioning requirements for today's modern electronic data processing systems consist of little more than a conventional installation for the space occupied.

In the data processing field, a dynamic standardizing program which is part and parcel of the design program and which keeps pace with technological advances, is bringing such equipment within the reach of more and more companies. There are impressive benefits, not only for the electronics industry, but for every industrial and commercial enterprise.

Use of established standards in simplification

Value and reliability are key elements in electronic component and equipment design. Value engineering is essential to make certain that component or item of equipment is designed as simply, as straightforwardly, and as economically as possible, in keeping with the functions it must perform. This means designing out complexities and parts which do not enhance capability and reliability. Frequently the simplicity derived from value engineering contributes to greater reliability and to cost reduction.

In RCA and, I believe, the entire electronics industry, the pre-eminent factor in maximizing both reliability and value is the full utilization of established standards. The following is an example from the files of one of the RCA value analysis teams: "A large

ground-based instrumentation tracking radar system, being produced in quantity, employs a boresight target for calibration purposes. The value team analyzed the boresight target assembly with the express purpose of reducing the then prevailing cost of \$3672. The original design contained several special castings, a rectangular box team, and complex leveling mechanisms." The team members posed this question: "Are there standard parts that will do the job?" There were. A complex truss beam was changed to a length of standard round aluminum pipe. All clamps, levels, and threaded castings were changed to standard commercial hardware. Practically every change made was possible because of the existence of an applicable standard to replace an expensive, specially tailored part. The resulting cost reduction was \$1412 per assembly. Project this saving to a modest and hypothetical production quantity of 1000 units and you have the tidy sum of roughly a million and a half dollars. This leaves no doubt in my mind as to the benefits available through standardization.

Thus far a discussion of standardization of products has been dealt with. But don't overlook the standardization benefits available in every other area to which purchasing and manpower dollars are committed. I am thinking of such facilities as office equipment, office furniture, printing devices, production and processing machinery, maintenance stores, stationery and office supplies. I also want to mention standardized numbering systems and paper work procedures.

Recently, for example, in one of our materials operations all available filing space for yellow copies was completely filled. While waiting for an additional filing cabinet the yellow copies piled up. An inquisitive manager noted the accumulation and questioned a clerk whose job it was to file yellow copies: "What happens after you file them — who uses them?" The answer was that nobody used them because they also had a pink copy file which nobody used much either. Needless to say a lot of yellow paper quickly disappeared. The filing cabinets and floor space were made available for constructive use. You can do a lot with this word standardization if you know how to use it.

The fact is that opportunities to derive benefits from standardization are everywhere about us. But at every point where I have used the term, I would like to prefix it with the word dynamic. To me, this means the constant change and advance needed to keep pace with progress. Few opportunities for dynamic standardization are going to present themselves; they must be sought out. They are evasive and frequently hidden behind a screen of paper work, established practice, company policy, entrenched habits, complacency, and preoccupation with current emergencies. Every company needs at least one "standardization oriented" individual to dig, question, analyze, reveal, and act upon opportunities. His salary can be your best investment.

Television from sound waves

A television camera which creates an image from sound waves instead of from light waves and which can give an X-ray-like picture of the internal structure of metals and other engineering components as well as of the human body, and which can show underwater objects, has been built by British scientists. Dr. C. N. Smyth of University College Hospital Medical School explained that sound waves are very similar to light

waves and can be focussed in the same way with lenses, so that the image of an object exposed to noise is formed and can be reproduced at a distance.

The ultra-sound "television" camera has a sound-sensitive receiving surface — a bare slice of crystalline quartz — which develops, on each point of its surface receiving a sound impact, a voltage proportional to the ultra-sound intensity.

Lenkurt

microtel

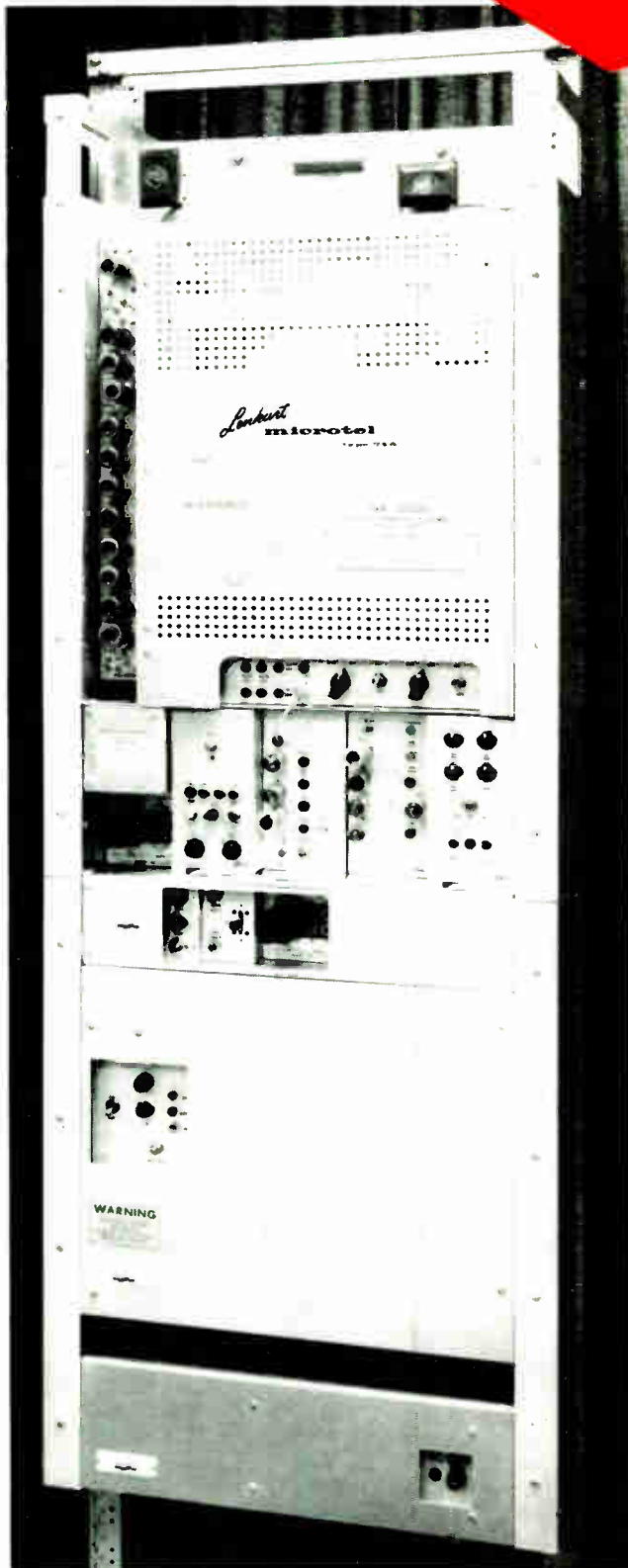

NEW microwave equipment for the 6000 mc. band.

Microtel is *new* . . . the most advanced microwave radio equipment on the market. Designed for high quality transmission of telephone, telegraph, teletyping, and other types of information, it can be equipped to operate throughout the range 5925 to 8500 megacycles.

Microtel is equally satisfactory whether the need is for only a few circuits or for a high density network requiring as many as 720 voice channels. It is available from Automatic Electric as a complete package—engineered, supplied and installed—on one order.

FEATURES

- ▶ **POWER OPTIONS**—Operates from standard office battery supplies or from 115-volt a-c mains.
- ▶ **LOW POWER CONSUMPTION**—Unique design permits economical office battery operation.
- ▶ **EASE OF INSTALLATION**—Standard 19-inch rack mounting; compact plug-in construction; space-saving—no rear access required.
- ▶ **EASE OF MAINTENANCE**—Components accessible from front; built-in test facilities fully alarmed.
- ▶ **STABLE OPERATION**—Use of reference cavity and heat sinks eliminates conventional ovens and blowers.
- ▶ **ECONOMICAL EXPANSION**—With Lenkurt 451X carrier, a single terminal can accommodate up to 240 channels; with r-f circulator, 2, 3 or 4 terminals can be added to same antenna system.
- ▶ **REPEATERS**—Back-to-back terminal equipment permits dropping and reinserting of channel groups; automatic switching permits unattended operation.

For complete information write or call your nearest Automatic Electric office.

Automatic Electric (Canada) Limited, 185 Bartley Drive, Toronto 16, Ontario. Branches in Montreal, Ottawa, Brackville, Hamilton, Winnipeg, Regina, Edmonton, Vancouver. 5816-R

AUTOMATIC  ELECTRIC

ORIGINATORS OF THE DIAL TELEPHONE



For complete details check No. 4 on handy card, page 41

**THE TYPE 86
TELEPHONE FOR
MULTIPLE SERVICE**



Type 86 Telephones provide an efficient and flexible trunk answering service, where a private branch exchange is not justified. They are also useful in conjunction with a branch exchange for personnel requiring frequent or rapid access to lines.

They can be used to answer and hold calls on up to 6 lines—in any combination of outside and local lines. One line can also be used for pushbutton signaling, or to disconnect extension or local line.

**TYPE 85 TELEPHONES
WITH 2-LINE
PICKUP**



Type 85-C . . . combines a unique push-and-turn button with two exclusion keys to provide complete switching facilities. Pressing the first key cuts off all extensions on Line 1, pressing the second reconnects them. Extensions are restored when handset is replaced. Turning the push-and-turn button connects a second line. Pressing it signals secretary.



Type 85-B . . . equipped with two push-buttons for linking or disconnecting extension phones. Can be wired for separate use of two lines. User switches to Line 2 by pressing button. Line 1 is reconnected when handset is replaced.



Type 85-A . . . wired for 2-line pickup and signaling. User turns a button to switch over to Line 2, and can also signal secretary by pushing button. Can be wired on the job for a variety of applications—for use as an extension telephone, for instance, or linking by the turn of a button with an extension phone or handset.



THE TYPE 88T TRANSISTORIZED SPEAKERPHONE

**TINY
MICROPHONE
PICKS UP VOICES
SEVERAL FEET AWAY**

Leaves both hands free for leafing through papers, writing, etc. When telephone rings, user simply presses "on" button and starts talking—in a normal tone, with complete freedom to move about his desk. When conversation is over he simply presses "off" button.

Can be used for telephone "conferences", too. Tiny microphone in base picks up voices several feet away and speaker volume can be controlled so others in room can hear. Transistorized construction eliminates bulky control unit.



**SPEAKER VOLUME CONTROL
IS BUILT INTO TELEPHONE**

For outgoing calls, user presses "on" button, and dials in the usual way, without lifting the handset. "Off" button disconnects. For private conversations, lifting handset cuts off speaker and microphone. To cut off the microphone only, depress the on-off button. A small light tells when handset is "off the hook", or "off" button has not been operated.

**SMALL, NEAT
SPEAKER TAKES ALMOST
NO ROOM ON DESK**

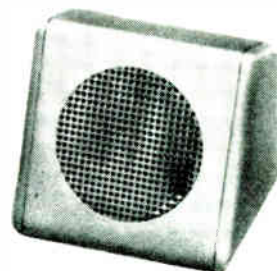

These aids to business efficiency mean **INCREASED REVENUES FOR YOU!** Special Telephones by Automatic Electric

Business organizations spend a lot of time and money looking for new ways to improve efficiency. But the key to efficiency, in many cases, is improved communications. Special Telephones now available from Automatic Electric, provide simple and effective solutions to many of the problems these organizations are faced with. Conferences, that otherwise could require hours of planning, can now be conducted in a few minutes over special telephones. Several calls can now be retained on the same telephone, and separate, private conversations carried on with the various callers. Some of the Special Telephones available—all useful sources of additional revenue for Canadian telephone companies—are described here. Call or write any Automatic Electric office for further details.

*Automatic Electric Sales (Canada) Limited, 185 Bartley Drive,
Toronto 16, Ontario. Branches in Montreal, Ottawa, Brockville,
Hamilton, Winnipeg, Regina, Edmonton, Vancouver.*



ORIGINATORS OF THE DIAL TELEPHONE



STANDARDS THAT DETERMINE
RELAY QUALITY . . . No. 2

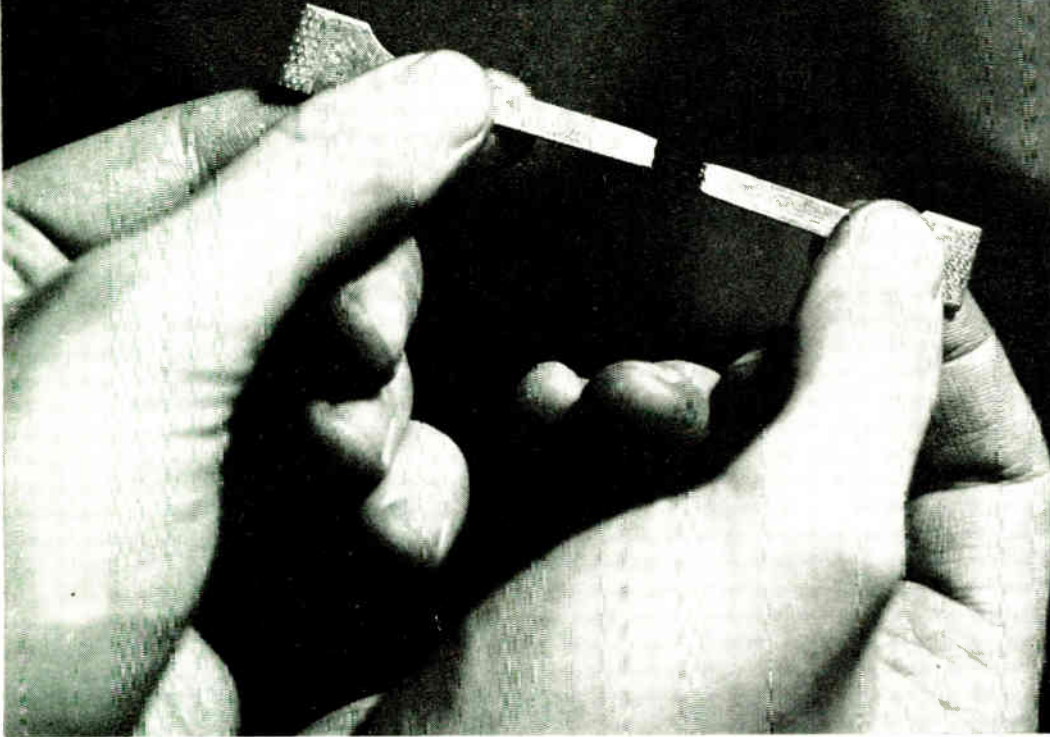

Elongation test of sample heelpiece metal typifies quality control measures that leave nothing to chance at Automatic Electric.

a distortion-proof heelpiece

53 dimensional checks assure perfect alignment

The heelpiece of a relay is the platform on which all other parts rest. To maintain accurate contact spacing and pressure, the heelpiece must never shift, never twist, never bend.

Automatic Electric insures flatness and dimensional stability on both Class A and Class B relays, by planishing the heelpiece to relieve strains. In addition, we exercise unusual accuracy in the positioning, drilling and tapping of the holes, in

forming the 90° angle bend, and in the contour or the armature end of the heelpiece.

On this single part, fifty-three specified dimensions are maintained and checked—many of which must be accurate to less than 0.002". Rigid tests and inspections safeguard the quality of the raw material itself—a very special sort of magnetic iron.

Care like this in the manufacture of each component makes it clear why Automatic Electric relays are the most reliable that money can buy.



Class "B" Relay, for outstanding endurance and dependability. Write today for information. Address: Automatic Electric Sales (Canada) Limited, 185 Bartley Drive, Toronto 16, Ontario. Branches across Canada.

AUTOMATIC  ELECTRIC

PIONEERS IN AUTOMATIC CONTROL



AN ORGANIZATION SERVING CANADIAN INDUSTRIES WITH COMMUNICATION, TIME AND CONTROL SYSTEMS

For complete details check No. 6 on handy card, page 41.

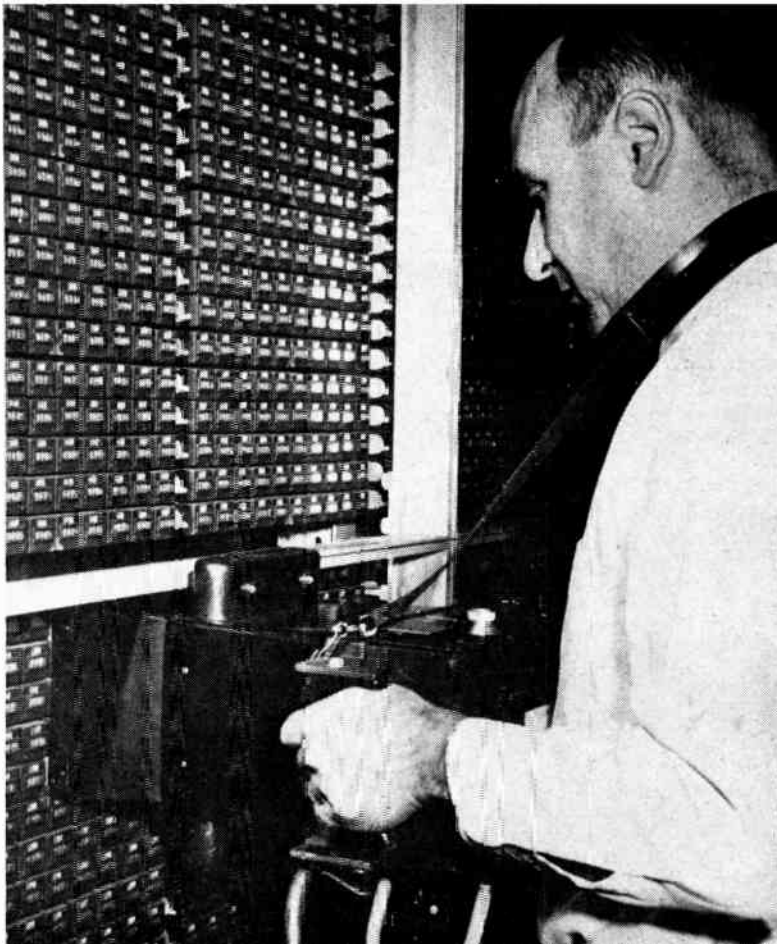

Figure 1

Specialized talents combine to produce fast and accurate billing tabulations for New York Telephone Company through the use of

Photographic registration of measured service 'phone calls

Accuracy, speed and simplicity are desirable in any process, in any business; and oftentimes in these days of specialization, it is wiser and more economical to produce segments of efficient operation rather than try to "do it yourself".

The telephone company uses the products of many manufacturers in striving for maximum efficiency of operation. One particularly interesting application involves the T-6 Factograph Camera, a product of Graflex, Inc., one of the world's foremost manufacturers of cameras and electronic equipment. The development of this unique camera was the result of cooperation between personnel from Bell Telephone Laboratories and Graflex, Inc.

The T-6 Factograph Camera is used in many telephone central offices to photograph monthly readings of measured-service registers for billing tabulation purposes. The camera photographs twenty-five message

registers at one time. Speed of operation is further enhanced by using a continuous roll of sensitized paper supplied in daylight-load cassettes on which eighty exposures can be made — 2,000 message registers per roll — and the camera cycle time is only three seconds per exposure. After each exposure the paper is automatically advanced and at the end of the roll the camera action stops automatically. Illumination for each exposure is provided by a built-in electronic flash unit (strobe type) that will last for a long period, and distortion due to camera movement is kept at a minimum by having a flash duration of approximately 1/800 second.

Details of complete measured-service billing procedure may vary, but the modern system used at the New York Telephone Company Western Division Headquarters, in Buffalo, may serve as a model.

On a specific day each month the camera is loaded

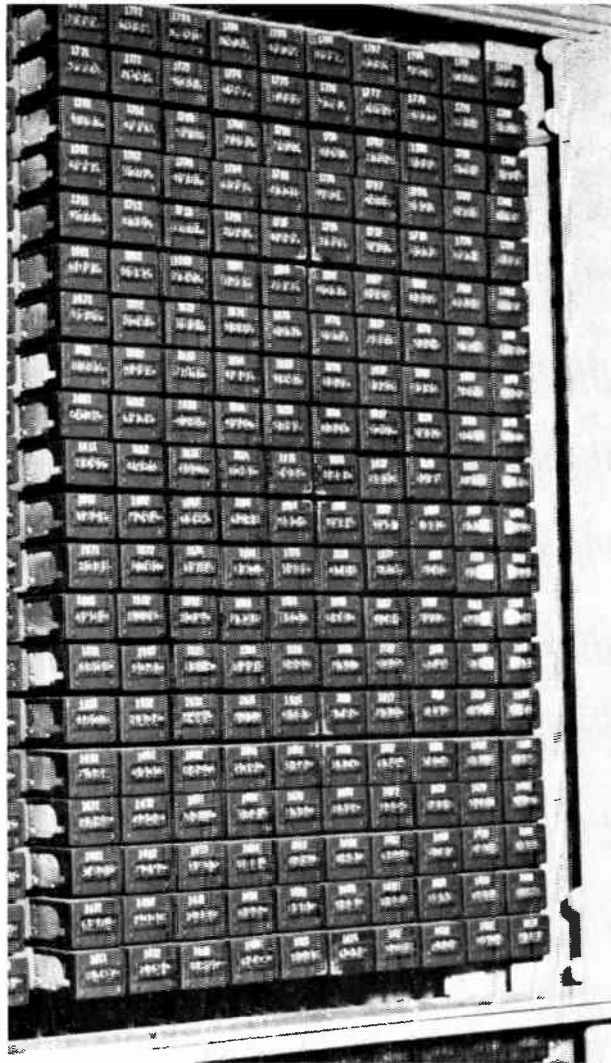

Figure 2

and takes a picture of each block of 25 message registers (see Figure 1). Figure 2 shows message register boards. Each block of twenty-five registers is marked off on the register frame to facilitate camera positioning and the same sequence of pictures is taken every month. At the Buffalo office, the photographer starts with the highest numbers and works progressively toward the lowest numbers. The finished roll will then have low numbers reading left to right. The camera is then unloaded and the exposed roll is taken to the Factograph processor for processing. This processor automatically develops, stabilizes and dries the roll. Total process time is only seven minutes and a permanent, direct-reading print is produced, eliminating the necessity of printing from a negative. Dependability of processing results is insured by having chemical kits furnished that contain the exact amount of processing material needed for the



Figure 4



Figure 3

solution used in the processor. No photographic experience is required of a new operator.

After the roll has been processed it is sent to the billing department where it is cut into strips containing 100 readings. An IBM operator then places the strips in an automatic illuminator which lights each number successively (see Figure 3). Collated IBM cards are placed in the key punch machine and as each successive register reading is illuminated the operator punches the reading in the corresponding IBM card (see Figure 4). Subsequent IBM operations automatically subtract the previous month's reading from the current month's reading, establish the billable number of calls, and do the actual billing. At the conclusion of the billing process the Factograph message register strip is filed for information and reference purposes. The strips are dated and the photograph of the actual register provides exact, indisputable evidence as to the number of calls recorded to that date. Empty cassettes are placed in handy mailing tubes and returned to Graflex where they are immediately reloaded with Factograph sensitized paper and shipped back to the telephone company for reuse.

T-6 Factograph equipment is now in use in many of the major cities in the United States. Its wide acceptance and successful operation is an excellent example of the good that can come when the talents of two different industries combine to solve a problem.

New Products

New Product specifications published in *Electronics and Communications* have been briefed for your convenience. If you require further information on any of the items published you may readily obtain such by using our Readers' Service, Page 41. Just mark the products you are interested in on the coupon on Page 41 and the information will be in your hands within a few days.

Servo system analyzer

Item 2304

The new Model H Servoscope, for analysis of servo systems, is announced by Servo Corporation of America, New Hyde Park, L.I., N.Y.

Measuring phase, transient response and gain, the Servoscope facilitates fast, accurate plotting of Nyquist, Bode or Nichols diagrams.

This latest addition to the Servoscope line covers frequency ranges 0.1 to 2.0 cps and 1.0 to 20 cps, and provides phase measurements to ± 1 degree accuracy.

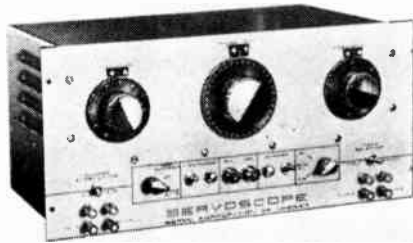

Direct reading of both amplitude and frequency plus direct read-out of phase lag simplify operation. Frequency accuracy is ± 5 per cent of setting, rather than of full scale.

The Model H generates sine wave and modulated carrier waveforms. Suitable for standard 19" rack or bench use, the instrument is ideal for general purpose, laboratory or field service. Weight is 30 lbs.; size is 19"W x 8 $\frac{3}{4}$ "H x 12"D.

For further information contact the Canadian sales representative — Mel Sales Limited, Arnprior, Ontario.

Cathode ray tube with helical P.D.A.

Item 2305

A new high-brightness, high-sensitivity instrument cathode ray tube employing helical post-deflection acceleration has been announced by Mullard Limited. The characteristics of this new tube (type DH10-78) have been carefully determined to suit it for a large variety of applications ranging from simple, inexpensive oscilloscopes to precision laboratory apparatus.

The tube has a 4"-diameter flat screen and an overall length of only 12". It uses electrostatic focussing and deflection, and is suitable for double symmetrical operation.

The post-deflection accelerator consists of a high-resistance coating applied in the form of a helix to the inside of the bulb. Unlike the normal, single-step accelerator, this helical electrode provides a continuous gradient of acceleration voltage, rising from a relatively low value near the deflector plates to a high final value. By this means pattern distortion is minimized and a higher p.d.a. ratio, up to 4:1, may be used. Thus pre-deflection acceleration may be kept low to ensure high sensitivity, while the final accelerating voltage may be made high to obtain maximum brightness. Under typical operating conditions "X" and "Y" sensitivities of, respectively, 30 and 10v/cm can be achieved with a post-acceleration voltage as high as 4kv.

An additional feature of the tube is that the shield between the two pairs of deflection plates is brought-out separately, so that the shield voltage may be adjusted

to correct pin-cushion and barrel distortion.

The screen of the DH10-78 is designed specifically for oscilloscopes and uses a high-sensitivity sulphide phosphor giving a bright actinic display. It has blue and yellow components giving, under normal excitation conditions, a green/white fluorescence of medium persistence.

Additional data on this tube may be had by writing to Mullard Ltd., Mullard House, Torrington Place, London W.C. 1, England.

1959 reference guide to silicone uses

Item 2306

A new comprehensive reference guide to silicone uses and applications has been compiled for 1959 by Dow Corning Silicones Limited of Downsview, Toronto, Ontario. The firm, whose slogan is "First in Silicones", claims to have pioneered the manufacture of silicones in 1943 and to continue to lead in the development of new silicone products and applications. This developmental program includes a competent staff of technical service men trained to assist Dow Corning customers. Chemical and engineering aid is available, in addition to extensive laboratory facilities and testing equipment.

Throughout the reference guide will be found reference numbers following descriptions of specific silicone products.

Write for 1959 reference guide to Dow Corning Silicones Limited, Tippet Rd., Downsview, Metropolitan Toronto, Ontario.

Bar-Ring instrument movement

Item 2307

Newly offered in all DC panel meter and portable sizes is the Triplett Bar-Ring type movement which provides self-shielded instruments of maximum torque and high performance.

The Bar-Ring design provides for maximum flux density in the working gap, the ultimate objective of most instrument magnetic systems. The short gap also helps insure permanence of the magnet.

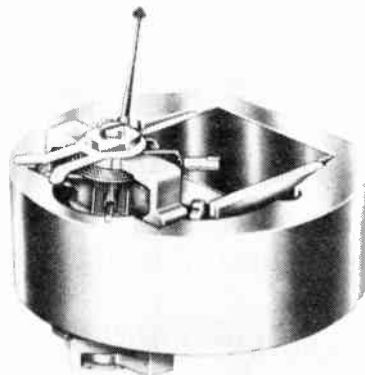

The anicco magnet is mounted external to the moving coil; thereby eliminating any restriction on magnet size. Linear scales are another advantage.

In this type instrument mechanism, a closed ring serves as one pole of the magnetic system, with an anicco bar magnet mounted so that one pole terminates in the ring, and the opposite polarity terminates in the pole piece.

The Triplett Electrical Instrument Co., Bluffton, Ohio, U.S.A.

Inertia-damped servomotor

Item 2308

Four major servo-design requirements are met by the newest Size 8 rotating component introduced by Helipot Division of Beckman Instruments, Inc., the Beckman Inertia-Damped Servomotor Model 8 IM 460.

This new servomotor is small enough (2.5 ounces, 1.680" long) to be used in sub-miniature systems. It will operate from a 115-volt, 400-cycle source. Acceleration and deceleration damping offer system stability without loss of velocity constant. High acceleration from stall insures rapid response to minimum error signals.

Damping is provided by the viscous friction induced by the magnetic coupling of a low inertia drag cup to a freely rotating magnet flywheel. The result: the same upper corner frequency improvement offered by notching filters . . . without the complicated networks demanded by this method.

Design of this servomotor permits use of a rotor which has an inertia of only 0.34 gm.cm.². Combined with comparatively high stall torque of 0.33 oz.in. this produces acceleration at stall of 68,500 rad/sec.².



Because of this swift, sure response to input signal, upper corner frequencies approaching 41 cycles per second can be attained. No-load speed is 6,000 rpm; flywheel inertia is 2 gm.cm.²; and the flywheel damping factor is 52 dyne-cm-sec/rad. Power input is 3.3 watts per phase.

Model 8 IM 460 has a stainless steel case, shaft and bearings, and all windings are completely encapsulated for positive protection against temperature extremes, humidity and vibration. As a result, Model 8 IM 460 will pass any humidity procedure or combination of procedures of MIL-E-5272A and will withstand shock loads to 100G's and vibrations of 30G's to 2,000 cycles in all major axes. Ambient temperature range is from -55° to +130°C; total unit temperatures can hit 200°C without degradation of motor performance.

Units are available within 30 days of order from R-O-R Associates, Ltd., 1470 Don Mills Road, Don Mills, Ontario, sales representative for Helipot.

Low voltage regulator

Item 2309

With an operating voltage well below presently available types of regulator tubes, the G55 1K is now available from Standard Telephones & Cables Limited.

Operating at a nominal 55 volts over the current range of 2 to 30 MA, the tube was developed to replace the neon bulb type of regulator which has long been a means of stabilizing voltage in this region.

The base connections and physical dimensions use the same as the OA2, OB2 series of tubes, to which it is complementary.

Additional characteristics of this tube are available from Standard Telephones and Cables Mfg. Co. (Canada) Ltd., 9600 St. Lawrence Blvd., Montreal 12, Que.

New Products

Ultrasonic delay line

Item 2310

An ultrasonic delay line with extremely low secondary levels and insertion loss as well as wide band width has been developed by the Arenberg Ultrasonic Laboratory, especially for Columbia University's Electronic Research Laboratory's program to improve the operation of radar systems. This unit, with a delay of 900 usec has an average maximum secondary level of over 70 db below the main delay, triple travel signals of 60 db and direct feed through over 80 db over a 10 MC band width centered at 40 MC.

The band width to the 3 db points is 22 MC. Insertion loss into 50 ohms is 55 db with a capacity of 60 uufds at input and output. The unit is 14½" diam. x 1" and weighs less than seven pounds in an evacuated aluminum case which will meet extreme military environmental test conditions.

A special feature of the design is a mid-transducer tap for optimizing matching network problems.

Arenberg Ultrasonic Laboratory, Inc., 94 Green St., Jamaica Plain 30, Mass., U.S.A.

Supersensitive thyatron grid control

Item 2311

The accompanying illustration shows VecTroL phase shift network for proportional control of thyatron outputs up to 20 kilowatts, with a DC control signal of 1 milliwatt. This unit, which measures 2 x 2¼ x 3¼ high, offers the following features: each unit provides balanced control for two full-wave thyatrons and thereby overcomes the majority of matching difficulties; phase-shift is linear for a full 180°, with a maximum of 270°, controlling output from zero to maximum; high sensitivity eliminates need for amplifier tubes in most applications; fail-safe operation — thyatron output is automatically cut off when control signal is removed.

This VecTroL Commercial Model is self-contained and is tested for insulation at 1,600 volts RMS. Typical applications are: regulated power supplies, adjustable speed motor drives, programmed speed controls, servo motors, studio and spectrographic light sources and machine-tool automation.

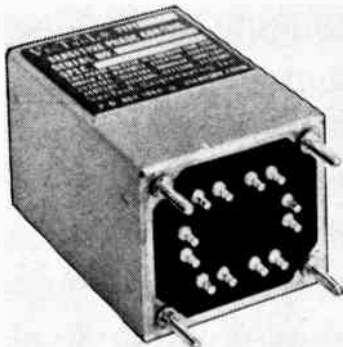

Four isolated DC control windings are provided to integrate control signals from more than one source if desired. It is thus possible to compensate for line and load variations simultaneously and provide current-limiting protection and anti-hunt circuitry where necessary.

Other Heavy Duty and MIL Spec Models are available for higher voltages and for controlling up to 30 kilowatts.

Write for full technical specifications and application information to: VecTroL Engineering, Inc., P.O. Box 1089, Stamford, Conn., U.S.A.

Miniature angle and T-drives

Item 2312

Metron angle and T-drives, Series 12, offer designers many advantages where power must be reliably transmitted at right angles in cramped space. These 1:1 ratio units may be integrally combined with any of Metron's miniature speed reducers, or between two or more of these speed reducers, thus permitting takeoffs with different speed reductions.

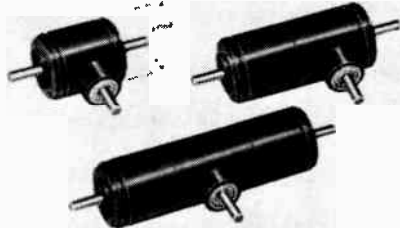

Drives handle up to 24 oz.-in of torque. Speeds to 10,000 rpm are reached without excessive wear. Maximum power transmitted is 0.025 HP.

Black anodized aluminum cases have size 11 servo mounts. Several other types of attachable mounts are available. Stainless steel shafts (⅜" diameter) run in double heavy-duty ball bearings. Smooth running 48 pitch, 20° PA miter gears are used. Gears are lubricated with MIL-G-3278 grease. The case OD is 1.062 inches.

Additional information obtainable from Metron Instrument Company, 432 Lincoln St., Denver 3, Col., U.S.A.

Controlled temperature ceramic condensers

Item 2313

In oscillator and I.F. circuits it is generally desirable that the condensers used for temperature compensation of the coils should have a stable capacity. The Close Controlled Temperature Coefficient Ceramic Condensers produced by The Telegraph Condenser Co. Ltd. of North Acton, London, England combine this characteristic with a wide selection of temperature coefficients and capacity values.

The other main features of this range are that it includes a temperature coefficient of zero and a choice of tolerances for each of the remaining four temperature coefficients. With such a wide choice it is anticipated that a suitable value will be found for every condition likely to be experienced.

The tubular ceramic bodies are made of selected low and medium permittivity materials and are contained in molded "boats" filled with "Plimoseal" to aid stability. This rock hard setting compound gives complete protection against moisture penetration in all working temperatures from -40°C to +100°C.

For further information regarding these condensers, write The Telegraph Condensers Co., Ltd., North Acton, London, W. 3, England.

Standard limit switches

Item 2314

A full line of long life, standard limit switches for aircraft, machine tools, appliances, vending machines and many in-plant uses has been introduced by Licon (R) Switch and Control Division of Canada Illinois Tools Limited, Toronto.

The Licon (R) Type-10 series switches offer movement differentials less than .0005" — for use in operations requiring extreme sensitivity — and the exclusive "serpentine" snap action of the switches consistently gives more than 10,000,000 actuations in tests. The manufacturer states that the serpentine switch mechanism largely eliminates the problem of switch fatigue and assures positive actuation of equipment. Since the switches have no pivot points — which can cause variation in snap — they have no dead center,

no flickering. The low stress design eliminates drift at the trip points.

The terminals of three Licon (R) switches are easily accessible and the mounting centers are the standard distance apart — 1". The Licon (R) Type-10 series has a 15 amp rating; a 20 amp rating heavy duty type is also available. The manufacturer states that in addition to their use in machine tools, appliances, vending machines, aircraft and in-plant, they are especially applicable where rigid government specifications must be met.

Seven different types of plunger, spring and lever actuators are available.

For further information, write to: Constellation Components Co., 136 Tower Drive, Toronto, Ontario.

Tent heater for winter line operations

Item 2315

A lightweight propane tent heater that speeds telephone companies' winter operations, and makes the lineman's job much easier, is now available in Canada from Automatic Electric Sales (Canada) Limited.

Known as the MoPeCo PTH-12, the heater is designed to provide fast, dependable heat for cable splicers working in cold, wet or windy conditions. It will produce 12,000 BTU's per hour for approximately 35 hours, from one 20-pound tank of propane. The heater can be readily adjusted to any required tent height, and produces air that is completely free from carbon monoxide.



For further details and illustrated literature, or for information on the complete line of MoPeCo Ventilating Heaters and accessories, write to: Automatic Electric Sales (Canada) Limited, 185 Bartley Drive, Toronto 16, Ontario.

Lightweight calibration unit

Item 2316

A fully portable, all semi-conductor device intended for precision alignment and calibration of electronics equipment such as FM record/reproduce systems was introduced recently by Ampex Corporation's Instrumentation Division.

The new calibrator, designated TC-10, contains a voltage standard accurate to 0.01%. Working calibration voltages are available in nine steps, each adjustable over a range of 10 per cent. Nine precision oscillators and seven binary dividers provide 63 accurate calibration frequencies ranging from 1,012 cycles to 151.2 kc. These can be introduced into a system for discriminator alignment or for comparison with the output of a voltage-controlled oscillator.

According to Ampex spokesmen, the 25-pound, fiberglass-housed unit was especially designed to withstand the rigors of field use. They described its highly stable and accurate voltage system as "an important advance in test instrumentation".

A brochure containing more detailed information on the TC-10 is available from the Advertising Department of Ampex Corp.'s Instrumentation Division, 934 Charter St., Redwood City, Calif., U.S.A.

New Products

DC to DC transistor converters

Item 2317

A new, complete line of reliable, highly efficient static DC to DC Transistor Converters has been introduced by Freed Transformer Company, Inc., Brooklyn, New York, and are available for immediate delivery from stock.

These new, rugged DC to DC Transistor Converters are carefully designed and constructed for quiet, maintenance free operation and long life service. They feature high power to weight ratio and arc-free operation. In addition, each unit is enclosed in hermetically sealed cans, with RF filters included inside the case.

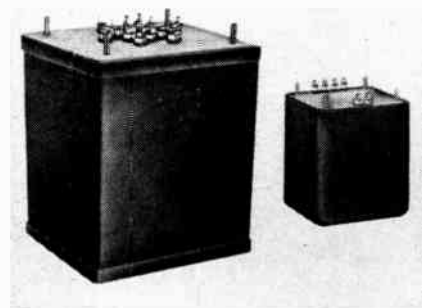

New Freed DC to DC Transistor Converter models are available from 6 to 26 VDC (battery) input, with an output voltage from 150 VDC to 600 VDC.

Freed Transformer Company, Inc., will also design DC to DC Transistor Converters to customer's specifications.

For further information about these new DC to DC Transistor Converters and DC to AC Transistor Converter models write directly to manufacturer, Freed Transformer Company, Inc., 1716 Weirfield Street, Brooklyn (Ridgewood) 27, New York, U.S.A.

Magnetic recording head

Item 2318

The Electronics Division of The Gresham Transformer Group, Ltd. has designed a recording head which, in line with the Gresham policy of quality in quantity, is to be produced in large quantities at a reasonable price to the highest specification now demanded by the high fidelity market.

The all-metal construction eliminates the build-up on tapes experienced with plastic heads through dust from the wearing plastic. There is permanent contact between the recording pole and the tape. The danger of static electricity build-up is eliminated by the all-metal construction. Thus there is absolutely no danger of the signal being recorded becoming distorted during the recording operation.

The extremely accurate Gresham Recording Head is being produced at such economical cost that manufacturers of high fidelity recording equipment and tape-decks can greatly improve their products with little increase in production costs.

Specification: single track record/replay head of 0.090 in. track width for recording two separate tracks on 1/4 in. magnetic tape. Head: fully laminated construction. Performs at frequencies well above audio range. Gap accurately lapped to give peak output of 4 mV at 2.5 Kc. per second, when tape speed is 7 1/2 in. per second. Front faces of pole pieces cylindrically ground flush with body. Mu-metal case completely surrounds the head and screens it. Dimensions: 0.5 in. diameter, 0.625 in. high. Especially suitable for miniature equipment. Mounting: single hole.

Gresham Transformers, Ltd., Hanworth, Middlesex, England.

Low cost DC supplies for industry

Item 2319

Sorensen Model MD Power Supplies, a new line of rugged, heavy duty DC supplies with magnetic voltage regulation has been developed by Sorensen & Company, South Norwalk, Conn.

The new supplies consist of conservatively rated magnetic-type voltage regulators, full-wave silicon diode rectifiers, and capacitive input filters. According to a Sorensen spokesman, the magnetic regulator which compensates for line changes, plus the low voltage drop in the silicon rectifier gives excellent voltage regulation with a minimum of circuit complexity. "This combination of elements," the spokesman added, "permits Sorensen to furnish the units at minimum costs consistent with heavy duty industrial ratings." Extremely rugged, the units cannot be damaged by output shorts.

The new Model MD units can be supplied from stock with output voltages ranging from 2.5 to 1,000 VDC, with power capacities of 25, 50, 100, 200, 400, 750, 1,500 and 3,000 watts. 19" rack-panel mounting for all units.

Specifications and additional data may be obtained from Sorensen & Company, Inc., Richards Ave., South Norwalk, Conn., U.S.A.

Clamp Pliers

Item 2320

Production of a new hand tool that cuts clamp installation time up to 50 per cent is announced by TA Mfg. Corp., 4607 Alger Street, Los Angeles, California.

The tool is a new kind of plier that secures bolt, while clamp is mechanically closed and locked in place. This frees both hands for attaching nut or for stacking additional clamps into lock position. Misalignment is prevented because proper closure is insured at all times. Worker fatigue is greatly reduced.

These pliers are particularly useful in cramped quarters when space restricts the use of both hands.

At present time the pliers are limited to the standard No. 8 or No. 10 size bolts.

Literature on this Model #82 plier is available upon request to TA Mfg. Corp., 4607 Alger St., Los Angeles, Calif., U.S.A.

Tube tester

Item 2321

New Triplett Model 3414 Tube Tester affords fast, accurate tests with maximum flexibility, and a non-obsolescence design.

All switch settings can be made before the tube warms up, making this one of the fastest of all tube testers. Burned out tubes are rejected instantly, without waiting for the filaments to heat. The Neon Indicator Shorts Test is new, fast and accurate.

Tubes tested include receiving types, gaseous rectifiers, series filament, resistor

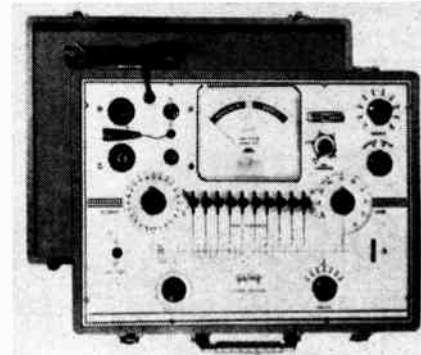

and ballast tube continuity, etc. The continuity test circuit may be used to check electrical appliances for shorts or open circuits.

The Triplett Electrical Instrument Co., Bluffton, Ohio, U.S.A.

Ultrasonic flaw detection equipment

Item 2322

Following are new additions to the range of Kelvin Hughes' ultrasonic flaw detection equipment:

The Ultrasonic Flaw Detector Mark 5F, a multi-frequency instrument, designed specifically for use in production units, and for laboratory investigation where this flexibility is invaluable, and where the applications involved can adequately be met with probes having twin or common transmitter receiver transducers.

The Ultrasonic Flaw Detector Mark 5AF, a single frequency instrument available for 1 1/2, 2 1/2 or 5 mc/s. operation. A specially developed amplifier is incorporated to give optimum performance when used with probes having single, twin or common transmitter receiver transducers.

Flaw Detector Mark 6 is designed for the dual role of production testing and laboratory investigation into transmission characteristics and for use with probes having single, twin or separate transmitter/receiver transducer heads.

Two Channel Flaw Alarm, which is an accessory for use with the Mark 5 series of portable flaw detectors and is designed to relieve operator fatigue of manual interpretation of signals on production flaw detection tests.

Mark 3 Depth and Thickness Gauge, which is an accessory to the Marks 5 and 6 flaw detectors and measures the thickness of material from 0.1 in. to 4 ins. without the necessity of circuit modifications.

Further details on any of this equipment are available from Kelvin & Hughes (Industrial) Ltd., Publicity Department, Livingstone College, Knotts Green, Leyton, London, E. 10, England.

Airborne tape recorder

Item 2323

An airborne tape recorder, described as the world's smallest, was recently announced by the Leach Corp., manufac-

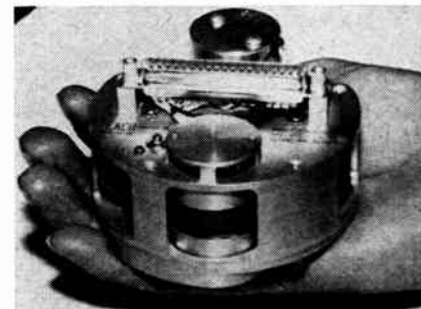

turers of components, systems and power and control equipment for aircraft and missiles.

The completely ruggedized device is so small it can be held in the palm of the hand and weighs only 24 ounces. It has been tested by Sandia Corp. under actual operating conditions for vibration of 15 times gravity without shock mounting (5 to 2,000 cps) and impact of 2,000g (X, Y and Z planes).

Other specifications include: size, 3 3/4" diameter by 2 1/2" long; tape speeds, 0.25, 0.5, 1.0, 1.875, 3.75, 7.5, 15 inches per second; tape widths, 1/2 inch and 1 inch; recording times, 60, 30, 15, 8, 4, 2 and 1 inches; wow and flutter (under static conditions), less than 1 per cent.

Other operating environment features: acceleration, 200g; temperature, minus 50 degrees to 200 degrees F; relative humidity, 0 to 100 per cent; power requirements, 24 volts DC.

Leach engineers say the tape recorder has many uses including in-flight tests, static tests, blast and explosion studies, wind tunnel studies, acceleration tests, actuation tests, oil well logging and atmospheric studies.

Leach Corporation, 18435 Susanna Rd., Compton, California, U.S.A.

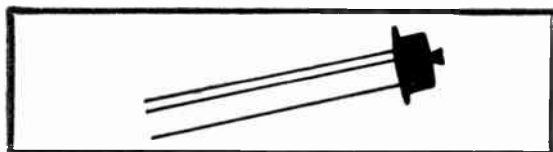

HOW THE C-G 4-POINT PLAN

SOLVE OUR

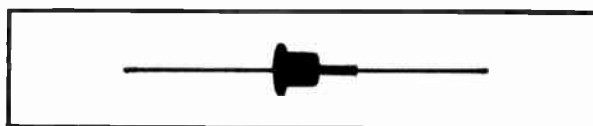

SEVERAL PROBLEMS

IN THE BOARD ON THE

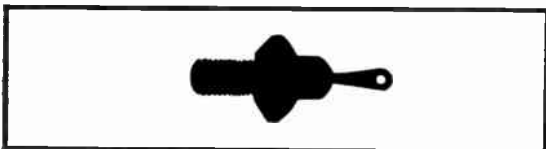

Canadian General Electric was first in Canada to produce semi-conductor products to meet the special needs of Canadian manufacturers of electronic equipment. They also realize that, with the rapidly expanding use of these comparatively new products, application and other problems may arise. To help you solve your semi-conductor problems, and give you better service, Canadian General Electric offers you this 4-point plan.

Technical Sales Team. The technically qualified members of C.G.E.'s sales team are at your service. You can depend on them for expert assistance in selecting the right product to do the best job at the lowest cost.

Application Engineering Lab. The experienced personnel in C.G.E.'s Application Engineering Lab are always ready to investigate your specific problems. Very often they can recommend alternative solutions that will lower your production costs and result in superior performance.

Production Know-how. Because of the first-hand experience gained from semi-conductor production, C.G.E. engineers can solve your problems right here in Canada. This eliminates time consuming and costly long distance solutions which very often prove unsatisfactory.

Complete Customer Service. C.G.E. fills your semi-conductor needs completely. They can supply you with other makes, as well as General Electric semi-conductors. Their efficient method of order expediting, complete warehouse stocks, and immediate price information on over 1,700 types of semi-conductors, saves you time, money and importation headaches.

When you need help with your semi-conductor problems, price and availability information, contact or write directly to Electronic Tube Section, Canadian General Electric Co. Ltd., Dufferin Street, Toronto, Ontario.



GENERAL ELECTRIC
SEMI-CONDUCTORS

Electronic Tube Section

1647-159

CANADIAN GENERAL ELECTRIC COMPANY LIMITED

For complete details check No. 8 on handy card, page 41

News Report

A monthly roundup of news and personnel changes in the Canadian electronics industry

S. D. Brownlee named Canadian Admiral president

At a board of directors' meeting held during March at Canadian Admiral Corporation Limited, Port Credit, Ontario, Stuart D. Brownlee was appointed president of the company succeeding Vincent Barreca. Mr. Barreca was recently named executive vice-president of Admiral Corporation, Chicago, Illinois.

Mr. Brownlee has been associated with the Canadian radio, television and appliance industry for the past twenty-five years. He was appointed executive vice-president and a director of Canadian Admiral three years ago. Previously Mr. Brownlee was president of Canadian Radio Patents Limited and general manager of the Electronics Industries Association of Canada, known at that time as RETMA of Canada.

New York IRE Show draws Canadian exhibitors

Registration records at the 47th annual Institute of Radio Engineers' convention and exhibition, held in the Coliseum in New York City from March 23 to March 26 inclusive, revealed an attendance of 57,709, which was slightly over 2,000 higher than the figures for 1958, although the goal of 60,000 visitors set by Show officials was not reached. There were 950 firms exhibiting.

The general consensus of opinion among booth-holders and visitors was that there is a steady year-to-year improvement in the presentation of the Show; that careful planning in the preparation of booth displays by exhibitors, with recourse to attention-drawing features such as lighting, moving parts, hand-outs, etc., pays off in attracting the crowds; and that increasingly product reliability is being stressed by exhibitors.

The president of the Institute of Radio Engineers for the year 1959-1960 is Dr. Ernst Weber, who is also president of the Polytechnic Institute of Brooklyn, N.Y.

The guest speaker at the annual awards banquet of the IRE, held on Thursday, March 26, was Dr. Lloyd V. Beckner, with whom the International Geophysical Year was closely identified, who forecast the vital part electronics must play in the space age into which man is directing his scientific knowledge and skill.

Western sales manager for Northern Electric

L. G. Bartlett has been appointed sales manager of the western zone of Northern Electric Company Limited, succeeding D. K. Atkinson, assistant zone manager, who becomes sales manager of the eastern zone with headquarters in Montreal.



L. G. Bartlett

Mr. Bartlett, who was born and educated in Vancouver, joined Northern Electric Company in that city in 1925. In 1934 he moved to Edmonton, covering Northern Alberta for three years before taking over the City of Edmonton territory. He was transferred again in 1940, this time to Trail, B.C., where he remained until 1945, when he went to New Westminster.

Mr. Bartlett became branch manager at Calgary in 1951 and region manager in Manitoba in 1957.

Tele-Radio Systems represent Airtronics

Tele-Radio Systems Ltd., of 3534 Dundas St. West, Toronto 9, have been appointed Canadian representatives for Airtronics International Corporation of Fort Lauderdale, Florida.

Airtronics have recently introduced a new program equalizer for use on broadcast wire line circuits. Also of specific interest to communications companies is their portable test hybrid for making cable measurements and determination of office wiring capacities.

Other products of interest to the telephone industry are under development.

Kay Electric distributes Sivers Lab meters

The Kay Electric Company of Pine Brook, New Jersey, has been appointed exclusive distributor in Canada and the United States for DRD Meters, the complete line of direct-reading digital frequency meters manufactured by Sivers Lab, Stockholm, Sweden.

CANADIAN EXHIBITORS AT NEW YORK IRE



(Upper left) Sinclair Radio Labs Ltd., Toronto, highlight of this exhibit was the model 150 Antenna Test Set as well as duplexers and filters — new products for both Canada and U.S. markets. (Upper right) E.M.I.-Cossor Electronics, Halifax. Among the new products featured for Canada and the United States' markets were precision deflection yokes, high speed oscillograph-ionospheric sounders, airborne radar civil safety beacon, V.H.F. transmission line filters and focus coils. (Lower left) Constanta Company of Canada Ltd., Montreal, featured deposited cracked carbon high stability precision resistors; from 1/10 watt up to 2 watts. Standard, molded and hermetically sealed. (Lower right) Consolidated Mining & Smelting Co. of Canada Ltd., Montreal, featured ultra pure metals of indium, antimony, lead, tin, zinc, silver, cadmium & bismuth with total metallic impurity contents of 1 part per million or less. The metal indium was shown, which had a purity of (99.9999%).

Calgary firm appointed Du Mont licensee

Electronic Research & Development Co. Ltd. of Calgary, Alberta, has been licensed to manufacture land-mobile radio communications equipment in Canada by Allen B. Du Mont Laboratories, Inc., of Clifton, New Jersey, acting through its Canadian licensing subsidiary, Du Mont Television and Electronics Ltd., Montreal, Quebec.

Electronic Research & Development Co. is not a newcomer to the electronics manufacturing field. Operating the only electronics plant in the Canadian "Petroleum Province" of Alberta, the company since 1948 has established a reputation for the manufacture and engineering of specialized electronic control and communications equipment.

With the acquisition of the Du Mont license, ERD now becomes the first manufacturer of VHF transmitters and receivers in Western Canada.

TR Services Limited opens Hamilton branch

TR Services Limited of 287 MacPherson Avenue, Toronto 7, Ontario, has announced the opening of a Hamilton branch in order that it may more effectively service that city and surrounding industrial areas.

TR Services Limited, consultants and contractors in the internal telephone — broadcasting — and time control fields, has achieved annual savings of many thousands of dollars in productive time for TR subscribers in the Metropolitan area alone.

TR Services Limited — a Canadian company organized by H. A. and H. S. Rogers in 1953 — is an affiliated associate in the world-wide TR organization of the parent company, Telephone Rentals Limited, with headquarters in the United Kingdom. There are twenty-eight operating companies in the TR Group serving industry throughout the world.

The growth of this Canadian company from a modest beginning six years ago has been somewhat phenomenal.

DDP contracts awarded in electronics field

During the latter half of February 1959 the following contracts for electronic test equipment were awarded by the Department of Defense Production: Beacons Optical and Precision Materials Co. Ltd., Montreal, Que., \$137,211; Renfrew Electric Ltd., Renfrew, Ont., \$82,060; R.O.R. Associates Ltd., Don Mills, Ont., \$33,000.

\$9 million contract awarded CGE by DDP

A \$9 million contract for production of height-finding radar equipment for the Pinetree radar line in Northern Canada has been awarded the Canadian General Electric Company Limited by the Department of Defense Production on behalf of the United States Air Force. The equipment will be installed as part of the integrated defense system of the North American Continent.

J. Herbert Smith, president of CGE, indicated recently that the present order is among the largest received to date by the Electronic Equipment and Tube Department of the company,

and is additional to an appreciable quantity being built for the RCAF.

While most of the equipment will be built at the company's Royce Works plant in Toronto, a sizable percentage will be subcontracted to Canadian suppliers, thereby making a substantial contribution to many branches of industry. Mr. Smith, in commenting on the impact of the order on the company's work force, stated that it would be carried through with existing facilities, extending job security to those presently employed rather than extending the work force. Preliminary work, he added, has already started on the order, with the first units scheduled for shipment this year.

LENKURT ELECTRIC COMPANY APPOINTMENTS



E. V. HIRD

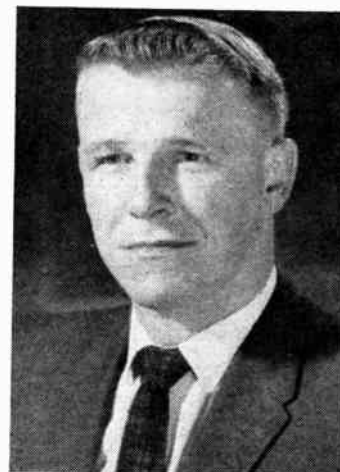

R. A. ROBINSON

Announcement is made by C. W. Hunter, vice-president and general manager of Lenkurt Electric Co. of Canada, Ltd., Burnaby, B.C., of the appointment of Edward V. Hird, P. Eng., Manager, Contract Projects, and Richard A. Robinson, as Manager, Sales Engineering, for the Company.

Mr. Hird, a U.B.C. graduate and R.C.A.F. veteran, is a member of the Association of Professional Engineers of B.C. He was a reserve officer in the Telecommunications Branch, R.C.A.F., from 1953 to 1955. Formerly an equipment engineer with B.C. Telephone Co., he joined Lenkurt as Applications Engineer in April, 1956.

Mr. Robinson, who is a member of the Association of Professional Engineers of Alberta, and also a member of the I.R.E., attended University of Alberta, the Imperial College of Science, London, England, and Colorado School of Mines. A veteran of the R.C.A.F. and R.A.F., he was formerly with California Standard, Northwest Telephone Company, and Bell Telephone. Since joining Lenkurt, he has held the positions of Manager, Radio Engineering Sales, and Manager, Contract Projects.

Canadian Astronautical Society and IRE

Dr. P. A. Lapp, president of the Canadian Astronautical Society, recently announced that the plans of the Society would not be affected by government action in regard to defense measures. As in the past, "we will continue to co-operate with the IRE and other technical societies in furthering our mutual aims," declared Dr. Lapp. "Far from being dis-

couraged by the drastic changes in defense policy, the Society feels even more that Canadian scientists and engineers should be involved in active astronautical research."

On Monday evening, March 16, a meeting of the Institute of Radio Engineers, Toronto Section, was arranged in cooperation with the Canadian Astronautical Society. David C. Wallace was the guest speaker, his subject being "Rockets and Space Travel".

New Products

Sub-miniature soldering instruments

Item 2324

A new range of sub-miniature soldering instruments, manufactured by Oryx Electrical Laboratories Limited of England, are now available in Canada.

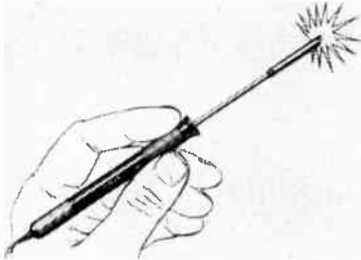

Claimed to be the world's smallest, these new Oryx irons come in a range of sizes from $\frac{1}{16}$ " diameter up to $\frac{3}{16}$ " and in a variety of shapes. They possess an unusually high heat efficiency with 6 watts producing 542 degrees F in the smallest size and up to 932 degrees from 24 watts in the largest.

The voltage range is 6 to 24 volts AC, provided by a special filament transformer unit, also serving as a mounting rack for the irons. The formerless helically wound heating element is contained within a woven Silicite insulation sleeve providing excellent shock protection. This design feature and the low voltage operation is claimed by the manufacturer to assure almost indefinitely long life.

The Oryx iron in the smaller sizes weighs less than $\frac{1}{4}$ oz. and is only 6" long. A complete transformer unit with two irons is quite inexpensive.

These instruments are suitable for a wide variety of uses in the radio and electronics field. They are ideal for such operations as the assembly of sub-miniature components to printed circuitry, instrument repairs or fine soldering of any type in inaccessible locations.

Oryx products are represented in Canada by Len Finkler Limited, 1794 Avenue Road, Toronto, Ontario.

Precision measuring relays

Item 2325

Designed and developed by the old-established firm of Brion Leroux & Cie. of Paris, these relays are based upon their patented spring suspension moving coil unit. For the past seven years they have been used in increasing quantities by French industry and government departments, particularly by the French Post Office. They are now available in the United Kingdom and British Commonwealth and Empire from the London stocks of Leland Instruments Limited.

The relay consists of a galvanometer movement, complete with scale and pointer, to which has been added a moving contact. On each side of this are arranged two fully adjustable contacts which are instantly accessible beneath a transparent plastic dust cover, and are adjustable over the full range of the scale.

Leland Leroux Sensitact Relays are fully shielded and are available in 16 different models, with moving coil resistances ranging from 2.5 ohms, to 7,500 ohms, and with full scale deflection current ratings ranging from 10mA down to 0.02mA. In the case of the most sensitive model the minimum change of control power necessary to make or break contact is of the order of 0.05 microwatts (five-hundredths of a microwatt). The relay contacts have a power handling capacity of 200 milliwatts.

Each of the 16 models is available either as a maximum-minimum indicator with scale covering 90° and calibrated 0-100 divisions, or in centre-zero form with scale calibrated 50-0-50 divisions.

Further particulars available from Leland Instruments Limited, London, S.W.1., England.

Air conditioning unit for electronic computers

Item 2326

Ellis and Watts Products, Inc., Cincinnati, Ohio, has developed a specialized air conditioning unit (Model BOMO) to maintain rigid temperature and humidity control in electronic systems used to compute the flight path of landing carrier-based or land-based aircraft.

Electronic computers are housed in a mobile van. For shipboard use the van is modified for installation on the carrier deck. The unit is suspended beneath the floor of the van, and does not interfere with design or placement of electronic equipment inside the van.

To minimize duct work, two Model BOMO units are employed to provide both supply air and return air at different locations. Return air enters the cooling unit through van floor. Conditioned air is ducted to top of van and discharged through a perforated ceiling to maintain adequate air circulation without objectionable drafts. Each unit furnishes two stages of heating as well as two stages of cooling.

Model BOMO unit is designed to withstand severe vibration, acceleration, shock and explosive atmosphere, and will function under adverse climatic and environmental conditions such as extreme temperatures and humidity, altitude, rain, sun, sand, dust, salt spray and fungus. Model BOMO unit is designed and built to both military and commercial specifications.

For additional information, write Ellis and Watts Products, Inc., Cincinnati 36, Ohio, U.S.A.

Continued on page 45

WE HAVE NEWS FOR YOU



The first week of June you will receive your copy of the Communications issue of **ELECTRONICS AND COMMUNICATIONS**. This issue will contain authoritative construction reports and expansion plans for the next 12 to 24 months of Canada's major communications' systems. An issue that will be **YOUR DIRECT LINE TO** where and on what multi-billions of dollars will be spent on major systems from the Yukon to the Maritimes. If you are not receiving your personal copy of **ELECTRONICS AND COMMUNICATIONS** — fill in the post paid return card (no obligation) in this issue. Over 10,500 monthly circulation.

Electronics and Communications
450 ALLIANCE AVE. TORONTO 9, ONT.

FOR PRECISION LABORATORY OR PRODUCTION TESTING



FREED 1110-AB INCREMENTAL INDUCTANCE BRIDGE AND ACCESSORIES

Accurate inductance measurement with or without superimposed D.C., for all types of iron core components.

- INDUCTANCE — 1 Millihenry to 1000 Henry
- FREQUENCY — 20 to 10,000 Cycles
- ACCURACY — 1% to 1000 Cycle, 2% to 10KC
- CONDUCTANCE — 1 Micromho to 1 MHO
- "Q" — 0.5 to 100
- SUPERIMPOSED D.C. — Up to 1 Ampere
- DIRECT READING — For use by unskilled operators.

ACCESSORIES AVAILABLE:

- 1140-A Null Detector, 1210-A Null Detector — V.T.V.M.,
- 1170 D.C. Supply and 1180 A.C. Supply.

INSTRUMENT DIVISION

FREED TRANSFORMER CO., INC.

1716 Weirfield St., Brooklyn (Ridgewood) 27, N.Y.

For complete details check No. 18 on handy card, page 41

New ROHN

SELF SUPPORTING COMMUNICATION TOWER



- ★ 120 ft. in height, fully self-supporting!
- ★ Rated a true HEAVY-DUTY steel tower, suitable for communication purposes, such as radio, telephone, broadcasting, etc.
- ★ Complete hot-dipped galvanizing after fabrication.
- ★ Low in cost—does your job with BIG savings—yet has excellent construction and unexcelled design! Easily shipped and quickly installed.

FREE details gladly sent on request. Representatives coast-to-coast.

ROHN Manufacturing Co.

116 Limestone, Bellevue,
Peoria, Illinois

“Pioneer Manufacturers of
Towers of All Kinds”

For complete details check No. 33

Ontario Premier opens Industrial Production Show

The Honorable Leslie M. Frost, Premier of Ontario, will formally open the National Industrial Production Show of Canada, 1959, on May 4 at the Exhibition Park, Toronto. This is on the request of the Canadian Industrial Management Association, one of the four societies sponsoring the Show, who are holding a seminar on the opening day, at which the guest speaker will be Professor Marvin J. Barloon, Professor of Economics, Western Reserve University, Cleveland, Ohio. The opening address by Mr. Frost will be at the conclusion of the seminar.

Premier Frost, in previous addresses, has been an advocate of the importance of Canadian industry keeping up with technological advances in production methods, equipment and techniques, in order to build up Canadian sales in competition with the rest of the world.

The other three sponsors of the Show — American Society of Mechanical Engineers, Canadian Welding Society, and Canadian Council of Foremen's Clubs — will be represented at the opening.

APPOINTMENT



James Boles

The Board of Directors of Ward Leonard of Canada Limited, manufacturers of electrical and electronic control apparatus, announces the election of James Boles, B.Sc., P. Eng., as president and a director. Mr. Boles comes to Ward Leonard from RCA Victor Company Limited and formerly served in various capacities with Canadian General Electric Company Limited and with Canadian Westinghouse Company Limited.

DESIGN ENGINEERS

Select the Right Choke
INSTANTLY!



ESSEX ELECTRONICS

R.F. Choke Kits

Epoxy-encapsulated, High-Reliability R.F. Chokes available in 4 handy kits for design engineers:

RFC — WEE	0.1 μ H to 1,000 μ H	0.150 Dia. x 0.375 L
RFC — S	0.1 μ H to 100 μ H	0.188 Dia. x 0.44 L
RFC — M	1.0 μ H to 1,000 μ H	0.25 Dia. x 0.60 L
RFC — L	1.0 μ H to 10,000 μ H	0.31 Dia. x 0.90 L

Data sheets available on request both for the Choke Kits and for the Essex Electronics Standard Line of Chokes. Both the kits and production quantities of chokes are available from stock.

Chokes • Delay Lines • Coils • Pulse Transformers
ESSEX ELECTRONICS
NOTES:
99 WRAGGE ST., TRENTON, ONTARIO, CANADA

For complete details check No. 17

**DIRECT READING OF
FM DEVIATION . . .**
25 to 500 mc. At Low Cost!



LAMPKIN 205-A FM MODULATION METER

- Indicates instantaneous peak modulation, plus or minus, on 0-12.5 or 0-25.0 KC scales.
 - Accuracy 10% of full scale.
 - Tunable 25 to 500 MC in one band, with fast and slow controls.
 - Sensitivity 20 millivolts or better throughout range.
 - Speaker for aural monitoring, oscilloscope output for visual monitoring.
 - Meets Department of Transport specs for mobile-radio maintenance.
 - Size only 7" x 12" x 7 1/4". Weight 13 lbs.
 - Price \$240.00 net (does not include duty). Satisfaction guaranteed or money refunded.
- To measure transmitter center frequencies, from 0.1 to 175 MC (to 3,000 MC by checking multipliers), with an accuracy better than 0.0025%, use the LAMPKIN 105-B MICROMETER FREQUENCY METER.

Write today for technical data on both instruments.

LAMPKIN LABORATORIES, INC.
Dept. 707, Bradenton, Florida, U.S.A.

For complete details check No. 25

General Radio exhibit at Acoustical Society meeting

The Acoustical Society of America will be holding a meeting at the Chateau Laurier in Ottawa from May 14 to 16 inclusive.

At the exhibit to be held in connection with this event visitors will have an opportunity to see the latest General Radio Company's instruments for acoustic measurements.

Among the new equipment to be displayed at the General Radio booth will be the new Type 1521-A Graphic Level Recorder, the Type 1551-B Sound Level Meter, and the Type 1554-A Sound and Vibration Analyzer. Also on display will be many other General Radio instruments for acoustic and radio-frequency measurements.

C.G.E. appoints sales specialist

The appointment of C. C. Strong as Microwave Communications Sales Specialist has been announced by P. T. Wilson, Communications Products manager, Electronic Equipment & Tube Department, Canadian General Electric Company Limited.



C. C. Strong

Mr. Strong will be C.G.E.'s representative in the growing field of microwave communications systems. He is well qualified in this highly specialized field through training and experience. While with the General Electric Company of England, he gained his diploma in electrical engineering at Coventry Technical College. Following war service as a navigation officer in the RAF, Mr. Strong rejoined C.G.E. in 1946 to develop test equipment.

Emigrating to Canada, Mr. Strong became associated with the Ontario Hydro in 1952, moving a year later to C.G.E.'s Electronic Equipment design section. Following two years in the sales department at C.G.E., Mr. Strong joined the New Brunswick Telephone Co. in 1957 as a radio engineer and served as project engineer for the New Brunswick portion of the Trans Canada microwave link.

Mr. Strong has now rejoined Canadian General Electric in Toronto to plan and supervise the construction of microwave communications systems for an increasing number of telephone and telegraph companies and other major utilities from coast to coast.

MORE ACTIVE! EFFECTIVE!



THE BEST FOR TV-RADIO WORK . . . EVERYTHING ELECTRICAL—Kester "Resin-Five"

Core Solder is better and faster than any solder ever developed. It has an activated flux-core that does a perfect job on all metals including zinc and nickel-plate. The flux residue is absolutely non-corrosive and non-conductive.

Available in all practical Tin-Lead Alloys; 40/60, 50/50 and 60/40 in diameters of $\frac{3}{32}$ ", $\frac{1}{16}$ ", $\frac{3}{16}$ ", $\frac{1}{8}$ " and others.

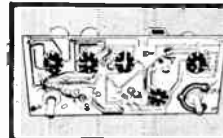

Printed Circuit Soldering
On Copper-etched boards use 60% Tin - 40% Lead Alloy . . . for those that are Silver-surfaced use 3% Silver-61½% Tin-35½% Lead

KESTER SOLDER COMPANY

OF CANADA, LTD., Dept. U Brantford, Canada

For complete details check No. 24 on handy card, page 41

MICRO-MINIATURE precision wire-wound RESISTORS fixed, noninductive

newly developed Kelvin "RELAXED WINDING" techniques practically eliminate resistance drift with age and "shorts" or "opens" due to thermal shock.

PLASTIC ENCAPSULATED SERIES "EP"

The 0.05W micro-miniature type EP-00 is .080" dia. x .325 long, 50K ohms max. resistance. Available with radial and axial lead wires. ALL CONNECTIONS ARE WELDED. High temperature epoxy plastic is used in an exclusive vacuum encapsulation process. Standard resistance tolerances to 0.1% (specials to 0.01%). Environmental temperature range: -65°C to +125°C.

CERAMIC SERIES "CB"

The 0.15W miniature type CB-05 is $\frac{1}{4}$ " dia. x $\frac{1}{4}$ " long, 500 K ohms max. resistance. Available with radial and axial lead wires, or lug terminals. Standard resistance tolerances to 0.1% (specials to 0.01%). Environmental temperature range: -55°C to +85°C.



Send for literature



*Kelvin Electric Company
Van Nuys, California*

Exclusive Canadian Distributor:
CONWAY ELECTRONIC ENTERPRISES
1514 Eglinton Avenue West
Toronto 10, Ontario; RU. 3-6576

For complete details check No. 23 on handy card, page 41

Publication E.1000

Second Edition

Free on request

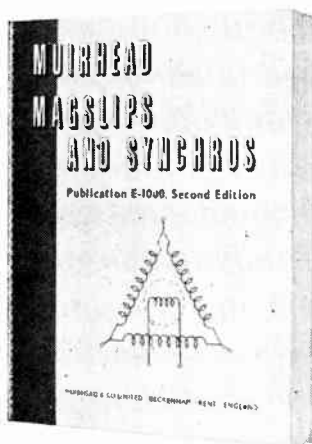

A new edition of Publication E.1000 having four additional chapters on synchros has been prepared and will be distributed to all recipients of the first edition and any other synchro or magslip user on request.



TECHNIQUE

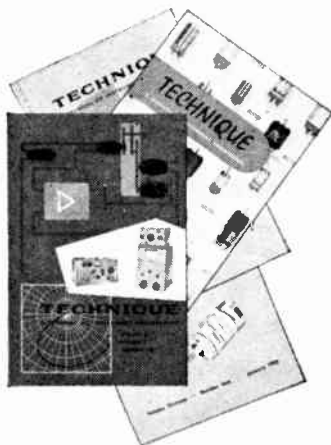

A Quarterly Journal of Instrument Engineering for Scientists, Technicians, Research Workers, Engineers. Mailed to any part of the world on request.

378/3ca

MUIRHEAD INSTRUMENTS LIMITED
STRATFORD · ONTARIO · CANADA

For complete details check No. 26 on handy card, page 41

\$2 million order for Ferranti-Packard Electric

Ferranti-Packard Electric Limited, with plants located in St. Catharines and Toronto, Ontario and Trois-Rivieres, Quebec, has recently been awarded a two million dollar order from Trans-Canada Airlines for electronic equipment which, it is claimed, will provide the fastest, most modern reservation system in the world. The order covers field and communications equipment which is used in conjunction with a central computer.

In 1952 TCA realized that a new reservation system must be developed to handle the projected increased volume of airline traffic. In 1954, TCA systems experts conceived the basic idea around which the present equipment is designed. Ferranti-Packard research and development engineers went into action to study the airline's business before designing and developing the system which resulted in a big production order for the company.

The system sold by Ferranti-Packard is that equipment which relays information to and receives answers from the control computer. The transactor is a device which will be located in every TCA sales office across Canada.

SALES REPRESENTATIVE



A. L. Pringle

Hackbusch Electronics Limited, Canadian distributors for Stromberg-Carlson, has announced the appointment of A. L. Pringle as sales representative for Stromberg-Carlson's hi-fidelity and stereophonic component line. Mr. Pringle, well known in the electronics field, is heading up a nation-wide sales program aimed at creating more dealerships in all provinces for consumer lines.

INDEX TO ADVERTISERS

Page number is on the right. Key number for use with READER SERVICE CARDS is on the left.

Key No.	Page No.
1. Adcola Products Ltd.	44
2. Airtron Canada Ltd.	13
3. Amphenol Canada Ltd.	13
4. Automatic Electric Sales (Canada) Ltd.	25
5. Automatic Electric Sales (Canada) Ltd.	26-27
6. Automatic Electric Sales (Canada) Ltd.	28
7. Bach-Simpson Ltd.	10
8. Canadian General Electric Co. Ltd.	34
9. Canadian Lister-Blackstone Ltd.	14
10. Canadian Marconi Co.	3
11. Computing Devices of Canada Ltd.	15
12. Crane Packing Co. Ltd.	47
13. Daven Co., The	44
14. Edo (Canada) Ltd.	49
15. Eitel-McCullough Inc.	43
16. Electronic Service Supply Co.	48
17. Essex Electronics of Canada Ltd.	38
18. Freed Transformer Co. Inc.	37
19. General Radio Co.	52
20. Helipot Division of Beckman Instruments	45
21. Hewlett-Packard Co.	2
22. International Resistance Co. Ltd.	13
23. Kelvin Electric Co.	39
24. Kester Solder Co. of Canada Ltd.	39
25. Lampkin Laboratories Inc.	38

(Continued overleaf)

APPLICATION FOR FREE SUBSCRIPTION

Please ADD my name to receive ELECTRONICS & COMMUNICATIONS.
 Please CHANGE my address for mailings.
NOTE — Card must be completed in full to be valid.

My Name (Please Print)

Mail copies to my home, or business address as noted below.

Street

City Zone Prov.

If you have recently CHANGED your address for receiving copies of ELECTRONICS & COMMUNICATIONS please note former address here:

Company Nature of Business
 (State, when applicable, whether electronic equipment or components are manufactured, sold, or used in manufacturing, etc.)

Signature Position
 4-59

PLEASE SEND FURTHER INFORMATION ON THE FOLLOWING NEW PRODUCT ITEMS AS NUMBERED BELOW — USE PRODUCT ITEM NUMBERS

- 2304 2305 2306 2307 2308 2309 2310 2311 2312 2313
 2314 2315 2316 2317 2318 2319 2320 2321 2322 2323
 2324 2325 2326 2327 2328 2329 2330 2331 2332

PLEASE SEND FURTHER INFORMATION ON THE FOLLOWING ADVERTISEMENTS AS NUMBERED BELOW — USE KEY NUMBERS

- 1 2 3 4 5 6 7 8 9 10 11 12
 13 14 15 16 17 18 19 20 21 22 23 24
 25 26 27 28 29 30 31 32 33 34 35 36
 37 38 39

Name Position

Company Nature of Business

Street City Prov.
 4-59

PLEASE SEND FURTHER INFORMATION ON THE FOLLOWING NEW PRODUCT ITEMS AS NUMBERED BELOW — USE PRODUCT ITEM NUMBERS

- 2304 2305 2306 2307 2308 2309 2310 2311 2312 2313
 2314 2315 2316 2317 2318 2319 2320 2321 2322 2323
 2324 2325 2326 2327 2328 2329 2330 2331 2332

PLEASE SEND FURTHER INFORMATION ON THE FOLLOWING ADVERTISEMENTS AS NUMBERED BELOW — USE KEY NUMBERS

- 1 2 3 4 5 6 7 8 9 10 11 12
 13 14 15 16 17 18 19 20 21 22 23 24
 25 26 27 28 29 30 31 32 33 34 35 36
 37 38 39

Name Position

Company Nature of Business

Street City Prov.
 4-59

BUSINESS REPLY CARD
No Postage Stamp Necessary if Mailed in Canada

5c POSTAGE WILL BE PAID BY

ELECTRONICS AND COMMUNICATIONS

450 Alliance Avenue

Toronto 9, Ontario



BUSINESS REPLY CARD
No Postage Stamp Necessary if Mailed in Canada

5c POSTAGE WILL BE PAID BY

ELECTRONICS AND COMMUNICATIONS

450 Alliance Avenue

Toronto 9, Ontario



BUSINESS REPLY CARD
No Postage Stamp Necessary if Mailed in Canada

5c POSTAGE WILL BE PAID BY

ELECTRONICS AND COMMUNICATIONS

450 Alliance Avenue

Toronto 9, Ontario



INDEX TO ADVERTISERS

(Continued)

Key No.	Page No.
26. Muirhead & Co. Ltd.	40
27. National Fibre Co. of Canada Ltd.	6
29. Northern Electric Co. Ltd.	8
30. R.O.R. Associates Ltd.	46
31. Renfrew Electric Co. Ltd.	13
32. Rogers Electronic Tubes & Components (A Division of Philips Electronics Industries Ltd.)	7
33. Rohn Mfg. Co.	38
34. Sanborn Co.	9
35. Stark Electronic Instruments Ltd.	44
36. Telephone Mfg. Co. Ltd.	46
37. Triplett Electrical Instrument Co., The	51
38. Tung-Sol Electric Inc.	4
39. Welwyn Canada Ltd.	49

ACTIVE CIRCULATION

It costs us a lot of active dollars annually to keep our circulation lists up-to-date and it's important enough to us that we have them audited every year by CCAB (Canadian Circulations Audit Board Inc.).

Advertisers trust CCAB audited figures so we get more advertisers and YOU get the high standard of editorial you have always wanted to read.

ELECTRONICS and COMMUNICATIONS

is a



audited publication



EIMAC Klystrons are used in most tropo-scatter installations



EIMAC 4KM50,000I.Q klystron

NOW, 400 TO 985 MEGACYCLES SPANNED WITH JUST TWO EIMAC 10KW KLYSTRONS

Exceptionally wide frequency coverage, 400 to 985 megacycles, is now available with just two interchangeable klystron amplifiers using the Eimac 4KM50,000I.A and LQ 10 KW klystrons. This important tropo-scatter and UHF-TV range can now be covered with a single transmitter. In addition, both tube types offer exclusive design advantages that have made Eimac klystrons the most widely used power tubes in tropo-scatter networks.

Field-Proved External Cavity Design

Extra wide tuning range with single set of tuning cavities. Lower original cost. Tube replacement cost much lower since external tuning circuitry need not be replaced.

Uniform bandwidth through inductive tuning plus greater broadbanding by external cavity loading.

Wide Range Load Coupler

One coupler covers entire frequency range.

Modulating Anode

Provides simplified overload protection.

Protects cathode from internal arc damage.

EMA Cathode

Combines ruggedness and long life of a pure metal emitter with the high efficiency of an oxide cathode.

Extra large area cathode conservatively rated for exceptional reliability.

Eliminates need for high voltage bombarder power supply, reducing system cost and total power consumption.

Series Connected Body Magnet Coils

Permits use of single power supply and control for body magnets.

Performance Proved Reliability

In tropo-scatter service, individual Eimac klystrons have logged more than 25,000 hours air time.

5906



Eimac First for high power amplifier klystrons.

EITEL-McCULLOUGH, INC.
SAN CARLOS CALIFORNIA



Quality Instruments
STARKIT
 Wired and Unwired

**CANADIAN
 DESIGNED
 KITS**

★ **OSK-1
 OSCILLOSCOPE
 KIT**

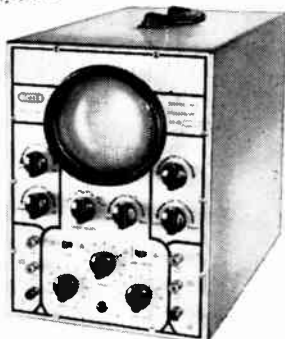

A general purpose 5" scope designed for rugged, dependable service. Allows complete visual analysis of electrical and electronic circuits, accurately portraying sinusoidal and non-sinusoidal wave forms. Horizontal and vertical amplifier 5 cycles to 400 kc, usable to 2.5 megacycles with full gain settings. Sweep range 15 cycles to 75 kc. FRENCH-ENGLISH assembly and operating instructions supplied with every kit. Available in Kit form — or — wired and calibrated.

KIT \$59.95
 WIRED \$99.50



MK-2



VMK-1



MK-1

★ **MK-2 MULTIMETER KIT**

10,000 Ohms per Volt DC; 5,000 Ohms per Volt AC. Measures Volts DC to 5,000; Volts AC to 1,000 V.; Milliampers to 500 ma; Ohms to 4 megohms; and Decibels from —20 to 62 dbs. Supplied with 1% deposited carbon resistors, special nylon switch, molded bakelite panel, test leads, assembly & operating instructions. Kit only.

KIT \$18.95

★ **VMK-1 VTVM KIT**

Assures unusual accuracy in checking high impedance circuits. 7 AC & 7 DC Ranges: 1.5 to 1200. 7 Peak to Peak Ranges: 4 to 3200. 7 Resistance Ranges: 0.2 ohms to 100 megohms. Frequency: AC to approx. 5 megacycles. Input Impedance: AC & DC to approx. 10 megohms. FRENCH-ENGLISH assembly and operating instructions included. Available in kit form — or — wired and calibrated.

KIT \$39.20
 WIRED \$53.95

★ **MK-1 MULTIMETER KIT**

20,000 Ohms per Volt multi-range multimeter kit. 7 AC & 7 DC Ranges from 3 to 3,000 V. 7 Output Ranges. Decibels: —20 to +57 dbs. 4 DC Mill Ranges: 3 ma to 12 amps. 3 Resistance Ranges from 2 ohms to 10 megohms. Complete with test leads and easy-to-follow assembly and operating instructions. Available in kit form — or — wired and calibrated.

KIT \$39.50
 WIRED \$47.90

STUDENT & PROFESSIONAL

Designed to suit the requirements of both student and professional, STARKITS are available in either kit form, or wired and calibrated. Every kit contains first quality components . . . explicit instructions, both clear and concise . . . and sharply detailed diagrams.

**HANDLED BY CANADIAN DISTRIBUTORS
 FROM COAST TO COAST**

★ RADIO KITS ★ TV KITS ★ SIGNAL GENERATOR KITS

Write for full particulars

**STARK ELECTRONIC SALES CO.
 AJAX, ONTARIO**

S-593

For complete details check No. 35 on handy card, page 41

ADCOLA
PROTECTIVE EQUIPMENT

REGD. TRADE MARK

MODERN SOLDERING EQUIPMENT

Illustrated
 Cat. No. 70 (1/8 BIT)

THE
 ELECTRONIC
 INDUSTRIES
 SOLDERING
 INSTRUMENT

Adcola
 The instruments
 with the correct
 soldering tempera-
 tures.

*Canadian Sales
 and Service*

L. J. LAMB
 Box 103
 Weston, Ont.
 CH. 1-5830

Developed for

**SOLDER
 POINTING
 RESISTORS
 CAPACITORS
 TRANSISTORS
 ETC.**

Adcola
 Universally
 in factory bench
 line production.

CSA APPROVED
 Canadian, British &
 Foreign Pats.
 Reg. Designs

**PROTECTIVE
 SHIELD**
 Cat. No. 68.

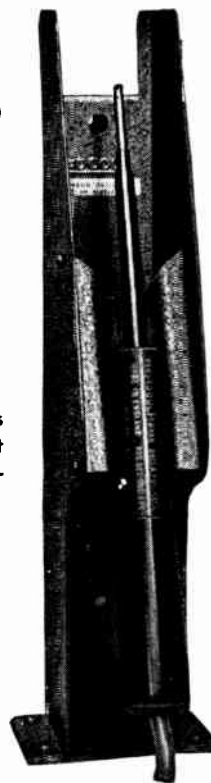

For complete details check No. 1 on handy card, page 41

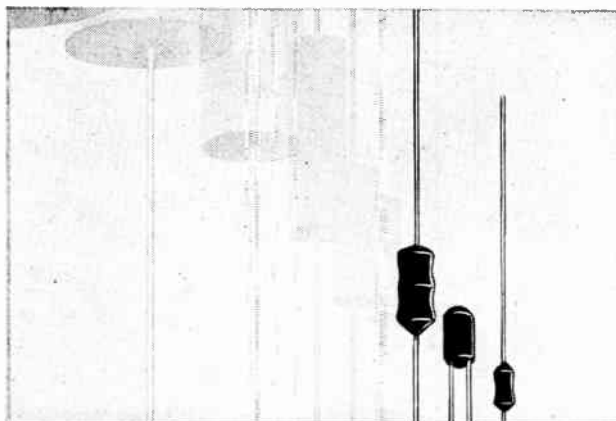

The INCREDIBLE SHRINKING RESISTOR...

Daven has always been the leader in the miniaturization of precision wire wound resistors. Now, due to further advances in resistor manufacture, Daven is able to offer higher resistance values in smaller sizes than ever before.

For guided missiles, airborne radar, telemetering, and for any application where extremely small size and dependability are of prime importance, specify Daven miniature wire wounds.



THE **DAVEN** CO.
 LIVINGSTON, NEW JERSEY

WORLD'S LARGEST MANUFACTURER OF ATTENUATORS
 In Canada: ADAMS ENGINEERING LTD., Montreal and Toronto

For complete details check No. 13 on handy card, page 41

New Products

Microwave signal generator

Item 2327

A new microwave signal generator with extremely wide range of modulation capabilities has been developed by Polarad Electronics Corporation, 43-20 34th Street, Long Island City 1, New York. This generator Model PMX covers the frequency range of 4,450 to 11,000 mc by use of two interchangeable plug-in tuning units. Frequency accuracy is $\pm 1\%$.

This versatile test instrument generates internal pulse, square wave or FM signals — or can be externally modulated. Its range of internal pulse capabilities include 0.2 to 10 microseconds variable width; 2 to 2,000 microseconds delay; and 10 to 10,000 pps repetition rate. Pulse rise and decay time is 0.1 microsecond.

Internal FM generation is a linear sawtooth wave with 5 mc frequency deviation. The instrument is capable of internal, external, pulse or sine wave synchronization. It generates synchronizing pulses of positive or negative polarity, delayed or undelayed.

Model PMX is a rugged, portable field or lab instrument featuring high stability and accuracy. Uni-Dial tuning, and non-contacting klystron cavity chokes for noiseless tuning and long equipment life.



It is recommended for all test applications requiring microwave energy of known and controllable power, frequency and modulation characteristics.

For further information please contact Polarad Electronics Corporation, 43-20 34th St., Long Island City 1, N.Y., U.S.A.

Panel meters

Item 2328

A new series of small Panel Meters especially designed for limited space applications has been added to the extensive HOYT Line, says the Burton-Rogers Company, 42 Carleton St., Cambridge 42, Mass., Sales Division of the Hoyt Electrical Instrument Works. These meters, embodying all the latest technological advances in miniaturization, are only $1\frac{1}{2}$ inches square, have a transparent plastic cover, are accurate to within 2%, and even include a front zero adjustment.

According to HOYT, a scale length of $1\frac{3}{4}$ inches makes them as easy to read as many larger 2 $\frac{1}{2}$ -inch meters. It is emphasized that all meters in this new line are of the front opening type and feature standard mounting dimensions to facilitate interchangeability. The company also points out that the lower front panel can be custom colored for appearance or functional identification at minimum expense.

Panel Meters in DC ranges are available from 100 microamperes, with an external shunt over 5 amps; and self-contained rectifier types, VU, and voltmeters up to 300 volts.

Hoyt Electrical Instrument Works, Inc., Burton-Rogers Company, 42 Carleton St., Cambridge 42, Mass., U.S.A.

Electro magnetic counter with electric reset

Item 2329

Counting Instruments Limited of Boreham Wood, England, announce that their Type 100 Electric Counter can now be supplied with electrically operated resetting facilities.

This takes the form of a solenoid mounted at the rear of the case, which momentarily energized operates the resetting mechanism to return the counter reading to zero. The counter incorporates Counting Instruments' proved balanced escapement mechanism, and the company claims that units taken from its standard production have now been run for well in excess of 50-million counts, at speeds of 1,200 counts per second. One of the many advantages of this form of resetting is that a number of counters can be reset to zero at the same time by operating a push button switch, which can be situated remotely from the counters.

Another feature of this counter is that it can be electrically reset when operating without causing any damage to the counter mechanism.

Coils for both resetting and counting can be supplied for operation on the following voltages — 24 48 volts DC, 110 115 volts AC, 50 and 60 cycles, and 230 250 volts AC.

Counting Instruments Limited, 5 Elstree Way, Boreham Wood, Hertfordshire, England.

High-voltage electrostatic generators

Item 2330

The complete line of "Sames" electrostatic generators — supplying up to 600 kilovolts DC — is now available for the first time in the United States from Beta Electric Division of Sorensen & Company, South Norwalk, Conn.

The Sames generators (so-called from their manufacturer, Societe Anonyme de Machines Electrostatiques, Grenoble, France) are extremely compact and better regulated compared to transformer-rectifier, filter-type supplies in similar kilovolt ranges. Available with adjustable outputs of 50, 80, 100, 140, 150, 250, 300, and 600 kilovolts, these power supplies have found wide application in Europe for testing of cable insulation, alternator windings and other dielectrics, flocking, electrostatic painting and precipitation, electron and nuclear particle accelerators and similar applications. In addition, the electrostatic generators are available in voltage-stabilized models that are particularly suitable for electron-microscopy and other critical applications.

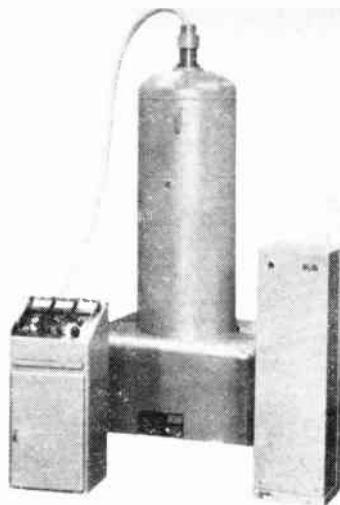

A new bulletin describing the Sames electrostatic generators is available from Beta Electric Division of Sorensen & Company, Richards Avenue, South Norwalk, Conn., U.S.A.

Direct reading flame photometer

Item 2331

A Direct Reading Flame Photometer has recently been announced by Baird-Atomic, of Cambridge, Mass. This new clinical instrument is used in hospital laboratories to determine the concentrations of sodium and potassium in samples of blood and other biological fluids. It has a unique new feature where Na and K are read directly in Meq/l from a meter on the instrument, eliminating tedious calculations as required previously.

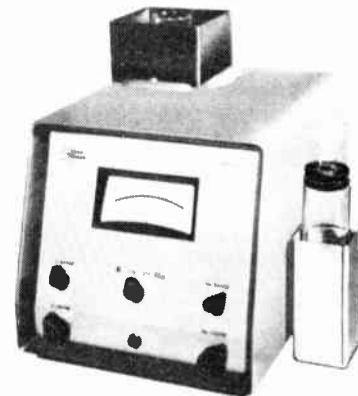

Another major feature of the Direct Reading Flame Photometer is that it is designed for microsampling techniques. Especially advantageous when samples are taken from infants or children, as little as 0.05cc of serum diluted 1:200, is needed to run the determinations and then rerun as a check. Both Na and K can be determined directly from the same micro-sample.

The B-A Flame Photometer needs no galvanometer, uses ordinary city or manufactured gas, is portable, has an internal standard and is very easily calibrated. Many months of field testing the new instrument show that it will reproduce readings accurately within $\frac{1}{2}$ of 1% during this extended period of time.

Complete technical information is available from the Canadian representative for the Atomic Instrument line for Baird-Atomic, Inc. — Radionics Ltd., 8230 Mayrand St., Montreal, Que.

Automatic television program controller

Item 2332

The Transmission Division of Pye Canada Limited announce the introduction of a new Automatic Television Program Controller capable of standard teletype operation using the international five hole card.

The Controller carries out those operations automatically, which are normally performed manually on the master control panel and accepts previously prepared instructions of these operations and their timing. A full 24-hour programming is stored by the equipment, timing being accurate to one second, with each instruction or group of instructions occurring at the same time prefaced by the time.

The Controller is capable of giving 169 different instructions with a basic capacity of 50 instructions being provided. Further groups of and circuits can be added to increase this capacity to the maximum.

Facilities are provided for the introduction of a sequence of operations not exceeding ten minutes in duration at any period during the 24 hours, covering any abnormal requirement. An additional facility allows the whole program to be retarded or run in advance of its scheduled timing. The Controller indicates the amount by which the program is running late or in advance.

Further information can be obtained from: Pye Canada Limited, Transmission Division, McMaster Avenue, Ajax, Ontario.



CONTROL KEY SWITCHES

for **LOW VOLTAGE MULTIPLE SWITCHING**

T.M.C. CONTROL KEY SWITCHES, precise in design and of robust construction, are today performing their vitally continuous work in varying apparatus all over the world.

Lever type control switch (Large)

■ Operators feeling the clean and positive "Make and break" action in any of the fifty standard spring combinations forget any fear of failure.

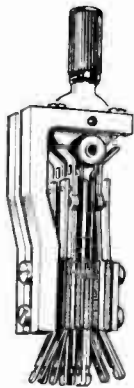
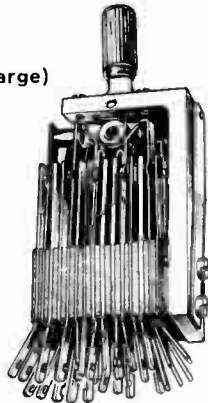

Lever type control switch (Small)

■ The contact springs made of nickel silver operated by hard plastic rollers on steel cams and silver contacts, ensure perfect performance.

Plunger type control key switches

■ Platinum or other metal can be supplied for special operating conditions.



Telephone EM. 6-5314 or write for T.M.C. Control Key Catalogue giving full technical data to:

**TELEPHONE
MANUFACTURING CO. LTD.**
SAXONY BUILDING • 26 DUNCAN STREET
TORONTO, ONT. Telephone EM. 6-5314

For complete details check No. 36 on handy card, page 41

NEW AUDIO SPECTRUM ANALYZER

The Audio Frequency Spectrometer Model 2110 is designed for electrical, electro-acoustical, and vibration measurements and analyses in the frequency range 2 c/s to 35000 c/s.

A unique feature is an internal arrangement to facilitate direct connection to the chart motor of the level recorder Model 2304. This connection provides continuous scanning of the filters and enables a complete frequency-amplitude analysis of complex signals to be recorded automatically on preprinted, frequency calibrated recording paper.

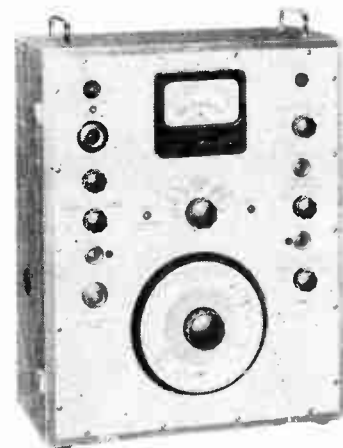

The rectifier and meter circuit of the spectrometer can be switched to measure either the peak, the arithmetic average or the true R.M.S. value of the input signal.

OTHER OUTSTANDING CHARACTERISTICS INCLUDE:

Frequency Range:

"Linear": 2 c/s to 35000 c/s within ± 0.5 DB
(± 0.3 DB in the range 5 c/s to 20,000 c/s).

Sensitivity:

Max. 100 μ V full scale deflection. Min. 1000 volts.
Variable in steps of 10 DB.

Amplification:

Max. 100 DB. Amplifier noise referred to input and max. gain: Approx. 15 μ V with open input and approx. 5 μ V with short-circuited input.



Manufactured by
BRUEL & KJAER

Write for complete applications
handbook and catalogue.

R-O-R ASSOCIATES LIMITED

1470 DON MILLS RD., DON MILLS, ONT.

TORONTO:
Hickory 4-4429

TELEPHONE

MONTREAL:
Hunter 1-0700

For complete details check No. 28 on handy card, page 41

Serving test centers installed by Bell

The largest of its kind in Canada, a new test and facilities board to increase the dependability and quality of Bell Teletype services, was recently installed in the Bell Telephone Company's Adelaide Street building in downtown Toronto. Known as a No. 2 test and facilities board, the new equipment is established in what telephone people call a Serving Test Center. Dozens of these centers are located throughout the Bell territory in Quebec and Ontario as part of a network which includes telephone



organizations throughout all of North America.

The centers operate simply, so far as customers are concerned. At each point where a customer has a specialized communications hook-up, he is given the number of the nearest STC (Serving Test Center) office. This office receives reports of any irregularity the customer might encounter, the message being taken down by a clerk serving on special STC reporting desks. These clerks immediately transcribe the information on a ticket and attach it to a card showing the circuit layout of the customer's network. The ticket is turned over to plant craftsmen who, within seconds, can begin tracing the difficulty and initiate corrective action when necessary.

In the accompanying illustration the operator checks out a difficulty encountered over the CBC-TV network. By watching the ultra-sensitive monitor and the oscilloscope below, the operator is able to identify and possibly isolate many TV transmission troubles before viewers notice any change on their TV sets at home.



FOR:
Guide
Bushings,
Vaness
and
Wear
Rings

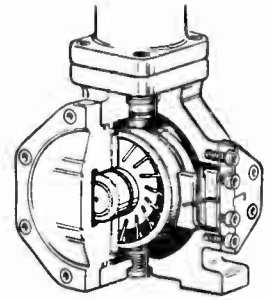

HAVE YOU CONSIDERED THE IMPORTANT ADVANTAGES OF FILLED TEFLON*?



Electronic Bushings,
Insulators
and
Tuning
Slugs

Rod & Tubing

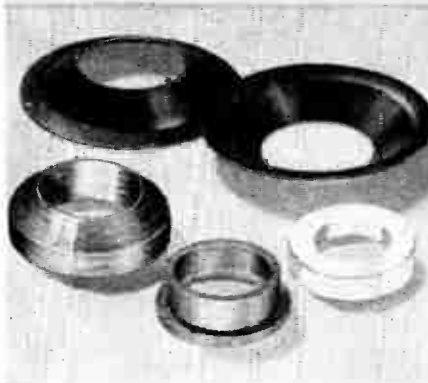

Formed
Gaskets

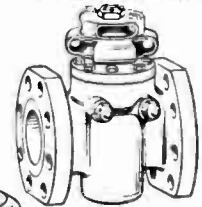

Valve
Seats
and
Packings

It has been definitely established that the value of Teflon can be considerably enhanced by the use of fillers in certain applications. Laboratory and field experience has demonstrated that the use of fillers permit Teflon to be more readily tailored to a wide variety of chemical, electrical and mechanical applications. Also, some mechanical properties can be improved. These include:

- 1) resistance to deformation under load
- 2) resistance to wear
- 3) thermal conductivity
- 4) compressive strength
- 5) hardness

By thus improving its properties, Teflon now offers even greater industrial potential. This is the reason filled Teflon has become an important item in the "John Crane" Chemlon® line of better Teflon products.

Chemlon is available with such fillers as glass fiber, carbon, graphite, copper and bronze, talc, calcium fluoride and other inorganic materials.

Tell us about your requirements. We'll tell you the advantages you can get from filled Chemlon. Request Bulletin T-104.

Crane Packing Company, Ltd., Box 134, Station C — Dept. DCP, Hamilton, Ontario.

*DuPont Trademark



For complete details check No. 12 on handy card, page 41

CANADA'S COMPLETE QUALITY PACKAGE

DU MONT[®] 2-WAY RADIO

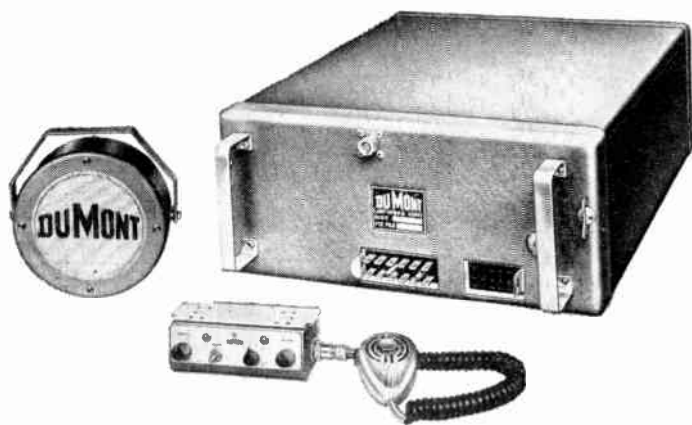

Now available at competitive prices, 30, 60 and 100 watt mobile equipment for full coverage and extended range. Dumont 30 mc/s and 150 mc/s equipment features "strip chassis" construction utilizing new electrical and mechanical designs to provide base station stability in a mobile unit. Vibrator, dynamotor, or transistorized power supplies now available for most models. All Dumont models fully certified for land-mobile service and comply with D.O.T. type approval requirements for split channel use.



(Made in Canada)

Features

- Superior receiver sensitivity for crystal-clear reception
- Defies obsolescence
- Rugged mechanical design
- Base station stability in a mobile unit
- New "No Juggle" microphone
- Precision protection circuits
- Low power drain
- Long service life
- Simplified servicing
- Extremely low maintenance cost

ELECTRONIC SERVICE SUPPLY COMPANY

210 - 9th Avenue East Calgary, Alberta

Branches or Representatives in Most Canadian Cities

For complete details check No. 16 on handy card, page 41

Comptroller appointed at CESCO

M. I. Rosenthal, president of Canadian Electrical Supply Co. Ltd., has recently announced the appointment of Jesse Cohen as comptroller for the company.

In his previous position Mr. Cohen held a similar comptroller appointment and brings considerable experience in credit, accounting, financing and administration to his new assignment. He will be responsible for organization and administration at Canadian Electrical Supply Co. Ltd., and it is expected that his appointment will further promote the smooth running of the five branches of CESCO and reflect on ultimate customer service.

IRE Canadian Convention invites technical papers

The Technical Program Committee of the IRE Canadian Convention is asking for papers to be submitted for the technical sessions for the IRE Canadian Convention to be held in Toronto at Exhibition Park, on October 7, 8 and 9, 1959. Authors need not necessarily be members of the Institute of Radio Engineers.

While papers may be submitted on any topic of interest to IRE members, it is expected that most of the papers will lie in one of the following fields: aeronautical and navigational electronics, antennas and propagation, audio, broadcast and TV receivers, broadcast transmission systems, circuit theory, communication systems, component parts, education, electronic computers, electron devices, engineering management, engineering writing and speech, industrial electronics, information theory, instrumentation, medical electronics, microwave theory and techniques, military electronics, nuclear science, production techniques, quality control, radio telemetry and remote control, ultrasonics engineering, vehicular communications.

Authors should submit the following information, in duplicate: 1. A 500 word summary of the paper, from which the committee can judge the suitability of the paper for the technical program; 2. A 100 word abstract of the paper, suitable for insertion in the Technical Program pamphlet if the paper is accepted.

Summaries and abstracts should be sent to: D. K. Ritchie, IRE Canadian Convention, 1819 Yonge St., Toronto 7, Ontario.

The deadline for receiving the above information is May 31, 1959.

CLASSIFIED

POSITIONS AVAILABLE

A Progressive All-Canadian Company Requires SENIOR ENGINEERS, with five years' minimum experience in servomechanisms; electronic design, including transistor circuits; computers (analog or digital); telecommunications, telemetering or radar. Please send resume to

Canadian Aviation Electronics Ltd.
Industrial Relations Dept.
Box 2030, Postal Station "O"
Montreal, Que.

SALES ENGINEER with Communications Systems Engineering background for position in antenna and transmission line field. Salary open.

Andrew Antenna Corporation Limited
606 Beech Street
Whitby, Ontario.

REGISTERED PROFESSIONAL ENGINEER for territory in Ontario. With sales experience in Process Instrumentation or application experience in Process Instrumentation. Car supplied. Pension and medical benefits. Application should be made in writing to:

Daystrom Limited
840 Caledonia Road
Toronto 19, Ontario.

PARTNERSHIP AVAILABLE

Small expanding business in the communications and signalling field. Some commercial experience desirable but not essential. Write for appointment to:

Box 5007
Electronics and Communications
450 Alliance Avenue, Toronto 9, Ont.

WANTED

Electronics Engineer. Toronto specialists, component manufacturer requires Design and Production Engineer. No age barrier. Replies held in strictest confidence.

Box 5008
Electronics and Communications
450 Alliance Avenue, Toronto 9, Ont.

SALES ENGINEER

With communications experience for component and apparatus sales to Electronic and Electro-Mechanical accounts in Ontario and Quebec.

Applicants to be between 25 and 35 years of age with good electronics engineering experience and liking for sales work. Bilingual, asset but not essential.

Position is salaried with prospects for advancement.

Application should be made in writing to the Sales Manager giving full details, age, qualifications, experience and salary bracket. All applications held in strict confidence.

Box 5009
Electronics and Communications
450 Alliance Avenue, Toronto 9, Ont.

WANTED

Electrical Engineer, for design of electronic supervisory control systems. Must have experience in or with Canadian power utilities. For new company.

Box 5010
Electronics and Communications
450 Alliance Avenue, Toronto 9, Ont.

HERE'S WHY ¹³ ~~12~~ INTERNATIONAL CARRIERS SELECT EDO LORAN

FOR JET-AGE LONG RANGE NAVIGATION

- AEROLINEAS ARGENTINAS •
- AIR FRANCE •
- BOAC •
- CUBANA •
- KLM •
- LUFTHANSA •
- NORTHWEST-ORIENT •
- PAN AMERICAN •
- QANTAS •
- SABENA •
- SAS •
- SWISSAIR •
- VARIG •

EDO AIRBORNE LORAN has, to date, been specified by 13 international air carriers for their jet and turbo-prop fleets.

Here are a few reasons why:

- Compact size and total weight of 29 lbs., designed for installation in limited cockpit space.
- Indicator scope, on adjustable swivel base or mounted in standard instrument panel cutout, is easy to read in daylight or artificial light.
- Direct-reading control unit, measuring $5\frac{3}{4}'' \times 4\frac{1}{8}''$, gives pilot or co-pilot instant line-of-position information — no interpolations or special training required.
- Pinpoint position fixes obtained in less than one minute.
- Complete dependability — all-new design featuring miniaturized circuits assures utmost reliability for aircraft operation.
- Fail-safe characteristic rules out possibility of error.
- All-channel availability — Edo Airborne Loran operates on all loran channels, assures world-wide loran coverage.

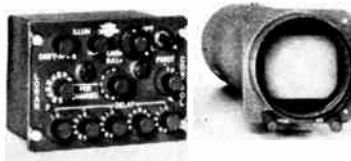

Edo LORAN is designed and manufactured by Edo, a major producer of advanced electronic systems. For complete data on Edo Model 345 Airborne LORAN, send for Technical Manual to Dept. E-4.

Edo

(CANADA) Ltd.

CORNWALL, ONTARIO

For complete details check No. 14 on handy card, page 41



a new
WELWYN
MOLDED

DEPOSITED CARBON RESISTOR

Welwyn Series N molded resistors employ a thermoplastic insulating material, combining economy with endurance and long term stability.

They meet the requirements specified by MIL-R-10509B and show negligible changes in resistance when subject to several one hour cycles of immersion in boiling water, along with D.C. polarization. Continuous operation at 150°C causes no damage.

The transparent molded insulation has an effective resistance in the order of 10^{13} ohms, and with a thermal conductivity 10 times that of air, vastly improves the load life under conditions of excessive dissipation.

Available in 4 physical sizes and in values of 10 ohms to 10 megohms.

For complete data and specifications write

WELWYN CANADA LIMITED

1255 BRYDGES STREET

LONDON, CANADA
H-8349

For complete details check No. 39 on handy card, page 41

editorial

Information: Basis of industry planning

It would be hard to find any other Canadian profession that has been buffeted around more by force of circumstances in the past ten years than that of the professional engineer.

The up and down demand for this category of professional personnel has changed with the rapidity of fickle March weather over the immediate past and at the present time there is a surfeit of engineers on the Canadian scene.

On the other hand it has not been unusual in recent times to see Canadian firms reach out as far as mid-European countries in their search and eagerness to engage technical personnel and then be forced to release such employees short months after their hire due to contract cancellations and other adverse business conditions.

One of the greatest causes, in recent times at least, for the extreme variations in the demand for professional personnel in Canadian industry has been the awarding and cancellation of defense orders. Canadian firms have time and again built up first-rate engineering teams following the awarding of defense contracts only to be forced into the discouraging position of having to disband such personnel by reason of work cancellations which would appear to be partially due to the lack of government long-range planning and indecision on the types of defense equipment required for our national security.

In all fairness to government planners, however, it must be realized that in this day and age of swift technological developments, especially in the area of defense, when concepts of warfare may be changed overnight, it is no easy task to determine equipment requirements very far in advance.

When changes in defense strategy do become necessary, it is not uncommon that industrial manufacturing complexes which have been developed to execute defense orders find themselves with cancellation directives on their hands. While it is bad enough to be the recipient of a cancellation order, it is further disturbing to be confronted with the necessity of disbanding hard-sought and hard-won technical teams that may be required at some future time to carry out further defense orders. It is in this latter respect, we believe, that government authorities could do much to assist manufacturers in retaining their valued teams of technical specialists following contract cancellations if defense authorities would take industrial management more into their confidence with regard to future weapons plans and logistics.

It is reasonable to assume that if this cooperation existed company management may at least be able to form some idea as to the worthwhileness of retaining technical personnel on their pay rolls in the knowledge that certain plans were in the offing in the matter of future defense equipment requirements.

Until some such arrangements are made it is feared that we will continue to see repeated disheartening events such as the recent mass exodus of engineers and scientists from the works of A. V. Roe and Orenda — engineers and scientists hard fought for but now lost to this company that may well again be called upon in the near future to execute some project yet held secret within the confines of warfare and tactics divisions of the three defense agencies.

That this trend of cooperation is desired by industrial management is indicated by the recent statement of one of Canada's leading industrialists who had the following to say:

"In the field of defense generally, it would be of great benefit if responsible representatives of industry could participate in discussions at the early planning stage of defense weapons. Such discussions would allow industry an opportunity to prepare itself for future defense programs. A more informed industry would then be able to invest in facilities, in manpower, and in research and development to prepare for impending defense programs. The result would be a competent Canadian manufacturing base which has spent its own dollars to be ready to undertake defense programs at very short notice."

WHEN YOU
THINK OF
SYMBOLS OF
PROGRESS...

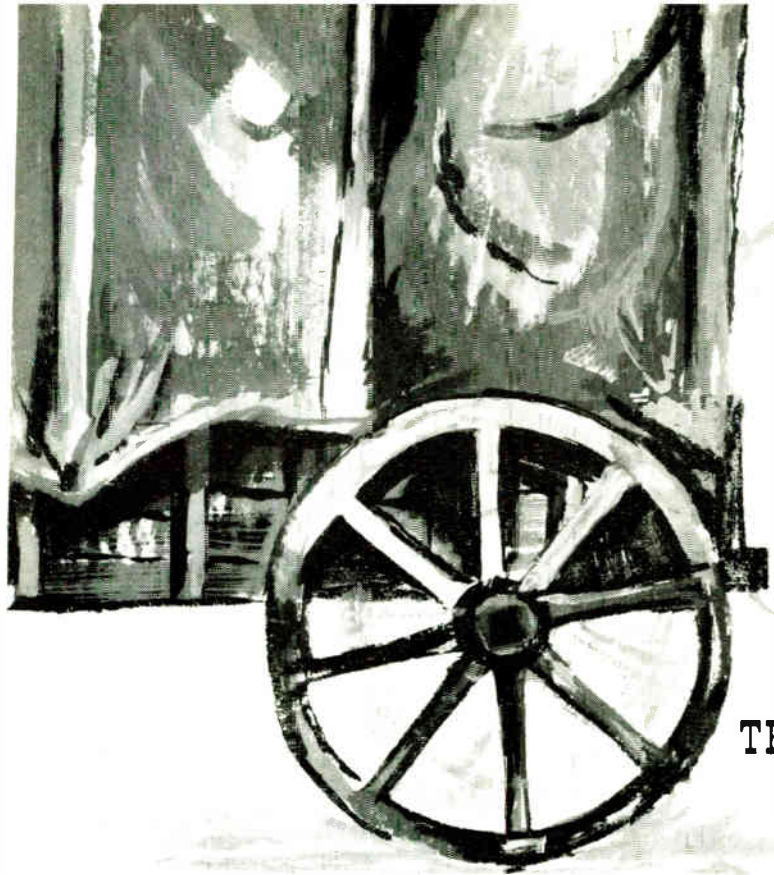

THE WHEEL



THE COLT 45 SIX-SHOOTER



TRIPLETT
MODEL 630 vOM

preferred by the professional
who insists on quality

- Popular streamlined tester with long meter scales arranged for easy reading
- Single control knob for all 34 ranges
- Easy Operation; Minimum burnout possibilities
- Completely enclosed selector switch of molded construction; eliminates harness wiring
- Wide range—tests AC-DC volts (DC at 20,000 O/V); DC Microamperes, Milliamperes, and Amperes; Ohms (to 120 Megohms) Decibel and Output
- Heavy molded case 1/4" thick for high impact, fully insulated

\$62³⁰_{NET}

TRIPLET

TRIPLETT ELECTRICAL INSTRUMENT COMPANY
BLUFFTON, OHIO

ACCURATE

μ , r_p , and g_m

STANDARD for VACUUM TUBES

h_i , h_r , h_f and h_o for TRANSISTORS

NEW Type 1661-A VACUUM-TUBE BRIDGE, \$975

An up-to-date design incorporating many improvements for increased versatility and convenience

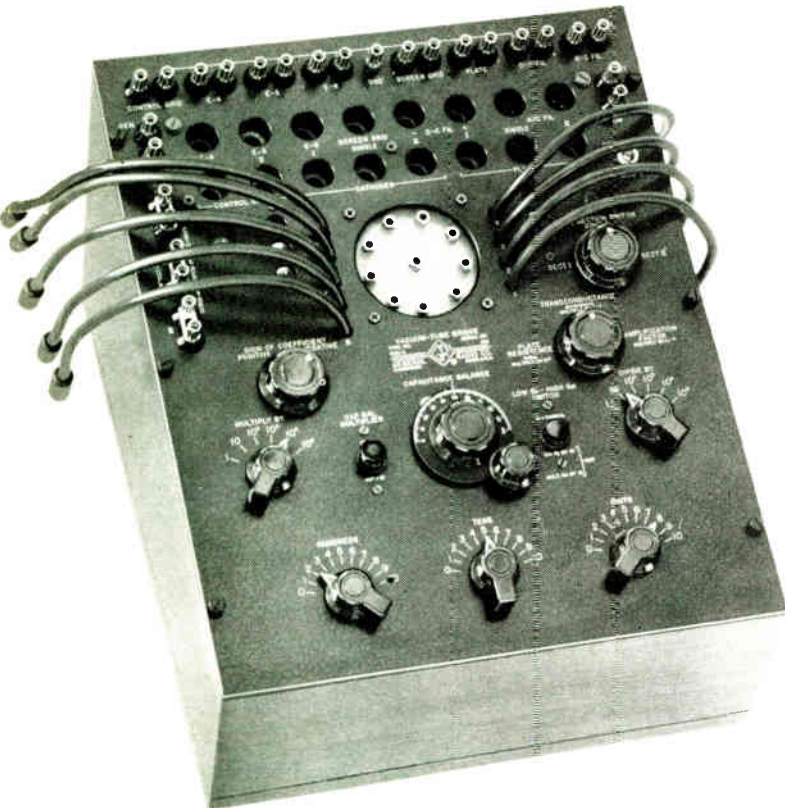

- ★ Indicates plate resistance, transconductance and amplification factor directly.
- ★ Transistor parameters can be measured quickly and easily; h_i and h_r are given directly, h_f (α or β) and h_o are readily calculated.
- ★ Bridge balancing is simple and straightforward. The quantity being measured can be read directly to three significant figures.
- ★ Meets requirements of IRE Standards for electron-tube testing.
- ★ Thirteen different adaptor plates permit convenient connection to any type tube or transistor.
- ★ Both sections of twin-section tubes can be measured without reconnecting patch cords.
- ★ Measurements can be made from 270 to 400 cycles, or at 1000 cycles.
- ★ Tests can be made with self-biasing resistors in the circuit. In twin-section tubes, panel switch connects resistor to each cathode or to both cathodes in parallel.
- ★ Panel switch permits selection of a 10,000-ohm or 100,000-ohm standard. Lower resistance standard improves sensitivity of balance and S/N ratio by a factor of 10 when measuring low-plate-resistance or high-transconductance devices.
- ★ Tubes requiring plate voltages up to 1500v and plate currents up to 400 ma can be measured.

Ranges:

Amplification Factor (μ): 0.001 to 10,000
Dynamic Plate Resistance (r_p): 50 ohms to 20 megohms
Transconductance (g_m): 0.02 to 50,000 micro-mhos

COMPANION INSTRUMENTS

Type 1214-E Unit Oscillator . . . 270 and 1000 cycles at 300-mw output . . . \$75

Type 1951-E Filter . . . for use at either 270 or 1000 cycles . . . useful for reducing background noise when making balances . . . \$80

Type 1212-A Unit Null Detector . . . for measurements from 20c to 5 Mc . . . 40 μ v at 1 kc gives 1% meter deflection . . . \$145. (1203-B Unit Power Supply required . . . \$40.)

Accuracy: $\pm 2\%$ where r_p is between 1 kilohm and 1 megohm. The expression $\mu = g_m r_p$ will check to $\pm 2\%$. At lower and higher values of r_p , error increases slightly.

Socket Mounts Provided for Popular Tubes and Transistors: Tube mounts for 4-pin, 5-pin, 6-pin, small 7-pin, large 7-pin, octal, miniature 7-pin, octal, miniature 9-pin (novel), 5- and 7-pin acorn, flat-press sub-miniature up to 7 wires, and 8-wire sub-minar.

Transistor mounts for 3- and 4-lead transistors. In addition, a universal adaptor-mount with nine soldering lugs, is provided so that unmounted tubes and transistors as well as those with non-standard bases can be measured conveniently.

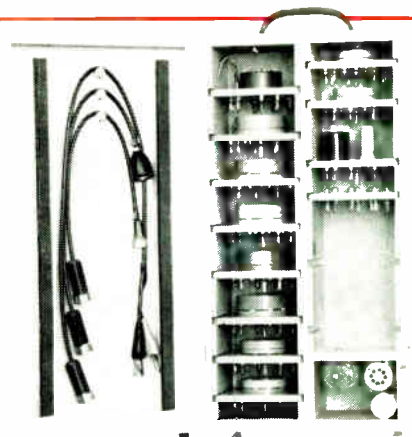

Write for complete information

GENERAL RADIO COMPANY

Canadian Engineering Office in TORONTO

99 Floral Parkway, Toronto 15, Ontario
Arthur Kingsnorth • Richard J. Provon
Tel.: CHerry 4-6221

Repair Service: Bayley Engineering Ltd., Ajax, Ontario