

MR F W PREZIOSI  
8 EASTGATE CRESCENT  
TORONTO 16 ONT

EPM  
QEL  
FEM  
7220

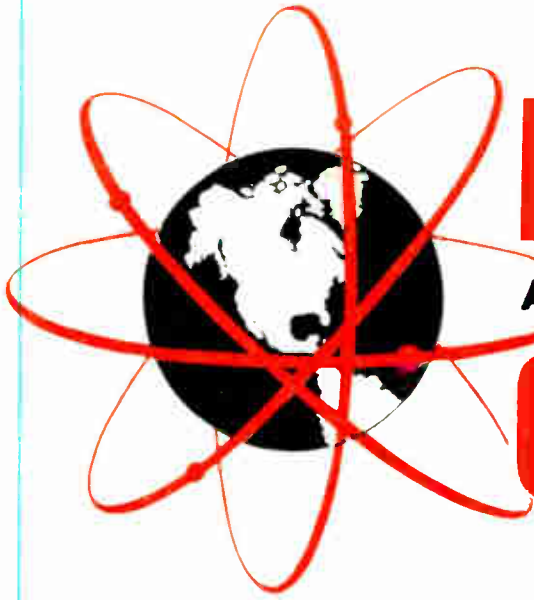

# ELECTRONICS AND COMMUNICATIONS

Design • Manufacture • Engineering • Application

November, 1957

An AGE Publication  
Toronto, Canada



Distribution Of This  
Issue Over 10,000 Copies



*Experimental High-Power Long-Range Radar Installation Developed By  
Massachusetts Institute Of Technology Lincoln Laboratory.*

# IRC<sup>®</sup>

## ***BREAKS THROUGH the reliability barrier***



As jet planes and missiles leave old barriers behind, electronic components find ever-tougher barriers of reliability ahead of them. Those designed for yesterday are already obsolete, those designed for today will soon be. But IRC resistors are ready now to leap ahead of tomorrow's new barriers. Designed ahead of their time, they are also produced by "ahead of their time" processes and quality control techniques. This pattern of progress makes IRC reliability a standard unto itself — a standard that is yours on the widest range of electronic components in the industry.

There is nothing theoretical about the IRC standard of reliability. In most of the major avionic progress-projects, it is being proved out by rigorous field tests. It is also apparent in the way IRC resistors withstand extreme temperature, humidity and mechanical conditions. It is evident, too, in resistance to shock and vibration . . . in improved shelf life . . . in the way IRC resistors consistently surpass MIL spec requirements.



### **INTERNATIONAL RESISTANCE CO. LTD.**

349 CARLAW AVE.

TORONTO 8, ONT.

Radiovision Sales Ltd.  
325 Tenth Ave. West  
Calgary, Alta.

SALES OFFICES:  
492 Somerset St. West  
Ottawa  
Ont.

1500 St. Catherine St. West  
Montreal  
Que.

RESISTOR	IRC TYPE	MIL TYPE	MIL SPEC.	WRITE FOR IRC BULLETIN
Fixed Composition	BT	RC	MIL-R-11B	B-1
Fixed Wire Wound (Low power)	BW	RU	JAN-R-184	B-5
Fixed Wire Wound (High power)	PWW	RW	MIL-R-26C	C-1
Fixed Wire Wound (Precision)	516L 316A	RB 17 RB 52	MIL-R-93A MIL-R-93A	PH
Meter Multiplier (Sealed precision)	MF	MF	JAN-R-29	D-2
Deposited Carbon	DC	RN	MIL-R-10509B	B-4
Deposited Carbon (Molded)	MD	RN	MIL-R-10509B	B-9
Baron Carbon	BC	RN	MIL-R-10509B	B-6
Baron Carbon (Molded)	MB	RN	MIL-R-10509B	B-8
High Frequency	MP HFR	RF RF50	MIL-R-10683A MIL-R-10683A	F-1

#### **COMPUTER COMPONENTS**

Pressure Transducers  
Digital Logic Elements

Packaged Custom Networks  
Differential Transformers

Integrators  
Static Switches

Magnetic Amplifiers  
Shift Registers

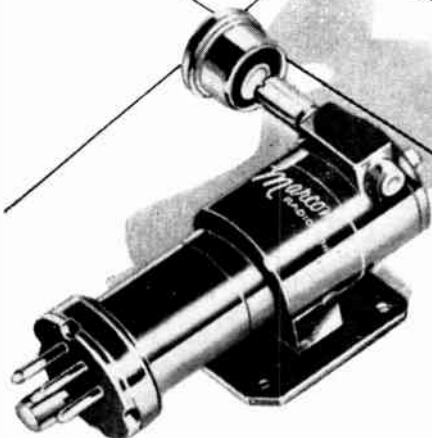
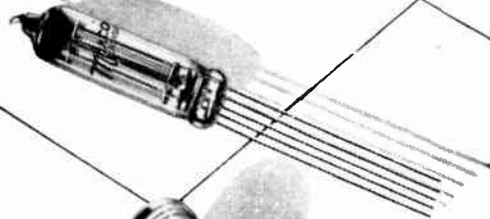
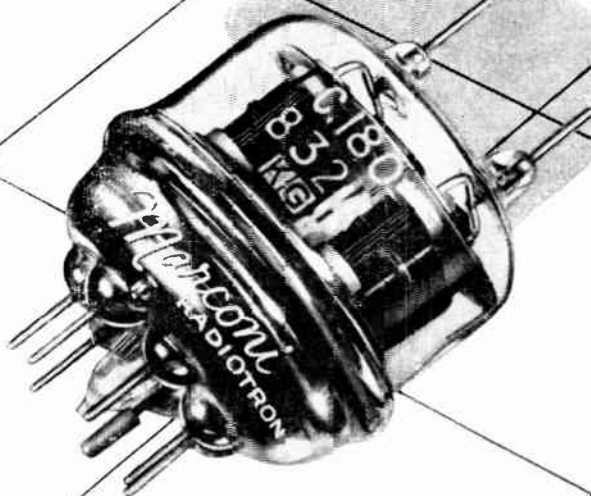
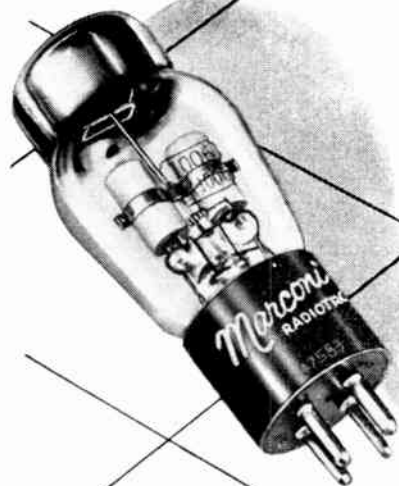

**JUST ONE THING  
IN COMMON...  
EACH IS OUTSTANDINGLY  
TOP OF ITS CLASS**

Detailed perfection is the trademark of every unit . . . the evidence of critical inspection at every stage of production . . . the proof that maximum standards of every specification are observed.

Marconi quality and volume combined with customer-conscious service offers the most for complete satisfaction.



**MARCONI**  **RADIOTRONS**

ELECTRONIC TUBE AND COMPONENTS DIVISION

CANADIAN **Marconi** COMPANY

830 BAYVIEW AVENUE • TORONTO, ONTARIO

BRANCHES: Vancouver • Winnipeg • Montreal • Halifax • St. John's, Nfld.



SIGNAL GENERATOR  
MS 25



NOISE GENERATOR  
TYPE DSG 1



VACUUM TUBE VOLTMETER  
TYPE RV 13



BEAT FREQUENCY  
OSCILLATOR HO 12

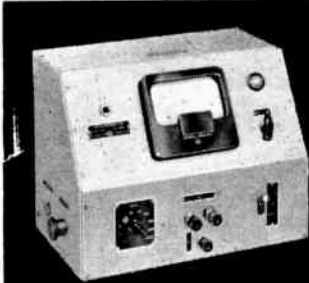

LIMIT BRIDGE TRB 1



AM STANDARD SIGNAL  
GENERATOR TYPE MS 15



DISTORTION METER BKF 5



CAPACITANCE BRIDGE  
TYPE CMB 1

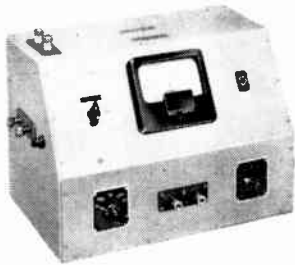

MEGOHMMETER 1 M 3



DELAY LINE KL 41



OSCILLOSCOPE OSG 41

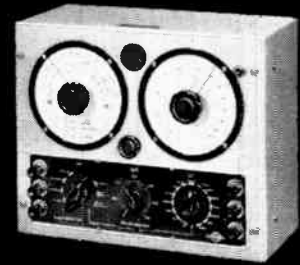

MULTIMETER TYPE MM 1



*your best  
move...*

... in any requirement for electronic instruments is to Radiometer — a well-established name in Canada, backed by Canadian service.

Before investing in any instrument, you owe it to yourself to try Radiometer — quality instruments in every sense of the word, at most attractive prices.

 **RADIOMETER**  
**ELECTRONIC INSTRUMENTS**

SOLD AND SERVICED  
IN CANADA BY

**Bach-Simpson**  
LIMITED

Cathode-Ray Oscilloscopes — FM and AM Standard-Signal Generators — Grid Dip Oscillators — Audio Oscillators — Frequency Response Recorders — Wave Analyzers — Distortion Meters — Vacuum Tube Voltmeters — Impedance Bridges — Capacitance Bridges — Q Meters — Megohmmeters — Galvanometers.

Write for catalogues and other literature.

1255 Brydges St.

London, Ontario

For further data on advertised products use page 65.

# Electronics And Communications

VOLUME 5

NOVEMBER, 1957

NUMBER 11

## FEATURES

Digital Data Transmission Over Telephone Facilities . . . . .	18
Sonic And Ultra Sonic Testing Of Materials . . . . .	20
Simultaneous Examination Of Electrical Parameters . . . . .	21
A Two-Element Ice-Alarm System . . . . .	22
Miniaturization Of UHF Beacon Transmitters . . . . .	24
Production Testing Digital Devices . . . . .	25
Equipment For Measurement Of Inter-Channel Crosstalk And Noise On Broad- Band Multi-Channel Telephone Systems . . . . .	26
by R. W. White, B.Sc., F.Inst. P., A.M.I.E.E. and J. S. Whyte, B.Sc. (Eng.), A.M.I.E.E.	
Electronic Measurement Of Moisture Content In Timber . . . . .	31
Short-Range Radio Navigation — Precise Control For Aircraft . . . . .	32
A Moving Target Simulator System . . . . .	34

## DEPARTMENTS

RETMA REPORT . . . . .	7
CRTPB Newsletter . . . . .	8
Editorial . . . . .	11
Editor's Page . . . . .	17
Business Briefs And Trends . . . . .	39
Technical Data Index For Engineers . . . . .	40
New Products . . . . .	42
News Report . . . . .	45
Book Review . . . . .	64

*President, NORMAN G. McHARDY; Editor, THOMAS W. LAZENBY; Consulting Technical Editor, LESLIE HILL, Ph.D. Eng.; Editorial Assistant, D. K. TROWELL; Advertising Manager, H. E. DALLYN; Assistant Advertising Manager, ARTHUR DIXON; Production Manager, NEVILL A. CAMPLING; Business Manager, CLIFFORD A. SPARKS; Circulation Manager, PAUL A. IRWIN; Art Editor, WM. McREYNOLDS; Photo Editor, GUIDO MILANESIO. United Kingdom and European Representative, NORMAN F. KEENAN, 47 Manchester Street, London W. 1, England.*

## PUBLISHED BY AGE PUBLICATIONS LIMITED

Founded in 1923 by Norton W. Kingsland

Publishers of Heating, Plumbing and Air Conditioning AGE • Restaurants and Institutions  
Oil and Gas Heat • Wine, Beer and Spirits in Canada • Industrial Aeronautics

TORONTO, ONT., CANADA: 31-35 Willcocks Street, Tel. WALnut 2-3115. MONTREAL, QUE., CANADA: Keith Edgar,  
116 Rue de Flandre, Montreal 23 (Preville), Quebec, Telephone: OR. 1-2020.

SUBSCRIPTION RATES: Canada, U.S.A. and British Possessions - \$5.00 per year • Foreign - \$10.00 per year.

Authorized as second class mail, Post Office Department, Ottawa

Printed, Engraved and Pro-  
duced in its entirety by  
AGE PRESS  
A Division of  
AGE PUBLICATIONS LIMITED

Member Canadian Circulations



Audit Board, Inc.

PRINTED IN CANADA  
60

# CKSL *proved it!*



STATION TECHNICIANS PLAYED A REEL OF "SCOTCH" MAGNETIC TAPE

*twice each day for nine months!*



"It was the first time we had checked the life of a tape. Frankly, we were surprised at the punishment that "SCOTCH" Brand Magnetic Tape III-A can take. Each day the spool was played twice and rewound twice on high speed equipment. Yet no distortion could be detected and a low noise level was maintained. Another thing, it erased clearly and did not curl throughout this nine-month period."

*Ron Turnpenny, Director of Engineering, CKSL, London, Ontario.*

On battery-operated portable tape recorders, the technicians of this same station have also found that "SCOTCH" Brand Magnetic Tape 120A provides higher output and reduces noise and overload problems.



TRADE MARK  
**SCOTCH**  
 BRAND  
**Magnetic Tapes**



**MINNESOTA MINING & MANUFACTURING OF CANADA LIMITED, LONDON • CANADA**

*Sales Offices: Halifax • Montreal • Toronto • Winnipeg • Calgary • Vancouver*

*Resident Salesmen: Moncton • Quebec City • Ottawa • Hamilton • North Bay • Regina • Saskatoon • Edmonton*

For further data on advertised products use page 65.

# RETMA Report



By Basil Jackson, A.R.Ae.S., Tech. M.C.A.I.

## Components Engineering Committee

The Components Engineering Committee met in Toronto on November 6. This committee, comprising twenty-four sub-committees dealing with electronic components, is under the chairmanship of J. W. Lucyk with F. H. Edwards as vice-chairman.

Reports of the sub-committee chairman were received and other technical business attended to.

## Service Committee

The Service Committee dealt with a full agenda when it met in Toronto recently. Under discussion was a proposed draft of a bulletin dealing with consumer education on television receiver service and the review of the relative usefulness of the technical bulletins published by RETMA from time to time for service technicians. At the 1957 series of Town Meetings for service technicians a questionnaire had been circulated to the 800 people attending enquiring about those technical bulletins most needed. The replies received indicated that the foremost subject on which information was required concerned horizontal circuits, sync circuits, deflection circuits, video amplifier circuits, IF circuits and front ends, in that order of precedence.

## 1957 RETMA Trade Directory

The 1957 RETMA Trade Directory (sixth edition) has recently been published. It is in three sections. Section 1 gives an alphabetical list of all Canadian electronic manufacturers who are members of RETMA - by divisions; Section 2 gives an alphabetical list of radio, television, and electronic components manufactured in Canada by members of the Components Division of RETMA; Section 3 gives an alphabetical list of the names and locations of foreign manufacturers and the names and locations of the companies that represent them in Canada.

This 32-page directory is issued to all members of RETMA and also to persons and companies who have a bona fide interest in the electronics industry; it has already been distributed to the Government departments connected with the industry, foreign embassies, and to the Canadian Trade Commissioners overseas. Requests for copies should be made to RETMA of Canada, 200 St. Clair Avenue West, Toronto 7, Ontario.

## RETMA Film Available

The sound color film entitled "Electronics In Canada", made on behalf of RETMA, is now available on loan, free of charge from the RETMA Office.

The film was produced to give Canadians an idea of the large independent electronics industry which has been built up in Canada since the early 1920's, and to encourage high school students, and others, to plan careers in the industry.

Of a non-commercial nature, the film is offered to companies, high schools, service clubs and similar organizations. Applications for borrowing it should be addressed to the RETMA Office, 200 St. Clair Avenue West, Toronto 7, Ontario.

# Newsletter

Canadian Radio Technical Planning Board

## Two New Members

As a result of a letter ballot carried out among the contributing sponsors of the Canadian Radio Technical Planning Board, two new members have been admitted. They are Western Canada Telecommunications Council and the Canadian Association of Chiefs of Police. This brings the number of contributing sponsors of the CRTPB to twenty.

## DOT Officials Attend ICAO Conference On Air Traffic Control

Three Department of Transport officials are attending an International Civil Aviation Organization (ICAO) meeting at Copenhagen to discuss the installation of a new communication technique over the Atlantic — "Very High Frequency Forward Scatter Radio". The new system has been designed to provide fast and reliable air traffic control and airline communications throughout the North Atlantic network.

The three departmental officials are: O. L. Britney, engineer in charge of planning and co-ordinating; B. J. McIntyre and J. W. Waller, radio engineers.

The conference consists of the technical co-ordination group of ICAO who will consider the technical and financial aspects of the new network installations.

Recommendations for a new communications system came after the International Civil Aviation Organization Jet Age Task Force found that "the world's outstanding case of immediate and compelling need for aviation improvement relates to air traffic control and communications in the North Atlantic region." This is the heaviest trans-oceanic traffic area in the world.

The new communications system is planned to consist of three "forward scatter" radio stations and possibly the use of a proposed Scotland-Iceland cable which would provide a direct voice and four teletype communication channels between Europe and North America. The forward scatter stations would be built near Narssaq in Greenland, Gander in Canada and Reykjavik in Iceland and, with the cable, would provide a reliable communications network over long stretches of water similar to landline services.

## FCC Urged To Widen Private Microwave Licenses

The United States Federal Communications Commission was recently presented with a submission by the Electronics Industries Association (EIA — formerly RETMA of U.S.) in which it was contended that there was in existence adequate spectrum space to provide a "healthy" private microwave communications industry. The FCC was urged to broaden the eligibility base of private microwave licensees and to assure these users a freedom of choice in selecting a communications medium.

EIA is scheduled to present a series of eight witnesses in connection with the FCC's fact-finding inquiry on the utilization of frequencies above 890 megacycles. This docket (11866) was announced by the Commission early last spring and extensive hearings began in late May.

It was pointed out that the EIA, on the basis of long and detailed consideration of microwave spectrum utilization, believes that there was spectrum space adequate to justify a liberal licensing policy for independent microwave systems under a disciplined pattern of spectrum control. It was also said that a vigorous and healthful independent microwave

industry could not exist without the "freedom of choice" principle operating within a liberal policy of licensing eligibility.

## 13th Annual Meeting Plans Ready

Plans have been completed for the 13th Annual Meeting of the CRTPB. It will take place on Tuesday, December 10, at 9:30 a.m. in Salon "D" of the Chateau Laurier Hotel, Ottawa. All representatives of contributing sponsors are urged to attend this important meeting.

## Addendum To CRTPB Newsletter Number 3

In the October (Number 3) Issue of CRTPB Newsletter mention was made of the paper entitled "A Canadian Point of View On Radio Frequency Spectrum Management" which was presented before the convention of the American Institute of Electrical Engineers in Montreal. However, the name of the author was omitted. He was C. M. Brant, Controller, Radio Regulations Division, Telecommunications Branch, Department of Transport.

Extra copies of this address, already circulated to contributing sponsors, are available from the CRTPB Office, 200 St. Clair Avenue West, Toronto 7, Ontario.

## Special Meeting Of Mobile Committee

A special meeting was held on November 22 in Ottawa of the Fixed, Land and Maritime Mobile Committee and representatives of the DOT in connection with the DOT interpretation of the requirements of DOT Specification 112 regarding non-compulsory fitted ships. All sponsors were invited to attend. The committee also held a meeting in Toronto on October 23.

## DOT And U.S. Officials Discuss Radio Frequencies

The CRTPB office has received the minutes of an informal meeting held in Ottawa last August between representatives of Canada and the United States regarding the question of radio frequencies to be made available for radio-telephone communications for vessels using the International Section of the St. Lawrence Seaway.

The importance of this subject was reflected by the attendance of the high-ranking officials who attended the meeting. Representing the U.S.A. were Mr. A. Lebel, of the U.S. State Department (chairman of the meeting), Mr. P. S. Bogart of the U.S. Embassy, Mr. A. L. McIntosh, Federal Communications Commission, Mr. J. L. Stewart, U.S. Coast Guard, and Lt. Col. E. J. Holliman and Mr. V. R. Goings, both of the U.S. Army. Canada was represented by Mr. F. G. Nixon, Director, Telecommunications Division, DOT, Mr. C. M. Brant, Controller, Radio Regulations Division, DOT, W. A. Caton, C. J. Acton, L. Britney, H. F. Salisbury, A. J. Dawson, and H. F. Jackson, all from the Telecommunications Division of DOT.

It was noted that there was increasing congestion on medium frequencies of the Great Lakes and associated canals and that these problems must be solved and reconciled with decisions made for the St. Lawrence Seaway.

It was decided to recommend to the respective countries that specified interim frequency complements be used pending decisions on International VHF allocations to be made in 1959 at the Internal Telecommunications Union Conference.

Canadian Radio Technical Planning Board  
200 St. Clair Avenue West, Toronto 7, Ontario

R. A. HACKBUSCH, President; F. H. R. POUNSETT, Vice-President; R. C. POULTER, General Co-ordinator and Director of Public Relations; F. W. RADCLIFFE, Secretary-Treasurer



# NEW Bendix MARKER RECEIVER

(1/4 ATR)

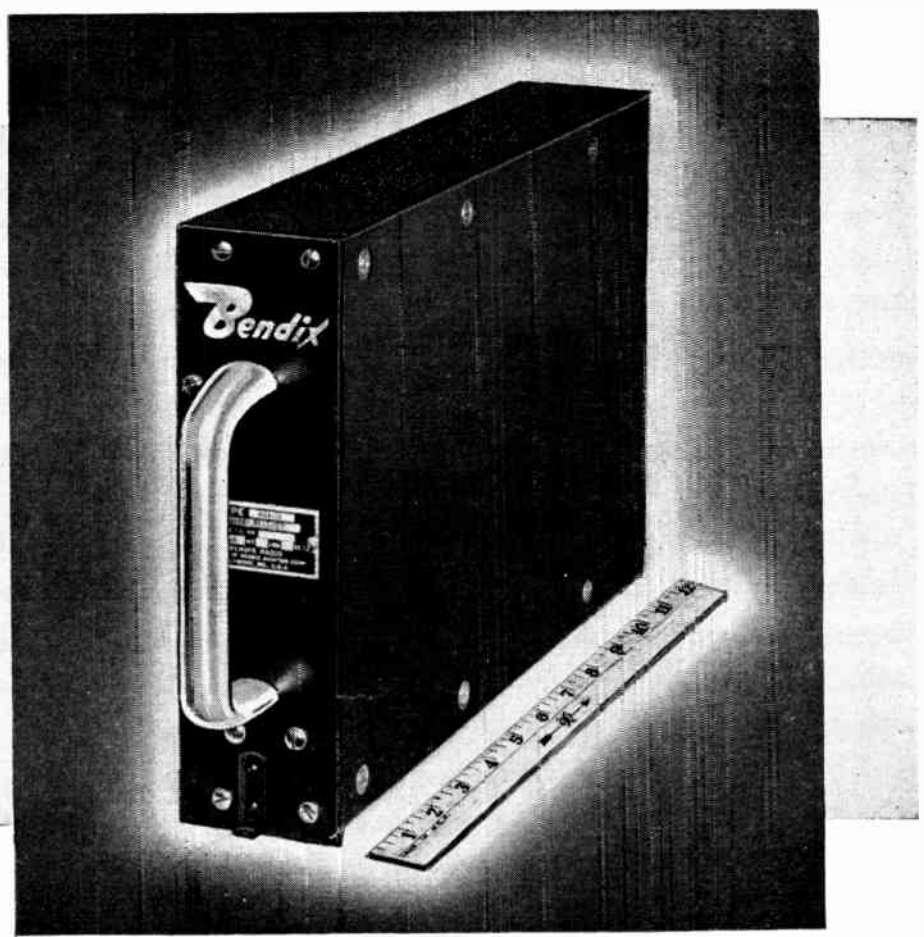

*Compact... Rugged... Weighs only 8½ pounds!*

Now from Bendix\*, makers of the world's standard in Marker-Receivers, comes a big advancement—the MKA-7A. Completely new from chassis to case, the Bendix MKA-7A Marker-Receiver is designed for dependable, trouble-free reception of signals from airways fan markers, station locator Z markers and ILS approach markers.

Smaller in size, lighter in weight, it is scheduled for use in Pan American Airways new fleet of DC-7C's.

Operating on a fixed frequency of 75 megacycles, the MKA-7A features improved circuitry that performs a two-fold function:

- (1) Greatly reduces the chance of television or FM interference.
- (2) Stabilizes gain under wide ranges of environmental conditions and line voltage fluctuations.

For further information, contact your Bendix Aviation Radio representative or write the factory direct. Address below.

\*Reg. U. S. Pat. Off.

### SPECIFICATIONS

- Antenna transmission line input impedance 52 ohms. Voltage standing wave ratio less than 1.2 to 1.
- AVC characteristics Audio output: is within a 6-db range at r-f input levels from 400 to 200,000 microvolts.
- Selectivity
 

Attenuation	Total Bandwidth
6 db	more than 40 kc
60 db	less than 250 kc
- Frequency stability ± 10 kc under all service conditions.
- Undesired response rejection Interference from adjacent channel television signals will not produce lamp threshold at input levels up to 3.5 volts.
- Audio output impedance 500 ohms, nominal.
- Power requirements
 

AC Power Supply	115 volts ac, 300-1000 cps, 35 VA with 27.5 volts dc for ON-OFF relay control, or
DC Power Supply	27.5 volts dc, 36 watts.
- Altitude performance Operates at barometric pressures equivalent to 30,000 feet altitude.
- Ambient temperature rating -40°C to +70°C (-40°F to +158°F).

Specifications subject to change without notice.



**COMPUTING DEVICES OF CANADA LIMITED**  
P.O. BOX 508 • OTTAWA • CANADA

WESTERN DIVISION — Commercial Building, Edmonton, Alberta

5716

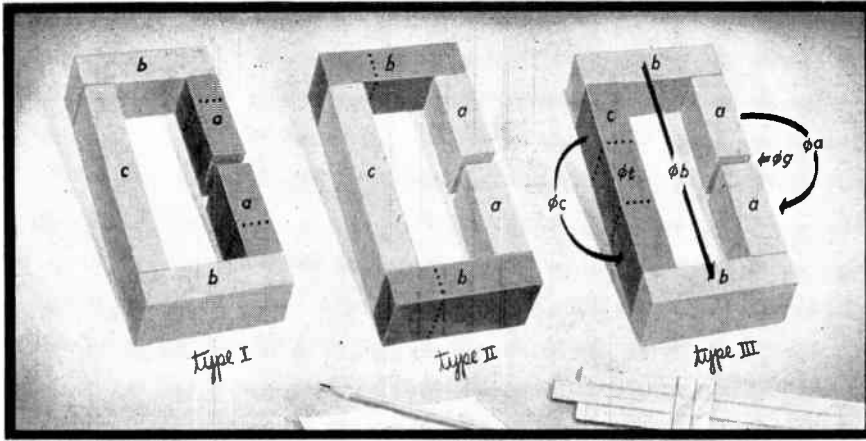

## How You Can Save Time Estimating Leakage Factors for Magnetic Circuits

Computing even approximate values for leakage flux in magnetic circuits is a time consuming job. The research department of Indiana Steel recently undertook a series of studies, supported by the U.S. Air Force, to simplify these computations. Dr. R. K. Tenzer reported the results of this work, which reduce the time in computing leakage flux up to 90% by diminishing the number of mathematical operations necessary.

The investigations were done on circuits with permanent magnets; the results were also found applicable to unsaturated electromagnetic circuits when the coil-covered parts were treated as permanent magnet parts.

After checking values obtained by this method with actual measured values for many Type I, II, and III magnetic circuits, deviations were found to be less than ± 10%.

### Leakage Flux, Leakage Factor

Because of magnetic leakage, only a part of the total flux through the neutral zone of the permanent magnet is found in the air gap. The difference between these two values is known as leakage flux. Mathematically this is:

$$\phi_L = \phi_t - \phi_g \quad (1)$$

In practical design, leakage is best considered as a factor stated thus:

$$\sigma = \frac{\phi_t}{\phi_g} = 1 + \frac{\phi_L}{\phi_g} \quad (2)$$

For simplification, the flux can be assumed to follow three basic, probable paths:  $\phi_a$  between parts  $a$ ,  $\phi_b$  between parts  $b$ , and  $\phi_c$  along part  $c$ . The equation above then becomes:

$$\sigma = 1 + \frac{\phi_a + \phi_b + \phi_c}{\phi_g} \quad (3)$$

With  $\phi = mmf \times P$ , this formula can be written:

$$\sigma = 1 + \frac{1}{P_g} \left( \frac{mmf_a}{mmf_g} P_a + \frac{mmf_b}{mmf_g} P_b + \frac{mmf_c}{mmf_g} P_c \right) \quad (4)$$

Letting the *mmf* ratios be denoted by  $K$ ,

$$\sigma = 1 + \frac{1}{P_c} \left( K_a P_a + K_b P_b + K_c P_c \right) \quad (5)$$

This becomes the basic equation for numerical calculations of leakage factors after introducing simple expressions for leakage permeances and *mmf* ratios.

### Simplified Leakage Permeances

The following formulas have been found satisfactory for leakage permeances between soft steel parts:

$$P_a = 1.7 \times U_a \times \frac{a}{a + L_g} \quad \text{where } U \text{ is cross-section perimeter;} \quad (6)$$

$$P_b = 1.4 \times b \times \sqrt{\frac{U_b}{c} + .25} \quad (7)$$

where  $U_b/c$  is greater than .25 and less than 4. The total length of part  $b$  is used.

Since permanent magnets have a neutral zone which does not contribute to leakage, the value of 2/3 of the magnet's total length is used when computing leakage permeances—this is the effective length  $a'$  and  $b'$  to compute  $P'$ ; thus the two equations above become:

$$P'_a = 1.7 U_a \frac{.67a}{.67a + L_g} \quad (6a)$$

and

$$P'_b = 1.4 \times .67b \sqrt{\frac{U_b}{c} + .25} = .67 P_b \quad (7a)$$

When part  $c$  consists of a permanent magnet (Type III) its permeance can be calculated as:

$$P_c = .5 U_c \quad (8)$$

The permeance of the air gap itself is

$$P_g = A_g / L_g \quad (9)$$

### Simplified MMF Ratios

Simplifying the *mmf* ratios is done by neglecting the reluctance in soft steel parts; so

$$mmf_a = mmf_b = mmf_g \text{ or } K_a = K_b = 1 \text{ (} mmf_c = 0 \text{ so } K_c = 0\text{).} \quad (10)$$

Since the *mmf* along permanent magnet parts is not constant, integral values ( $\overline{mmf}$ ) are used. Experiments showed that 2/3 of the  $mmf_g$  was the effective *mmf* for leakage flux between permanent magnet parts; thus

$$\overline{mmf}_a = \overline{mmf}_b = \overline{mmf}_c = 2/3 mmf_g$$

or

$$K_a = K_b = K_c = 2/3. \quad (11)$$

### Basic Formulas

By inserting the permeances for soft steel into equation (5), the general formula becomes:

$$\sigma = 1 + \frac{L_g}{A_g} \left( K_a \times 1.7 U_a \frac{a}{a + L_g} + K_b \times 1.4 b \sqrt{\frac{U_b}{c} + .25} + K_c \times .5 U_c \right) \quad (12)$$

This formula contains only constants and dimensions; and by the two following rules this can be modified into the three basic equations for the Type I, Type II, and Type III circuits.

Rules: (1) For leakage flux paths between soft steel parts, use total lengths and constant  $K$  of 1. (2) For leakage flux paths between permanent magnet parts, use 2/3 of lengths and  $K$  of .67.

The following provide the leakage factors for the three types of circuits:

#### Type I:

$$\sigma = 1 + \frac{L_g}{A_g} \times .67 \times 1.7 U_a \frac{.67a}{.67a + L_g}$$

#### Type II:

$$\sigma = 1 + \frac{L_g}{A_g} \left( 1.7 U_a \frac{a}{a + L_g} + .67 \times .67 \times 1.4 b \sqrt{\frac{U_b}{c} + .25} \right)$$

#### Type III:

$$\sigma = 1 + \frac{L_g}{A_g} \left( 1.7 U_a \frac{a}{a + L_g} + 1.4 b \sqrt{\frac{U_b}{c} + .25} + .67 \times .5 U_c \right)$$

For variations on these basic formulas, write today for the April-June issue of *Applied Magnetism* which also shows examples of the formulas in use.

### NEW DESIGN MANUAL READY

Write today for your copy of the newest edition of the Indiana Permanent Magnet Design Manual No. 6. Write to Dept. A-11.



**THE INDIANA STEEL PRODUCTS COMPANY**  
OF CANADA LIMITED  
KITCHENER, ONTARIO

**THE WORLD'S LARGEST MANUFACTURER OF PERMANENT MAGNETS**

INDIANA  
PERMANENT  
MAGNETS

For further data on advertised products use page 65.

# Electronics And Communications

Volume 5

November, 1957

Number 11

## A Matter For Appraisal And Action

From amongst the published reports that have resulted from the successful launching of an earth satellite by the Russians, there is one question that has been asked by many and which stands out in our mind as one of the most alarming possibilities of the whole episode. It is the question of whether Russia has been enabled to accomplish this remarkable achievement by reason of a fuller possession of knowledge in the field of pure science than that possessed by the United States.

Although the United States government and industry are spending millions of dollars annually on research, the greater proportion of it is reportedly being devoted to applied research as opposed to investigations into the fundamental nature of matter. While the United States may be regarded as a world leader in technology, she has, according to the expressed statements of many of her leading scientific authorities, relied heavily on other countries — mostly European — for the basic knowledge of matter that has been derived from the pursuit of basic research.

It has now been stated that a large share of the blame for this situation may be laid at the doors of American educational institutions and it is encouraging to note that one of the results of the Russian scientific success of placing an earth satellite in outer space is the expressed intention of American authorities to take a closer look at the state of American participation in the field of basic research as well as the ability of her educational institutions to adequately train personnel for this task.

If American authorities find it necessary to self-analyze themselves in the matter of any suspected failing in the sphere of basic scientific research and the educational training prerequisite to it, then Canadian authorities would be well advised to initiate similar action and take a good long look in the mirror of self-appraisal for the same reason.

There is, in our estimation, little doubt that the engineering and scientific standards of Canadian universities lag far behind the long established standards of European universities. Any appraisal of the caliber of Canadian scientific education would, however, have to start at the high school level and criticism be directed to our provincial departments of education who seem content to run our high schools more in the manner of social centers than institutions of serious learning. It has been said, and from personal examination we believe it, that a high school graduate of the British educational system is as far advanced in scientific subjects as an engineering or science graduate of a Canadian university. A comparison of the text books used by the English high school student and the Canadian university graduate confirms this belief.

That such a situation exists is due largely, in our estimation, to the willingness on the part of provincial education authorities to accept the status quo in high school educational standards and the apparent lack of initiative on their part in the matter of accelerating the mechanics of learning. The average Canadian high school curriculum would seem to have just "grewed up" like

Topsy, and the time is far past when some sweeping changes based on realistic academic objectives in keeping with the needs of our times should be instituted.

If the future should hold any likelihood of a revision in the curricula of our high schools — a revision that is absolutely essential if we are to raise the level of our formal education to meet the needs of our times — a good place to start may be by reducing summer holidays from two months to one, by eliminating Christmas and Easter holidays and by commencing the school day at nine in the morning and working through to five at night. Social activities, if such must be regarded as part of school life, could be confined to week-ends.

There will be many who will regard such suggestions as idiotic and archaic, but they need only look to the fact that at this moment it is the graduates of such accelerated and concentrated systems of education that have placed Russia as the undisputed leader in the scientific field and it is the British and European graduates of similarly advanced techniques of teaching to whom the Western world is looking for assistance in the matter of regaining our lost prestige in the world of science.

It follows, therefore, that if the curriculum standards of high schools are to be upgraded, then there will necessarily have to be some drastic upgrading in the curricula of our colleges and a general change of attitude impressed upon the student body. For too long Canadian and American university life has been regarded by the average student as a mixture of equal parts of learning and social activity and for this reason the scope for improved efficiency in Canadian university educational methods is far greater than that existing at the high school level. In this respect we agree wholeheartedly with the already expressed opinion that university authorities consider the advantages that could be derived by reducing the ridiculous length of college holidays from five months to one. How absurd it seems that nearly half of the year should be consumed in holidays for the university student. By reducing summer holidays to one month per year, more than a full year's tuition could be gained over the period of four years. Comparative statistics on the number of engineers being graduated by Russia and the Western countries is now old hat. What better place to start remedying our deficiency in this respect than by using to the fullest the time at our disposal.

Altogether it would seem that the time is overdue when there should be a drastic revamping of the entire Canadian educational system, a revamping that would eliminate the last traces of the "Whiffenpoof" and "coon coat" era from our high schools and universities and replace the lost time in over-extensive holidays and spare periods with an accelerated program of advanced and serious study. The time has come, we believe, when we should ask ourselves whether our educational authorities are pedagogues or procrastinators. Such action is needed, we believe, in view of the alarming deficiencies in our educational system as reported by Robert C. Cowan in the *CHRISTIAN SCIENCE MONITOR*, a report which is reprinted on the Editor's page of this issue of *ELECTRONICS AND COMMUNICATIONS*.

# THE NATIONAL SCENE



**KEEPING "ELECTRONIC BRAINS" FROM LOSS OF MEMORY.** One of science's greater marvels is IBM's 705 Electronic Data Processing Machine—which makes intricate calculations and logical decisions in millionths of a second. Heart of this "electronic wizard" is its main magnetic core memory. Designed for use with the machine's high-speed printer is the IBM 760 Control and

Storage Unit containing its own core memory of 1,000 positions which allows central processing to continue in the 705 while other data are being printed. Helping the 760 remember what information is to be printed is a job for PHENOLITE® Laminated Plastic. PHENOLITE's unique combination of properties makes it ideal for this application.

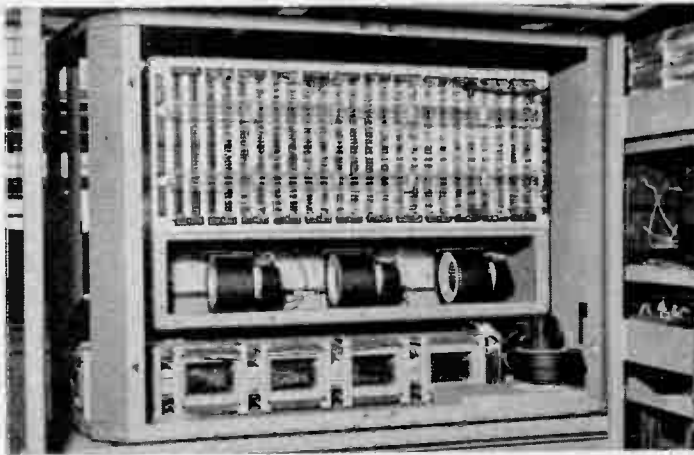

**MOST ADVANCED FORM OF ELECTRONIC STORAGE.** The 1,000-position core memory for the IBM 760 Control and Storage Unit—a portion of which is shown here—consists of pinhead size cores strung on copper-wired frames of PHENOLITE. Electrical impulses, passing through wires, alter the magnetic state of cores so that a group of them stand for a word or figure. Reversing the process recalls information from storage. PHENOLITE frames safeguard the circuit and permit stacking of core planes as shown.

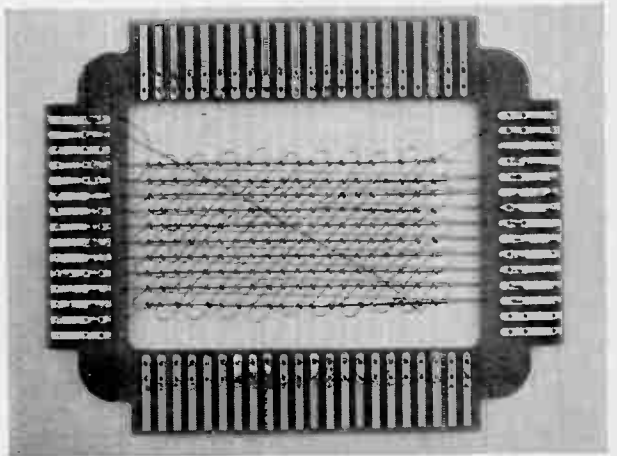

**PHENOLITE MEETS CRITICAL STANDARDS.** Core frames like the one shown are punched out of laminated PHENOLITE by IBM. Each frame has printed circuit type terminal strips and soldered connections. PHENOLITE proves an ideal material for this application because it is mechanically strong and stiff, punches cleanly, etches well, remains flat, has high dielectric properties and withstands the heat of dip soldering.

**NATIONAL CAN HELP YOU** reduce unit product cost or improve product performance at no added cost. Here's why . . . You can select the "one best material" from over 100 grades of PHENOLITE, Vulcanized Fibre and National Nylon—without compromise in properties or cost. You can simplify production and purchasing with the timed delivery of 100% usable parts—from a single reliable source. You gain competitively with National's new materials and grades—the direct result of programmed materials-research.



**NATIONAL**

**FIBRE COMPANY OF CANADA, LTD.**  
ATLANTIC & HANNA AVENUES, TORONTO  
1411 CRESCENT STREET, MONTREAL

You benefit by calling National first. Check Telephone Directory Yellow Pages, or write Toronto—Dept. O11.

For further data on advertised products use page 65.

# Laboratory Accuracy Production-Line Speed



## Type 1605-A Impedance Comparator

- ✓ No manual balancing. Phase-angle and impedance-magnitude differences between the unknown and a standard impedance are read directly from two meters.
- ✓ An impedance bridge for *dynamic* measurement of impedance changes caused by varying environmental conditions.
- ✓ Can be readily incorporated into automatic-sorting equipment.

**Wide Range of Internal-Test Frequencies**  
100, 1000, 10,000 and 100,000 cps.

**Impedance Range**  
Resistance: 2 ohms to 20 megohms  
Capacitance: 40  $\mu\text{f}$  to 500  $\mu\text{f}$   
Inductance: 20  $\mu\text{h}$  to 10,000  $\mu\text{h}$

**Direct-Reading Meter Ranges**  
Impedance-Magnitude Differences:  
0.3%, 1%, 3%, and 10% of full scale.  
Phase-Angle Differences:  
.003, .01, .03, 0.1 radians full scale.

**Over-All Accuracy**  
3% of full scale (.01% over-all accuracy  
on 0.3% impedance magnitude range).

**\$790**

**Vitramon**  
CORPORATION

manufacturers of vitreous enamel dielectric capacitors, have taken full advantage of the Impedance Comparator's versatility:

**Engineering** The Impedance Comparator's ability to perform dynamic measurements without instrument readjustments allows considerable convenience in development. Capacitors, placed in a test cabinet containing a heating lamp and reflector, are measured for changes in dissipation factor and capacitance with temperature. The continuous measuring feature of the bridge eliminates any need for thermostatic heat control; the operator merely records thermocouple temperature and Comparator readings to obtain an accurate plot of conditions.

**Pre-Production** A statistical sampling of capacitors from each production lot is subjected to accelerated life tests at 130°C and 150% of rated voltage for 250 hours. These life-test measurements for dissipation factor and capacitance give information as to dielectric quality. Pre-production samples are also measured to determine mean and extreme capacity values so that the distribution of each production lot is known. Accurate data from the Impedance Comparator make effective production control at "VITRAMON" a certainty.

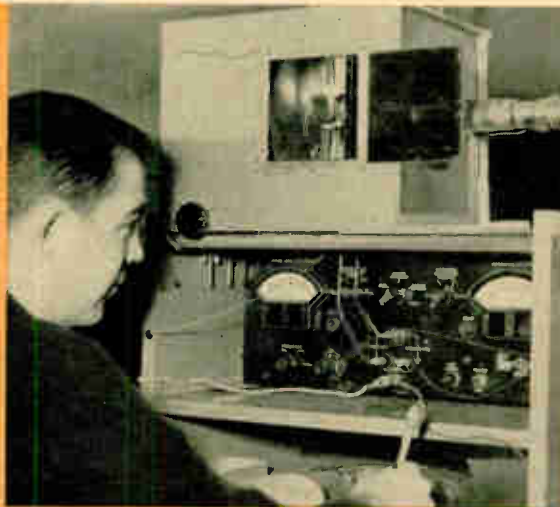

**Post-Production** A G-R Type 722 Precision Capacitor, converted for guarded operation, is used as a standard. Easy and rapid testing provided by the "No-Knob" balancing feature of the Impedance Comparator permits "VITRAMON" to perform a 100 per cent check of production lots without significant increases in labor costs.



# GENERAL RADIO Company

Cambridge, Massachusetts, U.S.A.



All G-R Products  
are now covered by a

**Canadian Office: 99 Floral Parkway, Toronto 15, Ontario**

Arthur Kingsnorth

Richard J. Provan

Repair Service:

Beyly Engineering, Ltd.,  
Worthington, Ontario

Telephone: CHerry 4-6221

**2-Year Warranty**

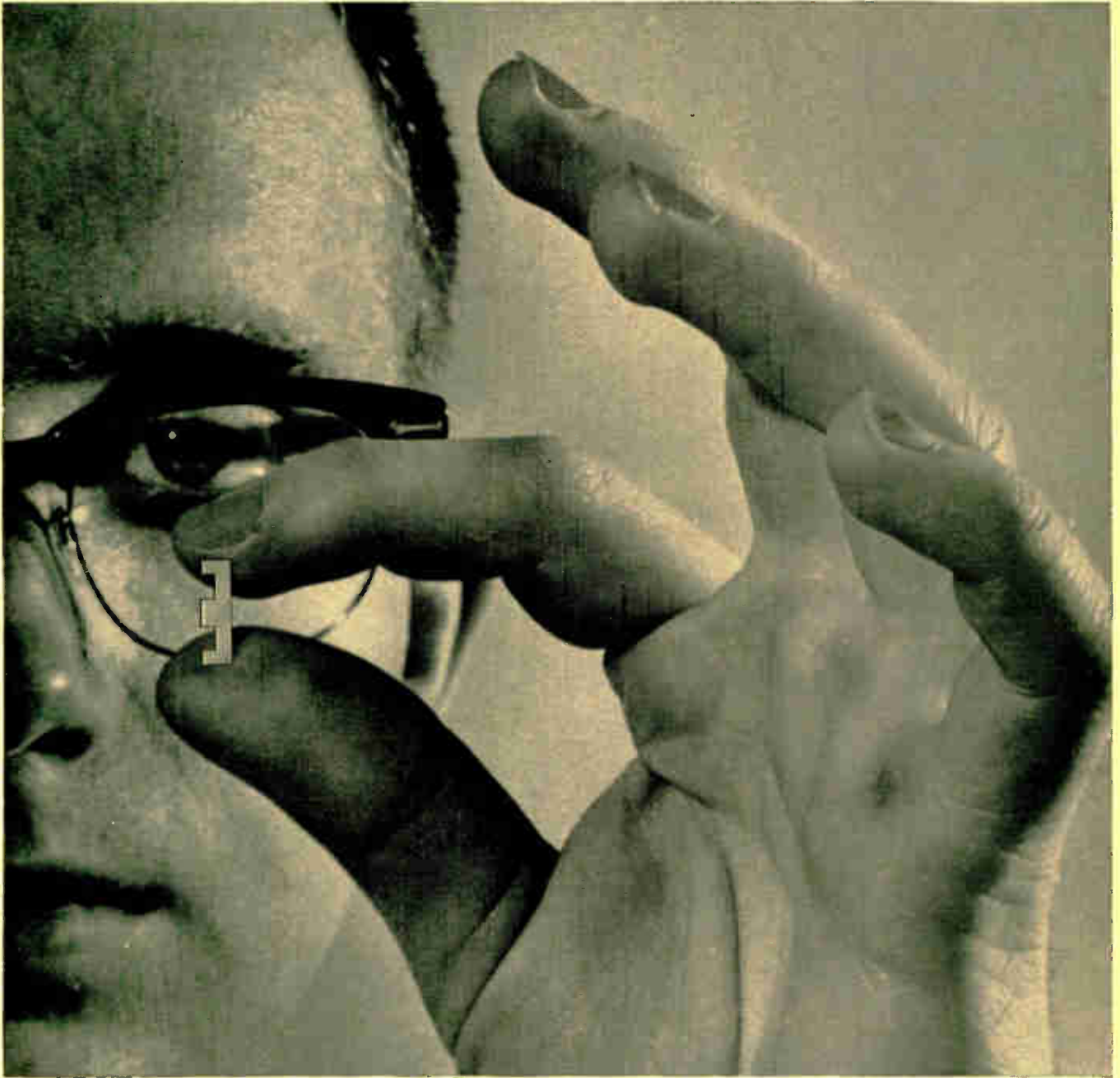

## Here are laminations for miniaturization

If you are making transformers for transistorized or other miniaturized equipment, information about our ultra-small size "performance-guaranteed" laminations can be important news to you. These nickel-iron laminations are produced in standard gauges, and are available in Hy Mu 80, 48 Alloy and, if required, Orthonol.

Dry-hydrogen annealed by our exclusive process, these laminations provide all-important uniform quality. This annealing at a dewpoint of  $-60^{\circ}\text{C}$ . brings our Performance-Guaranteed laminations to ultimate permeability from as little as 5% of that value in the unannealed state.

Like all laminations from Magnetics, Inc., the "miniatures" are packed in standard nine-inch boxes to facilitate handling in your plant, and are immediately available from stock. These features alone provide substantial savings.

Edges of these fine tolerance laminations are cut off squarely and cleanly to minimize air gap where mating parts are butted. Thus, high operating efficiency is insured.

There's no room here for the really detailed story, but for complete information on our "Performance-Guaranteed" magnetic laminations, send for our newest catalog—just published—ML-301. Write today. *Magnetics, Inc., Dept. EC 41, Butler, Pennsylvania.*

**MAGNETICS inc.**

For further data on advertised products use page 65.

**are you fighting space?**

*connect  
with  
cannon!*

Are you looking for complete electrical circuit dependability in a very, very small space?

If so, you should use Cannon carefully engineered miniature and sub-miniature multi-contact connectors. In  $\frac{1}{2}$  or  $\frac{1}{3}$  the usual space, they give you up to 50 contacts, the same number as a standard connector, and still retain all the factors of utility, reliability, and mechanical strength found in Cannon's standard size connectors. They are very rugged, easy mating, unusually versatile, neat and compact.

Miniatures—Maximum Dimensions Only 1" x 2"



High-dielectric insulation. Rack, panel, chassis types . . . receptacles and plugs, standard, pressurized, or hermetically sealed . . . box, wall, or cord mountings . . . for audio, control, and instrument use. D sub-miniatures have steel shells. DPA, K, and MC miniatures have die-cast shells. Five-ampere gold plated contacts are found in all miniatures and sub-miniatures, excepting miniature hermetic sealed receptacle. Larger contacts have higher current rating. Co-ax contacts are also available in several types, including the K miniature.



*first in connectors*

**CANNON  
PLUGS**

Write for Cannon Miniature and Sub-Miniature Bulletin.

**CANNON ELECTRIC CANADA LIMITED**, 160 Bartley Drive, Toronto 16, Ontario.

Montreal Office: Montreal Airport, Dorval, P.Q.

Factories also in Los Angeles, Salem, London, Melbourne.

Licences in Paris, Tokyo.

5703

.....  
 • A 130-mile Westinghouse "proving ground" has been set up between Hamilton and Kinmount, Ontario. Here Westinghouse engineers obtain actual operating results to assist you in planning your communication system.  
 •.....

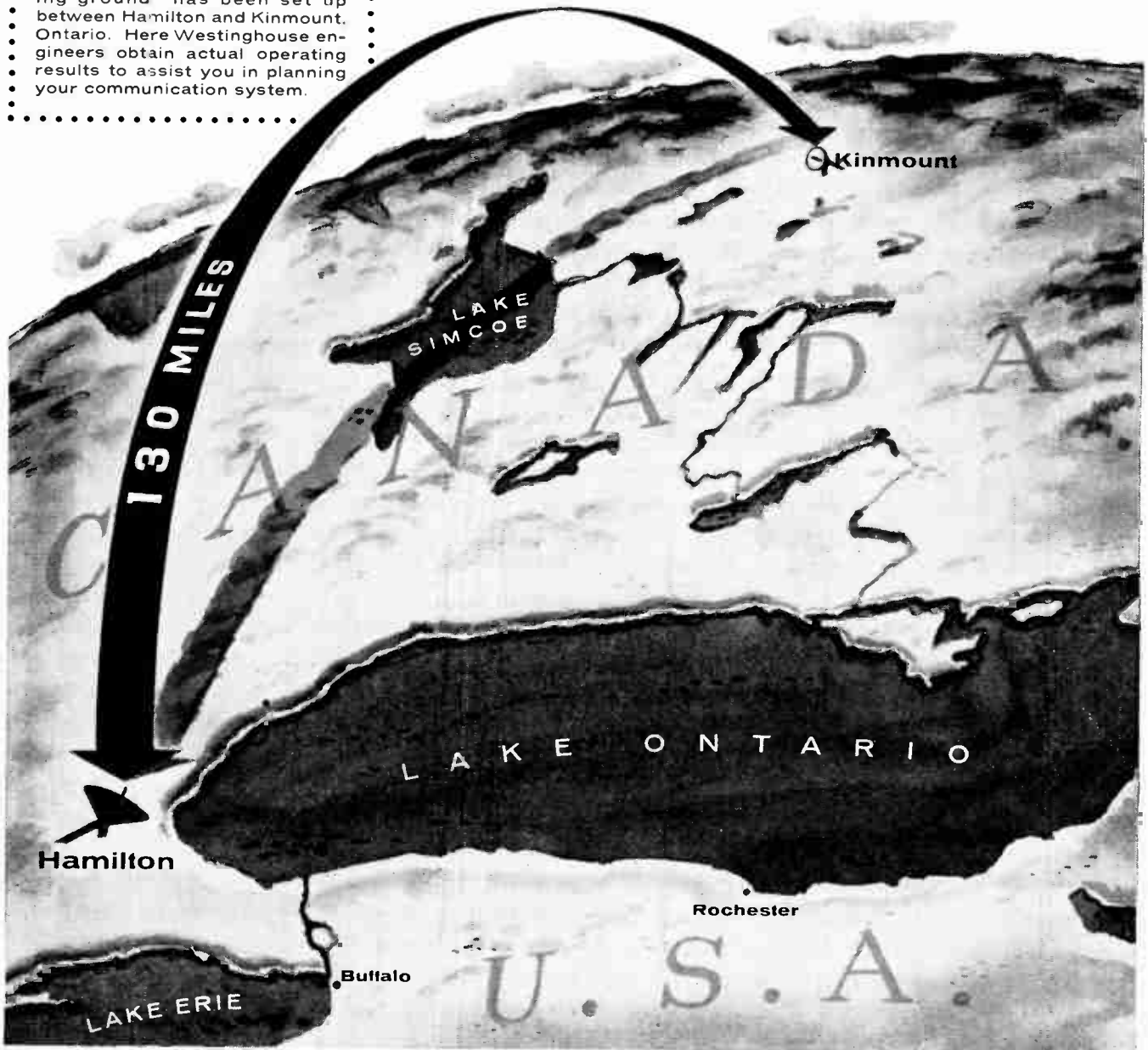

ANOTHER WESTINGHOUSE FIRST!

57-B-745

# SHF "Scatter" Transmission

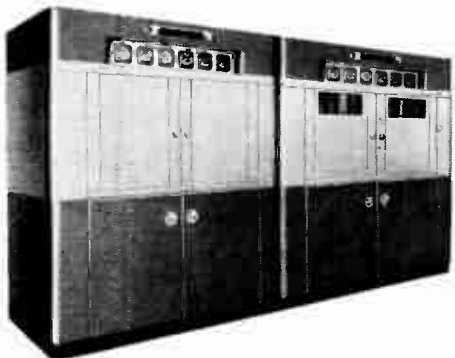

New Westinghouse 4400-5000 mc. Transmitting and Receiving Equipment is compactly and durably designed for truck mounting or fixed installation for either commercial or military application.

• Now for the first time in the communications field, scatter equipment for super-high frequency transmission for fixed or transportable operation has been introduced by Canadian Westinghouse.

• The new Westinghouse "Scatter" communications equipment is designed for high quality, high reliability transmission of voice, teletype, telemetering, facsimile, television and data signals over hops of 100 to 200 miles. Voice capacity for multi-channel operation extends to 120-150 channels.

• Contact your local Westinghouse Sales Office for Descriptive Bulletin H83-100 or write Canadian Westinghouse Company Limited, Electronics Division, Hamilton, Canada.

**WATCH WESTINGHOUSE ELECTRONICS**

...WHERE BIG THINGS HAPPEN FIRST

Enjoy Television's Top Dramatic Show. Westinghouse STUDIO ONE, every Monday at 10:00 o'clock



# the editor's page

*A commentary on affairs  
pertinent to the electronics  
and communications industries.*

## Worth Repeating

One of the most beneficial results that Russia's Sputnik and Mutnik have had on the American people — and we hope the Canadian people too — has been their influence in compelling us to look to the standards and quality of the scientific education dispensed by our institutions of higher learning. So far the information that has been revealed is anything but flattering in the matter of comparative standards between our high schools and universities and those of Europe and Russia. The following report by Robert C. Cowan, Natural Science Editor of the CHRISTIAN SCIENCE MONITOR is typical of the many reports that have been published on this subject since it was brought to the fore as a result of Russia's scientific achievement in launching her earth satellites.

"Soviet school children are getting a natural science education that makes American high school science teaching seem inconsequential by comparison.

"This is believed to be a principal factor in the present scientific and technological strength of the Soviet Union.

"For example, Kenneth Holland, president of the Institute for International Education, has recently returned from a tour of the U.S.S.R. to report that the 10-year general schooling that all Soviet youngsters get features five years of physics, four of chemistry, three of natural science and biology, plus two years each of zoology and botany.

"American high school students, on the other hand, are considered well rounded if they take one year of physics and of chemistry with perhaps a year of biology or botany thrown in.

"Or to look at it another way, Dr. Nicholas DeWitt of the Russian Research Center at Harvard University recently reported that Soviet school children receive some 4,750 instruction hours of natural science and mathematics. This amounts to five to six times the minimum entrance requirements for the Massachusetts Institute of Technology.

"He told a conference on engineering and scientific education at Chicago that Soviet physics and chemistry textbooks used in the last two grades of the 10-year general school are on a par with many American freshmen college textbooks.

"Just to keep the record straight, it should be pointed out that the same thing could also be said for books used by good British or German secondary schools.

"However, this does not change the assessment of many experts that American high school natural science and mathematics preparation is quite inadequate, especially for those who want to go on to study these subjects in college.

"To return to the situation in the U.S.S.R., Mr. Holland pointed out that, beyond the 10-year general school, there are higher and secondary institutions to which Soviet students can advance if they qualify in the tough screening procedures that have been established.

"Many of these secondary schools are technical institutions which can train students for important technician's work to complement that of higher-grade natural scientists and engineers.

"At the higher institution level, according to Dr. DeWitt, a typical engineering course usually lists five and a half years as compared to four years for bachelor degree candidates in engineering in this country. However, as in

the case of British or European engineering and natural science college bachelor degree candidates, the more appropriate level of comparison is with master degree candidates in an American university.

"Point by point comparisons are, of course, impossible because of the great differences between the educational systems of the United States and the Soviet Union. However, Dr. DeWitt's main conclusion which summarized his findings is that Soviet scientific and engineering higher education is certainly at least on a par with that obtainable in this country.

"To this is added the great advantage of the high-quality natural science and mathematics preparation the students have already received in their 10-year general schooling.

"Mr. Holland reported a phenomenal thirst for knowledge among Soviet school children. This thirst, encouraged by the high standing of Soviet natural scientists and their work and gratified by the intensive science teaching in the Soviet 10-year schools, is believed to be a leading factor in building Soviet technological strength today."

## TV Industry Beats Inflation

A recent report from the Radio-Electronic-Television Manufacturers Association of Canada has the following to say about inflation:

"One of the most commonly used words today is inflation. It is generally thought of as representing a steady and rapid upward spiralling of prices which affects the average man or woman where it hurts most — in the pocketbook.

"Of great interest to every Canadian would be the discovery of a product which has shown a consistent reversal of this common inflationary trend. Television is that product.

"From 1951 to the present time the average selling price to the consumer of television sets has fallen from \$523 to below \$300, a reduction of over 40 per cent. This has been achieved in spite of a 25 per cent tax (15 per cent excise tax and 10 per cent sales tax) imposed on all television sets and in face of the same inflationary pressures which have affected other industries such as increased costs of materials, higher labor costs, increased taxation and services.

"Before 1951, television set prices were higher due to the complete lack of Canadian television stations. The market was confined to localities where United States programs could be received and, as the sales market was so limited, production costs were high.

"The television industry has been able to achieve this reduction in consumer prices since 1951 by the application of the results of long-range research, advances in mass production techniques, and by the rapid penetration of sales as television stations have opened across the country.

"Indications are that prices will level off now and it is not expected that any further lowering of prices will occur in the immediate future. However, the electronics industry is determined to continue its leadership in combating the ever-present forces of inflation."

Management of this segment of the Canadian electronics industry are to be commended for their successful fight against inflation in the past with the consequence that the Canadian public have been able to purchase television receivers at a reasonable price.

## Some Practical Aspects Of - - -

# Digital Data Transmission Over Telephone Facilities

The increasing demand for data circuits is becoming of great importance to telephone and telegraph operating companies. In the future, data transmission may become a major source of revenue. This article discusses some of the practical problems of transmitting high-speed data over ordinary telephone facilities and lists briefly some of the data transmission systems presently employed or proposed.

*Lenkurt Electric Company of Canada Limited\**

**D**IGITAL data is information in the form of successive discrete signals. Present-day concern and controversy over data transmission often obscures the fact that its transmission is as old as man.

The simplest message that can be transmitted by digital means is the information necessary for a receiver to make a correct choice between two different equally possible events or conditions: yes or no, on or off, black or white, something or nothing, 0 or 1, etc. Since the two possible messages correspond to the two symbols in the system of numbers called the binary digit system, a unit of information based on two symbols came to be called a binary digit and was abbreviated *bit*.

Modern digital data transmission began in 1832 when Samuel F. B. Morse invented the telegraph. Machine transmission and reception occurred just before the beginning of the Twentieth century. The earliest machine transmitters and receivers were teletypewriters and dial telephones. Until recently, the only other major uses of digital data transmission have been for telemetering, remote control, and indication.

During the past ten years, the tremendous increase in electronic business machine and computer usage has raised the question, "Why can't business machines and computers 'talk' directly to each other over telephone circuits without converting the messages into human language?"

The answer is, "They can to a limited extent." In fact, it seems probable that "conversation" between busi-

ness machines or computers will someday become as commonplace as telephone calls between people.

## Transmission Rates

The practical aspects of digital data transmission over telephone channels are related to two theoretical questions. First, what is the theoretical maximum rate at which data can be transmitted without error over a channel of a certain bandwidth and signal to noise ratio? Second, what are the characteristics of telephone channels that affect data transmission?

C. E. Shannon provided the answer to the first question by a mathematical analysis of the nature of data or information. His results, illustrated graphically in Fig. 1, show that the maximum data transmission rate can be increased by increasing the bandwidth or signal to noise ratio. However, to achieve the transmission rates indicated, three conditions must be met.

First, the transmission medium must be distortionless. This applies to both phase and amplitude distortion. Second, the noise in the channel must be random (equal noise power across the frequency band). Third, the encoding system must be so complex that no possible combination of noise impulses will ever cause erroneous information to be transmitted. None of these conditions can be met exactly or even closely approached with present day techniques. Hence, the information rates attainable are much slower than the maximum rates indicated by Fig. 1.

## Telephone Channel Characteristics

If telephone channels were designed specifically for data circuits, strong emphasis would be placed on achieving characteristics that would permit a maximum transmission rate with minimum error. Such characteristics would include small phase distortion, freedom from noise — especially impulse noise, level stability, and frequency stability.

These characteristics are also desirable for speech transmission, but the lack of them does not necessarily prohibit successful transmission. For example, we talk on circuits that are so noisy they cause us to repeat words, but we still get the information through. We talk on circuits with high impulse noise peaks but never know they are there. We talk on circuits with enormous amounts of phase distortion, but our ears fail to detect it. We talk on circuits that attenuate the message so greatly that we have to shout, but we adapt ourselves to the condition.

The reason we can talk on such imperfect circuits is

\* Courtesy Lenkurt Demodulator.

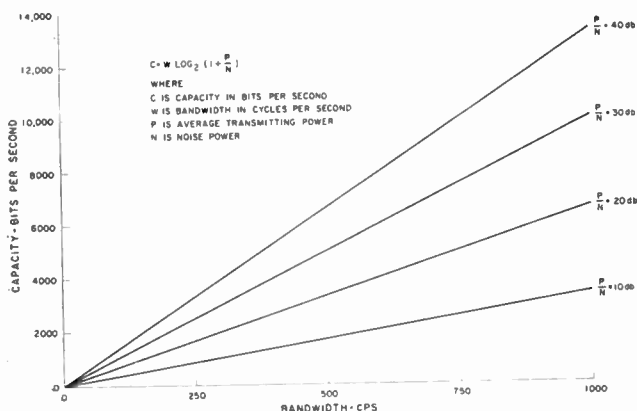

● Fig. 1. The relationship between maximum transmission rate (capacity), band-width, and signal-to-noise ratio.

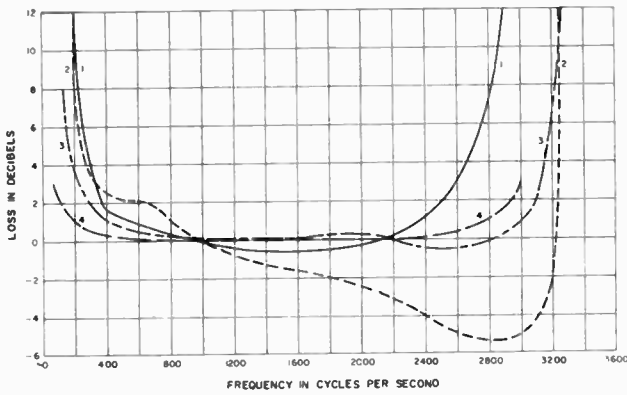

● Fig. 2. Attenuation-frequency characteristics of typical carrier channels.

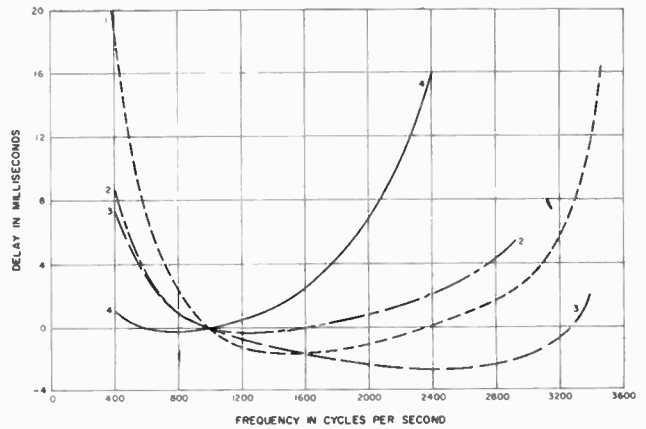

● Fig. 3. Delay characteristics of typical telephone channels.

that speech is very redundant. That is, it contains much repetition and extraneous information not needed to convey simple messages. This has resulted in the use of many different types of transmission facilities with widely varying characteristics. Figures 2 and 3 show some of the amplitude and phase distortion characteristics of different telephone facilities in common use.

**Data Transmission**

When telephone circuits are used for data transmission, the imperfections which do not greatly affect voice transmission have to be carefully considered.

For example, noise in its various forms has a much greater effect on data circuits than it does on voice circuits. A commonly stated noise objective for long-distance telephony is that a circuit should have an *average* noise of no more than 38 dba (a signal power to noise ratio of about 44 db). This means that the circuit will have more than 38 dba of noise half of the time and less half of the time. For short periods of time, the noise may greatly exceed 38 dba.

Such performance is entirely adequate for speech transmission but could cause serious errors in the transmission of digital data. To avoid errors from noise,

**TABLE I**  
Typical Data Transmission Systems

BASIC TELEGRAPH SYSTEMS						
Type	Number of Channels	Spacing	Type of Keying	Total Band Required	Bits per Second	Notes
A. T. & T. Lenkurt Signal Corps	16	170 cps	F-M & A-M	340-3060 (16 ch)	74 per ch 1187	100 wpm/channel
Western Union Telegraph	20	150 cps	F-M	300-3300 (20 ch)	57 per ch 1136 74 per ch 1484	75 wpm/channel 100 wpm/channel
Collins Synchronous Telegraph	Up to 40	110 cps for each 2 ch.	Phase shift	550-2750 delay equalized (40 ch)	74 per ch 2968	All channels must be synchronized. Makes use of special synchronizing signal to effectively regenerate all channels. All channels must originate and terminate together.
VOICE CHANNEL DATA SYSTEMS						
IBM Card-to-Card Transceiver	4	450 cps	A-M	650-2450 (4 ch)	180 bits/channel Transmits 11 cards per minute	Used on leased toll circuits with echo suppressors removed. Uses code which includes two error checking bits for each 6 information bits.
A. T. & T. (experimental)	1	—	F-M	700-1600	750	Designed to work over any telephone circuit which may be dialed. Error rate between 1 in 10,000 and 1 in 100,000.
A. T. & T. Teletypesetter	1	—	A-M	1000-2800	510	Phase delay equalization required.
SAGE	1	—	A-M (Vestigial Sideband)	500-3000	1600	Phase delay equalization required from 1000-2500 cps. Sensitive to impulse noise. Error rate of less than 1 in 100,000.
Western Union Sub-band	2	1500	F-M	300-3300 (2 ch)	1800 delay equalized 1500 unequalized	Under development. For operation on same voice channels as Western Union Telegraph Systems. These voice channels are not the ordinary "dialed-up" channels but are special for W. U. Telegraph.
Signal Corps AN/TSQ-7 AN/TSQ-8	1	—	A-M Double Sideband	975-2500	750	Delay equalization required.

data circuits must be designed on the basis of adequate signal-to-peak noise ratio rather than signal-to-average noise ratio. If the noise present on a circuit is impulse noise (a common type on wire and cable circuits) the noise peaks may be of such great amplitude that they make data transmission impractical.

One of the most serious difficulties encountered in transmitting data over telephone circuits is the unequal transmission velocities of different frequencies. This is called phase distortion or sometimes phase delay. The human ear is relatively insensitive to phase distortion and does not recognize it as a speech impairment. But to data circuits, this is one of the most severe types of distortion that can occur. The reason for this is that the short bursts of energy necessary for data pulse transmission contain many frequencies having fixed relationships to each other in time. If some of these frequencies are transmitted at a slower rate than others, the received pulse does not have the same shape as the transmitted pulse and errors can occur — especially if the pulses are short.

#### *Companders and Echo Suppressors*

The interfering effects of noise, cross-talk, and echo on speech are often reduced by the use of companders and echo suppressors. These devices take advantage of certain peculiarities of human conversation. Their use, however, often renders a circuit unfit for many types of data transmission.

Companders give an apparent reduction in noise on voice circuits by increasing the circuit loss between syllables and words of speech. If amplitude-modulated (on-off) type data signals are transmitted through a compander, some of the pulses may be badly distorted by the varying loss characteristic. Frequency-shift type data signals are not appreciably distorted by a compander since their power level remains essentially constant. But, neither are they provided with any signal-to-noise ratio improvement.

Echo suppressors are frequently used on long circuits to prevent the echo of reflected speech from annoying the talker. They are simple devices which short-circuit the return path when a person is talking. In effect echo suppressors permit transmission in only one direction at a time. They limit the use of a circuit for data transmission since they do not permit a data receiver to ask for the repeat of a message in which an error has been detected.

#### *Practical Data Transmission Systems*

Despite the shortcomings of present-day telephone facilities for digital data transmission, there are a number of practical systems in use or about to be introduced. Generally, these systems can be divided into two broad categories: (1) slow-speed narrow-band systems originally designed for teletypewriter service, and (2) high-speed systems using a major part of the speech channel bandwidth.

Among the slow-speed systems there are three transmission rates in common use: 45.5, 57, and 74 bits per second. These correspond to teletypewriter speeds of 60, 75, and 100 words per minute.

Slow-speed data transmission systems can be used for many applications where the time required to transmit the information is not too important. Signals from the transmitting business machine or computer can be stored on paper or magnetic tape and then re-transmitted at will. At the receiving end, the information can again be stored on tape and fed into the receiving computer or business machine at any convenient rate and time.

The most recent data transmission methods involve the use of all or a major portion of a voice channel. They usually require that the phase delay of frequencies within the channel be equalized — either by design or auxiliary devices — and that channel noise be maintained below certain levels. One system, still in the experimental stage, is being designed to operate over the majority of existing telephone channels without phase delay equalization or special noise treatment. Table I gives the basic characteristics of the typical data systems of the various types.

#### *Conclusions*

The immediate future should see greatly expanded use of existing communications channels — both telephone and telegraph — for dialed data circuits. The use of "private line" circuits requiring special engineering will also become more common. A large increase in private line usage is already evident in applications such as SAGE circuits for the Air Force and data circuits for brokerage houses, railroads, airlines, and banks.

In the distant future, when more complex business machines and computers are put to use, higher data transmission rates than any shown in Table I will become economically desirable.

---

## **Sonic And Ultra Sonic Testing Of Materials**

FOR many years tests of destruction have proved useful but not entirely satisfactory, if only for the reason that compacting conditions could not be the same in the specimen and the structure. There has been a long felt need by engineers for a non-destructive method of testing concrete and sonic and ultrasonic equipment has been developed to fill this need.

The ultrasonic concrete tester is designed mainly for field use. It is particularly suitable for investigations such as concrete, wood, plastic, refractories, etc., and is equally satisfactory for elasticity and strength investigation in other materials. The capacity of measurement of the new testing instruments ranges from a few centimeters up to eight feet.

To measure the wave velocity, two identical transducers are placed on either side of the specimen, and the associated instrument measures the time taken for an ultrasonic pulse to pass from the transmitting to the receiving head.

The advantages of this equipment permit on-site tests

where large structures contain materials to be tested, and is superior to the usual method of testing small samples in the laboratory.

#### *Sonic or Electro-Dynamic Tester*

This instrument is designed for use in the plant or laboratory and differs from the ultrasonic in design and principle of operation.

The electro-dynamic method requires a small electro-mechanical vibrator of thrust adequate to vibrate any specimen that is used. At the opposite end of the specimen a miniature barium titanate vibration pick-up is used to convert the vibration into electrical voltages for identifying resonance.

To determine material frequency of any specimen, it is necessary to clamp the specimen at the center, vibrating it at one end, and varying the applied vibration frequency until the resonant point is reached, as evinced by the maximum amplitude of vibration.

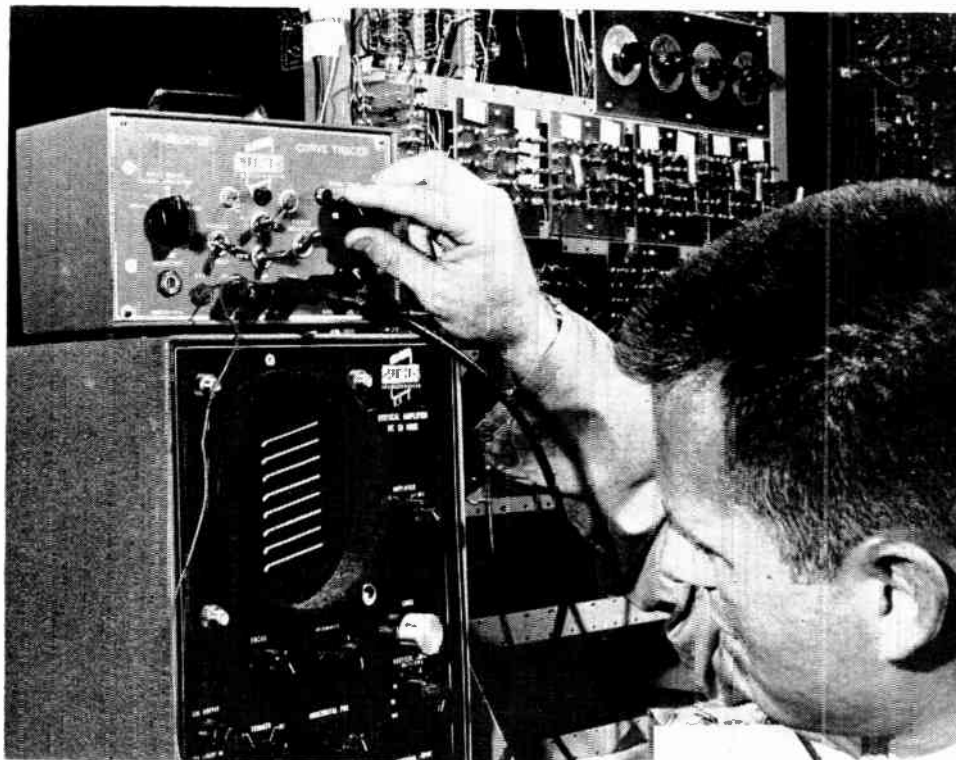

● Newly Developed Equipment Permits The Rapid Laboratory Evaluation of Transistors and Helps Speed Design.

## Simultaneous Examination Of Electrical Parameters

Production line tests on NPN or PNP Germanium or Silicon transistors up to 200 units per hour is now possible with transistorized equipment.

SINCE transistors normally vary considerably in electrical characteristics from unit to unit, even within a given model or type, circuit designers often find it useful to measure small-signal characteristics of each transistor before using it in a new design. However, point-by-point static measurement of such electrical characteristics is a time-consuming task.

A new technique has now been developed for dynamically measuring these characteristics and enabling the circuit designer to simultaneously examine a series of electrical parameters in the circuit laboratory. The transistor circuits are so arranged that a quick check of desired operating characteristics is easy to accomplish. The circuit designer can try out hundreds of different types of individual transistors, both NPN and PNP, under actual operating conditions, before choosing a specific unit for inclusion in a breadboard or finished circuit.

Employing a multi-purpose switching circuit composed of two transistors, the new examination technique permits quantitative measurements using a calibrated oscilloscope for rapid design analysis. Quick qualitative looks at new or existing transistor types can be accomplished in extremely short time with the useful testing scheme.

Developed by engineers of the Cubic Corporation, the new technique makes use of a curve tracer manufactured by the same organization. In a typical circuit laboratory setup, a family of curves of transistor characteristics is displayed on the face of a standard cathode ray oscilloscope. The specific ranges of examination can be controlled so that one or more characteristic curves can be selected and

the inclusive electrical boundaries of the curves as presented can be varied over wide limits.

Biasing of either NPN or PNP transistors is conveniently provided for in the curve tracer equipment. Incrementally-varying base current is applied to the transistor under test while the collector voltage is varied in the grounded-emitter connection. The result, when the collector voltage and current are applied to an oscilloscope, is a family of curves in which the distance represents the current gain of the transistor under test. The slope of each curve is an indication of the collector-to-emitter resistance. Each curve is a plot of collector current as a function of collector bias voltage at a specific value of base current.

### *Production Tests Possible*

Linearity, breakdown points and performance anomalies can be easily detected and measured with the technique, along with small signal characteristics. If volume testing is required, the curve tracer can be connected to test up to 200 transistors per hour. Also, semiconductor Zener diodes can be conveniently evaluated with the equipment involved.

For production control purposes, comparison of new transistors with standard units can be rapidly made using the same equipment. Auxiliary equipment is available to continuously display a standard set of curves for rapid comparison with the curves of transistors under test. Using this auxiliary transistorized equipment, relatively unskilled personnel can perform production-line tests on NPN or PNP germanium or silicon transistors at rates up to 200 units per hour.

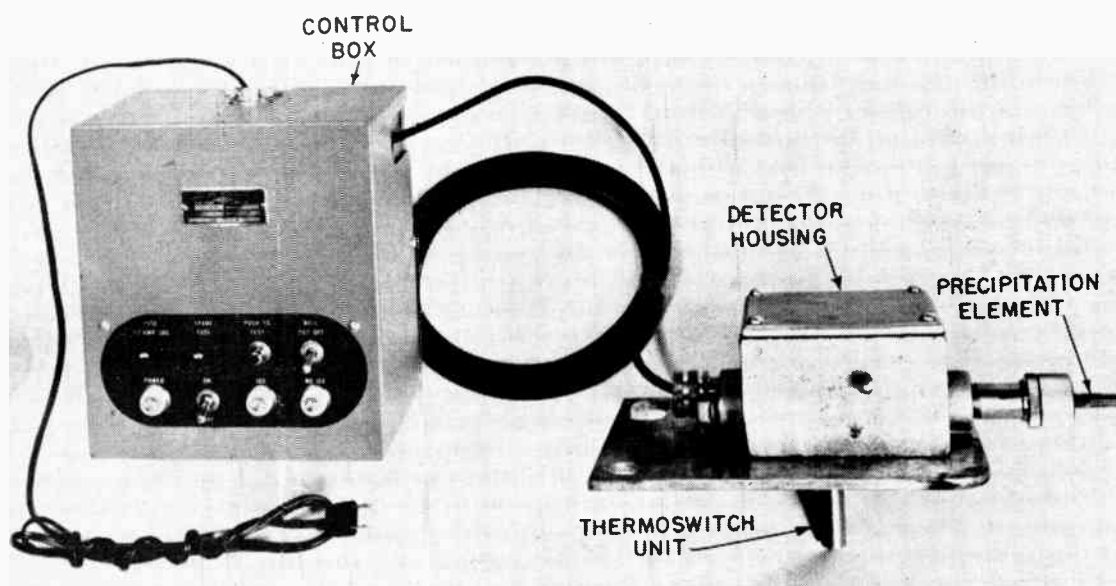

● Fig. 1. Complete ice alarm system developed by American Instrument Co.

## A Two-Element Ice-Alarm System

A sleet and ice-alarm system designed to detect incipient icing conditions on antenna towers is yet another advance in the battle to combat and reduce the effect of the elements. Approximately 100 of the systems which have been engineered and manufactured by the American Instrument Company have been furnished for protecting radar towers on the DEW Line and Project Alice.

**I**CING is a problem on antenna towers, not only because it deposits a heavy and sometimes hazardous weight on the structure, but also because it distorts the beam pattern and increases power leakage. Besides radar tower applications, this new sleet and ice alarm system has been designed to detect incipient icing conditions around airports, buildings, highways, and other locations where advance warning of icing would provide valuable operational guidance.

The system differs from existing ice alarm systems, such as the venturi-type or strain-gage type, in that it responds when atmospheric conditions favor ice formation — before the ice actually forms. Because it gives early warning, the system enables the necessary precautions to be taken before conditions become troublesome. Aside from the time factor, another advantage of an advance ice warning is that power consumption by antenna heaters is reduced since the heaters seldom have already-deposited ice to cope with. In remote northern areas, the reduction of antenna heat requirements constitutes an important economy because all supplies, including the fuel to operate power generators, must be flown in during the few months of relatively good flying weather.

The instrument system, (Fig. 1) consists of two parts: (1) the detection unit, which is installed on the antenna

or other outdoor location, and (2) the control box and associated alarm devices, which are installed indoors. This system can anticipate icing because it is actuated by two types of sensing elements which respond to the two ice-forming conditions, that is, low temperature and precipitation. The two sensing elements are connected in series so that the alarm system will remain inoperative unless both conditions exist concurrently. When the alarm circuit actuates, a SPDT relay switches off the "no ice" indicator light on the control box, energizes the "ice" indicator light and sounds an alarm bell. The alarm circuit will also turn on the antenna heaters, if desired. As soon as the icing conditions pass, the system clears itself automatically.

### Detection Unit

The two sensing elements in the detection unit consist of a specially-developed element to monitor for precipitation and a Fenwal snap-action Thermoswitch unit to sense air temperature. This particular type of thermostat (Figure 2) was selected for several reasons. First, it can withstand the wide climatic variations of the far north since it can be exposed indefinitely to  $-100$  F. and to well above  $125$  F and still operate precisely at its setpoint temperature. Second, there is a direct and constant relationship between angular rotation of the temperature

setting screw and the amount of adjustment in setpoint temperature (1 full turn = 23 F). This made it possible to equip the thermostat with a direct-reading temperature dial and pointer so that the unit can be set in the field without reference to a calibration table — an arrangement that is more than a casual convenience to a tower man at the top of a 400-ft. antenna. Third, the compact head of the unit permitted it to be installed, even with the added dial and pointer, in the detection-unit housing where clearance is severely limited. This model Fenwal Thermo-switch unit has a total operating range of  $-75$  to  $+125$ . However, in this application only the range of  $+30$  to  $+50$  is used, and the dial is so calibrated. The thermostat usually is set to actuate at 35 F dry bulb, since icing can occur outdoors a few degrees above freezing because of evaporative cooling.

The precipitation detector, which was developed by American Instrument, consists of two parallel coils of fine Nichrome wire wound around the outside of a plastic coil form. A drop of water on the detector provides sufficient conductivity to short out the windings and complete the circuit to ground (provided the contacts of interlocking thermostat are closed). The inside of the tubular coil form contains a potted 2.8-watt, 6-volt heater which operates continuously while the system is in use. This heater serves two purposes: it changes any snow or sleet falling on the detector to water so that the element will be equally responsive to all types of precipitation; second, by keeping the detector warm, it accelerates drying which enables the system to clear itself quickly when the precipitation stops.

#### Control Unit and Circuitry

The control unit, which operates on a 125-volt a.c. supply, contains a cathode-follower amplifier and an associated alarm circuit (Fig. 3). The amplifier and detection units are powered through a 1:1 isolation transformer, the 2.8-watt heater being supplied from the 6-volt tap of the transformer through the cable shield. The combination of closed thermostat contacts and shorted windings of the precipitation element develops a small voltage (on the order of a few volts) between the grid and ground. This produces a sufficient current change through the cathode-follower and its biasing resistor to actuate the 1-amp d.c. relay of the alarm circuit. The amplifier circuit contains a 5-megohm variable resistor to enable the operator to

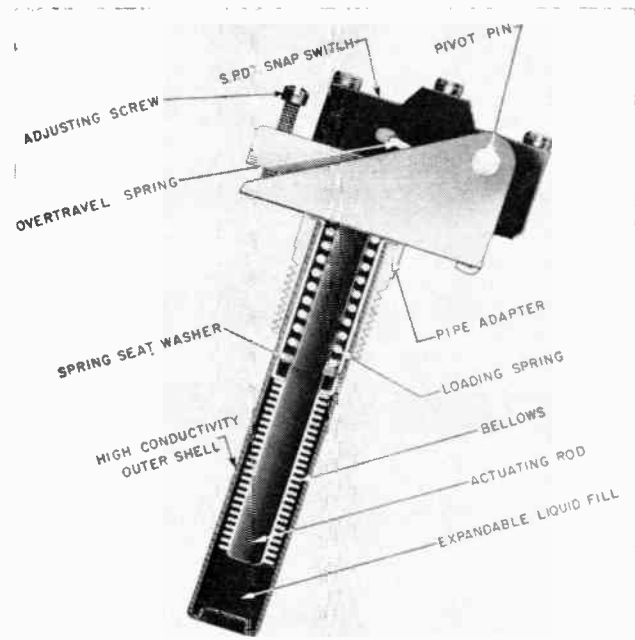

● Fig. 2. Cut-away of Fenwal snap-action Thermo-switch unit which provides the temperature-sensing part of the detection unit.

adjust the threshold sensitivity of the unit to compensate for resistance changes on the precipitation element windings from the accumulation of dirt. A test switch is also provided to test the amplifier and alarm circuits.

Each control box may be connected to one or two detection units wired in parallel. The detection units may be placed up to 1000 feet away from the control box using RG-69/U cable, and 2000 feet away using RG-62/U cable. Ground connections for the detection unit are usually made by mounting the cast aluminum housing directly on the metal antenna tower. The housing of detection unit is fully moisture-proofed by a gasket in the cover and by gasketing in the bushings where the Thermo-switch unit and precipitating element are threaded into the housing.

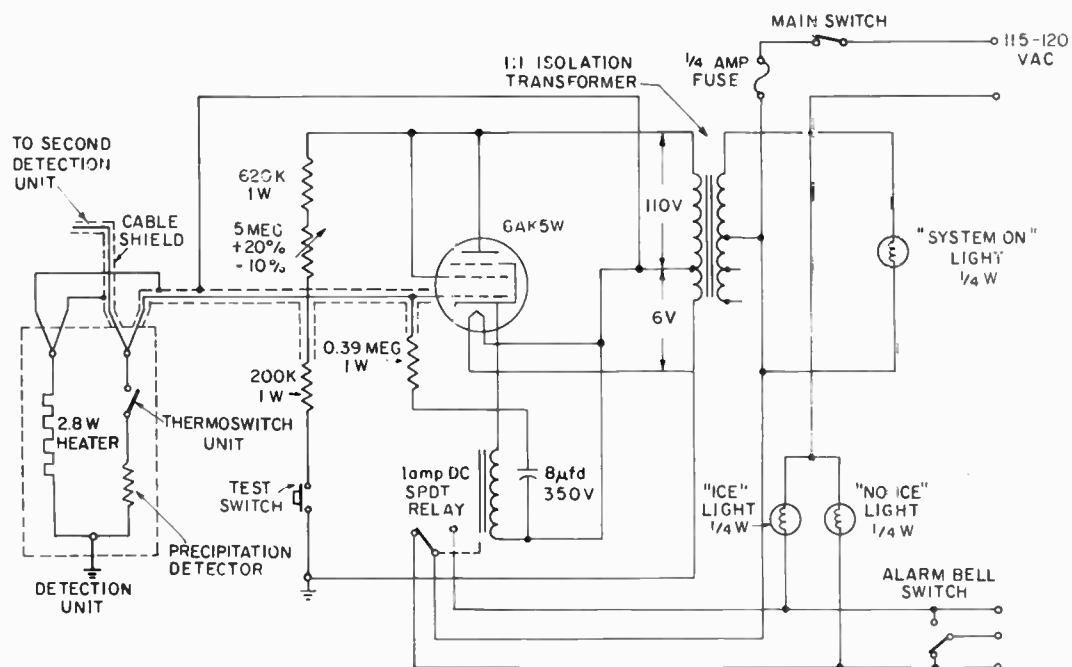

● Fig. 3. Circuit diagram of the ice alarm system.

A combination of transistors  
and printed circuitry aids  
in the . . . .

## Miniaturization Of UHF Beacon Transmitters

**A** COMPLETELY transistorized UHF Beacon Transmitter, so small that it has been built inside a standard size sardine can and using printed circuitry throughout is capable of sending radio signals a distance of 25 miles continuously for a period of 24 hours.

Designed primarily for military applications as an emergency signalling and communications device, the "sardine can" transmitter can be modified for voice or code operation at frequencies other than the 280 to 322mc. for which it was designed.

A new application of printed or etched circuits was revealed in the tiny tone amplitude modulator and transistorized transmitter power supply. The circuit itself is etched on two copper surfaces which adhere to and are separated by Kelf laminate, a fluorocarbon of extremely

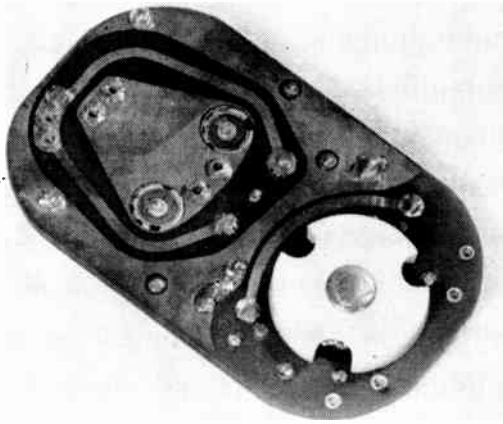

● Fairchild's UHF beacon's oscillator tank circuit is largest of printed loops. White object to right is toroidal power transformer. A Kelf laminate has been used for the "printed" circuit.

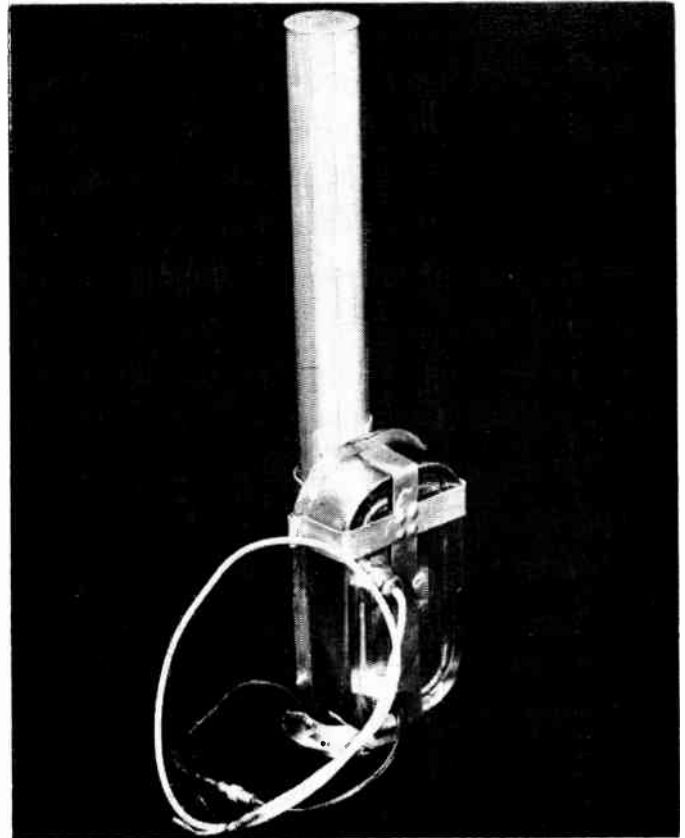

● Collapsed antenna and UHF Beacon is only 12" high. Fairchild's printed circuit transmitter is hermetically sealed in a standard sardine can that has been stripped of its lacquer coating and then silver plated.

low loss dielectric material. Selection of this type insulator is essential with the use of high frequency circuits.

A toroidal type power supply is built into the sardine can. Size of the standard sardine can is 2 $\frac{3}{4}$ " by 4 $\frac{1}{2}$ " by 1". Cans are stripped of lacquer coating and silver plated before use. Finished can weighs less than eight ounces.

The output feeds a standard sub-miniature 50 ohm coaxial cable which is attached to a simple self-erecting quarter-wave antenna radiator.

The antenna is housed in a hermetically sealed tube only 12" long, but is exploded into action by a small gun powder charge. This makes a two foot antenna mast surmounted by a 1 foot radial, with six one foot ground plane radials projected at a 45° angle from the base of the radiator tube.

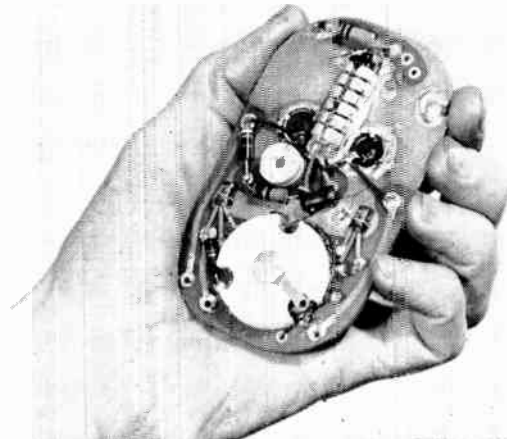

● Two transistors and a toroidal power transformer make up the power supply. Battery pack is separate unit. On right is power oscillator tube, two plate condensers and a tuning condenser.



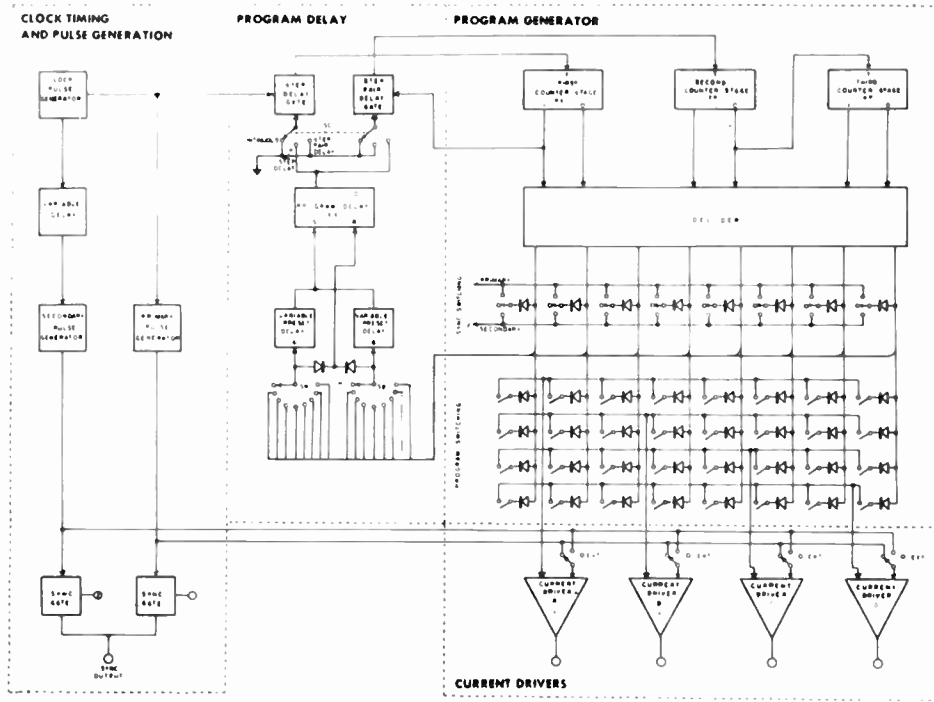

● Fig. 1. Block diagram of Model 1020 shows the four major circuit groupings: Clock Timing and Pulse Generation, Program Generator, Program Delay and Current Drivers.

# Production Testing Digital Devices

A PACKAGED system of specialized pulse equipment that provides precisely controlled, fully programmed current pulses for the research development and production testing of digital systems and components is distinguished by its ability to generate stable, high-level current pulses from a high source impedance, making it especially effective for use in analyzing highly inductive magnetic elements or for driving complete magnetic core logic systems. Incorporated in this recently developed instrument

are an extremely flexible program generator; highly stabilized, heavy-duty power supplies; two negative and two positive output current drivers. Operating at 525 volts DC, two current drivers deliver negative pulse currents to 3 amperes from source impedance as high as 20,000 ohms, while two deliver positive pulse currents to 4.5 amperes from a voltage-type source.

Programming is based on an eight step, periodically repeated pattern as shown in (Fig. 2), with a maximum step repetition frequency of 200 Kc. Pulse repetition frequencies of up to 400 Kc. may be obtained through incorporation of both a primary and a controlled delay secondary pulse during each step. With the use of the RESE Program Delay system, the program may be automatically stopped at any one or two of its eight steps and made to repeat the scheduled pulse up to 2000 times (Fig. 3). In addition, any one or two adjacent step pairs may be repeated up to 1000 times (Fig. 4).

Enabling the engineer to exercise full control over the final current wave shape, primary or secondary pulse width is continuously adjustable from 0.5 microseconds to 50 microseconds. Linear and exponential rise time is continuously variable from 0.08 microseconds to 2 microseconds, while exponential fall time is continuously variable from 0.15 microseconds to 2 microseconds. Output amplitude is highly stabilized, remaining constant over duty-factor extremes, and at average output current levels approaching half an ampere, positive or negative.

Other features of the equipment known as Model 1020 include synchronization with external equipment before any one or more discrete pulse events, ten turn current controls on all four amplifiers, forced, filtered air cooling and complete incorporation of the system into a single, standard relay rack.

The equipment developed by Rese Engineering Incorporated is looked upon as one of the most modern assists in the technology of production testing digital systems and components.

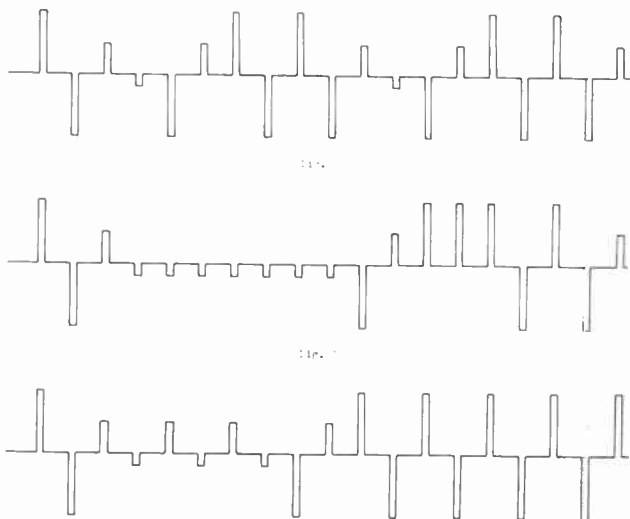

FIG. 4

- Fig. 2. Typical periodically repeated 8 step program.
- Fig. 3. Pulse program of Fig. 1, with steps 4 and 7 repeated.
- Fig. 4. Pulse program of Fig. 1, with step-pairs 3 and 4 and 7 and 8 repeated.

# An Equipment For Measuring - - - Inter-Channel Crosstalk And Noise On Broad- Band Multi-Channel Telephone Systems

A multi-channel telephone signal can be simulated by using a band of random noise extending over the same frequency range, and a technique based upon this has been developed for intermodulation measurements on microwave radio links carrying multi-channel telephone traffic. The method is equally applicable to coaxial-cable systems.

By R. W. White, B.Sc., F.Inst.P., A.M.I.E.E. and J. S. Whyte, B.Sc. (Eng.), A.M.I.E.E.\*

WHEN a large amount of telephone traffic has to be carried by coaxial cables, or by broad-band radio relay links which have to be integrated with a coaxial-cable network, it is now almost universal to employ frequency-division multiplexing with a 4 kc/s spacing, and the number of channels provided is normally an integral multiple of 60. The multiplex telephone signal comprises many rapidly changing components of various frequencies, and non-linear distortion in the transmission system introduces

unwanted harmonics and intermodulation products of these components. When distortion is severe, unwanted products are heard by the telephone subscriber as an interference resembling random noise.

Standards of transmission performance for long-distance trunk circuits have been agreed internationally by the C.C.I.F.<sup>1</sup> and, for the topics under discussion in this article, the most important of these standards is the requirement that, for a 2,500-km telephone circuit, the noise measured at a point of zero relative level in any audio channel shall not exceed 10,000 picowatts psophometric for more than 1 per cent of the busy hour. One-quarter of this figure is normally allotted to the terminal multiplexing equipment and the remainder (i.e., 7,500 pW) is therefore the upper limit for all forms of noise and intermodulation introduced in the transmission path. This is, no doubt, an excellent method of specifying performance from the ultimate users' point of view; but it is quite impracticable for precise specification of equipment performance, for acceptance testing of new systems, or for routine testing and maintenance purposes. For these, the

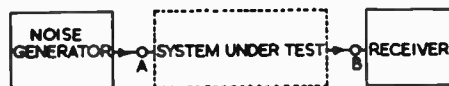

(a) General arrangement of equipment.

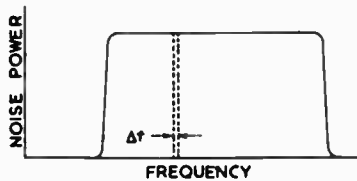

(b) Noise signal before passing through band-stop filter.

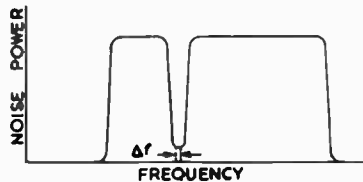

(c) Transmitted noise signal.

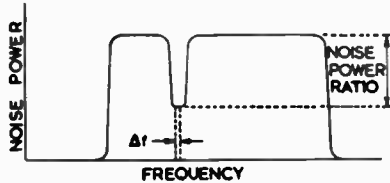

(d) Received noise signal.

● Fig. 1. Principle Of Noise Testing Method.

\* The authors are respectively, Senior Executive Engineer and Executive Engineer, at the Post Office Radio Laboratory, Castle-ton, Cardiff, Wales.

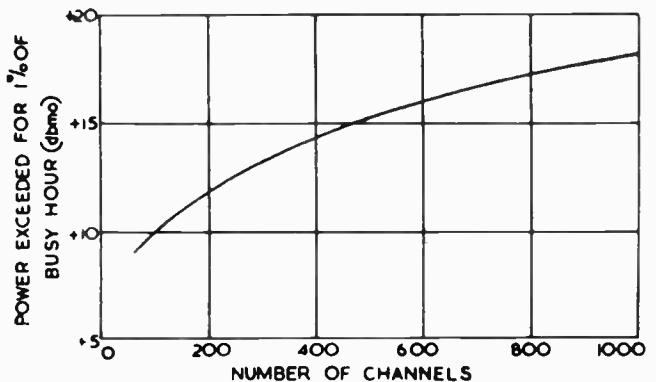

● Fig. 2. Traffic Loading.

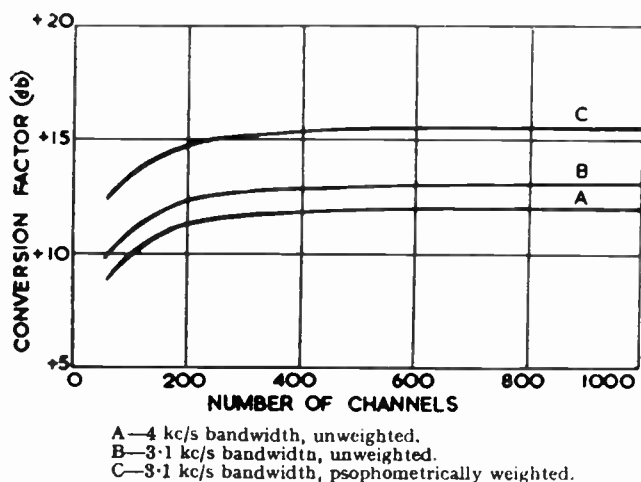

● Fig. 3. Conversion Factors.

C.C.I.F. noise requirement must be translated into target figures in some form of measurement which can be carried out rapidly under accurately controlled conditions, and which can be repeated readily and consistently whenever and wherever required.

In coaxial-cable practice, it is normal to check the linearity of a multi-channel telephone system by measuring either the harmonics of a single tone or the intermodulation products between two or three tones transmitted over the system. Such methods can give accurate information on changes of performance and are very useful for routine maintenance; they have the great advantage that they can be applied to working systems, provided that suitably located channels can be freed of traffic. In line systems, second-order and third-order distortion products are generally predominant; but since quite small amounts of high-order harmonic production can give rise to considerable intermodulation on a multi-channel signal<sup>1</sup>, it is important to search for and to measure very low levels of high-order products when only one or two tones are applied.

The loading of a system with one, two or three tones does not correspond at all closely with normal loading by a large number of telephone channels, and even when all significant harmonics have been measured at various loading levels, interpretation of the results in terms of performance on normal traffic loading is a matter of considerable difficulty. In addition, as the tone techniques are concerned only with non-linear distortion, separate measurements of basic noise are required before any estimate can be made of the anticipated signal-to-noise ratio in an audio channel.

When the situation that arises on broad-band radio relay systems is considered it is soon evident that single-tone or two-tone testing is of little value as an accurate indication of traffic performance, and may at times give distinctly misleading results. Angular modulation\* is almost universally employed in these radio systems, and a major source of non-linearity and intermodulation is therefore delay distortion<sup>1</sup>, i.e., non-uniformity of the group-delay/frequency characteristic in the R.F. transmission path. The type of delay distortion normally encountered in modulators, filters, amplifiers and demodulators may be expected to give rise to distortion products which are predominantly of low order; but echo signals having appreciable time delay relative to the main signal (e.g., from mismatched aerial feeders, or multi-path propagation) can give rise to sinusoidal variations in group delay within the band of frequencies occupied by the transmitted signal. In the latter case, the relative contributions of various odd-order and even-order components will vary with changes of center frequency, and the order of distortion which is predominant will increase with increasing deviation. Thus, with single-tone or two-tone

tests it is most difficult to obtain consistent or accurately repeatable results, and it is virtually impossible to interpret from them what the traffic performance will be. Many products have to be measured at many loading levels if comprehensive data are required, and if only second-order and third-order products are measured an entirely misleading result may be obtained.

It is evident, therefore, that a new approach to the measurement of intermodulation is required for use on multi-channel telephone systems which may at any time be subject to high-order non-linear distortion, and this article is concerned with the technique and equipment now coming into use on broad-band radio links.

### Noise Intermodulation Technique

In systems carrying a fairly large number of telephone channels, say 60 (one supergroup) or more, the multi-channel signal under busy conditions can be simulated with reasonable accuracy by a band of random noise extending over the same frequency range.<sup>1</sup> It is this band of noise which is passed through a very narrow band-stop filter, the resultant signal will be a fair approximation to the traffic on a heavily loaded system with one quiet channel. This type of test signal can be used to load a multi-channel system in a manner closely resembling actual traffic loading, and at the far end of the system measurements of crosstalk and noise can be made in the narrow stop-band.

### Outline Description of Equipment

Two items of equipment are required — a “generator” at the input end of the system under test, and a “receiver” at the output end — the general arrangement being as shown in Fig. 1 (a).

The generator produces a band of random noise having a uniform power/frequency spectrum, and the band edges are then determined by a low-pass and a high-pass filter (Fig. 1 (b)); the latter has a cut-off frequency of 60 kc/s, but alternative low-pass filters are provided so that various numbers of channels may be simulated. Finally, the signal is passed through one or more band-stop filters having an insertion loss of at least 80 db. A diagrammatic representation of the transmitted signal spectrum, with one bandstop filter in circuit, is shown in Fig. 1 (c).

After transmission over the broad-band system under test, the received signal spectrum (at point B) might appear as in Fig 1 (d). Due to noise of all kinds introduced by the relay system, including intermodulation between component frequencies of the noise signal, the “hole” in the noise spectrum is now less deep than it was at point A. A special receiver is used to measure the change in noise level as the band-stop filter is switched in and out. This receiver is essentially a device of the insertion-loss measuring type, since it operates always at full gain and measurements are made by means of a calibrated attenuator preceding it. The receiver bandwidth,  $\Delta f$ ,\* must be less than the bandwidth of any of the stop filters at their —

\* The term angular modulation includes not only frequency and phase modulation but also modulation systems intermediate between these two, such as may be produced by the use of pre-emphasis in the modulator.

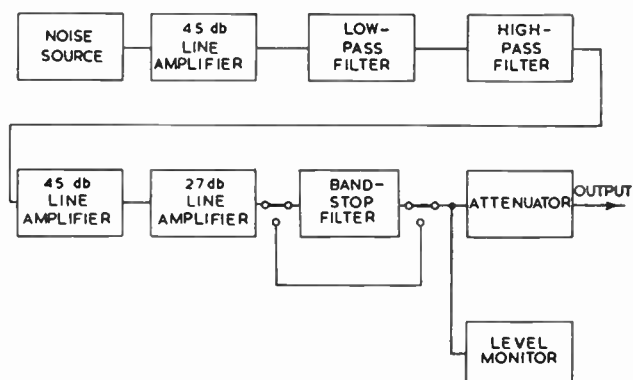

● Fig. 4. Block Schematic Diagram Of Noise Generator.

<sup>1</sup> For references see end of article.

80 db. points.

The method of making a measurement is very simple. The generator is set to the desired number of channels and a flat band of noise applied at appropriate level to the system under test. The output of the system is applied to the noise-measuring receiver, which is set to the selected stop-band frequency, and the input attenuator of the receiver is adjusted so that mid-scale deflection of the output meter is obtained. The appropriate band-stop filter is then switched into circuit at the sending end, and the input attenuator of the receiver readjusted to restore mid-scale deflection of the meter. The difference between the two attenuator settings on the receiver is the "noise-power ratio" for that particular loading level and stop-band frequency.

### Noise and Traffic Loading

The best-known study of load-rating theory for multi-channel amplifiers is the classic paper by Holbrook and Dixon.<sup>5</sup> In that paper, curves were derived relating the number of channels in a system and equivalent volume

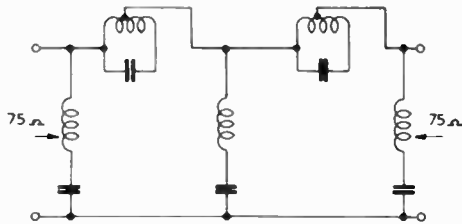

● Fig. 5. Typical Band-Stop Filter.

levels exceeded for 1 per cent of the time, with and without volume limiting in individual channels. These curves were a most valuable contribution to telephone transmission theory, and have been widely accepted; but it must be remembered that they were based on the traffic characteristics of a specific system at a particular stage of development. Modifications are therefore required for differences in speech characteristics and telephone habits of typical subscribers, local line levels, signalling arrangements, carrier leak and pilot levels, amount of V.F. telegraph traffic, etc., before they can be applied to other trunk telephone systems.

The relationship between number of channels and the level exceeded for 1 per cent of the busy hour, which is given in Fig. 2, is believed to be a reasonable approximation to conditions which would exist in the British trunk network if it employed C.C.I.F. signalling levels. Fig. 2 indicates the basic level at which the noise signal is applied in testing a multi-channel system. Levels are several decibels higher than this on the present British trunk network, due to the high level of tones used in the current 2 V.F. signalling system. As multi-channel loading data are at present under review, the curve shown in Fig. 2 must be regarded as a tentative one, and may therefore be expected to be subject to confirmation or slight amendment from time to time.

### Noise-Power Ratio and Signal-to-Noise Ratio

The noise-power ratio (N.P.R.) of a system loaded with a particular level of noise test signal may be defined as the ratio of the noise power in an arbitrary small bandwidth of the pass-band to the noise power in the same bandwidth within a stop-band. The N.P.R. will vary with loading, and generally with the position of the stop-band in the noise frequency spectrum, so that it cannot be expressed as a single figure. Results are most conveniently given in the form of curves (or tables) of N.P.R. against loading for each measuring frequency, or of N.P.R. against frequency for each loading level. These curves provide fundamental data on system performance in an accurate, simple and readily repeatable form: most important of all, the system is loaded in a realistic manner and account

is taken of noise from any source and intermodulation products of any order falling in the measuring channels.

Signal-to-noise ratio is at present a much more familiar term than N.P.R. However, both are normally expressed in decibels, and conversion from N.P.R. to the ratio of channel test tone to noise is simply a matter of adding a "conversion factor" which is given in Fig. 3. It is important to note that, in signal-to-noise measurements on multi-channel systems, the noise may be measured (a) unweighted in a 4 kc/s nominal channel, (b) unweighted in a 3.1 kc/s channel, or (c) with psophometric weighting, and care should be taken to use the conversion factor appropriate to the method of measurement.

The conversion factor may be regarded as an allowance for the difference between channel test-tone level and the proportion of the total noise-power loading which is effectively applied to any one channel. For example, if we wish to obtain 1 per cent busy-hour performance data on a 600-channel system, noise loading would be applied at a level of +16dbm;\* but, when making the upper measurement of a pair for N.P.R. (band-stop filter out), this noise power is spread evenly from 60 kc/s to 2,540 kc/s, a total of 2,480 kc/s. The noise power in, say, 3.1 kc/s is 3.1/2,480 of the total power (i.e. -29 db. relative to the total power) and so is +16 - 29 = -13 db. relative to test-tone level. A conversion factor of 13 db. must therefore be added to the N.P.R. to get the unweighted 3.1 kc/s bandwidth signal-to-noise ratio. Psophometric weighting of uniform noise in a 300-3,400 c/s band introduces a further factor of approximately 2.5 db., and the conversion factor which must be added to N.P.R. to get the weighted signal-to-noise figure is therefore 13 + 2.5 = 15.5 db.

It has sometimes been suggested that a higher value of conversion factor can be used for the low-frequency channels of a system in which non-linear distortion is predominantly second order. This hypothesis is based on the facts that (1) speech energy is not distributed uniformly over the 300-3,400 c/s band, but has a maximum at about 1,000 c/s and (2) second-order distortion components in the lower part of the baseband spectrum are predominantly difference products: thus the intermodulation spectrum with speech loading will be non-uniform and will have maxima in the lower part of the baseband around integral multiples of 4 kc/s. Much of the distortion would then be at the top and bottom ends of an audio channel, and the psophometric weighting network would provide additional

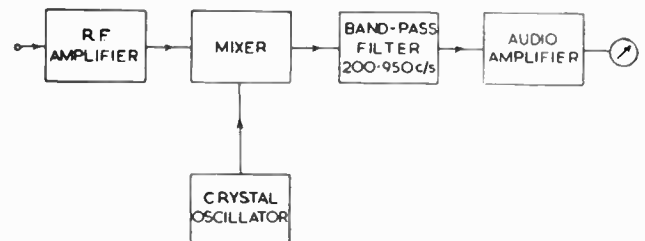

● Fig. 6. Block Schematic Diagram Of Noise Receiver.

discrimination. Against this it may be argued that V.F. telegraphy on a number of the channels, and various V.F. signalling tones on most of them, invalidate the assumption of a clearly defined energy maximum within each channel. Further, the assumption of predominantly second-order distortion is of doubtful validity in the long-term operation of any actual system, and it is considered, therefore, that the conversion factors of Fig. 3 should be used for all channels quite independently of their position in the baseband spectrum.

Since the conversion factors are based on the traffic-loading data given in Fig. 2, they are subject to the same provisos about applying them to other systems and they may require slight revision with changing practice and new developments. It is partly for this reason that the authors prefer to regard N.P.R. as a more fundamental

\* Strictly speaking,  $\Delta f$  is equal to twice the cut-off frequency of the receiver audio-frequency filter. The noise-power bandwidth of the receiver is slightly less than this, since its audio amplifier does not transmit frequencies much below 200 c/s.

\* The term  $x$  dbm is used to mean a power level of  $x$  db. relative to 1 milliwatt.

The term  $x$  dbm<sub>0</sub> is used to mean a power level of  $x$  db. relative to test level.

figure than signal-to-noise ratio for the comparison of multi-channel telephone systems. It is suggested that minimum figures for N.P.R. at particular loading levels might well be used in specifications for, and acceptance testing of, new broad-band systems.

**Equipment Details**  
**Requirements of Level and Sensitivity**

The requirements for the output level available from the noise generator and for the sensitivity of the receiver are as follows:

- (a) The noise generator must produce sufficient power to supply a baseband signal at the appropriate level to the input of the system under test.
- (b) The receiver sensitivity must be adequate to enable it to measure the anticipated values of noise power in the stop-band at the output of the system.
- (c) The noise generator output and receiver sensitivity must together be such that the receiver can measure the characteristics of the noise generator when receiver and generator are used "back-to-back." Such a test will demonstrate that the equipment is functioning properly before measurements are made.

In present coaxial-cable practice, test-tone level at the traffic input point of the system is -45 dbm. The relation existing between test-tone level and multi-channel signal power for a given number of channels has been given in Fig. 2; thus for 960 channels the noise power required would be  $(-45 + 18) = -27$  dbm. Higher levels than this may be required for checking the overload margin or for tests made on a system with the noise injected other than at the traffic input point.

The standard test-tone level at the traffic output point of coaxial cable systems is -15 dbm., and if test-tone-to-noise† ratios of 90 db. are to be measured the noise power which the receiver will have to measure will be -111 dbm. per kc/s. Similar traffic levels will probably be encountered on radio systems.

In order to cater for the back-to-back testing of the noise source and receiver the following level requirements must be met:

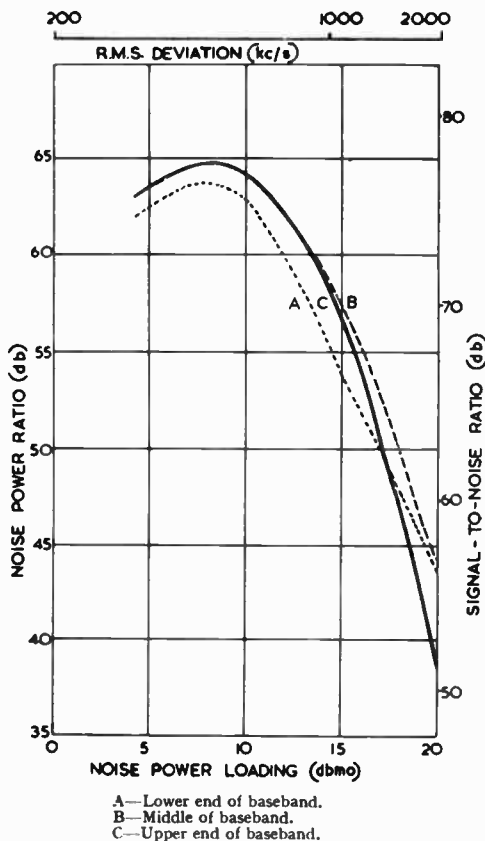

● Fig. 7. Performance of a 240 Channel Frequency Modulator and Demodulator.

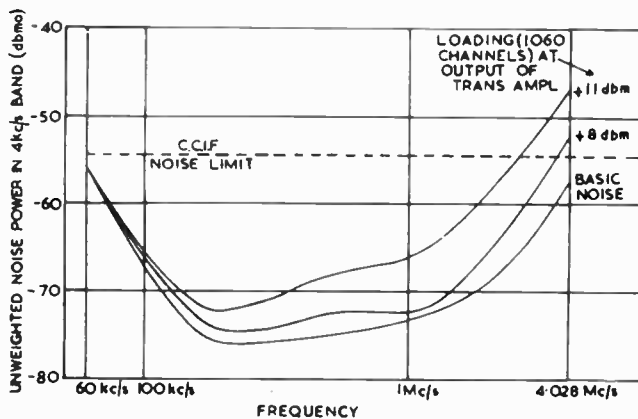

● Fig. 8. Performance of a 335 Mile Coaxial Cable Link.

Let the receiver sensitivity be  $-P$  dbm†, the maximum loss introduced by the band-stop filter  $Q$  db., and the multi-channel signal bandwidth  $R$  kc/s. If the receiver is to be just capable of measuring the noise in the stop-band the total noise power must be such that the noise in bandwidth  $\Delta f$  kc/s (the power bandwidth of the receiver) in the absence of the band-stop filter is  $(-P + Q)$  dbm. A total noise power of  $\{-P + Q + 10 \log (R/\Delta f)\}$  dbm is therefore required.

For the purpose of the present design  $P$  has been made 110,  $\Delta f$  is about 1.5 and  $Q$  has been assumed to be 80; thus for 960 channels ( $R = 3,968$ ) the total noise power required is approximately +4 dbm.

**Noise Generator and Filters**

The first stage of the noise generator uses a CV138 valve, and the output is provided by a combination of shot and partition noise plus the thermal noise from the grid resistor. Since the lowest frequency required is 60 kc/s, flicker noise can be ignored. The anode load of this stage is inductance compensated and its gain (and hence the noise output) may be varied by adjusting the screen voltage; a panel control is provided for this purpose. A cathode-follower stage follows the noise generator and makes the output available in an impedance of 75 ohms. The overall noise factor of the first two stages is about 34 db.

A noise diode is not a convenient alternative to the above arrangement. If a diode operating at 10 mA anode current with a 75-ohm anode load were used, the noise power available would be 22 db. less than with the CV138 arrangement. In addition, the diode life is short (the average life of a CV172 is 100 hours at 20 mA) and a stabilised D.C. heater supply is necessary.

This generator is followed by three coaxial line amplifiers in tandem, providing 90 db. of gain, and the resultant noise output is uniform within 1 db. between 60 kc/s and 4,028 kc/s when the band-stop filters are not connected. It is essential that the overload capacity of the amplifiers should be adequate to avoid clipping of the peaks of noise. The low frequency cut-off is fixed at 60 kc/s by a high-pass filter and the high-frequency cut-off can be switched to either 4,028 kc/s, 2,540 kc/s, 1,052 kc/s or 552 kc/s according to whether it is desired to simulate 960, 600, 240 or 120 channels. Five band-stop filters are provided, each of which has an insertion loss of not less than 80 db. in a narrow band centered on 70, 534, 1,002, 2,438 or 3,886 kc/s. These filters may be connected in or out of circuit by means of keys. The frequencies have been chosen so that whatever number of channels is being used, there is always a band-stop filter having a frequency just above the lowest frequency, and just below the highest frequency, of the band. In addition, no filter frequency is a multiple of 4 kc/s or of 60 kc/s, nor is there any known high-power B.B.C. or Post Office trans-

† Measured in 4 kc/s bandwidth.  
‡ This is the input power required to give a standard deflection on the receiver output meter.

mitter within several kilocycles of each filter center frequency.

Fig. 4 is a block schematic diagram of the noise generator. For the sake of clarity only one band-stop filter has been shown in Fig. 4. Several factors are involved in the choice of position of the various filters and these are enumerated below:

- (1) If the band-stop filters are placed after the final amplifier there is no possibility of intermodulation in this amplifier reducing the available noise-power ratio.
- (2) If the band-stop filters were placed before the final amplifier they would be operating at a lower level and there would be reduced possibility of intermodulation occurring in the filters. In the present design it has been found that this is of less importance than factor 1.
- (3) It is convenient to place the high-pass and low-pass filters before the final amplifier, to avoid wasting available overload capacity in this amplifier by loading its input with noise outside the frequency band of interest.
- (4) By separating the band-stop filters from the other filters with an amplifier no isolating pads are necessary.

The design of the high-pass and low-pass filters is based on Darlington's method of network synthesis.<sup>9</sup> In each case a prototype low-pass filter having a variation of loss in the pass-band limited to  $\pm \frac{1}{2}$  db. is the basis of the design. The band-stop filters were all designed by the method of Cocci<sup>7</sup> and Fig. 5 shows a circuit diagram of a typical band-stop filter.

A switched attenuator and level monitor complete the facilities provided on the noise generator.

#### Noise Receiver

Fig. 6 is a block schematic diagram of the noise receiver. The receiver is pre-tuned to five different frequencies, corresponding to the frequencies of the various band-stop filters, and the desired frequency is selected by a switch. No intermediate-frequency amplifier as such is used, the local oscillator converting the incoming signals directly to audio frequency. The advantage of this procedure lies mainly in the fact that it solves the image-rejection problem; if a conventional-type receiver with intermediate-frequency gain were used an image ratio of at least 90 db. would be required. The intermediate-frequency response ratio would also need to be not worse than 90 db.

By following the mixer valve with a band-pass filter (200-950 c/s) and arranging that the R.F. signal circuit bandwidth is never less than about 3 kc/s the effective receiver bandwidth is 1,500 c/s, irrespective of the signal frequency.

It is necessary that intermodulation produced in the receiver prior to the audio-frequency filter should be small, as such distortion would otherwise lead to erroneous results, due to those intermodulation products which fall inside the audio filter pass-band being recorded on the output meter. With this objective the audio-frequency gain has been made as high as is readily possible, up to the limit imposed by hum and microphony, in order that the signal level at the mixer grid should be as low as possible.

A second feature that is required of the receiver is a very good adjacent-channel selectivity prior to the mixer grid, because when the receiver is used to measure the very small noise power existing in the stop-band, there is present simultaneously a spectrum of energy only a few kilocycles per second away from the tune frequency, which may be at a level 60 to 70 db. higher. Sufficient of this unwanted energy may reach the grid of the R.F. amplifier valve or mixer valve to cause intermodulation (resulting in errors of measurement) if the R.F. selectivity is inadequate.

In addition to providing good R.F. selectivity, negative feedback is used on the R.F. stage to improve its linearity. The mixer stage uses a type CV2209 valve, and an anti-

microphonic valve-mounting is employed. The first audio stage uses a low-noise pentode type CV2135 and the coils of the audio filter are wound on ferrite cores and enclosed in mu-metal boxes to reduce induced hum voltages due to stray fields. A maximum sensitivity of about -120 dbm. (for standard deflection of the output meter) can be obtained but this is usually reduced to about -110 dbm for normal use.

#### Applications of the Equipment

Fig 7 illustrates some measured results which were obtained on an experimental arrangement comprising a 240-channel modulator and demodulator connected back-to-back at the intermediate frequency of 60 Mc/s. By varying the noise power into the modulator the frequency deviation may be varied, and it is clearly seen that there is an optimum value for the deviation. Reducing the deviation reduces intermodulation noise but causes basic noise to rise, whereas increasing the deviation reverses this effect.

The equipment can be used to measure the ratio of test tone to basic noise, and for this purpose no band-stop filters are used. The appropriate level of noise is injected into the modulator and the noise-receiver input attenuator adjusted for mid-scale deflection on the output meter. The noise input to the modulator is then removed and the new setting required on the noise-receiver attenuator noted. The difference in the two settings plus the conversion factor gives the test tone to basic noise figure. Provided the test-tone level at the measuring point is known, it is possible to express the results in terms of the actual noise power existing in a 4 kc/s band if this is preferred.

It would be normal practice to have a generator and receiver at each end of a system under test, so that the system may be tested in both directions. Correct operation of the equipment may be confirmed by connecting the noise generator and noise receiver back-to-back without any intervening equipment and measuring the noise-power ratio at each band-stop filter frequency. The measured N.P.R. should exceed 75-80 db. in all cases.

In general, the distortion encountered on coaxial-cable systems is of comparatively low order and the advantage conferred by the noise-testing method compared with tone methods is not so great, but nevertheless interesting and useful results can be obtained. Fig. 8 shows some measured results taken over 335 miles of route on a C.E.L. 4 television system, when the loading was equivalent to 1,060 telephone channels.\* It will be noticed that there is a sharp rise in the basic noise at frequencies below 200 kc/s. Subsequent investigations<sup>†</sup> have shown that this was due to hitherto unsuspected sources of noise on various neon cable-indicator lamps, and steps have been taken to eliminate this noise on future systems, which will have to carry television or multi-channel telephone traffic.

Yet another sphere in which the new technique is finding increasing use is that of microwave propagation testing. Under certain conditions multi-path propagation can occur between a microwave transmitter and the distant receiver to which it is working. Under these conditions the delayed signal (or signals) interfere with the main signal and give rise to interchannel crosstalk on the baseband signal. Such experimental evidence as exists at present suggests that, for fades greater than about 10 db., the degradation of signal-to-noise ratio that will occur in a speech channel may be considerably greater than that which would occur due to the fall in received carrier power alone. If this is true, it is obvious that propagation testing which merely records the received carrier power of an unmodulated test signal transmitted at constant power will not give a full picture of the conditions. A recording version of the noise receiver has therefore been developed which enables a continuous record to be made

\* At the time that these measurements were made the low-pass filter necessary for the simulation of 960 channels was not available and an existing low-pass filter having a slightly higher cut-off frequency was used. This accounts for the somewhat unusual figure of 1,060 channels.

References.

of the received power in a stop-band. Since the microwave receiver A.G.C. will hold the baseband signal level constant, the noise power in the stop-band gives a direct measure of the signal-to-noise ratio, when the system is loaded with the random noise test signal.

### Conclusions

A method of testing broad-band frequency-division multiplex telephone systems has been described which:

- (a) takes into account intermodulation products of any order which may be present,
- (b) is not affected by dependence of distortion on modulating frequency,
- (c) includes effects of thermal noise, valve noise, and most forms of interference, wherever they may arise on the system,
- (d) uses a test signal which closely simulates actual traffic, and
- (e) gives results which can be converted very simply into normal traffic performance data.

The method has the disadvantage that it cannot be

applied to a system which is carrying traffic; but the noise generator and receiver which have been developed enable measurements to be made rapidly and accurately.

### Acknowledgments

The authors wish to acknowledge the help of colleagues in the development of this equipment, and particularly the work of Messrs. E. R. Broad and E. J. P. May, who were responsible for the filters in the noise generator.

<sup>1</sup> C.C.I.F. Livre Jaune, Tome III bis. Florence 1951. p. 121.

<sup>2</sup> Brockbank, R. A., and Wass, C. A. A. Non-Linear Distortion in Transmission Systems. *J.I.E.E.*, Vol. 92, Part III, No. 17, p. 45, 1945.

<sup>3</sup> Whyte, J. S. An Instrument for the Measurement and Display of V.H.F. Network Characteristics. *P.O.E.E.J.*, Vol. 48, Part II, p. 81, Jul. 1955.

<sup>4</sup> Peterson, E. Gas Tube Noise Generator for Circuit Testing. *Bell Laboratory Record*, Vol. 18, p. 81, Nov. 1939.

<sup>5</sup> Holbrook, B. D., and Dixon, J. T. Load Rating Theory for Multichannel Amplifiers. *B.S.T.J.*, Vol. 18, p. 624, Oct. 1939.

<sup>6</sup> Darlington, S. Synthesis of Reactance 4-poles. *Bell Telephone System*, Monograph No. B1186.

<sup>7</sup> Cocci, G. Filtri con numero minimo di elementi. *Alta Frequenza*, Vol. XI, Nov.-Dec. 1942.

<sup>†</sup> By the Post Office Research Station.

*Acknowledgment is made to British Communication and Electronics magazine in which the foregoing article was first published and to the United Kingdom Information Office for their co-operation in making available to Electronics and Communications magazine the first North American publishing rights for the article.*

# Electronic Measurement Of Moisture In Timber

## A Two Minute Technique For Determining Water Content Of Wood

It is an accepted practice in the timber world that wood, from the time it leaves the drying kiln until it receives its final processing, should be subjected to a series of moisture tests backed by moisture specifications. It is an accepted practice because it is a reasonable one. Nevertheless, it has been a somewhat inconvenient one in the past. The standard method of carrying out a moisture test was to cut off a portion of timber from near the end (but not at the end) of the block, weigh it, dry it and immediately weigh it again. This process demands the presence of saw, weighing machine and oven, all of which will presumably be available where moisture measurements are constantly being made, but otherwise will probably not. In any case the complete test takes some time, probably an hour, and has to be carefully organized if several samples are to be handled simultaneously. There is also the important matter of the spoiling of a block of timber.

Procedure with the modern electronic moisture meter is very different. The instrument is completely self-contained, has a carrying strap and weighs in all some 20 to 25 lbs. The meter is switched on, the electrode with its needles pressed into the timber, a turn or two of a dial, and the percentage of moisture is read off, probably in a matter of two minutes at the outside. The instrument is suitable for sorting timber for the kiln, grading for shipment or checking moisture gradients.

The moisture meter measures the insulation or leakage resistance between the needle points of the electrode and translates these resistance readings into percentage moisture figures. Accordingly it must stand or fall on two points: 1. Its resistance measurement accuracy, and 2. The correlation of resistance with moisture content.

The usual electronic moisture meter generally claims an accuracy figure of approximately 1 per cent and it is of interest to consider the necessity for a tolerance of this amount. It certainly does not arise from an inherent inaccuracy of the meter as a measurer of resistance, for a 1 per cent change in moisture content will cause as much as 50 per cent change in resistance. Hence, if the resistance measurement is accurate to 5 per cent, a conservative figure, the percentage moisture accuracy will be at least within 0.2 per cent. The larger tolerance is needed because, not only has every type of wood its own resistance-

moisture content relationship, but also every specimen differs slightly from every other specimen of the same kind of wood, not very much but sufficient to demand the 1 per cent tolerance. On these grounds, therefore, there is a tendency to treat the electronic method as inferior, only slightly inferior perhaps, but definitely inferior, to the older method.

When the normal accuracy level of chemical balances and thermometers and the conditions obtained in a well-run laboratory are considered, one would certainly be surprised if moisture measurements made under such conditions could not always be guaranteed to considerably closer than 1 per cent. The crux of the matter is, of course, that conditions like this do not invariably exist where moisture measurements are made. There are far too many human factors coming into a measurement of this sort. There are the important questions of the cleanliness of the saw, the cleanliness of the specimen when it is weighed for the first time, the accuracy of weighing, the thoroughness of drying, the certainty that, except for water, all the original wood and nothing but that wood is weighed on the second occasion, the accuracy of the second weighing and the accuracy of the final computation. With the modern electronic method we have the question of resistance measurement accuracy of the meter, the accuracy of reading and the calibration factor for wood.

An accuracy lies in the relationship between moisture content and resistance of the wood. Figures based on a number of weighing determinations under carefully controlled laboratory conditions show that for a given species of wood the relationship can be relied on to an accuracy of better than 1 per cent moisture content.

Comparing the electrical and weighing methods we have apparently close but somewhat questioned accuracy of the old method against the definite 1 per cent tolerance of the moisture meter, the time factor of hours against minutes, and the combined probabilities of saw, balance, oven and skilled technician, against that of the one unit, the moisture meter.

On balance, the electronic moisture meter has proved to be as accurate as the older technique and is immeasurably speedier and more convenient. The instrument mentioned above is manufactured by Dawe Instruments Limited.

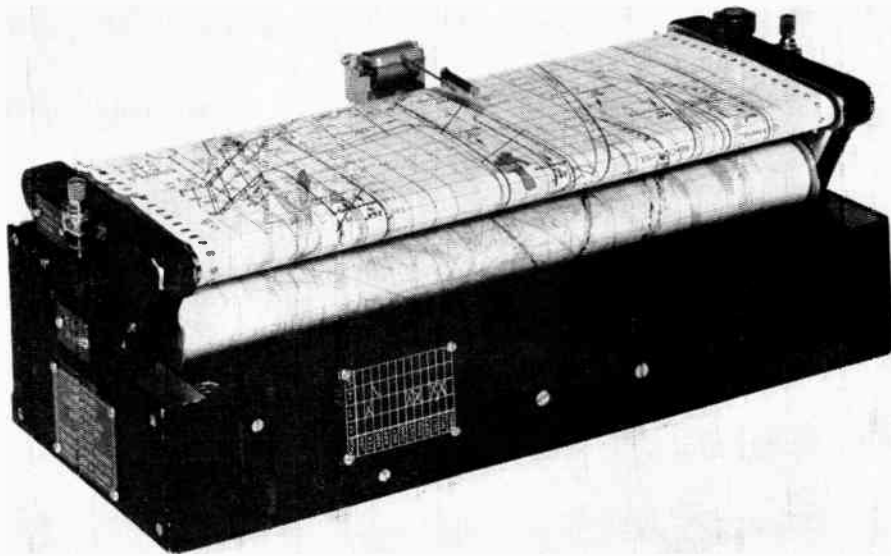

● This "highway map" plots the exact position of an aircraft at all times as a black line traced on the chart by the pen.

## Short-Range Radio Navigation — A Precise Control For Aircraft

A new link in a rapidly growing navigation chain of radio stations that can make possible additional "sky lanes" by defining the lanes more precisely was officially opened at Quebec City, November 5, by John R. Baldwin, Deputy Minister of Transport.

**T**HE Bendix-Decca system is a low-frequency radio navigation aid designed to provide precise "maps in the sky" for economical and practical air traffic control — from departure and climb to in-flight checks, and arrival at the terminal area. It will show at any moment where an aircraft is, where it has been, its heading, distance covered, distance to go, and ground speed.

A "road map" or flight log mounted in the cockpit automatically provides a continuous pictorial display to the pilot of his track in relationship to his take-off point and destination. It permits maximum utilization of air space at all flight altitudes. With it a pilot can maintain minimum track separation.

The area-coverage system, based on the phase comparison of continuous wave transmission, operates in the 100-kilocycle band. Transmissions from the sending stations are phase-locked. This technique permits overlapping of the phase patterns that are produced between stations to form a 360-degree navigational grid. The grid

is made by the lines of phase difference transmitted by the stations.

The system requires the use of groups of "chains" of ground transmitting stations — consisting of "master" and "slave" stations that transmit wave patterns occupying precisely known and stable geographical positions. Each Decca chain consists of the master identified as "black", and three slave stations — "green", "red", and "purple". A continuous "fix" or location is provided by the intersection of position lines supplied by radio signals from two stations. These position lines are detected by a receiver and the information is recorded on dial indicators called decometers, and also displayed instantly and automatically on the flight plotter.

This "highway map" consists of a specially prepared navigation chart of the area being covered with the electronic position lines printed over it. A pen tracks the position of the aircraft on the map, and provides the precise navigational information to the pilot.



The new chain established in Quebec, officially opened November 5 by John R. Baldwin, Deputy Minister of Transport, is the first of its type to be constructed in North America. Called a Mark 10 chain, it will improve nighttime coverage and transmit a signal to provide automatic lane identification with high accuracy, as well as identify the zone in which a plane is travelling.

### *System Expedites Traffic*

Both Bendix-Decca and Bendix Dectra can be used for aviation and marine navigation. For example, it is being evaluated in Europe to modernize air traffic control; and an aerial "traffic cop" system based on Decca was instituted for evaluation last year for the London flight information region.

The techniques in this area for aircraft equipped with the Decca equipment permitted the setting up of "double-barrelled" air lanes, which permit air traffic to climb and descend through all altitudes with precisely known lateral separation. This lateral separation is provided by the use of parallel Decca tracks on opposite sides of an 11½-mile-wide (10 nautical miles) airway. Each Decca track is located about one and two-tenths miles from the edge of the airway.

With aircraft flying in the same direction at the same altitude, both lateral and longitudinal separations are used. This has enabled Decca-equipped traffic to be spaced five minutes apart, instead of the usual ten minutes. Decca-equipped aircraft are separated immediately, which has reduced the take-off separation time from five to two minutes.

In connection with the introduction of this Decca flight procedure, the British Ministry of Transport noted that it was done to take advantage of the "high accuracy" of the system, "which will expedite traffic by employing reduced separation standards."

In economic terms, the system is of vital importance to the aviation industry, particularly with the use of jet airliners on commercial routes. For example, a Viscount uses an extra gallon of fuel for each 2.32 miles flown when operated in a holding pattern at altitudes between 2,000 and 5,000 feet. If held at the low altitude, by jet standards, for 34.6 miles, an extra 15 gallons of fuel are used — amounting to 119 pounds.



● The "flight log" which interprets continuous signals from the ground stations to give immediate course and position information is seen in the center of this photograph.

The need for more precise scheduling — particularly in the jet age — is also apparent from the following figures: in England present longitudinal separations of aircraft not equipped with Decca require that aircraft be spaced at a minimum of 10 minutes apart when they are on the same airway and at the same altitudes. This means a separation of 35 miles between DC-3's, 46 miles for Convaers, and 58 miles for DC-7's. The spacing will require above 81 miles for future jet airliners.

Some estimates have placed the savings in flight time on some routes as high as 11 per cent for aircraft equipped with the new devices. The flight time can be saved because of the accurate navigation information supplied to the pilot as he leaves a holding pattern and lines up his aircraft for the ground approach.

### *Initial Trans-Ocean Flight*

In connection with the opening of the Quebec Bendix-Decca chain on November 5, the first trans-ocean flight of an aircraft using the navigation aid on the North Atlantic route between England and the Canadian mainland was scheduled.

A Valiant bomber operated by an R.A.F. crew for the British Ministry of Supply made the flight, using the short-range and long-range Bendix-Decca and Bendix Dectra systems.

The scheduled flight was timed to arrive at the Quebec City airport at about 11:30 a.m., November 5. Take-off point was Boscombe Down airport in the south of England. Its route was from Boscombe via Ireland on short-range Decca chains, switching to long-range Dectra for the trans-atlantic crossing from Ireland to Gander. From Gander to Quebec, the aircraft flew on Decca coverage provided by chains opened during the summer in Newfoundland and Nova Scotia.

These chains, along with the Quebec chain, cover an area of one million square miles. In addition to providing a precise navigation aid for aircraft, they also will enable trans-atlantic ships to make Cape Race and also provide coastal navigation for all types of ships, including fishing vessels, and shippers on the St. Lawrence route.

This system has been used for years in European waters, giving continuous track and position data to ships without the necessity for taking conventional fixes.

The system was first used because of its accuracy and reliability to guide the allied invasion forces in the Normandy landings of World War II. After the war it was used by commercial interests on the British coast, and now covers most of Europe.

### *Future Application*

The flexibility of the system in its application to the air traffic control problem is based on its ability to meet local conditions at the terminal area, according to Computing Devices of Canada officials, the Canadian company which holds Canadian rights to both systems for manufacture and sale. These conditions may be due to the weather, or to local traffic control operations and requirements.

For example, holding areas in a terminal area can be set up and changed as often as needed without moving ground equipment; the size of the air space for each holding pattern can be held to a precise minimum dependent upon local conditions; and since a pilot knows his precise position at all times with the pictorial display of his "track" before him, he is able to leave the area at an exact time designated by the control tower, thus helping to facilitate the flow of traffic in landing.

It also enables a pilot to report his precise position to the tower controller who, in turn, can quickly identify a reporting aircraft on a radarscope without complex air-ground communications.

In addition, any desired number of approach and departure "tracks" can be set up and displayed on the flight chart — a pilot being told to follow a specific line or track — with radar being used in the role of a monitor by air traffic control.

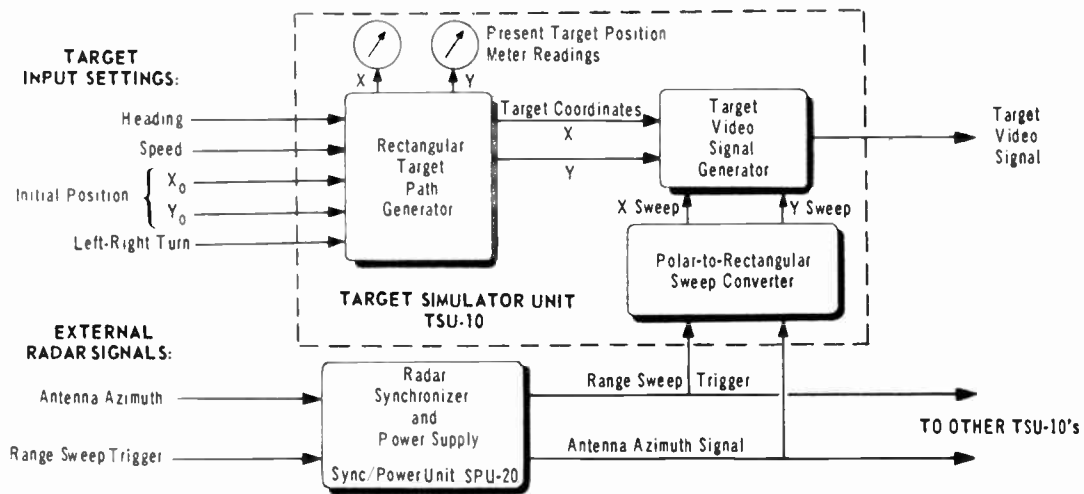

BASIC ELEMENTS OF TARGET SIMULATOR SYSTEM TSS-50

# A Moving Target Simulator System

**Realistic but inexpensive training for land, sea and airborne radar operators is provided by new Moving Target Simulator, which provides up to six separate moving targets for immediate viewing on standard radar indicators.**

**T**HE development of a new Radar Moving Target Simulator System which will generate the display of up to six individual moving targets on any standard radar indicator is one of the latest developments in this field to be announced by the industry.

One of the new, specialized devices being engineered and manufactured for all branches of the United States Armed Services and prime military contractors, the Target Simulator System features simplified circuitry and what is claimed to be much greater reliability than any similar device on the market today.

It can be used for training radar operators with aircraft and missile targets; testing radar PPI, B-scan and A-scan indicators; testing and analysis of radar data-processing and for in-flight training of airborne early warning personnel.

Two models of the system have been designed and produced — one for laboratory installations and one for mobile field use. A third stripped down model for airborne use is presently under development and is designed to operate with an airborne power supply.

The TSS-50 system for laboratory installations consists of six Target Simulator Units and one Sync/Power Unit enclosed in a steel cabinet. This system provides for the immediate viewing of up to six separate moving targets on standard radar indicators. Target positions, paths and velocities can be adjusted to simulate a variety of realistic flight paths for both training and testing purposes. Aircraft and missile speeds up to 10,000 nautical miles per hour are easily generated.

## *Control Trainer*

Simulated target video signals can be used to operate and trouble-shoot radar data processing equipment,

track-while-scan computing systems and to familiarize operators with aircraft control techniques.

This moving target simulator equipment is especially useful for testing closed loop aircraft control systems where the use of real aircraft is difficult or expensive.

One Target Simulator Unit is required for each target to be displayed. However, more than six may be used simultaneously. The common Sync/Power Unit can be coupled to an existing radar system or can generate dummy antenna azimuth information and radar triggers if desired.

A single Target Simulator Unit consists of a path generator in rectangular coordinates which receives initial position, speed, and heading inputs. Each unit includes a rectangular to polar conversion circuit which determines the time at which the target should appear. In addition, the individual unit is equipped with a video generator which is essentially a coincidence circuit followed by a shaping circuit to generate the appropriate target signal.

The smaller field-type Target Simulator System, Model TSS-52, is similar to the laboratory installation in its functions. It is capable of tracing up to six simulated targets but contains only one set of meters, capable of monitoring one target position at a time.

A variety of simulator controls permits the highly realistic generation of target video signals. Target heading and speed can be set up in polar coordinates. The target can then be made to turn either to the left or right at a constant defined turning rate. Target position can be determined at any time. A separate beam width adjustment is provided, for each target, making the simulated target appear realistically on the scope presentation.

Designers and manufacturers of the equipment are the Electronics Division of the Fairchild Controls Corporation.

**Toll dialing by alternate  
routing now possible with  
FOUR-WIRE TERMINATING for  
two-wire toll switching centres!**

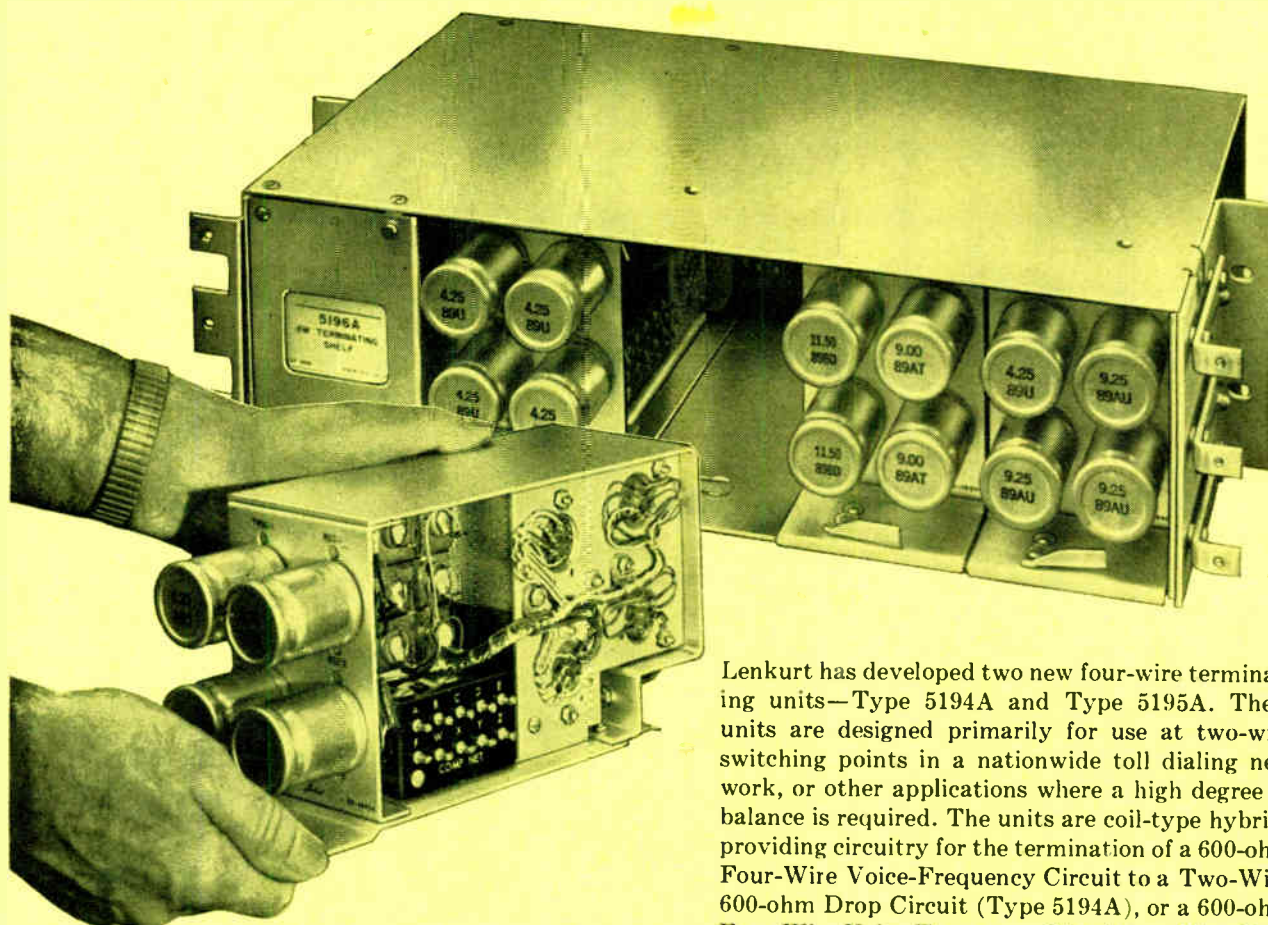

Lenkurt has developed two new four-wire terminating units—Type 5194A and Type 5195A. These units are designed primarily for use at two-wire switching points in a nationwide toll dialing network, or other applications where a high degree of balance is required. The units are coil-type hybrids providing circuitry for the termination of a 600-ohm Four-Wire Voice-Frequency Circuit to a Two-Wire 600-ohm Drop Circuit (Type 5194A), or a 600-ohm Four-Wire Voice-Frequency Circuit to a Two-Wire 900-ohm Drop Circuit. (Type 5195A).

Each terminating unit has provision for connection to an adjustable built-in compromise network, or to an external precision balancing network, as well as facilities for A and B lead or simplex signalling. Lenkurt Four-Wire Terminating Units are mounted on a single shelf for 19-inch rack mounting.

Write for complete information.

*Automatic Electric Sales (Canada) Limited, 185 Bartley Drive, Toronto 16, Ontario. Branches in Montreal, Ottawa, Brockville, Hamilton, Winnipeg, Regina, Edmonton, Vancouver.*

**AUTOMATIC  ELECTRIC**

ORIGINATORS OF THE DIAL TELEPHONE



# Transistorized... telephones and



## TYPE 80

**TRANSISTORIZED MONOPHONE**—Ideal for noisy locations or where the signals received are unusually weak. Provides normal telephone reception for people who are hard-of-hearing. Volume can be adjusted instantly to the desired level. Telephone companies who first tried this Monophone state that their hard-of-hearing subscribers are well pleased with the improved reception, eliminating misunderstandings, embarrassment and discomfort.

Using a single transistor, only  $3\frac{3}{8}$ " long, the amplifier can boost weak incoming signals up to 16 times. The transistor amplifier and the high impedance receiver are matched to provide the highest possible efficiency throughout the speech range. The transmitter circuit uses an induction coil and balancing network that greatly improves anti-sidetone balance.

Other advantages of this Monophone as with the ordinary Type 80 are: extremely light handset which automatically slides right back into the cradle; improved dial; improved ringers; sleek modern design; and a choice of ten smart modern colours.

## OTHER SPECIAL HANDSETS FOR NOISY LOCATIONS

—Other types of noise excluding handset—designed for use in locations where more expensive equipment is not warranted—are also available. Some of these—for instance the Type 25 and Type 27B incorporate a "press-to-listen, release-to-talk" pushbutton. This allows the caller to listen without noise passing from the phone mouthpiece to the receiver. Another handset, the Type 38 employs a specially shaped mouthpiece and damped diaphragm transmitter to help exclude off noises.



## OPERATOR'S TRANSISTORIZED HEADSET

Enables operator to hear very weak signals. Amplified up to 16 times. Transistor amplifier is so small (only  $2\frac{1}{2}$ " x  $1\frac{3}{8}$ ") that it is a part of the plug housing. Draws all required current from ordinary telephone circuit. Convenient volume control, enables operator to adjust gain to any required hearing level.

# and other special purpose

# accessories by AUTOMATIC ELECTRIC

**TYPE 88 LOUD SPEAKING TELEPHONE**—A regular telephone, a loud speaking telephone and a conference telephone combined in one instrument. Leaves both hands free for turning pages, writing, etc. Call is made by pressing "ON" button (1) and dialing number without raising the handset. Pressing the "OFF" button (2) terminates the call. To receive a call, you just press the "ON" button, and talk. A signal light (3) glows while call is being made, and acts as a reminder if you should forget to press the "OFF" button when call is terminated. The volume is controlled by the volume control knob (4). A built-in microphone (5) in the base picks up the normal voice; the other party's voice is transmitted through a separate speaker (6). Others may join in the conversation by gathering around the desk and speaking towards the microphone. Raising the handset cuts off the speaker and affords complete privacy.

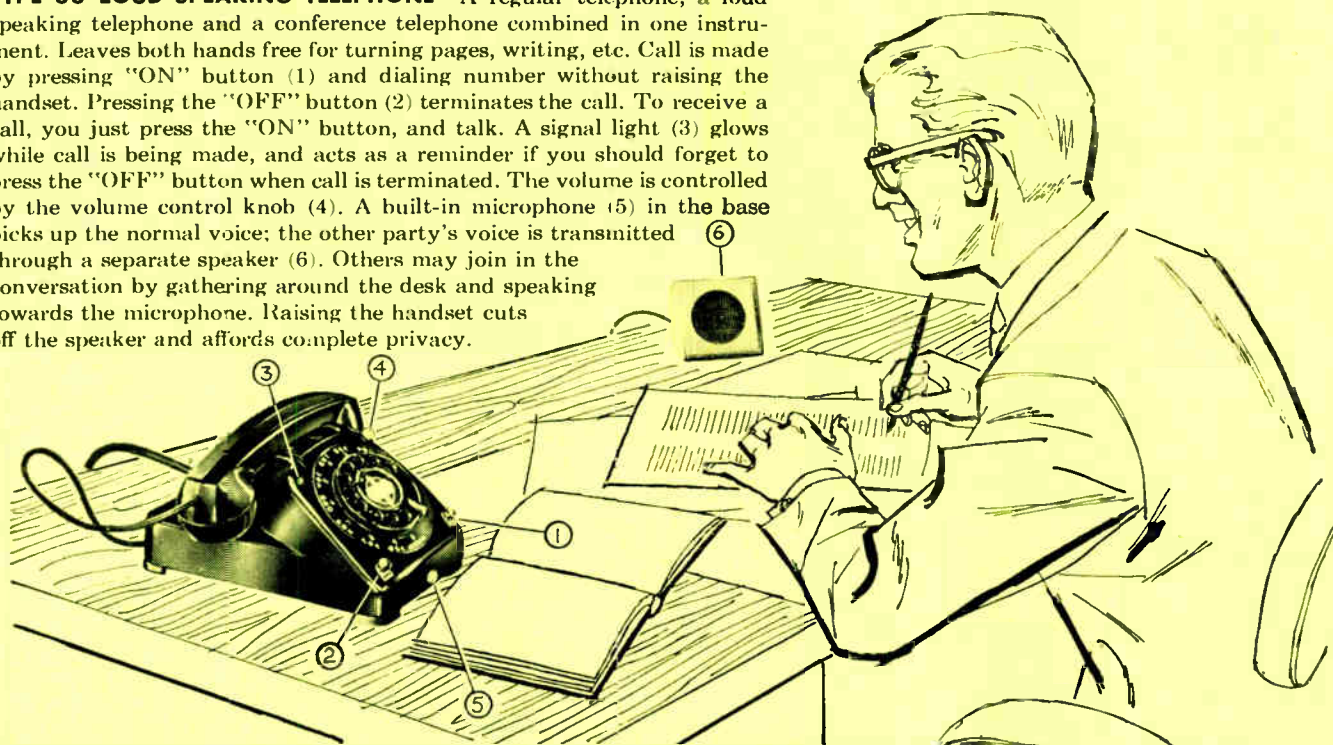

### THE ROANWELL CONFIDENCER—

Solves the problem of carrying on telephone conversations in noisy locations. Neutralizes surrounding noises but transmits speech in ample volume. Noises are directed through separate sound chambers to both sides of the diaphragm, so that their effects cancel out. Mouthpiece specially designed to fit close to the lips, is an additional help in excluding off noises.

The Confidencer is supplied only in the form of conversion kits. Kits include modified transmitter caps, all the special parts required and complete instructions.

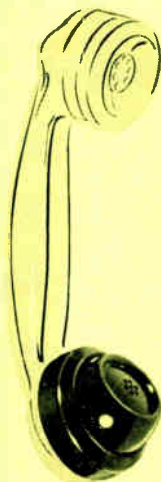

Write us for free literature—today.

Automatic Electric Sales (Canada) Limited, 185 Bartley Drive, Toronto 16, Ontario. Branches in Montreal, Ottawa, Brockville, Hamilton, Winnipeg, Regina, Edmonton, Vancouver.

## AUTOMATIC ELECTRIC

ORIGINATORS OF THE DIAL TELEPHONE



5774

For further data on advertised products use page 65.

# complete money-saving service

You can save enormously on time, materials and labour, with rural distribution wire and supplies from Automatic Electric. The wire is insulated, colour coded and formed like cable. It is put up fast and economically. All that's needed is a single bracket at each pole for proper attachment. Here is a typical installation:

## for all your rural distribution wire and supplies

**PROTECTED TERMINAL** Can be supplied for either cable or station protection. Weather-tight and designed for either pole or crossarm mounting. Available for 6, 11 and 16 pair wire.

**DISTRIBUTION WIRE** The economical solution for expanding rural and suburban telephone facilities. 19 gauge solid copper conductors are polyethylene insulated and P.V.C. jacketed. The conductors are twisted together in pairs around an insulated messenger. 6 pair wire illustrated, 11 and 16 pair also available.

**TYPE "B" BRACKET** attaches the messenger directly to the pole as shown. If there were no terminal box, the wire would lie on the bracket—protected from rubbing by a plastic guard. A type "C" bracket is available for crossarm mounting.

**WIRE VISE** Jaws of steel hold the support wire in a never relaxing grip. The fastest and neatest way of dead ending wire and cable.

**WIRELINK** for splicing the messenger. Uses the same principle as the wire vise. Simply insert the wires in the ends until a click is heard. The wirelink will then never let go.

**UNPROTECTED TERMINAL** for pole or crossarm mounting. Weatherproof, durable, reliable and very inexpensive. Available for 6, 11 and 16 pair wire.



These are just a few of the money-saving items Automatic Electric offer to thrifty-minded telephone companies. For helpful information and better service on your own particular requirements contact your nearest Automatic Electric office. Branches in Montreal, Ottawa, Brockville, Hamilton, Winnipeg, Regina, Edmonton and Vancouver. Head Office: 185 Bartley Drive, Toronto 16, Ontario.

## AUTOMATIC ELECTRIC

SALES (CANADA) LIMITED

5623

For further data on advertised products use page 65.

# business briefs and trends

★ Permission has been granted to the University of Toronto to erect an atomic energy reactor at a cost of \$439,000. It is expected that the reactor will be ready for operation early in 1958. Its operation will be under the jurisdiction of the Faculty of Applied Science and Engineering. The reactor is being built with a view to educating young Canadian students for the atomic age.

\* \* \*

★ Tests were conducted during the past summer on the world's first commercial use of a scatter link system — for voice transmission only — between Kenora and Red Lake, Ontario, a distance of about 95 air miles. The scatter link system was installed for the Northern Telephone Company at Kenora by the Collins Radio Company of Canada at a cost of approximately \$180,000. The unit is mobile, self-operating and requires only routine maintenance checkups by technicians.

\* \* \*

★ The B.C. Telephone Company anticipates spending nearly \$500 million on expansion and improvement during the ten-year period 1957-1966, more than three times the amount spent in the previous ten years.

\* \* \*

★ It has been estimated that the field of automatic data processing has a present gross expenditure in the United States of over \$4¼ billion.

\* \* \*

★ The Association of Professional Engineers of Ontario announces that there are 16,094 registered professional engineers in Ontario, an increase of 1,317 over 1956. The number of applications for registration continues at a rapid rate, with 1,917 being received this year.

\* \* \*

★ The B.C. Telephone Company is undertaking a major expansion of its TV transmission facilities, with the installation of a switching center for the province located in Vancouver and an extensive TV cable network throughout the city. The center is scheduled to be completed in conjunction with the opening of the B.C. section of the Trans-Canada microwave radio relay system in June, 1958.

\* \* \*

★ A transistor test set that will indicate noise level and apply all the usual checks has been put into production by a British electronic engineering firm. Believed to be the only one of its kind, the set is designed to be of universal application — in production work, for routine testing, in the service department and in the laboratory. It is expected to be of particular value in the manufacture of hearing aids.

\* \* \*

★ The Metro planning board of Toronto, over a period of two years, has been collating data on the travel habits of Metro citizens. All this information has been transferred into perforations on punched cards and fed into new electric computing machines. Rental of the machines so far has cost the city approximately \$76,000, or roughly six cents for each Metro resident.

\* \* \*

★ The number of Independent Telephone Systems within the jurisdiction of Ontario as of December 31st, 1956, was 370, a net reduction through sales, consolidations etc., of 35 from 1955. Telephones operated by the Independents were 176,052, (42,338 on dial, 133,714 on manual) as of the 31st of December, 1956.

\* \* \*

★ Automation in the future will create more — not fewer — jobs. R. M. Robinson, Vice-President and General Manager of the Electronic Equipment and Tube Department, Canadian General Electric Company Limited, told the Technical Conference on Electrical Maintenance, that he was convinced now as never before that "the progressive automation of industry greatly increases the number of employment opportunities in associated fields".

\* \* \*

# Technical Data Index

## For Engineers

### Metal Film Precision Resistors

A new kind of precision resistor, the Riteohm Series 77 metal film resistor, now available, is described in an informative bulletin newly released by the Ohmite Manufacturing Company. Outlined in full detail are the complete characteristics compared with MIL specifications, resistance range, dimensions, and other important data.

The advanced, new Ohmite Riteohm metal film resistors were developed to meet tough, new military and industrial demands. They represent a radical departure in construction from wire wound precision resistors. For complete information, write for a copy of Bulletin 155, Ohmite Manufacturing Company, 3661 Howard Street, Skokie, Illinois.

### Environmental Testing Facility

Facilities and functions of a new environmental testing laboratory available to industry and government agencies for the critical operating examination of electronic and electro-mechanical products and systems are explained in a four page Technical Bulletin 58-116 issued by BJ Electronics, Borg-Warner Corp., Santa Ana, California.

### Microwave Products Catalog

A new four-page short form catalog (57-BG) describing all of the products manufactured by Microwave Associates is now available. Listed in Brochure 57-BG are: pulsed and CW magnetrons, TR and ATR duplexing tubes, microwave silicon diodes, silicon power rectifiers, flange-mounted and solderable waveguide pressure windows, waveguide components, and test equipment.

Operating characteristics are tabulated for a majority of the products. Copies of the catalog are available upon request by writing to the Burlington, Mass. firm or E. G. Lomas, 227 Laurier Avenue West, Ottawa, Ont.

### Ferrite Magnetic Materials

An eight-page illustrated bulletin entitled "Ferramics for General Applications up to 200 Megacycles" is available from General Ceramics Corporation, Keasbey, N.J. Fully described is the nature of ferrites, their advantages and limitations and method of production. Also included is a detailed comparison of Ferramic bodies and their specific applications to the electrical and electronics industries.

### How To Use Capacitors

How to use capacitors — GEA-5632B — 12 pages, describes the why, where and how of industrial capacitor applications. Publication describes units and equipments available; discusses problems and solutions in selection of industrial capacitors, and includes diagrams and pictures.

A brief explanation of how capacitors lower power costs, release system capacity, improve voltage levels and reduce power losses is also included. General Electric Co., Schenectady 5, N.Y.

### New Dalic Plating Booklet

"Practical Brush Plating With The Dalic Process" is the title of a new booklet, available upon request from Marlane Development Company. It is based on a paper by Marv Rubinstein, metal finishing consultant, which was presented at the technical proceedings of the 43rd annual convention of the American Electroplaters' Society.

The new 12-page booklet, extensively illustrated, is available free of charge from Marlane Development Co., 153 East 26th Street, New York 10, N.Y.

### Technical Paper On Selenium Rectifiers

A 12-page illustrated bulletin, discussing the advantage of "Selenium Rectifiers for High Voltage DC Power Supplies", is offered by Beta Electric Division, Sorensen & Company, New York City.

Substantial reductions in size and weight effected by use of selenium rectifiers is shown by several examples, including a 300 KV, 5 milliamperes unit.

A bibliography is included.

Copies can be obtained by writing Beta Electric Division, Sorensen & Co., Inc., 333 East 103rd Street, New York 29, N.Y.

### Plug-In Computer Elements

A new technical manual describing transistorized, plug-in computer elements and their applications has just been issued by Ransom Research. Copies may be obtained free by asking for bulletin C-24. Requests should be addressed directly to: Ransom Research, 323 West Seventh Street, San Pedro, California.

### Phasemaster Bulletin

A new bulletin on the recently developed Model PM-1B Phasemaster is now available from the manufacturer, Statham Development Corporation, Los Angeles, California.

This bulletin describes in detail the specifications and applications of the Phasemeter as well as significant features. In addition, the bulletin contains illustrations and a diagram of the new unit.

Copies may be obtained by writing to: Statham Development Corporation, 12411 West Olympic Boulevard, Los Angeles 64, California.

### Closed Circuit Television Camera

New four page catalog sheet on self-contained Closed-Circuit Television Camera, Model PD-500, lists outstanding features and fully describes the design characteristics of the camera, built-in power supply, and control accessories for complete remote operation. Detailed specifications and dimensions are also provided. General Precision Laboratory Inc., 63 Bedford Rd., Pleasantville, New York.

### U.S. Components Condensed Connector Catalog

U.S. Components, Inc. of New York, N.Y. has made available a condensed version of its comprehensive catalog of power and electronic circuit connectors, and associated equipment.

This new short-form catalog illustrates the complete U.S. Components line of connectors, and lists key specifications and operating characteristics. The line covers sub-miniature and miniature power and electronic connectors in several configurations; pressurized, waterproof and hermetically-sealed. Also printed circuit connectors and card receptacles.

Copies may be obtained from U.S. Components, Inc., 456 East 148th St., New York 55, N.Y.

#### NOTE

**Requests for technical data should be addressed directly to the company concerned.**



# Technical Data Index

## For Engineers

### Transistor Servo Amplifier

"Transistor Servo Amplifier" M. TEN BOSCH, INC. brochure, four pages, covers the performance characteristics of production models of the 60 and 400 c.p.s. TRAMPS. Miniaturized units capable of providing up to 9 watts controlled power at a weight factor of less than 1 ounce per watt are described in detail. An engineering application questionnaire is included to assist in the selection of the TRAMP and control system companions which were designed to military specifications.

### Connector Brochure

A completely revised and new 12-page brochure on Continental Connector's subminiature series connectors has just been issued by the Electronic Sales Division of DeJur-Amsco Corporation. Specifications, outline drawings, illustrations, and general information make this latest catalog a valuable addition to company libraries, and engineering and purchasing files. For a free copy, write to Electronic Sales Division, DeJur-Amsco Corporation, 45-01 Northern Blvd., Long Island City 1, N.Y.

### Acoustic Excitation Testing

A new system developed for environmental testing of critical jet and missile components is described in a brochure just issued by RCA.

This brochure, "RCA High Intensity Noise Systems" covers general specifications for two available models of test chambers. It gives application information, explains the operation of the noise systems, and describes testing procedure. Charts show frequency response characteristics of the RCA High Intensity Noise Systems and sound levels at various locations on typical jet aircraft.

For free copies of this informative brochure, write Radio Corporation of America, Electronic Instruments section, Bldg. 15-5, Camden 2, New Jersey. Request form 3R3182.

### Digital Pulse Decoder

A 12-page engineering manual describing the Secode type 49 digital pulse decoder and its numerous applications has just been released. A copy may be obtained by writing to: Electrical Communications, Inc., 765 Clementina Street, San Francisco 3, California.

### Centralab Switch Catalog

A new 35 page manufacturer's switch catalog with complete specifications on rotary, slide, and lever switches is available from Centralab. (a Division of Globe-Union Inc.).

This new catalog provides specifications on the complete line of Centralab switches capable of handling power from a kilowatt to a microwatt. For further information, write Gerry Klein, Centralab, (a Division of Globe-Union Inc.), 900 E. Keefe Avenue, Milwaukee, Wisconsin.

### Non-Synchronous Resistance Welding Control

Non-Synchronous Resistance Welding Control — Bulletin GET-2683, 12 pages, furnishes electrical and mechanical information on standard components comprising non-synchronous welding control to assist users in selecting proper equipment to meet particular application requirements and determine necessary electrical interconnections. The bulletin is illustrated by 18 diagrams, charts, and schematic drawings. — General Electric Co., Schenectady 5, New York.

### Single Channel Differential Analyser

A new 2-page, 2-color bulletin covering the company's Model 695 Single-Channel Differential Analyzer is announced by The Victoreen Instrument Company.

The bulletin outlines suggested uses for the instrument and gives complete performance and specification data, dimensions, weights, etc.

Copies of Form 3005-7 "Victoreen Single-Channel Differential Analyzer" are available on request to The Victoreen Instrument Co., 5806 Hough Avenue, Cleveland 3, Ohio.

### Oscillographic Recording Systems

A new four-page folder describing and illustrating Sanborn "150 Series" 1-, 2-, 4-, 6-, and 8-channel oscillographic recording systems has been published recently. Included are descriptions and specifications of all Basic Assemblies; the 12 different presently available interchangeable plug-in Preamplifiers; 2- to 8-channel output recording systems; and the new 6- and 8-channel mobile console systems and Programmer for analog computer readout.

Copies of the Short Form catalog are available on request from the Industrial Division of Sanborn Co., 175 Wymar St., Waltham 54, Mass.

### Eimac Quick Reference Catalog

A new 16-page, 3-color Quick Reference Catalog has been published by Eitel-McCullough, Inc., San Bruno, California, manufacturer of Eimac electron power tubes.

Summarized electrical and physical data is given in handy tabulated form for each of the company's line of triodes, tetrodes, pentodes, klystrons, high vacuum and mercury vapor rectifiers, vacuum capacitors, vacuum switches, ionization gage, contact finger stock, heat dissipating connectors, air system sockets and chimneys.

Copies of the new Quick Reference Catalog have been mailed to all Eimac catalog holders. Others may obtain the new catalog by writing Eitel-McCullough, Inc., San Bruno, California.

### T&B Color-Keyed Method

Thomas and Betts have recently published a bulletin on a new connecting tool for sizes No. 8AWG to 250 MCM copper conductors. Snap-in dies are Color-Keyed to match color of the connector. The tool creates tons of pressure on closed compression. Dies can not come loose or misaligned.

A complete list of copper compression connectors, including lugs, are also contained in the brochure . . . plus die and connector color chart. Write for informative bulletin CK563. Thomas and Betts Ltd., 759 Victoria Square, Montreal, Quebec.

### Tube Quality Test Brochure

A 16-page, 2-color technical brochure has been published by Eitel-McCullough, Inc., of San Bruno, California, dealing with a new quality test for use in the production of power vacuum tubes. Entitled A POSITIVE GRID VOLTAGE — SPACE CURRENT DIVISION TEST FOR POWER VACUUM TUBES, the paper was delivered by James A. Jolly, Eimac Assistant Manager of Engineering, at the March 1957 annual convention of the IRE. Existing test techniques and their limitations are discussed and the new method is described with sample data included.

Copies of this paper have been mailed to all Eimac catalog holders. Others may obtain the new brochure by writing Eitel-McCullough, Inc., San Bruno, California.

# New Products

New Product specifications published in *Electronics and Communications* have been briefed for your convenience. If you require further information on any of the items published you may readily obtain such by using our Readers' Service, Page 65. Just mark the products you are interested in on the coupon on Page 65 and the information will be in your hands within a few days.

## Electronic Battery

### Item 1734

American Electronic Laboratories, Inc. of Philadelphia, Pa. announces the Model 170 Electronic Battery. This device is designed to replace storage battery and floater combinations widely used for spectrophotometers, sensitive d.c. amplifiers and other applications where stability, low noise, and transient requirements are severe. Input is 105-125 210-250 volts, 50/60 c.p.s. Output 6 volts adjustable  $\pm 5$  per cent, 0-5 amperes; 2 volts adjustable  $\pm 5$  per cent, 0-100 milliamperes. Ripple and noise at 6 volt output is 1 millivolt RMS max, at the 2 volt output this figure is 0.5 millivolts RMS max. Recovery time of the unit is .001 seconds (63 per cent). Line regulation for both the 6 and 2 volt output is .01 per cent max, with no load to full load regulation .05 per cent for 6 volt output and 5 per cent for 2 volt output.

American Electronic Laboratories, Inc., 121 N. 7th St., Philadelphia 6, Pa., U.S.A.

## Vacuum Tube Voltmeter Kit

### Item 1735

Stark Electronic Sales Co. of Ajax, Ont., has introduced a vacuum tube voltmeter kit — under the trade name of STARKKIT — Model V MK-1 — a highly versatile unit, the specifications of which are:

Power Supply — 105-125ACV, 60 cycle.  
Power Consumption — 20 watts at 115 volts.

Ranges: @ DC volts 0-1.5, 3, 12, 30, 120, 300, 1200 (seven ranges); @ AC volts 0-1.5, 3, 12, 30, 120, 300, 1200 (seven ranges); @ Peak to Peak: 0-4, 8, 32, 80, 320, 800, 3200 (seven ranges); @ Ohms: 2 ohms to 1000 megohms in seven ranges.

Frequency: AC measurement to approximately 2 megacycles. (RMS and peak to peak.)

Input Impedance — @ Volts DC, 10.5 megohms; @ Volts AC approximately 10 megohms shunted by 150 MMFD.

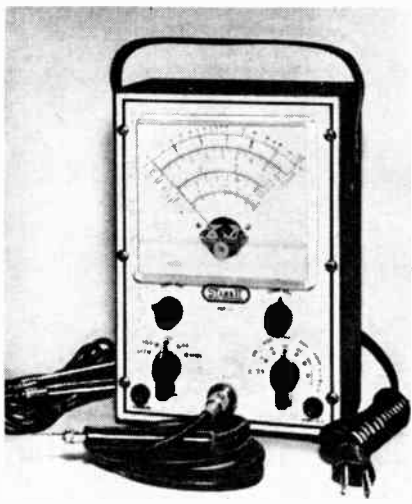

Meter: 5" unbreakable lucite front, sensitivity: 350 microamps.

Tubes: 12AU7 — Balanced Bridge; 6AL5 — rectifier.

Physical size: 8½" high, 5¾" wide, 4" deep — weight 4¼ lbs.

This is another product from the STARK-KIT division of Stark Electronic Instruments Ltd. For further information write Stark Electronic Sales Co., Ajax, Ontario.

## Fully Adjustable Sensitive Relay

### Item 1736

The first all-purpose, fully adjustable sensitive relay is being introduced by Weston Electrical Instrument Corporation, Newark, N.J., a division of Daystrom, Inc.

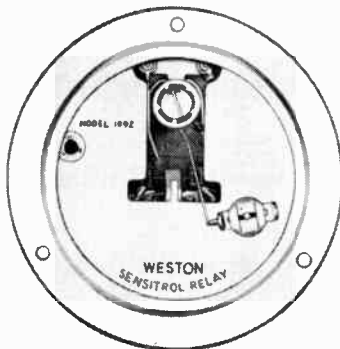

It offers engineers, designers and builders of alarm or control devices an all-purpose relay at relatively low cost. In breadboard circuits the new relay eliminates the need for pinpointing operating values of current or voltage through elaborate calculations or electrical measurements. The relay's wide range of adjustments permits an almost infinite number of accurately repeatable settings by turning one adjusting screw.

The new unit, which contains a built-in re-set mechanism, can be set to close at any value of DC from 5 to 50 microamps or a comparable millivolt span of 10 to 100, and will handle 100 milliamperes at 120 volts AC without chatter.

For further information write to Daystrom Limited, 840 Caledonia Road, Toronto 10, Ontario, Canada.

## Deflection Yoke Cores

### Item 1737

New two-piece ferromagnetic deflection yoke cores of Stackpole Ceramag® give virtually the same deflection sensitivity as single-piece cores, yet allow easier assembly, greater savings in weight.

Designed for the new 110-degree picture tubes, the new Stackpole cores are molded as single units, then halved for assembly into the deflection coils. Thanks to special handling during the halving process, the cracks can scarcely be detected. Air gaps and flux leakage are minimized . . . deflection sensitivity greatly improved.

The flared shape of the Stackpole 110-degree yoke core lends itself to material savings up to thirty per cent — and with consequent savings in weight and cost compared with conventional cylindrical cores.

Details on available grades and shapes of Ceramag 110-degree deflection yoke cores are available on request to Canadian Stackpole Ltd., 550 Evans Ave., Etobicoke, Toronto 14, Ontario, Canada.

## Single Decade Impulse Counters

### Item 1738

The group of the well known Sodeco Small Remote Impulse Counters Type TCE. . . . E has recently been expanded by a new model, which shares with the existing types the extremely low burden making it suitable for direct control by electronic tubes or transistors. Available for the same standard DC voltages of 4, 6, 12, 24, 36, 48, 60, 72, 95, 110, 160, 220 volts, the new Type is also available for impulse frequencies of up to 10 or 25 impulses per second, with the same coil resistances and current consumptions as Types TCE. . . . E. The front panel of Type ITD. . . . is 22 x 44 mm (0.865" x 1.731"), the overall depth is 111 mm (4.375"). But here the similarity ends: instead of the 4, 5, or 6 cyclometer rolls on a horizontal spindle of type TCE. . . . E, Type ITD. . . . has behind a window 6 x 12 mm (0.236" x 0.473") one single roll on a vertical spindle with large (½" x ⅜") white figures 0 . . . 9 on black. Each impulse advances the drum by half a figure and the spring actuated return of the released armature to its off-position completes the count.

The new counters can be supplied for forward motion 1, 2, 3 . . . 0 (ITD. . . .) or for backward motion 9, 8, 7 . . . 0 (ITDI. . . .), without auxiliary contacts, or with one normally open or with two normally open 1 Amp contacts or with one normally open and one normally closed 1 Amp contact. Those contacts can be provided either at position "0" or at position "9". They are actuated after the interruption of the impulse has brought the drum to the position of that figure and similarly released after the drum has been brought to the next figure.

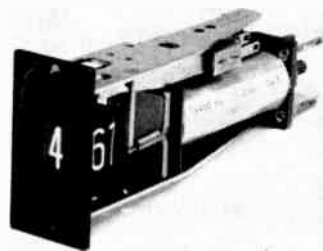

The manufacturers claim that the new type of Single Decade Counters are valuable building stones for the solution of counting problems where the large size of the figures is important and for the transmission of remote numerical indication. The auxiliary contacts not only facilitate the combination of decade counters to any desired number of digits, but by their use for predetermining control they are said to be important elements in the automation of manufacturing processes.

The high-quality materials — the escapement is of hardened steel, the drum and gearwheel of special plastic material — combined with excellent workmanship, are claimed to guarantee a long life which according to tests carried out thus far even at the higher impulse frequency of 25 imp./sec. promises to lie on the outside of fifty million impulses.

For more information write to The J. W. Ellis Industries, 42 Lombard St., Toronto 1, Ontario, Canada.

## New Products

### Reliable Relays For Printed Circuits

Item 1739

Adaptation of the versatile miniature Class 11 Relay series for printed circuit application is announced by Magnecraft Electric Co., of Chicago, Illinois.

Class 11 Printed Circuit Relays are especially adaptable to low voltage sensitive applications where reliability is important and for requirements where one relay must perform a number of switching functions with minimum input power. They can be furnished with great resistance to shock and vibration and to withstand wide temperature variations in compliance with military specifications.

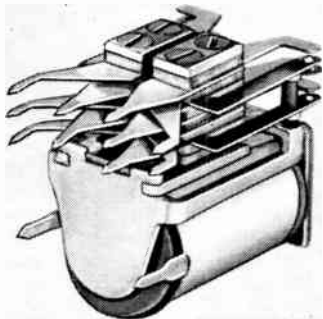

Available for DC operation, any voltage to 230, also with full wave rectification for operation from 20 to 400 CPS. Furnished with a great variety of contact combinations; snap action contacts, time delay, and heavy current contacts.

Descriptive literature on request to the Magnecraft Electric Co., 3354 RC W. Grand Ave., Chicago 51, Illinois, U.S.A.

### Appraisal Kits For Thermistors

Item 1740

Four new engineering appraisal kits which provide the electronic engineer greater latitude in determining which thermistor is applicable to his circuitry problems have been announced by the Permanent Magnet Section, Canadian General Electric Company Limited.

Each of the kits is designed to meet either a resistance range or a functional application.

According to Canadian General Electric engineers, kit A is packaged with low resistance disk type thermistors in the 10 to 500 ohm range; kit B includes high resistance disk and rod thermistors in the 1,000 to 10,000 and 10,000 to 100,000 ohm range; kit C consists of 3/4-inch washer type thermistors and necessary hardware for experimental purposes.

The fourth package, kit D, is packaged entirely with 1,000 ohm resistance disk thermistors to enable an engineer to make evaluations on the effect of thermistor mass on its dynamic or static characteristics — where resistance level is not the governing criteria.

The kits include 10 to 12 experimental components and sell for about \$15.00 each.

Permanent Magnet Section, Canadian General Electric Company Ltd., 214 King St. West, Toronto, Ontario.

### Frequency Induction Heating Generator

Item 1741

A new concept in electronic induction heating is now offered by Philips Industries Limited of Toronto in their latest 25 KW High Frequency Induction Heating Generator.

The important feature of the new generator is a continuous work coil matching device. This new device provides for optimum power transfer to the work piece by

the simple turn of a wheel. At the same time it controls the power output to the desired level. The improved efficiency in many cases permits the use of a smaller, less expensive generator than would normally be used.

Another feature of the generator is a remote control "On-Off" foot or hand switch which can be worked in conjunction with a number of available process timers. For processes in which temperature fluctuations must be kept within narrow limits, an optional temperature control can be supplied.

The generator is housed in two cabinets; the oscillator unit, which is placed next to the work; and the power supply unit which can be stationed in any convenient location.

Philips Industries Limited, Scientific & Industrial Apparatus Division, 116 Vanderhoof Ave., Leaside, Toronto 17, Ontario.

### Balancing Machines

Item 1742

A new multi-purpose line of dynamic balancing machines that are used in four different ways to correct vibration and unbalance problems has been announced by the manufacturer, International Research and Development Corporation, 797 Thomas Lane, Columbus, Ohio.

The new balancing machines — available in three models — 101, 102, 103 — are four-way versatile in that they are (1) used for dynamic and single plane balancing of motors, spindles, turbines, impellers, flywheels, blowers, and the like. Yet the electronic console of the balancing machine is readily disconnected for portable use, (2) to check vibration tolerances of assembled machinery, (3) to pinpoint the causes and analyze all frequencies of vibrations in assembled machinery, and (4) for "in-place" or portable balancing.

The line of dynamic balancing machines is intended for production balancing—where fast, simple operation is important; for plant maintenance — where quick, easy setup is required; and for motor repair and balancing service shops — where versatility and capacity range is essential.

The electronic console of the balancing machine consists of any of the various models of portable IRD Vibration Analyzers. Angle of unbalance is observed on the workpiece under a brilliant white stroboscopic light. Amount of unbalance is observed directly on a meter of the analyzer. Two adjustable workpiece supports contain dynamic pickups to convert the transverse motion of the workpiece to electrical signals. The workpiece is belt-driven from an electric motor through a jackshaft to control belt tension. Workpiece may be mounted either between bearing supports or in an outboard manner.

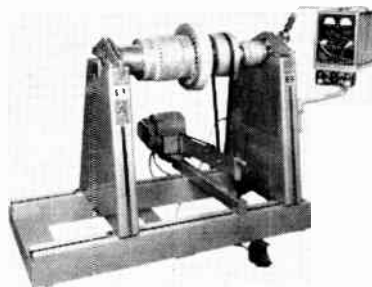

An electrical plane separation system is incorporated for eliminating cross effects when balancing in two-correction planes. Production balancing of similar rotors is thus accomplished in only one run.

Rotors weighing 5 to 300 pounds are handled on the Model 101, from 50 to 1,000 pounds on the Model 102, and from 250 to 2,500 pounds on the Model 103.

Literature describing features, operation, and application of the complete line is available and may be obtained by writing to the Canadian representatives, Martin Industrial Sales, Ltd., 41 West Ave., N., Box 463, Hamilton, Ontario.

### AC Insulation Tester

Item 1743

The Bendix Red Bank A-C Insulation Tester type 1106900-1-A is a precision instrument that fulfills the need for a safe, versatile and portable insulation breakdown tester. This unit is specifically designed for a wide voltage range (up to 3,500 volts at 2 to 15 milliamperes) and provides a stable trip current adjustment despite variations in line voltage.

Special safety features permit application of the tester under a wide variety of operating conditions. For example, test probes are not grounded to the tester frame or input power supply. A third wire is provided to ground the tester chassis through a polarized plug. None of the cords unplug, thereby preventing their loss and the substitution of unsafe high voltage leads. The probes are of the non-locking, spring retracting type that prevent high voltage parts from being exposed except when being manipulated by the operator. Metallic contact tips are removable to permit replacement.

The tester has a two per cent meter with a 3 1/2 inch scale which provides easy reading of the output voltage at the test probes. Output voltage is continuously adjustable from 0 to 3,500 volts by means of a convenient front panel control knob.



The maximum current through the test probes is limited by an electronically controlled relay. This special circuit cuts out the high voltage and turns on a warning light. The circuit must then be reset before testing can be continued. Variations in line voltage do not affect the preset current limiting feature.

Complete information and details are available from Aviation Electric Limited (Canadian affiliate of the Bendix Aviation Corporation) 200 Laurentien Blvd., Montreal, P.Q.

### Pre-determined Electronic Counter

Item 1744

Designed primarily to provide a printed record of the lineal footage output of paper mills but adaptable to most applications where a record of count or lineal measurement is required, is the Post Model LF-1A Lineal Footage Counter.

The LF-1A can be quickly set up to control and record the number of objects per batch, the number of turns on a coil, or the number of feet of textile, paper, wire, rope, metal sheet, etc., produced by a machine.

The system consists of a Post Electronic Counter, a decoder, a digital printer, and a suitable sensing device such as a lineal footage photohead, magnetic switch or a conventional photo-electric head. Further information is available from M.E.L. SALES, a Division of Measurement Engineering Limited, Arnprior, Ontario, Canada.

## New Products

### Portable Tube Tester *Item 1745*

The Stark model TV7C/U is a rugged portable tube tester, dynamic mutual conductance type, ideal for all electronic servicing and engineering purposes.

Test: Dynamic Mutual Conductance (for amplifier tubes); Emission test (for rectifier tubes); Short test; Gas test (amplifier tubes); Noise test; Continuity test (ballast tubes); Pilot lamp test.



Accessories Supplied: Pin straightener for 7 pin and 9 pin miniature tubes; Special subminiature adaptor for testing subminiature tubes with long leads; 829 and 832 tube adaptor; Sockets for British Basing types B4 (British 4 pin), B5 (British 5 pin), B7 (British 7 pin) B9G (9 pin octal); MO (Mazda octal); Data supplied for many CV type tubes; Test Leads Spare fuse. All accessories are neatly and securely mounted in the lid.

Special Features: Bias, plate, screen and signal voltage are precision calibrated. Choice of three signal voltages, 0.5V, 1.0V, 5.0V AC; Precision type bias potentiometer; Hermetically sealed transformer; Ruggedized JAN approved meter construction; Ruggedized construction throughout; Rubber sealed case; Approved construction design by Canadian Armed Forces.

Dimensions: 15½" wide x 9" deep x 6¼" high.

Net Weight: 18½ lbs.

For further information and price, write to Stark Electronic Sales Co., Box 670, Ajax, Ontario.

### Front-Mounting Fasteners

#### *Item 1746*

Two entirely new concepts in front-mounting fasteners were recently announced by Dominion Fasteners Limited, Canadian licensee and manufacturer of Tinnerman SPEED NUT brand fasteners.

Designed primarily for automotive fender application, the new self-retaining (SPEED) GRIPS eliminate costly welding and staking operations and permit ready installation where assemblies are not easily accessible.

One of the new front-mounting fasteners is a nut-retainer which is easily drifted into locked, bolt-receiving position with a simple tool. Affording ample float to offset normal manufacturing tolerances, the fastener also provides excellent "pullout" resistance. Applied after painting, the new nut-retaining SPEED GRIPS eliminate the possibility of weld flash damage and time-consuming retapping of stripped or paint-clogged threads.

Counterpart of the new Tinnerman nut-retainer is a fastener which retains a rigidly fixed bolt. It operates on the same basic principle as the nut-retainer, and the bolt itself can serve as the drifting device. Simply tipped into a mounting hole from the front side, the new bolt-retainer locks itself firmly in place as it is drifted into perpendicular position.

Both of the new Tinnerman SPEED GRIP fasteners are available for a wide range of screw and nut sizes and panel thicknesses and are expected to find virtually thousands of assembly applications.

Dominion Fasteners Limited, Hamilton, Ontario, Canada.

### Fast, Accurate Balancing Of Rotating Parts

#### *Item 1747*

A new type of sensitive and highly accurate equipment, for balancing rotating components quickly and easily, is described in an illustrated leaflet published by Dawe Instruments Ltd.

The equipment — Type 1253 — indicates the amount and location of unbalance, and also the points where material should be added or removed to correct the fault. It provides production testing of workpieces from 1 ounce to 4 lbs. in weight, measuring from 1½ inches to 7 inches in diameter. Other models for handling larger, heavier, or specially shaped workpieces, are also available.

Detailed information is available by writing to Dawe Instruments Ltd., Canadian Division, 1654 Bank Street, Ottawa 1, Ont.

### Magnetostriction Filters

#### *Item 1748*

The Electronic Development Department of the Missile Systems Division of Raytheon Manufacturing Company is actively engaged in the production of magnetostriction filters and audio spectrum analyzers which utilize these filters. These filters are now being produced in a variety of frequencies and bandwidths for use on spectrum analyzers, as narrow band circuit filters, as the frequency-determining element for oscillators, and for use as comb-filter arrays in classified equipment.

Magnetostriction filters and filter arrays are readily adaptable to either transistor or vacuum tube circuits. They can be used in telemeter systems, coding and decoding devices, and other systems where single or multiple narrowband filter channels are required. In combination with a single vacuum tube or transistor, they provide a very stable oscillator circuit.

Up to now, the majority of the filters have been produced for use in Raytheon's spectrum analyzers, but much wider use is visualized. These analyzers combine excellent resolution with an analysis speed far higher than that afforded by conventional techniques. The spectrum to be analyzed is applied simultaneously to many magnetostriction filters which cross over in frequency at approximately the three db points and which cover the desired frequency spectrum. The energy at the output of each filter is sampled in sequence by a high-speed capacitance commutator. Out-of-phase vector summation of the scanned filter outputs results in maximum frequency resolution and noise cancellation.

The use of multiple filters in Raytheon's Rayspan Spectrum Analyzer allows it to instantly and simultaneously identify a large variety of spectral characteristics such as pitch, tone, resonance, intensity, and range for both steady-state and transient signals, thus opening up a wide field of use in military and industrial applications.

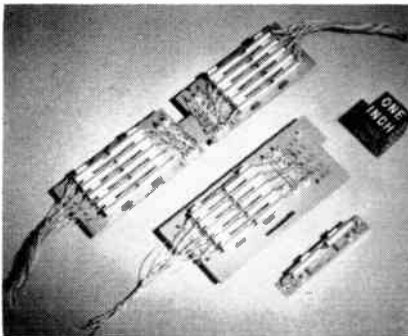

The magnetostriction filters themselves are being investigated for use in radar and communication systems, their small size, light weight, relative insensitivity to shock and vibration, low power requirement, and impedance characteristics matching those of transistors making them ideally suited for a variety of systems applications.

Application inquiries are invited. Address: Raytheon Manufacturing Company, Missile Systems Division, Electronic Development Dept., Bedford, Mass., U.S.A.

### Capacitance Bridge

#### *Item 1749*

Commercial and military specifications for capacitors of 1000 micro-microfarads and less call for measurement of capacitance and dissipation factor at a frequency of one megacycle. The Type 716-CS1 General Radio, Capacitance Bridge has been designed specifically for these measurements, and is now offered in a complete assembly, Type 1610-AK, including generator and detector.

Although calibrated for a frequency of one megacycle, the bridge can be used at any frequency between 0.1 and 5 megacycles. Accessories are also available which enhance the usefulness and convenience of the assembly for specific measurements. For the measurement of small capacitors with parallel side-by-side leads, the Type 1691-A Test Fixture is recommended. For measurements of dielectric constant and dissipation factor on specimens of dielectric materials, the Type 1690-A Dielectric Sample Holder should be used.

The Type 716-CS1 Capacitance Bridge is distributed in Canada by Canadian Marconi Company, 6035 Cote de Liesse Road, Montreal 9, P.Q.

### AC-DC Converter For E-I Digital Voltmeters

#### *Item 1750*

This newest AC-DC converter module converts average AC signals to DC with an 0.1 per cent accuracy. When combined with the new E-I Universal Power Module and DC Switch Module input data is automatically digitized. Measurements are presented on 1" high edge-lighted numerals contained in the face panel of the switch module.



Like other instruments in the new E-I line of modular digital test equipment, the new AC-DC converter module is fully transistorized. This transistorized approach provides an unusually reliable and rugged instrument. Low heat dissipation virtually eliminates temperature problems.

Ranging of the unit is automatic from 30 to 10,000 cycles, yet contact closures are available for programmed ranging without additional modules. The dynamic range has been increased from 0.1 mv. to 1,000 volts. The excellent stability and accuracy is due to a hi-gain feed back amplifier. Other advantages include conversion linearity of more than 0.05 per cent, almost no temperature effects, an accuracy independent of transistor characteristics, no drift due to an AC coupled input, no radio noise or line transients to disturb other equipment and no modifications for machine readout or system integration.

Complete specifications are given below: Accuracy: 0.1 per cent of reading or 2 mv.

Frequency Response: 30-10,000 cycles.

Range: .0001-999.9 volts.

Zin: 1 volt scale, 1 meg. 20 mmf. Other scales, 10 megs. 20 mmf.

Ranging: Automatic contacts available for programmed ranging.

Automatic overload indication over 1,000 volts.

Average Read-Out Time: 3 seconds.

Front Panel: On-Off Switch, fuse.

Size: 3½" x 19" x 12".

Information on the new E-I modular digital instruments is available from the Canadian Sales Representative — Electro-mechanical Products, Markham Road, Agincourt, Ontario.

(Turn to page 54)

# News Report

*A monthly roundup of news and personnel changes in the Canadian electronics industry*

## I. J. Kaar Addresses Radio Fall Meeting — Tells Of West Coast Development

As guest speaker at the Radio Fall Meeting annual banquet, Ira J. Kaar of Hoffman Electronics Corporation described to more than 200 assembled delegates the phenomenal growth of the electronics industry on the United States west coast.

In tracing the development of the electronics industry on the Pacific coast, Mr. Kaar said that the beginning of California and the West as a factor in electronics was really the result of two forces; one, a rather belated realization on the part of military people during the war that there existed a much needed pool of high caliber scientists and engineers on the Coast who would not leave and that, invasion area or no, they had better be used and, secondly, an abiding determination of a few businessmen that the West must make its proper contribution to the war effort. It could be recalled, Mr. Kaar said, that nationally, in the early days of the war, materials and components were the bottlenecks — much more so, even, than facilities for end product manufacture. So, to spur the development and manufacture of components, the first military equipment contract placed in California required that 90 per cent of the value of the end product be produced or procured in the West. It was done, and before the war ended, billings of the electronics industry had grown to 400 millions annually from a modest 25 millions at the outset.

Concurrent with this growth was the increasing recognition on the part of the military that engineering and scientific work placed in the colleges and industrial firms of the West got done, on time and well. It was this recognition which eventually led to the establishment of several military laboratories and testing facilities in the West — such places as San Diego, Inyokern, Point Magu, Pasadena and Fort Huachuca.

In 1940 the RETMA handbook listed a national total of 104 member firms, of which, in the five western states of Arizona, California, New Mexico, Oregon and Washington, only one was listed. The 1957 handbook records 349 firms, of which 49 are located in those same states. But membership in the RETMA, now the EIA, is not the full story. Actually there are today 485 electronics firms in the Los Angeles area alone.



● Pictured above are the head table speakers at the Radio Fall Meeting Annual Banquet held in the King Edward Hotel on November 12. Top left, D. G. Fink; top center, I. J. Kaar, guest speaker; top right, R. A. Hackbusch. Bottom left, W. H. Jeffrey, President of the Radio-Electronics-Television Manufacturers Association of Canada; bottom center, Judge John W. V. Allen, General Counsel; bottom right, James D. Secrest, Executive Vice-President of Electronic Industries Association.

## Toronto Hi-Fi Show Acclaimed Huge Success By Industry

The 1957 Toronto High Fidelity Exposition, the first industry-sponsored Hi-Fi Show of the Dominion High Fidelity Association, which was held in the Park Plaza Hotel, Toronto, from October 30 to November 2, inclusive, was acclaimed a huge success by exhibitors, and association and show officials. With a paid attendance of 7,814 adult persons, which was augmented by over 1,000 dealers, exhibitor personnel and industry "top brass", to whom were extended courtesy guest badges, it is claimed to be the largest attended high fidelity show ever staged in Canada.

Interest in the exhibits on the part of the public was extremely high and reports have reached Show Manager John Rochford of good dealer business being transacted and a lively interest on the part of visitors who contacted exhibitors after the show to inquire where they could make purchases.

Opened by Dr. Leslie Bell, well known Canadian choral director, who was assisted by Miss Toronto 1957, the exposition was designed to promote public interest in high fidelity reproduction of music in the home and to demonstrate and explain high fidelity developments and equipment.

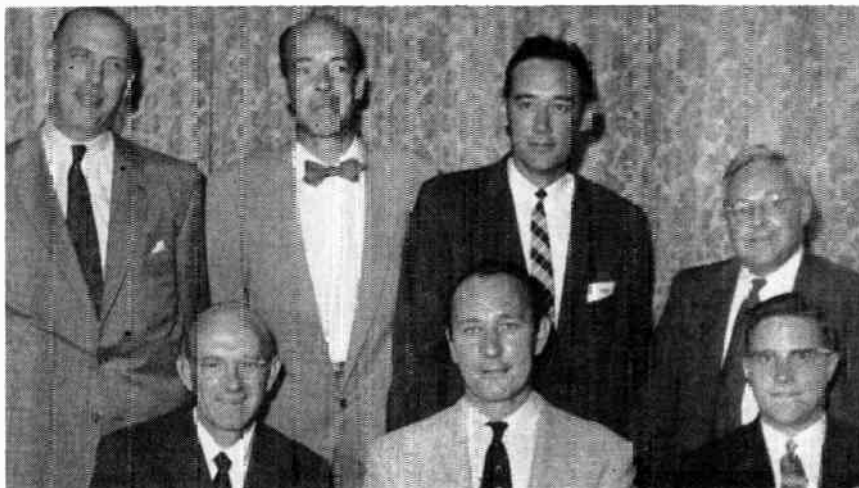

● Members of the Toronto Hi-Fi Show Committee pictured above are: back row, left to right, H. Roy Gray, H. B. Knap, K. G. Summerville, John Rochford; front row, left to right, John R. Tilton, R. C. Kahnert and Dave Simmonds.

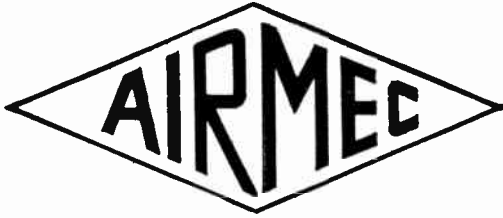

# INDUSTRIAL ELECTRONIC EQUIPMENT

## Electronic Batch Counter

for

### COUNTING — PACKING — MEASURING

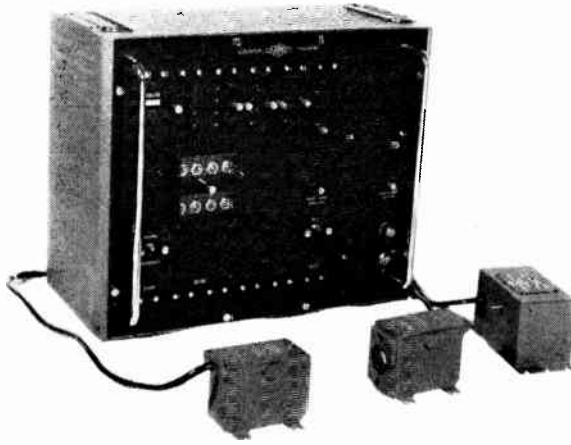

Dimensions: 19" x 15.5" x 10" Weight: 50 lbs.

- Counts at any speed up to 1000/s.
- Counts batches in single units, multiples of 10, 100, dozens, gross, 16's, 256's. Pre-selection by toggle switches on panel.
- Remote control of feeding hoppers and conveyor belts and channels.
- Automatic, manual and external resetting in .02 seconds.
- Maximum batching rate: 5 batches/s.

## TIME INTERVAL METER

- Measures time intervals from 10 ms. to 60 s.
- Seven interval ranges.
- Direct indication by meter.
- Works also with photo-cell equipment when electrical contacts not available.
- Ten different measurements.



Dimensions: 13" x 9½" x 7½" Weight: 15½ lbs.

*Full information on these and other Airmec products, such as Time and Frequency Meters, Frequency Standards, Oscillators, Signal Generators are yours on request to:*



## RADIO COMMUNICATIONS

475 METROPOLITAN BLVD.

For further data on advertised products use page 65.

# ELECTRONIC INSTRUMENTS by

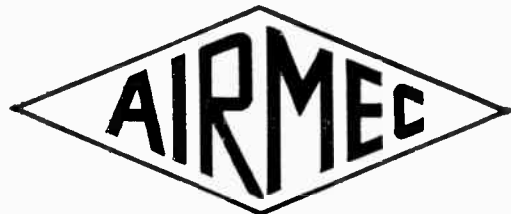

## TRANSISTOR TESTER

- For P-N-P junction & point type transistors.
- Static tests to 40 mA and max. collector voltage of 80V.
- Direct measurement of small signal parameters by bridge method at 420 c/s.
- Built-in bridge oscillator and detector.
- Facilities for connection of external test apparatus.

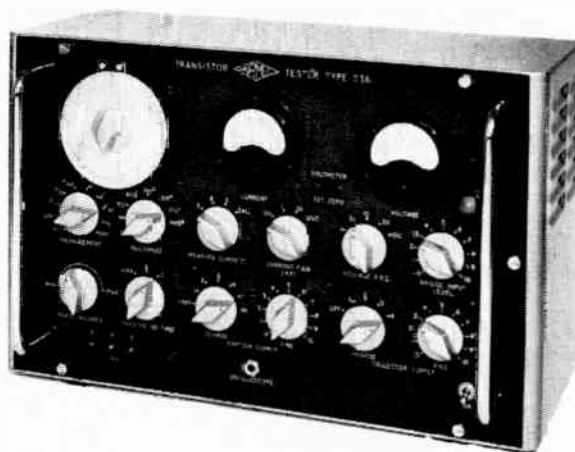

Dimensions: 19" x 12" x 10" Weight: 45 lbs.

## 20 kV IONISATION TESTER

for

## NON-DESTRUCTIVE TESTING

- Two separate units connected by 36 ft. cable (E.H.T. unit: Control unit).
- Audible, visible and external indication.
- Suitable for 19" rack mounting.
- Extremely useful for
  - Grading Components
  - Checking dampness in armatures and windings
  - Determination of component operating voltages
  - Testing cables, etc.
- 5 kV tester also available.

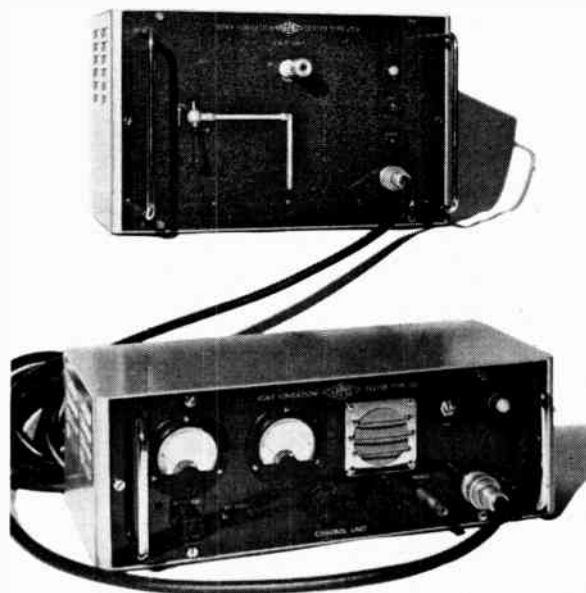

*Send for your copy of catalog with complete descriptions of these and other Airmec electronic products such as Tachometers, Photocell controls, Temperature and Level Controlling Equipment, Radio and TV servicing equipment.*

## EQUIPMENT & ENGINEERING Ltd.

LACHINE, MONTREAL 32



## Hammond Manufacturing Company Moves To New Factory

Hammond Manufacturing Company Ltd., transformer specialists, have recently completed the move to their new factory building located on a 12 acre site off Highways No. 6 and No. 7 Bypass, in the heart of Guelph's new industrial basin.

Increasing need for additional space has been met by the 90,000 square feet provided in this new one-storey, sprinklered, brick and steel factory with curtain wall construction.

Laboratory research and testing facilities have been greatly expanded in the new factory and increased emphasis may now be placed on research enterprises devoted to all types of transformers.

The Hammond metal equipment department has been expanded, with the latest types of processing, finishing and painting equipment installed.

The new factory will permit a broader manufacturing scope, and additional lines and larger production runs may be undertaken. For a number of years Hammond has operated from two factory buildings in Guelph.

L. M. Hammond, president and general manager of the company, in making this announcement has also stated that consolidation with improved space and facilities reflect the company's desire to provide the highest standards in service and deliveries for all customers.



● Architect's sketch of the new Hammond factory which will provide 90,000 sq. feet of additional manufacturing space.

## Hughey & Phillips Appoints Canadian Rep

John Ganzenhuber, president of Hughey & Phillips, Burbank, (Calif.) manufacturer of tower lighting equipment, recently announced the appointment of Donald F. Beechey, 290 Lawrence Avenue West, Toronto 12, Ontario, as sales representative for Eastern Canada.

## Manual To Dial Changeover Takes Two Minutes

A new dial exchange was put into operation during October in the city of North Bay, Ontario, with practically no interruption in telephone service. Early Sunday morning was selected as the appropriate time for the changeover.

The actual changeover was made according to a carefully co-ordinated program, requiring split-second timing, to ensure that the period of "silent" telephones was kept to a minimum.

Although the manual exchange has closed down, 85 operators are needed to provide long distance and information service and to render assistance to persons unaccustomed to using the dial system.

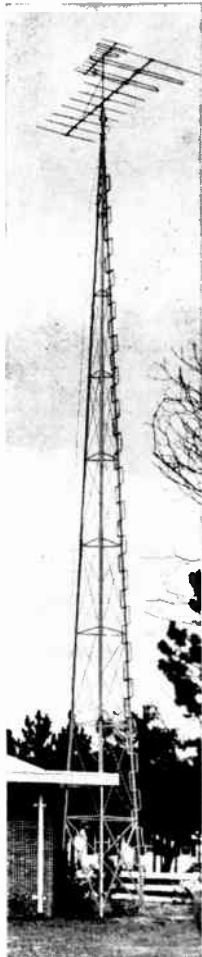

# ANTENNA TOWERS

for TV — AMATEURS  
— COMMUNICATIONS

Check these features — they're found in all Aermator Steel Antenna Towers.

**SELF-SUPPORTING** — no cumbersome guy wires needed.

**HEAVILY GALVANIZED AFTER FABRICATION** — completely protected against rust.

**EASILY ASSEMBLED**

**STRONG** — towers safely sustain loads of 1500 lbs. — safe in winds to 85 MPH.

← **TYPE MI-98**

For TV Antenna up to 6 square feet of projected area. Heights to 100'.

**TYPE MP-5** →

For Amateur Beams up to 20 square feet of projected area. Heights to 97'3".

**TYPE MP-9 (Not illustrated)**  
Meets "RETMA" Standard TR-116 Specifications. Heights to 123'5".

**TYPE MP-15 (Not illustrated)**  
In heights up to 149' for heavy duty radio and TV applications.

**TYPE MP-29 (Not illustrated)**  
In heights of 40 - 80 and 100' for heavy duty Microwave Antenna applications.

Write today for complete information on Aermator Steel Antenna Towers and an Aermator Franchise in your territory.

**AVIATION ELECTRIC LIMITED**

200 Laurentien Blvd., Montreal  
Halifax • Toronto • Calgary • Vancouver

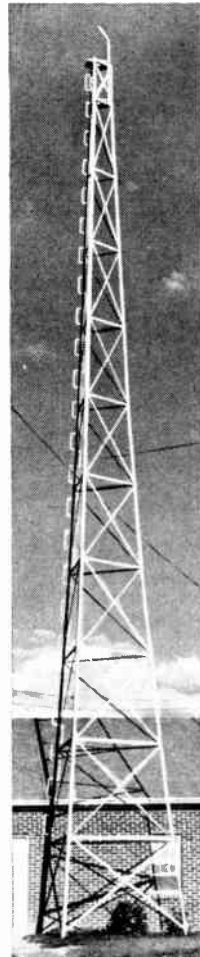

## NEW! OBSTRUCTION LIGHTS

HIGH QUALITY — LIGHT WEIGHT  
SIMPLE — POSITIVE LATCH  
FOR EASIER MAINTENANCE

In accordance with CAA Spec. L-810  
by HUGHEY & PHILLIPS, INC.  
— your most dependable source of  
Obstruction Lighting Equipment  
— the widest selection of Control and  
Alarm Apparatus in the Industry.



**MODEL OB21** is of the SIDE ENTRANCE conduit fitting type in order to facilitate installation on horizontal conduit runs. Available in 3/4" or 1" conduit tap



**MODEL OB20** is of the BOTTOM ENTRANCE conduit fitting type to facilitate installation on vertical conduit stubs. Available in 3/4" or 1" conduit tap



**MODEL OB22 DOUBLE LIGHT** is available with or without CABLE SUPPORT — also available with TRANSFER RELAY. 1" conduit tap

## HUGHEY & PHILLIPS, INC.

3200 NORTH SAN FERNANDO BLVD.  
BURBANK, CALIF.

Manufacturers of  
300' MM Beacons, Obstruction Lights,  
Photo-Electric Controls, Beacon  
Flashers, Special Junction Boxes,  
Microwave Tower Light Control &  
Alarm Systems, Remote Lamp Failure  
Indicator Systems, and Complete  
Kits for: Tower Lighting, Sleet  
Melter Power & Control.

In Canada:

**BEECHEY ENTERPRISES**  
TORONTO 12, ONTARIO

For further data on advertised products use page 65.



## New Products

### Helipot Division Opens \$3 Million Plant

Helipot Division of Beckman Instruments, Inc., recently dedicated its new \$3,000,000 facility in Newport Beach, Calif.

In construction for more than a year, the 156,000-square-foot ultra-modern building overlooking Balboa-Newport Bay houses manufacturing and administrative functions for the production of Beckman Helipot's principal product, the helical potentiometer, which has wide application in electronic instrumentation, supersonic aircraft, radar and guided missiles.

Beckman Helipot also maintains plants at Mountainside, N.J., and Toronto, Canada.

### American Geloso Electronics Represented In Canada

American Geloso Electronics, Inc. of New York City, the North American sales division of Societa per Azioni Geloso, Milan, Italy, has announced the appointment of sales representatives to handle the Geloso Hi-Tone miniature tape recorder.

The Ron Merritt Company of 120 West Thomas, Seattle, Washington, will cover the Pacific Northwest and Western Canada.

### APPOINTMENT



G/C. C. H. COTTON

● F. Bandi, president, Aviation Electric Limited, has announced the appointment of Group Captain C. H. Cotton as special assistant to the president. G/C Cotton recently retired from the R.C.A.F. where he held the position of acting chief of Aeronautical Engineering. In his new position he is located in Ottawa and his primary duty is to serve as a liaison between Aviation Electric Limited and customers located in that area.

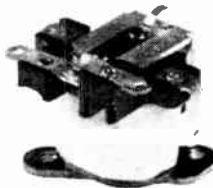

This relay may look like just another Sigma 11F, but this is not the case. It's the new 11F with AC adjustment. As such, it is the only AC relay available in the low price field that can boast such small size and all-around satisfactory performance within its ratings. This is why it sits so smugly at the top of the page, without even a headline.

It should be pointed out here and now that this relay is strictly an on-off deal... if you're looking for something fancier, Sigma probably has it (at a higher price). But, where you don't need the frills—in such items as water heater controls, tape recorders, and small battery-powered

emergency lights used in restaurants, gambling casinos and federal penitentiaries—the 11F-ACS has no peer.

For the less technical-minded (who can't figure out the specs from the comprehensive application data above), the AC 11's have an operating level of 0.3 volt-ampere and will switch one ampere resistive loads at 28 VDC or 120 VAC. They are suitable for applications requiring UL Approval. Size, 1<sup>3/32</sup>" square x 1" high, max. Price ranges from about \$2.00 to \$3.00 list in sample quantities (which are available), to about half that in quantities the designers dream about.



Packaging of the Series 11F relays is also an exclusive in the relay field. The relays fit snugly into specially designed molded foam layers which hold 25 or 50 relays apiece and stack neatly (i.e. the bottom of the top layer is the top of the bottom), eliminating the need for individual wrappers, fillers, boxes, bags, etc., and which might simplify inspection and assembly handling. The executives illustrated are really contemplating possible end-uses for these white foam layers. Suggestions so far include: raw material for making Christmas decorations, lawn ornaments, backyard toboggan runs, and a replacement for marshmallow fluff in peanut butter sandwiches. Any other constructive suggestions will be welcomed.

Inquiries about the 11F AC relay are also invited.

# SIGMA

SIGMA INSTRUMENTS, INC., 85 Pearl Street, South Braintree 85, Mass.

Canadian Representatives:

SAMUEL C. HOOKER (CAN.) LTD., Montreal and Toronto; ARJA, Vancouver, B.C.

**EXECUTIVE CHANGES AT CANADIAN MARCONI**



L. N. DALEY



A. G. McCAUGHEY



W. V. GEORGE



F. T. WINTER



W. H. HOPKINS

• S. M. Finlayson, president, recently announced the following appointments at Canadian Marconi Company: Wm. H. Hopkins, assistant general manager and secretary; A. G. McCaughey, comptroller and treasurer; W. Victor George, assistant to the president; L. M. Daley, manager, broadcast and television receiver division. Simultaneously, C. P. McNamara, manager of the commercial products division, announced the appointment of F. T. Winter as assistant manager of that division.

**Radionics Limited Appointed Exclusive Canadian Rep**

Radionics Limited of 8230 Mayrand St., Montreal 9, Que. has recently been appointed as exclusive Canadian representative for Fenske, Fedrick and Miller Inc. of 12820 Panama St., Los Angeles, California.

The major product manufactured by this company is revolutionary, multichannel two and three dimensional plotting equipment. In addition they manufacture automatic electronic test equipment for radio control systems, a unique frequency calibrator for speeding and simplifying the problem of calibration of oscillators and discriminators in FM/FM telemetering systems as well as differential frequency meter for comparing two signals, indicating not only their frequencies but also the magnitude and sign of their frequency difference.

**Microwave System Links Quebec Province Cities**

New microwave across the St. Lawrence River in 98 mile, 4-hop system, linking Quebec City and Montreal with Jonquiere, was placed in operation for Canadian National Telegraph by the Philco Company of Canada — without field tests or equipment alignment. The system was switched on prematurely at the CBC's request to relay the world series baseball games to CKRS-TV, Jonquiere.

for an entirely new range of time delays

**delay intervals:**  
1/10 to 5 seconds

**recovery rate:**  
extremely rapid



**G-V HOT WIRE TIME DELAY RELAYS**

Series H

specify sturdy, thoroughly field-tested

**G-V HOT WIRE TIME DELAY RELAYS**

Over two years of successful field service in electronic, aeronautical and industrial equipment prove these new G-V relays to be dependable, efficient and accurate.

- Adjustable Delay even though hermetically sealed
- DC or AC of any frequency for energization
- Small and Light, 3/4" diameter, 2 3/8" length. Weight: 1 oz.
- Wide Ambient Range compensating from -70°C to 100°C or higher
- Continuous Energization without damage
- Available in 7-pin Plug-in and Flanged designs

**G-V** Write for Pub. No. 35 — engineering data and drawings  
**G-V CONTROLS INC.**

54 HOLLYWOOD PLAZA, EAST ORANGE, NEW JERSEY  
Represented in Canada by:  
LEONARD ELECTRIC, LTD., 346 Bering Ave., Toronto 18

**MJS Test Equipment**

"You can't get more for less, NOR AS MUCH for so little"



**BJ-1**—Checks all kinds of condensers for capacity, leakage, opens, shorts or intermittent conditions. Direct reading .00001 to 1000 MFD. Resistance from 100 ohms to 5 megohms. \$34.95

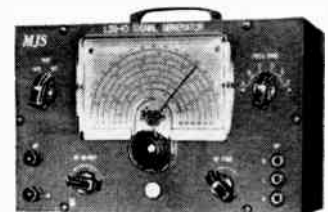

**LSG-10** — Compact, handy, high quality RF signal generator suitable for service technicians, amateurs, instructors and etc. Frequency up to 130 MC. fundamental. 260 MC harmonic; AF output 2-3 volts at 400 cycles; RF output over 100,000 microvolts. \$39.95



**PD-3** — Compact 2000 ohms volt pocket multi-tester. Measures AC and DC to 1200 Volts. DC current, resistance, capacity and inductance. \$13.95



**MT-6D** — Versatile compact 20,000 ohms/volt millimeter. Measures AC volts to 1200. DC volts to 6000. Current; resistance; capacity and inductance. Proven dependability. \$24.95

Distributed and serviced by

**STARK ELECTRONIC SALES CO.**  
A J A X O N T A R I O  
SOLD THROUGH LEADING CANADIAN JOBBERS 5574

## News Report

### Ivor H. Nixon Forms Manufacturers' Agency

Ivor H. Nixon has recently announced the formation of Tele-Radio Systems, a manufacturers' agency offering specialized electronic representation on behalf of U.S. and overseas principals.

The new organization, operating temporarily at 44 Robin Hood Road, Toronto 18, will provide liaison between Canadian users and manufacturers in other countries who have specialized products requiring competent technical representation as well as a thorough knowledge of the Canadian market.

In this connection Tele-Radio Systems has been appointed exclusive Canadian representative for the Trepac Corporation of America, Englewood, N.J., designers and manufacturers of the Trepac — a static replacement (using semi-conductor devices) for the polar relay commonly used in teletypewriters.

Mr. Nixon recently resigned from Pye Canada Limited which he joined in 1950. Since 1953 he had been a director and sales manager in charge of technical sales of a wide variety of radio and telephone communications equipment for both commercial and government use. Previously he had been associated with two other electronic manufacturers, and during the war had extensive radar experience.

### D.O.T. Officials Attend Overseas ICAO Conference

Three Department of Transport officials are attending an International Civil Aviation Organization (ICAO) meeting at Copenhagen, Denmark, to discuss the installation of a new communication technique over the Atlantic — "Very High Frequency Forward Scatter Radio", it was announced recently. The new system has been designed to provide fast and reliable air traffic control and airline communications throughout the North Atlantic network.

The three departmental officials are: O. L. Britney, engineer in charge of planning and co-ordinating; B. J. McIntyre and J. W. Waller, radio engineers. The conference consists of the technical co-ordination group of ICAO who will consider the technical and financial aspects of the new network installations.

The new communications system is planned to consist of three "forward scatter" radio stations and possibly the use of a proposed Scotland-Iceland cable which would provide a direct voice and four teletype communication channels between Europe and North America. The forward scatter stations would be built near Narssaq

in Greenland, Gander in Canada and Reykjavik in Iceland and with the cable, should provide a reliable communications network over long stretches of water similar to landline services.

### Toronto Sales Office For Todd Co. Of Canada

Opening of a new Toronto sales office of the Todd Company of Canada, Ltd., has been announced by Jack M. Young, manager.

The new office is located at 65 Front Street, East.

The new facilities, including 2,200 square feet of space, will house sales, service and office personnel.

The firm, a subsidiary of the Burroughs Corp., distributes cheques, cheque-writing and signing machines, and business systems for banks and commercial firms.

### San Fernando Electric Appoints Canadian Rep

E. S. Gould Sales Company of Montreal has recently been appointed Canadian sales representative for Quebec and Ottawa by the San Fernando Electric Manufacturing Co. of San Fernando, California.

The company manufactures West-Cap capacitors and filters and general scientific potentiometers.

(Turn to page 52)



Subminiature relay IR 207

### From subminiature relays to multi-line switches:

80 years of service to the communications and electronics industry have given the LM Ericsson Group of Companies unrivalled skill in the design and manufacture of relays and automation components.

You are cordially invited to let this skill and experience work for you.

#### Some of the fields in which Ericsson and North relays and switches are now serving:

- Airborne Navigational Aids
- Computing Machines
- Automatic Weighing
- Airline reservations network ("Reservisor")
- Missile Firing Platforms
- Industrial Controls
- Hydro Power Supervisory Controls

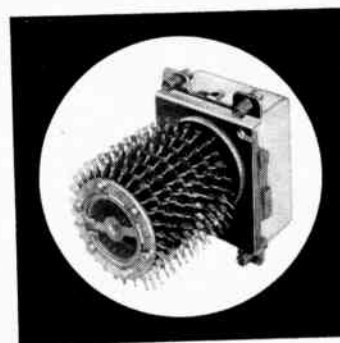

High precision rotary switch RVF

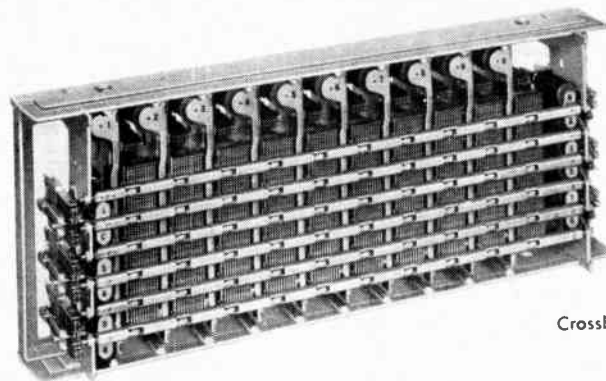

Crossbar switch

Distributors  
in Canada for  
**NORTH ELECTRIC COMPANY**  
Galion, Ohio.

# ERICSSON

TELEPHONE SALES  
OF CANADA LIMITED

130 Bates Road, Montreal, P.Q. Telephone REgent 1-6428.

## News Report

### Toronto Section, IRE Schedule Of Meetings

Subjects and speakers for the winter and spring meetings of the Toronto Section of The Institute of Radio Engineers are as follows:

#### Monday, December 2nd, 1957

Metropolitan Toronto's New Police Despatch And Communication Control System

Inspector G. H. Long  
Communication Department

#### Monday, January 13th, 1958

Industrial Television Applications  
Mr. R. P. De Karwin  
Canadian General Electric Co. Ltd.

#### Thursday, February 13th, 1958

Students' Night

Joint Meeting With A.I.E.E.

Three Papers by Senior University Students, in competition for cash prizes.

#### Monday, March 3rd, 1958

Recent Developments In Video Tape Recording Equipment

Mr. J. E. Detoler

Canadian Division, Ampex Corp.

#### Monday, March 31st, 1958

High Speed Digital Computers And Their Application In Industry  
Speaker to be announced on meeting card

Remington-Rand Ltd.

#### Saturday, April 12th, 1958

Ladies' Night

Dining — Dancing — Entertainment  
And Prizes

#### Monday, April 21st, 1958

Annual Meeting

Panel discussion on the "Grading and Registration" of qualified technicians by The Association of Professional Engineers.

Panel to be announced on meeting card.

Meeting will be open for a question and answer period from the floor.

IRE members of all grades and their friends are cordially invited to attend the informal dinners usually held at 6:00 p.m. sharp on the day of the meeting. Reservations must be made by calling Mrs. P. Hatch at EM. 6-6531 before 12:00 noon on the Friday preceding the meeting. The place is announced on the meeting cards.

### J. P. Gordon Joins

#### Pye Canada Limited

W. Jones, managing director of Pye Canada Limited, has announced the appointment of J. P. Gordon as general sales manager of the company.

Mr. Gordon's experience covers a decade of successful sales background. He will be responsible for the company's national sales in communications, domestic, instrument and telephone divisions.

Mr. Gordon replaces Ivor H. Nixon formerly with the company.

### Wallace Barnes Co. Appoints Factory Manager

Don A. Jackson, a veteran of seventeen years with the company, has been promoted to factory manager of The Wallace Barnes Company Ltd., Hamilton, Ontario, the Canadian subsidiary of Associated Spring Corporation, according to an announcement by Robert M. Buchanan, general manager. He succeeds Douglas Park, who has been appointed purchasing agent of Associated Spring's B-G-R division in Plymouth, Mich.

Born in Hamilton in 1921, Mr. Jackson went to work for the spring-manufacturing company in 1940 immediately after graduating from Hamilton High School. A year later, he was transferred to the spring engineering department, and in 1944 was assigned to estimating and planning. He has been head of this department for the past four years.

### Daly-Arrow Appoints Rep

Daly-Arrow Limited, 140 Kendal Avenue, Toronto 4, announce the appointment of Mr. Wm. T. Barron, 939 Lakeshore Road, New Toronto, as their exclusive representative for the sale of electrolytic capacitors to the Electronic Industry.

Daly-Arrow manufactures a complete range of single and multi-section electrolytics in aluminum and cardboard containers for standard and printed circuit mountings.



## Bring your SMALL MOTOR problems to ALLIANCE

For small motors of all types . . . for skilled engineering advice and assistance . . . for special applications and variations . . . your best bet is Alliance Motors, Canada's foremost designer and manufacturer of small motors and Canadian engineering representatives of Howard Industries Inc., Motor Manufacturers of Racine, Wis. Just write or phone



**ALLIANCE MOTORS** • SCHELL AVE • TORONTO (10) ONT. RE 6124

## LEADERS IN QUALITY, AVAILABILITY

For a complete line of  
RECEIVING AND PICTURE TUBES

POWER AND TRANSMITTING TUBES

TRANSISTOR, DIODES AND RECTIFIERS



# Electronic TUBES

CANADIAN GENERAL ELECTRIC COMPANY LIMITED

For further data on advertised products use page 65.

## New Products

### Canadian Appointed To Important Post

Douglas M. Park has been appointed purchasing agent of Associated Spring Corporation's B-G-R division, Plymouth and Ann Arbor, Michigan, according to a recent announcement by Charles J. Stofko, general manager of the division.



D. M. PARK

Mr. Park was previously factory manager of The Wallace Barnes Company Ltd., of Hamilton, Ont., the Canadian subsidiary of Associated Spring Corporation. He joined the Hamilton firm as a salesman in 1929, after studying business at the University of Toronto, and was elected vice-president in charge of manufacturing in 1947.

### J. S. Parsons Appointed CDC Vice-President (Engineering)

J. S. Parsons has been appointed Vice-President (Engineering) of Computing Devices of Canada Limited, it was announced recently by C. F. Hembury, President of CDC.

Parsons joined CDC six years ago to set up a new Analog Systems Department, and shortly after became Technical Director and Chief Engineer. In 1953, he was elected a Director.



J. S. PARSONS

During this period the Ottawa electronics and instrumentation company has grown six-fold, to just under 600 employees, with continued strong emphasis on original research and development activities.

Under Parsons' direction, CDC's Instrumentation Department developed the well-known Position and Homing Indicator, the Mk 3 version of which is now in production.

Parsons is an Associate Fellow of the Canadian Aeronautical Institute, and a Member of the Institute of Aeronautical Sciences, the Institute of Navigation, and the Association of Professional Engineers of Ontario. He is the holder of several patents in the field of navigations instruments.

Watch For Our  
DIRECTORY ISSUE  
Published Next Month



● H. W. Cowan, left, General Manager, Daystrom Instruments Limited. Canadian representatives for the Heath Company of Benton Harbor, Michigan, is shown describing some of the wide range of Heathkits exhibited at the recent Heathkit exhibition held in Toronto. The interested onlooker is N. McHardy of Age Publications.



**CLM  
RECTIFIERS**  
nurse  
your  
batteries

You'll protect your investment in station-type batteries when you install CLM Electronic Regulated Selenium Rectifiers.

**CONSTANT OUTPUT VOLTAGE.** In a CLM rectifier the output voltage is kept constant from no load to full load which increases battery life.

**SELF-PROTECTING.** CLM rectifiers are self-protecting on overload as the voltage curve drops off rapidly after 115 percent load is reached. CLM electronic regulated rectifiers are convection cooled, noiseless and require a minimum of maintenance.

**FREE BULLETIN.** For your *free* copy of Bulletin SR-14 which describes in detail, the performance characteristics of CLM rectifiers for station-type batteries write: Jack West, Sales Manager, Rectronic Division, Canadian Line Materials Limited, Toronto 13, Canada.



**SELENIUM RECTIFIERS**

# Westinghouse 2-Way Radio

*puts scattered plant vehicles  
as close to you as this mike!*



WHEREVER they're working, you reach all your vehicle operators instantly. You co-ordinate action . . . deliver instructions without delay . . . keep your equipment on the job, carrying more payloads per day! Westinghouse Link 2-Way Radio eliminates all the costly factors that slow up materials handling—idle time, dead mileage, confusion and paperwork!

Obtain the facts! A Westinghouse communications specialist will show you actual case histories—he'll point out the cost savings of others. Let him analyze your operations and explain how a Westinghouse Link 2-Way Radio system can make similar savings for you.

Take advantage of this service. Just call your nearest Westinghouse office or write Electronics Division, Canadian Westinghouse Company Limited, Hamilton, Canada.

## WESTINGHOUSE ELECTRONICS

57C745

## New Products

### Pole Bearing Plate

Item 1751

The A. B. Chance Company of Canada Ltd. has announced its new Pole Bearing Plate.

Used in pairs, at the butt of a pole, Pole Bearing Plates are designed to prevent uplift forces from pulling a single pole out of the ground or upsetting the balance of poles on H-frame transmission lines. Weighing 18 pounds per unit, a pair of Pole Bearing Plates provides a collective 200 square inches of coneshaped bearing surface.

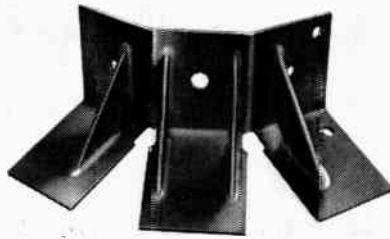

Made of one-quarter-inch mild steel, Chance Pole Bearing Plates are available in either an asphalt-paint or a hot-dip galvanized finish.

A. B. Chance Company of Canada Ltd., Toronto 13, Ontario.

### Harmonic Reference Oscillator

Item 1752

Developed by Manson Laboratories, Inc. and called the RD-110 Harmonic Reference Oscillator, a new instrument combines, in an exceptionally compact unit, an ultra-stable 1-megacycle crystal oscillator, a high-level harmonic pulse generator, a balanced mixer, and all necessary regulated DC power, to provide a frequency-source system unique for its completeness and small size. It not only meets the highest standard of accuracy for this type equipment, but as a result of the advanced engineering techniques that have been employed—particularly in connection with crystal stabilization and in the method of pulse generation—this precision is achieved at a substantially lower cost than has hitherto been possible.

The stability of the oscillator is better than 1 part in 10<sup>6</sup> per day. The circuit design is such that the output frequency is independent of all parameters except the crystal; the crystal itself is non-microphonic and temperature stabilized in a proportionally-controlled oven.

The output waveform may be taken as either sinusoidal (3 volts r.m.s. across 50 ohms) or pulse (40 volts peak across 250 ohms) the latter being exceptionally sharp, i.e., better than 20 milli-microseconds rise time, and maximally free from jitter. Usable harmonics extend to the kilomegacycle region without degradation to noise.

A very useful and unusual feature of the RD-110 is a circuit which allows adjusting the fundamental frequency  $\pm 25$  cycles, without loss of stability. This circuit employs an ultra-linear dial with a direct-reading frequency counter; settable accuracy is 0.01 c.p.s.

A balanced mixer, usable up to 1000 mc. for determining unknown external frequencies, is incorporated as an integral part of this instrument.

Exceptionally miniaturized in size, the RD-110 occupies only 5 $\frac{1}{4}$ " in height and 11 $\frac{3}{4}$ " in depth. Its 19"-panel front permits standard relay-rack mounting. Only 115-volt, 60-c.p.s. input power is required, as the necessary B+ and filament supplies are entirely self-contained.

Full details are available from Manson Laboratories, Inc., P.O. Box 594, 207 Greenwich Avenue, Stamford, Conn., U.S.A.

(Turn to page 57)

# FREED MAGNETIC AMPLIFIERS and SATURABLE TRANSFORMERS FOR IMMEDIATE DELIVERY

### FAST RESPONSE MAGNETIC AMPLIFIERS

2 $\sim$  response Phase reversible

Cat. No.	Supply Freq. C.P.S.	Power Out. Watts	Volt. Out. V. AC	AC or DC signal voltage req'd for full output.
MAF-1	60	13	110	1.0 —
MAF-6	400	5	57.5	1.2 0.4
	400	10	57.5	1.6 0.6
MAF-7	420	15	57.5	2.5 1.0

### SINGLE ENDED MAGNETIC AMPLIFIERS

Cat. No.	Supply Freq. C.P.S.	Power Out. Watts	Sig. req'd for full outp. MA-DC	Total res. contr. wdg. K !!	Load res. ohms
MAO-1	60	4.5	3.0	1.2	3800
MAO-2	60	20	1.8	1.3	700
MAO-4	60	400	9.0	10.0	25
MAO-5	60	575	6.0	10.0	25

### PUSH-PULL MAGNETIC AMPLIFIERS

Phase reversible

Cat. No.	Supply Freq. C.P.S.	Power Out. Watts	Volt. Out. V. AC	Sig. req'd for full outp. MA-DC	Total res. contr. wdg. K !!
MAP-1	60	5	115	1.2	1.2
MAP-2	60	15	115	1.6	2.4
MAP-3	60	50	115	2.0	0.5
MAP-3-A	60	50	115	7.0	2.9
MAP-4	60	175	115	8.0	6.0
MAP-7	400	15	115	0.6	2.8
MAP-8	400	50	110	1.75	0.6

### SATURABLE TRANSFORMERS

Phase reversible

Cat. No.	Supply Freq. in C.P.S.	Power Out. Watts	Volt. Out. V. AC	Sig. req'd for full outp. MA-DC	Total res. contr. wdg. K !!
MAS-1	60	15	115	6.0	27
MAS-2	400	6	115	4.0	10
MAS-5	400	2.7	26	4.0	3.2
MAS-6	400	30	115	4.0	8.0
MAS-7	400	40	115	5.5	8.0

All units designed for 115V-AC operation

Write for detailed listing, or special requirements, and copies of complete Transformer and Laboratory Test Instrument Catalogs.

## FREED TRANSFORMER CO., INC.

1716 Weirfield Street  
Brooklyn (Ridgewood) 27, New York

For further data on advertised products use page 65.

*it's as simple as ABC on ...*  
**The DAVID DOWLING**  
**Model 713 Bench ENGRAVING MACHINE**

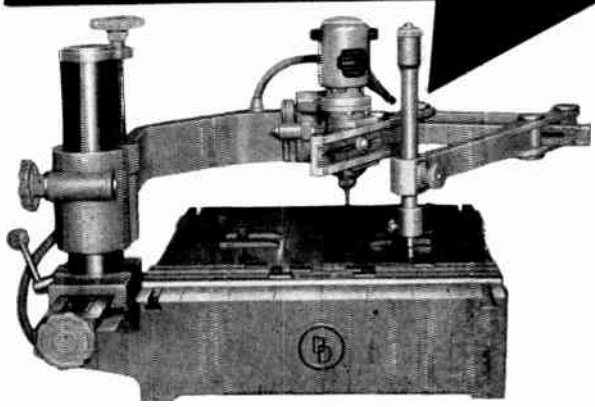

Gives reductions of from 1:2 to 1:8 as required. Exceptionally fast operation enabling engraving to be carried out nearly as fast as ordinary writing. Stepless spindle speeds from 6,000 to 12,000 r.p.m. cover all materials. Exceptionally sensitive pantograph, with all pivots mounted on ball journals, is balanced with adjustable tension, giving automatic withdrawal of cutter and tracer. Maximum area covered with 1:2 reduction, 15 in. by 10 in. or with 1:8 reduction, 15 in. by 4 in.

*Further details on request*

Sole Canadian Agents

**EMPIRE ENGINEERING CO.**

738 DUNDAS STREET EAST, TORONTO, ONTARIO • Empire 4-2928

**HAMMOND**  
 presents a new line of  
**CONSOLES • TURRETS • EQUIPMENT TABLES**

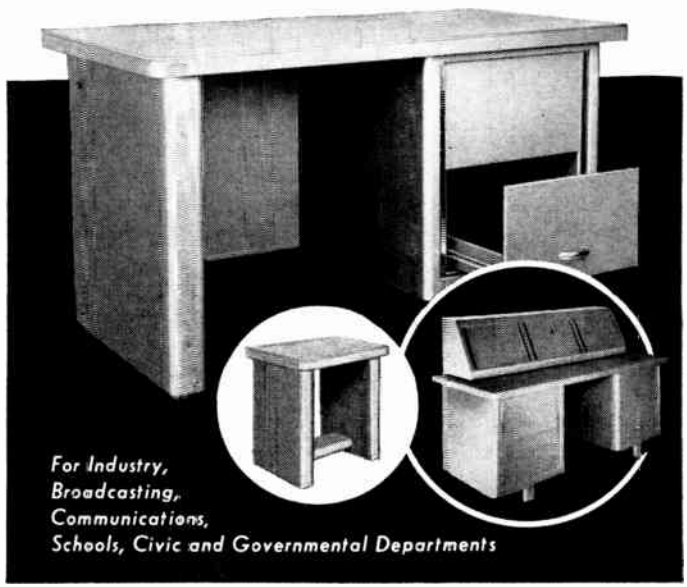

*For Industry,  
 Broadcasting,  
 Communications,  
 Schools, Civic and Governmental Departments*

**SINGLE, DOUBLE AND TRIPLE CONSOLES:** . . . of heavy gauge steel, beautifully finished in beige-brown or gray "Hammerlin". Tops are covered in colour keyed linoleum, and bright metal moulding conceals all mounting screws. Single and double models have one 10½" x 19" panel and a sliding drawer of the same size. Triple Consoles have three panels and one drawer. All models have 21" removable, rear panels.

**SINGLE, DOUBLE AND TRIPLE EQUIPMENT TABLES:** . . . produced in the same materials and finish as the console models. The three standard sizes are suitable for carrying a variety of equipment.

**TURRETS:** . . . in matching finish and materials, for mounting on Consoles or Equipment Tables. Front panels set at 30° angle with screws covered by bright metal strip. Single-piece, removable, locking rear panels, well louvered, are designed for maximum accessibility. Rear knockouts are provided in each unit.

*complete data bulletin 5060 sent on request*



**DESK TYPE CABINET RACK:**  
 In 9 standard sizes with panel space from 8¾" to 54¼".



**"HANDY" CASES**  
 Better accessibility to components than conventional boxes.



**UTILITY CASES:**  
 For portable equipment, and prototype development.

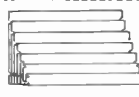

**CABINET AND RACK PANELS:**  
 Exclusive Hammond alloy works, punches, drills cleanly; also in steel.



**EQUIPMENT CABINETS:**  
 Give "original" equipment a professional look.



**STANDARD RELAY RACKS (floor type):**  
 Mounting alignment is retained under extreme equipment loads.

Hammond also specializes in "original" equipment built to your own design. For further information contact —  
**HAMMOND MANUFACTURING COMPANY LIMITED**  
 Guelph, Ontario, Canada

Since 1927 — Canada's Transformer Specialists

H/57/1

**new booklet** on new materials for design and maintenance

Send for your copy today

**POLYPENCO® Industrial Plastics**

... highest quality materials engineered in basic forms for modern industry:

- Polypenco Nylon • Polypenco Teflon • Nylaflow Pressure Tubing
- ... and other industrial plastics.

*Distributors and Sales Engineers:*

**Peckover's Limited:**  
 115 McCarmack St., Toronto  
 2052 St. Catherine St. W., Montreal

**C. M. Lavsted & Co. (Canada) Ltd.:**  
 Vancouver • Edmonton • Calgary

**POLYPENCO, INC.**

2150 Fairmont Ave., Reading, Pennsylvania, U.S.A.



# ADCOLA

REGD. TRADE MARK

MAKERS OF HIGH QUALITY SOLDERING INSTRUMENTS, HAND PYROMETERS, ETC.

Soldering Instruments Available With 1/8", 3/16" and 1/4" Tips

All Voltages Supplied

List No. 64  
3/8" Detach Bit



CSA Approved  
Canadian,  
British and  
Foreign Pats.,  
Reg. Designs,  
Etc.

Canadian Rep: L. J. LAMB  
Box 103  
Weston, Ont.

U.S. Agents: STRATFORD ELECTRONICS  
P.O. Box 1114, New York

## how large is small?

DAVEN'S NEW  
MINIATURE WIRE  
WOUND RESISTORS  
PROVIDE AS MUCH  
AS 400K  
RESISTANCE IN  
1/4" X 5/16" SPACE

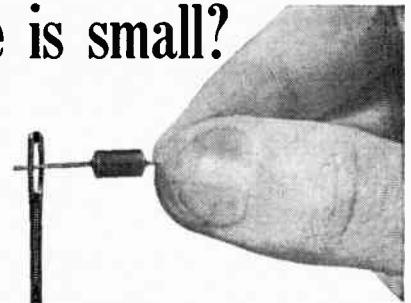

Types and Specifications

Type	Dia.	Length	Max. Ohms	Max. Watts
1274	3/16	3/8	100K	0.25
1273	1/4	5/16	400K	0.25
1283	1/4	5/16	400K	0.25
1284	1/4	27/64	.5 Meg.	0.25
1250	1/4	1/2	900K	0.33
1170A	7/16	1/2	1.2 Meg.	0.50
1170	1/2	1/2	1.8 Meg.	0.50



Write for our new resistor catalog.

THE **DAVEN** CO.  
Livingston, N.J.

Special temperature coefficients  
can be supplied on request.

IN CANADA:  
Adams Engineering Ltd.  
Montreal and Toronto



Now!  
**ARROW-HART**  
SWITCH  
CONTROLS

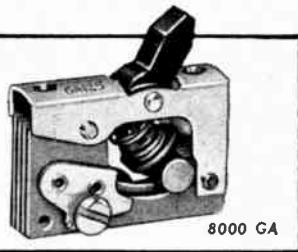

FOR ALL YOUR  
ELECTRICAL  
APPLIANCES

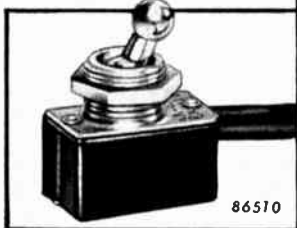

A complete range of one-hole mounting, quick make and break switches for vacuum sweepers, fans, power tools, etc., and radio and electronic equipment.

Send for your copy of the new illustrated Bulletin Z-2, today. Ask us for any additional advice and information you may need.

**ARROW-HART & HEGEMAN**  
(CANADA) LIMITED

Industry Street, Toronto 15, Ontario  
Telephone RO. 2-1101

Representatives:

Cochrane Stephenson (Western) Ltd., Winnipeg, Calgary,  
Edmonton, Vancouver; George C. Robinson, Saint John, N.B.



5703



Sir Isaac Newton  
1642-1727

*"When the time is short  
and the pressure's frightening,  
They serve my systems  
with the speed\* of lightning!"*



BECKMAN / BREADBOARD PARTS

*For the standard parts  
to breadboard your system,  
Send for catalog 115E,  
where we show 'em and list 'em.*

\*Within 3 days of order!

Beckman® / **Helipot** Corporation, Newport Beach, Calif.  
a division of Beckman Instruments, Inc.  
Canadian Factory: No. 3 Six Points Rd., Toronto 18, Ont.  
Sales Representative: R-O-R Associates, Ltd.  
1470 Don Mills Road, Don Mills, Ont.

1206



## New Products

### Tab Terminals

Item 1753

A new narrow tab terminal P.E.C. (Packaged Electronic Circuit) has been developed by Centralab, A Division of Globe-Union Inc., for use with printed or etched board circuitry. Originally designed for automatic insertion, it can also be manually inserted.

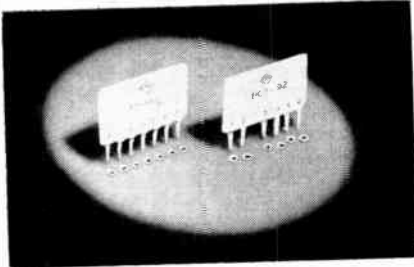

The new narrow tab terminals are designed for easy "plug-in" to .055 holes with perfect alignment of terminals on .172" centers, approved RETMA standard spacing. This new tab is now available on request on all of Centralab's basic plate sizes. For further information, write Centralab Canada Ltd., A Division of Globe-Union Inc., 804 Mt. Pleasant Road, Toronto 12, Ontario.

### The C-W-H Relay

Item 1754

A new product manufactured in Canada is the C-W-H Relay for Cascading Street Lights and the Control of Water Heaters.

Electrical specifications are as follows: (1) Relay is capable of withstanding high current inrush (characteristic of incandescent light load). (2) Normal current capacity 30 amperes (3,000 watts). (3) Load fuse — 30 amps. screw plug-mounted outside bottom of case. Easily inspected and removed. (4) Instrument type fuse-protected relay coil. (5) Multi-point lightning protection surge gap. (6) 4-double break 3/8" dia. pure fine silver contacts (double gap quenches any tendency to arc). (7) Contact springs carry no current. (8) 30" pigtail connections color coded and marked. (9) Relay may be supplied either normally open or closed.



The housing, which is spun aluminum, requires neither gasket nor snug fitting parts and may be removed while on pole by simply loosening two screws — a slight twist — and lift. This exposes for service the relay, contacts, coil and surge gap for easy inspection.

The mounting piece is first fastened to pole or arm and relay is slipped into taper slot.

For further particulars write the manufacturer, John Herring & Company Ltd., 3468 Dundas St. West, Toronto, Ontario. (Turn to page 58)

Even the specials  
are STANDARD!

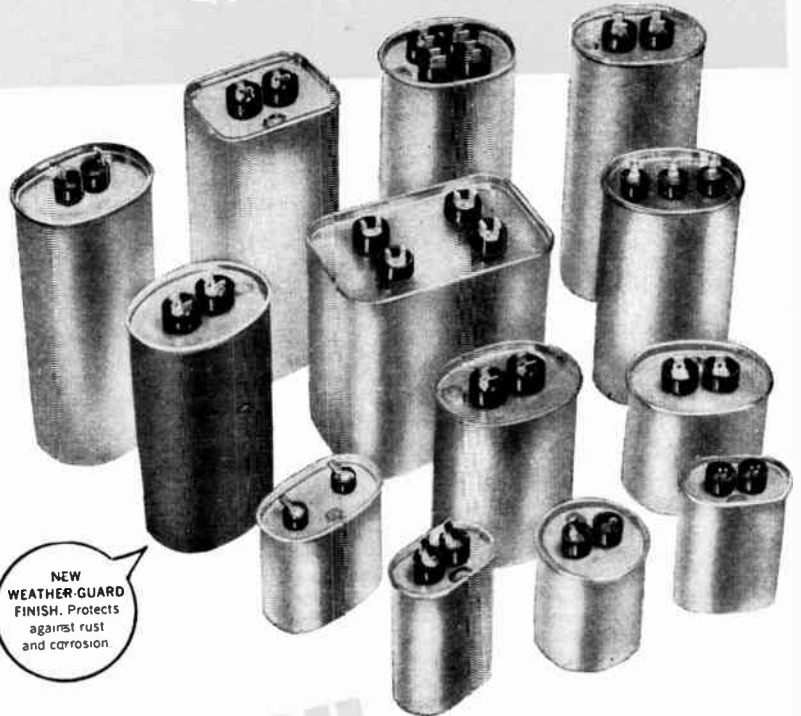

NEW WEATHER-GUARD FINISH. Protects against rust and corrosion.

AEROVOX

has the motor-run capacitor for your AC application!

No matter what the rating . . . no matter what the size . . . no matter what the power-factor requirements . . . you always get the right motor-run capacitor from Aerovox. The right capacitor is one designed specifically for your application for trouble free service without expensive field failures.

Aerovox offers a complete range of motor-run and motor-start capacitors in a broad selection of standard types. When your application requirements call for special designs Aerovox's design-engineering representatives have the training and experience to assist you in solving your special problems.

Years of pioneering experience in the air-conditioning, refrigeration and motor fields assure you of the right capacitor of the highest quality available when you need them. Call or write today for complete details on the full line of Aerovox AC capacitors.



Standardize with AEROVOX

**AEROVOX  
CANADA LIMITED**  
HAMILTON, CANADA

Manufacturers of fixed capacitors for all radio, TV, and electronic equipment.

Western Sales:  
Chas. L. Thompson Ltd., Vancouver, B.C.  
In U.S.A.:  
Aerovox Corporation, New Bedford, Mass.

5706

# CRYSTAL OVENS

## Canadian Engineered and Manufactured

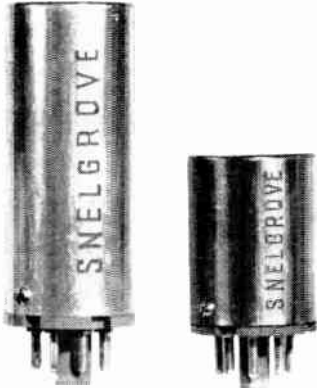

Extensive Research has been devoted to eliminating causes of failure. Following tests under severe field conditions, we now offer Crystal Ovens with exceptional reliability — all models one year warranty.

Operating voltages 6-12-24 accommodating one or two HC 6/u or HC-13/u Holder. Operating temperatures and tolerances to suit your most exacting requirements.

Insist on Crystals and Crystal Ovens by:

C. R. **SNELGROVE** CO. LIMITED

DON MILLS (TORONTO), ONT.

HI. 4-1107-8

Canada's Foremost Frequency Control Specialist — Licensed Under Bell System Patents

## DIESEL ENGINES FOR EVERY PURPOSE

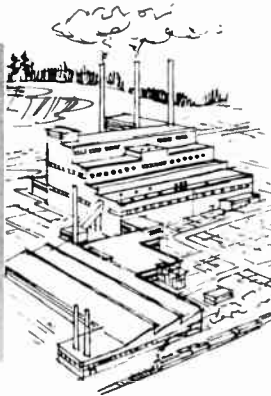
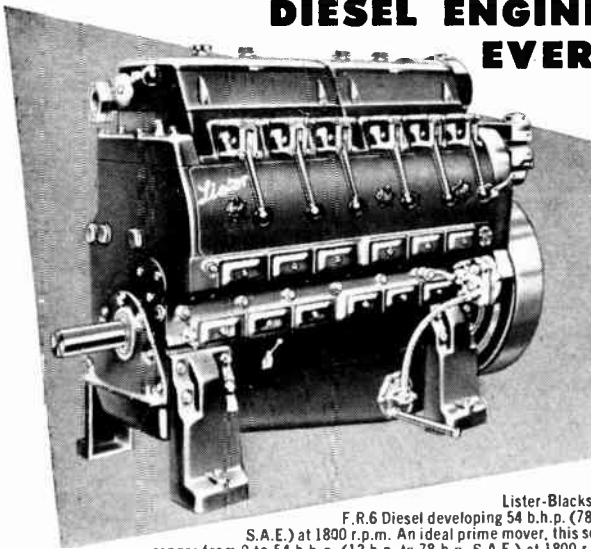

Lister-Blackstone  
F.R.6 Diesel developing 54 b.h.p. (78 h.p.  
S.A.E.) at 1800 r.p.m. An ideal prime mover, this series  
ranges from 9 to 54 b.h.p. (13 h.p. to 78 h.p. S.A.E.) at 1800 r.p.m.

Built in a tradition of reliability, Lister-Blackstone engines incorporate the very latest improvements in Diesel design. The full line includes engines from 3½ to 1300 h.p. and there are models for every purpose. Ease of maintenance and economical operation are assured when you specify Lister-Blackstone. Service and spare parts are available from coast to coast. Write for Bulletin F.R.1-6.

## CANADIAN LISTER-BLACKSTONE LIMITED

1921 EGLINTON AVE. E., TORONTO 13 • 3135 WEST BROADWAY, VANCOUVER  
25 ST. JAMES ST., VILLE ST. PIERRE, MONTREAL

Distributors: B.C. Equipment Co. Ltd., 551 Howe Street, Vancouver • Bruce Robinson Electric (Edm.) Ltd., 10056-109th Street, Edmonton • Medland Machinery Limited, 576 Wall Street, Winnipeg • Russel-Hipwell Engines Ltd., Owen Sound • Consolidated Engines & Machinery Co. Ltd., 5645 Pare Street, Town of Mount Royal, P.Q. • Russel-Hipwell Engines Ltd., 1298 Barrington Street, Halifax • Clayton Construction Co., Ltd., P.O. Box 118, Muir Bldg., St. John's, Nfld.

## New Products

### Pre-TR Tube

Item 1755

Bomac Laboratories, Beverly, Mass., announces the BL-612, an L-band pre-TR tube designed with ceramic windows for use in high power applications. Preliminary tests

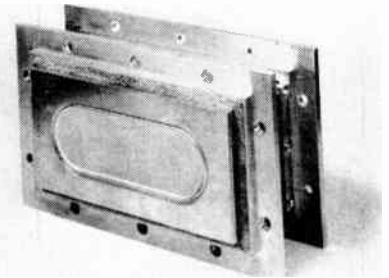

indicate that successful operation at 6 megawatts (peak) and 12 kilowatts (average) is possible and the bandpass is from 1250 to 1350 megacycles. Two gaskets are supplied with the BL-612 to allow mounting in a standard 10-hole L-band mounting seat.

The tube weighs approximately 5½ pounds and is 8¼ inches long, 5⅝ inches wide and 3.600 inches (maximum) in height.

Bomac Laboratories, Beverly, Mass., U.S.A.

### Airborne Electronic Heat Exchanger

Item 1756

Model RR20090 airborne electronic heat exchanger has a nominal heat dissipation rate of 6000 watts total for both fluid circuits while maintaining a maximum liquid outlet temperature of 180°F from sea level to 20,000 ft. The maximum cooling air temperatures at this performance rating are 131°F at sea level and 118°F at 20,000 ft.

The dual pump is designed to circulate coolant through separate circuits. One element of the pump has a minimum rated capacity of 1 g.p.m. with a 65 p.s.i. gage discharge pressure and the other element has a minimum rated capacity of 1 g.p.m. with a 30 p.s.i. gage discharge pressure pumping 10 Centistoke Dow Corning 200 Silicone Fluid.

The basic components that make up the unit are a liquid-to-air heat exchanger, an electric motor driven axivane fan and an electric motor driven liquid pump. Both motors are continuous duty and operate on 208 volts, 3 phase, 400 cycle. The pump motor is rated at 0.25 h.p. at 2,500 r.p.m. and the fan motor is rated at 1.25 h.p. at 11300 r.p.m.

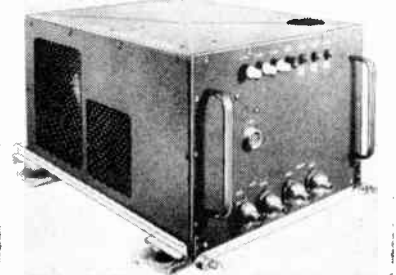

Incorporated in the unit for warning purposes is a flow switch in each fluid circuit and a liquid hi-temperature cutout switch for electrical interlock in the external electronic circuit. Also included is a fluid pressure reservoir, a power time delay relay to eliminate starting current surge through the interlock circuits, and panel warning lights to indicate low liquid flow and high liquid temperatures.

For more information write or telephone: Lear-Romec Division, Lear, Inc., Elyria, Ohio, U.S.A.

(Turn to page 60)

# you can't match **TRIPPLET** model 630 VOM

for **SPEED  
ACCURACY  
DURABILITY  
CONVENIENCE!**

*heavy molded case*

—1/4" thick for high impact.  
Fully insulated.

*sure grip battery contacts*

Balanced double-spring tension grip assures permanent contact.

*"this wide-range model*

tests AC-DC Volts (DC at 20,000 O/V); DC Microamperes, Milliampere, and Ampere; Ohms (to 100 Megohms); Decibel and Output. Its easy-to-read scales are the longest in this type tester."

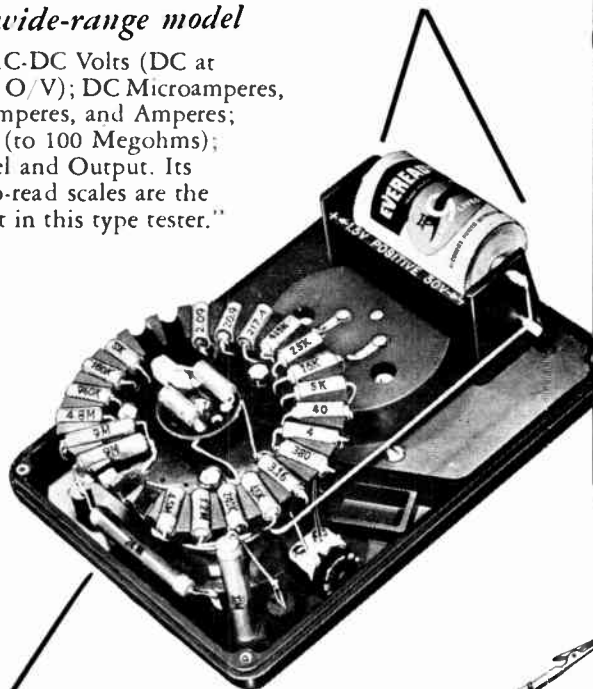

BURTON BROWNE ADVERTISING



*streamlined design*

No protruding knobs on switch or ohms control—both are flush with the panel.

*king size recessed knob*

—Only one switch; (fully enclosed) selects both circuit and range. Just turn the switch and make your reading.

*for quick positive connections*

—Banana jacks and plugs on test leads are best. Alligator clips are provided to slip on test prods for extra convenience.

*for convenience in reading*

—Available as an extra (only 50c), this special stand tilts meter at best angle for easy reading

*for most efficient meter use*

—With every Model 630 you receive complete, simplified instructions on how to use and maintain most efficiently.

*no slip feature*

Four rubber feet furnished as standard equipment fit in back of the case to prevent slipping on smooth surfaces.

*advanced engineering*

—Molded mounting for resistors and shunts allow direct connections without cabling. No chance for shorts. Longer life and easy-to-replace resistors in their marked positions.

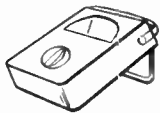

## MODEL 630

**\$62<sup>30</sup>**

Suggested Canadian Dealer Net

**TRIPPLET ELECTRICAL INSTRUMENT CO.**  
Bluffton, Ohio



### THE MIGHTY NINE VOM LINE

- 631**  
Combination V-O-M—VTVM
- 630-NA**  
For Best Testing Around The Lab, Production Line or Bench
- 630**  
The Popular All-Purpose V-O-M
- 630-A**  
A Good Lab and Production Line V-O-M
- 310**  
The Smallest Complete V-O-M With Switch
- 630-T**  
For Telephone Service
- 666-HH**  
Medium Size For Field Testing
- 625-NA**  
The First V-O-M With 10,000 Ohms/Volt AC
- 666-R**  
Medium Size With 630 Features

**New Products**

**F.M./A.M. Signal Generator**

*Item 1757*

The TF 1066/1, a new F.M./A.M. signal generator, introduced by Marconi Instruments, is a special quality version of the widely-used TF 1066.

The instrument has carrier-frequency range from 10-470 Mc/s. Output can be set at any level between 0.2 uV and 200 mV. A.M. is monitored and variable to any depth up to at least 40 per cent.

Facilities for incremental tuning include stepped as well as continuous control. The stepped control of incremental frequency provides fixed positive or negative shifts of 5, 10 and 15 kc/s., ensuring ease of rapid checks of receiver bandwidth during production testing.

Also incorporated is a fine-tuning control covering a range of approximately 25 kc/s. Carrier frequency drift is no greater than 0.0025 per cent in a 10 minute period, which corresponds to less than 800 c/s per minute at 300 mc/s.

Canadian Marconi Company, Instrumentation Department, 6035 Cote de Liesse Rd., Montreal, Que.

**A Recording Microvoltmeter**

*Item 1758*

The Kipp Micrograph, a highly sensitive, quick-acting DC recording microvoltmeter, having a sensitivity of 50 microvolts for full scale deflection, 1 second speed of indication and accurate within 1 per cent, answers a need in many industries and sciences.

The voltage to be measured is detected by a mirror galvanometer which is shock-proof to the extent that it needs no clamping and is very stable. The galvanometer forms part of a DC to AC photo-electric amplifier. The light reflected by the galvo's mirror falls on a combination of photocells, and the displacement of the light spot over the photocells results in an AC signal. The signal is amplified and is used to operate a servo motor which moves a sliding contact over a potentiometer wire.



As a result, the galvanometer receives a compensating voltage, causing it to return to zero. As the compensating voltage becomes equal to the measured voltage the signal disappears, and the motor stops. Thus the displacement of the sliding contact is fully independent of the linearity of the amplifier and is a linear function of the input voltage.

The displacement is recorded by a pen connected to the sliding contact.

For additional information write to R. M. Nichols Limited, 2781 Dufferin St., Toronto, Ontario, Canada.

(Turn to page 62)

Uses standard or ruggedized vacuum tube

Circuit components are potted for long life

Plugs into octal socket

**Compact Oscillator Drives 400 CPS Chopper**

Enables you to obtain advantages of high-frequency chopper in equipment powered from 60 CPS or from batteries, is small, self-contained.

- Operates from conventional filament and plate voltages
- Separates chopper frequency from hum frequency
- Gives faster response to chopper amplifier

**AIRPAX**  
PRODUCTS COMPANY  
DESIGNERS  
CAMBRIDGE DIVISION  
JACKTOWN ROAD  
CAMBRIDGE  
MARYLAND  
ENGINEERS

**MORE ACTIVE! EFFECTIVE!**

**KESTER "RESIN-FIVE" CORE SOLDER**

**THE BEST FOR TV-RADIO WORK . . . EVERYTHING ELECTRICAL - Kester "Resin-Five" Core Solder is better and faster than any solder ever developed. It has an activated flux-core that does a perfect job on all metals including zinc and nickel-plate. The flux residue is absolutely non-corrosive and non-conductive.**

Available in all practical Tin-Lead Alloys; 40/60, 50/50 and 60/40 in diameters of 3/32", 1/16", 3/64", 1/32" and others.

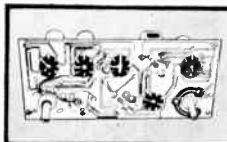

**Printed Circuit Soldering**  
On Copper-etched boards use 60% Tin - 40% Lead Alloy . . . for those that are Silver-surfaced use 3% Silver-61 1/2% Tin-35 1/2% Lead

**KESTER SOLDER COMPANY**  
OF CANADA, LTD. Dept. U Brantford, Canada

# CLM DARCY RELAYS

Now you can get fast delivery with Canadian made relays. All standard types are available and all are electrically and mechanically interchangeable with other makes.

Illustrated are only a few telephone type relays. Other spring and coil combinations are available.

For full information call or write Jack West, Sales Manager, Relectronic Division, Canadian Line Materials Limited, Toronto 13, Canada.

SALTS OFFICES AND WAREHOUSES  
ST. JOHN'S Nfld. • HALIFAX • SAINT JOHN • MONTREAL • OTTAWA  
FORT WILLIAM • WINNIPEG • REGINA • CALGARY • VANCOUVER

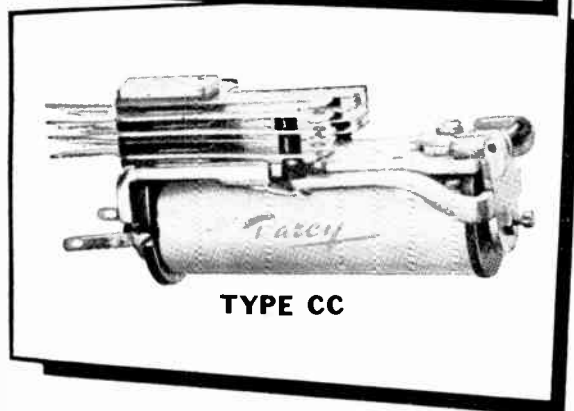
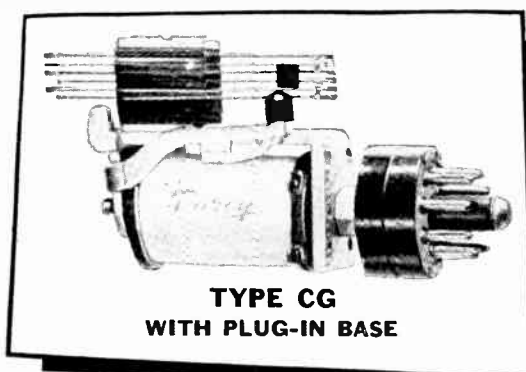

**CLM-DARCY  
RELAYS**

ELECTRONICS & COMMUNICATIONS, NOVEMBER, 1957

## MICRO SWITCH PRECISION SWITCHES

Small, rugged, high capacity switches designed to meet requirements of communications and electronic equipment and aircraft

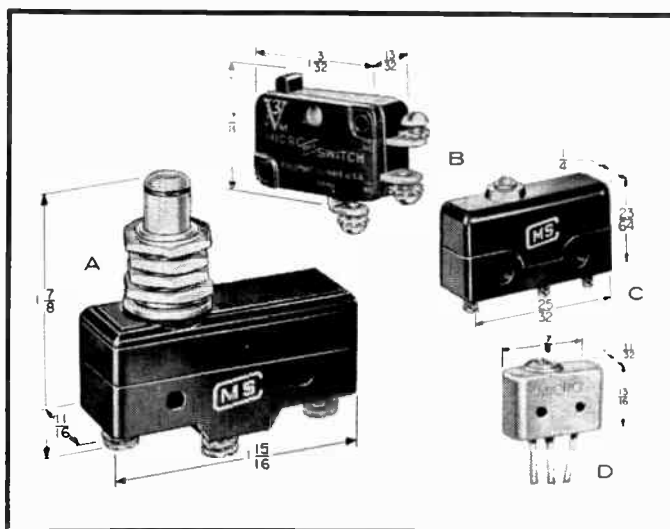

**A. "Q1" Plunger Switches.** Single-pole, double-throw basic switches for mounting through panels as manual or mechanical push button switches, as door switches, or for operation by slow moving cams. Conforms to JAN-S-63.

**B. Type "V3" Basic Switches.** Small, single-pole, double-throw switches. Lightweight with highest electrical capacity. Suitable as limit, control or safety switch where space is limited. Conforms to MIL-S-6743.

**C. Subminiature Pin Plunger Type Basic Switch.** Single-pole, double-throw pin plunger switch for use where travel of actuating mechanism is accurately controlled or with auxiliary actuators and enclosures. Conforms to MIL-S-6743.

**D. Sealed Subminiature Switch.** The smallest lightest weight switch of this type available. Completely sealed . . . gives trouble-free operation in a temperature range from minus 65° to plus 180° F.

**MICRO SWITCH**  
A PRINCIPLE  
OF GOOD DESIGN

MICRO SWITCH produces a complete line of switches to conform to military specifications. Available with a selection of actuators. Literature on request.



**MICRO SWITCH**

A DIVISION OF HONEYWELL CONTROLS LIMITED, TORONTO 17, ONTARIO.

For further data on advertised products use page 65.

# 08 Synchros join the Muirhead range



ACTUAL SIZE

**MUIRHEAD**
**SYNCHROS**
**Types 26V08CX4(B), 26V08CT4(B)**

**DATA, DELIVERY AND PRICES ON REQUEST  
FROM 'MUIRHEAD THE SYNCHRO PEOPLE'**

**MUIRHEAD INSTRUMENTS LIMITED  
STRATFORD · ONTARIO · CANADA · Phone 3717**

305/3Ca

## New Products

### Wide-Tuning-Range Klystron Amplifier Tube

*Item 1759*

Varian Associates announce a revolutionary, new, wide-tuning-range klystron amplifier tube with internal resonant cavity circuits capable of tuning from 1700 to 2400 megacycles. The VA-800 klystron is one of a line of high-power, high-gain, low-noise CW power tubes delivering 10kW and 1 kW of power for tropospheric communication service in the frequency range from 375 Mc to 8500 Mc.

Uniquely, the only rf connections to the Varian VA-800 are an input line with less than one watt of drive power and an output line to carry 10,000 watts of rf power to the antenna. All resonant circuits are an internal part of the tube and can be tuned readily to any spot in the 1700 to 2400 Mc band. No other physical adjustments are required for the tube to operate at optimum performance at all times. The only electrical requirements are supplies for the cathode, beam voltage, and the beam focusing magnet. Because these are not critical, no warm-up adjustment periods are necessary.

The resulting freedom from physical, electrical, and vital maintenance adjustments removes the possibilities for misadjustment, eases systems maintenance, and helps provide the simplicity required for reliability and low cost operation.

These high power amplifier klystrons provide bandwidths sufficient for hundreds of telephone and teletype channels, or one or two television channels and are used in over-the-horizon forward scatter communication circuits, many of which provide vital communications in remote and inaccessible areas.

Additional information available from Varian Associates of Canada, Ltd., Georgetown, Ontario.

### Audio Sweep Oscillator

*Item 1760*

20 cycles to 20 kc range in a single dial sweep is a unique feature of the new Model 207A Audio Sweep Oscillator recently announced by the Hewlett-Packard Company. The instrument employs a new variation of the time tested r-c oscillator circuit and achieves its extreme frequency range without bandswitching and with greater stability than other audio sweeping types. The accuracy of the Model 207A is  $\pm 4$  per cent including warmup drift and aging of tubes and components.

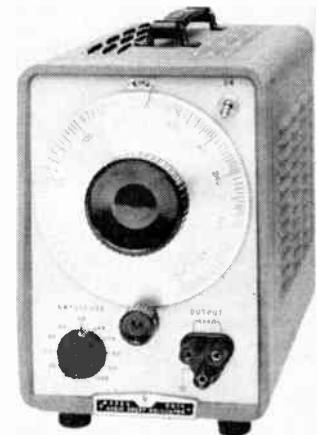

The oscillator has been designed for motor drive, the company states, to speed the testing of audio circuits and devices of many kinds.

For further information, apply to Atlas Radio Corp. Ltd., 50 Wingold Ave., Toronto, Ontario.

## News Report

### Canada Wire Appointments

The following appointments have been announced by L. G. Lumbers, vice-president and general manager of Canada Wire and Cable Company Limited, Toronto (Leaside). Frank Ashworth has been appointed general manager, product engineering and product control; J. F. Maskell, controller, with particular emphasis on methods used throughout all of the company's operations; J. H. Stevens, manager of general plant planning and engineering and R. L. Hart, manager of industrial relations reporting directly to general management.

The appointment of D. S. Grant as General Works Manager of Canada Wire and Cable Company Limited, Toronto (Leaside) has also been announced by O. W. Titus, president of the company.

Mr. Grant succeeds F. A. Pankhurst who has relinquished his duties in this capacity for reasons of health after a long and distinguished career. Mr. Pankhurst now takes on the post of executive representative reporting directly to the president and vice-president. Mr. Grant, who has been with the company since 1938, moves up from general superintendent of the Leaside plant.

## CLASSIFIED

### SALES MANAGER

Small electronics instrument firm wants an aggressive executive to take full charge of sales, advertising and publicity. Unlimited opportunity for advancement as a member of one of Canada's growing manufacturers of testing equipment. Technical ability not necessary, sales contacts highly desirable. *Joie de vivre a necessity!*

Apply Box 5000,  
Electronics and Communications,  
31 Willcocks Street, Toronto 5, Ont.

### ELECTRICAL ENGINEER

Senior circuit engineering vacancy on airborne electronic instruments and servo-systems, with a rapidly expanding organization in the Metropolitan Toronto area. Applicants must be conversant with modern techniques, including magnetic, thermionic and transistor amplifiers and experienced in working to MIL specifications. A knowledge of control stability theory is essential and familiarity with RF and pulse circuitry is desirable. Excellent working conditions and employee benefits. Salary from \$6600.00 per annum, based on experience. Write giving full resume as to age, experience, educational qualifications and present salary. All replies will be held in strict confidence and acknowledged promptly.

Box 91  
ELECTRONICS and  
COMMUNICATIONS  
31 Willcocks St. Toronto 5, Ont.



## CHANGE

DEW—line may never sight an enemy. But if it does... and if it fails... who will promise us a second chance?

The reliability of every component is crucial. That's why Sprague high reliability components are specified in critical military electronic equipment.

## SPRAGUE<sup>®</sup>

**CANADIAN MANUFACTURING REPRESENTATIVE**

Micarta Fabricators Limited  
18 Toronto Street  
Toronto, Ontario  
Phone EMPire 8-4251

## New Bendix SM-E Connector

*(smaller, lighter than AN-E but equally dependable)*



Here is the newest in the ever growing family of Bendix\* environment resistant connectors. The new SM-E Series (Short "E") will provide the same performance as the standard AN-E connectors, but is shorter, lighter and more easily serviced. Not only does this connector conform to the vibration resistant requirements of the "E" connector in the MIL-C-5015C government specification, but it also provides effective moisture barriers both at the solder well ends and mating surfaces using the full range of wire sizes. Of particular interest to production and maintenance people is the back nut design, which provides a jacking action on the grommet during disassembly, thereby lifting it free of the solder wells. This feature when combined with the new Bendix "slippery rubber" grommets makes easy work of wire threading and grommet travel over the wire bundles.

Available in all standard AN shell sizes and tooled for most of the popular AN configurations. Write for complete descriptive folder.

\*TRADEMARK



Comparison based on size 40 mated assemblies. Space savings for smaller sizes are proportional.

**Bendix** SCINTILLA DIVISION of **Bendix**  
SIDNEY, NEW YORK AVIATION CORPORATION

Export Sales and Service: Bendix International Division, 205 East 42nd St., New York 17 N. Y.

FACTORY BRANCH OFFICES:

117 E. Providencia Ave., Burbank, Calif. • Paterson Building, 18038 Mack Ave., Detroit 24, Mich. • 545 Cedar Lane, Teaneck, N. J. • 5906 North Port Washington Rd., Milwaukee 17, Wisc. • Hulman Building, 120 W. Second St., Dayton 2, Ohio • 2608 Inwood Road, Dallas 19, Texas • 8425 First Ave., South, Seattle 8, Washington • 1701 "K" Street, N.W. Washington 6, D. C.

## Book Review

**Basic Mathematics For Electricity, Radio And Television** by Bertrand B. Singer.

This textbook is designed for a practical course in mathematics for students preparing for the electrical, radio and television trades. It is also for refresher courses in mathematics for skilled mechanics in these trades.

The author covers the basic mathematics required to solve problems arising in the electrical, radio and television trades. The mathematical principles are presented as dynamic tools for solving electrical problems. These principles are introduced in simple stages, and they are applied directly to the solution of practical problems in electrical installation and radio and television servicing.

The material is presented in "job" form. Each "job" — (a) develops either a new mathematical operation or a new electrical concept; (b) is illustrated by a series of examples which increase in both arithmetical difficulty and electrical scope; (c) has its own set of practical problems which have been carefully graded with answers for all.

**Basic Mathematics For Electricity, Radio And Television** is published by McGraw-Hill Company of Canada Limited, 253 Spadina Rd., Toronto 4, Ontario, contains 513 pages, hard cover bound, price \$7.50.

**Elements Of Magnetic Tape Recording** by N. M. Haynes, Engineering Vice-President, Amplifier Corporation of America.

This volume falls into three logical sections. The Introduction in Part I contains chapters on Magnetic Fundamentals, Electroacoustic Fundamentals, Magnetic Tape Nomenclature, The Recording Medium.

In Part II, the reader gets to the heart of the actual magnetic tape process in the Recording Process, The Playback Process, The Erasing Process, Single-, Dual-, and Multi-track Recording, and others.

Part III deals with the Apparatus of Tape Recording, including Flutter, Tape-Handling Elements and Mechanisms, Battery-Operated Recorders, Basic Maintenance and Repair.

Regardless of the nature of the reader's own scientific background, he will get from this carefully organized, readable volume a solid understanding of the subject that can lead to a profitable hobby or career in sound recording. He will also become thoroughly familiar with the requirements of a superior tape recording system, and know what to look for when buying or building his own tape recorder.

**Elements Of Magnetic Tape Recording** is published by Prentice-Hall, Inc., 70 Fifth Avenue, New York 11, N.Y., contains 392 pages, hard cover bound, price \$7.95.

**Synthesis Of Passive Networks** by Ernst A. Guillemin, Professor of Electrical Communication, Department of Electrical Engineering, Massachusetts Institute of Technology.

Here is a logical, comprehensive approach to linear passive network synthesis. The author scrupulously avoids so-called "short cuts" in this treatment. He covers both the approximation problem and the realization techniques, two essential parts of synthesis procedure. The coverage is sufficiently detailed so that the reader who digests this material will be able to work independently in this field.

Included are numerous illustrative and practice problems. A good understanding of essential mathematics and basic circuit analysis is considered pre-requisite to the use of this volume.

**Synthesis Of Passive Networks** is published by John Wiley & Sons, Inc., 440 Fourth Avenue, New York 16, N.Y., contains 741 pages, hard cover bound, price \$15.00.

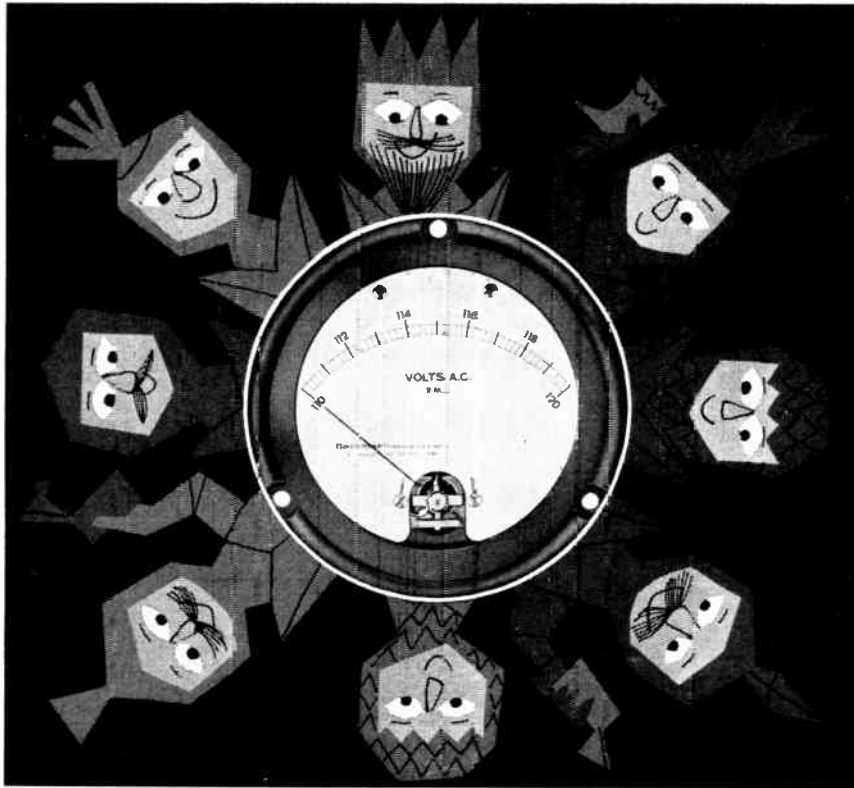

*Even when set at an illogical, illegible angle, Beckman Expanded Scale Voltmeters read*

## RIGHT at a glance

BECKMAN EXPANDED SCALE VOLTMETERS always read billboard-clear, even when the installation's angular, tangular, bothersome or bewildering. Needle position tells all—you don't have to read the fine type.

HOW COME? The meter's selective: non-essential parts of the scale have been eliminated, and the useful portion expanded. And so we bid farewell to crowded divisions at one end of the scale. Instead, meet real easy reading.

AC OR DC? Either. Also, they're as small as 2½" dia., as accurate as 0.3% of center-scale voltage. Resolution's as high as 0.1 volt.

HOW MANY MODELS? The 126 standard models—available in commercial and military versions—are for panel installations in ground power facilities, test equipment and aircraft. On special order, meters can be adapted for non-standard voltage ranges, scales, accuracies, shapes and sizes.

WANT MORE? Write for data file 114E.

Beckman Helipot Corporation

Newport Beach, California  
a division of  
Beckman Instruments, Inc.  
Canadian Factory:  
No. 3 Six Points Rd., Toronto 18, Ont.  
Sales Representative:  
R-O-R Associates, Ltd.  
1470 Don Mills Road, Don Mills, Ont.

1172

For further data on advertised products use page 65.



# INDEX TO ADVERTISERS

Page number is on the right.  
Key number for use with  
READER SERVICE CARDS is  
on the left.

Key No.	Name	Page No.
1.	Adeola Products Ltd.	56
2.	Aerovox (Canada) Ltd.	57
3.	Airpax Products Co.	60
4.	Alliance Motors	52
5.	Arrow-Hart & Hegeman (Canada) Ltd.	56
6.	Automatic Electric Sales (Canada) Ltd.	35
7.	Automatic Electric Sales (Canada) Ltd.	36-37
8.	Automatic Electric Sales (Canada) Ltd.	38
9.	Aviation Electric Ltd.	48
10.	Aviation Electric Ltd.	70
11.	Bach-Simpson Ltd.	4
12.	Bell Telephone Co. of Canada. The	68
13.	Bendix Aviation Corp.	63
14.	Bud Radio Inc.	67
15.	Canada Wire & Cable Co. Ltd.	72
16.	Canadian Applied Research Ltd.	71
17.	Canadian General Electric Co. Ltd.	52
18.	Canadian Line Materials Ltd.	61
19.	Canadian Line Materials Ltd.	53
20.	Canadian Lister-Blackstone Ltd.	58
21.	Canadian Marconi Co.	3
22.	Canadian Westinghouse Co. Ltd.	16
23.	Canadian Westinghouse Co. Ltd.	54
24.	Cannon Electric (Canada) Ltd.	15
25.	Computing Devices of Canada Ltd.	9

## ATTENTION CIRCULATION MANAGER

Please  ADD my name to the mailing list for **ELECTRONICS & COMMUNICATIONS** (no obligation).

My Name .....  
(Please Print)

Mail copies to my  home, or  business address as noted below.

Street .....

City ..... Prov. ....

If you have recently CHANGED your address for receiving copies of E & C please note former address here:

Company ..... Nature of Business .....

Signature ..... Position .....  
11-57 (Card not valid without signature)

### PLEASE SEND FURTHER INFORMATION ON THE FOLLOWING NEW PRODUCT ITEMS AS CHECKED BELOW — USE PRODUCT ITEM NUMBERS

- |                               |                               |                               |                               |                               |                               |                               |                               |                               |                               |
|-------------------------------|-------------------------------|-------------------------------|-------------------------------|-------------------------------|-------------------------------|-------------------------------|-------------------------------|-------------------------------|-------------------------------|
| <input type="checkbox"/> 1734 | <input type="checkbox"/> 1735 | <input type="checkbox"/> 1736 | <input type="checkbox"/> 1737 | <input type="checkbox"/> 1738 | <input type="checkbox"/> 1739 | <input type="checkbox"/> 1740 | <input type="checkbox"/> 1741 | <input type="checkbox"/> 1742 | <input type="checkbox"/> 1743 |
| <input type="checkbox"/> 1744 | <input type="checkbox"/> 1745 | <input type="checkbox"/> 1746 | <input type="checkbox"/> 1747 | <input type="checkbox"/> 1748 | <input type="checkbox"/> 1749 | <input type="checkbox"/> 1750 | <input type="checkbox"/> 1751 | <input type="checkbox"/> 1752 | <input type="checkbox"/> 1753 |
| <input type="checkbox"/> 1754 | <input type="checkbox"/> 1755 | <input type="checkbox"/> 1756 | <input type="checkbox"/> 1757 | <input type="checkbox"/> 1758 | <input type="checkbox"/> 1759 | <input type="checkbox"/> 1760 |                               |                               |                               |

### PLEASE SEND FURTHER INFORMATION ON THE FOLLOWING ADVERTISEMENTS AS NUMBERED BELOW — USE KEY NUMBER

- |                             |                             |                             |                             |                             |                             |                             |                             |                             |                             |                             |                             |
|-----------------------------|-----------------------------|-----------------------------|-----------------------------|-----------------------------|-----------------------------|-----------------------------|-----------------------------|-----------------------------|-----------------------------|-----------------------------|-----------------------------|
| <input type="checkbox"/> 1  | <input type="checkbox"/> 2  | <input type="checkbox"/> 3  | <input type="checkbox"/> 4  | <input type="checkbox"/> 5  | <input type="checkbox"/> 6  | <input type="checkbox"/> 7  | <input type="checkbox"/> 8  | <input type="checkbox"/> 9  | <input type="checkbox"/> 10 | <input type="checkbox"/> 11 | <input type="checkbox"/> 12 |
| <input type="checkbox"/> 13 | <input type="checkbox"/> 14 | <input type="checkbox"/> 15 | <input type="checkbox"/> 16 | <input type="checkbox"/> 17 | <input type="checkbox"/> 18 | <input type="checkbox"/> 19 | <input type="checkbox"/> 20 | <input type="checkbox"/> 21 | <input type="checkbox"/> 22 | <input type="checkbox"/> 23 | <input type="checkbox"/> 24 |
| <input type="checkbox"/> 25 | <input type="checkbox"/> 26 | <input type="checkbox"/> 27 | <input type="checkbox"/> 28 | <input type="checkbox"/> 29 | <input type="checkbox"/> 30 | <input type="checkbox"/> 31 | <input type="checkbox"/> 32 | <input type="checkbox"/> 33 | <input type="checkbox"/> 34 | <input type="checkbox"/> 35 | <input type="checkbox"/> 36 |
| <input type="checkbox"/> 37 | <input type="checkbox"/> 38 | <input type="checkbox"/> 39 | <input type="checkbox"/> 40 | <input type="checkbox"/> 41 | <input type="checkbox"/> 42 | <input type="checkbox"/> 43 | <input type="checkbox"/> 44 | <input type="checkbox"/> 45 | <input type="checkbox"/> 46 | <input type="checkbox"/> 47 | <input type="checkbox"/> 48 |
| <input type="checkbox"/> 49 | <input type="checkbox"/> 50 | <input type="checkbox"/> 51 |                             |                             |                             |                             |                             |                             |                             |                             |                             |

Name ..... Position .....

Company ..... Nature of Business .....

Company Address ..... City ..... Prov. ....  
11-57

### PLEASE SEND FURTHER INFORMATION ON THE FOLLOWING NEW PRODUCT ITEMS AS CHECKED BELOW — USE PRODUCT ITEM NUMBERS

- |                               |                               |                               |                               |                               |                               |                               |                               |                               |                               |
|-------------------------------|-------------------------------|-------------------------------|-------------------------------|-------------------------------|-------------------------------|-------------------------------|-------------------------------|-------------------------------|-------------------------------|
| <input type="checkbox"/> 1734 | <input type="checkbox"/> 1735 | <input type="checkbox"/> 1736 | <input type="checkbox"/> 1737 | <input type="checkbox"/> 1738 | <input type="checkbox"/> 1739 | <input type="checkbox"/> 1740 | <input type="checkbox"/> 1741 | <input type="checkbox"/> 1742 | <input type="checkbox"/> 1743 |
| <input type="checkbox"/> 1744 | <input type="checkbox"/> 1745 | <input type="checkbox"/> 1746 | <input type="checkbox"/> 1747 | <input type="checkbox"/> 1748 | <input type="checkbox"/> 1749 | <input type="checkbox"/> 1750 | <input type="checkbox"/> 1751 | <input type="checkbox"/> 1752 | <input type="checkbox"/> 1753 |
| <input type="checkbox"/> 1754 | <input type="checkbox"/> 1755 | <input type="checkbox"/> 1756 | <input type="checkbox"/> 1757 | <input type="checkbox"/> 1758 | <input type="checkbox"/> 1759 | <input type="checkbox"/> 1760 |                               |                               |                               |

### PLEASE SEND FURTHER INFORMATION ON THE FOLLOWING ADVERTISEMENTS AS NUMBERED BELOW — USE KEY NUMBER

- |                             |                             |                             |                             |                             |                             |                             |                             |                             |                             |                             |                             |
|-----------------------------|-----------------------------|-----------------------------|-----------------------------|-----------------------------|-----------------------------|-----------------------------|-----------------------------|-----------------------------|-----------------------------|-----------------------------|-----------------------------|
| <input type="checkbox"/> 1  | <input type="checkbox"/> 2  | <input type="checkbox"/> 3  | <input type="checkbox"/> 4  | <input type="checkbox"/> 5  | <input type="checkbox"/> 6  | <input type="checkbox"/> 7  | <input type="checkbox"/> 8  | <input type="checkbox"/> 9  | <input type="checkbox"/> 10 | <input type="checkbox"/> 11 | <input type="checkbox"/> 12 |
| <input type="checkbox"/> 13 | <input type="checkbox"/> 14 | <input type="checkbox"/> 15 | <input type="checkbox"/> 16 | <input type="checkbox"/> 17 | <input type="checkbox"/> 18 | <input type="checkbox"/> 19 | <input type="checkbox"/> 20 | <input type="checkbox"/> 21 | <input type="checkbox"/> 22 | <input type="checkbox"/> 23 | <input type="checkbox"/> 24 |
| <input type="checkbox"/> 25 | <input type="checkbox"/> 26 | <input type="checkbox"/> 27 | <input type="checkbox"/> 28 | <input type="checkbox"/> 29 | <input type="checkbox"/> 30 | <input type="checkbox"/> 31 | <input type="checkbox"/> 32 | <input type="checkbox"/> 33 | <input type="checkbox"/> 34 | <input type="checkbox"/> 35 | <input type="checkbox"/> 36 |
| <input type="checkbox"/> 37 | <input type="checkbox"/> 38 | <input type="checkbox"/> 39 | <input type="checkbox"/> 40 | <input type="checkbox"/> 41 | <input type="checkbox"/> 42 | <input type="checkbox"/> 43 | <input type="checkbox"/> 44 | <input type="checkbox"/> 45 | <input type="checkbox"/> 46 | <input type="checkbox"/> 47 | <input type="checkbox"/> 48 |
| <input type="checkbox"/> 49 | <input type="checkbox"/> 50 | <input type="checkbox"/> 51 |                             |                             |                             |                             |                             |                             |                             |                             |                             |

Name ..... Position .....

Company .....

Street ..... City ..... Prov. ....  
11-57

**BUSINESS REPLY CARD**  
No Postage Stamp Necessary if Mailed in Canada

5c POSTAGE WILL BE PAID BY

**ELECTRONICS AND COMMUNICATIONS**

31 - 35 Willcocks Street

Toronto 5, Ontario



**BUSINESS REPLY CARD**  
No Postage Stamp Necessary if Mailed in Canada

5c POSTAGE WILL BE PAID BY

**ELECTRONICS AND COMMUNICATIONS**

31 - 35 Willcocks Street

Toronto 5, Ontario



**BUSINESS REPLY CARD**  
No Postage Stamp Necessary if Mailed in Canada

5c POSTAGE WILL BE PAID BY

**ELECTRONICS AND COMMUNICATIONS**

31 - 35 Willcocks Street

Toronto 5, Ontario



**INDEX — Continued**

Key No.	Name	Page No.
26.	Daven Co., The	56
27.	Empire Engineering Co.	55
28.	Ericsson Telephone Sales of Canada Ltd.	51
29.	Freed Transformer Co. Inc.	54
30.	G-V Controls Inc.	50
31.	General Radio Co.	13
32.	Hammond Manufacturing Co. Ltd.	55
33.	Helipot Corp.	56
34.	Helipot Corp.	64
35.	Honeywell Controls Ltd.	61
36.	Hughey & Phillips Inc	48
37.	Indiana Steel Products Co. of Canada Ltd., The	10
38.	International Resistance Co. Ltd.	2
39.	Kester Solder Co.	60
40.	Magnetics Inc.	14
41.	Minnesota Mining & Mfg. Co. of Canada Ltd.	6
42.	Muirhead & Co. Ltd.	62
43.	National Fibre Co. of Canada Ltd.	12
44.	Polypenco Inc.	55
45.	Radio Communications Equipment & Engineering Ltd.	46-47
46.	Rogers Majestic Electronics Ltd.	69
47.	Sigma Instruments Inc.	49
48.	Snelgrove & Co. Ltd., C. R.	58
49.	Sprague Electric International Ltd.	63
50.	Stark Electronic Instruments Ltd.	50
51.	Triplett Electrical Instrument Co., The	59

# ADD THESE UP

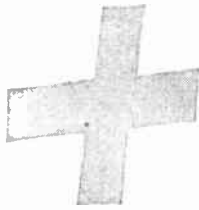

**SUPERIOR PRODUCTS  
COMPLETE LINE  
QUICK DELIVERY  
ADVERTISING TO YOUR CUSTOMERS**

for more profit on **BUD** Sheet Metal Housings . . .

Built to high standards, all Bud products meet the requirements of your customers for quality and value. Soundly engineered and expertly built Bud housings enhance the appearance and performance of the equipment they contain.

Purchasing all your needs from one source reduces your shipping and accounting costs. Hundreds of styles and sizes for every type of buyer means no lost sales.

Large production facilities using the most modern equipment insures a steady flow of products and delivery when requested on most popular items.

Bud's consistent advertising to your customers appears in Electronic, Electrical and Design publications each month results in brand name identification plus inquiries for you.

Just simple arithmetic will convince you that you will make more sales . . . more profit by stocking and selling Bud Products.

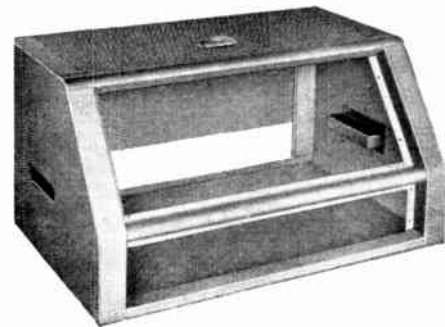

#### **SLOPING PANEL PRESTIGE CABINETS**

Offer high style, custom appearance at standard stock prices. Top panel swept back for easy viewing. Panel trim bar is removable to permit easy withdrawal of chassis attached to either or both panels. Available in three sizes.

*and these new products mean  
extra sales for you!*

#### **HEAVY DUTY CABINET RACKS**

Designed for installation where increased depth is required. Panel mounting rails are an integral part of the cabinet. The Add-A-Cab feature provides increased panel space where vertical height is limited. Units are shipped knocked down for easy storage and lower transportation costs. Three sizes available.

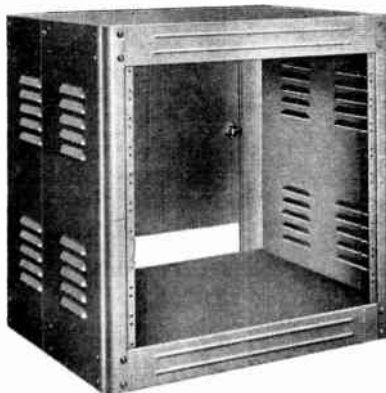

#### **SPACE SAVER RELAY RACKS**

Provide necessary panel height and width but have a shallower depth to fit where space is limited. The Add-A-Rack feature is available. Panel mounted rails are an integral part of the rack. Shipped knocked down with necessary assembly hardware. Especially desirable for use with Bud Panel Mounting Chassis. Three standard sizes.

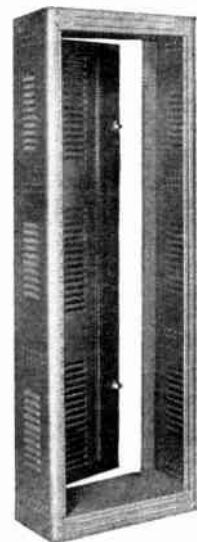

*Write for literature and prices on these new products.*



### **TENATRONICS, LTD.**

Davis Drive, East

Newmarket, Ontario

Exclusive Canadian Representative for

### **BUD RADIO CORP.**

2118 East 55th Street

Dept. EC

Cleveland 3, Ohio

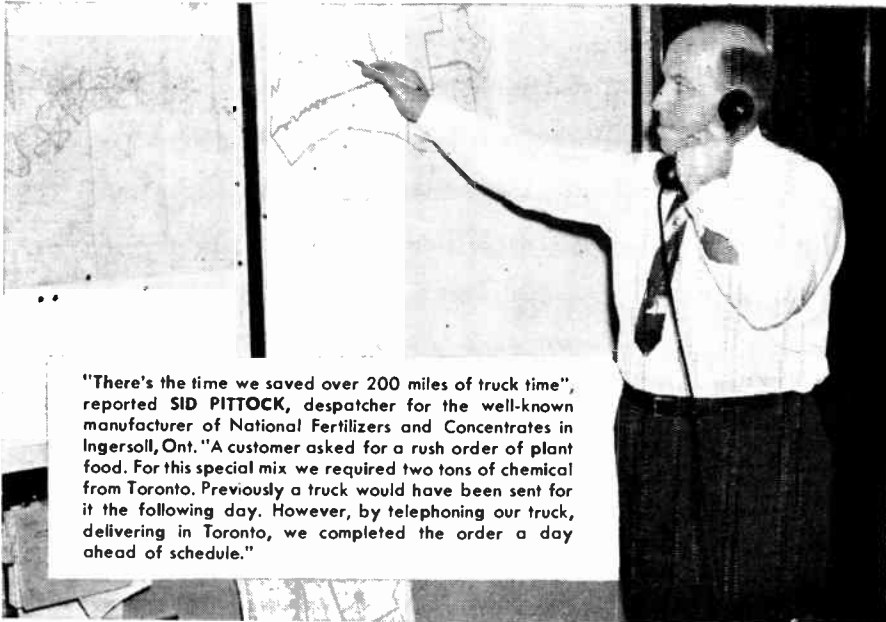

"There's the time we saved over 200 miles of truck time", reported SID PITTOCK, dispatcher for the well-known manufacturer of National Fertilizers and Concentrates in Ingersoll, Ont. "A customer asked for a rush order of plant food. For this special mix we required two tons of chemical from Toronto. Previously a truck would have been sent for it the following day. However, by telephoning our truck, delivering in Toronto, we completed the order a day ahead of schedule."

## WILLIAM STONE SONS LIMITED saves miles of costly truck travel with BELL MOBILE TELEPHONE Service

We could give you many more examples like this, but why not let us *show* you how Bell Mobile can reduce your gas, tire, service and depreciation costs as well as drivers' time and perhaps your number of vehicles.

At the same time you will see how you can give your customers faster service. *No equipment to buy! No maintenance or replacement problems!*

**YOU PAY ONLY FOR SERVICE!**

Ask your nearest Bell Telephone business office for a communications study and recommendation for your operations, without cost or obligation.



"Another typical example", said W. JILLINGS driver of the telephone-equipped truck, "was the time I checked with the dispatcher and was told to go on to Brantford. I was just west of Hamilton and I'd no sooner hung up than he called back and directed me to make a pick-up about a quarter of a mile from where I was located. His call saved me from driving an additional 40 to 50 miles."



**THE BELL TELEPHONE  
COMPANY OF CANADA**

BELL Mobile Telephone Service  
doesn't cost, it pays!

## BOOK REVIEW

(Continued from page 64)

**Analytical Design of Linear Feedback Controls** by George C. Newton, Jr., Leonard A. Gould and James F. Kaiser, all of the Massachusetts Institute of Technology.

In this book "analytical design" is identified as the design of control systems by application of the methods of mathematical analysis to idealized models which represent physical equipment. Taking as their starting point the system specifications, the authors include descriptions of the input, the disturbances, and the desired response. They also include a statement of the basis on which the system performance will be judged; this statement is in the form of a performance index. The design objective is to minimize (or maximize) the chosen performance index. Analytical design theory, the authors show, is a presentation of the ways and means for accomplishing this objective.

Included is a comprehensive discussion of the analytical design procedure for two performance indices.

**Analytical Design of Linear Feedback Controls** is published by John Wiley & Sons, Inc., 440 Fourth Avenue, New York 16, N.Y., contains 419 pages, hard cover bound, price \$12.00.

**Transistor Circuits And Applications**, edited by John M. Carroll, Associate Editor, Electronics.

This book comprises 106 feature technical articles that appeared in Electronics magazine during the years 1950 to 1956. All the basic amplifier, oscillator, pulse and switching circuits are shown with typical component values.

The book furnishes characteristics of typical transistors, descriptions of basic types, important design considerations, and formulas. Many applications of transistors to home-entertainment, military, broadcasting, communications, computing, control, industrial, scientific, and medical equipment are described — with complete circuit schematics.

The volume will be of value to all circuit designers and engineers whose work includes design of transistor circuits. Students in universities, colleges and technical institutes will discover that it provides a convenient practical orientation when read collaterally with textbooks on the design of transistor circuits or on semi-conductor electronics.

**Transistor Circuits And Applications** is published by McGraw-Hill Company of Canada Limited, 253 Spadina Rd., Toronto 4, Ontario, Canada, contains 283 pages, hard cover bound, price \$9.00.

**Transistor Circuit Engineering**, written by eight members of the staff of General Electric Company, pioneers in the field of transistor research, and edited by Richard F. Shea, Knolls Atomic Power Laboratory, General Electric Company.

This book was prepared to show how transistor theory can be put to work in typical circuits. It provides all the necessary tools for doing actual circuit designs and developing usable circuits in all potential fields of application. It enables the reader to build successful audio amplifiers, radio frequency amplifiers, etc. using available transistors. Moreover, it shows him how to combine these elements into radio receivers, television sets, and high fidelity audio systems.

In addition, the book gives up-to-date information on the development of new devices and their application in broad new fields.

**Transistor Circuit Engineering** is published by John Wiley & Sons, Inc., 440 Fourth Avenue, New York 16, N.Y., contains 468 pages, hard cover bound, price \$12.00.

For further data on advertised products use page 65.

**The 6922 E88CC Double Triode** is one of a line of Rogers Special Quality\* ruggedized tubes. Its gold plated frame grid construction assures high transconductance, close tolerances and consistent performance. The tube also has gold plated pins to minimize contact resistance and corrosion. Under fair conditions of use, its life should exceed 10,000 hours.

Produced under exacting design and production measures, this Rogers Double Triode is especially suitable for reliable cascode amplification, high speed computer applications, and low noise, high gain RF Amplifiers.

*\*Rogers Special Quality tubes are finding more and more applications in all types of professional equipment. The greater reliability and lower maintenance cost of the apparatus in which they are used more than compensates for the higher initial cost.*

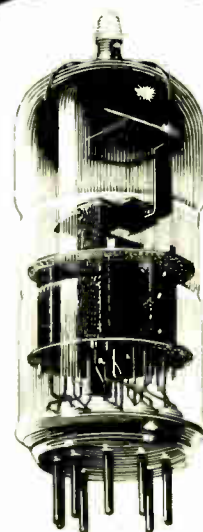

# ROGERS

*electronic tubes & components*

11-19 BRENTCLIFFE ROAD, TORONTO, ONTARIO / BRANCHES: MONTREAL, WINNIPEG, VANCOUVER

★ Rogers Electronic Tubes are sold through Canada's Independent Electronic Parts Distributors

SPECIALLY BUILT TO WITHSTAND SEVERE OPERATING CONDITIONS



# HARD GLASS TUBES



6094  
BEAM POWER AMPLIFIER

6384  
BEAM POWER AMPLIFIER

6754  
FULL-WAVE RECTIFIER

- Ideal for modern high-performance aircraft and missiles.
- Processing at higher vacuum and under the higher heat permitted by the hard glass reduces gas and contamination and provides greater operating stability at higher temperatures.
- Ceramic element separators prevent emission loss from high heat and vibration.
- Solid aluminum oxide heater-cathode insulator eliminates shorts, reduces leakage.

For further information, write AVIATION ELECTRIC LIMITED, 200 LAURENTIEN BLVD., MONTREAL, P.Q.

ELECTRICAL RATINGS*	6094 Beam Power Amplifier	6384 Beam Power Amplifier	6754 Full Wave Rectifier
Heater Voltage (AC or DC)**	6.3 volts	6.3 volts	6.3 volts
Heater Current	0.6 amp.	1.2 amp.	1.0 amp.
Plate Voltage (Maximum DC)	300 volts	750 volts	350 volts
Screen Voltage (Maximum DC)	275 volts	325 volts	—
Peak Plate Voltage (Max. Instantaneous)	550 volts	750 volts	—
Plate Dissipation (Absolute Max.)	14.0 watts	30 watts	—
Screen Dissipation (Absolute Max.)	2.0 watts	3.5 watts	—
Heater-Cathode Voltage (Max.)	±450 volts	±450 volts	±500 volts
Grid Resistance (Maximum)	0.1 Megohm	.1 Megohm	—
Grid Voltage (Maximum)	5.0 volts	0 volts	—
Grid Voltage (Minimum)	-200 volts	-200 volts	—
Cathode Warm-up Time	45 sec.	45 sec.	45 sec.

\*For greatest life expectancy, avoid designs which apply all maximums simultaneously.

\*\*Voltage should not fluctuate more than ±5%.

MECHANICAL DATA	6094	6384	6754
Base	Miniature 9-Pin	Octal T-11	Miniature 9-Pin
Bulb	T-6½	3½	T-6½
Maximum Over-all Length	2½"	2½"	2½"
Maximum Seated Height	2½"	2½"	2½"
Maximum Diameter	¾"	1½"	¾"
Mounting Position	Any	Any	Any
Maximum Altitude	80,000 ft.	80,000 ft.	80,000 ft.
Maximum Bulb Temperature	300°C	300°C	300°C
Maximum Impact Shock	500G	500G	500G
Maximum Vibrational Acceleration	50G	50G	50G



HALIFAX • TORONTO • MONTREAL • CALGARY • VANCOUVER

For further data on advertised products use page 65.

World Radio History

## TECHNICAL PERSONNEL AVAILABLE

**ELECTRONIC TECHNICIAN** — age 27, with 9 years' experience in repair, service and testing desires responsible position with company engaged in development and production. Extensive professional training in radio and television, pulse and microwave techniques. Worked 3 years in Canada with VHF and UHF amplifiers and related equipment; during past 14 months head of Production Quality Control. Final goal: P. Engineering. Reply to Box 512, Electronics and Communications.

**ELECTRONIC TECHNICIAN or ENGINEERING TECHNICIAN** — age 26, with considerable experience in communications. Has worked extensively with microwave at 2000 and 6000 mcs., AM and FM radio at HF, VHF and UHF frequencies. Has also had experience with power line carrier, telephone, telemetering, remote control, multiplex, etc., equipments. Reply to Box 513, Electronics and Communications.

**ELECTRONIC TECHNICIAN** — with fifteen years' experience in all phases of electronics, desires part time work on maintenance or construction of electronic equipment. Reply to Box 514, Electronics and Communications.

**ELECTRONIC TECHNICIAN** — age 31, fifteen years' experience in radio, electronics, servicing and army communications, the last three years in Canada, seeks responsible position with opportunities for betterment. Willing to relocate anywhere. Reply to Box 515, Electronics and Communications.

**ELECTRONIC ENGINEER, P. Eng.** — Member of IRE, 1950 University of Toronto Graduate. Up-to-date Canadian experience in technical and commercial aspects of receiving and picture tubes, semiconductor diodes and transistors in equipment maker and replacement markets. Factory and technical sales experience. Seeking responsible position with growth possibilities, preferably in the semiconductor field. Reply to Box 516, Electronics and Communications.

ANOTHER FIRST BY CANADIAN APPLIED RESEARCH LTD.

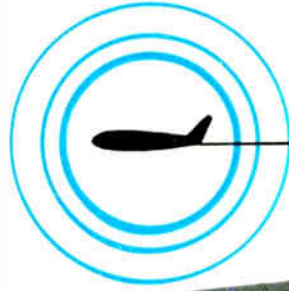

## The World's most efficient Ice Detection System . . .

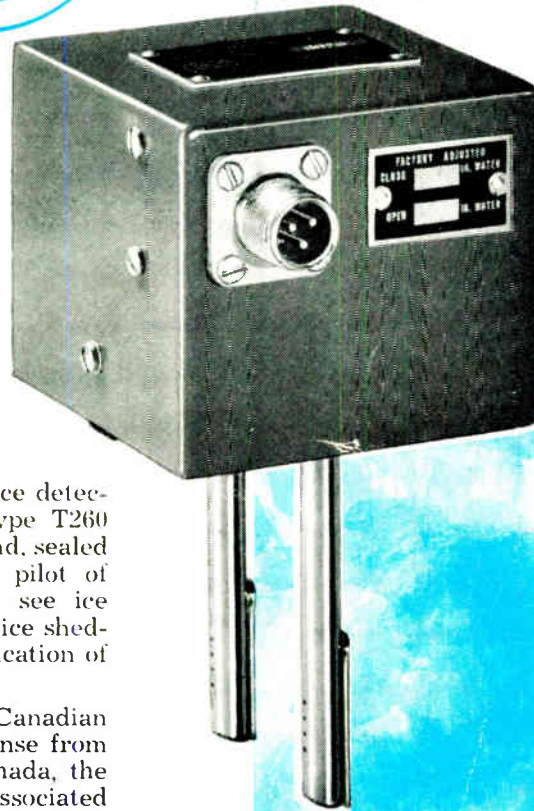

You are looking at the most efficient ice detection system yet developed — the Type T260 dual probe detector. Here is a 1 $\frac{3}{4}$ -pound, sealed package unit that either warns the pilot of icing conditions long before he can see ice forming, or automatically controls his ice shedding system — depending on the application of the 28 volt output pulse.

Engineered and manufactured by Canadian Applied Research Limited, under license from the National Research Council of Canada, the detection and reference probes and associated pressure switch are contained in a sealed unit, eliminating inter-connecting pneumatic tubing and reducing electrical cable requirements. Operationally proven by the RCAF and now standard equipment on the Avro CF-100 and its Orenda jet engines, the ice detection system is now available to private and commercial aircraft operators. Write us for literature and quotations.

### Specifications:

- Size — 3 $\frac{1}{8}$ " x 3 $\frac{1}{8}$ " x 5 $\frac{2}{32}$ "
- Probes — 3" long,  $\frac{5}{16}$ " diameter
- Weight — 1 $\frac{3}{4}$  pounds
- Power — 28 volts, 15 amps. Intermittent

### Canadian Applied Research Limited

*(formerly PSC Applied Research Limited)*

1500 O'CONNOR DRIVE  
TORONTO 16, ONTARIO, CANADA  
PLYMOUTH 5-3371

MEMBER: A. V. ROE CANADA LIMITED & HAWKER SIDDELEY GROUP





\*  
**TEFLON** may be your answer!

## what problems can it solve for you?

Capable of continuous service at temperatures as high as 250°C., Canada Wire's Teflon insulated wires and cables break the heat barrier that has held up development of many projects . . . perhaps yours! Here are the facts:

- Teflon insulation available on magnet wires, lead-in and hook-up wires and power cables in a complete range of sizes.
- Meets all these specifications, where applicable: MIL-W-19583, MIL-W-16878B (Types E & EE), MIL-W-7139A.
- Teflon-insulated wires and cables remain flexible even at -100°C.
- It is inert to practically all chemicals and solvents. Unaffected by outdoor weathering or fungus. Extremely resistant to moisture absorption.
- Teflon insulation is non-flammable—has good arc-resistance and will not track.
- Produced with excellent dielectric characteristics over a wide range of temperatures and frequencies.
- Processed for increased abrasion resistant qualities.
- Multi-conductor cables available.
- Wires of all metals and alloys, such as Resistance, Thermocouples, etc. can be coated with Teflon.
- Available in solid colours and combination of braided tracers.

\*TEFLON is a Du Pont trade mark

## Canada Wire and Cable Company Limited

Factories:

TORONTO • MONTREAL • FORT GARRY • VANCOUVER

Magnet Wire Division: Simcoe, Ontario

A Canadian Company Manufacturing and Selling Coast to Coast



TRADE MARK  
 REGISTERED