

Electronics Today

INTERNATIONAL

JANUARY 1981

Special Publication
\$3.95
MM70947

PROJECTS BOOK No.2



25 Electronic Projects

from ETI Magazine

CHARGE



CHEQUE OR MONEY ORDER

DOMINION RADIO ELECTRONICS

Address:
535 Yonge St.
Toronto, Ont.
M4Y 1Y5
Phone: (416) 922-1818
No collect calls please.

KITS

LIGHTING EFFECTS
*3 channel 500 watt Colour Organ \$ 21.95
*3 Channel 1500 watt Colour Organ \$ 32.95
*16 Channel Light Chaser ... (up-down-pulse) \$22.95
16 Channel 8-mode Programmable Light Chaser ... \$32.95

AUDIO KITS
* 1 watt Audio Amp 17.95
* 5 watt Audio Amp \$19.95

POWER SUPPLY KITS
* 0-24 volts 1 amp \$ 39.95
* \pm 5 volt and +12v @ 1 amp .. \$14.95
* \pm 12 volts and +5v @ 1 amp .. \$14.95
* Kits come with etched, drilled and plated P.C. boards.

RESISTORS

Values from 1 ohm to 10 meg. 1/4 or 1/2 watt. Still Only 3 1/2¢ each.

CAPACITORS NISSEI POLYESTER FILM

	Price	uF	Price	uF	Price	uF	Price
.0010	.20	.012	.20	.0027	.20	.027	.25
.0012	.20	.015	.20	.0033	.20	.033	.25
.0015	.20	.047	.30	.0039	.20	.039	.25
.0018	.20	.056	.30	.0047	.20	.12	.35
.0022	.20	.068	.30	.0056	.20	.15	.40
.0068	.20	.082	.30	.018	.25	.18	.45
.0082	.20	.10	.30	.022	.25	.22	.50
.010	.20						

CAPACITORS

ELNA ELECTROLYTIC AND TANTALUM CAPACITORS

AXIAL LEAD

uF	WV(SV)	WV(SV)	WV(SV)
	16 (20)	25 (32)	50 (63)
1			.25
2.2			.25
3.3			.25
4.7			.25
10	.25	.25	.30
22	.30	.30	.35
33	.30	.35	.35
47	.35	.35	.35
100	.35	.40	.50
220	.35	.40	.55
330	.40	.50	.65
470	.45	.55	.75
1000	.60	.70	1.00
2200	.75	1.05	
3300	1.05	1.35	
4700	1.65	1.95	

RADIAL LEAD

uF	WV(SV)	WV(SV)	WV(SV)
	16 (20)	25 (32)	50 (63)
1			.25
2.2			.25
3.3			.25
4.7		.25	.25
10	.25	.25	.25
22	.25	.25	.25
33	.25	.25	.30
47	.25	.30	.35
100	.30	.30	.35
220	.30	.35	.45
330	.35	.40	.60
470	.40	.50	.85
1000	.60	.75	
2200	1.00		

DIPPED SOLID TANTALUM Capacitance Tolerance +/-20%

uF	WV(SV)	WV(SV)	WV(SV)
	16 (20)	25 (32)	35 (46)
0.22			.35
0.33			.35
0.47			.35
0.68			.35
1.0			.35
1.5			.35
2.2			.35
3.3			.35
4.7	.35		.35
6.8	.35		.35
10	.45	.50	.55
15	.50	.55	.85
22	.55	.65	1.35
33	.65	1.20	2.25
47	1.95	2.75	
68	2.75		
100	3.50		

POWER SUPPLY

1400	16	.65	6800 Com	25	6.95
1600	16	.65	15000 RPE	10	4.50
2200	16	.75	12000 COM	40	6.95
2500	10	.65	14000 COM	40	7.50
1000 Can	16	1.50	15000 RPE	10	4.50
4700 Elec	40	1.75	15000 CAN	25	5.50
4700 COM	100	8.95	15000 COM	50	11.95
6800 RPE	25	6.95	44000 COM	35	14.95
			80000 Com	20	14.95

TTL (DIGITAL) IC's

7400	.45	7423	.55	7472	.55	74123	1.10
7401	.45	7425	.65	7473	.70	74125	.98
7402	.45	7426	.65	7474	.70	74141	1.15
7403	.40	7427	.55	7475	.98	74150	2.50
7405	.75	7430	.45	7476	.70	74151	.98
7406	.85	7440	.45	7485	1.40	74154	2.50
7407	.95	7441	1.35	7486	1.50	74160	1.75
7408	.75	7442	1.35	7490	1.15	74164	1.25
7409	.45	7446	1.45	7491	1.15	74177	1.45
7410	.39	7447	1.65	7492	.85	74190	1.65
7411	.55	7448	1.75	7493	.85	74191	1.60
7412	.55	7454	.65	74121	.65	74192	1.55
7413	.85	7460	.40	74122	.90	74193	2.95
7420	.45						

4000 SERIES CMOS IC's

4000	.50	4015	1.50	4026	2.35	4044	1.05
4001	.45	4016	.50	4027	.85	4045	1.78
4002	.45	4017	1.30	4028	1.50	4047	1.09
4006	1.25	4018	.75	4029	1.25	4049	.45
4007	.20	4019	1.65	4030	.40	4050	1.50
4008	1.15	4020	1.25	4033	1.95	4069	.45
4010	.75	4021	1.95	4040	1.29	4510	1.95
4011	.65	4024	1.25	4041	2.05	4511	1.95
4013	.65	4025	.40	4043	1.30	4516	1.35
4014	.90						

Micro-Processor IC

LS SERIES	PRICE						
74LS00	.85	74LS32	.80	74LS109	.80	8080	8.95
74LS04	.60	74LS33	.60	74LS125	1.00	8212	3.00
74LS08	.65	74LS38	.80	74LS132	1.40	8216	3.50
74LS10	1.50	74LS74	.70	74LS151	1.60	8224	8.95
74LS11	.75	74LS75	1.10	74LS155	1.10	8228	6.25
74LS20	.70	74LS86	.70	74LS247	1.18	8255	8.95
74LS30	.65	74LS90	.95	Z80	14.95	4116	7.95

1 Watt zener diodes

49CEA	TYPE #	VOLTAGE	WATTAGE			
	BZX61-C75	3.3V	1W	IN758A	10	1W
	IN4623	4.3	1W	IN759A	12V	1W
	IN751A	5.1	1W	IN964B	13	.5
	IN4733A	5.1	1W	3E216D5	14	1W
	IN4734	5.6	1W	IN966	16	1W
	14-515-04	6.2	1W	BZX61-C18	18	1W
	114574	6.2	.5	H220C	20	1W
	IN753A	6.2	1W	BZX61-C20	20	1W
	IN754A	6.8	1W	GE5028	20	.1W
	IN752A	5.6	1W	14-515-31	22	.5
	17-515-35	6.8	1W	IN4751A	30	1W
	HZ7B	7	1W	BZX61-C30	30	1W
	IN755A	7.5	1W	BZX79C36	36	.5W
	IN74738A	7.5	1W	BZX61-C56	56	1W
	IN757A	9.1	.5W	IN5045	56	.5W
	IN4739A	9.1	.5	BZX61-C68	68	1W
	BZX61-C9V1	9.1	1W	IN4764A	100	1W
	IN757A	9.1	1W	IN5593B	183	1W

Transistor replacement list

PART No	REPLACE	DLR. PRICE						
2N2906	- ECG - 159	1.79	2SC1025-	ECG - 175	2.95	2SC940	- ECG - 283	11.95
BF-245	- ECG - 133	1.99	2SC1304-	ECG - 124	2.59	2SC939	- ECG - 163A	12.95
2N3391	- ECG - 199	1.15	2SC1104-	ECG - 124	2.59	BF245A	- ECG - 133	2.25
BF-199	- ECG - 161	1.59	2SD24Y	- ECG - 124	2.59	2SC945	- ECG - 199	.89
TIS 92	- ECG - 128	2.40	AD162	- ECG - 131	3.99	2SC1685-	ECG - 199	.89
BD136	- ECG - 185	2.99	AD139	- ECG - 104	1.89	2SC454	- ECG - 289	1.59
BD135	- ECG - 184	2.79	2SC1160-	ECG - 175	3.50	2SC839	- ECG - 123A	1.59
2SC1505-	ECG - 198	2.95	2N3614	- ECG - 121	3.95	2N6558	- ECG - 191	4.25
2SC1520-	ECG - 198	3.00	2SC1106-	ECG - 162	9.95	2SC458	- ECG - 289	1.69
2SC1507-	ECG - 198	2.95	BD182	- ECG - 130	4.79	2SB77	- ECG - 102A	1.99
2SC1446-	ECG - 198	2.95	BU205	- ECG - 165	9.95	2N1613	- ECG - 128	1.99
MJE2370-	ECG - 242	3.59	BU108	- ECG - 165	9.95	AC-187	- ECG - 103A	2.30

* All Semiconductors prime stock
* Use DRE quality components for optimum results
* First grade quality components at surplus pricing
* This is only a partial listing of our semiconductor line
* Catalogue available upon request
* Minimum order \$10.00

PRICES SUBJECT TO CHANGE WITHOUT NOTICE

Electronics Today

January 1981

High Performance Stereo Preamplifier7
Moving Coil Preamp.13
Two projects to take care of the front end of our Series 4000 system.



Power Supply18
Suitable for the Series 4000 stereo system.



60W Amplifier Module . . .21
Really excellent specifications and the output stage for the Series 4000.



Series 4000 Amplifier27
How the individual projects mate together to give you an excellent Hi-Fi system.



Rumble Filter34
How to eliminate unwanted low frequencies from your Hi-Fi system.



Dynamic Noise Filter36
Provides significant improvement in the perceived signal-to-noise ratio of your tape deck.



Logic Probe39
A useful piece of test gear for digital circuitry.



Battery Condition Indicator44
Test the state of your batteries with this handy checker.



Cable Tester46
Of considerable interest to those who are continually using mobile equipment.



Function Generator49
Several different waveforms can be produced over a wide range of frequencies.



Rain Alarm54
Produces an audible warning as soon as it begins to rain.



Egg Timer56
Hard or soft — this kitchen gadget will time your breakfast.



This is a Special Publication from:
Electronics Today International
(Canada) Limited
Unit 6, 25 Overlea Blvd.
Toronto, Ontario M4H 1B1
Telephone (416) 423-3262
Printed by: RBW Inc., Owen Sound, Ont.
Newsstand Distribution: Master Media

Publisher and Editor
HALVOR W. MOORSHEAD

Assistant Editor
JOHN VAN LIERDE

Production
SARAH-JANE NEWMAN

Subscription Department
BEBE LALL
CINDY BAKER

Accounts Department
NANCY ALLEN

Advertising Manager
MARK CZERWINSKI

Marketing Representative
SENGA HARRISON

Advertising Services
CAROLYN WYATT

Projects Book No.2

Patch Detector 59
Will unearth the dents in an automobile that has been filled rather than reshaped.



Digital Tachometer 61
Gives you an accurate indication of your engine speed.



Variwiper 64
Converts your single speed wipers to intermittent operation.



Porch Light 67
Automatically switches on your porch light when the sun sets.



Spirit Level 70
Doesn't stop you drinking but does show you the effect on your reactions.



Party Grenade 74
An electronic version of the old 'hot potato' party game.

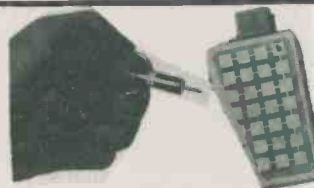

Two Octave Organ 76
A neat little, inexpensive, monophonic organ.

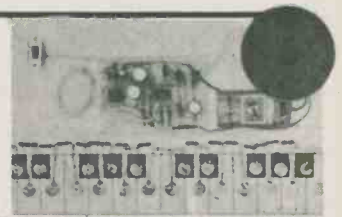

Light Chaser 79
Make your own light flashing unit.



Test Bench Amplifier 83
A well designed and useful addition to your test gear.



Shutter Speed Timer 88
Accurately test the shutter speed settings on your camera.



Ni-Cad Charger 92
A constant current charger for use with Ni-Cad cells.



ETIWet 95
Our automatic waterer to keep your plants in peak condition.



COPYRIGHT
All material is subject to worldwide copyright protection. All PCB patterns are copyright and no company can sell boards to our design without our permission.

LIABILITY
Whilst every effort has been made to ensure that all constructional projects referred to in this magazine will operate as indicated efficiently and properly and that all necessary components to manufacture the same are available, no responsibility whatsoever is accepted in respect of the failure for any reason at all of the project to operate efficiently or at all, whether due to any fault in design or otherwise and no responsibility is accepted for the failure to obtain component parts in respect of any such project. Further no responsibility is accepted in respect of any injury or damage caused by any fault in the design of any such project as aforesaid.

COMPONENT NOTATION AND UNITS
We normally specify components using an International standard. Many readers will be unfamiliar with this but it's simple, less likely to lead to error and will be widely used everywhere sooner or later. ETI has opted for sooner!
Firstly decimal points are dropped and substituted with the multiplier, thus 4.7uF is written 4u7. Capacitors also use the multiplier nano (one nanofarad is 1000pF). Thus 0.1uF is 100n, 5600pF is 5n6. Other examples are 5.6pF=5p6, 0.5pF=0p5.
Resistors are treated similarly: 1.8M ohms is 1M8, 56k ohms is the same, 4.7k ohms is 4k7, 100 ohms is 100R and 5.6 ohms is 5R6.

PCB SUPPLIERS
The magazine does not supply PCBs but these are available from the following companies. Not all companies supply all boards. Contact these companies direct for ordering information.
B&R Electronics, P.O. Box 6326F, Hamilton, Ontario, L9C 6L9
Spectrum Electronics, Box 4166, Stn 'D', Hamilton, Ontario, L8V 4L5
Wentworth Electronics, R.R. No.1, Waterdown, Ontario L0R 2H0
Danolnths Inc. P.O. Box 261, Westland, MI 48185, USA.
Exceltronix Inc., 319 College St., Toronto, Ontario, M5T 1S2
Arkon Electronics Ltd., 409 Queen St. W., Toronto, Ontario, M5V 2A5.

Back Issues From ETI



February 1977

Features: CN Tower, Blorhythm Calculator, VCT, 555 Timer Applications, Yamaha B1 Review, Scope Test Your Car.

Projects: 5W Stereo Amp, Phillips Speaker System, Reaction Tester, Patch Detector, Heads or Tail, SCR Tester.



August 1978

Features: Getting into Shortwave, Using a 'Scope, Semiconductor Guide, Intro To Amateur Radio 2.

Projects: Sound Level Meter, 2 Chip Siren, Induction Balance Metal Locator, Porch Light.



May 1977

Features: Projection TV, 741 Cookbook, Easier Way to Make PCBs, Choosing a Microcomputer.

Projects: Burglar Alarm, Ceramic Pre-amp, Ni-Cad Battery Charger, Power Supply, Fuzz Box, Stereo Rumble Filter.



October 1978

Features: Personal Computing Commentary, CMOS Quickies, SSB by Phasing, History of Electronics In Medicine.

Projects: UFO Detector, CCD Phaser, Strobe.



July 1977

Features: A Generation Away, I²L Explained, CB Supplement, Intro to Computers.

Projects: Mastermind, DVM, Overled, Turn Indicator Cancellor.



June 1979

Features: Op Amps, Inside Info From Ultrasound, Computer Catalogue.

Projects: Colour Organ, LCD Thermometer, Colour Sequencer, VHF Antenna, Bip Beacon.



May 1978

Features: Tools Catalogue, Data Sheet Special on Memory Chips, Microbiology.

Projects: White Line Follower, Add-on FM Tuner, Audio Feedback Eliminator.

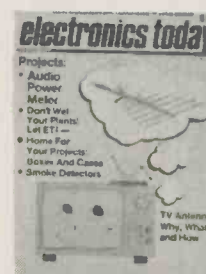

August 1979

Features: Casing Survey, Smoke Detectors, TV Antennas, Reed Switches, Magnetic Field Audio Amp, Industrial Electronics.

Projects: Audio Power Meter, Shoot-out, ETI-Wet Plant Waterer.



July 1978

Features: Digital Multimeter Survey, Pinball Machines, Intro to Amateur Radio, TI Programmer.

Projects: Real-Time Analyser, Electronic Race Track, Proximity Switch, Accenuated-Beat Metronome.



December 1979

Features: LM10 Circuits, Police Radar Speed Meters, Practical Guide to Triacs, Fluorescent Displays.

Projects: High Performance Stereo Preamp, Photographic Development Timer, Logic Trigger.

The back issues shown and described above are available direct from us. Please order by Issue, not by feature. They are \$3.00 each or 5 for \$10.00.

BACK ISSUES
ETI Magazine
Unit 6,
25 Overlea Boulevard
Toronto, Ontario
M4H 1B1

High Performance Stereo Preamplifier

This is designed to complement our 60 watt low distortion amplifier module and forms part of a complete stereo system, our "Series 4000" project.

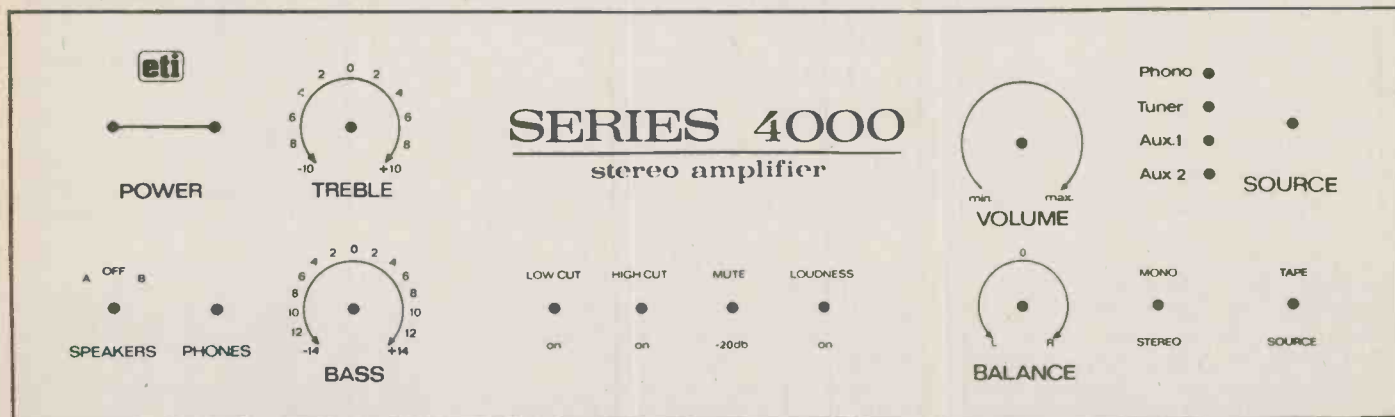

THIS stereo preamplifier is designed to drive two 60 watt, low distortion amplifier modules described elsewhere.

The requirements for this preamplifier/control unit were set down after many hours of office discussion. In fact it would be fair to say that the final design was evolved, rather than conceived.

Amongst the first requirements were low hum and noise and low distortion — much lower distortion than the amplifier modules it would be required to drive. Low distortion in a preamplifier is relatively easy to achieve and makes the subsequent addition of a high quality class A headphone amplifier worthwhile.

In the final design, we feel we have achieved performance figures well up front amongst commercial equipment.

Features considered essential included loudness, high cut and low cut filters. These are common in commercial preamp/control units but lacking on most kit designs. The low cut filter incorporated in our design will effectively reduce bass rumble while the high cut filter is useful for reducing tape hiss or 'monkey chatter' and heterodynes from an AM tuner.

The disc amplifier stage of a preamp must be capable of handling very high input signals before clipping to preserve

dynamic range, especially as moving coil cartridges with voltage boosting transformers and/or amplifiers are finding increasing popularity. The disc input of this design can handle 400 mV peak-to-peak before clipping, giving it a dynamic range in excess of 100 dB!

Finally, and by far the most difficult of our requirements to implement, was the idea that all switches and potentiometers be mounted directly onto the pc board, with as few links and external leads as possible. All this, while preserving an attractive and stylish front panel layout! The advantage of this is that assembly is easy, and straightforward and there is less room for wiring errors to creep in and, should it be necessary, the board can be removed for servicing in its complete, functional form. All interconnections to and from the board are via RCA sockets using standard audio 'jumper' leads.

The 60 watt power amplifier module and this preamp/control unit project form the basis of our "Series 4000" high performance stereo amplifier project, complete details of which we plan to present next issue.

Construction

All the components, including the pots, switches and LEDs, are mounted onto the pc board. The board is then fixed,

component side forward, behind the mounting panel of the case using standard 25 mm spacers and countersunk screws. A dummy fascia — with the control markings etc on it, is subsequently held in place by the switch nuts.

If all directions are followed, then construction is quite straightforward — it's easier to do than describe!

Firstly, the mounting panel and fascia must be cut and drilled to the dimensions shown on the drawing (or, you can mount everything off board, as shown at the end of this article). The drilled pc board may be used as a template. Dimensions shown in brackets refer to the fascia panel which must be cut slightly smaller if you wish to use the same case for your stereo as we have.

The holes for the pot shafts are only 7 mm in diameter on the fascia panel to ensure correct knob alignment. Countersunk holes are drilled in the mounting panel, but not in the fascia, for the bolts securing the pc board through the spacers.

Once the mounting panel and fascia are drilled, carefully check the alignment of all holes with the corresponding holes in the pc board. The drilling must be reasonably accurate.

STEREO PREAMPLIFIER SPECIFICATIONS (Measured on prototype)

<p>Distortion 0.015% at 1 kHz 0.015% at 10 kHz (For all inputs, with 500 mV RMS output — distortion is mainly 2nd harmonic).</p> <p>Hum and Noise 83 dB unweighted (With respect to 10 mV phono input).</p> <p>Frequency Response Phono: Within 0.5 dB of RIAA from 20 Hz to 20 kHz (Follows new IEC curve).</p> <p>Other inputs: 20 Hz to 20 kHz ± 0.5 dB</p> <p>Subsonic rolloff: 6 dB/octave below 20 Hz</p>	<p>Output 7 V p-p before clipping</p> <p>Tape output 150 mV RMS</p> <p>Sensitivity For 500 mV RMS output phono: 3 mV RMS other: 150 mV RMS (Phono overload level is 400 mV p-p).</p> <p>Tone controls Bass: ± 13 dB at 50 Hz Treble: ± 11 dB at 10 kHz</p> <p>Filters High: 6 dB/octave, -3 dB at 5 kHz Low: 6 dB/octave, -3 dB at 100 Hz</p> <p>Loudness8 dB boost at 15 kHz and 10 kHz.</p> <p>Mute switch20 dB attenuation</p>
--	--

Once this mechanical work is completed the components may be mounted on the pc board. Start with the RCA sockets. Take care not to use too much force on the nuts and check that electrical contact has been made to the ground plane of the pcb using an ohm-meter. Join the centre pin of the RCA sockets to the pc board pads using lengths of tinned copper wire — refer to the overlay.

Mount the potentiometers next so that their terminals are directly above the pads on the pc board. The lower pot terminals can be cut, bent down and soldered directly onto the pads. Connect the upper pot terminals to the pc board, as shown in the overlay, using tinned copper wire.

All switches are mounted on the board using pig tail leads. The rotary is a

type commonly available almost anywhere. When mounting switches on the pcb, make sure all switch and pot bushings are in the same plane.

Once the major parts are assembled onto the pc board, all the minor components may be loaded and soldered in place. Make sure that any large components (electrolytics particularly) are less than 25 mm high, otherwise they will foul the front panel. Check that all transistors, tantalums and electrolytics are correctly oriented. Refer to the overlay as you proceed.

The switches and LEDs must be mounted and spaced correctly off the pc board. Solder 50 mm lengths of tinned copper wire onto each of the switch terminals and LED leads (see illustration). Pass the wires through the corresponding pc board holes for these

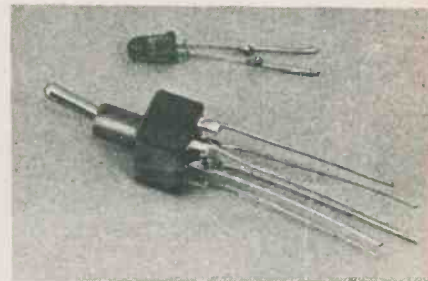

Above: The switches and LEDs have lengths of wire soldered on to them so that they can be inserted into the pcb before being attached to the front panel. They can then be soldered in place. This procedure ensures that there is no strain on the joints. Below: The completed unit.

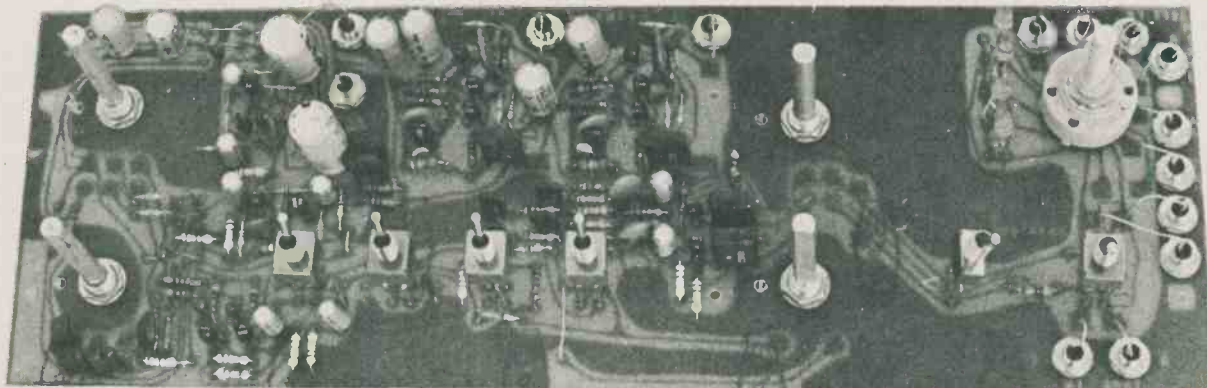

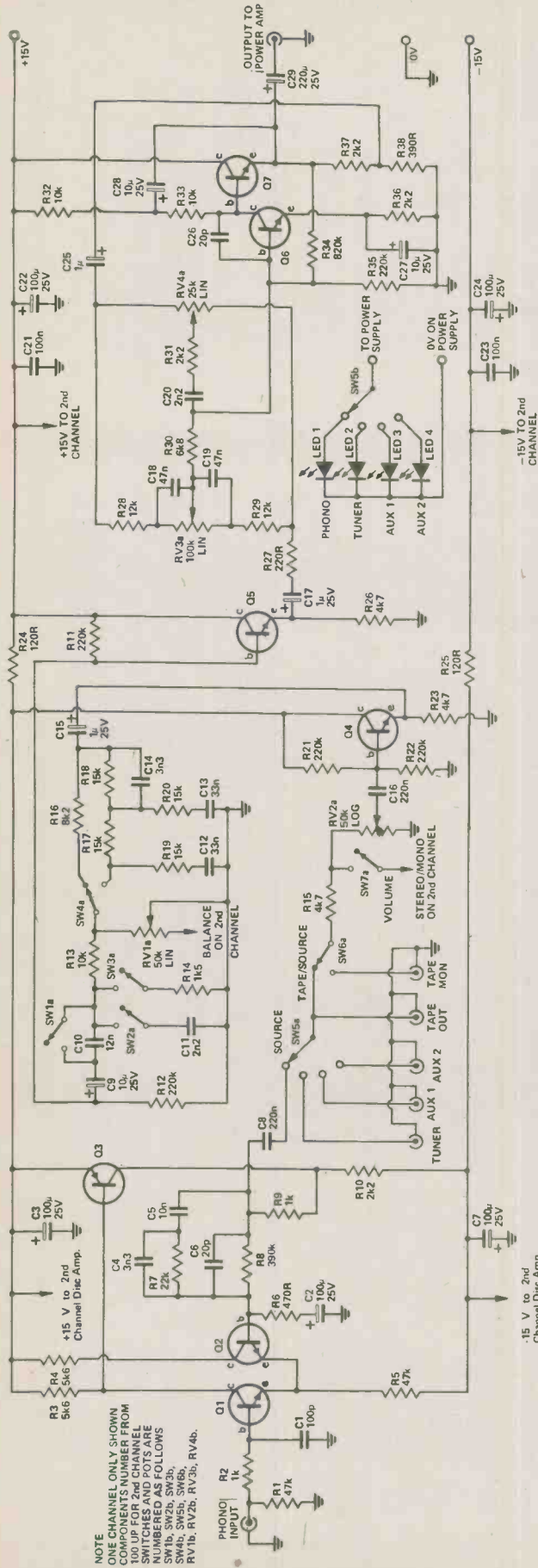

Fig. 1. Preamplifier circuit diagram. Only one channel has been shown for clarity. The component numbering of the other channel begins at 101.

HOW IT WORKS

The signal from a magnetic cartridge is fed to the base of Q1 via a low pass filter, (R2 and C1) for attenuation of radio frequencies. Q1 and Q2 form a differential pair, each half operating at low collector current to minimise noise. The output of the differential pair is taken from the collector of Q1 and further amplified by Q3. Feedback is taken to the base of Q2, the negative input of the differential pair, through the RIAA equalisation network. Overall gain of the phono stage is set by the ratio of the feedback network impedance to the value of R6.

Subsonic bass roll-off of 6 dB/octave, to conform to the new IEC 65 specification, is achieved by a high pass filter consisting of C8 and RV2.

Output from the disc preamplifier is then fed via the Source Switch (SW5), Tape-Source switch (SW6), R15 and the volume control (RV2), to an emitter follower, Q4. This emitter follower presents a high impedance for the aux inputs and a constant impedance for driving the filters.

When switched in, the loudness network boosts the high and low frequencies with respect to the midrange. In actual fact, all frequencies are attenuated but the midrange is attenuated more. When the loudness is switched out, R16 approximates the impedance of the network.

Muting is achieved by switching R14 to earth. The ratio of R14 to R13 sets the attenuation to 20 dB. C11 shunts high frequencies to earth for high cut, while C10 reduces low frequency content when switched in, providing low cut.

A second emitter follower, Q5, presents a constant impedance to the filters and acts as a low impedance source to the tone control stage.

A Baxandall tone stage is used here, a common circuit in many designs. Q6 is a gain stage with a bootstrapped collector load, via C28, to the output. Bootstrapping increases the gain by increasing the effective collection load impedance. Q7 is an emitter follower connected directly to the collector of Q6. This provides a very low output impedance. DC bias for Q6 is

taken from the output.

Some of the output signal is fed back to the tone controls and split into high and low frequencies by RV3 and RV4. By adjusting the controls the percentage of the input to the negative feedback signal appearing at the base of Q6 can be varied, thereby varying the overall gain of the amplifier at either high or low frequencies. The gain of the tone stage is set by the ratio of R37 to R38. As R38 is reduced in value the negative feedback is reduced and therefore the overall gain is increased.

To preserve the very low output impedance of the pre-amplifier the balance control is placed ahead of, rather than after, the tone stage.

Power supply filtering and decoupling is provided by 100 μ F capacitors and resistors in each rail.

Source indication is by LEDs from the spare section of the source switch. No current limiting resistor is on the pc board for the LEDs as one will be included in the power supply.

components but do not solder them in place yet. Check that the LED leads are the right way round.

Assemble the pc board onto the case mounting panel (using the 25 mm spacers and countersunk screws). Place the fascia over the front panel, securing it in place with the switch nuts (three hands and a prehensile nose might help! ... a little sticky tape and deft juggling is all that's really necessary). Once you've got it all together the protruding wires may be soldered to the pc board. Ensure that no short circuits have occurred.

That completes the assembly. For servicing purposes the pc board and all switches, LEDs and pots — all the operating controls — may be removed simply by undoing several nuts, removing the fascia and the countersunk screws beneath.

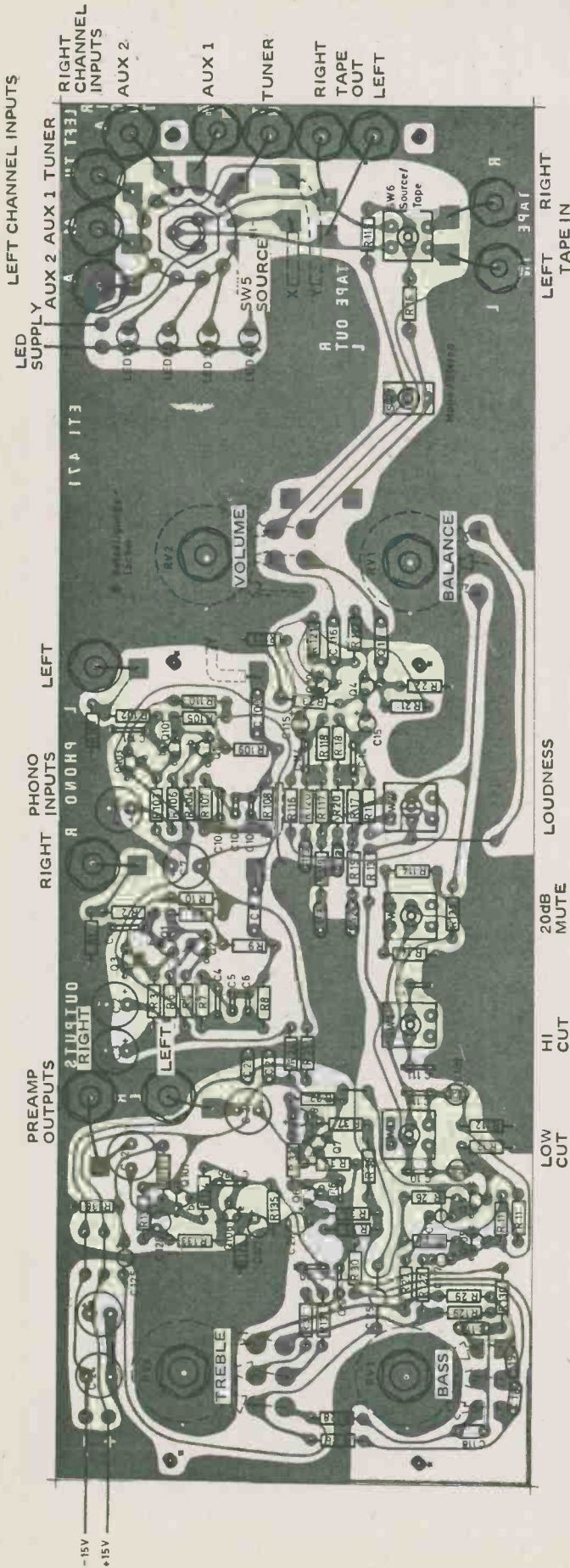

PARTS LIST

- Resistors** all 1/4W 5%
- R1, R101 47k
 - R2, R102 1k
 - R3, R4, R103 5k6
 - R104 47k
 - R5, R105 47k
 - R6, R106 470R
 - R7, R107 22k
 - R8, R108 390k
 - R9, R109 1k
 - R10, R110 2k2
 - R11, R12 220k
 - R13, R113 10k
 - R14, R114 1k5
 - R15, R115 4k7
 - R16, R116 8k2
 - R17 - R20
 - R17, R120 15k
 - R21, R22 220k
 - R23, R123 4k7
 - R24, R25 120R
 - R26, R126 4k7

- R27, R127 220R
- R28, R29
- R128, R129 12k
- R30, R130 6k8
- R31, R131 2k2
- R32, R33
- R132, R133 10k
- R34, R134 820k
- R35, R135 220k
- R36, R37
- R136, R137 2k2
- R38, R138 390R

Potentiometers

- RV1 50k single linear
- RV2 50k dual log
- RV3 100k dual linear
- RV4 25k dual linear

Capacitors

- C1, C101 100p ceramic
- C2, C3, C102 100µ 25V electro
- C4, C104 3n3 mylar
- C5, C105 10n mylar

- C6, C106 20p ceramic
- C7 100µ 25V electro
- C8, C108 220n
- C9, C109 10µ 25V electro
- C10, C110 12n mylar
- C11, C111 2n2 mvlar
- C12, C13
- C112, C113 33n mylar
- C14, C114 3n3 mylar
- C15, C115 1µ 25V tantalum
- C16, C116 220n mylar
- C17, C117 1µ 25V tantalum
- C18, C19
- C118, C119 47n mylar
- C20, C120 2n2 mylar
- C21 100n mylar
- C22 100µ 25V electro
- C23 100n mylar
- C24 100µ 25V electro
- C25, C125 1µ 25V tantalum
- C26, C126 20p ceramic
- C27, C28
- C127, C128 10µ 25V electro
- C29, C129 220µ 25V electro

Semiconductors

- Q1, Q2
- Q101, Q102 MPS 6515
- Q3, Q103 2N5086
- Q4-Q7, Q104
- Q107 MPS 6515

LED1-LED4 red LED

Switches (see text)

- SW1-SW4 DPDT min toggle switch
- SW5 3 pole 4 pos rotary switch
- SW6 DPDT min toggle switch
- SW7 SPDT min toggle switch

Miscellaneous

- 14 RCA panel mounting single hole sockets, pcb, tinned copper wire, length shielded cable, 25 mm spacers, 30 mm screws, nuts, mounting panel and fascia plate.

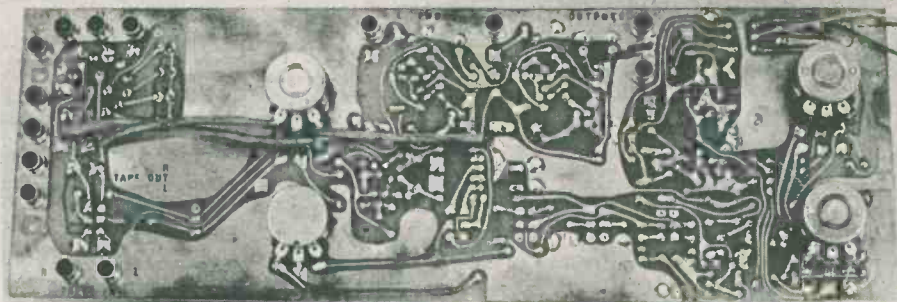
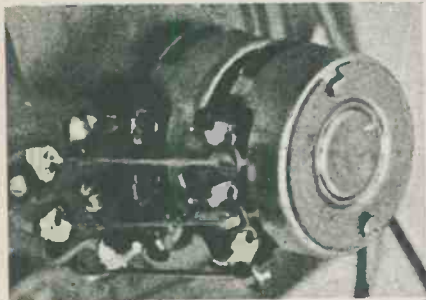

Potentiometer connections to the pcb are made via lengths of tinned copper wire.

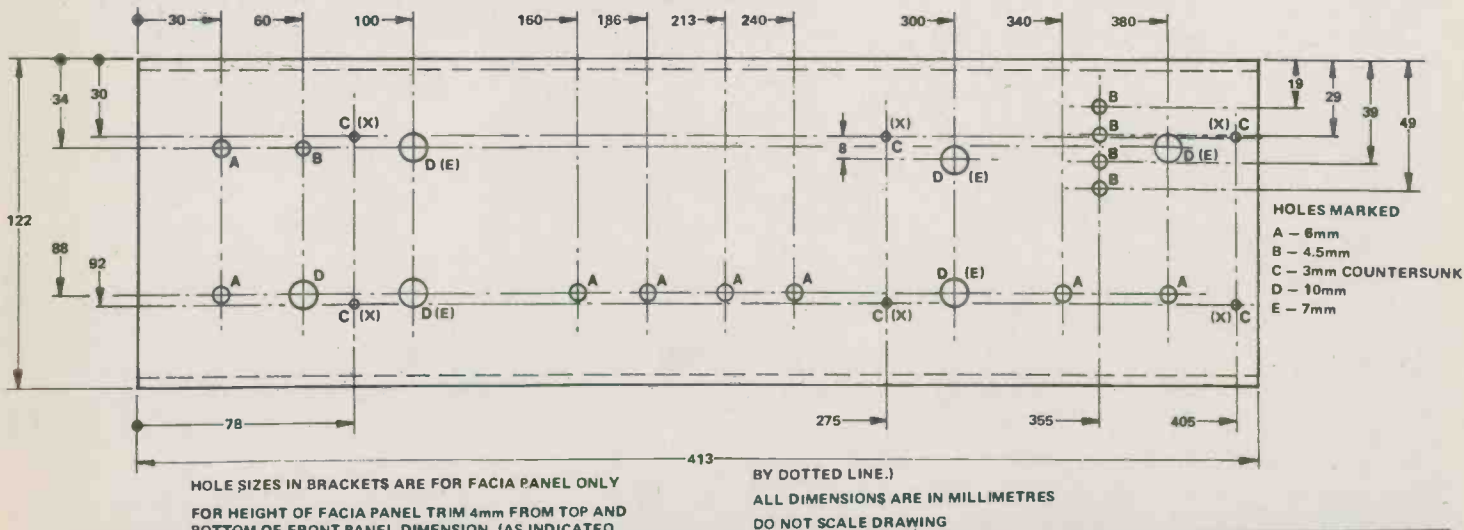

ORION

Electronic Supplies Inc.

ELECTRONIC DISTRIBUTOR

INDUSTRIAL - EDUCATIONAL - COMMERCIAL - HOBBYIST



Authorized distributor for RCA, COSMAC VIP

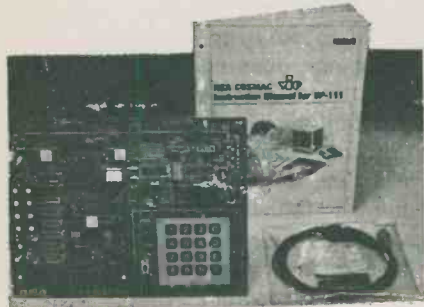

New! VP 111 **\$129.50**
Microcomputer....

- RCA 1802 Microprocessor.
- 1K Bytes static RAM.
- Expandable on-board to 4K.
- Expandable to 32K Bytes total.
- 512 Byte ROM operating system.
- CHIP-8 interpretive language or machine language programmable.
- Hexadecimal keypad.
- Audio tone generator.
- Single 5-volt operator!

Assembled* and tested.

- Video output to monitor or modulator.
 - Cassette interface—100 Bytes/sec.
 - Instruction Manual with 5 video game listings, schematics, CHIP-8, much more.
- Ideal for low-cost control applications.
Expandable to full VIP capability with VP-114 Kit.

*User need only connect cables (included) a 5-volt power supply and speaker.

START WITH ORION FOR A NEW ERA IN THE WORLD OF ELECTRONICS

We have the most complete selection of electronic components.

Full line of TTL, CMOS, Linear, ICs, Computer Interface, Support Chips and CPUs.

SIEMENS

DISK DRIVE ★SALE★

- FDD 100-5 Single 5".....\$425.75
- FDD 200-5 Double 5".....\$597.75
- FDD 100-8 Single 8".....\$649.75
- FDD 200-8 Double 8".....\$1175.75

Visa/Master Charge add 3%

Please send more information on Siemens disk drives.

AP Products

The all-new line of ACE All-Circuit Evaluators WITH POWER

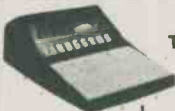

POWERACE 103
Triple-output power supply for prototyping both linear and digital circuits.

POWERACE 101
The general purpose model for prototyping all types of circuits.

POWERACE 102
The complete digital prototyping lab with FREE logic probe built in!

\$159.00

\$107.93

\$159.00

Orion Electronic Supplies Inc.

40 Lancaster Street West
Kitchener, Ontario N2H 4S9
(519) 576-9902

Master Charge & Visa, COD, Cheque, Money Orders accepted. CODs, shipping & insurance extra. Write for our FREE catalogue!

lets you create and play video games and generate graphics!!!!

- Easy to operate • Easy to program
- A challenge for the serious hobbyist
- AND It's Expandable!!!

VIP-Hobby Computer An assembled micro-computer. Built-in cassette interface, video interface, 10-key keypad, 2K RAM, ROM operating system, CHIP-8 language and power supply. Output drives video monitor or rf modulator.

RCA COSMAC VIP



\$259.75



VIP Color Board Depicts VIP output in color! Program control of four background colors and eight foreground colors. CHIP-8X language adds color commands. Includes two sockets for VP-580 Expansion Keyboards.

\$94.75



VIP Simple Sound Board Provides 256 different frequencies in place of VIP single-tone output. Ideal for use with VP-590 Color Board for simultaneous color and sound. Great for simple music or sound effect! Includes speaker.

\$39.75



VIP Super Sound Board Turn your VIP into a music synthesizer! Provides two independent sound channels. Frequency, duration and amplitude envelope (voice) of each channel under program control. On-board tempo control. Provision for multi-track recording or slaving VIP's. Output drives audio preamp. Does not permit simultaneous video display.

\$67.50



VIP Super Sound 4-Channel Expander Package VP-551 provides four (4) independent sound channels with frequency duration and amplitude envelope for each channel. Package includes modified VP-550 super sound board, VP-576 two board expander, data cassette with 4-channel PNH-B program, and instruction manual. Requires 4K RAM system and your VP-550 Super Sound Board.

\$99.75

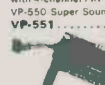

VIP Expansion Keyboard Adds two-player interactive game capability. 18-key keypad with cable. Connects to sockets provided on VP-590 Color Board or VP-585 Keyboard Interface Board.

\$27.98



VIP Keyboard Interface Board Interfaces two VP-580 Expansion Keyboards directly to the VIP. Not required when VP-590 Color Board is used.

\$22.50



VIP Memory Expansion Board Plug-in 4K static RAM memory. Jumper locates RAM in any 4K block in first 32K of VIP memory space.

\$128.70



ASCII Keyboard Fully encoded. 128-character ASCII alphanumeric keyboard. 58 light touch keys (2 user-defined). Selectable "Upper-Case-Only".

\$99.75

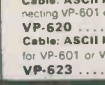

ASCII/Numeric Keyboard ASCII Keyboard identical to VP-601 plus 16 key numeric entry keyboard for easier entry of numbers.

\$129.95



ASCII Keyboards to VP-711 Flat ribbon cable, 24 in. length, for connecting VP-601 or VP-611 and VP-711. Includes matching connector on both ends.

\$27.50



ASCII Keyboards Flat ribbon cable, 36 in. length with mating connector for VP-601 or VP-611 Keyboards. Other end is unterminated.

\$27.50

Prices subject to change without notice.

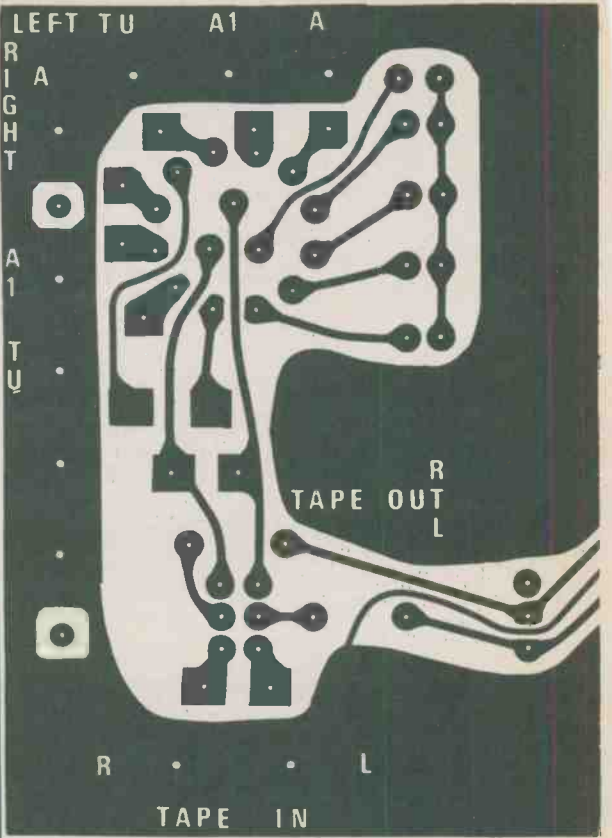
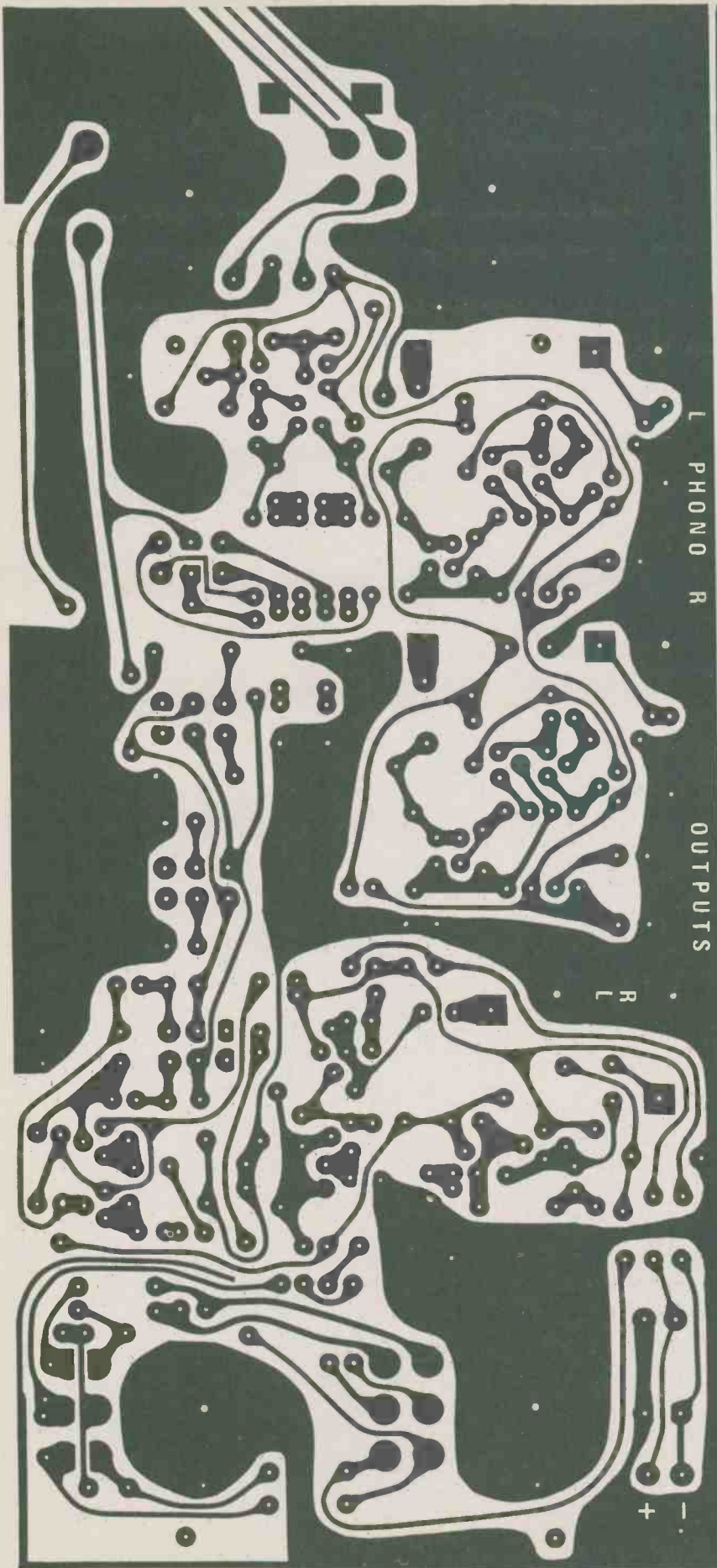

The printed circuit for the preamplifier. Because of its size, we had to cut it up. Full size copies are available for \$1.00 and a stamped self addressed business envelope. We will not process orders without an SASE.

**YOUR
COMMUNITY
NEEDS
YOU NOW.**

Please give generously to
the United Way

**YOUR
NEIGHBOURS
WILL THANK
YOU**



United Way

Series 4000 Moving Coil Preamp

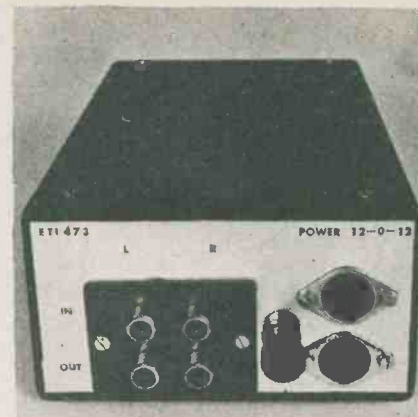

Designed to complement our popular Series 4000 stereo amplifier, this project features performance equal to, or better than, top quality commercial preamps currently available.

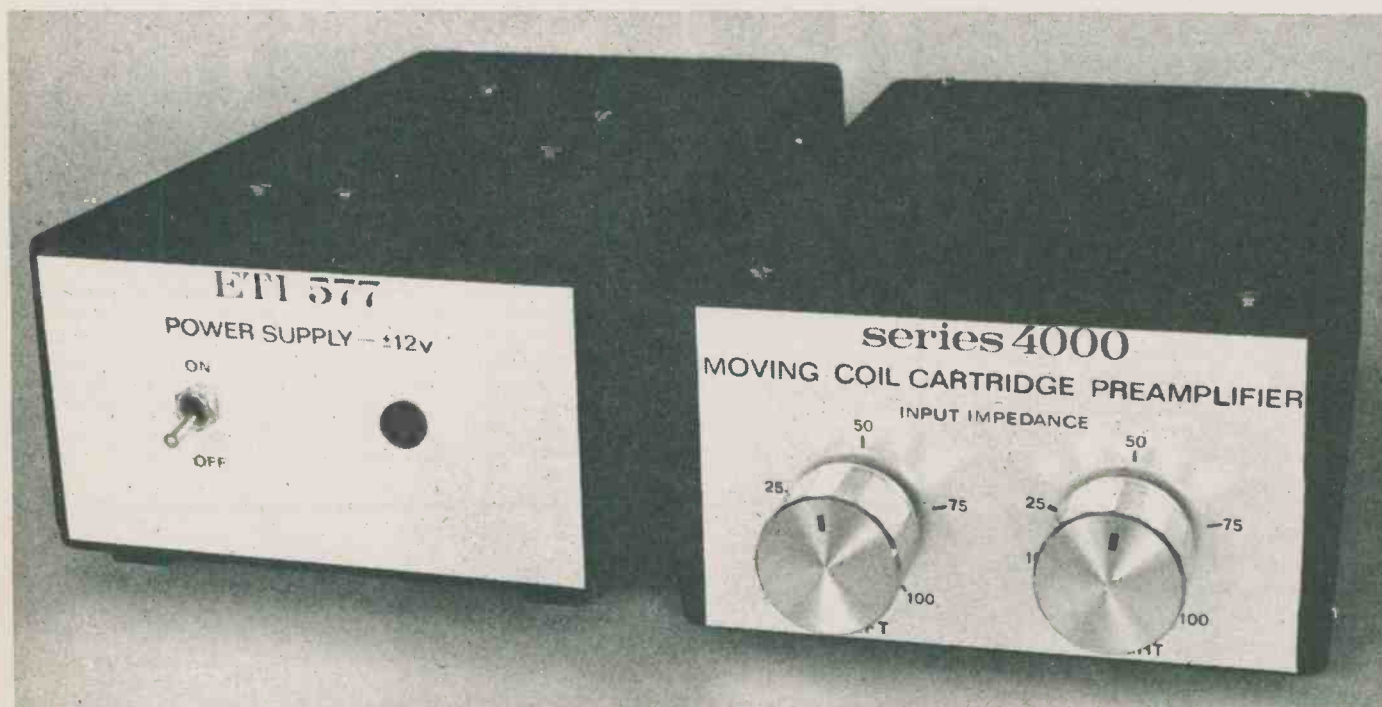

OVER THE LAST several years there has been a dramatic increase in the number of moving coil cartridges released. The design of this type of cartridge results in a number of advantages over the more usual phono cartridge which works on a moving magnet principle.

Modulations on the wall of the record are tracked with a diamond stylus attached to a long arm called a cantilever. In the moving-magnet cartridge a small magnet is attached to the cantilever so that stylus movement causes movement of the magnet. Two pick-up coils are mounted close to the

magnet so that the windings of the coils intersect the lines of magnetic flux from the magnet. As the stylus moves the magnetic flux seen by the pick-up coils varies in direct proportion to the stylus movement, and small electrical signals are generated in the coils.

The moving-coil cartridge works in a similar way but inverts the roles of the pick-up coils and magnet. The magnet assembly is held stationary while the pick-up coils are mounted on the cantilever assembly and move with the stylus modulations (hence the name 'moving coil').

The pick-up coils are reduced

drastically in size and weight compared to the coils used in moving magnet cartridges. This results in a total cantilever weight that is much smaller than in the typical moving magnet cartridge. Since the weight is greatly reduced the ability of the stylus to react to transients is increased and an overall improvement in signal accuracy results. Moving coil cartridges generally have superior frequency response characteristics and improved phase response at high frequencies. But they also have disadvantages.

The small pick-up coils have a very low impedance resulting in much lower

signal levels than available from normal phono cartridges. In fact, the voltages present on the typical moving-coil cartridge at a recording velocity of 10 cm/sec can be in the order of 150 μ V! This is generally insufficient to drive an amplifier to anything like full power. Furthermore, since the output level is some 30 dB below that expected by the amplifier then a great reduction in the signal-to-noise ratio will result. An amplifier with a short circuit signal to noise ratio of 80 dB for example, which is quite a good figure, will end up with a signal noise ratio of about 50 dB — which is distinctly *bad*.

The internal impedance of moving-coil cartridges is around 5 ohms and to achieve the low recommended load impedance required it is clearly not satisfactory to simply load down the input of the average phono input with a resistor since this does nothing to overcome the signal-to-noise ratio problems.

The solution to these problems is to insert some voltage gain between the output of the cartridge and the phono input. This can be done in two ways. Firstly, it is possible to use a transformer to boost the voltages up to the desired level and they are capable of very good results. But, transformers are still limited in transient performance and noise. To obtain the necessary voltage gain the turns ratio must be relatively high. Since the impedance ratio is related to the square of the turns ratio, the output impedance must, of necessity, be high also — usually around 30 k for a 50 Ω input impedance. This is substantially higher than the output impedance of normal phono cartridges and degrades the noise figure of the phono input stage. A solution to this is to use a pre-preamplifier instead of a transformer to achieve the necessary voltage gain.

Performance Features

The total equivalent input noise of this unit was measured at 0.3 nV/ $\sqrt{\text{Hz}}$. With respect to a noise bandwidth of 20 kHz, this corresponds to an input noise of 42 nV, giving a signal to noise ratio with respect to an input signal of 150 nV (0.15 mV) of 71 dB. At this level, the noise generated by the cartridge itself will be one of the dominant noise sources.

The circuit uses a symmetrical configuration with NPN and PNP transistors set up in such a way that asymmetrical distortions tend to cancel. Normally distortion products are generated differently for positive and

SPECIFICATIONS

Gain	28 dB (x 25 approx).
Frequency response	29 Hz to 48 kHz \pm 1 dB.
Input impedance	Adjustable 3.3 to 100 ohms.
Noise	Total equivalent input noise 0.3 nV/ $\sqrt{\text{Hz}}$. Over a 20 kHz noise bandwidth—42nV. Signal-to-noise ratio, with respect to an input level of 150 μ V: -71dB.
Total Harmonic distortion	With respect to an input level of 0.2mV, unmeasurable (below noise). Calculated to be 0.0015% (see text). Rising to 0.015% for a 30 mV input signal at 1 kHz.
Channel separation	Better than 61 dB.
Input overload margin	better than 80 dB.

HOW IT WORKS

The input stage consists of Q1 to Q8 plus associated circuitry. Q1 to Q4 and Q5 to Q8 are in parallel to reduce the current density providing a low input impedance stage having very low noise.

Capacitor C1 and C2 fix the upper frequency roll-off characteristics as well as shunting the input with the desired load capacitance for the moving-coil cartridge. The configuration of R1 and R2, C1 and C2 was found to give the best loading for a variety of moving-coil cartridges.

The potentiometer RV1 allows the input impedance to be varied over the range most commonly recommended by cartridge manufacturers.

Negative feedback is applied via the network consisting of R28, capacitors C5 and C6 and resistors R5 and R6. Some degenerative feedback for the input stage is applied to the first stage by the emitter resistors R7 and R8. Capacitors C9 and C10 are coupling capacitors to the

second stage while bias for this stage is determined by R11, R12, R13 and R14.

The power supply consists of a series regulator Q13 and Q14. The potential dividers R21/R23 and R22/R24 divide the voltage present at the output of the regulator and drive the transistors Q15 and Q16, and the LEDs. The transistor base-emitter junction in series with the LED will drop 0.6 + 1.65 volts. Therefore, whenever the voltage present at the centre of the potential divider tries to increase above 2.3 volts the transistor increasingly, conducts decreasing drive to the pass transistors Q13 and Q14.

This is a relatively low noise regulator since the voltage reference is LED and not a zener diode which is a noisy device. Resistors R19 and R20, together with capacitors C12 and C13 form 6 dB per octave low-pass filters on the supply rails to further reduce noise that may be generated by the regulated supply.

negative signal excursions and this tends to produce second harmonic distortion products. The configuration used in this circuit results in very low second and third harmonic distortion. This has enabled a total harmonic distortion figure of around 0.0015% to be obtained.

The problem with quoting distortion figures of this order is that they are too low to be measured directly, being well hidden under the noise level. The only way a figure can be obtained is to remove the overall negative feedback, measure the distortion and then divide by the gain difference when the feedback is reapplied. Unfortunately, feedback does not affect all the distortion products equally, but the figure is still meaningful.

Another advantage of the symmetrical design of the input stage is that it does away with the need for an input capacitor. This is a definite advantage

when dealing with low input impedances since the value of the capacitor would have had to be very large to obtain a flat frequency response at low frequencies.

The signal voltages present in the pre-amplifier are naturally extremely low and for this reason the power supply has been kept as a separate unit to reduce the possibility of 60 Hz induction from the power transformer.

A voltage regulator supplies the necessary \pm 6 volts. As it is critical to achieve low noise it is important that the regulator does not put noise onto the supply rails which would degrade the noise performance of the unit. Normally the voltage reference used for regulators of this type is a zener diode but, as the zener is reverse biased, it generates a comparatively large amount of noise. In this design an LED was used as the voltage reference. A red LED operated in the forward-biased

mode drops a constant 1.65 volts and generates very little noise.

Construction

Construction is relatively straightforward since most components are on the mounted pc board. Other construction methods are possible but performance may not match that of our prototype.

Mount the resistors and capacitors first, followed by the transistors. Since there are quite a few transistors on the board placed close to each other, don't make the mistake I did and get them mixed up! Cut the necessary lengths of shielded cables and solder them onto the board keeping the ends as short as possible. Solder the necessary lengths of hookup cable to the board and after checking all components mount the board in the chassis.

I used a diecast aluminum box and quite frankly wish I hadn't. The shielding to external magnetic fields really isn't good enough. I found I had to be careful where the preamp was placed or it would pick up hum from the magnetic field produced by the power amp's transformer. Use a steel box if you can, if not, just be careful where it is placed.

Once the board is mounted in the chassis, the pots and rear panel hardware can be mounted and the wiring completed according to the wiring layout diagram shown. Here again I came unstuck. The first system I used to ground the shielded cables caused a

monumental hum loop (and I still don't really understand why!). The final method tried is shown in the wiring diagram and this works very well. The shielded cables coming from the outputs on the board have only one of their shields connected to the output RCA sockets which are wired together and connected to the chassis at the ground terminal. This type of terminal is supplied with the necessary hardware to connect firmly to the case to provide the necessary ground connection. It is important that the RCA sockets be insulated from the case and that the ground connection made to them is according to the wiring diagram. If the unit is going to be used with the recommended power supply there should be no hum problems. This power supply, ETI 557, is described later in this issue. It is wired so that the 0 volt line is not connected to the chassis of the power supply. This is important, otherwise a hum loop around the units' line grounds will result. If you wish to use a power supply other than the 577 then it will be necessary to ensure that the 0 volt line from the supply does not connect to the power supply chassis. Do not 'cure' the problem by disconnecting the ground wire at the 120 volt plug as this will remove any ground connection from the power

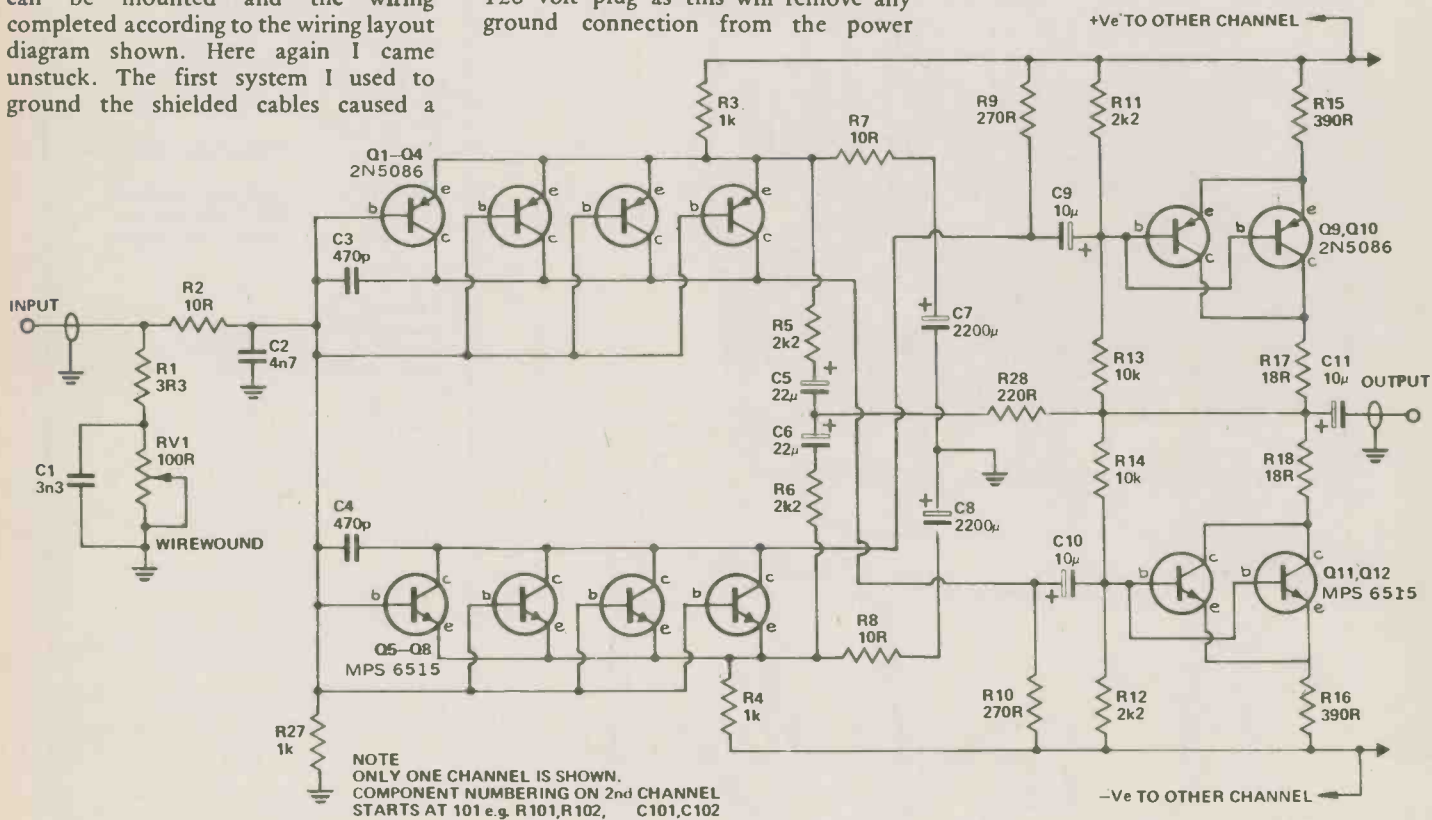
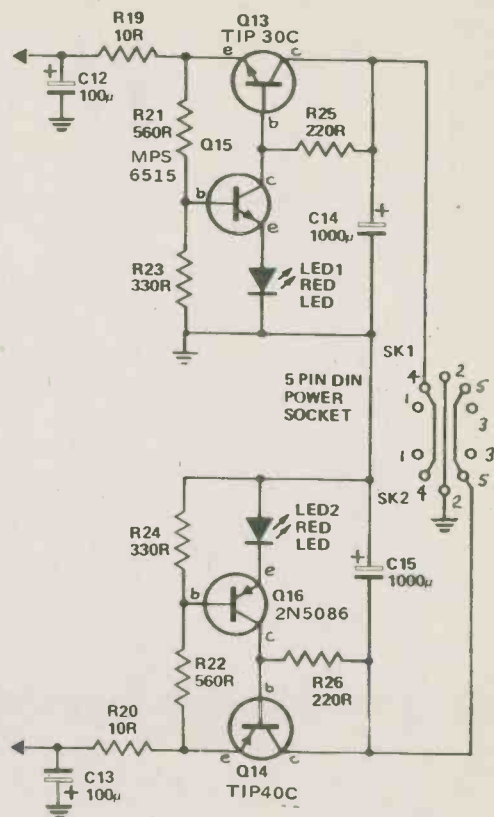

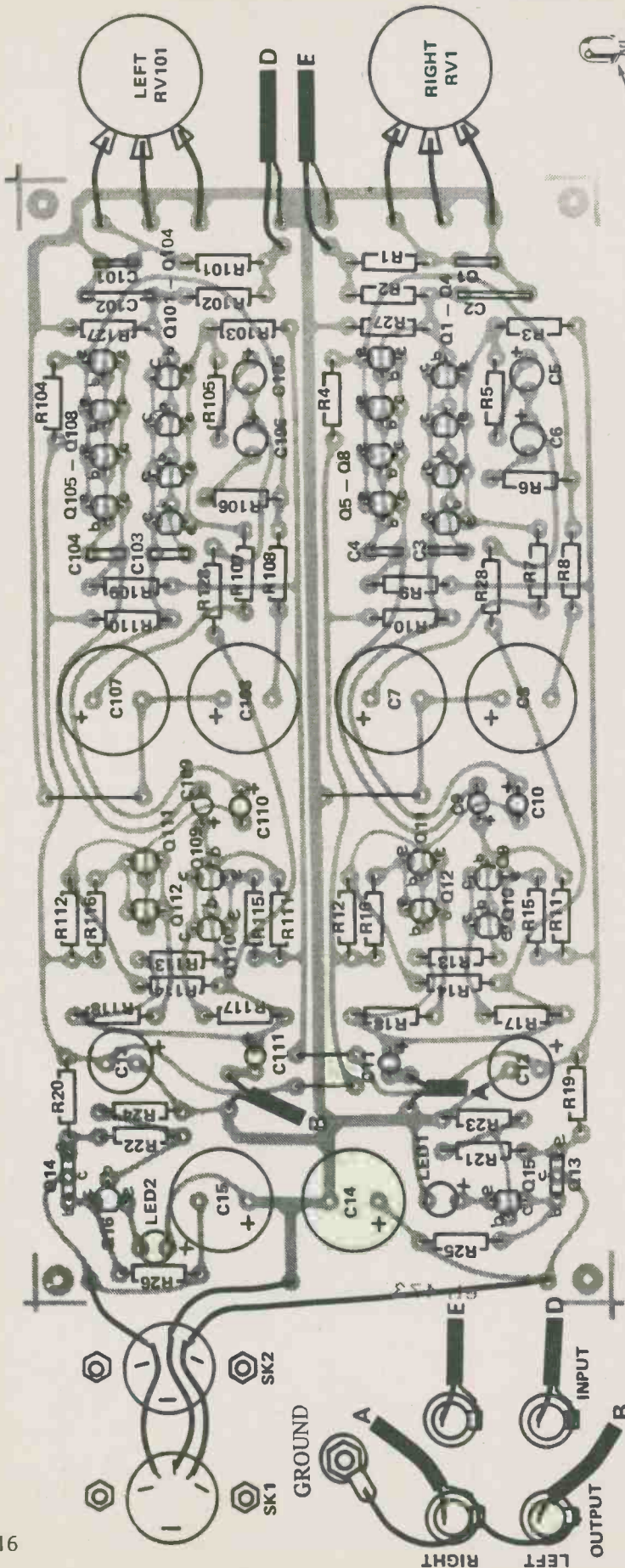

supply chassis. This is not only dangerous, it's illegal.

Powering Up

Before turning the unit on make a final check of the board. Check the orientation of the transistors, electrolytic and tantalum capacitors and the LEDs. If all is right, turn down the volume control completely and switch the power supply on. The LEDs in the

PARTS LIST

RESISTORS all 1/2W, 5%

- R1, R101 . . . 3R3
- R2, R102 . . . 10R
- R3, R4, R103, R104 . . . 1k
- R5, R6, R105, R106 . . . 2k2
- R7, R8, R107, R108 . . . 10R
- R9, R10, R109, R110 . . . 270R
- R11, R12, R111, R112 . . 2k2
- R13, R14, R113, R114 . . 10k
- R15, R16, R115, R116 . . 390R
- R17, R18, R117, R118 . . 18R
- R19, R20 . . . 10R
- R21, R22 . . . 560R
- R23, R24 . . . 330R
- R25, R26 . . . 220R
- R27, R127 . . . 1k
- R28, R128 . . . 220R

CAPACITORS

- C1, C101 3n3 ceramic
- C2, C102 4n7 ceramic
- C3, C4, C103, C104 470p ceramic
- C5, C6, C105, C106 22µF 16V tantalum
- C7, C8, C107, C108 2200µF 25V electro
- C9-C11, C109-C111 . . 10µF 16V tantalum
- C12, C13 100µF 25V electro
- C14, C15 1000µF 25V electro

TRANSISTORS

- Q1-Q4, Q101-Q104 . . 2N5086
- Q5-Q8, Q105-Q108 MPS 6515
- Q9, Q10, Q109, Q110 . . 2N5086
- Q11, Q12, Q111, Q112 MPS 6515
- Q13 TIP 29C
- Q14 TIP 30C
- Q15 MPS 6515
- Q16 2N5086

LED1, LED2 . . . standard red LED

POTENTIOMETERS

RV1, RV101 . . . 100R wirewound linear

MISCELLANEOUS

SK1, SK2 5 Pin DIN socket
Four RCA sockets (insulated from case),

preamp's regulator should come on immediately. I used standard RCA to RCA cables from the output of the preamp to the phono input and had some trouble with hum induction into the leads. Fortunately, we had been sent a set of Audio-Technica type AT620 cables for evaluation several days before and these cured the problem completely.

Perhaps I am biased, but the sound quality of this preamp is extremely good! Using a Nakamichi MC1000 cartridge, this preamp showed distinct improvement over the transformer I was using previously. There is an openness that never existed before and the bass end showed a great improvement being firmer and much more defined. I trust you'll be as satisfied with your project as I have been.

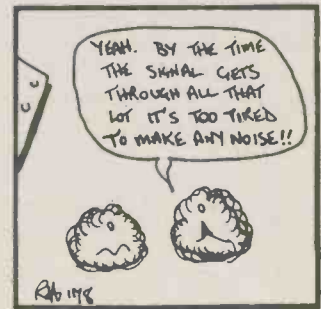
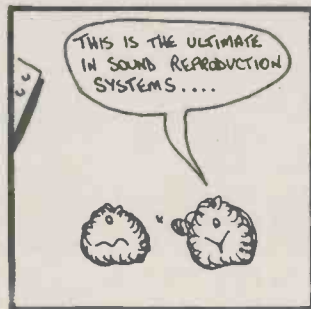
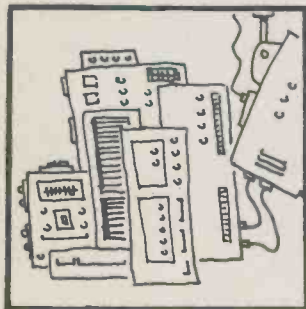
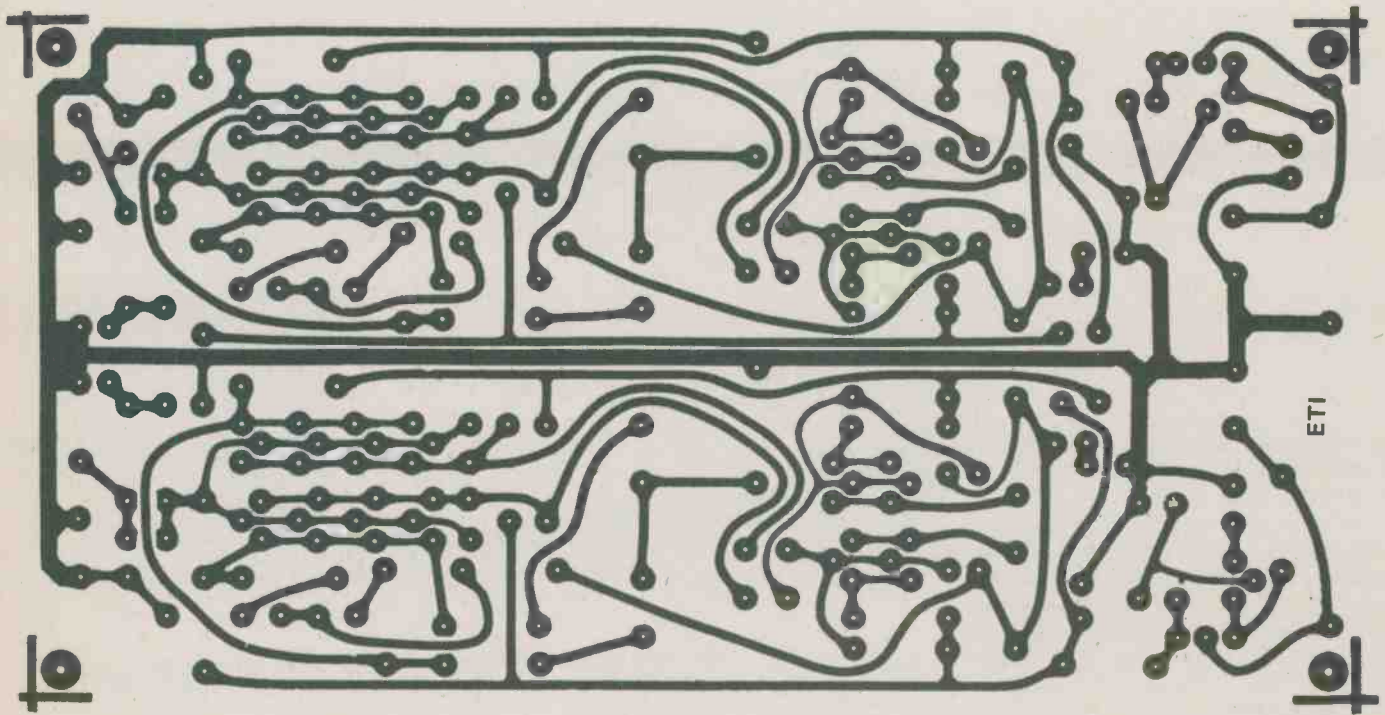
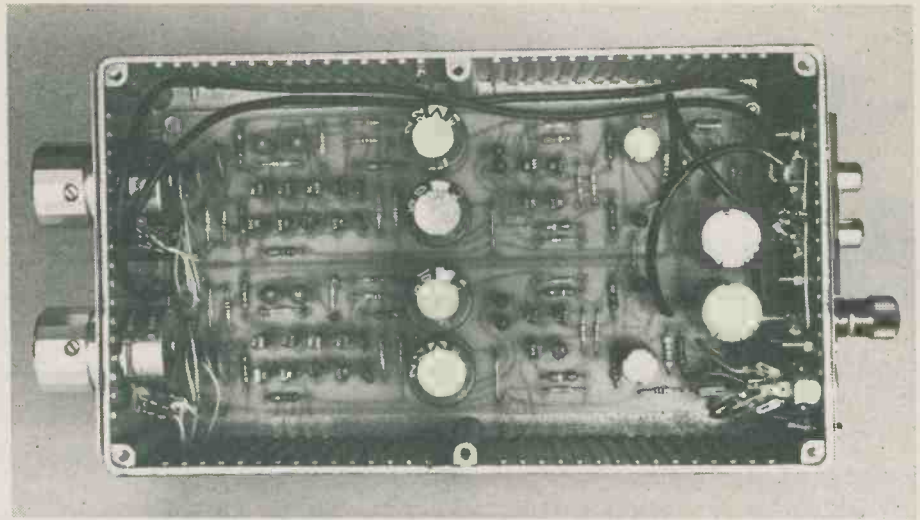

General Purpose Power Supply

Whilst this supply was designed specifically to power the Series 4000 moving-coil cartridge preamp it should find application in many electronic projects.

THIS POWER SUPPLY provides the ± 12 volts needed by the Series 4000 moving coil cartridge preamplifier. We intend designing a range of hi-fi system 'add-ons' like the M.C. preamp and rather than have a power supply in each unit they will be powered from this supply. This decreases the cost of building the units and just as importantly removes the major source of hum from within the chassis.

The supply delivers positive and negative 12V dc at 1A while the IC series regulators provide short circuit and temperature protection. These regulators have a tendency to oscillate at around 3 MHz and for this reason must have their output pins bypassed to ground through an appropriate capacitor. If they are allowed to oscillate the device quickly overheats and its thermal protection cuts in.

The regulators are mounted onto the chassis which acts as a heat sink. If the recommended power transformer is used, the voltage after rectification is approximately 17 volts. The regulators must drop 5 volts at a worst-case current of one amp, so they are dissipating a maximum of five watts which is well within their ratings.

Assembly of the pc board is not difficult as it has relatively few components. If you are using the same box we did it is easier to solder pc board pins onto the board, slot the board into place, bolting the regulators down, and then make the necessary wiring interconnections. Both regulators must be insulated from the case using the appropriate mounting hardware. The case of these regulators is connected to pin 2. For the 7812 this is the ground connection, and accidental connection to case will cause a hum loop when the unit is connected to the moving coil cartridge pre-amp. In the 7912, pin 2 is the input to the regulator and as such has 17 volts directly from



Our prototype was in a diecast box to match that used for our Series 4000 moving-coil cartridge preamp, although any suitable box may be used if the power supply is intended for another application.

the bridge rectifier connected to it. Accidental connection of this to ground will probably damage the rectifier diodes, so check with a multimeter that the case of this regulator is well insulated from the chassis before powering up.

The LED is mounted onto the front panel with a standard LED mounting grommet and connected to the board by two short lengths of hook-up cable.

Make absolutely certain that all 120 volt connections are secure and that the line cable ground lead is connected to chassis as shown in the wiring diagram. The line cord must be secured to the chassis, either with a clamp-type

grommet where it enters the box or with a cable clamp on the inside.

Go, Caution, Stop!

Before applying power to the unit make a final check of the board and all connections to the power transformer. Check the 120 volt connections and ensure that the regulators are satisfactorily insulated from the chassis. If all is correct, turn the power supply on. The LED on the front panel should come on immediately. Check the voltage present on the output DIN socket which should be very close to 12 volts (certainly within 0.25 V). Make sure the positive and negative supply connections terminate on the correct DIN socket pins.●

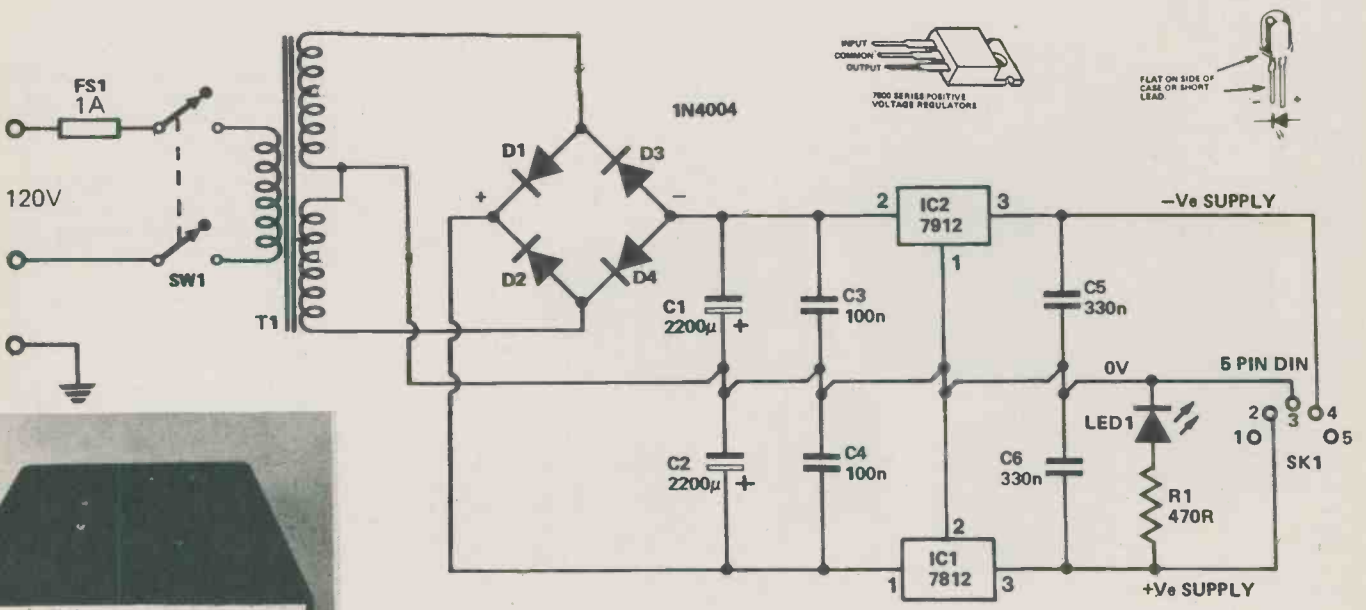
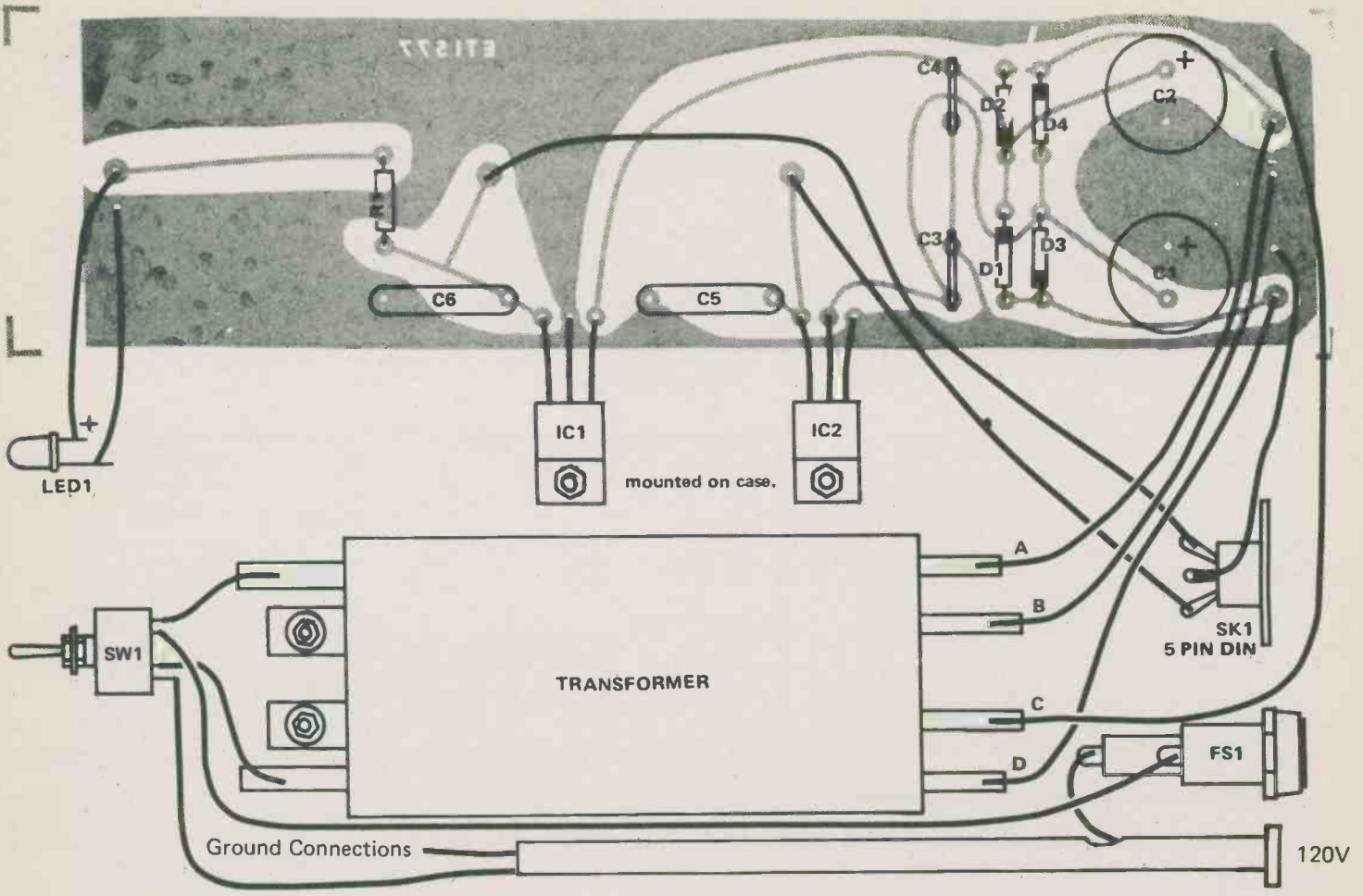

Rear view of the power supply.

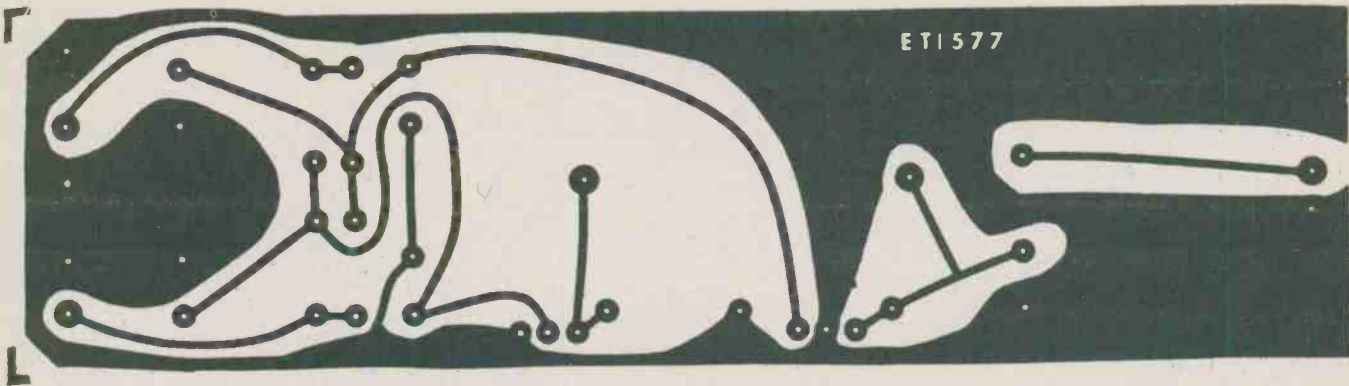

HOW IT WORKS

Line 120VAC is applied to the primary of the transformer via a 1A fuse. The transformer secondary consists of two 15 V windings with tapings at 12V. The 12 V tapping of one is joined to the O V of the other — this junction (effectively a centre-tap) forming the 0 Volt rail.

A bridge rectifier D1-D4 rectifies the ac voltage from the transformer and supplies around 17 volts to the inputs of the regulator ICs. Capacitors C1-C4 filter the input to the regulators while C5 and C6 ensure high frequency stability of the regulators.

The IC regulators provide a stable, regulated output very close to the specified 12 Vdc and can supply up to one amp of dc current. Overload and thermal protection is provided internally on the IC chip. These regulators are convenient, inexpensive and require the minimum number of components.

PARTS LIST

Resistors	all 1/2W, 5%	IC2	7912 or LM320-12 volt-age regulator (negative)
R1	470R	Miscellaneous	
Capacitors		T1	transformer, 15V-0-15V, 1.3 amps
C1, C2	2200µF 25V electro	SW1	DPDT switch
C3, C4	100n	F1	1A, 3AG type fuse
C5, C6	330n	SK1	Chassis mounting 5 pin DIN socket
Semiconductors			Chassis mounting 3AG fuse holder, 5 pin DIN plug, Diecast aluminum box 190 x 60 x 110 mm.
D1-D4	1N4004, or sim		
LED1	Red led, TIL220R or sim		
IC1	7812 or LM340-12 volt-age regulator (positive)		

The alternative to custom enclosures

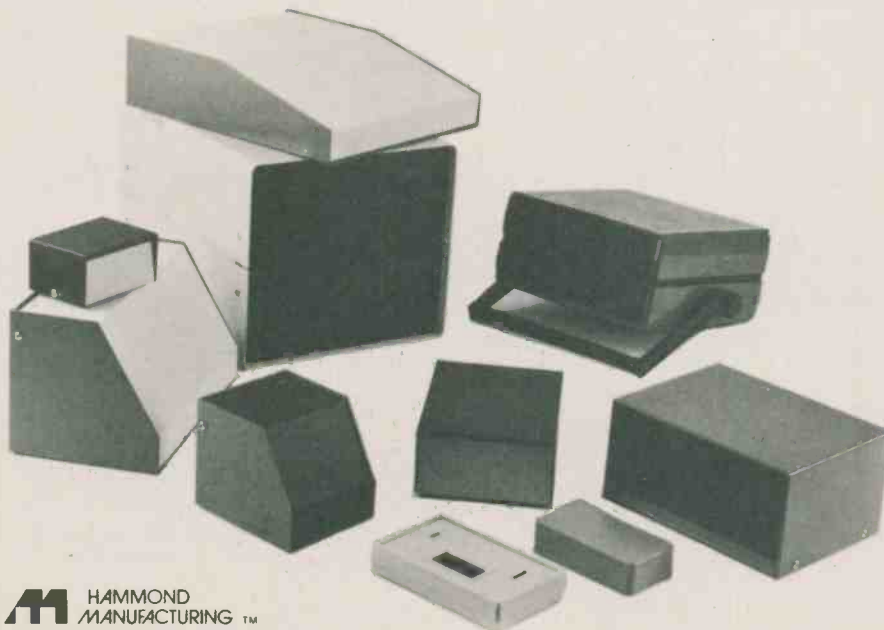

The problem with custom fabricated enclosures is the cost of tooling and the cost of making changes.

We offer you an alternative; one of the largest selections of small enclosure designs, shapes, sizes and colours available in Canada today. We have IN STOCK, miniature enclosures, small enclosures, meter housings, desktop component and keyboard consoles; in steel, aluminum and plastic. In all, over 750 models available in many different colours. No stocking, tooling or manufacturing problems for you.

Investigate the alternative, call your local Hammond distributor and have a hard look at cost, availability and design freedom. We think you will like what you find.

HM HAMMOND MANUFACTURING™

W HAMMOND MANUFACTURING CO. LTD.
394 Edinburgh Rd. Guelph Ontario N1H 1E5 (519) 822-2960 or (416) 456-3770

Simple 60W Low Distortion Amplifier

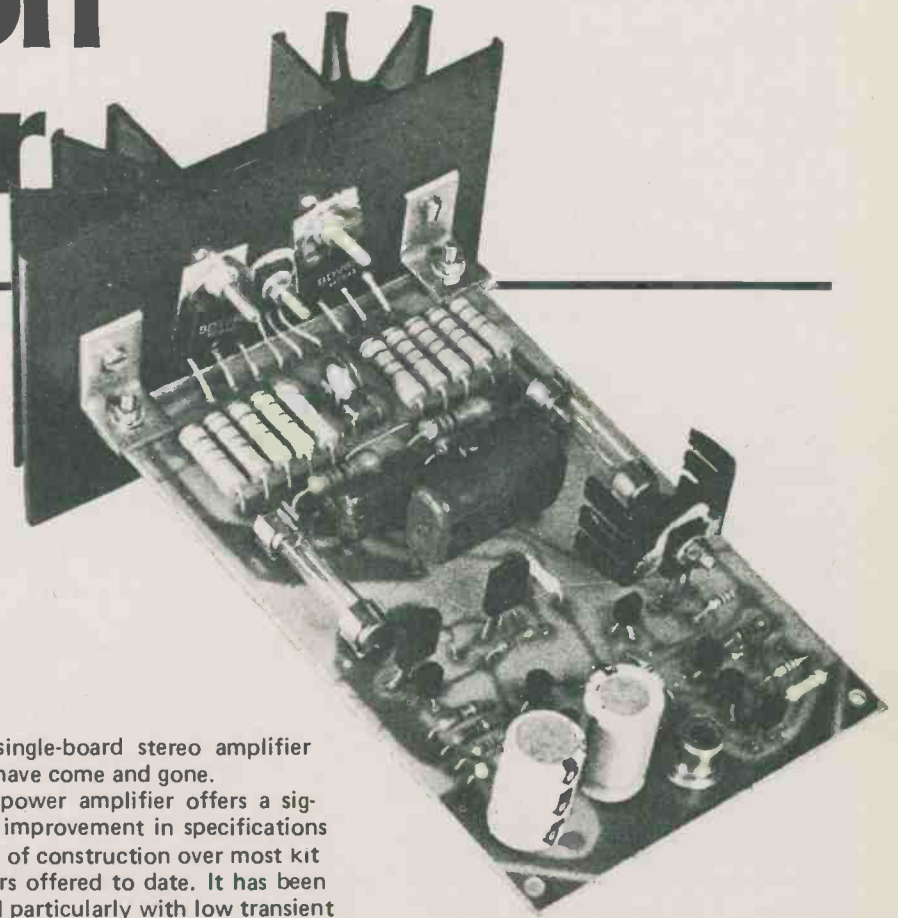

The popularity of our first 50W 'universal' amplifier modules has been very high since they were published. This project, designed by Phil Wait from an original circuit by Trevor Marshall, is intended to replace the ETI 480 and features simpler mechanical construction, low distortion (particularly) TID) and generally better performance.

MANY DIFFERENT amplifier circuits have appeared in popular electronics magazines over the years.

While these seemed to have satisfied a large demand, our attention has been drawn to the need for something a 'step up' from there — something that approaches the current 'state of the art' for hi-fi equipment. Lower distortion than previously obtained, better bass performance and flexibility was the message we received from reader's letters and kit and component suppliers ("Why don't you . . .", "What I'd like to see . . .", "I need a . . .", etc.).

Late last year we set in motion the 'wheels' necessary to bring this project into fruition.

A great many factors place sometimes quite severe constraints on project design — particularly component availability and ease of construction; not forgetting that this design had to perform significantly better than those that came before it.

There is clearly little point in describing a project that includes components that are impossible to get or one that is difficult to construct.

A strong point that came across to us from reader feedback and from the popularity of our 480 series of amplifiers was that constructors favoured a modular concept. It seems that the days

of the single-board stereo amplifier project have come and gone.

This power amplifier offers a significant improvement in specifications and ease of construction over most kit amplifiers offered to date. It has been designed particularly with low transient intermodulation distortion in mind.

Although a difficult parameter to measure, transient intermodulation distortion is an inherent characteristic of many amplifier designs — especially those which incorporate large amounts of feedback to even out frequency response and reduce harmonic distortion. The heavy feedback 'school' of design produces an impressive list of specifications — but the difference *to the ear* between such an amplifier and one designed for low TID has to be heard to be believed.

Choice of Power Supply

The design of the power supply can mean the success or failure of an otherwise well-designed amplifier. The supply voltage should be well-regulated, varying less than 10% from no load to full load, and be able to supply high peak currents.

However, if a voltage regulator is employed it too must be capable of delivering the very high peak currents

occasionally demanded. This necessitates an expensive regulator device and large, expensive filter capacitors.

The alternative is to use a fairly large transformer and large value filter capacitors on a capacitor-input bridge rectifier. This is what we chose.

The circuit given here shows a power supply suitable for supplying a stereo amplifier using two of these modules. The filter capacitors C8 and C9 consist of two 2500 μF , 50 volt electrolytic capacitors connected in parallel. This is the minimum we would recommend.

In general, the largest value filter capacitor one can afford is a good rule of thumb! *It has been suggested to us that values as high as 20 000 to 50 000 μF makes an audible difference in performance.* (Watch the rectifier specifications though!).

Improved performance can be

obtained for a modest increase in cost by having a separate supply for each channel module. This improves the regulation, reduces crosstalk and increases the amount of power available before output clipping commences.

The choice of transformer will determine power output. A 28-0-28 volt, 2A transformer will power a module to 60 watts (RMS) power output, while a 26-0-26 volt, 2 A type will permit 40 watts.

The power supply output should be limited to a peak DC voltage of about 40 volts (for 60 W output). A C-core transformer will generally improve the hum and noise output figures apart from having a reduced field, thereby reducing possible hum pickup problems.

If the amplifier module is to be used with a 4-ohm speaker system the supply voltage must be limited to about 30 volts maximum, otherwise the output devices will attempt to deliver over 100 watts followed by rapid self destruction!

Adventurous constructors may wish to try adding a second set of Darlington output devices, with their own emitter resistors as per the circuit, connected in parallel with the original pair. This combination may supply 100 watts or more into a four ohm speaker load. This technique is also recommended if you are contemplating driving highly reactive loads such as electrostatic loudspeakers.

Construction

All components are mounted on a pc board – including the output devices. This method of construction is recommended. The module has been designed so that it is mechanically simple to assemble, much simpler than our ETI 480 module. Wiring errors are also avoided when a pc board is used.

Firstly, assemble and solder all the components on to the printed circuit board with the exception of Q12, Q13 (the output Darlington) and Q8. Carefully observe the polarity of all the electrolytic capacitors and orientation of the transistors.

The board is then mounted hard against the heatsink using small right-angle brackets. Be careful to avoid shorting the ends of the one ohm emitter resistors, R15-19 and R20-24, to the brackets.

Once the board is attached to the heatsink the output Darlington, Q12 and 13, and Q8 may be mounted. Insert them in the pc board and then press them back against the heatsink to form their leads to the right shape. Do not solder their leads yet.

SPECIFICATIONS

Power Output	60 watts into 8 ohms (±40V supply)
Frequency Response	10 Hz to 100 kHz ±0.5 dB
Input Sensitivity	500 mV rms for 60 W output
Hum and Noise	better than -110 dB on full output (dependent on power supply)
Feedback Ratio	35 dB
Distortion	at 1 kHz, 30 V p-p output into 8 ohms, Closed Loop 0.04 % (open loop 1 %)
Stability:	The amplifier was found to be completely stable when operated into reactive loads consisting of R + C, L + C and pure L
Intermodulation (calculated values)	at 1kHz, 30 V p-p output into 8 ohms, 3rd order less than 0.015 % 5th order less than 0.0023 % (Intermodulation reduces with reduced power)

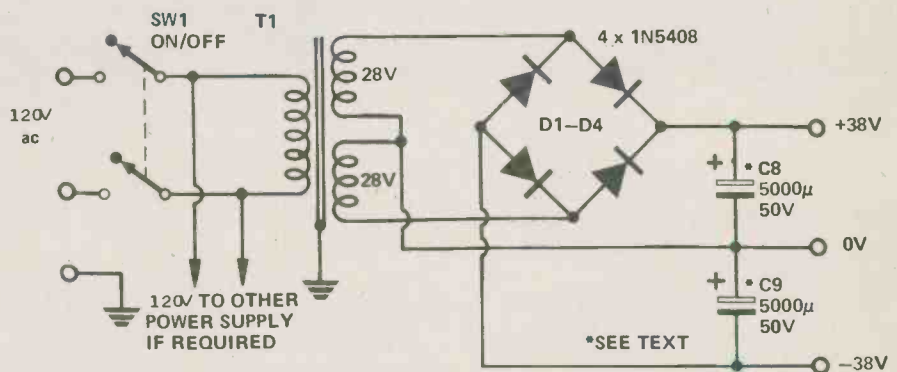

WHY LOW TID?

Looking at the circuit and a quick glance at the specifications, there's little in the circuit that looks outstandingly different from others. So what makes this amplifier special?

The difference in concept that makes this amplifier unique is the use of a very linear, high gain driver stage (Q10, Q11), with a constant current source (Q6, Q7), so that the gain of *this* stage is dependent upon the input impedance of the output transistors. However, *their* input impedance is dependent upon their gain, and therefore *the gain of the amplifier stage is dependent solely upon the characteristics of the output devices.*

Series and shunt feedback is used with Q10 and Q11 which results in a highly linear stage with a very low input impedance (about 28 ohms). The gain of the differential pair when

fed into this low impedance is close to unity, so almost all the gain of the amplifier is concentrated in Q10 and Q11.

Provided the phase shifts in the differential pair and the gain stage are negligible the feedback loop is unconditionally stable.

There are two other design features which result in low TID.

The total open loop (feedback disconnected) distortion is only 1% at 30 V p-p output. So, very little feedback is necessary to reduce this to an acceptable level.

Protection of the output transistors is done by fuses, rather than electronically, and very high transient currents can be fed to the speaker without being affected by the (inevitably) non-linear impedance of an electronic protection circuit.

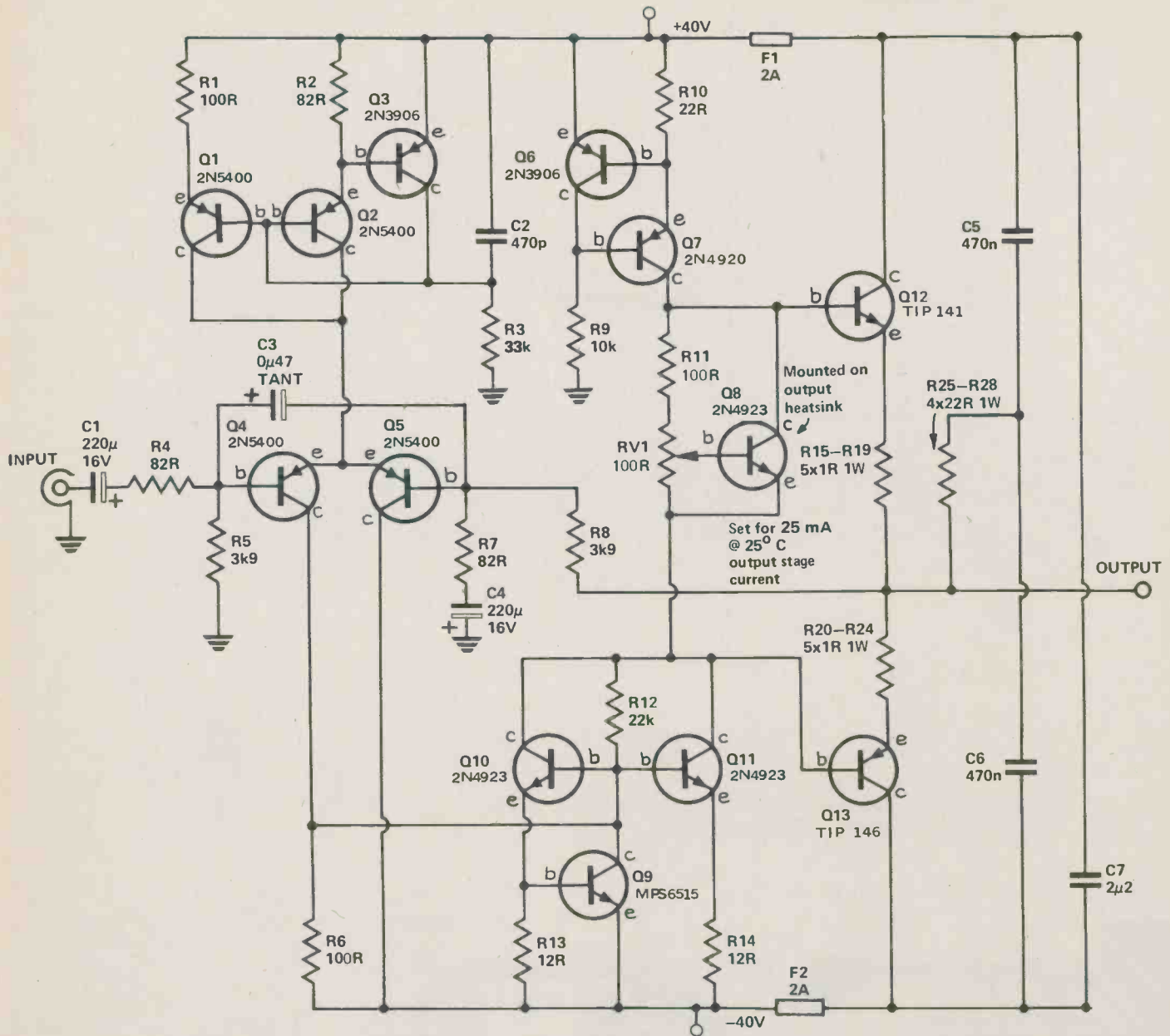

HOW IT WORKS

The input stage of the amplifier consists of an emitter coupled differential pair (Q4, Q5) with a constant current source (Q1, Q2 and Q3). The use of a constant current source reduces distortion, as well as the possibility of high frequency oscillation and prevents any ripple on the positive supply from unduly affecting the input stage. Unequal emitter resistors (R1, R2) allow the currents in Q4 and Q5 to be optimised. Input lag compensation is provided by C3, limiting the slew rate of the amplifier to reduce high frequency intermodulation. The gain of the differential pair, driving Q10 and Q11, is very low.

Almost all the gain of the amplifier

is obtained from the parallel pair Q10 and Q11. They are operated with series (R13, R14) and shunt (R12) feedback, and a constant current source (Q6, Q7). This results in a highly linear stage.

Q9 protects Q10 and Q11 from high peak currents or damage should a fault occur. When the current through R13 exceeds the safe limit, Q9 conducts and shorts out the drive to Q10 and Q11.

Bias from the output stage is set by RV1 and a shunt regulator (Q8). Q8 is mounted on the same heatsink as the output stages and stabilises the output bias current against heatsink temperature rise. Resistors R15-R24 in the emitters of the output Darlings, Q12 and Q13,

maintain operation in their safe region as well as reducing the chance of thermal run away.

Protection against ultrasonic oscillation is provided by C7 and the network consisting of R25-R28 and C5, C6.

Both DC and AC feedback is taken from the output, via R8, to the negative input of the differential pair, the amount of feedback being set by the ratio of R8 to R7. C4 increases the feedback, and therefore decreases the overall gain, at very low frequencies. The feedback also automatically holds the DC output voltage at close to zero volts.

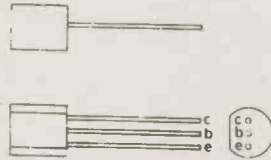
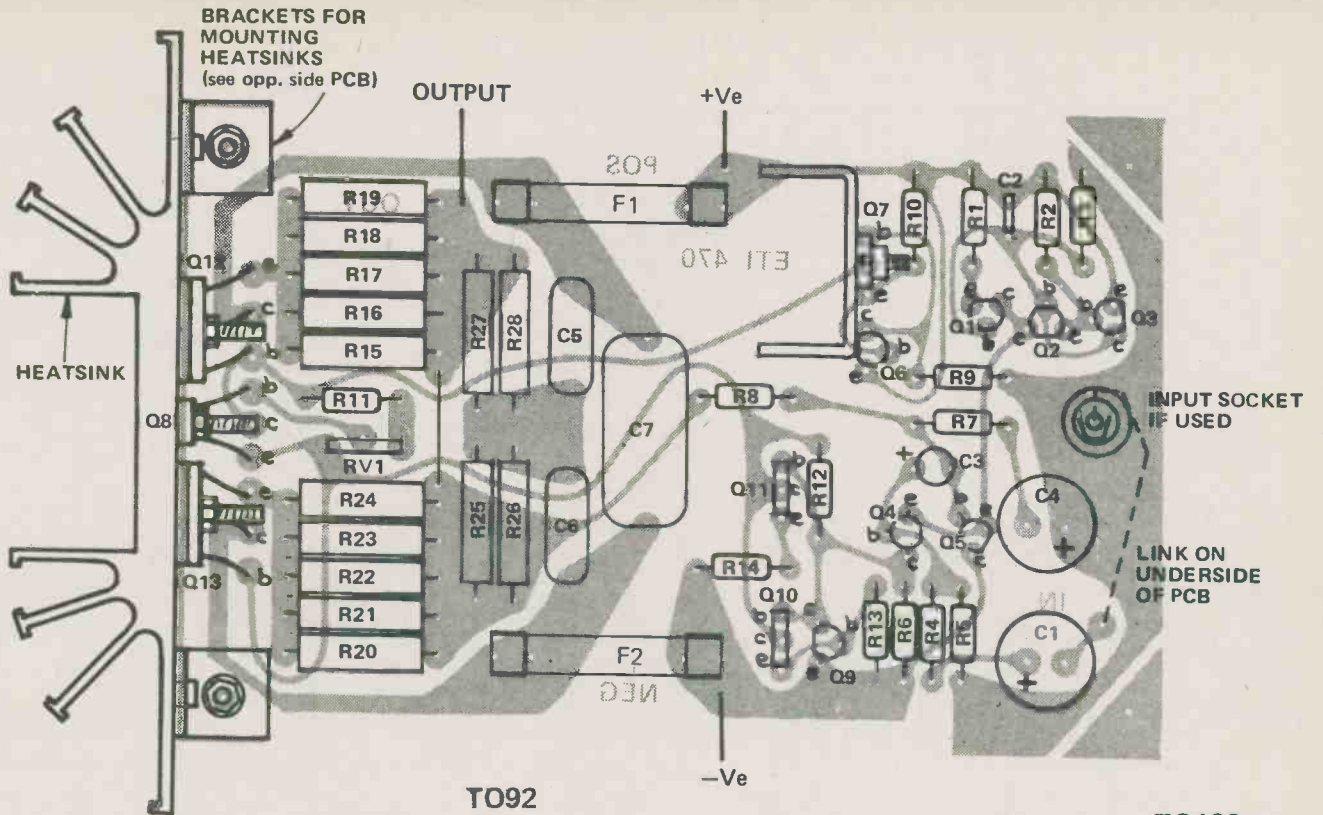

Check pinouts of your TO-92 transistors before using. Follow e-b-c lettering on positioning diagram.

TO126
2N4923
2N4920

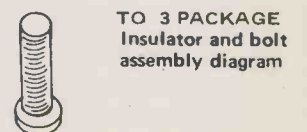
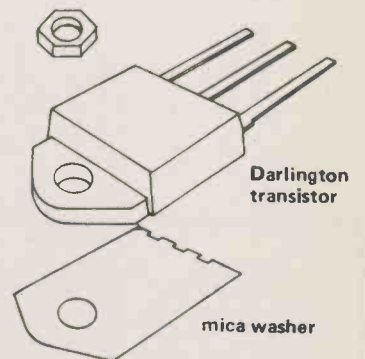
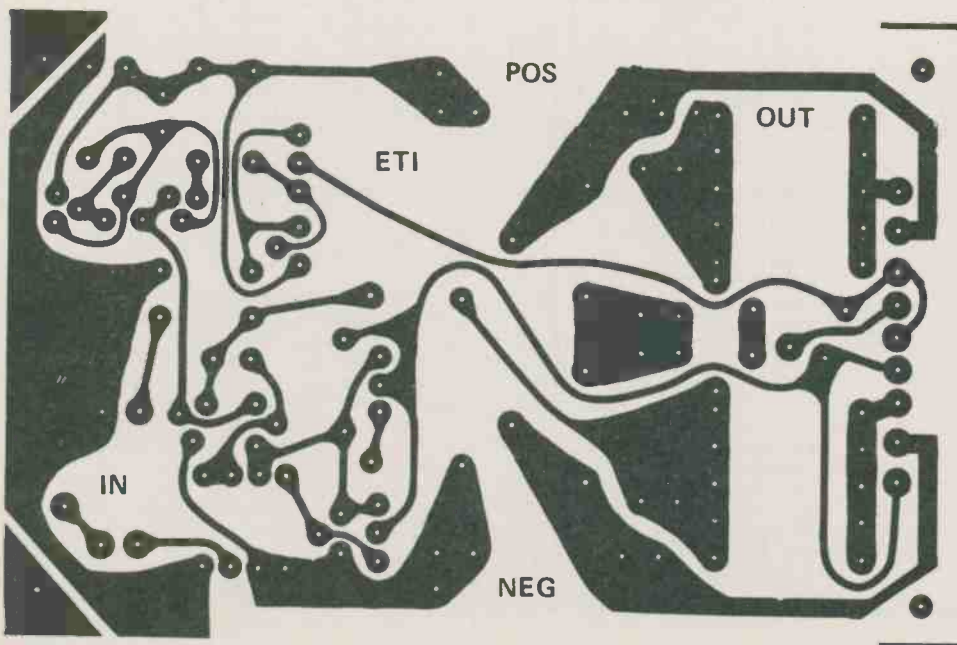
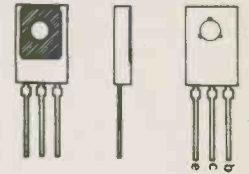

Smear heat conducting compound on either side of the mica insulators (don't use too much though) and insert these between the devices and the heatsink.

Assemble the washers and mounting bolts for these, finally checking with an ohm meter that there is not a short circuit between the metal tags (collectors) of the devices and the heatsink.

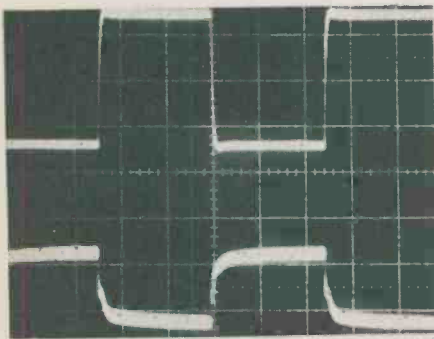
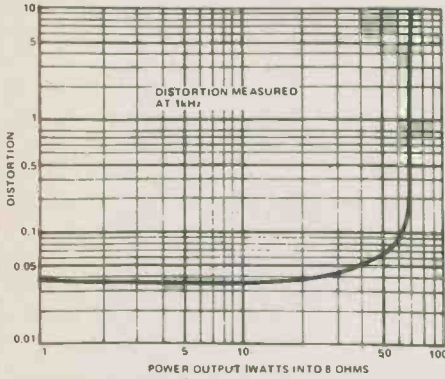

Operation into severely reactive loads was examined by looking at the ac component of the Vbe of Q10 as a measure of the 'overshoot' of the loop and to see if transient overload occurred.

f=1 kHz. CRO is 0.2 mS/div. Output is 30 V into 8 ohms. Upper trace 10 V/div. Output into 8 ohms. Lower trace 10 mV/div. Vbe of Q10, Q11 gain stage. No evidence of transient overload was visible.

The input connection to the module is via a single-hole mounting RCA socket. This is mounted directly on the pc board. The centre pin connects to C1 via a short length of tinned copper wire.

If this facility is not required the RCA socket may be omitted and a length of shielded cable soldered directly between C1 and the pc board common.

The power supply and speaker connections are soldered directly to the appropriate copper lands on the underside of the pc board.

The ground side of the speaker must be returned directly to the zero volt connection of the power supply, as close to the filter capacitors as possible (preferably direct to the negative terminal). Do not connect this side of the speaker to the amplifier board.

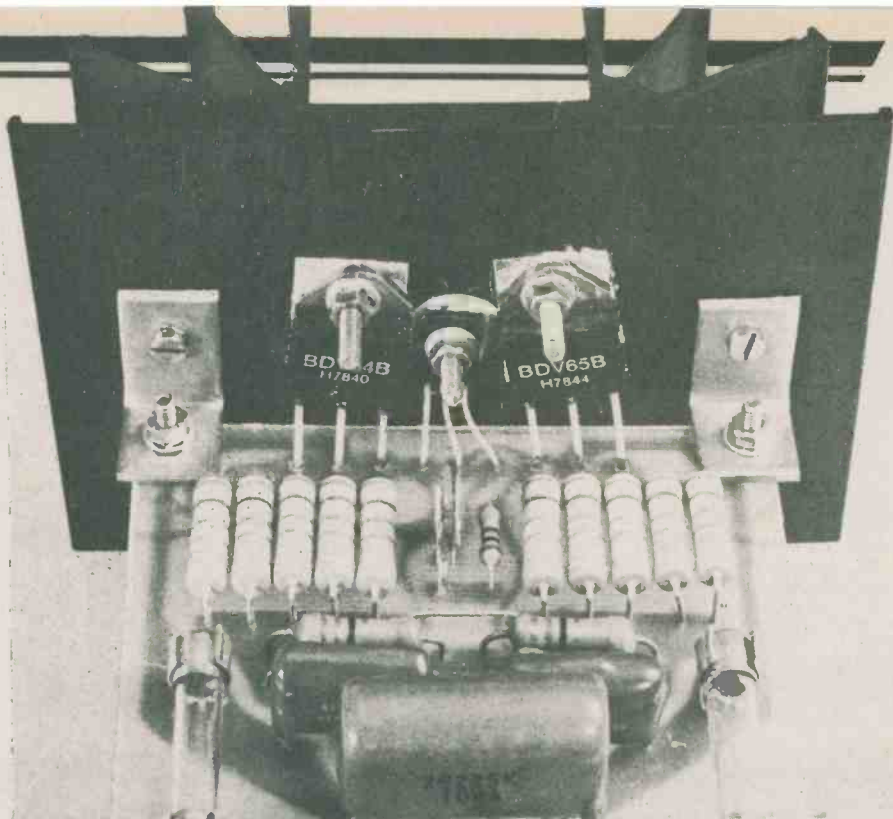

Above: Close-up view of the output stage showing how the Darlington transistors are mounted and how the pc board attaches to the heatsink.

Components

Most semi-conductors are available from Future Electronics and similar suppliers.

The only difficulty might arise finding the 2N4920 & 2N4923 transistors. These are available from Electronicon. The TIP 29 & TIP 30 will work the leads are backwards. Remember, it is imperative that Q8 is mounted on the heatsink. In this respect the lead geometry is critical.

There are two varieties of TO 92 small signal transistors available. We have given drawings for both. Verify the leads before soldering them in.

Heatsinks

Heatsinks on any amplifier are a compromise between cost and temperature rise.

Unless you are going to play long passages of organ music, or run a disco, you will probably find that relatively small heatsinks run quite cool.

However, Darlington transistors are hard to temperature stabilise and should be run as cool as possible. This is why we have opted for a fairly large heatsink compared to other designs. The transistors should be bolted directly to the heatsink, not through a steel chassis. A slit could be cut in a chassis large enough to slide the assembled amplifier through the rear. Heatsink fins should always be vertical to provide the most efficient convection cooling.

The heatsink used with the output devices in this project is a flat-sided type with radial fins, 75 mm in length. Other flat-sided types are available with straight fins, and these too would be suitable. A similar length should be used. In general the heatsink should have a thermal resistance, mounting surface to ambient, of around 1°C per watt.

A small 'flag' heatsink is attached to Q7, a 2N4920 flatpack transistor. A commercial heatsink may be employed

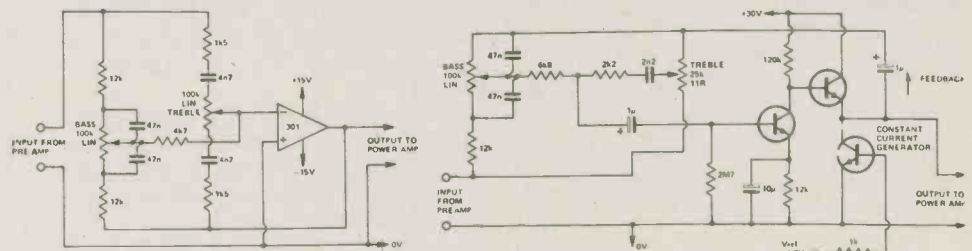

Two suggested tone control circuits for a preamp to suit this module. Low output impedance is an important consideration. Choice of discrete or IC circuitry is given. All transistors, 2N3904.

PARTS LIST

Resistors all 1/4W, 5%, except R15-R28

- R1 100R
- R2 82R
- R3 33k
- R4 82R
- R5 3k9
- R6 100R
- R7 82R
- R8 3k9
- R9 10k
- R10 22R
- R11 100R
- R12 22k
- R13, 14 12R
- R15-R24 1R 1 watt
- R25-R28 22R 1 watt

Potentiometer
RV1 100R mini trimpot (vertical)

- Capacitors**
- C1 220µ 16V electrolytic
 - C2 470p ceramic
 - C3 0µ47 35V tant
 - C4 220µ 16V electrolytic
 - C5, 6 470n mylar
 - C7 2µ2 mylar

Semiconductors

- Q1, 2 2N5400
- Q3 2N3906
- Q4, 5 2N5400
- Q6 2N3906
- Q7 2N4920
- Q8 2N4923
- Q9 MPS6515
- Q10, 11 2N4923
- Q12 TIP141
- Q13 TIP146

Miscellaneous

- SK1 single hole, panel mounting RCA socket.
- F1, F2 2 Amp 3AG Fuses.
- Fuse holders, heatsink for Q7, mica insulating kits (for Q8, Q12 and Q13), flat sided heatsink (75mm x 110mm), angle brackets, pcb.

Parts List for Power Supply

- D1-D4 IN5404 or sim
- C8, 9 5000µ 50V electro (see text)
- SW1 120 V DPDT switch
- T1 28V-0V-28V, 2 amp transformer

(they're only about 60 cents) or a small strip of aluminium may be bent up, drilled, and bolted to the transistor. See that the metal area of the 2N4920 and a face of this heatsink are in contact. Heatsink compound should be used.

Setting up

Once the amplifier has been assembled and carefully checked, the bias current for the output devices must be set. Remove the fuses, F1 and F2 and connect a 100 ohm resistor across each fuse holder. Remove any input signal. Connect the power supplies and measure the voltage drop across each of these resistors. Adjust the trim pot RV1 for a reading of 2.5 volts across each resistor. This corresponds to a bias current of 25 mA. The reading should be nearly the same across each resistor. Next check that there is no DC voltage across the output terminals.

If the reading across each of the resistors cannot be adjusted, or if there is a DC voltage across the output greater than one volt then there is a fault and the fuses should not be inserted.

If all is well, remove the two resistors and insert the fuses. Connect the speaker and away you go.

Preamp Considerations

The input impedance of this amplifier is relatively low, falling at very high frequencies. Consequently, it must be fed from a low impedance source.

When driving the amplifier with a preamp-tone control unit, the output is best taken from an emitter follower circuit (to provide the required low source impedance) or directly from the output of an operational amplifier. In either case, it *must* be taken from the point where the output is fed back to the tone control circuitry.

Two suggested tone control circuits suitable for the application are illustrated in Figure 5. Both use a 'Baxandall' type tone control network with feedback derived from the output point.

The circuit at right uses discrete components which may suit some constructors better. The left circuit, using a commonly available op-amp, has higher distortion than the discrete circuit.

A preamp-control unit project to suit the amplifier module will be described in a forthcoming issue along with details of how to construct a complete stereo amplifier system of high quality. ●

Oxfam

**People
To
People
Development**



OXFAM supports small, self-help projects in developing communities around the world. OXFAM projects stress self-reliance and seek maximum participation by the local population. OXFAM is more than a charity. It is a movement for social justice.

YOUR CONTRIBUTION CAN MAKE THE DIFFERENCE

OXFAM-CANADA

BOX 18,000
TORONTO
OTTAWA
HALIFAX
ST. JOHN'S

BOX 12,000
WINNIPEG
REGINA
CALGARY
VANCOUVER

HERE IS MY DONATION OF \$ _____
FOR YOUR WORK.

NAME _____

ADDRESS _____

ALL DONATIONS ARE TAX-DEDUCTIBLE

Series 4000 Stereo Amplifier

How to combine our 60W power amplifier and single board preamp into one unit.



The complete stereo amplifier is shown here mounted in a handsome rack-mounting case.

HAVING DESCRIBED suitable amplifier modules and preamplifier, we now turn our attention to tying the whole thing together.

We chose to build the amplifier into a single box, being the most economical method as only one box and power supply is used for the preamp and both power amplifiers. However, this method has several drawbacks. Firstly, since the preamp and power amp share the same power supply, the regulation for the preamp must be very good, otherwise low frequency instability can occur, caused by the drop in supply line voltage when the outputs draw high current getting back into the preamplifier.

Hence we have chosen IC regulators for the preamplifier supply lines. Secondly, the magnetic field from

the large transformer and associated AC wiring required to supply the power amplifier modules is quite large and almost impossible to keep out of the sensitive preamp stages. Therefore you will notice that the specification for hum in the completed amplifier is lower than that of the individual units. We took this measurement using a standard EI lamination transformer after rotating it for minimum hum.

The hum induced by the transformer can be further reduced by using a C-core type, or better still a toroidal transformer, which have a contained field, but these are often hard to get and expensive to the hobbyist.

We feel that the specifications of the amplifier are very good, however the purist (with plenty of money) may like to do it this way:

The two power amplifier modules, together with individual power supplies using say, 30 000 uF capacitors, could be mounted in a separate box to the preamplifier, which could then be powered from the ETI 581 regulated supply.

This would no doubt improve the power output and transient performance of the amplifier but the cost would be much greater.

Construction

Construction details for the preamplifier and power amplifiers have been described previously, all that remains is to house them together, with the power supply, in a suitable box. As we said before, many variations are possible — here is how we did it.

Assemble the power supply board first, taking care to correctly orientate the semiconductors, IC regulators and capacitors. To simplify construction we used pc pins for all terminations to the boards.

The photo of the rear panel shows the position of the input and output connections. Slots are cut in the panel for the connector blocks and a large cut running across the back panel is used to inset the power amplifier modules from the rear. Holes then must be drilled for the ground terminal, external power socket, power cord, mounting screws for the terminal blocks and holding screws for each power amplifier — which pass through the top of each heatsink fastening it to the panel.

The case measures approximately 420 x135x285mm. and was constructed from aluminum angle stock with anodised aluminum sides. This gave us a rigid chassis suitable for rack mounting. If you use any kind of anodised chassis be sure to break the finish in order to make good electrical contact.

One thing to watch though is that anodised aluminum does not conduct electricity and, after assembling the box, the various metal parts will probably not be connected to each other, causing a multitude of problems. To overcome this, strap the rear and side panels to the common ground point at the head phone jack on the front panel. (Yes, we found this out the hard way).

After the preamplifier/front panel, power amplifiers and power supply have been mounted in the box and the input/output sockets mounted onto the rear panel the unit can be wired as shown in the wiring diagram.

Common to all amplifier designs, the ground wiring is very critical. Most instability and hum problems can be traced to ground "loops" or incorrect wiring.

The common lead from each channel speaker is returned directly to the OV point on the power supply. A wire is then taken from this point and fed to one power module, to the other, and then to the preamplifier. To avoid a ground loop the braid of the shielded cables from the preamplifier to the power amplifier is not carried through the connector block on the rear panel. OV leads for the LEDs and external power are also returned to the power supply common. The common is then grounded to the chassis at the headphone socket together with the transformer shield and lines ground. This is the ONLY ground point onto the chassis.

All the ac and speaker wiring is fed along the back and down the left side of the case as shown, well away from the sensitive parts of the amplifier. The dc wiring from the power supply to the preamplifier is carried along the front.

Lengths of shielded cable with RCA plugs on one end are used to connect the input sockets to the preamplifier. These can be made by cutting RCA patch cords to the appropriate length, one cord making two leads. The shields of these cables should not be connected together or to the case at the input sockets.

All that remains is to solder the 330 ohm resistors from the speaker switch to the plugs on the headphone socket.

Check that all wiring is correct and there are no frayed ends. The procedure for setting the bias current for the output transistors is given in the Nov. issue. As soon as this is done insert the 2 A fuses and the amplifier can be switched on.

If you have the older 50 watt ETI

SPECIFICATIONS

Power output	60 watts @ 0.1% THD one channel driven 55 watts @ 0.1% THD both channels driven
Distortion	0.05% THD @ 30 V p-p output across 8 ohm load, both channels driven.
Hum	-70 dB on full output using standard transformer
Noise	-80 dB on full output
Damping factor	57 (measured at 100 Hz, 1 kHz and 10 kHz).
Frequency Response	Phono: Within 0.5 dB of RIAA from 20 Hz to 20 kHz (Follows new IEC curve). Other inputs: 20 Hz to 20 kHz ± 0.5 dB Subsonic rolloff: 6 dB/octave below 20 Hz
Tape output	150 mV RMS
Sensitivity	For 500 mV RMS output phono: 3 mV RMS other: 150 mV RMS (Phono overload level is 400 mV p-p).
Tone controls	Bass: ± 13 dB at 50 Hz Treble: ± 11 dB at 10 kHz
Filters	High: 6 dB/octave, -3 dB at 5 kHz Low: 6 dB/octave, -3 dB at 100 Hz
Loudness	8 dB boost at 150 Hz and 10 kHz.
Mute switch	20 dB attenuation

480 modules these could probably be used in place of the ETI 470 module, though we haven't tried it.

Power Supply

The power supply for this amplifier uses a 28V-0-28V transformer rated at 2 A to provide +/- 40 Vdc rails for the power amplifiers. Two regulators, IC1 and IC2, supply very stable +/- 15 V rails for the preamplifier.

Current limit resistors are mounted on the pc board to power the front panel LEDs. This permits some flexibility to allow us to think up other things to do with the LEDs later.

Fuses are also provided on the board to protect the power supply from a short circuit in the dc output lines. If the dc output facility on the rear panel is not used the fuses can be short

circuited, as each power module is protected by its own fuses.

When an amplifier is first switched on, the two supply lines rarely come up to full voltage simultaneously. This causes a loud 'thump' in the speakers which may damage them.

To avoid this an "anti-thump" circuit connects the speakers several seconds after the amplifier is turned on.

It works this way; as the power rails come up to voltage a capacitor, C7, charges via R3. Transistor Q1 conducts pulling in the relay, RL1, and connecting the speakers after the power rails have had enough time to stabilise.

At first we tried mounting the power supply board in front of the

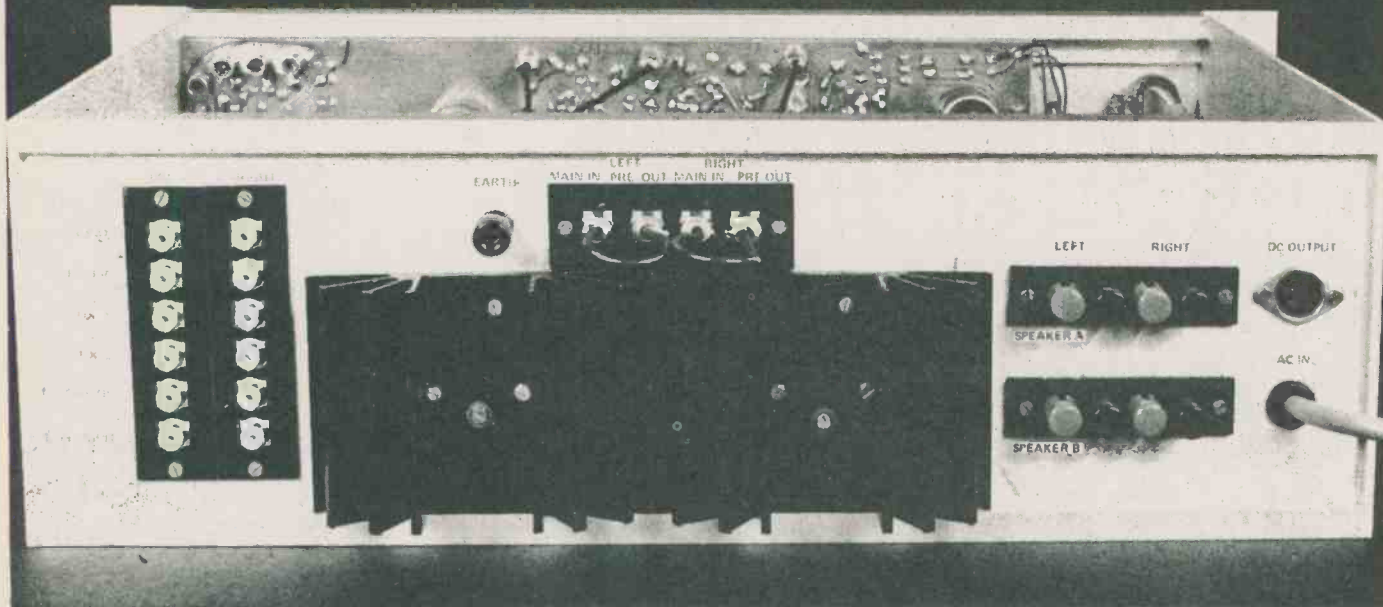

PARTS LIST

Resistors

R1, R2 2k 1W 5%
 R3 47k ¼W 5%
 R4 470R 1W 5%

Capacitors

C1 33n 120VAC metallized paper
 C2-C5 2500µ 50V electro
 C6, C7 47µ 50V electro
 C8, C9 10µ 25V tantalum

Semiconductors

D1-D4 IN5404 or sim
 D5 IN4004, or sim
 Q1 2N3904

IC1 7815, LM340-15, 15V regulator
 IC2 7915, LM320-15, -15V regulator

Miscellaneous

T1 28-0-28 VAC, 2A transformer
 FS1, FS2 2 amp fuses (if used)
 RL1 2PST 12V relay
 SW1 2 pole 120VAC miniature toggle switch.

Headphone socket 6.5 mm jack skt.
 Speaker switch two pole, two position, centre off min. toggle switch
 16 RCA plugs or eight patch leads cut in half, two short RCA patch leads, power lead and clamp.
 Two, 330R, 1W resistors
 Two, 3-way plastic terminal strips
 Two, 4-way speaker terminals
 Two, 6-way RCA panel sockets
 One, 4-way RCA panel socket
 One, 5-pin DIN socket

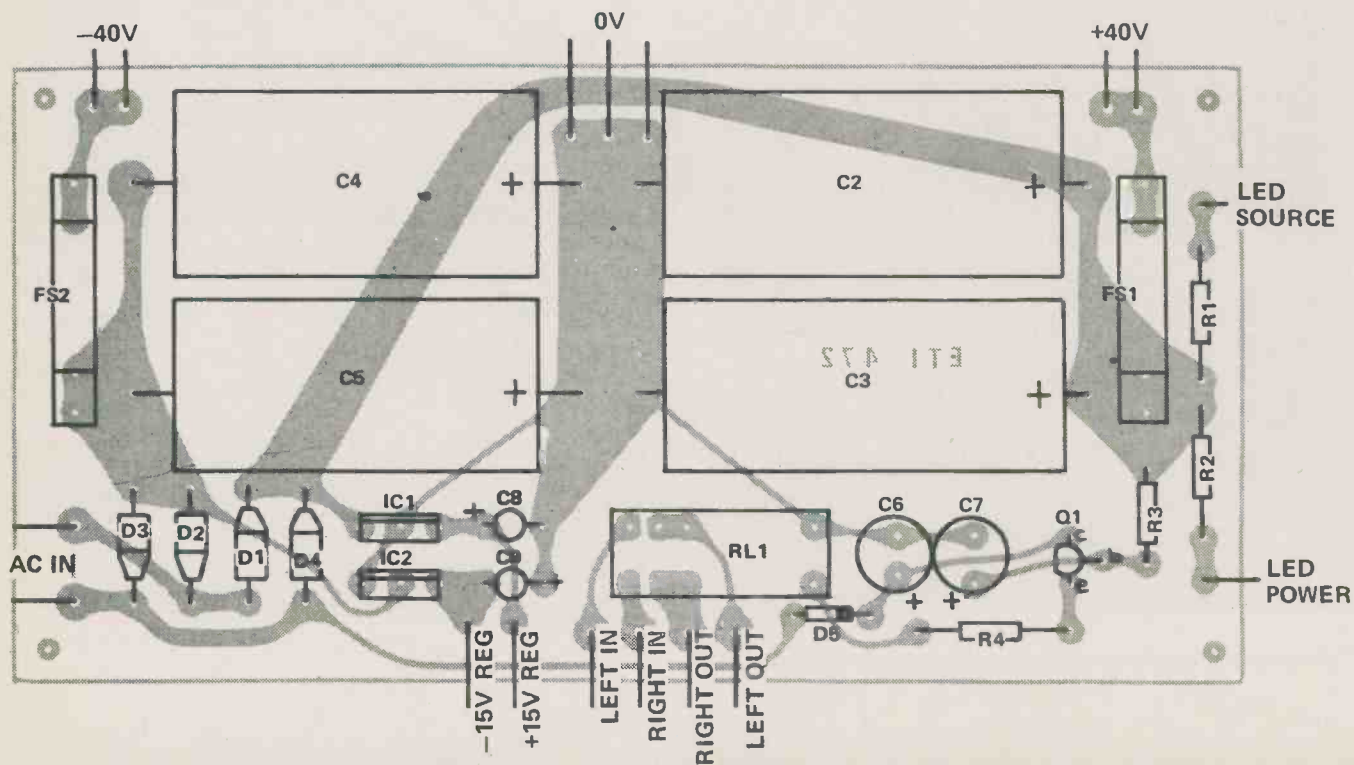

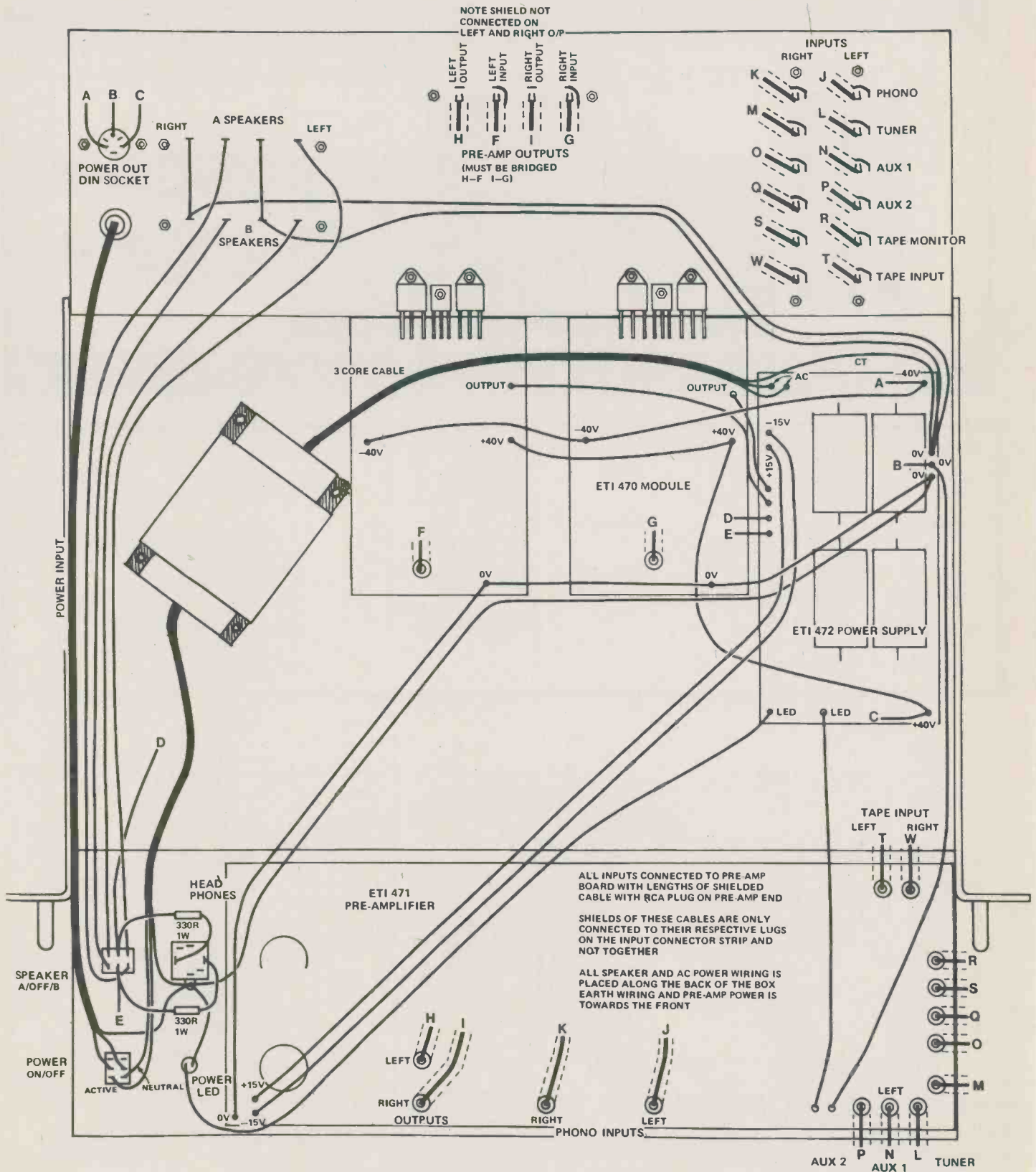

Internal wiring and interconnection diagram of the stereo amplifier.

transformer near the preamplifier, but found the proximity of the speaker wiring to the tone control stage caused high frequency instability if the treble control was advanced. The power supply board is now mounted at the opposite side of the case to the transformer and the ac secondary wiring run across the back.

Two three-terminal connector strips are mounted on top of the transformer, using the holes in the mounting plates, to take primary and secondary connections. The shield (green wire) makes up the third wire on the primary side and is run together with the 120V wiring to the front panel. We used three-core line cord for connections from the transformer to the power switch and the power supply pc board. A suppression capacitor (C1) is mounted across the transformer primary connector block.

Short patch leads will have to be made up to connect each of the pre-amplifier outputs to their respective power amplifier inputs.

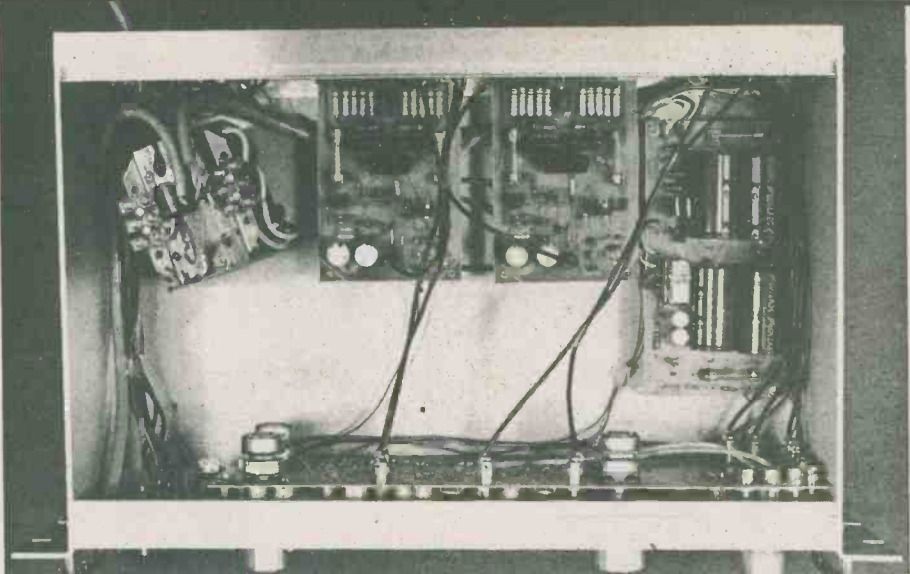

This internal view shows the placement of the main modules and the orientation of the power transformer. The latter will have to be oriented individually to reduce hum levels to the minimum obtainable.

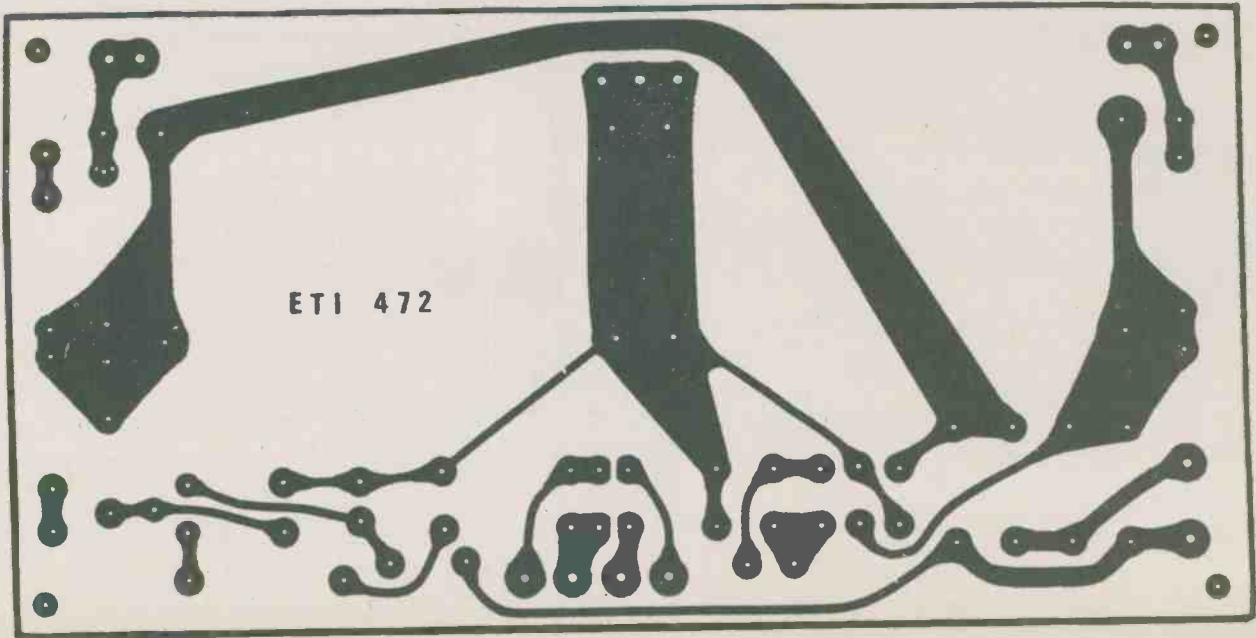
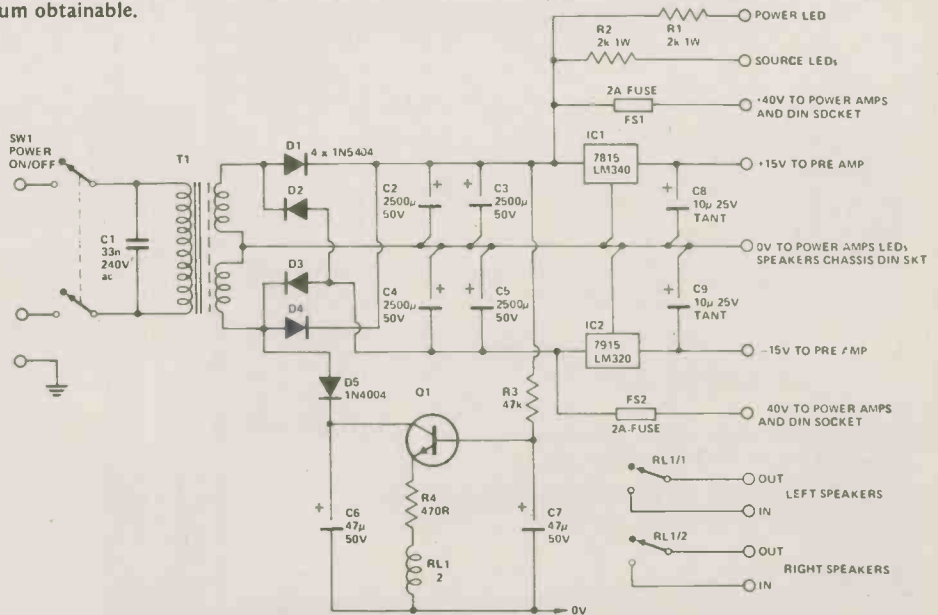

Babani Books from

BP1: First Book of Transistor Equivalents & Substitutes \$2.80

More than 25,000 transistors with alternatives and equivalents make up this most complete guide. Covers transistors made in Great Britain, USA, Japan, Germany, France, Europe, Hong Kong, and includes types produced by more than 120 different manufacturers.



BP14: Second Book of Transistor Equivalents & Substitutes \$4.80

This handbook contains entirely new material, written in the same style as the "First Book of Transistor Equivalents & Substitutes". The two complement each other and make available some of the most complete and extensive information in this field.



BP24: Projects Using IC741 \$4.25

The popularity of this inexpensive integrated circuit has made this book highly successful. Translated from the original German with copious notes, data and circuitry, a "must" for everyone, whatever their interest in electronics.



BP33: Electronic Calculator Users Handbook \$4.25

An invaluable book for all calculator users whatever their age or occupation, or whether they have the simplest or most sophisticated of calculators. Presents formulae, data, methods of calculation, conversion factors, etc., with the calculator user especially in mind, often illustrated with simple examples.

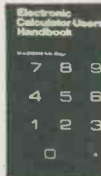

BP35: Handbook of IC Audio Pre-amplifier & Power Amplifier Construction \$5.50

This book is divided into three parts: Part I, Understanding Audio ICs; Part II, Pre-amplifiers, Mixers and Tone Controls; Part III, Power Amplifiers and Supplies. Includes practical constructional details of pure IC and Hybrid IC and Transistor designs from about 250mW to 100W output. An ideal book for both beginner and advanced enthusiasts alike.



NO.205: First Book of HI-FI Loudspeaker Enclosures \$3.55

The only book giving all data for building every type of loudspeaker enclosure. Includes corner reflex, bass reflex, exponential horn, folded horn, tuned port, klipschorn labyrinth, tuned column, loaded port and multi speaker panoramic. Many clear diagrams are provided showing all dimensions necessary.



BP37: 50 Projects Using Relays, SCR's & Triacs \$5.50

Relays, silicon controlled rectifiers (SCR's) and bi-directional triodes (TRIACs) have a wide range of application in electronics today. These may extend over the whole field of motor control; dimming and heating control; delayed, timing and light sensitive circuits and include warning devices, various novelties, light modulators, priority indicators, excess voltage breakers, etc.

The enthusiast should be able to construct the tried and practical working circuits in this book with a minimum of difficulty. There is a wide latitude in component values and types, allowing easy modification of circuits or ready adaptation of them to individual needs.



BP39: 50 (FET) Field Effect Transistor Projects \$5.50

The projects described in this book include radio frequency amplifiers and converters, test equipment and receiver aids, tuners, receivers, mixers and tone controls, as well as various miscellaneous devices which are useful in the home. This book contains something of particular interest for every class of enthusiast — short wave listener, radio amateur, experimenter or audio devotee.



BP42: 50 Simple L.E.D. Circuits \$3.55

50 interesting and useful circuits and applications, covering many different branches of electronics, using one of the most expensive and freely available components — the Light Emitting Diode (L.E.D.). Also includes circuits for the 707 Common Anode Display. A useful book for the library of both beginner and more advanced enthusiast alike.



BP44: IC 555 Projects \$7.55

Every so often a device appears that is so useful that one wonders how life went on before without it. The 555 timer is such a device. It is manufactured by almost every semiconductor manufacturer and is inexpensive and very easily obtainable.

Included in this book are Basic and General Circuits, Motor Car and Model Railway Circuits, Alarms and Noise Makers as well as a section on the 556, 558 and 559 timers.



BP46: Radio Circuits Using ICs \$5.90

This book describes integrated circuits and how they can be employed in receivers for the reception of either amplitude or frequency modulated signals. Chapters on amplitude modulated (a.m.) receivers and frequency modulation (f.m.) receivers. Discussion on the subjects of stereo decoder circuits, the devices available at present for quadrophonic circuits and the convenience and versatility of voltage regulator devices. An extremely valuable addition to the library of all electronics enthusiasts.



BP47: Mobile Discotheque Handbook \$5.90

The aim of this book is to give you enough information to enable you to have a better understanding of many aspects of "disco gear". The approach adopted is to assume the reader has no knowledge and starts with the fundamentals. The explanations given are simplified enough for almost anyone to understand.



BP48: Electronic Projects For Beginners \$5.90

The newcomer to electronics, will find a wide range of easily made projects and a considerable number of actual component and wiring layouts. Many projects are constructed so as to eliminate the need for soldering. The book is divided into four sections: "No Soldering" Projects, Miscellaneous Devices, Radio and Audio Frequency Projects and Power Supplies.



BP49: Popular Electronic Projects \$6.25

A collection of the most popular types of circuits and projects which will provide a number of designs to interest the electronics constructor. The projects selected cover a very wide range. The four basic types covered are: Radio Projects, Audio Projects, Household Projects and Test Equipment.



BP50: IC LM3900 Projects \$5.90

The purpose of this book is to introduce the LM3900; one of the most versatile, freely obtainable and inexpensive devices available to the Technician, Experimenter and the Hobbyist. It provides the groundwork for both simple and more advanced uses.

Simple basic working circuits are used to introduce this IC. The reader should set up each of these for himself. Familiarity with these simple circuits is essential in order to understand many more complicated circuits and advanced uses.



BP51: Electronic Music and Creative Tape Recording \$5.50

This book sets out to show how electronic music can be made at home with the simplest and most inexpensive of equipment. It then describes how the sounds are generated and how these may be recorded to build up the final composition.

For the constructor, several ideas are given to enable him to build up a small studio including a mixer and various sound effects units. All the circuits shown in full have been built by the author. Most of the projects can be built by the beginner.



BP62: BOOK 1. The Simple Electronic Circuit & Components \$8.95

BP63: BOOK 2. Alternating Current Theory \$8.95

BP64: BOOK 3. Semiconductor Technology \$8.95

BP77: BOOK 4. Microprocessing Systems & Circuits \$12.30

Simply stated the aim of these books is to provide an inexpensive introduction to modern electronics. The reader will start on the right road by thoroughly understanding the fundamental principles involved.

Although written especially for readers with no more than ordinary mathematical skills, the use of mathematics is not avoided, and all the mathematics required is taught as the reader progresses.

The course concentrates on the understanding of the important concepts central to electronics. Each book is a complete treatise of a particular branch of the subject and, therefore, can be used on its own. However, latter books assume a working knowledge of the subjects covered in earlier books.

BOOK 1: This book contains fundamental theory necessary to develop a full understanding of the simple electronic circuit and its main components.

BOOK 2: This book continues with alternating current theory.

BOOK 3: Follows on semiconductor technology, leading up to transistors and integrated circuits.

BOOK 4: A complete description of the internal workings of microprocessors.

BP65: Single IC Projects \$6.55

All the projects contained in this book are simple to construct and are based on a single IC. A strip board layout is provided for each project, together with any special constructional points and setting up information, making this book suitable for beginners as well as more advanced constructors.



These books are specially imported from England by us.
 All prices include handling and postage.
 To order, use the order form in this publication or
 write to:
 ETI Magazine, Unit 6, 25 Overlea Boulevard,
 Toronto, Ontario, M4H 1B1.

BP66: Beginners Guide To Microprocessors & Computing \$7.55

This book is intended as an introduction to the basic theory and concepts of binary arithmetic, microprocessor operation and machine language programming. The only prior knowledge which has been assumed is very basic arithmetic and an understanding of Indices. A helpful Glossary is included. A most useful book for students of electronics, technicians, engineers and hobbyists.



Counter Driver and Numerical Display Projects



BP67: Counter Driver & Numerical Display Projects \$7.55

The author discusses and features many applications and projects using various types of numeral displays, popular counter and driver IC's, etc.

BP68: Choosing & Using Your HI-FI \$7.25

The reader is provided with the fundamental information necessary to enable him to make a satisfactory choice from the extensive range of stereo equipment currently on the market. This should aid him in understanding the technical specifications of the equipment he is interested in buying. Full of helpful advice on how to use your stereo system properly so as to realise its potential to the fullest and also on buying your equipment. A Glossary of terms is included.



Electronic Games



BP69: Electronic Games \$7.55

The author has designed and developed a number of interesting electronic game projects using modern integrated circuits. The book is divided into two sections, one dealing with simple games and the latter dealing with more complex circuits. Ideal for both beginner and enthusiast.

BP70: Transistor Radio Fault-Finding Chart \$2.40

Author Mr. Chas. Miller has drawn on extensive experience in repairing transistor radios to design this book. The reader should be able to trace most of the common faults quickly using the concise chart.



Electronic Household Projects



BP71: Electronic Household Projects \$7.70

Some of the most useful and popular electronic construction projects are those that can be used in or around the home. These circuits range from such things as '2 Tone Door Buzzer' and Intercom through Smoke or Gas Detectors to Baby and Freezer Alarms.

BP72: A Microprocessor Primer \$7.70

A newcomer tends to be overwhelmed when first confronted with articles or books on microprocessors. In an attempt to give a painless approach to computing, this small book will start by designing a simple computer that is easy to learn and understand. Such ideas as Relative Addressing, Index Registers, etc. will be developed and will be seen as logical progressions rather than arbitrary things to be accepted but not understood.



Remote Control Projects



BP73: Remote Control Projects \$8.58

This book is aimed primarily at the electronics enthusiast who wishes to experiment with remote control and many of the designs are suitable for adaptation to the control of other circuits published elsewhere. Full explanations have been given so that the reader can fully understand how the circuits work and see how to modify them. Not only are Radio control systems considered but also Infra-red, Visible light and Ultrasonic systems as are the use of Logic ICs and Pulse position modulation etc.

BP74: Electronic Music Projects \$7.70

Although one of the more recent branches of amateur electronics, electronic music has now become extremely popular and there are many projects which fall into this category, ranging in complexity from a simple guitar effects unit to a sophisticated organ or synthesiser.

The purpose of this book is to provide the constructor with a number of practical circuits for the less complex items of electronic music equipment, including such things as Fuzz Box, Waa-Waa Pedal, Sustain Unit, Reverberation and Phaser-Units, Tremolo Generator etc.



BP75: Electronic Test Equipment Construction \$7.30

This book covers in detail the construction of a wide range of test equipment for both the hobbyist and radio amateurs. Included are projects ranging from a FET Amplified Voltmeter and Resistance Bridge to a Field Strength Meter and Heterodyne Frequency Meter.

Not only can the home constructor enjoy building the equipment but the finished project can also be usefully utilised in the furtherance of his hobby. An ideal book for both beginner and advanced enthusiast alike.



Power Supply Projects



BP76: Power Supply Projects \$7.30

Power supplies are an essential part of any electronic project. The purpose of this book is to give a number of power supply designs, including simple unregulated types, fixed voltage regulated types, and variable voltage stabilised types, the latter being primarily intended for use as bench supplies for the electronic workshop. The designs are all low voltage types for use with semiconductor circuits.

There are other types of power supplies and a number are dealt with in the final chapter, including a cassette supply, Nicad battery charger, voltage step up circuit and a simple inverter.

BP78: PRACTICAL COMPUTER EXPERIMENTS \$7.30

This book aims to fill in the background to microprocessors by describing typical computer circuits in discrete logic and it is hoped that this will form a useful introduction to devices such as adders, memories, etc. as well as a general source book of logic circuits.

An essential edition to the library of any computer and electronic enthusiast.



Radio Control for Beginners



BP79: Radio Control For Beginners \$7.30

The aim of this book is to act as an introduction to Radio Control for beginners to the hobby. The book will commence by dealing with the conditions that are allowable for such things as frequency and power of transmission. This is followed by a "block" explanation of how control device and transmitter operate and receiver and actuator(s) produce motion in a model.

Details are then given of actual solid state transmitting equipment that the reader can build. Plain and loaded aerials are then discussed and so is the field strength meter to help with proper setting up.

The radio receiving equipment is then dealt with, this includes a simple receiver and a crystal controlled superhet. The book ends with electro-mechanical means of obtaining movement of the controls of the model.

BP80: POPULAR ELECTRONIC CIRCUITS—BOOK 1 \$8.25

Another book by the very popular author, R.A. Penfold, who has designed and developed a large number of circuits which are accompanied by a short text giving a brief introduction, circuit description and any special notes on construction and setting up that may be necessary.

The circuits are grouped under the following headings: Audio Circuits, Radio Circuits, Test Gear Circuits, Music Project Circuits, Household Projects, and Miscellaneous Circuits.

An extremely useful book for all electronic hobbyists, offering remarkable value for the number of designs it contains.



NO.213: Electronic Circuits For Model Railways \$4.50

The reader is given constructional details of how to build a simple model train controller; controller with simulated inertia and a high power controller. A signal system and lighting for model trains is discussed as is the suppression of RF interference from model railways. The construction of an electronic steam whistle and a model train chuffer is also covered.

NO.215: Shortwave Circuits & Gear For Experimenters & Radio Hams \$3.70

Covers constructional details of a number of projects for the shortwave enthusiast and radio "Ham". Included are: an add-in crystal filter, adding an "S" meter in your receiver; crystal locked H.F. Receiver; AM tuner using phase locked loop; converter for 2MHz to 6MHz, 40 to 800MHz RF amplifier, Aerials for the 52, 144MHz bands, Solid State Crystal Frequency Calibrator, etc.

NO.221: Tested Transistor Projects \$5.50

Author Mr. Richard Torrens has used his experience as an electronics development engineer to design, develop, build and test the many useful and interesting circuits in this book. Contains new and innovative circuits as well as some which may bear resemblance to familiar designs.

NO. 223: 50 Projects Using IC CA3130 \$5.50

In this book, the author has designed and developed a number of interesting and useful projects using the CA3130, one of the more advanced operational amplifiers that is available to the home constructor. Five general categories are covered: Audio Projects, R.F. Projects, Test Equipment, Household Projects and Miscellaneous Projects.

NO.224: 50 CMOS IC Projects \$4.25

CMOS IC's are suitable for an extraordinary wide range of applications and are now also some of the most inexpensive and easily available types of IC's. The author has designed and developed a number of interesting and useful projects. The four general categories discussed in the book are: Multivibrators, Amplifiers and Oscillators, Trigger Devices and Special Devices.

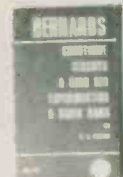

Stereo Rumble Filter

Active filter design improves clarity of bass reproduction.

IN BYGONE DAYS rumble filters were very popular because even the best of turntables, used then, generated considerable vibration due to bearing and motor deficiencies. These vibrations, mechanically transmitted to the pickup cartridge, resulted in an audible output. Hence high-pass filters were often incorporated in amplifiers to reduce this objectionable rumbling sound to an acceptable level, and as bass response seldom extended below 50 Hz, a simple RC filter with 6 dB per octave roll-off below 50 Hz was considered adequate.

Modern turntables have far smoother bearing and drive arrangements than their early counterparts – and for this reason many amplifier manufacturers no longer include a rumble filter facility.

Those that do are rarely satisfactory. Their slope is generally inadequate and the main effect of switching them in is to roll off the low-frequency response to the detriment of programme content.

At first sight it would seem better to exclude the rumble filter altogether and just make sure that our turntables do not generate any appreciable rumble.

Surprisingly perhaps, a rumble filter is still very much required and if designed correctly can make an appreciable improvement to reproduction – even when used with turntables that generate no rumble at all!

The reason why will be clearly apparent if you take the front grille

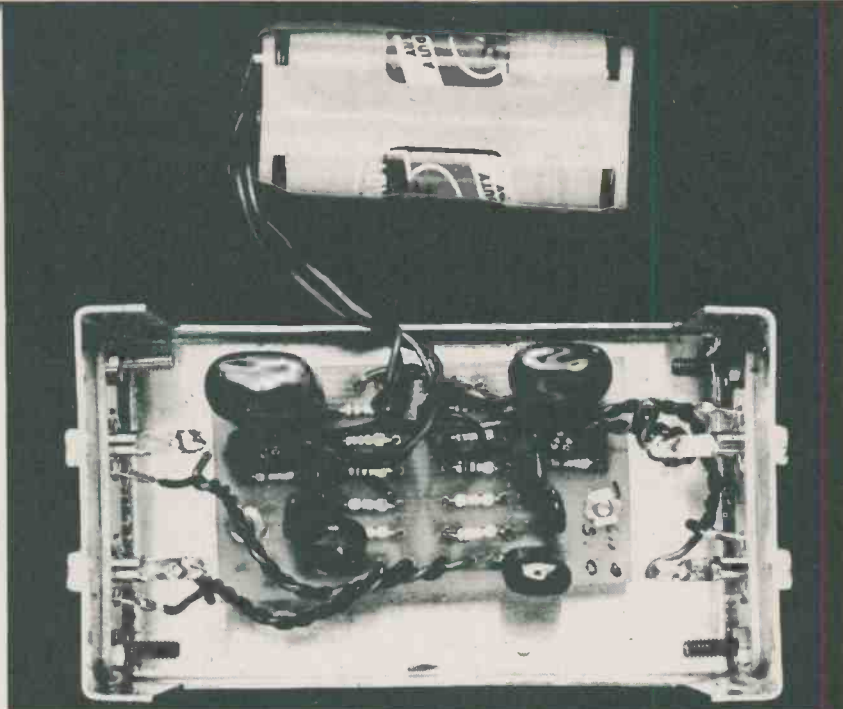

This internal view shows how the rumble filter is assembled

the filter must be situated before the preamplifier. This also poses problems as the signals at this point are very low-level, and there is a danger of introducing hum which would be merely replacing one fault by another.

The Solution

To maintain response down to at least 50 Hz, whilst obtaining 30 dB or more attenuation to LF noise, we must use a filter which has a sharp knee and an ultimate attenuation slope of 24 dB per octave. The most satisfactory (and cheapest) method of doing this is to use an active high-pass filter – and this is the approach we have used. To obviate the possibility of hum-pickup, the unit uses a battery power supply, one each for left and right channel filters. The use of separate batteries prevents ground loops and ensures that channel separation is maintained. As current drain is very low the batteries may be expected to last their shelf life (12 months or so) and for that reason an on/off switch has not been included.

The unit fits between the turntable and the amplifier, cuts any frequency below 35 Hz and has a total attenuation of 37 dB at 10 Hz

increasing at 24 dB/octave below that.

Construction

We built our unit onto a small printed circuit board, but layout is not critical and other alternative methods, such as matrix or Veroboard, may be used successfully.

The signal levels involved are extremely small (about 100 μ V at 50 Hz) and for this reason a metal box is a must if hum pickup is to be minimized. And, as said before, two separate battery supplies should be used in order to avoid ground loops. We used a conventional four-way battery holder to hold the two sets of batteries. These holders normally connect all four batteries in series. However it is a simple matter to snip the connection between the two sets of two cells.

The phono sockets for both input and output should be insulated from the metal case. When connecting the unit we found minimum hum was introduced by grounding the turntable to the metal box and then, by taking a separate ground from the metal box to the amplifier. However experimentation in the positioning of grounds may well show that some other configuration is best for your particular setup. ●

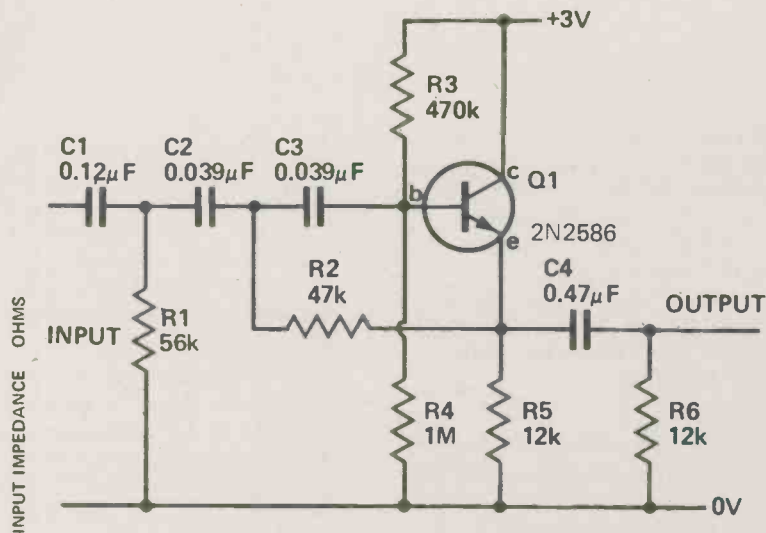
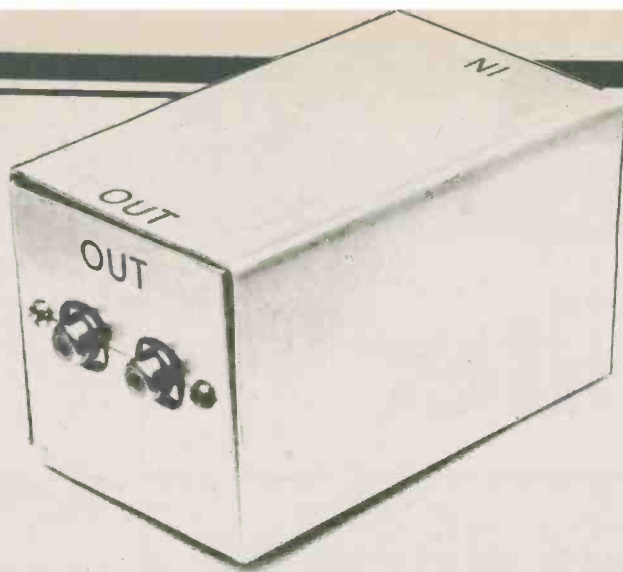
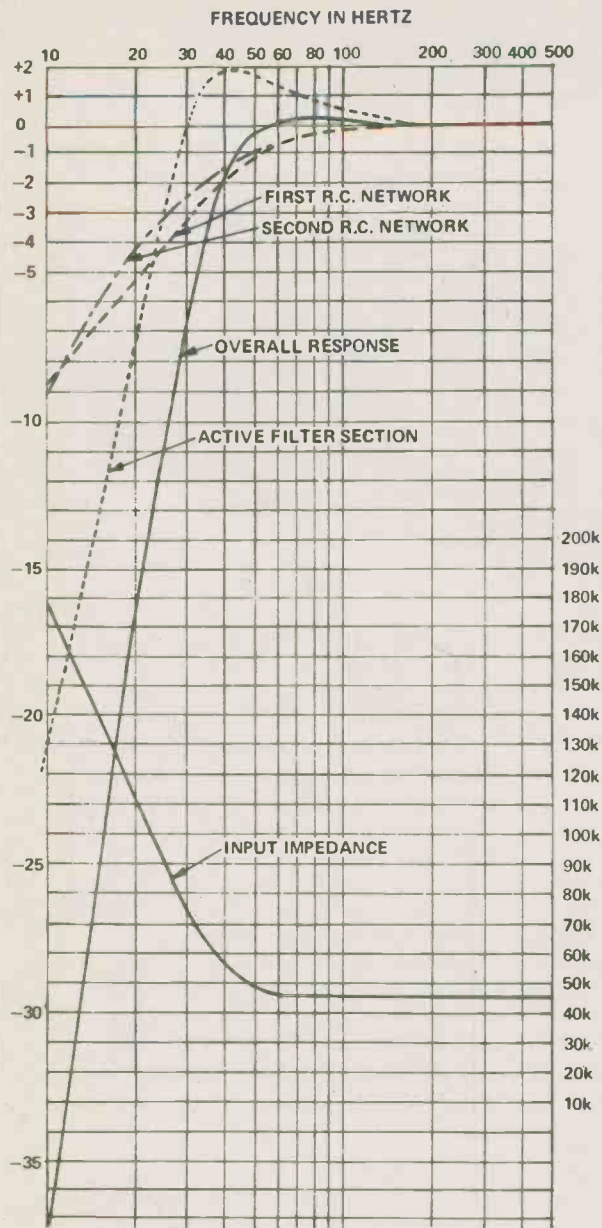
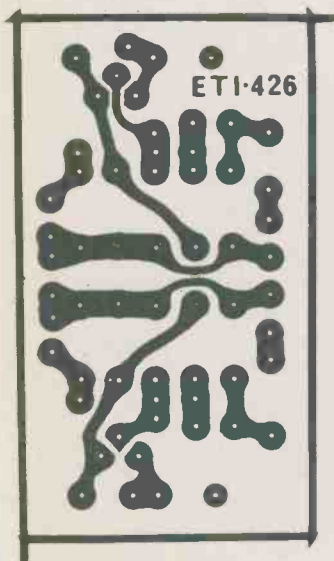

Fig. 1. (Above right) Circuit diagram of the rumble filter. Two required for stereo.

Fig. 2. (Bottom left) Printed circuit board layout for the rumble filter 40mm x 70mm.

Fig. 3. (Above) The finished Stereo Rumble Filter.

Fig. 4. (Left) Characteristics of the rumble filter.



SPECIFICATION

Input Impedance (rises below 50 Hz)	47k
Output Impedance	< 5k
Input voltage (maximum)	250mV
Cut-off Frequency (-3dB)	36 Hz
Cut-off Slope (maximum)	24dB/octave
Attenuation at 10 Hz	37 dB
Gain at 1 KHz	-0.2 dB.

Perform a death-defying act.

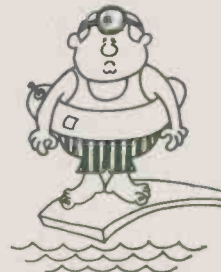

Exercise regularly.

Give Heart Fund

Dynamic Noise Filter



Annoyed by tape hiss? Save yourself sanity with this project.

THE HUMAN BRAIN IS a funny thing really! Its connections to the outside world are via the five senses and it relies on these senses to transmit reliable and accurate information about the outside world. However, as you are probably aware, this information can quite often be distorted (think of the countless optical illusions).

Missing Links.

It is not so often that audio illusions are in the news, probably because they are harder to detect, but that doesn't mean they don't exist, eg. The fact that the ear cannot detect small gaps, say 5 mS, in a passage of music allowed us to build a click eliminator. Every time a click (which always have a duration of less than 5 mS) is detected, the sound is automatically cut out for about 5 mS. The final effect being one of apparent continuity of music without the gaps or clicks.

Hissed Up

Our tape hiss reduction system functions on the principle that on a continuous passage of music the difference between the music and the hiss (signal/noise ratio) is so great that we cannot hear the hiss for the music. All well and good. On a more spasmodic piece of music, where there are gaps of more than say 50 mS between signals, then these gaps have (apparently) a much lower signal/noise ratio, not because the noise level has gone up, but because the signal level has gone down. This means that the hiss is more pronounced.

During these time intervals our device filters out the high frequency

tape noise using a current controlled filter (CCF) — immediately allowing high frequency sound through again when a signal comes along. (The illusion of one type of sound covering up another of about the same frequency is called masking.)

Construction

Printed circuit board construction should be relatively straightforward. We suggest a step by step approach be adopted and testing of each stage be undertaken before construction of the following stage. The main reason for this is that the circuit, although having few components, is quite tricky in operation and this makes fault-finding difficult in cases of malfunction.

First, build up the on-board power supply section (D3, D4, C17, C18, IC3, R28 and LED 1). Check with a voltmeter for 12 V DC at its output ie, between the output of IC3 and ground. If the LED lights up it is a good indication that the supply is working correctly.

Next the buffer amplifiers and associated components (C1, C2, R1, R2, R3, R4, R20, R21, C11, Q1 and Q2) should be inserted. If a signal source and scope are available put signals at the inputs to the circuit and observe the signals at the emitters of Q1 and Q2. They should be the same as the transistors are operating as non-inverting buffers.

Following this, the control circuitry (consisting of R5, R6 through to Q3, R17 and C10 on the circuit diagram) should be soldered in place and this stage now tested. With RV1 at mid-position and a high impedance voltmeter or a scope in

DC mode connected across C10, it should be seen that the voltage across the capacitor varies with varying signal input. If an audio waveform from, say, a cassette deck is used as a signal, then the voltage should be seen to increase with the higher frequencies (above about 7 kHz) but stay quite low for frequencies below this. Adjusting RV1 should adjust the overall voltage range across the capacitor.

Finally, IC3 and the rest of the components can be inserted and the complete board tested and set up. The signal at the output should be of the same amplitude as that at the input.

Setting Up

Once you are sure that everything is working correctly, then setting up is a very simple job. Erase a section of tape and play it back through the unit. Take the output from the unit and amplify it.

Turn RV1 completely anti-clockwise and listen. Slowly turn the preset clockwise until there is a barely perceptible increase in hiss noise. Then, step it back just a fraction, so that the hiss just goes. The device is now set for the tape unit and use with any other tape will require resetting.

A final setup test can be carried out, if necessary, with a signal generator plus an oscilloscope. With an input of about 500 mV, the bandwidth of the device should be up to about 25 or 30 kHz. However, an input of 50 mV should give an output bandwidth of only 6 kHz.

HOW IT WORKS

The device consists of two buffer amplifiers, two current controlled low-pass filters and control circuitry to detect the presence of a signal. The current produced by the control circuit is used to vary the bandwidth of the CCF to allow the signal through ie when sufficient signal is present to be able to mask the noise, the lowpass filter frequency range covers the whole audio spectrum — however, when there is little or no signal and the noise appears louder then the filter's lowpass range is lowered to a minimum of approximately 1 kHz. The noise is effectively filtered out.

As soon as a signal in the same frequency range as the noise comes along (ie above 7 kHz) the control circuit detects it and applies current to the CCFs thereby increasing the frequency range, allowing the signal through.

The buffer amps are built around the two emitter follower transistors (high I/P impedance — low O/P impedance) and the CCFs around IC2, the LM 13600 which is a new National chip, a dual operational transconductance amplifier. Resistor R19

applies a fixed current to control pins 3 and 14 of the chip, fixing the minimum bandwidth at 1 kHz. The greater the current into these pins the greater the frequency bandwidth.

The control current itself is obtained from the voltage across C10 by connection via R18. As V_{C10} increases then by Ohm's law the current I_{R19} must also increase. The energy stored on C10 is provided from IC1b and Q3, etc. connected as a peak detector. AC into this part of the circuit gives DC out to C10. The values of R17 and C10 are chosen to allow a fast attack time (something under 1 mS) and a comparatively slow decay time (about 40 mS).

IC1a is a mixer, bandpass filter, amplifier. It mixes a sample of signal from both channels via R5 and R6, filtering out frequencies below about 7 kHz, so that only signals with the same general frequencies as that of tape noise will affect the CCFs, and amplifies the signal with a gain of 100.

RV1 adjusts for different noise levels, dependent on a particular tape unit.

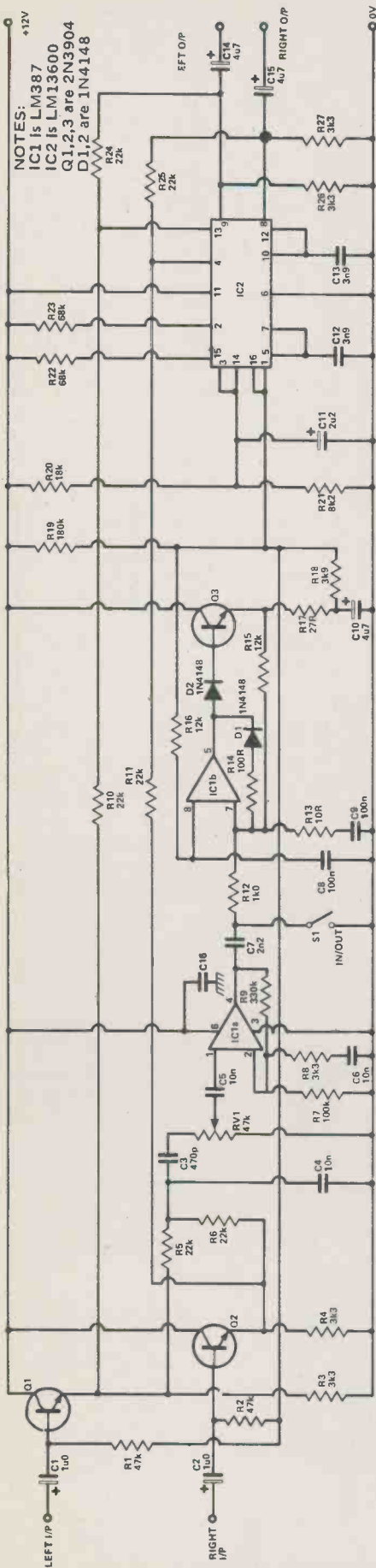

Fig. 1. Circuit diagram of the dynamic tape noise reduction system.

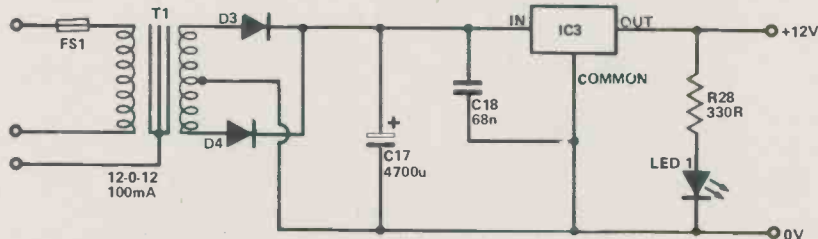

Fig. 2. The power supply.

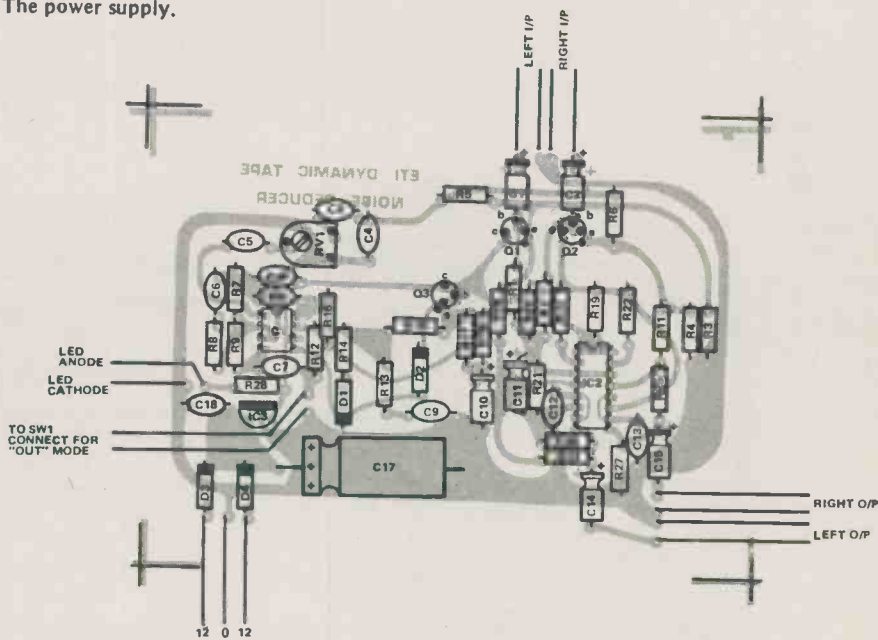

Fig. 3. (above) The component overlay for the Dynamic Noise Filter system. Note that the power supply circuit as shown in Fig. 1 is included on this board, and the input 12-0-12 comes straight from the transformer. As the system is mainly based on just two IC's sockets are heavily recommended!

DYNAMIC NOISE FILTER

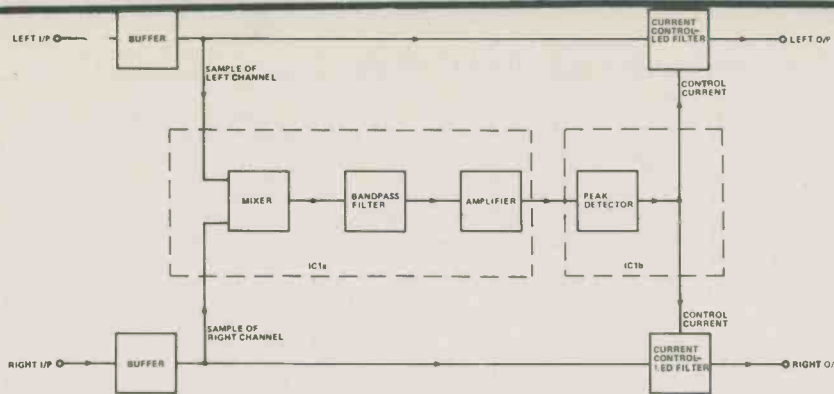
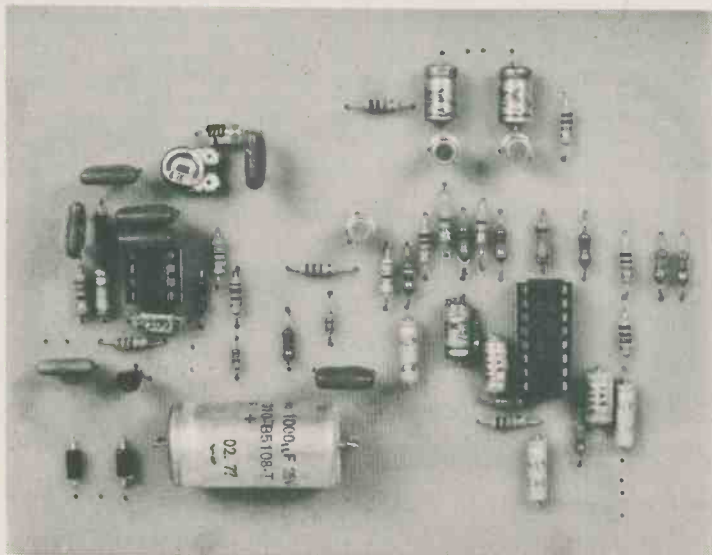

Fig. 4. (above) Block diagram to the Dynamic Noise Filter project. Not shown on this simplified diagram is the in/out (bypass) switching. This operates by grounding the output from the first stage. Such operation will thus prevent the peak detector from operating the filter stage and thus leave a full bandwidth at the output regardless of input level.



PARTS LIST

RESISTORS 'all 1/4W 5%'

R1, 2	47k
R3, 4, 8	3k3
R5, 6, 10,	
11, 24, 25	22k
R7	100k
R9	330k
R12	1k
R13	10R
R14	100R
R15, 16	12k
R17	27R
R18	3k9
R19	180k
R20	18k
R21	8k2
R22, 23	68k
R26, 27	3k3
R28	330R

POTENTIOMETERS

RV1	47k
-----	-----

CAPACITORS

C1, 2	1u0 electrolytic
C3	470p ceramic
C4, 5, 6	10n polyester
C7	2n2 polyester
C8, 9, 16	100n polyester
C10, 14, 15	4u7 electrolytic
C11	2u2 electrolytic
C12, 13	3n9 polyester
C17	4700u electrolytic
C18	68n polyester

SEMICONDUCTORS

IC1	LM387
IC2	LM13600
IC3	78L12
Q1, 2, 3	2N3904
D1, 2	1N4148
D3, 4	1N4001
LED	TIL220

MISCELLANEOUS

T1	12-0-12 c.t. secondary
FS1 + holder,	spot toggle switch, case to suit

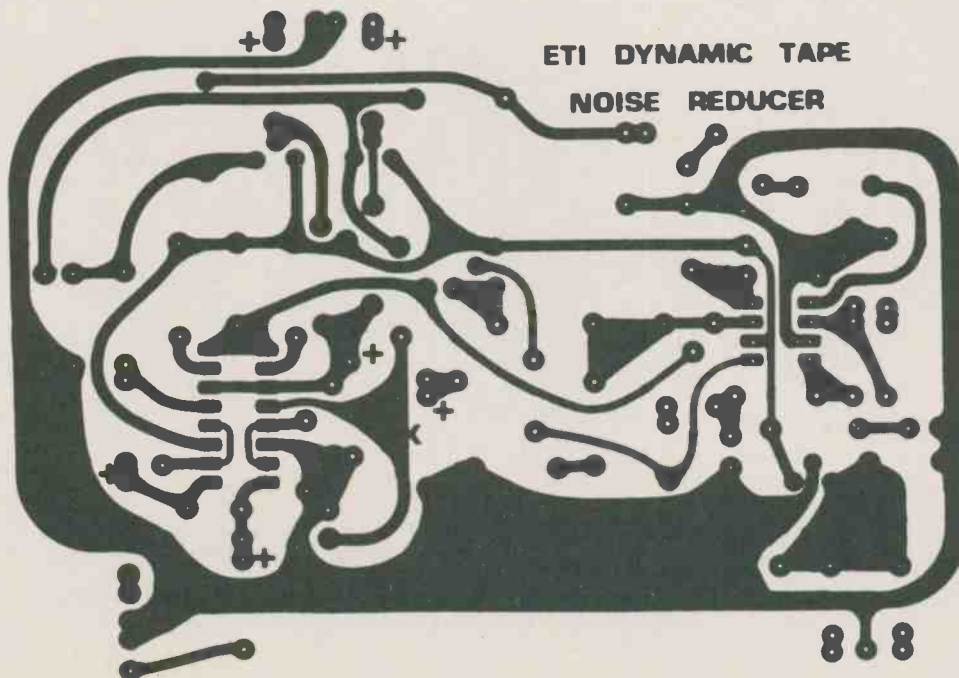

(above left) Close-up on the board — the only board — for the filter project.

Using this in conjunction with the component overlay shown overleaf should identify all the component positions, and make sure you don't get any polarised components in the wrong way round. The holes are leadout positions, and if you're left with any over don't call us. . .

Versatile Logic Probe

If you work or experiment with logic circuitry this project should be invaluable for debugging circuits. Inexpensive to build, it may be used both with TTL and CMOS circuitry, and indicates HI and LO conditions as well as pulse trains above 1 MHz. It will also detect short, isolated pulses having widths down to 500 ns.

INTEREST in digital electronics has grown rapidly in the past few years with the advent of microprocessors and large scale integration. The most essential test instrument for experimenting with digital circuitry is a logic probe.

In its most basic form this should provide an indication of the logic level at any point in a circuit without overloading the section being tested. Other desirable features are the ability to follow high frequency pulse trains (preferably over 1 MHz) and to detect isolated, narrow pulses less than 1 μ sec in width. Finally, the instrument should be compatible with both TTL and CMOS ICs and be able to operate from a wide range of supply voltages (say five to 15 volts).

Commercial logic probes that satisfy all these requirements are available, but they invariably cost over \$30. The probe design described here offers comparable performance for less than \$10. Combined with an excuse to enjoy a good cigar — a cigar tube is used for the case!

Indication is by means of three LEDs. Two red LEDs indicate either a HIGH or a LOW condition on the point under test, a green LED is used to indicate that a pulse train is occurring.

The circuit uses a single CMOS IC and a handful of resistors and capacitors. The components are mounted on a small pc board and housed in a tubular case such as an aluminum cigar tube or a length of plastic conduit. The power is

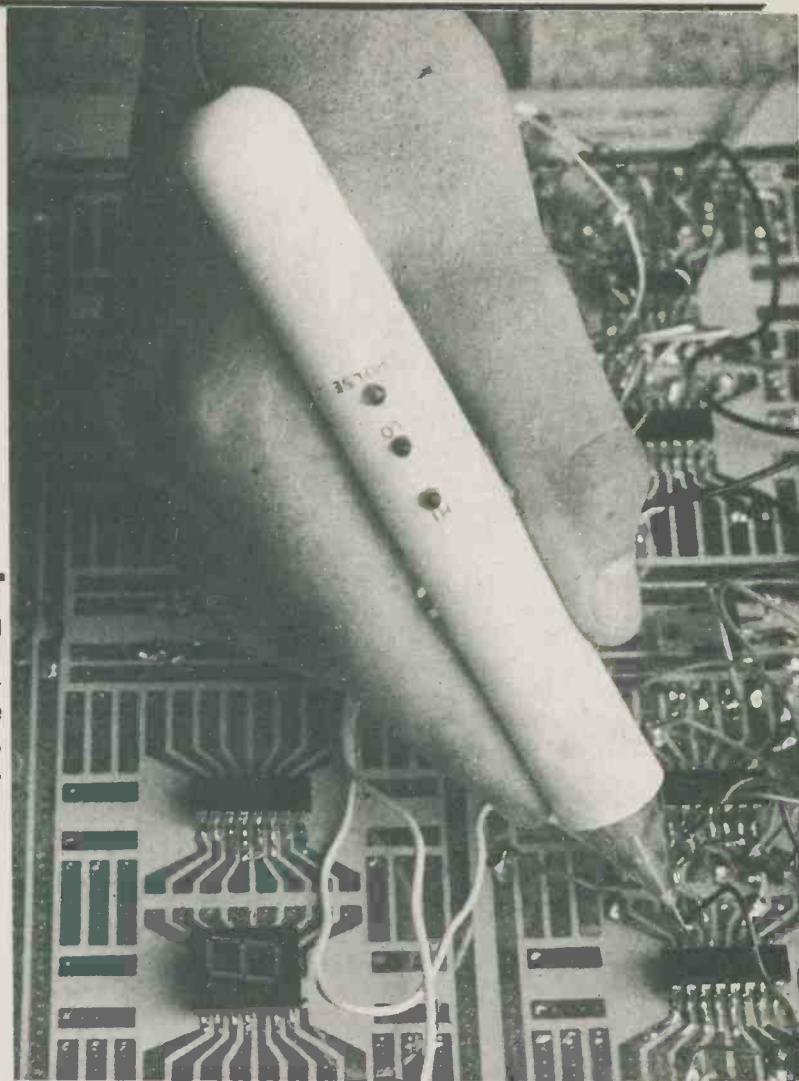

A logic probe is an invaluable aid for debugging or servicing digital circuitry. This project is inexpensive and easy to build.

supplied from the actual circuit under test and the performance characteristics of the prototype are described in the specification listed here.

Construction

A printed circuit board is recommended for this project to provide consistent performance characteristics.

Before attempting to mount the components on the printed circuit board check to see that it fits easily into the case. The board must be a loose enough fit to allow it to be moved up and down within the case over a range of at least 5 mm. (Refer to the diagram).

If this is not possible, the width of the board can be reduced slightly with a file or coarse sandpaper, taking care not to remove too much or to damage the copper portions of the board.

The other alternative is to use a larger case — buy a bigger cigar! This movement within the case is necessary so that the LEDs can be juggled into position in the holes in the casing (see later).

Mount the wire links, the resistors and the capacitors on the pc board, keeping all components as close to the board as possible. Note that C3 is mounted on the underside of the board. Next, install the three LEDs. The height of the LEDs above the pc board must be such that the assembly will slide into the case with the board pushed down against the bottom of the case (see diagram). For a 20 mm diameter case this height should be about 12 mm. If the LEDs are not high enough, then it will not be possible to push the assembled board up into a position where the LEDs project through the holes in the case.

Next, add the power leads (without clips or E-Z hooks at this stage) and the 10 cm wire to the probe tip. Last of all solder IC1 into position, observing all heat sink, grounded soldering iron, pins 8 and 16 soldered first.

The probe tip housing on my proto-

type was turned from plexiglass and a 2 mm hole drilled through the centre. The probe tip wire is soldered to the end of a darning needle which is cemented into the housing with epoxy, allowing the needle to project about 15 mm beyond the end of the housing. It is not necessary to use a perspex cone, turned up as I have it. A flat-faced plug of a suitable material will suffice equally well.

Drill the 3mm holes for the LEDs at 10 mm intervals, starting 75 mm from the front of the case. The hole for the supply leads is drilled in the back of the case and fitted with a small rubber grommet (or plastic LED housing) to prevent the case rubbing through the insulation on the leads.

Before mounting the assembled pc board in the case check the circuit for dry joints, solder bridges, incorrectly mounted components, etc. Then test the device as follows. Connect to a five volt supply and observe the three LEDs. None should light with the probe tip isolated. If the LOW LED (LED 2) comes on or flashes, then R2 is too small and must be replaced by a slightly larger resistor (say 820k). Touching the probe tip with the fingers may cause LED 2 to light, but this should go off when the tip is isolated. Touching the probe tip to either supply rail should light the appropriate LED, with the

HOW IT WORKS

Three of the six inverter/buffers in IC1 are used in the high/low detection circuit. IC1c is connected to the probe tip via R9. When the input goes HIGH (logic 1), IC1c output goes low and illuminates LED 2 through R5. Similarly when the input goes LOW (logic 0), the series pair IC1e and f illuminate LED 1 through R4. The resistor network R1, R2 and R3 ensure that the outputs of both IC1c and IC1f remain high when the input is 'floating'. C1 is connected across R2 as a 'speed-up capacitor' to maintain a sharp pulse shape into IC1e and so improve the ability to follow high frequency pulse trains (over 1MHz)

The two inverters IC1a and b form a monostable circuit that stretches short pulses (less than 500 nsec) out to 15 msec (0.7RC) using C3 and R8. The input

of the monostable comes from the output of IC1c and is isolated from the DC level of this output by C2. The combination of R7 and D1 normally holds IC1b input high. When a negative going pulse is fed into IC1b through C2, the output goes high, forcing IC1a to go low and illuminate LED 3. Diode D1 ensures that the input to IC1b is kept low (0.7V above zero) so long as the output of IC1a remains low. This prevents subsequent pulses from re-triggering IC1b until the monostable itself re-triggers via discharge of C3 to earth through R8, and allows IC1a output to go high, switching off LED3.

Capacitors C4 and C5 (optional) confer immunity to spikes or pulses in the supply lines, which are taken from the circuit being tested.

SPECIFICATIONS

- TTL or CMOS compatible
- Supply voltage: 5 to 15 volts
- Input impedance: over 400k
- Indicates HIGH (1), LOW (0) or floating states
- Follows high frequency pulse trains — over 1.5 MHz
- Detects single pulses down to 500 nsec in width, and stretches these to 15 msec.
- Relative brightness of HIGH/LOW LEDs indicates duty cycle of pulse trains.

PARTS LIST

- Resistors all 1/4W, 5%
- R1,7 . . . 2M2
 - R2 . . . 680k*
 - R3 . . . 560k*
 - R4,5,6 . . . 820R
 - R8 . . . 220k
 - R9 . . . 1k
- Capacitors
- C1,2 . . . 100p Ceramic
 - C3 . . . 100n
 - C4 . . . 10n
 - C5 . . . 1μ Tantalum (Optional)
- Semiconductors
- IC1 . . . 4049
 - LED 1,2 . . 3mm red
 - LED 3 . . . 3mm green
 - D1 . . . 1N4148 (or equivalent)

Miscellaneous
pcb; red and black leads with alligator clips or E-Z hooks;
cigar case (or equivalent) — minimum dimensions 20mm ID, 140mm long;
plexiglass rod for probe tip housing
darning needle.

* Resistors R2 and R3 may have to be altered slightly (in the range 470k to 820k) to suit the transfer characteristics of IC1 — see text.

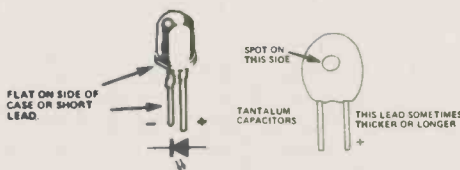
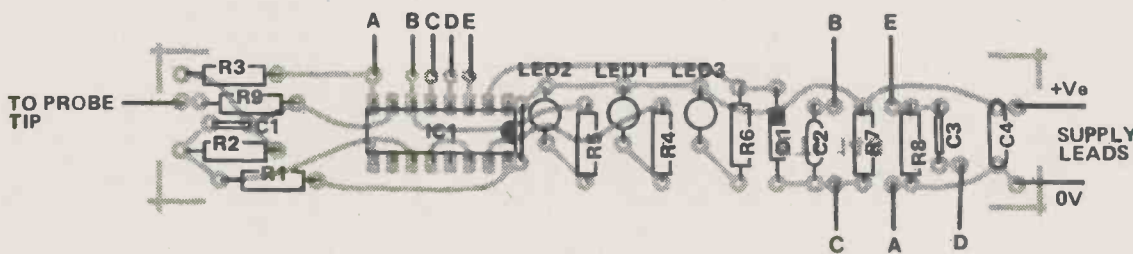
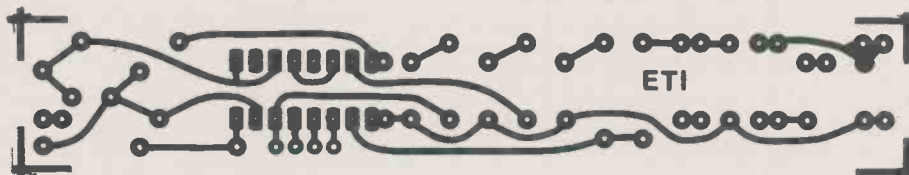

NOTE
C5 IF USED IS MOUNTED ACROSS C4 (OBSERVE POLARITY)

CONNECT RESPECTIVE LETTERS TOGETHER
A TO A B TO B etc.

Component overlay for the pc board. Refer to the construction diagrams below for correct assembling of the LEDs.

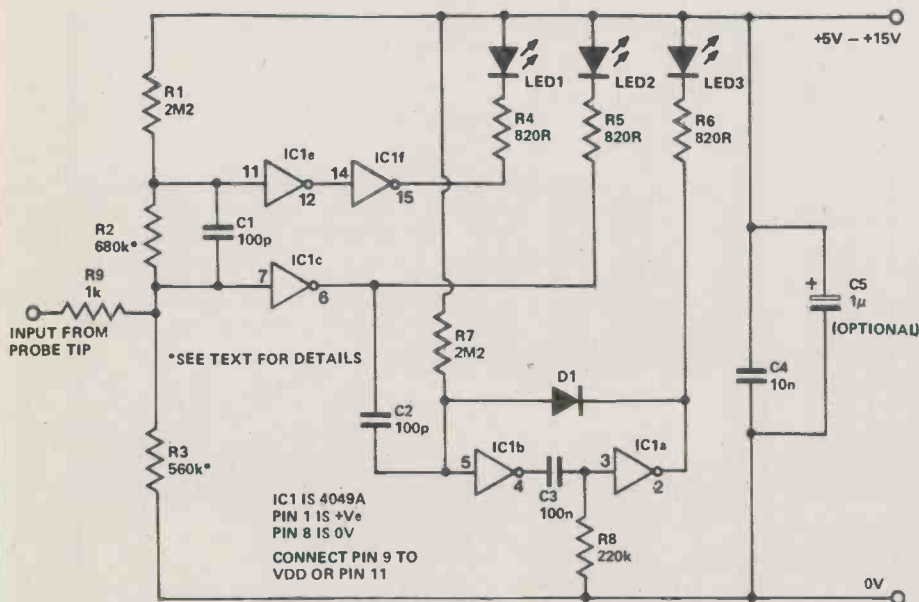
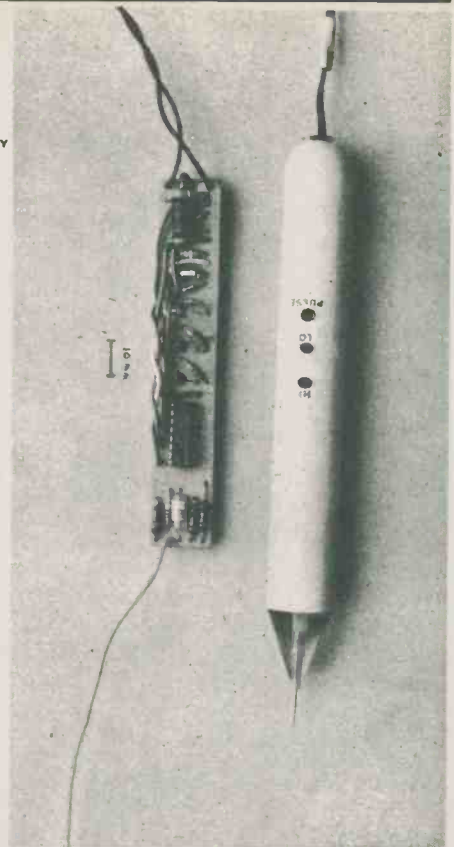
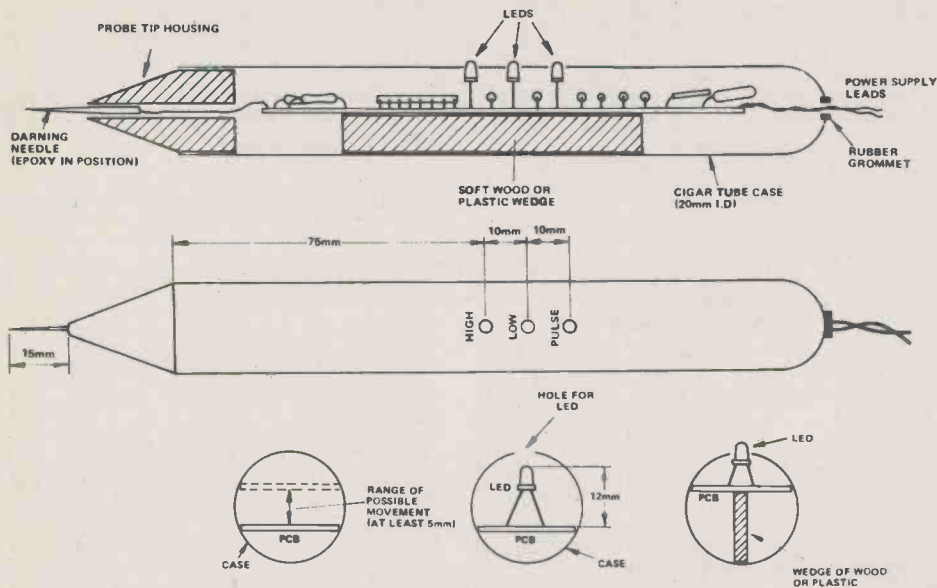

These diagrams to the top left and the picture above show the general construction of the probe and the drilling of the cigar tube or whatever case is used.

(Left) The circuit is simple, involves a single CMOS IC, three LEDs and a handful of other components.



The long thin PCB should look like this when it's finished.

PULSE LED flashing when the tip first touches the positive rail. If the LOW LED does not light when the probe is connected to 0V, then R2 is too large. Change R2 to 560k and repeat the sequence above.

Now try a 15 volt supply. Again, all LEDs should be extinguished when the probe tip is isolated. The HIGH LED (LED 1) may glow very faintly. If this glow is too strong, reduce the value of R3 to say 470k. However, if R3 has to be altered it will be necessary to recheck the circuit at 5V to see that the low voltage performance is still satisfactory. At 15 volts repeat the process of touching the probe tip to the two supply rails. The results should be the same as

in the case of the 5 volt supply, but the LEDs will be considerably brighter.

When satisfied that the circuit works correctly mount it in the case. First, cover the edges of the pcboard with strips of tape to insulate it from the case and apply a thin smear of epoxy cement around the base of each LED. Feed the power supply leads through the back of the case, followed by the assembled board. Jockey the board into a position where the LEDs are directly under the holes in the case and then push the assembly up into a position so that the LEDs protrude through the holes in the case. The epoxy around the base of the LEDs will anchor them in position. In addition to this means of holding the

board in place, a small wedge of soft wood, plastic or similar insulating material can be inserted into the space between the bottom of the board and the case. The probe tip and its plastic housing is then inserted in the front of the case and epoxied in position.

When the epoxy has set, fit the clips or E-Z hooks to the ends of the supply leads, label the three LEDs and give the whole instrument a coat of protective lacquer. The completed logic probe is now ready for use — but don't forget to smoke the cigar! ●



JUST WRAP™ WIRE WRAPPING TOOL

WHY CUT? WHY STRIP? WHY SLIT?
WHY NOT JUST WRAP?

JW-1-B	BLUE WIRE	\$24.95
JW-1-W	WHITE WIRE	\$24.95
JW-1-Y	YELLOW WIRE	\$24.95
JW-1-R	RED WIRE	\$24.95



RIBBON CABLE ASSEMBLY SINGLE END

26 AWG Rainbow Coded flat cable.

SE 14-24	WITH 14 PIN DIP PLUG 24" LONG (609MM)	\$6.45
SE 14-48	WITH 14 PIN DIP PLUG 48" LONG (1218MM)	\$7.10
SE 16-24	WITH 16 PIN LONG DIP PLUG 24" LONG (609MM)	\$6.79
SE 16-48	WITH 16 PIN LONG DIP PLUG 48" LONG (1218MM)	\$7.40



JUST WRAP REPLACEMENT ROLLS

R-JW-B	BLUE WIRE	50 ft. Roll	\$4.98
R-JW-W	WHITE WIRE	50 ft. Roll	\$4.98
R-JW-Y	YELLOW WIRE	50 ft. Roll	\$4.98
R-JW-R	RED WIRE	50 ft. Roll	\$4.98



UNWRAP TOOL FOR JUST WRAP

JUW-1	UNWRAPPING TOOL	\$5.85
-------	-----------------	--------



JUST WRAP KIT

JWK-6	JUST WRAP KIT	\$41.75
-------	---------------	---------



"HOBBY" WIRE WRAPPING TOOL BATTERY POWERED

BW-2630	FOR AWG 26-30	\$33.50
---------	---------------	---------

Use "C" size NICAD Batteries, not included. Bits not included.

BT-30	BIT FOR AWG 30	\$7.15
BT-2628	BIT FOR AWG 26-28	\$14.35



HOBBY WRAP TOOLS



WSU-30	REGULAR WRAP	\$12.55
WSU-30M	MODIFIED WRAP	\$14.35



PRE-STRIPPED WIRE WRAPPING WIRE

Wire for wire wrapping, AWG-30 (0.25mm) KYNAR® wire, 50 wires per package stripped 1" both ends.

© KYNAR PENNVALT

30 B 50 010	30-AWG Blue Wire, 1" Long	\$2.60
30 Y 50 010	30-AWG Yellow Wire, 1" Long	\$2.00
30 W 50 010	30-AWG White Wire, 1" Long	\$2.00
30 R 50 010	30-AWG Red Wire, 1" Long	\$2.00
30 B 50 020	30-AWG Blue Wire, 2" Long	\$2.16
30 Y 50 020	30-AWG Yellow Wire, 2" Long	\$2.16
30 W 50 020	30-AWG White Wire, 2" Long	\$2.16
30 R 50 020	30-AWG Red Wire, 2" Long	\$2.16
30 B 50 030	30-AWG Blue Wire, 3" Long	\$2.35
30 Y 50 030	30-AWG Yellow Wire, 3" Long	\$2.35
30 W 50 030	30-AWG White Wire, 3" Long	\$2.35
30 R 50 030	30-AWG Red Wire, 3" Long	\$2.35
30 B 50 040	30-AWG Blue Wire, 4" Long	\$2.49
30 Y 50 040	30-AWG Yellow Wire, 4" Long	\$2.49
30 W 50 040	30-AWG White Wire, 4" Long	\$2.49
30 R 50 040	30-AWG Red Wire, 4" Long	\$2.49
30 B 50 050	30-AWG Blue Wire, 5" Long	\$2.60
30 Y 50 050	30-AWG Yellow Wire, 5" Long	\$2.60
30 W 50 050	30-AWG White Wire, 5" Long	\$2.60
30 R 50 050	30-AWG Red Wire, 5" Long	\$2.60
30 B 50 060	30-AWG Blue Wire, 6" Long	\$2.79
30 Y 50 060	30-AWG Yellow Wire, 6" Long	\$2.79
30 W 50 060	30-AWG White Wire, 6" Long	\$2.79
30 R 50 060	30-AWG Red Wire, 6" Long	\$2.79

TRI-COLOR DISPENSER

WD-30-TRI	TRI-COLOR DISPENSER	\$13.35
-----------	---------------------	---------

R-30-TRI	REPLACEMENT ROLLS	\$9.98
----------	-------------------	--------

WIRE DISPENSER

WD-30-B	BLUE WIRE	\$8.30
WD-30-Y	YELLOW WIRE	\$8.30
WD-30-W	WHITE WIRE	\$8.30
WD-30-R	RED WIRE	\$8.30

DISPENSER REPLACEMENT ROLLS

R-30B-0050	30-AWG BLUE 50 FT. ROLL	\$4.98
R-30Y-0050	30-AWG YELLOW 50 FT. ROLL	\$4.98
R-30W-0050	30-AWG WHITE 50 FT. ROLL	\$4.98
R-30R-0050	30-AWG RED 50 FT. ROLL	\$4.98

© KYNAR-PENNVALT

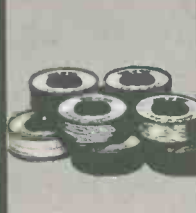

HOOK-UP WIRE

HK-18	18 AWG	25 FT.	SOLID CONDUCTOR	\$2.15
HK-20	20 AWG	25 FT.	SOLID CONDUCTOR	\$1.79
HK-22	22 AWG	50 FT.	SOLID CONDUCTOR	\$2.45
HK-24	24 AWG	50 FT.	SOLID CONDUCTOR	\$2.45
HK-26	26 AWG	50 FT.	SOLID CONDUCTOR	\$2.45
SHK-18	18 AWG	25 FT.	STRANDED CONDUCTOR	\$2.15
SHK-20	20 AWG	25 FT.	STRANDED CONDUCTOR	\$1.79
SHK-22	22 AWG	50 FT.	STRANDED CONDUCTOR	\$1.79
SHK-24	24 AWG	50 FT.	STRANDED CONDUCTOR	\$2.45
SHK-26	26 AWG	50 FT.	STRANDED CONDUCTOR	\$2.45



DIP PLUG WITH COVER FOR USE WITH RIBBON CABLE

14-PLG	14 PIN PLUG & COVER	\$2.95
16-PLG	16 PIN PLUG & COVER	\$3.20

QUANTITY: 2 PLUGS, 2 COVERS

RIBBON CABLE ASSEMBLY DOUBLE END

DE 14-2	WITH 14 PIN DIP PLUG - 2"	\$6.79
DE 14-4	WITH 14 PIN DIP PLUG - 4"	\$6.95
DE 14-8	WITH 14 PIN DIP PLUG - 8"	\$7.15
DE 14-12	WITH 14 PIN DIP PLUG - 12"	\$6.79
DE 14-16	WITH 14 PIN DIP PLUG - 16"	\$6.85
DE 14-24	WITH 14 PIN DIP PLUG - 24"	\$7.50
DE 16-2	WITH 16 PIN DIP PLUG - 2"	\$7.50
DE 16-4	WITH 16 PIN DIP PLUG - 4"	\$7.69
DE 16-8	WITH 16 PIN DIP PLUG - 8"	\$7.85
DE 16-12	WITH 16 PIN DIP PLUG - 12"	\$7.40
DE 16-16	WITH 16 PIN DIP PLUG - 16"	\$7.55
DE 16-24	WITH 16 PIN DIP PLUG - 24"	\$8.25
DE 24-6	WITH 24 PIN DIP PLUG - 6"	\$10.00
DE 24-8	WITH 24 PIN DIP PLUG - 8"	\$10.85
DE 24-12	WITH 24 PIN DIP PLUG - 12"	\$11.50
DE 24-16	WITH 24 PIN DIP PLUG - 16"	\$11.85
DE 24-24	WITH 24 PIN DIP PLUG - 24"	\$12.79

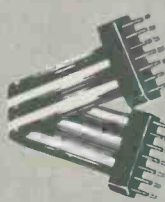

DIP SOCKETS

14 DIP	14 PIN DIP SOCKET	\$1.40
16 DIP	16 PIN DIP SOCKET	\$1.65
24 DIP	24 PIN DIP SOCKET	\$2.49
36 DIP	36 PIN DIP SOCKET	\$4.15
40 DIP	40 PIN DIP SOCKET	\$4.98

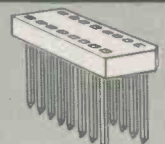

DIP IC INSERTION TOOLS WITH PIN STRAIGHTNER

Narrow profile. Pin straightener built into tool. Automatic ejector.

INS-1416	14-16 PIN DIP/IC INSERTER	\$6.35
----------	------------------------------	--------

MOS, CMOS-SAFE

GROUND STRAP NOT INCLUDED

MOS-1416	14-16 PIN, MOS CMOS SAFE INSERTER	\$14.35
MOS-2428	24-28 PIN, MOS CMOS SAFE INSERTER	\$13.25

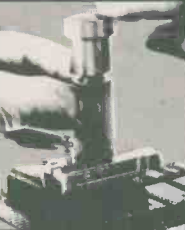

36-40 PIN CMOS-SAFE IC INSERTION TOOL

Aligns bent out pins. Includes terminal lug for attachment of ground strap.

GROUND STRAP NOT INCLUDED

MOS-40	36-40 PIN CMOS SAFE INSERTION TOOL	\$14.35
--------	---------------------------------------	---------

DIP IC EXTRACTOR TOOL

Extracts all LSI, MSI and SSI devices of from 8 to 24 pins.

EX-1	EXTRACTOR TOOL	\$2.70
------	----------------	--------

24-40 CMOS-SAFE EXTRACTOR TOOL

Removes 24-40 pin IC's, .600" centers. C-MOS safe. Includes terminal lug for attachment of ground strap.

GROUND STRAP NOT INCLUDED

EX-2	CMOS SAFE EXTRACTOR TOOL	\$13.30
------	--------------------------	---------

Available at your nearest Electronics Parts Distributor Write for complete OK Machine & Tool catalogue

len finkler limited

80 Alexdon Road, Downsview, Ontario, M3J 2B4 Tel: (416) 630-9103 Telex: 065-24322

(Prices subject to change without notice)





PRB-1 DIGITAL LOGIC PROBE

- DC to > 50 MHz
- 10 Nsec. pulse response
- 120 K Ω impedance
- Automatic pulse stretching to 50 Msec.
- Automatic resetting memory
- Open circuit detection
- Automatic threshold resetting
- Compatible with all logic families 4-15 VDC
- Range extended to 15-25 VDC with optional PA-1 adapter
- Supply O.V.P. to \pm 70 VDC
- No switches/no calibration

PRB-1	DIGITAL LOGIC PROBE	\$61.95
-------	---------------------	---------

PROTOTYPE BOARD (CM-100)

TERMINALS: 1,020 TEST POINTS. 188 separate 5 point terminals, plus 2 horizontal bus lines of 40 common test points each.

SIZE: 6 1/2" Wide, 5" Long.

CM-100	MODULAR PROTOTYPE BOARD	\$43.45
--------	-------------------------	---------

PROTOTYPE BOARD (CM-200)

TERMINALS: 630 TEST POINTS. 94 separate 5 point terminals, plus 4 bus lines of 40 common test points each.

SIZE: 6" Wide, 3 1/2" Long.

CM-200	MODULAR PROTOTYPE BOARD	\$27.50
--------	-------------------------	---------

PROTOTYPE BOARD (CM-300, CM-400)

CM-300 and CM-400 have two separated rows of five interconnected contacts each. Each pin of a DIP inserted in the strip will have four additional tie-points per pin to insert connecting wires. They accept leads and components up to .032 in. diameter. Interconnections are readily made with RW-50 Jumper Wire. All contact sockets are on a .100 in. square grid (1 1/4 in. wide).

CM-300	MODULAR PROTOTYPE BOARD	\$16.65
CM-400	MODULAR PROTOTYPE BOARD	\$4.15

MODULAR BUS STRIP

CM-500 is a bus strip to be used in conjunction with CM-300 and CM-400 for distribution of power and common signed lines. Two separate rows of common terminals, grouped into clusters of five. All contact sockets are on a .100 in. square grid.

CM-500	MODULAR BUS STRIP	\$3.29
--------	-------------------	--------

JUMPER WIRES

50 Preformed wires, from 1 1/2 to 4 inches, 20 AWG solid wire, white insulation.

RW-50	JUMPER WIRES	\$4.98
-------	--------------	--------

"CLIP AND STRIP" TOOL

For cutting and stripping 1 in. insulation from 30 AWG wire.

CAS-130	CLIP AND STRIP	\$3.55
---------	----------------	--------

THE ABOVE CUT AND STRIP TOOL IS NOT APPLICABLE FOR NYLON OR TEFLON INSULATION

MINI SHEAR

MS-10	MINI-SHEAR	\$8.95
-------	------------	--------

MINI SHEAR WITH SAFETY CLIP

MS-20	MINI-SHEAR WITH CLIP	\$10.75
-------	----------------------	---------

VACUUM VISE

ABS construction, 1 1/2 in. wide jaws.

V V-1	VACUUM VISE	\$5.85
-------	-------------	--------

WIRE WRAPPING KITS

WK-2, WK-3, WK-4

WK-2-B	WIRE-WRAPPING KIT (BLUE)	\$20.95
WK-2-Y	WIRE-WRAPPING KIT (YELLOW)	\$20.95
WK-2-W	WIRE-WRAPPING KIT (WHITE)	\$20.95
WK-2-R	WIRE-WRAPPING KIT (RED)	\$20.95
WK-3B (BLUE)	WIRE-WRAPPING KIT	\$27.35
WK-4B (BLUE)	WIRE-WRAPPING KIT	\$41.90

WIRE WRAPPING KIT WK-5

BW-630, WSU-30M, CON-1, EX-1, INS-1416, TRS-2, MS-20, 14, 16, 24 and 40 DIP sockets, WWT-1, WD-30-TR1, H-PCB-1.

WK-5	WIRE-WRAPPING KIT	\$120.85
------	-------------------	----------

PC BOARD

4 x 4.5 x 1/4 in. board, glass coated EPOXY laminate, solder coated 1 oz. copper pads. The board has provision for a 22/44 two sided edge connector. .156 in. spacing. Edge contacts are non-dedicated for maximum flexibility.

The board contains a matrix of .040 in. diameter holes on .100 in. centers. Component side contains 76 two-hole pads.

Two independent bus systems are provided for voltage and ground on both sides of the board.

H-PCB-1	HOBBY BOARD	\$9.00
---------	-------------	--------

TERMINAL BOARD

.062 thick glass coated epoxy laminate. Outside dimensions 6.3 in. x 3.94 in. Not plated.

A-PC-01	TERMINAL BOARD	\$5.79
---------	----------------	--------

PC BOARD

Same specifications as A-PC-01 except matrix pattern is copper plated and solder coated on one side.

A-PC-02	PRINTED CIRCUIT BOARD	\$9.95
---------	-----------------------	--------

PC BOARD

Same specifications as A-PC-01. Each line of holes is connected with copper plated and solder coated parallel strips on one side.

A-PC-03	PRINTED CIRCUIT BOARD	\$9.95
---------	-----------------------	--------

PC BOARD

Same specifications as A-PC-01. One side has horizontal copper strips, solder coated. Second side has vertical parallel bars.

A-PC-04	PRINTED CIRCUIT BOARD	\$13.30
---------	-----------------------	---------

PC BOARD

The A-PC-05 features numbered contacts for easy reference along with a numbered matrix for easy hole locations. Made of .062 in. thick epoxy laminate. 4.5 in. x 5 in. Edge Connector Board.

A-PC-05	PRINTED CIRCUIT BOARD	\$9.15
---------	-----------------------	--------

Same as A-PC-05 except outside dimensions are 4.5 in. x 6.5 in. Edge Connector Board.

A-PC-06	PRINTED CIRCUIT BOARD	\$11.65
---------	-----------------------	---------

Same as A-PC-05 except outside dimensions are 4.5 in. x 7 in. Edge Connector Board.

A-PC-07	PRINTED CIRCUIT BOARD	\$14.99
---------	-----------------------	---------

TERMINALS

WWT-1	SLOTTED TERMINAL	\$5.39
WWT-2	SINGLE SIDED TERMINAL	\$5.39
WWT-3	IC SOCKET TERMINAL	\$7.20
WWT-4	DOUBLE SIDED TERMINAL	\$3.59

TERMINAL INSERTING TOOL

For inserting WWT-1, -2, -3 and -4 terminals.

INS-1	INSERTING TOOL	\$4.50
-------	----------------	--------

P.C.B. TERMINAL STRIPS

TS-4	4-POLE	\$2.50
TS-8	8-POLE	\$3.40
TS-12	12-POLE	\$4.69

MODULAR TERMINAL STRIPS

TS-6MD	2-POLE	\$3.00
--------	--------	--------

(3 per Package)

PC CARD GUIDES

TR-1	CARD GUIDES	\$3.40
------	-------------	--------

QUANTITY — ONE PAIR (2 PCS.)

PC CARD GUIDES & BRACKETS

TRS-2	GUIDES & BRACKETS	\$6.85
-------	-------------------	--------

QUANTITY — ONE SET (4 PCS.)

PC EDGE CONNECTOR

44 pin, dual read-out, .156 in. spacing, wire-wrapping.

CON-1	P.C. EDGE CONNECTOR	\$6.35
-------	---------------------	--------

Available at your nearest Electronics Parts Distributor Write for complete OK Machine & Tool catalogue

len finkler limited

80 Alexdon Road, Downsview, Ontario, M3J 2B4 Tel: (416) 630-9103 Telex: 065-24322

(Prices subject to change without notice)



Battery Condition Indicator

Ever been caught by a battery that went flat at an embarrassing moment—like when you've just offered a friend a lift? The conversation goes a little flat when you're both riding the bus to work, 20 minutes late.

THE OLD, RELIABLE lead-acid battery may be way ahead of what ever is in second place for vehicle electrical systems, but they do need a 'weather eye' kept on them. Particularly if they're out of warranty. The same applies to 'reconditioned' batteries, so often found in secondhand vehicles of some age.

That's the problem with cars — running out of gas and running out of battery produces the same heart-rending result. Immobility.

Most vehicles have a gas gauge. Few have an equivalent for the battery. Many 'older' cars included a 'charging current' meter. This told you something about the car's generator-regulator and required some interpretation to figure out whether the battery was in good health.

Probably the best way to check on the state of your battery is to use a hydrometer. However, hydrometers have a number of drawbacks. Being made of glass, they're fragile and can't be used while a car is in motion. The small amount of battery acid that remains on them presents a storage problem — the drips and fumes attack most metals and materials. They're okay for the corner garage but justifying their cost, for the occasional use they get in home workshops, is not always possible.

Another method of testing battery condition is by checking the voltage 'on load'. A lead-acid vehicle battery in a reasonable state of charge will have a terminal voltage under normal working load somewhere between 11.6 and 14.2 volts. When a battery shows a terminal voltage below 11.6 volts its capacity is markedly decreased and it will discharge fairly quickly. Like as not, it won't turn the starter motor for very long! On the other hand, if the voltage on

load is above 14.5 volts then the battery is definitely fully charged! However, if it remains that way for any length of time while the car is on the road, the vehicle's alternator-regulator system is faulty and the battery may be damaged by overcharging.

Reading the battery voltage can be done in a number of ways. You could use a digital panel meter, set up as a voltmeter. Their drawback is that they cost nearly ten times as much as a hydrometer! The next best method is to use an 'expanded-scale voltmeter'. Reading the voltage range between 11 and 15 volts on a meter face calibrated 0-16 volts is a squint-and-peer exercise. On a 0-30 volts scale, as used on many modern multimeters, it's worse. A meter which reads between 11 volts at the low end of the scale and 16 volts at the high end is ideal. Hence, the term 'expanded-scale'.

However, you don't want to be peering at a meter on the dash board when you're driving through traffic. The range of voltage over which your battery is healthy is some two volts. An indicator which simply requires the occasional glance, and needs no 'interpretation', is what is really needed.

With this project, that's exactly what we've done.

We have devised a simple circuit that indicates as follows:

Yellow: battery 'low'
Green: battery okay
Red: battery overcharging

When the battery voltage is below 11.6 volts, a yellow indicator lights. This indicates the battery is most likely undercharged or a heavy load (such as



high power driving lights) is drawing excess current. When it is between 11.7 and about 14.2 volts the green indicator lights, letting you know all is sweet. If the red indicator lights, as it will if the voltage rises above 14.2 volts, maybe the vehicle's voltage regulator needs adjusting or there is some other problem.

The Circuit

The circuit is ingeniously simple, having barely a handful of parts. Reliability should be excellent.

We actually started out with a somewhat complex circuit. It used only two indicators and required you to 'interpret' what was happening. In trying to convert that to a yellow-green-red style of indication it sort of grew like topsy. This circuit had four transistors, a dozen resistors etc and didn't look at all attractive as a simple project that the average hobbyist or even handyman could build one Saturday afternoon and get going immediately. A rival circuit was devised by another staff member using a common IC. This sparked a controversy as to which was the better! Certainly, both did the job required . . . but maybe there was a simpler method.

It was discovered that different coloured light emitting diodes (LEDs), which we had decided to use for the indicators in the project, had different voltage drops when run at the same current. Seizing on this idea, the original circuit (four transistors, a dozen resistors . . .) was modified to exploit this characteristic and the simple circuit you see here was the result.

Construction

Construction is straightforward. If you haven't soldered electronic components before — and this project was designed for the motorist/handyman as well as

electronics enthusiasts — then we suggest you practice on something before tackling this project.

We recommend you use the printed circuit board designed for this project. The actual layout of the components themselves is not critical but a printed circuit board reduces the possibility of errors.

It is best to mount and solder the resistors first. Follow this by soldering in the diodes D1 and the zener diodes ZD1, ZD2 and ZD3. Carefully follow the accompanying component overlay making sure the diodes are all inserted the correct way around. Next, mount the transistors, again referring to the overlay, checking to see they are inserted correctly before soldering.

Finally, mount the light emitting diodes. These too may only be inserted one way. Check with the component overlay and connection diagrams. Make sure they are in the correct sequence. On the component overlay, LED 1 is the red LED, located at the left. The yellow LED is on the right, marked with a '2'. The green LED, marked '3' is between them.

The circuit could be tested at this stage if you have a variable power supply, or access to one. Simply vary the voltage across the range between 11 and 16 volts and note whether the LEDs light up in the correct sequence and close to the voltages indicated.

Mounting

As vehicles vary so much in dash panel layout, we can only make general suggestions.

Clearly, the indicator should be mounted such that the three LEDs are not in direct sunlight. A low part of the dash, but make sure it's readily visible from your normal driving position, will pretty well ensure the display may be easily read during the daytime. Alternatively, if you have an 'overhung' dash, or a portion which overhangs (usually where the instruments are mounted anyway), then a suitable position will generally suggest itself.

Exact mechanical details will have to be determined according to your particular situation. Two holes are provided in the pc board for mounting bolts. Alternatively, the whole assembly may be mounted from the LEDs. Three LED holders inserted through part of the dash panel, or an escutcheon plate mounted on the dash, will hold the LEDs quite securely. Providing the leads on the LEDs are fairly short, the pc board will place little strain on them

and the assembly should be mechanically secure.

Connection

The indicator may be installed in vehicles having positive or negative ground electrical systems.

The component overlay shows the connection for a negative ground vehicle. The 'battery +ve' lead goes to the ignition switch — the indicator only operates when the vehicle is being used — the battery negative lead should be taken to a good 'ground' point on the vehicle frame.

For a positive or negative ground vehicle, the lead marked 'battery -ve' goes to the ignition switch connection, while the 'battery +ve' lead goes to the vehicle frame.

PARTS LIST

RESISTORS all 1/4W 5%

R1 470R
R2 100R
R3, R5 10k
R4 680R

SEMICONDUCTORS

D1 1N914
ZD1, ZD2 .. 6V8 400 mW zener
ZD3. 11V 400 mW zener
Q1, Q2 2N3904 or
common silicon
NPN type

MISCELLANEOUS
pcb

HOW IT WORKS

This circuit depends for its operation upon the different voltage drops across different colour LEDs.

At 20 mA the voltage drops across red, yellow and green LEDs are typically 1.7, 3.0 and 2.3 volts respectively. When the vehicle battery voltage is too low to cause either ZD1/ZD2 or ZD3 to conduct, Q1 and Q2 are held off by R3 and R5. Under these conditions the yellow LED is forward biased and conducts via D1 producing a potential of about 3.7 volts at point A (see circuit diagram). When the supply rises above about 11.6 volts ZD3 conducts, biasing Q2 on. By virtue of its lower voltage requirements the green LED conducts, reducing the voltage at point A to approximately 2.6 volts. This is not enough to bias D1/LED3 on, so the yellow LED goes off. The green LED 'steals' the bias from the yellow LED. When the supply rises above about 14.2 volts, Q1 is biased on and the red LED 'steals' the bias from the green. The potential at point A falls to two volts and only the red LED conducts.

R1 limits the current through the LEDs. R2 and R4 limit the base currents into Q1 and Q2.

The printed circuit board pattern



The circuit diagram and component overlay (below). During construction, make sure all of the diodes and LEDs are the right way round.

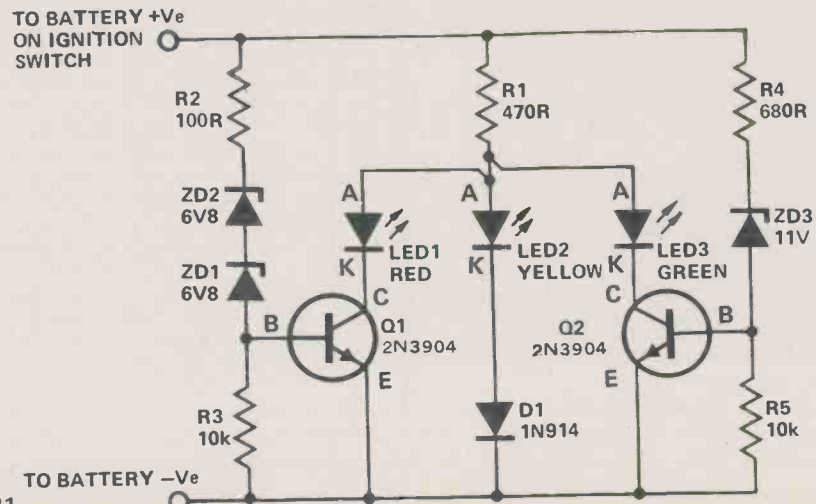
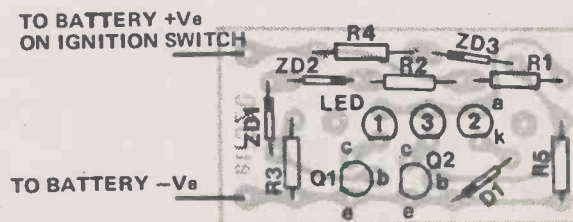

Cable Tester

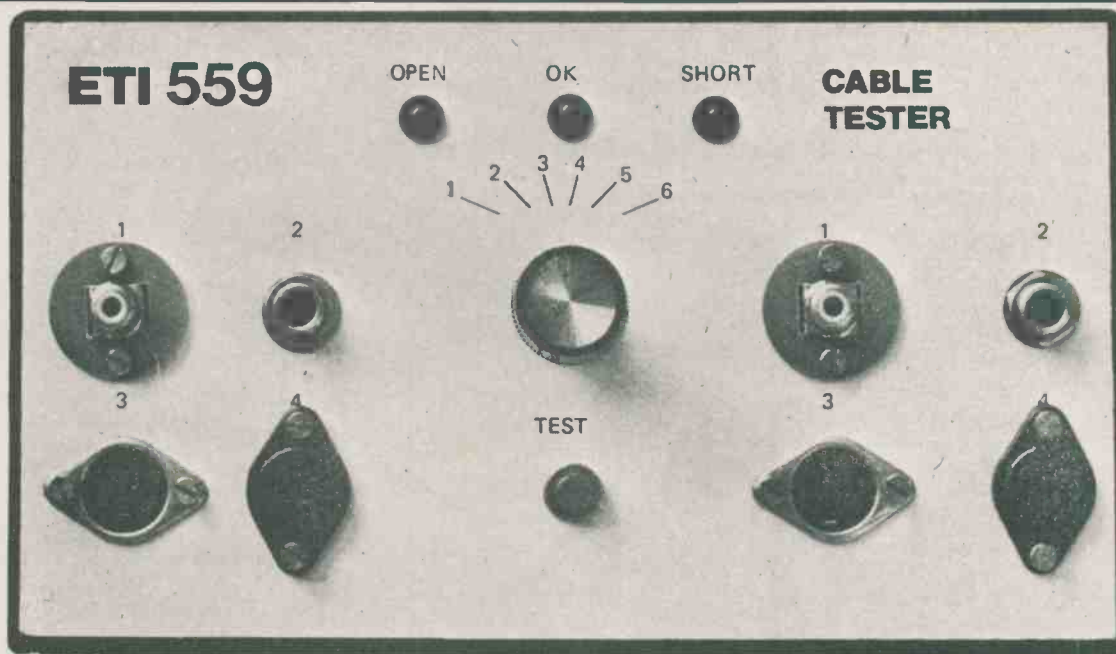

Quickly test audio cables with this ingenious project.

ALMOST ALL THE faults in an audio system are caused by cables. Have you ever tried to find which cable is broken among the many connections in a stage audio system, especially with anxious people looking over your shoulder?

The answer is to check each cable before the performance, a rather tedious business.

This Cable Tester checks each wire in turn for both open circuits and short circuits to ground. Each cable can then be thoroughly tested before use and hopefully faults can be found before they cause problems.

The circuit makes cunning use of a 7474 dual D flip flop to light one of three LEDs after the test switch is pushed, indicating short, open, or OK.

Construction

The unit is mounted on a standard plastic box measuring 196 x 113 x 60 mm. If it is to be used on-stage, then use the strongest box you can find, such as diecast aluminum.

Wiring the switch is the only difficult part of the construction. Note that some of the switch contacts are linked together as shown in table 1.

The sockets we have chosen for the prototype are the most common type, however there is no reason why others

can't be substituted. The jack plugs, J1, 2 and the RCA sockets SK1, 2 must be insulated from the metal front panel, or the ground connections will be permanently connected together

through the panel. RCA sockets are available with insulating mountings, while insulating washers can be made from plastic sheet for mounting the jack sockets.

HOW IT WORKS

To understand the operation of the cable tester refer to the simplified diagram and the truth table in fig. 1.

IC1 is a 7474 dual D flip-flop with its clock (CLK) and D inputs held at 0V.

First let's assume an open circuit cable. ZD1 conducts, as it has 12 V across it, and turns on Q2, which holds the preset (PR) input on IC1/1 low. The PR input of IC1/2 remains high because ZD2 is not biased. When the test switch is pressed, putting a 0 on the CLR input, the outputs of IC1/1 become: Q, high; Q, low. When the test switch is released, leaving both the CLR inputs high, the following outputs are obtained: IC1/1 - Q, high; Q, low; IC1/2 - Q, low; Q, high. Since the output of Q, IC1/1 is low, Q3 is turned off. Therefore LED1 is on, LED2 is off, and LED3 is off.

Now let's look at the 'short to ground' condition. The 12 V rail is shorted to ground through D1 (exit one diode). Q2 is turned off leaving the PR input of IC1/1 high. The PR input of IC1/2 is held low. When the test button is pressed the outputs of IC1/1 go: Q, low; Q, high. When the

button is released, placing a high on the CLR inputs, these outputs remain the same. The outputs of IC1/2 are: Q, high; Q, low. Therefore LED1 is off, LED2 is off because the base of Q3 is held low by IC1/2, and LED3 is on, indicating a short.

Finally, if the cable is OK, the voltage across ZD1 is held at 3.3 V by ZD2. Q2 is off because ZD1 (6.8 V) is not conducting. The PR input of IC1/1 is left high and the PR input of IC1/2 is also high. When the test button is released the outputs of IC1/1 go: Q, low; Q, high. The outputs of IC1/2 go: Q, low; Q, high, when the button is pushed and remain the same when it is released. Both the Q outputs are low so LEDs 1 and 3 are off and the Q outputs are high so Q3 is conducting and LED2 is on.

The only difference between this circuit and the final circuit is that D1 in the simple circuit has been replaced with a FET constant current source, Q1. SW1 selects the wires to be tested and a power supply has been included.

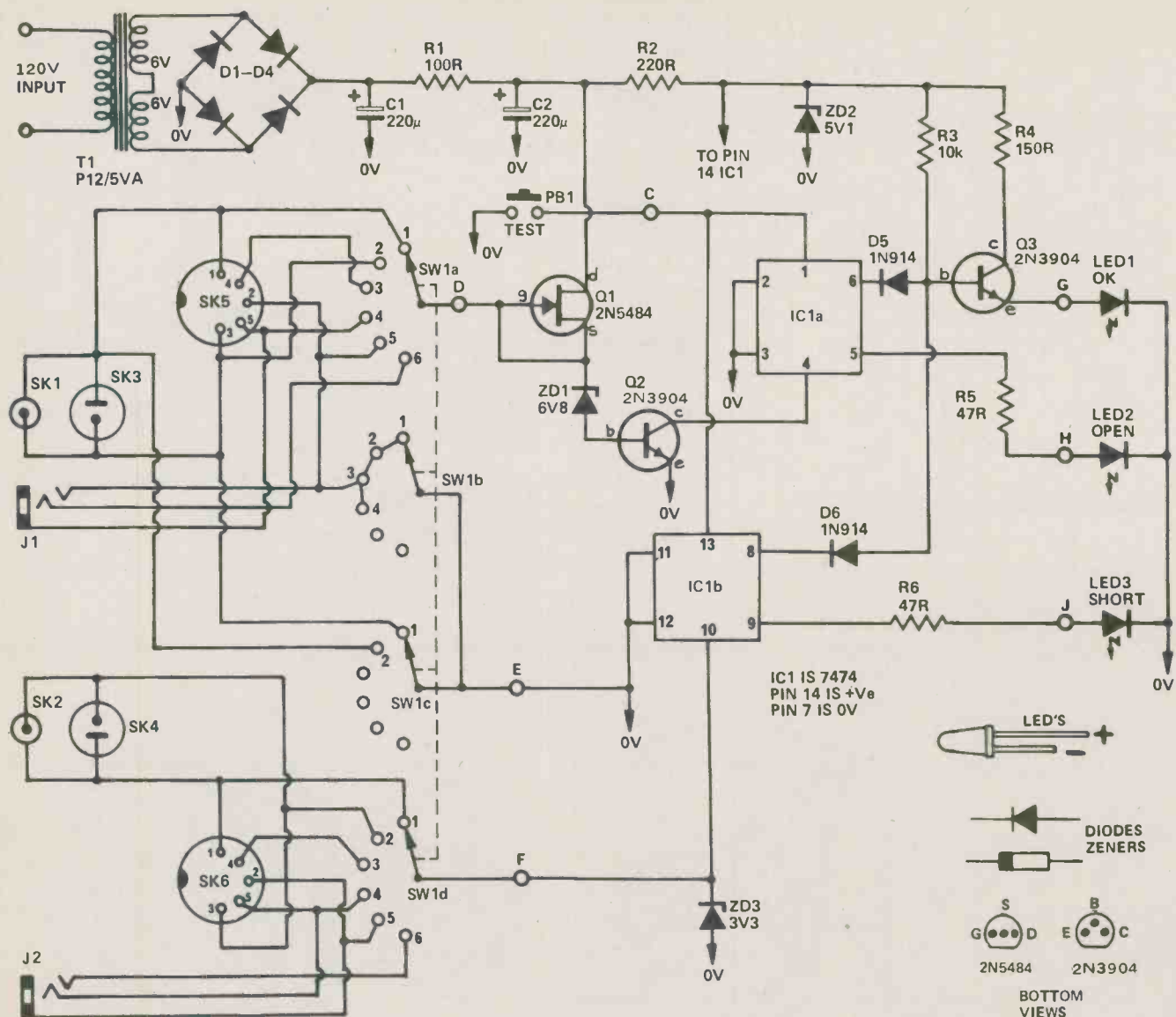

Fig. 2. Final circuit of the Tester.

PARTS LIST

RESISTORS all $\frac{1}{4}W$, 5%

R1 100R
R2 220R
R3 10k
R4 150R
R5 47R
R6 47R

CAPACITORS

C1 220 μ 25VW
C2 220 μ 25VW

SEMICONDUCTORS

IC1 7474

Q1 2N5484 FET

Q2, 3 2N3904 or equivalent

D1-D4 1N4001 or equivalent

D5-D6 1N914 or equivalent

ZD1 6V8 400 mw zener
ZD2 5V1 400 mw zener
ZD3 3V3 400 mw zener
LED1-LED3 Red LEDs

SOCKETS

SK1, SK2 RCA Socket
SK3, SK4 2 pin DIN socket
SK5, SK6 5 pin DIN socket
J1, J2 Stereo jack socket

MISCELLANEOUS

SW1 4 pole 6 pos
switch
T1 120V to 12V.5A

PB1 miniature momentary
contact pushbutton

Box to suit (195 x 110 x 60 mm);
Power cord, plug, etc.

Fig. 4. Printed circuit board pattern (full size).

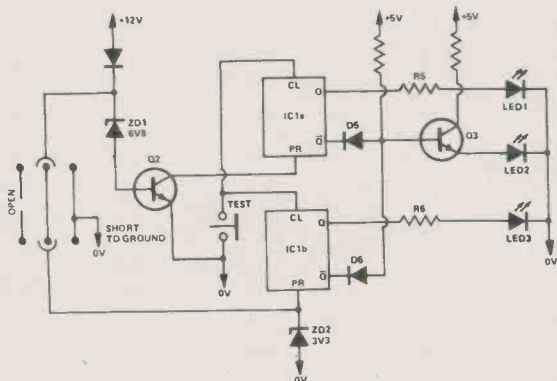
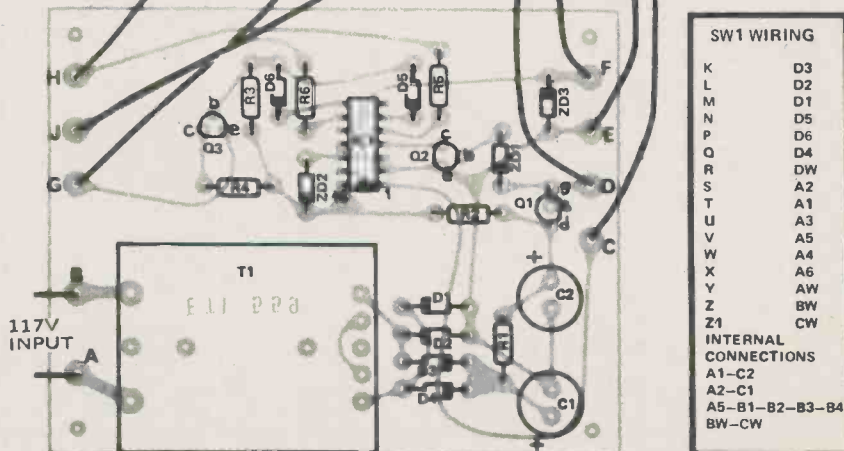
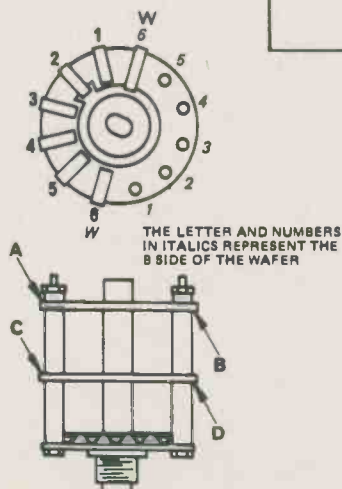
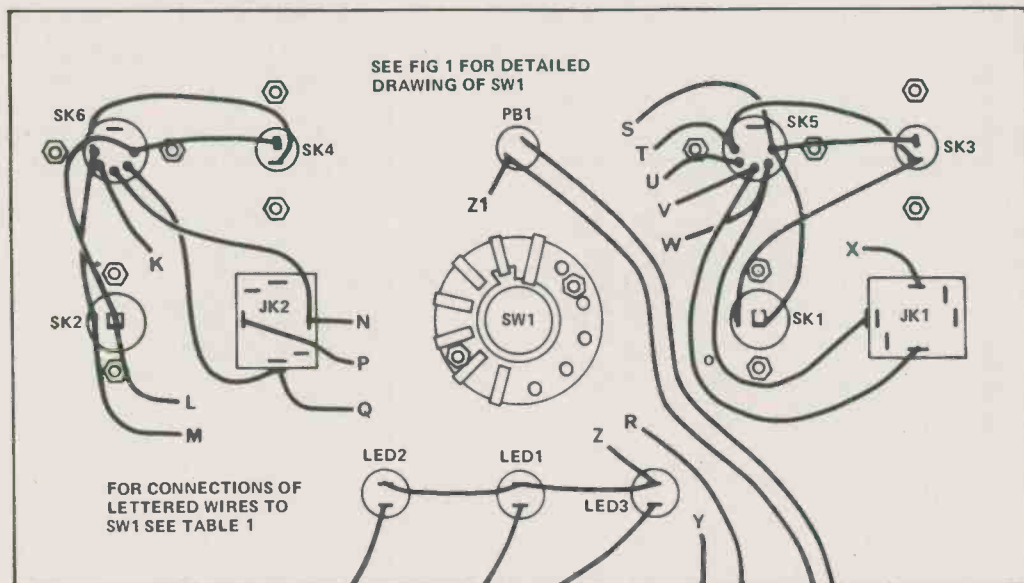
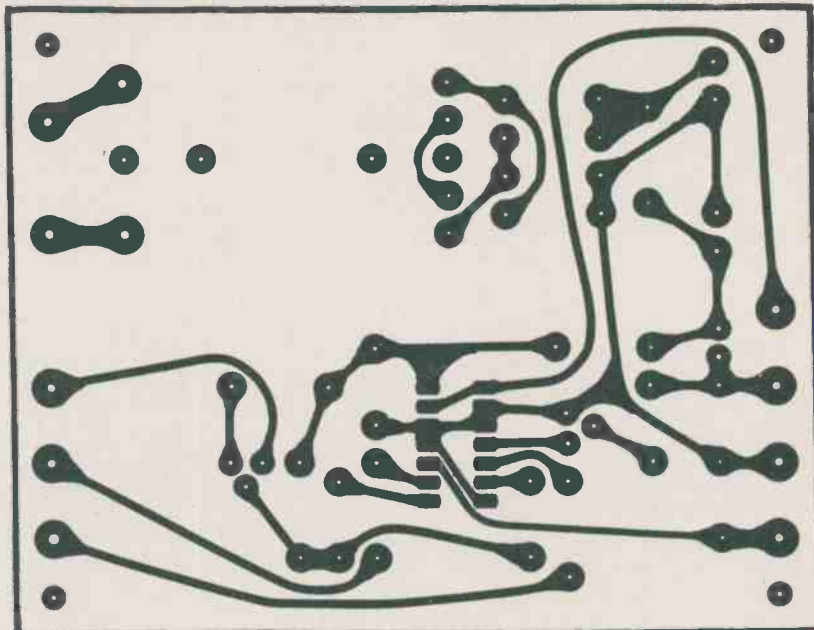

Fig. 1. Simplified diagram of the Cable Tester.

TRUTH TABLE

INPUTS				OUTPUTS	
PR	CLR	CLK	D	Q	\bar{Q}
L	H	X	X	H	L
H	L	X	X	L	H
L	L	X	X	H*	H*
H	H	↑	H	H	L
H	H	↑	L	L	H
H	H	L	X	00	00

Fig. 3. Component overlay and front panel connections.



Function Generator

A wide range (1Hz – 100kHz) sine/triangle and square wave generator with built-in analogue frequency meter.

The main characteristic of a function generator is that it produces a basic fixed-amplitude waveform other than a sine wave, from which a fixed-amplitude sine wave is then synthesized. The main advantage of this technique is that the resulting output waveforms of the generator are immune to amplitude 'bounce' when they are swept through their frequency ranges, thus enabling amplifier or filter gain/frequency tests, etc. to be carried out very rapidly. The only disadvantage of the technique is that the resulting sine wave has an inherently higher degree of distortion than is obtainable from good 'Wien bridge' and similar 'tuned' oscillator circuits.

The ETI function generator produces three output waveforms (sine, triangle and square) and covers the frequency range 1 Hz to 100 kHz in five decade ranges. The sine wave output typically produces a THD (total harmonic distortion) value of only 0.5%, has a maximum amplitude of 2 volts rms, and is ideal for general purpose testing. The triangle output has a typical linearity of 1%, a maximum peak-to-peak amplitude of 5V6 and is ideal for cross-over distortion testing of class-AB amplifiers, etc. The square wave output is positive-going, has a maximum peak amplitude of 8 volts, has typical rise and fall times of less than 200 nS and is ideal for testing digital circuits. All output waveforms of the generator are DC coupled, with the sine and triangle waveforms swinging symmetrically about the zero volts line.

Our function generator incorporates a number of additional, very attractive features. It has a built-in analogue frequency meter, for ease of calibration. It has two output ter-

minals, each with its own attenuator network. A sine or triangle waveform is available from one output and a square wave is available from the other. The square wave output is available at all times, is synchronous with the sine/triangle waveform and can thus be used to provide synchronisation signals to an oscilloscope timebase during sine wave testing, etc. The unit is battery powered, for maximum user convenience.

A fine unusual feature is that the frequency ranges are alternately contra-connected, so that to increase frequency you turn the 'fine' control clockwise on one range, anticlockwise on the next range, etc. This facility enables the frequency to be swept through several decades very rapidly when testing the frequency response of amplifiers and filters, etc. As we said in the introduction, this is a really nice piece of test gear.

Construction

Most of the circuit is built up on a single large PCB. At this stage access to a distortion meter is desirable, so that RV3 and RV4 can be trimmed for minimum distortion. With care, a THD figure of 0.5% can be obtained.



Calibration

Calibration of the unit is fairly tricky and requires access to an oscilloscope and some kind of frequency reference (you can use the 'scope timebase as a reference if it is known to be reasonably accurate). The calibration procedure is as follows:

- (1). Set the unit to the SINE mode. Set the attenuator controls for maximum output. Set the frequency controls for approximately 1 kHz on the 1-10 kHz range. Set all pre-set pots at mid value. Switch the unit on, and use a 'scope to check that some kind of waveform is available (the waveform may be pretty awful at this stage). Check that the frequency is variable via RV6.
- (2). Reset RV6 for a 1 kHz output and adjust RV1 for a pk-pk amplitude of about 5V6. Adjust RV4 for a 'passable' sine wave, and then readjust RV1 for 5V6. Now alternately adjust RV4 for MINIMUM DISTORTION and RV3 for best SYMMETRY, occasionally readjusting RV1 for 5V6 pk-pk until a good sine wave is produced. Adjust RV5 for zero offset (so that the output waveform swings symmetrically about the zero volts level) and retrim RV3 and RV4 for a good sine wave.

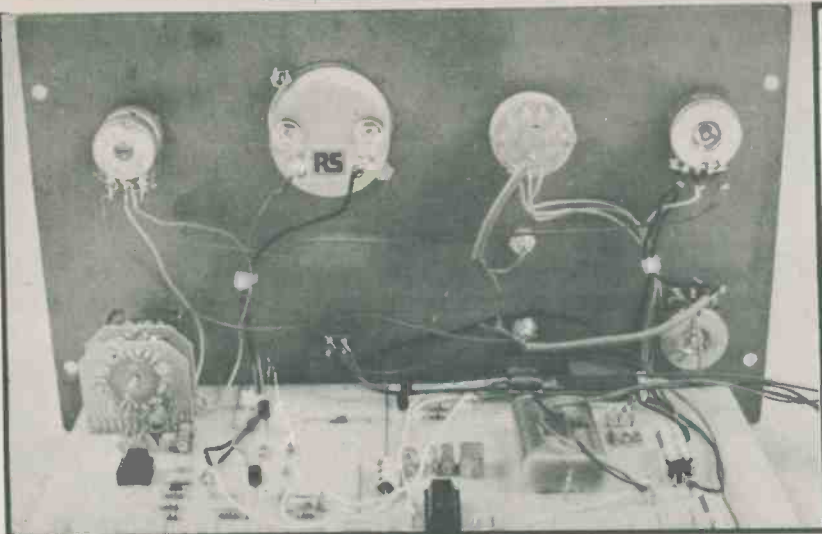

Rear view of the front panel controls.

Fig. 2. This simple twin-T filter can be used to set the generator for minimum distortion.

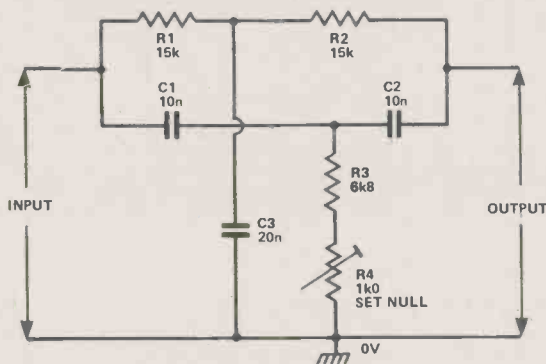

In the absence of a distortion meter, the simple twin-T 1 kHz filter of Fig. 2 can be used in conjunction with the oscilloscope or with a millivoltmeter to set the generator for minimum distortion at 1 kHz. The procedure is to apply the sine wave output of the generator to the input of the filter at about 1 volt rms at approximately 1 kHz and take the output of the filter to the input of the 'scope or millivoltmeter. Next, adjust the generator frequency and R4 of the filter to give minimum output indication and, finally, adjust RV3 and RV4 of the generator to reduce the output indication of the filter to the minimum possible value. At final balance, the output of the filter corresponds to approximately 0.1% thd per mV rms of indicated reading, ie if the indicator shows a reading of 5 mV rms, the thd of the generator approximates 0.5%. Now retrim OFFSET control RV5. The sine wave calibration procedure is then complete.

- (3). Set the unit to TRIANGLE mode. Monitor the waveform on the 'scope and adjust RV2 for a pk-pk amplitude of 5V6.
- (4). Check that the unit is functional on all ranges, in all waveform modes.
- (5). Switch the unit to its top frequency range, set the output frequency to 100 kHz and adjust RV7 for full scale deflection. If necessary, slightly reduce the value of C3 so that 100 kHz can be obtained.
- (6). Repeat the frequency calibration procedure on all ranges, using the appropriate pre-set (RV8 to RV11), noting that a very 'Jerky' reading will be obtained on the lowest (1 Hz to 10 Hz) range. The calibration procedure is then complete, and the unit is ready for use.

A final point to note is that we used 10-turn cermet for all pre-sets on our prototype unit. A slight touch of luxury, this. You can get away with ordinary presets, if you prefer, but in this case you'll have to make slight modifications to the PCB.

PARTS LIST

RESISTORS ALL 1/4W, 5%

R1,2,14	10k
R3,17	1k0
R4,5,10	2k2
R6,7,9	22k
R8	470R
R11,18	100R
R12,13,	
15 & 16	47R
R19	11R

POTENTIOMETERS

RV1,2	47k cermet multiturn (3/4")
RV3	22k cermet multiturn (3/4")
RV4	470R cermet multiturn (3/4")
RV5	4k7 cermet multiturn (3/4")
RV6	100k lin dual gang
RV7-10	10k
RV11	100k cermet multiturn (3/4")
RV12,13	1k0 lin

CAPACITORS

C1,2	100u 25V electrolytic
C9	150p polystyrene
C3	820p polystyrene
C4,13	10n polyester
C5,10,14,11	100n polyester
C6,15	1u0 polycarbonate
C7,8	10u 25V electrolytic
C12	1n0 polystyrene

SEMICONDUCTORS

IC1	XR2206CP
IC2	NE555
Q1,3	2N5209
Q2,4	2N5086
D1-3	1N4148
ZD1	5V6 ZENER

MISCELLANEOUS

SW1	DPDT toggle
SW2	4 pole 5 way wafer switch assembly and 2 PCB wafers (2 pole 6 way)
SW3	DPDT toggle
SW4	1 pole 3 way rotary switch
2 BNC connectors, 2 9V batteries, case to suit, PCB.	

Actual construction on the PCB is fairly straightforward, but take extra care to observe the polarities of all electrolytics and all semiconductor devices. When construction is complete, fit the board into a suitable case and complete the interwiring to the remaining switches, pots and to the moving coil meter. The unit is then ready for testing and calibration.

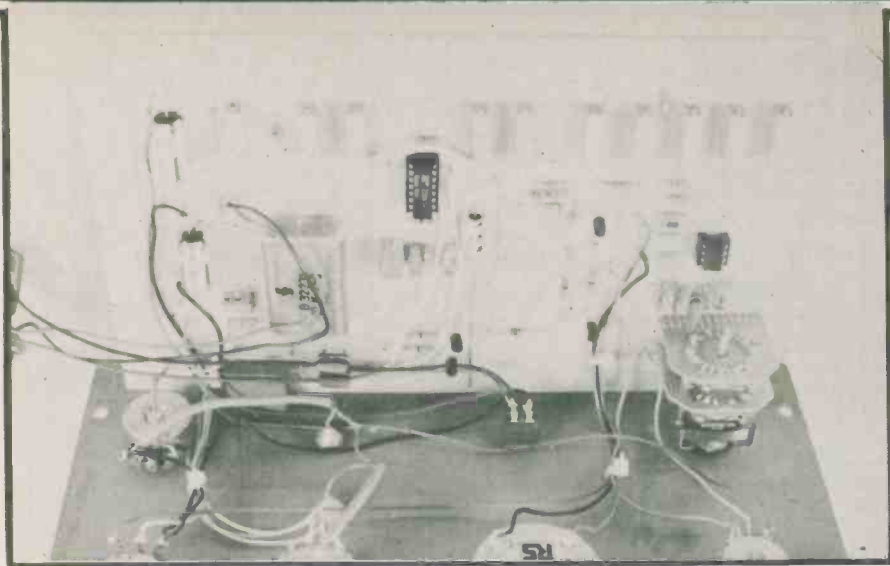

The printed circuit board is mounted at right-angles to the front panel.

HOW IT WORKS

There is not an enormous amount we can say here, since most of the work of the circuit is carried out inside IC1, which is a special function generator chip that produces a square wave output from pin 11 and a sine or triangle wave from pin 2. The purity of the sine wave can be trimmed via RV3 and RV4 and the maximum amplitude can be pre-set via RV1. The maximum triangle amplitude can be pre-set via RV2 and both waveforms can be offset via RV5. The sine/triangle waveforms are made available to the outside world via buffer amplifier Q3-Q4 and the associated attenuator network. The square wave is made available, in positive-going form only, via the Q1-Q2 buffer and RV12.

The operating frequency of the generator is variable via timing capacitors C3 to C7 and via resistor network R2-RV6. The frequency is monitored on a simple analogue frequency meter that is designed around 555 timer IC2, which is triggered via the square wave output of the Q1-Q2 buffer amplifier.

The entire circuit is powered from two 9 volt batteries, and the circuit consumes a typical total current of about 30 mA.

The component sitting on the PCB

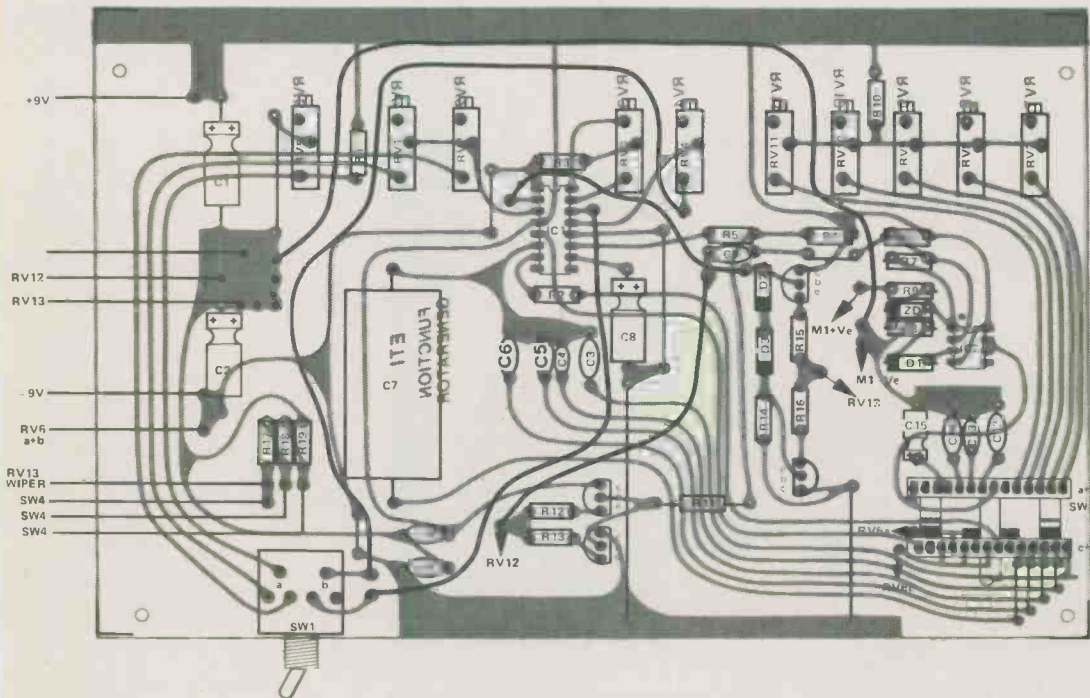

SPECIFICATIONS

Frequency range	1 Hz to 100 kHz in 5 decade ranges.
Output waveforms:	
Sine: distortion (typical)	0.5% at 1 kHz.
Triangle: linearity (typical)	1% at 1 kHz.
Square: rise/fall times (typical)	less than 200 nS.
Waveform stability (typical)	.002% per °C.
Maximum output levels (with 9-0-9 V supply).	.01%/V supply sensitivity.
	Sine = 2 V rms.
	Triangle = 5V6 pk-pk.
	Square = 8 V peak.
Supply	Two 9 V batteries.
Total current consumption	30 mA typical.

PCB foil pattern for the Function Generator.

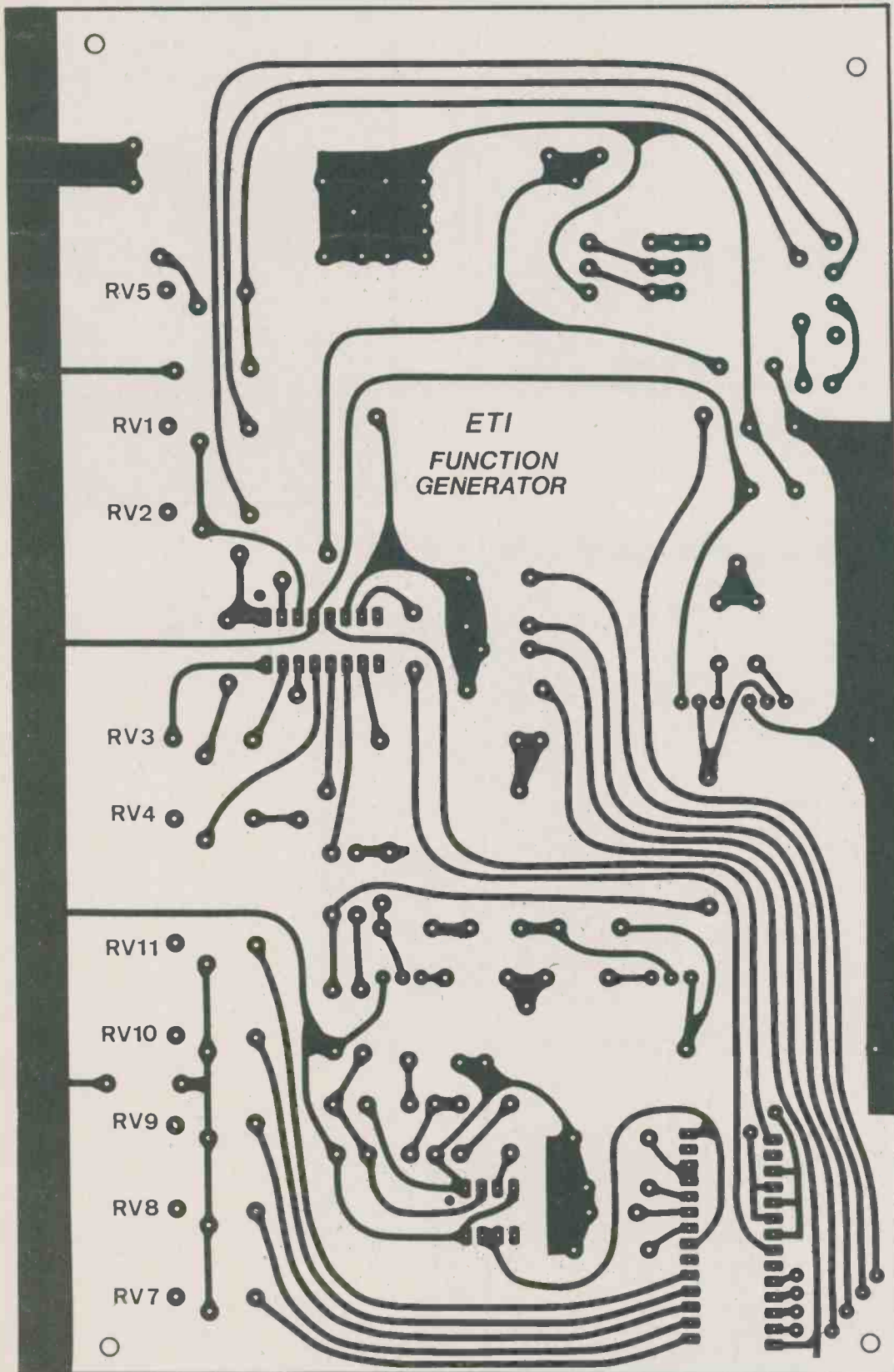

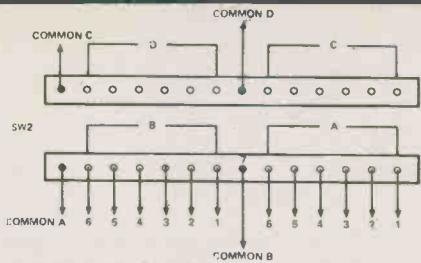

NOTES:
 IC1 is XR2206CP
 IC2 is NE555
 D1, D3 are 1N4148
 Q1, Q3 are 2N5209
 Q2, Q4 are 2N5086
 ZD1 5V6 zener
 SW2 POSITIONS
 1=10kHz-100kHz
 2=10Hz-1kHz
 3=100Hz-1kHz
 4=100Hz-10kHz
 5=1Hz-10Hz

Fig. 3. Range switch wifer pin-out
 Fig. 4. Circuit diagram

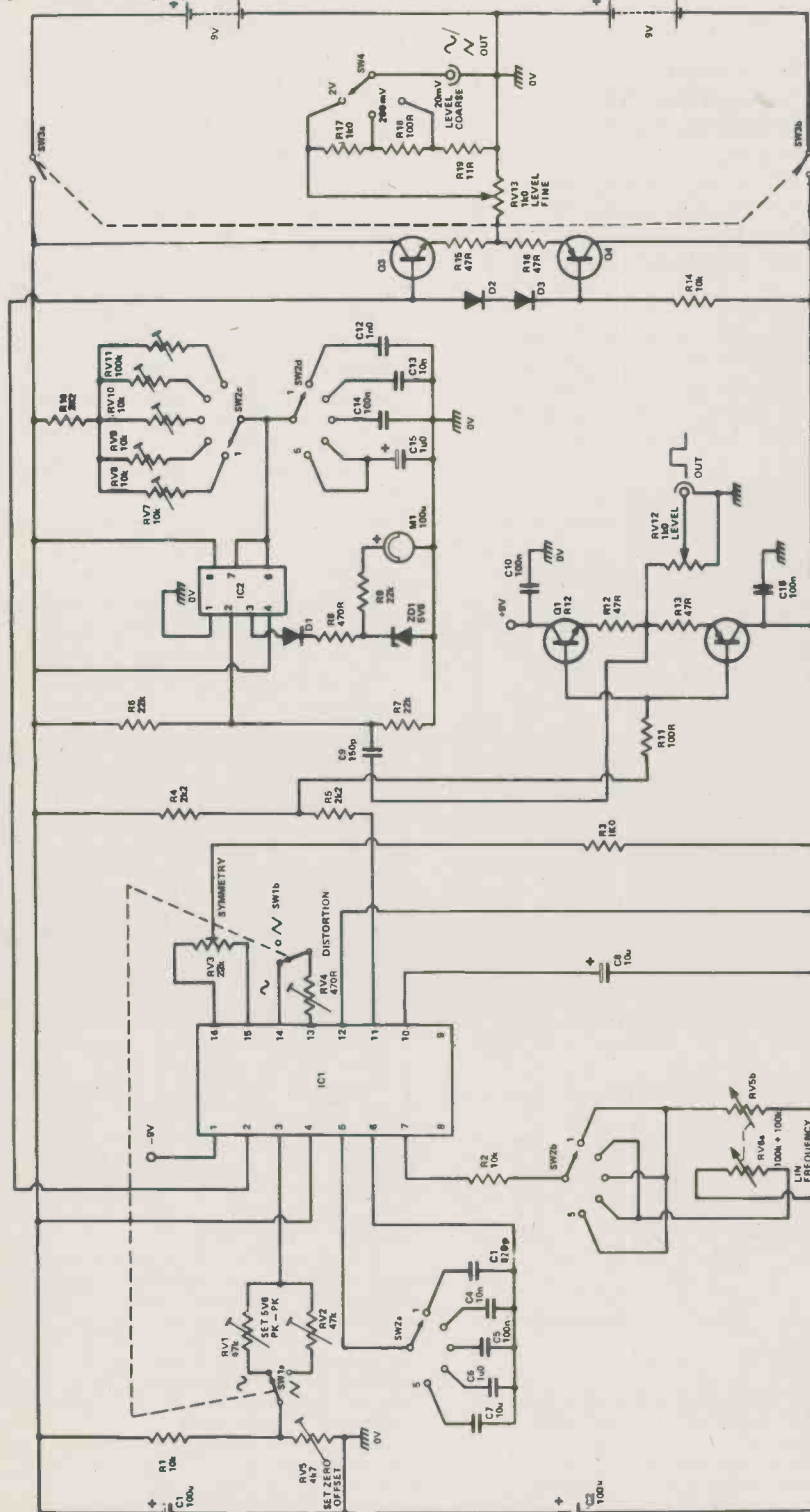

He's back on the job

He survived heart attack because coronary care units, new drugs and modern methods of rehabilitation are helping doctors restore more cardiacs to productive life.

Your Heart Fund dollars helped produce the advances that helped put him back on the job.

Beat the Big One...
Heart Attack

Give Heart Fund



Rain Alarm



Don't get washed away with this useful gadget.

THERE ARE MANY TIMES when you want to know whether (?) it's raining outside, without having to sit looking outside the window for hours on end. It may be the plants you're trying to shelter, or perhaps the washing that's supposed to be drying, but whatever the purpose this unit will alert you as soon as it gets wet.

It may Rain

It's here that the good guys of the ETI project team come to the rescue with their Rain Alarm. This little fellow might well upstage any canine companion as a housewife's best friend, at least on washday, by giving a warning at the first sign of rain, giving plenty of time to get the washing in before it gets too wet.

The rain alarm should be placed out in the open and a length of two conductor wire run between it and an eight ohm speaker. We used an old intercom sub-station to provide a

home for our speaker but a car extension speaker or indeed any suitably boxed eight ohm device would be fine.

Any rain falling on the sensor track, formed as part of the PCB, will set off the alarm and produce a distinctive, intermittent bleep-bleep.

Construction

Construction is straightforward if the PCB layout shown is used and in the case of this project we would recommend that the PCB is used, as this adds to the attractiveness of the project.

Assemble the components according to the overlay, ensuring that the tantalum capacitor is connected the right way round. If you do not use a socket for IC1, solder pins seven and fourteen before the others (this allows the device's internal protection circuitry to function).

In our prototype we used a value of 4M7 for R1 which acts as a sensitivity adjustment. This value leads to a 'hair trigger' alarm and the value could well be reduced according to the level of sensitivity required.

When construction is complete and the alarm has been tested the area of the PCB that holds the components should be covered with some suitable non-conducting potting compound — epoxy resin should do — to render it waterproof.

Power to Your

Power consumption of the unit is so low when the alarm is not triggered that it was not thought necessary to provide an on/off switch.

While this unit is not as effective as a device to control the weather — still working on that one — it should at least prevent some of those washday blues. ●

HOW IT WORKS

THE rain alarm is formed by two gated CMOS oscillators and an audio output stage.

The basic CMOS oscillator is shown in Fig. 2. Upon switch on, with C discharged, the output of inverter B will be low, the input to A low and its output high. Capacitor C will now commence to charge towards supply, the voltage level at A's output, via resistor R

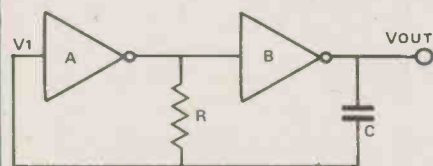

Fig. 2. Basic oscillator circuit

We can consider a CMOS gate to be a comparator that will change output state when the level of voltage at its input reaches a specified value, the transfer voltage (V_{tr}), usually about half supply. Thus as the voltage on C increases due to the charge current being supplied by R there will come a point when the voltage on the input of A will pass its transfer voltage and the output of B will go high.

At this point the charge on C corresponds to a voltage level of approximately half supply.

As the inverters A and B change states the end of C that was held at 0 volts is now at

supply and the end of C that was connected to supply via R is now returned to 0 volts via the same resistor.

These changes together with the charge stored on C mean that the potential across C is now supply plus the transfer voltage of gate A. This is shown in Fig. 3.

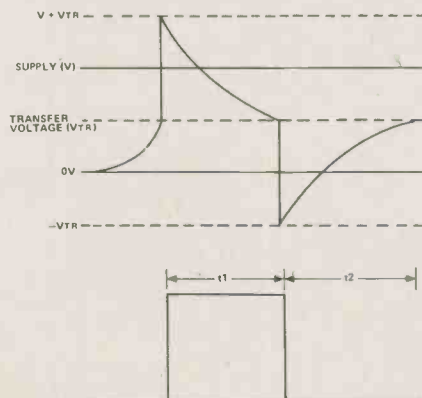

Fig. 3 Waveforms

Capacitor C will now discharge via R until once again the transfer voltage of A is reached whereupon the outputs of the inverters will assume their original states.

The conditions are not quite the same as at

switch on because, as can be seen in Fig. 3, the Potential across C is now a negative value equal to A's transfer voltage.

The final circuit diagram (Fig. 1) of the Rain Alarm shows that the inverters are in fact formed from the four NAND gates of a 4011 package. In each oscillator, while one gate is configured as a straightforward inverter, the other has one input that can act as a control input, oscillator action being inhibited if this input is held low.

From this point C charges via R again to repeat the cycle.

The output is shown in Fig. 3 where $t_1 = t_2 = 1.1 RC$ (the time taken for C to charge (discharge) via R to two-thirds of the maximum value of voltage across it).

In practice, due to the protection networks associated with modern CMOS devices, it is necessary to include a resistor in series with the input of A in order to ensure that the voltages across C are allowed to reach the values shown in Fig. 3.

The first oscillator (IC1a and IC1b) has this input tied low via a high value resistor (R1) that acts as a sensitivity control. Thus this oscillator will be disabled until the control input is taken high. Any moisture bridging the sensor track will so enable the output which is a square wave at about 10 Hz. This in turn will gate on and off the 500 Hz oscillator formed by IC1c and IC1d.

This latter oscillator drives the loud-speaker via R6, the Darlington pair formed by Q1 and Q2 and resistor R7.

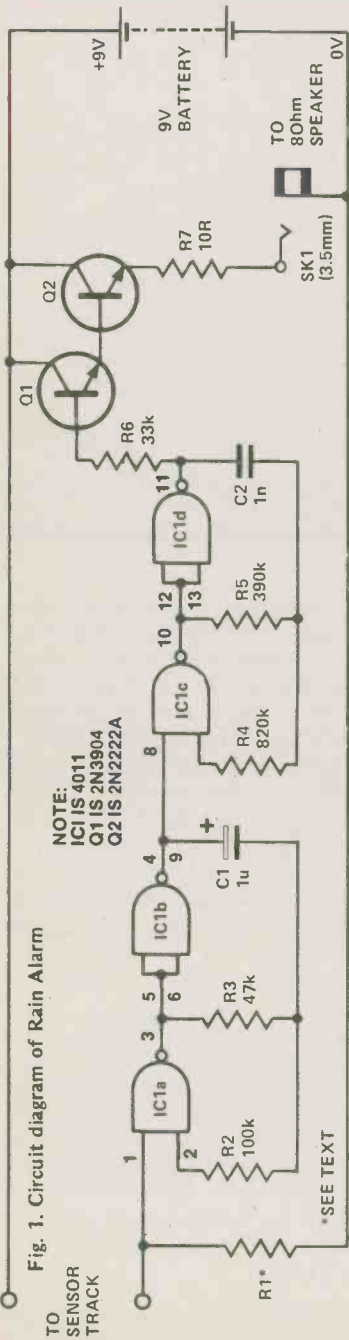
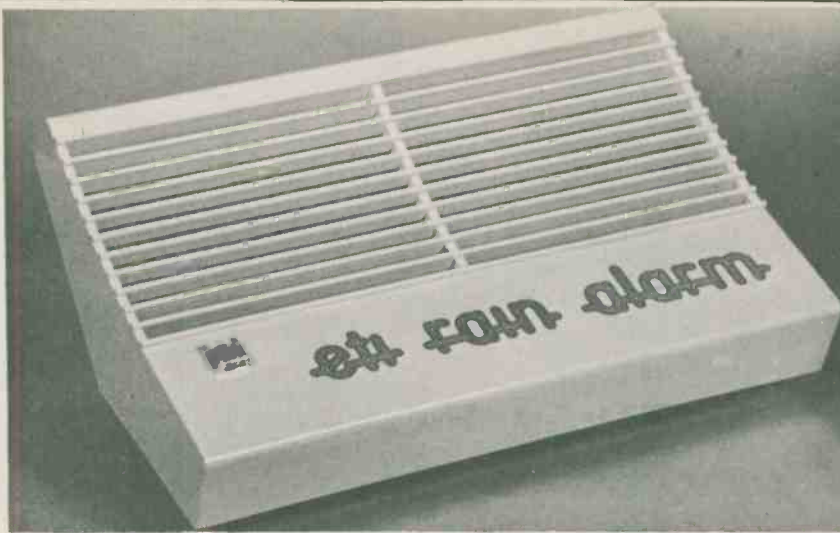

Fig. 1. Circuit diagram of Rain Alarm

PARTS LIST

RESISTORS (all 1/4W 5%)

R1	See text
R2	100k
R3	47k
R4	820k
R5	390k
R6	33k
R7	10R

CAPACITORS

c1	1u0 16 V tantalum
c2	1n0 polyester

SEMICONDUCTORS

IC1	4011
Q1	2N3904
Q2	2N2222A

MISCELLANEOUS

PCB as pattern, 3.5mm jack socket, 8 ohm speaker, battery.

Fig. 4. Overlay of the section of the Rain Alarm PCB that holds the components.

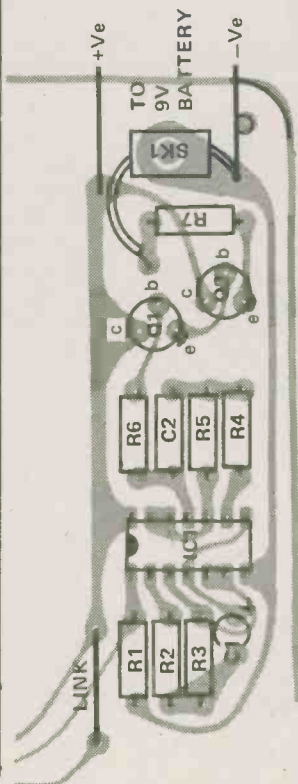

Egg Timer

Jonathan Scott is generally otherwise occupied while his breakfast eggs are on the boil — or so he tells us. "Having to get up in the morning is tedious enough without having to keep your eyes peeled for when the egg timer runs out", he says. An interesting argument, and an interesting solution. . .

OKAY, so you've got an egg timer. Odds on it's nothing like this one!

Conventional egg timers — the coloured-granules-in-a-three-minute-hour-glass variety — do their job efficiently, but silently. You have to watch them to see when your egg is ready. Either you stand and stare at it for the duration or you need sharp wits to instinctively 'know' when the time's up. Lack of audible indication on conventional egg timers is a consequence of inadequate design. Lack of sharp wits in the morning is a consequence of soft living.

This project tackles the first problem, the second is up to you!

Features

Conventional egg timers (even electronic ones we've seen) lack the option of 'hard' or 'soft' timing. Even if the electronic ones have an audible indication, they have the disadvantage of including an on/off switch.

This egg timer project includes the hard/soft option, does not include an on/off switch and 'bleats' when your egg is ready. We could have had it go 'cluck, cluck' or even 'cock-a-doodle-doo', but considered this a little *too* corny, and besides, it complicated the project unnecessarily!

Operation is very simple. First, you pick it up and shake it — the device lets you know with a soft bleep when it's been shaken enough. You then put it down on one end. Which end depends on whether you want a long time period (for a hard egg) or a shorter period (for — you guessed it — a runny one). After the appropriate period has elapsed the timer will issue a one second-long bleat and turn itself off until shaken awake again.

Has it got a microprocessor inside?

The egg timer is 'set' by giving it a few good shakes and setting it down on one end. The ends are labelled 'hard' and 'soft' — according to how you like your egg, you set it down on either one end or the other. An on/off switch is unnecessary.

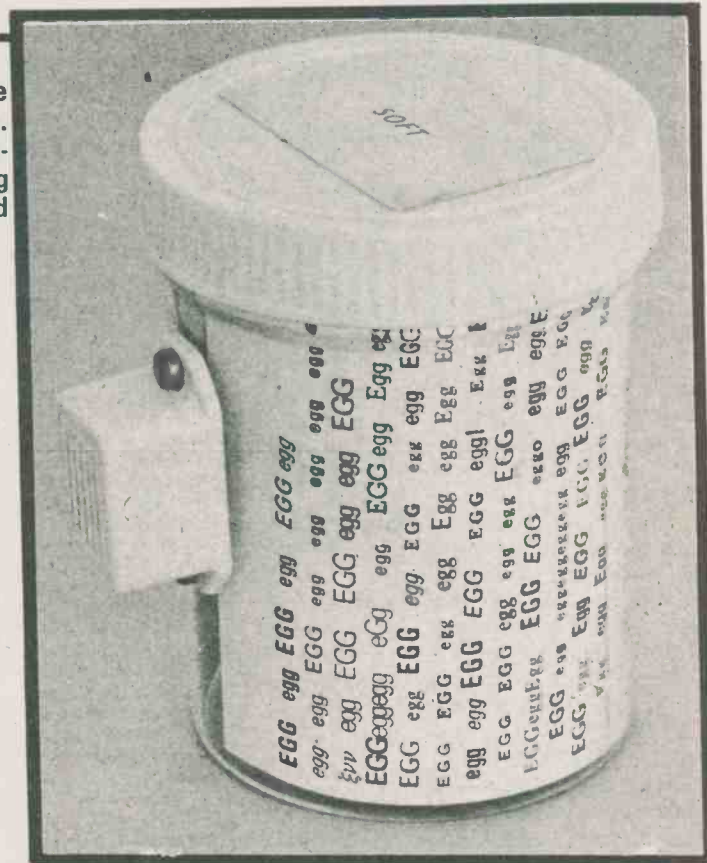

No, it's all done with one CMOS IC, a couple of transistors and a dollar's worth of mercury switch.

Construction

The project is best constructed on the printed circuit board designed for it. Be sure to get the IC, transistor and diodes correctly oriented when inserting the components in the board. Take care also with the electrolytic capacitors

Carefully follow the overlay diagram and you should experience little difficulty.

The choice of a housing for the project depends a little on your kitchen decor — select a container that's large enough to enclose the pc board and battery though. We've used a plastic jar and a salt shaker as examples.

However, that plastic ornamental emu's egg that Aunt Aggie gave you for Easter may do just as well — assuming it will stand securely on either end (. . . maybe that's not such a good idea after all).

The buzzer may be mounted either onto the outside of the container or on the inside. The latter will result in a loss of volume though. A few holes in the case will allow the buzzer to be heard better if you wish to mount it inside.

The whole assembly should be packed in the container chosen using sponge rubber scraps — it has to stand a lot of shake, rattle and roll.

When you do this, make sure that the metal case of the battery does not come in contact with the copper side of the pc board.

Adjustments

If you like your eggs super hard — or perhaps extremely runny, or even somewhere between these extremes, the time periods may be changed by altering the value of R2 or R3 — one will alter the softness of the 'hard' egg, the other the density of the 'soft' egg. See 'How it Works' for an eggsplanation of the circuit operation (these puns will have to stop . . . Ed.).

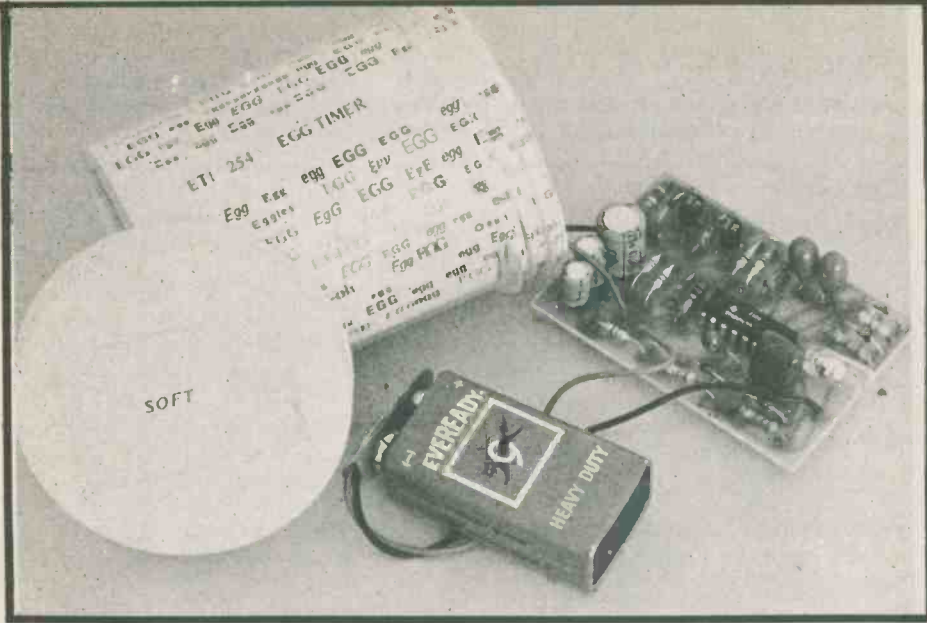

(Left) The pcb and the battery should be protected against the shaking which this project is bound to receive. We suggest stuffing the case well with something soft.

(Below) One CMOS IC, two transistors and a handful of components make up this timer. No on/off switch is necessary.

(Bottom Left) Printed circuit board overlay. (OverLAY?). Take care with the orientation of the diodes and electrolytic capacitors.

(Bottom Right) The ETI egg timer foil pattern.

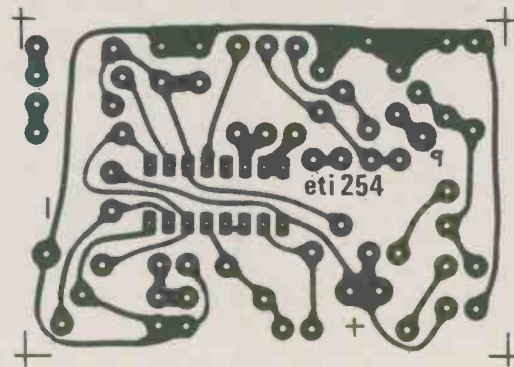
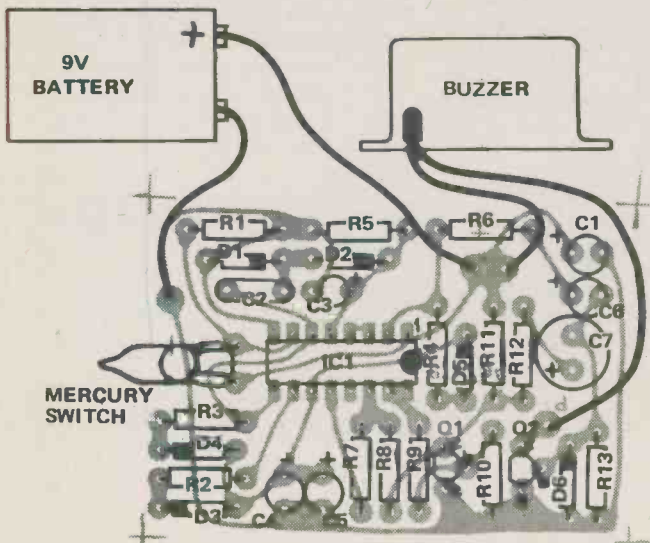
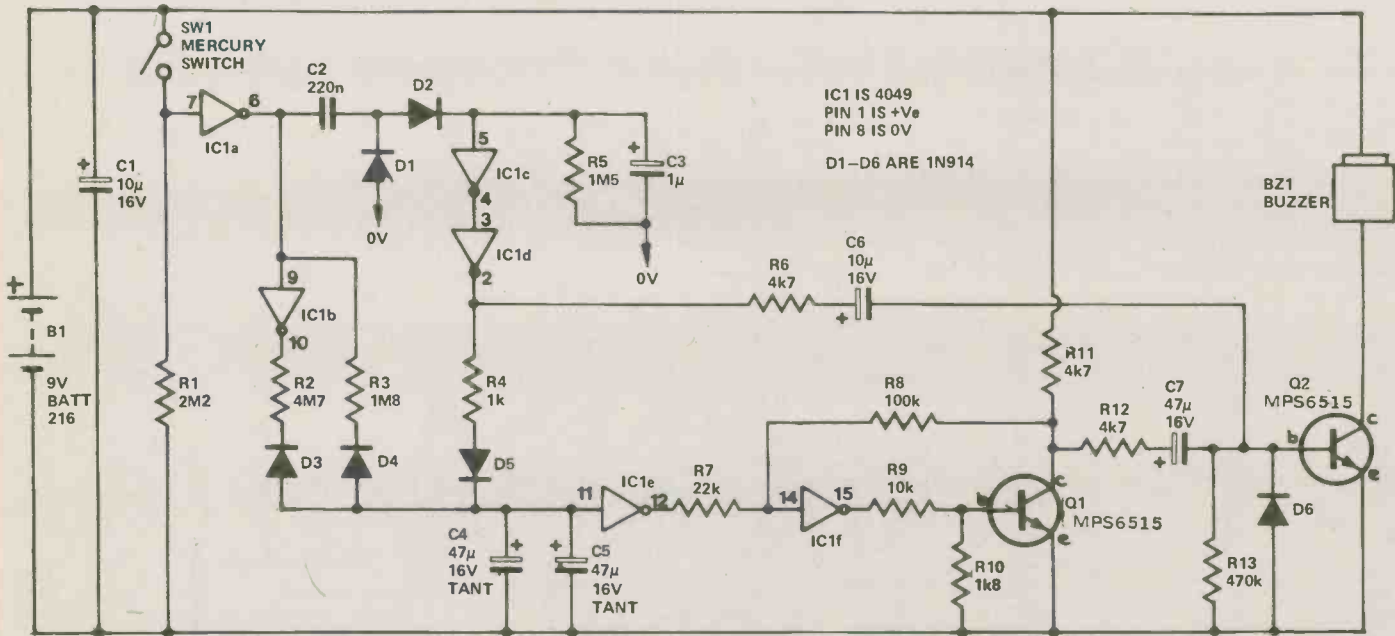

HOW IT WORKS

The timing period is initiated by shaking the egg timer. Initially, C3, C4 and C5 are discharged and both transistors are biased off. IC1a is a buffer whose output is high when SW1 is open and low when it is closed. Shaking the timer will therefore cause an alternating voltage to appear on the output of IC1a. C2, C3, D1 and D2 form a rectifying network which charges C3 using this output of IC1a. Once C3 has charged past the threshold voltage of IC1c (indicating that the timer has been shaken), two things will happen: Firstly, C6/R6 will pass current to turn-on Q2 and thus the buzzer, to indicate that it has been shaken enough. Secondly, C4 and C5 start charging via D5 and R4. When C4 and C5 have charged to the threshold voltage of the Schmidt trigger formed by IC1f and Q1, Q1 will turn on and terminate the bleep.

Meanwhile, C3 will have discharged through R5 (assuming you're not still shaking the thing) and IC1c and IC1d will have reverted to their original state.

C4 and C5 will then discharge via either R2/D3 or R3/D4, depending on whether SW1 is closed or open. This is the really clever part. SW1 is now only used to start the timing period but, depending on which end of the device is uppermost during that timing period SW1 will either be open or closed and either R2 or R3 will determine the length of the period.

When C4/C5 have discharged sufficiently, Q1 will switch off, charging C6 via the base of Q2, causing the final one-second bleep.

Not bad for one CMOS IC, eh?

PARTS LIST

Resistors	all 1/4W 5%
R1	2M2
R2	4M7
R3	1M8
R4	1k
R5	1M5
R6	4k7
R7	22k
R8	100k
R9	10k
R10	1k8
R11, R12	4k7
R13	470k

Capacitors	
C1	10µ 16V electro
C2	220n
C3	1µ 16V electro
C4	47µ 16V tant
C5	47µ 16V tant
C6	10µ 16V electro
C7	47µ 16V electro

Semiconductors	
D1-D6	.IN914 or sim
Q1, Q2	MPS6515
IC1	.4049

Miscellaneous	
B1	.9 volt, battery
BZ1	.piezo electric buzzer

SW1Mercury switch
Suitable container, battery clip, packing material, pcb.

FINGERS TO DONUTS



KIT 650

Photo-Etch Kit for Printed Circuits with Negative Acting Resist

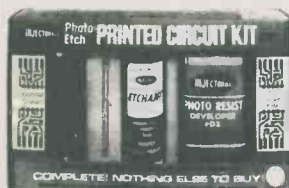

KIT 650 is a complete kit using a photographic method to produce professional quality printed circuits. No dark room is necessary. Contains 2 photo-sensitized 3 x 4" phenolic boards, a photographic test negative & an ultraviolet light source. Materials are included to make negatives of magazine layouts. Also contains exposure glass, clamps, developer, etchant, trays, resist remover, drill and complete instructions. Ideal for solid-state and integrated circuits. Packed in a display box. Weight 3 lbs.

omnitronix Ltd.
2056 Trans Canada Hwy. Unit 7, 6295 Shawson Dr.
Dorval, Quebec. Mississauga, Ontario.
H9P 2N4 L5T 1H4
(514) 683-6993 (416) 678-7170
Telex: 05-822692 Telex: 06-968653

IT TAKES A STRONG WILL TO BEAT CANCER

Imagine for a moment a world where cancer is as obsolete as the dinosaur. It can happen. The research is willing but unfortunately

the funds are weak.

All bequests received by the Canadian Cancer Society are used to support cancer research, unless otherwise stipulated in the will. That's where you come in. Please insert one simple sentence in your will: "I give to the Canadian Cancer Society the sum of _____ dollars."

Our hope is to free the world from cancer. And where there's a will, there's a way.

Canadian Cancer Society ↓

CAN CANCER BE BEATEN? YOU BET YOUR LIFE IT CAN!

Patch Detector

For \$50 worth of filler, an auto's value can go up considerably. This gadget will help you find a car's true value!



THERE IT STANDS: gleaming. On the surface, a secondhand car in really good nick but think! Modern materials, especially resin body filler and a quick paint job with the spray gun can make a rusty heap look like a new car.

Our Patch Detector will quickly find areas of the body-work which have been filled — or even patched with aluminum.

Only a handful of components are used. The key to the operation is the transistor output transformer; we used several types and they all worked without any difficulty.

It is necessary to modify the transformer. First remove the shroud over the laminations. Then, using a pair of fine-nosed pliers carefully remove the laminations. These are held together by wax: the first lamination may be tricky to remove but thereafter you won't have any difficulty. The laminations

in the AT49 (and the others we tried) are E shaped with a bar enclosing the exposed end, they are layed alternately.

When all the laminations have been removed reassemble them all the same way round to form an E. Fit this back into the transformer and replace the shroud.

We used a small plastic hand-held box and built a small PCB to hold the components. The transformer can't fit directly onto the PCB so two thick wires are soldered to the shroud, these in turn are soldered to the PCB, this effectively stands the transformer away from the board.

A hole is necessary in one end of the plastic box to take the transformer's face; the open ends of the E should face out.

The circuit is simple and will only be used with an earphone so an on-off

switch will just complicate matters. Instead the switch section of the earphone socket is bent so that it switches on when the earphone is inserted.

An Eveready 216 will fit nicely across the end of the box if one of the plastic buttresses on the pillar and two pips inside the same area are cut away.

The circuit is really a simple metal locator. In free air an audio tone is heard but when run along the body of a car the note is lower. When filler is encountered the note rises: even aluminum causes note change. There is no danger of the unit scratching the paintwork as the only thing to touch the bodywork is the soft plastic of the transformer's former.

A change in note can be detected when sheet steel is about 10mm (3/8in) from the laminations. Greater sensitivity is not an advantage incidentally.

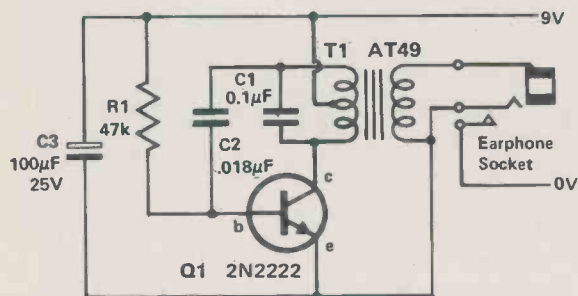

Fig. 1. Circuit diagram of the detector.

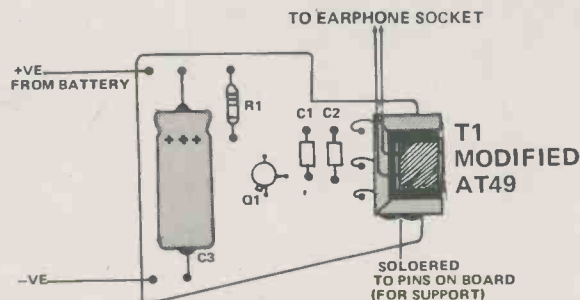

Fig. 2. Component overlay

HOW IT WORKS

The circuit is a Hartley oscillator using an AT49 as the inductor. The primary of T1 is tuned by C1 and feedback is provided by C2. The secondary of T1 connects via the socket/switch to the earphone.

Due to the modification of the transformer, when metal is brought near to the open end of the E laminations this alters the inductance of the primary and consequently the frequency of the note produced.

C1, C2 and R1 all affect the note produced and as long as R1 is not reduced below 33k, these may be modified to give the desired frequency. Current drain from the battery will be between 5 and 10mA.

PARTS LIST

- Q1 Transistor 2N2222 etc
- R1 Resistor 47k 1/4W
- C1 Capacitor 0.1µF disc ceramic etc
- C2 " 0.01µF "
- C3 " 100µF 12V electrolytic
- T1 Armaco AT 49 (Electrosonic)

Earphone: 8Ω type, 3.5mm Jack plug
 Earphone socket, 3.5mm
 PCB to design shown
 II plastic box
 Battery

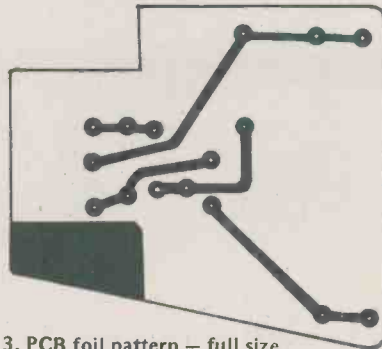
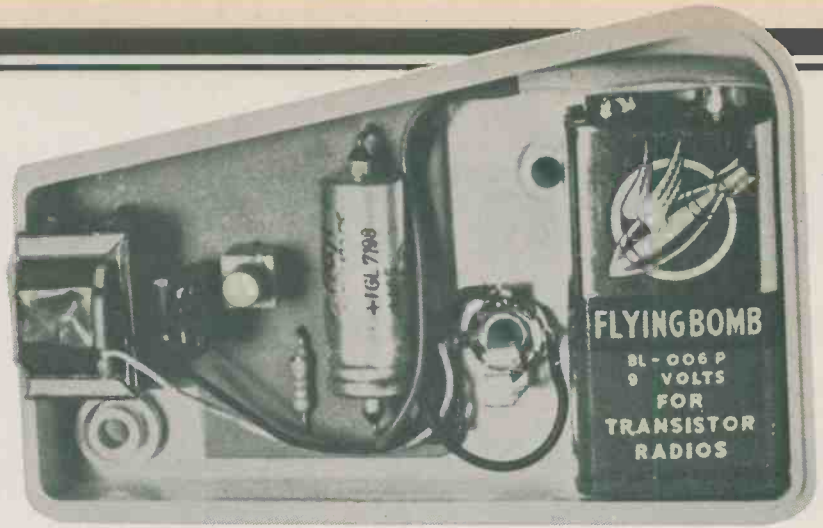

Fig. 3. PCB foil pattern — full size.

Internal view of our Patch Detector. Note how the transformer fits through a hole cut in the short end of the case.

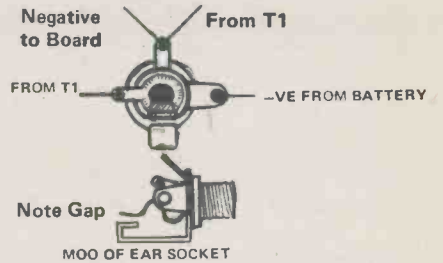
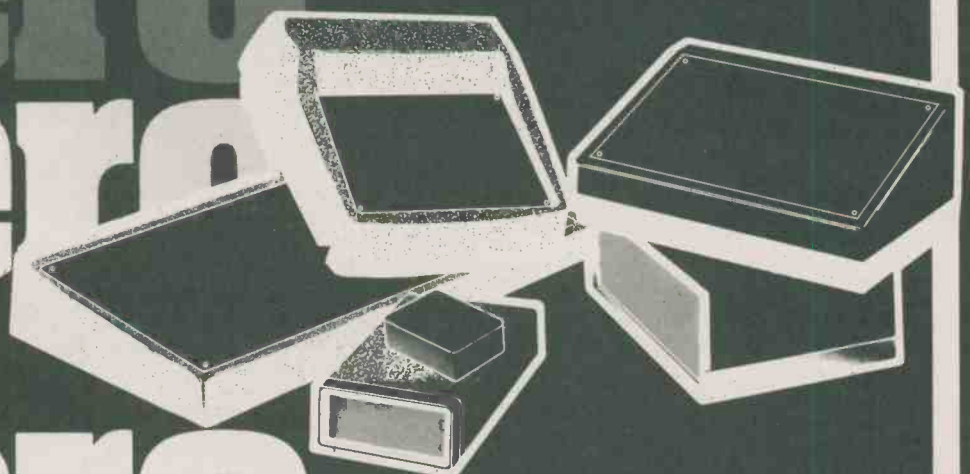

Fig. 4. The wiring and modifications to the earphone sockets.

vero
vero
vero

Plastic Boxes



Our catalogue contains a whole range of plastic boxes to suit every project. There are case-boxes, sloping front and flip-top boxes, general purpose and potting boxes — there's even some with integral battery compartments. We've also got circuit boards, accessories, module frames and metal cases — all to the highest standard to give your equipment the quality you demand.

ELECTRONIC PACKAGING SYSTEMS LTD.
 Retail Department.
 P.O. Box 481, Kingston, Ontario
 K7L 4W5 Telephone (613) 384-1142



DEALERS REPLY ON LETTERHEAD

Digital Tachometer

Compact unit offers both 10 rev resolution and short response time.

WE HAD OFTEN considered the design of a digital tacho for automobile use, but had rejected several schemes as we were unable to get both good resolution and response time — the two seemed to provide a very good demonstration of Heisenberg's Uncertainty Principle.

Consequently, we were rather pleased with this phase-locked loop based design which got round the problem.

This tacho features a fast response time, coupled with 10 Hz resolution, through the use of a phase locked loop frequency multiplier. It can be set up, by means of a single link, to work on 4, 6 or 8 cylinder motors.

Design Features

To measure the revolutions per minute of a motor is simply a matter of counting the number of ignition pulses over a given time. With a four cylinder, four stroke motor there is such a pulse twice per revolution. Therefore if we count these pulses for 30 seconds we will have revs/min with a one cycle resolution. Obviously this is much too long a sample period for practical use in a car and some compromise has to be made. The usual solution is to use a 100 rev resolution and a sample time of 0.3 seconds (on 4 cylinders). We considered this inadequate which is why we have not published a design until now.

In this design an oscillator is used which is phase locked to the ignition pulses except at a higher frequency (x8 for 4 cylinder) allowing a short sample time (0.375 sec) with a 10 rev resolution. By using a different multiplication factor compensation for different numbers of cylinders can be made. Unfortunately with the multiplication factors used (x8, x6, x4) the sample time for 6 cylinders is not exactly the same as that



used for 4 and 8 cylinder motors. Altering the ratios to x12, x8 and x6 would enable a 0.25 sample time to be used for all ranges, but this is not possible with the divider IC utilised in this design.

Construction

Assemble the pc board with the aid of the overlay ensuring the components are oriented correctly. The tantalum capacitors normally have a + mark indicating the positive lead, or a dot on the side. When soldering the CMOS ICs (4, 6, 7) ground the tip of the soldering iron.

Note that there is one feedthrough or link between the two sides of the board near C10.

Calibration

Initially place a link between the point 'C' and the terminal corresponding to the number of cylinders. Now with the power supply connected feed a 50 Hz signal of between 12 and 30V into the points input using the 0V as common. Now adjust RV1 until the display reads 1500RPM for 4 cylinders, 1000 for 6 or 750 for an eight cylinder car.

PARTS LIST

RESISTORS all 1/4W 5% unless stated otherwise

R1,239k
 R3,422k
 R51k5
 R6100k
 R7100R
 R8not used
 R910k
 R10390k
 R1110k
 R12270k
 R1310k
 R14not used
 R15-R21 .27R

POTENTIOMETER

RV125k trim

CAPACITORS

C110μ 25V tantalum
 C2,356n polyester
 C410μ 25V tantalum
 C54μ7 25V tantalum
 C610n polyester
 C71μ0 25V tantalum
 C8470p ceramic
 C956n polyester
 C1010n polyester
 C1110n ceramic

SEMICONDUCTORS

IC17805 regulator
 IC2555 timer
 IC37413 dual schmitt
 IC44046 PLL
 IC574123 dual mono
 IC64018 divide by n
 IC774C925 4 digit counter

Q1MPS6515
 Q2-Q52N2222A

D11N4004

DisplayNSB5881 (National)

MISCELLANEOUS

PC board
 Case to suit

SPECIFICATIONS

Range	100 to 9990 RPM
Resolution	10RPM
Reading rate	
4 or 8 cylinders	2.66 per second
6 cylinders	3 per second
Power supply	7 to 15V @ 400mA
Suitable ignition systems	standard CDI transistor assisted * it will not operate on 'pointless' systems.

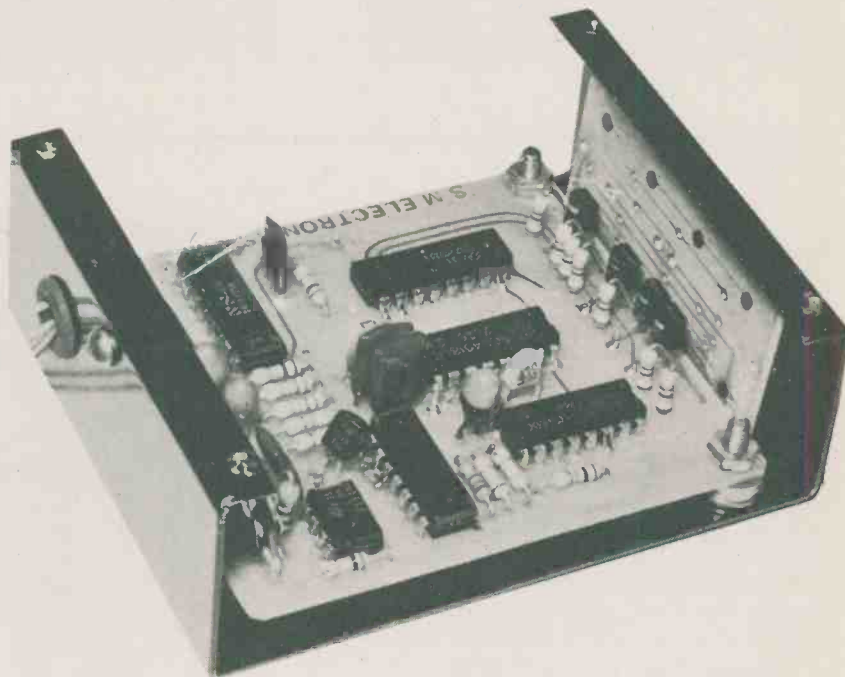

HOW IT WORKS

The output from the points of the distributor is basically a 0 to 12V square wave with a 200 volt pulse on the rising edge. A filter network, R1-R4, C2, 3 is used to remove the high voltage pulse (and points bounce) and Q1 buffers it giving a +5 to 0V output or its collector. As the filter network removes the sharp edge of the input a schmitt trigger is needed on the output of Q1 to give fast edges. IC3/1 is used for this.

The output of IC3/1 is connected to the input of the phase-locked loop IC (4046). This IC has an internal voltage controlled oscillator and its output is divided by 4, 6 or 8 by IC6 and this lower frequency is fed back to the phase-locked loop IC. The IC then compares this frequency to that at its input and adjusts the internal oscillator until it is the same. The result is a frequency which is an exact multiple of the input.

The time base is generated by IC2 (555) which has a negative output pulse, about 300 μ s wide every 375 ms (or 333 ms for 6 cylinder). This is inverted by IC3/2 and is used as the strobe pulse for the 4 digit counter IC7. This pulse also triggers the first of the monostables in IC5 which gives a 200 μ s delay before triggering the second half of IC5; this gives a 40 μ s pulse to reset IC7 back to zero.

IC7 is a 4 digit counter with a latch (store) and seven segment decoder driver. It needs four external transistors to drive the digits but the segment drivers are internal. As we need only a three digit counter, i.e. for a 10 Hz resolution, with the right hand permanently zero the least significant digit is connected to the second right digit, etc., with the most significant digit connected to the right hand digit. Provided one does not exceed 9990 RPM this digit will remain on 0 as intended!

The 555 timer, the TTL and the 74C925 needs a regulated +5V and IC1 provides this with D1 preventing damage which might be caused by reverse polarity input.

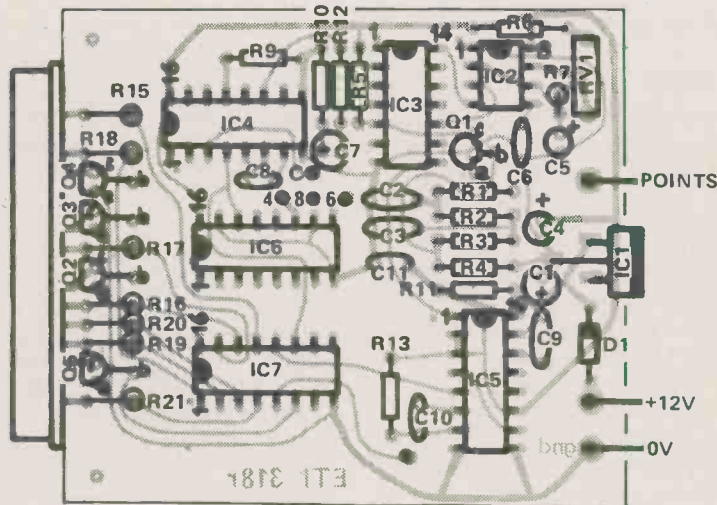

Fig. 1. The component overlay for the board. The board is double sided although only the lower surface is shown here. Note the link between the two surfaces of the board near C10. Also check the orientation of the transistors carefully.

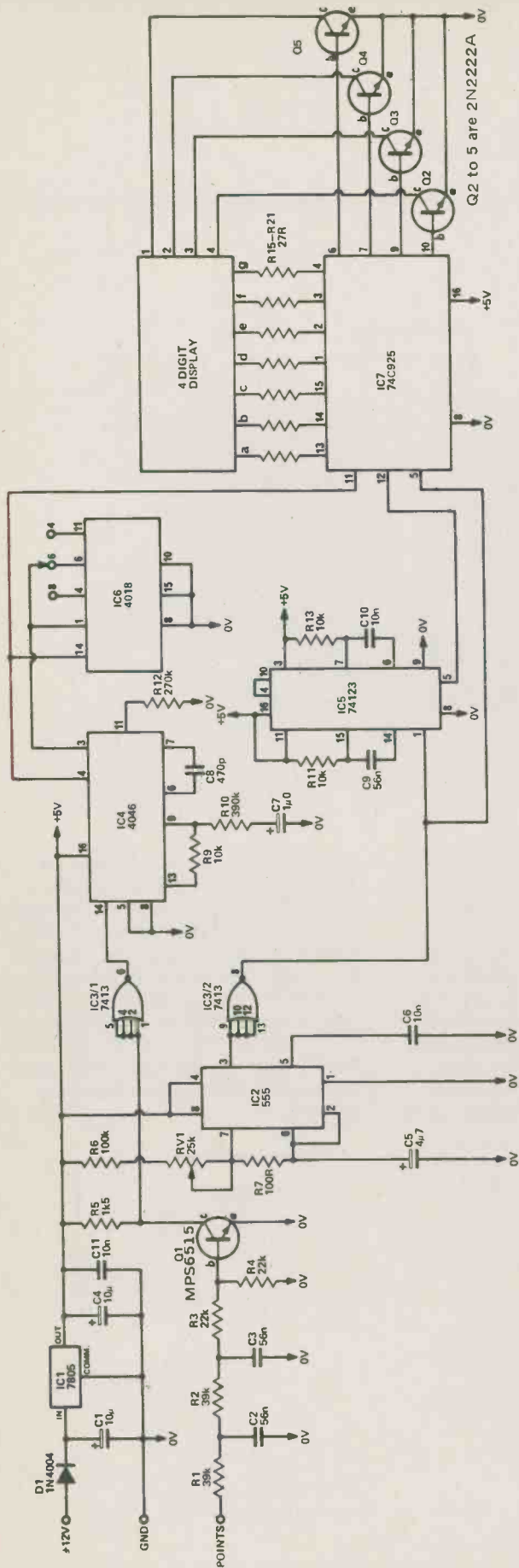

Fig. 3. The circuit diagram of the digital tachometer.

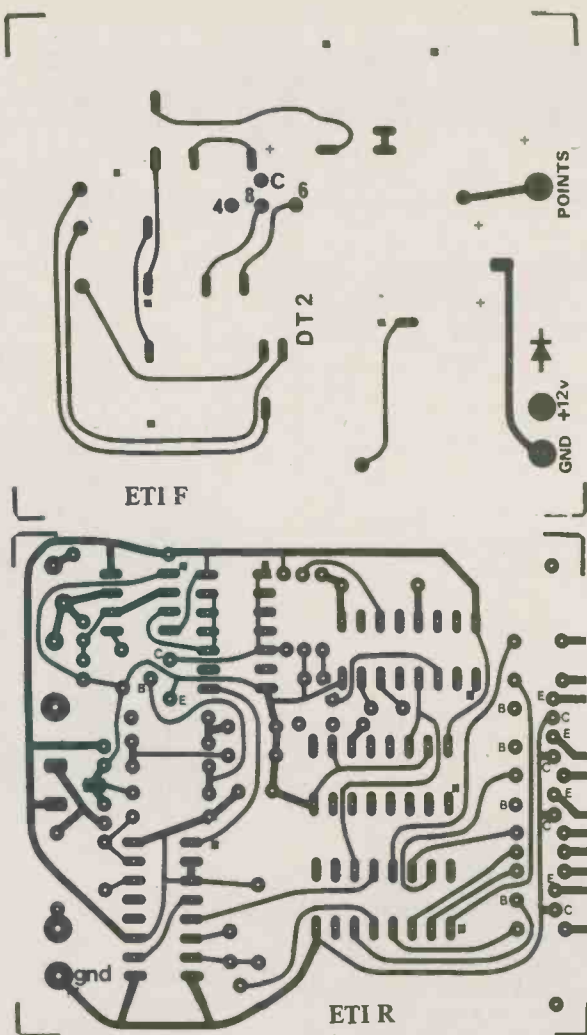
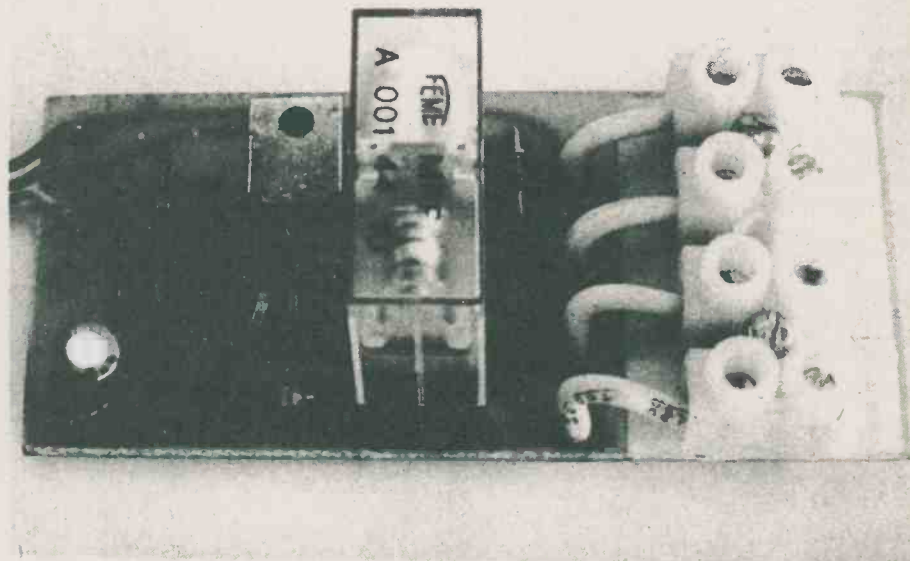

Fig. 2. The pc patterns shown full size. The second side can be printed, or simply a guide for jumper wires.



Variwiper

This pulsed windshield wiping circuit can be used on cars fitted with most types of modern motors.



WHEN OPERATING IN heavy rain windscreen wipers often have difficulty providing adequate visibility. However, during light rain or mist all that is necessary is an occasional sweep of the blades at intervals of a few seconds.

Turning them on and off repeatedly takes the driver's concentration off the road, and his hands off the wheel, increasing the risk of an accident. Alternatively, if the wipers are kept working all the time in such conditions the blades tend to scrape on dry glass, wearing out the rubber inserts, your nerves, and worse still, the screen itself.

The answer is obvious; have the wipers operate intermittently at a duration which can be varied to suit the conditions.

Figure 1 shows the circuit of a modern wiper assembly. Dynamic braking is achieved by applying a short across the armature, by a cam-actuated change-over switch synchronised with the wiper blades. When the wipers are switched off, the change-over switch shorts out the motor armature via the main wiper ON/OFF switch.

The circuit of fig. 2 is suitable for use with negative earth cars fitted with permanent magnet motors. Some early model cars are fitted with wound field coil motors and are not suitable

for use with this circuit (more about them later).

Some types of permanent magnet wiper motors, especially those on British cars, have a fifth wire extended to the wiper switch. These motors are designed to operate independently of a ground to allow for their use on either positive or negative ground vehicles. The circuit of fig. 2 can also be used with these motors provided they are fitted to a negative ground car. However, some more expensive American cars have wiper motors which are reversed in the parking sequence to lower the blades below the bottom of the windscreen when not in use. The Vari-Wiper unit described cannot be used with these wipers.

Before installing the Vari-Wiper unit make sure that you have one of the types of permanent magnet wiper motors described. If necessary remove the cover of the motor and identify the wire to the centre contact of the cam-operated switch.

Normal Wiper Operation
Conventional operation of the wipers is

obtained by using the vehicle wiper switch in the normal way. Figure 2 shows the sliding contacts of this switch in the correct position for each function. Note that in the off position the switch shorts lead B to lead C. In the SLOW position the short is removed and an ground is extended to B, while in the FAST position the ground is removed, from B and extended to A. For single speed wipers slide contact A will be omitted.

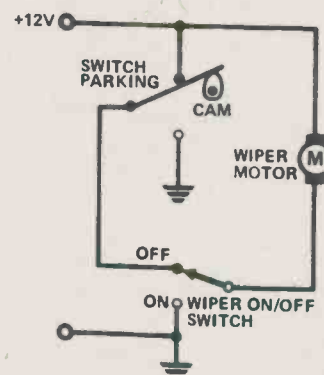

Fig. 1. Circuit of modern wiper motor assembly. Dynamic braking is achieved by applying a short across the armature.

HOW IT WORKS

The timing circuit is energized by operating switch SW1, which is part of switch/potentiometer RV1. This switch applies power to the unijunction/SCR circuit via the still-closed parking switch contacts.

Capacitor C1 charges via RV1 and R1, at a rate determined by the setting of RV1, until the unijunction 'fires', producing a positive going pulse which triggers the SCR into conduction. Resistor R4 ensures that the SCR latches on, thus energizing relay RL1.

Relay contacts RL1 (1) now change-over, removing the short circuit from the motor armature before energizing the motor by extending an ground via the now-closed relay contacts.

As the motor gathers speed, the associated cam-actuated switch changes over, removing power from the timing circuit (causing the relay to drop out) and extending an ground to the wiper motor via wiper switch contacts B and C, the now de-energized relay contacts, and the cam-actuated switch.

The wipers continue their sweep across the screen, but on their return the cam-actuated switch cuts in just before the end of the sweep. This removes power from the wiper motor and places a short circuit across the armature.

Operation of the ETI319A unit is similar except the motor, which does not require dynamic braking, can be driven directly from the SCR, saving the cost of a relay. Note that either D1 or D2 become redundant depending on the polarity of the vehicle.

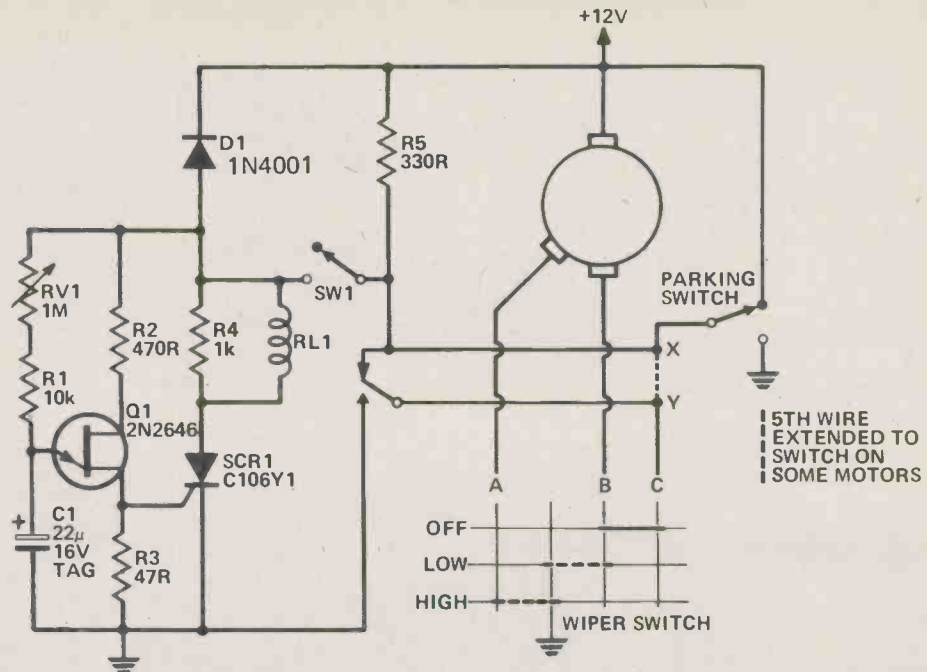

Fig. 2. The ETI Vari-Wiper circuit using relay output for use with permanent magnet motors.

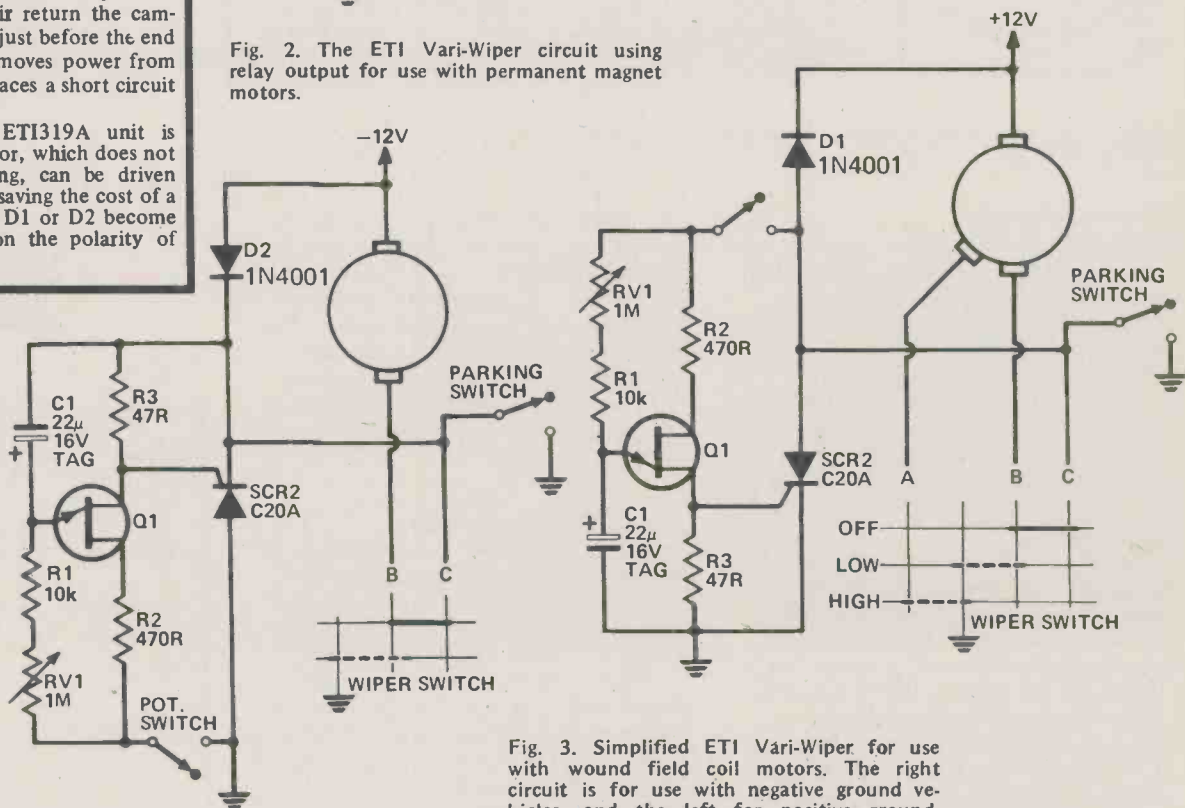
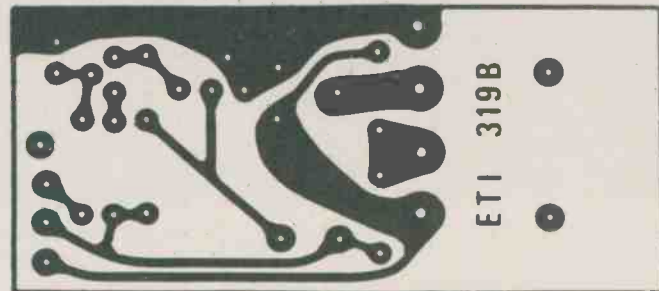

Fig. 3. Simplified ETI Vari-Wiper for use with wound field coil motors. The right circuit is for use with negative ground vehicles, and the left for positive ground. Both share the same PCB.



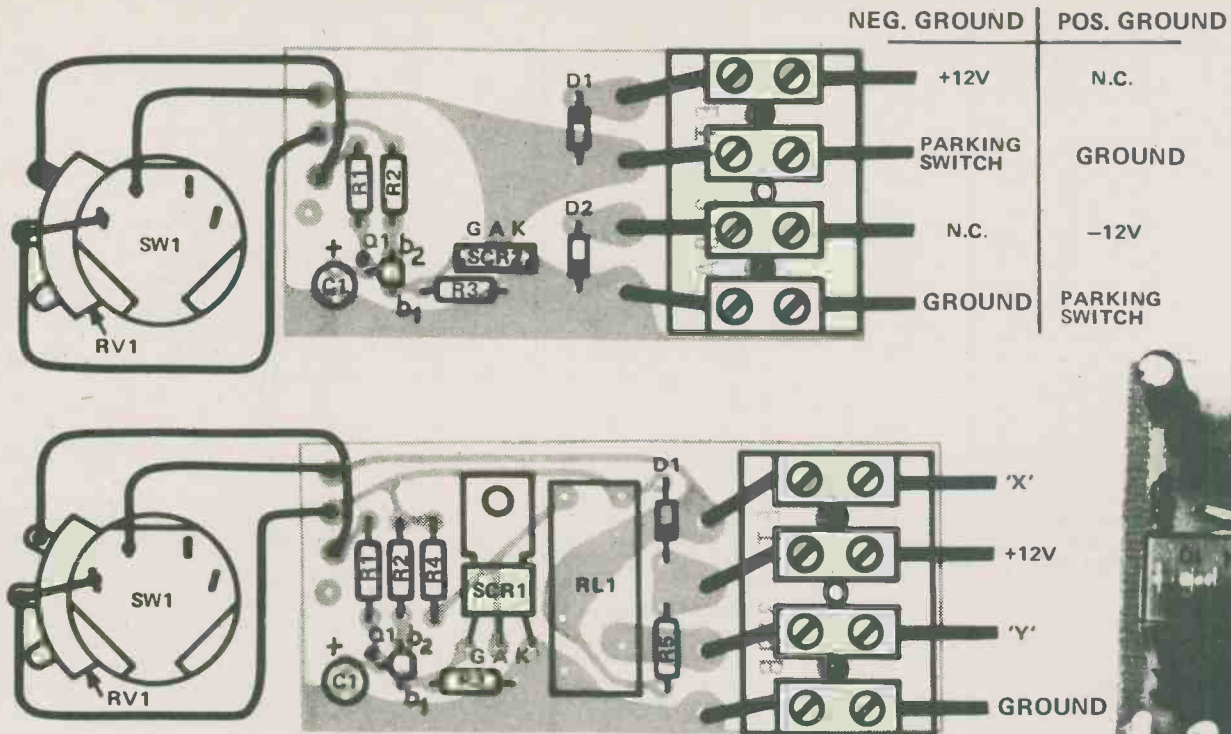

Fig. 5. Component overlays. Note that the same PCB is used for both ground polarities on the ETI Vari-Wiper

Delayed Operation

When delayed operation is required, the upper switch is left in the OFF position and the timing circuit energised by operating SW1 which is part of the switch/potentiometer RV1.

After a time which is set by the position of RV1 (0.5-25 secs.) the relay contacts RL1 (1) change over, removing the short circuit from the motor armature before energising the motor by extending a ground via the now closed relay contacts.

As the motor gathers speed the associated cam-operated switch changes over, removing power from the timing circuit (causing the relay to drop out), and extending a ground to the wiper motor via the wiper switch contacts B and C, the now de-energised relay contacts, and the cam-activated switch.

The wipers continue their sweep across the screen, but on their return the cam-operated switch cuts in just before the end of the sweep. This removes power from the wiper motor and places a short across the armature. The motor is thus dynamically braked and remains stationary until the next relay closure from the timing circuit. When this arrives the sequence is repeated.

Construction

Because wound field coil motors do not

use dynamic braking, the Vari-Wiper can be made without a relay. Figure 3 shows the simplified Vari-Wiper circuit and its connections to either a positive or negative ground vehicle. The same printed circuit is used for both arrangements. Operation is similar to the previously described unit, having a ground extended through the SCR to start the motor.

Wound Field Coil Motors

Assemble and solder all components on the printed circuit board as shown in fig. 5. Do not bend the lugs of the SCR too close to its case and ensure all semi-conductors are the right way round.

To connect the unit to the wiper motor circuit, the existing lead from the centre pole of the wiper motor change-over switch to the wiper ON/OFF switch (shown in dotted lines in fig. 2), should be broken at points X and Y and these leads taken to the normally closed contacts on the relay. Ensure that point X goes to the fixed contact and point Y to the moving one.

The potentiometer should be connected to the unit with just enough wire to allow the printed circuit to be mounted in a convenient position under the dash. The potentiometer can be mounted through a 10 mm hole drilled in the fascia panel or by attaching it to a bracket mounted in a convenient place.

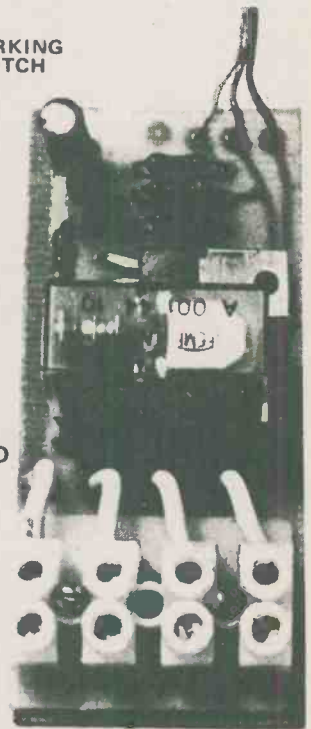

PARTS LIST
Relay Output Unit

- Resistors all 1/4W 5%
 - R1 10k
 - R2 470R
 - R3 47R
 - R4 1k
 - R5 330R
- Potentiometer
 - RV1 1M switch pot
- Capacitor
 - C1 22µ 16 V electro
- Semiconductors
 - D1 1N4001
 - Q1 2N2646 or MU10 unijunction
 - SCR1 C106Y1
- Miscellaneous
 - RL1 Mini PC heavy duty 12 V relay
- PCB ETI 319B
- Nylon terminal strip

SCR Output Unit

- All components identical, except:
 - R5 deleted
 - D1/2 1N4001
 - SCR2 C20A
 - RL1 deleted
- PCB ETI 319A

Porch Light

An attractive project that should banish night-time gloom from the front door step.

WHEN RETURNING HOME on a dark winter's night, with gusting winds and pouring rain making the thought of gaining the inner warmth of home very appealing, it is no fun when the front door proves difficult to find in the gloom. The solution is to install a porch light to banish the all prevailing gloom forever. Things being what they are, however, in order to ensure that this guiding light is present whenever it is required would mean an extortionate demand from your friendly local hydro company.

The answer is the circuit presented here. It arranges for the porch to be lit for a short time when required, and here's the clever bit, it uses the bell push to turn it on — No need to install a separate switch.

The unit will only operate when it is dark enough to require it — you choose the level, and turns off automatically unless latched on from inside the house. Flicking the internal switch also operates the light.

As well as saving money the circuit is also a valuable addition to the domestic security arrangements. Thus, while friends will soon realise that just because the porch light comes on you need not be at home, the light should put off any unwelcome callers.

Constructive Thinking

Construction of the project should pose no problems if the PCB shown is used and the component overlay followed carefully. Take care to ensure that the components are mounted close to the board if space is at a premium.



Putting it in

When installing the unit note that the bulb is powered by a DC voltage and thus if an existing porch light is used care must be taken when installing the unit as two separate wires are required from the porch unit to the bulb.

The other points to note are the connections to the bell push. If the bell circuit is operated with an AC

supply there will be no problem. If a DC supply is used take care to ensure that the positive side of the push is connected to point F

When installed the unit can be operated in three different ways. It will be activated when the bell push is operated or if the interior switch is turned on briefly. The porch light can also be turned on for as long as is required by moving the interior switch to the on position. ●

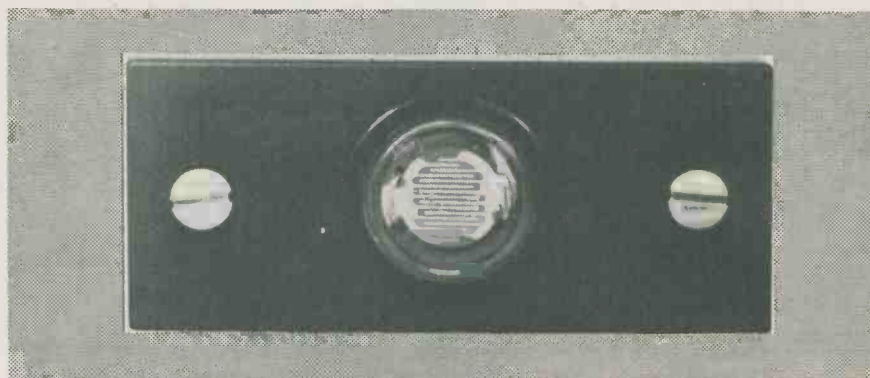

The light sensitive resistor was mounted in a standard bell push unit (not the one that operates the bell).

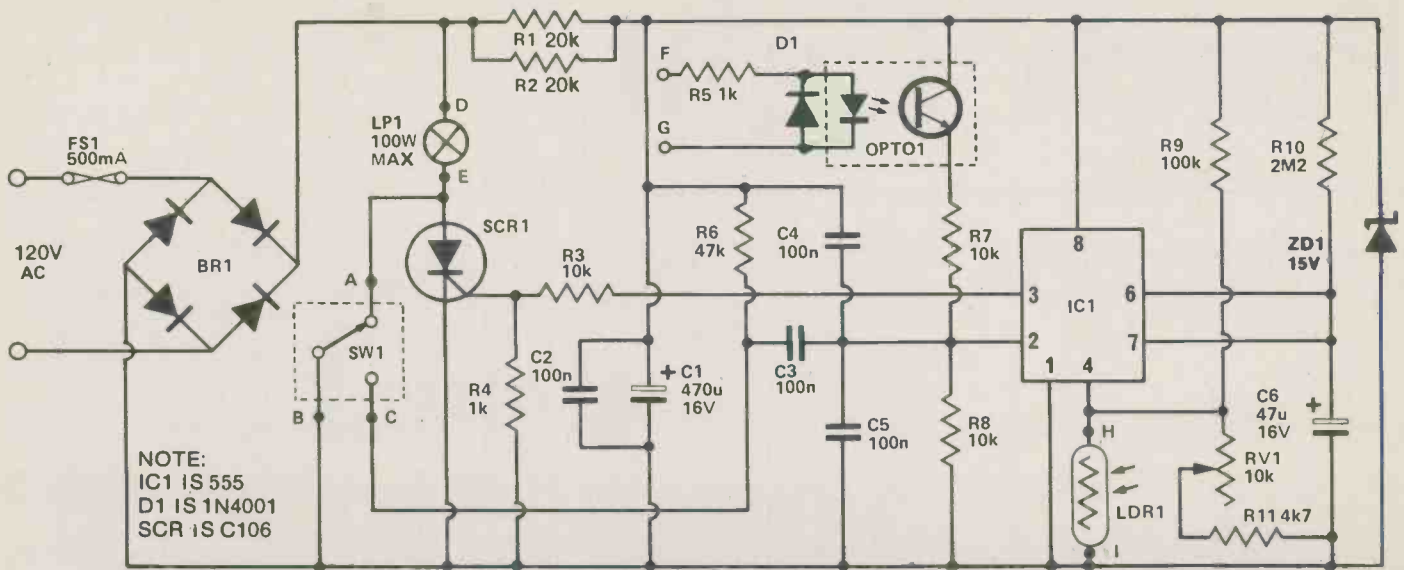
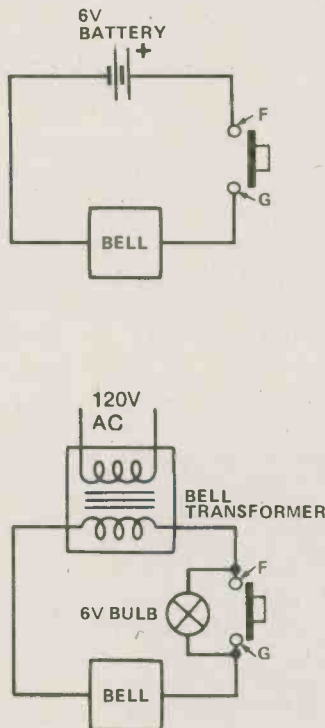

Fig. 1. The full circuit diagram of the Porch Light is shown above.

Fig. 2. The diagrams below show two of the most common bell circuits. In each case the diagrams indicate the points that should be connected to the Porch Light circuit.



HOW IT WORKS

THE porch light circuit is formed by a timer, based on IC1, with an isolated trigger circuit formed by OPTO 1, circuitry to control the lamp, and finally a power supply section.

The timer is formed by a 555 configured in the monostable mode. Under quiescent conditions the output of this device (pin 3) is low. If, however, the voltage at the trigger input (pin 2) is taken below one third of supply voltage, the output at pin 3 will go high for a period of time determined by the timing components R10, C6.

The voltage at this trigger input is usually held high by the action of the opto-isolator, OPTO 1. This device consists of an optically coupled infra-red Gallium Arsenide LED and silicon photo-transistor encapsulated in a six pin DIL package.

The action of the photo-transistor is similar to that of other transistors, except that collector current flow can be initiated (the device turned "on") either by biasing the base in the usual manner, or by illuminating the exposed semiconductor junction with light. In our application, with the base open circuit, device operation is controlled solely by the amount of light falling on the junction, which in turn is controlled by the current flowing in the infra-red LED.

This current, derived from the voltage applied to points F and G, is limited by R5. D1 is included to protect the LED from any reverse bias voltage. The voltage referred to above is supplied by the external bell circuit. This circuit must supply a voltage to this point at all times except for the period of

time when the bell push is pressed. Thus the photo transistor is turned on, maintaining a high voltage at the 555's trigger pin until the bell is operated, when R8 pulls pin 2 low to activate the timer.

The time period may also be initiated by a negative pulse applied to the trigger input via C3. This pulse is derived from S1 which, in normal operation, connects point B to point C. By momentarily operating this switch a negative pulse is generated to activate the timer.

The potential divider network formed by R9, R11, RV1 and LDR1, which is connected to the 555's reset pin (pin 4), also controls timer operation. If the reset pin is held below 0.4V the timer's action is inhibited. The LDR's resistance varies between 10 M and 130R, the more light incident upon it the lower the resistance, and with the values shown this ensures that the circuit is inoperative during daylight hours.

The output of the 555 is fed, via the potential divider R3 and R4, to the gate of the thyristor SCR1. This is a sensitive gate device which is triggered by an 0.8V, 0.2mA gate pulse.

The thyristor is connected in series with the porch light and is powered by the 120V AC line voltage derived from the bridge BR1. Thus the lamp is on at all times when the 555's output is high.

Power to the rest of the circuit is derived via R1 and R2.

The circuit is protected from spurious triggering by components C1, C2, C4 and C5.

CAUTION

Extreme care should be taken to properly insulate this circuit from possible human contact as it is directly connected to the AC line. This includes

being careful if operating the circuit out of its case during initial testing. A lethal shock may result from touching this circuit while it is operating.

PARTS LIST

RESISTORS (all 1/4 W 5% unless stated)

R1,2	20k 2W
R3,7,8	10k
R4,5	1k
R6	47k
R9	100k
R10	2M2
R11	4k7

POTENTIOMETER

RV1	10k preset
-----	------------

LIGHT DEPENDENT RESISTOR

LDR1	Clairex CL705HL
------	-----------------

CAPACITORS

C1	470u 16 V electrolytic
C2,3,4,5	100n polyester
C6	47u 16 V tantalum

SEMICONDUCTORS

IC1	555
D1	1N4001
SCR1	C106
BR1	0.9 A 400 V
OPTO 1	Opto-Isolator 4N29
ZD1	15V Zener 400mW

SWITCH

SW1	AC SPDT Switch
-----	----------------

MISCELLANEOUS

AC surface mounting box,
fuse plus holder, PCB as
pattern.

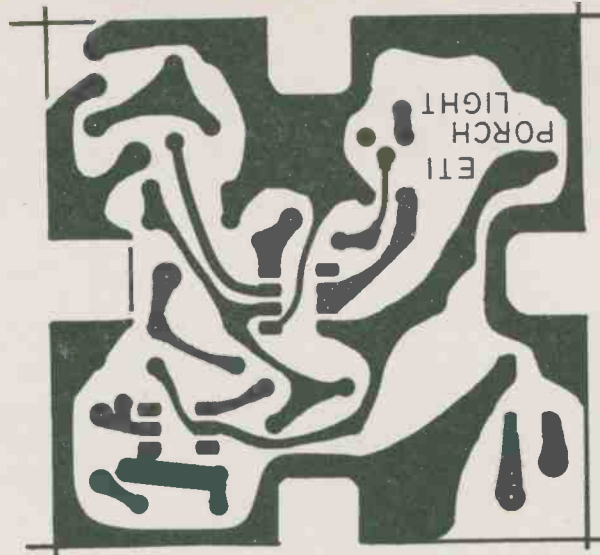

Fig. 3. the foil pattern for the porch light is shown full-size (70x70mm)

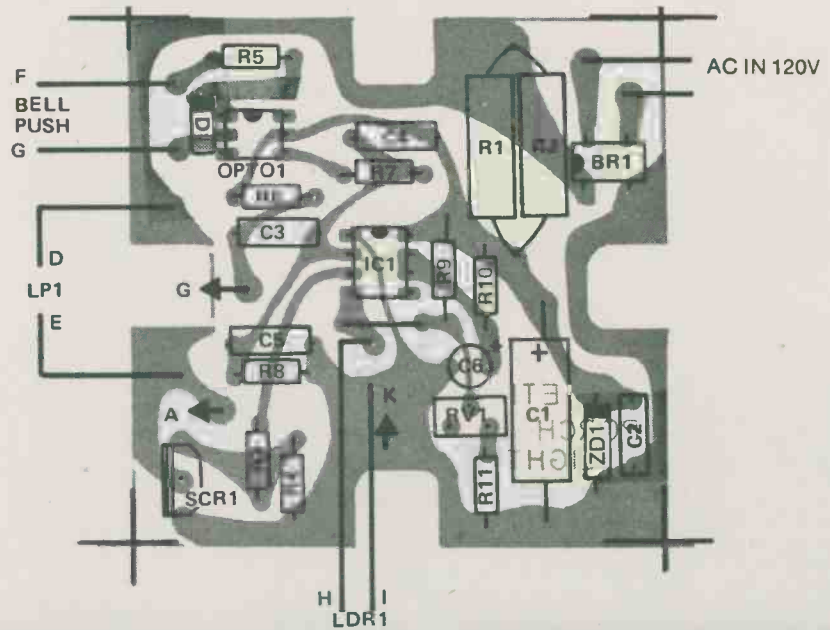
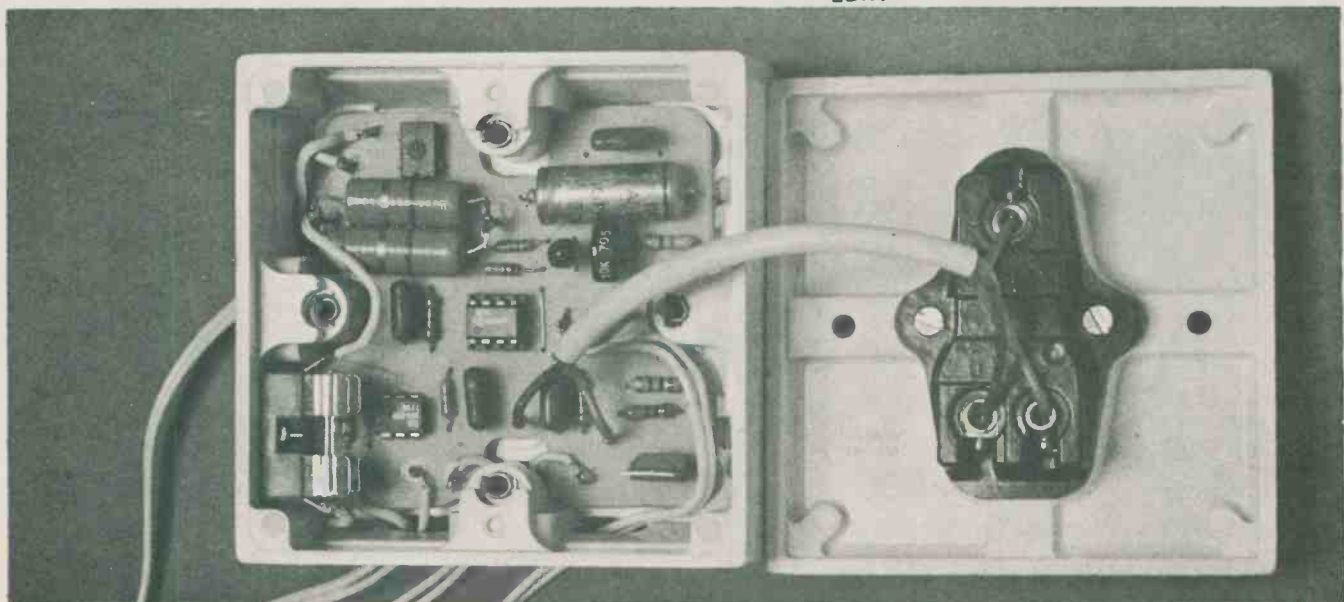

Fig. 4. (Below) shows the component overlay for the Porch Light project

Photograph showing the internal layout of the project. Note — a set of ventilation holes should be drilled in the mounting box above and below resistors R1 and R2. These holes will also allow access to RV1.



Spirit Level



U.K. staff field testing the design. Following a thorough test, staff reportedly returned to work.

Direct from our foreign office in the U.K., something for the British national sport.

about 0.4 seconds to cycle from 0 to 9.

Originally we had a shorter 'wait' period before the oscillator was switched on, but this was too easy to anticipate — any longer and it becomes boring. Slower cycle times are not a good idea, since there will then have to be a greater effect to make any difference to the score. Make it quicker by all means — see 'How it Works' for the relevant details if you intend to meddle!

Half and Half Pint

Take a reading before you touch the ale. We found the average to be 3 or 4 (in a sober condition!). As the evening progresses and the number of pints rises, so will your score. Even one pint, if given time to be ingested, can take away that 'edge', and add one to your score. If you were averaging 3 half an hour ago, and now can't do any better than 6 you're only half the driver you were!

Now before our readers condemn us as converts to Alcoholics Anonymous, let us add this was conceived as a 'fun' project and remains so. Drinking and driving is never a good idea, and you'll get much more fun out of the game if you *don't* have to play it in earnest to avoid being breathalized.

Construction Points

The only problem to be faced in construction of our Spirit Level is that of keeping the size down sufficiently to make it portable. Why oh why does *nobody* produce a decent small box to fit a 9V battery and a PCB?? The Vero box we employed is *nearly* ideal, but a few millimetres more would allow the battery to slot in sideways, and make the box much more versatile. Anyway, gripe over.... back to work. Build up the board as per the overlay, keeping components as close to the PCB as possible. Leave the ICs until last or,

IN ORDER TO DRIVE a car safely your mind must be clear, and your reaction to situations as sharp as possible. Drink not only dulls the brain, but slows reaction time as well. Unfortunately it also seems to make most drivers over-confident of their ability to drive correctly, usually with the result that they get 'bugged' by the police — and rightly so!

What we are offering here is a simple method of proving to someone, especially yourself, that those 24 pints HAVE had some effect after all! Although the device operates by demonstrating an increase in the time taken to react to a given stimulus, it is *not* meant as an accurate 'reaction timer', and should not be treated as such.

Down to Nine

To use the Spirit Level, switch on and press the reset button. After what seems like an hour (actually about 8 seconds) the light will begin to 'move' rapidly up the column of LEDs as the circuit cycles through. When it reaches the top, it will stop there. Your task is to prevent it reaching '9'. Pushing the 'Stop' button holds the LED on whatever number it was passing through at that instant.

So the more you drink, the slower you will be able to react, and the higher up the column will rise the glow (if you can't stop it at all before it reaches the top — put a pillow on the floor quick, you're about to pass out!). With component values as we have them, it takes

better still, use holders, low profile versions of which should just go in. As the chips are CMOS — watch it when handling them.

Keep all wires to the LEDs as short as you reasonably can so that when the box is closed up too much strain is not placed on the components inside due to overcrowding. Refer to the internal photograph to see how our workshop layed theirs out if you are in any doubt or trouble.

Before switching on, check the polarity of the LED column, and the orientation of the chips, it can be an expensive 'short cut' not to bother!

Getting the Bird

People's reactions to the Spirit Level can be quite hilarious, especially after a few 'jars'. We found disbelief and accusations of cheating to be the most common. For some reason our prototype possessed the property of attracting the pub parrot who insisted on his turn! He failed miserably so if home tonight and see a car driven by a parrot heading for you — not only are you sloshed, so is he!



Above; Our most unusual subject! Long John here insisted (by flapping his wings and squawking at 100dB) upon his turn. He failed. Maybe he couldn't find the button the smell of alcohol was too much for him.



HOW IT WORKS

The LED display column is driven from the output of a 4017 CMOS decoder. This counts and outputs, in decimal form, the input pulses presented to pin 14.

These are produced by IC2 a 555 wired as an astable. Timing period for this is determined by R5 and C2 according to the formula $t=1.4RC$.

IC1c and IC1d are wired as a toggle circuit, normally holding the reset pin low so that operation is inhibited. Upon switching on C1, starts to charge through R1 giving the time delay to avoid anticipation on the part of the player. After about 8 seconds IC1b's input goes high, the output goes low and the toggle action takes the 555 reset, pin 4, high so that the oscillator will run.

IC3, the 4017, will count the pulses until output 'a' is enabled. Normally the chip would recycle to nought and start again. However the connection to the inverter, IC1a will reset the toggle and stop the astable by forcing the reset pin low.

Pressing the reset button PB1 takes IC3 reset to zero and sets the toggle back to inhibit. The 'Stop' facility is provided by PB2 and R4 which reset the toggle by halting IC2.

PARTS LIST

RESISTORS

R1	150k
R2	100R
R3,4	470k
R5	68k
R6	1k

CAPACITORS

C1	47u 16V
C2	1u 16V
C3,4	10n polyester
C5	4u7 16V

SEMICONDUCTORS

IC1	4011
IC2	555
IC3	4017
LED1-9	TIL209 or similar.

SWITCHES

PB1,2	push to make single pole. rocker action
SW1	single pole

TEST GEAR

1 barrel IPA draught bitter
2k5 bottles high stability Scotch
5 litres Vodka (high tolerance)
1 Parrot (optional)
1 Drunk (obligatory).
CASE
Verobox 65 2518 H

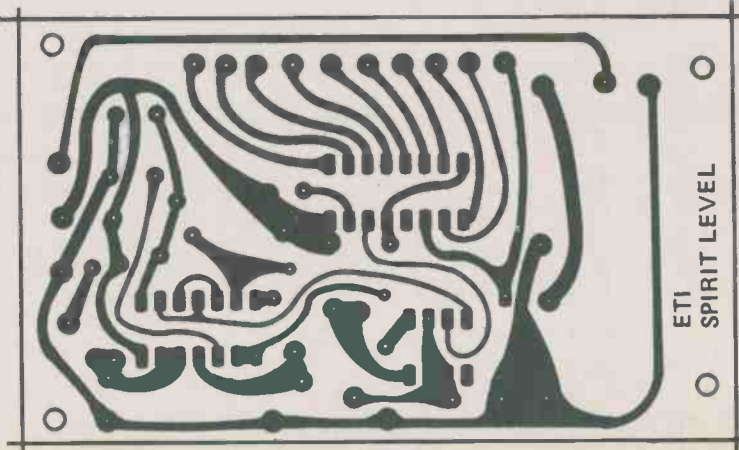

Overlay and full size foil pattern for our Spirit Level

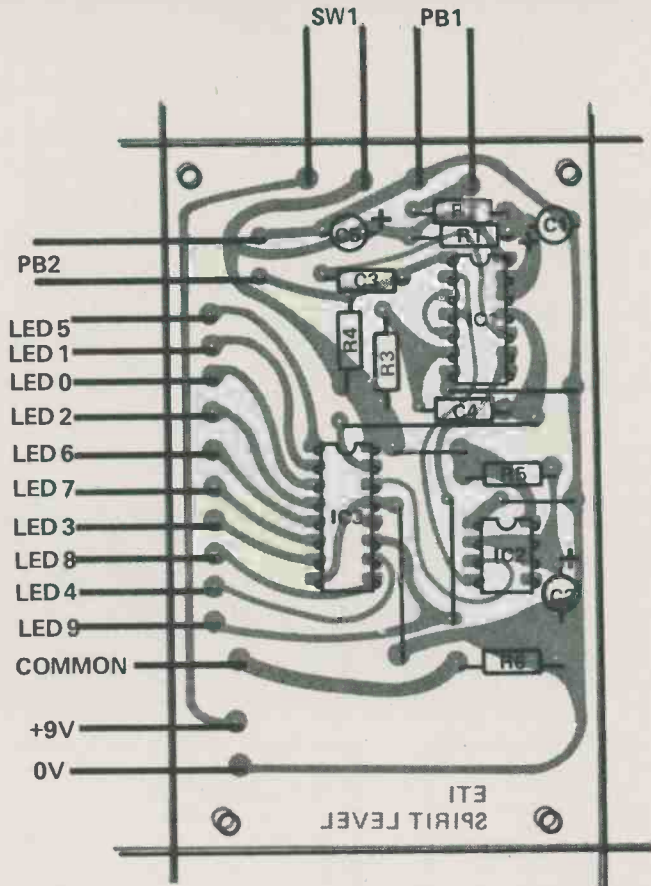

Circuit diagram for the ETI Spirit Level.

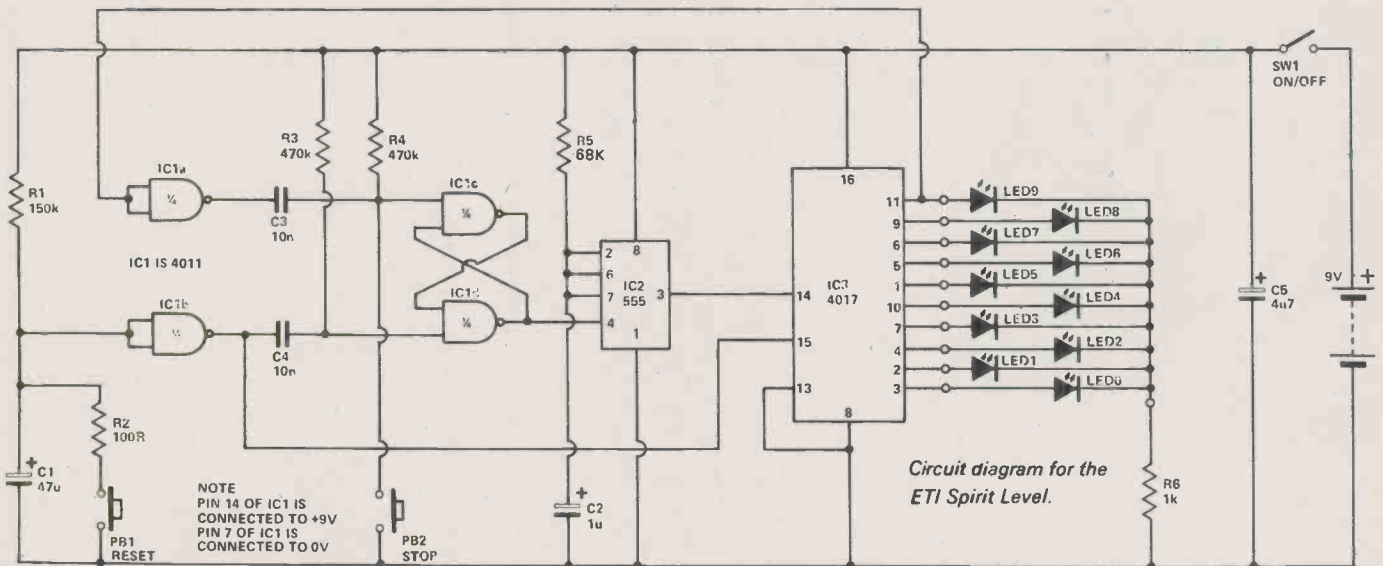

Circuit diagram for the ETI Spirit Level.

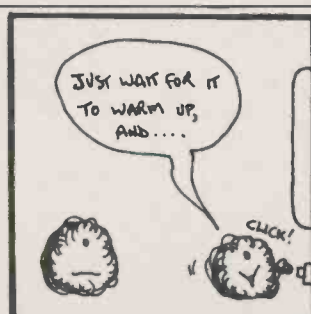
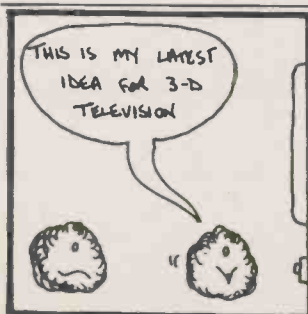

To get yours, fill in the form in this issue or write to ETI Magazine, Unit 6, 25 Overlea Blvd., Toronto, Ontario M4H 1B1. Please allow six weeks for delivery. Due to sometimes uncertain supplies, some books may not be in stock, please indicate whether you wish your order held or if you wish your money refunded.

- Master Handbook Of 1001 Practical Circuits**
TAB No. 800 \$18.30
- Master Handbook Of 1001 More Practical Circuits**
TAB No. 804 \$18.35
- Here are 10 and transistor circuits for practically anything and everything — with ALL the data needed to put them to work. The ideal schematic source-book for all active technicians, engineers, experimenters, amateurs — for anyone who must occasionally or regularly construct or adapt electronic circuits for any purpose whatsoever. You'll find any circuit you're ever likely to need in the pages of this rich volume. The schematics are classified according to general application, and the Sections themselves appear in alphabetical order.
- 99 Test Equipment Projects You Can Build**
TAB No. 805 \$11.75
- Here's the A to Z guide you need to build all sorts of electronic test equipment — from a simple signal tracer to a sophisticated modularized 50 MHz counter — and virtually everything in between! Here are voltmeters and ammeters, capacitance meters, resistance and impedance measurers, testers for solid-state components, digital voltmeters, calibrators and frequency standards, signal generators, frequency counters, oscilloscopes, and a variety of RF test equipment. The variety is incredible and almost endless... virtually every test instrument you could possibly want to build for yourself. It's perfect for the hobbyist — and indispensable for the professional because you can incorporate each one — or a combination of several — into your work bench setup or other gear.
- The Power Supply Handbook**
TAB No. 806 \$11.75
- A complete one stop reference for the hobbyist and engineer. Contains high and low voltage supplies as well as mobile and fixed units. Everything you need to keep your project peaking with the right volts and amps.
- Build Your Own Working Robot**
TAB No. 841 \$8.55
- Here are complete instructions — plans, schematics, logic circuits, and wiring diagrams — for building Buster. Not a project for novices, Buster is a sophisticated experiment in cybernetics. You build him in phases, and watch his personality develop as you add progressively more advanced circuitry to his mainframe. The first of this three-phase robot, Buster I, is "leash-led" and dependent on his master for decision-making. You create the "animal" and give him wheels, steering capability, and the capacity to "understand" your basic commands. Phase II makes Buster more independent. Now he has a basic brain he can use to decide when he's in need of a battery charge, or trapped into a physically binding situation he can't get out of.
- 57 Practical Programs & Games In Basic**
TAB No. 1000 \$11.55
- From arithmetic progression to statistical permutations to one-arm bandits, here are 57 practical, useful and fun programs designed to help you really put your minicomputer to work!
- Game programs include blackjack, one-arm bandit, craps, and two space war games. Math and accounting programs include compounding, straight-line depreciation, statistical permutations, instant derivatives, and solutions for integrals — even a whole section of geometric solutions for modern-day Euclid. For history buffs, there is a Day-of-the-Week program for any date back through 1753.
- Each program begins with an introductory paragraph describing its capabilities, and continues with a typical program sequence and flowchart. All programs will run on any floating point BASIC.
- Tower's International Transistor Selector**
TAB No. 1010 \$9.85
- Here are transistor substitutions, outline diagrams, terminal identifications, manufacturers' codes and specs for more than 13,000 devices made in the U.S., Japan, Europe, and England. This ultra-complete reference guidebook is an absolute MUST for anyone who deals with transistors or the equipment in which they're used... makes it as easy to locate transistor substitutes for Japanese and European imports as for mass-market U.S. consumer electronic products. Contains info on device ratings, characteristics, case and terminal identification, applications, manufacturers and addresses, and voltage ratings — collector-to-base, collector-to-emitter, and emitter-to-base.
- A Beginner's Guide To Computers & Microprocessors — with projects**
TAB No. 1015 \$9.70
- Here's a plain-English introduction to the fascinating world of the microcomputer — its capabilities, parts, functions, and programming... and how you can have one in your own home. Numerous projects, using actual computer parts, demonstrate the operation of a computer and lead to the assembly of a working minicomputer capable of performing many useful functions around the home and office.
- A typical family-sized computer, with video screen, printer, and keyboard, is fully described.
- How To Design, Build & Test Complete Speaker Systems**
TAB No. 1064 \$11.85
- If you've always wanted to build your own speaker system, here's a book crammed with everything you need to know to do it right... the first time! It contains a variety of ready-to-build speaker system projects, from simple speaker-in-a-box setups to complex multi-driver systems, plus all the information even a beginner needs to design and build his or her own.
- This clear guide shows you exactly how a speaker works, how its power and resonance are attained, and how speakers may differ from one another. It's as thorough a book as you'll find on the complete subject of speakers, speaker systems, and enclosures.
- International Transistor Selector**
TAB No. 1070 \$12.35
- Are you looking for ways to really put your microcomputer to work? This book tells you how to go about it — how to measure energy produced by pressure, force, position, temperature, etc. into an electrical voltage or current that your microcomputer can deal with. It's for the user who views the microcomputer as a bit of hardware to be applied, and who views software as either a simple set of instructions to make the machine go or, more importantly, as a valid substitute for hardware. It presents information, in handbook style, for users of microcomputers who want to design a device or system with a microcomputer at its heart.
- Very simply, this book is for the microprocessor/computer user who wants to use the machine to measure certain conditions, or to control external devices.
- The Complete Handbook Of Robotics**
TAB No. 1071 \$10.90
- Create your own robot? All the information you need to build a walking, talking friend and companion or a helpful servant appears in this book!
- Your robot can take on many forms and operate in any way you choose. Every possible option is covered in minute detail — including light, sound, heat, and proximity sensors, minicomputer "brains" and more.
- Whether you want a robot for an experimenting, for a security application or to perform some task suitable for a "smart" machine, all the ideas you need are packed into this book.
- Artificial Intelligence**
TAB No. 1076 \$11.55
- Artificial Intelligence is the branch of computer science devoted to programming computers to carry out tasks that, if carried out by human beings, would require intelligence. Here is a book that deals with the entire subject of artificial intelligence. It describes what we consider intelligence where computers are concerned, and presents an interesting summary of the step-by-step advancement of computer complexity toward the rudiments of human-type intelligence.
- Illustrated Dictionary Of Microcomputer Terminology**
TAB No. 1088 \$11.85
- This reference book contains clear and detailed explanations for nearly 4000 terms currently used in the exploding field of microcomputers.
- Anyone having trouble understanding the "buzz" words, the jargon, the technical language to the computer crowd — and the domain of the personal computer in particular — will find this authoritative reference book of terminology absolutely indispensable.
- OSCAR: The Ham Radio Satellites**
TAB No. 1120 \$7.75
- If you want to get in on one of the hottest new frontiers in amateur radio, this book is for you! It's your thorough guide to communications via the Orbital Satellite Carrying Amateur Radio (OSCAR) satellites. If you think amateur radio is fun now, wait till you see what can be done by using satellite communications. This easy-to-read manual will tune you in on one the latest trend in ham radio, and at the same time show you all the details you need to start your own amateur earth station.
- The Active Filter Handbook**
TAB No. 1133 \$9.75
- A designer's and users' guide to the theory and applications of active filter circuits.
- For anyone interested in electronics, this handy one-stop guide to modern filter technology will prove invaluable: It introduces filters and their purpose, compares different filters, and covers LC passive filter operation, op amps, Butterworth filters, Chebyshev filters, low-pass filters, high-pass filters, etc. This all-inclusive manual offers coverage of electronic math and basic electronic theory also. Cannot be beat for a complete and practical discussion and examination of filter techniques.
- Antenna Data Reference Manual**
TAB No. 1152 \$11.75
- Since the antenna system has a large influence on what you get out of a ham or CB station or get into a shortwave or an AM/FM receiver, best results are obviously achieved with the best possible antenna. This book will show you how to make and install hundreds of antennas, among them half-wave dipoles, inverted vees, verticals, yagis, quads, deltas, FM broadcast, and CB antenna and transmission line, plus limited space and hidden antennas. Included are precise specifications for a huge variety of different designs tuned to work on most amateur, marine, international broadcast, AM/FM broadcast and CB bands.
- The Giant Handbook Of Computer Projects**
TAB No. 1169 \$13.75
- If microcomputers have caught your interest, or if you've been through the ready-made hardware routine, you're ready for this book. It's a huge collection of ready-to-use information designed for the enterprising hobbyist who wants more flexibility — and practicality — than that offered by systems assembled for the mass market.
- Model Radio Control — 3rd Edition**
TAB No. 1174 \$9.75
- This all new and complete revision will thoroughly acquaint you with everything you need to know about model radio control — how it works, how to design a system, how to install it, and how to operate model airplanes, cars, boats, toys or virtually anything by radio control. Starting out with fundamental RC concepts, the author takes you through all the latest and most modern equipment, including coding and coders, relays, superregenerative receivers, decoders, power control circuits, servo motors, tone-operated and proportional control systems and much more!
- If you want to keep up with the changes in radio-controlled modeling, or if you want to get in on the ground floor of the hobby, this lucid guide should be part of your library.
- 21 Custom Speaker Enclosure Projects You Can Build**
TAB No. 1234 \$11.75
- If you really want to get some truly great sounds out of your audio system, this unique new book shows you 21 good ways to do it. From simple closed-box systems to complex omnidirectional speakers, you get complete descriptions, design and construction details for 21 build-it-yourself projects — virtually every kind of audio speaker you could want. You can pick and choose your own project — from the simplest to the most advanced... for home or car, stereo or quad... even for a van or RV.
- How To Build Your Own Self-Programming Robot**
TAB No. 1241 \$11.75
- This is a straightforward how-to book about machine intelligence — a practical guide that shows you how to build a robot capable of learning how to adapt to changing circumstances in its environment. The unique little creature described in this book, named Rodney, can pick up signals and stimuli from his environment and develop perceptions just like humans and higher animals do. Yet Rodney is fully trainable, and his "personality" can be altered and molded by human intervention. All in all, Rodney is a class by himself, and is a most remarkable and fascinating machine — he can program himself to deal with the problems of the moment and devise theories for dealing with similar problems in the future. Yes, Rodney is self-programming, and as a result no two Rodneys behave exactly the same way. In fact, if you wipe out his self-generated memory, he'll develop another one that's somehow different from the first.
- An Introduction to Personal & Business Computing**
SYBEX C200 \$10.75
- This is a basic introductory text on microcomputers. Its main goal is to answer the question: "What do I need for...?" in specific detail. No previous technical background is assumed. The author addresses progressively all the essential topics of interest to the microcomputer user (as opposed to the designer). How a system works. Which modules are required for which function. How much memory is needed. Which peripheral should be used. The cost. The software. Differences between existing microcomputers. Is a mini-BASIC sufficient? The real cost of a business system. Its limitations. Can you really manage a mailing list on a floppy disk? Packages and other programs. The traps for the hobbyist. Application techniques. New systems and facilities.
- The book is designed to educate the reader in all the aspects of a system, from the selection of the microcomputer to the required peripherals. No computer background is required.
- Programming the 6502**
SYBEX C202 \$18.75
- An educational text designed to teach you programming from the ground up. Already one of the most successful programming books ever published, it has been revised and expanded at both the low and high end of the spectrum. The range of programming concepts and techniques presented is such that it addresses the needs of virtually every programmer interested in using the 6502 microprocessor, from beginner to expert.
- Programming the Z80**
SYBEX C280 \$20.75
- This book has been designed both as an educational text and as a self-contained reference book. As such, it can be used as a complete introductory book on programming, ranging from the basic concepts to advanced data structures manipulations.
- It also contains a comprehensive description of all the Z80 instructions as well as its internal operation, and should provide a comprehensive reference for the reader who is already familiar with the principles of programming, but wishes to learn the Z80. All concepts are explained in simple yet precise terms, building progressively towards more complex techniques.
- Programming the Z8000**
SYBEX C281 \$22.75
- This book was designed as both an education text and a self-contained reference manual. This book presents a thorough introduction to machine language programming from basic concepts to advanced programming techniques. Detailed illustrative examples and numerous programs show the reader how to write clear, well-organized programs in the language of the Z8000.
- With over 113 illustrations, a thorough index, and 5 appendices, Programming the Z8000 is an indispensable text for engineers, students, PDP-11 users and anyone interested in learning machine language programming skills.
- 6502 Applications Book**
SYBEX D302 \$18.75
- This book presents practical applications techniques for the 6502. You will build a complete home alarm system, including fire detection, as well as an electronic piano, a motor speed-regulator, a time-of-day clock, a simulated traffic control system, and a Morse code generator. You will also design an industrial control loop for temperature control, including analog-to-digital conversion, and your own simple peripherals from paper-tape reader to microprinter.
- Truly the "input-output" book for the 6502, it includes more than 50 exercises designed for testing yourself at every step.
- 6502 Games Book**
SYBEX G402 \$18.75
- This book is designed as an educational text on advanced programming techniques. It presents a comprehensive set of algorithms and programming techniques for common computer games. All the programs are developed for the 6502 at the assembly language level.
- The reader will learn how to devise strategies suitable for the solution of complex problems, typical of those encountered in games. He/she can also use all the resources of the 6502, and sharpen higher skills at advanced programming techniques. All the games presented in this book can be played on a real board (the SYM), and require a very small amount of additional components.

Party Grenade

This Christmas, we think you should give your kids (and yourself) a treat and build something with no useful purpose — something just for fun.



Fig. 1. The connection diagram of the Party Grenade. Make sure you follow it carefully and your project should go like a bomb!

IF YOU HAVE kids (or can borrow some), they make a great excuse for building this project! Don't think that it's purely for children, though — judging from the reactions we saw from adults (especially our staff!) the game is just as good for anyone young at heart.

The basic idea started from the old 'hot potato' game in which an object — the hot potato — is passed from person to person until some cue occurs, such as the music stopping, as in musical chairs. The holder of the object is then out of the game and it proceeds with one person less. Eventually, all but one person is excluded and he or she wins the game.

In this new version (which the office wag dubbed 'Irish Roulette') the tossed object is a grenade. Once the 'pin' (a shorted 2.5mm jack plug) is removed, the grenade becomes active. After that, making touch contact between the two PCB plates on the outside of the box causes a capacitor to charge. When it has charged to a preset level, which is the same as saying that the grenade has been handled by the people in the game for the required time, the buzzer goes off — with no damage to life or limb!

The grenade will go off while a particular person is holding it. It is highly unlikely to go off in mid-air (though very wet hands can leave enough moisture to set it off). The faster your reaction and the quicker you get rid of the grenade the less likely you are to get 'blown up'. The grenade times at a rate independent of damp hands or strength of grip, and is reset by putting the pin back in.

Construction

The first job to undertake is the construction of the PCB. Take care that the diode, capacitor, transistor and the IC are inserted the right way round. As usual we recommend the use of an IC socket.

Mark and drill whatever case you are using to allow for the jack socket, buzzer and two touch contact-plates. The touch contacts are made from shaped pieces of PCB, etched in the pattern shown in the photographs, to imitate the visual appearance of a grenade and are simply glued to the side of the case.

Drill holes in the box underneath the places where the PCB touch contact board wires are to run. It is best to drill the small holes in the boards first to enable you to mark the positions of the holes to be made in the box. One touch contact can be glued on the outside of the case now, but the one which must cover the screws will obviously need to be left till last.

You can mount your PCB on the inside of the case using nuts and bolts if you wish but we preferred to hold ours down using one of the proprietary brands of double sided, adhesive pads available.

Interconnect the board, buzzer, battery and jack socket as in the diagram, mount the battery using double sided pads or jam it in place with some foam rubber and screw on the lid.

Finally, the second touch contact is glued on the remaining side of the case. We found that a few small drops of cyanoacrylate adhesive was best, as it maintains good adhesion during normal use, but the board can be prised sharply off when the time comes to change the battery. Remember to follow the manufacturers' instructions when using the adhesive, it can be dangerous.

The pin is made by simply shorting the two connections together. Then if you drill a small hole through the cover of the plug a key ring can be used as a finger pull.

The circuit counts the period of time that the grenade is held after the 'pin' has been pulled and operates the buzzer when this period reaches several seconds.

Initially, a shorted plug (the 'pin') is inserted in JK1, shorting C2. Resistor R1 holds the inputs of IC1a high. Its output is therefore low, so no current flows through R2/D1 (No relation to R2-D2!)

The output of IC1d is high, so that Q1 is biased off and the output of IC2c is held low. Quiescent current flowing in this state is negligible — less than 0.5uA.

If the device is picked up and the skin resistance of a hand placed across the touch contacts, the output of IC1a goes high and a small current flows through R2, but C2 remains shorted out by the pin.

When the pin has been removed, however, holding the device causes C2 to charge. D1 prevents rapid discharging when the touch is removed by preventing current flowing back through R2.

When C2 charges to the threshold of IC1b, its output goes low and a monostable formed by IC1c and IC1d turns Q1, and thus the buzzer, on for about a second.

The pin is then replaced to reset the circuit, ready for another attack.

Resistors (All 1/4W, 5%)

R1	560k
R2	220k
R3	100k
R4	10k

Capacitors

C1, 3	10u 16V tantalum
C2	22u 16V tantalum

Semiconductors

D1	1N4148
Q1	2N3906
IC1	4011

Miscellaneous

6 to 12V solid state buzzer	
2.5mm jack plug and socket	
case Vero 75-1799E	

Fig. 2. The circuit diagram is shown below.

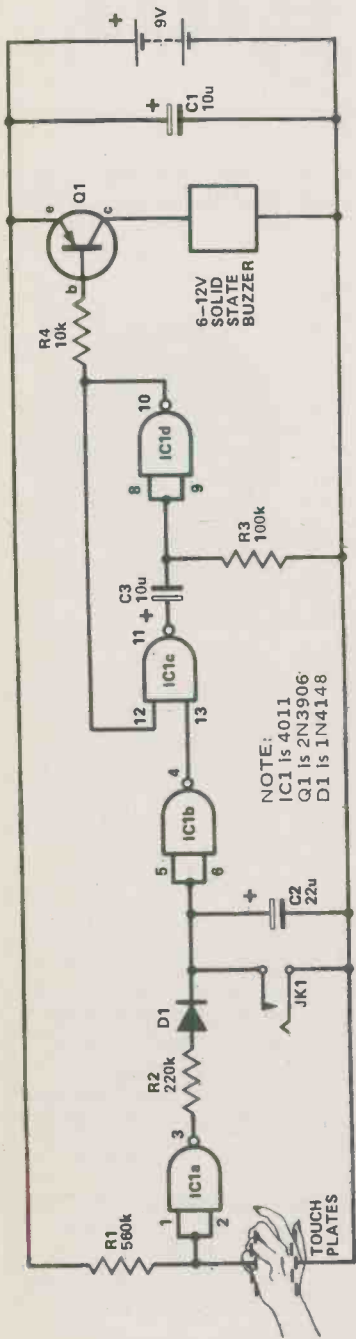

NOTE:
IC1 is 4011
G1 is 2N3906
D1 is IN4148

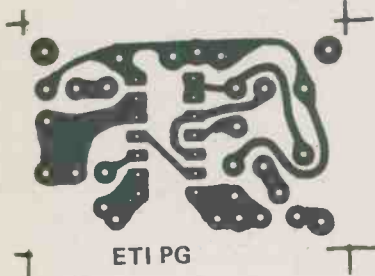

PCB pattern for the Party Grenade.

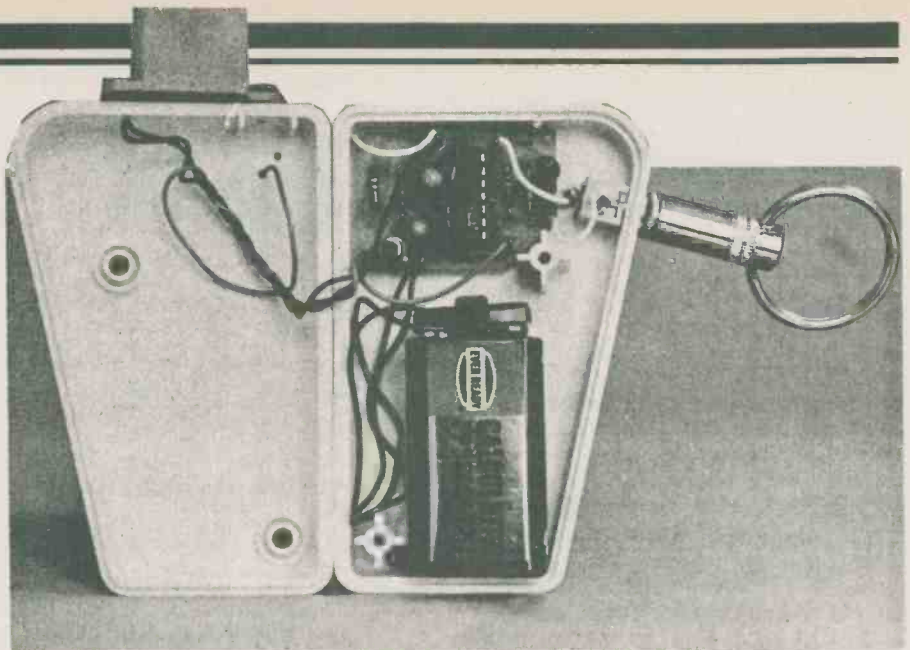
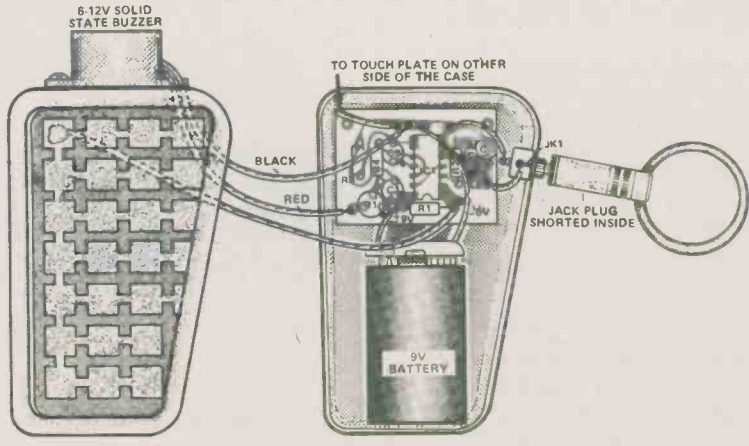
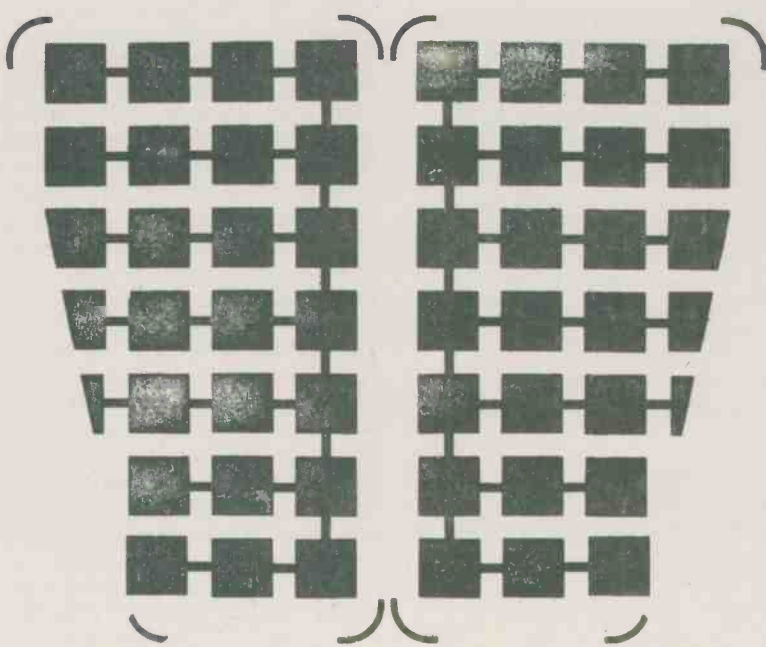

Fig. 4. The inside of the case. There's not a lot of room left, is there?



Below: The foil pattern for the Party Grenade touch contact boards.



Two Octave Organ

HERE'S A PROJECT where you can well and truly utilise your ingenuity!

A monophonic organ is limited in its scope simply in that only one note can be played at a time — that is you cannot play chords. In practice this is not as big a limitation as it might seem and a monophonic organ of this type will provide a great deal of pleasure and amusement for youngsters and older people who quickly find how easy it is to play.

The organ covers the range from C (262 Hz) to C (1047 Hz), with 12 notes per octave (that is it includes sharps and flats).

The frequency (pitch) of each note is determined by an associated resistor in the chain R8 through R31. We have made some minor compromises in that we have used standard readily available resistor values nearest to those actually required to obtain the exact pitch for each note. The pitch errors are quite small but if you need the pitch to be *exact* all you need to do is wire additional resistors in series or parallel with the appropriate chain resistor until the exact pitch of that note is obtained.

The overall pitch is adjusted by potentiometer RV1 and the volume by potentiometer RV2. Tremolo may be switched in or out by switch SW1. The depth of tremolo may be altered by changing resistor R2.

As shown in our main circuit drawing and component overlays the circuit includes two output transistors (Q1 and Q2) and a loudspeaker. This enables the unit to be totally self-contained. Nevertheless it has been so designed that you can run into any other suitable amplifier or hi-fi system. If you wish to use an external system as suggested above simply leave out Q1 and Q2, change C6 to 1.0 μ F, and increase RV2 to 10 k. The positive end of C6 should be connected directly to pin 3 of IC2 and the input to the amplifier or hi-fi system taken from the point on RV2 which is currently wired to the speaker.

Construction

The organ consists of two main assemblies, plus a battery or other nine volt power supply, and a loudspeaker.

Main board construction is quite straightforward — the usual precautions must be taken to ensure critical com-

Although cheap and simple to build, this monophonic electronic organ is tuneable, covers a full two octave range, and has an adjustable tremolo control.

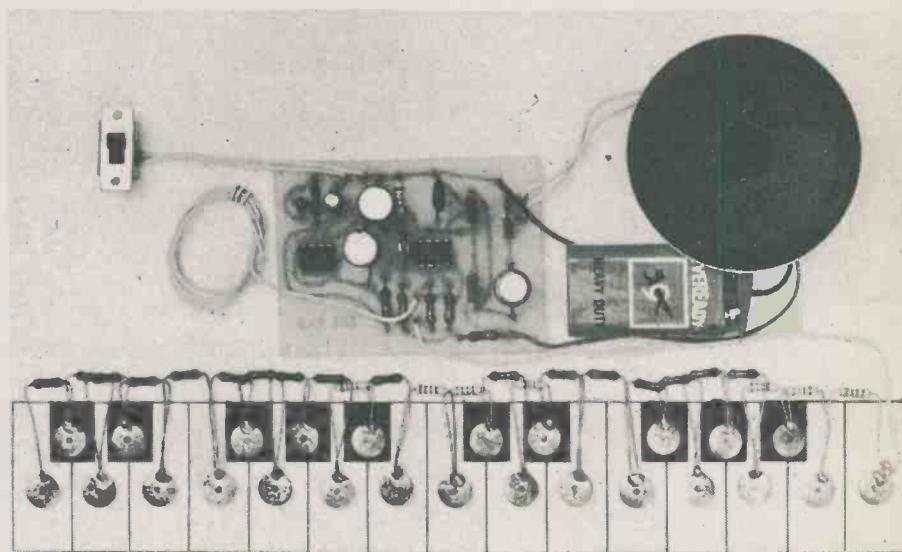

ponents are inserted the right way round and do check for solder bridges, particularly if you are using the Veroboard method of construction.

The second assembly is the keyboard. Here you have unlimited potential for modification. We have shown what we believe to be the cheapest possible construction — 25 pins stuck into a piece of heavy cardboard! But if you want to, you can build up a far more elaborate affair using proper metal or woodworking techniques.

The requirements for the keyboard are very basic. You need to arrange some way by which one common wire may be caused to touch any one of a series of contacts. Our prototype shows a very basic way indeed. We have a series of drawing pins stuck into a piece of heavy cardboard with a keyboard pattern drawn on. The common wire is connected to a sharp probe and you simply touch the drawing pin heads with this probe. If this basic method is used a suitable probe can be made by epoxying a needle into the end of an old ball point pen. Note that the probe handle must be insulated to prevent

60 Hz line voltage included in one's body modulating the pitch. A more elaborate way would be for each key to be sprung in such a fashion that when depressed it touched a common strip running right along the front of the keyboard. If you have the facilities for so doing, yet another way is to etch a keyboard on a strip of pc board material.

When completed, the chain of resistors should be soldered in place. Do make sure you have good sound soldered joints as the failure of any one joint in this chain will prevent the organ from operating.

Finally connect the two assemblies together, connect up a battery and away you go!

Some refinements may be made it is possible to delete the trim potentiometers currently shown located on the circuit board, replacing these with larger rotary potentiometers located remotely.

Resistor R2 may be changed to vary the depth of tremolo or replaced by a potentiometer (10 k in series with a 3k3 resistor) to allow immediate adjustment.

Circuit diagram of complete unit.

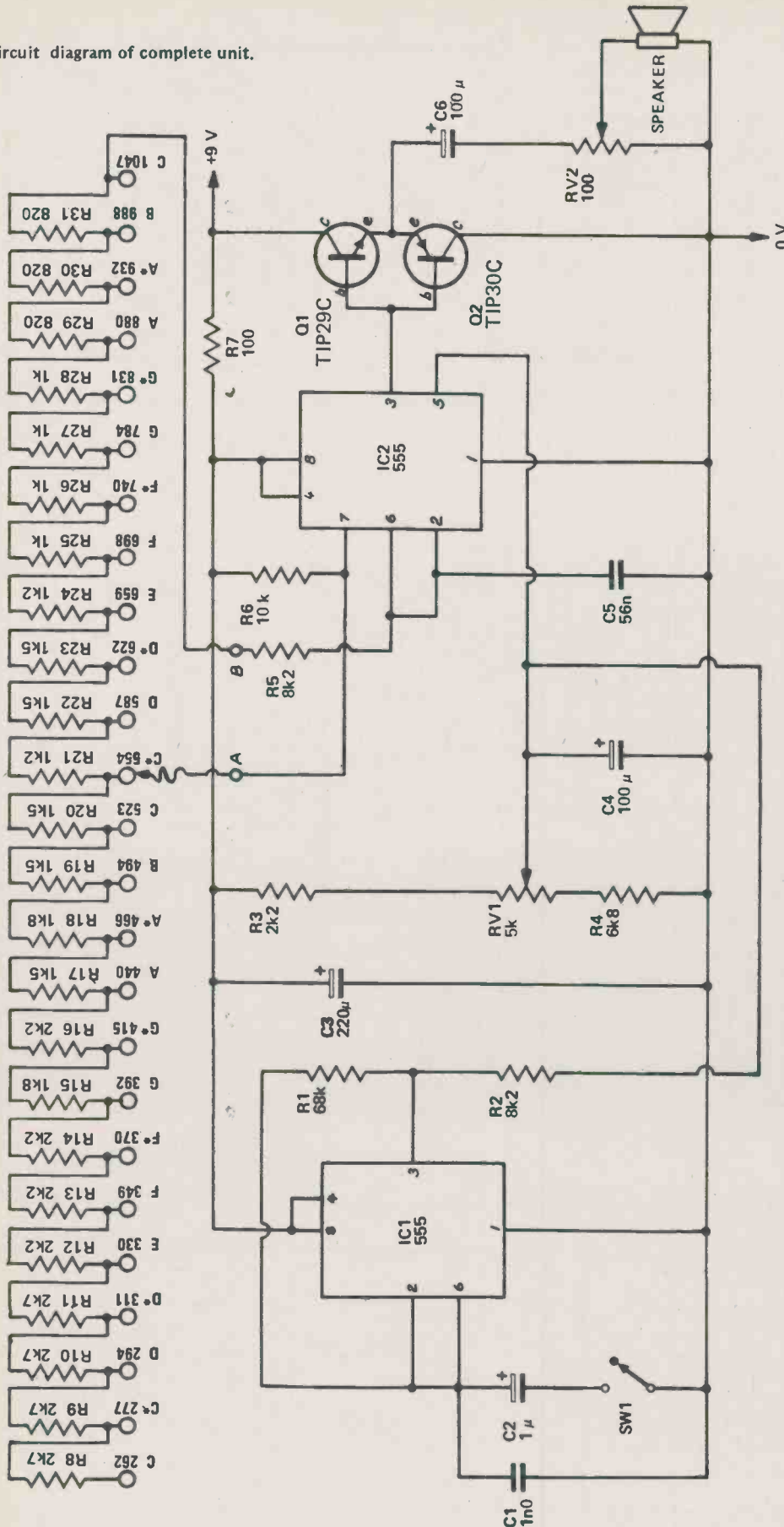

HOW IT WORKS

series or parallel if an exact scale is required.

The output of IC2 is approximately a square wave. This is buffered by Q1 and Q2 before driving the loudspeaker. The control circuitry is decoupled by R7/C3 from the nine volt supply to prevent load fluctuations varying pitch. Potentiometer RV1 adjusts the over-

Firstly consider IC2. This is a 555 oscillator circuit which oscillates at a frequency determined by whatever resistor in the chain R8 to R31 is selected. These resistors have been selected to give the closest possible approximation to the standard spacing between notes. These Other resistors may be added in

all frequency of the circuit thus acting as a pitch control.

Tremolo is generated by IC1. This IC oscillates at either 5 Hz or 5 kHz depending on the position of SW1. When switched to the 5 Hz position the output is applied to pin 5 of IC2 thus modulating the output of that IC. Capacitor C4 'kills' the

output when IC1 is switched to the 5 kHz position. The reason for this apparent anomaly is that it is desirable for the tremolo oscillator to be running at all times — whether tremolo is switched in or not — to eliminate the minor change in overall pitch otherwise caused by the load of IC1 being switched on or off.

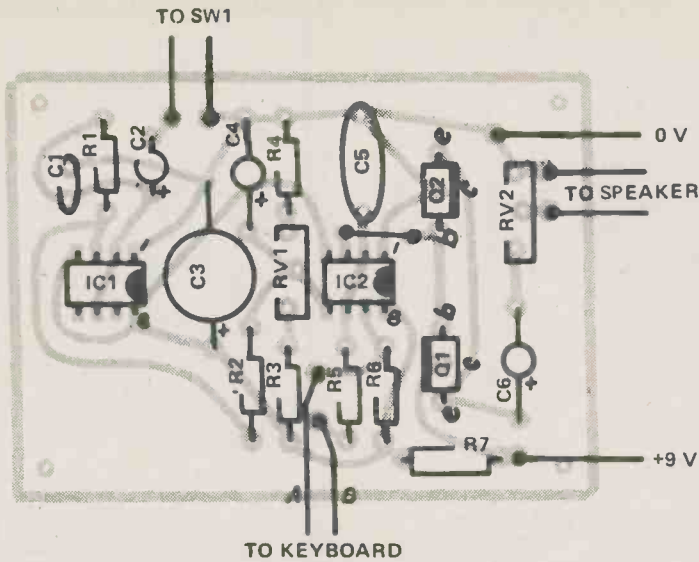

Component overlay for printed circuit board version.

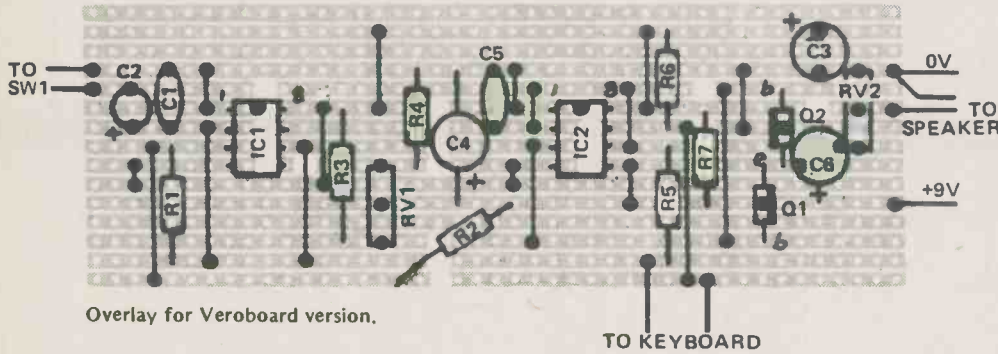
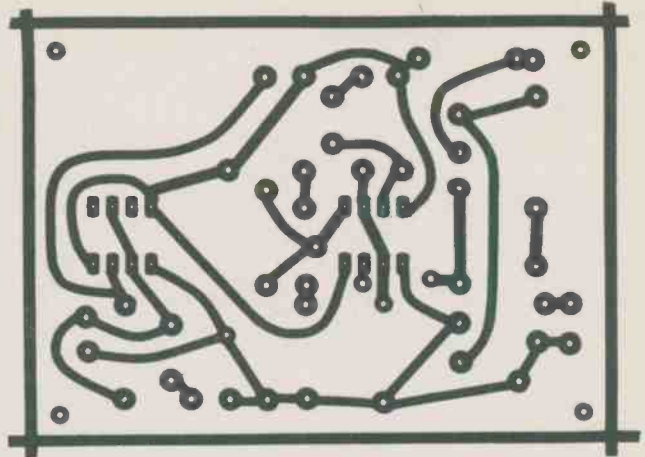

Overlay for Veroboard version.

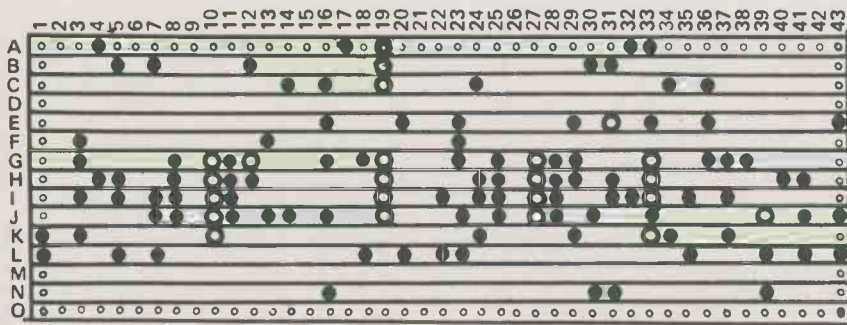

Drilling details for Veroboard.

PARTS LIST

RESISTORS		
R1	68k	1/2 W 5%
R2	8k2	" "
R3	2k2	" "
R4	6k8	" "
R5	8k2	" "
R6	10k	" "
R7	100 ohms	" "
R8-R11	2k7	" "
R12-R14	2k2	" "
R15	1k8	" "
R16	2k2	" "
R17	1k5	" "
R18	1k8	" "
R19-R20	1k5	" "
R21	1k2	" "
R22-R23	1k5	" "
R24	1k2	" "
R25-R28	1k	" "
R29-R31	820	" "
RV1	Trimpot 5k	
RV2	" 100 ohm	
CAPACITORS		
C1	1n0 polyester	
C2	1 uF electrolytic 16 V	
C3	220 uF " "	
C4	100 uF " "	
C5	56 n polyester	
C6	100 uF 16 V electrolytic	
IC1/IC2	integrated circuits 555	
Q1	transistor TIP29C	
Q2	transistor TIP30C	
Printed circuit board or Veroboard		
SW1 single pole switch		
Nine volt battery and clip		
Small speaker		

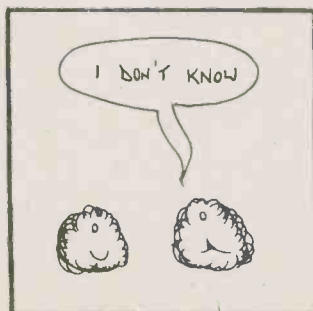
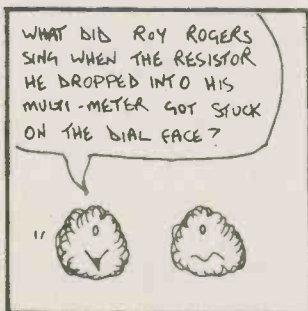

Light Chaser

Low cost, simple design handles up to 1000 W per channel and can be expanded if required.

A LIGHT CHASER is a mechanical, or in this case, electronic, gadget which controls three or more sets of lights arranged in a chain. These are flashed on, one at a time in sequence, to create an illusion of movement. Such devices can be seen at fairgrounds, on advertising signs and in shop windows. Here is a design that is simple and cheap to build, and suitable for any of these applications.

Design Features

We have seen many designs for light chasers ranging from three relays switched sequentially by a motor and cam follower contacts to elaborate phase control circuits. We chose to steer for a happy medium retaining features like easily adjustable rate and zero crossing switching but still being simple and cheap to build.

To reduce cost, we decided against using an isolation transformer. Because of this, the *entire* circuit is at line voltage and should therefore be treated with due respect. By using a series capacitor which costs about \$1.50, we save a power transformer (\$4.50) and three pulse transformers (about \$2.00 each), resulting in a \$9 – \$10 saving.

The unit can be expanded beyond three channels if desired by moving the reset line of IC4 (pin 15) from the fourth output to the (n+1)th, where n is the desired number of channels. The sequence in which the pins on IC4 go high is 3,2,4,7,10,1,5,6,9 and 11. Therefore for a 6 channel unit pin 5 will be connected to pin 15. The output stage consisting of the NAND gate, transistors, capacitor and triac will of course have to be duplicated for each additional channel.

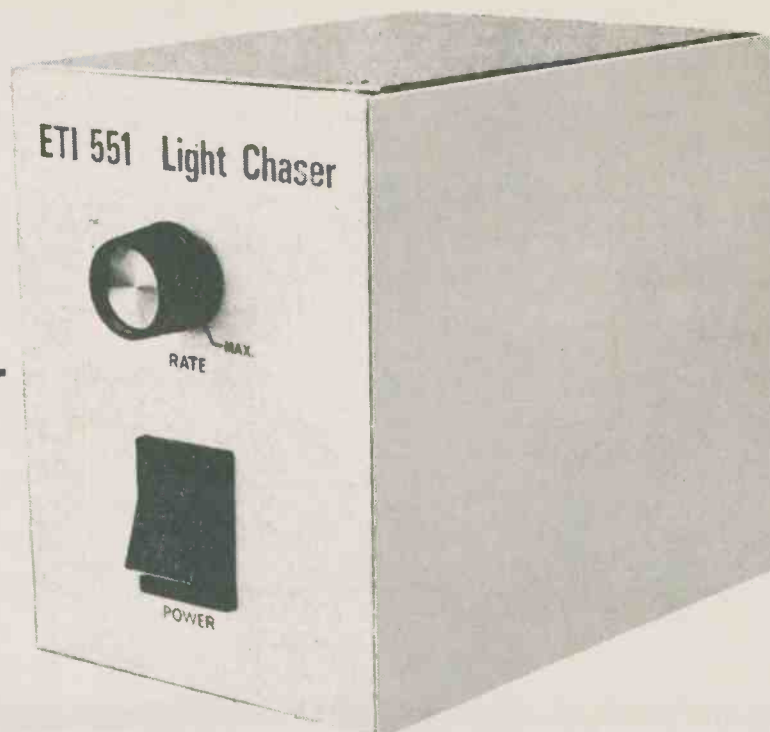

WARNING

The circuit described here does not use an isolation transformer and therefore all sections of the circuit must be considered dangerous.

If the unit does not work when switched on, disconnect the AC line and then, using a separate DC power supply, apply 10 V across C2. Now add a 60Hz AC signal of 12 – 32 V onto the normal AC input. In this way the control circuitry can be safely checked up to the triacs.

The unit as described is suitable for about 500W per channel but if additional heatsinks are used this could be raised to the 15 A limit of the triacs or, if different triacs are used (e.g. Teccor Q2025C) even higher currents can be handled.

The pc board should be assembled with the aid of the overlay in fig. 2. Ensure that the diodes, capacitors and transistors are oriented correctly.

Construction

The CMOS ICs should be inserted last ensuring that the pins are not handled more than necessary and that pins 7 and 14 (the power supply rails) are soldered first.

The heatsinks and the triacs used

depends on the intended load. We used about 2500 square mm of aluminum on each triac, and found this to be satisfactory for about 500W per channel. The tabs of the triacs are live and separate heatsinks, insulated from ground, should be used or the triacs should be insulated from the heatsink.

We mounted our prototype into a simple folded aluminum box, with an external rate potentiometer and three 3-pin sockets. If an external potentiometer is not required a trim potentiometer can be mounted on the board. To adjust this potentiometer an insulated trimming tool must be used. The unit can be wired according to fig. 2 taking care with insulation as many points are at 120V ●

Fig. 1. The circuit diagram of the complete chaser.

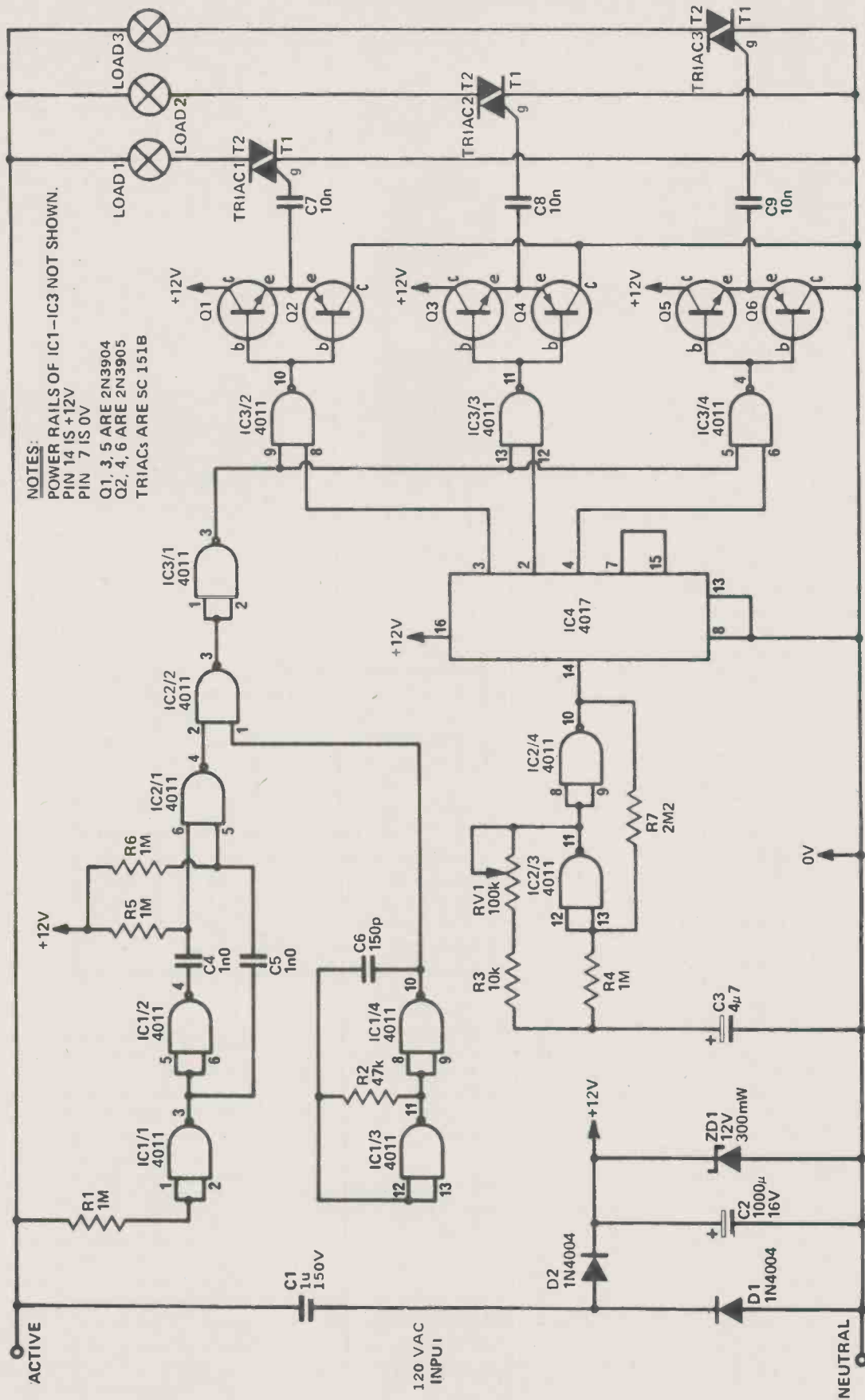

HOW IT WORKS

A light chaser consists of three or more ac switches which are turned on, one at a time, in sequence. To make this explanation simpler, we have separated the circuit into several sections.

Power Supply

The 120 VAC is reduced to the 12 VDC required to operate the control circuitry by the use of a series capacitor C1, the diodes D1 and D2, the smoothing capacitor C2, and is then regulated by zener diode ZD1.

Synchronization Generator

The input to IC1/1 is connected to the 120 VAC supply via the 1 M resistor R1. The value of this resistor, combined with the effects of the protection diodes inside the IC, prevent damage to the IC. The output of this device is a 60Hz square wave which is synchronized with the line. IC1/2 is used to invert this square wave and then the RC networks R5/C4 and R6/C5 are used to generate negative pulses on the two inputs of IC2/1 on each zero crossing of the 60Hz signal - i.e. 120 pulses per second. The width of these pulses is about 0.6 ms.

High Frequency Oscillator

This is formed by IC1/3 and IC1/4, and runs at about 80 kHz. Its output is gated with the synchronizing pulses by IC2/2; this results in 600 μ s long bursts of 80 kHz at the start of each half cycle.

Low Frequency Oscillator

This is formed by IC2/3 and IC2/4 and its frequency is variable by RV1 from 1 Hz to 10 Hz. We have used this form of oscillator in preference to that used for the high frequency oscillator to prevent reverse biasing the tantalum capacitor.

Counter

This is IC4 which is normally a divide-by-ten counter with ten decoded outputs which go high in sequence. By connecting the fourth output back to the reset, a divide-by-three is formed. This IC is clocked by the low frequency oscillator.

Driver & Output Stages

There are three identical output stages consisting of a two input NAND gate, a two transistor buffer, a series capacitor and a triac. The function of the gate is to direct the high frequency tone bursts onto the appropriate triac gate. The counter IC4 selects the required gate.

General

The use of a short tone burst at the start of each half cycle is intended to minimise RFI as the triac can only switch on at this point. This does, however, limit its use to incandescent loads. For use on fluorescent loads C4 and C5 can be increased to 10 n.

The fact that we have not used an isolation transformer reduces the cost, but it does mean that the complete circuit must be considered live! We did not use fuses in the prototype, but they can be used if required in the input leads. Ensure that the fuses used will protect the triac.

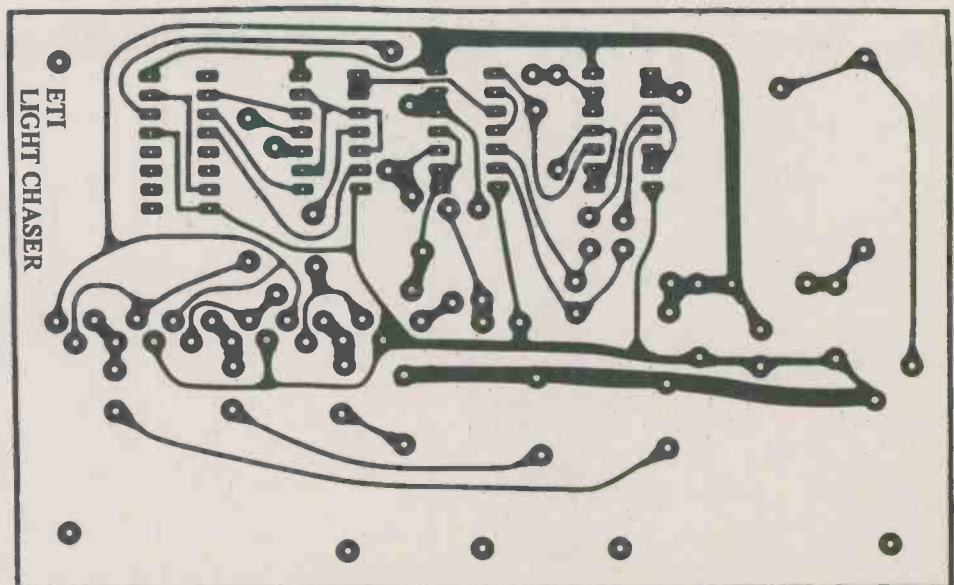
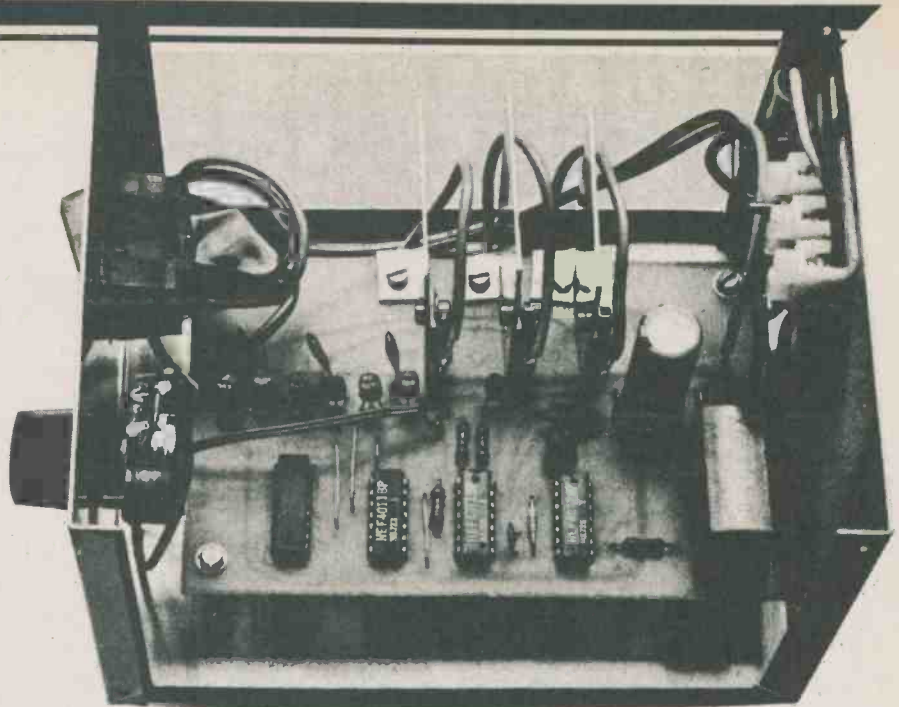

PARTS LIST

RESISTORS all 1/2W 5% unless stated otherwise

R1 1M
R2 47k
R3 10k
R4-R6 . . . 1M
R7 2M2

POTENTIOMETER

RV1 100k lin (trim or rotary)

CAPACITORS

C1 1 μ 150 VAC
C2 1000 μ 16V electro
C3 4 μ 7 25V tantalum
C4, 5 1n0 polyester
C6 150p ceramic
C7-C9 10n polyester

SEMICONDUCTORS

IC1-IC3 . . . 4011 (CMOS)
IC4 4017 (CMOS)

Q1, 3, 5 . . . 2N3904

Q2, 4, 6 . . . 2N3905

D1, 2 1N4004

ZD1 12V, 300mW

TRIAC 1-3 SC151B

MISCELLANEOUS

PC board
Metal box to suit
Three 3 pin power outlets
Power switch

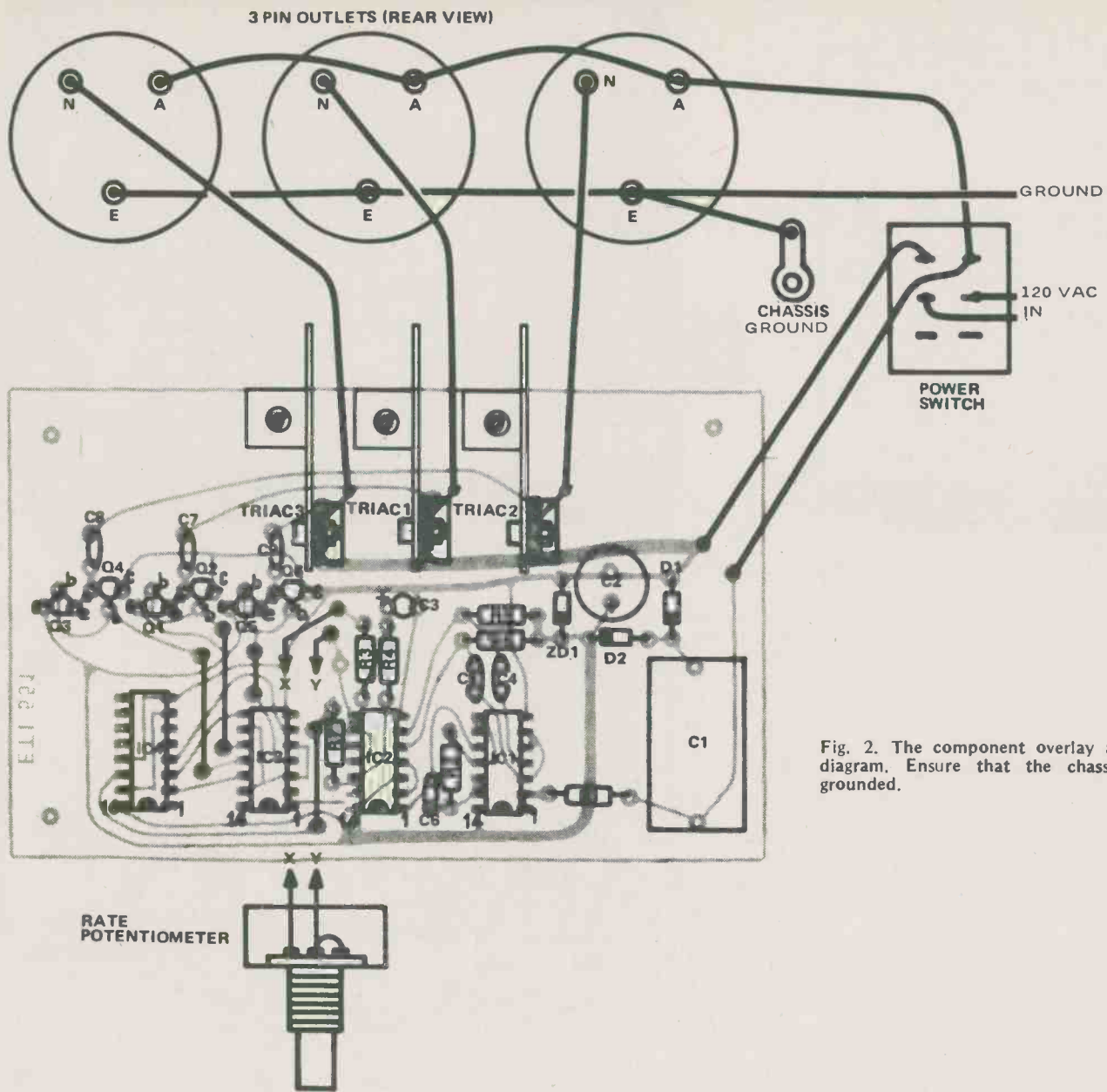
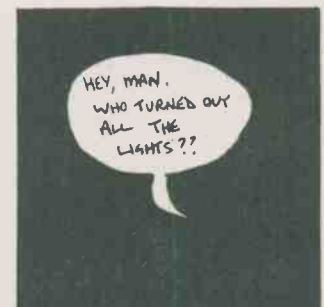
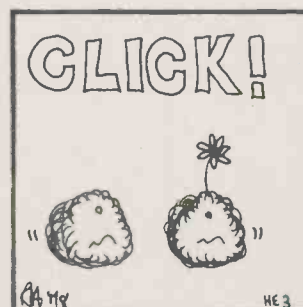
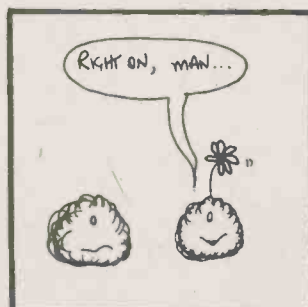

Fig. 2. The component overlay and wiring diagram. Ensure that the chassis is well grounded.



Bench Amp



THE AMPLIFIER TO BE described here differs in one major respect to most others - it can be used as an accurate millivoltmeter! One of the most awkward things to measure in a lab is an audio signal of less than a volt. Specialist meters are expensive, and rarely justifiable for an amateur: hence this project. This provides at least an 'order of magnitude' reading, and in most cases an accurate value can be assigned to the signal.

The circuit is basically an audio pre- and power amplifier combination, with switchable preamp gain. Depending on which sensitivity is selected, the gain of the 741 is so adjusted as to produce the specified input to drive the LM380 to the point of clipping. This voltage in turn is just sufficient to cause the LED to light.

To measure an A.C. signal, turn the volume control to maximum, and apply the input to the socket and work down from the lowest sensitivity until LED just comes on. The value of the input is now indicated by the switch. We tried several 380s and

several dozen LEDs to see if our results were repeatable: they were. In all cases we were within 10% of the value of the signal!

Continued on page 60

HOW IT WORKS

The gain of IC1 is set by the ratio $R9/R1 - 6$ resistors $R1 - 6$ vary this from ≈ 20 to ≈ 0.5 . Thus to produce 100mV across RV1, inputs from 5mV to 200mV are required. $R7$ and $R8$ bias the non-inverting input to 4.5V and $R10$ is included to protect the chip. Since D.C. gain of the circuit is unity, the output will set at +4.5V D.C., providing maximum swing capability. To minimize output offset due to bias current, the value of $R7$ and $R8$ in parallel should be approximately the same value as $R9$. Bear this in mind if you intend to alter the supply voltage.

$R11$ and $C2$ provide decoupling for the 741 rail, as $C6$ does for the LM380. This capacitor can be increased in value to advantage with a supply not entirely stable. If another value of impedance speaker is employed, $R12$ will have to be altered to maintain the conditions.

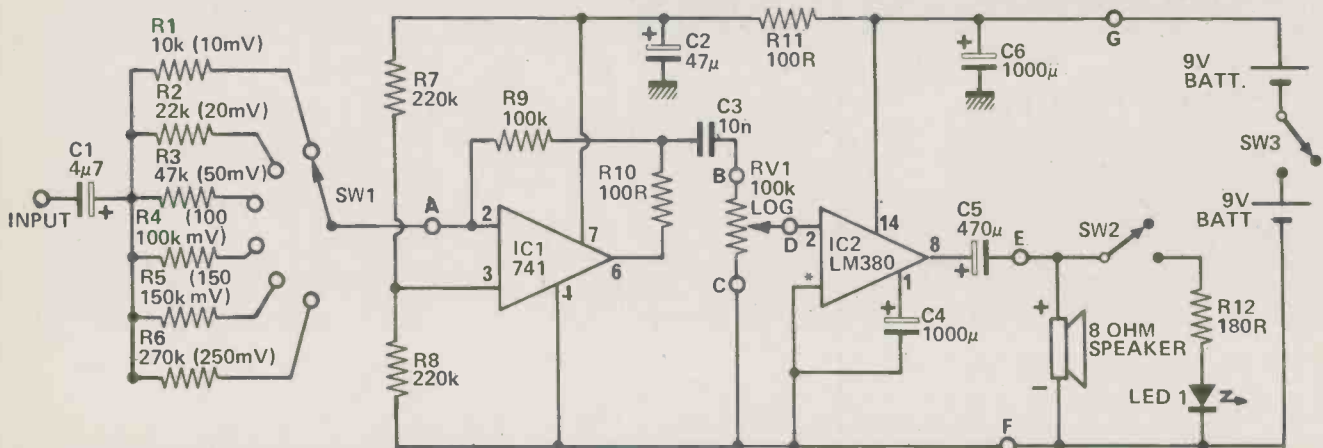
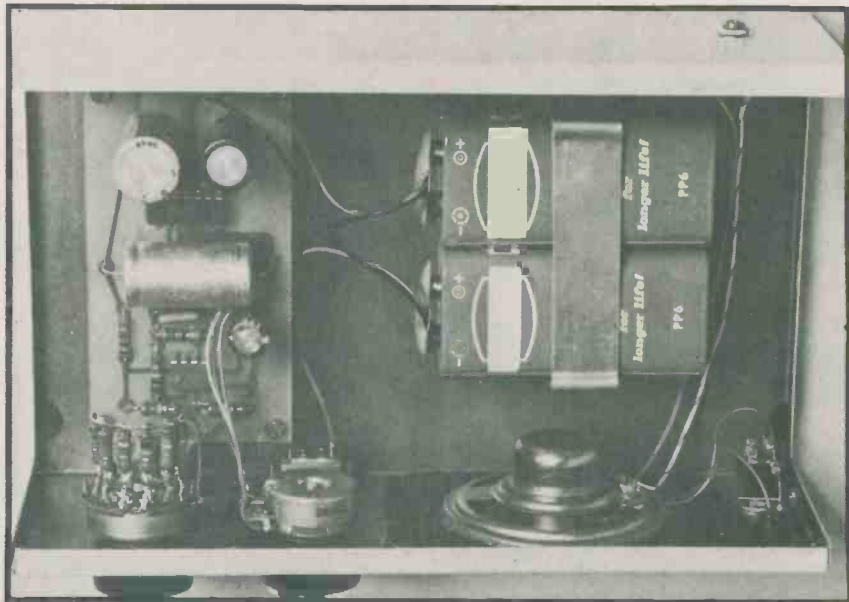

Circuit diagram of the Bench Amp

* PINS 3, 4, 5, 7, 10, 11, 12 ARE CONNECTED TO 0V

Continued from page 42

Construction is not critical, but a metal box is a good idea to help screen the amplifier from extraneous radiations etc.

Further sensitivities can be easily added by using a larger switch with more poles, and adding the appropriate resistors. The quality of the circuit is good enough to feed an external loudspeaker, and a socket is provided to enable this to be accomplished. ●

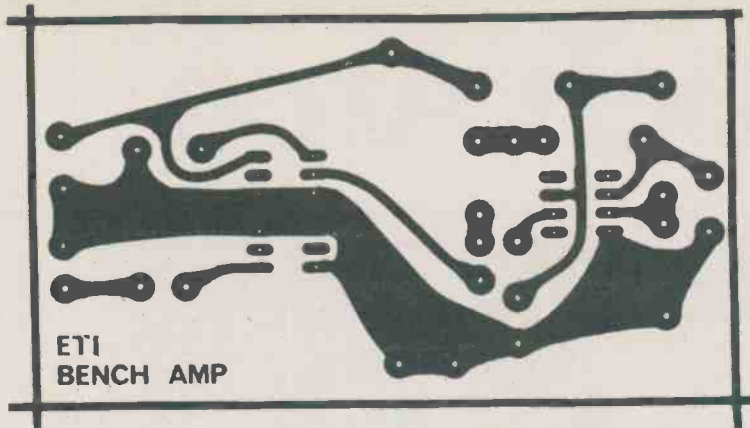

PCB foil pattern for the Bench Amp.

PARTS LIST

RESISTORS	MISCELLANEOUS
R1 10K	Phono socket
R2 22K	Nuts, bolts, etc.
R3 47K	3.5mm jack socket
R4,9 100K	CAPACITORS
R5 150K	C1 4u7 16V electrolytic
R6 270K	C2 47u 16V electrolytic
R7,8 220K	C3 10n ceramic or similar
R10,11 100R	C4 1000u 16V electrolytic
R12 180R	C5 470u 16V electrolytic
All 1/2W 5%	C6 1000u 25V electrolytic
POTENTIOMETER	SWITCHES
RV1 100K Log rotary	SW1 1 pole 6-way rotary
SEMICONDUCTORS	SW2 single pole / Off-On toggle
IC1 741 op-amp	SW3 single pole / Off-On rocker
IC2 LM380 power amp	SPEAKER
LED1 0.2" type	LS1 2 1/4" 8Ω type

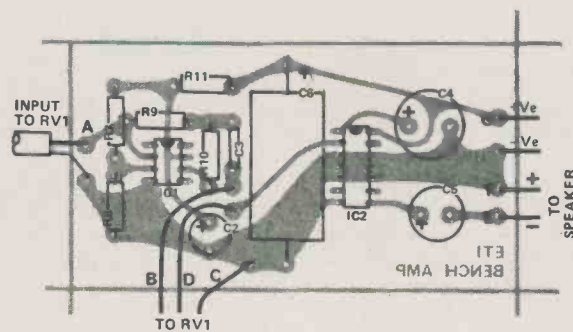

Component overlay for the Bench Amp

WANT to know more about Microcomputing?

6502, Z80, KIM, Z8000 . . . What do they mean? Sybex Books tell you what you need to know about architecture, instruction sets and programming microprocessors and microcomputers. Whether you're a student, engineer, or just plain interested, you'll find Sybex Books indispensable. Prices shown include postage and handling. Use the handy order form provided elsewhere in this issue or send cheque or money order (no C.O.D.) to Electronics Today International, Unit 6, 25 Overlea Blvd., Toronto, Ontario M4H 1B1.



An Introduction to Personal & Business Computing
SYBEX C200 \$10.75

This is a basic introductory text on microcomputers. Its main goal is to answer the question: "What do I need for . . . ?" in specific detail. No previous technical background is assumed. The author addresses progressively all the essential topics of interest to the microcomputer user (as opposed to the designer). How a system works. Which modules are required for which function. How much memory is needed. Which peripheral should be used. The cost. The software. Differences between existing microcomputers. Is a mini-BASIC sufficient? The real cost of a business system. Its limitations. Can you really manage a mailing list on a floppy disk? Packages and other programs. The traps for the hobbyist. Application techniques. New systems and facilities.

The book is designed to educate the reader in all the aspects of a system, from the selection of the microcomputer to the required peripherals. No computer background is required.

Programming the 6502
SYBEX C202 \$18.75

An educational text designed to teach you programming from the ground up. Already one of the most successful programming books ever published, it has been revised and expanded at both the low end and high end of the spectrum. The range of programming concepts and techniques presented is such that it addresses the needs of virtually every programmer interested in using the 6502 microprocessor, from beginner to expert.

6502 Applications Book
SYBEX D302 \$18.75

This book presents practical applications techniques for the 6502. You will build a complete home alarm system, including fire detection, as well as an electronic piano, a motor speed-regulator, a time-of-day clock, a simulated traffic control system, and a Morse code generator. You will also design an industrial control loop for temperature control, including analog-to-digital conversion, and your own simple peripherals from paper-tape reader to microprinter.

Truly the "input-output" book for the 6502, it includes more than 50 exercises designed for testing yourself at every step.

6502 Games Book
SYBEX G402 \$18.75

This book is designed as an educational text on advanced programming techniques. It presents a comprehensive set of algorithms and programming techniques for common computer games. All the programs are developed for the 6502 at the assembly language level.

Because programs must reside within less than 1K of memory in order to reside on a single board microcomputer (such as the SYM used in this book), the book covers virtually all aspects of advanced programming: effective algorithm design, data structures design and effective coding techniques related to storage economy.

The reader will learn how to devise strategies suitable for the solution of complex problems, typical of those encountered in games. He/she can also use all the resources of the 6502, and sharpen his/her skills at advanced programming techniques. All the games presented in this book can be played on a real board (the SYM), and require a very small amount of additional components.

Programming the Z80
SYBEX C280 \$20.75

This book has been designed both as an educational text and as a self-contained reference book. As such, it can be used as a complete introductory book on programming, ranging from the basic concepts to advanced data structures manipulations.

It also contains a comprehensive description of all the Z80 instructions as well as its internal operation, and should provide a comprehensive reference for the reader who is already familiar with the principles of programming, but wishes to learn the Z80. All concepts are explained in simple yet precise terms, building progressively towards more complex techniques.

Programming the Z8000
SYBEX C281 \$22.75

This book was designed as both an educational text and a self-contained reference manual. This book presents a thorough introduction to machine language programming from basic concepts to advanced programming techniques. Detailed illustrative examples and numerous programs show the reader how to write clear, well-organized programs in the language of the Z8000.

The book also contains a comprehensive description of the Z8000 architecture as well as programming instructions. The author has arranged the instructions logically, rather than simply alphabetically by mnemonic name. This feature enables the reader to gain insight into the overall capabilities of the machine.

With over 113 illustrations, a thorough index, and 5 appendices, Programming the Z8000 is an indispensable text for engineers, students, PDP-11 users and anyone interested in learning machine language programming skills.

ETI ORDER FORM

BACK ISSUES: Please circle issues desired.

1977	February	May	July	November			
1978	March	May	June	July	August	September	
	October	November		December			
1979	January	February	March	April	May	June	July
	August	September	October	November	December		
1980	January	February	March	April	May	June	July
	August	October	November				

QTY.	ITEM	AMOUNT
.....	.Back issues @ \$3 (mark choice above)	\$
.....	.Canadian Projects Book No. 1 @\$3.45	\$
.....	.ETI Circuits Book @ \$5.45	\$
.....	.'More Circuits' Book @ \$4.95	\$
.....	.Set(s) of Panel Transfers @ \$5.00	\$
.....	.ETI T-shirts @ \$5.50	\$
	Small () Medium () Large ()	
.....	.ETI Binders @ \$6.75	\$
	Ontario residents add 7% PST on last three only.	\$
.....	.Subscriptions @ \$16.95/\$29.95	\$
.....	.Hobby Projects @ \$3.95	\$
.....	.Electronic Circuit Design @ \$3.95	\$

QTY.		BABANI		BABANI	
..	BP1	\$2.80	\$No.223 \$5.50 \$
..	BP14	\$4.80	\$No.224 \$4.25 \$
..	BP24	\$4.25	\$		TAB
..	BP33	\$4.25	\$	QTY.	
..	BP35	\$5.50	\$No.800 \$18.30 \$
..	BP37	\$5.50	\$No.804 \$18.35 \$
..	BP39	\$5.50	\$No.805 \$11.75 \$
..	BP42	\$3.55	\$No.806 \$11.75 \$
..	BP44	\$7.55	\$No.841 \$8.55 \$
..	BP46	\$5.90	\$No.1000 \$11.55 \$
..	BP47	\$5.90	\$No.1010 \$9.85 \$
..	BP48	\$5.90	\$No.1015 \$9.70 \$
..	BP49	\$6.25	\$No.1064 \$11.85 \$
..	BP50	\$5.90	\$No.1070 \$12.35 \$
..	BP51	\$5.50	\$No.1071 \$10.90 \$
..	BP62	\$8.95	\$No.1076 \$11.55 \$
..	BP63	\$8.95	\$No.1088 \$11.85 \$
..	BP64	\$8.95	\$No.1120 \$7.75 \$
..	BP65	\$6.55	\$No.1133 \$9.75 \$
..	BP66	\$7.55	\$No.1152 \$11.75 \$
..	BP67	\$7.55	\$No.1169 \$13.75 \$
..	BP68	\$7.25	\$No.1174 \$9.75 \$
..	BP69	\$7.55	\$No.1234 \$11.75 \$
..	BP70	\$2.40	\$No.1241 \$11.75 \$
..	BP71	\$7.70	\$		SYBEX
..	BP72	\$7.70	\$	QTY.	
..	BP73	\$8.58	\$C200 \$10.75 \$
..	BP74	\$7.70	\$C202 \$18.75 \$
..	BP75	\$7.30	\$C280 \$20.75 \$
..	BP76	\$7.30	\$C281 \$22.75 \$
..	BP77	\$12.30	\$D302 \$18.75 \$
..	BP78	\$7.30	\$G402 \$18.75 \$
..	BP79	\$7.30	\$		* BABANI SUBTOTAL
..	BP80	\$8.25	\$		
..	.No.205	\$3.55	\$		
..	.No.213	\$4.50	\$		
..	.No.215	\$3.70	\$		
..	.No.221	\$5.50	\$		
	BABANI SUBTOTAL	\$	*		

QTY.		SYBEX	
..	.C200	\$10.75	\$
..	.C202	\$18.75	\$
..	.C280	\$20.75	\$
..	.C281	\$22.75	\$
..	.D302	\$18.75	\$
..	.G402	\$18.75	\$
	* BABANI SUBTOTAL		

TOTAL ENCLOSED

If we cannot complete your order, do you wish the balance refunded? YES NO

Save up to 28% on the Newsstand price!

One Year Subscription to ETI Magazine: \$16.95 (a 23.8% saving over the newsstand price)

Two Year Subscription to ETI Magazine : \$29.95 (a 28.6% saving over the newsstand price)

Fill out the coupon on the reverse of the order form or send your cheque (or Visa or Mastercharge Card number and expiry date) to:

Subscription Department,
ETI Magazine,
Unit 6, 25 Overlea Boulevard,
Toronto, Ont., M4H 1B1



PLEASE PUT YOUR NAME AND ADDRESS ON REVERSE SIDE OF THIS FORM.

SUBSCRIBE NOW!

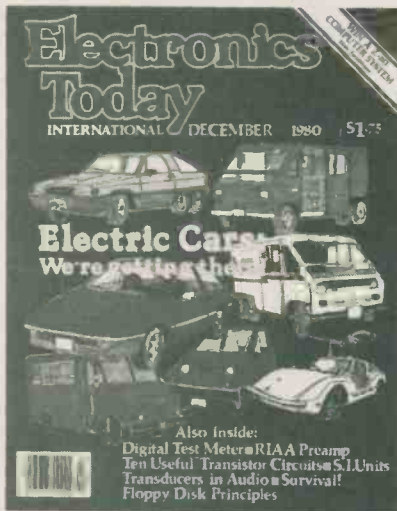

BOOKS, BACK ISSUES BINDERS—SEE OVER

Electronics Today Magazine, Unit 6, 25 Overlea Blvd., Toronto, Ontario M4H 1B1.

SUBSCRIPTIONS: NEW SUBSCRIPTION? OR... RENEWAL? Please check one.

One year subscription (12 issues) \$16.95 Two year subscription (24 issues) \$29.95
Postage and handling to Canada is included, for U.S. please add \$3, other countries add \$5/yr.

FOR OFFICE USE

Code _____

PLEASE PRINT CLEARLY

NAME _____

ADDRESS _____

TOWN/CITY _____ PROVINCE/STATE _____

CODE _____ DATE _____

Cheque enclosed DO NOT send cash.

Bill Mastercharge. A/C No. _____

Bill Visa A/C No. _____

Signature _____ Expiry Date _____

PLEASE ALLOW 6-8 WEEKS FOR YOUR FIRST MAGAZINE TO ARRIVE

TP2-1-81

Number One ETI CIRCUITS

The ultimate ideas book for the experimenter. Get yours now!

ALARMS

- Basic Alarm
- Photo Intruder Alarm
- Intruder Alarm
- Photo Electric Relay
- Low Temperature/Lights out
- Temperature Sensor
- Coolant level
- Water Level
- Electronic Lock
- Car Battery Watchdog
- Simple Car Alarm
- Simple Lock

AMPLIFIERS & PREAMPLIFIERS

- High Input Impedance
- High Impedance Buffer
- Low Output Impedance
- High Input Impedance
- Low Frequency Extender
- Virtual Earth Preamp
- IC Tape Head Preamp
- Simple Stereo Tape Player
- 2.5 Watt
- 20 Watt Slave
- 10 Watt
- Loudspeaker Microphone
- Voltage Controlled Amp
- Wide Band Amplifier
- Video Power Amp
- Broadband Amp

SIGNAL PROCESSORS

- Fuzz Box
- Guitar Fuzz
- Fuzz Box
- Waa Waa
- Disco Autofade
- Simple Autofade
- Information Transfer
- Optical Pulse Conditioner
- TV Sound Pickoff
- Cracklesfree Potentiometer
- Voltage to Frequency
- Sine to Square Wave
- Precision AC to DC
- Voltage Processor
- Universal Meter
- Double Precision
- Fast Half Wave
- Simple Chopper
- Noise Rejecting SCR Trigger
- Phase Shifter

SIGNAL GENERATORS

- Simple
- Variable Duty cycle
- Fast Edge
- FET
- Improved Multivibrator
- Variable Duty cycle
- Stable R.C.
- Cheap (CMOS)
- Simple TTL XTAL
- Uncritical XTAL
- Pulse
- Zero Crossing
- Simple Pulse
- Needle Pulse
- Stable Linear Sawtooth
- Zener
- Noise
- Pink
- Simple Relaxation
- Triangle with independent slope
- Exponential
- Widerange Multivibrator
- Multiple Waveform
- Linear Sweep
- Step Frequency
- Beeper
- 7400 Siren
- Simple Siren
- Ship Siren
- Two Tone
- Tor Siren
- Kojak, Star Trek, Z Cars
- Sound Effects
- Sound Effects

FILTERS

- Bandpass
- Low & High Pass
- Rejection Notch
- Bandpass
- Cartridge EQ & Rumble
- Hum Slopper
- Tape Hiss Reduction
- Simple Crossover

DIGITAL

- Thermometer
- Heads or Tails
- Binary Calculator
- Voltmeter
- Seven Segment to Decimal
- Die
- Random Binary
- CMOS Die
- Multiplexer Hints
- Learning Memory
- CMOS Clock

Simple Transistor/SCR

- SCR Tester
- Crystal Checker
- Crystal Checker
- Good/Bad Battery Tester
- Battery Tester
- Op Amp Tester
- Op Amp Checker
- Cheap Logic Probe
- Audible TTL Probe
- Audible Slow Pulses
- Logic Probe
- Logic Analyzer
- Lead O Display Probe
- Simple High Impedance
- Vollmeter
- Audio/RFF Tracer
- Thermocouple Thermometer
- Metering Stabilised supplies
- Simple Frequency Meter

TIMERS & DELAYS

- Low Standby Drain
- 741 Timer
- Self Triggering Timer
- Pulse Timer
- Pulse Delay
- Voltage Controlled Monostable
- Sequential Relays
- Door Chime Delay

SWITCHING

- Touch Triggered Bistable
- Touch Sensitive Switch
- Electronic Switch
- Sound Operated 2 Way
- SPST Switch Flip Flop
- Two Signals on one Wire

INDICATORS

- Line-O-Light
- 3 Step Level
- Light Level
- Bargraph Display
- Fuse Failure
- Blowdown Fuse
- Back Up Lamp
- DC Lamp Failure
- FM Tuner Station
- Current Flow
- Disco Cue

AUTOMOBILE

- Brake Lamp Failure
- Courtesy Light Delay
- Simple Hazard Light
- Light Extender & Reminder
- Four Way Flasher
- Headlamp Dipper
- Wiper Delay
- Suppressed Zero Voltmeter
- Rev Counter/Tachometer
- Auxiliary Battery

POWER SUPPLIES

- Constant
- Temperature Stable
- Constant
- Voltage Controlled
- Precision Voltage Divider
- Dual Polarity
- Simple Balanced
- Voltage Divider
- Low Regulated
- Short Circuit Protected
- Simple TTL Supply
- Zener
- Stable Reference
- Transformerless Inverter
- DC to DC AC
- Voltage Multiplier
- Automobile Converter
- Shaver Adaptor
- DC-DC
- High Voltage From Battery
- Variable +ve or -ve output
- Simple
- 12V from Battery Charger
- Bucket Regulator
- Adjusting Zener Voltage
- Variable Zener
- Zener Boosting of Regulators
- High Power
- Electronic Fuse
- Better Fuse
- Regulator & Fuse
- Fast Acting
- SCR Crowbar
- Quick JFET Test
- Current Gain Tester
- Basic Transistor Tester

TEST

- Diode Checker
- GO/NO GO Diode Tester
- Zener Check
- GO/NO GO Transistor Tester
- Voltmeter
- Current Segment to Decimal
- Die
- Random Binary
- CMOS Die
- Multiplexer Hints
- Learning Memory
- CMOS Clock

FLASHERS

- Dancing Lights
- Low Frequency Strobe
- Flasher
- Ultra Simple

POWER CONTROL

- LDR Mains Control
- Floodlamp Control
- Zero Crossing Sync
- Train Controller
- Low Differential Thermostat
- Simple Temperature Control
- Full Wave SCR Control

DETECTORS & COMPARATORS

- Peak Detect & Hold
- Window Detector
- Peak Program
- Positive Trigger
- Reaction Comparator

RADIO FREQUENCY

- Crystal Marker
- 100 kHz Marker
- RF Voltmeter
- RF Detector
- LED RF Indicator
- RF Amplifier Protection
- FET-Radio
- Op-Amp Radio

MISCELLANEA

- Phase Locked Loop
- Touch Doorbell
- Phase Lock Control
- Audio Mixer
- Virtual Earth Mixer
- Plot Eliminator
- Loudspeaker Protection
- Digital Capacitance Probe
- Digital Tape Recorder Adaptor
- Breakdown Diode Substitution
- Dual Function Charger
- Dual Mode Amp
- Capacitor Substitution
- Electronic Capacitor
- Speeding Up Darlington
- Shutter Saver
- Thyristor Sensitivity
- Sound Operated Flash
- Strength Tester
- Logic Noise Immunity

TIPS

- Identifying 74 Series
- Supply Pins
- Soldering IC's
- Tinning With Solder Wick
- PCB Stencils
- Front Panel Finish
- DIL Drilling
- Fluorescent Starting
- Avoiding Insulated Heat Sinks
- TTL Max Interface
- Boost Your Mains
- High Resistance on Low Meters
- High Voltage Electrolytics
- Transistor Identification
- Template & Heat Sink for
- Power Transistors
- Transistor Socket
- Solder Flow Problems
- Odd Resistor Values
- Resistors in parallel
- CMOS DIL Handling
- Identifying Surplus ICS
- Extending Battery Life
- Battery Snaps
- Power Supply or Battery
- Battery Checking
- Muck Remover
- Transformers in reverse
- Loudspeaker Checking
- Improving UJT Linearity
- Signal Tracer
- Crystal Earpieces
- Cheap Varicaps
- Zener Lifts Capacitor Rating

DATA

- 741 Op-Amp Date
- BC 107-109 Data
- BC 177-179 Data
- CMOS & TTL Data
- 2N3055 Data
- MU2955 Data
- Bipolar Data Tables
- Bipolar FETs Rectifiers
- Diodes Pinouts Zener Misc

SEND \$500 TODAY
to: ETI Circuits, ETI Magazine
Unit 6, 25 Overlea Boulevard
Toronto, Ont. M4H 1B1

Add 45¢ for postage and handling.



ORME

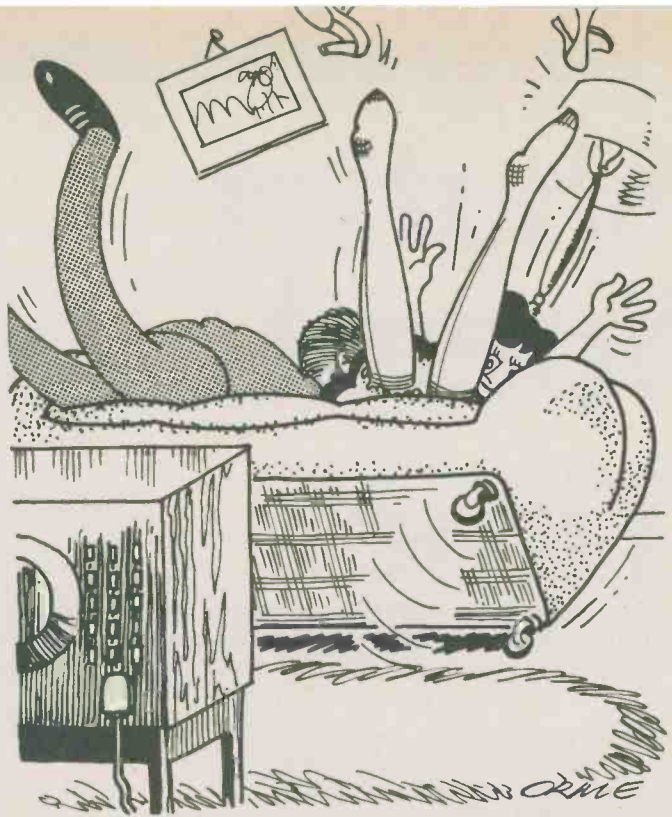

I thought we were going to play your new TV game?



For the man who has everything else...

ETI Binders keep your issues in perfect shape. \$6.75 inc postage (Ontario residents add 7% PST). Send to: ETI Binders, Unit 6, 25 Overlea Blvd, Toronto, Ont. M4H 1B1

A world free from early heart attack and stroke

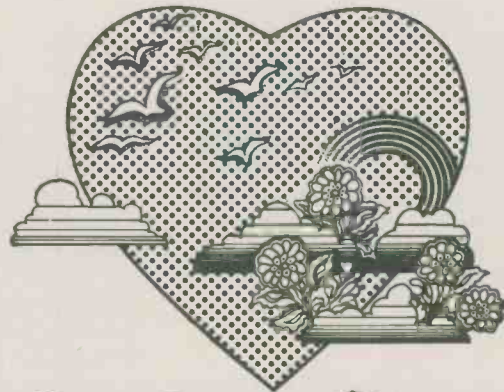

That's what we're all about.

Ask your Heart Association  Give Heart Fund

Shutter Speed Timer

A project from the amateur photographer from ETI's project team to enable accurate checking of the mechanical bits!

THE NUCLEUS of good photography is correct exposure. This is a combination of shutter speed and lens aperture as determined by an exposure meter. If either speed or aperture is not as indicated on the camera the results will be less than perfect.

While the lens aperture is a simple mechanical operation and unlikely to be in error the same cannot be said about the shutter with its springs and things. (*Typical electronic engineer's attitude—Ed.*) Not only may the speed not be exactly as indicated on the dial, it may (probably) change as the camera gets older. Therefore it is desirable that a simple method of determining the actual speed should be available.

This project describes the design and construction of a unit which is capable of measuring times from 1/10000 sec. to 10 sec. This allows the actual speed to be measured and then used to calculate the correct aperture when taking those important photos.

SPECIFICATIONS

Timing range	0.1 ms to 9.99 sec.
Sensor	Photo transistor
Display	3 digit LED
Power supply	9 volt batteries 65 – 160 mA LEDs on 20 mA LEDs off
Battery life	≈6 hours – normal ≈20 hours – alkaline

It is suitable for checking cameras with a hinged or removable back so that the sensor can be placed in the film plane. For cameras where the film fits into a slot this unit cannot be used.

Construction

Commence construction with the PCB adding initially the nine links required. Next add the resistors and capacitors in the appropriate locations as shown in the component overlay. Note that capacitor C5 is polarised and must be inserted the correct way round.

The transistors and the displays can now be soldered in place taking care with orientation of the transistors.

The ICs are the last components to be installed and these must be in the correct location and orientation. When soldering them in, solder the corner pins (the power supplies), pins 7 and 14 or 8 and 16 first as this allows the internal protection diodes to work while you solder the other pins.



The front panel can now be drilled and cut. A piece of polarised plastic helps as a display window. The switches, pushbutton and phone jack can now be fitted and connected to the PCB as shown in the component overlay. The only point which could cause problems here is that the phone jack connections sometimes vary, and you should check yours before connection.

The PCB can now be mounted onto the support bracket with 6 mm spacers and the bracket into the box with two screws. When positioned correctly, the display will be visible through the window and the battery holders will be held in position at the other end.

Sensortive

The sensor plate which contains Q1 and R1 can now be made. We used a piece of PCB material, although any non-conductive material which is opaque or translucent may be used. Start by cutting the plate to size and drilling a

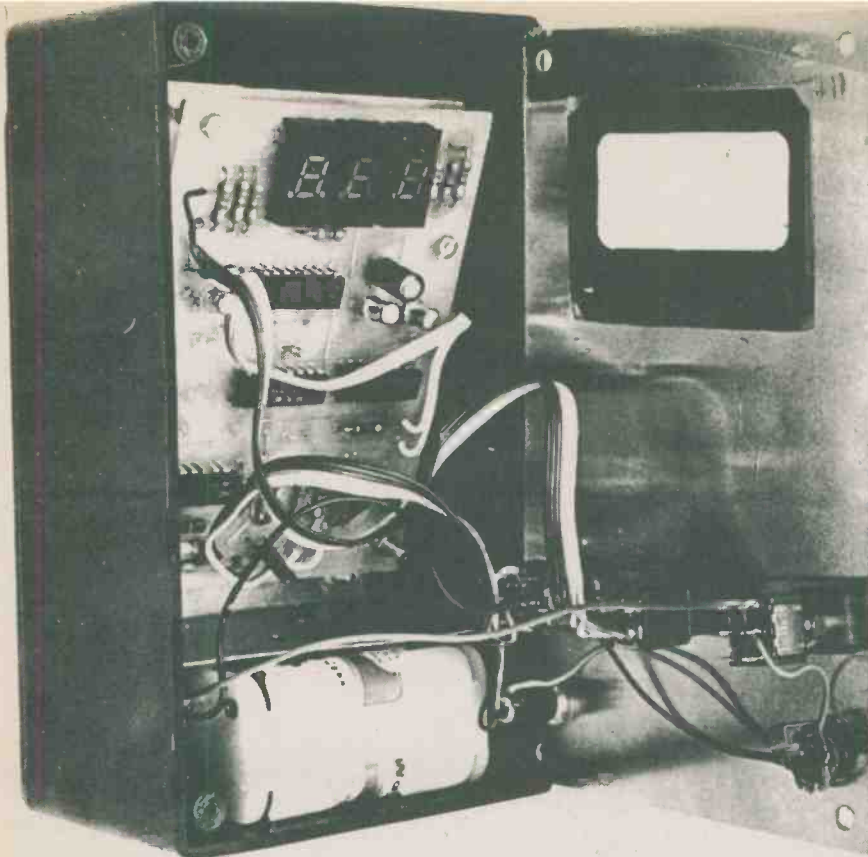

6 mm hole in the centre. The photo-transistor Q1 should be mounted with the curved surface (which is the active side) into the hole and R1 soldered to the leads, the whole assembly then being glued onto the plate with quick dry epoxy. Ensure that all conductive parts are covered with epoxy to prevent touching when in use.

Calibration

The unit can be calibrated accurately enough with the aid of a stopwatch with a second hand. Set the camera up as detailed in the operational notes and using the single-shot mode, open the lens for five seconds. By adjusting RV1 get the reading close to 5s.

Now use a longer time, say 20 s, noting

HOW IT WORKS

To measure the time the shutter is open we use a phototransistor, Q1, positioned in the film plane in the camera. When the shutter is operated and if the camera is focusing a bright light on to the transistor, the voltage across R4 will rise to about 7 V for the duration of the shutter being open. The transistor used is a Darlington type and is normally too slow for measuring times shorter than 1 ms. The addition of R1 increases the speed at the expense of sensitivity – hence the need for a bright light.

The output across R4 is squared up by the Schmitt trigger formed by IC1/1,2. The output of this controls the input to the 10 kHz oscillator IC2. This is an ordinary 555 oscillator where the frequency is set by C1, R2, R3 and RV1. The output of IC2 is divided by 10 in IC3/1 and again by 10 in IC3/2. We use the enable inputs of IC3 as they give clocking on the negative edges, which is what we need. We now have three outputs of 10 kHz, 1 kHz and 100 Hz. One of these outputs is selected by SW2/1 which is a centre off toggle switch. When it is in the off position, 1 kHz is selected via R8, while in the other positions the 1 kHz signal is swamped by the low output impedance of the other dividers.

Whichever frequency is selected clocks IC4 which is a 3 decade counter-latch-multiplexer. We are not using the latch in this application. This IC simply counts the number of pulses it receives and with the help of IC5 (7 segment decoder-driver) and Q2 – Q4 displays the result on the LED displays. During the counting period the display is blanked to prevent ripple on the supply rail upsetting the 555 timer. The ripple would occur as the current changes with different digits displayed. The decimal point is controlled by SW2/2.

Two modes, single-shot and add, are provided. In the single-shot mode when light hits Q1 operating the Schmitt trigger the monostable formed by IC1/3 gives a pulse about 50 μ s long which resets the main counter IC4 and the /10 dividers, IC3. Pins 1 and 9 on IC3 which have to be low to allow clocking are taken high during the reset pulse only because it made the PCB easier and does not affect the operation. In the 'add' mode the reset pulse does not occur and unless the reset button is pressed the second and successive counts will simply add on to the previous count. This allows say ten tests to be made and the total divided by ten to find the average.

PARTS LIST

RESISTORS all $\frac{1}{2}$ W 5%

R1	1M
R2	82k
R3	10k
R4	2k2
R5	100k
R6	220k
R7,8	10k
R9–R16	220R

POTENTIOMETER

RV1	50k
-----	-----

CAPACITORS

C1–C4	1n0 polyester
C5	10u 16 V electrolytic

SEMICONDUCTORS

IC1	4011
IC2	555
IC3	4518
IC4	14553
IC5	4511
DISPLAY 1–3	DL704
Q1	2N5777
	Photo-Darlington
Q2–Q4	2N3905

SWITCHES

SW1,3	toggle switch SPDT
SW2	toggle switch DPDT centre off

MISCELLANEOUS

PCB/plastic box, push button, phone jack and plug, battery holder, battery clip, support bracket, spacers, nuts, bolts, wire etc.

that the first digit will be missing. (i.e. a reading of 8.52 represents 18.52 s while 2.31 would be 22.31 s) and finally adjust RV1.

To aid setting up a push button can be substituted for the phototransistor but the 'add' position should be used and the timer manually reset as contact bounce can cause the display to reset on release of the button.

Operation

While the camera can be hand-held it is recommended that a tripod be used. Mount the camera on the tripod pointing at a light of 100 – 500 Watts about 2 – 3 feet away. Open the back of the camera and position the sensor plate so that the light is focused on the sensor. Initially, have the lens wide open; if enough light is hitting the sensor, the display will be blanked. Stop the lens down until the display comes on then go back one stop.

This sets the sensitivity and by selecting the appropriate range the shutter speed can be checked. ●

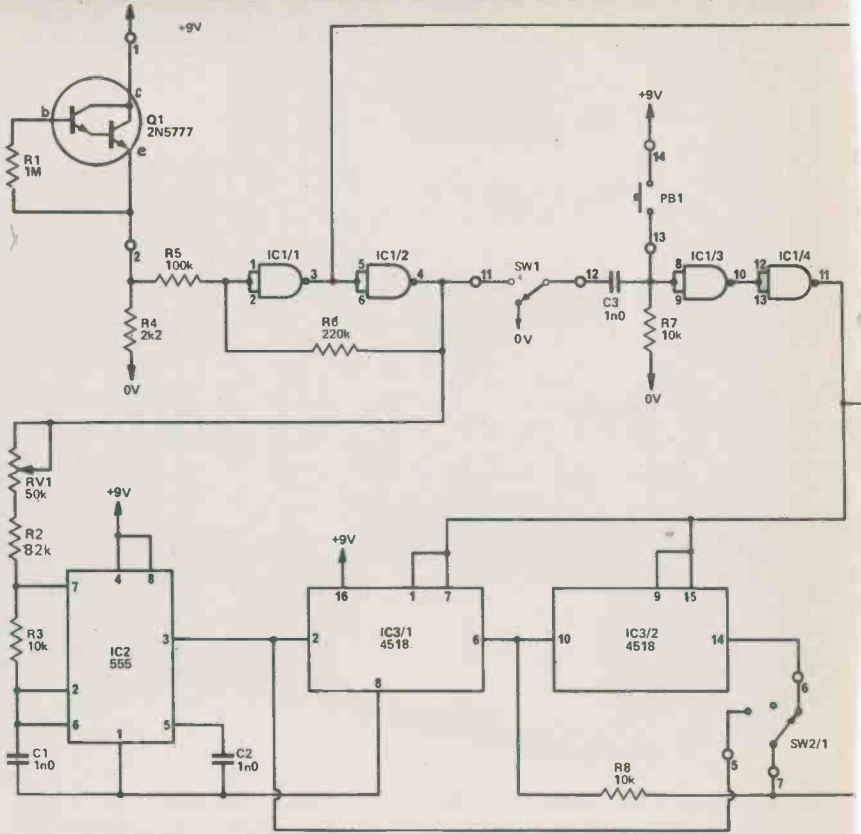
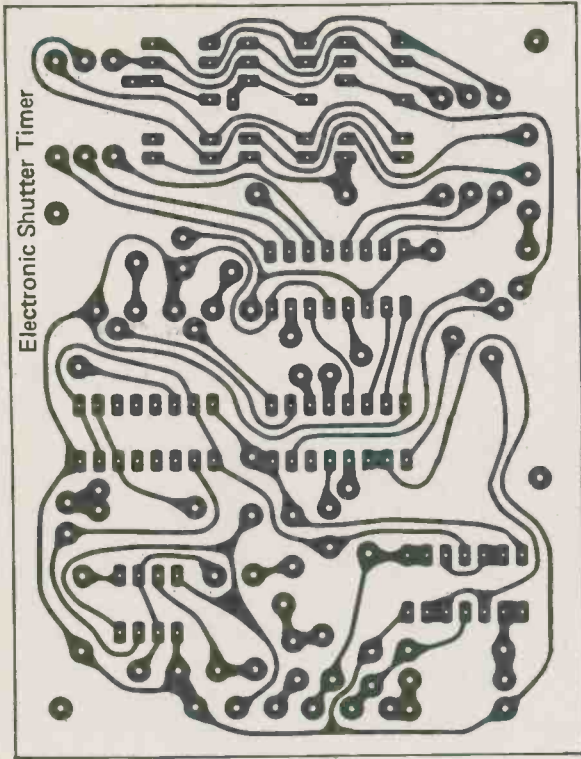

Fig. 1. Circuit diagram of the timer

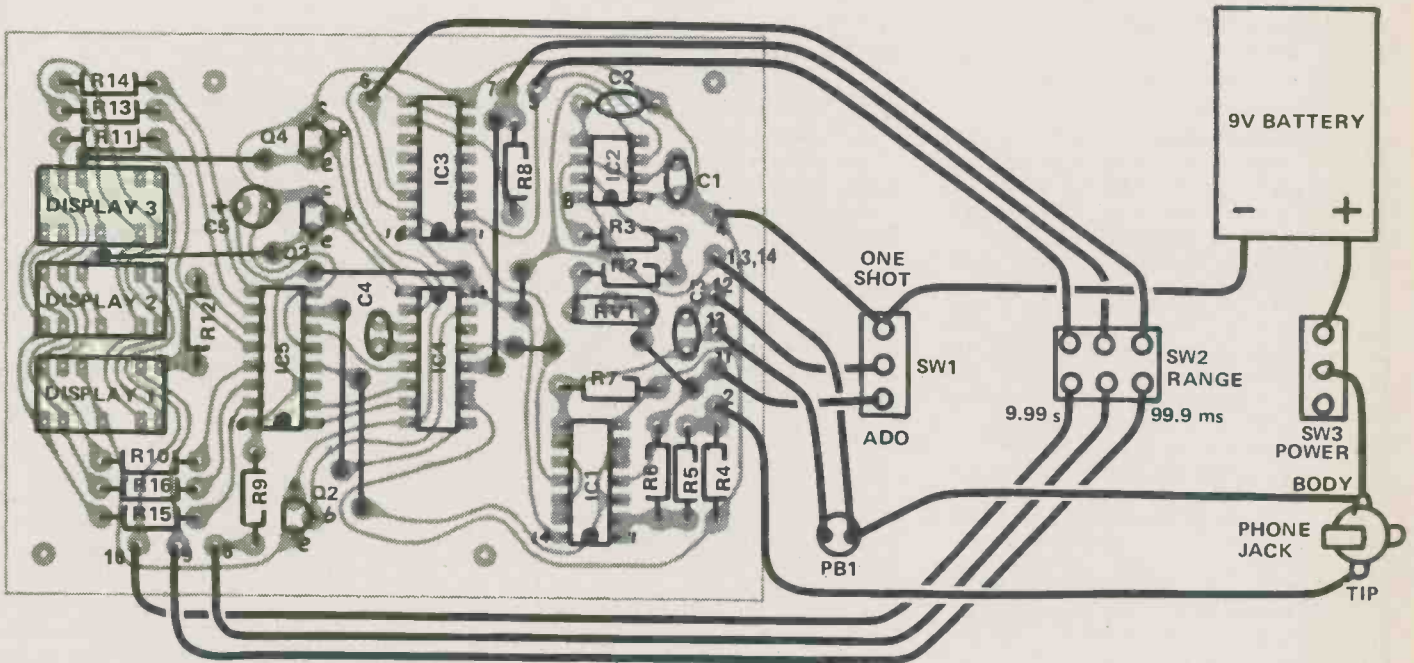

Fig. 2. Component overlay and wiring diagram.

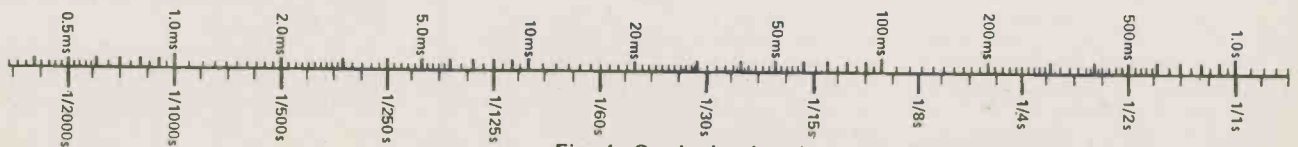

Fig. 4. Graph showing the relationship between time and shutter speed. Each of the small divisions on the right hand side corresponds with a 1/4 stop.

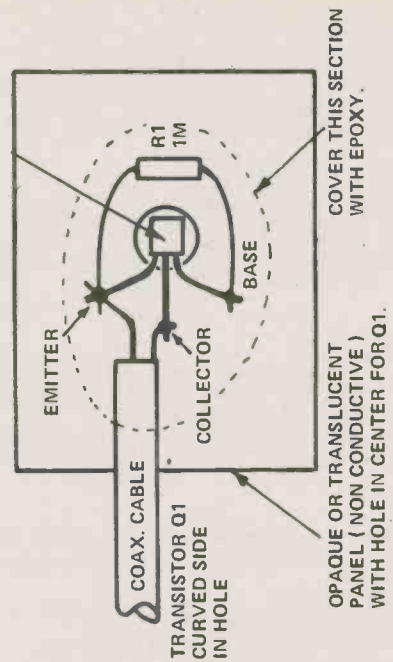
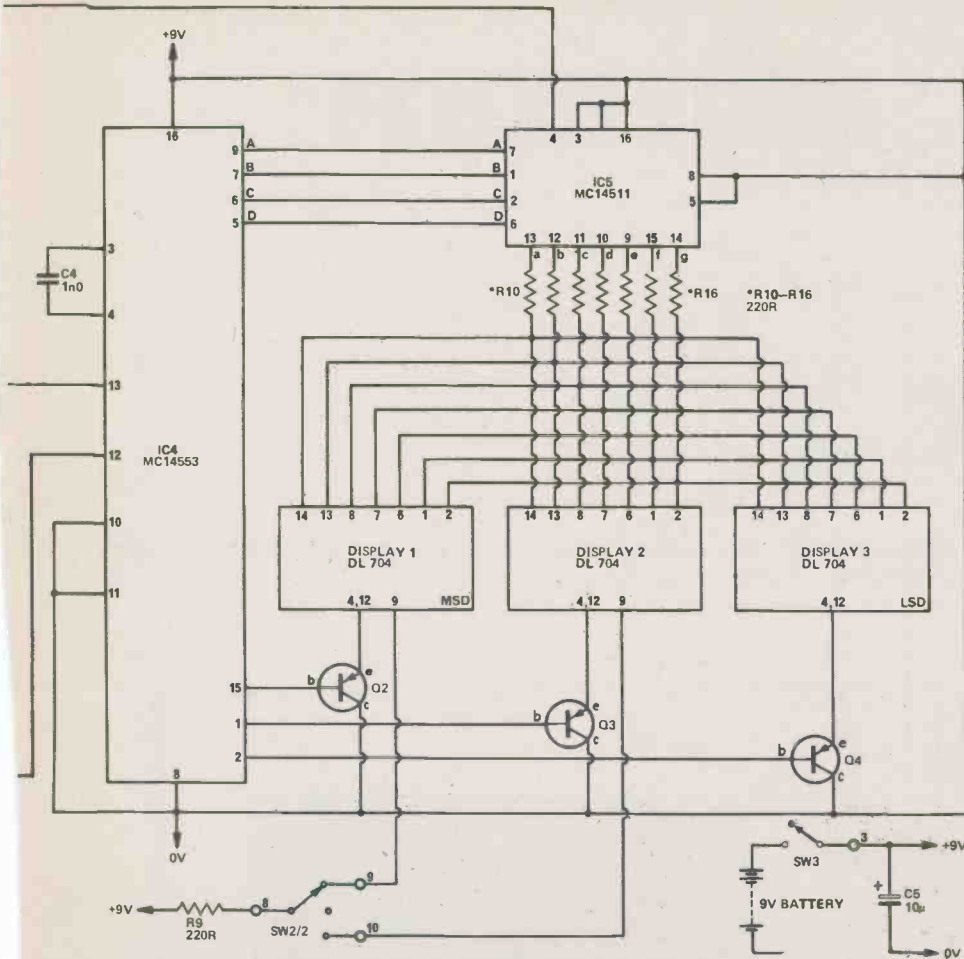

Fig. 3. Connection of the transistor on the sensor plate.

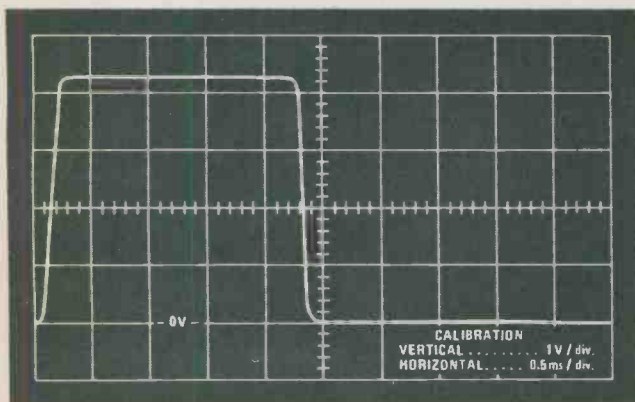

Fig 5. Waveform on the input (point 2) with the camera on 1/500 sec. The actual time was 2.1 ms.

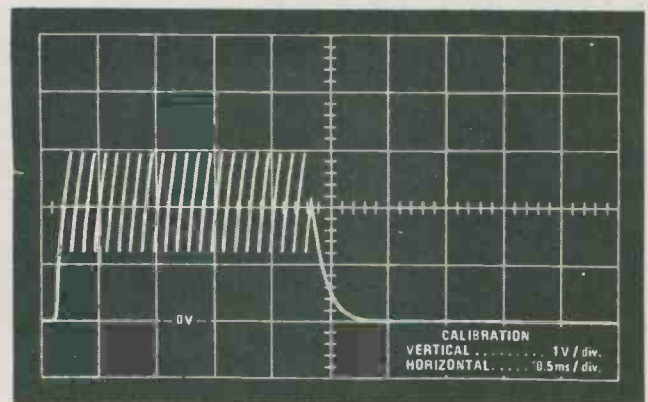

Fig. 6. Voltage across C1 during operation

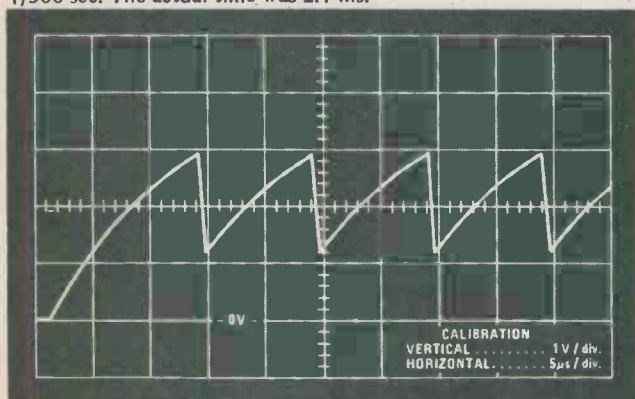

Fig.7. Expanded view of the start of the above wave form.

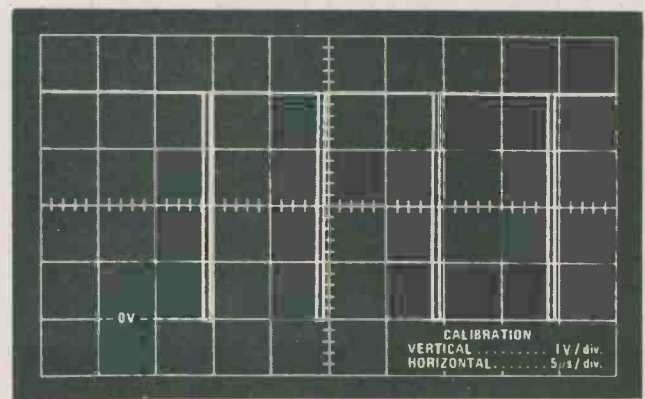

Fig. 8. The output of the 555 showing the first four pulses.

Nickel-Cadmium Battery Charger

Universal unit charge practically any nickel-cadmium battery currently in use.

THERE is an increasing proliferation of portable equipment, such as flash guns and calculators, which could, or already do, use rechargeable batteries of the nickel-cadmium type.

If the equipment was originally fitted with rechargeable batteries, a charger may well have been provided. But when replacing ordinary dry cells with rechargeable types a charger will be required. Unfortunately, nickel-cadmium battery packs come in a variety of voltages and ampere-hour ratings and a charger supplied for one piece of equipment (eg, an electronic flash) will seldom, if ever, be suitable for other equipment such as an electronic calculator.

The ETI 519 battery charger will charge almost any nickel-cadmium battery in use today. The charging rate is switch-selectable for batteries from 50 mA/h to 2500 mA/h capacity.

Any battery voltage up to 20 volts is *automatically* accommodated. No voltage selection is required.

Charging time is approximately 14 hours for a flat battery and proportionally less for one that is partially discharged.

Overcharging at the correct ampere/hour rate will not damage a nickel-cadmium battery. Thus an overnight charge for a partially discharged battery may be safely given. In fact, provided the correct ampere/hour charging rate has been selected no damage will occur if left on charge for 48 hours.

Construction

The circuit is a very simple one. Practically any method of construction may be used provided

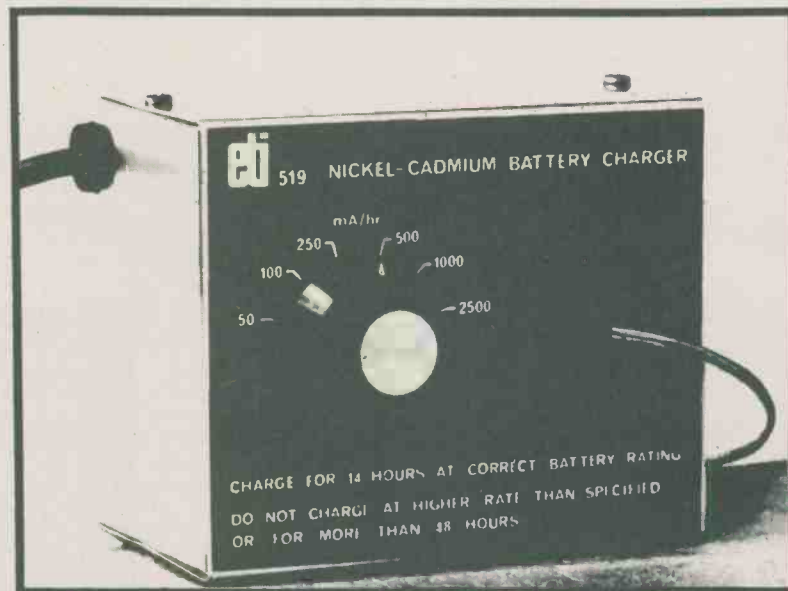

care is taken with the insulation of 120 Vac wiring.

In our prototype unit we assembled all components on tag strips, with the exception of the range resistors which were mounted directly on the range switch itself.

If only a single range is required, a single resistor may be used. Its value in ohms should be 6000 divided by the mA/h rating of the battery. The nearest 5% nominal value to that calculated as above will be adequate.

By virtue of the nature of the constant current supply any battery,

or bank of batteries up to 20 volts may be charged. If the 20 volt capability is not required a different transformer may be used as detailed in Table 1.

The transistor dissipates a fair amount of heat and hence should be mounted on a piece of aluminium to act as a heatsink. This piece of aluminium should be insulated from the case, or if not, the transistor should be mounted on the aluminium via a mica washer and insulating bushes. ●

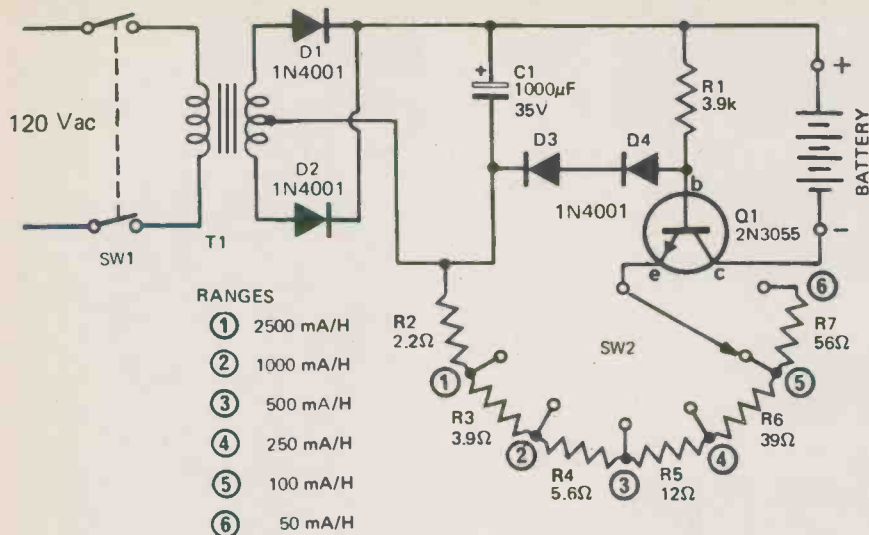

Fig. 1. Circuit diagram of the Nickel-Cadmium Battery Charger

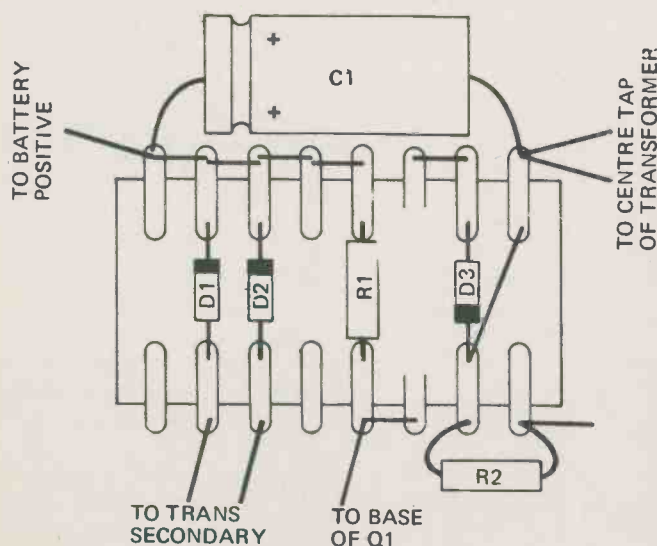

Fig. 2. Layout of components on the tag-strip

HOW IT WORKS

Current regulators operate in opposite fashion to voltage regulators. In a current regulator, the current remains constant regardless of changes in load impedance — the output voltage varies to maintain constant load current.

In this circuit, the 120 Vac line is reduced by T1 to 40 Vac. This is then rectified by D1, D2 and filtered by C1 to provide approximately 28 Vdc.

This dc supply is then regulated by Q1 and its associated components to produce a current level selected by SW2.

Transistor Q1 is biased by D3 and D4 such that there is about 1.2 V between the base of Q1 and the negative side of C1. As there is 0.6 V between base and emitter of Q1, there will be 0.6 V developed across the resistor network R2-R7. Therefore the emitter current of Q1 must be 0.6 V divided by the resistor value selected by SW2.

The emitter current generated as above will produce an approximately equal collector current which charges the battery and remains constant provided there is at least one volt between the collector and emitter of Q1.

TABLE 1

BATTERY VOLTAGE	TRANSFORMER**	R1
1.25—3.75	12.6 V CT	1.8k
5—10	24 V CT	2.2k
11.25—20	40 C CT	3.9k
21—30*	60 V CT	5.6k

* Capacitor C1 voltage rating should be 50V.

** Current rating of the transformer, in mA, should be greater than the maximum mA/h battery rating divided by 10. A single winding transformer of half voltage may be used if a bridge rectifier is employed.

PARTS LIST

R1	Resistor	3k9	¼W	5%
R2	"	2R2	"	"
R3	"	3R9	"	"
R4	"	5R6	"	"
R5	"	12R	"	"
R6	"	39R	"	"
R7	"	56R	"	"
D1-D4	Diodes	1N4001 or similar		
C1	Capacitor	1000mF 35V electrolytic		
Q1	Transistor	2N3055		
T1	Transformer	120V pri 40Vct sec 500mA		
SW1	Two-pole on-off switch			
SW2	Six-position single-pole rotary switch			

Metal box, bracket for 2N3055, line cord and plug.

Oxfam

Working with People
Who Are Helping Themselves.

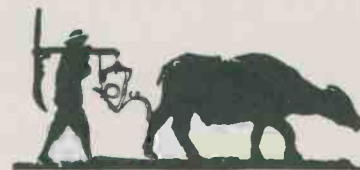

OXFAM supports small, self-help projects in developing communities around the world. OXFAM projects stress self-reliance and seek maximum participation by the local population. OXFAM is more than a charity. It is a movement for social justice.

**YOUR CONTRIBUTION CAN
MAKE THE DIFFERENCE**

OXFAM-CANADA

BOX 18,000 TORONTO, OTTAWA,
HALIFAX, ST. JOHN'S
BOX 12,000 WINNIPEG, REGINA,
CALGARY, VANCOUVER
HERE IS MY DONATION \$ _____
FOR YOUR WORK.

NAME _____

ADDRESS _____

ALL DONATIONS ARE TAX DEDUCTIBLE.

If you love life, make sure the love affair lasts.



The Seven Steps to Health are simple things you can do to help prevent cancer. You owe it to yourself to know and follow them.

1. Have a medical and dental check-up.
2. Watch for any change in your normal state of health.
3. Find out about any lump or sore that does not heal.
4. Protect yourself from too much sunlight.
5. Do not smoke.
6. Have a Pap test.
7. Do a monthly breast self-examination.

If you love life, take the first step.

Learn the Seven Steps to Health.



"Help Me Save a Child..."



Anne Murray—mother of two, sponsor of children in the developing world, Honorary Chairperson of **Save the Children**, and international celebrity—admits that one of the best joys in life is being able to help children.

She is one of the many Canadians who help youngsters in need through **Save the Children**. Over the past 60 years, **Save the Children** has brought hope to young refugees left starving and homeless, and to children who suffered through conflicts and natural disasters in Spain, Europe, the Middle East, Africa, Vietnam, Korea, India and the Americas.

Save the Children relies on your donations to provide self-help programs for children and their communities in more than 30 countries including Canada.

Anne believes that every child is a "Child of Mine" ... of yours ... of ours ...

Please support her belief by sending your cheque today to **The Canadian Save the Children Fund**, 720 Spadina Avenue, Toronto, Ontario M5S 2W3

There are so many ways you can save a child—please write to **Save the Children** for further details.

ETI Wet: Plant Waterer



If your plants suffer from a drink problem let our ETI WET look after them when you are away, ensuring that they get their daily dose of life giving liquid.

WATER, WATER, EVERYWHERE and not a drop to drink runs an old poem, well plants need to quench their thirst as well as humans — and during holiday time most are left to wilt. In the interests of flower power we decided to produce a unit that would refresh the plants that owners could not reach, hence the ETI WET.

The unit consists of a sensor, timer and electric water pump. The sensor is embedded in the soil and when dry the electronics operate the water pump for a preset time — thus infusing the plant with thirst quenching water. When the plant has drunk its fill and the sensor is dry again the cycle repeats. In this way you can soak up the sun in the knowledge that your prize plant is getting its fair share at home.

Construction And Calibration

The electronics are mounted on the PCB, using a socket for the IC. We used a plastic card filing box for the case and a 5 litre container to hold the water supply. Make sure you drill an extra small hole in the cap of the water container — so that air can replace water when the pump operates.

We used a small 6V pump (see buy lines) but other pumps can be

used. For example a pet shop can probably supply small pumps (used in fish tanks) and pumps are available from most car accessory shops (used for windshield washer). If the pump you use needs 12V the battery will need changing — the electronics will work at this higher voltage.

The moisture control and water flow control need careful setting — to ensure that the plant gets enough water, but not too much. When first switched on the ETI WET will pump water for the time set by the water flow control — use this water to wet the soil around the plant, with the probe in position.

With a properly watered plant, adjust the moisture control until the ETI WET feeds more water — then reduce the setting.



Head on view of the complete prototype, the LED can be left out if you want extended battery life.

PARTS LIST

R1, 3	100k
R2	4M7
R4	47k
R5	22k
R6	470R
POTENTIOMETERS	
RV1	500k linear
RV2	100k linear
CAPACITORS	
C1, 2	100n polycarbonate
C3	100u 10V tantalum
C4	2200u 16V electrolytic
SEMICONDUCTORS	
IC1	D4011
Q1	2N3905
Q2	TIP31
D1	1N914
D2	LED

MISCELLANEOUS

Toggle switch 6v lantern battery Box to suit, PCB, water pump, tubing, water container, etc.

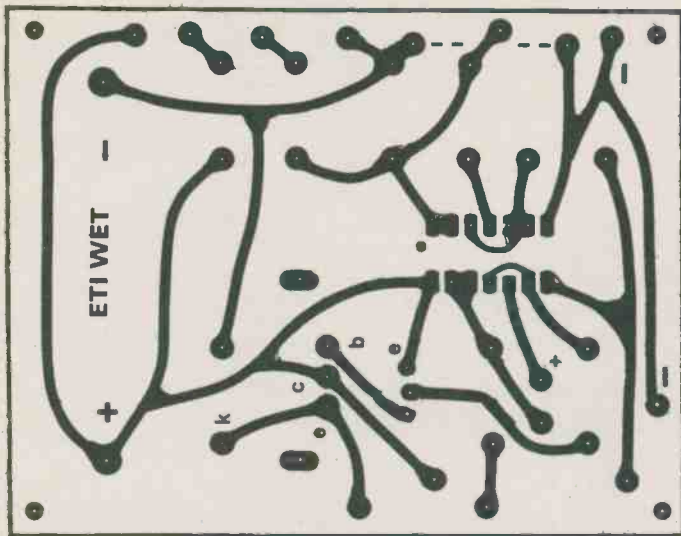

Above Right: An internal shot of our prototype, notice how we used screws to give extra 'bite' to the epoxy holding the tube connections on the front panel.
 Above is the overlay for the PCB shown full size (70mm by 90mm).
 Right: The complete system, the probe used was made from a jack plug.

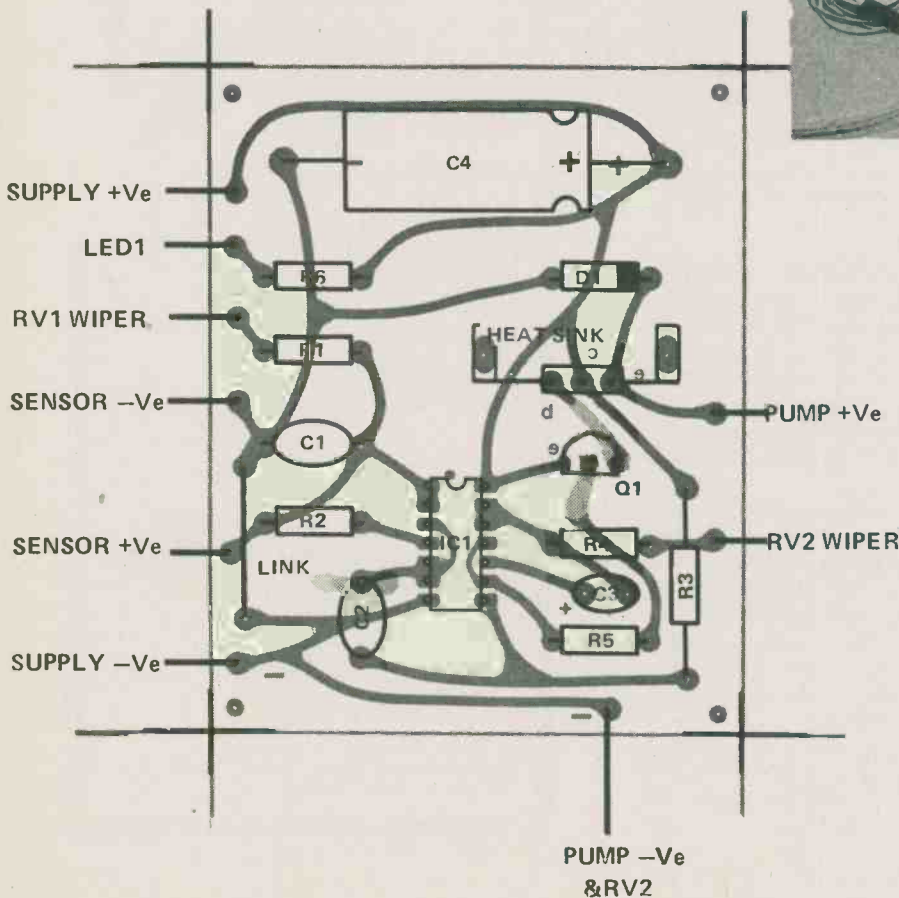
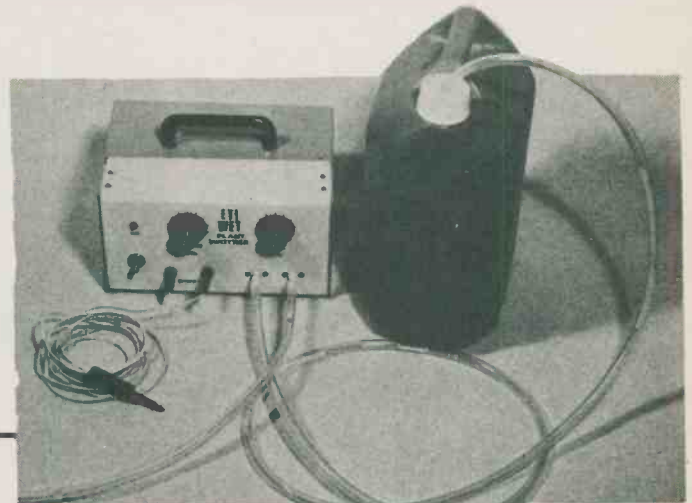
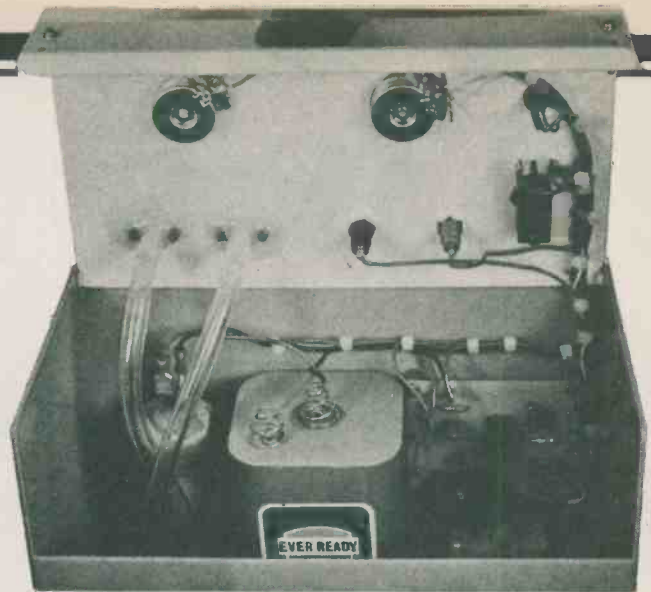

HOW IT WORKS

The circuit is composed of three main sections: Level sensitive Schmitt trigger, variable time monostable and output driver. The level sensitive Schmitt is formed from IC1a and IC1b with the probe and R1, RV1 forming a potential divider on its input. When the resistance across the probe increases beyond a set value (ie the soil dries), the Schmitt is triggered. C2 feeds a negative going pulse to the monostable when the Schmitt triggers and R2 acts as feedback, to ensure a fast switching action.

The monostable (IC1c and IC1d) time period is determined by the values of C3 and R4, RV2. When triggered by the Schmitt the monostable turns on Q1, Q2 which drive the water pump. The monostable will only trigger with negative going input pulses, and therefore unless the probe has been shorted (by water) the Schmitt cannot retrigger the monostable. This acts as a fail safe to prevent the plant from drowning!

Thus the "water flow" and "moisture level" controls must be adjusted to provide at least enough moisture to pull the input of IC1a low. This is of course a compromise. We decided on this method over simply controlling the pump from the moisture "resistance" signal directly, since in the latter system a broken wire, or accidentally removed sensor would ask the pump for infinite quantities of water, and drench not just the plant, but the carpet also.

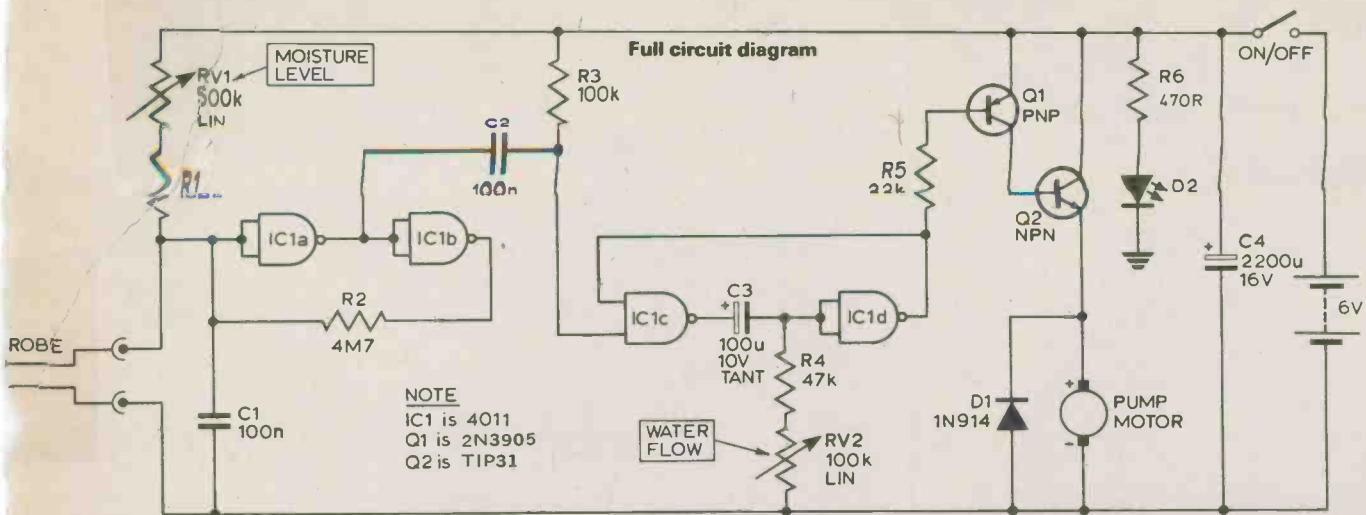

Classified

CHALLENGER SOFTWARE. Quality software now available for Superboard/Challenger systems. Send \$1.00 for listing (refundable with first order). Dealer enquiries welcome, write on letterhead or phone (416) 789-4458 for information. **CHALLENGER SOFTWARE**, 1912A Avenue Rd., Toronto, Ontario M5M 4A1 or **CHALLENGER SOFTWARE**, P.O. Box 6984, Orlando, Fl. 32803.

J&J ELECTRONICS LTD., P.O. Box 1437E, Winnipeg, Manitoba R3C 2Z4. Surplus Semiconductor Specialists. Do you get our bargain flyer? Send \$1.00 to receive the current literature and specials and to be placed on the mailing list for future publications.

LOW-PRICED, high quality ETI Project Boards. Glass epoxy, drilled, tinned, guaranteed. Custom computer interfacing - hardware and software available. Enquire about our low cost TRS-80 (TM) printer interface. For latest flyer send stamp to: **K.S.K. ASSOCIATES**, P.O. Box 54, Morriston, Ontario, N0B 2C0.

WSI RADIO - SWL Radios - Ham radios 18 Sheldon Avenue North, Kitchener, Ontario N2H 3M2. Tel. (519) 579-0536. Write for giant catalogue, free of course!! (VE3EHC).

DYNAMIC-BIAS Super Class-A Preamps and Power-amps *Colorful LED VU and Power meters *New Professional Parametric Equalizer *Bench Power Supplies *Transistor Tester *Sound, Light or Touch Activated switches *Electronic Roulette with Sound *FM Wireless Mic *Plus many other Quality Kits *Also a Complete line of 'Sound Barrier' and 'Sparkomatic' Car Stereo *Write for your **FREE CATALOGUE: CLASS-A ENTERPRISES, INC**, 104-206 E. 6th Ave., Vancouver, B.C. V5T 1J8.

KITSTRONIC INTERNATIONAL, Box 577, Station J, Toronto, Ont, M4J 4Z2. Amplifier kits and semiconductor specialists. ECG replacement transistors available. 200W, 30A Audio transistors MJ15003, 15004 \$9.00 per pair. MJ802, 4502 \$8.00 per pair. Send \$1.00 for our Catalogue (refundable with order).

SUPREME ELECTRONICS, P.O. Box 6370 Stn. C, Victoria, B.C. V8P 5M5. Send \$1.00 to receive your 1980 catalogue... Give us a try for all your electronic needs.

PRINTED CIRCUIT BOARDS available for all ETI projects. Custom work available upon request. Enquire about our large selection of parts. For details write to: **WENTWORTH ELECTRONICS**, R.R.1, Waterdown, Ontario, Canada. L0R 2H0.

PRINTED CIRCUIT BOARD BONANZA Try B & R Electronics for all your PC Board requirements We stock boards for all projects in this Canadian Project Book 2, and Summer '80 Special Projects Book. We also stock boards for ETI magazine projects since February 1977. Full list free. Send cheque, Money Order, or COD. Post and Pack 50¢. **B & R ELECTRONICS**, Box 6326F, Hamilton, Ontario. L9C 6L9

**VOUS SEUL POUVEZ
OFFRIR LE DON
DE LA VIE!**

**Donnez du sang
régulièrement à la
CROIX-ROUGE**

**Perform a
death-defying
act.**

Give Heart Fund.

Give Heart Fund

ETI SPECIALS

Electronic Circuit Design
 92 pages
 A collection of major articles on various aspects of circuit design including CMOS, Audio Amplifiers, Power Supplies, SCR's, Op-Amps. Using the 3080 and Temperature Control. A large number of useful circuits are given but the emphasis is on guidance and how to tackle the design for yourself.

\$3.95

Special Publication
 Summer 1980



Canadian Projects Book No. 1
 100 pages
 25 of our most popular projects from our earlier issues including: Audio Limiter, 5W Stereo, Bass Enhancer, Modular Disco, 50W/100W Amp Modules, 1B Metal Locator, Touch Organ, Electronic Mastermind, Double Dice, Reaction Tester, Sound Operated Flash Burglar Alarm, Injector-Tracer, Digital Voltmeter.

\$3.00



Hobby Projects
 100 pages
 First published Summer 1980. Contains 25 straight-forward projects most of which have never appeared in the magazine including: Stereo Amp, Audio Mixer, Scratch and Rumble Filter, Constant Volume Amp, Graphic Equaliser, Envelope Generator, White Noise Effects Unit, Linear Scale Ohmmeter, Intercom, Drill Speed Controller, LED Tacho, Parking Meter Timer, Electronic Organ, Touch Switch, Electronic Dice, Siren, Simple Receivers.

\$3.95

Special Publication
 Summer 1980



More Circuits
 Over 150 circuits plus articles on Construction, Test Gear, a project on a Digital Panel Meter, Design notes on Crossovers, TTL pin-outs, Design notes on Crystal Oscillators.

\$4.50



Available from your local electronic parts store or direct from ETI (please add 45c each to cover postage).
 Send money to:
 Electronics Today Magazine,
 Unit 6, 25 Overlea Blvd.,
 Toronto, Ont.,
 M4H 1B1

60 YEARS OF SERVICE

Technical Books
5000 titles
 to choose from!
10% OFF
ALL COMPUTER BOOKS

OPTO SPECIAL
 SLV R — SLV Y — SLV G
\$0.10 each or
SAVE!
 Buy 100 for **ONLY**
\$8.99

LOW PRICES!!

Centralab Specials

CAP.	VOLTAGE	PART#	PRICE	CAP.	VOLTAGE	PART#	PRICE
5 PF	1000 Volt	DD-050	.12	001 MFD	1000 Volt	DD-102	.12
8 PF	1000 Volt	DD-080	.12	002 MFD	1000 Volt	DD-202	.21
10 PF	1000 Volt	DD-100	.12	0022 MFD	1000 Volt	DD-222	.19
15 PF	1000 Volt	DD-150	.12	003 MFD	1000 Volt	DD-302	.16
25 PF	1000 Volt	DD-250	.12	0033 MFD	1000 Volt	DD-332	.10
27 PF	1000 Volt	DD-270	.14	0047 MFD	1000 Volt	DD-472	.16
33 PF	1000 Volt	DD-330	.16	01 MFD	25 Volt	UK25-103	.12
47 PF	1000 Volt	DD-470	.16	01 MFD	50 Volt	UK50-103	.12
50 PF	1000 Volt	DD-500	.18	01 MFD	1000 Volt	DD-103	.17
68 PF	1000 Volt	DD-680	.16	022 MFD	18 Volt	UK18-223	.20
100 PF	1000 Volt	DD-101	.12	05 MFD	10 Volt	UK10-503	.16
150 PF	1000 Volt	DD-151	.12	05 MFD	12 Volt	UK12-503	.20
220 PF	1000 Volt	DD-221	.14	05 MFD	20 Volt	UK20-503	.14
270 PF	1000 Volt	DD-271	.18	05 MFD	25 Volt	UK25-503	.22
330 PF	1000 Volt	DD-331	.16	05 MFD	50 Volt	UK50-503	.36
390 PF	1000 Volt	DD-391	.12	01 MFD	600 Volt	DD-603	.32
470 PF	1000 Volt	DD-471	.15	1 MFD	10 Volt	UK10-104	.16
500 PF	1000 Volt	DD-501	.13	1 MFD	12 Volt	UK12-104	.25
680 PF	1000 Volt	DD-681	.18	1 MFD	18 Volt	UK18-104	.25
750 PF	1000 Volt	DD-751	.16	1 MFD	20 Volt	UK20-104	.29
				1 MFD	25 Volt	UK25-104	.44

MICROCOMPUTERS

S100 MODULES - SPECIAL OF THE MONTH
CALIFORNIA COMPUTER SYSTEMS

CCS-2810A	Z80 Based CPU A&T	\$276.00
CCS-2065A	64K Dynamic Ram Board A&T	645.00
CCS-2422A	Floppy Disk Controller & CP/M A&T	339.00
CCS-2200K	Card Cage Kit	575.00

SD SYSTEMS — S100

SD-Z80K	Z80 Based Starter Kit	\$460.00
SBC 200	Single Board CPU Kit	433.00
PROM-100	Programming Board Kit	271.00
EXPANDOPROM	PROM Board Kit	238.00
EXPANDORAM II	Memory Board (No RAM) Kit	309.00
RAM UPGRADES	Ram Upgrades 200NS	50.00/16K
VDP 8024	80 x 24 Video Board Kit	499.00
VERSAFLOPPY II	Floppy Disk Controller Kit	439.00

ASK ABOUT SSM AND DELTA PRODUCTS

look

Memories

NO.	DESCRIPTION	PRICE
2508	250 ns.	35.00
2516	16K EPROM	12.00
2716	16K EPROM	20.00
25L32	32K EPROM	120.00
2532	32K EPROM	36.00
2564	64K EPROM	270.00
4116	200 ns.	6.75
4164	64K RAM	135.00
2114L	450 ns.	8.00

CMOS

TYPE NO.	PRICE	TYPE NO.	PRICE	TYPE NO.	PRICE
4001	.34	4040	1.16	4082	.29
4002	.30	4045	1.05	4093	1.03
4010	.64	4049	.55	4174	1.28
4011	.34	4050	.51	4175	1.33
4012	.35	4051	1.01	4490	1.60
4013	.50	4078	.38	4508	2.30
4015	1.46	4069	.34	4511	.90
4020	1.46	4070	.48	4512	1.03
4023	.35	4071	.30	4516	1.29
4024	.60	4072	.29	4518	1.15
4025	.35	4073	.40	4520	.85
4028	.65	4075	.38	4538	1.00
4029	1.16	4076	.90	4572	.50

SCR's and TRIACS

TIC 116B	1.26
TIC 126B	1.42
TIC 216B	1.29
TIC 226B	1.23
TIC 236B	1.80
TIC 246B	1.82

PLASTIC POWER TRANSISTORS

TIP29	.50	TIP42	.85
TIP30	.52	A, B, or C	.70
A, B, or C	.52	TIP115	.80
TIP31	.55	TIP120	.94
A, B, or C	.55	TIP122	.94
TIP32	.59	TIP125	.94
A, B, or C	.59	TIP127	1.08
TIP41	.75	TIP2955	1.07
A, B, or C	.75	TIP3055	.91

7400 LS

74LS00N	.29	74LS27H	.40	74LS83N	.80	74LS164N	.82	74LS273N	1.70
74LS01N	.27	74LS30N	.35	74LS85N	1.10	74LS165N	1.60	74LS275N	5.50
74LS02N	.36	74LS32N	.50	74LS90N	.56	74LS166N	2.00	74LS279N	.75
74LS03N	.29	74LS38N	.42	74LS91N	1.02	74LS170N	2.00	74LS280N	3.25
74LS04N	.36	74LS40N	.42	74LS92N	.60	74LS173N	.94	74LS283N	1.20
74LS05N	.35	74LS42N	.58	74LS93N	.49	74LS174N	.66	74LS290N	1.08
74LS08N	.36	74LS47N	.90	74LS95N	.70	74LS175N	.68	74LS293N	.90
74LS09N	.40	74LS48N	1.50	74LS96N	.80	74LS181N	1.00	74LS295N	1.30
74LS10N	.30	74LS51N	.37	74LS107N	.48	74LS190N	1.00	74LS299N	3.50
74LS11N	.42	74LS54N	.30	74LS112N	.50	74LS191N	1.00	74LS323N	6.25
74LS12N	.34	74LS55N	.36	74LS122N	.69	74LS192N	.84	74LS324N	1.40
74LS13N	.46	74LS73N	.46	74LS123N	.90	74LS193N	1.10	74LS348N	2.50
74LS14N	.61	74LS74N	.85	74LS124N	1.18	74LS194N	.90	74LS352N	1.50
74LS20N	.34	74LS75N	.50	74LS125N	1.00	74LS195N	.84	74LS353N	1.50
74LS21N	.36	74LS76N	.50	74LS126N	.60	74LS196N	1.20	74LS362N	10.00
74LS26N	.40	74LS78N	.44	74LS132N	.65	74LS197N	1.26	74LS365N	.90
				74LS136N	.60	74LS221N	1.12	74LS366N	1.00
				74LS138N	.80	74LS240N	1.40	74LS367N	1.00
				74LS139N	.80	74LS241N	1.40	74LS368N	1.00
				74LS145N	1.60	74LS243N	1.28	74LS373N	1.90
				74LS148N	1.90	74LS244N	1.40	74LS374N	1.90
				74LS151N	.58	74LS245N	2.50	74LS375N	1.00
				74LS153N	.55	74LS247N	1.10	74LS377N	1.80
				74LS155N	1.10	74LS248N	1.50	74LS378N	1.50
				74LS156N	1.10	74LS249N	1.20	74LS379N	2.00
				74LS157N	.65	74LS251N	1.00	74LS390N	2.00
				74LS158N	.60	74LS253N	.74	74LS393N	2.00
				74LS160N	1.10	74LS257N	.80	74LS395N	1.30
				74LS161N	1.10	74LS258N	.80		
				74LS162N	1.10	74LS259N	2.00		
				74LS163N	1.10	74LS266N	.60		

Sockets

8 Pins	.10
14 Pins	.16
16 Pins	.18
20 Pins	.22
22 Pins	.24
24 Pins	.26
40 Pins	.42



FOR \$1695⁰⁰, YOU GET

Apple II 16K	1695 ⁰⁰
16K Memory	100 ⁰⁰
RF Modulator	41 ⁰⁰
OR	reg.1836⁰⁰
Apple II 16K	1695 ⁰⁰
RF Modulator	41 ⁰⁰
Cassette Recorder	65 ⁰⁰
	Reg.1801⁰⁰

NEW! THE 1981 CESCO HOBBY ELECTRONICS CATALOGUE

For your **FREE** copy of the CESCO Hobby Electronics Catalogue send this coupon to the address below.

Name _____ Apt. _____
 Street _____
 City _____ Prov. _____ Postal Code _____

ALL PRICES ARE CANADIAN FSTP

CESCO
 electronics ltd.

4050 Jean Talon Street West,
 Montreal, Que. Canada H4P 1W1
 Tel.: (514) 735-5511 Telex: 05-25590
 Twx: 610-421-3302

Prices subject to change without notice.

FREE
TEXAS INSTRUMENTS
WATCH (value
 \$44.95) with every
 \$150.00 purchase!
 Offer valid until
 March 1, 1981

GLADSTONE ELECTRONICS

Logical Systems



318 SILENCER — Noise Reduction Kit. Up to 15 db hiss reduction on any programme source, with no loss of high end! Adjustable trigger level. Ideal for tape playback and record. ... \$219.95



1081 REAL TIME AUDIO ANALYZER KIT. 10 channel LED display forms a picture of any audio signal. Built in noise generator shows any audio system's response in its environment and allows you to equalize to improve the overall response. 19" rack-mount size.



VSA VOICE STRESS ANALYZER. Unique kit analyzes the harmonic content of any voice to detect the presence of "stress". Not a lie-detector, the VSA Kit can be used in person, for TV and radio, and over the phone. LED display indicates the degree of stress in the subject's voice. Reviewed in ETI Jan. 81. ... \$149.95

PAIA



PAIA ELECTRONIC MUSIC SYNTHESIS EQUIPMENT ...

From the analog basics to computer controlled digital systems, PAIA kits offer unprecedented value for the hobbyist as well as serious musician. Pictured: 4700/J Computer/Synthesizer Package with Polyphonic capability. Includes digitally encoded keyboard, D/A converter, two balanced modulators (VCA's), three VCO's, noise source, filter, two envelope generators, reverb, three watt block power supplies, and two road-module cabinets. All this for ... \$1,250.00



SUB-WOOFER ELECTRONIC CROSSOVER. 18 db/octave slope, 100 Hz crossover frequency. Using low-tolerance components for state-of-art systems. Model 5000 Kit ... \$163.55

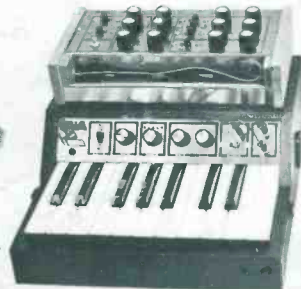

GNOME Micro-Synthesizer. Perfect introduction to electronic music, the Gnome kit provides two envelope generators, VCA, VCO, and VCF in a low cost, easy to use package. ... \$129.00
OZ Mini-Organ. A battery-operated polytonic keyboard instrument, with built-in speaker and amplifier. Over 6 1/2 octave range, with adjustable tuning, plus a "pitch-blender" for special effects. Complete kit only ... \$225.00
SAVE \$15.00! Both for ... \$339.00

Ace Audio

SUBSONIC FILTER (18 db/octave). Prevents over-driving of woofers, and consequent waste of amplifier power. Sharp cut-off at 20 Hz with distortion typically .005%. Model 4000 Kit ... \$123.99

GLADSTONE'S SPEAKERMART

is Canada's

15" SUPER SYSTEM

150 WATT COMBINATION

\$169.95

Gladstone Electronics carries a wide selection of speaker components, many not available from other sources. Full details are listed in our catalogue — free upon request. Brand names carried in STOCK and set-up for DEMONSTRATION include: * PHILIPS DEFOREST * KEF * PEERLESS * DECCA * JBL * MOTOROLA * CELESTION * FALCON CROSSOVERS

Shown at left is our popular Philips DeForest 15" Super-System — comparable with factory complete systems at \$400-\$500.

Sinclair ZX80

PRICE and PERFORMANCE breakthrough in a personal computer! The ZX80 operates in BASIC, the most common, easy-to-use computer language. It matches or surpasses other personal computers costing several times more.

- * 4K Integer BASIC
- * 32 character by 24 line display
- * Unique "one touch" entry. Key words (RUN, PRINT, etc.) have their own single-key entry
- * Automatic error detection
- * Powerful string editing facilities
- * Programmable in machine language
- * 22 graphics symbols
- * Up to 26 string variables of any length
- * Build-in random number generator



ONLY \$349.95

Price includes TV and Cassette connectors, AC Adapter, and 128-page Guide-to-ZX80-Computing Manual.

COMING: 16K Memory Expansion.



Digital Multimeters

TM351 3 1/2 digits with L.C.D. Display. Up to 4000 hours of battery life. Measures AC and DC volts and current (up to 10A), ohms to 20 Meg. Basic accuracy is .1%. Professional quality instrument. ... \$359.00
TM353. 3 1/2 digit L.C.D. with .25% accuracy. ... \$289.00

DMMs with LED Displays

PDM35 3 1/2 digit hand-held \$ 89.95
DM235 3 1/2 digit bench/portable 109.95
DM350 3 1/2 digit high accuracy 194.95
DM450 4 1/2 digit high accuracy 239.95
 Limited time/quantity specials!

thandar TEST INSTRUMENTS

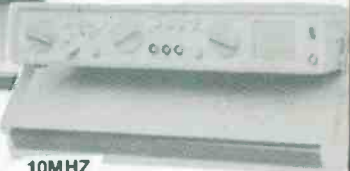

10MHZ PORTABLE OSCILLOSCOPE

A full-performance scope, light-weight and battery-operated, only 2" thick! Impossible? No, the Thandar SC110 weighs 2 1/2 lbs, runs off standard "C" cells (or nicad rechargeables), and offers a surprisingly useful trace on a 2" diagonal CRT. Full trigger facilities. Sensitivity down to 10 mV/division. Full range of accessories available. SC110 ... \$529.00



AUDIO MODULES

5 POWER AMPLIFIERS

- * Built in heatsinks
 - * Full circuit protection
 - * 5 simple connections
- HY30** 15 watts RMS into 8 ohms \$ 29.95
HY50 30watts RMS into 8 ohms 34.50
HY120 60 watts RMS into 8 ohms 67.50
HY200 121 watts RMS into 8 c. rms 93.50
HY400 240 watts RMS into 4 ohms 117.00

FIVE YEAR WARRANTY!
 super-clean for hifi ...
 reliable for pro systems!

2 PREAMPLIFIERS

- * Low Distortion — 0.005%
 - * Require only pots, switches, plugs and sockets
- HY8** Mono preamp \$31.95
HY86 Stereo preamp 59.95

Unique Electronic Products from

GLADSTONE ELECTRONICS

1736 Avenue Rd. Toronto, Ont. M5M 3Y7

Telephone Orders
 (416) 787-1448

Request FREE GLADSTONE ELECTRONICS CATALOGUE
 Order by MAIL or PHONE. VISA and MASTERCHARGE Accepted.
 ONTARIO RESIDENTS: Shop in Person Tuesday to Saturday.
 Prices in effect as of issue date, subject to change