

\$1.95  
MM70924

# Electronics Today

INTERNATIONAL

January 1982

TEMPERATURE  
CONTROLLED  
SOLDERING  
IRON

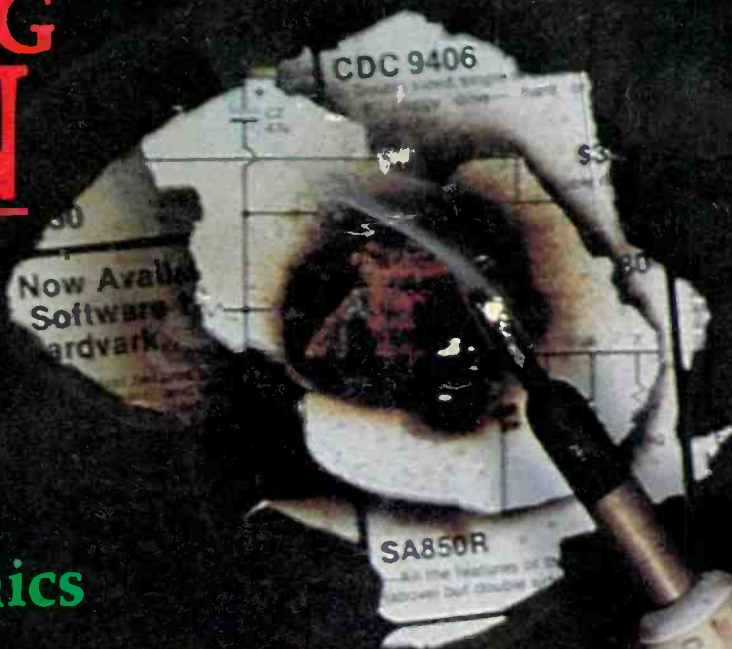

Big Bang

SLR Electronics

Stores Directory

Micropower Circuits

1981  
INDEX



4-WAY  
LOUDSPEAKERS

3773 0482 03  
LY  
EVENSON  
ON K1Z 6M9

# ARKON electronics ltd



## WE ARE THE BEST!

**Discover our world of electronics**  
 We welcome you; whether you're a hobbyist or industrial developer to visit us in downtown Toronto or give us a call. Qualified staff is always on hand to solve your problems or fill your order. What ever your needs you can lean on us.

We stock these fine computer product lines and more

 Rockwell International

 **Mullen**

  **COSMAC VIP**

**Value packed RCA Cosmac Microcomputer VP711**

Features RCA COSMAC Microprocessor. 2K RAM, expandable to 32K (4K on-board). Built-in cassette interface and video interface. 16 key hexadecimal keypad. ROM operating system. CHIP-8 language and machine language. Tone generator and speaker, 8-bit input port, 8-bit output port, and full system expansion connector. Power supply and 3 manuals (VP-311, VP-320, MPM201B) included. Completely assembled.

**VP711 \$342.00**

Beginners set, 1K expandable to 32K. User must install cables (supplied) and Furnish 5 volt power supply and speaker.

**VP111 \$162.50**

**Every Day Memory SPECIALS**

4116-150NS	\$ 3.15
4116-200NS	\$ 2.50
4116-300NS	\$ 1.80
2114-200NS	\$ 3.75
2114-450NS	\$ 2.95
2102-250NS	\$ 1.75
5101 CMOS	\$ 3.95
2708 EPROM	\$ 4.25
2716 EPROM	\$ 5.50
2732 EPROM	\$12.50
2532 EPROM	\$16.75

**There's just no comparison**

**OHIO SCIENTIFIC**

**Superboard II Microcomputer**

Includes extra 4K memory and one video modulator.

**Compare what you get for \$455.00**

**AARDVARK TECHNICAL SERVICES**

**Ohio Scientific Software**

We've always been an AARDVARK dealer, we know the product and we have the most extensive stock anywhere.

**8" and 5 1/4" FLOPPY DISK DRIVES**



MICRO PERIPHERALS INC.

**MODEL 51**  
 250K-BYTE capacity single sided double density  
 48 TPI **\$399.95**

**MODEL 52**  
 500K-BYTE capacity double sided double density  
 48 TPI **\$549.95**

**MODEL 91**  
 500K-BYTE capacity single sided double density  
 96 TPI **\$549.95**

**MODEL 92**  
 1 MEGABYTE capacity double sided double density  
 96 TPI **\$712.95**

**Super Special**  
 Siemens 8" Drive  
 FDD-100-8 Single sided, single or double density  
**\$625.00 2 for \$1200.00**

**SUP 'R' MOD II**

Wide band black and white or colour compatible interface system intended to convert the home TV to a full video display. Great for home computer. Includes coaxial cable and antenna transformer. Assembled. Super 'R' MOD II video modulator.

**\$44.95**

**ASCII KEYBOARDS**

Just another everyday low, low price. Microswitch. Two types to choose from.

**\$39.95**

**IC Sockets Soldertail \$1 SAVINGS**

8 pin	10 for \$1.00
14 pin	8 for \$1.00
16 pin	8 for \$1.00
18 pin	6 for \$1.00
22 pin	5 for \$1.00
24 pin	4 for \$1.00
28 pin	4 for \$1.00
40 pin	3 for \$1.00

**Way under a penny a pin.**



**5 1/4" DISKETTES**

104/1 SSSD Soft Sector 35 TRK 5/BX	7.50
107/1 SSSD 10 Sector 35 TRK 5/BX	7.50
105/1 SSSD 16 Sector 35 TRK 5/BX	7.50
104/1D SSDD Soft Sector 35 TRK 5/BX	8.50
107/1D SSDD 10 Sector 35 TRK 5/BX	8.50
105/1D SSDD 16 Sector 35 TRK 5/BX	8.50
205/1D SSDD 96/100 10/BX	12.50
104/2D DSDD Soft Sector 35 TRK 5/BX	9.95
107/2D DSDD 10 Sector 35 TRK 5/BX	9.95
105/2D DSDD 16 Sector 35 TRK 5/BX	9.95
205/2D DSDD 96/100 10/BX	14.95

**8" DISKS**

3740/1 SSSD 10/BX	9.25	3740/1D SSDD 10/BX	11.50
		3740/2D DSDD 10/BX	13.00

**TTL, CMOS, Linear Microprocessors**

Check out our latest prices. They just can't be beat.

**Call 868-1315**

**This month's Instock Specials**

6809 P	\$24.95
4164-150NS	\$16.25
4016-150NS	\$16.25

Pin for pin with TMM2016

Send certified cheque, money order, (VISA, Master Card or American Express)...include expiry date, card number and signature. We process only prepaid orders. Minimum order \$10.00. Add 5% (minimum \$2.00) for shipping and handling. Ontario residents add 7% sales tax.

**ARKON ELECTRONICS LTD.**  
 409 Queen Street West, Toronto, Ontario M5V 2A5 868-1315

Send \$2.50 for Arkon 81/82 Catalogue 100 pages

(add 60¢ postage)



**BOOKS**

Our book room is bigger and better than anything you have ever seen. Over 1000 titles in stock now.

# Exceltronix

Components & Computing Inc.

Start off your New Year right with "the best" . . . Exceltronix.

Super Draw — every mail order over \$25.00 received between Jan 1st and Feb 28th will be entered in a draw for a Multiflex Z80.

## YOU CAN'T BEAT THE BEST!

### NEW 6809 SINGLE BOARD COMPUTER

We are pleased to announce the arrival of this versatile new computer, which is extensively used by the University of Toronto for teaching purposes. Among its standard features are: 16K of RAM memory (expandable to 48K on board), 2 serial ports, 2 6522 parallel ports, a cassette interface, and an extremely powerful monitor. This month we are offering this state-of-the-art computer, with an extra 16K of RAM (32K in total), in kit form for the special price of \$495.

Kit Price **\$495**  
Assembled **\$695**

### MEMORY SUPER SPECIALS

very good stock

4164-150ns	13.95
(1 x 64K single (+5V) supply)	
4116-150ns (1x16k)	2.79
4116-200ns (1x16k)	2.50
4116-300ns (1x16k)	1.69
2117-200ns (1x16k)	3.95
(Single +5V supply)	
2114L-200ns low power	3.25
TMM 2016 (2 k x 8 static RAM)	
NOTE: 1 of these can do the job of 4 2114's but uses only one 24 pin socket	<b>\$13.95</b>
2102 CFPC	\$1.57
5101 CMOS	3.85
2708 EPROM (1k)	3.50
2716 EPROM (2k)	6.35
2732 EPROM (4k)	13.45
2532 EPROM (4k)	15.75

FOR QUANTITIES OF OVER 33 PIECES CONTACT US FOR SPECTACULAR PRICING

### Rockwell AIM-65 Computer \$635

Good stock of Aardvark software available at super prices

Ohio Scientific SUPERBOARD II with 8K of memory only **\$439<sup>00</sup>**

RF Modulator kit only \$8.95 extra



### MULTIFLEX Z80A COMPUTER SYSTEM

You've heard all about it. If not check the May ETI for an independent review

Almost everybody has one . . . have you? **\$375.00** kit \$475.00 assembled and tested.



**64K Memory board**  
Using 4164s, 150ns, dynamic RAMS requiring only single +5V  
Kit price **\$249.00**

### GOOD STOCK ON MICROPROCESSORS AND SUPPORT SPECIALS

1802	\$13.50	6502 CPU	6.95	8228	5.00
1822	9.50	6504 CPU	8.95	8251	5.65
1824	4.49	6505	9.25	8253	7.99
1824	2.50	6507	6.99	8255	5.60
1852	1.80	6522	9.99	8257	6.75
1853	1.80	6532	13.50	8259	8.68
		6532	13.95		
6800	5.69	6551			
6802	8.75				
6809	21.95	8080A CPU	4.99	Z80A CPU	7.95
6810	3.39	8085 CPU	5.99	Z80A PIO	8.75
6820	3.95	8212	2.10	Z80A CTC	9.50
6821	3.35	8214	3.75	Z80A DMA	19.75
6845	17.99	8216	2.10	Z80A SIA/1	35.75
6850	3.39	8224	3.75	Z80A SIO/2	35.95
6852	3.37	8226	2.10	Z80A SIO/9	21.50
				Z80A DART	18.75

### PRICE POLICY

Remember that at Exceltronix, all prices are negotiable for quantity purchases. If you cannot afford large quantities on your own, how about starting a Co-op.

### Hameg Oscilloscopes

The specials continue on German-made Hameg scopes:

model	reg.	sale price
HM307	\$550.00	\$495.00
HM312	\$855.00	\$769.00
HM412	\$1277.00	\$1149.00
HM512	\$2000.00	\$1795.00

### Floppy Disk Drives

**CDC 9406 \$650**  
— Double sided, single or double density 8" floppy drive— hard or soft-sectored

**Shugart SA400 \$390**

— Single sided, single or double density 5 1/4" floppy drive  
— Soft or hard sectored

**SA450 \$580**

— All the features of the SA400 (above) except double sided

**SA801R \$685**

— Single sided, single or double density 8" floppy drive  
— Hard or soft-sectored  
— Designed for side-by-side mounting of two drives in a standard 19-inch rack

**SA850R \$950**

— All the features of the SA801R (above) but double sided



SAVE . . . now we have an Interface making the SA400 disk drives fully compatible with your **Apple II**

Contact us for more information.

### MAIL ORDERS

Send a certified cheque or money order (do not send cash). Minimum order is \$10 plus \$3 for shipping. Ontario residents must add 7% provincial sales tax. Visa and Mastercard accepted: send card No., signature, expiry date and name of bank.



VERSAFLOPPY II Disk Controller	<b>\$498</b>
SBC209 Single-Board Computer	<b>\$445</b>
EXPANDORAM II Memory Board	<b>\$319</b>
VDB 8024 Video Board	<b>\$539</b>
MPB100 CPU Board	<b>\$348</b>
PROM 100 EPROM Programmer	<b>\$279</b>
MPC4 4-Channel Serial I/O Board	<b>\$685</b>
EXPANDOPROM EPROM Board	<b>\$197</b>
Z80 Starter Kit	<b>\$485</b>

For descriptions and photos, refer to ETI June 1981.

We also provide assembled and tested S.D. Systems boards at \$85 extra. Versafloppy 2 is \$130 extra since it requires critical tuning.

**\$100 Back Plane with 7 slots . . . \$25.00**  
(S100 connectors extra \$5.00 each)  
**\$100 Back Plane with active termination 13 slots . . . \$48.00**  
(Signal line isolation)  
**\$100 Prototyping Board — \$34.95**

**Apple II + with 48K**  
This month only **\$1779.00**  
Apple drive with controller . . . **\$785.00**

**Centronics Printers**  
730-1 . . . **\$945.00**  
730-3 Serial interface . . . **\$979.00**  
739-1 Parallel . . . **\$1195.00**  
EPSON MX80 . . . **\$819.00**

Check out our selection of **DIGITAL SIGNS**



319 COLLEGE STREET, TORONTO, ONTARIO, CANADA, M5T 1S2 (416) 921-5295  
ALL PRICES ARE IN CANADIAN FUNDS, 9% FEDERAL SALES TAX INCLUDED

**Electronics Today International**  
 Editorial and Advertising Offices  
 Unit 6, 25 Overlea Boulevard,  
 Toronto, Ontario, M4H 1B1  
 Telephone (416) 423-3262

**Publisher and Editor**  
 HALVOR W. MOORSHEAD

**Assistant Editor**  
 STEVE RIMMER

**Advertising Manager**  
 SENG HARRISON

**Advertising Services**  
 CAROLYN WYATT

**Subscription Department**  
 BEBE LALL  
 NADIA MARAR

**Accounts Department**  
 NANCY ALLEN

**Art Director**  
 TERRY FLETCHER

**Production**  
 CINDY BAKER

**Contributing Editors**  
 WALLACE PARSONS



**INTERNATIONAL EDITIONS**  
 Electronics Today International,  
 145 Charing Cross Road,  
 London WC2H 0EE, UK  
 Electronics Today International,  
 Ryrie House, 15 Boundary Street,  
 Rushcutters Bay, Sydney, Australia  
 Eirad  
 Kommanditgesellschaft, Bissendorfer  
 Strasse 8, 3000 Hannover 61, Germany  
 Electronica Top Internationaal  
 Postbus 93, Bilthoven, Holland

**ETI Magazine is Published by:**

Electronics Today International (Canada) Limited  
 Newsstand Distribution: Master Media, Oakville,  
 Ontario

**SUBSCRIPTIONS**  
 \$16.95 (one year), \$29.95 (two years). For US  
 add \$3/yr., other countries add \$5/yr. Please  
 specify if subscription is new or a renewal.

**BACK ISSUES AND PHOTOCOPIES**  
 Previous issues of ETI Canada are  
 available direct from our offices for  
 \$3.00 each; please specify by month, not by  
 feature you require. See order card  
 for issues available.  
 We can supply photocopies of any article  
 published in ETI Canada; the charge is  
 \$2.00 per article, regardless of length. Please  
 specify both issue and article.

**POSTAL INFORMATION**  
 Second Class Mail Registration No.3955.  
 Mailing address for subscription orders, undeliverable  
 copies and change  
 of address notice is:  
 Electronics Today International, Unit 6,  
 25 Overlea Blvd., Toronto,  
 Ontario, M4H 1B1.

**COPYRIGHT**  
 All material is subject to worldwide copyright protec-  
 tion. All PCB patterns are copyright and no company  
 can sell boards to our design without our permission.

**LIABILITY**  
 While every effort has been made to ensure that all  
 constructional projects referred to in this magazine  
 will operate as indicated efficiently and properly and  
 that all necessary components are available, no  
 responsibility whatsoever is accepted in respect of the  
 failure for any reason at all of the project to operate  
 efficiently or at all whether due to any fault in the  
 design or otherwise and no responsibility is accepted  
 for the failure to obtain component parts in respect of  
 any such project. Further no responsibility is accepted  
 in respect of any injury or damage caused by any fault  
 in design of any such project as aforesaid.

# Electronics Today

INTERNATIONAL

JANUARY 1982 Vol. 6 No. 1

## Features

**Loudspeaker Design Principles (part 2) . . . . . 10**

This month, David Tilbrook finishes his discussion of the dark and mystical arts of loudspeaker design alchemy. Understand all those complex formulae with nothing more than a calculator and an incantation.

**Stores Survey . . . . . 23**

If you need parts and live someplace you really shouldn't, this listing will probably be immensely useful to you. . . unless there really isn't a parts store in your town.

**Big Bang . . . . . 31**

One theory of the creation of the universe is that it began with a huge explosion. There is considerable evidence for this idea, as, shortly after it was created, four people called the cops.

**Looking Into The ATOM . . . . 36**

The Acorn Atom is a new computer with all sorts of amazing features and capabilities, including the ability to turn itself into a live alligator and devour would be computer thieves. Won't buy that last bit, aye? Well, check out our mini-review for the CROC function.

**SLR Electronics . . . . . 39**

Cameras are another one of those areas where advances in electronics have advanced the state of the art. Are we about to see a 32K, 16 bit Instamatic?

**Micropower Circuits . . . . . 45**

A look at circuits that use so little energy that if they were people you'd swear they were civil servants.

**Into Linear IC's . . . . . 50**

Before you can expect to get heavily into Linear IC's, you're going to have to know how to work with them. Otherwise, says Ian Sinclair, they'll become non-linear; the output signal will always be non-existent.

**1981 Index . . . . . 64**

A listing of the sum total of man's knowledge minus any of it we didn't happen to publish last year.

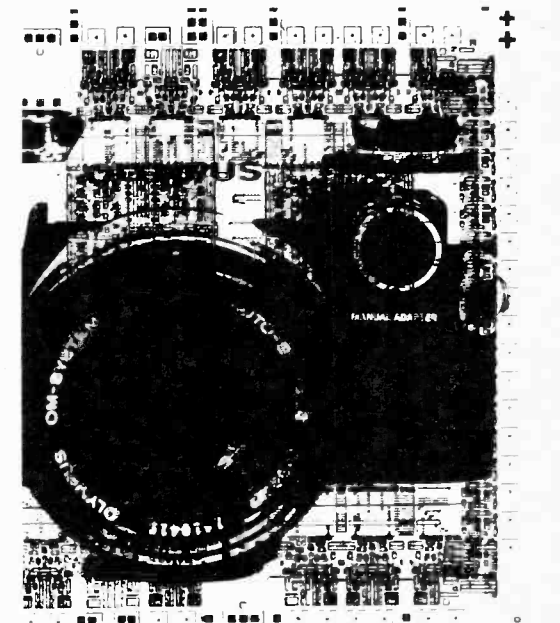
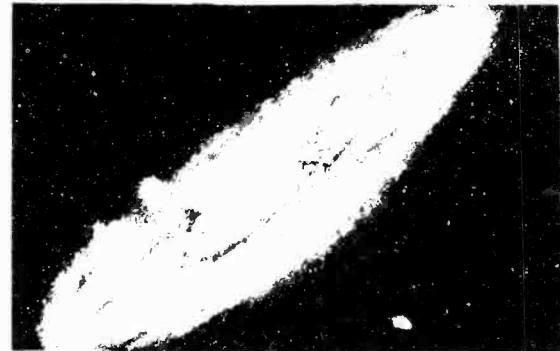

A white hot soldering iron is great for evaporating troublesome components, branding cattle and re-attaching the wings of fighter planes. For smaller jobs, though, it can be handy to be able to cool the thing down to just a dull red glow. Enjoy a full range of control with our temperature controlled soldering iron on page 68.

(For NEW ETI asbestos binders, see the classifieds)

ISSN 0703-8984

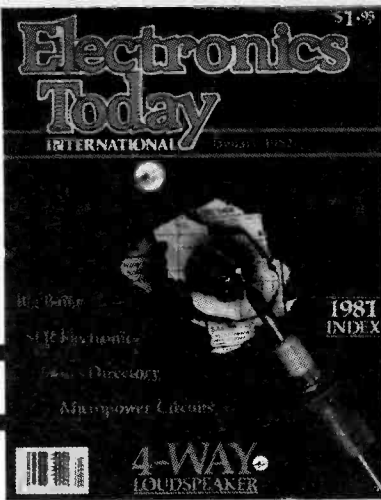

Page 14

# Projects



## 4 Way Loudspeaker . . . . . 14

Yes, lather up grand daddy's rip saw and pull up the floorboards; it's ETI's speaker project. Build two for stereo or four for really loud table legs.

## Movement Alarm . . . . . 33

This simple little circuit will warn you should anybody move who isn't supposed to. Perfect for mortuaries with unscrupulous salesmen.

## Temperature Controlled Soldering Iron . . . . . 68

With but a single pot dial any soldering temperature from tepid to complete incineration of your work table.

Page 36



# Columns News & Info

News . . . . .	7
Books From ETI . . . . .	20
Reader Service Card . . . . .	44
Order Form . . . . .	48
Subscriptions . . . . .	49
Next Month in ETI . . . . .	53
T Shirts . . . . .	57
Fun of Electronics . . . . .	61
Tech Tips . . . . .	66
Binders . . . . .	70

## ADVERTISERS' INDEX

Active Component Sales Corp. . . . .	43
Arkon Electronics . . . . .	2
Audiovision . . . . .	8
BCS Electronics . . . . .	65
Classified . . . . .	62
Dominion Radio and Electronics . . . . .	71
Electronic Packaging Systems . . . . .	68
Epitek Electronics Ltd . . . . .	8
Exceltronix . . . . .	3
General Electronics . . . . .	6
Gladstone Electronics . . . . .	30,35
Hammond . . . . .	7
International School of Electronics . . . . .	38
Len Finkler Limited . . . . .	8
McGraw-Hill . . . . .	29
Mode . . . . .	41
Noramel . . . . .	8
Nu West Video Systems Ltd . . . . .	68
Omnitronix . . . . .	67
Orion Electronic Supplies . . . . .	69
Protec . . . . .	70
Radionics Limited . . . . .	65
R-A-E Industrial Electronics Ltd . . . . .	68
H. Rogers Electronic Instruments . . . . .	6
Sheppard Agencies . . . . .	68
Surplus Electro Quebec . . . . .	44
Torch International Computers Ltd . . . . .	72

### Editorial Queries

Written queries can only be answered when accompanied by a self-addressed, stamped envelope. These must relate to recent articles and not involve the staff in any research. Mark such letters ETI-Query. We cannot answer telephone queries.

### Binders

Binders made especially for ETI are available for \$6.75 including postage and handling. Ontario residents please add provincial sales tax.

### Sell ETI and ETI Special Publications

ETI is available for resale by component stores. We can offer a good discount when the minimum order of 15 copies is placed. Readers having trouble in obtaining the magazine could ask their local electronics store to stock the magazine.

### Component Notation and Units

We normally specify components using an international standard. Many readers will be unfamiliar with this but it's simple, less likely to lead to error and will be widely used everywhere sooner or later. ETI has opted for sooner!

Firstly decimal points are dropped and substituted with the multiplier: thus 4.7uF is written 4u7. Capacitors also use the multiplier nano (one nanofarad is 1000pF). Thus 0.1uF is 100nF, 5600pF is 5n6. Other examples are 5.6pF = 5p6 and 0.5pF = 0p5.

Resistors are treated similarly: 1.8Mohms is 1M8, 56kohms is the same, 4.7kohms is 4k7, 100ohms is 100R and 5.6ohms is 5R6.

### PCB Suppliers

ETI magazine does NOT supply PCBs or kits but we do issue manufacturing permits for companies to manufacture boards and kits to our designs. Contact the following companies when ordering boards.

Please note we do not keep track of what is available from who so please don't contact us for information on PCBs and kits. Similarly do not ask PCB suppliers for help with projects.

K.S.K. Associates, P.O. Box 54, Morriston, Ont. N0B 2C0.

B&R Electronics, P.O. Box 6326F, Hamilton, Ont., L9C 6L9.

Wentworth Electronics, R.R.No.1, Waterdown, Ont., L0R 2H0.

Danocinths Inc., P.O. Box 261, Westland MI 48185, USA.

Arkon Electronics Ltd., 409 Queen Street W., Toronto, Ont., M5V 2A5.

A-1 Electronics, 5062 Dundas Street W., Islington, Ont., M9A 1B9.

Beyer & Martin Electronic Ltd., 2 Jodi Ave., Unit C, Downsview, Ontario M3N 1H1.

Spectrum Electronics, Box 4166, Stn 'D', Hamilton, Ontario L8V 4L5.

# SABTRONICS

 "making performance affordable"

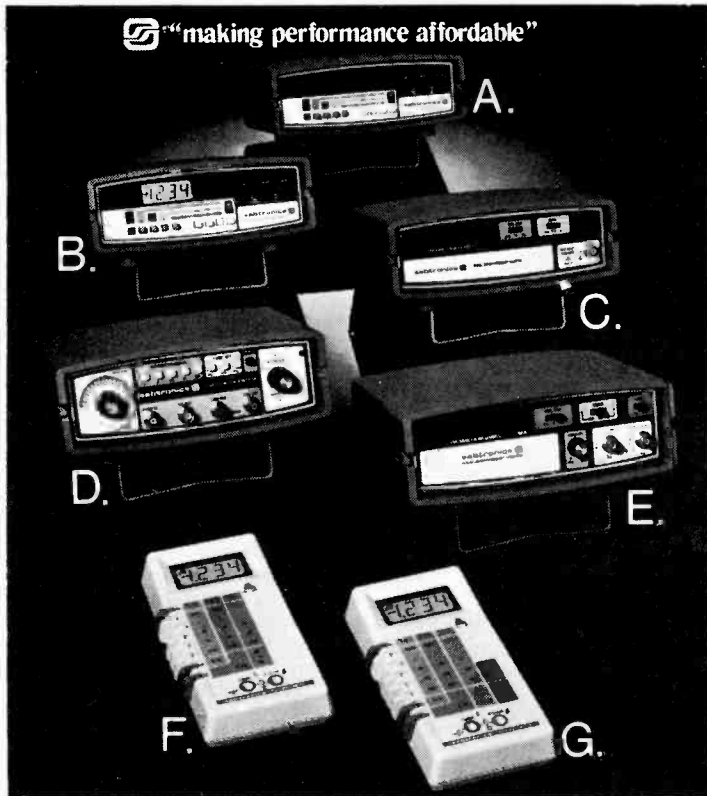

## TEST EQUIPMENT

Now available from:

General Electronics 5511 Yonge Street,  
Willowdale, Ont., M2N 5S3, (416) 221-6174

Model No.	Description	Kit	Assembled
(A) 2010A	LED Bench DMM	\$166.32	\$216.72
(B) 2015A	LCD Bench DMM	\$199.92	\$250.32
(F) 2035A	LCD Hand Held DMM	\$132.72	\$166.32
(G) 2037A	LCD Hand Held DMM/ Thermometer & Probe	\$167.93	\$199.92
(C) 8110A	100MHz Frequency Counter	\$149.52	\$183.12
(C) 8610A	600MHz 8 Digit Frequency Counter	\$199.92	\$250.32
(E) 8610B	600MHz 9 Digit Frequency Counter	\$233.52	\$284.43
(E) 8000B	1GHz Frequency Counter	N/A	\$399.95
(D) 5020A	1Hz - 200 KHz Function Generator	N/A	\$216.72
PSC-65	600MHz Prescaler	N/A	\$ 89.95
THP-20	Touch & Hold Probe	N/A	\$ 33.60
HVP-30	High Voltage Probe	N/A	\$ 49.95
AC-110	Battery Eliminator	N/A	\$ 16.95
AC-120	AC Adapter/Charger	N/A	\$ 13.95
NB-120	NiCd Batteries (set of 4)	N/A	\$ 39.95
LFP-10	Audio Frequency Probe	N/A	\$ 33.95
RFA-10	Telescopic RF Pick-up Antenna	N/A	\$ 16.95

Send Certified Cheque or Money Order. Ont. Residents please add 7% to your cost price. 9% Federal Sales Tax is included. All orders will be shipped F.O.B. our warehouse Best Way. Prices subject to change without notice.

**Full Factory Service at 5511 Yonge St. Willowdale, Ont.**

To see our other products - Send \$1.50 for **GENERAL ELECTRONICS** Full Line Catalogue.

Circle No. 10 on Reader Service Card

## HICKOK MX SERIES DMM'S World's Fastest Troubleshooters



**MX333 \$325.00**

**MX331 \$219.00**

Compact size, unique shape and easy-to-read-from-almost-any-angle sloped display facilitates use as a hand held, bench top or belt mounted instrument.

VARI-PITCH, audible signal on MX333 provides instant indication of the resistance, voltage or current measured for quick and easy troubleshooting. The audible response is instantaneous and proportional to the reading.

- 0.1% Basic Accuracy
- LCD Display in Unique sloped View Case
- Uses Single 9V Battery
- Compact Size. Rugged Construction
- Superior Overload Protection
- Exclusive VARI-PITCH Audible Output (MX333)
- Fast LOGI-TRAK Logic Function (MX333)
- 20Ω Range (MX333)

LOGI-TRAK function on MX333 combines the features of a high performance logic probe and voltmeter in one convenient function. Use any 10:1 high frequency scope probe to measure all logic signals and DC voltages from 10mV to 20V. Audible tone output identifies logic Hi's, Lo's, pulses as narrow as 5 nsec as well as marginal and faulty logic states and pulse trains.

Duty and FST included. Charge (VISA) accepted. Ont. res. add 7% sales tax. Shipping Extra.

**ROGERS** electronic instruments Ltd.

P.O. Box 310, 595 Mackenzie Avenue Units 1 & 2  
Ajax, Ontario L1S 3C5. Tel. (416) 683-4211

**CONDENSED SPECIFICATIONS: MX331 and MX333**  
DC VOLTS (5 RANGES): 200mV to 1000V full scale. RESOLUTION: 0.1mV. ACCURACY: ±0.1% + 1 digit. INPUT IMPEDANCE: 10MΩ. OVERLOAD PROTECTION: 1000V DC or peak AC + up to 6kV transients all ranges.

AC VOLTS (5 RANGES): 200mV to 1000V full scale. RESOLUTION: 0.1mV. ACCURACY: ±1% + 2 digits. 45 Hz to 1kHz. ±5% + 5 digits to 5 kHz. INPUT IMPEDANCE: 10mΩ. OVERLOAD PROTECTION: 1000V DC/750 RMS.

RESISTANCE (7 RANGES): 20Ω to 20MΩ full scale except no 20Ω range on MX331. RESOLUTION: 0.01Ω on MX333. 0.1Ω on MX331. ACCURACY: 0.1% + 1 digit except 0.2% on 200Ω, 1% on 20MΩ, and 3% on 20Ω ranges. OVERLOAD PROTECTION: 500V DC on RMS all ranges plus 2A fuse on 20Ω range. TEST VOLTAGE: Low power. 0.25V max of full scale.

DIODE TEST (1 RANGE): Measures forward voltage drop across diode and transistor junctions at 2mA nominal current.

AC/DC CURRENT (5 RANGES): 2mA to 10A full scale. RESOLUTION: 1μA. ACCURACY: ±1.2% + 1 digit DC. ±2.5% + 1 digit AC. OVERLOAD PROTECTION: 250V @ 2A all ranges except 10A, max 15A on 10A range.

VARI-PITCH (MX333 ONLY): Variable pitch proportionate to reading, off at open circuit, increasing frequency as resistance approaches "0" on ohms function. Increasing frequency as input increases on volts and current functions. RESPONSE: Instantaneous (less than 100 msec.)

LOGI-TRAK (MX333 ONLY): 0-20V range using Hickok SP-7 (not incl.) or other 10:1 scope probe. HI/LO INDICATION: High or low audible tone. PULSE INDICATION: Audible "chirp" plus lighted colon on display. MIN PULSE WIDTH: 5 nsec typical. MAX FREQUENCY: 80 MHz. ACCURACY: ±0.25% + 1 digit + probe accuracy. INPUT IMPEDANCE: 10MΩ. INPUT PROTECTION: 300V DC or RMS.

GENERAL: Dimensions: 2.2x6.7x6 in. (5.6x17x15.2 cm). Weight: 22 oz. (7kg). Power: 9V battery (incl.) or Hickok AC adapter. Battery Life: 200 Hrs. typical. Temperature: 0-50°C operating, -35 to +60°C storage. INCLUDES: Deluxe safety test leads, battery, manual and belt clip.

### ACCESSORIES

SP-7 10:1 Divider Probe for Logi-Trak Input	\$59.50
TP-20 (C or F) Temperature Probe	\$79.75
VP-14 RF Probe (0.25V to 40V rms)	\$61.25
VP-40 40KV DC Probe (0 to 40KVDC)	\$69.50
CC-4 Deluxe Vinyl Carrying Case	\$24.00
RC-3 AC Adapter	\$15.00

Circle No. 8 on Reader Service Card

# NEWS

## Lithium Thionyl Chloride Batteries.

A new brochure available from GTE describes high-energy, long-life lithium thionyl chloride batteries that operate reliably under extreme environmental conditions as they power industrial, defense and medical equipment.

The 12-page, illustrated brochure, entitled *Continuum™ Energy Cells: The New Line of Long-Life Batteries*, details operating capabilities and quality assurance standards of the units and their multiple applications. These include power sources for oil and gas exploration equipment, emergency locator transmitters, animal telemetry, sonobuoys, seismic sensors, navigational aids, oceanographic measuring instruments and heart pacemakers. In addition, future customized designs of the GTE batteries for medical implant devices, government and industry are described.

GTE's Strategic Systems Division produces primary lithium batteries which are utilized as active and stand-by power sources. They perform efficiently at temperatures of -40 to +50 degrees Celsius (-40 to +125F) and at greater temperature extremes.

A copy of the brochure may be obtained by writing on letterhead stationery to: Richard S. Wissoker, Marketing Manager, GTE, Power Systems, 520 Winter Street, Waltham, Mass. 02254.

## Videotape Controller

A new videotape controller system from TeleMart International Limited allows videotape units to be programmed and operated via a microcomputer in a fashion similar to videodisc players. The TMS-VTRI controller from TeleMart allows random access

to a videotape, using a single key from an on-screen updatable menu to select various sequences or individual frames within  $\pm 1$  frame.

Programmable random access of videotapes opens up exciting new retail, business and educational uses. Each of these markets needs "picture

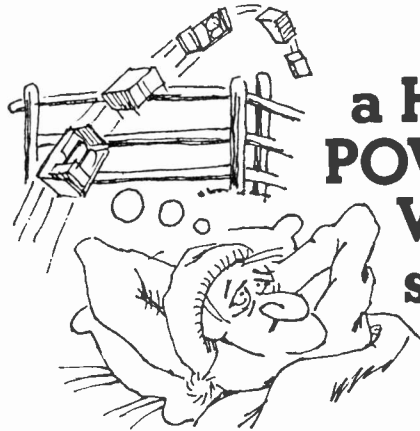

## a HAMMOND POWER SUPPLY Will let you sleep nights

Hammond Power Supplies  
are designed 3 ways better for  
maximum reliability, long life  
and your peace of mind.

### 1. QUALITY COMPONENTS

Our design uses hermetically sealed IC Regulators and Integrated Darlington Transistor output regulation stages. Reliability is increased 4:1 over competitive economy units using plastic devices. The reduced component count further increases efficiency by as much as 2:1. We also use enclosed, wire wound pots for output voltage adjustment to provide much longer service than the open carbon types used by some competitors.

### 2. CONSERVATIVE RATINGS

Our smaller units use a 100 watt hermetically sealed output stage compared to the 30 to 60 watt plastic transistors typically used. Our larger models feature a TO - 3 hermetically sealed dual rectifier derated to 30% or less of its capacity to eliminate rectifier failure.

### 3. BETTER CONSTRUCTION

Our transformers are electrostatically shielded isolation types which, together with a high frequency by-pass capacitor filter circuit, reduce noise and H.F. transients by more than 4:1. We mount the TO - 3 can directly on the frame for optimum heat transfer and use more dissipation material than others to ensure much higher output current at elevated temperature.

### HOW MUCH BETTER?

Enough to show a MTBF of 50,000 hours.  
60,000 hours for the same units at 10%  
derating. Enough that we don't hesitate in  
giving you a full 2 year warranty.  
Invest in some peace of mind. Ask for us by  
name at distributors across Canada or circle our  
number on the reader card for catalogue  
and prices.

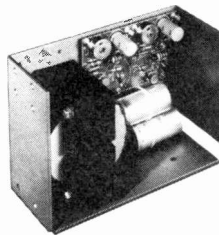

**M** HAMMOND  
**W** MANUFACTURING ..

HAMMOND MANUFACTURING COMPANY LIMITED  
394 EDINBURGH RD. GUELPH ONT. N1H 1E5  
PHONE (519) 822-2960 OR (416) 456-3770

Circle No. 20 on Reader Service Card.

# MARBLE M SOUND

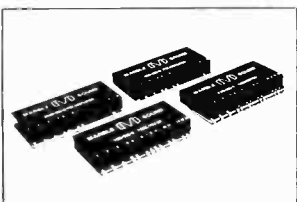

Marble Sound, a division of Epitek Electronics, has a quality line of audio modules based on ultra reliable thick film technology. The application of thick film also provides a comparative size reduction in the modules. Nothing but high quality components are utilized throughout, and major design efforts have been made to reduce noise levels to a minimum. The product line includes all the active elements required to build a high quality audio amplifier. Other audio components, such as PA or intercom system can be built as well.

"DEALERS INQUIRIES  
INVITED"

Write for bulletin or  
telephone



## MARBLE SOUND

814 Proctor Avenue  
Ogdensburg, N.Y.

100 Schnelder Road,  
Kanata, Ont.

Circle No. 11 on Reader Service Card.

# AUDIO KIT

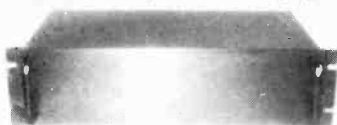

- A. 125W/Ch Stereo Class A Integrated Power Amp. Kit with Regulated Power Supply and Mic Mixer. Freq. Response from 0 to 100Khz, S/N 110 db, THD 0.005% ..... \$189.50
- B. 19" x 5" x 12" Rack Mount Cabinet ..... \$ 43.50
- C. Power Transformer, 56 VCT, 12A ..... \$ 45.00
- D. Accessory Parts for Above .. \$ 40.40

PACKAGE Total ..... \$318.40

\* PACKAGE Special ... \$299.95

\*Completely Assembled & Tested (1 year warranty) ..... \$389.95

\*Special Offer expires February 28, 1982. Send cheque or money order, Visa or Master Card (include card number, expiry date and signature) plus \$5.00 for shipping, handling and insurance (Ontario residents add 7% P.S.T.) to

## AUDIOVISION

578 Marlee Ave,  
(Just one block West of Glencairn Sub-  
way)  
Toronto, Ont. M6B 3J5  
Tel: (416) 781-3263

## NORTH AMERICAN ELECTRONICS EST. 1949

— WE STOCK —

**AMIDON** — FERRITE MATERIALS: TOROIDAL CORES, "E" CORES, POT CORES, BEADS, RODS, SHIELDED COIL FORMS, ETC. ....

**J.W. MILLER** — COMPLETE COVERAGE OF COILS: RF, ANTENNA, CHOKES, OSCILLATOR, ADJUSTABLE, FORMS, SLUGS, ETC  
ALSO: XCELITE TOOLS, WELLER, MAGNET WIRE, VEROBOARD, CABLE, SEMICONDUCTORS, SWITCHES, PCB MATERIALS, CONNECTORS, ETC  
..... AND MUCH MORE .....

WRITE for our free 1982 catalog (specify French or English) or CALL US.

**NORAMEL**  
2407, STE. CATHERINE ST. E.,  
MONTREAL, QUE., H2K 2J7.  
(514) 522-8422

Circle No. 17 on Reader Service Card.

WHY CUT? WHY STRIP? WHY SLIT?  
WHY NOT...

# JUST WRAP

**NEW**

Hand held wire wrapping tool.

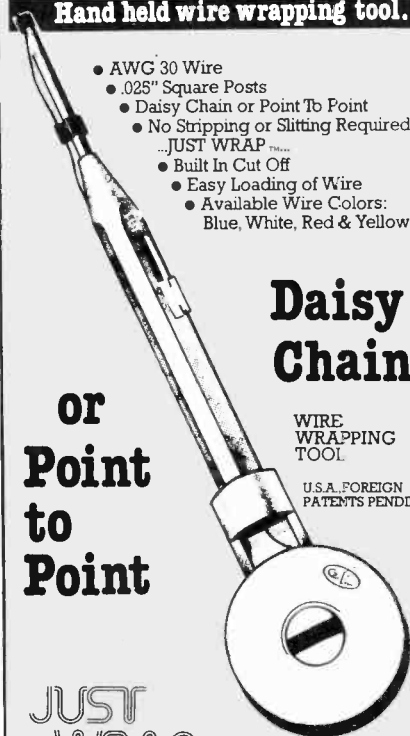

- AWG 30 Wire
- .025" Square Posts
- Daisy Chain or Point To Point
- No Stripping or Slitting Required
- JUST WRAP™
- Built In Cut Off
- Easy Loading of Wire
- Available Wire Colors:  
Blue, White, Red & Yellow

## Daisy Chain

WIRE  
WRAPPING  
TOOL

U.S.A. FOREIGN  
PATENTS PENDING

or  
Point  
to  
Point

JUST  
WRAP

## Wire Wrapping



## OK MACHINE & TOOL CORPORATION

Name

Address

City  Prov.

Postal Code

For more information on this, and other O. K. Machine products complete the coupon and mail today to:

**len finkler limited**

80 Alexdon Road, Downsview Ontario M3J 2B4



Circle No. 15 on Reader Service Card.



## NEWS

catalogues" with a variety of information which can be accessed by users when and as needed. Until now, only laser optical videodisc systems could provide this capability. Now the more popular and less expensive videotapes can also be used to make in-house programs, saving time and expense and providing new uses for existing videotape program materials.

TeleMart designs, manufactures and supports an advanced line of Canadian videotex systems which are capable of displaying both television and digital data on the same screen.

For more information contact Stuart Mak, Telemart International Ltd., 361 Steelcase Rd. W., Markham, Ont. L3R 3V8 (416) 495-2380.

### Microcomputer with A/D Converter

Motorola Integrated Circuits Group announces availability of the MC68705R3 microcomputer unit (MCU) with analog to digital converter (A/D).

This 8-bit microcomputer contains a CPU, on-chip clock, EPROM bootstrap ROM, RAM, I/O, a timer, and analog to digital converter (A/D). Features include: 112 bytes of RAM, 3776 bytes of user EPROM, internal 80-bit timer with 7-bit prescaler and zero-crossing detection on interrupt input. It also emulates the MC6805R2, has an on-chip clock generator, and 24 TTL/CMOS compatible bidirectional I/O lines (8 lines will drive LEDs). The analog to digital (A/D) converter offers 8-bit conversion, is monotonic and can select 1 of 4 analog inputs,  $\pm \frac{1}{2}$  LSB total error (max).

The part will be available in December. For further information contact your local Motorola sales office or Motorola distributor.

### AbilityPhone Terminal

The AbilityPhone™ terminal is a microprocessor-based telecommunications and environmental control device. As a telephone terminal, its major function is to provide equivalent telephone service for severely disabled individuals. To accomplish this, the AbilityPhone™ terminal features include automatic answering, dialing and redialing (when there is no answer) of calls. The number builder is a feature which allows the user to enter and confirm a phone number before the number is automatically dialed. An optional feature is a voice synthesizer that will speak all keyboard and index items.

Another function of the AbilityPhone™ terminal is to provide increased security and



independence. Automatic emergency dialing calls three predetermined phone numbers in sequence. The emergency dial function is activated from the keyboard or an external switch. With the voice option, the AbilityPhone™ terminal can transmit a spoken emergency message. Another option allows coded data messages to be automatically sent to a TDD/TTY.

To give added independence, the AbilityPhone™ terminal's monitor function can periodically ask "ARE YOU OK?". If the user does not respond within a specified period of time, the emergency dial sequence is automatically activated. Medical, burglar and fire alarms also trigger the emergency dial function.

With the environmental control function, up to 15 lights and appliances can be turned on or off. In addition, the AbilityPhone™ terminal can operate as a calculator using the keyboard or a single switch input. The user can add, subtract, multiply or divide.

If the user is unable to use the keyboard, he can use an external switch. Index items can be scrolled continuously or one at a time on the 32-character display, allowing selection of any index item desired.

Each AbilityPhone™ terminal can be customized to accommodate specific capabilities. This includes choosing ring tone, display rates, delay times for acceptance of keyboard or external switch entries, etc., from a selection of nine choices. Because only certain features are needed in living or working environments, other features can be deleted from the index. Unused keys can be covered with snap-on inserts. Thus, the AbilityPhone™ terminal can be made very simple to operate. However, as the user becomes more familiar with the AbilityPhone™ terminal and desires other features, functions can be added back into the index.

The AbilityPhone™ terminal

has self-diagnostic capability to warn of certain failures. A two-year limited warranty is included with the purchase and an extended service contract is available. For more information, contact Basic Telecommunications Corporation, 4419 E. Harmony Rd., Fort Collins, CO 80525.



### Satellite Systems Ltd.

The advertisement in our December issue gave incorrect prices for the 100° LNA (which should have read \$1495) and the 85° LNA (which should have read \$1995). We apologise to readers for any inconvenience caused.

### Earth Station

Heath Company has announced the availability of the Heathkit Earth Station, a parabolic antenna, which allows home viewers to enjoy the increasing variety of satellite television programming. The antenna system, which consists of a three-meter parabolic dish, a foundation kit, low noise amplifier/down converter and television receiver kit, is said to be comparable in quality to professionally installed systems costing over \$15,000. The design is such that the system provides high "gain" (the ability to receive even weak signals at acceptable performance levels), great strength (the antenna can withstand winds of 100 mph) and even a security circuit to foil theft.

Prospective users may purchase a Site Survey Kit to help them determine the suitability of the proposed antenna site before the system is acquired. This kit, priced at \$45, includes a comprehensive manual on satellite television and the features of the Heathkit Earth Station.

The Heathkit Home Earth Station is available for as little as \$10,995, at or through Heathkit Electronic Centres in Mississauga, Calgary, Montreal, Winnipeg, Edmonton, Ottawa and Vancouver.

### Howling Feedback

A while ago, we bought a huge computer to take care of some of the facets of running ETI. . . well, actually, it's not that huge. But it has been working out rather well. One of the things that it handles is the reader service cards, those little bingo things for getting free information. It takes all the little circles, crosses, ticks, triangles, coffee stains and blood stains on the cards and translates them into huge stacks of printouts.

Because this function is so easy to do, we've added a new feature to the reader service cards, that of editorial feedback. Many of the articles in this month's issue have little boxes associated with them, containing reader service card numbers. By circling the appropriate number on the card, you can tell us what you like and don't like. And we can get a better idea of what you'd like to see in ETI.

We hope you'll take advantage of this idea to help us make ETI a more interesting, enjoyable publication. Please note that using the reader service card for editorial feedback will in no way slow down any manufacturer's literature you might request.

# SPEAKER DESIGN Part Two

This month David Tilbrook concludes with a discussion on crossovers, and a design.

LAST MONTH'S article dealt with the characteristics of a typical moving-coil direct-radiating loudspeaker and the interactions that are likely to occur with the loudspeaker enclosure. Once these problems are understood and the bass performance has been optimised, we are in a position to finish the design. I have discussed the bass end of the audio spectrum first not because it is the most important, but simply because it is the most difficult to optimise. The mid-range is by far the most critical part of the audio spectrum since it is midrange distortion that the ear objects to more than any other.

It was shown last month that drivers have limited frequency responses and that it is therefore necessary to use several drivers, each covering its own frequency range. By far the most common arrangement is the three-way, so called because it uses three drivers to cover the audio range. A woofer covers the bass end, crossing over to a midrange driver somewhere between 400 Hz and 1 kHz. The midrange driver, sometimes called a 'squawker', carries the frequency range from this crossover point up to where the tweeter takes over, usually around 3 kHz to 5 kHz. The tweeter covers the remainder of the audio spectrum up to around 18 kHz, about the limit of human hearing. A crossover is used to separate the input signal from the output of the power amplifier into the three frequency bands.

## Passive Loudspeaker Crossovers

The design of the crossover for any particular group of drivers must be done only after a thorough investigation into the characteristics of the drivers has been carried out. It is essential to choose drivers with an adequate overlap in their frequency responses, or a 'hole' will result in the response of the final loudspeaker. The amount of overlap needed depends on the slope of the filters used in the crossover. If a fast slope is

used a smaller overlap is required, but filters with very fast slopes are complicated and expensive.

The basic crossover filter consists of a low pass and a high pass section. In a two way loudspeaker only one of these sections would be used, while in a three way loudspeaker two sections are used, one for the bass-mid crossover and the other for the mid-treble crossover. The simplest crossover is called a first-order crossover and has a slope in its attenuating region of 6 dB/octave. An octave is a range of frequency such that the highest frequency in the band is double the lowest frequency; for instance, an octave above 50 Hz is the frequency range 50 Hz to 100 Hz, while an octave above 5 kHz to 10 kHz. This is not a precise definition of an octave but is essentially correct and is adequate for loudspeaker analysis.

Figs. 2 and 3 show circuit diagrams for series and parallel first-order crossovers. The series configuration is less commonly used since it is only applicable to two-way loudspeakers and has no advantages over the parallel type. If the first-order crossover is terminated with ideal resistive loads, the two slopes will add to give a linear response with the phase response perfectly preserved. In this respect it is fairly unusual since no other simple passive crossover will give a response that is

Fig. 1 Typical frequency response curves of a two-way crossover network. The graph shows three different pairs of

linear in both frequency and phase. Unfortunately 6 dB/octave slopes require a choice of drivers with very broad overlapping frequency responses. Generally it is necessary to have a usable response from a driver to a frequency where the crossover this would be two octaves above the crossover point. A woofer crossing out at 500 Hz would be very unlikely to have a response to 2 kHz, so a 6 dB/octave filter could not be used.

The most common crossover is the second order crossover, having a slope of 12 dB/octave. Figure 4 and 5 show the circuit diagrams for series and parallel second-order crossovers. Once again the series configuration is less commonly used. When terminated with ideal resistive loads the second-order crossover does not give an overall flat response. The phase characteristic causes the outputs of each half of the crossover to approach a 180 degree phase difference at the crossover point. The two outputs cancel each other, leaving a massive hole in the frequency response of the system. The 'cure' is to invert one of the drivers so that it is driven out of phase normally. The phase inversion around the crossover point brings the two drivers in phase again and the two outputs add, instead of cancelling. Unfortunately they still don't add perfectly and the result is an overall response that has

filters, each having a different rate of attenuation.

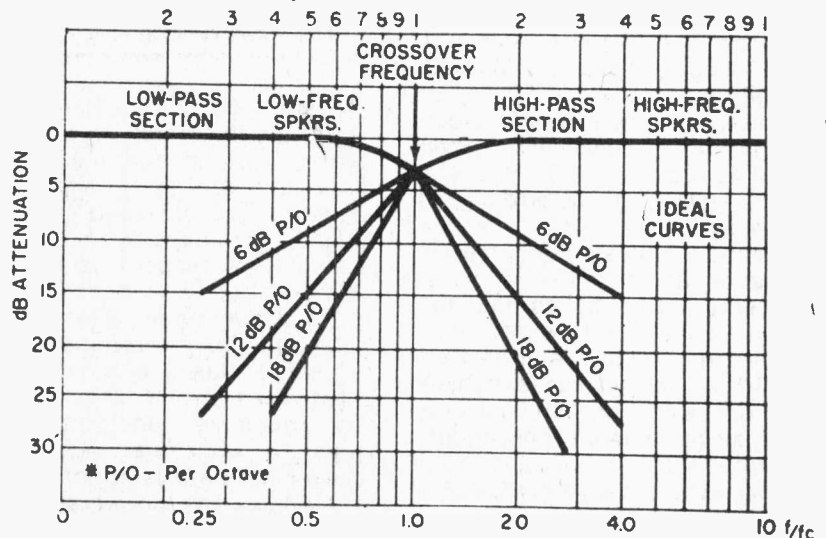

a slight hump in the frequency response of around 2 dB. This is not really noticeable, as few drivers have responses that are flat to this degree.

At the present time there is a great deal of discussion as to whether this non-ideal phase response is audible. Some manufacturers insist that it is audible and design their loudspeakers accordingly, while others are most emphatic that it is not audible. The first work that I know of that was done on the subject was by Helmholtz, in his "Sensations of Tone". The quality of any sound was said to be a result only of the relative intensities of the component sine waves and not their phase relationships. The waveshape could therefore be totally different but they would sound the same.

There is another source of phase error caused by the misalignment of the acoustic centres of the drivers. The conventional way to mount the drivers is to simply bolt them to the front panel. This lines up the chassis of the drivers, but since different drivers have different depths, the voice coils of the drivers are all at different distances from the listener. If two notes are sent simultaneously to both the woofer and the tweeter for example, the note sent to the tweeter will get to the listener momentarily before the note from the woofer. Furthermore, the woofer cone is heavier than the tweeter or midrange cones, and this combined with the effect of the air load on the drivers moves their actual acoustic centres even further away from the chassis. Manufacturers concerned with this effect mount the drivers on a multi-level front panel so that the tweeter is further away from the listener than the midrange. Similarly, the midrange is mounted on a plane that is further away from the listener than the woofer. This gives the sound from the midrange and woofers a head start over the tweeter, and attempts to correct for the differences in their acoustic centres.

Both types of phase errors need to be recognised and dealt with independently if a meaningful analysis of the audibility of phase errors in loudspeakers is to be carried out. Even if phase errors of this magnitude are audible (and only experiment can tell us), an extremely good loudspeaker can still be constructed along the more conventional techniques using second-order crossovers with drivers mounted on a plane baffle.

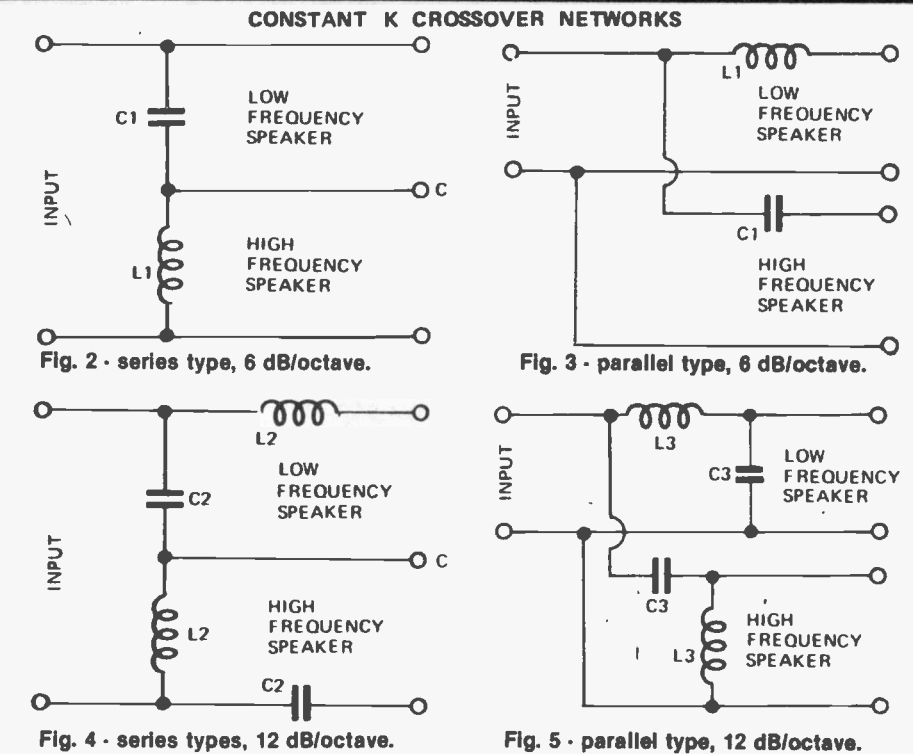

Fig. 2 - series type, 6 dB/octave.

Fig. 3 - parallel type, 6 dB/octave.

Fig. 4 - series types, 12 dB/octave.

Fig. 5 - parallel type, 12 dB/octave.

FREQ.	C1	C2	C3	L1	L2	L3
100	199	281	141	12.7	9	18
150	133	188	93.8	8.49	6	12
200	99.5	141	70.3	6.37	4.5	9
250	79.6	113	56.3	5.09	3.6	7.2
300	66.3	93.8	46.9	4.24	3	6
350	56.8	80.4	40.2	3.64	2.57	5.14
400	49.7	70.3	35.2	3.18	2.25	4.5
500	39.8	56.3	28.1	2.55	1.8	3.6
600	33.2	46.9	23.4	2.12	1.5	3
750	26.5	37.5	18.8	1.7	1.2	2.4
1000	19.9	28.1	14.1	1.27	.9	1.8
1250	15.9	22.5	11.3	1.02	.72	1.44
1500	13.3	18.8	9.38	.849	.6	1.2
2000	9.95	14.1	7.03	.637	.45	.9
2500	7.96	11.3	5.63	.509	.36	.72
3000	6.63	9.38	4.69	.424	.3	.6
3500	5.68	8.04	4.02	.364	.257	.514
4000	4.97	7.03	3.52	.318	.225	.45
5000	3.98	5.63	2.81	.255	.18	.36
6000	3.32	4.69	2.34	.212	.15	.3
7500	2.65	3.75	1.88	.17	.12	.24
10000	1.99	2.81	1.41	.127	.09	.18

**Table 1: Component values for constant K loudspeaker crossover networks. Inductance in millihenries, capacitance in microfarads, speaker impedance = 8 ohms.**

The loudspeaker project in this issue use the more conventional approach to driver mounting and crossover design to simplify construction and decrease cost. If you choose to experiment with the audibility of phase in loudspeakers, and construct a loudspeaker with a stepped front panel, the best way to establish the correct distance between the panels is by experiment. The drivers should be connected to the crossover and mounted in separate enclosures. The size of these enclosures is not critical.

Supply the power amp driving the loudspeaker with a source of low

repetition pulses (or a low frequency square wave around 20 Hz). If the loudspeaker is now monitored with a microphone and the output of the mic amplifier fed to an oscilloscope, the transient performance of the loudspeaker can be determined.

When the front baffles of the enclosures are aligned, as would be the case in a conventional loudspeaker, the input pulses will be seen to be converted into a series of pulses. Each pulse corresponds to one of the drivers. If the enclosures are moved slowly back with respect to the woofer enclosure these pulses will merge into a single pulse. This is

the correct position for the baffles, and using these measurements the final enclosure can be built. If you have the necessary equipment to do this experiment we would be interested in hearing about your results.

The crossovers described so far belong to a class of filters call constant-K filters. These filters are designed on the assumption that the product of the impedances of the capacitor and the inductor in the stage is equal to the square of its characteristic resistance, i.e.

$$Z_C \times Z_L = R_o^2$$

The characteristic resistance of a filter is that resistance into which there is maximum power transfer. Originally, 'K' was used instead of the now more common symbol  $R_o$  for the characteristic resistance, hence the name constant K. Table 1 gives values for constant-K filters for a variety fo crossover points assuming an 8 ohm resistive load.

**M-derived Filter Sections**

The assumptions made to simplify the design of the constant-K filters lead to some non-ideal characteristics. It is sometimes mistakenly thought that constant-K implies constant impedance. This is a variable with the effect occuring mostly around the crossover point. The other problem with constant-K filters is that the slopes are slowest near the crossover point. The solution to these problems has been known since 1923, when Zobel proposed that other sections could be used to flatten the response within the passband and sharpen the roll-off point. These stages are called M-derived sections, since the values of inductance and capacitance used in the filter are obtained by first deriving them for a constant-K type filter and then converting these values into M-derived values with the use of a mathematical equation that contains the term M. M is simply a number between 0 and 1, usually around 0.6 for crossover applications. Either the phase or frequency characteristics may be optimised but not both at once; 0.6 is a good compromise. Table 2 and Figs. 6 to 9 give values for inductors and capacitors for M-derived crossovers with  $M = 0.6$ .

The other major advantage of this filter is that it allows a third-order or 18 dB/octave filter to be built. Third-order filters can be made to

have a linear frequency characteristic when the outputs of the two channels are summed, but like the second-order filters described before, suffer from a very non-linear phase response. Each filter shifts the phase at the crossover point by 180 degrees, so there is a 360 degree phase shift between the two outputs.

**Loudspeaker Impedance**

So far I have assumed that the loudspeakers connected to the crossover are fixed 8 ohm loads, but as was seen in last month's article, this is most definitely not the case. Most drivers have an impedance characteristic that presents maximum impedance at their resonant frequency, dropping to the nominal DC resistance of the driver at a frequency above this, followed by a generally increasing impedance as frequency rises (see Fig. 2 in last month's issue). Provided the driver is not being used near its resonant frequency, which should always be the case with midranges and tweeters, this impedance variation can be corrected by a series capacitor-resistor network placed in parallel with the loudspeaker. Fig. 10 shows a typical circuit. This network has an impedance that decreases with increasing frequency, tending to cancel the increasing impedance of the driver. The component values shown are applicable to an average woofer, although the actual values in any specific application are best established by experiment. This works very well and it is not difficult to obtain impedance response that is flat within one ohm over most of the driver's operating range.

**Matching Sensitivities**

Once the crossover points have been established from an analysis of the driver's best operating regions, the final step is to equalise the various sensitivities of the different drivers. This is done by a resistor divider network as shown in Fig. 11. A simple resistor placed in series with the driver would of course decrease the power in the loudspeaker for a given signal voltage, but this increases the impedance seen by the rest of the crossover, altering the crossover frequency point. The resistive divider network shown in Fig. 11 can be set to represent a fairly constant 8 ohm load. Resistor R2 is placed in parallel with the driver, resulting in a decreased total impedance. This impedance is then brought back up to the desired

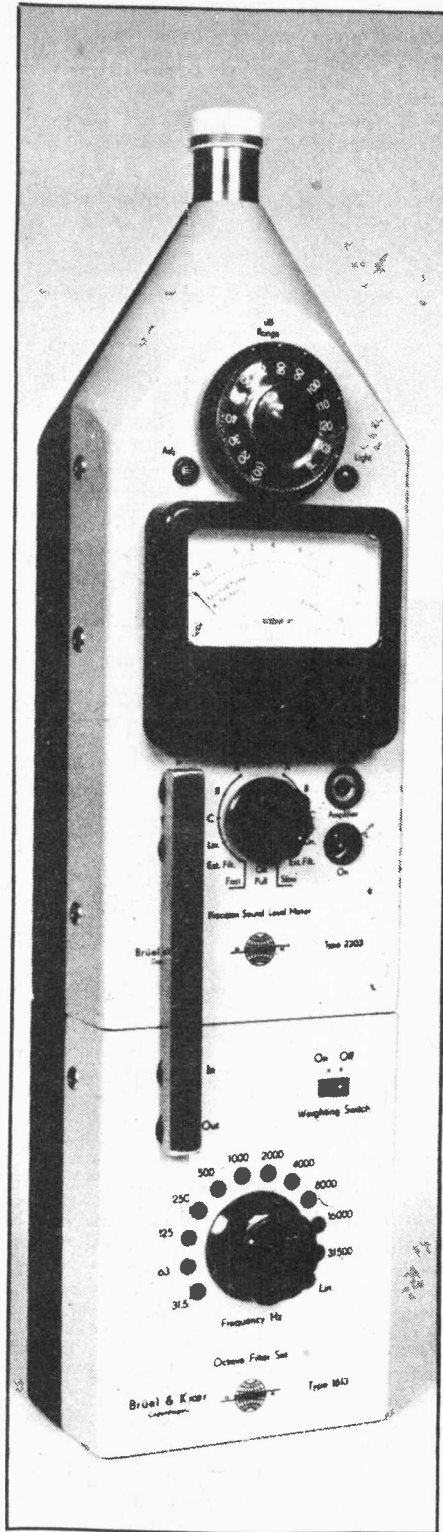

A Bruel and Kjaer sound level meter. Instruments like this are used to determine the frequency response of a loudspeaker. This instrument has several weighting curves built in as well as a one octave filter set to allow pink noise analysis.

impedance by placing R1 in series. The correct values for R1 and R2, assuming an 8 ohm loudspeaker system, are given by the following three simple equations.

1.  $d = \text{antilog} \frac{\text{signal drop in dB}}{20}$
2.  $R2 = \frac{8d}{1-d}$
3.  $R1 = \frac{64}{8 + R2}$

First establish the amount of attenuation that is required in dB. Normally by this stage a frequency response curve has been established by measuring the loudspeaker, and an estimate of the required attenuation can be obtained from this. Now use equation 1 above. The antilog of a number can be found either using log/antilog tables or the inverse log key on any scientific calculator. I have used the symbol 'd' for the result of equation 1 mainly to simplify the written form of equation 2, but in reality 'd' is equal to the voltage across the loudspeaker divided by the voltage from the amplifier. i.e.

$$d = \frac{V_s}{V_i}$$

where 'V' is the signal voltage across the loudspeaker and 'V<sub>i</sub>' is the applied signal voltage from the amplifier.

The result of equation 1 is plugged into equation 2, which yields the correct value for R2. The value of R2 is then used in equation 3 to obtain the value of R1. For example, if a midrange is to be decreased in sensitivity by 3 dB, equation 1 becomes:

$$d = \text{antilog} \frac{-3}{20}$$

$$d = \text{antilog} -0.15 = 0.7079$$

So a 3 dB drop in output signal level is equivalent to decreasing the signal voltage across the loudspeaker to 0.7079V<sub>i</sub>. Plugging this into equation 2 gives

$$R2 = \frac{8 \times 0.7079}{1 - 0.7079} = 19.4 \text{ ohms.}$$

Using this result in equation 2 gives

$$R1 = \frac{64}{8 + 19.4} = 2.3 \text{ ohms.}$$

The nearest value resistors to these would be 18R and 2.2R, and with these resistors the impedance

### M-DERIVED CROSSOVER NETWORKS

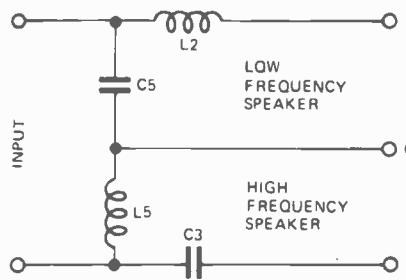

Fig. 6 - series type, 12 dB/octave.

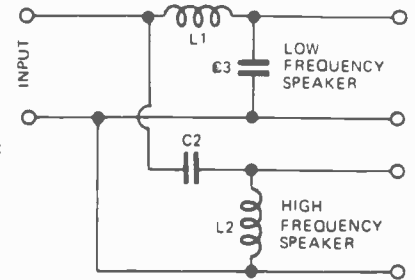

Fig. 7 - parallel type, 12 dB/octave.

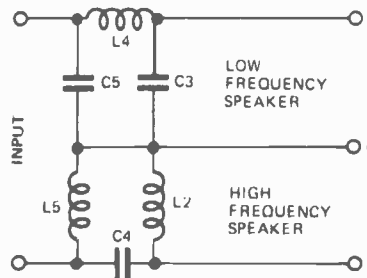

Fig. 8 - series type, 18 dB/octave.

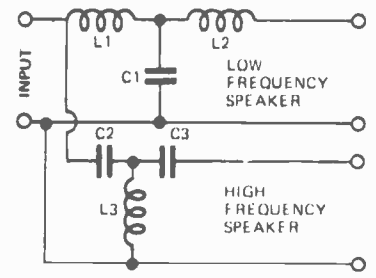

Fig. 9 - parallel type, 18 dB/octave.

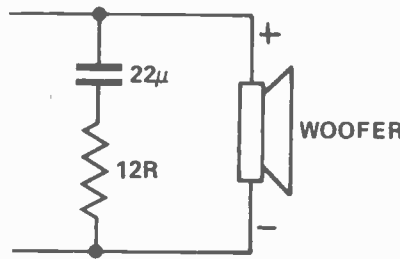

Fig. 10 Circuit to improve the apparent impedance of a loudspeaker.

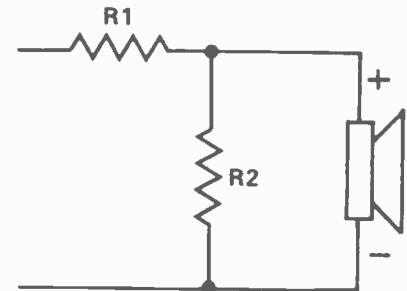

Fig. 11 Potential divider used to compensate for different loudspeaker sensitivities.

FREQ.	C1	C2	C3	C4	C5	L1	L2	L3	L4	L5
100	398	124	199	99.4	318	20.3	12.7	6.37	25.4	7.96
150	265	82.9	133	66.3	212	13.5	8.49	4.24	16.9	5.31
200	199	62.1	99.4	49.7	159	10.1	6.37	3.18	12.7	3.98
250	159	49.7	79.5	39.7	127	8.15	5.09	2.55	10.1	3.18
300	133	41.4	66.3	33.1	106	6.79	4.24	2.12	8.49	2.65
350	114	35.5	56.8	28.4	90.9	5.82	3.64	1.82	7.28	2.27
400	99.4	31	49.7	24.8	79.5	5.09	3.18	1.59	6.37	1.99
500	79.5	24.8	39.7	19.9	63.6	4.07	2.55	1.27	5.09	1.59
600	66.3	20.7	33.1	16.5	53	3.4	2.12	1.06	4.24	1.33
750	53	16.5	26.5	13.2	42.4	2.72	1.7	.849	3.4	1.06
1000	39.7	12.4	19.9	9.95	31.8	2.04	1.27	.637	2.55	.796
1250	31.8	9.95	15.9	7.96	25.4	1.63	1.02	.509	2.04	.637
1500	26.5	8.29	13.2	6.63	21.2	1.36	.849	.424	1.7	.531
2000	19.9	6.22	9.95	4.97	15.9	1.02	.637	.318	1.27	.398
2500	15.9	4.97	7.96	3.98	12.7	.815	.509	.255	1.02	.318
3000	13.2	4.14	6.63	3.32	10.6	.679	.424	.212	.849	.265
3500	11.4	3.55	5.68	2.84	9.09	.582	.364	.182	.728	.227
4000	9.95	3.11	4.97	2.49	7.96	.509	.318	.159	.637	.199
5000	7.96	2.49	3.98	1.99	6.37	.407	.255	.127	.509	.159
6000	6.63	2.07	3.32	1.66	5.31	.34	.212	.106	.424	.133
7500	5.31	1.66	2.65	1.33	4.24	.272	.17	.085	.34	.106
10000	3.98	1.24	1.99	.995	3.18	.204	.127	.064	.255	.08

Table 2: Component values for M-derived loudspeaker crossover networks. Inductance in millihenries, capacitance in microfarads, M = 0.6, speaker impedance = 8 ohms.



# 4-WAY LOUDSPEAKER

**A first class four way speaker system, to compliment any of the ETI power amps, your current stereo ... not recommended for automotive use, though. David Tilbrook gets inside.**

LOUDSPEAKERS still remain the weakest link in the hi-fi chain and the total sound of any system will depend more on the loudspeakers than any other single hi-fi component. So it is important to get the best loudspeakers, even if this means accepting a slightly lower performance amplifier or turntable. In most systems, the performance of the cartridge, turntable and amplifier greatly exceeds that of the loudspeakers, so an improvement in the loudspeaker department will often yield a radically improved system.

Unfortunately, there are very few really good kit loudspeakers. This project is an attempt to rectify that situation by providing a loudspeaker suitable for home construction that rates amongst the best available. This is not an inexpensive project, but the finished product will rival commercial units at three times the price.

### Choosing the drivers

In order to build a good loudspeaker it is obviously important to use good drivers, but availability is just as important a criterion as performance. For this reason we had a close look at the drivers commonly available in Canada and finally decided to use drivers from huge range of Philips loudspeakers.

The system is a four-way sealed enclosure loudspeaker using 12 dB/octave crossover slopes. The original design for our prototype used an 18 dB/octave M-derived crossover (see 'Speaker Design' in last month's and this month's issues) but it was enormously expensive and complex, and would have contributed little to the overall sound finally achieved with the 12 dB/octave crossover. The four-way approach allows

closer control over the final frequency response than does a three-way. More importantly a major part of the mid-range normally handled by the woofer can be dedicated to a separate mid-range driver. The basic design idea was to use the woofer only up to 150 Hz. A separate mid-range driver would then take over up to 750 Hz where a second mid-range would come in. The lower mid-range driver, crossing in at 150 Hz needs a usable response down to around 60 Hz (i.e. one octave) so that the crossover region will have a reasonably flat response. Similarly, the woofer crossing out at 150 Hz needs to have a usable response to at least 300 Hz.

After a great deal of testing it was finally decided to use the Philips AD12250/W8 unit for the woofer. This is a 100 watt driver with a free air resonance of 26 Hz. When mounted in the enclosure the fundamental resonance rises to around 31 Hz, an excellent figure. This driver seems to have a bad hole in its response at 350 Hz, but this is unimportant in this loudspeaker.

The AD70601/W8 unit was chosen as the lower mid-range as it has a free air resonant frequency at 45 Hz. This driver is actually a woofer and does not have the integral sealed enclosure common to many mid-range drivers. The enclosure must be provided by the cabinet construction and the volume chosen in the system increases the 45 Hz fundamental resonance of this driver to around 55 Hz, which is ample.

The response between 750 Hz and 3 kHz, where the tweeter takes over, is handled by the latest Philips dome (AD02161/SQ8) mid-range. This driver has a 50 mm textile dome giving a good frequency response and wide dispersion

at higher mid-range frequencies.

Above 3 kHz the AD01610/T8 tweeter is used. We tested a large range of Philips tweeters and this was the best, followed closely by the AD01605/T8, which suffered a little from roll-off of the frequencies above 10 kHz.

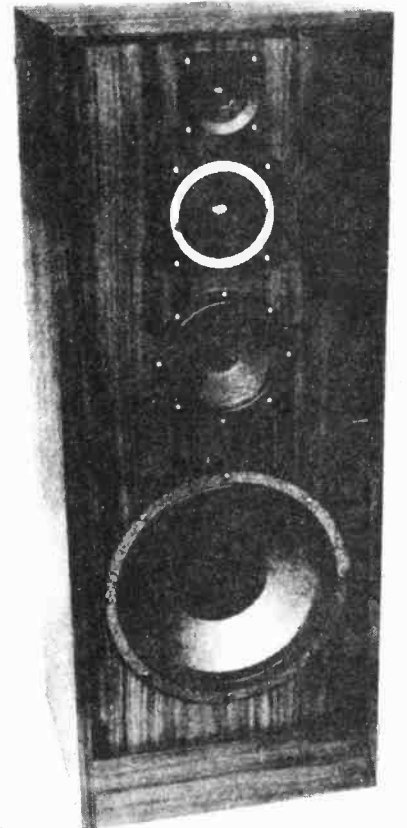

The 4000/1 loudspeaker, without the front grille, showing the drivers. It stands about one metre tall.

## HOW IT WORKS

The input signal from the output of the amplifier is fed to the 4 way crossover that divides the signal into the different frequency bands covered by each of the drivers. The loudspeaker cabinet is divided into two sections, the larger one forming the base chamber for the woofer and the smaller one forming the midrange chamber. These two chambers are sealed from each other so that interactions cannot occur between the back radiations of the woofer and lower midrange. The other two drivers have their own enclosures as an integral part of the driver. For a detailed account of the design approach and the problems that occur in loudspeaker design read 'Principles and problems in loudspeaker design' in this month's and last month's issues.

The last stage before mounting the drivers is to line the box with 25 mm thick loudspeaker damping. Line the back, sides, top and bottom of both the bass and mid-range chambers. Attach the damping firmly to the sides of the box using tacks or thin nails and glue.

The tweeter and dome mid-range drivers are supplied with mounting washers so that good seals can be made between the drivers and the baffle. Use adhesive foam tape, available from most hardware stores, to make a good seal around the lower mid-range unit and the woofer. Stick the tape to the front of the baffle around the edge of the holes cut for the woofer and mid-range so that when the drivers are mounted a good seal results.

Solder the wires to each of the drivers making sure you know which wire is connected to the positive terminal on the loudspeaker. This terminal is marked on the driver either by a red terminal or a red dot near one of the terminals. Mark the other ends of the cables so that it is clear which cables connect to which drivers. *This is important*; if the outputs of the crossover are connected to the wrong drivers this could result in damage to the drivers.

Once all of the drivers are mounted the final stage is the construction and mounting of the crossover. If the crossover is mounted inside, instead of under the box, it will be necessary to leave mounting of the woofer until last. After all of the drivers have been mounted, connect a 1.5 volt battery to the woofer wires and watch the lower mid-range cone. If it moves, the seal between the bass and mid-range chambers is not complete.

## Construction

If you are constructing the boxes yourself start by assembling the sides, top, bottom and back of the cabinet. The bottom panel is placed 100 mm above the bottom of the box and the cavity formed under the box can be used to mount the crossover instead of putting it inside the box as is the usual practice. Now insert the two pieces of wood that form the mid-range enclosure. It is essential that there is a perfect seal between the bass and mid-range chambers, as well as between these two chambers and the outside air. Line every joint carefully with caulking compound or glue so that no possibility of an air leak exists. This is probably the best stage of the construction to drill the holes for the wiring to the loudspeakers. Three holes need to be drilled in the bottom of the mid-range chamber to allow for cables for the two mid-range drivers and the tweeter. Cut suitable lengths of 120 V line cord and insert these through the holes. Seal between the cables and the holes with sealing compound or a glue like Silastic. If the crossover is to be mounted under the loudspeaker, drill four holes through the bottom of the box and run the cables exactly as with the mid-range enclosure. Drill the holes so that they are closer to the rear of the box to allow ample room

for mounting of the crossover. The input terminals should be mounted on the back of the enclosure, below the bottom panel if the crossover is mounted under the loudspeaker.

It is not necessary to have the front baffle removable since the drivers are external mounting types. It is probably easier to cut the holes for the drivers before mounting the baffle onto the front of the cabinet. The base panel and mid-range enclosure panel should have been cut so that 38 mm remains between these and the front edge of the side and top panels. When the front panel is fitted, 19 mm should remain between the front of the baffle and the front edge of the sides and top. This space will be taken up by the grill cloth frame. Seal the remaining joints between the front baffle and the rest of the box. The only remaining part of the box construction is to attach the small 100 mm high wooden panel to the bottom of the box. The front grill is made by constructing a rectangular frame that fits into the remaining cavity on the front of the baffle. Stretch the grill cloth (use proper speaker grill material to avoid absorption of the treble) tightly over the frame.

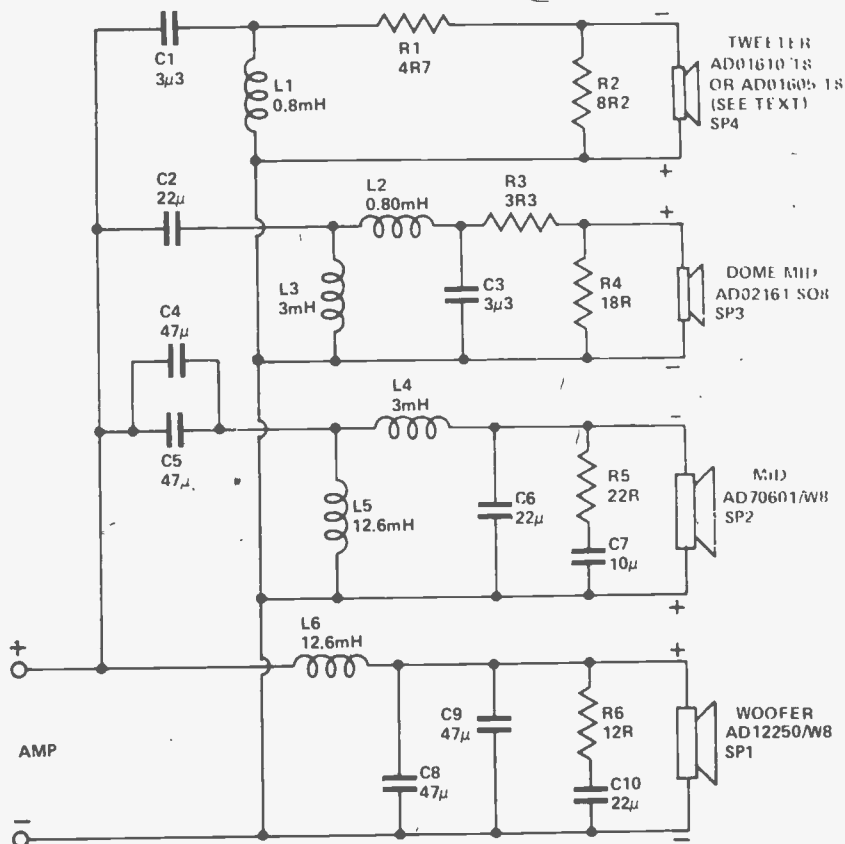

Circuit diagram for the four-way system. Driver polarity is important. Note that the "dome mid" driver, AD02161/SQ8, is available in two models, the other being AD02160/SQ8, which is different in appearance but electrically equivalent.

# 4-WAY LOUDSPEAKER

The inductors used in the crossover are too big to be mounted on the PC board. All the other crossover components are on the PC board. Start construction of the crossover by mounting and soldering the capacitors to the PC board. Next, solder the resistors into place spacing them approximately 10 mm off the

board. This is necessary to prevent charring the PC board should these resistors get hot when the speaker is used with high power amplifiers. The remaining two inductors should be glued onto the pc board and then the leads soldered.

The prototype crossover was mounted on a sheet of aluminium 200

mm by 330 mm, but this is optional. If you elect to use this method of construction screw the remaining four inductors onto the aluminium sheet and solder the leads from these onto the PC board. Solder the leads from the drivers and input terminals onto the PC board and mount the PC board onto the aluminium base using 6 mm

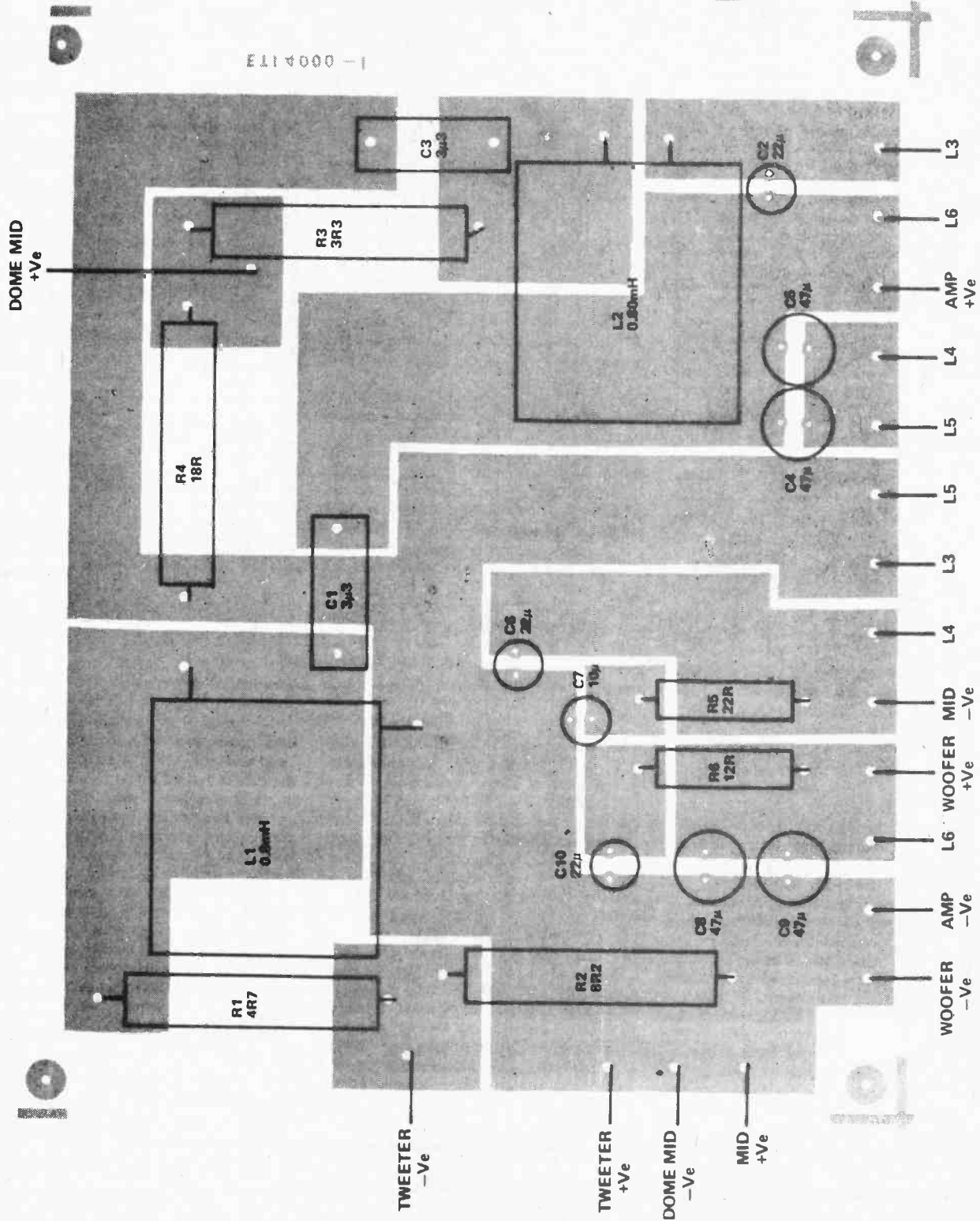



spacers. Finally, the whole crossover can be screwed to the bottom of the loudspeaker box. If you are not using the aluminium base the PC board and inductors are mounted directly to the bottom of the loudspeaker box. The advantage of using the aluminium base is so that the crossover can be handled as one complete unit.

### Powering up

Before connecting the loudspeaker to an amplifier touch the input of the loudspeaker to a *single* 1½ volt penlight battery. With the positive of the battery connected to the positive input (red terminal) of the loudspeaker the woofer cone should move forward and the loudspeaker should make a loud thump. Listen to all the drivers separately while connecting and disconnecting the battery to check that all of the drivers are operating. Don't use a battery any bigger than 1½ volts for this test or you could damage the woofer.

If all is well, connect the speakers to an amplifier and turn the volume up slowly.

### Performance

Power handling figures for loudspeakers are a very dubious quantity. Some manufacturers (not many) quote continuous sine wave power handling at a particular frequency, but it is doubtful that this is a really meaningful figure. Probably the best way of measuring power handling is with pink noise. This is a type of noise which contains equal energy per octave over the entire audio range. Using this technique, these loudspeakers are rated at 100 watt power handling. The bipolar electrolytic capacitors used in the crossover are rated at 50 volts. This corresponds to 156 watts into an 8 ohm load so this should be considered the *absolute maximum* power for the loudspeaker. It is sometimes mistakenly thought that the power handling figure represents the power below which the loudspeaker cannot be damaged. The most dangerous condition for any loudspeaker is a heavily clipping amplifier. In this state the output of the amplifier approaches dc and even a 20 watt amplifier can do irreparable damage if operated incorrectly.

## PARTS LIST

The following is a parts list for one only loudspeaker so two of every component will be needed for a stereo pair.

### Drivers

SP1	Philips AD12250/W8
SP2	Philips AD70601/W8
SP3	Philips AD02161/SQ8 Philips AD02161/SQ8 or AD02160/SQ8
SP4	Philips AD01610/T8 or AD01605/T8, see text.

### Inductors

L1, L2	0.8 mH max dc resistance 0.5 R
L3, L4	3.0 mH max dc resistance 0.5 R
L5, L6	12.6 mH max dc resistance 0.7 R

### Capacitors

C1	3µ3 polycarbonate
C2	22µ bipolar electrolytic 50 V
C3	3µ3 polycarbonate
C4, C5	47µ bipolar electrolytic 50 V
C6	22µ bipolar electrolytic 50 V
C7	10µ bipolar electrolytic 50 V
C8, C9	47µ bipolar electrolytic 50 V
C10	22µ bipolar electrolytic 50 V

### Resistors

R1	4R7 10 W 5%
R2	8R2 10 W 5%
R3	3R3 10 W 5%
R4	18R 10 W 5%
R5	22R 5 W 5%
R6	12R 5 W 5%

### Miscellaneous

pc board  
Wire, one pair of spring terminals,  
particle board, screws, glue, etc.  
Speaker grill cloth, innerbond.

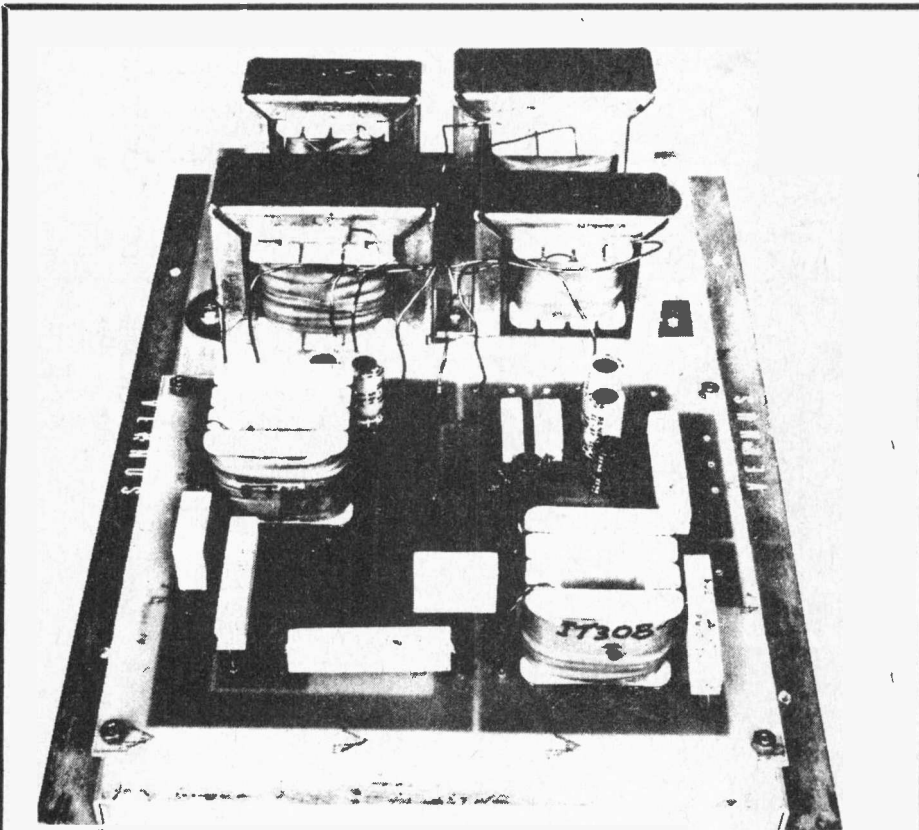

We mounted the crossover network assembly on an aluminium plate, bent as shown. The whole assembly was then screwed to the bottom of the loudspeaker and each driver connected as per the overlay.

Your ears are the best indication that the loudspeakers are operating safely. If the sound becomes distorted or unpleasant at higher power levels, turn down your amplifier. Nine times out of ten it will be the amplifier and not the loudspeaker that is running out of power.

The loudspeaker has been designed in accordance with extensive tests that reveal the "ideal" frequency response characteristics for most listening environments. This response is not flat but has a tapered top end, so that the extreme treble is attenuated slightly with respect to the mid-range and bass.

The subjective test revealed just how good the loudspeakers are. The frequency response is smooth and extended and the bass and treble are present only when they should be!

Above all, the sound is clean and easy to listen to for extended periods, even at very high listening levels. I hope you get as much enjoyment from your speakers as I have.

# 4-WAY LOUDSPEAKER

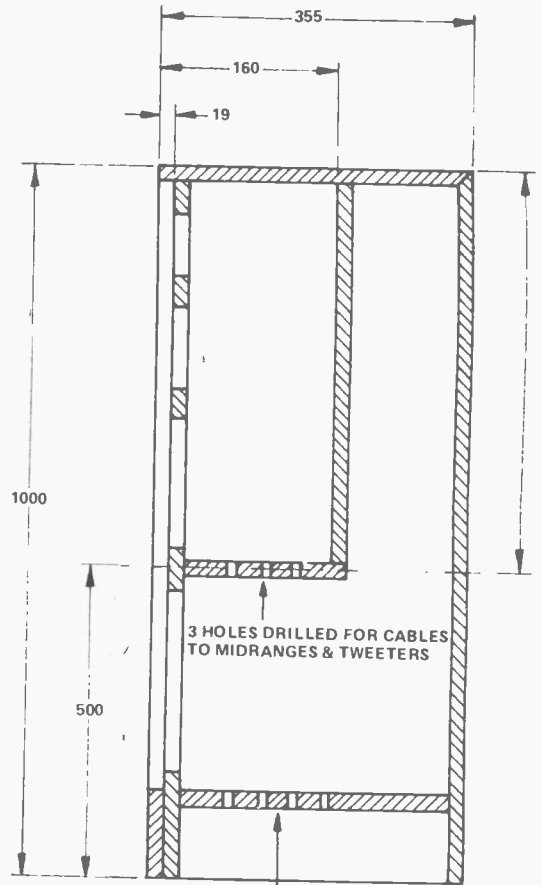
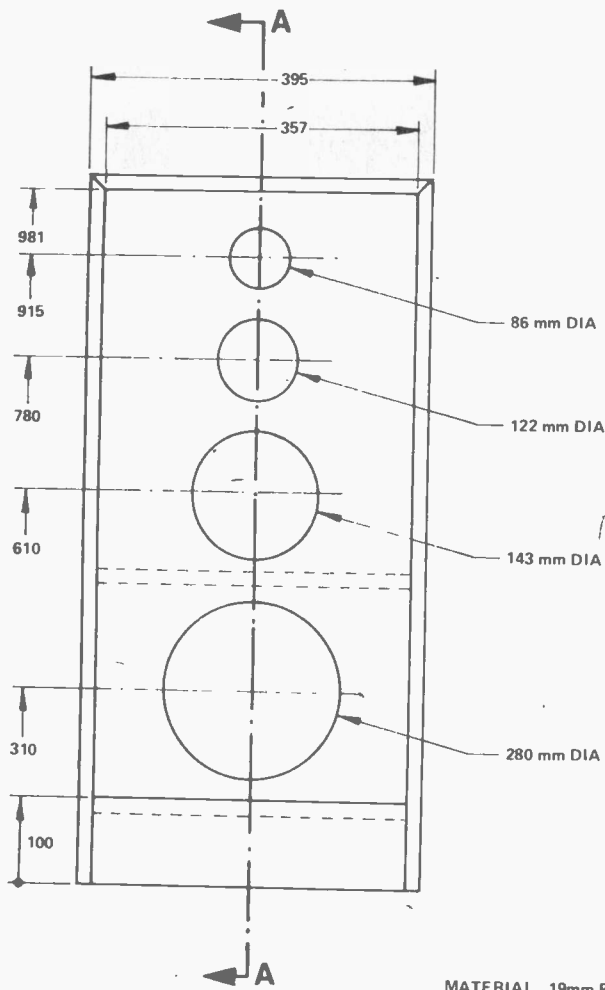

Complete cutting and assembly details for the four-way loudspeaker box. It is important that all joints be well sealed.

MATERIAL 19mm PARTICLE BOARD  
ALL DIMENSIONS ARE IN MILLIMETRES  
NOT TO SCALE

3 HOLES DRILLED FOR CABLES TO MIDRANGES & TWEETERS  
4 HOLES DRILLED TO ALLOW CABLES TO BE BROUGHT OUT THE BOTTOM OF THE BOX IF CROSSOVER IS TO BE MOUNTED IN THE BASE.

SECTION AA



*'It's a decade counter... It's been running since 1962!'*

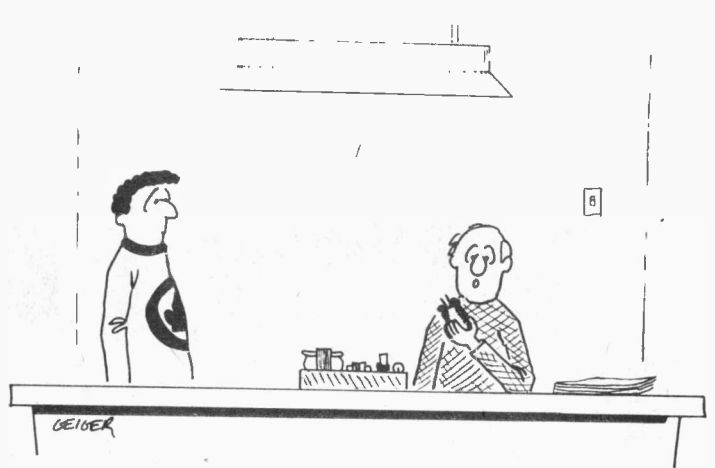

*'The instructions say I need a trimmer capacitor... maybe I can thin this one out by squeezing it in a vice.'*

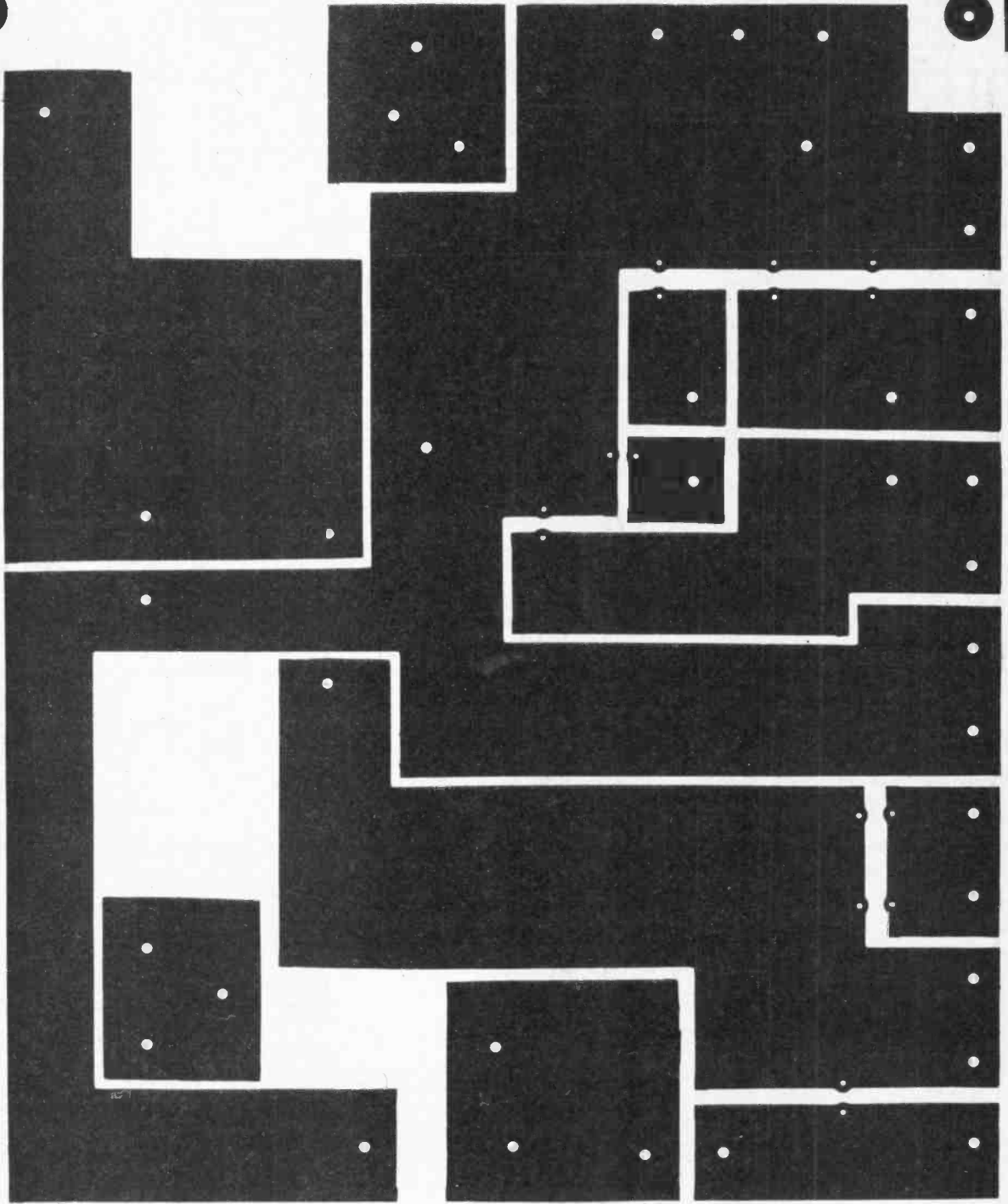

PCB for 4 Way Loudspeaker

If you liked this project, please circle  
Reader Service Card number 57.  
If you didn't, circle number 58.



# EMM

## BOOKS

### COMPUTERS

(HARDWARE)

#### A BEGINNER'S GUIDE TO COMPUTERS AND MICROPROCESSORS — WITH PROJECTS.

**TAB No.1015 \$13.45**  
Here's a plain English introduction to the world of microcomputers — its capabilities, parts and functions — and how you can use one. Numerous projects demonstrate operating principles and lead to the construction of an actual working computer capable of performing many useful functions.

#### BP66: BEGINNERS GUIDE TO MICROPROCESSORS AND COMPUTING

**TAB No.1015 \$13.45**  
E.F. SCOTT, M.Sc., C.Eng.  
As indicated by the title, this book is intended as an introduction to the basic theory and concepts of binary arithmetic, microprocessor operation and machine language programming.

There are occasions in the text where some background information might be helpful and a Glossary is included at the end of the book.

#### BP72: A MICROPROCESSOR PRIMER

**TAB No.1015 \$13.45**  
E.A. PARR, B.Sc., C.Eng., M.I.E.E.  
A newcomer to electronics tends to be overwhelmed when first confronted with articles or books on microprocessors. In an attempt to give a painless approach to computing, this small book will start by designing a simple computer and because of its simplicity and logical structure, the language is hopefully easy to learn and understand. In this way, such ideas as Relative Addressing, Index Registers etc. will be developed and it is hoped that these will be seen as logical progressions rather than arbitrary things to be accepted but not understood.

#### BEGINNERS GUIDE TO MICROPROCESSORS

**TAB No.995 \$10.45**  
If you aren't sure exactly what a microprocessor is, then this is the book for you. The book takes the beginner from the basic theories and history of these essential devices, right up to some real world hardware applications.

#### HOW TO BUILD YOUR OWN WORKING MICROCOMPUTER

**TAB No.1200 \$16.45**  
An excellent reference or how-to manual on building your own microcomputer. All aspects of hardware and software are developed as well as many practical circuits.

#### BP78: PRACTICAL COMPUTER EXPERIMENTS

**TAB No.1200 \$16.45**  
E.A. PARR, B.Sc., C.Eng., M.I.E.E.  
Curiously most published material on the microprocessor tends to be of two sorts, the first treats the microprocessor as a black box and deals at length with programming and using the "beast". The second type of book deals with the social impact. None of these books deal with the background to the chip, and this is a shame as the basic ideas are both interesting and simple.

This book aims to fill in the background to the microprocessor by constructing typical computer circuits in discrete logic and it is hoped that this will form a useful introduction to devices such as adders, memories, etc. as well as a general source book of logic circuits.

#### HANDBOOK OF MICROPROCESSOR APPLICATIONS

**TAB No.1203 \$14.45**  
Highly recommended reading for those who are interested in microprocessors as a means of accomplishing a specific task. The author discusses two individual microprocessors, the 1802 and the 6800, and how they can be put to use in real world applications.

#### MICROPROCESSOR/MICROPROGRAMMING HANDBOOK

**TAB No.785 \$14.45**  
A comprehensive guide to microprocessor hardware and programming. Techniques discussed include subroutines, handling interrupts and program loops.

#### DIGITAL INTERFACING WITH AN ANALOG WORLD

**TAB No.1070 \$14.45**  
You've bought a computer, but now you can't make it do anything useful. This book will tell you how to convert real world quantities such as temperature, pressure, force and so on into binary representation.

#### MICROPROCESSOR INTERFACING HANDBOOK: A/D & D/A

**TAB No.1271 \$14.45**  
A useful handbook for computerists interested in using their machines in linear applications. Topics discussed include voltage references, op-amps for data conversion, analogue switching and multiplexing and more.

#### COMPUTER TECHNICIAN'S HANDBOOK

**TAB No.554 \$17.45**  
Whether you're looking for a career, or you are a service technician, computer repair is an opportunity you should be looking at. The author covers all aspects of digital and computer electronics as well as the mathematical and logical concepts involved.

#### THE ESSENTIAL COMPUTER DICTIONARY AND SPELLER

**AB011 \$9.45**  
A must for anyone just starting out in the field of computing, be they a businessman, hobbyist or budding computerist. The book presents and defines over 15,000 computer terms and acronyms and makes for great browsing.

#### HOW TO TROUBLESHOOT AND REPAIR MICROCOMPUTERS

**AB013 \$10.45**  
Learn how to find the cause of a problem or malfunction in the central or peripheral unit of any microcomputer and then repair it. The tips and techniques in this guide can be applied to any equipment that uses the microprocessor as the primary control element.

#### TROUBLESHOOTING MICROPROCESSORS AND DIGITAL LOGIC

**TAB No.1183 \$13.45**  
The influence of digital techniques on commercial and home equipment is enormous and increasing yearly. This book discusses digital theory and looks at how to service Video Cassette Recorders, microprocessors and more.

#### HOW TO DEBUG YOUR PERSONAL COMPUTER

**AB012 \$10.45**  
When you feel like reaching for a sludge hammer to reduce your computer to fiberglass and epoxy dust, don't. Reach for this book instead and learn all about program bug tracking, recognition and elimination techniques.

#### THE COMPLETE HANDBOOK OF ROBOTICS

**TAB No.1071 \$13.45**  
All the information you need to build a walking, talking mechanical friend appears in this book. Your robot can take many forms and various options — light, sound, and proximity sensors — are covered in depth.

#### HOW TO BUILD YOUR OWN SELF PROGRAMMING ROBOT

**TAB No.1241 \$13.45**  
A practical guide on how to build a robot capable of learning how to adapt to a changing environment. The creature developed in the book, Rodney, is fully self programming, can develop theories to deal with situations and apply those theories in future circumstances.

#### BUILD YOUR OWN WORKING ROBOT

**TAB No.841 \$11.45**  
Contains complete plans — mechanical, schematics, logic diagrams and wiring diagrams — for building Buster. There are two phases involved: first Buster is leashed, dependent on his creator for guidance; the second phase makes Buster more independent and able to get out of tough situations.

## COMPUTERS

(SOFTWARE)

#### BEGINNER'S GUIDE TO COMPUTER PROGRAMMING

**TAB No.574 \$16.45**  
Computer programming is an increasingly attractive field to the individual, however many people still overlook it as a career. The material in this book has been developed in a logical sequence, from the basic steps to machine language.

#### BP86: AN INTRODUCTION TO BASIC PROGRAMMING TECHNIQUES

**S. DALY \$8.25**  
This book is based on the author's own experience in learning BASIC and in helping others, mostly beginners, to program and understand the language. Also included are a program library containing various programs, that the author has actually written and run. These are for biorhythms, plotting a graph of Y against X, standard deviation, regression, generating a musical note sequence and a card game. The book is complemented by a number of appendices which include test questions and answers on each chapter and a glossary.

#### THE BASIC COOKBOOK.

**TAB No.1055 \$9.45**  
BASIC is a surprisingly powerful language... if you understand it completely. This book picks up where most manufacturers' documentation gives up. With it, any computer owner can develop programs to make the most out of his or her machine.

#### PET BASIC — TRAINING YOUR PET COMPUTER

**AB014 \$16.45**  
Officially approved by Commodore, this is the ideal reference book for long time PET owners or novices. In an easy to read and humorous style, this book describes techniques and experiments, all designed to provide a strong understanding of this versatile machine.

#### PROGRAMMING IN BASIC FOR PERSONAL COMPUTERS

**AB015 \$10.45**  
This book emphasizes the sort of analytical thinking that lets you use a specific tool — the BASIC language — to transform your own ideas into workable programs. The text is designed to help you to intelligently analyse and design a wide diversity of useful and interesting programs.

#### COMPUTER PROGRAMS IN BASIC

**AB001 \$14.45**  
A catalogue of over 1600 fully indexed BASIC computer programs with applications in Business, Math, Games and more. This book lists available software, what it does, where to get it, and how to adapt it to your machine.

#### PET GAMES AND RECREATION

**AB002 \$12.45**  
A variety of interesting games designed to amuse and educate. Games include such names as Capture, Tic Tac Toe, Watchperson, Motie, Sinners, Martian Hunt and more.

#### BRAIN TICKLERS

**AB005 \$8.00**  
If the usual games such as Bug Stomp and Invaders from the Time Warp are starting to pale, then this is the book for you. The authors have put together dozens of stimulating puzzles to show you just how challenging computing can be.

#### PASCAL

**TAB No.1205 \$16.45**  
Aimed specifically at TRS-80 users, this book discusses how to load, use and write PASCAL programs. Graphic techniques are discussed and numerous programs are presented.

#### PASCAL PROGRAMMING FOR THE APPLE

**AB008 \$16.45**  
A great book to upgrade your programming skills to the UCSD Pascal as implemented on the Apple II. Statements and techniques are discussed and there are many practical and ready to run programs.

#### APPLE MACHINE LANGUAGE PROGRAMMING

**AB009 \$16.45**  
The best way to learn machine language programming the Apple II in no time at all. The book combines colour, graphics, and sound generation together with clear cut demonstrations to help the user learn quickly and effectively.

#### Z80 USERS MANUAL

**AB010 \$14.45**  
The Z80 MPU can be found in many machines and is generally acknowledged to be one of the most powerful 8 bit chips around. This book provides an excellent 'right hand' for anyone involved in the application of this popular processor.

#### HOW TO PROGRAM YOUR PROGRAMMABLE CALCULATOR

**AB006 \$10.45**  
Calculator programming, by its very nature, often is an obstacle to effective use. This book endeavours to show how to use a programmable calculator to its full capabilities. The TI 57 and the HP 33E calculators are discussed although the principles extend to similar models.

#### BP33: ELECTRONIC CALCULATOR USERS HANDBOOK

**M.H. BABANI, B.Sc.(Eng.) \$4.25**  
An invaluable book for all calculator users whatever their age or occupation, or whether they have the simplest or most sophisticated of calculators. Presents formulae, data, methods of calculation, conversion factors, etc., with the calculator user especially in mind, often illustrated with simple examples. Includes the way to calculate using only a simple four function calculator: Trigonometric Functions (Sin, Cos, Tan); Hyperbolic Functions (Sinh, Cosh, Tanh) Logarithms, Square Roots and Powers.

## PROJECTS

#### BP48: ELECTRONIC PROJECTS FOR BEGINNERS

**F.G. RAYER, T.Eng.(CEI), Assoc.IERE \$5.90**  
Another book written by the very experienced author — Mr. F.G. Rayer — and in it the newcomer to electronics, will find a wide range of easily made projects. Also, there are a considerable number of actual component and wiring layouts, to aid the beginner.

Furthermore, a number of projects have been arranged so that they can be constructed without any need for soldering and, thus, avoid the need for a soldering iron.

Also, many of the later projects can be built along the lines as those in the 'No Soldering' section so this may considerably increase the scope of projects which the newcomer can build and use.

#### 221: 28 TESTED TRANSISTOR PROJECTS

**R.TORRENS \$5.50**  
Mr. Richard Torrens is a well experienced electronics development engineer and has designed, developed, built and tested the many useful and interesting circuits included in this book. The projects themselves can be split down into simpler building blocks, which are shown separated by boxes in the circuits for ease of description, and also to enable any reader who wishes to combine boxes from different projects to realise ideas of his own.

#### BP49: POPULAR ELECTRONIC PROJECTS

**R.A. PENFOLD \$6.25**  
Includes a collection of the most popular types of circuits and projects which, we feel sure, will provide a number of designs to interest most electronics constructors. The projects selected cover a very wide range and are divided into four basic types: Radio Projects, Audio Projects, Household Projects and Test Equipment.

#### EXPERIMENTER'S GUIDE TO SOLID STATE ELECTRONIC PROJECTS

**AB007 \$9.45**  
An ideal sourcebook of Solids State circuits and techniques with many practical circuits. Also included are many useful types of experimenter gear.

#### BP71: ELECTRONIC HOUSEHOLD PROJECTS

**R. A. PENFOLD \$7.70**  
Some of the most useful and popular electronic construction projects are those that can be used in or around the home. The circuits range from such things as '2 Tone Door Buzzer', Intercom, through Smoke or Gas Detectors to Baby and Freezer Alarms.

#### BP94: ELECTRONIC PROJECTS FOR CARS AND BOATS

**R.A. PENFOLD \$8.10**  
Projects, fifteen in all, which use a 12V supply are the basis of this book. Included are projects on Windscreen Wiper Control, Courtesy Light Delay, Battery Monitor, Cassette Power Supply, Lights Timer, Vehicle Immobiliser, Gas and Smoke Alarm, Depth Warning and Shaver Inverter.

#### BP69: ELECTRONIC GAMES

**R.A. PENFOLD \$7.55**  
In this book Mr. R. A. Penfold has designed and developed a number of interesting electronic game projects using modern integrated circuits. The text is divided into two sections, the first dealing with simple games and the latter dealing with more complex circuits.

#### BP95: MODEL RAILWAY PROJECTS

**\$8.10**  
Electronic projects for model railways are fairly recent and have made possible an amazing degree of realism. The projects covered include controllers, signals and sound effects; stroboid layouts are provided for each project.

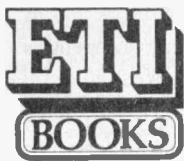

## PROJECTS (CONTINUED)

### BP76: POWER SUPPLY PROJECTS \$7.30

**R.A. PENFOLD**  
Line power supplies are an essential part of many electronics projects. The purpose of this book is to give a number of power supply designs, including simple unregulated types, fixed voltage regulated types, and variable voltage stabilised designs, the latter being primarily intended for use as bench supplies for the electronics workshop. The designs provided are all low voltage types for semiconductor circuits.

There are other types of power supply and a number of these are dealt with in the final chapter, including a cassette power supply, Ni-Cad battery charger, voltage step up circuit and a simple inverter.

### BP84: DIGITAL IC PROJECTS \$8.10

**F.G. RAYER, T.Eng.(CEI), Assoc.IERE**  
This book contains both simple and more advanced projects and it is hoped that these will be found of help to the reader developing a knowledge of the workings of digital circuits. To help the newcomer to the hobby the author has included a number of board layouts and wiring diagrams. Also the more ambitious projects can be built and tested section by section and this should help avoid or correct faults that could otherwise be troublesome. An ideal book for both beginner and more advanced enthusiast alike.

### BP67: COUNTER DRIVER AND NUMERAL DISPLAY PROJECTS \$7.55

**F.G. RAYER, T.Eng.(CEI), Assoc. IERE**  
Numerical indicating devices have come very much to the forefront in recent years and will, undoubtedly, find increasing applications in all sorts of equipment. With present day integrated circuits, it is easy to count, divide and display numerically the electrical pulses obtained from a great range of driver circuits.

In this book many applications and projects using various types of numeral displays, popular counter and driver IC's etc are considered

### 213: ELECTRONIC CIRCUITS FOR MODEL RAILWAYS \$4.50

**M.H. BABANI, B.Sc.(Eng.)**  
The reader is given constructional details of how to build a simple model train controller, controller with simulated inertia and a high power controller. A signal system and lighting for model trains is discussed as is the suppression of RF interference from model railways. The construction of an electronic steam whistle and a model train chuffer is also covered.

### BP73: REMOTE CONTROL PROJECTS \$8.60

**OWEN BISHOP**  
This book is aimed primarily at the electronics enthusiast who wishes to experiment with remote control. Full explanations have been given so that the reader can fully understand how the circuits work and can more easily see how to modify them for other purposes, depending on personal requirements. Not only are radio control systems considered but also infra-red, visible light and ultrasonic systems as are the use of Logic ICs and Pulse position modulation etc

## CIRCUITS

### BP80: POPULAR ELECTRONIC CIRCUITS — BOOK 1 \$8.25

**R.A. PENFOLD**  
Another book by the very popular author, Mr. R.A. Penfold, who has designed and developed a large number of various circuits. These are grouped under the following general headings: Audio Circuits, Radio Circuits, Test Gear Circuits, Music Project Circuits, Household Project Circuits and Miscellaneous Circuits.

### THE GIANT HANDBOOK OF ELECTRONIC CIRCUITS

**TAB No.1300 \$24.45**  
About as thick as the Webster's dictionary, and having many more circuit diagrams, this book is ideal for any experimenter who wants to keep amused for several centuries. If there isn't a circuit for it in here, you should have no difficulty convincing yourself you don't really want to build it.

### BP39: 50 (FET) FIELD EFFECT TRANSISTOR PROJECTS \$5.50

**F.G. RAYER, T.Eng.(CEI), Assoc.IERE**  
Field effect transistors (FETs), find application in a wide variety of circuits. The projects described here include radio frequency amplifiers and converters, test equipment and receiver aids, tuners, receivers, mixers and tone controls, as well as various miscellaneous devices which are useful in the home.

This book contains something of particular interest for every class of enthusiast — short wave listener, radio amateur, experimenter or audio devotee.

### BP87: SIMPLE L.E.D. CIRCUITS \$5.90

**R.N. SOAR**  
Since it first appeared in 1977, Mr R.N. Soar's book has proved very popular. The author has developed a further range of circuits and these are included in Book 2. Projects include a Transistor Tester, Various Voltage Regulators, Testers and so on.

### BP42: 50 SIMPLE L.E.D. CIRCUITS \$3.55

**R.N. SOAR**  
The author of this book, Mr. R.N. Soar, has compiled 50 interesting and useful circuits and applications, covering many different branches of electronics, using one of the most inexpensive and freely available components — the Light Emitting Diode (L.E.D.). A useful book for the library of both beginner and more advanced enthusiast alike.

### BP82: ELECTRONIC PROJECTS USING SOLAR CELLS \$8.10

**OWEN BISHOP**  
The book contains simple circuits, almost all of which operate at low voltage and low currents, making them suitable for being powered by a small array of silicon cells. The projects cover a wide range from a bicycle speedometer to a novelty 'Duck Shoot', a number of power supply circuits are included.

### BP37: 50 PROJECTS USING RELAYS, SCR'S & TRIACS \$5.50

**F.G. RAYER, T.Eng.(CEI), Assoc.IERE**  
Relays, silicon controlled rectifiers (SCR's) and bi-directional triodes (TRIACS) have a wide range of applications in electronics today. This book gives tried and practical working circuits which should present the minimum of difficulty for the enthusiast to construct. In most of the circuits there is a wide latitude in component values and types, allowing easy modification of circuits or ready adaptation of them to individual needs

### BP44: IC 555 PROJECTS \$7.55

**E.A. PARR, B.Sc., C.Eng., M.I.E.E.**  
Every so often a device appears that is so useful that one wonders how life went on before without it. The 555 timer is such a device. Included in this book are Basic and General Circuits, Motor Car and Model Railway Circuits, Alarms and Noise Makers as well as a section on the 556, 558 and 559 timers.

### BP24: 50 PROJECTS USING IC741 \$4.25

**RUDI & UWE REDMER**  
This book, originally published in Germany by TOPP, has achieved phenomenal sales on the Continent and Babani decided, in view of the fact that the integrated circuit used in this book is inexpensive to buy, to make this unique book available to the English speaking reader. Translated from the original German with copious notes, data and circuitry, a "must" for everyone whatever their interest in electronics.

### BP83: VMOS PROJECTS \$8.20

**R.A. PENFOLD**  
Although modern bipolar power transistors give excellent results in a wide range of applications, they are not without their drawbacks or limitations. This book will primarily be concerned with VMOS power FETs although power MOSFETs will be dealt with in the chapter on audio circuits. A number of varied and interesting projects are covered under the main headings of: Audio Circuits, Sound Generator Circuits, DC Control Circuits and Signal Control Circuits.

### BP65: SINGLE IC PROJECTS \$6.55

**R.A. PENFOLD**  
There is now a vast range of ICs available to the amateur market, the majority of which are not necessarily designed for use in a single application and can offer unlimited possibilities. All the projects contained in this book are simple to construct and are based on a single IC. A few projects employ one or two transistors in addition to an IC but in most cases the IC is the only active device used

### BP 50: IC LM3900 PROJECTS \$5.90

**H.KYBETT, B.Sc., C.Eng.**  
The purpose of this book is to introduce the LM3900 to the Technician, Experimenter and the Hobbyist. It provides the groundwork for both simple and more advanced uses, and is more than just a collection of simple circuits or projects.

Simple basic working circuits are used to introduce this IC. The LM3900 can do much more than is shown here, this is just an introduction. Imagination is the only limitation with this useful and versatile device. But first the reader must know the basics and that is what this book is all about.

### 223: 50 PROJECTS USING IC CA3130 \$5.50

**R.A. PENFOLD**  
In this book, the author has designed and developed a number of interesting and useful projects which are divided into five general categories: I — Audio Projects II — R.F. Projects III — Test Equipment IV — Household Projects V — Miscellaneous Projects.

### 224: 50 CMOS IC PROJECTS \$4.25

**R.A. PENFOLD**  
CMOS IC's are probably the most versatile range of digital devices for use by the amateur enthusiast. They are suitable for an extraordinary wide range of applications and are also some of the most inexpensive and easily available types of IC.

Mr. R.A. Penfold has designed and developed a number of interesting and useful projects which are divided into four general categories: I — Multivibrators II — Amplifiers and Oscillators III — Trigger Devices IV — Special Devices.

### THE ACTIVE FILTER HANDBOOK

**TAB No.1133 \$11.45**  
Whatever your field — computing, communications, audio, electronic music or whatever — you will find this book the ideal reference for active filter design. The book introduces filters and their uses also presents many practical circuits including a graphic equalizer, computer tape interface and more.

### DIGITAL IC'S — HOW THEY WORK AND HOW TO USE THEM

**AB004 \$10.45**  
An excellent primer on the fundamentals of digital electronics. This book discusses the nature of gates and related concepts and also deals with the problems inherent to practical digital circuits.

### MASTER HANDBOOK OF 1001 PRACTICAL CIRCUITS

**TAB No.800 \$20.45**  
**MASTER HANDBOOK OF 1001 MORE PRACTICAL CIRCUITS**  
**TAB No.804 \$19.45**  
Here are transistor and IC circuits for just about any application you might have. An ideal source book for the engineer, technician or hobbyist. Circuits are classified according to function, and all sections appear in alphabetical order.

### THE MASTER IC COOKBOOK

**TAB No.1199 \$16.45**  
If you've ever tried to find specs for a so called 'standard' chip, then you'll appreciate this book. C.L. Hallmark has compiled specs and pinouts for most types of ICs that you'd ever want to use.

### ELECTRONIC DESIGN WITH OFF THE SHELF INTEGRATED CIRCUITS

**AB016 \$10.45**  
This practical handbook enables you to take advantage of the vast range of applications made possible by integrated circuits. The book tells how, in step by step fashion, to select components and how to combine them into functional electronic systems. If you want to stop being a "cookbook hobbyist", then this is the book for you.

## AUDIO

### BP90: AUDIO PROJECTS \$8.10

**F.G. RAYER**  
Covers in detail the construction of a wide range of audio projects. The text has been divided into preamplifiers and mixers, power amplifiers, tone controls and matching and miscellaneous projects.

### HOW TO DESIGN, BUILD, AND TEST COMPLETE SPEAKER SYSTEMS.

**TAB No.1064 \$13.45**  
By far the greatest savings in assembling an audio system can be realized from the construction of speakers. This book contains information to build a variety of speakers as well as instructions on how to design your own.

### 205: FIRST BOOK OF HI-FI LOUDSPEAKER ENCLOSURES \$3.55

**B.B. BABANI**  
This book gives data for building most types of loudspeaker enclosure. Includes corner reflex, bass reflex, exponential horn, folded horn, tuned port, klipschorn labyrinth, tuned column, loaded port and multi speaker panoramic. Many clear diagrams for every construction showing the dimensions necessary.

### BP35: HANDBOOK OF IC AUDIO PREAMPLIFIER AND POWER AMPLIFIER CONSTRUCTION \$5.50

**F.G. RAYER, T.Eng.(CEI), Assoc.IERE**  
This book is divided into three parts: Part I, understanding audio IC's, Part II, Preamplifiers, Mixers and Tone Controls, Part III Power Amplifiers and Supplies. Includes practical constructional details of pure IC and Hybrid IC and transistor designs from about 250mW to 100W output.

### BP47: MOBILE DISCOTHEQUE HANDBOOK \$5.90

**COLIN CARSON**  
The vast majority of people who start up "Mobile Discos" know very little about their equipment or even what to buy. Many people have wasted a "small fortune" on poor, unnecessary or badly matched apparatus.

The aim of this book is to give you enough information to enable you to have a better understanding of many aspects of "discos" gear.

### HOW TO BUILD A SMALL BUDGET RECORDING STUDIO FROM SCRATCH. . .

**TAB No.1166 \$16.45**  
The author, F. Alton Everest, has gotten studios together several times, and presents twelve complete, tested designs for a wide variety of applications. If all you own is a mono cassette recorder, you don't need this book. If you don't want your new four track to wind up sounding like one, though, you shouldn't be without it.

### BP51: ELECTRONIC MUSIC AND CREATIVE TAPE RECORDING \$5.50

**M.K. BERRY**  
Electronic music is the new music of the Twentieth Century. It plays a large part in "pop" and "rock" music and, in fact, there is scarcely a group without some sort of synthesiser or other effects generator.

This book sets out to show how electronic music can be made at home with the simplest and most inexpensive of equipment. It then describes how the sounds are generated and how these may be recorded to build up the final composition.

### BP74: ELECTRONIC MUSIC PROJECTS \$7.70

**R.A. PENFOLD**  
Although one of the more recent branches of amateur electronics, electronic music has now become extremely popular and there are many projects which fall into this category. The purpose of this book is to provide the constructor with a number of practical circuits for the less complex items of electronic music equipment, including such things as a Fuzz Box, Waa-Waa Pedal, Sustain Unit, Reverberation and Phaser-Units, Tremelo Generator etc.

### BP81: ELECTRONIC SYNTHESISER PROJECTS \$7.30

**M.K. BERRY**  
One of the most fascinating and rewarding applications of electronics is in electronic music and there is hardly a group today without some sort of synthesiser or effects generator. Although an electronic synthesiser is quite a complex piece of electronic equipment, it can be broken down into much simpler units which may be built individually and these can then be used or assembled together to make a complete instrument.

### ELECTRONIC MUSIC SYNTHESIZERS

**TAB No.1167 \$10.45**  
If you're fascinated by the potential of electronics in the field of music, then this is the book for you. Included is data on synthesizers in general as well as particular models. There is also a chapter on the various accessories that are available.

See the order form on  
page 48

## TEST EQUIPMENT

### BP75: ELECTRONIC TEST EQUIPMENT CONSTRUCTION

**F.G. RAYER, T.Eng. (CEI), Assoc. IERE \$7.30**  
This book covers in detail the construction of a wide range of test equipment for both the Electronics Hobbyists and Radio Amateur. Included are projects ranging from an FET Amplified Voltmeter and Resistance Bridge to a Field Strength Indicator and Heterodyne Frequency Meter. Not only can the home constructor enjoy building the equipment but the finished projects can also be usefully utilised in the furtherance of his hobby.

### 99 TEST EQUIPMENT PROJECTS YOU CAN BUILD

**TAB No.805 \$14.45**  
An excellent source book for the hobbyist who wants to build up his work bench inexpensively. There are circuits to measure just about any electrical quantity. The variety is endless and includes just about anything you could wish for!

### HOW TO GET THE MOST OUT OF LOW COST TEST EQUIPMENT

**AB017 \$9.45**  
Whether you want to get your vintage 1960 'TestRite' signal generator working, or you've got something to measure with nothing to measure it with, this is the book for you. The author discusses how to maximize the usefulness of cheap test gear, how to upgrade old equipment, and effective test set ups.

### THE POWER SUPPLY HANDBOOK

**TAB No.806 \$16.45**  
A complete one stop reference for hobbyists and engineers. Contains high and low voltage power supplies of every conceivable type as well mobile and portable units.

### BP70: TRANSISTOR RADIO FAULT- FINDING CHART

**CHAS. E. MILLER \$2.40**  
Across the top of the chart will be found four rectangles containing brief descriptions of various faults; vis. — sound weak but undistorted; set dead; sound low or distorted and background noises. One then selects the most appropriate of these and following the arrows, carries out the suggested checks in sequence until the fault is cleared.

### ELECTRONIC TROUBLESHOOTING HAND- BOOK

**AB019 \$9.45**  
This workbench guide can show you how to pinpoint circuit troubles in minutes, how to test anything electronic, and how to get the most out of low cost test equipment. You can use any and all of the time-saving shortcuts to rapidly locate and repair all types of electronic equipment malfunctions.

### COMPLETE GUIDE TO READING SCHEMATIC DIAGRAMS

**AB018 \$9.45**  
A complete guide on how to read and understand schematic diagrams. The book teaches how to recognize basic circuits and identify component functions. Useful for technicians and hobbyists who want to avoid a lot of headscratching.

## RADIO AND COMMUNICATIONS

### BP79: RADIO CONTROL FOR BEGINNERS

**F.G. RAYER, T.Eng.(CEI), Assoc. IERE. \$7.30**  
The aim of this book is to act as an introduction to Radio Control for beginners to the hobby. The book will commence by dealing with the conditions that are allowable for such things as frequency and power of transmission. This is followed by a "block" explanation of how control-device and transmitter operate and receiver and actuator(s) produce motion in a model.

Details are then given of actual solid state transmitting equipment which the reader can build. Plain and loaded aerials are then discussed and so is the field-strength meter to help with proper setting up.

The radio receiving equipment is then dealt with which includes a simple receiver and also a crystal controlled superhet. The book ends with the electro-mechanical means of obtaining movement of the controls of the model.

### BP91: AN INTRODUCTION TO RADIO DXing

**\$8.10**  
This book is divided into two main sections one to amateur band reception, the other to broadcast bands. Advice is given to suitable equipment and techniques. A number of related constructional projects are described.

### No. 215: Shortwave Circuits & Gear For Experimenters & Radio Hams

**\$3.70**  
Covers constructional details of a number of projects for the shortwave enthusiast and radio "Ham". Included are: an add-in crystal filter, adding an "S" meter in your receiver; crystal locked H.F. Receiver; AM tuning using phase locked loop; converter for 2MHz, 40 to 800 MHz RF Amplifier, Aerials for the 52, 144MHz bands, Solid State Crystal Frequency Calibrator, etc.

### BP46: RADIO CIRCUITS USING IC's

**J.B. DANCE, M.Sc. \$5.90**  
This book describes integrated circuits and how they can be employed in receivers for the reception of either amplitude or frequency modulated signals. The chapter on amplitude modulated (a.m.) receivers will be of most interest to those who wish to receive distant stations at only moderate audio quality, while the chapter on frequency modulation (f.m.) receivers will appeal to those who desire high fidelity reception.

### BP1: FIRST BOOK OF TRANSISTOR EQUIVALENTS AND SUBSTITUTES

**\$2.80**  
**B.B. BABANI**  
This guide covers many thousands of transistors showing possible alternatives and equivalents. Covers transistors made in Great Britain, USA, Japan, Germany, France, Europe, Hong Kong, and includes types produced by more than 120 different manufacturers.

### BP14: SECOND BOOK OF TRANSISTOR EQUIVALENTS AND SUBSTITUTES

**\$4.80**  
**B.B. BABANI**  
The "First Book of Transistor Equivalents" has had to be reprinted 15 times. The "Second Book" produced in the same style as the first book, in no way duplicates any of the data presented in it. The "Second Book" contains only additional material and the two books complement each other and make available some of the most complete and extensive information in this field. The interchangeability data covers semiconductor manufacturers in Great Britain, USA, Germany, France, Poland, Italy, East Germany, Belgium, Austria, Netherlands and many other countries.

### TOWER'S INTERNATIONAL OP-AMP LINEAR IC SELECTOR

**TAB No.1216 \$13.45**  
This book contains a wealth of useful data on over 5 000 Op-amps and linear ICs — both pinouts and essential characteristics. A comprehensive series of appendices contain information on specs, manufacturers, case outlines and so on.

### CMOS DATABASE

**TAB No.984 \$14.45**  
There are several books around with this title, but most are just collections of manufacturers' data sheets. This one, by Bill Hunter, explains all the intricacies of this useful family of logic devices — the missing link in getting your own designs working properly. Highly recommended to anyone working with digital circuits.

### BP68: CHOOSING AND USING YOUR HI-FI

**MAURICE L. JAY \$7.25**  
The main aim of this book is to provide the reader with the fundamental information necessary to enable him to make a satisfactory choice from the extensive range of hi-fi equipment now on the market.

Help is given to the reader in understanding the equipment he is interested in buying and the author also gives his own opinion of the minimum standards and specifications one should look for. The book also offers helpful advice on how to use your hi-fi properly so as to realise its potential. A Glossary of terms is also included.

## REFERENCE

### THE BEGINNER'S HANDBOOK OF ELEC- TRONICS

**AB002 \$9.45**  
An excellent textbook for those interested in the fundamentals of Electronics. This book covers all major aspects of power supplies, amplifiers, oscillators, radio, television and more.

### ELEMENTS OF ELECTRONICS — An on-going series

**F.A. WILSON, C.G.I.A., C.Eng. \$8.95**

**BP62: BOOK 1. The Simple Electronic Circuit  
and Components**

**BP63: BOOK 2. Alternating Current  
Theory \$8.95**

**BP64: BOOK 3. Semiconductor  
Technology \$8.95**

**BP77: BOOK 4. Microprocessing Systems  
And Circuits \$12.30**

**BP89: BOOK 5. Communication \$12.30**

The aim of this series of books can be stated quite simply — it is to provide an inexpensive introduction to modern electronics so that the reader will start on the right road by thoroughly understanding the fundamental principles involved.

Although written especially for readers with no more than ordinary arithmetical skills, the use of mathematics is not avoided, and all the mathematics required is taught as the reader progresses.

Each book is a complete treatise of a particular branch of the subject and, therefore, can be used on its own with one proviso, that the later books do not duplicate material from their predecessors, thus a working knowledge of the subjects covered by the earlier books is assumed.

**BOOK 1:** This book contains all the fundamental theory necessary to lead to a full understanding of the simple electronic circuit and its main components.

**BOOK 2:** This book continues with alternating current theory without which there can be no comprehension of speech, music, radio, television or even the electricity utilities.

**BOOK 3:** Follows on semiconductor technology, leading up to transistors and integrated circuits.

**BOOK 4:** A complete description of the internal workings of microprocessor.

**BOOK 5:** A book covering the whole communication scene.

### BP85: INTERNATIONAL TRANSISTOR EQUIVALENTS GUIDE

**ADRIAN MICHAELS \$12.25**  
This book will help the reader to find possible substitutes for a popular user-orientated selection of modern transistors. Also shown are the material type, polarity, manufacturer selection of modern transistors. Also shown are the material type, polarity, manufacturer and use. The Equivalents are sub-divided into European, American and Japanese. The products of over 100 manufacturers are included. An essential addition to the library of all those interested in electronics, be they technicians, designers, engineers or hobbyists. Fantastic value for the amount of information it contains.

See the order form on  
page 48

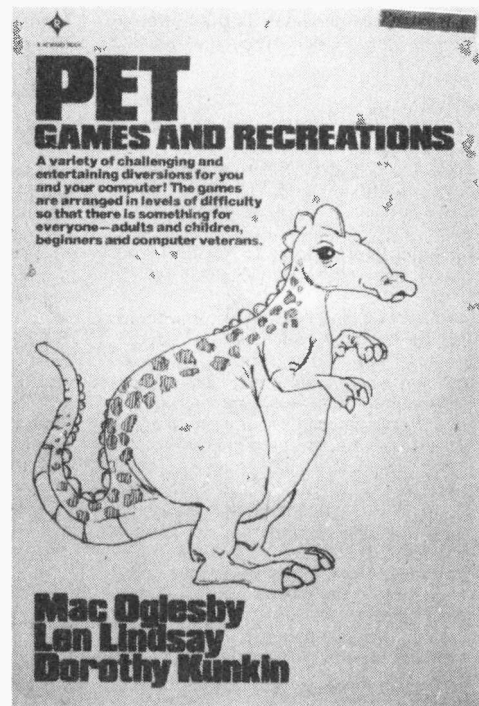

Book of the Month

Pet Games And Recreations . . . . . AB002 . . . . . \$12.45

Is your PET becoming dull and listless due to insufficient amusement in its life? Do you frequently hear it muttering to itself, rhyming off random numbers and functions? Poor little computer: it's just not having any fun. It doesn't want to calculate pi to the 1024th decimal place. It wants to hunt Martians. If you don't give it a break pretty soon, it'll no doubt be on strike by the end of the month. Just look what happened with the electronic oregano pickers in San Juan.

*PET Games and Recreations* is just the book to save you all sorts of nasty labour troubles, and let you have a lot of fun with that glorified adding machine as well. It contains many of the classic games, including Qwert, Reverse and Dr. Factor, with complete listings and explanations. There's also an appendix of "Guest Lectures", which outlines a few of the unusual things you can do with your PET and some short programs.

This listing of Electronics Stores has been compiled from our own lists and with the cooperation of several subscribers to the magazine. They were asked to supply details of their local stores or any that they purchased from. We then wrote to all stores and this listing is what they supplied; the wording and the details are those given to us by stores.

# DIRECTORY OF ELECTRONIC STORES

## KEY

ETI ETI Magazine sold here  
 EC Supplies Electronic Components  
 CA Sells Computers and Accessories  
 RTV Sells Radio and TV parts  
 TG Sells Test Gear  
 EK Sells Electronic Kits  
 MO Company does Mail Order  
 CAT Catalogue available. The cost of this, or if it free, is shown

### BRITISH COLUMBIA

#### Kamloops

**Cam Gard Supply Limited**  
 825 Notre Dame Dr, Kamloops, B.C. V2C 5N8  
 Tel. (604) 372-3338  
 EC, RTV, TG, EK, MO  
 National wholesaler of electronic parts and equipment including such lines as B & K, Potter and Brumfield, Jana, Belden, Hammond, semis.

#### Trail

**IUS Electronics Ltd.**  
 P.O. Box 81, Trail, BC V1R 4L3, (604) 364-2786.  
 EC, MO, CAT, Free  
 Specialise in Speaker Kits, Finished Speakers, and Raw Drivers. (VISA, MC, ETC.)

#### Vancouver

**Active Component Sales Corp.** ETI  
 3070 Kingsway, Vancouver, BC, V5R 5C7 Tel. (604) 438-3321.

Active Components, specializing in electronic components for hobbyist, industrial and educational markets. Products range from semi conductors by major manufacturers, assembled kits, microcomputers, electronic measuring instruments, TI calculators, cases, chemicals, solder, P.C. aides and technical books.

#### Cam Gard Supply Ltd

2055 Boundary Rd, Vancouver, British Columbia. V5M 3Z2. Tel. (604) 291-1441.  
 EC, RTV, TG, EK, MO, CAT

National supplier of electronic parts and components. Amphenol, Beckman, Belden, Buss Fuses, Delhi (General Instrument), Hammond, ITT Components, Mallory Duracell, Philips, Potter & Brumfield, Spectro, Texas Instrument, Westinghouse, Xcelite, 3m Cable & Connectors.

#### Computer Innovations

1500 West Georgia Street, Vancouver, B.C. V6G 2Z6. Tel. (604) 687-5545  
 CA  
 Sales and support for Nabu, Apple and Crumenco.

#### Conti Electronics Ltd.

7204 Main Street, Vancouver, B.C. V5X 3J4 Tel. (604) 324-0505  
 EC, CA, TG, MO

AP Products, Armaco, Commodore Business Machines, EZ Hook, Fluke, GC, Plessey, Sanken, Silicon General, Synertek and more. (Line card available), NEC, EPSON, TEC, Mannesmann Tally.

#### Glenwood Trading Company Limited

278 East First St., North Vancouver, BC V7L 1B3. Tel. (604) 984-0404  
 TG, MO, CAT (Free)

Canada's largest mail order supplier of amateur radio equipment, accessories, antennas, books. Microphones, power supplies, receivers, rotors, transceivers.

ETI - JANUARY 1982

#### Heathkit Electronic Centre

3058 Kingsway, Vancouver, B.C. V5R 5J7 CA, EC, CA, RTV, TG, EK, MO, CAT, FREE  
 Heath/Zenith self-instruction courses. Earth satellite receiving stations, Heathcraft Furniture line, Digital products for home, car and boat, Amateur Radio Equipment including antennas Shortwave, Radio, Control, Marine, TV and Audio equipment, Automotive test equipment. Over 400 kits to choose from.

#### Intek Electronics Ltd.

10 — 8385 St. George St., Vancouver, B.C. V5X 4P3 Tel. (604) 324-6831  
 EC, EK  
 Electronics parts distributors handling products such as: Alpha, Beckman, C&K Dale, Exar, Harris, ITT, Littlefuse, Motorola, Opto-22, PMI, Silicon General, Teledyne Semiconductor, Robinson Nugent, Mallory.

#### R-A-E Industrial Electronics Limited

3455 Gardner Court, Burnaby, B.C. V5G 4J7 Tel. (604) 291-8866  
 EC, CA, RTV, TG, EK, MO, CAT, \$12.00  
 Western Canada's largest inventory of industrial electronic components. R-A-E stocks 165 manufacturers' product lines with over 26,000 separate items to choose from. Visa and Mastercard welcome.

### Victoria

**Queale Electronics Ltd** ETI  
 1004 North Park Street, Victoria, British Columbia. V8Z 2E6 Tel. (604) 388-6111  
 EC, CA, RTV, TG, EK, MO.  
 Broad line distributors, all phases of electronics parts, equipment consumer & industrial plus audio visual.

### ALBERTA

#### Calgary

**Active Component Sales Corp.** ETI  
 5809 MacLeod Trail S., Unit 109, Calgary, Alberta, T2H 0J9. Tel. (403) 259-6408.  
 EC, CA, RTV, TG, EK, MO, CAT, Free  
 Active Components, specializing in electronic components for hobbyist, industrial and educational markets. Products range from semi conductors by major manufacturers, assembled kits, microcomputers, electronic measuring instruments, TI calculators, cases, chemicals, solder, P.C. aides and technical books.

#### B & E Electronic Supply Limited

442 Manitou Rd. S.E., Calgary, Alberta T2G 4C4 Tel. (403) 243-3177  
 EC, RTV, TG, EK, MO

## CAM GARD SUPPLY LTD.

"National Suppliers of Electronic Parts & Components"

Amphenol	Hammond	Spectro
Beckman	ITT Components	Texas Instruments
Belden	Mallory Duracell	Westinghouse
Buss Fuses	Philips	Xcelite
Delhi (General Instrument)	Potter & Brumfield	3M Cable & Connectors

VANCOUVER (604) 291-1441 CALGARY (403) 297-0620 EDMONTON (403) 454-5254 RED DEER (403) 346-2088 SASKATOON (306) 852-8424  
 REGINA (306) 525-1317 WINNIPEG (204) 785-9401 TORONTO (416) 252-5031 OTTAWA (613) 820-6740  
 FREDERICTON (506) 456-8881 MONCTON (506) 856-2200 HALIFAX (902) 454-6681

## STORES DIRECTORY

**Cardinal Industrial Electronics Ltd.** ETI  
10 — 5920 — 10th St. S.E., Calgary, Alberta  
T2H 2M4 Tel. (403) 259-6817  
EC, RTV, TG, MO, CAT, \$10.00  
Hammond, Rockwell, Intersil, P & B, Amphenol  
Weller, B & K, Belden, Alpha, Microswitch.  
FREE: on company letterhead requests.

**Heath Company** ETI  
12863 97th St., Edmonton, Alberta T5E 4C2 Tel.  
(403) 475-9331  
CA, TG, EK, MO, CAT, FREE  
Shortwave Radios, Amateur Radio Equipment,  
Radio Control Equipment, Marine Equipment,  
Video, Hi-Fi and other kits.

**Cam Gard Supply Ltd.**  
1303 Scarth St. Regina, Saskatchewan. S4R  
2E7. Tel. (306) 525-1317.  
EC, RTV, TG, EK, MO, CAT  
National supplier of electronic parts and components. Amphenol, Beckman, Belden, Buss Fuses, Delhi (General Instrument), Hammond, ITT Components, Mallory Duracell, Philips, Potter & Brumfield, Spectro, Texas Instrument, Westinghouse, Xcelite, 3m Cable & Connectors.

### CARDINAL Industrial Electronics

Edmonton: 10630-172 St. (Box 12000)  
T5J 2P4 (403) 483-6266 Telex  
037-2372

Calgary: 10-5920-11St. NE T2H 2M4  
(403) 259-6817 Telex 038-27992

**\*STOCKING:** Alpha, Agastat, Amphenol, Amprobe, B&K, Bleden, Buss, EECO, Fluke, Gen. Inst., Hammond, P&B, Microswitch, Rockwell, Siemens, Intersil, Teccor. Semis; CMOS, TTL, LS & more.

**Cam Gard Supply Ltd.**  
640 - 42nd Ave. S.E., Calgary, Alberta. T2G 1Y6.  
Tel. (403) 287-0520.  
EC, RTV, TG, EK, MO, CAT  
National supplier of electronic parts and components. Amphenol, Beckman, Belden, Buss Fuses, Delhi (General Instrument), Hammond, ITT Components, Mallory Duracell, Philips, Potter & Brumfield, Spectro, Texas Instrument, Westinghouse, Xcelite, 3m Cable & Connectors.

**Computer Innovations**  
4546 - 14th Street N.E., Calgary, Alberta. T2E  
6T7. Tel. (403) 276-8906. Telex. 03-822-751.  
CA  
Sales and support for Nabu, Apple and Crumm-co.

**Computer Innovations**  
103 - 723-14th Street N.W., Calgary, Alberta.  
T2N 2A4. Tel. (403) 283-0751.  
CA  
Sales and support for Nabu, Apple and Crumm-co.

**Computer Innovations**  
107 - 4014 MacLeod Trail South, Calgary, Alberta. T2G 3R7. Tel. (403) 243-3846.  
CA  
Sales and support for Nabu, Apple and Crumm-co.

**Visions Liesure Electronics**  
232 — 7th Avenue S.W., Calgary, Alberta, T2P  
0W6. Tel. (403) 233-2249.  
CA, RTV, MO, CAT, Free  
Visions is a specialty video, electronics and video retailer. Major lines carried: Exidy, Atari, Mattel, Magnavox, Electrohome, C.Itoh and Hitachi. Sister company Spectra Electronics is Canadian distributor for Exidy Data Products Inc.

**Edmonton**  
**Cardinal Industrial Electronics Ltd.** ETI  
10630 — 172 St., Box 12000, Edmonton, Alberta  
T5J 2P4 Tel. (403) 483-6266  
EC, RTV, TG, MO, CAT, \$10.00 (FREE: on company letterhead requests.)  
Sales area — Alberta, Saskatchewan, British Columbia and the Territories. Hammond, P&B, Fluke, Amphenol, Intersil, Weller, B & K, Belden, Alpha, Microswitch and many others. Call us.

**Cam Gard Supply Ltd.**  
16236 - 40 - 116 Avenue, Edmonton, Alberta.  
T5M 3V4. Tel. (403) 453-6691.  
EC, RTV, TG, EK, MO, CAT  
National supplier of electronic parts and components. Amphenol, Beckman, Belden, Buss Fuses, Delhi (General Instrument), Hammond, ITT Components, Mallory Duracell, Philips, Potter & Brumfield, Spectro, Texas Instrument, Westinghouse, Xcelite, 3m Cable & Connectors.

**Intek Electronics (Alberta) Ltd.** ETI  
4616 - 99 Street, Edmonton, Alberta. T6E 5H5.  
Tel. (403) 437-2755.  
EC, CA, RTV, TG  
Motorola, Harris, Silicon General, ITT, National, Hutson, PMI, Philips, Semiconductors - Beckman, Dale, Philips. Resistors - Philips, Mallory, Rubycon, Evox, ITT, Stetner, Capacitors. Little Lite and Little Fuse.

**R-A-E Industrial Electronics Ltd** ETI  
11680 — 170th St., Edmonton, Alberta T5S 1J7  
Tel. (403) 451-4001  
EC, CA, RTV, TG, EK, MO, CAT, \$12.00  
Western Canada's leading electronics distributor. Over 160 product lines including AMD, Belden, Beckman, B&K, Cherry, Hammond, Mostek, Nec, RCA, GI, Waldom and many more.

**Medicine Hat**  
**Base 2 Consulting Limited**  
42 Rossmere Close, S.E., Medicine Hat, Alberta  
T1B 2J8 Tel. (403) 526-0594  
CA, MO  
CPIM Software

**Red Deer**  
**Cam Gard Supply Ltd.**  
#5 - 6841 - 52nd Avenue, Red Deer, Alberta.  
T4N 4L2. Tel. (403) 346-2088.  
EC, RTV, TG, EK, MO, CAT  
National supplier of electronic parts and components. Amphenol, Beckman, Belden, Buss Fuses, Delhi (General Instrument), Hammond, ITT Components, Mallory Duracell, Philips, Potter & Brumfield, Spectro, Texas Instrument, Westinghouse, Xcelite, 3m Cable & Connectors.

**SASKATCHEWAN**  
**Moose Jaw**  
**Sonic Supplies Ltd.**  
Box 1265 — 111 Main St. N., Moose Jaw, SK  
S6H 0V9. Tel. (306) 692-6486.  
EC, CA, RTV, TG, EK, MO  
Stereo components, video cassette tapes, electronic parts, amateur radio equipment, semiconductors, tools, wire, TV antennas, TV distribution equip., sound equipment.

**Regina**  
**B & E Electronic Supply Ltd.**  
1433 Scarth St. Regina, Sask., S4R 2G1. Tel.  
(306) 522-7866.  
EC, RTV, TG, EK

**Radio Supply & Service (1977) Limited**  
3033 Saskatchewan Dr., Regina, Sask. S4T 1H5  
Tel. (306) 352-8642 Telex. 071-2661  
EC, CA, RTV, TG, EK, MO  
We are wholesale distributors of radio, TV electronics parts and industrial components, serving dealers, Hi-Fi trade, broadcast, industrial, government, amateur radio accounts. We supply manufacturers' catalogues/brochures free on request. Directory of lines available.

**Saskatoon**  
**Cam Gard Supply Ltd.**  
1501 Ontario Ave., Saskatoon, Sask. S7K 1S7  
Tel. (306) 652-6424.  
EC, RTV, TG, EK, MO, CAT  
National supplier of electronic parts and components. Amphenol, Beckman, Belden, Buss Fuses, Delhi (General Instrument), Hammond, ITT Components, Mallory Duracell, Philips, Potter & Brumfield, Spectro, Texas Instrument, Westinghouse, Xcelite, 3m Cable & Connectors.

**Swift Current**  
**G W Colortronics Ltd.**  
616 Cheadle Street West, P.O. Box 1270 Swift  
Current, Saskatchewan. S9H 3X4. Tel. (306)  
773-3672, Telex. 071-21166  
EC, RTV, TG, EK, MO.  
WR — VHF 2-way Radios, Leader Test Equipment, Sylvania Tubes and Electronic Parts, Satellite Earth Receiving Stations, Winegard TV Antenna Systems, Cable TV Supplies, Columbia, Cable, Lindsay Towers and Antennas. TOA Professional Sound Systems, MATV Systems design and supplies.

**MANITOBA**  
**Winnipeg**  
**Cam Gard Supply Ltd.**  
1777 Ellice Avenue, Winnipeg, Manitoba. R3H  
0W5. Tel. (204) 786-8481  
EC, RTV, TG, EK, MO, CAT  
National supplier of electronic parts and components. Amphenol, Beckman, Belden, Buss Fuses, Delhi (General Instrument), Hammond, ITT Components, Mallory Duracell, Philips, Potter & Brumfield, Spectro, Texas Instrument, Westinghouse, Xcelite, 3m Cable & Connectors.

**Heathkit Electronic Center**  
1315 Portage Ave., Winnipeg, Man. R3G 0V3  
Tel. (204) 783-3334  
CA, TG, EK, MO, CAT, FREE  
Kit Televisions, Amateur Radio, Weather Instruments, Marine Equipment, Stereo and Speaker Equipment. Service of Heath Products and Parts.

**J. & J. Electronics Ltd.**

**J & J Electronics Limited** ETI  
310 Notre Dame Ave., P.O. Box 1437, Winnipeg,  
Man. R3B 1P4/R3C 2Z4 Tel. (204) 943-6916  
EC, RTV, EK, MO, CAT, \$1.00  
Mail order electronics distributors, specializing in semiconductors. Prime quality materials and surplus specials. Serving Canada since 1962.



### Mode Electronics

1777 Eillice Ave., Winnipeg, Manitoba. R3H  
0W5. Tel. (204) 786-3133.  
EC, RTV, TG, EK, CAT, FREE  
Plugs, Jacks, Patch Cords, Switches, Pots,  
Microphones, Headphones, Speakers, Meters,  
Educational Kits, Telephone & T.V. Accessories.  
Exclusive Canadian Agents for T.C.G. Replace-  
ment Semiconductors.



**HEAD OFFICE:**  
1777 Eillice Ave.  
Winnipeg, Manitoba

**BRANCH LOCATION:**  
88 Horner Avenue  
Toronto, Ontario

Plugs, Jacks, Patch Cords, Switches, Pots, Micro-  
phones, Headphones, Speakers, Meters, Educational  
Kits, Telephone & T.V. Accessories

*"Exclusive Canadian Agents for TCG Replace-  
ment Semiconductors"*

### W.E.S. Electronics Limited

ETI  
1515 King Edward St., Winnipeg, Manitoba R3H  
0R8 Tel. (204) 632-1260  
EC, CA, RTV, TG, EK, MO  
Wholesale industrial electronics distributor for:  
Fluke, Magnecraft, Hammond, Delhi, Belden,  
Powersonic, Diamond Tools, Eveready, Cinch  
Jones, Sylvania, Raytheon, Siemens, Semi-  
conductors, B & K, Rockwell Microcomputer,  
Phonix.

### ONTARIO

#### Bramalea

##### Double-Dollar-Paks

P.O. Box 2068, Bramalea, Ont., L6T 3S3  
EC, MO, CAT  
Prime quality packaged parts available for \$2.00  
per package. Absolutely no "fall-outs". Eventual  
listing of 2000 "Paks". Catalogue No. I 600 Paks  
\$2.00, Catalogue No. II 300 Paks \$2.00.

#### Kit-King

P.O. Box 2068, Bramalea, Ont., L6T 3S3.  
EK, MO, CAT  
Design, development, and marketing of elec-  
tronic kits. P.C. Board work, prototyping, and co-  
op Marketing of Kits. Catalogues and bulletins  
available by yearly subscription, \$3.50.

#### Brampton

##### Bryan Electronics

90 Kennedy Rd. S., Brampton, Ont. L6W 3E7  
Tel. (416) 457-9269  
EC, RTV, TG, EK, MO, CAT  
Suppliers of electronic parts, equipment, home  
and car audio, specialty items, etc. More than  
100 catalogues available at nominal cost. Free  
flyers.

**NEUTRON**

**ELECTRONICS**

**LTD.**

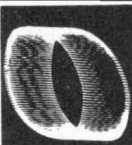

#### Guelph

##### Neutron Electronics Limited

ETI  
485 Silvercreek Pkwy N., Guelph, Ont. N1H 7K5  
Tel. (519) 836-9220, 836-9221  
EC, CA, RTV, TG, EK  
Distributor for Hammond Xfmr's — cabinetry —  
power supplies, Sylvania — tubes and trans-  
istors, Westinghouse — industrial tubes and  
semiconductors, Jana Kits, B & K, Amprobe Test  
Equipment, — Ungar — solder equipment,  
Ceresist, Panavise, OK Machine, Video-Satellite  
T.V. Systems.

#### Hamilton

##### Spectrum Electronics

P.O. Box 4166 Station D, Hamilton, Ontario L8V  
4L5  
EC, MO, CAT, FREE  
Manufacturer of printed circuit boards for hob-  
byists, educational institutions, and industrial  
proto-types - Also provide EPROM programming  
service and sub-assembly runs for industry.

#### Steel City Surplus

ETI  
212 King William St. (at Ferguson), Hamilton,  
Ont., L8R 1A9. Tel. (416) 526-8551  
EC, CA, RTV, TG, EK  
Surplus Electronics of every description com-  
ponents, semiconductors, assemblies, test  
equipment, computer parts etc.

#### Kingston

##### Altair Electronics Enterprises Ltd.

ETI  
660 Progress Avenue, Kingston, Ontario. K7M  
4W9. Tel. (613) 384-3876.  
EC, CA, TG, EK, MO  
Serving Students, Hobbyists and Industry with  
quality parts and components plus microcom-  
puter boards, software with accessories  
specializing in Ohio Scientific. OEM pricing  
available on request.

#### Computer Innovations

70 Princess St., Kingston, Ont. K7L 1A5 Tel.  
(613) 544-6830  
CA  
Sales and support for Nabu, Apple and Crumem-  
co

#### Kingston Electronic Supply Co.

ETI  
147 Joseph St., Kingston, Ont., K7K 2H8. Tel.  
(613) 549-3773  
EC, CA, RTV, TG, EK, MO, CAT, FREE  
Mode, Tenco, OK Machine, Leader, Hioki, Ceres,  
Eveready, Fanon, Bogen, Phillips, Vero Pro-  
ducts, Len Finkler, Lloyds, Ar-mas, Sinclair,  
Sylvania, Tab Books, Astatic, ILP, Sprague.

#### Kitchener-Waterloo

##### K-W Surplus Clearinghouse

ETI  
327 Breithaupt St., Kitchener, Ont. N2H 5H6  
Tel. (519) 745-2661  
EC, CA, RTV, TG, EK  
Surplus electronics of every type including com-  
ponents assemblies, test equipment etc. Open  
only Wed., Thurs., Fri., 12pm to 9pm. Sat. 9am to  
5 pm. Store is both retail and wholesale.

#### Orion Electronics Supplies

##### Incorporated

ETI  
40 Lancaster Street West, Kitchener, Ontario.  
N2H 4S9. Tel. (519) 576-9902  
EC, CA, RTV, TG, EK, MO, CAT, FREE  
Mode, Lenline, G.C. Electronics, Eico, Daveco,  
Cosrad, Lenbrook, Lindsay, Ceresist, Leader,  
A.P. Products, Sinclair, Tab Books, Sams Books,  
National Semiconductor, Motorola, R.C.A. Etc.  
General Electric, Texas Instrument.

#### Waterloo Electronic Supply Co. Inc.

ETI  
219 Hartwood Ave., Waterloo, Ontario N9J 3Z9  
Tel. (519) 745-9421.  
EC, RTV, TG, EK, MO.  
Industrial — PB Relays, Hammond, Belden,  
Burgess Switch, Buss, AP Products.  
Test Equipment — B&K, Leader, Beckman, Am,  
probe, Eico.  
Hi-Fi — Sanyo, Lloyds. Car Sound — Sanyo,  
Sound Barrier, Lear Jet.  
CB — Cobra, President.  
Antenna Systems — Kay Towne, Delhi, Delta,  
Benco.

#### London

##### R.J. Buckland Company

ETI  
P.O. Box 367, Station B, London, Ontario. Tel.  
(519) 672-8390.  
EC, RTV, TG, EK, CAT, FREE.  
Also Surplus Electronic Equipment and Sup-  
plies.

#### Forest City Surplus Ltd.

ETI  
781 Dundas St., (near fairgrounds) London,  
Ont., N5W 2Z6 Tel. (519) 438-0233.  
EC, CA, RTV, TG, EK.  
Surplus electronics of every description from  
just about everywhere. Components, semicon-  
ductors, assemblies, test equipment, our stock  
changes continuously. Also bargain priced  
tools, machinery, household items.

#### Mississauga

##### Atwater Electronics Limited

ETI  
886 Dundas Hwy E., Mississauga, Ont. L4Y 2B8  
Tel. (416) 276-4550  
EC, RTV, TG, EK, MO.  
Suppliers and consultants of Philips speakers,  
Sylvania tubes and ECG semiconductors, B & K  
Test Equipment, Concord Car Components, TDK  
and Maxell Tapes, Eico and Jana Kits, Tab  
Books and Sam's Books, Weller and Ungar  
Soldering Supplies, Industrial Wire, Batteries,  
Plugs and Jacks, Etc.

#### Heathkit Electronic Centre

ETI  
1478 Dundas Hwy. E, Mississauga, Ont. L4X  
2R7 Tel. (416) 277-3191  
CA, TG, EK, MO, CAT, FREE.  
Heath/Zenith Computer products, Amateur  
Radio Equipment, Radio Control, Marine &  
Automotive Equipment, T.V. & Hi-Fi Equipment,  
Test Equipment, Panasonic Shortwave, Home &  
Auto Alarms and other kits.

#### K.S.K. Associates

P.O. Box 54, Morriston, Ontario N0B 2C0, (416)  
878-9721.  
CA, MO, CAT, FREE (send stamp).  
Designers and consultants for micro-computer's.  
Custom circuit design including P.C. Board  
fabrication. ETI Project Boards handled.

#### Ottawa

##### Active Component Sales Corp.

ETI  
1050 Baxter Road, Ottawa, Ont., K2C 3P2. Tel.  
(613) 820-9471.  
EC, CA, RTV, TG, EK, MO, CAT (Free).  
Active Components, specializing in electronic  
components for hobbyist, industrial and educa-  
tional markets. Products range from semi con-  
ductors by major manufacturers, assembled  
kits, microcomputers, electronic measuring in-  
struments, TI calculators, cases, chemicals,  
solder, P.C. aides and technical books.

#### Cam Gard Supply Ltd.

P.O. Box 6565 Station J, Ottawa, Ontario. K2A  
3Y7. Tel. (613) 820-6740.  
EC, RTV, TG, EK, MO, CAT  
National supplier of electronic parts and com-  
ponents. Amphenol, Beckman, Belden, Buss  
Fuses, Delhi (General Instrument), Hammond,  
ITT Components, Mallory Duracell, Philips, Pot-  
& Brumfield, Spectro, Texas Instrument,  
Westinghouse, Xcelite, 3m Cable & Connectors.

#### Compumart

(A Division of Emile State Inc.) 411 Roosevelt  
Ave., P.O. Box 6132, Station J, Ottawa, Ont.  
K2A 1T2 Tel. (613) 725-3192  
CA  
We carry Apple and Commodore microcom-  
puters, and a large selection of books,  
magazines and software for the TRS-80, Apple  
and PET.

## STORES DIRECTORY

### Computer Innovations

1719 St. Laurent Blvd., Ottawa, Ont. K1G 3V4  
Tel. (613) 526-1426, Telex: 0533622

CA

Sales and support for Nabu, Apple and Crumemco.

### Gervais Electronics Limited

ETI

333 Cumberland St., Ottawa, Ont. K1N 7J3 Tel. (613) 238-3101

EC, RTV, TG, EK, MO.

Astatic — ECG and SK Semiconductors — Tenco — Oaktron and Peerless Speakers — Thor-darson — Buss Fuses — Vaco — Tech Spray — Chemtronics — B & K — Hioki — Leader — C.D.E. — EduKits — TDK — Ampex — Eveready — Lenline — Workman — Columbia & Provo Wire

### Heath Company

ETI

866 Merivale Rd., Ottawa, Ont. K1Z 5Z6 Tel. (613) 728-3731

CA, TG, EK, MO, CAT, FREE

Shortwave Radios, Amateur Radio Equipment, Radio, Control Equipment, Marine Equipment, Video, HI-FI, and other kits.

### Kris Electronics

ETI

(A Division of 365781 Ontario Limited) 1070 Morrison Dr., Unit 1-B, Ottawa, Ont. K2H 8K7 Tel. (613) 820-4986

EC, RTV, TG, EK, MO, CAT, \$1.00

Modekits, Edukits, I.L.P., Ritron Equalizers, Mixers, Hioki — Sinclair — Univolt Multimeters, Philips — Oaktron Speakers, Veroboards — Ceresist — Injector P.C. Boards & Chemicals, Northern Telecom Telephones/Accessories, Electronic Components, Ultrasonic Alarms.

### Wackid Radio

ETI

312 Parkdale Ave., Ottawa, Ont. K1Y 1G3 Tel. (613) 728-1821

EC, CA, RTV, TG, EK, MO

We sell 232 product lines in 16 categories, including video, C.B., Ham and HI-FI etc. (Line card available — free on request).

### Owen Sound

#### North Western Electronic Supply Limited

ETI

370-2nd Ave S.E., Owen Sound, Ont. N4K 5T1 Tel. (519) 371-1071

EC, RTV, TG, EK, MO

### Thunder Bay

#### Audio Service Centre/A.S.C.II Computing

ETI

223 Algoma Street South, Thunder Bay, Ontario. P7B 3C3. Tel. (807) 345-7334/5/6.

CA, CAT FREE

We serve Northwestern Ontario with the Complete COMMODORE line, Intertec, Centronics, Epson, & Peachtree Products. We also provide custom software & manufacture, for national distribution, an IEEE to RS232 Interface.

### Toronto

#### A-1 Electronics

5062 Dundas St. W., Islington, Ont. M9A 1B9 Tel. (416) 231-4331

EC, CA, RTV, TG, EK, MO, CAT, FREE

Mississauga and Etobicoke's largest electronics store. OSI Computers, TV Tubes, Shure Cartridges, Hammond, Texas Instrument, Ceresist, Fairchild, AP Products, OK Machine And Tool, Philips Speakers, Leader, Jana, National Semiconductor, Maxell Tapes, Sam's Books, Ungar, Intel IC's, ETI P.C. Boards, Ademco Burglar Alarms, Tab Books, Eveready Batteries, Tenco.



409 Queen St. W.  
Toronto Ont.  
M5V 2A5  
(416) 868-1315

## DISCOVER OUR WORLD OF ELECTRONICS. CANADA'S LARGEST HOBBY COMPUTER STORE

We are stocking distributors of:

**COMPUTER PRODUCTS:** RCA Cosmac, SSM, S.D. Systems, Mullen, Spectronics MPI, Siemens, Vector, Sanyo, Electrohome, Rockwell Alm, Texas Instrument, Centronics, Trendcom, Epson, Amdek, Applikation, Programma, Electronic Protection Devices, BSR, Alf, D.C. Hayes Heuristics, Lazer Systems, M & R Associates, Microsoft, Mountain Computers, Versa Computing, Videx, Dysan, 3M.

**TEST EQUIPMENT:** Philips, Leader, Global, Fluke, Mode, Univolt, Hitachi, Keithley, Hioki.

**ELECTRONIC COMPONENTS AND HARDWARE:** Stackpole, Remee Wire, Hammond, Lindstrom, Injectorall, Global, OK Machine, A P Products, Rubycon, Omega, Scotchflex, Galleria Acc., Noma, Chemtronics, Fuji, Eagle, Mode, Lenline, Edsyn, Cramco, Pana Vise, Beeco, Star Micronics, Weller, Xcelite, Ungar, Bondo, Bishop, Duracell, Hiwatt, ETI P.C.B.

**BOOKS:** Addison Wesley, Compusoft, Creative Computing, Dilithium Press, Haydon, Kilobaud, Micro, Osborne, Prentice Hall, Quallity, Sams, Scelbi, Sybex, Tab, ARRL, ETI Publications, Babani.

**MAGAZINES:** Byte, 73, QST, Creative Computing, Compute, Nibble, Computing Today, Interface Age, Which Computer, Kilobaud, Sync, Feelings, Micro, Personal Computing, 80 Microcomputing, S-100 Microsystem, Desktop Computing, Electronics Today, Radio Electronics, Popular Electronics, Elementary Electronics, Elektor, On Computing, InfoWorld, Popular Computing, Apple Orchard, Softalk, Polyphony, Wireless World, Video World, Practical Electronics, Robotics Age, Dr. Dobb's Journal, Short Wave.

**SOFTWARE:** Digital Research, Lifeboat Ass., Adventure International, Beagle Brothers, Big Five, Automated Simulations, Broderbund, California Pacific, Compumax, Creative Computing, Data Soft, Edu-Ware, Hayden, Sams, Instant Software, Microlab, Micropro, Microsoft, Muse, On Line, PDI, Peachtree, Personal Software, Programma, Softape, Sirius, Strategic Simulations, Synergistic, Syntonic, Aardvark.

Also, visit our sister companies:

M&W Computer Stores Inc.  
407 Queen Street West  
Toronto, Ontario  
M5V 2A5  
(416) 368-5705

M&W Computer Stores  
2155 Leanne Blvd.  
Unit 3  
Mississauga, Ontario  
L5K 2K8  
(416) 822-8080

Interested Dealers  
for Computer accessories  
and magazines, call  
MICRON DISTRIBUTING  
(416) 363-6058

### Active Component Sales Corp.

ETI

4800 Dufferin Street, Downsview, Ont., M3H 5S9. Tel. (416) 661-1115.

EC, CA, RTV, TG, EK, MO, CAT (Free)

Active Components, specializing in electronic components for hobbyist, industrial and educational markets. Products range from semi conductors by major manufacturers, assembled kits, microcomputers, electronic measuring instruments, TI calculators, cases, chemicals, solder, P.C. aides and technical books.

### Active Surplus Annex

ETI

345 Queen St W., Toronto, Ontario M5V 2A4 Tel. (416) 368-7936

EC, CA, RTV, TG, EK

Large stock of electronic components. New and used electronic equipment including transformers and motors. Used 12 Volt 5" and 7" Sony T.V.'s.

### Arkon Electronics Limited

ETI

409-407 Queen St W., Toronto, Ont. M5V 2A5 Tel. (416) 868-1315

EC, CA, RTV, TG, EK, MO, CAT, \$2.50

Complete industrial and hobbyist outlet. Professional Staff always on hand to answer any question and take your order.

### Batteries Included

71 McCaul St., Toronto, Ont. M5T 2X1 Tel. (416) 596-1405.

CA, CAT (Free).

We carry a complete selection of calculators as well as being authorised Commodore PET dealers. We are also the Canadian distributors for Microtechnology Unlimited (MTU) and Connecticut Micro Computer (CMC) products.

### Cesco Electronics Ltd.

24 Martin Ross Ave. Toronto, Ontario. M3J 2K9 Tel. (416) 661-0220

EC, CA, RTV, TG, EK, MO, CAT, FREE.

Cesco stocks semi-conductors and components by major manufacturers including Texas Instruments, Motorola, RCA, Allen Bradley, Corning, Scotchflex, Amphenol, Cutler Hammer, Signetics, Apple, Commodore, Centronics, Mallory.

### Cam Gard Supply Ltd.

88 Horner Avenue, Toronto, Ontario. M8Z 5Y3. Tel. (416) 252-5031

EC, RTV, TG, EK, MO, CAT

National supplier of electronic parts and components. Amphenol, Beckman, Belden, Buss Fuses, Delhi (General Instrument), Hammond, ITT Components, Mallory Duracell, Philips, Potter & Brumfield, Spectro, Texas Instrument, Westinghouse, Xcelite, 3m Cable & Connectors.

### Computer Innovations

4800 Yonge Street, Willowdale, Ontario, M2N 5M7. Tel. (416) 221-7000

CA

Sales and Support for Nabu, Apple and Crumemco.

### Dominion Radio and Electronics

ETI

535 Yonge St., Toronto, Ontario. M4Y 1Y5. Tel. (416) 922-1818

EC, RTV, TG, EK, MO, CAT (Free).

### Efstonscience Inc.

3500 Bathurst St., Toronto, Ont., M6A 2C6 Tel. (416) 787-4583.

\*Please note: after February 1st, 1982, address will be — 3350 Dufferin St. Toronto, Ontario, M6A 3A4 Tel. (416) 787-4583.

EK, MO, CAT \$2.00

This company specializes in optics, electronic instruments and kits of educational, research and/or industrial use. A new line of high quality electronic measuring instruments, speciality tools, tool kits and cases. All available through mail order or at our retail premises. Canadian Distributor for; Jensen Tools of Phoenix, ARIZ. Edmund Scientific of Barrington, N.J. Two catalogues, Jensen Tools and Efston Science. \$2.00 each or both for \$3.00.

## KEY

ETI ETI Magazine sold here  
EC Supplies Electronic Components  
CA Sells Computers and Accessories  
RTV Sells Radio and TV parts  
TG Sells Test Gear  
EK Sells Electronic Kits  
MO Company does Mail Order  
CAT Catalogue available. The cost of this, or if it free, is shown

**Electro Sonic Inc.**  
 1100 Gordon Baker Road, Willowdale, Ont.,  
 M2H 3B3. Tel. (416) 494-1555.  
 EC, TG, EK, MO, CAT (\$15.00).  
 Coast-to-coast service with Canada's largest inventory of semiconductors, electronic components, and equipment. Specialists in supplying the needs of the industrial and educational markets.

## ELECTRONICS 2001

5529 YONGE STREET  
 WILLOWDALE, ONTARIO M2N 5S3  
 223-8400

**AUTHORIZED DEALERS FOR COMMODORE AND ATARI COMPUTERS, RCA VIDEO RECORDERS, SHARP AND CASIO CALCULATORS. WRITE OR CALL FOR MORE INFORMATION.**

**Electronics 2001** ETI  
 5529 Yonge St., Willowdale, Ont., M2N 5S3 Tel. (416) 223-8400.  
 CA, MO  
 Commodore and Atari Computers, RCA video recorders, computer books, magazines. Software for Commodore, Atari, Apple, TRS-80. telephones, answering machines, auto dialers, TV cable converters, calculators from Sharp, Casio, electronic games.

**Exceltronix Components & Computing Incorporated** ETI  
 319 College St., Toronto, Ont. M5T 1S2 Tel. (416) 921-5295  
 EC, CA, TG, EK, MO, CAT, FREE  
 We have exceptional stock and prices of LS-TTL and memory chips. Main products: digital and linear IC's, memories, transistors, passive components, computer systems, boards and software by Multiflex and Ohio Scientific. We distribute: AP Products, Jana Kits, Jana Industrial, Lenline, Ungar, OK Tools. SD Sales, Apple, Atari, SSM Products. Digital Moving Light Displays.

**General Electronics** ETI  
 5511 Yonge St., Willowdale, Ont., M2N 5S3. Tel. (416) 221-6147.  
 EC, CA, RTV, TG, EK, MO.  
 Complete Hobbyist Supply House. Specializing in kits, parts speakers and equipment. Vero, Hameg, Electronakit, Mode, Sabtronics, factory-priced excellent speakers. Ask for our free kit catalogue. We, the staff, are hobbyists - we understand your needs.

**Gladstone Electronics** ETI  
 1736 Avenue Rd., Toronto, Ont. M5M 3Y7 Tel. (416) 787-1448  
 CA, TG, EK, MO, CAT, \$1.00  
 Speakers (Philips, KEF, JBL, Celestion, Decca, Motorola), ILP Audio Modules. Thandar & Leader Test Equipment, Kits (Ace Audio, Eico), Sinclair and Acorn Computers. Software.

**Home Computer Centre** ETI  
 6101 Yonge Street, Willowdale, Ontario. M2M 3W2. Tel. (416) 222-1165  
 CA, MO, CAT, FREE.  
 PET, Apple, North Star Horizon, Atlas and VIC.

**House of Computers Inc.**  
 368 Eglinton Ave. W., Toronto, Ont. M5N 1A2 Tel. (416) 482-4336  
 CA, MO  
 Commodore, Apple, North Star, I.D.S., Centronics, EPSON, Jim-Pak, 3-M, Memorex, Olivetti, NEC, Versatile. Full selection Software, Hardware, Books. Canada's largest Commodore Dealer.

# WENTWORTH ELECTRONICS

R. R. 1, WATERDOWN, ONTARIO, CANADA L0R 2H0

**CUSTOM P.C.Bs      PROFESSIONAL QUALITY WITH THE PERSONAL TOUCH      E.T.I. PROJECT BOARDS**

**PRINTED CIRCUIT BOARDS FOR ALL YOUR NEEDS**



**COMPUTER STORES INC.**

407 QUEEN STREET WEST, TORONTO, CANADA,  
 M5V 2A5, (416) 368-5705

## AUTHORIZED APPLE AND ATARI DEALER

We stock peripherals including Printers, modems, disk drives, monitors, dysan diskettes, joy sticks, game paddles, and much much more.

We also feature the most extensive line of application software for the APPLE, PET and TRS 80.

Backup support includes our staff of hardware and software specialists as well as an in-house repair department.

**M & W Computer Stores Inc.**  
 407 Queen St. W., Toronto, Ont. M5V 2A5 Tel. (416) 368-5705  
 CA, MO  
 Apple Computers, Atari Computers, Trendcom, Centronics Printers, Personal Software, Instant Software, Creative Software, for all Microcomputers, Dysan Disks, Mountain Hardware, and much more.

**Mode Electronics**  
 88 Horner Ave., Toronto, Ontario, M8Z 5Y3. Tel. (416) 252-5031.  
 EC, RTV, TG, EK, CAT, FREE  
 Plugs, Jacks, Patch Cords, Switches, Pots, Microphones, Headphones, Speakers, Meters, Educational Kits, Telephone & T.V. Accessories. Exclusive Canadian agents for T.C.G. Replacement Semiconductors.

**NEWTRONICS ENGINEERING INC.**



208 Spadina Ave., Suite 110,  
 Toronto, Ontario, Canada M5T 2W3

**Newtronics Engineering Inc.**  
 208 Spadina Ave., Suite 110, Toronto, Ontario. M5T 2W3. Tel. (416) 368-8994.  
 EC, RTV, TG, EK, MO, CAT, FREE  
 Wholesale of Electronic Kits and Parts, Engineering of Special Projects.

**Radio Trade Supply Limited** ETI  
 490 Yonge St, Toronto, Ontario M4Y 1X5 Tel. (416) 966-5151  
 EC, RTV, TG, EK  
 These products are available from us: Aiphone, B & K, Belden, Bogen, Buss, Cinch Joives, Delhi, E.C.G. Sylvania, Eveready, Hammond, Hioki, I.R.C., International Rectifier, Mallory, Memorex, Microswitch, Motorola, Photoswitch, Spectro, Sprague, Switchcraft, Tubes, Ungar, Wellier, Xcelite.

**Zenith Radio Canada Limited** ETI  
 1020 Islington Ave, Toronto, Ont. M8Z 5X5 Tel. (416) 231-4171  
 EC, RTV, TG  
 B & K Test Equipment, Jerrold Converters, Fanon Auto Sound, Record-a-Call Telephone Answering Equipment, Leader Test Equipment, Vaco Tools

**Waterdown Wentworth Electronics**  
 R.R. 1, Waterdown, Ontario. L0R 2H0.  
 EC, MO, CAT, FREE  
 A mail order company with a complete selection of P.C.B.'s for all ETI Projects. Custom work and quantity discounts available. Small selection of parts.

**Waterford Copeland Electronics**  
 46 Main St S., Waterford, Ont. N0E 1Y0 Tel. (519) 443-4163  
 EC, CA, RTV, TG, EK  
 Jana, Daveco, Sylvania, ECG, Principal business — TV, stereo, auto stereo, sales and service.

## SURPLUS ELECTRO QUEBEC

SPECIAL No. 1: Approximately 1000 electronics parts: capacitor — resistor — relay — switch — etc, etc, for \$10. Special No. 2: Assortment of 50 tantalum capacitors 1 uf to 100 uf (6 to 35VDC) for \$10. Special No. 3: 500 assorted Disc. ceramic capacitors for \$10. All new and first quality parts with unconditional money-back guarantee. Free flyer

**2264 Monte Gagnon  
 Blainville, P.Q. J7E 4H5**

**QUEBEC Blainville Surplus Electro Quebec**  
 2264 Montee Gagnon, Blainville, P.Q. J7E 4H5  
 EC, MO, CAT, FREE  
 Mail Order only. Surplus from manufacturers of commercial radio in H.F. — VHF — UHF. Importer of the famous line of LORLIN switches from England at a more than competitive price — Sample & info on request.

**Amtrex Electronique Inc**  
 5350 Boul. Henri Bourassa, ss.70,  
 Charlesbourg, PQ G1H 6Y8, (418) 627-1050.  
 EC, RTV, MO, FREE  
 Resale: National Semis, Texas Inst. RCA, Motorola, Intel Fairchild, Raytheon, General Electric, General Instrument, NEC, Toshiba, Sanyo, Sony, Phillips.

**Longueil Master Vox Ltd.**  
 400 St. Jean, Longueil, PQ, J4H 2X6. Tel. (514) 670-1550.  
 EC, MO, CAT (\$5.00).

## STORES DIRECTORY

### Mont-Joli

#### JMC Distribution Inc.

C.P. 142, 88 Ave Laval, Mont-Joli, PQ G5H 3K9.  
Tel. (418) 775-2231.

EC, RTV, MO, CAT (\$1.00).

One stop shopping for electronics parts, commercial or industrial. Genuine Jap. parts, Transistors (2SA, 2SB, 2SC...) IC and general replacement for solid state JMC Products same as ECG. Recorder and projector belts, Tapes, Cassette, 8-Track, videocassette, reel-to-reel.

### Montreal

#### Active Component Sales Corp.

ETI

5651 Ferrier St., Montreal, PQ, H4P 2K5 Tel. (514) 731-7441.

EC, CA, RTV, TG, EK, MO, CAT (Free)

Active Components, specializing in electronic components for hobbyist, industrial and educational markets. Products range from semi-conductors by major manufacturers, assembled kits, microcomputers, electronic measuring instruments, TI calculators, cases, chemicals, solder, P.C. aides and technical books.

#### Addison Electronic Ltd.

8018-20e Ave., Montreal, Quebec. H1Z 3S7. Tel. (514) 376-1740

EC, RTV, CAT (\$1.50)

#### Cite Electronique (1979) Inc.

ETI

3185 Hochelaga, Montreal, P.Q. H1W 1G4 Tel. (514) 525-2551

EC, CA, RTV, TG, EK, MO

Alwa, Amphenol, Armaco, Astatic, Bach Simpson, Bechman, Belden, Bishop, Graphics, Calestro, Celestion, Cornell Dubelier, Cutler Hammer, Daveco, Delta Wakefield, Eagle and more. Product card available.

#### Cesco Electronics Ltd.

ETI

4050 Jean Talon St. W., Montreal, Quebec. H4P 1W1 Tel. (514) 735-5511

EC, CA, MO, CAT, FREE

Cesco stocks semiconductors and components by major manufacturers including Texas Instruments, Motorola, RCA, Allen Bradley, Corning, Scotchflex, Amphenol, Cutler Hammer, Intersil, Signetics, Apple, Commodore, Centronics, Mallory.

#### Etco Electronics

183 Hymus Blvd., Pointe Claire, PQ, H9R 1E9. Tel. (514) 695-0400.

EC, RTV, TG, EK, MO, CAT (Free)

We publish a very interesting American catalogue available free to our Canadian customers. Also branch at North Country Shopping Center, Plattsburg, NY 12901 and 464 Mc Gill St., Montreal, PQ.

#### Hamilton Avnet Electronics

2670 Sabourin, St. Laurent, PQ, H4S 1M2 Tel. (514) 331-6443

EC, CA

Distributor for AMD, Fairchild, Harris, Hewlett Packard, Intel, ITT, Litronix, Motorola, National Semiconductor, RCA, Rockwell, Signetics, Sillconix, TRW LSI, Centronics printers, Hazeltine, Novation (modems), Shugart etc.

#### Heath Company

ETI

1400 Sauve Ouest, Montreal, P.Q. H4N 1C5 Tel. (514) 332-3666

CA, TG, EK, MO, CAT, FREE

Shortwave Radios, Amateur Radio Equipment, Radio Control Equipment, Marine Equipment, Video, HI-FI and other kits.

#### North American Electronics Co. Ltd.

(Noramel®)

ETI

2407 Ste-Catherine St. East, Montreal, P.Q.

H2K 2J7 Tel. (514) 522-8422

EC, RTV, MO, CAT, FREE

Toroidal Cores, R.F. Chokes, Wire & Cable, Resistors, Capacitors, Cabinets, Hardware, Semiconductors, Tubes, Switches, Meters, Ferrites, Coil Forms, Tools, Insulators, Connectors, Copperclad, and more.

#### Super Electronic (Canada) Company

1963 Centre St., Montreal, P.Q. H3K 1J1 Tel. (514) 932-5636

EC, RTV, TG, EK, MO

Electric Motors, Cables & Wires, Switches, Non Contact Voltage Detectors, Insulators, Capacitors (Computer Grade, Electrolytic, Oil, Disc, Polystyrene, Tantalum, etc.), Relays, Resistors (Precision, regular, large, medium, small), Tubes, Semi Conductors.



ACTIVE COMPONENTS is Canada's leading over-the-counter distributor of semiconductors and industrial electronic components, stocking over 100 manufacturers. ACTIVE stores are conveniently located in major cities across Canada. Those clients who do not have access to our stores should use our extensive mail order service located in Montreal. Our new product catalog is now available. Please write for your free copy.

#### Montreal

5651 Ferrier St.  
MTL, Que.,  
H4P 2K5

#### Ottawa

1050 Baxter Road  
Ottawa, Ont.  
K2C 3P2

#### Toronto

4800 Dufferin St.  
Downsview, Ont.  
M3H 5S9

#### Calgary

5809 McLeod Trail S.  
Unit 109  
Calgary, Alta.  
T2H 0J9

#### Vancouver

3070 Kingsway  
Van., B.C.  
V5R 5C7

Mail Order at 237 Hymus Blvd., Pointe Claire, Que. H9R 5C7.

Addison ELECTRONIC Ltée/Ltd.

8018 — 20e AVENUE  
MONTREAL, QUE., H1Z 3S7

#### Radio Payette Inc.

730 St-Jacques, Montreal, Quebec. H3C 1G2.  
Tel. (514) 878-4771

EC, CA, RTV, TG, EK.

Radio-communications, audio and video equipment, telephone systems. Product card available on request.

#### Radio Hovsep Co. Ltd.

5945 Park Ave., Montreal, Quebec. H2V 4H4.  
Tel. (514) 274-0589

EC, RTV, TG, EK, MO.

Authorized Grundig Service Depot for Canada. Parts and Accessories for European makes. Large stock of old and new receiving tubes.

#### Produits Electroniques Ltee/ Electronic

##### Wholesalers Co. Limited

1935 Avenue de L'Eglise, Montreal, P.Q. H4E 1H2 Tel. (514) 769-8861

EC, RTV, TG, EK, MO

General line distributor with portfolio of 200 lines. Principal penetration industrial. Hammond, P & B, Amphenol, Edac, TRW, C & K, Beckman, Philips, A.P., Mallory, I.R.C., Homite, B & K, Belden, Alpha. Fluke Test Equipment, Midland Communications Equipment, Delhi Satellite Equipment, Sony.

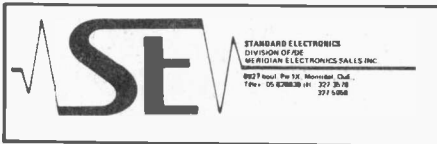

#### Standard Electronics

8927 Boul. Pie IX, Montreal, P.Q. H1Z 3V3 Tel. (514) 327-3578, 327-5958, TLX. 05-828838

Japanese, Europeans and Americans Semiconductor's Specialist, for radio, TV, CB, VTR, Communications Equipment, Computers, industrial controls, any brand as RCA, Solid-State, Motorola, National, etc. Ask for our free price list.

#### Noranda

##### Simtronique Inc.

ETI

C.P. 365-230 Ave. Carter, Noranda, P.Q., J9X 5A9. Tel. (819) 762-1874/762-5144.

EC, RTV, TG

Bach Simpson, Astatic, Leader, Fluke, Cobra, Bogen, Mallory, Eveready, Hammond, Delhi, Amp, Sylvania Tubes, Sylvania Transistors, Chromalox, Audio Vox Intercom, Fanon Intercom, Magnavox TV & Amp, Clarostat Controls.

#### Quebec City

##### Cite Electronique, Jean-Marc Emond Inc.

ETI

383 Canardiere, Quebec, Quebec. G1L 2V1. Tel. (418) 529-5793.

EC, MO

CASE POSTALE 2036  
ST-ROMUALD  
QUEBEC. G6W-5M3

**SELCO  
ELECTRONIQUE**

#### Selco Electronique

P.O. Box 2036, St-Romuald, Quebec. G6W 5M3. Tel. (418) 839-8367.

EC, MO, CAT, Free.

Your saving place for parts and accessories. We stock a very wide range of parts and we've got the lowest price on Machine & Tool and AP Products. Don't forget to ask for your free catalogue.

#### Video Payette

1375, boul. Charest ouest, Quebec, Quebec. G1N 2E7. Tel. (418) 687-5050.

EC, CA, RTV, TG, EK

Radio-communications, audio and video equipment, telephone systems. Product card available on request.

Continued on page 69

ETI - JANUARY 1982

# New from NRI! The first at-home training in videocassette recorder repair with exclusive videotaped lessons.

**Learn Video/Audio Servicing... includes RCA state-of-the-art VCR, NRI Action Video lessons, plus full training in color TV and audio repair.**

Now, you can learn the hottest, most wanted skill in home entertainment electronics... servicing and repairing videocassette recorders and video disc players. Well over 2 million units have already been sold and the demand is just starting! Already, qualified VCR technicians are in short supply... people are waiting up to a month for VCR repair. Good jobs at good pay are going begging. And NRI can get you in on the action with convenient and effective at-home training.

## Choice of Specialized Training

NRI offers you three Master Courses in Video/Audio Servicing, each complete, each with equipment and training for the specialty you want. Each course thoroughly prepares you for color TV plus audio and video equipment. Then, you take the specialized hands-on training on the equipment you select.



Learn as you work with equipment you keep.

You can get specialized audio experience as you build your own AM/FM stereo system complete with speakers. Or gain real bench experience with hands-on TV training as you build a 25" (diagonal) fully-computerized, programmable color TV and professional test instruments. Or train with your own RCA videocassette recorder and NRI's exclusive Action Video servicing lessons on videotape.

## State-of-the-Art VCR

This modern VCR features high-technology design with electronic pushbutton tuning, remote control, three recording speeds with up to 6-hour capacity, high-speed visual search, built-in clock/timer, memory rewind and audio dubbing capability. Direct drive motors and azimuth recording give outstanding picture reproduction.

It's yours to keep, as part of your training. You'll not only use it to learn operation and servicing techniques, but to play the absorbing NRI Action Video lessons that come as part of your specialized training. In word and picture, you'll learn theory, construction, and service procedures, see them explained in graphic closeups. And you get this unique training only with NRI!

## Learn at Home at Your Convenience

No need to quit your job or tie up your evenings at night school. No time away from your family or expensive travel. NRI comes to you. You are a class of one, getting both theory and practical hands-on training backed up by our staff of experienced educators.

## NRI the Pros' Choice

More than 65 years and a million and a half students later, NRI is still the first choice in home-study schools. A national survey of successful TV repairmen



shows that more than half have had home-study training, and among them, it's NRI 3 to 1 over any other school.

That's because you can't beat the training and you can't beat the value. Only NRI combines exclusive fast-track training techniques with modern state-of-the-art equipment to give you the skills you need for success quickly and easily. Only NRI offers such complete training with so many timely options for specialized bench experience. Send for our free catalog and get all the facts on these exciting Master Courses in Video/Audio servicing.

## Rush Card for Free Catalog

Mail the postage-paid card today for your free copy of our 100-page look into tomorrow. It shows all the equipment you get, describes each lesson in detail. And it tells you about other important career opportunities in Microcomputers and Microprocessors, Digital and Communications Electronics, Electronic Design Technology, and more. Send today and get started on a big new future for yourself. If card has been removed, please write to us.



## NRI SCHOOLS

McGraw-Hill Continuing

Education Center

330 Progress Avenue

Scarborough, Ontario M1P 2Z5

or telephone 416-293-1911

**We'll give you tomorrow.**

# New! Acorn Atom 12K Colour Computer

Telephone orders:  
(416) 787-1448  
Use Visa, Mastercard  
or American Express

Fully assembled  
only

**\$549.00**

complete with manual



The Acorn Atom is a powerful, full facility computer at an extraordinary low price. It has a full size professional keyboard and a hardware/software combination of incredible power and versatility. And it's easy to use! Just connect directly to any domestic TV and you are ready to begin. (AC Adapter optional extra)

## ATOMIC THEORY AND PRACTICE

David Johnson-Davies



### FREE MANUAL

Free with every ATOM is a computer manual. The first section explains and teaches you BASIC, the language that most personal computers and the ATOM operate in. The instructions are simple and learning is a pleasure. You'll soon be writing your own programs. The second section is a reference section giving a full description of the ATOM's facilities and how to use them. Both sections are fully illustrated with sample programs.

Also available:

**8K ROM/ 2K RAM  
Black & White ATOM  
only  
\$479.95**

Extra memory and colour may be added!

### THE ACORN ATOM 12K COLOUR COMPUTER includes:

#### Hardware

\*Full-sized QWERTY keyboard \*6502 microprocessor \*Rugged injection molded case \*12K RAM \*12K ROM \*Audio cassette interface \*TV output with high resolution Colour Graphics \*Sound

#### Software

\*32 bit arithmetic \*10 digit floating point math routines \*High speed execution \*43 BASIC commands \*Variable length strings (up to 256 characters) \*String manipulation functions \*27 additional arrays \*Random number function (useful for games & simulations) \*Mnemonic assembler \*16 letter file names \*PUT and GET byte \*WAIT command for timing \*DO-UNTIL Instruction \* Logical operators (AND, OR, EX-OR) \*PLOT commands, DRAW and MOVE \*Direct printer drive \*Link to machine code programs \*ASSEMBLER and BASIC may be combined \*Many more.

\*Expandable internally to 40K RAM.

- \*FULL-SIZED KEYBOARD
- \*BASIC AND ASSEMBLER
- \*HIGH RESOLUTION GRAPHICS
- \*SOUND
- \*USE WITH STANDARD TV AND CASSETTE
- \*PRINTER OUTPUT
- \*10 DIGIT ACCURACY

## ACORN SOFTWARE ON CASSETTE.

### GAMES PACKS:

Each cassette consists of 3 programs all at one low price. All feature high resolution graphics; challenging and fun!

1. Asteroids. Sub Hunt. Breakout.
  2. Dogfight. Mastermind. Zombie.
  3. Rat Trap. Lunar Lander. Black Box.
  4. Star Trek. Four Row. Space Attack.
  5. Invaders. Wumpus. Reversi.
  6. Dogdems. Simon. Amoeba.
  7. Green Things. Ballistics. Snake.
- Price each pack \$25.00.

**SOFT VDU:** provides 128 characters with mathematical symbols. Can be mixed with high resolution graphics, and DESIGN program allows new characters to be created. \$25.00.

**MATHS PACKS 1:** Plot. Simultaneous equations. Regression. \$25.00.

**UTILITY PACK 1:** Disassembler. Fast COS (increases cassette speed to 1200 baud). Renumber. \$25.00.

**WORD PACK ROM:** A 4K ROM chip which plugs into the ATOM's utility ROM socket. Ideal for preparation of leaflets, documents, etc. Adds the commands EDIT and TEXT to ATOM's command set. TEXT EDITOR enables upper/lower case, allows insertions/deletions/and moving text. WORD PROCESSOR enables pages to be printed in any format, justified as required, automatic insertion of page numbers, and many more. All for only \$50.00!

Will support PASCAL FORTH, an LISP.

MAIL ORDER TO: Gladstone Electronics, 1736 Avenue Rd., Toronto, Ont. M5M 3Y7

Name \_\_\_\_\_ Total amt. encl. \_\_\_\_\_ ( ) Cheque ( ) Money order  
Address \_\_\_\_\_ Charge to ( ) Visa ( ) Mastercard ( ) American Ex  
City \_\_\_\_\_ Prov. \_\_\_\_\_ Code \_\_\_\_\_ Card No. \_\_\_\_\_ Expiry \_\_\_\_\_  
Signature \_\_\_\_\_

Qty.	Item	Price	Total
	ACORN ATOM Colour, with 12K RAM/12K ROM. Assembled. Complete with manual	549.00	
	ACORN ATOM. Black and white, 12K RAM/12K ROM. Assembled. Complete with manual	479.00	
	AC Adapter - nominal 8V	25.00	
	"ATOM BUSINESS" - 110 pages of business applications & programmes	19.95	
	SOFTWARE: GAMES PACK 1,2,3,4,5,6,7 SOFT VDU		
	MATHS PACK 1 UTILITY PACK 1, WORD PACK ROM. Ring choice.		
	Shipping Charge all orders		7.50
	Ontario Residents add 7% P.S.T.		
	<b>TOTAL</b>		

**GLADSTONE ELECTRONICS**

1736 Avenue Rd. Toronto, Ontario

Circle No. 19 on Reader Service Card.

# THE BIG



# BANG

Over billions of years gas clouds condensed into stars and planets. The primeval soup bubbled. Self-replicating organisms writhed. Fish struggled onto the land and took their first breath of air (dramatic stuff). The result of it all — A.S. Lipson. Here, in "Roots" (Part .001), he discusses how it all began.

ONE OF THE MANY QUESTIONS that has intrigued man since he first learned to speak is that of the origin of the universe. How did it all begin? Where did our world come from and what caused its existence? Scientists, being only human, (or so we are told) have not been immune to this type of curiosity — even Isaac Newton hypothesized about the origins of the stars. However, it is only fairly recently (during the second half of this century) that any research on this topic has been viewed as 'respectable', or fit material for a serious investigation. During this time, two main opposing theories as to the origin of the universe have developed; the Steady-state theory and the Big Bang theory. It is the latter which tends to be generally accepted these days, as we shall see later. But first we'll need to look at some of the background information . . . . .

## The Red Shifts Mystery . . .

It was found during the 19th century that when light from the Sun was passed through a narrow slit and then split into a spectrum by a prism, the spectrum showed hundreds of tiny dark lines across it. The reason for this was not known until the advent of quantum mechanics this century, but it was noted that the lines always occurred in the same positions in the spectrum, corresponding to set frequencies or wavelengths of the light. In 1868, it was found by Sir William Huggins that not only were all the same lines found in the spectra of stars, but in some stars, the lines were shifted very slightly from their positions in the solar spectrum. Sometimes the shift was towards shorter wavelengths; the blue end of the spectrum, and sometimes to longer wavelengths; the red end of

the spectrum. With a disappointing lack of originality these two changes became known as the blue shift and the red shift, respectively. In order to explain the shifts, Huggins used an analogy with sound. When you are standing still, and are suddenly passed by a fast moving car (of course Huggins, working in 1868, did not explain it in terms of cars, but anyway . . .) which is emitting some sound, you may have noticed that as the car passes you the pitch of the sound drops. (Producing the eeeee-owwww sound beloved of motor sport enthusiasts.) This change in pitch, or frequency of the sound waves is caused by the relative velocity between the car and yourself. It follows that light, which is also a wave, is affected in the same way by relative motion between the object emitting it and the object receiving it. In fact, the light from a star moving away from us at great speed is shifted slightly to the red end of the spectrum, and a star moving towards us has its light shifted very slightly to the blue end of the spectrum. This explains the red and blue shifts. Now, it so happens that the wavelength of the dark lines in a spectrum is one of those quantities which physicists find relatively easy to measure with extreme accuracy. By doing this, and comparing the wavelengths of dark lines in the spectra of stars to the wavelengths of dark lines in the spectra of stars to the wavelengths of the same lines in the spectrum of the Sun, it is possible to calculate fairly precisely just how fast a star is moving towards or away from the Earth.

## In The Beginning . . .

Things really began to get interesting, though, when astronomers looked at the shifts in the spectra of other galaxies. They discovered that the distant galaxies appear to be moving away from our own galaxy — the Milky Way. There are one or two exceptions; for instance, the Andromeda Nebula, the closest large galaxy to our own, appears to be mov-

If you liked this article, please circle Reader Service Card number 51. If you didn't, circle number 52.

ing towards us at about 300 kilometres per second. In general, however, the other galaxies seem to be moving away. In fact it appears that almost every galaxy we can see is rushing away from every other galaxy. This can be simply expressed by saying that 'the universe is expanding'. As a general rule, distant galaxies show a distinct red shift in their spectra and the further away the galaxy, the greater the red shift tends to be, indicating that the further away a galaxy is, the faster it is likely to be travelling away from us.

It began to look as though a long time in the past, all the galaxies were squashed up together and then a massive explosion sent them flying apart. This is the bare bones of what became known as the Big Bang theory and various calculations have shown that if this is indeed what happened, then the 'beginning' — the creation of the universe — took place about 10-20 billion years ago.

## Before Genesis

Some cosmologists, however, were somewhat unhappy with this explanation of the expansion of the universe. It involves a 'beginning' and therefore raises the awkward question of what was 'before'. In fact, it was reasoned, it would be much more satisfying philosophically if a theory could be found which did not involve a 'beginning' for the universe, (this idea, that a theory ought to be philosophically satisfying, is not quite as silly as might be thought. Time and again in physics, the theory which *fee/s* best has been the correct one). In the late forties Hoyle, Bondi and Gold proposed the Steady-state theory. This takes care of the expansion of the universe in a most ingenious manner; although the various galaxies are receding from each other all the time, new matter is continuously being created to 'fill up the gaps'. As more matter is created, it collapses by gravitational attraction to form new galaxies. Thus there is no need in this theory for there ever to have been a beginning — the universe is as it is simply because it

has always been the same. According to the Steady-state theory, there never was a beginning to the universe, and presumably there will never be an end — it will just keep expanding, old galaxies dying, new ones forming. This theory does have a certain 'neatness' about it that is rather satisfying.

As a first impression it might seem that it would be impossible to tell which of the two main theories — Big Bang or Steady-state — is correct. The only real difference to the universe now would be that, if the Steady-state theory is correct, the rate of expansion would be constant, whereas if the Big Bang theory is correct, the expansion would be slowing down somewhat, as gravitational attraction attempts to pull the galaxies back together again. This slowing-down, however, is far to slight for us to be able to measure. So how can we decide which theory is correct?

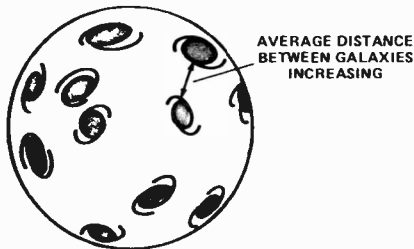

**Fig. 1** If you visualise our three-dimensional universe as being on the two-dimensional surface of an expanding balloon, you can see that, although the galaxies are getting further away from each other, the centre of expansion is not on the surface.

the structures of galaxies then and now, we might conclude that the Big Bang theory is correct. But we can't look at the past. Or can we? When we look at the stars, we do not see them as they are, but as they were when they emitted the light we see. Light takes only about eight minutes to reach us from the Sun, but nearly four and a half years from even the closest star. When we look at the more distant galaxies, we see them as they were many millions of years ago. Evidence is not 100% conclusive (it rarely is in cosmology) but weighing the facts one against the other, it seems it is the concept of the 'Big Bang' that is correct.

**The Microwave Background**

Now it is time, then, to elaborate a little on the Big Bang theory. A common misconception is that this theory states that about 15 billion years ago, a massive explosion occurred at one

the vast and intense quantities of energy that had just sprung into existence with the universe were making the temperature of the universe an incredible 30 billion degrees on the Kelvin scale (at temperatures as high as this, the Kelvin and Centigrade scales are virtually identical). Apart from the pure energy in the form of photons, a lot of electrons and positrons were in existence, together with equally large numbers of particles called neutrinos. In addition, there was a slight contamination of heavier particles, like protons and neutrons. After a second or so, the temperature had dropped to only ten billion degrees or so and this was still far too hot for protons and neutrons to form atomic nuclei. This process didn't begin until three or four minutes after the beginning, when the temperature had dropped to a mere (. . . a mere. . . !!! . . .) 900 million degrees. Even though nuclei had

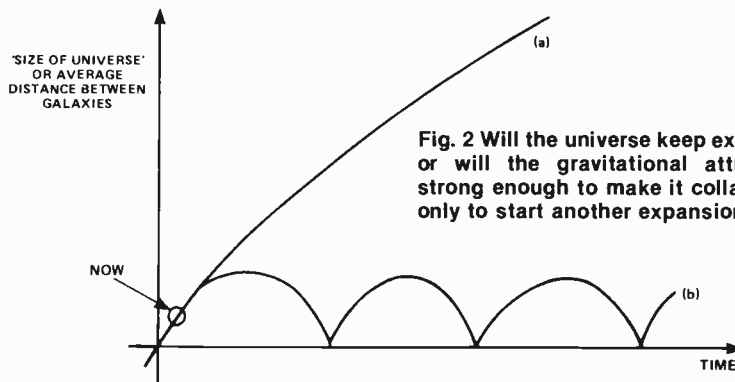

**Fig. 2** Will the universe keep expanding (a) or will the gravitational attraction be strong enough to make it collapse again, only to start another expansion (b)?

Well, for a start, there are one or two things which can only be explained in terms of the Big Bang theory. One of these is the abundance of the element helium in the universe — there is far too much of the stuff around for it to be explained in terms of the Steady-state theory (exactly why doesn't really concern us here). Another is the 'three degree Kelvin microwave background' — which we will consider later. Finally, there is this; according to the Steady-state theory, the universe has always been much the same as it is now, whereas according to the Big Bang theory, it has only evolved to its present state slowly, and it was different in the past. If only we had some way of looking at the past of the universe, we could compare it with the present. If the two were largely similar, we could conclude that the Steady-state theory is roughly correct. If, however, there was a noticeable difference in, say,

point in space, throwing out matter which eventually condensed into stars, galaxies, planets and (finally) us. In fact, this is not correct. The explosion is not imagined to have occurred at one particular point in space. It took place at every point in space, occupying the entire universe. It makes no sense, then, to ask "Where was the explosion?" The best way of understanding this is to imagine our universe as being on the two-dimensional surface of a balloon, which is being inflated. It makes no sense to ask where on the surface of the balloon is the centre of expansion; every point is just as much the centre as any other.

We will now see what it is thought the precise beginning of the universe was like. Nobody actually knows what the universe was like during the first few fractions of a second; our knowledge only starts after this. After the first tenth of a second or so,

been able to form, there was still far too much energy for electrons to be able to join up with the nuclei to form stable atoms. It took nearly three quarters of a million years for that to occur and by that time, most of the original electrons and positrons had vanished. (When an electron meets a positron, the two disappear, giving off energy. This is what is thought to have happened, leaving just a few particles behind.) Gradually, gravity clumped the atoms together, and then clumped the clumps, to form stars and galaxies. Eventually, life developed, but that happened much later.

**Cold Radiators**

So how can we test this theory? Well, if it is correct, there should still be some radiation hanging around from this beginning. The appropriate calculations have been performed, and it turns out that the radiation

*Continued on page 70*



# MOVEMENT ALARM



Are you picking up good vibrations? Here's something for the bad ones. Alarm your would be snoopers with this 'nifty little gadget'.

DO YOU SUSPECT that people are looking in your drawers? If so, then this project is for you. The ETI movement alarm will catch them red-handed.

The circuit really is quite simple and should pose no problems to the aspiring amateur. A thyristor's latching action is used to hold the alarm on until the whole circuit is turned off by disconnection from its battery supply. Thyristor operation means that the device can be interfaced directly to a low voltage alarm, e.g. a piezoelectric buzzer (or similar), or if you really want to raise the roof, then a line powered alarm can be used. In this case it is safest to use the thyristor to latch a relay on, which in turn switches the alarm. Although this may seem a somewhat lengthy process, it is preferable to directly operating the AC device via the thyristor — things can go badly wrong unless the builder is experienced. Dare we say, a shocking time could be had by all.

Now the smart ones among our readers will at this point be one step ahead of us and thinking to themselves — won't the alarm be triggered as the drawer is shut by the owner? Well, due to a disabling time delay of about 10 seconds — no!



All joking apart, this Veroboard project really is quite a novelty being so simple, easy to build and yet so sensitive. A preset resistor adjusts for different sound levels, microphones and personal taste, while battery operation means absolute portability.

Fig. 1 Circuit diagram of the ETI Movement Alarm, ensure the thyristor THY1 is connected the right way round.

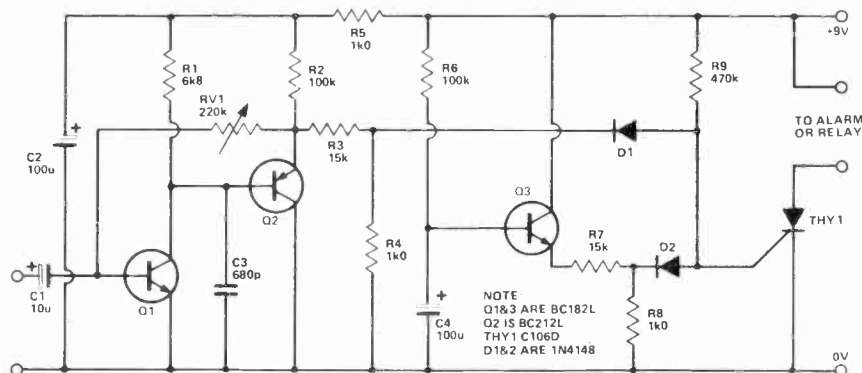

## HOW IT WORKS

The title 'Movement Alarm' is a slight misnomer really. The device doesn't actually pick up movement but sound. The sound of a drawer opening will tend to be of a fairly low frequency, so the main part of the device is a microphone followed by a low-pass pre-amplifier. Q1 and Q2 form the pre-amplifier which cuts off frequencies above about 2kHz. A low frequency sound picked up by the crystal mic is therefore amplified and triggers the thyristor THY1. RV1 adjusts for varied levels of gain to allow for a range of microphones and sound levels.

As the supply is DC the thyristor latches and holds the alarm or relay in its activated position until the supply is turned off.

Diodes D1 and D2 give an AND function at the gate of the thyristor, thus disabling it until both anodes are at positive potential. Transistor Q3 forms a simple time delay circuit holding the emitter of Q3 low for a period of about 10 seconds after switch on. During this time it doesn't matter what sound is picked up and amplified by the pre-amplifier, the thyristor cannot be turned on due to the D1 and D2 AND gate.

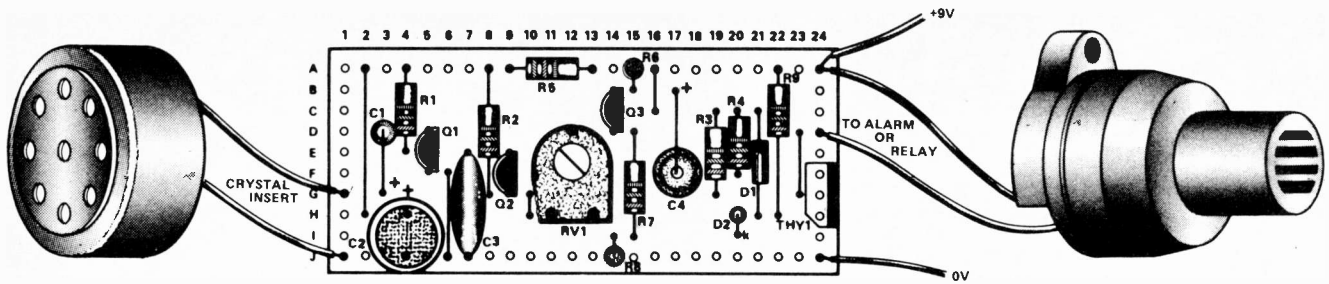

Fig. 2 Connection details and Veroboard layout of the ETI Movement Alarm. The crystal insert can be of any convenient type.

If you liked this project, please circle Reader Service Card number 59. If you didn't, circle number 60.

**PARTS LIST**

**RESISTORS (All 1/4 W, 5%)**

- R1 6k8
- R2,6 100k
- R3,7 15k
- R4,5,8 1k
- R9 470k

**POTENTIOMETERS**

- RV1 220k Miniature horizontal preset

**CAPACITORS**

- C1 10u 16V electrolytic
- C2,4 100u 16V printed circuit mounting electrolytic
- C3 680p polystyrene

**SEMICONDUCTORS**

- Q1,3 2N2926 NPN transistor
- Q2 2N3905 PNP transistor
- THY1 C106D or ECG 5457 Thyristor
- D1,2 1N4148 Diode

**MISCELLANEOUS**

- 10 x 24 hole Veroboard, 0.1 inch.
- Crystal microphone.
- 6 V Relay or solid state buzzer.
- Battery clip.
- Case to suit.

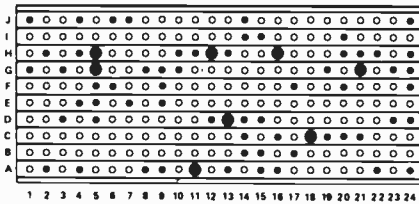

Veroboard layout, the large black circles show breaks in the copper tracks. The smaller dots show the position of the components.

The completed Movement Alarm shown with its case.

**Construction**

There's not a lot to be said really. Veroboard is an easy method of joining all the components leads together in the right places. That is as long as you insert the components in the right holes and that you solder them in carefully without joining adjacent copper strips. Also remember to cut the strips in the correct places.

Of course, neatness is the key. Try to keep all components close to the board; in this way short circuits are minimised.

Finally, connect your battery and go. The circuit is quite simple and should work first time.

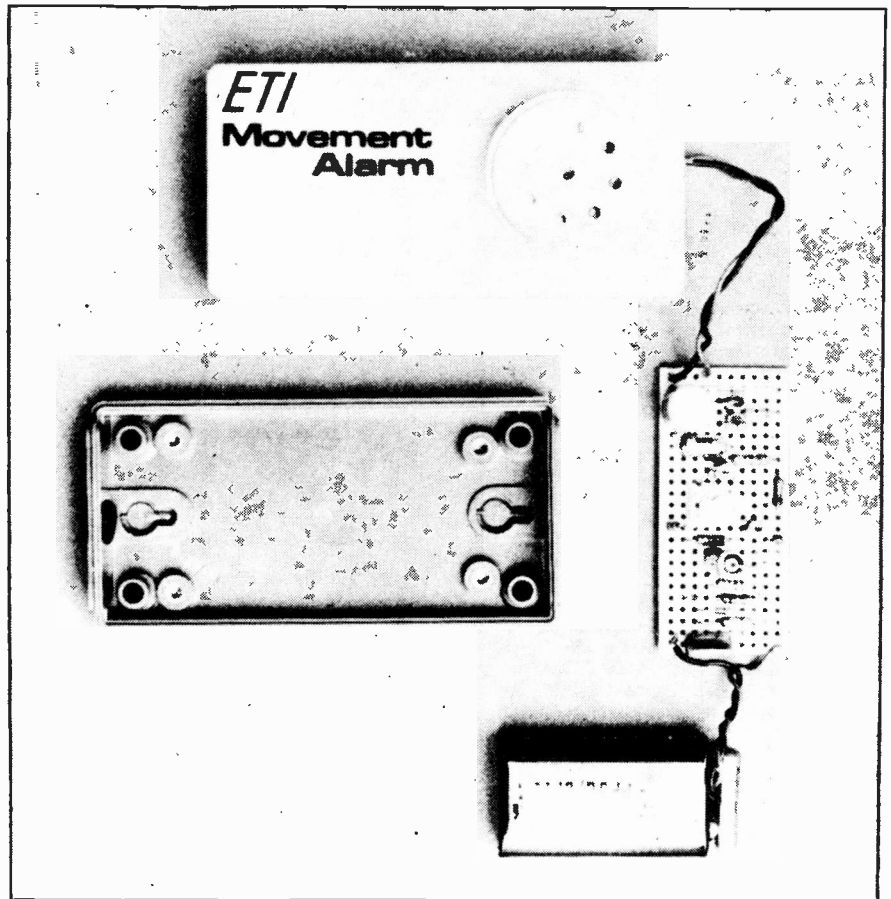

Will it keep beating?



It depends on YOU  
Be a RED CROSS Blood Donor

# New! Sinclair ZX81 Personal Computer Kit.

## Lower price: higher capability.

Sinclair's new ZX81 personal computer is a tremendous advance over the highly successful ZX80. It offers far more computer capability, yet Gladstone Electronics is able to offer the ZX81 in kit form at **half the ZX80 price!**

How is it possible? Quite simply, by design. The ZX81 uses only 4 chips (as opposed to 21 in the original ZX80). The secret lies in the totally new Master chip. Designed by and custom-manufactured for Sinclair, this unique chip replaces 18 chips from the ZX80.

## Easy-to-build Kit.

And because the chips have been reduced to only four, the kit is incredibly simple to build. A couple of hours work with a fine-tipped soldering iron and the ZX81 is ready to use.

## The ZX81's advanced capability.

The ZX81 uses the same fast microprocessor (Z80A), but incorporates a new, more powerful 8K BASIC ROM — the "trained intelligence" of the computer. This chip works in decimals, handles logs and trig, allows you to plot graphs, and builds up animated displays. And the ZX81 incorporates other operation refinements — the facility to load and save named programs on cassette, or to select a program off a cassette through the keyboard.

## New BASIC Manual.

Every ZX81 comes with a comprehensive manual — a complete course in BASIC from first principles to complete programs.

## Uses standard TV & cassette.

## New, Improved specification.

- Unique 'one-touch' key word entry: eliminates a great deal of tiresome typing. Key words (PRINT, LIST, RUN, etc.) have their own single-key entry.
- Unique syntax-check and report codes identify programming errors immediately.
- Full range of mathematical and scientific functions accurate to eight decimal places.
- Graph-drawing and animated-display facilities.
  - \* Multi-dimensional string and numeric arrays.
- Up to 26 FOR/NEXT loops.
- Randomize function.
- Programmable in machine code.
- Cassette LOAD and SAVE with named programs.
- 1K-byte RAM expandable to 16K.
- Full editing facilities.
- Able to drive the new Sinclair ZX Printer (to be available shortly).

## Kit builder guarantee:

If for any reason should you be unable to complete your ZX81 kit, you may return it with a cheque for \$25.00, and it will be completed and returned to you.

## If you own a ZX80...

The new 8K BASIC ROM as used in the ZX81 is available as a drop-in replacement chip. (Complete with new keyboard template and operating manual). With the exception of animated graphics, all the advanced features of the ZX81 are now available on your ZX80 — including the ability to drive the Sinclair ZX Printer.

## Software and users group.

With your order you will receive a listing of ZX81 software and publications plus a FREE copy of the users group magazine!

**GLADSTONE ELECTRONICS**  
1736 Avenue Rd. Toronto, Ontario

# \$149.95

**Telephone Orders**  
**(416) 787-1448**

Use Visa,  
Mastercharge or  
American  
Express



**16K  
RAM  
PACK  
\$169.95**

## SPECIAL INTRODUCTORY OFFER

Sinclair ZX81 Computer Kit PLUS 16K RAM memory expansion module for only \$299.95! Save \$20.00 from individual prices! Due to anticipated high demand, we suggest you order now to avoid disappointment. Allow 14-28 days for delivery. Mail coupon or order by phone.

MAIL ORDER TO: Gladstone Electronics, 1736 Avenue Rd., Toronto, Ont. M5M 3Y7

Name \_\_\_\_\_ Total amt. encl. \_\_\_\_\_ ( ) Cheque ( ) Money order  
Address \_\_\_\_\_ Charge to ( ) Visa ( ) Mastercard ( ) American Ex  
Card No. \_\_\_\_\_ Expiry \_\_\_\_\_

Qty.	Item	Price	Total
	Ontario residents add 7% p.s.t.		
	Sinclair ZX81 Personal Computer Kit(s), includes BASIC manual, TV & cassette connectors, excludes power supply	<b>\$149.95</b>	
	AC Adapter (500 mA- suitable for ZX81 alone)	<b>9.95</b>	
	AC Adapter (650 mA- suitable for ZX81 & 16KRAM)	<b>19.95</b>	
	16 K-BYTE RAM pack(s)	<b>169.95</b>	
	ETI SPECIAL OFFER — ZX81 & 16K RAM (not incl. power supply)	<b>299.95</b>	
	8K ROM to upgrade ZX80	<b>59.95</b>	
	Shipping charge, all orders		<b>\$ 5.00</b>
	New 64-PAGE CATALOGUE available. Computer hard ware, software, test gear, audio. Cost: \$1.00.		

Circle no. 9 on Reader Service Card.

From little Acorns doth grow the mighty computer systems that dim the house lights upon powering up. Steve Rimmer investigates the seedlings.

THE THING ABOUT COMPUTERS is that one is forever going "Oh wow, man, check this one out (or words to this effect). . . like, this has to be the most astounding system in existence for now and until the end of time or until the car's paid off, whichever comes first. It has every conceivable feature plus a three way can opener and a software controlled elephant tick remover. There will never be . . . oh, uh hang on, I think this one over here might be better."

This, of course is the exception. Let it be stated (to prove beyond question some people never learn) that the Acorn Atom may well be the most highly neat computer available today. We were planning to have a full scale review of the machine this month, but, sadly, customs delays and other sub-paragraphs of Murphy's law have conspired to hold up our review sample until about three hours prior to going to press. The profound niftiness and generally good karma of the thing does require some mention though, so we're going to let you have a look at it now, and do a proper dig next issue.

A nice drool can be very good for you.



#### ATOM and the ANS

The essential Atom, with 12K of RAM and colour, goes for \$549.00. In addition you'll need a TV and a tape recorder. The Atom comes with one of the best manuals going, probably the only one that goes all the way from the introductory PRINT "YOUR NAME" right through to machine code programming.

Acorn also sells a complete range of software for the atom, including the inevitable games, math and business packages, utilities and software upgrades. The Atom is supported with a selection of peripherals, including port expansion, disks, printers, communication interfaces, and, of course memory expansion. All the plug-ins are actually in . . . they don't hang out the back for the squirrels to munch on.

The Atom is supplied with on-board BASIC, but other languages can be substituted, like Pascal, FORTH and LISP. The BASIC is a little wierd, and quite unlike the more common Microsoft version as found in PETs and TRS-80's. Many of the immediate differences are syntactical, such as "P." for PRINT, instead of "?". The question mark is used as a combination PEEK and POKE statement. . . It takes some getting used to, but it's certainly no more difficult to deal with than the usual languages. In many cases, it's a great deal more powerful, too.

One of the really nice features of the Atom BASIC is that you can do machine code programming right there in the BASIC. There's a full blown assembler built right in. Provided the ML mnemonics are preceded by a "I" and ended with a "J", the computer will go through the program prior to running it and compile all the code for you. The code can then be attached to by a LINK statement, which is like a SYSTEM command except that it gets back into BASIC when the thing's done.

The Atom is particularly handy for doing machine code on because it has two levels of program interruption available from the keyboard. It's acutally possible to generate a CPU interrupt to get out of botched machine code loops and still get the program back.

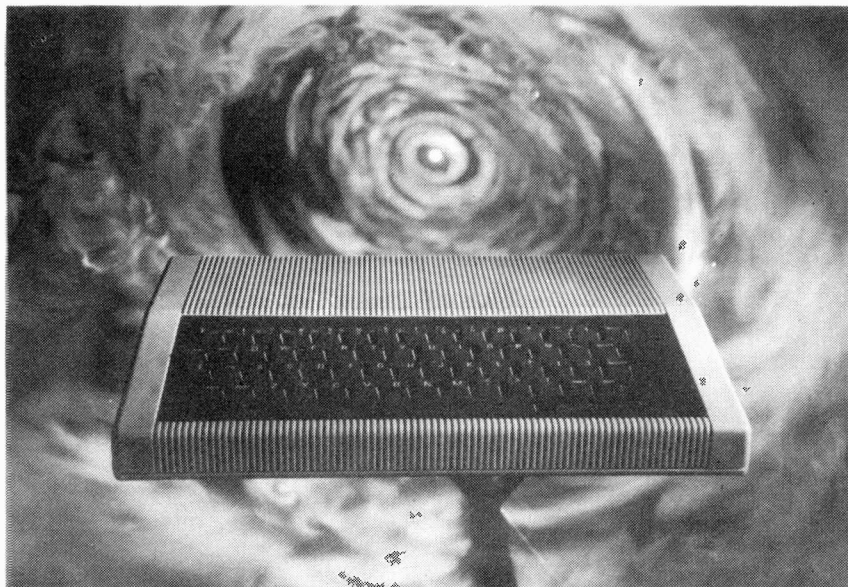

Fig. 1 The Acorn Atom in all its glory, hardly larger than its keyboard. This Atom contains 12K of RAM, with room for 32K more.

JUST LOOK  
INSIDE FOR  
SAVINGS YOU  
WON'T BELIEVE

**TOP BRAND  
MERCHANDISE!  
BEST SELECTION  
ANYWHERE!**

**COMPUTER PRODUCTS:** RCA Cosmac, SSM, S.D. Systems, Mullen, Spectronics MPI, Siemens, Vector, Sanyo, Electrohome, Rockwell Aim, Texas Instrument, Centronics, Trendcom, Epson, Amdek, Applekation, Programma, Electronic Protection Devices, BSR, Alf, D.C. Hayes, Heuristics, Lazer Systems, M & R Associates, Microsoft, Mountain Computers, Versa Computing, Videx, Dysan, 3M.

**TEST EQUIPMENT:** Philips, Leader, Global, Fluke, Mode, Univolt, Hitachi, Keithley, Hioki.  
**ELECTRONIC COMPONENTS AND HARDWARE:** Stackpole, Remeo Wire, Hammond, Injectorall, Global, OK Machine, AP. Products, Rubycon, Scotchflex, Galleria Acc., Noma, Chemtronics, Fuji, Eagle, Mode, Lonline, Edsyn, Cramco, Pana Vise, Beeco.

# SUPER SAVINGS FLYER

WINTER 1981/82



409 QUEEN ST. WEST  
TORONTO, CANADA  
M5V 2A5 (416) 868-1315

## DISCOVER OUR WORLD OF ELECTRONICS!

**BOOKS:** Addison Wesley, Compusoft, Creative Computing, Dilithium Press, Hayden, Kilobaud, Micro, Osborne, Prentice Hall, Quality, Sams, Scelbi, Sybex, Tab, ARRL, ETI Publications, Babani.  
**MAGAZINES:** Byte, 73, QST, Creative Computing, Compute, Nibble, Computing Today, Interface Age, Which Computer, Kilobaud, Sync, Peelings, Micro, Personal Computing, 80 Microcomputing, S-100 Microsystem, Desktop Computing, Electronics Today, Radio Electronics, Elektor, On Computing, Info World, Popular Computing, Apple Orchard, Softalk, Polyphony, Wireless World, Video World, Practical Electronics, Robotics Age, Dr. Dobb's Journal, Short Wave.  
**SOFTWARE:** Digital Research, Lifeboat Asc., Adventure International, Beagle Brothers, Big Five, Automated Simulations, Broderbund, California Pacific, Compumax, Creative Computing, DataSoft, Edu-Ware, Hayden, Sams, Instant Software, Microlab, Micropro, Microsoft, Muse, On Line, PDI, Peachtree, Personal Software, Programma, Softape, Sirius, Strategic Simulations, Synergistic, Syntonic.

**PRICES EFFECTIVE  
UNTIL JAN. 15th, 1982**

**ARKON IS  
CANADA'S  
LARGEST  
HOBBY  
COMPUTER  
STORE...**

# WE HAVE A PROFESSIONAL MAIL ORDER SERVICE



## TC-100/ST WITH TOOLS \$583.88

Sturdy, spacious tool case available with selection of tools or empty for field service work. Unique design provides space for 53 individual screwdrivers, nutdrivers, pliers and wrenches, 31 Series 99 interchangeable screwdriver/nutdriver sets, plus pockets for service manuals and ample room in the case bottom for additional tools, parts and test equipment.

Series 99 Tools				
99-1	99-X-10	99-125	99-764	99-821
99-1-R	99-38	99-250	99-811	99-822
99-4-R	99-20 thru 26	99-312	99-820	99-964
99-X-5	99-61 thru 69			
Pliers, Wrench, Snips, Stripper, Seizer, Knife				
42H	51CG	57CG	66CG	103-S
46CG	53CG	59CG	86CG	K-22
50CG	54CG			
Screwdrivers				
R-144	R-3164	R-5325	S-5166	XST-102
R-146	R-3166	S-388	SX-101	P-18
R-181	(insulated)	S-3161	XST-100	P-19
R-184	R-3323	S-5161	XST-101	
Nutdrivers				
HS-6	HS-11	HS-16	8M	P3 thru P12
HS-8	HS-12	HS-18	10M	TA-2 Handle
HS-10	HS-14			
Sets, etc.				
M-60	XL-75	600		



## TEMPERATURE-CONTROLLED SOLDERING & DE-SOLDERING STATIONS & IRONS

### CONTROLLED OUTPUT SOLDERING STATION

#### MODEL WTCPN \$81.38

Re-designed successor to popular WTCPL. Unique closed-loop system automatically controls tip temperature at 600°, 700°, or 800°F to protect sensitive components. Temperature selected by changing heat sensing tip. Heat-shielded soldering pencil. On/off switch, red indicator light, larger tip-cleaning sponge and receptacle, non-heat-sinking tool stand, non-burning silicon rubber iron cord, 3-wire power cord. 120V 50/400 Hz 60W. Furnished with 1/16" 700°F tip (PTA7).



## WELLER® MINI SHOP KIT

### MODEL 601K \$64.83

46-piece kit enables craftsman, hobbyist, or home repairman to brush, clean, polish, sand, shape, grind, sharpen, drill, cut, rout, deburr...to handle hundreds of jobs with a single, compact, comfortably balanced power unit. Precision-wound permanent magnet motor with 28,000 RPM output speed. 120V, 1.1 amp, 60 Hz, with 3-wire cord only. Plastic carrying case. Includes all Accessories listed at right except safety goggles and replacement motor brushes. Booklet illustrates use of each accessory and has Order Form for replacements.

### MODEL 651K VARIABLE SPEED \$94.95

Identical to 601K except power unit's output speed adjustable by continuously variable, solid-state control knob on base giving speeds from 5000 to 28,000 RPM. Permits matching speed to material being machined. Includes high-speed steel engraving tip for marking permanent identification on most surfaces except hard steel and glass.

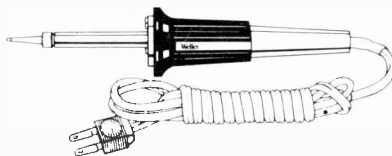

## SOLDERING IRONS FOR INDUSTRIAL APPLICATIONS/TRADESMAN/HOBBYISTS

### PROFESSIONAL SOLDERING IRONS

#### (Series WP)

Top quality, industrial grade. Rugged stainless steel barrel. Long life double-coated tips. Popular pencil styling. Light blue handle with black heat shield, cool, comfortable grip. Only 7 7/8" long; 1 3/4 oz.

#### MODEL WP25 \$16.29

25 watt. 1/16" Screwdriver tip. 2-wire cord. 120V

#### MODEL WP25-3 \$18.29

As above with 3-wire cord. Boxed.

#### MODEL WP40 \$20.01

40 watt. Screwdriver tip. 2-wire cord. 120V.



## SPECIALIZED SOLDERING KITS

### SOLDERING HOBBY KIT

#### MODEL 230K \$17.24

12-piece kit for soldering, leather tooling, wood burning, plastic sculpturing, model-making, etc. Includes SP23 iron; hot knife tip, smoothing tip, and four other tips; sponge; hot-iron rest; soldering aid tool; rosin-core solder; instruction booklet; and plastic carrying case. UL listed.



## NO. 99SMW SERVICE MASTER TOOL KIT

\$137.59

27-piece kit contains same tools as No. 99SM (above), plus WP25 soldering iron with 1/16" screwdriver tip, ST3 1/8" screwdriver tip, No. 100 wire stripper/cutter, and 99SMWK plastic-coated canvas case.



## NO. 99SM SERVICE MASTER TOOL KIT

\$105.70

24-piece kit contains 99-1 (Regular) and 99-3 (Stubby) handles, nine regular nutdrivers (99-6 thru 99-16), three stubby nutdrivers (99-58 thru 99-512), two slotted screwdrivers (99-811, 99-250), two Phillips screwdrivers (99-821 and 99-822), one reamer (99-38), extension blade (99-X10), 6" long nose cushion grip plier (52CG), 5" diagonal cushion grip plier (55CG), 6" cushion grip adjustable wrench (46CG), plastic-coated canvas case (99SMK).



## ELECTRONIC TOOL KIT

### MODEL 250K

\$48.15

12 pieces. For the kit-builder, hobbyist, budding technician, handyman, or general use in dozens of electronic jobs. Contains Weller WP25 Soldering Iron with 1/16" screwdriver tip, 1/32" conical and 3/32" screwdriver extra tips, soldering aid tool, and rosin-core solder, plus Xcelite 1/4" nutdriver, 1/8" slotted screwdriver, No. 1 Phillips-type driver, 4" short chain-nose pliers, 4" diagonal cutting pliers, wire stripper/cutter, and plastic carrying case, UL listed.



## ETCHING STARTER KIT #500

Clad, pen, ink solvent, etchant drill, plastic case.

Complete — \$19.85

Purchase over \$150.00 and receive this slim line clock pen with time, seconds and date features! A \$49.95 value reg.



# Electronic Protection Devices

## APPLICATIONS

Computers, Printers, Disk Drives, Stereo's, TV's, VCRs and Microwave Ovens.

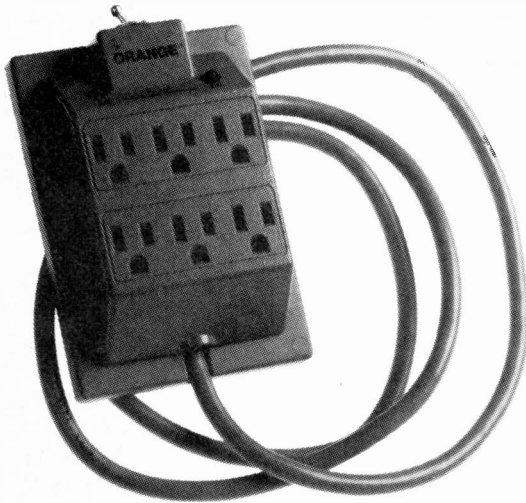

**The Orange** \$197.95  
EMI-RFI Filtered, AC Surge Protector  
Combination of Plum and Lime.



**The Lime**  
AC Surge Protector \$126.95  
Same as the Lemon but comes with  
6 ft. 3 wire power cord and power on/off  
switch.

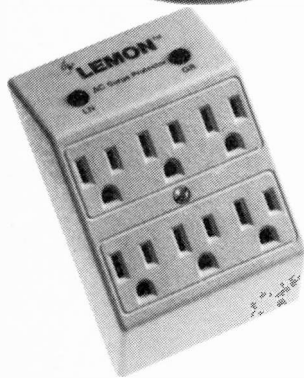

**The Lemon**  
AC Surge Protector \$84.95  
Squeezes out sour juice  
on the AC power line  
glitches, spikes surges  
and transients. Forward  
surge 1440 Amps for  
1/120 seconds, Peak Pulse Power 10,800  
Watts for one S. Dielectric Test-3000  
Volts AC 60 Hz 15 Amp, 125 Volts AC 6  
outlets.

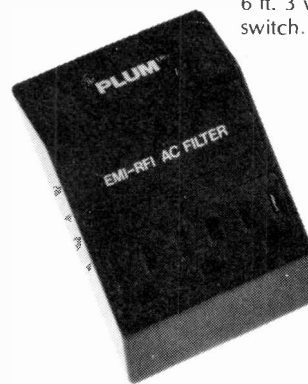

**The Plum**  
EMI-RFI Filter \$69.95  
Filters noises on the AC  
power line, 3 Grounded  
Outlets, 15 Amp 125  
Volts AC, Freq. 150  
KHZ-30HZ, Attenuation  
5db-58db.

# Semiconductors

Just a sample of our everyday low, low prices

### MICRO PROCESSORS

Z80A	\$ 8.95
Z80B	\$29.95
1802	\$11.25
6502	\$ 8.95
6800	\$ 6.50
6802	\$10.95
6809	\$24.95
8035	\$11.95
8080A	\$ 6.95
8085A	\$ 9.95

### EPROMS

2708	\$ 4.25
2716	\$ 5.50
2716T	\$24.95
2532	\$16.75
2732	\$12.50
2758	\$ 9.95
2764	\$99.95

### DYNAMIC MEMORY

4116-300NS	\$ 1.80
4116-200NS	\$ 2.50
4116-150NS	\$ 3.15
4164-150NS	\$16.25

### STATIC MEMORY

2114L-300NS	\$ 3.50
2114L-250NS	\$ 3.75

2114L-200NS	\$ 3.95
2114-450NS	\$ 2.95
2114-300NS	\$ 3.35
2114-200NS	\$ 3.75
5101-450NS	\$ 3.95
4016-150NS	\$16.25

### FLOPPY CONTROLLERS

1771B	\$21.95
1791B	\$61.95
1795B	\$91.95

### REGULATORS

7805UC	\$ 1.15
7812UC	\$ 1.15
7815UC	\$ 1.15
7905UC	\$ 1.40
7912UC	\$ 1.40
7915	\$ 1.40
LM723CN	\$ .65

### SPECIAL FUNCTION AND LINEAR

MM5313	\$ 4.50
MM5314	\$ 3.75
MM5316	\$ 3.75
9400	\$ 8.25
RC4151	\$ 1.75
1408L8	\$ 2.75
TDA1022	\$ 8.95

LM380-14	\$ 1.75	TL075	\$ 3.20
LM301	\$ .45	TL080	\$ .65
LM308	\$ .80	TL081	\$ .65
LF355	\$ 1.50	TL083	\$ 1.65
LF356	\$ 1.50	TL084	\$ 2.25
LF357	\$ 1.50	NSM3915	\$ 8.95
LF358	\$ .70	NSM3916	\$ 8.95
LM382	\$ 1.75	11C90	\$19.95
NE555	\$ .30	5501	\$24.95
NE556	\$ .75	MM5369	\$ 1.65
NE566	\$ 2.50	7106	\$19.95
NE567	\$ 1.20	7107	\$17.95
LM741	\$ .30	7208A1J1	\$21.95
LM1488	\$ .95	72161A1J1	\$34.95
LM1489	\$ .85	7217A1P1	\$10.95
LM1889	\$ 2.50	7226A1P1	\$11.95
CA3010	\$ 1.50	8T26	\$ 2.75
CA3080	\$ 1.40	8T28	\$ 2.75
CA3130	\$ 1.60	8T96	\$ 2.50
CA3140	\$ .80	8T97	\$ 2.50
LM3900	\$ .85	8T98	\$ 2.50
LM3909	\$ 1.40	XR2206	\$ 5.40
LM3914	\$ 3.95	XRL555	\$ 1.60
LM3915	\$ 3.95	XRL556	\$ 3.75
LM3916	\$ 3.95	AY5-3600	\$14.95
TL062	\$ 1.50	AY5-1015	\$ 5.25
TL064	\$ 2.50	AY5-1013	\$ 8.50
TL071	\$ .80	AY3-8910	\$11.95
TL072	\$ 1.25	AY3-1015	\$ 4.95
TL074	\$ 2.30	AY3-1014	\$14.25

**CALL US FOR ALL YOUR SEMICONDUCTOR NEEDS**

# PHILIPS

Philips Test & Measuring Instruments, Inc.

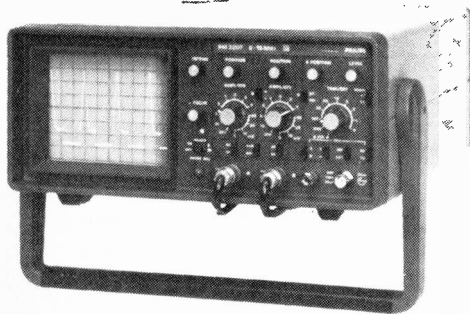

**PM3207** \$995.00  
15 MHz. Dual Trace Oscilloscope with Autotriggering.



**PM5705** \$875.00  
10 MHz. Pulse Generator.

**INTRODUCING  
PHILIPS TEST  
EQUIPMENT**



**PM6668** \$915.00  
1 GHz High Resolution Frequency Counter.

**PM6667** \$570.00  
120 MHz. High Resolution Frequency Counter.



**PM5519** \$1860.00  
NTSC Colour Pattern Generator.

## Applektion PP II Printer Card

The PP II parallel card for the Apple II computer is designed to allow effective use of your printer which has special functions such as bold and enlarged face print available through the use of escape sequence commands. Since the Apple II does not send escape characters the software on this board does it for you with control characters from the keyboard. One of the main designs of the PP II card is that it contains space enough for 8 independent printer driver programs so new printers are not a problem. The PP II is software compatible with both Apple Basics as well as \*CP/M or \*Pascal.

\*CP/M or Pascal disks providing the appropriate bios patches are available on special request.

PP II printer card (with cable) MX-80 or 737.  
\$199.95

## VECTOR 4609 UNIVERSAL MICROCOMPUTER PLUGBOARD APPLE II, PET COMMODORE & SUPER-KIM



apple computer inc.

- I/O, peripheral interfacing, experiments or memory expansion
- Extra I/O edge connector for ribbon wire plug
- Solder or wrap wiring
- Heavy dual bus between dip leads for short, easy bend-&-solder or wrap-&-solder connection
- Uncommitted pattern for any size IC on 0.1 inch grid
- Mounts 22 16-pin DIPs, or 18 16-pin and 2 40-pin DIPs, etc. on bus
- Fast solder mounting of DIPs, wrap post sockets, transistors, resistors, capacitors, E/M or S.S. relays, terminals, switches, etc.
- Gold plated contacts
- Extended length 7.7 in. for 1.9 sq. in. extra area without interference. Convenient bare end may be cut off for 7 inch std.

**WE ALSO DO INDUSTRIAL SALES** **CALL: 868-1315**



# Three good reasons to buy a handheld DMM from Fluke

## MODE D804: THE INVESTIGATOR

- Nine functions  
dc voltage  
ac voltage  
dc current  
ac current  
resistance  
diode test  
conductance (1/R)  
logic level and continuity detect  
temperature (K-type thermocouple)
- Peak hold on voltage and current functions
- Selectable audible indicator for continuity or level detection
- 3 1/2-digit resolution
- 0.1% basic accuracy
- LCD display
- Overload protection
- Safety designed test leads
- Full year parts & labor warranty

FLU-D804 **\$339.95**

## MODEL D802: THE ANALYST

- Seven functions  
dc voltage  
ac voltage  
dc current  
ac current  
resistance  
diode test  
conductance (1/R)
- 3 1/2-digit resolution
- 0.1% basic dc accuracy
- Overload protection
- Safety-designed test leads
- Full year parts & labor warranty

FLU-D802 **\$258.95**

## MODEL D800: THE TROUBLESHOOTER

- Six functions  
dc voltage  
ac voltage  
dc current  
ac current  
resistance  
diode test
- 3 1/2-digit resolution
- 0.5% basic dc accuracy
- LCD display
- Overload protection
- Safety-designed test leads
- Full year parts & labor warranty

FLU-D800 **\$172.95**

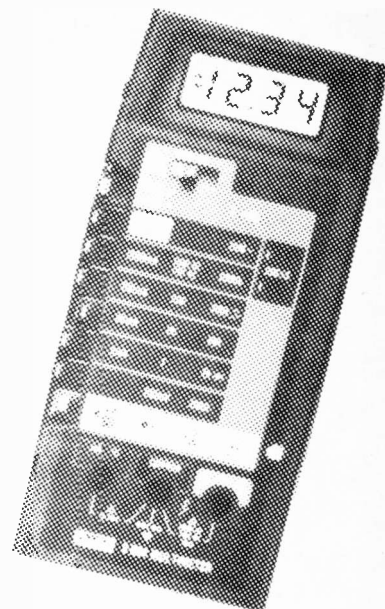

## LOW COST DMM'S FOR BENCH OR FIELD

The D810 and D811 are general purpose, bench/portable digital multimeters that are identical except for power sources. The D810 operates on line voltage, while the D811 is also equipped with rechargeable batteries that provide 15 to 40 hours of operation depending on functions used.

Because these DMM's measure the true rms value of ac signals, even complex inputs such as square waves and peaked waveforms can be measured with accuracy and confidence to 50 kHz ( $\pm 3$  dB to 200 kHz typical).

The wideband, low-noise measurement accuracy in these two benchtop multimeters is made possible by a Fluke-manufactured hybrid rms converter.

- 3 1/2 LCD display
- Auto zero, auto polarity
- AC or battery operated models
- One year warranty
- Many other features not found in other DMM'S!

FLU-D810 **\$365.95**

FLU-D811 **\$418.95**

(with Ni Cad batteries)

### FLUKE DMM ACCESSORIES

FLU-Y8205 Carrying case (FLU-D810, D811) ....	51.95
FLU-C90 Carrying case (FLU-D800, D802, D804)	15.95
FLU-A81 AC adaptor (FLU-D800, D802, D804).	29.95
FLU-80J10 10 Amp current shunt .....	44.95
FLU-Y8133 Deluxe test lead set .....	27.95
FLU-Y8134 Deluxe test lead set with safety connectors .....	27.95
FLU-Y8140 Slim test lead set.....	27.95
FLU-80T150C Temp. probe (°C) .....	176.95
FLU-80T150F Temp. probe (°F) .....	176.95
FLU-Y8102 Sheath thermocouple (D804).....	74.95
FLU-Y8103 Bead thermocouple (D804).....	34.95
FLU-Y8104 Thermocouple termination (D804)...	14.95
FLU-Y8008 Touch and hold probe (D810, D811)	65.95
FLU-80K40 40KV high voltage probe .....	115.95
FLU-81RF 100 MHz rf probe.....	65.95
FLU-801600 Clamp-on AC current probe 600A.	136.95
FLU-Y8100 200A AC/DC current probe.....	262.95
FLU-Y8101 150A AC current xformer .....	108.95

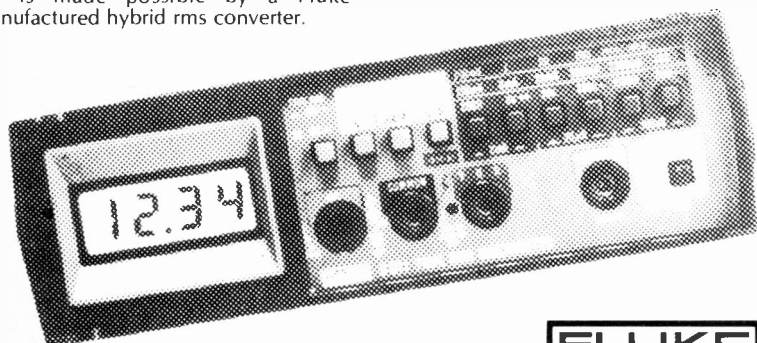

**We also carry LEADER TEST EQUIPMENT**

# MANY OTHER COMPUTER BOARDS AVAILABLE

## S-100 COMPUTER BOARDS

### S.D. SYSTEMS COMPUTER BOARDS

	Reg.	Now
EXPANDORAM I — Expandable Ram Memory Board Kit, 2.7mhz, uses 4116, up to 64K	\$370.00	\$260.00
EXPANDORAM I — Assembled and Tested, Same as above with 64K installed	\$500.00	\$370.00
EXPANDORAM II — Expandable Ram Memory Board, Kit, 4.0mhz, uses 4116 or 4164, up to 256K	\$395.00	\$275.00
VERSAFLOPPY I — Versatile Floppy Disk Controller Kit (SS or DS - SD)	\$415.00	\$290.00
VERSAFLOPPY II — Double Density Disk Controller Kit (SS or DS - SD or DD)	\$545.00	\$380.00
SBC-100 — 2MHz Single Board Controller Kit	\$499.00	\$350.00
SBC-200 — 4MHz Single Board Controller, Kit	\$545.00	\$380.00
VDB-8024 — 80 x 24 Mapped Video Board Kit	\$640.00	\$450.00
EXPANDOPROM — Expandable to 32K using 2716's, Kit	\$289.00	\$205.00
PROM 100 — Versatile Eprom Programmer, Kit	\$345.00	\$240.00
MPC-4 — Multi-Port Communicator with Four Serial Ports, Kit	\$870.00	\$610.00
MPB-100 — Versatile Micro Computer CPU Board (Z80), Kit	\$589.00	\$425.00

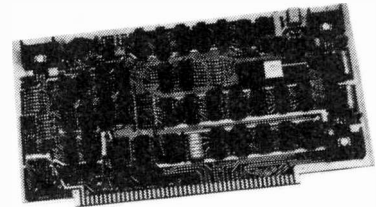

**SD**  
SYSTEMS

### SSM COMPUTER BOARDS

CBIA — 2MHz 8080A CPU Single Board Controller, Kit	\$255.00	\$180.00
CBIA — 2MHz 8080A CPU Single Board Controller, Bareboard	\$ 65.00	\$ 50.00
VBI — Memory Mapped Video Board 64 x 16, Bareboard	\$ 55.00	\$ 38.50
102 — Parallel I/O Board, Kit	\$ 95.00	\$ 65.00
102 — Parallel I/O Board, Bareboard	\$ 55.00	\$ 38.50
SBI — Music Synthesizer, Kit	\$345.00	\$240.00
SBI — Music Synthesizer, Bareboard	\$ 70.00	\$ 50.00
MB7 — Low Power 16K Static Ram Board, Bareboard	\$ 60.00	\$ 42.00
PBI — 2708/2716 Eprom Programmer, Kit	\$250.00	\$175.00
MTI — 15 Slot Motherboard, Bareboard	\$ 80.00	\$ 56.00

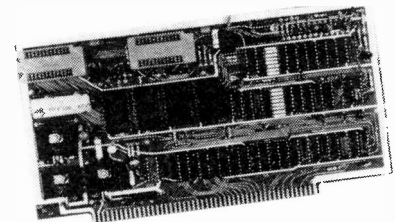

**SSM**

### MULLEN COMPUTER BOARDS

TB-2 — S-100 Extender Board/Logic Probe, Kit	\$ 89.95	\$ 62.95
CB-1 — Controller Board, Kit	\$199.95	\$139.00
CB-10p — Ac Relay Option 500 Watt, Module	\$ 36.95	\$ 25.95

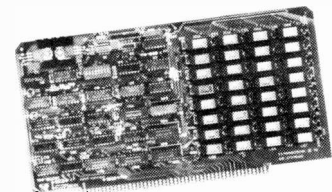

**Mullen**

### ARKON ELECTRONICS COMPUTER BOARDS

CPIO — Central Processor and I/O System Card, Assembled and Tested	\$495.00	\$395.00
AMB-100B — 6. Slot Motherboard, Bareboard	\$ 24.95	\$ 19.95
AXB-100B — S-100 Extender Board, Bareboard	\$ 24.95	\$ 19.95

**arkon**  
electronics ltd

Please call for complete information and specifications on all products!

## Computer Show Special

The Solid State Oscilloscope with 4MHz Bandwidth

LBO-310A — 3" CRT. **\$319.95**

- general purpose application in industry, service, education and communications
- monitors waveforms to 450MHz on direct input at 10vp-p or better
- 4 MHz vertical bandwidth plus 20mvp-p/div vertical sensitivity
- 10Hz to 100KHz sweep frequency in 4 ranges
- AC and DC coupled vertical input for extended capabilities wherever used

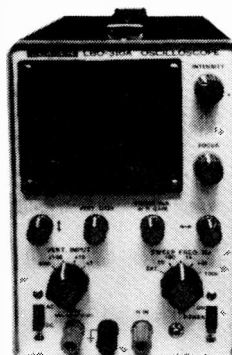

## Joysticks

Build your own video controller, or?  
High quality. High reliability

- 20K ohm four pots \$11.95
- 100K ohm four pots \$11.95
- 150K ohm two pots \$15.95

\*150K joystick is ideal for Apple Computer

# BOOKS and SOFTWARE

We have over 1,000 titles in stock now!

## ADDISON WESLEY

Basic and the Personal Computer	\$18.95
A Bit of Basic	\$ 7.95
Software Tools	\$23.95
Interfacing Micro's to the Real World	\$25.95

## COMPUSOFT PUBLISHING

The Basic Handbook (new edition)	\$27.95
----------------------------------	---------

## CREATIVE COMPUTING

Computers for Kids — Apple	\$ 5.25
Computers for Kids — TRS-80	\$ 5.25
Computers for Kids — Atari	\$ 5.25
More Basic Computer Games	\$10.50
Basic Computer Games	\$10.50
Basic Computer Games TRS-80 Edition	\$10.50

## DILITHIUM PRESS

Take Aim Vol. 1	\$21.95
Beginning Basic	\$14.95
Continuing Basic	\$12.95
Microsoft Basic	\$14.95
How to Get Started with CPM	\$12.95
Microsoft Fortran	\$19.95
How to Make Money with Your Microcomputer	\$12.95

## MICRO

Best of Micro Vol. 1	\$ 7.95
Best of Micro Vol. 2	\$10.95
Best of Micro Vol. 3	\$12.95
Micro Apple (with disk)	\$32.95

## HAYDEN

The S-100 Bus Handbook	\$20.50
What to Do After You Hit Return	\$20.95
Basic Computer Programs for Business Vol. 1	\$13.95
Basic From the Ground Up	\$15.25
Introduction to VSAM	\$16.75
The 8086 Primer	\$13.95
More Telephone Accessories You Can Build	\$ 8.35

## OSBORNE

Pet and the IEEE 488 BUS	\$19.95
An Introduction to Microcomputers Vol. 0	\$ 9.95
An Introduction to Microcomputers Vol. 1	\$16.95
4 and 8 Bit Micro Proc. Handbook	\$24.95
16 Bit Micro Proc. Handbook	\$24.95
The 8086 Book	\$21.95
6809 Assembly Language Programming	\$21.95
PET/CBM Personal Computer Guide	\$18.95

## TAB

The MC6809 Cookbook	\$ 8.95
---------------------	---------

## SYBEX

The CP/M Handbook	\$18.95
Programming the Z-80	\$19.95

## APPLE II SOFTWARE

### BRODERBUND

Alien Typhoon	\$34.95
Alien Rain	\$34.95
*Snoggle	\$45.95
Galatic Empire	\$34.95
Galatic Trader	\$34.95
Galatic Revolution	\$34.95
(*Now with joystick option)	

### CALIFORNIA PACIFIC

Ultima	\$54.95
Appleoids	\$42.95
Akalabeth	\$47.95
Trilogy	\$42.95
Space Album	\$54.95

### BUDGE CO.

Raster Blaster	\$42.95
----------------	---------

### DATASOFT

Micropainter	\$51.95
--------------	---------

### MUSE

ABM	\$34.95
Robot War	\$54.95

### SIRIUS

Cyberstrike	\$55.95
Star Cruiser	\$34.95
Space Eggs	\$42.95
Pulsar II	\$42.95
Gorgon	\$55.95
Sneakers	\$42.95
Epoch	\$48.95

### MICROSOFT

Typing Tutor (cass. int.)	\$ 20.95
Typing Tutor (A+)	\$ 34.95

We are Canada's largest software mailorder company

Adventure	\$ 41.95
Fortran-80	\$269.95
Olympic Decathlon	\$ 34.95
Cobol-80	\$999.95

## MICROLAB

Data Factory	\$199.95
--------------	----------

## PROGRAMMA

World Processing System (specify 40 col., Videx, Superterm)	\$140.00
Colour Micro Invaders	\$ 27.95

## BEAGLE BROS.

#1 Text Train, Sub Search, Pick & Pair	\$34.95
#2 Wowzo, Elevators, Quick-draw	\$34.95
#3 Magic Pack, Slippery Digits, Oink	\$34.95
#4 Buzzword, Triple Digits, Corn Game	\$34.95
Doss Boss: Disk Command Editor	\$34.95

## TRS 80 SOFTWARE LEVEL II

### MICROSOFT

Level III Basic (cass.)	\$ 68.95
Typing Tutor (cass.)	\$ 27.95
Editor/Assembler Plus (cass.)	\$ 41.95
Olympic Decathlon (cass.)	\$ 34.95
Adventure	\$ 41.95
Fortran-80	\$138.95
Assembly Language	\$138.95
Basic Compiler	\$269.95
Mumath	\$103.95
Olympic Decathlon Disk	\$ 34.95

### AUTOMATED SIMULATIONS

Morloc's Tower L2 16K (cass.)	\$26.95
Star Warrior L2 16K (cass.)	\$53.95
Star Fleet Orion L2 16K (cass.)	\$32.95
Datestones of Ryn L2 16K (cass.)	\$26.95

### STRATEGIC SIMULATIONS

Computer Bismark (cass.)	\$68.95
--------------------------	---------

### BIG FIVE SOFTWARE

Super Nova	T/\$21.95	D/\$27.95
Galaxy Invasion	T/\$21.95	D/\$27.95
Attack Force	T/\$21.95	D/\$27.95
Cosmic Fighter	T/\$21.95	D/\$27.95
Robot Attack	T/\$21.95	D/\$27.95
T/ TRS-80L2 16K Cass. Model 1-3		
D/ TRS-80L2 32K Cass. Model 1-3		

## TRS-80 COLOUR COMPUTER SOFTWARE

### DATASOFT

Sigmon	\$41.95
Screen Edit	\$41.95

### 8" SOFTWARE

#### DIGITAL RESEARCH SOFTWARE

	PROGRAM & MANUAL	MANUAL
CP/M 2.2	\$225.00	\$35.00
MP/M II	\$630.00	\$50.00
PL/1-80 1.3	\$700.00	\$50.00
RMAC, Link-80, LIB	\$280.00	\$35.00
Link-80, LIB, PL-180 Run Time Library	\$145.00	\$ N/A
MAC 2.0	\$130.00	\$20.00
SID 1.4	\$120.00	\$20.00
Z SID 1.4	\$145.00	\$20.00
TEX 2.1	\$145.00	\$15.00
Despool 2.0	\$ 75.00	\$ 5.00
CP/NET	\$280.00	\$25.00
CP/M 86 1.0	\$350.00	\$50.00
BT-80 1.0	\$280.00	\$35.00
C Basic	\$215.00	\$45.00
C Basic 86	\$455.00	\$45.00
C Basic 16	\$455.00	\$45.00
CB80	\$700.00	\$45.00

### ARKON SOFTWARE

Fort/80	\$120.00	\$35.00
---------	----------	---------

### MICROPRO

Wordstar 3.0	\$660.00	\$80.00
Mailmerge Option	\$200.00	\$35.00

### MICROSOFT

Basic-80 (M Basic)	\$483.00	\$ N/A
--------------------	----------	--------

### CREATIVE COMPUTING 8" CP/M SOFTWARE

Basic Games I	\$34.95
Basic Games II	\$34.95
Basic Games III	\$34.95
Basic Games IV	\$34.95
Adventure Bilingual	\$34.95
Adventure Land & Pirate Adventure	\$34.95

ALL SOFTWARE ON DISK UNLESS OTHERWISE STATED

# SPECIAL DISCOUNTS FOR SCHOOLS!

# ARKITS *(all kits include instructions, parts and P.C. board)*

## COLOUR MODULATOR \$19.95

This video modulator has been designed to complement the small home computer. It allows the standard colour television to be used as a high quality colour video monitor. Uses state of the art integrated circuit technology. Direct coupling is employed to provide white level compensation in the vestigial sideband output. The gain device of the LM1889's chroma oscillator is used to buffer, level shift, and invert the incoming composite colour input. The signal then passes to the RF Modulator where a channel 2 carrier is provided. Requires 12 volt DC for operation.

## VIDEO TO RF MODULATOR \$ 7.95

Converts a video signal to a RF signal. The RF output terminals connect to the antenna of your TV. Connecting in the video and supplying 5 volt DC is all that is needed. You turn your channel selector to 2 or 3 and tune the adjusting coil for a suitable display.

## MAD BLASTER \$ 4.95

The MB-1 produces a loud "ear shattering" and attention getting siren-like sound. This kit can supply to 4 watts of obnoxious audio into an 8 ohm speaker. Requires +15 volts DC for operation.

## COLOUR ORGAN \$14.95

Good for home colour organ to light up your sound system. Three channel, four level controls. Up to 500 watts per channel (more with heatsinking).

## ETI BOARDS

Bare boards, Top quality tinned P.C.

STK #	NAME	DATE	PRICE
1	Fuzz box	May 77	1.50
2	G.P. pre-amp.	445 CPB 1	2.75
3	Complex sound gen.	Apr. 80	9.25
4	60 watt amp.	470 Nov. 79	5.25
5	Drum synthesizer	Mar. 81	12.95
6	Audio compressor	490 Apr. 79	3.25
7	Speaker protection unit	Sept. 80	5.25
8	Two chip siren	Aug. 78	1.50
9	CCD phaser unit	Oct. 78	6.25
10	Click eliminator	May 80	8.25
11	300 watt amp.	Aug. 80	11.25
12	Hum filter	Mar. 81	3.75
13	Proximity switch	July 78	4.25
14	Microcomputer supply	635 Apr. 78	5.75
15	*Cassette interace	June 81	4.75

## CODE OSCILLATOR/TONE

**GENERATOR \$ 2.95**  
Can be used as a code oscillator (1 KHZ) burglar alarm, light operated oscillator, light operated burglar alarm, variable frequency audio oscillator and much, much more. Runs on +3-12 volts.

## LED BLINKER \$ 2.95

Great attention getter with many applications. Alternates flashing of two LED's. Flashing rate is determined by two capacitors which can be changed to increase or decrease the rate of flashing. Runs off voltages up to 12 volts.

## BI-POLAR LED BLINKY KIT \$ 3.95

Another great attention getter. Same as #12 however, it uses 1 LED. The LED changes from red to green. Requires 3-12 volts DC.

## FM WIRELESS MIKE KIT \$ 5.95

The FM-2 is a small circuit used to transmit onto the FM band. Requires crystal to dynamic mike and 3-9 volts DC. Transmits 100 feet.

## DECISION MAKER \$ 5.95

A random flashing of two LED's. Red for no, green for yes. Requires 4-12 volts DC.

## ARKON LOGIC PROBE LOGIC 1 \$24.95

Easy to build Logic Probe Kit. A full performance logic probe. With it, the logic levels in a digital circuit translates into light from the Hi or Lo LED. Pulses as narrow as 300 nano seconds are stretched into blinks of the pulse LED's. Specs-300 Kohm imp. Power-30ma at 5 volts, 40ma at 15 volts, 15 volts max. Max. Speed - 300 nano seconds 1.5 MHZ. Input Protection - +50 volts DC continuous, 117 volts AC for 15 seconds (case included).

STK #	NAME	DATE	PRICE
17	Function generator	June 80	10.25
18	Light chaser	551 Feb. 79	3.75
19	Simple Sirobe	Oct. 78	3.25
20	Model train controller	541 Nov. 79	1.75
21	High performance pre-amp.	Dec. 79	9.25
22	Guitar practice amp.	452 Nov. 80	7.00
23	Dynamic noise filter	June 80	5.75
24	Audio feedback eliminator	486 May 78	6.25
25	Graphic equalizer	Oct. 77	12.25
26	Rumble filter	426 May 77	1.50
27	Tape noise eliminator	Dec. 80	1.50
28	Expander/compressor	Jan. 78	6.25

## SIREN KIT \$ 3.95

The siren kit will duplicate the sound of a police siren at a low volume (200 MW) or at a high volume (5 watts) depending upon construction. Closing of the pushbutton will produce the upward wail typical of a police siren, opening will cause the tone to fall downward. Requires 3-12 volts DC.

## LM380 AMP-SUPER SNOOP \$ 6.95

Many applications for this kit, intercom, mini P.A. system, telephone amplifier, room bug amplifier and more. Uses ceramic or crystal mike for input with 8 ohms output. Requires 9-20 volt DC for operation.

## CRYSTAL TIME BASE KIT \$ 6.95

The crystal time base kit provides a highly accurate source of 60 HZ which is useful for operating digital clocks when there is no source of 60 HZ power available.

## ELECTRONIC UNIVERSAL TIMER KITS \$ 5.95

The universal timer kit provides the basic parts required to provide a source of precision timing and pulse generation. The U.T. makes use of the versatile 555 timer IC which is capable of both astable and monostable operation. Supply is 5-15 volts DC.

## TONE DECODER KIT \$ 6.95

Can be used as a touch-tone decoder. Its frequency range is 500HZ to 100KHZ Bandwidth 2% to greater than 15% of center frequency. Output sink current 100ma. Requires 5-9 volts DC. Audio input level should be 50-100MV. Useful for touch-tone burst detection, or as a stable tone encoder.

## LED POWER METER \$24.95

Uses the popular LM3915 display driver. Features jumper selectable peak or average peak power level indication. The front end utilizes precision half wave rectification. LED displays included 30 db (-24 db to +3 db) dynamic range.

## LED VU/POWER METER \$29.95

Same as LED power meter but uses NSM series display. Please specify type. Two types: NSM 3915-30 db (-24 db to +3 db power) NSM 3916-23 db (-20 db to +3 db VU)

## KIT DISCOUNTS

10 kits one type 10% off  
25 or more one type 20% off

Prices on larger orders available upon request.

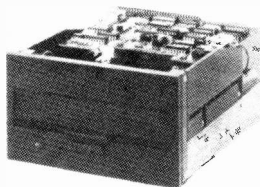

MPI's high performance mini floppy disk drive family includes single-sided double-density, and double-sided double density drives in both 48 and 96 TPI configurations. Unique features of the MPI drives are: • a patented stepper-band positioner • the industry's longest

carriage • proprietary clutch and diskette ejector mechanisms • electronics packaged on a single PCB • low power consumption.

**MODEL 51**  
250K-BYTE CAPACITY, SINGLE SIDED, DOUBLE DENSITY, 48 TPI \$399.95

**MODEL 52**  
500K-BYTE CAPACITY, DOUBLE SIDED, DOUBLE DENSITY, 48 TPI \$635.00

**MODEL 91**  
500K-BYTE CAPACITY, SINGLE SIDED, DOUBLE DENSITY, 96 TPI \$635.00

**MODEL 92**  
1 MEGABYTE CAPACITY, DOUBLE SIDED, DOUBLE DENSITY, 96 TPI \$822.00

## SIEMENS

**RUGGED AND RELIABLE!**  
Siemens 8" Drive FDD-100-8 \$625.00  
Single sided, single or double density  
Even better savings, 2 for \$1200.00

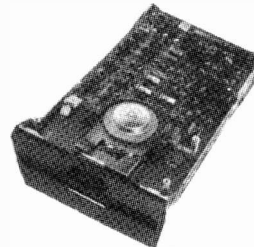

## DISKETTE DRIVE HEAD CLEANING KIT

With diskette drives, as with other pieces of data processing equipment, periodic maintenance and preventive care are necessary to assure efficient, smooth and error-free operation. Unlike other peripheral devices, the read/write head(s) on all diskette drives are extremely difficult to access without partially disassembling the drive. The unique design feature of the FD-08 allows a user of diskette equipment to safely, quickly and efficiently clean the drive head(s) without field engineering assistance. The cleaning diskette can be used for both single and dual sided drives.

FD-08 \$39.95 each kit For 8" drives  
FD-05 \$39.95 each kit For 5" drives

Send \$2.50 for Arkon Electronics 100 Page Catalogue or pick it up in our store when you're in our area. We have the largest computer and electronic hobbyist store in Canada. Add 6% postage.



Send Certified cheque, Mastercard, Visa, American Express . . . include expiry date, card number and signature. We process C.O.D.'s for Canpar or Canada Post. Minimum order \$10.00. Add 5% (minimum \$2.00) for shipping and handling. Ontario residents add 7% Sales Tax.

## ARKON ELECTRONICS LTD.

409 Queen St. West, Toronto, Ontario M5V 2A5  
(416-868-1315)

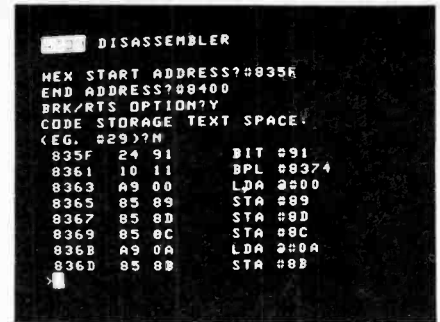
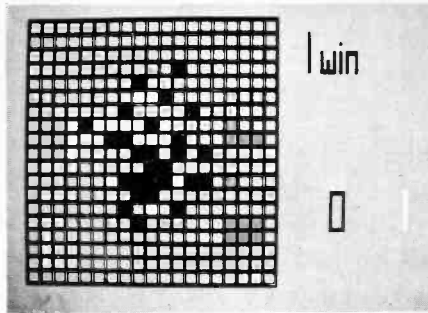
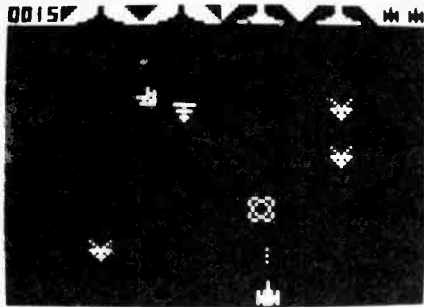

**Ports of Scrawl**

The graphics capability of the Atom is really hot. In its highest resolution mode, it can display a matrix of 256 by 192 pixels, or about the same resolution as an APPLE. It has all the handy BASIC graphics commands, like PLOT, MOVE and DRAW. Colour further enhances the permutations.

The Atom's I/O is quite respectable. There's a complete on board Centronics printer interface, a parallel port and even a built-in speaker. There is, of course, a cassette interface as well. This probably deserves some mention too, as it's a mite uncommon of design. Most cassette operating systems just fire the data onto the tape and leave it at that. The Atom system, however, puts it down in bursts, so that if there's a glitch in one section, the rest of the information will still be salvagable. This does make it a bit slower than most other COS systems, but there's a software upgrade which increases the 300 baud transfer rate up to 1200 baud, which more than compensates for the slight increase in tape longitude. Not for those of us who use Canadian Tire tapes on a spring driven recorder, though.

If the Atom sounds fairly mind blowing, what can hang off it should really do you. Chief among these

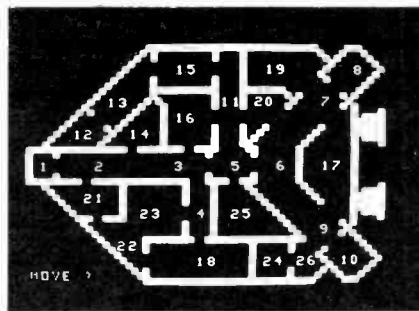
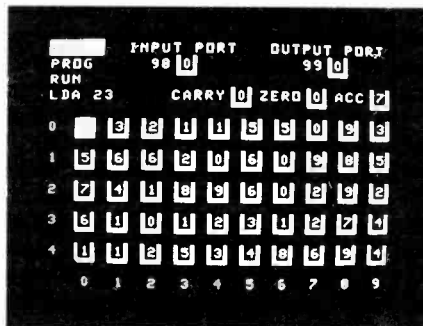
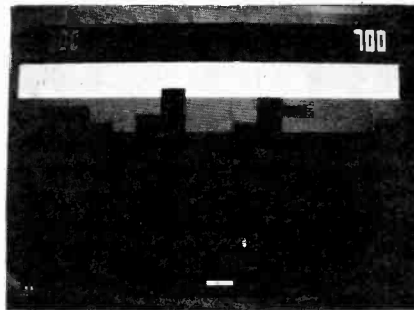

crowns of technology is something called Econet, an arrangement whereby multiple Atoms can be strung together to form... yes, of course... molecules. No, wait... better still, a computer network. One machine can view what's going on with any other machine, a master machine can feed several slaves, and central peripherals, like disks and printers, can be shared by all. The Econet system provides for all the data routing, bus management and time sharing functions.

The Acorn Atom, and all its little add-ons and bits, are made in Great Britian, by Torch Computers. It uses a standard 6502 processor. In fact, all the components are off the shelf, and all the chips socketed for easy repair.

Next month we're planning a complete scrutinization of the works and printings of the Atom. If you simply cannot wait 'til then, might we recommend your contacting Torch Computers' Canadian office, the details of which will be found on the back cover of this very issue.

Arrgh, Billy... 'ave ye ever been t' sea?

No, Captain Highliner.

Well, Billy, here let me program an ocean for ye...



If you liked this article, please circle Reader Service Card number 53. If you didn't, circle number 54.

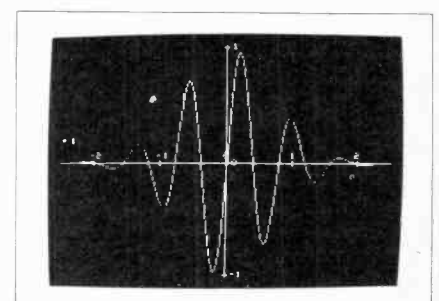
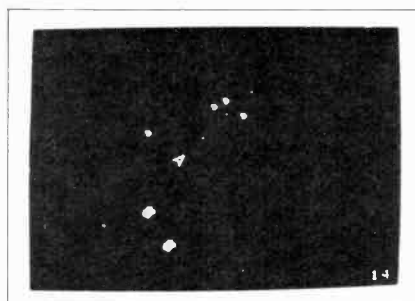
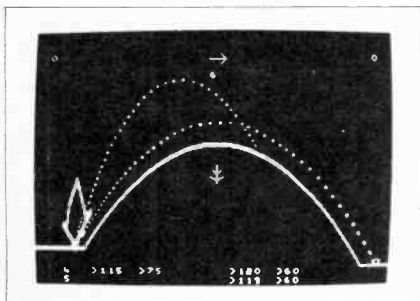



# INSTITUT SUPERIEUR D'ELECTRONIQUE INTERNATIONAL SCHOOL OF ELECTRONICS

Proudly Presents:

Correspondence Courses in Electronics and Programming with VIDEO TAPES Given in ENGLISH OR FRENCH.

Your course will be just like you are in a live classroom with your teacher. Learn with your TV and VIDEO TAPES. If you don't understand a lesson, just rewind your video tape and play your lesson again and again until you fully understand your course.

## ELECTRONICS

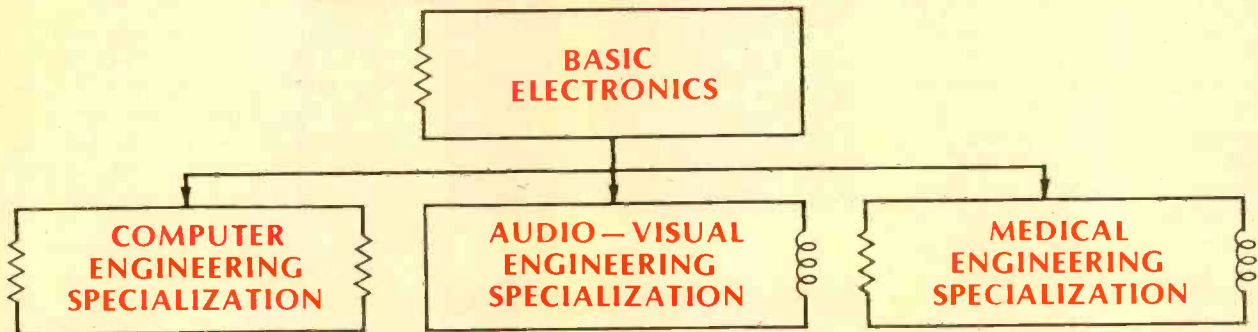

Upon completion of Basic Electronics you can choose one of the specializations mentioned above COMPUTER ENGINEERING, AUDIO VISUAL ENGINEERING, MEDICAL ELECTRONIC ENGINEERING. Included are three electronic instruments in kit form.

— Instruments and Computer Kit included with the course.

## PROGRAMMING

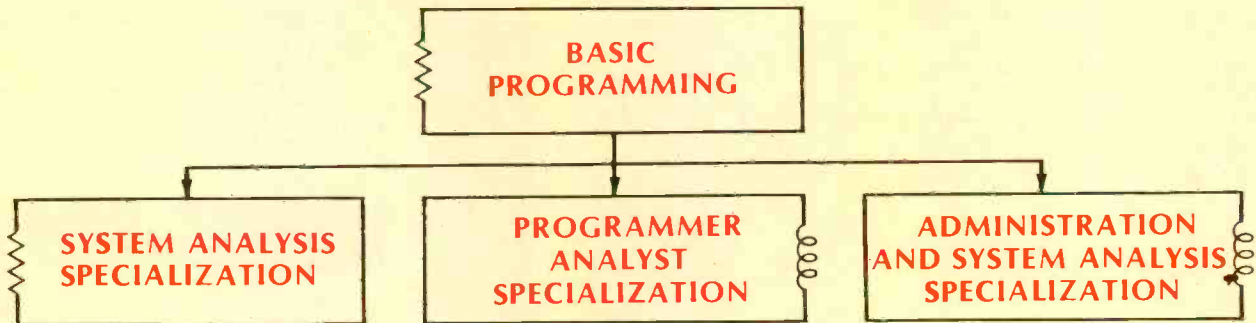

Upon completion of Basic Programming you can choose one of the specializations mentioned above: SYSTEM ANALYSIS, PROGRAMMER ANALYST, ADMINISTRATION AND SYSTEM ANALYSIS. A Microcomputer is included in the course.

**OTTAWA:** St. Patrick School  
290 Nepean Street  
Ottawa, Ont.  
K1R 5G2  
Phone: (613) 232-2647.

**MONTREAL:** 1435 Bleury,  
Suite 501  
Montreal, Que.  
H3A 2H7

### SEND FOR FREE BROCHURE

Send to: St. Patrick School, 290 Nepean Street,  
Ottawa, Ont., K1R 5G2

NAME \_\_\_\_\_

STREET \_\_\_\_\_ APT \_\_\_\_\_

CITY/TOWN \_\_\_\_\_ STATE/PROV. \_\_\_\_\_

POSTAL CODE \_\_\_\_\_ DATE \_\_\_\_\_

# SLR ELECTRONICS

THE POINT AND SHOOT' phenomenon was for many years associated with cheaper non-reflex cameras, designed to be idiotproof, with ease of film loading and exposure in mind. Now, however, most manufacturers have at least one automatic SLR (single lens reflex) model in their range.

The 35 mm SLR is the most popular and versatile camera type in use today. It's versatile, because a typical SLR offers a range of interchangeable lenses and matched add-ons — motor-drive, power winder, electronic flash, bulk film pack, databack, etc. Further, because the viewfinder shows the image seen through the lens, the effect of any lens can be seen immediately — the photographer sees what the film 'sees'.

## Meter Manual

In a manual TTL (through the lens) meter, light passes through the lens and is reflected by a mirror up to a prism at the top of the camera and out through the viewfinder eyepiece. Photocells mounted on the prism measure the brightness of the incoming light. Film speed and, typically, shutter speed are preset by the photographer. Adjusting the aperture of the lens causes a needle visible in the viewfinder to move towards a + (over exposure) or a - (under exposure). When the needle is central, the film will be exposed correctly when the shutter release is pressed.

However, this system cannot be used to operate an automatic system. It's easy to see why. You switch on the meter and compose your picture. The automatic meter selects the appropriate shutter speed (in an aperture priority system). When you press the shutter release, the mirror up, it is not seeing the view through the lens any more. The end result is a wrongly exposed film. The answer is to provide some means of storing or remembering the meter measurement during the exposure. One method involves the use of a capacitor to store the meter control voltage.

## Direct Measurement

The Olympus OM-2 uses TTL metering, but its SBS (Silicon Blue Cell) sensors face the film, and so they measure the light actually reaching the film emulsion during the exposure. This makes the memory device used in other cameras obsolete. The OM-2's system doesn't have to remember its light reading, because the reading is taken during the exposure itself. Its advantage is that it can compensate for changes in light levels after the beginning of the exposure. By eliminating a memory device power consumption is reduced.

Also, in flash photography, the sensors can follow the flash intensity as it increases in fractions of  $1/10,000$ S and cut off the camera's flash unit when the correct exposure is reached. Of course, a dedicated flash system is needed.

The humble 35 mm SLR camera has changed a great deal in recent years. Ian Graham investigates one aspect of electronics in photography, the development of camera electronics.



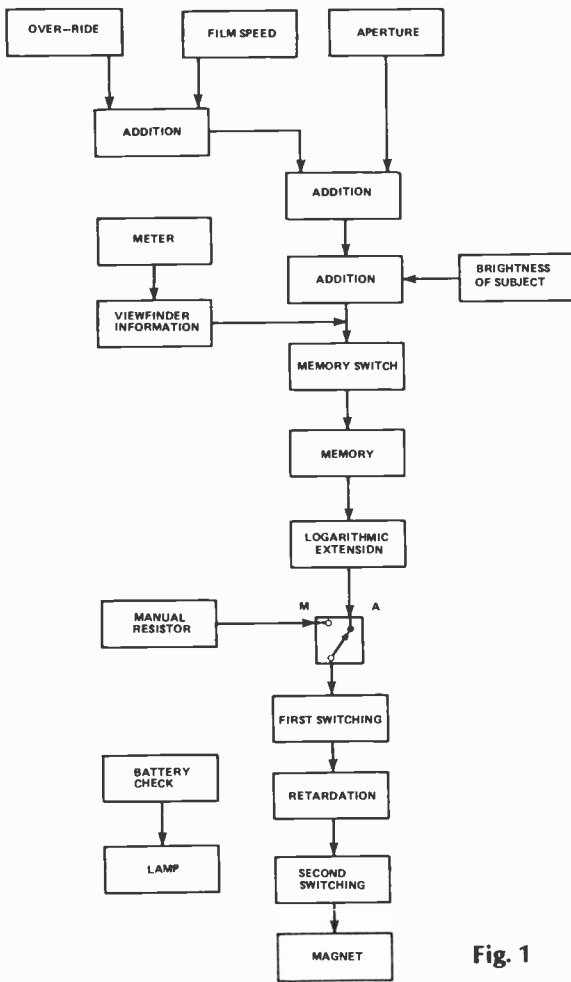

Fig. 1

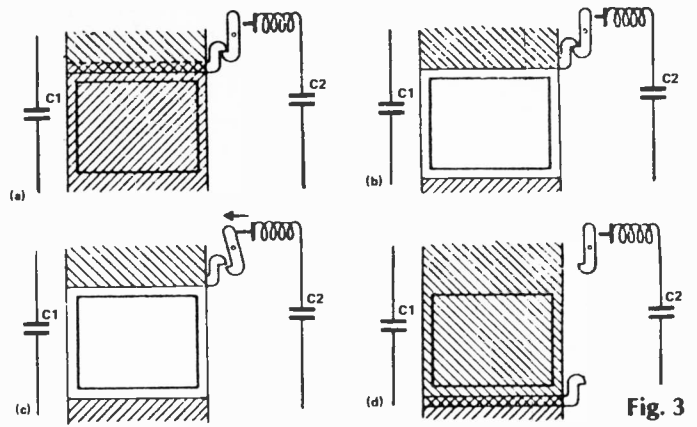

Fig. 3

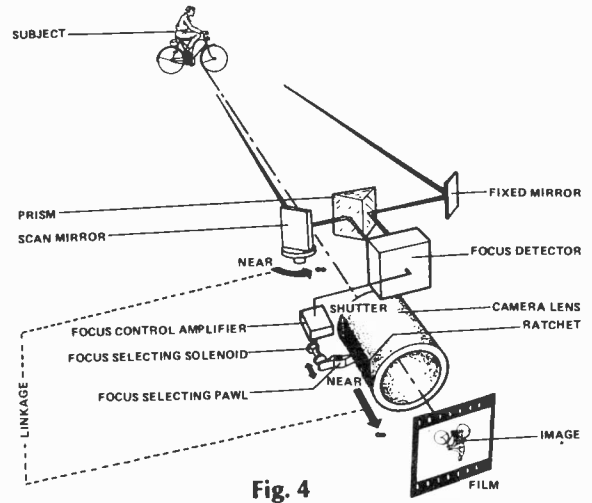

Fig. 4

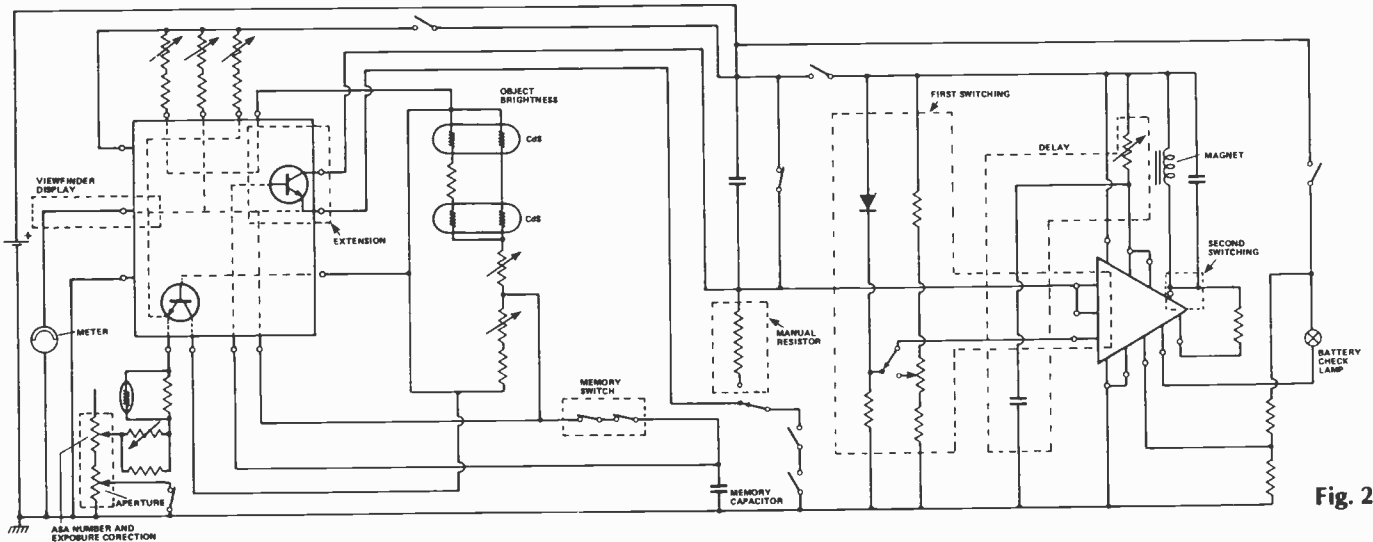

Fig. 2

Fig. 1 Block diagram of the manual/automatic exposure control employed by the Minolta XE-1.

Fig. 2 Circuit diagram of the exposure control system used by the Minolta XE-1.

Fig. 3 Mamiya's moving coil electronic shutter consumes a tenth the power of electromagnetic systems. In addition, the consumption remains constant whatever the shutter speed. Up to 100,000 exposures can be made with one 6V silver oxide cell. (a) The shutter is closed. The moving coil energising capacitor (C2) is normally charged. Current is not flowing. (b) The first blind moves, opening the shutter when the shutter release button is pressed. The exposure time control capacitor (C1) begins to charge. The latch holds back the second blind. The charge time of C1 is determined by the shutter speed.

(c) The instant of exposure. When C1 reaches a preset voltage, C2 discharges, energising the moving coil. This releases the second blind. (d) The second shutter blind moves, closing the shutter. C2 charges in a very short time, consuming very little power — ready for the next exposure.

Fig. 4 Konica developed the first self-focusing camera — the C35 AF. Light from the subject passes through two windows on the front of the camera on to two mirrors, one fixed and one moveable. When the shutter release is pressed, the moveable mirror turns until the two images coincide on the focus detector. A focusing control signal is then used to focus the lens correctly — all within 80 mS.



# MODE

## QUALITY KITS

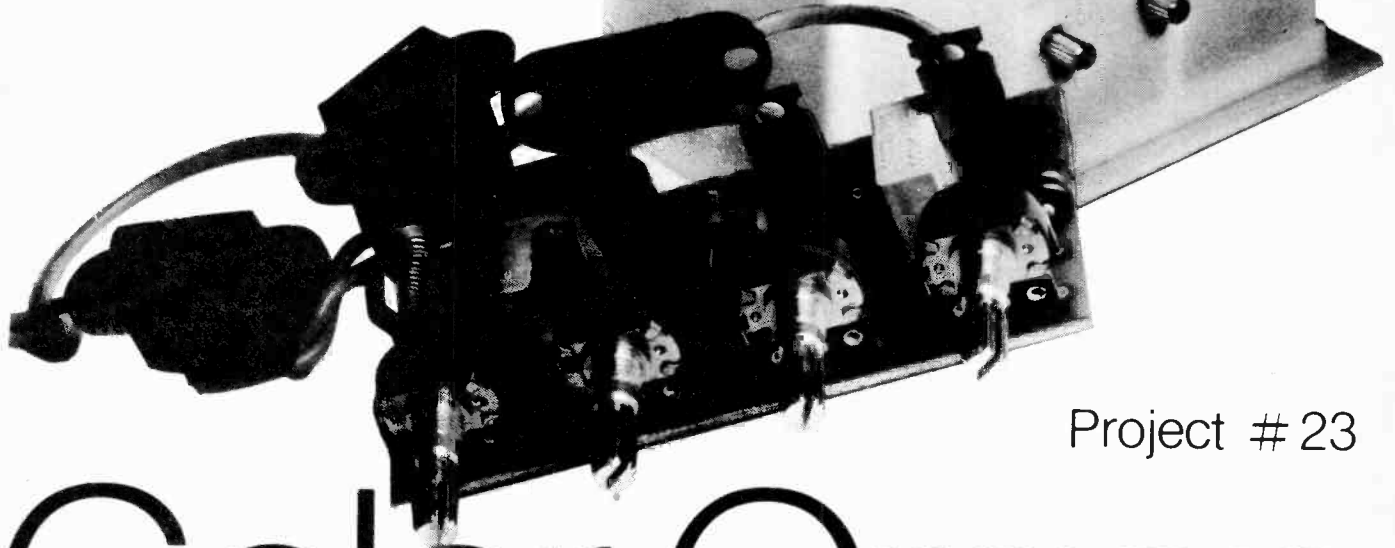

Project # 23

# Color Organ

The Mode Color Organ is an ideal project for the experimenter who is a musician or a serious audiophile. This project is a three channel color organ with a capacity of 200 watts per channel\*. It comes complete with the PC board and instructions and its high power capability makes it ideal for all kinds of lighting effects, either with spotlights or backlit lucite panels.

Remember, Mode projects come complete with electronic components of the exact value, so there's no need to substitute or hunt for specific capacitors, transistors or IC's.

Pick up a Mode Color Organ Kit at your nearest Mode dealer today and while you're there, check out our other Quality Kits.

### Mode kits for many useful and entertaining purposes.

1. Automatic Headlight Reminder
2. Battery Operated Fluorescent Light
3. Bug Shoo
4. Code Oscillator
5. Crystal Radio
7. Curiosity Box II
8. Dally Lighter
9. Decision Maker
10. Fish Caller

11. Hi Power 12V DC Flasher
12. Photo Electric Night Light
15. 0-20V Power Supply
16. Single Channel Color Organ
17. Electronic Siren
18. Shimmer Strobe Light
19. Tone Generator
20. 5 Transistor 1 Watt Amplifier
22. Xenon Strobe
23. 3 Channel Color Organ
24. Loudmouth Siren

25. Roulette Wheel
26. Electronic Sheet Game
27. Electronic Dice
28. Super Roulette
29. FM Mini Broadcaster
31. Electronic Shoot Out
32. Road Runner Sound Effects
33. Love-O-Meter
34. Soldering Iron Kit
35. Audio Power Watt Meter
36. Steady Hand Game
37. Decision Maker D.C.

# MODE

▶ ELECTRONICS

#### HEAD OFFICE

1777 ELLICE AVE. WINNIPEG, MANITOBA  
R3H 0W5 PH: (204) 786-3133

#### BRANCH LOCATION

88 HORNER AVE. TORONTO, ONTARIO  
M8Z 5Y3 PH: (416) 252-4838

Circle No. 16 on Reader Service Card.

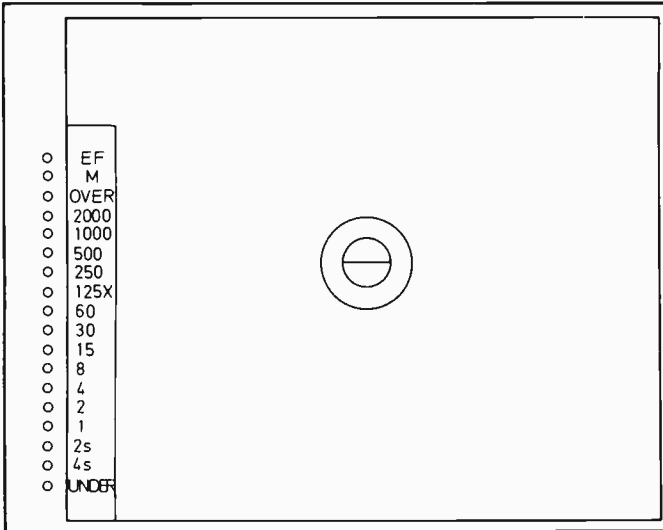

Fig. 5 The Pentax ME Super displays data by means of a three-colour line of LEDs. At 1/60S and above, the speed selected by the camera will turn on the appropriate green LED. If you see green, it's OK to shoot. If the camera selects 1/30S or below, the LED lit is yellow, warning you that, although the exposure is correct, there is a danger of blur due to camera shake. At each end of the scale there is a red LED to indicate under or over exposure. If exposure compensation is being used, a red EF LED comes on. Manual operation is similarly shown (green LED).

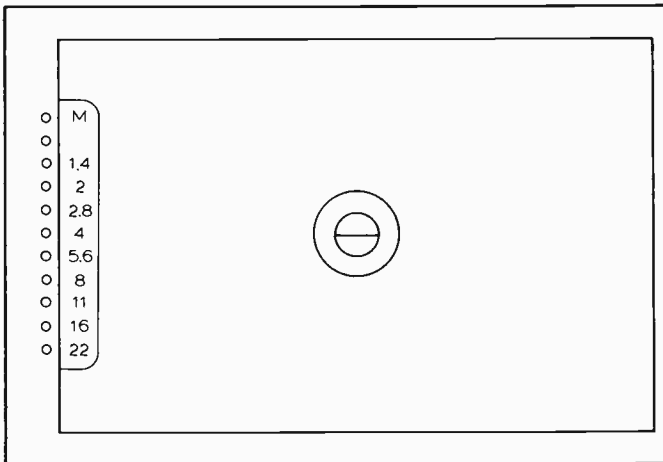

Fig. 6 The Konica FS-1 uses a simple all-red LED display to give details of aperture selected, under/over exposure, battery check, flash ready and manual mode.

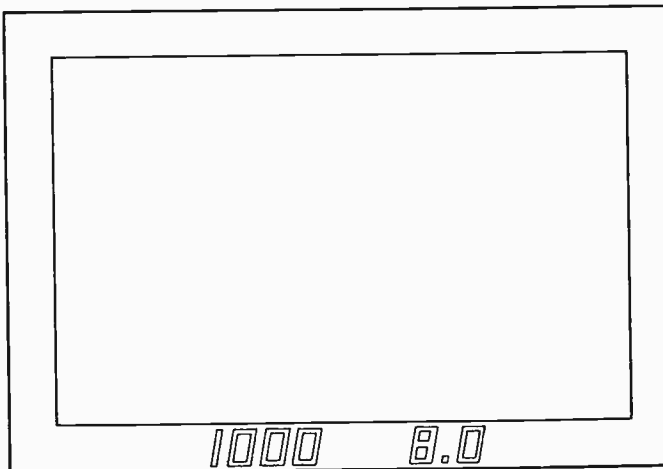

Fig. 7 The Canon A-1's alphanumeric LED display gives the photographer data on just about all the camera's functions — aperture, shutter speed, under/over exposure, flash ready, manual mode, B setting, out of range and operating error. There's even an automatic brightness control to match the display brightness to that of the image in the viewfinder.

The OM-2 manages to combine centre and average exposure weighting. At high shutter speeds (over 1/60S) the light level reading is taken from the shutter curtain. Its reflective coating pattern produces a centre-weighted reading. At lower speeds (below 1/15S) the measurement is made directly from the whole film surface.

**Logarithms**

The shutter speed settings follow the simple geometric progression 1S, 1/2S, 1/4S, . . . 1/250S, 1/500S, 1/1000S. If, for ease of calculation, we start with a meter circuit output of 0V1 and double it for each successive stop on the shutter speed dial, by the time we reach the last speed setting, the output voltage would be:

$$0V1 \times 2^{10} = 102V4$$

Because of the size, weight and expense of batteries, no camera can use a 100V supply.

The answer is logarithmic compression of the voltage steps, so the the maximum power requirement is given by:

$$0V1 \times 10 = 1V$$

In practice, most of the cameras available now derive their supply requirements from a single 6V silver oxide cell or two 1V5 silver oxide cells.

**Metering**

One exception is the Konica FS-1, powered by four alkaline-manganese penlight cells. However, the FS-1 is no ordinary camera. It looks much the same as any other, except for the lack of a wind-on lever. It doesn't need one — it has its own built-in power winder, yet the combination is smaller and much lighter than a conventional SLR plus add-on winder.

The four size AA cells power the winder and camera electronics. The obvious advantage is that the photographer need carry only one spare set of batteries. Normally camera and winder batteries are not interchangeable.

**Processing**

The FS-1 employs a digital CPU (Central Processing Unit) together with support ICs to take care of light measurement, exposure calculation and motor control to provide total electronic control. The tiny CPU manages to pack in more than 110 gates and 250 transistors, impossible to fit inside a camera just a few years ago.

Information from the Gallium Arsenide Phosphide photocell about the light level is compared with preset values for film speed and shutter speed to compute the appropriate aperture (f/stop). This analogue value is converted to a digital input for the f/stop register. The aperture information is also displayed in the viewfinder.

The Pentax ME Super has a wind-on lever, but no shutter speed dial. In manual mode, shutter speeds are selected by pressing one of two buttons on the top of the camera — one causes the shutter speed selected to increase one LED at a time, the other causes it to decrease, until the desired speed is reached.

*Continued on page 63*

## LAST CHANCE ACT NOW!



**\$55.50**

**1981 IC MASTER**  
Offer expires Jan. 31, 1982

### ACTIVE'S "ALL NEW" 1982 Catalogue Available

Write for a free copy

Name \_\_\_\_\_  
Address \_\_\_\_\_  
City \_\_\_\_\_  
Prov. \_\_\_\_\_ Postal Code \_\_\_\_\_

### TTL STANDARD AND LOW POWER SCHOTTKY

7400N	30	74165N	83	74LS125N	57
7401N	33	74166N	88	74LS126N	70
7402N	31	74170N	255	74LS132N	70
7403N	31	74172N	64	74LS133N	218
7404N	34	74173N	103	74LS135N	70
7405N	34	74174N	86	74LS136N	73
7406N	47	74175N	75	74LS139N	77
7407N	47	74176N	80	74LS145N	142
7408N	39	74178N	152	74LS147N	255
7409N	36	74179N	176	74LS148N	186
7410N	33	74180N	96	74LS149N	218
7412N	61	74182N	68	74LS153N	55
7413N	55	74184N	311	74LS155N	113
7414N	55	74185N	307	74LS156N	129
7416N	59	74190N	88	74LS157N	57
7417N	54	74191N	88	74LS158N	73
7420N	38	74192N	94	74LS159N	90
7421N	35	74193N	94	74LS161N	70
7422N	35	74194N	94	74LS162N	73
7423N	35	74195N	94	74LS163N	75
7425N	42	74196N	72	74LS165N	143
7426N	51	74198N	103	74LS164N	75
7427N	42	74197N	94	74LS165N	52
7428N	62	74198N	195	74LS166N	286
7430N	29	74199N	70	74LS170N	207
7432N	55	74221N	88	74LS173N	73
7433N	55	74226N	87	74LS174N	77
7437N	49	74243N	1.80	74LS175N	57
7438N	49	74251N	1.03	74LS176N	73
7440N	33	74259N	2.34	74LS189N	259
7442N	57	74273N	3.11	74LS190N	94
7443N	57	74274N	1.55	74LS191N	74
7446N	109	74278N	3.09	74LS192N	83
7447N	85	74279N	77	74LS193N	83
7450N	33	74280N	1.43	74LS194N	103
7451N	38	74293N	1.16	74LS299N	312
7453N	38	74298N	1.09	74LS197N	114
7454N	38	74300N	1.09	74LS198N	116
7472N	47	74365AN	90	74LS250N	180
7473N	49	74366N	90	74LS241N	198
7474N	47	74374N	90	74LS242N	177
7475N	55	74396N	75	74LS243N	177
7476N	55	74392N	125	74LS244N	239
7483AN	62	74393N	1.68	74LS245N	239
7484AN	177	7485N	86	74LS246N	142
7486N	51	74LS01N	29	74LS249N	143
7490AN	55	74LS02N	29	74LS251N	01
7491AN	57	74LS03N	29	74LS252N	01
7492AN	49	74LS04N	35	74LS257N	116
7493AN	49	74LS05N	35	74LS258N	73
7494AN	86	74LS06N	29	74LS259N	186
7495AN	70	74LS07N	36	74LS260N	163
7496N	77	7497N	2.46	74LS111N	36
7497N	2.46	74LS112N	31	74LS275N	610
74100N	2.03	74LS121N	31	74LS279N	82
74104N	83	74LS131N	47	74LS280N	57
74107AN	57	74LS141N	66	74LS281N	57
74109N	57	74LS20N	29	74LS283N	155
74110N	58	74LS21N	36	74LS290N	94
74111N	94	74LS26N	65	74LS293N	215
74116N	179	74LS27N	38	74LS296N	114
74120N	1.79	74LS30N	23	74LS299N	376
74121N	62	74LS32N	47	74LS300N	358
74122N	70	74LS37N	38	74LS322N	644
74123N	62	74LS38N	38	74LS323N	644
74125N	90	74LS42N	62	74LS324N	707
74126AN	62	74LS47N	68	74LS324N	423
74128N	63	74LS48N	129	74LS348N	345
74132N	59	74LS51N	31	74LS352N	189
74136N	68	74LS54N	42	74LS353N	215
74141N	109	74LS55N	31	74LS362N	1294
74142N	42	74LS73N	47	74LS365N	68
74143N	493	74LS74N	47	74LS366N	68
74144N	493	74LS75N	47	74LS367N	109
74145N	87	74LS76N	55	74LS368N	68
74147N	172	74148N	1.16	74LS373N	213
74148N	1.16	74LS83N	90	74LS374N	213
74150N	187	74LS85N	109	74LS375N	83
74151N	57	74LS86N	47	74LS377N	183
74153N	49	74LS90N	51	74LS378N	129
74154N	187	74LS91N	116	74LS379N	142
74155N	62	74LS92N	62	74LS380N	127
74157N	68	74LS93N	51	74LS393N	136
74159N	198	74LS95N	62	74LS395N	155
74160N	62	74161AN	83	74LS447N	48
74162N	83	74LS107N	55	74LS460N	246
74163AN	83	74LS109N	62	74LS603N	110
74164AN	83	74LS121N	67	74LS609N	109
74164AN	83	74LS122AN	69	74LS676N	215

### CMOS

CD4001BE	29	CD4075BE	38
CD4002BE	23	CD4076BE	78
CD4006BE	77	CD4078BE	36
CD4007BE	74	CD4088BE	220
CD4008BE	31	CD4108BE	220
CD4009BE	51	CD4511BE	77
CD4010BE	51	CD4512BE	94
CD4011BE	29	CD4514BE	218
CD4012BE	23	CD4515BE	218
CD4013BE	43	CD4516BE	97
CD4014BE	73	CD4519BE	68
CD4015BE	73	CD4520BE	73
CD4017BE	42	CD4522BE	101
CD4017BE	42	CD4522BE	101
CD4018BE	68	CD4527BE	207
CD4019BE	62	CD4528BE	94
CD4020BE	88	CD4531BE	109
CD4021BE	74	CD4532BE	109
CD4022BE	103	CD4533BE	77
CD4023BE	25	CD4543BE	187
CD4024BE	57	CD4553BE	376
CD4025BE	26	CD4555BE	75
CD4026BE	188	CD4556BE	75
CD4027BE	55	CD4581BE	246
CD4028BE	70	CD4582BE	90
CD4029BE	90	CD4584BE	51
CD4030BE	90	CD4585BE	103
CD4033BE	217	CD4702BE	135
CD4034BE	317	CD4081BE	32
CD4035BE	69	CD4082BE	25
CD4040BE	90	CD4085BE	61
CD4041BE	116	CD4086BE	77
CD4042BE	70	CD4093BE	73
CD4043BE	70	CD4099BE	207
CD4044BE	68	CD4104BE	327
CD4045BE	103	40099TIC	108
CD4047BE	94	40098PC	126
CD4049BE	49	74C00N	53
CD4050BE	42	74C14N	36
CD4051BE	103	74C20N	95
CD4052BE	103	74C27N	52
CD4053BE	103	74C85N	162
CD4060BE	116	74C107N	45
CD4066BE	70	74C161N	181
CD4067BE	31	74C163N	181
CD4069BE	32	74C173N	199
CD4070BE	38	74C175N	135
CD4071BE	38	74C192N	182
CD4072BE	36	74C193N	172
CD4073BE	36		

### Bi-Fet OP AMPS

TL061CP	Low Power	94
TL062CP	Dual Low Power	1.43
TL064CN	Quad Low Power	2.53
TL071CP	Low Noise	7.20
TL072CP	Dual Low Noise	1.25
TL074CN	Quad Low Noise	2.46
TL081CP	J-Fet Input	55
TL082CP	Dual J-Fet Input	1.10
TL084CN	Quad J-Fet Input	2.07
TL495CN	Switch Volt. Reg. 25mA	5.03
TL497AC	Switch Volt. Reg. 500mA	2.86
TL430CPL	Adj. Shunt Volt. Reg.	1.25
TL431CPL	Adj. Pos. Volt. Reg.	1.25

### VOLTAGE REGULATORS

78XXKUC	1 AMP TO-220 Package	1.01
78XXKUC	1 AMP TO-3 Package	2.20
78LXXAAX	100 MA TO-92 Package	.47
NEGATIVE		
79XXKUC	1 AMP TO-220 Package	1.16
79XXKUC	1 AMP TO-3 Package	2.20
Available voltages 5, 6, 8, 12, 15, 18 & 24		

### "H" PATTERN

85H48WEDP	Epoxy glass composite, 4.8" x 1/16"	\$4.95
170H48WEDP	Epoxy glass, 4.8" x 1/16"	\$8.95

### "G" PATTERN

42G24ELDP	Epoxy glass composite, 4.8" x 8.5" x 1/16"	\$4.95
85G24ELDP	Epoxy glass composite, 4.5" x 17" x 1/16"	\$9.95

### COPPER CLAD BOARD FOR ETCHED CIRCUITS

42G22WEC1DP	4.5" x 8.5" x 1/16" epoxy glass composite, copper 1 side	\$4.40
64P44-062EPC1DP	4.5" x 6.5" x 1/16" epoxy paper, copper 1 side	\$2.95
101P44CDP	4.5" x 10.1" x 1/16" phenolic, 1 oz. copper 2 sides, "P" pattern except 1" unpunched on width to allow etching connector fingers	\$3.10

### SHIFT REGISTERS

1404A	TO-5 Single 1024 bit	\$3.87
3341APC	FIFO 10MHz	\$5.79
3342PC	64 bit	\$5.14
3347PC	80 bit	\$4.49

### Microprocessor Chip Sets

6800 FAMILY	6500 FAMILY	8080 FAMILY					
6800 CPU	7.35	6502 CPU	9.04	8035 CPU	9.43	8224	4.47
6802 CPU	11.25	6504 CPU	9.69	8039 CPU	10.34	8226	3.04
6808 CPU	10.99	6505 CPU	9.69	8080A CPU	6.44	8228	6.46
6809 CPU	25.94	6509 CPU	9.69	8085 CPU	10.34	8251	7.74
6810	3.45	6520	7.09	8155	11.70	8253	10.99
6821	3.45	6522	10.21	8748	46.80	8255	7.74
6845	35.69	6522	14.11	8755	41.60	8257	10.99
6850	3.84	6532	14.11	8212	2.93	8259	10.99
6852	7.48	6551	15.15	8214	5.53	8279	12.81
				8216	2.57		

### SCR'S and TRIAC'S

TIC106D	SCR	5 amp	400V	TO-202	.51
TIC47	SCR	0.6 amp	200V	TO-92	.77
TIC116B	SCR	8 amp	200V	TO-220	1.38
TIC116C	SCR	8 amp	400V	TO-220	1.55
TIC126B	SCR	12 amp	200V	TO-220	1.53
TIC126D	SCR	12 amp	400V	TO-220	1.92
TIC216B	Triac	6 amp	200V	TO-220	1.46
TIC226D	Triac	6 amp	400V	TO-220	1.22
TIC260D	Triac	8 amp	400V	TO-220	1.63
TIC236D	Triac	12 amp	400V	TO-220	1.49
TIC246D	Triac	16 amp	400V	TO-220	2.08
2N1595	SCR	1 amp	50V	TO-220	.84
2N6401	SCR	16 amp	100V	TO-220	1.46

### PLASTIC POWER TRANSISTORS

TIP29B	.60	TIP41C	1.01	TIP125	.95
TIP29C	.65	TIP42B	1.01	TIP126	1.21
TIP30B	.64	TIP42C	1.09	TIP127	1.12
TIP30C	.69	TIP110	.86	TIP140	2.20
TIP31A	.64	TIP111	.91	TIP141	2.52
TIP31B	.66	TIP112	1.01	TIP142	3.00
TIP31C	.70	TIP115	.86	TIP145	2.70
TIP32A	.65	TIP116	.95	TIP146	2.87
TIP32B	.71	TIP117	1.04	TIP147	3.41
TIP32C	.77	TIP120	.85	TIP2955	1.21
TIP41A	.86	TIP121	.95	TIP3055	1.10
TIP41B	.95	TIP122	1.01		

### BRIDGE RECTIFIERS

1.5 AMPS, 25°C TEMP. AT 50A SOURCE		
Volts	Part No.	Price
200	W02M	

EACH KIT \$1.99 —  
ALL NEW MATERIAL  
MONEY-BACK GUARANTEE  
MAIL ORDER ONLY  
ADD \$2 PER ORDER TO COVER  
POSTAGE & HANDLING

**SURPLUS  
ELECTRO  
QUEBEC**  
2264 Montee Gagnon  
Blainville, P.Q.  
J7E 4H5

KIT 1000 - APPROX. 1000 PCS  
VALUE OVER \$100... FOR \$10!  
TRANSISTOR  
RELAY, DIODE  
RESISTOR  
CAPACITOR  
HARDWARE... ETC...



# NEED MORE INFORMATION?

If you would like more information on the products or services mentioned in the advertisements:

1. Fill in the attached card with your name, address, etc.
2. Circle the appropriate Reader Service number for further information about advertised products.
3. Mail the card and the advertiser will send you literature free of charge. If the card has been removed, or if you want the information in a hurry, phone or write direct to the advertiser and refer to the ETI issue and page number.

Your Company Classification (if applicable):

- A. Manufacturer
- B. Retailer
- C. Government
- D. R&D
- E. Servicer/Installer
- F. Distributor/Representative
- G. Educational Institution

In the field of:

1. Computer and Related Equipment
2. Communications Equipment & Systems
3. Navigation, guidance or Control Systems
4. Test & Measurement Equipment
5. Consumer Products
6. Industrial Controls & Equipment
7. Components & Subassemblies
8. Other (Please specify on the card)

Your major job function (if applicable):

- A. Buying
- B. Technologist
- C. Educator
- D. Not employed in an electronics-related field
- E. Engineering
- F. Technician
- G. Management
- H. Sales
- I. Other (Please specify on the card)

What interests you most about ETI?  
(your favourite five or less):

- A. Audio
- B. Video
- C. Ham Radio
- D. Shortwave Listening
- E. Servicing
- F. Components & Technology
- G. Reports on the Electronic Industry
- H. Microcomputers
- J. Projects
- K. News Digest
- L. Other (Please specify on the card)
- M. Tech Tips

 DVR MICA 1 to 3000 PF 82-1: 20 Asst'd	 CERAMIC CAPACITOR 1 to 5000 PF 82-2: 50 Asst'd	 DIPPED TANTALUM 1 to 100 UF 15 to 35V 82-3: 10 Asst'd	 SILVER MICA METALLIC CAP. 7 to 1000 PF 350 V 82-4: 10 Asst'd	 FEED-THRU CAP. 10 to 1000 PF 82-5: 20 Asst'd	 TRIMMER CAP. 82-6: 10 Asst'd
 VARIABLE CAPACITOR 0.01UF 100V .25% 82-7: 5 Asst'd	 PRECISION CAPACITOR 0.01UF 100V .25% 82-8: 20 per kit	 MYLAR CAPACITOR 0.01 to 1 UF 82-9: 20 Asst'd	 ELECTROLYTIC CAPACITOR 10 to 2000 UF 82-10: 10 Asst'd	 TANTALUM CAPACITOR 1 to 100 UF 82-11: 10 Asst'd	 82-12 MINIMUM OF 200 COMPONENTS ON P.C.B.s.
 RESISTOR 5-7-10-20W 82-13: 20 Asst'd	 VARIABLE RESISTOR 20 ohms to 5 Meg 82-14: 10 Asst'd	 VARIABLE MINIATURE 1 to 500K 82-15: 20 Asst'd	 Asst'd RESISTORS 82-16: 4W 200X 82-17: 1W 200X 82-18: 1W 100X 82-19: 2W 50X	 NPN - PNP TRANSISTORS 82-20: 20 Asst'd	 DIODE, ZENER THERMISTOR RECTIFIER 82-21: 20 Asst'd
 INTEGRATED CIRCUITS 82-22: 10 Asst'd	 TRANSFORMER & CHOKE 82-23: 4 Asst'd	 PLUG & SOCKET 4 to 20 contacts 82-24: 2 pairs	 R.F. COILS FIXED 82-25A: 50 Asst'd 82-25B: 50 Asst'd	 TRANSISTOR HEATSINK 82-26: 20 Asst'd	 TUBE SOCKET 82-27: 20 Asst'd
 MIKE HANGER 82-28: 5 Asst'd	 ONE FILTER 82-29: 455 KHZ 82-30: 10.7 MHZ	 SWITCHES 82-31: 5 Asst'd	 AIR COIL c/w CLIPS 82-32: 4 Asst'd	 12V LIGHT & SOCKET 82-33: 5 sets	 CHASSIS INSULATOR 82-34: 4 Asst'd
 R.F. CONNECTOR 82-35: PL-259 82-36: 50-239 4 per kit	 TERMINAL 2 to 12 term 82-37: 4 Asst'd	 CRYSTALS 82-38: 10 Asst'd	 82-39 GROMMET 82-40 PLUG BUTTON 50 per kit	 ONE ADJ. SWITCH 82-41: 1P. 12POS. 82-42: 2P. 6POS. 82-43: 3P. 4POS. 82-44: 4P. 3POS.	 P.C.B. TERMINALS 82-45: 50 Asst'd
 MALE & FEMALE PHONO CONNECTOR 82-46: 10 pairs	 POWER TRANSISTOR INSULATOR 82-47: 25 Asst'd	 FUSE HOLDER KIT 82-48: one box 82-49: 10 sets	 3 to 2" THREADED SPACER 82-50: 25 Asst'd METAL SPACER 82-51: 50 Asst'd	 TERMINAL 2 to 8 LUGS 82-52: STANDARD 82-53: MINI 50 per kit	
 WASHER 82-54: FLAT 82-55: LOCK 200 Asst'd	 NUTS GR. QTY 82-56: #10 100x 82-57: # 8 150x 82-58: # 6 175x 82-59: # 4 200x	 VOL. CONTROL NUT 82-60: 3/8" 82-61: 15/32" 50 per kit	 SOLDER 60/40 82-62: 2 X 10'	 Asst. BOLTS 1-14" 82-63: #4 200x 82-64: #6 150x 82-65: #8 100x 82-66: #10 50x	 HOOK UP WIRE 32-67: #1G 100' 82-68: #20 100' 82-69: #22 100' 82-70: #24 100' 82-71: #26 100'
 HARDWARE 82-72: 300 pcs	 TERMINALS REGULAR & INSULATED 82-73: 100 Asst.	 GROUND TERMINALS 82-74: 200 Asst.	 METAL KNOBS FOR 1/8" SHAFT c/w set screw 82-75: 10 Asst'd	 COAX RELAY 82-76 One per kit	 FUSE 82-77: 25 Asst'd
 LOT OF SPAGHETTI SLEAVING 82-78	 RUBBER FEET 82-79: 25 Asst'd	 RELAY 82-80: 2 Asst'd	 4" SPEAKER 82-81: 2 Asst'd	 TOROID CORE 82-82: 10 Asst'd	 LEVER SWITCH 82-83: 2 Asst'd

### ATTENTION DISTRIBUTORS!

Now available in Canada, the famous line of LORLIN switches imported directly from England at a more than competitive price. Free sample on request.

Inexpensive single wafer rotary switch.  
Moulded construction. Adjustable stop.

**DISTRIBUTED IN CANADA BY SURPLUS ELECTRO QUEBEC**  
2264 Montee Gagnon, Blainville, Quebec, Canada J7E 4H5

#### ELECTRICAL AND MECHANICAL SPECIFICATIONS:

Maximum working voltage: 300V =  
Proof voltage: 1,000V  
Current carrying capacity: 5A  
Contact rating: 150mA 250V =  
Insulation resistance: > 25,000MΩ  
Contact resistance: < 50mΩ

Contacts: Silver plated brass ensures a life  
> 10,000 cycles  
Indexing: 30°  
Material: Glass filled nylon  
Stops: Adjustable 2-12 or fully rotating

(N.B.: SHORTING TYPE AND METRIC  
SIZE AVAILABLE ON REQUEST.)

TYPES AVAILABLE, NON-SHORTING TYPE	QTY	PRICE
CK-1024 1 POLE 2-12 POSITIONS ADJUSTABLE	1 - 24	\$2.00 ea.
CK-1025 2 POLE 2-6 POSITIONS ADJUSTABLE	25 - 99	\$1.75 ea.
CK-1026 3 POLE 2-4 POSITIONS ADJUSTABLE	100-499	\$1.50 ea.
CK-1027 4 POLE 2-3 POSITIONS ADJUSTABLE	500 or more	\$1.25 ea.

Circle No. 12 on Reader Service Card.

# next month

## 50 Circuits

Next month, we'll be presenting fifty circuits to explore, build, impress your friends with, and, ultimately, connect the batteries in backwards to and smoke irreparably. What fun!

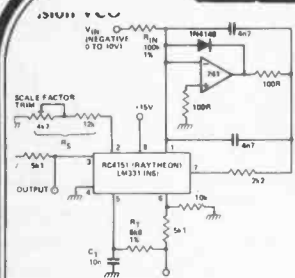

$$f = \frac{1}{2\pi C_2} \left[ \frac{1}{R_1} + \frac{1}{R_2} + \frac{1}{R_3} + \frac{1}{R_4} \right]$$

Minimum frequency = 10 kHz  
 stability = 0.05%  
 response time = 10 us  
 amp powered from a 15 V

### Triangle/Square Wave Oscillator

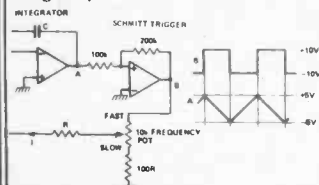

Output frequency  $f = \frac{1}{2RC} \ln \frac{R_B}{R_A}$   
 Full fraction can be 1/1 to 1/100, giving a 100 to 1 range from the pot  
 Variable frequency range = 8.01 Hz to 50 kHz  
 Run op-amps from a 12 V

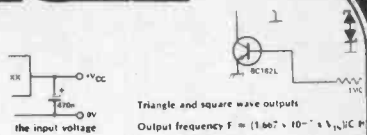

Triangle and square wave outputs  
 Output frequency  $f = (1.867 \times 10^{-4}) \times V_{IN} / RC$   
 If  $C = 1n0$  and  $V_{IN} = 10V$ , then  $f = 1.867 kHz$   
 Changing both R's from 100k to 10k will increase frequency by 100x  
 For low frequencies use TL081 op-amps  
 Frequency range 0.1 Hz to 10 kHz

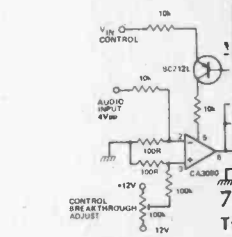
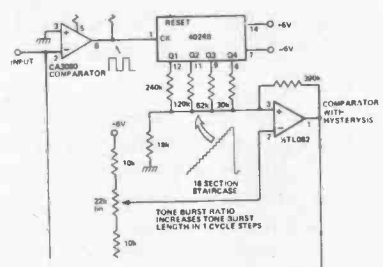
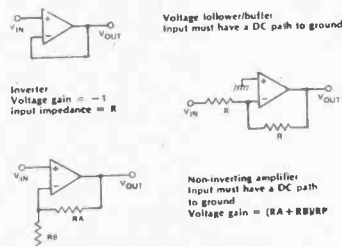

## dbx

While not as well known as the Dolby noise reduction system, many studio engineers regard the dbx headroom expanders as the better way to go. Even better than headroom expanding drugs.

### 8 Variable Length Tone Burs

Input is a sine wave or any other periodic wave  
 a 2 V, maximum frequency 100 kHz  
 Output is a tone burst variable from one cycle on, one cycle off  
 All devices powered from a 6 V

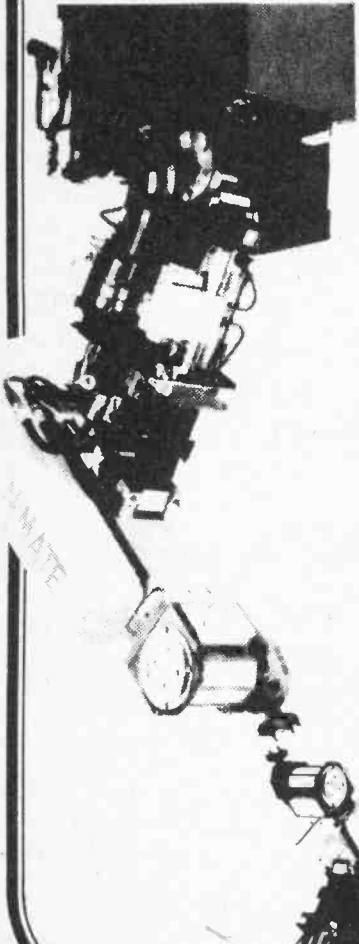

## Industrial Robots

They weld, they paint, they lift heavy stuff, and they never complain or go on strike. Certainly not human, you say? Of course not, they're robots, and they're changing the manufacturing world.

## Flash Sequencer

Create unusual pictures with this exciting photographic accessory. Not as much fun as a nude model, but easier to get into the magazine. We'll replace it with a model if we figure a way around the stapling problem by next issue.

## Sound Bender

At last! A guitar effect that hasn't been used by the Police. . . yet. Get your copy of the January issue as early as you can, though. Those guys are fast.



## Enlarger Timer

An electronic circuit which more accurate than even the renoun 'one Mississippi, two Mississippi. . . ' method, as well as being a great deal more Canadian. Next time.

# FEBRUARY IN ETI

# MICROPOWER CIRCUITS

Ray Marston looks at some unique micropower monitor and oscillator circuits which give years of continuous operation from a battery supply.

ANALOGUE ALARM-TYPE MONITOR circuits have a variety of practical applications in the home and in industry. Such sound or voltage levels and activate an alarm or relay when preset levels are exceeded. The trouble is, such circuits almost invariably draw fairly high quiescent currents and have to be line powered, since they would otherwise flatten a supply battery after only a day or two of continuous operation. In this article we'll look at ways of designing micropower versions of such monitors, which will give years of continuous operation from a single supply battery.

## Conventional Checking

Fig. 1 shows the circuit of a conventional precision temperature monitor, which operates a relay when the temperature of TH1 rises above a value preset by PR1. Here, R1 and R2 are wired as one half of a Wheatstone bridge and apply a fixed reference voltage to the non-inverting terminal of voltage comparator IC1; NTC thermistor TH1 and PR1 are wired as the other half of the bridge and feed a temperature-dependent voltage (which falls with increasing temperature) to the inverting terminal of the comparator. In use, PR1 is adjusted so that the bridge is very slightly unbalanced at the desired alarm temperature, thus driving the output of IC1 high when the temperature reaches or exceeds the preset level and actuating the relay via VFET Q1. Note that the action of this circuit can be reversed, so that it acts as a precision under-temperature switch or monitor, by simply transposing the positions of TH1 and PR1.

An outstanding advantage of the Fig. 1 circuit is that, because TH1-PR1-R1-R2 are bridge-configured, the trip point of the circuit is not influenced by variations in the supply voltage, and the design thus gives true 'precision' operation. A major disadvantage of the circuit is that it draws a quiescent current of about 5 mA and will flatten a 9V battery after less than two days of continuous operation. In actual fact, however, the circuit does not (logically) need to be continuously powered, for the following reason.

## Micropower Sampling Techniques

The Fig. 1 circuit monitors the temperature continuously and thus draws continuous power. In reality, however, temperature is a slowly varying parameter and thus does not need to be monitored continuously; instead, it can be efficiently monitored by briefly inspecting or sampling it only once every second or so. If the sample periods are very brief (say 300  $\mu$ s) relative to the sampling interval (1 s) the mean current consumption of the monitor can be reduced by a factor equal to the interval/period ratio (eg a factor of 3300) by using the sampl-

ing technique; for example, the 5 mA consumption of the Fig. 1 circuit can be reduced to a mean value of a mere 1.6  $\mu$ A. The sampling technique thus enables micropower monitor designs to be implemented.

Fig. 2 shows the basic circuit of a micropower or sampling version of the precision temperature monitor, which operates the relay when the TH1 temperature rises above a preset value but which draws a mean quiescent current of only a few microamps. The TH1-PR1-R1-R2-IC1 monitor network is almost identical to that of Fig. 1, but instead of being continuously powered it is powered by a sample pulse generator and Q1. Note that the output of IC1 is fed to temporary memory store R4-C1 via D1, and that the memory store operates the relay via VFET Q2.

Thus, if the TH1 temperature is below the trip level when the sample pulse arrives, IC1 output will remain low and no charge will be fed to C1, so Q2 and the relay will be off. If the TH1 temperature is above the trip level when the sample pulse arrives the IC1 output will switch high for the duration of the pulse and thus rapidly charge C1 up via D1, driving the relay on via Q2; the C1 charge will then easily hold the relay on until the arrival of the next sample pulse.

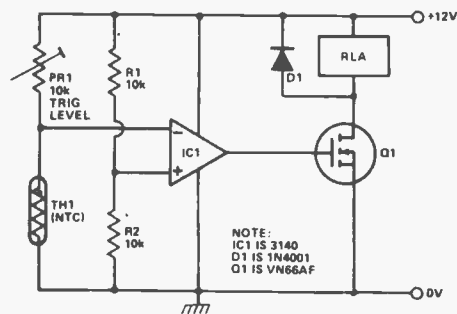

Fig. 1 this over-temperature alarm consumes a quiescent current of about 5 mA and will flatten a PP9 battery in under two days.

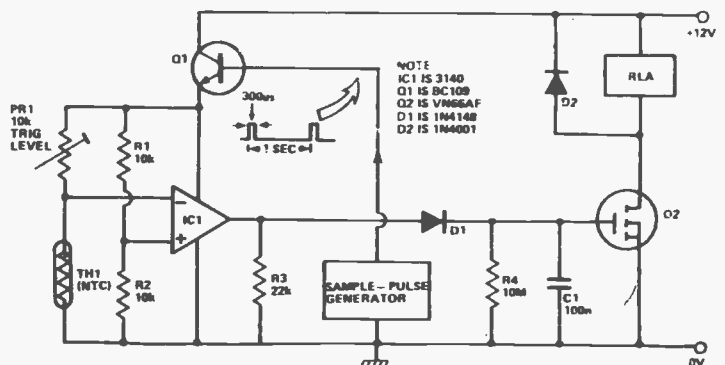

Fig. 2 This micropower or sampling version of the circuit consumes a mean quiescent current of only a few microamps and gives years of operation from a PP9.

The Fig. 2 circuit, then, illustrates the basic principles of the micropower sampling technique. In reality, the sampling interval used (and thus the reduction in mean power consumption) will depend on the specific application. If, for example, you wish to monitor the temperature of a large vat, which has massive thermal inertia, you can happily use sampling intervals of several minutes and thus run the monitor with only nanoamps of current. If, on the other hand, you wish to monitor transient changes in light or sound levels with minimum durations of 100 ms, you may have to use a 50 ms sampling interval and a 1 ms sample pulse, in which case the mean current consumption of your circuit will be reduced by a factor of 'only' 50!

In some cases you may have to slightly modify the operating principle of the sampling circuitry to obtain the desired micropower operation. Fig. 3, for example, shows the basic circuit of a micropower 5 kHz tone-signal monitor which consumes a quiescent current of under 10  $\mu$ A and in which the monitored tone signals have minimum durations of 250 ms. Thus, the sample pulse generator is designed to produce a minimum pulse width of 200  $\mu$ s so that it can 'capture' at least one full 5 kHz tone cycle, and the sampling interval is set at 200 ms so that part of a tone burst will always be captured. The sampling circuitry thus gives a 100:1 reduction in monitor current consumption. The Fig. 3 circuit is designed to produce a high output when it receives a tone burst that is greater than a preset amplitude and duration, and operates as follows.

A crystal microphone is used to monitor the tone signals and has its output fed to the input of variable-gain amplifier IC1; this IC is a CA3140 op-amp and its input terminal is grounded by R1-R2, so it produces an

Fig. 3 This micropower 5 kHz tone-signal monitor consumes less than 10  $\mu$ A of stand-by current.

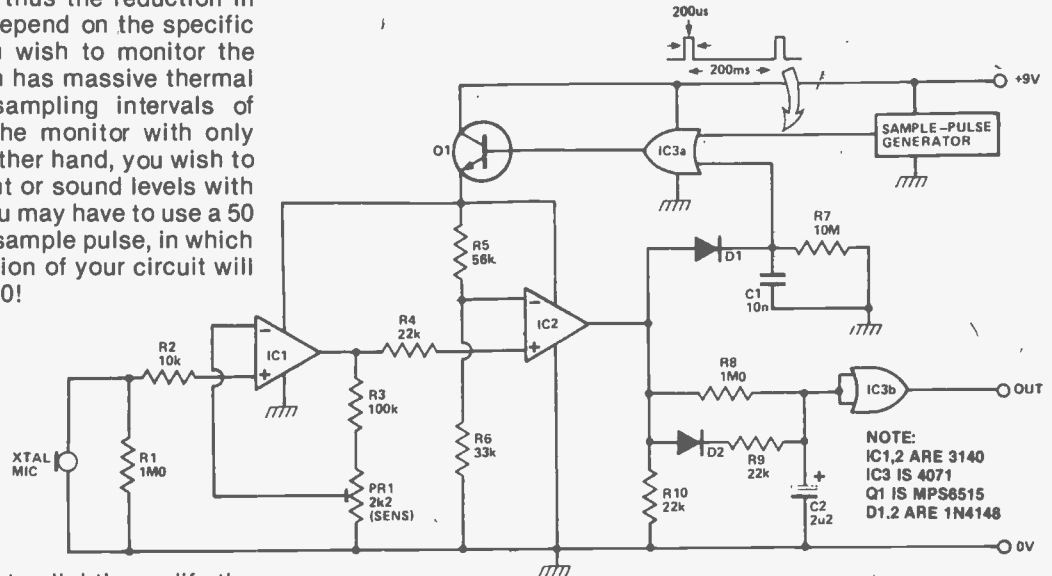

output that is equal to an amplified and positively rectified version of the input signal. This is fed to the input of non-inverting voltage comparator IC2, which thus produces a high output when the tone signal amplitude exceeds a value preset by PR1. The IC1-IC2 circuit would normally consume about 6 mA, but in this design is sampled by a 200  $\mu$ s pulse once every 200 ms via OR gate IC3a and Q1 and thus consumes a mean current of only 6  $\mu$ A.

If no output is produced from the monitor during the 200  $\mu$ s sampling period, the circuit will simply send another sample pulse 200 ms later. If, however, an output is produced during the 200  $\mu$ s sample period the resulting output pulse will be captured by D1-C1-R7 and use to fully connect the supply to the IC1-IC2 monitor circuitry via OR gate IC3a and Q1: the circuit will then temporarily operate in the conventional mode in which the 5 kHz input tone burst produces a train of square wave output signals from IC2. These signals are then 'conditioned' by D2-R9-R8-C2 and IC3b, which produces a high output only if the signals are continuously present for at least 50 ms. The sampling and conditioning circuitry thus gives very high overall immunity to false triggering by transient signals and other glitches.

Looking again at the Fig. 2 and 3 circuits, it is obvious that if the sampling systems is to be truly efficient, the actual sample-pulse generator must itself consume negligible current, and this immediately makes us think of using a CMOS oscillator in this position. Unfortunately, however, conventional CMOS oscillators are not good enough for the sampling application, so some rather special designs are called for. Let's look at this subject.

### CMOS Oscillators

Figs. 4 and 5 show the circuits and waveforms of a standard and a ring-of-three B-series astable respectively. Note that each of these circuits has a period of 132 ms and consumes a mean current of 12  $\mu$ A from a 6V supply or 75  $\mu$ A from a 10V supply. Also note that both circuits use a 10M timing resistor, so these relatively high current-consumption levels are clearly attributable to the actual CMOS chips and not to the timing networks.

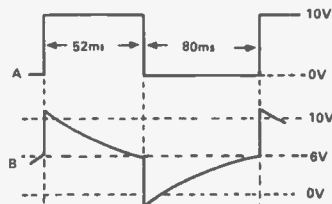
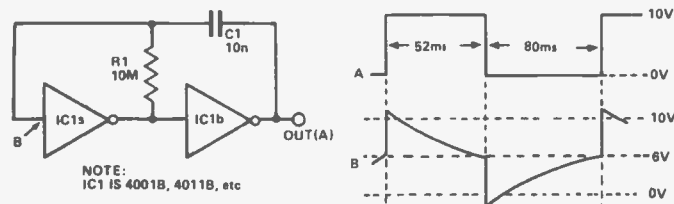

Fig. 4 This standard CMOS astable consumes 12  $\mu$ A at 6V, 75  $\mu$ A at 10V.

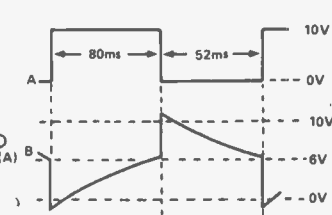
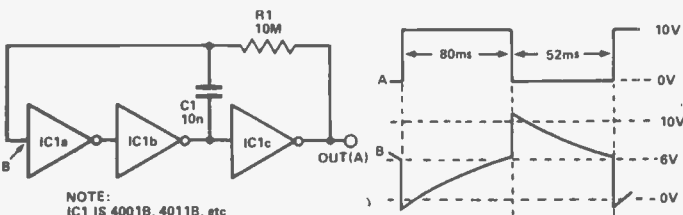

Fig. 5 This ring-of-three CMOS astable consumes 12  $\mu$ A at 6V, 75  $\mu$ A at 10V.

## MICROPOWER CIRCUITS

The Fig. 4 and 5 astable circuits are designed around modern B-series buffered CMOS chips: even higher current-consumption figures are obtained if old-fashioned A-series unbuffered chips are used in the designs. A-series chips are no longer readily available, but you can simulate them by using a 4007UB dual complementary pair plus inverter chip (see Fig. 6). Fig. 7 shows how to connect a 4007UB so that it acts like an unbuffered ring-of-three astable; note in this case that the circuit consumes 280  $\mu$ A from a 6V supply or 1.6 mA from a 10V supply.

The reason for the high current consumption of the Fig. 4, 5 and 7 circuits can be explained by looking at

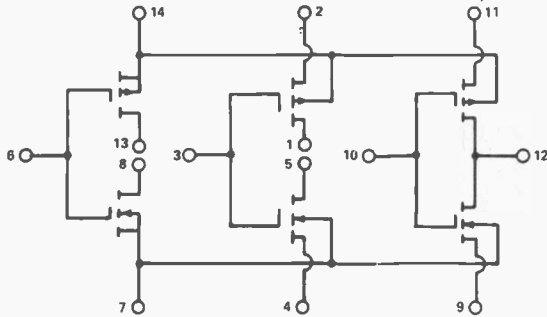

Fig. 6 Functional diagram of the 4007UB dual complementary pair and inverter.

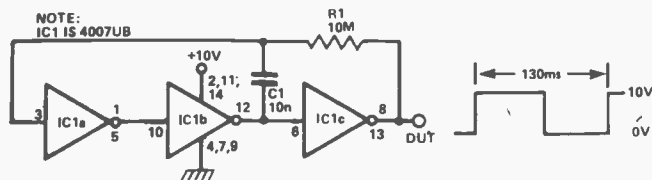

Fig. 7 This 'unbuffered' version of the ring-of-three astable consumes 280  $\mu$ A at 6V, 1.6 mA at 10V.

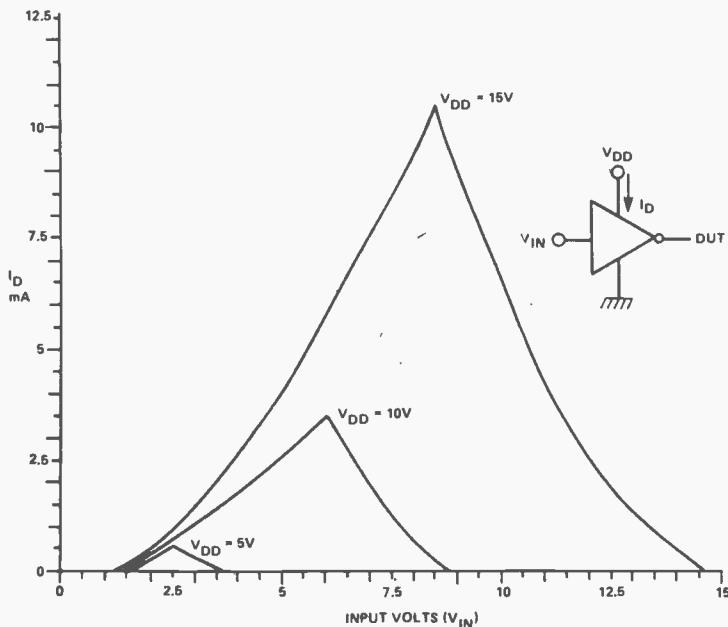

Fig. 8 Typical current and voltage transfer characteristics of a CMOS inverter stage (4001, 4007, 4011 etc).

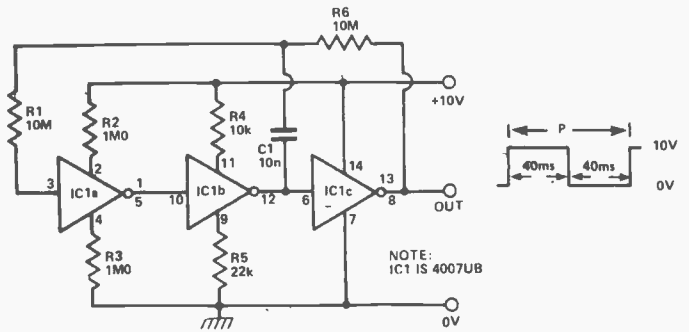

Fig. 9 This micropower ring-of-three symmetrical astable consumes 8  $\mu$ A at 10V, or 1.5  $\mu$ A at 6V.

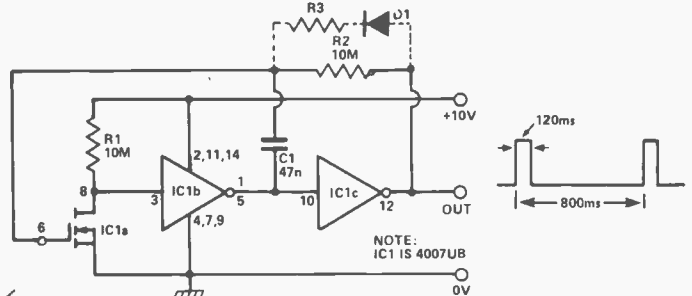

Fig. 10 This asymmetrical ring-of-three astable consumes 5  $\mu$ A at 10V, 2  $\mu$ A at 6V.

the typical current/voltage transfer characteristics of a CMOS inverter stage, as shown in Fig. 8. As the inverter is driven into its 'linear' region both halves of its complementary MOS stages are driven on and fairly high currents flow through these stages. Looking back at the basic waveform of the Fig. 4 and 5 astables, you can see that the input of IC1a is almost permanently driven into the linear region, hence the high mean current consumptions of the circuits.

Now that we've discovered the cause of the high current consumption of the conventional CMOS astable, it is a fairly easy matter to solve the problem and come up with a useful micropower CMOS astable design, as shown in Fig. 9. Here, the 4007UB IC is configured as a ring-of-three astable, but current-limiting resistors are wired in series with its IC1a and IC1b stages, to limit its 'linear mode' currents to very low levels. The resulting circuit consumes a mere 1.5  $\mu$ A at 6V or 8  $\mu$ A at 10V and produces a symmetrical output waveform, although the frequency stability of the circuit is not particularly good, with the period varying from 200 ms at 6V to 80 ms at 10V.

Fig. 10 shows how to wire the 4007UB as an asymmetrical ring-of-three astable that consumes 2  $\mu$ A at 6V or 5  $\mu$ A at 10V. The circuit produces a 120 ms pulse once every 800 ms: the pulse width of the circuit can, if desired, be reduced below the 120 ms value by shunting R2 with a diode-resistor series combination, as shown dotted by R3-D1 in the diagram; the R3 value determines

the pulse width. Note that this circuit has the desired characteristics of the sample pulse generator that we are looking for.

Fig. 11 shows a practical example of the modified version of the Fig. 10 circuit. In this case the circuit produces a 300  $\mu$ s pulse once every 900 ms and consumes 2  $\mu$ A at 6V or 4.5  $\mu$ A at 10V. In the diagram, the output is shown feeding directly to an acoustic transducer,



which thus produces a repetitive 'tick-tick' sound: this circuit can usefully be fixed to a lamp or other object, so that the object can be easily sound-located in the dark, or by the blind.

The current consumption of the Fig. 11 circuit can be even further reduced by simply wiring a 22K resistor between pin 2 of the 4007UB and the positive supply line, as shown in Fig. 12. This modification is of value if truly minimal current consumption is essential, or if the circuit is to be used as a sample pulse generator with a brief sample interval. The table shows two typical sets of performance figures obtained using alternative R1 and C1 values.

Note at this point that there is little practical value in spending extra money in reducing the current consumption of a micropower circuit to values that are so low that they are insignificant compared to the leakage current of a conventional battery. The basic Fig. 2 circuit, for example, can, in theory, operate continuously for 50 years from a single 9V battery, but, in practice, the battery itself has a shelf life of only two years, so there is no point in seeking to obtain further reductions in the current consumption!

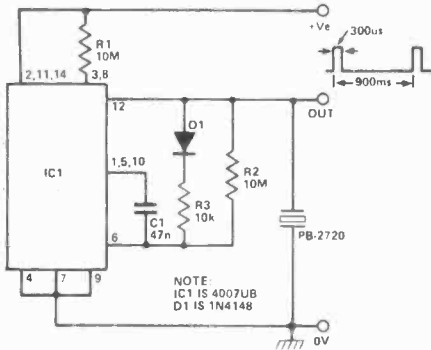
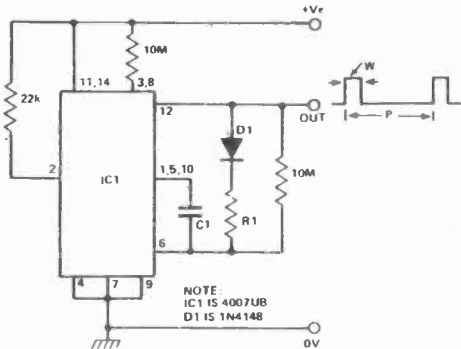

Fig. 11 This transducer-driving version of the Fig. 10 circuit acts as a tick-tick generator or acoustic object-finder. It consumes 2 uA at 6V, or 4.5 uA at 10V.



C1/R1 VALUE	I MEAN AT 9V	W	P
47n/10k	1.5uA	300us	900ms
10n/33k	3.5uA	160us	180ms

Fig. 12 This version of the micropower asymmetrical astable consumes absolutely minimal currents.

If you liked this article, please circle Reader Service Card number 45. If you didn't, circle number 46.

ETI

# ETI ORDER FORM

BACK ISSUES: Please circle issues desired.

1977	February	July					
1978	May	June	July	August	September		
	October	November		December			
1979	January	February	March	April	May	June	July
	August	September	October	November	December		
1980	January	February	March	April	May	June	July
	August	October	November		December		
1981	January	February	March	April	June	July	
	August	September	October	November	December		

QTY.	ITEM	AMOUNT
.....	Back issues @ \$3 (mark choice above)	\$.....
.....	More Circuits @ \$4.95	\$.....
.....	Hobby Projects @ \$3.95	\$.....
.....	Electronic Circuit Design @ \$3.95	\$.....
.....	Projects Book No. 2 @ \$3.95	\$.....
.....	Subscriptions @ \$16.95/\$29.95	\$.....
.....	ETI T-shirts @ \$5.50	\$.....
.....	Small ( ) Medium ( ) Large ( )	\$.....
.....	ETI Binders @ \$6.75	\$.....
Ontario residents add 7% PST on last two only.		

BABANI		TAB	
QTY.			
.....	BP1 \$2.80	.....	No.554 \$17.45
.....	BP14 \$4.80	.....	No.574 \$16.45
.....	BP24 \$4.25	.....	No.785 \$14.45
.....	BP33 \$4.25	.....	No.800 \$20.45
.....	BP35 \$5.50	.....	No.804 \$19.45
.....	BP37 \$5.50	.....	No.805 \$14.45
.....	BP39 \$5.50	.....	No.806 \$16.45
.....	BP42 \$3.55	.....	No.841 \$11.45
.....	BP44 \$7.55	.....	No.984 \$14.45
.....	BP46 \$5.90	.....	No.995 \$10.45
.....	BP47 \$5.90	.....	No.1015 \$13.45
.....	BP48 \$5.90	.....	No.1055 \$9.45
.....	BP49 \$6.25	.....	No.1064 \$13.45
.....	BP50 \$5.90	.....	No.1070 \$14.45
.....	BP51 \$5.50	.....	No.1071 \$13.45
.....	BP62 \$8.95	.....	No.1133 \$11.45
.....	BP63 \$8.95	.....	No.1166 \$16.45
.....	BP64 \$8.95	.....	No.1167 \$10.45
.....	BP65 \$8.95	.....	No.1183 \$13.45
.....	BP66 \$6.55	.....	No.1199 \$16.45
.....	BP67 \$7.55	.....	No.1200 \$16.45
.....	BP68 \$7.25	.....	No.1203 \$14.45
.....	BP69 \$7.55	.....	No.1205 \$16.45
.....	BP70 \$2.40	.....	No.1216 \$13.45
.....	BP71 \$7.70	.....	No.1241 \$13.45
.....	BP72 \$7.70	.....	No.1271 \$14.45
.....	BP73 \$8.58	.....	No.1300 \$24.45
.....	BP74 \$7.70	<b>PRENTICE-HALL</b>	
.....	BP75 \$7.30	.....	AB001 \$14.45
.....	BP76 \$7.30	.....	AB002 \$12.45
.....	BP77 \$12.30	.....	AB003 \$9.45
.....	BP78 \$7.30	.....	AB004 \$10.45
.....	BP79 \$7.30	.....	AB005 \$8.00
.....	BP80 \$8.25	.....	AB006 \$10.45
.....	BP81 \$7.30	.....	AB007 \$9.45
.....	BP82 \$8.10	.....	AB008 \$16.45
.....	BP83 \$8.20	.....	AB009 \$16.45
.....	BP84 \$8.11	.....	AB010 \$14.45
.....	BP85 \$12.25	.....	AB011 \$9.45
.....	BP86 \$8.25	.....	AB012 \$10.45
.....	BP87 \$5.90	.....	AB013 \$10.45
.....	BP89 \$12.30	.....	AB014 \$16.45
.....	BP90 \$8.10	.....	AB015 \$10.45
.....	BP94 \$8.10	.....	AB016 \$10.45
.....	No.224 \$4.25	.....	AB017 \$9.45
.....	No.205 \$3.55	.....	AB018 \$9.45
.....	No.213 \$4.50	.....	AB019 \$9.45
.....	No.215 \$3.70		
.....	No.221 \$5.50		
.....	No.223 \$5.50		
		<b>TOTAL ENCLOSED</b>	

If we cannot complete your order would you like a refund  or held for a backorder

REMEMBER TO PUT YOUR NAME & ADDRESS ON REVERSE OF THIS FORM.

**THE ONLY WAY TO BE SURE OF  
YOUR ISSUE EACH MONTH**



**SUBSCRIBE**

**BOOKS, BACK ISSUES  
BINDERS — SEE OVER**

Code

Electronics Today Magazine, Unit 6, 25 Overlea Blvd., Toronto, Ontario M4H 1B1.

ORDER  Please fill out form overleaf  
SUBSCRIPTIONS:  NEW SUBSCRIPTION?  Or...  RENEWAL? Please check one.

One year subscription (12 issues) \$16.95  Two year subscription (24 issues) \$29.95 Postage and handling to Canada is included, for U.S. please add \$3  other countries add \$5/yr.

NAME

ADDRESS

TOWN/CITY

CODE

PROVINCE/STATE

DATE



- Cheque enclose DO NOT send cash
- Bill MasterCard A/C No.
- Bill Visa/A/C No.

Signature

Expiry Date

**PLEASE ALLOW 6—8 WEEKS FOR YOUR FIRST MAGAZINE TO ARRIVE**

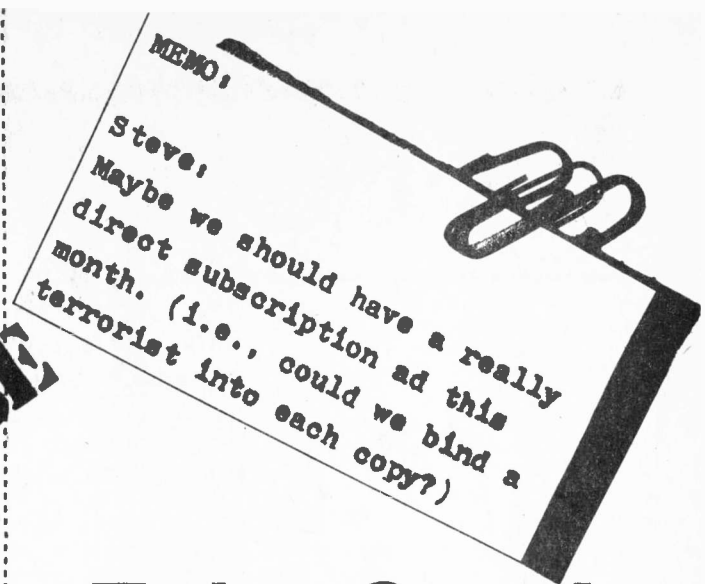

**Take Out A  
Subscription  
to ETI  
Magazine or  
We Will Put  
A Hex on  
You!**

(Just \$16.95 for one year, or \$29.95 for two.)

**Send your money to;**

**ETI Magazine  
25 Overlea Blvd.  
Unit 6  
Toronto, Ontario  
M4H 1B1**

# INTO LINEAR IC's

## (Part Two)

Part two already. This month Ian Sinclair digresses for a moment to take a look at the gentle art of PCB construction, soldering and layout before we get down to the real business of linear ICs.

IF YOU'VE JUST BECOME accustomed to laying out transistor circuits, then your first look at a circuit diagram for an IC project is a bit off-putting, mainly because so many connections have to be made to one small unit. Don't worry, it's not only easier than it looks, it's even easier than laying out transistor circuits, thanks to the use of DIL packages.

### Soldering IC's

A solderless breadboard is first-rate for testing-out circuits, particularly any circuits which have been modified a bit, but it's not the method we'd use for a permanent circuit — that's a soldering job. Now you've probably used a soldering iron already, but if your experience of soldering is only on transistor circuits, or possibly not at all, then perhaps a little bit of advice might be useful.

One essential point is to have a soldering iron which is suitable for working on ICs. Because of the 2.5 mm spacing between IC pins, an iron with a large bit is definitely out. Most modern soldering irons have replaceable bits, so that it's possible to attach a very fine bit for soldering IC's and then change to a larger one for bigger stuff. A suitable power is around 15-25 watts. Much less than 15, and you find that the solder never readily melts properly, because the copper of the printed circuit board conducts too much heat away. Much more than 25W, and you find that you are overheating the tiny strips on the board, causing them to pull away. Make sure, too, that your iron can be grounded with a ground wire correctly fitted to a three-pin plug. The circuits we're dealing with in this series don't need a grounded iron, but if you ever use the type of digital IC's called CMOS, or have to use FET's then you'll need a grounded iron — so why not start now?

The technique for soldering an IC goes something like this. First of all, you place the IC on the board, with its pins in the correct places — and then you check. Check that it's the correct IC for that part of the board (unless there's only one!), and that it's the correct type of IC — they look pretty much alike. Then locate pin 1 on the IC and check that it's placed in the hole that is intended for pin 1. On a small board, this is easy enough, but checking takes longer if you have a large board which takes twenty or more IC's. Use the small bit on the iron, and fine gauge resin-cored solder.

### Soldering On

Having checked, solder pin 1 onto its pad. Turn the board over so that it's resting on the IC, hold the tip of the bit of the soldering iron against the track pad just where the IC pin comes through, then touch this point with the end of the solder. When a small drop of solder flows on take the solder away, move the tip of the iron

around the pin of the IC so that the solder forms a neat blob around the pin and the pad. At this point take the iron away and blow on the joint to cool it.

Most IC's are fairly heat-resistant, but if you have any doubts about how long it'll take to solder a pin into place, then protect the IC with a heat sink. This doesn't have to be anything elaborate, just a paper clip of the Bulldog variety clipped onto the IC and touching the pins just where they are bent over at the sides of the casing (Fig. 4). Having soldered in pin 1, check again that you have the right IC, in the right place and the right way up. This may sound unnecessary, but at this point the IC can be removed very easily by heating the solder and pulling the IC out — after you've soldered in a few more pins, removal is a major operation! Having soldered in pin 1, now solder in the pin which is opposite, pin 5 on an 8-pin chip, pin 8 on a 14-pin chip, or pin 9 on a 16-pin chip. Check again — it's your last chance! If it still looks fine, solder in the rest of the pins, let them cool down, and then check that each pin is properly soldered, with no break in the solder around each pin and no little bridges of solder between one track and the next.

### De Method Of Desoldering

Even with all the care which you've taken (and you did, didn't you?) inevitably some day you will find that there's one IC in the wrong place, the wrong way up, or of the wrong type, and you have to remove it. If the IC has failed, and you're absolutely sure that it's failed — removal is easy. You simply cut through each pin at the body of the IC, using side-cutters, then take the pins out one by one, holding the remains of the pin in tweezers, and pulling the pin out as you melt the solder with the

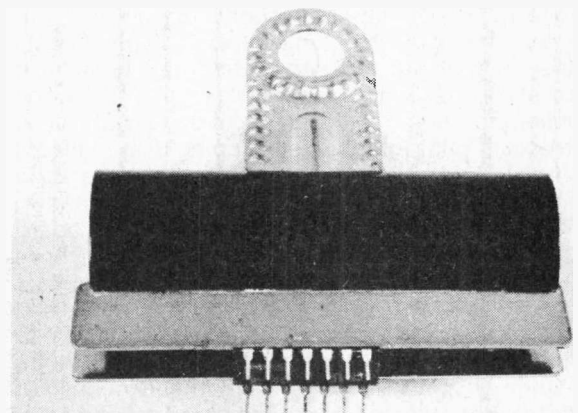

Fig. 1. Using an office paper clip as a heat-sink. These clips come in various sizes which are suitable for all the common linear ICs.

iron. If, however, there's nothing wrong with the IC and you want to use it again or in another part of the board, then gentler methods are called for.

Various desoldering tools can be bought, but unless you're going to do an awful lot of desoldering (it's cheaper to get the darn thing in the right place first time, folks), the cheapest and simplest method is to make use of copper braid, variously called solderwick or solder-braid. The idea behind this is that solder, like other molten metals, has a large amount of surface tension which pulls it into narrow tubes and small gaps. Copper braid is a mass of small gaps, so that molten solder runs into braid the way oil soaks into lampwick. To use desoldering braid, lay a clean piece of braid over the joint which you want to desolder. It helps if there's a faint coating of flux on the braid — I keep an old tin of Fluxite (which I bought in 1949) handy. Then clean the solder from the bit of the iron by wiping it quickly with a damp cloth, and lay the hot bit on top of the braid so that the braid is sandwiched between the bit of the iron and the joint. Keep the iron in contact until you see the solder on the joint melt and run into the braid — then remove the iron and the braid together. You'll find that it helps to hold the braid with tweezers — it gets mighty hot during this operation. Don't leave the braid soldered to the joint!

This procedure should lap up all the solder from the joint, leaving only a very thin silvery film of solder. If it doesn't take all the solder first time (which means that you're putting too much solder on your joints), then cut off the piece of braid which is now stiff with solder, and try again with a fresh piece of braid. When all the solder has been removed from each pin of the IC, it should be possible to pull the IC away from the board without a struggle. With any reasonable luck, if you check each IC as you go, in the way we've described, you will never have to go through this procedure.

**Board Stiff?**

That covers the jobs of soldering and de-soldering, but what about the circuit-boards themselves? What you use as a printed-circuit board (PCB) very much depends on what sort of project you are building. You may, for example, be constructing a project for which a ready-made board is available, in which case your only problem (apart from paying for it and getting it delivered in one piece) is to make sure that each component is soldered in the right place.

You can often save yourself a lot of time and money by etching your own boards.

The etching material is ferric chloride (Iron (III) Chloride to you chemists). It's not very strongly acid, but don't splash it in your eyes (remedy: wash in plenty cold water, then in eyewash, and see a doctor just in case). It will also stain the fingers, so I always play safe and wear rubber gloves and goggles. Make up just what you need. I use a photographic developing tray which I bought from a junk-shop, and I measure out the solid ferric chloride into it, then pour on hot water and stir. When the solid has completely dissolved, put the board in, copper side up, and keep the solution hot from above by shining a desk lamp on to the copper from about six inches above the top — but don't take any risks, and make sure that the desk lamp is properly grounded in case it falls in. If you use a metal tray for etching, it can be kept warm on a hotplate, but I wouldn't be inclined to use the cooker for this job. Move the board around a bit, using tweezers, so that it's always in contact with fresh solution.

You will see the unwanted copper steadily etching away, and when it's all gone, lift out the board and rinse it in warm water. Now use fine sandpaper or Ajax to remove the transfer material — you'll have to scrub fairly hard. Dry the board, and drill through each solder-pad so that your components can be mounted. You can, if you like, drill before you scrub off the print.

You'll need a small drill-bit for this job and something suitable to use it in. The used ferric chloride solution can be kept in a labelled and well-stoppered bottle until the next time, though it's best made up fresh unless you are etching again in a week's time or so.

Etching is done in exactly the same way, no matter how the board is printed; the important part of the process is cleaning the copper before applying the pattern. Any trace of dirt or grease on the copper (and that includes fingerprints) can cause faulty etching.

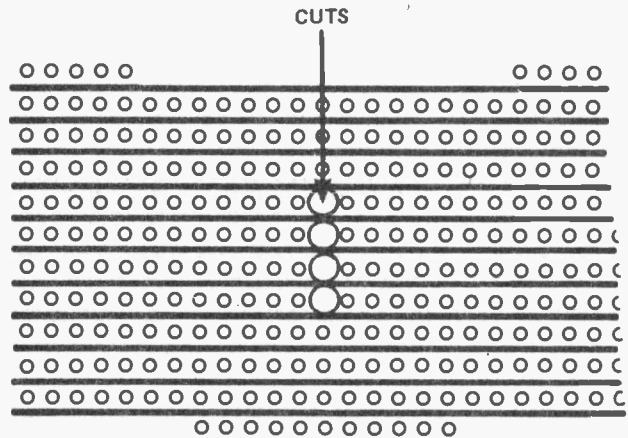

Fig. 2. Veroboard to take an 8 pin IC.

**Strip-Tease**

There are still a few methods left if you don't want to get involved with etching and marking-out copper laminate. These methods involve the use of stripboards — PCB boards which have been machined or etched so as to have parallel strips of copper set at 2.5 mm apart so as to suit the pins of ICs. The original Veroboard consists of long strips made in this pattern and also drilled at 2.5 mm intervals. Other patterns are now available, with short tracks. If you use the long strips, you will have to cut the tracks, as shown in Fig. 6, so that the IC pins do not short to each other.

Stripboards can be used for any IC circuit, providing that they use 2.5 mm pitch strip. Unfortunately,

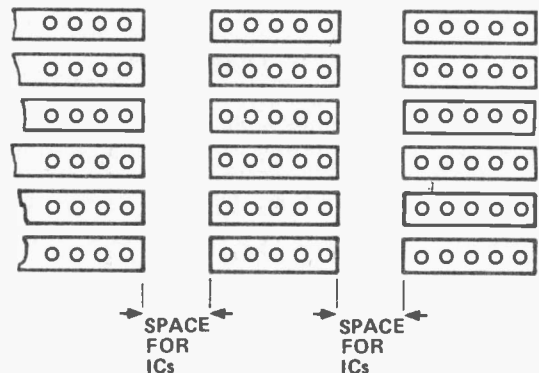

Fig. 3. The track pattern of DIL-board. Using this type of board saves on cutting.

most stripboards are not numbered nor lettered (don't ask me why, it can't be for lack of being asked!) so that you will have to do this for yourself unless you can get hold of ready-numbered material. One way is to stick some masking-tape at the end of the strips and write the strip numbers on it. Another method is to make use of the white correcting fluid which is used by typists to cover mistakes (sold as Liquid Paper etc.) and paint a stripe of this down one edge of the board. Let it dry for a minute (it's fast-drying) and then write the numbers in pen or pencil on it. Remember to number each side of the board, unless you are using single-sided board. Single-sided board is undrilled, so that the components are mounted on the same side as the copper tracks, with each leadout wire butted against the track and then soldered to the track. Circuit layout, circuit tracing, and troubleshooting are all much easier when this type of board is used, because you don't have to keep turning it over.

That's covered the possible constructional methods that you can use; but there's one important point to attend to before we start making linear IC circuits and getting them to work. It concerns power supplies — an important feature of all IC circuits.

### Volts Without Faults

The small-scale circuits that we're going to feature can all be battery operated, though a few of the later circuits will take rather a lot of current from the batteries. If you don't have an AC power pack, or if you have a power supply which doesn't suit linear ICs, then the use of batteries is an attractive proposition. All of the circuits have been designed to work from either single or twin 9 V batteries.

Some circuits specify dual supplies, meaning that there is a positive and a negative supply with a common ground return line. This is particularly easy to arrange when you see batteries, connecting two batteries as shown in Fig 8. A deluxe arrangement consists of the two batteries held in a plastic box, with their connectors wired to a miniature three-pin socket.

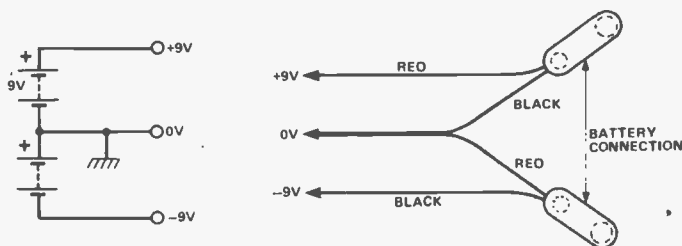

Fig. 4. Using two batteries for a power supply.

### Line Supply

A power supply, is of course, very useful, particularly if you are interested in trying out IC amplifier circuits which operate loudspeakers. These circuits can flatten small batteries pretty quickly, so that extensive work of this kind really calls out for an AC supply. building such a supply is not difficult. But you have to remember that the input to such a supply is 120V and you can't afford to take any risk with the high voltage.

Suppose you don't want to undertake the construction of a power pack, but you don't fancy using batteries? There are still a few ways out. One is to buy a power supply — a suitable unit would provide 9-0-9 volts of smooth DC at 0.5A. This unit could be pricy, but it's certainly quick and safe. Another way is less costly and

a bit unusual. Every motorist's accessory shop sells power supply units — called battery chargers. A lot of junk shops also sell them second-hand; there must be millions of them around, and they're only used in the winter. Now, the output from these battery-chargers doesn't look much like DC, but if a smoothing capacitor of 5,000  $\mu$ F, 35V, is added, as shown in Fig. 9, they convert nicely into power supply units with an output of up to 18V or so. Don't try to put the capacitor inside — there's seldom room, and you may disturb the wiring to the extent of causing a short circuit.

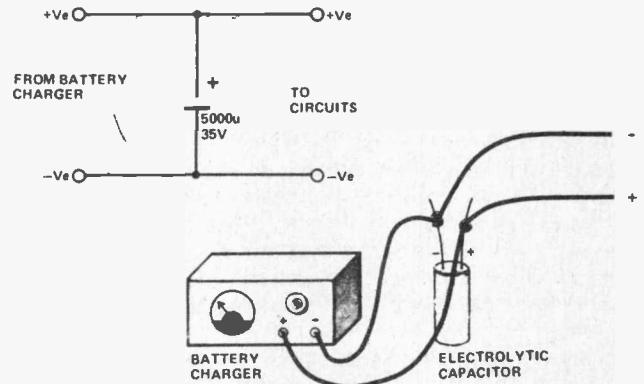

Fig. 5. Adding smoothing to a battery charger — a cheap way to get a single voltage supply suitable for many circuits.

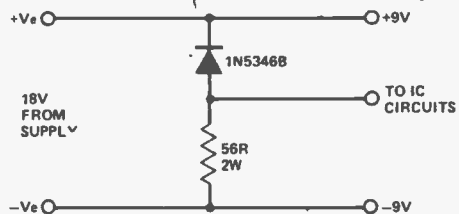

Fig. 6. Obtaining dual supplies from a single 18V supply. The 1N5346B is a 9.1V zener diode rated at 5W.

### Variable Power

Fig. 10 shows how such a supply can be adapted to provide 9-0-9 V for the circuits which need a dual power supply. This circuit is also useful if you happen to have a power-pack which has an 18V output and no negative output. The circuit consists of a 9V zener diode and a resistor, with the ground line taken from the place where the diode and the resistor connect. Even if the power supply doesn't deliver exactly 18V, this version of a dual power supply works well enough for all the dual-supply projects in this series. Remember that dual-supply circuits use fewer components.

For circuits that use low currents (like many of the 741 and 555 circuits) the voltage across the zener diode in Fig. 10 can be used as a single supply, leaving the -9 V lead disconnected, but the higher-power circuits can't be operated in this way because the resistor in series with the zener diode won't pass enough current. Another solution will have to wait until Part 7: it's the use of a linear IC which acts as a voltage stabiliser.

The ultimate in power packs, of course, is a variable stabilised AC unit, giving both positive and negative supplies and which can be set to any voltage required. Don't worry if you can't aspire to this, though, every circuit in this series can still be operated by the good old pair of 9V's.

If you liked this article, please circle Reader Service Card number 47. If you didn't, circle number 48.

The language in which computers mutter to themselves is a most curious thing. A few of the mysteries of machine code revealed.

THE PRINT STATEMENT, in BASIC, would seem to be a fundamental building block of programming, but, if you consider exactly what happens when you execute this simple command, you'll realize that it is exceedingly complex. You may also begin to wonder if it might not be comprised of a number of more fundamental components. After all, when you tell the computer to PRINT, it must, at the very least, figure out where the screen is in its RAM, decide where on the screen its cursor is supposed to be, decide whether the material following the PRINT statement is a literal, variable, expression, function, or whatever, develop a string of actual character codes to place on the screen, find the appropriate bit patterns in its character ROM and, finally, stash the whole mess in the appropriate screen memory locations. It becomes increasingly clear that PRINT is not a command so much as it is a subroutine, and a very large one at that.

The question, of course, is if PRINT is a component of the language BASIC, and it is, in fact, a subroutine, what components, in turn, make it up? The answer is that it's comprised of machine language commands. Machine language is the 'other' language you can use to talk to your computer. . . the one they don't try to tell you about in the 'Introduction To Programming' manual.

This month, we're going to have a look at a bit of the machine language for the 6502 microprocessor. Unlike BASIC, ML code is very different on different chips. However, the 6502 is a fairly popular processor, found in PETs, VICs, OSIs, Apples and many of the small, one board machines like KIM, SYM and AIM. Be warned, though, don't try to use the stuff herein on machines equipped with other CPUs, such as the 8080, Z80, and so on, or your computer will get quite uncomfortable. Machine code works at the nervous level of a computer, down where there's no protection, and even the slightest error will crash the system.

We'll look at Z80 programming in a few months (with luck).

## Hex

You will, first of all, need a 6502 programming book. There are two fairly useful ones around; *Programming the 6502*, by Rodney Zaks, published by Sybex, and the *MCS6500 Microcomputer Family Programming Manual*, by MOS Technology, of which the former is somewhat better. These books contain, among other things, the 6502 instruction set, which illustrates what the various commands do. The Sybex book also has a really good hexadecimal conversion table at the back.

Yes, sadly, all machine code is done in hexadecimal format. However, hex isn't as bad as it first seems. To go over it quickly; we think in base ten, probably because we have ten fingers (those of us who aren't all thumbs). Two digits of base ten can express one hundred separate states, from 00 to 99. The number 23, in base ten is actually  $(2 \times 10^1) + (3 \times 10^0)$ . Well, hexadecimal, which is base sixteen, is exactly the same. . . sort of. Two digits of hex can express two hundred and fifty six different states, from 000 to 255. It can do this because each digit can be any of sixteen, rather than ten, values. The number 23, in base sixteen, then, is  $(2 \times 16^1) + (3 \times 16^0)$ . They don't represent the same value, of course.

The tricky bit with hex is that it utilizes decimal notation to express digits, i.e., 0 to 9, but it has sixteen individual levels to deal with. Thus, the hex numbers from 10 to 15 are held by the letters A to F. Counting in hex goes 00, 01, 02, 03, 04, 05, 06, 07, 08, 09, 0A, 0B, 0C, 0D, 0E, 0F, 10, 11, and so on, up to FF for the limit of two digit numbers. FF is the biggest number you can store in one 8 bit byte, which is what the 6502 uses. Bigger numbers use two bytes.

Each instruction in machine language occupies one byte, and may utilize from zero to two more for data. This would mean that there can be up to 256 6502 instructions, although, in actuality, there are considerably fewer. Each instruction is given a three letter code to make it a bit easier to use. These codes don't exist

in the CPU; they're just for human use. However, as we'll see, each code can specify more than one instruction.

The 6502 has a little bit of internal scratch pad memory, called *registers* and *flags*. Flags can hold either one or zero, while registers can be loaded with up to FF, or 255. The registers we'll be talking about here are the X register and the A register, or the *accumulator*. Most instructions are either for moving the program pointer around or manipulating these registers.

Oh ya, the program pointer. Well, this, too, is something you don't have to deal with directly in BASIC. However, when you're running a BASIC program, it should be clear that, at any given instant, the machine is only looking at one particular line. This is also true in ML programming; it has a pointer that aims at one particular byte. Where it winds up determines what happens, just like GOSUBS, GOTOs, and so on.

## Instructions

This is a machine language program:

033C	A9 00	LDA 00
033E	A2 00	LDX 00
0340	9D 00 1E	STA
0343	E8	INX
0344	69 01	ADC 01
0346	C9 FF	CMP FF
0348	F0 65	BEQ 05
034A	4C 40 03	JMP 0340
034D	EA	NOP
034E	EA	NOP
034F	4C 00 00	JMP 0000

(Alternate line for MONITOR'd systems)

034F	00	BRK
------	----	-----

## Program 1

What it actually does is to print out all the characters from ASCII 0 through 255 on the screen of a VIC computer. It resides in the cassette buffer, beginning at 828, which is 033C hex. The screen of the VIC is located at 7680, or 1E00 hex. It could actually be used on most high level 6502 machines if these values were adjusted to fit. However, the main thing is to see what it does.

The first column of mnemonics on the left is, as you may have guessed, addresses in hex. These are actually addresses of the *instructions* only. As I said a while back, some instructions tie up one or two additional bytes for data. Thus, the addresses are not sequential.

The next column over holds a bunch of hex numbers. The first number in each line is the instruction. Each instruction requires a particular number of bytes after it to be used as data, and, when the machine sees, say, a three byte instruction (that is, one byte for the instruction itself, plus two more for the data), it knows to gobble up the next three bytes. While the lines are presented here as being distinct, in the machine they are just one long string of numbers with no delineators.

This presentation, by the way, is called a *dis-assembly*, or *source code*. When all you've got is a string of bytes, it's called *op code*. New verbage to use at parties.

After the actual program information, there's a column of those three letter codes we spoke of, and, after that, in some cases, the actual data being used by the instructions. These two things are put there solely for our benefit; the machine doesn't have anything to do with them.

Now, let's see what it does.

The functioning of the program can be seen quite easily by this analog:

```
10 A = 0
20 X = 0
30 POKE (7680 + X),A
40 X = X + 1
50 A = A + 1
60 IFA = 255 THEN 80
70 GOTO 30
80 END
```

#### Program 2.

The instruction LDA means *load data into the accumulator*. There are actually several different LDA's, the choice of which is determined by where we want the data to come from. A9 is the immediate LDA, which means that the data is the next hex byte after the instruction, 00 in this case. However, we can also specify that the data come from the X (or Y) register, or from a specific memory location. In this case, the instruction codes would be different. Since memory locations are usually bigger than FF, LDA's that snatch data from memory (and, in fact, most instruc-

tions that deal with specific locations), are three byte deals. The exception to this is the 'Page 0' group of instructions, of which there are two LDA's. They can only specify addresses up to FF, or 255 decimal. However, they are usually faster than the general versions of the instructions, and, of course, require one less byte of memory. This is why many programs and most operating systems leave the first page of memory alone to be used for flags, data storage, and such like.

LDX is about the same as LDA, except that it stores data in the X register, as opposed to the accumulator.

The first two instructions, then, set the accumulator and the X register to 0.

STA is the opposite of LDA. It's the *STASH* instruction (I don't think this is a universally accepted designation). It reads the data in the accumulator, and copies it somewhere else. Like LDA, there are several different possible ways to stash data; it can go to a page 0 location, somewhere else in memory, and so on. The 9D stash is an 'Absolute X', which is really quite neat. It means that the data in the accumulator goes to the memory location specified in the data plus the number in the X register. The number in the data is actually 7680, the beginning of the screen RAM, so it would be 7680 + 0, since the X register was set to 0. The number in the accumulator, 0, in this case, would thus get stuck in this location.

The next instruction, INX, is a one byte instruction, which effectively means that it doesn't do any data manipulation outside the registers. What it does do is to increment the X register by one. As you have probably figured out, this means that when we get back to the stash instruction, it will do its stashing in the next byte of RAM along.

There is, incidently, a DEX, or decrement the X register, instruction as well.

ADC is *add with carry*, and, again, it can get what it adds from any of a number of places. In this case, the 69 instruction specifies that it add the number in the data, which is 01. In other words, this just increments the accumulator, as INX did with the X register. Unfortunately, there is no one byte instruction to increment the accumulator.

Now for the peculiar bits.

CMP is *compare*. It can compare

the contents of the accumulator to any one of a number of other things. In this case, it is to a fixed number in data, so it is said to be an *immediate* compare. The number to be compared to is FF, the highest character code. No matter what the comparison turns out to be, this instruction won't do anything directly. However, it will set some flags, depending upon whether the accumulator is less than, equal to or greater than the compared to number. Mysterious, isn't it?

BEQ is a *branch* instruction. Branch instructions are among the most difficult things to deal with you can imagine. This is because branches are usually relative, which means that you don't branch to a location or an instruction. . . you just branch forwards or backwards by a given *displacement*. This is further confused when you discover that the centre of this range, i.e., not getting either forwards or backwards, is not 0, or something simple like that, but 128 (60 hex, half of FF). Thus, a branch which specifies that one branch 65 means that you count forward five bytes. Quite messy.

BEQ means to *branch* if the CMP instruction has set the flag that indicates that the comparison was equal. Otherwise, the program pointer just skips along to the next instruction.

The next instruction is a JMP, which means *JUMP*. Really. It's just like a BASIC GOTO, and sends the program pointer to whatever address is after it. In this case, it loops back up to the stash in the third line.

The EA's are *NOPs*, or *no operations*. They just fill up holes in the program. The reason they're here is because there used to be an instruction in this spot. I strongly recommend the use of these NOPs when you're getting used to working with branches, as they provide a sort of landing target for the branch to hit. If you aim for the middle of a clump of NOPs and you haven't quite calculated the branch right, the pointer will just chew up NOPs until it gets to an executable instruction. If, on the other hand, the pointer comes down in the middle of some data, thinking it's got an instruction, there will be great woe and unpleasantness.

If the branch succeeds, as it eventually will when the accumulator reaches 255, the pointer will encounter the final instruction. If this program is used on any sort of machine equipped with a monitor, this instruction can just be 00, which

is BRK, or *break*. This hands the pointer back to the monitor, which will usually tell you the resultant values of the flags and registers. However, especially in high level systems, like PETs and VICs, i.e., machines where you're essentially dealing with BASIC all the time, and have to SYS out to get to ML routines, just breaking can be a bit disastrous, because the pointer becomes lost, and doesn't know how to get back into BASIC.

Poor little pointer.

To rescue this helpless little waif, you must direct it back to its warm cozy fire. There are lots of ways to do this, most of which are unique to the systems they're used on. However, it is usually the case (almost always) that the first three bytes down there on zero page, are a JMP instruction which, when executed, fires the pointer right smack dab into BASIC, with a minimum of discontentment. Sometimes it does produce an error message. This is certainly good enough for this demonstration. Therefore, what we do in this last instruction is to JMP to 00. Alternately, one could PEEK the value of the address in bytes 1 and 2 of page 0, and JMP to them directly.

Furthermore

Once you understand the basic ideas of machine language programming, quite a number of which are tackled in this program, you will probably find that your skill as an ML programmer will quickly ascend to your level of ability in BASIC. The concepts are quite similar; it's really just a bit more nit picking, and, of course, the syntax is much different. Still, with a decent 6502 programming manual, this isn't hard to pick up.

Now, we have mentioned *monitors*, and, if you really haven't done any ML code at all, this might be a bit strange to you. A monitor is a little bit of software which allows you to manipulate your program in memory; it's analagous to the screen editor on a BASIC machine. It will usually display a number of sequential memory locations, and let you modify their contents, plus give you a reading of the contents of the registers and flags. The better monitors for the high level machines also do really lovely things like single stepping through a program, letting you view the results of every instruction, calculating relative branches, and so forth.

A monitor may be built into your machine; on the newer PETs, for in-

```

100 REM ASTOUNDING          BASIC          MONITOR
110 REM COPYRIGHT (C)      1981 STEVE RIMMER
120 POKE36879,8:PRINT"!"
130 PRINT"#####ASSEMBLER OR DISASSEMBLER":INPUTL$
140 IFLR$<"A"ANDLR$<"D"THEN130
150 IFLR$="A"THEN600
160 PRINT"#####SOURCE OR OP CODE LISTING":INPUTTR$
170 IFTR$<"S"ANDTR$<"O"THEN160
180 PRINT"#####START LOCATION":INPUTL
190 IFTR$="O"THENGOSUB250:GOTO580
200 GOSUB400:GOTO580
210 D1=16:FORX=240TO0STEP-16:D1=D1-1:IFN-X>-1THENX=0
220 NEXTX:K=D1:GOSUB230:B$=A$:J=N-(D1#16):K=J:GOSUB230:Z$=B$+A$:RETURN
230 A$=STR$(K):IFK>9THENA$=CHR$(K+55)
240 A$=RIGHT$(A$,1):RETURN
250 PRINT"J":FORQ=LTO(L+111):N=PEEK(Q):GOSUB210:PRINTZ$ " ":IFPEEK(211)>20THENP
RINT
260 NEXTQ:V=Q-1:GOSUB520:PRINTCHR$(13)"LAST ADDRESS:"Q-1,CHR$(13) (HEX "C$")."
:RETURN
270 REM 6502 INST DATA
280 DATA 1,0A,00,18,08,5B,88,CA,88,E8,C8,4A,EA,48,08,68,28,2A,6A,40,60
290 DATA 38,F8,78,AA,AA,98,BA,8A,9A
300 DATA 3,0D,6D,7D,79,2D,3D,39,0E,1E,2C,CD,DD,D9,CD,DD,D9,EC,CC,CE,DE
310 DATA 4D,5D,59,EE,FE,4C,6C,20,AD,BD,B9,AE,6E,AC,BC,4E,5E,0D,1D,19,2E,3E
320 DATA 6E,7E,ED,FD,F9,8D,9D,99,8E,8C,END
330 REM LOOK UP THE BYTE
340 B=1:T=0
350 READJ$:IFJ$=Z$THENT=B
360 IFJ$="3BYTE"THENB=3
370 IFJ$<"END"THEN350
380 IFT=0THENT=2
390 RESTORE:RETURN
400 REM DISASSEMBLE
410 R=L
420 N=PEEK(R):C9=C9+1:GOSUB210:T=0:B=0:GOSUB330
430 V=R:GOSUB520
440 PRINTC$ " "Z$ " "
450 IFT=1THENR=R+1:PRINT:GOTO480
460 FORR=(R+1)TO(R+T-2):N=PEEK(R):GOSUB210
470 PRINTZ$ " "NEXTR:PRINT
480 IFC9<19THEN420
490 V=R:GOSUB520
500 PRINT"NEXT INSTRUCTION AT: "R (HEX "C$")."
510 RETURN
520 REM GET HEX ADDRESS
530 FORT1=3TO0STEP-1:G1=(16↑T1):G2=G1#15
540 D1=16:FORX=G2TO0STEP(-1#G1):D1=D1-1:IFV-X>-1THENX1=X:X=0
550 NEXTX:K=D1:GOSUB230:Z1$=Z1$+RIGHT$(A$,1)
560 V=V-X1:NEXTT1:C$=Z1$:Z1$=""
570 RETURN
580 PRINT"#####HIT ANY KEY!"
590 GETTT$:IFTT$=""THEN590
600 CLR:GOTO130
610 REM HEX TO DECIMAL CONVERTER
620 JF$=LEFT$(JQ$,1):GOSUB650:TD=16*KY
630 JF$=RIGHT$(JQ$,1):GOSUB650:TD=TD+KY
640 RETURN
650 REM HEX DIGIT TO WEIGHT
660 KY=VAL(JF$):LT=ASC(JF$):IFLT>64ANDLT<73THENKY=(LT-55)
670 RETURN
680 REM ASSEMBLER
690 PRINT"J"
700 PRINT"#####START ADDRESS (DEC)":INPUTV
710 VK=V:PRINT"J"
720 GOSUB520
730 PRINTC$ " . . . . .":INPUT"#####";MX$
740 IFMX$="END. . ."THEN130
750 IFRIGHT$(MX$,1)=". "THENMX$=LEFT$(MX$,LEN(MX$)-1):GOTO750
760 Z$=LEFT$(MX$,2):GOSUB330
770 IFLen(MX$)<>2(2#T)THENPRINT"J":GOTO730
780 FORGQ=1TOLEN(MX$)STEP2
790 JQ$=MID$(MX$,GQ,2)
800 GOSUB610
810 POKEVK,TD
820 VK=VK+1:NEXTGQ
830 V=VK:GOTO720
840 REM *****
READY.
    
```

stance, SYS(4) gets you into the monitor. It may have to be loaded from tape, or, in the case of the VIC, it may be on a pluggable ROM.

If you haven't got a monitor, you can, of course, POKE these values in from BASIC. A bit tedious, this, as you must calculate the decimal value of each of the hex numbers. However (since we haven't gotten the monitor for the VIC yet), I've concocted a BASIC monitor. It can (1) view an ML program in memory and present it as either source or op code and (2) let

you enter an ML program in source code, which it will POKE into RAM for you. See Fig. one (see Fig. one after the ball. The ball is wed).

This program was written on my PET, and downloaded to the VIC at our offices. (For what it's worth, if you do this, the VIC eats the first statement, which should be an expendable REM). It should run on any 6502 BASIC system if it's changed to deal with page 0 locations and screen size.



If you want to plough through it, the program's fairly self explanatory. When you run it, it will ask you if you want to ASSEMBLE or DISASSEMBLE code. If you opt for the former it will Inquire as to whether you want SOURCE or OP code. It will then hit you for a starting location. The only proviso is that it can't tell instructions from data in the SOURCE mode; if it isn't started on an instruction, it will produce garbage until its pointer lands on a one byte instruction and it gets its head together.

In the assemble mode, it will, again, ask you for a start address, and then present you with something like

```
033C . . . . .
```

with the cursor on the first dot. The hex number is the start address converted to hex (828 decimal, which is the start of the VIC's cassette buffer, a good place to store ML programs so long as you don't try to use the cassette). At this point, you can enter a line of code, and hit return. The monitor is self checking, inasmuch as if you enter an instruction followed by an inappropriate number of bytes, it will erase the line you've entered and let you have another guess. When you enter a line, it will load it into RAM at the displayed address, and then calculate the address of the next instruction. To stop entering code, type END, which will get you back to the ASSEMBLER/DISASSEMBLER choice. At this point it doesn't hurt to use the DISASSEMBLER to check your work. When everything's cool, BREAK from the program and use the SYS function to start the ML program (keeping your fingers crossed).

It's only fair to say that this is a very primitive monitor in most respects (although it does do a good disassembly), and if you're planning to get into ML programming seriously, you should get a proper one.

Just a few notes on entering this program. First off, it's important to get the mnemonics in the DATA statements right, as these are used in the disassembler and the assembler self check. The easiest way to do this is to use checksums. Enter the program, SAVE it on tape, and then type the following direct commands;

```
FORX = 0TO10000:READA$:A = A
+ASC(LEFT$(A$,1):NEXTX
```

This will give you an OUT OF DATA ERROR, which is cool. Now type

?A

this should give you 4872. Enter RESTORE, and then A=0, and then repeat this line with the LEFT\$ changed to RIGHT\$. This time ?A should give you 5252. These numbers are the added up PET ASCII values of the left and right digits of the mnemonics.

Secondly, if you're unfamiliar with the exact peculiarity of the PET type screen codes, you may be wondering what those reversed out characters do. They do screen functions like cursor positioning, clear the screen, home, and so forth. To get them, you type an opening quote, and then hit the appropriate control keys. Instead of doing what they should do, you'll get these funny characters. When these literals are subsequently printed by the program, these things will make the cursor or the screen do whatever it would have done when you typed them if you hadn't been in the quote mode.

The codes used here are as follows; the heart as in line 130 clears the screen, the Q moves the cursor down one, the R makes all subsequent characters reversed out (REV ON), and the horizontal line makes all subsequent characters normal (REV OFF). The vertical line, as in line 730, moves the cursor backwards.

If you are using a non-Commodore machine, you'll want to change these to whatever's cool.

Lastly, line 120 is peculiar to the VIC, and should be deleted for other systems. The POKE statement produces a black screen, instead of the blue one the machine has in it when it comes on, and the shifted E control character makes the cursor white. These things aren't essential; it's just that our VIC's hooked to a black and white set at the moment, which makes all the colours look grey.

### Send Us Stuff . . .

If you have a favourite computing bit, send it to *Computing Today*. If we think it's wonderful, we'll send you either up to \$30.00 or a baby hippopotomous (our choice). To find out more about what we think is wonderful, write or check out *Computing Today* in the December 1981 issue.

# Perform a death-defying act.



## Give Heart Fund.

Give Heart Fund 

# TEMPERATURE CONTROLLED SOLDERING IRON



## Tame your soldering iron with this ingenious temperature controlled soldering station

A MAJOR FACTOR in the art of soldering concerns the ability of your soldering iron to do its job. For instance, if the iron is a high wattage type, say 100 watt, it obviously shouldn't be used to solder sensitive ICs into circuit (you may even find it lifts the track from the board

because of the intense heat — never mind damaging the ICs!). Likewise, if the iron is only a 15 watt job, then it won't have the necessary power to solder components onto a hefty ground bus.

There are two ways in which an efficient level of soldering can be obtained — either use a specific iron for a corresponding job (which means you need a selection of three or four irons) or use a

temperature controller which heats the iron to the correct temperature for any chosen use. It is a well documented fact that good control over soldering tip temperature not only improves the quality and integrity of soldered connections but also greatly increases efficiency and extends tip life, while reducing troublesome oxide buildup on the tip.

## HOW IT WORKS

MEASURED BETWEEN COMMON (-Vcc) & POINTS INDICATED.  
WARNING: COMMON IS AT LINE POTENTIAL ABOVE GROUND.

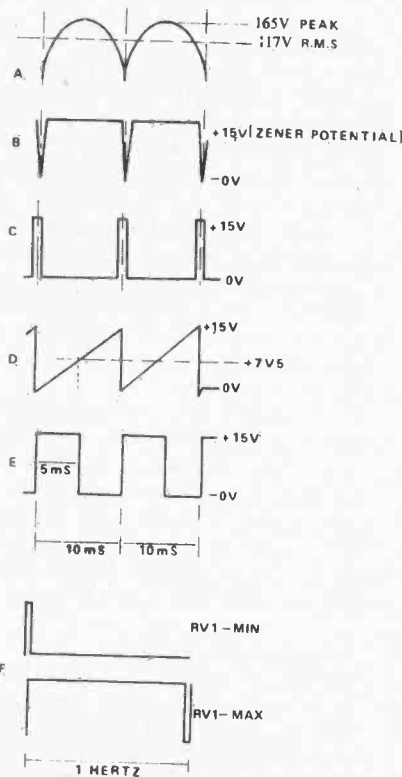

The incoming line voltage is switched via SW1 which is integral with the temperature control RV1. The line voltage is then full wave rectified by D1-D4. The resulting pulsating DC (illustrated in waveform 'A') can deliver the same heating power to a resistive element as 120V AC. The pulsating DC will heat the soldering iron element and illuminate the neon whenever the silicon controlled rectifier SCR1 is gated on by the combined logic of IC1 (1 hertz variable duty cycle multivibrator) and IC2 (zero voltage crossover detection and SCR gate driver). Without gate drive SCR1 will cease to conduct each time the pulsating DC returns to 0V.

The line potential pulsating DC is dropped via R1 and R2 and clamped to a pulsating +15V via ZD1. Waveform 'B', which is produced by the clamping action of ZD1 also pre-regulates the supply voltage for the integrated circuits. D5 prevents the power supply filter capacitor C1 from filtering out the sync pulses.

IC1 and the associated components form a variable duty cycle astable multivibrator with a frequency of 1 Hz.

At the fully counter-clockwise position of RV1, the output of this astable is low (logic 0) for 99% of the 1 second period. At the fully clockwise or maximum setting of the RV1, the astable output is high (logic 1) for 99% of the period. Waveforms 'F' show

these two modes. Mid-positions of RV1 produce outputs which vary between these two extremes. In summary, the setting of RV1 will vary the ratio between the logic '1' state and the logic '0' state (duty cycle) without appreciably altering the period of the complete cycle.

The line synchronisation signal illustrated in waveform 'B' is coupled to the input of IC2a via voltage divider R8 and R9 which protects IC2a from the sync signal which is a slightly higher in potential from IC2's operating supply. IC2a inverts the line sync signal shown in waveform C and improves the transition between the logic levels. IC2b, c and d serve as a logic AND gate i.e. only when its two inputs (pins 5 AND 6) are at logic 1, will the output (pins 10 and 11) be at logic 1.

Therefore, whenever the line sync pulse is at 0V (logic 0 inverted to logic 1 by IC2a) and the output of the proportionally controlled astable is at logic 1, a pulse is applied to the gate of the SCR. This applies power to the soldering iron element in fully controlled bursts.

The combination of all sections described above results in SCR1 being gated on only near zero crossings of the line voltage. This eliminates RFI. The on-off ratio and therefore the soldering iron temperature is proportional to the setting of the temperature controller RV1.

Now, all this sounds great. All you have to do is rush out and buy yourselves one of these tremendous gadgets and then you can solder away to your heart's content, whatever the job. But here's where you will hit a slight problem. A complete soldering system will cost you quite a few weeks' pocket money.

One simple alternative to holding up the local bank is the ETI temperature controlled soldering station, which will enable you to convert any 15-100 W soldering iron to a fully controlled iron, capable of intermittent hobby use to full time production use, as well as providing a convenient soldering stand. (If you have a choice, most electronic soldering applications are best handled using a 40 watt to 60 watt iron with this controller).

The 4000 series CMOS ICs were selected for their cheapness and versatility and to give the electronics enthusiast some insight into just how versatile these ICs are. The design has incorporated zero voltage switching which eliminates radio frequency interference (RFI) caused by phase control of line voltage and the potentially destructive spikes created by thermostatically or 'magnetically' controlled soldering irons. The soldering iron temperature can be varied from full off to full on while the iron is in use. A visual indication of controller operation is also provided.

The output waveform consists of controlled bursts of pulsating DC and is, therefore, suitable for resistive element soldering irons only. (Soldering irons or guns that use transformers cannot be used with the project). This waveform was selected to simplify power supply design, reduce internal power dissipation and eliminate costly sensitive-gate triacs which would be required for direct interface with CMOS logic.

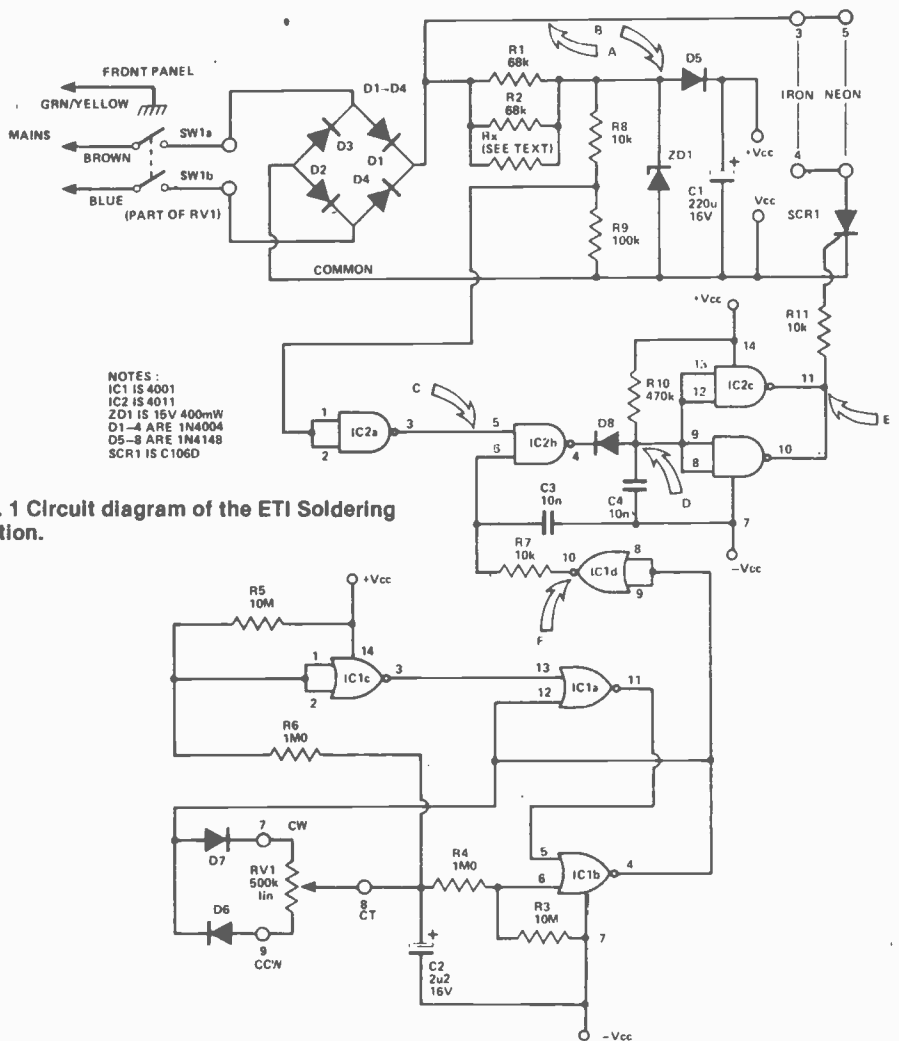

Fig. 1 Circuit diagram of the ETI Soldering Station.

### Construction

Construction is reasonably straightforward — start with the PCB. Nothing special here, just remember to mount R1 and 2 (along with Rx if used) about three or four mm from the board, to help heat dissipation.

Remember that IC1 and 2 are CMOS and we advise the use of IC holders (not essential, but helpful). Next, mount the spring and holding bolt, neon and RV1 on the front panel and follow the wiring diagram of Fig. 3 to connect up your soldering station.

The cable ties at the line input and iron output grommets are necessary to avoid strain on the cable connections. The PCB simply slides into one of the grooved slots in the case, eliminating the use of special mounting procedures. Finally, make sure that the ground connection on the front panel is a good one.

### Testing and Setting Up

Plug the controller into the AC line. Advance the temperature control clockwise until the power switch clicks on. Advance the control further clockwise until the neon lamp just begins to flash. This is the

lowest temperature setting of the controller. At this setting the soldering iron tip will be barely warm to the touch. Advance the control further clockwise. You will note that the on-off ratio of the neon lamp will slowly change as the control is advanced fully clockwise. Whenever the neon lamp is lit, power is being applied to the heating element. At the maximum clockwise position of the temperature control the neon lamp will remain on continuously and the soldering iron will produce full output.

The controller takes advantage of the 'thermal mass' of the soldering iron in maintaining a reasonably constant temperature at the tip (the larger the iron, the better the regulation). Any fluctuations in tip temperature due to increased or decreased loading can be easily compensated for by adjusting the temperature control as required. If the neon lamp comes on at full intensity at the full counter-clockwise position and does not flash on and off, the wires to the 100k potentiometer (R3) are probably reversed.



# TEMPERATURE CONTROLLER

**NOTE:**

Rx — Install an additional 33k 1 Watt resistor if the line voltage in your area falls below 110 volts.

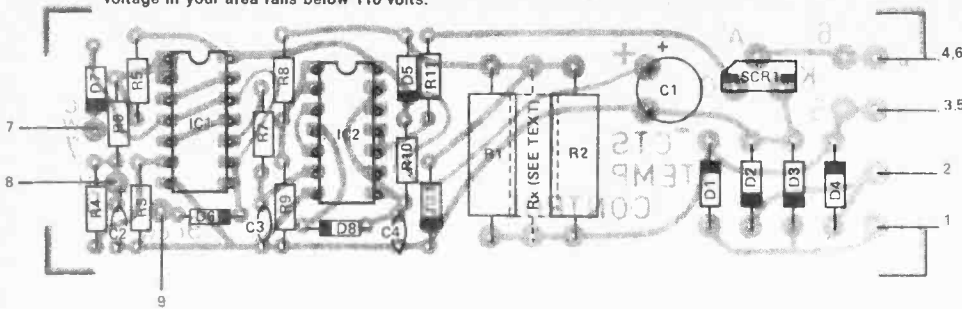

Fig. 2 Overlay diagram for the Soldering Iron controller.

## PARTS LIST

**RESISTORS** (All 1/4W, 5%, except where stated)

- R1,2,x 33k watt
- R3,5 10M
- R4,6 1MΩ
- R7,8,11 10k
- R9 100k
- R10 470k

**POTENTIOMETERS**

- RV1 500 k lin with double-pole, single-throw switch

**CAPACITORS**

- C1 220μ 16 V printed circuit mounting electrolytic
- C2 2u2 16V tantalum
- C3,4 10n ceramic

**SEMICONDUCTORS**

- IC1 4001 quad NOR gate
- IC2 4011 quad NAND gate
- ZD1 15V 400 mW zener diode
- D1-4 1N4004
- D4-8 1N4148
- SCR1 C106D

**MISCELLANEOUS**

- Spring mount for soldering iron
- Neon with integral resistor
- Knob for potentiometer
- Case to suit
- Grommets and cable clips
- Heavy weight (for bottom of case)

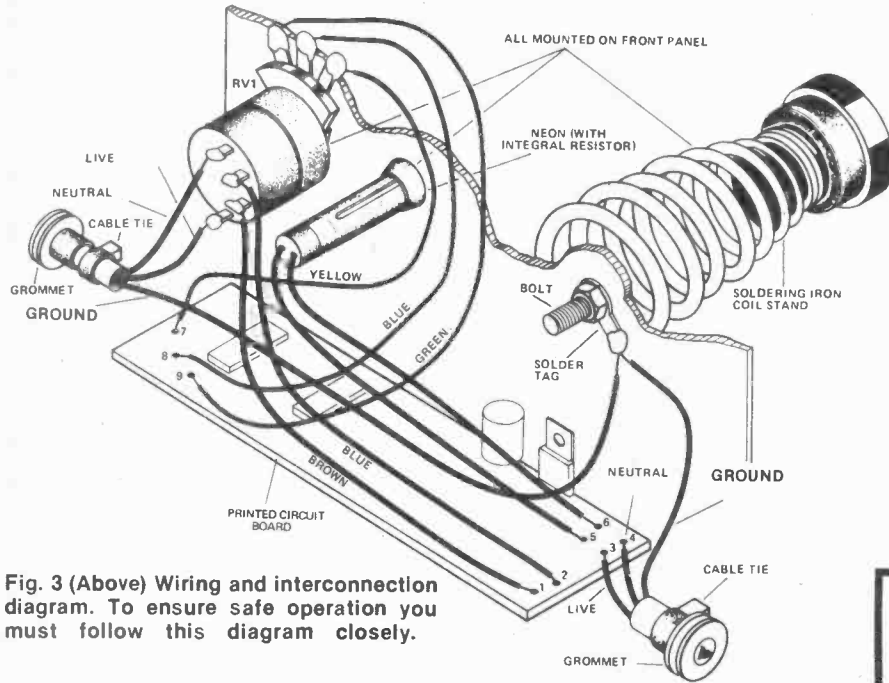
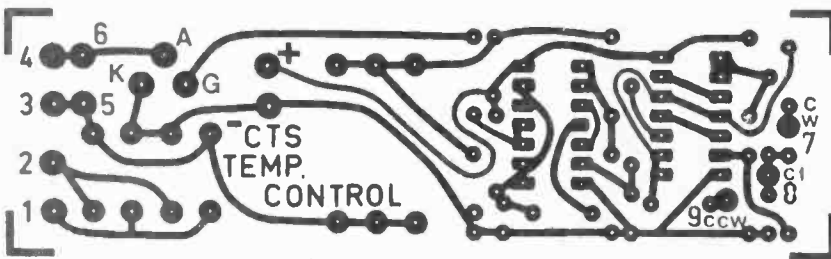

Fig. 3 (Above) Wiring and interconnection diagram. To ensure safe operation you must follow this diagram closely.



**Warning**

The circuit described here does not use an isolation transformer and therefore all sections of the circuit must be considered dangerous.

It is advisable not to operate the device without its case.

If you liked this project, please circle Reader Service Card number 55. If you didn't, circle number 56.

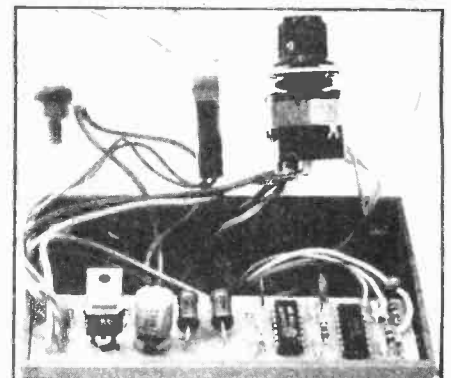
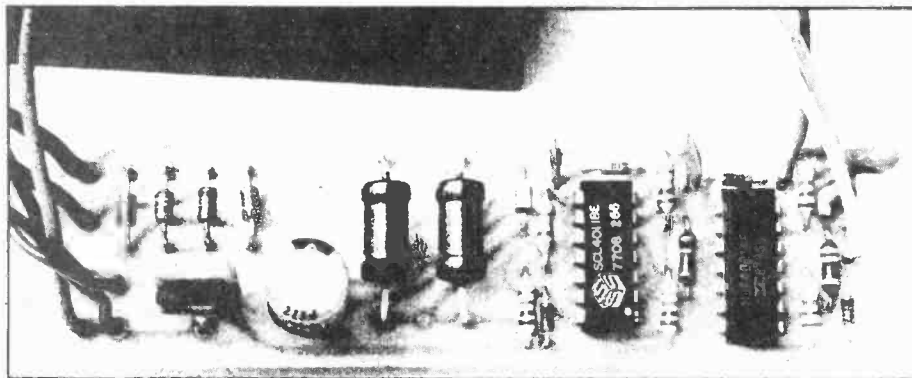

# The Fun of Electronics

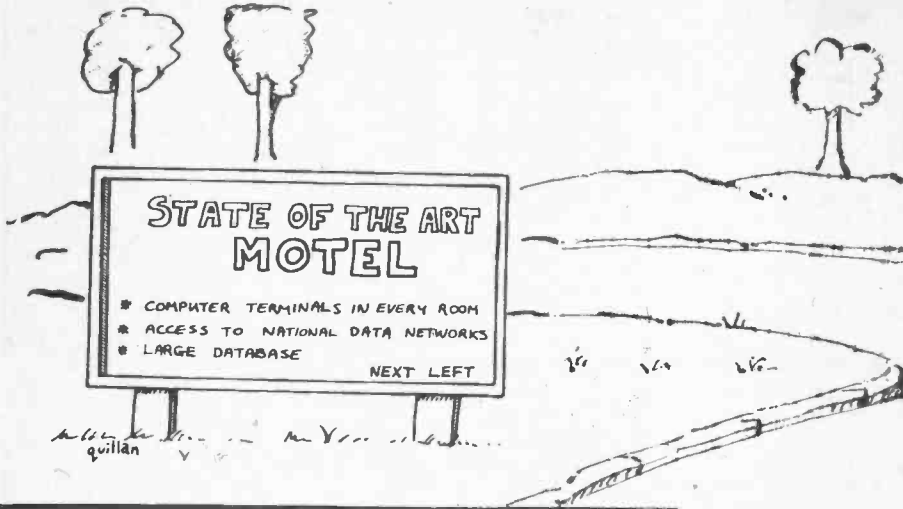

Following the recent news of the development of an inductive eddy-current heating system for saucepans we are unable to confirm reports that Professor Eric - Maglev - Laithwaite Foresees snags when the pans are empty!

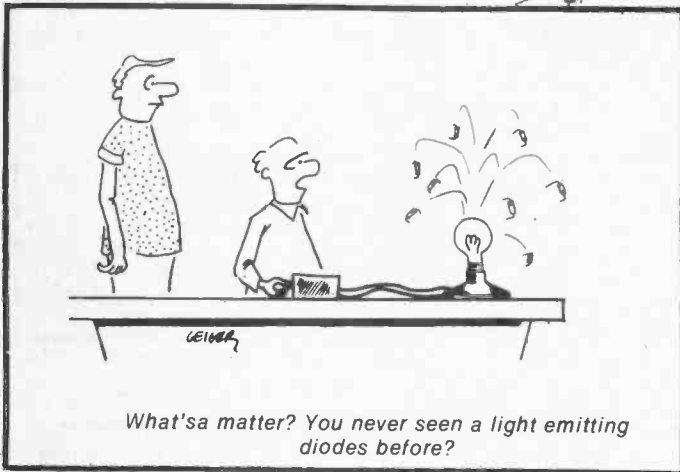

What's a matter? You never seen a light emitting diodes before?

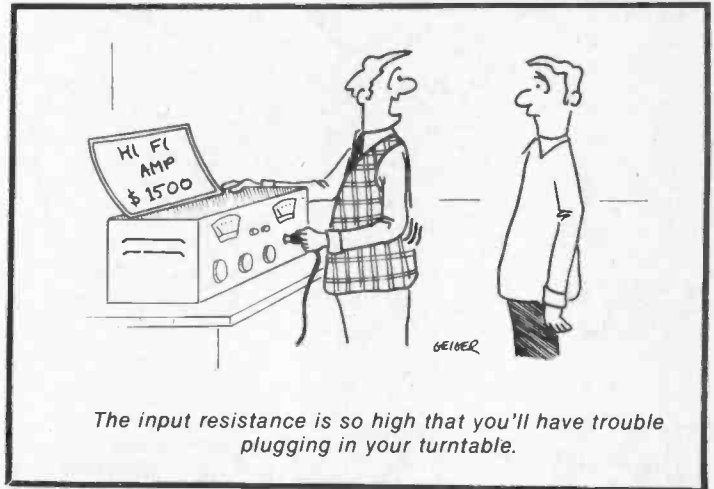

The input resistance is so high that you'll have trouble plugging in your turntable.

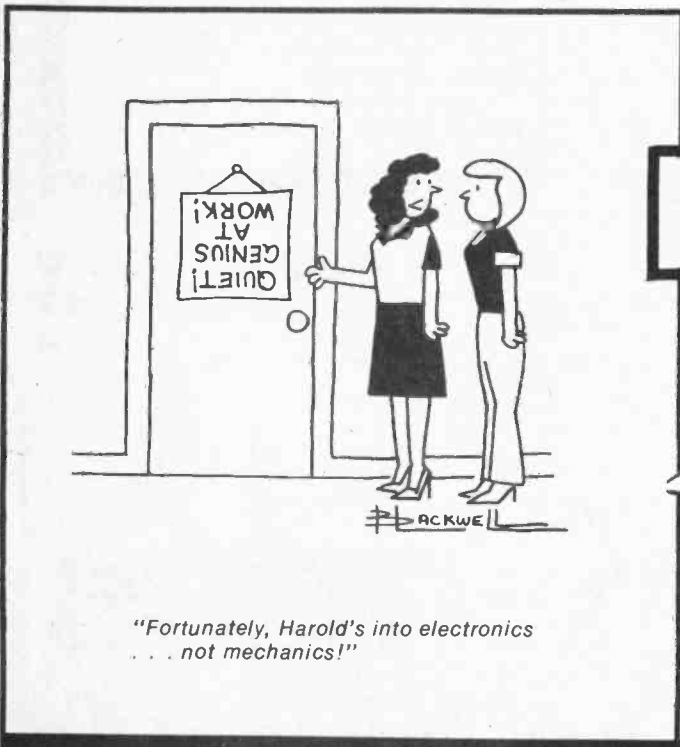

"Fortunately, Harold's into electronics ... not mechanics!"



You were right. It's the most powerful desoldering tool I've ever used. Now how do I get my television set out of it?

# CLASSIFIED ADVERTISING

ETI's classified advertising section allows you to reach 30,000 Canadian readers nation-wide for 75¢ per word. For as little as \$15 per insertion (there's a 20 word minimum) you can promote your business from coast-to-coast.

## WHAT DO YOU DO?

Send us your typewritten or clearly printed words, your permanent address and telephone number, and your money (no cash please). Make your

cheque or money order payable to 'ETI Magazine'. We're at Unit 6, 25 Overlea Blvd., Toronto, Ontario. M4H 1B1.

## WHAT DO WE DO?

We typeset your words (and put the first word and your company name in **BOLD** capital letters). If we get your message by the 14th of the month, it will appear in ETI 1½ months later. For example if we receive it by October 14th you (and thousands more) will see it in the December issue.

**GROWING** continuously, our inventory includes anything we can fit into the store. Bargain prices on all kinds of manufacturers surplus. **FOREST CITY SURPLUS**, 781 Dundas (near fairgrounds), London, Ontario. 519-438-0233

**AUDIO** Exchange. Quality solid state and tube equipment bought & sold. Send self addressed/stamped request/offer to **ROYAL VIEW ELECTRONICS**, 2327 Bloor St. W. Toronto, 416-762-8655.

**ELECTRONIC PIANO** Kits now available in Canada. Both 7¼ and 6 octave instruments are designed for professional, stage of home use and are fully touch sensitive. Features include three piano voices, harpsicord, honky-chorus, phaser and pedals. Other quality kits include string synthesizers, programmable rhythm units, organ rotors etc. Just the thing for your winter project. Send now for full details to **G&R ADVANCED ELECTRONIC DESIGNS INC.** P.O. Box 38, Streetsville, Ontario L5M 2B7.

**SEMIS & KITS** MJ15003, 15004 \$10 per pair/ 250W class A amplifier kit \$239.95/ 160W \$149.00/ 140W \$84.95/ 60W \$60.00. Send \$1.00 for our catalogue. Add 5% for shipping **KITSTRONIC INTERNATIONAL**, Box 577, Station J, Toronto M4J 4Z2.

**COMPLETE** new catalogue with hundreds of interesting items. Send \$1 for your copy today: **KRIS ELECTRONICS**, 1070 Morrison Drive, Unit 1(b), Ottawa, Ont. K2H 8K7. 1-(613) 820-4986.

**J&J ELECTRONICS Ltd.**, P.O. Box 1437E, Winnipeg, Manitoba R3C 2Z4. Surplus Semiconductor Specialists. Do you get our bargain flyer? Send \$1.00 to receive the current literature and specials and to be placed on the mailing list for future publications.

**WSI RADIO** — SWL Radios — Ham radios 18 Sheldon Avenue North, Kitchener, Ontario N2H 3M2. Tel. (519) 579-0536. Write for giant catalogue, free of course!! (VE3EHC).

**HYDROGEN GAS GENERATOR** plans, \$10.00. Starter Kit, \$5.00 extra. **PRAIRIE POWER RESEARCH AND DEVELOPMENT** P.O. Box 62, Regina, Sask., S4P 2Z5.

**SATELLITE** Television information on building or buying your earth station. Six pages of what's needed, where to get it, costs, etc. \$4.00 U.S. to **SATELLITE TELEVISION**, R.D. 3, Oxford, N.Y. 13830.

**FAST EPROM** programming. While you wait service for copies from masters, 24 hr. service for copies from HEX listing and for erasing. Prices (master/listing): 2708 \$5/\$30.; 2516, 2716 \$5/\$60.; 2532, 2732 \$6/\$100.; 2564 \$9/\$190. Erasing 50¢ each. Please provide your own EPROMs. Call **NEFF SYSTEMS LTD.** 498-6129. 61 Tambrook Dr., Agincourt, M1W 3L8

**CLEARANCE SALE!** Don't miss our lowest prices ever on quality parts and assortments. Integrated Circuits, digital and linear, some house numbers, 100 assorted for \$8.95 or 500/\$40; Potentiometers - 25/\$3.99; Slide Switches - 25/\$3.99; Capacitors, assorted types - 100/\$3.99; Disc Capacitors - 100/\$1.49; Epoxy Caps, unmarked - 100/\$1.00; Terminal Strips -40/\$2.49; Linecords - 4/\$1.99; Resistors - 200/\$2.49 or 1000 for \$10; Electrolytic Caps - 20/\$2.19; 1N4148 - 20/\$1.00; N8T 80A-\$1.99 or 20/\$30; We're overstocked on the following IC's you choice -16¢ each - 709, 741, 711, 9601, 7413, 74L73. \$10 minimum order (Certified Cheque or Money Order). Add 5% (Minimum \$2.00) for P&H. Bargain Flyer -\$1.00. **ELECTRONICS**, Box 68, Whitecourt, Alberta, T0E 2L0.

**CORONET ELECTRONICS**, 649A Notre Dame W., Montreal, Que. H3C 1H8, Catalogue IC's, Semi's, Parts, send \$1.00 to cover postage. Monthly specials at crazy prices.

**GET** off, eh! . . . at Yonge & Finch and visit the General for your electronic needs, parts, kits, speakers, ETI Project Circuit Boards and advice. Do you want to sell some of your equipment . . . let's talk. Great (White North) prices. Custom circuits designed and built at low prices. Send for free Electronakit catalogue. Sabtronic Test Equipment. **GENERAL ELECTRONICS**, 5511 Yonge St., Willowdale, Ont. M2N 5S3. (416) 221-6174.

**SECRETS OF REPAIRING TV'S** REVEALED. Anyone can do it . . . Easy. Money back Guarantee. Details Free. **RESEARCH** Box 517ET, Brea, Calif. 92621.

**ROBOTICS** - The World of Tomorrow Today - from **DACOR LIMITED**, ROBOTICS DIVISION. We start with an upgraded and expanded design of ETI HEBOT, July 1980 - write for details **-DACOR LIMITED**, ROBOTICS DIVISION, P.O. Box 683, Station Q, Toronto, Canada, M4T 2N5.

**RECEIVING** tubes. Brand new & boxed RCA, CBS etc. Liquidating distributors stock. Hundreds of older types. All \$2 each. Send S.A.S.E. for list. **WOLVERTON ENTERPRISES**, 5 South Hythe, Burnaby, BC, V5B 3H6.

**DACOR Limited** - Excellent hobbyist response to our **DEALER ONLY** advertisements for ETI related items changes our policy - NOW, our mail order facilities will service all ETI readers direct - refer to our ETI PCB catalogue in the December 1981 issue of ETI for great savings . . . write direct to us for new issue PCB and special **HOT-HOT GOODIES** monthly. **DACOR LIMITED**, HOT-HOT GOODIES Dept., P.O. Box 683, Station Q, Toronto, Canada, M4T 2N5.

**AMAZINGLY** Low Prices on P.C.B.'s. Fourway Loudspeaker P.C.B. - \$11.99; Temperature Controlled Soldering Iron - \$1.29. Prices in effect until February 1st. Boards available for all E.T.I. projects. Inquire about our custom made P.C.B.'s. **WENTWORTH ELECTRONICS**, R.R. 1, Waterdown, Ontario, L0R 2H0.

**FREE** Catalog of Electronic Designs. Radio, Audio, Telephone, Self Defense & Surveillance. **Peter - Schmitt Enterprises**, Dept. ETI, Box 07071, Milwaukee, WI 53207.

**PC** boards for all magazine projects. Etched and drilled 30¢ sq. in. Etched only 25¢ sq. in. Send photocopy of etch patterns and cheque or money order to **SAKURA ELECTRONICS** Box 166, 55 McCaul Street, Toronto, Canada, M5T 2W7.

**FREE EPROM** 2716, Programmed for only \$55.00. Your HEX. table. **AKHITRONIC LTD.** P.O. Box 3011 Str. "D", Willowdale, Ontario, M2R 3G5.

**S.E.A.** Equalizer Preamp with cabinet, Class-A Amplifiers, Parametric Equalizer, Electronic Speaker Protector, Colourful LED Meters, Power Supply, DC Voltage Doubler/Tripler, FM Mic, Programmable Music Box, Digital Clocks, Electronic Roulette with Sound and Much More. Send \$2.00 for your Catalog and future special flyers. **CLASS-A ENTERPRISES, INC.**, #104-206 East 6th Avenue, Vancouver, B.C. V5T 1J8.

**DACOR LIMITED** - ETI August 1980 "Brute" 300 Watt Amplifier - Special Heatsink & PCB Package \$19.95 - Add \$3.50 for postage and handling - certified cheque or money order only. Ontario add 7% PST. P.O. Box 683, Station Q, Toronto, Canada, M4T 2N5.

**FREE**

**THE GREAT ELECTRONIC THINGS & IDEAS BOOK!**

HUNDREDS OF UNUSUAL PARTS, GADGETS & IDEA ITEMS. UNAVAILABLE IN STORES OR CATALOGS ANYWHERE! Bargain prices on everything! New items in every issue! Rush postcard for your copy!

**ELECTRONICS**  
Dept. 306  
Plattsburgh, N.Y. 12901

**Multi-mode**

Up to now I have been describing cameras using either shutter speed priority or aperture priority. But, it is possible to have both. In fact, the Canon A-1 has no less than five automatic programmes.

1. Shutter speed priority — useful for action photography.
2. Aperture priority — useful if you know that your subject is not going to get up and run away.
3. Stopped down — with the meter reading the light entering the lens, accessories which don't couple directly to the camera electronics can be used.
4. Programmed — the camera decides the shutter speed and aperture.
5. Flash — using a flashgun which couples directly to the camera electronics, automatic flash photography is possible.

The viewfinder alphanumeric LED display gives a complete run-down on just about everything. The A-1's self-timer allows selection of a 2S or 10S delay. As the timer is completely electronic, it can be cancelled at the touch of a button, unlike most mechanical self-timers.

The A-1 and the Nikon FE (an aperture priority model) both have a memory lock facility. Suppose you are photographing your loved one (or wife) against a bright window. Click — and there you have an interesting silhouette. The meter has exposed the film for the bright window, not for the subject.

With the A-1 and FE, you can take a correct exposure reading from the subject's face, turn on the memory lock and take the picture. The meter will 'remember' the correct exposure until the lock is turned off.

**Screen Data**

The information displayed in the viewfinder and the method of display varies enormously from camera to camera. Some give full alphanumeric data on everything. Others rely on a very simple three-LED system — red, green, red meaning under-exposed, correct and over-exposed (manual TTL system).

Typically, slight pressure on the shutter release button switches the meter on. Some cameras still use an on/off switch mounted on the camera body. If yours does, remember to switch it off! The first-pressure type is foolproof, even with an absent-minded photographer to contend with. Table 1 is a quick guide to a few popular automatic mode 35 mm SLRs, giving details of the camera's electronic systems. It is by no means exhaustive and is not intended to be used as a buyers' guide.

The space available for components and PCBs inside the camera is severely limited. Nowadays the circuitry is commonly mounted on and in flexible, paper-thin, plastic film PCBs, which can be wrapped round the familiar shape of the major features of the camera under the thin metal skin. The flexible tracks greatly reduce the number of flying leads and solder joints necessary. The fewer connections, the less chance there is of a broken wire or a dry joint.

**Finally . . .**

The microprocessor is only now beginning to make an impression on amateur photography, so the camera is probably at the simple four-function pocket calculator stage. Look what has happened to calculators in a very few years — LCD displays, programmable, sound effects, talking displays, etc. It will be interesting to watch how the designers transfer this kind of technology to cameras.

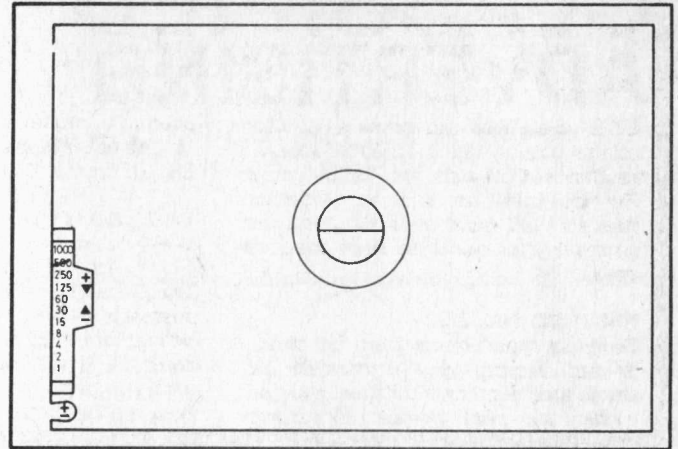

Fig. 8 The Olympus OM-2's bright viewfinder display shows the shutter speed by means of a needle on a scale. Information about under/over exposure, flash ready, exposure compensation, etc is also shown. When you switch to manual, the shutter speed scale disappears and you are left with the conventional needle display described earlier. When the camera is switched off, the viewfinder display disappears completely.

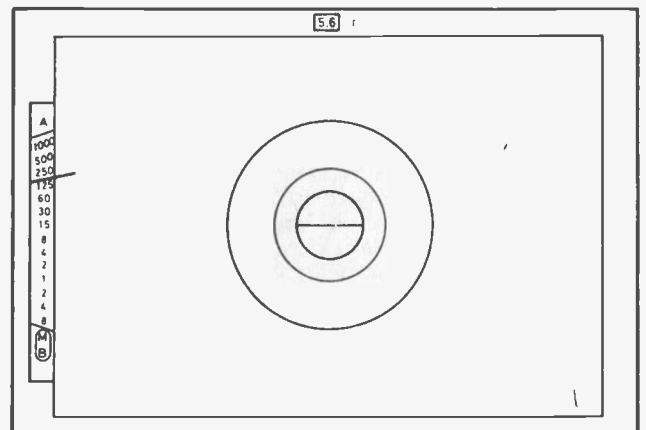

Fig. 9 Like the OM-2, the Nikon FE's display of shutter speed is a needle-on-scale type. The Silicon Photodiodes used in the FE are filtered to match the spectral response of the human eye.

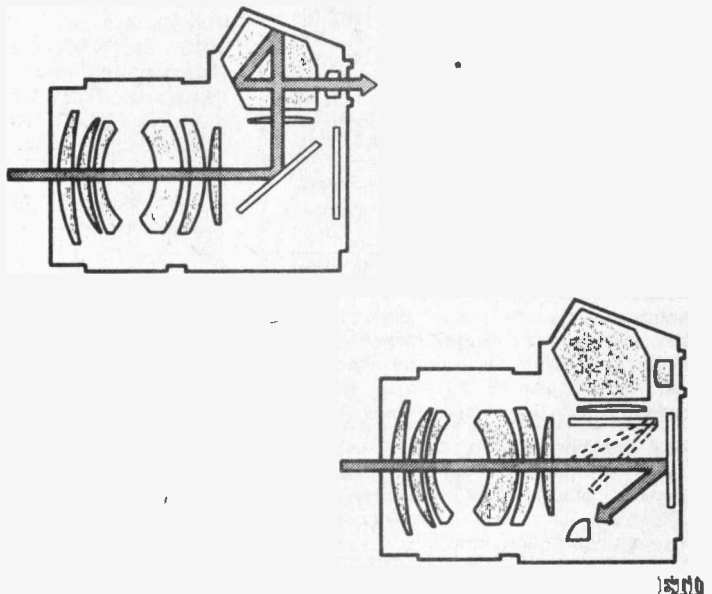

Fig. 10 With the mirror in the down position (top), the Nikon FE looks much the same as any other camera, but when the mirror flips up (above) a light reading is taken directly from the film plane.

# 1981 INDEX



The ETI Annual index is among the finest in the world . . . especially if you're looking for something in ETI. Not as effective if you're after a feature from "Flower Arranging Quarterly".

## General

Studio Techniques pt 1	Jan 10
Power to the People	Jan 23
Battery Tests	Jan 26
Electronics in Photography	Feb 13
Studio Techniques pt 2	Feb 52
The Ubiquitous Oscilloscope	March 13
Logic State Analyser	March S-4
Tracking Down Faults	March S-7
Service Updating	March S-11
Test Gear	March S-12
Service News	March S-14
Introduction to Lasers	April 10
Radiometric Exploration	May 10
Auto Sound Survey	July 23
IC Master Review	July 65
Tape Recording	Aug 18
Sabtronic DMM Review	Sept 19
Hum Loops	Sept 35
Polapulse Batteries	Sept 41
Oscilloscope Survey	Oct 8
Dolby C	Oct 27
TV Quality Control	Oct 45
IEEE Report	Dec 34
Early Radio in Canada	Dec 36

## Computers

So you want a computer, eh?	Feb S-6
ZX80 Review	Feb S-10
Modern Modems	Feb S-14
Choosing a Printer	Feb S-17
Computers, an Overview	Feb S-18
Selecting a Floppy Disk	Feb S-22
Interfacing made easy	March 44
Multiflex Z-80A	May 38
Computerized DJ	May 49
Typewriter Terminals	May 43
Computerese	June 24
Anatomy of a Micro	Aug 25
A Look at CP/M	Sept 23
I/O Devices	Oct 25
POKEing the ZX80	Nov 37
VIC-20 Review	Nov 39

## Circuit Theory & Components

Stores Directory	Jan 35
Alarm Circuits	Jan 58
Audio Filter Design	Feb 26
Piezo Electricity	Feb 28
VFET Applications	March 20
Catalog Survey	March 31
Photocells	March 50
Dominion Radio's Distributing	March 71
Test Meter Circuits	April 23
4017 Applications	May 66
Solder	June 15
LM3914 Circuits	July 14

How to Solder	July 18
Project Fault Finding	July 62
Wein Bridge Oscillator	Aug 35
555 Astable Circuits	Aug 39
Thick Film Circuits	Sept 10
GM Revisited	Sept 27
EX-OR Gates	Sept 39
Graphic Equalizer Design	Oct 19
Digital Design Handbook	Nov 10
PWM Explained	Nov 51
Band Pass and Beyond	Dec 18
Tubes	Dec 26
Speaker Design	Dec 52

## Science & Technology

Edison Effect	Jan 31
Voice Stress Analyser	Jan 45
Eddy Currents	April 61
Project Galileo	June 35
Story Behind Stereo	June 42
Michael Faraday	July 25
Current Affairs	July 29
Holograms	Aug 31
Black Holes	Oct 31
James Clark Maxwell	Nov 27
Canada in Space	Nov 31

## Projects Home & Automobile

Electronic Ignition	Jan 14
Coin Toss	Jan 41
Ultrasonic Burgular Alarm	Feb 22
Process Timer	Feb 49
Shark	March 81
Ultrasonic Switch	April 31
Auto probe	April 65
Chuffer	May 14
Nobell Doorbell	May 16
Touch Switch	May 18
Two Tone Train Horn	May 57
Flash Trigger	May 64
Freezer Alarm	May 71
Bargraph Car Voltmeter	July 22
Infra Red Alarm	Aug 11
Wired Sound	Aug 49
LED Tachometer	Sept 31
Antenna Extender	Oct 41
Headlight Delay	Nov 24
Musical Doorbell	Dec 31

## Projects Audio & Music

Fuzz Sustain Unit	Feb 31
Hum Filter	March 26
Drum Synthesizer	March 35
Stereo Image Co-ordinator	April 16
Guitar Preamplifier	May 20
Stereo Powermeter	May 25
1537A VCA	June 54

LED VU Meter	Sept 16
Tape Optimizer	Oct 35
Drum Machine	Nov 45
4 Input Mixer	Dec 50

## Projects Test Equipment

Digital Frequency Meter	Jan 18
EPROM Eraser	Jan 28
High Impedance Volt Meter	May 68
Jack Tester	May 70
Engineer's Stethoscope	July 25
Bench PSU	Aug 41
Pulse Generator	Oct 54
Universal Counter	Dec 10

## Projects Misc

High Speed Cassette Interface	June 11
Double Dice	June 19
Bicycle Speedometer	June 29
Universal Timer	July 10
Motherboard	July 49
Russian Roulette	Sept 25
Win Indicator	Oct 50
Alien Attack	Nov 21
Joysticks	Nov 59

## Designer Circuits

Low Power Flashing Light	Jan 17
Single Op Amp Oscillator	Jan 22
Power Supply with IC Regulator	Feb 35
Automatic Fader	Feb 59
Tremolo Unit	Feb 59
CMOS Logic Probe	March 19
Christmas Tree Light Flasher	April 69
Metronome	April 69
Morse Practice Oscillator	Oct 24
Cassette Pre-Amplifier	Oct 25
Waa-Waa Unit	Oct 38
Transistor Tester	Nov 17
Low Power Flashing Light	Nov 28

## Major Series

Audio Today	Jan-Dec
Into Electronics	Jan-Sept
What's New	Feb-Sept
Fun of Electronics	Jan-Dec
Computing Today	Dec-
Into Linear IC's	Dec-

Most of these articles are still available in ETI back issues at \$3.00 each. See page 48.



# HAMEG Oscilloscopes

Top Performance  
In Every Range

HM 307



**HM 307** **\$550.**  
 Y: Bandwidth DC-10MHz (-3dB) • Sensitivity 5mV-20V/cm (±5%)  
 X: Timebase 0.2s-0.2μs/cm (±5%) • Triggering 2Hz-30MHz (3mm)  
 Built-in component tester • Calibrator • Screen 6x6cm • 1kV

**HM 203** **\$760.**  
 Y: Bandwidth DC-20MHz (-3dB) • Sensitivity 5mV-20V/cm (±3%)  
 X: Timebase 0.2s-40ns/cm incl. x5 Magn. • Trig. 3Hz-30MHz (4mm)  
 Dual trace • X-Y Operation • Calibrator • Screen 8x10cm • 2kV

**HM 412** **\$1277.**  
 Y: Bandwidth DC-20MHz (-3dB) • Sensitivity 2mV-20V/cm (±3%)  
 X: Timebase 2s-40ns/cm incl. x5 Magn. • Trig. DC-40MHz (5mm)  
 Dual trace • Algebr. addition • X-Y Operation • Screen 8x10cm  
 Sweep delay • Overscan, Trigger, Delay indications • Trigger filter  
 Z-Modulation • Calibrator • Graticule illumination • 2kV

**HM 512** **\$2070.**  
 Y: Bandwidth DC-50MHz (-3dB) • Sensitivity 5mV-50V/cm (±3%)  
 X: Timebase 5s-20ns/cm incl. x5 Magn. • Trig. DC-70MHz (5mm)  
 Dual trace • Algebr. addition • X-Y Operation • Screen 8x10cm  
 Delay line • Sweep delay • After delay triggering • Trigger filter  
 Single shot + Reset • Overscan, Trigger, Ready, Delay indications  
 var. Hold-off • Z-Modulation • Graticule illumination • 12kV

**HM 812** **\$4630.**  
 Y: Bandwidth DC-50MHz (-3dB) • Sensitivity 5mV-50V/div. (±3%)  
 X: Timebase 5s-20ns/div. incl. x5 Magn. • Trig. DC-70MHz (0.5div.)  
 Dual trace analog storage with var. Persistence and Auto-Storage  
 Algebr. addition • X-Y Operation • Screen 8x10div. (7.2x9cm)  
 Delay line • Sweep delay • After delay triggering • Trigger filter  
 Single shot • Overscan, Trigger, Ready, Delay, AS indications  
 var. Hold-off • Z-Modulation • X-Guard circuit • Calibrator • 8.5kV

HM 812  
storage



We service all makes of Oscilloscopes:  
 TEKTRONIX • HEWLETT-PACKARD •  
 GOULD • ETC.  
 From coast to coast. Call us next time.

980 Alness St., Unit 35, Downsview,  
 Ontario (416) 661-5585 M3J 2S2

Circle No. 42 on Reader Service Card.

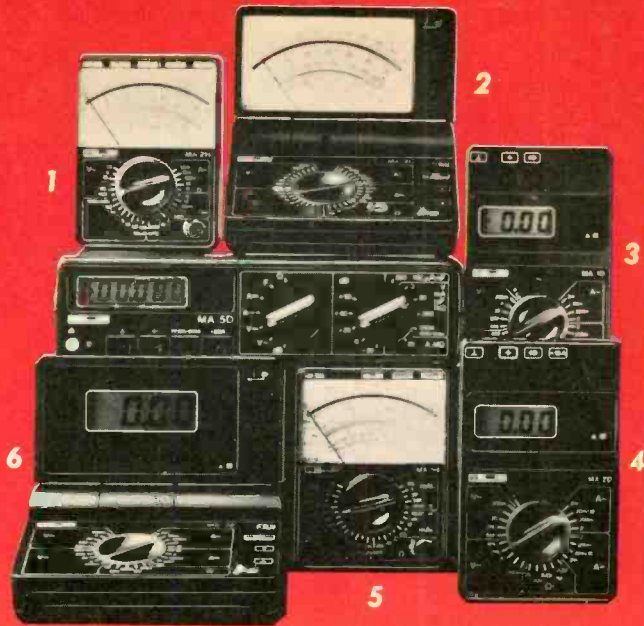

*New!*

## DIGITAL and ANALOG MULTIMETERS 20% OFF!

**1. MA2H**

Analog, 15A range  
 500V AC/DC, 1M ohm  
 200K uF

List Price \$140.00

**Sale Price \$112.00**

**3. MA1D**

3-1/2 Digits, 2A range  
 650 V AC/DC, 20M ohms

List Price \$164.00

**Sale Price \$132.00**

**5. MA1H**

Analog, 5A range  
 500V AC/DC, 1M ohm

List Price \$105.00

**Sale Price \$84.00**

**2. MA3E**

Analog, 10A range  
 1Kv AC/DC, 20M ohms  
 Folding Case

List Price \$265.00

**Sale Price \$212.00**

**4. MA2D**

3-1/2 Digits, 10A range  
 650V AC/DC, 20M ohms

List Price \$184.00

**Sale Price \$148.00**

**6. MA3D**

3-1/2 Digits, 10A range  
 650V AC/DC, 20M ohms  
 Folding Case

List Price \$298.00

**Sale Price \$238.00**

**Free 10 day trial, money refunded if not satisfied.  
 Mail personal cheque or money order to  
 Scarborough Address.**

Please add \$2.00 for postage and handling; Ontario  
 Residents only add 7% for Provincial Tax.  
 Sale Price in Cdn. dollars, F.S.T. included.



## radionics limited

1240 Ellesmere Road, Scarborough, Ontario  
 M1P 2X4. (416) 292-1575

**Montreal** **Ottawa** **Vancouver**

(514) 335-0105 (613) 521-8251 (604) 732-7661

**PRODUCT EXCELLENCE SINCE 1955**

Circle No. 14 on Reader Service Card.

# TECH TIPS

ETI is happy to consider ideas or circuits submitted by readers; all items used will be paid for. Drawings should be as clear as possible and the text preferably typed. Anything submitted should not be subject to copyright. Items for consideration should be sent to the Editor.

## Active 'Stereo' Bass Guitar J. Smalley,

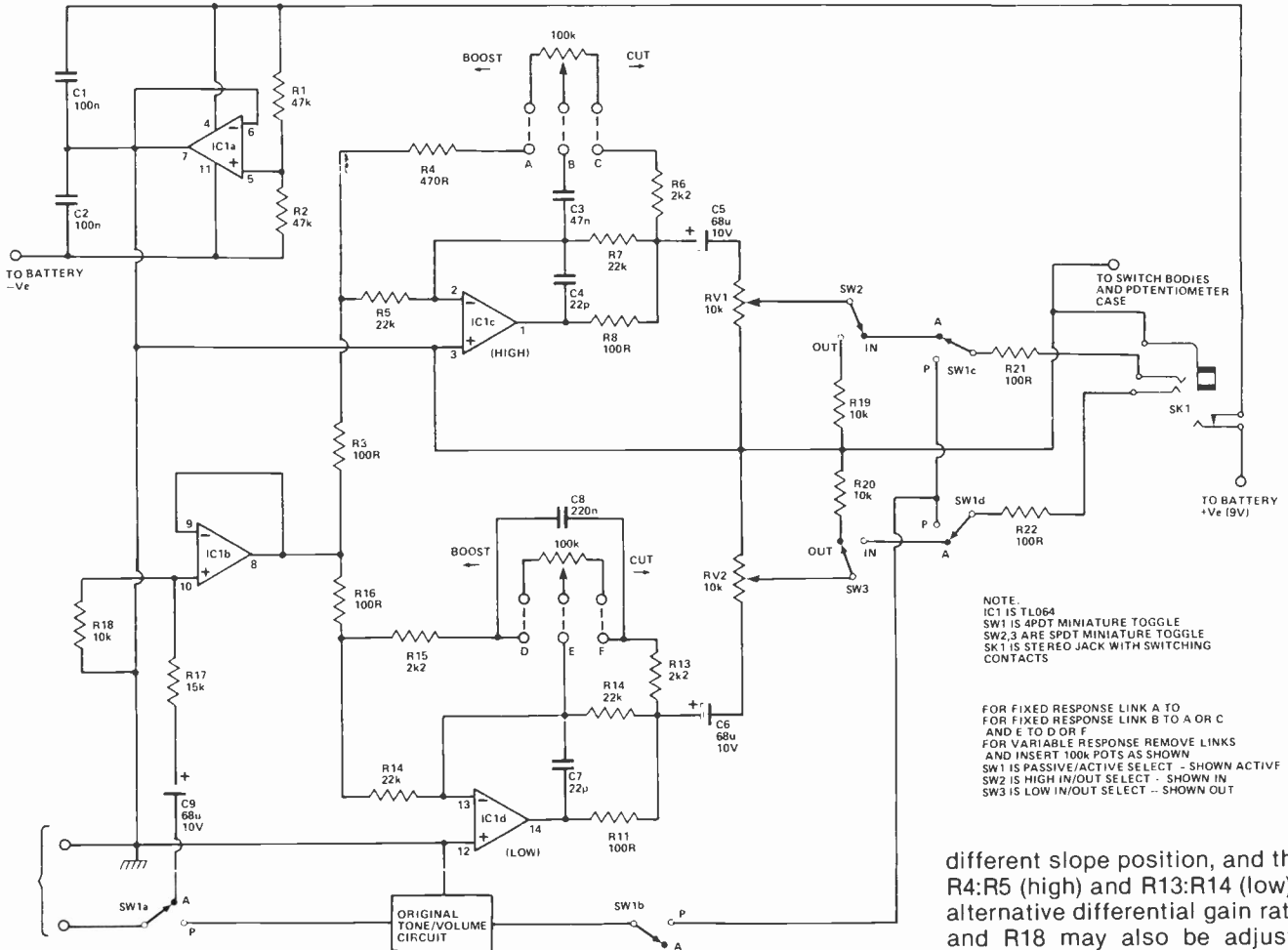

The circuit was designed to increase the musical capability and performance of a single pickup, passive bass guitar. While having a performance advantage over many 'off the shelf' active basses, this system also allows the musician to have his favourite bass converted to active status.

For optimum noise and consumption of battery current (650 uA quiescent), the TL064 BIFET quad op-amp was chosen. As a result, the circuit may be broken down as follows:

IC1a is a voltage follower and provides a low impedance 0V rail to bias the remaining amplifiers. IC1b is also a voltage follower and serves to isolate the two filters from the pickup. IC1c,d are the high and low filters respectively. The response of each filter exhibits a shelving curve which rolls at 6dB/octave. In rough musical terms, the slope break points are arranged so that bass notes are handled by the low filter and the higher notes by the high filter.

C3 or C8 may be adjusted for a

different slope position, and the ratio R4:R5 (high) and R13:R14 (low) for an alternative differential gain ratio. R17 and R18 may also be adjusted for pickups with different output levels. SW2 and SW3 allow the filters to be 'in' or 'out', and SW1a-d allows the original tone circuits to be connected to the output jack, and totally disconnects the electronics. Battery on/off is via a pair of insulated switching contacts on the stereo jack socket. In the instrument modification, the original jack socket is removed and a stereo version fitted in its place.

Musical use is very much a matter of experiment, but the best results were obtained when using a stereo lead with a twin amplifier.

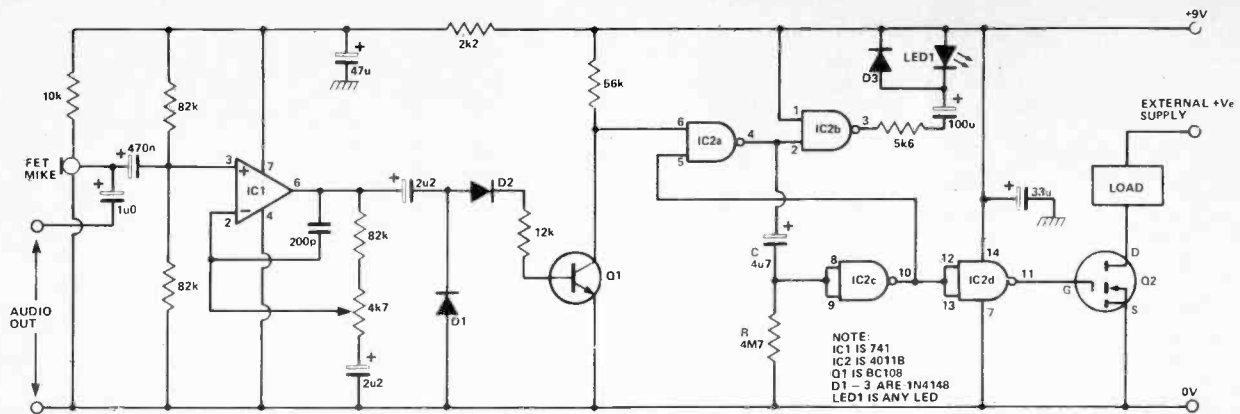

**Micro-power VOX**  
David Ian

Previously published voice operated switches seem limited in application due to their disproportionately high current requirements relative to the subsequently switched circuitry, eg battery operated baby alarms, portable transmitters and so on.

Including a visible indicator this design has, at 9V, a quiescent consumption of a meagre 800 uA, rising to a maximum of 1.6 mA when triggered, but is capable of cleanly switching at least 250 mA at up to 30V.

The 741 is wired as a decoupled, high-gain preamp, with RV1 controlling the switching point over a wide range of audio levels — anything from a whisper to a shout. The resulting voltage level triggers (via Q1) the monostable formed by three gates of a 4011. When the output of the third, inverting, gate goes high the N-channel VMOS FET, Q2, is enabled, thus completing the power supply of an external device.

The 'on' resistance of a VMOS FET is less than 2R ('off' is tens of megohms) and quite large currents may be safely handled before a heat-sink becomes necessary.

To aid setting to a given sound level the unusual, but current-saving, arrangement at the output of the remaining 4001 gate provides a single flash from LED1 whenever the monostable is triggered.

C and R were selected for the particular requirement of an 'on' time of 14 seconds; 1u0 and 1M0 gives approximately one second delay, depending on the individual gate's transition point. Any medium to high impedance microphone could be used; the electret type shown was handy.

NOTE:  
IC1 IS 741  
IC2 IS 4011B  
Q1 IS 2N3904  
D1-3 ARE 1N4148  
LED1 IS ANY LED

# No other 50-MHz oscilloscope gives you as many features as the LEADER LBO-517.

Compare the LBO-517 with all other 50-MHz oscilloscopes. Only Leader gives you total capability with:

- Calibrated delayed time-base
- Simultaneous display of main and delayed time-bases.
- Two trigger-view channels.

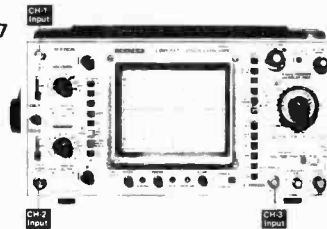

- 1 mV sensitivity (10 MHz).
- Alternate/composite triggering.
- Variable trigger hold-off with B-ends-A mode.
- 20 kV accelerating potential dome-mesh CRT.
- Two-year warranty.

## WAREHOUSING



Fact: No waiting for LEADER instruments. Off-the-shelf deliveries any-where in Canada from franchised distributors backed by Montreal and Toronto warehouses.  
Fact: Every LEADER instrument is carefully performance tested before shipment.  
Fact: LEADER instruments are specified by engineers in over 80 countries.  
Fact: A free trial use of any LEADER instrument is available to qualified companies.

## WARRANTY

Fact: Less than 1% of all LEADER products are returned for service during the 2-year warranty period.  
Fact: LEADER Instruments Corporation warrants its products to be free from defects in materials and workmanship for a period of two years from the date of purchase.

## omnitronix ltd.

2056 South Service Rd., Trans-Canada Hwy.  
Dorval, Quebec H9P 2N4  
Tel. (514) 683-6993 - Telex. 05-822692

6295 Shawson Drive Unit 7,  
Mississauga, Ontario L5T 1H4  
Tel. (416) 678-7170 - Telex. 06-968653

# SATELLITE TV



DEXCEL DXP 1000 SATELLITE SYSTEM

**\$2995**

THE DXP 1000 SYSTEMS IS THE LATEST IN STATE-OF-THE-ART SATELLITE COMMUNICATION COMPONENTS FROM DEXCEL. THE SYSTEMS CONSISTS OF THE DXR 1000 RECEIVER AND THE DEXCEL LOW-NOISE AMPLIFIER/DOWN CONVERTER. IT IS DESIGNED FOR AUDIO AND VIDEO RECEPTION SUPERIOR TO STANDARD EARTH FACILITIES.

A SIX-CHANNEL AUDIO SELECTOR ALLOWS THE COMPLETE SELECTION OF SIX SUBCARRIERS, AND THE DXP 1000 IS ABLE TO RECEIVE 24 DISTINCT CHANNELS WITH AMAZING CLARITY. THE 10-MHZ INPUT CONNECTOR ACCEPTS STANDARD COAXIAL TERMINATION FROM THE ANTENNA.



(604) 324-3343 Nu. West Video Systems Ltd.

6590 VICTORIA DRIVE, VANCOUVER B.C. V5P 3X9

Circle No. 13 on Reader Service Card.

# RAEKIT

RAEKIT  
1540

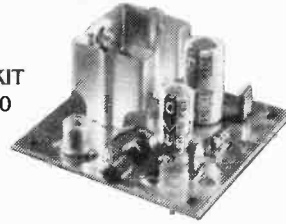

**Audio  
Amplifier**  
**\$14.95**

This new general purpose audio amplifier delivers up to 10 Watts of power. The wide supply voltage range of 5-18 Volts D.C. makes the kit ideally suited to automotive applications. The 150K high-impedance input is sensitive enough to be driven directly by a microphone, while the output load can be as low as 2 Ohms. The amplifier features short circuit and thermal overload protection, low noise, low distortion and an onboard volume control.

Circle No. 4 on your Reader Service Card for your  
**New RAEKIT Catalogue**

## MAIL ORDER INFORMATION

Payment by, VISA/Mastercard (Include signature, number and expiry date), cheque or money order. Add \$2.00 for shipping, B.C. residents add 6% Sales Tax.

Visit our new Edmonton store

R-A-E Industrial Electronics Ltd.  
3455 Gardner Court, Burnaby, B.C.  
V5G 4J7 Phone: (604) 291-8866



Circle No. 4 on Reader Service Card.

**YOU CANNOT SKI  
DOWN  
OUR  
SLOPES**



# VERO

But VERO SLOPING FRONT CASES do make attractive housings for many projects.

They are available in two sizes, made from high quality, two tone plastic, with anodised aluminium front panels. Both cases have integral circuit board fixing points in the base.

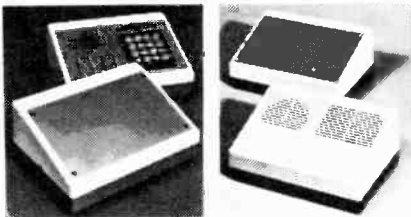

65 - 2523E and 75 - 1798K make ideal housings for test equipment, audio gear (faders, mixers, rhythm generators etc.) and control boxes.

See them at your local electronics shop and judge for yourself.

For your Free Catalogue circle No. 3 on Reader Service Card, Dealers reply on letterhead.



ELECTRONIC PACKAGING SYSTEMS LTD.  
Retail Department  
P.O. Box 481, Kingston, Ontario  
K7L 4W5 Telephone (613) 384-1142

# Avantek

**Lower cost  
120° K TVRO LNA.  
Model AWC - 4215.**



The Model AWC-4215 is specified for lower cost manufacture, yet offers the same top performance as the thousands operating in cable systems worldwide.

## Miniature transistor amplifier modules.

The GPD-200, -400, -1000 Series are in T0-12 packages, ready to operate in a microstrip circuit upon application of DC voltage. Bandwidths are 5 to 200 MHz., 5 to 400 MHz. and 5 to 1000 MHz.

## Varactor Tuned Oscillators.

The VT0-8000 Series covers 400 MHz. to 9600 MHz. in ten models. Thin film construction in T0-8 package.

Avantek is a leader in wide-band low-noise solid state amplifiers covering the frequency range from a few hertz to 18 GHz.



**Sheppard Agencies Limited**

P.O. Box 8, Georgetown, Ontario L7G 4T1  
Telephone: (416) 877-9846 Telex: 06-97500

Circle No. 1 on Reader Service Card.

**STORES DIRECTORY** *Continued from page 28*

**Thetford Mines**  
**Elektronixx Enr.**

276 Notre Dame Nord., Thetford-Mines, P.Q.  
G6G 5R9 Tel. (418) 338-2330  
EC, CA, RTV, TG, EK, MO  
We can etch any size, any kind of circuits with photoresist or silk screen. We buy electronics components from U.S., England, Japan, et. — so we have unusual parts. We have optical products, chemical products etc — all for electronic projects.

**Sherbrooke**

**Master Vox Ltd.**  
981 Wellington St. West. Sherbrooke, Que., Tel. (819) 563-9363.  
EC, MO, CAT, \$5.00

**Trois Rivieres**

**Matteau Electronique** ETI  
2045 Royale, Trois Rivieres, PQ, G9A 4L3 Tel. (819) 375-4779.  
EC, RTV, MO

**NEW BRUNSWICK**

**Moncton**

**Amphion Electronics Limited**  
4 Lockhart Ave., Moncton, N.B. E1C 6R1 Tel. (506) 855-3337  
EC, RTV, TG, EK  
We handle audio components, auto sound equipment, audio visual (video) equipment, amateur radio.

**Cam Gard Supply Ltd.**

P.O. Box 266, Rookwood Avenue, Fredericton, New Brunswick. E3B 4Y9. Tel. (506) 455-8891.  
EC, RTV, TG, EK, MO, CAT  
National supplier of electronic parts and components. Amphenol, Beckman, Belden, Buss Fuses, Delhi (General Instrument), Hammond, ITT Components, Mallory Duracell, Philips, Potter & Brumfield, Spectro, Texas Instrument, Westinghouse, Xcelite, 3m Cable & Connectors.

**Cam Gard Supply Ltd.**

15 Mount Royal Blvd. Moncton, New Brunswick. E1C 8N6. Tel. (506) 855-2200.  
EC, RTV, TG, EK, MO, CAT  
National supplier of electronic parts and components. Amphenol, Beckman, Belden, Buss Fuses, Delhi (General Instrument), Hammond, ITT Components, Mallory Duracell, Philips, Potter & Brumfield, Spectro, Texas Instrument, Westinghouse, Xcelite, 3m Cable & Connectors.

**NOVA SCOTIA**

**Halifax**

**Amphion Electronics Limited**  
2411 Agricola St., Halifax, N.S. B3K 4C1 Tel. (902) 429-7211  
EC, RTV, TG,  
We handle audio components, auto sound equipment, audio visual (video) equipment and amateur radio.

**Basic Computer Sales Ltd.**

6061 Young St., Halifax, NS, B3K 2A3 Tel. (902) 454-8344.  
CA, MO, CAT, Free.  
Stocking dealer for the following microcomputers: Texas Instruments, Hewlett Packard, Zenith-Heathkit, Atari software and computer books, OKI Data Printers.

**Cam Gard Supply Limited** ETI

3065 Robie St., Halifax, N.S. B3K 4P6 Tel. (902) 454-8581  
EC, RTV, TG, EK, MO, CAT  
National supplier of electronic parts and components. Amphenol, Beckman, Belden, Buss Fuses, Delhi (General Instrument), Hammond, ITT Components, Mallory Duracell, Philips, Potter & Brumfield, Spectro, Texas Instrument, Westinghouse, Xcelite, 3m Cable & Connectors.  
**MiniComp Systems Limited**  
5666 Stanley St., Halifax, N.S. B3K 2G1 Tel. (902) 455-5123  
CA, MO

Sales/Service/Programming of the Complete Commodore Computer line. Specialists in small business applications. Computer Bulletin Board and Program Exchange by Modem on (902) 455-2091 after 5 p.m. daily. Dealers wanted for our comprehensive business packages.

**Sydney**

**Fisher Electronics Limited**  
337 Welton St., Sydney, N.S. B1P 5S4 Tel. (902) 539-3949  
EC, RTV, TG, MO  
Learjet, Jensen, Sencore Test Equipment, Belden and Columbia wire, RCA Semiconductors, Bogen, University, Bearcat, Shure, Electrovoice, Astatic, Hammond, Blonder Tongue, Mirtone, Telex, Sony, Sprague, Tenco, Lenline.

**PRINCE EDWARD ISLAND**

**Charlottetown**

**Island Radio Centre Limited** ETI  
102 Queen St, Charlottetown, P.E.I. C1A 4B1.  
Tel. (902) 892-1291.  
EC, RTV, TG, EK, MO  
Bogen B & K, Switchcraft, Basf, Belden, Cooper Tool, C.G.E., Dual, ElectroVoice, Eico, Fanon, Hammond, I.R.C., J.B.L., Lindsay, Marsland, Sams, Paco, Sylvania, Shure, Sencore, Telex, University, Ungar, Uher.

**NEWFOUNDLAND**

**St. John's**

**Electronic Centre Limited** ETI  
115 Ropewalk Lane, St. John's, NF A1E 4P1  
Tel. (709) 579-5021  
EC, RTV, TG, MO  
Armaco, B & K, Beldon, Simpson, Centralab, Delhi, Dynacharge, Electrohome, General Cement, Hammond, Hitachi, IRC, Midland, Potter and Brumfield, RCC Schematics, ECG, Switchcraft, Tech Spray, Ungar, Vaco, Weller, Xcelite.

**ORION**

**Electronic Supplies Inc.**

**ELECTRONIC DISTRIBUTOR**

INDUSTRIAL — EDUCATIONAL — COMMERCIAL — HOBBYIST



Authorized distributor for RCA, COSMAC VIP

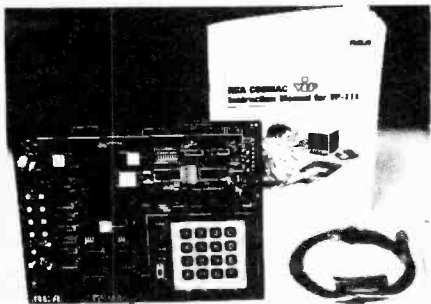

**New! VP 111 Microcomputer \$139.50**

- Assembled\* and tested.**
- RCA 1802 Microprocessor
  - 1K Bytes static RAM
  - Expandable on-board to 4K
  - Expandable to 32K Bytes total
  - 512 Byte ROM operating system
  - CHIP 8 interpretive language or machine language programmable
  - Hexadecimal keypad
  - Audio tone generator
  - Single 5-volt operation
  - Video output to monitor or modulator
  - Cassette interface — 100 Bytes/sec
  - Instruction Manual with 5 video game listings, schematics, CHIP 8, much more
  - Ideal for low-cost control applications
  - Expandable to full VIP capability with VP-114 Kit
  - \*User need only connect cables (included), a 5-volt power supply and speaker

**START WITH ORION FOR A NEW ERA IN THE WORLD OF ELECTRONICS**

We have the most complete selection of electronic components.

Full line of TTL, CMOS, Linear, ICs, Computer Interface, Support Chips and CPUs.

**INTERACT COMPUTER**

**16K LEVEL II**

**Just \$595.**



Write for our flyer on Interact Computer

A powerful microcomputer with a full standard 53 key typewriter style keyboard and built-in cassette recorder for use in entering and storing programs. Utilizing the versatile Intel 8086 micro processor, the Interact computer has 16K of RAM and 2K of ROM at its disposal. Output is on color on your own TV screen. Sound is also generated through your TV set and can consist of exhilarating computer beeps or two full octaves of music. This is truly a powerful computer capable of developing and handling a variety of programs, and with available software provides true educational stimulus (examples: Star Track, Chess, Concentration, etc.). The Interact computer offers the ideal opportunity to learn BASIC, the most popular computer language for small business and hobbyists, and with the use of the 84 page manual, you learn at your own pace.

**INSTALLATION:** Attach to antenna terminals of your color TV set and plug into 120 VAC wall outlet. Computer includes built-in RF modulator, FCC approved and UL and CSA listed

**PROGRAMING:** Most Micro-computers start you off with an abbreviated 4K BASIC, and then later you have to return to the more powerful language. Since this computer has 16K of RAM, we start you with Level II Microsoft 4.7 BASIC. BASIC is the most popular Micro-computer language using commands that are words we are ordinarily used to such as PRINT, NEW, GOTO (For go to), END, COLOR, JOY, INPUT, etc. To help you learn programming we have included an 84 page instruction manual plus a 20 page book of program examples.

**Educational and Entertaining!**

**ASCII Keyboard** Fully encoded, 128-character ASCII alphanumeric keyboard. 58 light touch keys (2 user defined). Selectable Upper-Case-Only **\$109.75**



**ASCII/Numeric Keyboard** ASCII Keyboard identical to VP-601 plus 16 key numeric entry keyboard for easier entry of numbers **VP-611 \$149.75**

**Cable: ASCII Keyboards to VP-711** Flat ribbon cable. 24 in. length for connecting VP-601 or VP-611 and VP-711 includes matching connector on both ends **VP-620 \$27.50**

**Cable: ASCII Keyboards** Flat ribbon cable. 36 in. length with mating connector for VP-601 or VP-611 Keyboards. Other end is unterminated. **VP-623 \$27.50**

**The ZX81 Personal Computer Kit \$149.95**

**NEW**

**The ZX81's advanced capability.**

The ZX81 uses the same fast microprocessor (Z80A), but incorporates a new, more powerful 8K BASIC ROM — the "trained intelligence" of the computer. This chip works in decimals, handles logs and trig, allows you to plot graphs, and builds up animated displays. And the ZX81 incorporates other operation refinements — the facility to load and save named programs on cassette, or to select a program off a cassette through the keyboard.

**New, improved specification.**

"Unique 'one-touch' key word entry: eliminates a great deal of tiresome typing. Key words (PRINT, LIST, RUN, etc.) have their own single-key entry. "Unique syntax-check and report codes identify programming errors immediately. "Full range of mathematical and scientific functions accurate

to eight decimal places. "Graph-drawing and animated-display facilities. "Multi-dimensional string and numeric arrays. "Up to 26 FOR/NEXT loops. "Randomize function. "Programmable in machine code. "Cassette LOAD and SAVE with named programs. "1K-byte RAM expandable to 16K. "Full editing facilities. "Able to drive the new Sinclair ZX Printer (to be available shortly).

**If you own a ZX80...**

The new 8K BASIC ROM as used in the ZX81 is available as a drop-in replacement chip. (Complete with new keyboard template and operating manual). With the exception of animated graphics, all the advanced features of the ZX81 are now available on your ZX80 — including the ability to drive the Sinclair ZX Printer.

**Orion Electronic Supplies Inc.**  
**40 Lancaster Street West**  
**Kitchener, Ontario N2H 4S9**  
**(519) 576-9902**

Master Charge & Visa, COD, Cheque, Money Orders accepted. CODs, shipping & insurance extra. Write for our FREE catalogue!

ought to be roughly equivalent to that emitted by a perfect radiator at a temperature of about three degrees Kelvin (minus 270° Centigrade). This doesn't seem to be a lot, (things that cold don't radiate much heat) but despite this it is measurable. In the mid-sixties, Penzias and Wilson measured this 'three degrees Kelvin radiation background', more or less by accident. At first they blamed poor readings on their equipment and on a pair of pigeons which had nested inside the horn-shaped antenna they were using!

That's it then. It looks very much as though the Big Bang theory is in fact the correct explanation of the origin of the universe. There are still unanswered questions, however.

**What's on Next?**

We've seen an explanation of how the universe began, but how will it end? Will it just keep expanding, getting larger and larger and cooler and cooler, or will gravitational attraction pull the galaxies back together again, the expansion of the universe slowing and eventually stopping, then 'going into reverse'? This depends on exactly how much matter there is in the universe. If there is enough, then the gravitational pull will be strong enough to make the universe collapse

back in again. If not, then the expansion will continue. In the former case, the universe is said to be 'closed', and in the latter case, 'open' Either way, the human race will certainly be long extinct before it happens. So we may never know which is the case. Some evidence seems to indicate that the universe is closed; some that it is open. Until fairly recently, it seemed that the universe was probably closed. However, it is now thought possible that the sub-atomic particles known as neutrinos might have mass, contrary to what has been thought for many years. There are so many neutrinos in the universe that, if this is the case, it might be enough to make the difference between an open and a closed universe.

We will finish with one more fascinating possibility. It has been suggested that, if the universe does collapse back on itself, it would first return to its original state of intense heat, and then possibly explode outwards again, beginning the whole thing all over again. We can imagine the universe forever exploding outwards, contracting again, exploding, contracting . . . Perhaps the universe we live in is formed from the remnants of the cycle before . . . Sadly we shall never know . . .

presented to the remainder of the crossover would be approximately 7.7 ohms which is close enough in practice.

**The Final Test**

Now that the bass performance has been optimised through a suitable choice of enclosure size and damping, the crossover points and slopes have been established, and the impedance and sensitivities of the various drivers corrected, the final subjective tests can begin. The importance of good subjective testing in loudspeaker design cannot be overestimated. The most common form of subjective analysis, other than simply listening to some good records, is an A-B test with other loudspeakers. Although this method can give some meaningful results, its validity is generally overestimated in my opinion. The best form of subjective testing is comparison to the original live performance. Simply recording a voice onto high quality recording equipment with a good microphone will tell you more about a loudspeaker than any amount of A-B testing.

If you liked this article, please circle Reader Service Card number 49. If you didn't, circle number 50.

**PROTEC**

---

**NEW**

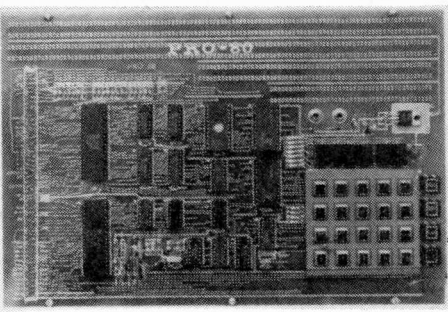

**THE PRO-80  
A COMPLETE  
Z-80 BASED  
MICROCOM-  
PUTER KIT  
FOR JUST  
\$195.00**

Hobbyist, technician, engineer, instructor, student, . . . . . Now you can "get into Z-80 microcomputing", thanks to the powerful and low cost PRO-80. This microcomputer comes complete with: Z-80 CPU; 2 parallel I/O ports (Z-80 PIO) 1 Kbyte RAM expandable on the board to 2K; 1 Kbyte monitor; another Kbyte EPROM available to the user; S-100 bus; wire wrap area for additional circuits; hex keyboard; 6 hex digit display; a voltage regulator (5 V., 1 A.) . . . . .

A detailed assembly and test manual (English or French) is also included. It explains all monitor functions, with several examples, diagrams, schematics and the integral listing of the PRO-80 monitor.

Also available: power pack: . . . . . **\$9.00**  
 technical manual only: . . . . . **\$7.00**  
 specify English or French.

Prepaid orders can be mailed to:  
 PROTEC, P.O. Box 271, St-Laurent, Que, Canada, H4L 4V6.  
 Or to our authorized distributor:  
 HTM, 2055 Peel St., suite 1100, Montreal, Que, H3A 3B8  
 Tel: (514) 844-1327  
 VISA accepted, please print your name, phone number, VISA number, expiration date and signature.

DEALER INQUIRIES INVITED

Circle No. 18 on Reader Service Card.

**ETI HUNTING FALCON**



In days gone by, falconry was the sport of gentlemen and kings . . . This noble and time-honoured tradition has never really reached these shores, and it is quite the pity, too. Just imagine the pride you'd feel standing in your own back yard while your very own hunting falcon swooped down upon unsuspecting neighbourhood dogs, cats and Toyotas.

For a limited time only, ETI is offering you the chance to experience the thrill of commanding your own bird of prey, with the new ETI Hunting Falcon/Magazine Binder. Swift of wing, sure of eye and made of genuine vinyl and cardboard, the ETI Hunting Falcon/Magazine Binder is the spitting image of the hunting birds of old to anybody suffering from cataracts. Release it from your arm, and it dives just like a traditional hawk. If it lands on a small animal, it will probably stun it. Plus, when you tire of the sport, and would rather go plug sparrows with a Howitzer, your ETI Falcon converts into a useful magazine binder that holds a full year's supply of ETI magazine. The new ETI Hunting Falcon/Magazine Binder will cost you not a farthing more than the old binder only used to go for; just \$6.75 plus 7% PST for Ontario residents. This includes postage and handling, so your falcon won't have to weary itself flying out to your abode.

**ETI Hunting Falcon/Magazine Binder**  
 25 Overlea Boulevard, Unit 6  
 Toronto, Ontario M4H 1B1

# DOMINION RADIO

## NEW WAREHOUSE SHOWROOM NOW OPEN!

151 Amber Street, Unit 6, Markham,  
Ontario.  
(416) 495-2528.

Our new location is in addition to our Downtown Store at 535 Yonge St.

Millions of \$\$\$  
worth of stock!

---

No downtown  
parking problems

Barry Greisman our new Manager  
will be pleased to serve you.  
Hours:

Monday-Friday . . . . . 10am-5pm

Dealer & Trade only.  
Cash & Carry.

Don't forget: our  
**30th Anniversary  
Celebration**  
is still in effect

---

1981 Technology at  
1951 prices





# CHOOSE ATOM POWER

**At work or play - everything you need in a personal computer**

**The Atom is a machine to be used. Every day, day after day. It's a full function machine - check the specification against others. It's rugged, easy to operate built to last and features a full-size typewriter keyboard.**

**Just look at some of the features!**

- More hardware support than any other microcomputer ● Superfast BASIC
- High resolution and comprehensive graphics ideal for games programmers and players\* ● Integral printer connection\*
- Software available for games, education, maths, graphs, business, word processing, etc.
- Other languages: Pascal, FORTH, LISP
- I/O port for control of external devices
- Built-in loudspeaker ● Cassette interface
- Full service/repair facility ● Users club

\* Expanded version only

### Optional Extras

- Network facility with Econet
- Disk ● PAL UHF colour encoder
- Add-on cards include 32K memory, analogue to digital, viewdata VDU, disk controller, daisywheel printer, plus many, many more!
- Power supply

### FREE MANUAL

The Atom's highly acclaimed manual comes free with every Atom and leaves nothing out. In just a while you'll be completely at ease with your new machine! Within hours you'll be writing your own programs.

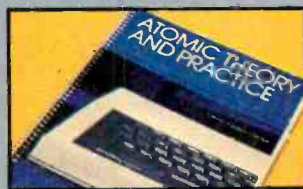

**ATOM SOFTWARE** is designed and produced by Acornsoft, a division of Acorn Computers, Trust the manufacturer to get the very best from its own product. Current software includes word processing, maths packs over 30 games, database, Forth and business packages.



**ATOM 12k RAM, 12k ROM**

**\$479.00**

(Black & White)

**\$549.00**

(Colour)



When you order your Atom we will include full details of all software packs and the optional hardware.

Mail Order to:  
Torch International Computers (Canada) Ltd., Suite 212,  
7240 Woodbine Avenue, Markham, Ontario, L3R 1A4.  
Or Call (416) 490-8622

Name .....

Address .....

Total amt encl ( ) Cheque ( ) Money order

Charge to ( ) Visa ( ) Mastercard ( ) American Express  
Card No. ....

Expiry .....

\$7.50 delivery - Ontario residents add 7% P.S.T.

Qty.	Item	Price
	Atom 12k RAM, 12k ROM (Black and White)	\$479
	Atom 12k RAM, 12k ROM (Colour)	\$549
	Power Supply	\$35

Delivery will be made by courier service where possible