

# Electronics Today

INTERNATIONAL JANUARY 1981

\$1.75

MM70924

Directory of  
Electronic Stores  
in Canada



**PREMIUM BATTERIES:**  
Are they good value?



**Also:**  
Studio Techniques ■ Electronic Ignition  
DFM Project ■ Alarm Circuits

# ARKON

electronics Ltd

LINEAR	TTL	CMOS
301..... 45	7400..... 40	4000..... 60
307..... 65	7402..... 50	4001..... 50
308..... 35	7403..... 40	4002..... 50
311..... 65	7404..... 45	4006..... 1.50
324..... 95	7405..... 60	4007..... 20
339..... 95	7406..... 50	4008..... 1.40
358..... 85	7407..... 80	4009..... 1.10
379..... 8.50	7408..... 50	4010..... 75
380..... 1.50	7410..... 30	4011..... 55
380 1/2..... 50	7414..... 65	4012..... 60
382..... 1.75	7416..... 50	4013..... 75
555..... 50	7420..... 45	4014..... 1.10
7555..... 1.95	7427..... 60	4015..... 1.50
556..... 95	7430..... 50	4016..... 90
565..... 1.75	7432..... 50	4017..... 1.05
566..... 2.95	7433..... 75	4018..... 1.50
567..... 1.75	7437..... 50	4019..... 1.60
709..... 50	7440..... 75	4020..... 1.50
711..... 1.00	7441..... 1.15	2021..... 1.50
723..... 1.55	7442..... 1.15	2022..... 1.80
733..... 1.75	7445..... 1.50	4023..... 50
739..... 1.40	7447..... 1.50	4024..... 1.50
741..... 50	7448..... 1.50	4025..... 50
747..... 75	7450..... 45	4026..... 1.90
1306..... 2.50	7451..... 50	4027..... 90
1312..... 95	7454..... 50	4028..... 1.75
1314..... 95	7473..... 65	4029..... 1.60
1315..... 95	7474..... 75	4030..... 50
1436..... 2.50	7475..... 75	4033..... 2.15
1455..... 95	7476..... 60	4034..... 4.25
1458..... 75	7479..... 95	4035..... 1.80
1488..... 1.75	7483..... 1.25	4040..... 2.15
1489..... 1.25	7484..... 1.50	4041..... 1.95
1496..... 1.50	7485..... 1.40	4042..... 1.70
1889..... 2.50	7486..... 65	4043..... 1.40
2206..... 5.25	7490..... 50	4044..... 1.95
3046..... 1.25	7491..... 70	4046..... 1.75
3140..... 2.50	7492..... 75	4047..... 1.75
3301..... 95	7493..... 75	4049..... 70
3302..... 95	7495..... 1.00	4050..... 95
3401..... 95	7496..... 95	4051..... 1.50
3900..... 95	74107..... 75	4052..... 1.75
3914..... 4.95	74121..... 60	4053..... 1.50
3915..... 4.95	74122..... 1.10	4060..... 2.50
3916..... 4.95	74123..... 1.05	4063..... 2.00
NSM3915..... 10.95	74125..... 95	4066..... 1.50
NSM3916..... 10.95	74138..... 1.50	4068..... 60
4136..... 1.60	74141..... 1.10	4069..... 50
5314..... 3.95	74145..... 1.50	4070..... 50
8629..... 6.00	74150..... 1.70	4071..... 50
13741..... 65	74151..... 95	4072..... 40
75477..... 1.50	74153..... 75	4073..... 50
76477..... 4.95	74154..... 1.65	4075..... 50
TL071..... 80	74155..... 95	4076..... 95
TL072..... 1.75	74157..... 1.10	4077..... 50
TL074..... 2.50	74161..... 1.25	4078..... 60
TL080..... 75	74162..... 1.75	4081..... 50
TL081..... 80	74163..... 1.25	4082..... 40
TL082..... 1.55	74164..... 1.00	4085..... 1.25
TL083..... 2.50	74165..... 1.50	4086..... 1.75
TL084..... 1.95	74175..... 1.30	4089..... 3.50
TL113..... 50	74176..... 95	4093..... 95
TL489..... 2.95	74190..... 1.40	4094..... 2.50
TL490..... 3.95	74191..... 1.50	4096..... 2.00
4N26..... 1.20	74192..... 1.35	4104..... 3.35
4N30..... 1.50	74193..... 2.25	4501..... 3.25
4N33..... 1.45	74194..... 1.60	4502..... 2.10
4N37..... 1.65	74365..... 95	4505..... 2.50
MCT2..... 50	74367..... 95	4508..... 3.50
SOC16..... 50		4510..... 1.95
TA7205AP..... 3.75		4511..... 1.25

4512..... 1.60
4514..... 4.95
4515..... 4.95
4516..... 1.45
4518..... 1.95
4519..... 95
4520..... 1.50
4522..... 2.10
4526..... 1.95
4527..... 1.65
4528..... 1.65
4531..... 1.90
4532..... 85
4536..... 7.95
4541..... 2.50
4543..... 2.25
4555..... 1.25
4556..... 2.50
4566..... 3.10
4578..... 2.50
4581..... 2.75
4582..... 2.50
4584..... 1.15
4585..... 2.75

74LS153..... 75
74LS154..... 2.25
74LS155..... 1.75
74LS157..... 75
74LS160..... 1.65
74LS161..... 1.65
74LS162..... 1.30
74LS163..... 1.75
74LS164..... 1.50
74LS165..... 2.20
74LS170..... 4.75
74LS173..... 1.35
74LS174..... 1.50
74LS175..... 1.10
74LS191..... 1.20
74LS192..... 1.85
74LS193..... 1.95
74LS194..... 1.95
74LS240..... 1.10
74LS241..... 2.15
74LS242..... 2.70
74LS243..... 2.15
74LS244..... 3.50
74LS245..... 7.50
74LS251..... 1.95
74LS257..... 1.10
74LS258..... 1.25
74LS259..... 2.65
74LS266..... 1.25
74LS273..... 1.95
74LS279..... 1.40
74LS280..... 2.95
74LS290..... 1.75
74LS293..... 95
74LS295..... 1.75
74LS298..... 1.95
74LS324..... 1.95
74LS348..... 5.25
74LS365..... 1.30
74LS367..... 1.30
74LS373..... 2.55
74LS374..... 2.75
74LS393..... 3.25
74LS395..... 1.65

LS
74LS00..... 40
74LS01..... 40
74LS02..... 50
74LS03..... 40
74LS04..... 55
74LS05..... 40
74LS08..... 65
74LS09..... 70
74LS10..... 60
74LS11..... 50
74LS12..... 40
74LS13..... 55
74LS14..... 1.25
74LS20..... 50
74LS21..... 55
74LS22..... 55
74LS27..... 60
74LS28..... 60
74LS30..... 40
74LS32..... 50
74LS37..... 55
74LS38..... 60
74LS40..... 60
74LS42..... 1.50
74LS51..... 45
74LS73..... 65
74LS74..... 80
74LS75..... 95
74LS83..... 1.30
74LS85..... 1.50
74LS86..... 95
74LS90..... 90
74LS91..... 1.50
74LS92..... 95
74LS93..... 1.50
74LS96..... 1.25
74LS107..... 70
74LS109..... 85
74LS122..... 1.10
74LS123..... 1.10
74LS124..... 1.35
74LS125..... 1.25
74LS126..... 95
74LS136..... 1.60
74LS138..... 1.60
74LS139..... 95
74LS145..... 2.60
74LS151..... 1.20

### VOLTAGE REGULATORS

7805..... 1.50
7808..... 1.50
7812..... 1.50
7815..... 1.50
7818..... 1.50
7824..... 1.50
7905..... 1.75
7912..... 1.75
7915..... 1.75
7918..... 1.75
7924..... 1.75
78M05..... 1.10
78M12..... 1.10
79M05..... 1.30
79M12..... 1.30
78L05..... 60
78L08..... 60
78L09..... 60
78L12..... 60
78L15..... 60
79L05..... 75
79L08..... 75
79L12..... 75
79L15..... 75
78H05..... 4.25
78GU..... 1.95
78HG..... 10.95

78MG..... 1.95
79GK..... 1.95
79GU..... 1.95
79HG..... 13.95
79MG..... 1.95
309K..... 1.95
317K..... 4.25
323..... 7.75
MC1469-R..... 1.25
CC1454-C..... 95

### SUPPORT

8131..... 2.35
8212..... 3.50
8216..... 3.60
8224..... 8.95
8226..... 3.75
8228..... 6.95
8255..... 8.95
6810..... 3.75
6821..... 8.50
1852..... 3.30
1854..... 13.95
1857..... 1.75
1858..... 2.25
1859..... 2.50

### EPROMS

2708 Triple Supply..... 9.50
2716 Single Supply..... 14.95
2716 Triple Supply..... 29.95

### MICROPROCESSORS

8080A..... 6.95
1802..... 19.50
6800..... 8.95
6802..... 14.95
Z80..... 12.95
Z80A..... 13.95
8085A..... 13.95

### MEMORY

2102-450NS..... 1.50
2102-250NS..... 1.90
2114-450NS..... 5.75
2114-300NS..... 6.25
2114-200NS..... 7.25
4116-300NS..... 5.95
4116-200NS..... 6.95
5101-450NS..... 6.50
T1B-0203..... 94.99

### MISCELLANEOUS

5501..... 40.00
MK5089..... 9.95
1771..... 59.95
R03-2513-001..... 13.95
R03-2513-002..... 13.95
KR2376..... 16.95
AY3-8910..... 19.95
AY3-1015..... 8.95
AY5-9100..... 4.95
11C90..... 19.95

Send certified cheque, money order, Charge, Master Charge ... include expiry date, card number and signature. We process C.O.D.'s for Canpar or Post Office. Minimum order \$10.00. Add 5% (minimum \$2.00) for shipping and handling. Any excess refunded. Ontario residents add 7% sales tax. All prices subject to change.

409 Queen Street West, Toronto, Ontario, M5V 2A5. 868-1315

OUR COMPETITIVE POLICY:  
IF YOU KNOW OF ANY PRICES BETTER THAN OURS,  
JUST TELL US AND WE'LL TRY TO BEAT THEM.  
ALSO, WE ARE OFFERING VERY ATTRACTIVE DEALS  
TO QUANTITY BUYERS.

319 COLLEGE STREET, TORONTO, ONTARIO, CANADA. M5T 1S2. (416) 921-5295

### LS-TTL (PARTIAL LIST)

74LS00 .29	74LS90 .57	74LS240 1.53
74LS04 .35	74LS93 .53	74LS241 1.48
74LS08 .35	74LS123 1.02	74LS244 1.76
74LS10 .30	74LS124 1.29	74LS245 3.49
74LS20 .33	74LS136 .75	74LS251 1.89
74LS30 .24	74LS138 .90	74LS253 .77
74LS32 .49	74LS161 1.11	74LS257 1.15
74LS47 .95	74LS163 1.11	74LS374 1.89
74LS48 1.50	74LS174 .57	74LS375 1.70
74LS74 .73	74LS175 .57	74LS377 1.85
74LS75 .55	74LS193 1.16	74LS640 3.40
74LS86 .68	74LS221 1.14	

### CMOS (PARTIAL LIST)

CD4001 .36	CD4024 .68	CD4508 2.29
CD4007 .55	CD4027 .64	CD4511 .94
CD4009 .69	CD4049 .57	CD4512 1.12
CD4010 .69	CD4050 .51	CD4514 2.54
CD4011 .36	CD4051 1.00	CD4518 1.76
CD4013 .51	CD4052 1.42	CD4522 1.16
CD4016 .51	CD4066 1.12	CD4528 1.09
CD4017 .94	CD4075 .38	CD4532 1.42
CD4018 .79	CD4081 .34	CD4543 2.49
CD4021 .95	CD4082 .29	CD4584 .68

CD4702 baud rate gen. 12.79

### MICROPROCESSORS, ETC.

Z80-CPU 11.30	8216 3.75	6802 14.95
Z80A-CPU 12.89	8224 4.45	6810 4.85
Z80-PIO 8.49	8226 3.80	6820 3.95
Z80A-PIO 9.99	8228 6.45	6821 4.85
8080A 6.95	8251 8.50	6850 4.99
8085 14.95	8255 7.95	6502 12.85
8212 3.55	6800 8.39	6522 12.85

IC SOCKETS: 14, 16, 20, 24, and 28 pin avail.  
A PENNY A PIN!

### MEMORY SPECIALS

● 4116 150nS, ceramic.....\$8.85	●
● 4116 200nS, ceramic.....\$6.30	●
*note: price is \$5.20 for 16 to 32	
● 4116 300nS, ceramic.....\$4.80	●
● 2102LFPC.....\$1.70	●
● 2114 200nS.....\$6.50	●
● 2114 450nS.....\$4.99	●
● 2716 450nS (triple supply).....\$19.00	●
● 2716 450nS (+5V only).....\$12.25	●
● 2708 450nS.....\$7.48	●
● 2732 450nS.....\$38.50	●

\*Remember, quantities are less\*

(GOOD NEWS: Now you can program your own 2708, 2716 or 2516 EPROM's right here in our store for FREE if the EPROM's are bought from us, or for \$2.00 per PROM if bought elsewhere.)  
Note: The PROM Burner you will be using is one of the many features of MULTIFLEX'S Z-80A Computer KIT. Please write for more info.

CD4096 8" floppy drive Shugart SA800 8" drive  
Single or Double sided Single sided  
Single or Double density Double density  
IBM 3740 compatible IBM 3740 compatible  
Soft Sectors \$649 Hard Sectors \$749

### WE HANDLE MAIL ORDERS

Send a certified cheque or money order (not cash).  
Minimum order is \$5 plus \$1 handling charge.  
Ontario residents must add 7% P.S.T. Master Charge and Card accepted: Send account no., signature and card expiry date.

### EXCELTRONIX KIT FEATURE

KIT NO. 15: PROGRAMMABLE LED CHASER \$19.95  
This kit is a complete 8-channel chaser which makes moving light patterns on its own LED array, or on larger displays (see below) which it can control.  
KIT NO. 16: PROGRAMMABLE CHASER EXPANDER \$16.95  
expands the LED chaser (above) to 16 channels, or even more. Add on as many expanders as you want.  
KIT NO. 17: OPTO-ISOLATED TRIAC BOARD \$23.95  
Connects to a chaser or expander to control 8 AC operated floodlights. Super for discos, rock shows.  
KIT NO. 18: "LIGHTNING BOLT" \$59.95  
connects to a chaser or expander to operate 8 built-in Xenon strobelights. Dazzling!

### COMPUTER PRODUCTS: MULTIFLEX TECHNOLOGY

SEE BELOW FOR FULL DESCRIPTION OF MULTIFLEX PRODUCTS  
CALL OR WRITE FOR MORE INFORMATION

### OHIO SCIENTIFIC

SUPERBOARD II MICROCOMPUTER.....\$389.00  
The first single-board microcomputer system.  
- Built-in video graphics interface, 8K Microsoft Basic, 4K of RAM expandable to 8K, audio cassette interface, full ASCII keyboard.  
- Fully assembled and tested, requires only +5V, 3A power supply and TV with RF modulator.  
RF MODULATOR KIT.....\$7.95

CHALLENGER CIP SERIES ALSO AVAILABLE, AND CIP-MF. See our ad in December ETI, or write for details.

### ANDICOM TECH. PRODUCTS

TRS-80 A/D CONVERTER.....\$217.00  
see December ETI for full line and prices.

WIRE-WRAP WIRE: black & brown \$3.85/100ft.



ALL PRICES ARE IN CANADIAN FUNDS, FEDERAL SALES TAX 9% INCLUDED



## NEW PRODUCTS FOR HOBBYISTS AND PROFESSIONALS

Advertisement

### Z80A Computer System:

Multiflex Technology, Inc. has introduced a new Z80A-based S-100 computer system designed with both hobbyists and industry in mind. By virtue of its high speed (4 MHz) CPU and S-100 bus system, it possesses both the computing power and infinite expandability desired by hobbyists, along with advanced features to assist hardware and software development engineers.

The basic system consists of a motherboard and an S-100 CPU card which can be purchased as a kit for \$375 or assembled and tested for \$450. The features of the motherboard include up to 4 S-100 card slots, a wire-wrap area for customizing, hex keyboard and display, a 2000 bit-per-second audio cassette interface (with two methods of calibrating your tape deck to insure proper operation), an optional RS-232 interface (with selectable baud rates), an on-board parallel interface with 24 I/O lines, and a built-in EPROM programmer for 2708, 2716, and (soon to be available) 2732 EPROMs. The processor board, which can be purchased separately, can be used to upgrade almost any S-100 computer. In addition to a fast 4 MHz Z80A microprocessor, it comes with 1K of RAM (with space for 3K more) and 8 EPROM sockets for either 2708 or 2716 devices. Two of these are normally occupied by the system monitor EPROMs. The memory on the CPU board can be located at any address by hardware jumpers.

Also provided is a powerful 4K system monitor to assist the user in machine-language programming. 14 monitor function keys on

the motherboard control such functions as moving and comparing memory in blocks of any size, examining and modifying memory locations, Z80A registers, and I/O ports, single-instruction step execution, breakpoints and delayed breakpoints (a powerful debugging feature), and calculation of relative branch offsets.

The system can be expanded using other Multiflex Products available now or in coming months, or S-100 boards from literally hundreds of other manufacturers.

### Dynamic Memory Boards:

A new series of dynamic RAM boards for the S-100 bus, using the latest memory interface technology, is also being produced by Multiflex. 16K, 32K, 48K, and 64K versions are available, with on-board refresh making them indistinguishable from static devices. The memory cards are S-100 standard and can be used with any S-100 computer. They also have a special bank-selection feature, which allows up to 8 boards to be used in a single system. If all boards are fully populated, an incredible 512K bytes (1/2 Megabyte) will be directly addressable.

### Logic State Analyzer:

One of the most sophisticated computer design and debugging tools, the logic state analyzer, is now available at a price the individual can afford. It allows you to take a high-speed "motion picture" of a digital system, and then replay it in slow motion to let you see what is really happening.

The analyzer, developed by Multiflex Technology, Inc. performs comparably to professional units costing over \$2500, but sells for only \$400. It works by monitoring 16 digital signals simultaneously, and recording 1024 consecutive 16-bit words after a user-specified bit pattern is detected. For example, if a program is running correctly until an instruction at location 3F18 is reached, and you don't know what happens after that, you could specify a trigger word of 3F17, and attach the Analyzer to the address bus. When 3F17 is accessed, the next 1023 addresses sent to the bus will be recorded. You could then slowly step through and look at each one, to see where your program actually went.

Alternatively, the data bus, control lines, or any other digital signals (which are stable with respect to a common clock) can be examined and recorded. You don't have to use the Analyzer on a computer at all. Dedicated logic devices, process controllers, or any complex digital systems can be troubleshooted with its help. Any number of Analyzers can be connected together to watch 32 bits, or 48, or 64, and so on. You can also set it up to trigger on any data that appears at the inputs, or to continuously collect data and stop when the trigger word is received.

The basic Logic Analyzer works at 5MHz, which is more than adequate for most microprocessors, but a 6.6 MHz version is also available, and even faster models are on the way. The Multiflex Logic Analyzers promise to revolutionize the design and debugging process for hobbyists and industry alike.

Multiflex products are available exclusively from Exceltronix, Inc.

Electronics Today International  
Editorial and Advertising Offices  
Unit 6, 25 Overlea Boulevard,  
Toronto, Ontario, M4H 1B1  
Telephone (416) 423-3262

Publisher and Editor  
HALVOR W. MOORSHEAD  
Assistant Editor  
JOHN VAN LIERDE

Advertising Manager  
MARK CZERWINSKI  
Marketing Representative  
SENGA HARRISON  
Advertising Representative  
JIM O'BRIEN  
Advertising Services  
CAROLYN WYATT

Subscription Department  
BEBE LALL  
Accounts Department  
NANCY ALLEN

Production  
SARAH-JANE NEWMAN  
CHERYL MAY

Contributing Editors  
WALLACE PARSONS  
STEVE RIMMER  
DICK CARTWRIGHT  
DAVID VAN IHINGER

#### INTERNATIONAL EDITIONS

Electronics Today International,  
145 Charing Cross Road,  
London WC2H 0EE, UK

Electronics Today International,  
Ryrie House, 15 Boundary St.,  
Rushcutters Bay, Sydney, Australia  
Elrad

Kommanditgesellschaft, Bissendorfer  
Strasse 8, 3000 Hannover 61, Germany  
Electronica Top Internationaal  
Postbus 93 Bilthoven, Holland

ETI Magazine is published by:  
Electronics Today International (Canada) Ltd  
Printed by:  
RBW Inc., Owen Sound, Ontario.  
Newsstand Distribution:  
Master Media, Oakville, Ontario.

**SUBSCRIPTIONS**  
\$16.95 (one year), \$29.95 (two years). For  
US add \$3/yr., other countries \$5/yr. Please  
specify if subscription is new or renewal.

**BACK ISSUES AND PHOTOCOPIES**  
Previous issues of ETI-Canada are available  
direct from our offices for \$3 each; please  
specify by month, not by feature you  
require. 1977 issues available: Feb, May  
July, Nov. 1978 issues NOT available: Jan,  
Feb, Mar, and Apr. We can supply photo-  
copies of any article published in ETI-  
Canada for which the charge is \$2 per  
article, regardless of length. Please specify  
both issue and article.

**POSTAL INFORMATION:**  
Second Class Mail Registration No. 3955.

Mailing address for subscription orders,  
undeliverable copies and change of address  
notices is:  
Electronics Today International,  
Unit 6, 25 Overlea Blvd., Toronto, Ontario,  
M4H 1B1.

# Electronics Today

## INTERNATIONAL

JANUARY 1981 Vol.5 No.1

## FEATURES

### Studio Techniques . . . . .10

What goes on inside a recording studio? We hear about multi-tracking, reverberation, vocoders and so on but how do they fit together? Steve Rimmer reports.

### Power to the People. . . . .23

Practically all electronic equipment needs some form of power: this may be from the line or from a battery. We look at the merits and applications of each.

### Battery Tests . . . . .26

Alkaline batteries are being pushed really hard by their makers but they're many times dearer than the traditional carbon types. Are they worth the extra money? We've been testing them.

### Edison Effect . . . . .31

Many famous discoveries were made by accident; this includes the Edison Effect. What makes this unusual is that this genius discovered the diode in 1880 but (unusually for him) failed to appreciate its significance.

### Directory of Electronic Retailers .35

We've been scouring Canada for details of electronics parts dealers — and there are a lot more of them than we anticipated. See inside for our 'yellow pages' listing of all those we were able to contact.

### Voice Stress Analyser. . . . .45

You can get an indication if someone is lying by analysing their voice electronically. John Van Lierde has been looking at a kit that is now available.

### Index for 1980 . . . . .52

Listing of our contents in 1980 plus corrections and amendments to projects during the last year.

### Into Electronics Part 4 . . . . .53

Ian Sinclair continues his series by examining the operation and principles of transistors.

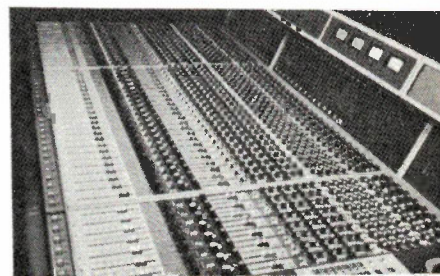

Studio Techniques, p.10



Battery Tests, p.26



Edison Effect,

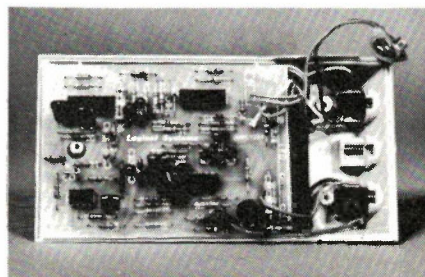

Voice Stress Analyser, p.45

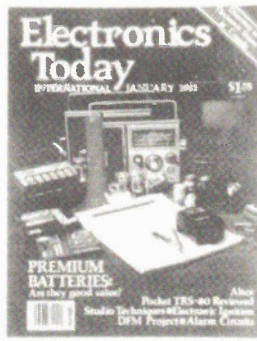

Cover: We've been checking out alkaline batteries to find out if they are good value.

ISSN 0703-8984

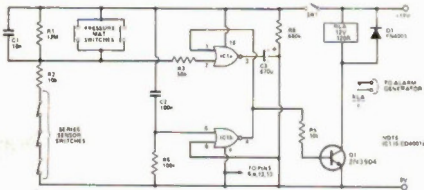

Alarm Circuits, p.58

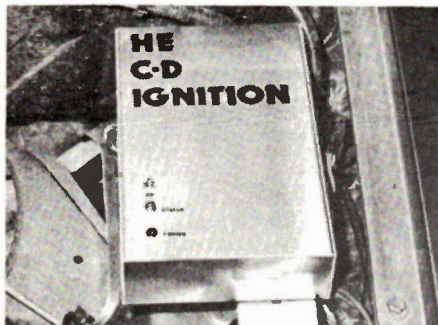

Electronic Ignition, p.14

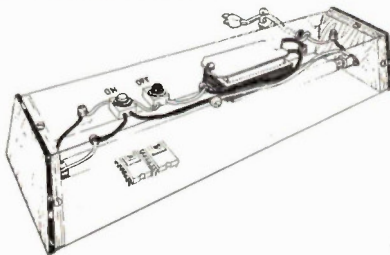

EPROM Eraser, p.28

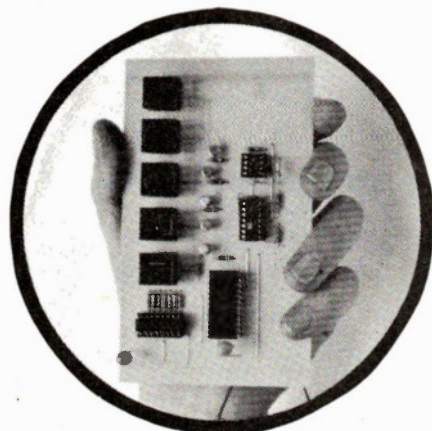

Digital Frequency Meter, p.18

## Alarm Circuits . . . . .58

Our circuits feature this month covers the area of security alarms. Their operation is described by Ray Marston.

# PROJECTS

## Electronic Ignition. . . . .14

Now, more than ever, you want to get the most from you gas dollar. Many, if not most of the 1981 cars use electronic ignition to peak the performance. Full constructional details inside.

## Digital Frequency Meter. . . . .18

A really neat, single board project which covers 20Hz to 2MHz in four ranges using just 4 ICs and 8 transistors.

## EPROM Eraser. . . . .28

Commercial EPROM erasers start at about \$100 but you can build your own very easily for about a third of this.

## Coin Toss. . . . .41

An inexpensive project to give you a pseudo-random choice from two possibilities.

# COLUMNS

## Designer Circuits. . . . .17,22

## Fun of Electronics. . . . .50

Paul Geiger

## Audio Today. . . . .62

Wally Parsons

## Tech-Tips. . . . .66

# NEWS / INFO

## News. . . . .7

## Subscriptions. . . . .40,48

## Computer Supplement Preview. . . . .47

## Reader Order Form. . . . .47

## Next Month in ETI. . . . .49

## ETI Special Publications. . . . .49

## ETI Book Service. . . . .51

## Babani Books. . . . .61

# ADVERTISERS' INDEX

Active Component Sales Corp . . . . .	72
A P Products . . . . .	8
Arkon Electronics . . . . .	2, 44
Audiovision . . . . .	34
BCS Electronics . . . . .	43
Bryan Electronics . . . . .	34
Classified . . . . .	70
Dominion Radio and Electronics . . . . .	6
Electronic Packaging Systems . . . . .	43
Electronics 2001 . . . . .	65
Equine Management. . . . .	8
Exceltronix . . . . .	3
Gladstone Electronics. . . . .	44
ICS Canadian . . . . .	34
Interfax Systems . . . . .	30
Len Finkler Limited. . . . .	71
McGraw-Hill. . . . .	29
Melco Sales . . . . .	7
Metermaster . . . . .	67
Montcalm Electronique Inc. . . . .	68
Noramel . . . . .	65
Omnitronix . . . . .	33,43,65
Orion Electronic Supplies . . . . .	69
Spectrum Electronics . . . . .	57
Tracker Industries . . . . .	69
Tuner Service Co. of Calgary . . . . .	8
Videoland . . . . .	34

**COPYRIGHT**  
All material is subject to worldwide copyright protection. All PCB patterns are copyright and no company can sell boards to our design without our permission.

**LIABILITY**  
Whilst every effort has been made to ensure that all constructional projects referred to in this magazine will operate as indicated efficiently and properly and that all necessary components to manufacture the same are available, no responsibility whatsoever is accepted in respect of the failure for any reason at all of the project to operate efficiently or at all whether due to any fault in design or otherwise and no responsibility is accepted for the failure to obtain component parts in respect of any such project. Further no responsibility is accepted in respect of any injury or damage caused by any fault in the design of any such project as aforesaid.

**EDITORIAL QUERIES**  
Written queries can only be answered when accompanied by a self-addressed, stamped envelope. These must relate to recent articles and not involve the staff in any research. Mark such letters ETI-Query. We cannot answer telephone queries.

**BINDERS**  
For ETI are available for \$6.75 including postage and handling. Ontario residents add 7% PST.

**SELL ETI**  
ETI is available for resale by component stores. We can offer a good discount and quite a big bonus, the chances are customers buying the magazine will come back to you to buy their components. Readers having trouble in buying ETI could ask their component store manager to stock the magazine.

**COMPONENT NOTATION AND UNITS**  
We normally specify components using an International standard. Many readers will be unfamiliar with this but it's simple, less likely to lead to error and will be widely used everywhere sooner or later. ETI has opted for sooner!

Firstly decimal points are dropped and substituted with the multiplier, thus 4.7uF is written 4u7. Capacitors also use the multiplier nano (one nanofarad is 1000pF). Thus 0.1uF is 100n, 5600pF is 56n. Other examples are 5.6pF=56p, 0.5pF=0p5.

Resistors are treated similarly: 1.8M ohms is 1M8, 56k ohms is the same, 4.7k ohms is 4k7, 100 ohms is 100R and 5.6 ohms is 5R6.

**PCB SUPPLIERS**  
This magazine does not supply PCBs or kits but we do issue manufacturing permits for companies to manufacture boards and kits to our designs. Contact the following companies directly when ordering boards. NOTE, we do not keep track of what's available from who, so please don't write to us for information on kits or boards. Similarly, do not ask our PCB suppliers for project help.

K.S.K. Associates, P.O. Box 54, Morriston, Ontario N0B 2C0.  
B & R Electronics, P.O. Box 6326F, Hamilton, Ontario, L9C 6L9  
Spectrum Electronics, Box 4166, Stn 'D', Hamilton, Ontario, L8V 4L5  
Wentworth Electronics, R.R. No.1, Waterdown, Ontario L0R 2H0  
Danocinths Inc. P.O. Box 261, Westland, MI 48185, USA.  
Exceltronix Inc., 319 College St., Toronto, Ontario, M5T 1S2  
Arkon Electronics Ltd., 409 Queen St. W., Toronto, Ontario, M5V 2A5.

A-1 Electronics, 5062 Dundas St. West, Etobicoke, Ontario M9A 1B9. (416) 231-4331.

# SPEAKER

# BARGAIN BLITZ!

Effective PRICE to JAN 31, 81

## Tweeters — Dome

		Regular Prices	Discount Prices 25% Off
AD00400T8/4	18MM	15.40	12.00
AD00800T8/4	18MM	14.25	10.70
AD00900T8/4	18MM	15.00	11.25
AD140T8/4	Polycarbonate	15.40	12.00
AD141T8/4	Textile	15.40	12.00
AD01600T8/4/15	Exposed Textile	19.25	14.44
AD01605T8/4/15	Square Exposed	19.40	15.85
AD0162T8/4/15*	Polycarbonate	17.40	13.05
AD0163T8/4/15*	Textile	17.30	12.98
AD01630T8/4/15	Textile	18.00	13.50
AD01631T8	Textile Square	21.20	15.90
AD01632T8	Paper	18.00	13.50
AD01633T8/4/15	Paper Square	21.00	15.75
AD01635T8/15	Diamond Cut Plt.	48.00	36.00

## Tweeters — Dome — Ferro Fluid

AD01404T8/4	Available	17.30	12.98
AD01624T8/4	Early	18.00	13.50
AD01634T8/4	81	18.00	13.50

## Tweeters — Cone

AD2273T8	2" Cone	5.45	4.09
AD2296T8	2" Cone	8.40	6.30

## Squawkers (Mid Range) Dome

AD0211SQ8/4*	5" Textile	39.90	29.93
AD02110SQ8/4		37.75	32.09
AD02150SQ8/4		44.25	33.19
AD02160SQ8/4		46.50	34.88
AD02161SQ8/4	Deluxe Version	52.15	39.11

## Squawkers — (Mid Range) Cone

AD5060SQ8/4*	5" Cone	28.00	21.00
AD5061SQ8/4	5" Cone	20.00	15.00
AD5062SQ8/4	5" Cone	28.65	21.41

## Woofers

AD4060W8/4	4" 30W	22.25	16.69
AD5060W8/4	5" 10W	20.55	15.41
AD70650W8	7"	31.20	23.40
AD70652W8/4	7"	28.50	21.38
AD08120W8	8"	8.62	6.47
AD80100W8/W8W	8" 40W	43.00	32.25
AD80601W8	8" 30W	25.95	19.46
AD80651W8/4	8" 50W	32.40	24.30
AD80652W8/4	8" 50W	30.00	22.50
AD80671W8/4	8" 50W	37.50	28.13
AD80672W8/4	8" 50W	36.00	27.00
AD1065W8*	30 W 10"	56.25	42.19
AD10100W8/4*	40 W 10"	75.00	56.25
AD10240W8/W8W	70 W 10"	67.50	50.63
AD10650W8	30 W 10"	54.00	40.50
AD12200W8	80 W 12"	78.00	58.50
A012240W8/W8W	70 W 12"	69.00	51.75
AD12250W8	100W 12"	85.50	64.13
AD12600W8	40 W 12"	46.80	35.10
AD12650W8	60 W 12"	52.00	39.00
AD15240W8/W8W	80 W 15"	69.75	52.31

## Combi Plates (Squawker & Tweeter on Aluminum Plate)

		Regular Prices	Discount Prices 25% Off
AD21160ST8	Diamond Cut	85.00	63.75
AD21161ST8	Flat Back	85.00	63.75

## Full Range

AD5061M8	10 W 5"	20.75	15.56
AD7062M8	30 W 7"	26.25	19.69
9710MC	20 W 8"	48.00	36.00
AD12100M8	25 W 12"	80.00	60.00

## Passive Radiators ("Drone Cones")

AD8000	Rubber Surround	14.25	10.69
AD8001	Rubber Surround	12.00	9.00
AD8002	Foam Surround	14.25	10.69
AD1000	Rubber Surround	34.50	25.88
AD10000/W	Foam Surround	15.00	11.25
AD12000	Foam Surround	18.75	14.06
AD1201	Rubber Surround	35.90	26.93

## Cross-Overs

ADF1500/8/4	2 way	9.75	7.31
ADF1600/8/4	2 way	9.15	6.86
ADF2000/8	2 way	9.15	6.86
ADF2400/8	2 way	7.50	5.63
ADF3000/8/4	2 way	8.85	6.64
AD3WXSP	3 way hi-Power	37.50	28.13
ADF6/5SP	3 way hi-Power	32.00	24.00
ADF7/3SP	3 way hi-Power	41.10	30.83
ADF500/4500/8	3 way	17.40	13.05
ADF700/2600/8/4	3 way	22.50	16.88
ADF700/3000/8/4	3 way	22.50	16.88
AD1SUBW	Sub Woofer	37.50	28.15

# NEW

# thandar

### PDM 35 Pocket Digital Multimeter

16 ranges; 1% basic accuracy **69<sup>95</sup>**

### DM 350 3½ Digit Multimeter.

34 ranges; 0.1% basic accuracy. **194<sup>00</sup>**

### PFM 200 Pocket Frequency Meter.

20 Hz-200 MHz 10mV sensitivity **189<sup>95</sup>**

### SC110 Single-Trace Portable Oscilloscope.

10 MHz band width; 10 mV/div sensitivity. **239<sup>00</sup>**

### DM 235 3½ Digit Multimeter

21 ranges; 0.5% basic accuracy. **109<sup>95</sup>**

### DM 450 4½ Digit Multimeter

34 ranges; 0.05% basic accuracy. **239<sup>00</sup>**



DOMINION RADIO & ELECTRONICS CO.  
535 Yonge Street,  
Toronto, Ontario M4Y 1Y5

## DOMINION RADIO & ELECTRONICS COMPANY

A DIVISION OF DRECO ELECTRONICS LTD.

THE HOME OF RADIO & ELECTRONIC SUPPLIES



# NEWS

## Motorola CMOS MPU

An 8-bit CMOS microprocessor, the first in a series of planned CMOS microcomputer parts, has been announced by the MOS Integrated Circuits Division of Motorola Inc.

The MC146805E2, has 61 basic instructions that are similar to those of the MC6800 microprocessor, plus a complete set of bit-manipulation instructions to allow any bit in RAM or any I/O pin to be individually set or cleared with a single instruction.

The low power requirement, twenty milliwatts at one megahertz and less than one milliwatt in standby, makes the part extremely useful for applications where power is a major consideration (portable instruments, telecommunications, point-of-sale terminals, appliance controllers, etc.) The voltage range is three to six volts.

On-chip functions include an eight-bit timer with software programmable seven-bit prescaler, 112-bytes of RAM, and a clock genera-

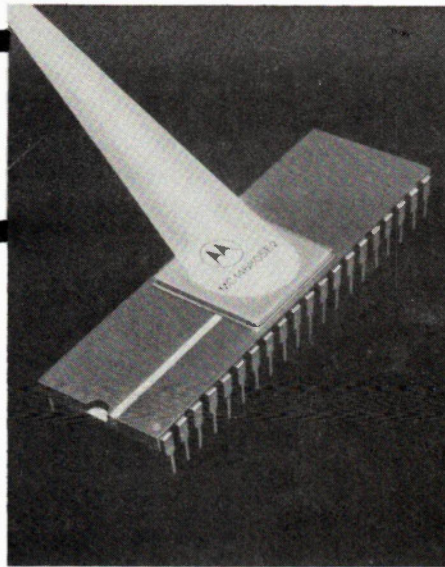

tor. The multiplexed bus has an 9K byte addressing range. A 2K byte CMOS ROM, the MCM65516, is a companion part that is also now available.

The processor is available in forty-pin cerdip or plastic packages, and is priced at \$45.00 in unit quantities (plastic). Availability is off-the-shelf from either factory or distributor stock. For further information contact your local Motorola sales office.

## Key Cat

Need a keyboard? Grayhill, Inc. has a new 34 page catalogue (no. 5) detailing their line of keyboards and pushbutton modules. If yer interested, write to A.C. Simmonds and Sons Ltd., 975 Dillingham Road, Pickering, Ontario L1W 3B2.

## New Webster

Webster Instruments Ltd. has a new office in British Columbia. The location is Suite 509, 4211 Kingsway, Burnaby, B.C. V5H 3Y6.

## A Source

Beeco Marketing Ltd offers a flyer containing various types of components, capacitors, CMOS etc. that they stock. This is really only of interest to retailers since the flyer refers to 100 and 1000 piece orders. Interested companies should write to Beeco Marketing Ltd., 5-11711 No. 5 Road, Richmond, BC, V7A 4E8.

## Safe as Houses

A reformed burglar tells how thieves operate and what can be done to protect yourself in a booklet titled 'Your Personal Guide to Home Security'. Copies are available from Robert J. Wood, Marketing and Sales Manager, ADT Security Systems, Suite 700, 4881 Yonge St., Willowdale, Ont., M2M 5X3.

## Learning

Heath has made available descriptive literature on their various educational products. In all there are five brochures: Learn to write your own programs in BASIC and Assembly languages; Fundamental electronics and test equipment; Advanced electronics (digital techniques microprocessors); Classroom educational programs; Problem solving mathematics.

Available at a Heath Electronic Centre or you can write to Heath Co., 1480 Dundas St. W., Mississauga, Ontario, L4X 2R7.

## Plastic Cat

Having trouble finding odd plastic bits like control & pushbutton knobs, handles and more? You should check out Harry Davies Molding Company's Catalogue of Standard Plastic Parts (catalogue no. 30). You can get it by writing to Atlas Electronics Ltd., 50 Wingard Ave., Toronto, Ontario M6B 1P7.

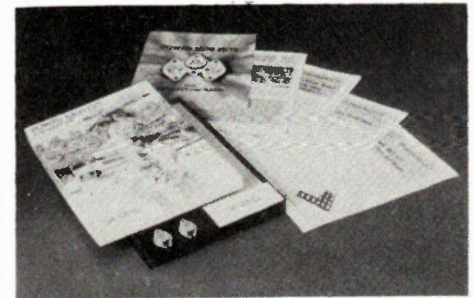

## Learning Power MOS

For those people eager to get on the power FET bandwagon, Hewlett-Packard offers the HPWR-6900. For \$60.31 (less taxes) you get two HPWR-6501 power FETs and a fistful of spec sheets and application notes. Write to Inquiries Manager, Hewlett-Packard (Canada) Ltd., 6877 Goreway Drive, Mississauga, Ontario L4V 1M8.

 **MITSUBISHI**  
AUDIO SYSTEMS

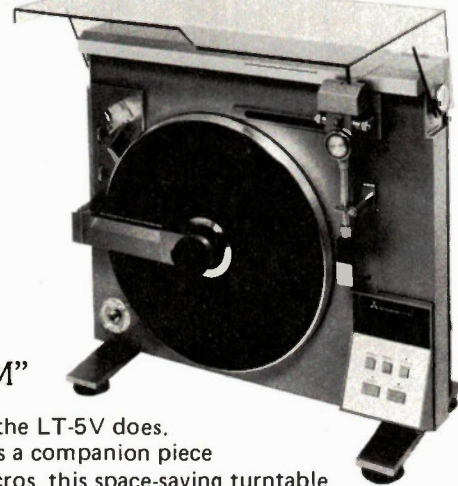

## "STAND UP AND PERFORM"

That's exactly what the LT-5V does. Designed primarily as a companion piece to the Mitsubishi Micros, this space-saving turntable operates vertically. This innovative unit features vertical linear tracking, with the stylus and tonearm travelling in a straight line across the disc. The brain of its fully automatic operations is an LSI computer on a specially developed chip. Low tracking error, fewer resonances and improved stereo channel balance are assured. A spring-loaded clamp secures the disc to the turntable, and the double-flywheel drive system ensures accurate balance. Fully electronic automatic control guarantees superb performance.

The LT-5V - Vertical Linear Tracking Turntable.

Sugg. List \$679.95

Expect more from Mitsubishi.

Melco Sales Canada Inc.,  
900C Denison Street,  
Markham, Ontario  
L3R 3K5  
(416) 495-7728

Circle No. 14 on Reader Service Card.

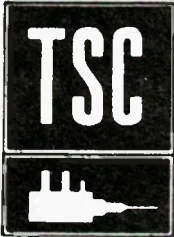

Serving The  
Technician  
Since 1971

— Tuners are  
our only  
business.

Tuners are cleaned ultrasonically, checked on new Wavetek sweep equipment for gain, bandwidth, oscillator tracking and AFC divergence. Shaft repairs a specialty. Affiliated with Tuner Service Corporation, Bloomington, Indiana. Only new parts are used, meeting manufacturer's specifications.

### \$16.95 VHF UHF Varactor

Same day service.

One year warranty on workmanship and materials on tuner repairs.

*Please do not send mounting brackets.*

### TUNER SERVICE Co. of CALGARY

P.O. Box 5823  
Station "A"

Calgary, Alberta T2H 1Y3  
(403) 243-0971

Circle No. 6 on Reader Service Card.



## HORSE PLAY!

KEL-CO CLASS  
THOROUGHbred  
COMPUTER!

The Racing Form is loaded with information; as per instructions, punch the right numbers into the computer and derive the ratings. The system provides a check list of "horse" factors so you can fine tune your selections.

You learn about the importance of purse levels and winning horses; fitness; and the different levels of racing among North American tracks.

A survey using the computer was recently conducted covering 200 races; obtain the results by sending \$1.00 to the address below.

**FULL PRICE: . . . . . \$125.00**  
(Includes 56 page manual)

Make cheque or money order payable to:

**EQUINE MANAGEMENT  
& INNOVATIONS**

P.O. Box 2214, Station D  
Ottawa, Ont. K1P 5W4

Phone Enquiries, Charge, or C.O.D.  
(613) 523-4202

VISA  MASTERCHARGE

Card No. . . . .

Expiry Date . . . . .

Signature . . . . .

Print Name: . . . . .

Address: . . . . .

\*Allow 2-3 weeks for delivery.

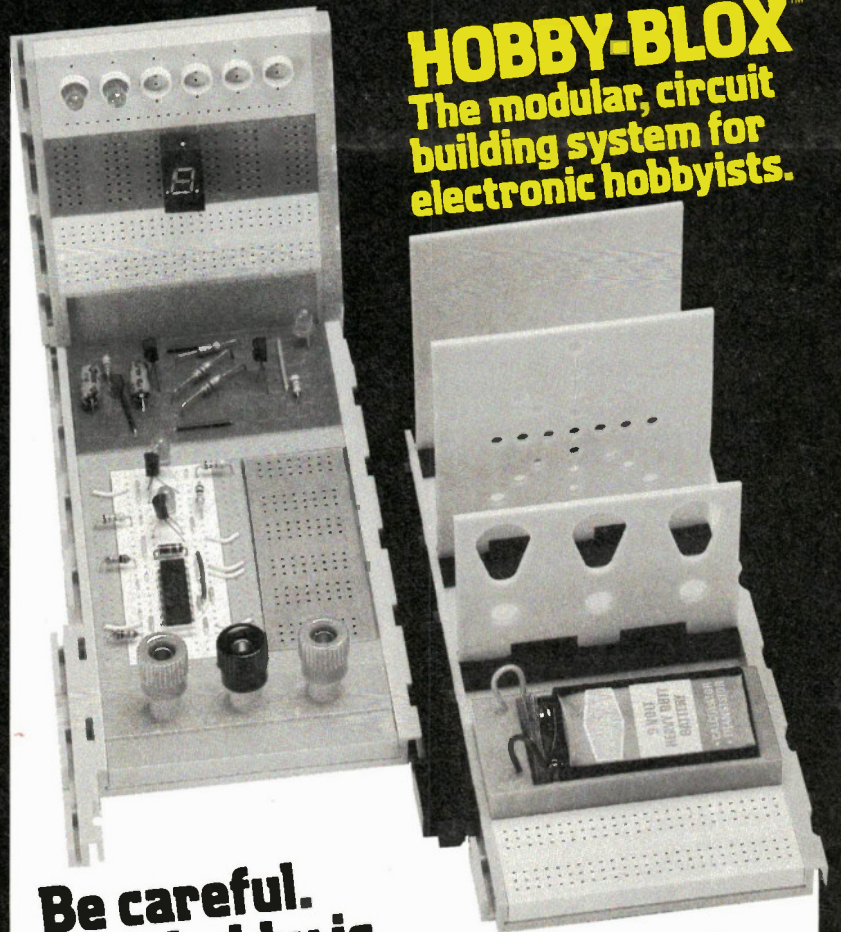

**HOBBY-BLOX™**  
The modular, circuit  
building system for  
electronic hobbyists.

**Be careful.  
Your hobby is  
about to become an obsession.**

The 14 modular units in the solderless, Hobby-Blox™ system are color-coded and cross-indexed. Projects go faster, easier.

For the beginner, there are two starter packs. One for integrated circuits, one for discrete components. Each has its own 10 project booklet.

Once you get into Hobby-Blox, look out. You're going to get hooked.

**For a free catalog, contact your local HOBBY-BLOX dealer listed below:**

Patents Pending.  
©AP PRODUCTS INCORPORATED 1980



**AP PRODUCTS  
INCORPORATED**

9450 Pineneedle Drive  
P.O. Box 603  
Mentor, Ohio 44060  
(216) 354-2101

**Free "Project of the Month" to Hobby-Blox purchasers!**

#### ALBERTA:

Calgary . . . . . (403) 287-0520  
Edmonton . . . . . (403) 454-5254  
Red Deer . . . . . (403) 346-2088

#### BRITISH COLUMBIA:

Kamloops . . . . . (604) 372-3338  
Vancouver . . . . . (604) 438-5545  
Vancouver . . . . . (604) 291-1441

#### MANITOBA:

Winnipeg . . . . . (204) 786-8481

#### ONTARIO:

Downsview . . . . . (416) 663-5563  
Downsview . . . . . (416) 663-5670  
Dresden . . . . . (519) 683-6147  
Kitchener . . . . . (519) 576-9902

Ottawa . . . . . (613) 820-9471  
Thunder Bay . . . . . (807) 345-7334  
Toronto . . . . . (416) 868-1315  
Toronto . . . . . (416) 921-5295  
Willowdale . . . . . (416) 221-6174

#### QUEBEC:

Montreal . . . . . (514) 731-7441  
Montreal . . . . . (514) 769-8861

#### SASKATCHEWAN:

Regina . . . . . (306) 525-1317  
Saskatoon . . . . . (306) 562-6424

#### MAIL ORDER:

London . . . . . (519) 432-8625  
Montreal . . . . . (514) 731-7441

Circle No. 5 on Reader Service Card.



## Micros In School

A survey, recently completed by The Ontario Institute For Studies In Education (OISE), has revealed that microcomputers are being used in more than 50% of Ontario schools. The survey reports that more than 652 machines are in use across the province. They are particularly invaluable in making rote learning more accurate, therefore leaving teachers free to show students how to use skills developed on the computer.

A major obstacle to increasing use of computers for educational purposes is the lack of adequate provincial funding. Indeed, more than 34% of the educators interviewed believed that additional funding would be required to expand current programs.

On the private industry side however, Commodore Business Machines will give schools a price break on Commodore PETs. Their 'three for two' marketing plan will donate one free PET to the school that purchases two. Because of this approach, 65% of the computers used in schools are PETs. There is also a Commodore Educational Advisory Board to facilitate communications between teachers and the company.

Teachers of school boards interested in the offer should contact James Dionne, Commodore Business Machines Ltd., 3370 Pharmacy Ave., Agincourt, Ontario M1W 2K4 or phone (416) 499-4292.

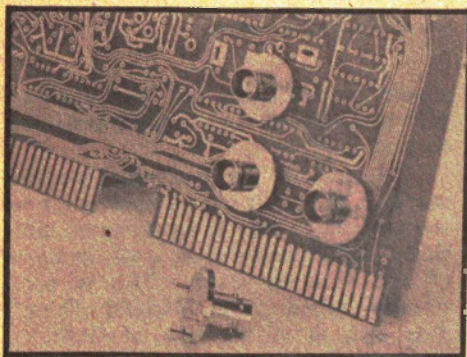

## PCB BNC

A family of low-cost pcb mounting BNC receptacles has been developed by Amphenol North America.

Applications anticipated for the receptacles include instrumentation and test equipment, communications equipment, and computer mainframes and peripherals, as an increasing number of circuit designs call for a direct interface between coaxial cable and PC boards.

Designated the Amphenol 31 Series, the receptacles mate with all other BNC-type connectors. Receptacles are affixed to PC boards quickly and easily by solder.

The receptacles are available for both 50- and 70ohm coaxial cable sizes. The receptacles exhibit nominal 50ohm impedance, with peak operating voltage of 500V. Dielectric withstanding voltage is rated at 1500V RMS. Thermal limits of the TFE insulator are  $-55^{\circ}$  to  $+199^{\circ}$ C ( $-67^{\circ}$  to  $+390^{\circ}$ F). Connector mating is via standard BNC two-stud bayonet lock.

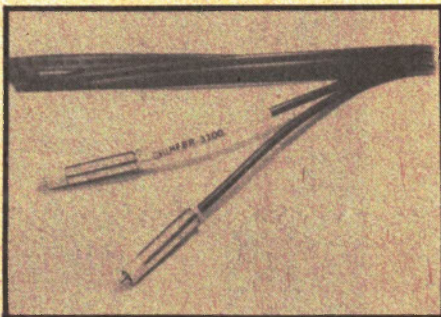

## Optical Zip Cord

Hewlett-Packard has introduced what we consider to be the greatest thing since zip lamp cord. Designated the HFBR 3100 Duplex Cable, it takes the form of two fiber optic cables designed for two way communication.

The duplex optical cables consist of two single fiber cables extruded together and surrounded by a common black polyurethane jacket to form an "easy-slit zip cord." A tracer along the outside of one of the two channels is for easy identification. The new HFBR-3100 is compatible with HP HFBR-1001, HFBR-1002, and HFBR-2001 transmitter and receiver modules.

Where two channel transmission is required, the dual-channel cable can be used in place of two HFBR-300 single channel assemblies. It weighs 17 grams per metre and measures 6.35mm by 3mm. The flexibility of HP's fiber optic cable has been maintained.

Cable lengths totaling up to 5 kilometres are \$6.75 per metre (Canadian). Connector installation is an additional \$67.64 per termination for up to 19 connectors. Write to Inquires Manager, Hewlett-Packard (Canada) Ltd., 6877 Goreway Drive, Mississauga, Ontario L4V 1M8.

## Intersil Short-Form Product Guide

Intersil, Inc. has published a 30-page condensed product guide which describes the company's broad line of analog, digital, horological and microprocessor integrated circuit products.

Devices in the new catalogue are fabricated with CMOS/LSI, MOS/LSI and bipolar LSI, in addition to a proprietary process relating to vertical MOS power FETs. Also included are data acquisition components and systems; memories, microprocessors, and development systems; multiplexers and switches; and discrete MOS and bipolar transistors.

This product guide is available from Lenbrook Industries Limited, 1145 Bellamy Road, Scarborough, Ontario M1H 1H5, telephone (416) 438-4610.

## LOOKING BACK

### NiCad Charger Designer Circuits, November 1980

C1 is incorrectly sited in the schematic. Its positive lead goes to the junction of D1,2, and its negative lead is connected to the transformer center tap. The original 'C1' is in fact the center tap connection to ground.

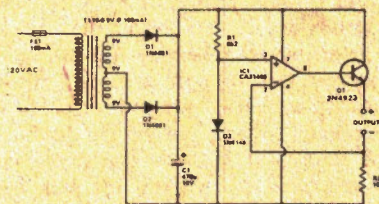

## The Last Word

We recently heard about a young university student who had been a keen electronics hobbyist since he was knee-high to a 6CW4. Apart from building the usual crystal sets, hee-haw sirens, home burglar alarms etc, he was a keen listener on the shortwave bands.

After some years doing quite nicely thank you at his philosophy course in university, he felt the need to do something a little more substantial with his hobby. He threw himself wholeheartedly into studying for his amateur radio licence.

Unfortunately, after some time he had to postpone sitting for his amateur licence exam as his Professor said his extracurricular activities were interfering with his university studies.

The poor lad had to put Descartes before the Morse!

## Mars; "It's a Dessert"

For all intents and purposes, the Viking mission of Mars is almost over. After photographing 97% of the planet's surface (some 52,000 pictures in all), scientists have found no evidence of Earth-like life.

Orbiter and lander craft have indicated that there is very little water in the atmosphere, although there are large amounts under the planet's surface in the form of ice. Additionally silicon (as in sand) comprises 45% of the planet's surface.

The project, which has cost \$1 billion so far, is not totally over. A full time staff of twenty-five Jet Propulsion Lab personnel will monitor meteorological data from the remaining operational lander craft until 1994. It seems, however, that further studies of the Red Planet are off for now.

# STUDIO TECHNIQUES

Do you feel a burning need to express yourself in music? Are you a band without a demo. If so then this article by Steve Rimmer is for you.

THOSE LITTLE K-Mart cassette tape recorders that go for about thirty dollars during the Greatful Dead birthday sale . . . they do have their limitations. You probably wouldn't catch the Beatles cutting their reunion disc on one, and probably for good reason. For one thing, if everyone were to get close enough to the "three way omni-directional all electronic built in condenser sonic transducer microphone" to be heard, Paul's bass would prod George in the eye, causing him to exclaim "My Sweet Lord" . . . which, as I recall, he did after their last breakup. John might get out the razor blades to edit the tape into "Revolution No. 10", only to discover that, at 1 7/8 ips, the width of blade encompasses three or four bars of music, or Yoko screaming hysterically . . . whichever the case may be. In order to minimize Ringo's beefing about not getting paid as much, the producer might very well want him to stay in France 'till the vocals get down, and then have him stick in the drums after the others have departed for New York, New Delhi, jail, or whatever . . . quite unlikely, as overdubbing is just not one of the features of a recorder where the power cord is extra.

If all there were were K-Mart cassette recorders, friends . . . well, we wouldn't even have a hope of some distant reprieve from Wings.

Fortunately, of course, tape is available in widths exceeding 3/16 of an inch, and tracks can surmount two in number. Some machines are even built without little plastic tape covers that break off after a few weeks. Sell the silver, mortgage the Sears "Assemble-It-Yerself" toolshed, and those two paltry channels can be multiplied to four, eight, sixteen, twenty-four . . . add a combiner, and go to forty-eight. Of course, these systems are much more complex than their humble predecessors. Not a built-in mike in

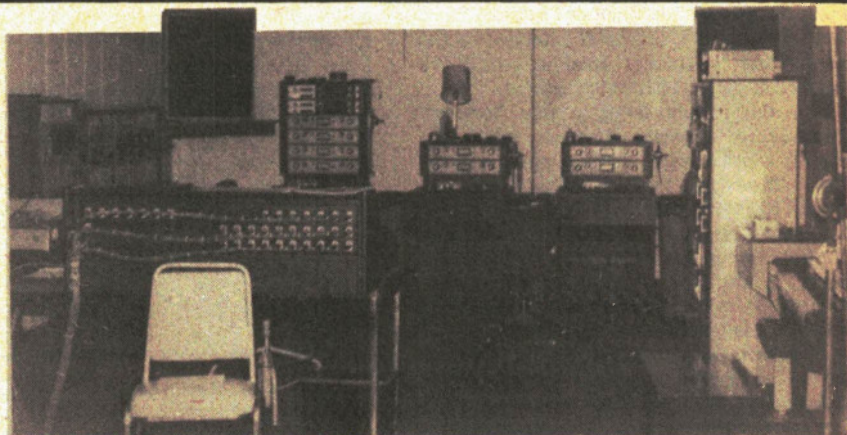

In actual life you don't need a lot to get into studio type recording.

the lot. And the batteries aren't included.

You'd think for three quarters of a million dollars, they wouldn't be so cheap.

In the following strange but true tale, we will have a peer at the fascinating world of multi-track recording. Very little will be said about those forty-eight track set ups, though, because the emphasis here is on getting the studio running for less than the price of a small war. A small studio is well within the reach of anyone with sufficiently long arms, and a bit of loose cash. Alternately, try sufficiently long fingers and someone with a loose wallet. Either way, with a bit of hardware, and some technique, the potential of a personal recording facility is quite phenomenal.

For the purposes of this treatise, we'll assume that a "studio" consists of a minimum level of hardware, and that all of it more or less works. It will also be assumed that everything is fairly well understood, that words like "EQ" and "master fader" are not complete mysteries. The studio need not be really heavy . . . no need to have gone to the Thunder Sound garage sale for equipment, or anything bourgeoisie like that. We'll be dealing, for the most part, with a four track to two track scene, and only the basic effects. An eight channel board

should be sufficient, and, four channels will probably do in a pinch, providing they all work.

The art of the personal recording studio is in that it can be used as a time warp system, a way to be doing multiple things simultaneously, at least, in terms of the finished reality. This is occasionally called "The Oldfield Thing". You can, as in the case of Oldfield's "Tubular Bells", play all the parts in a piece yourself, using the ability of a multiple track recorder to overdub, to make them all come together. The advantages of this are subtle, but real, especially if you are into fairly complex work. First off, you, presumably, know what you want to do. If you do everything yourself, you needn't try to explain your brainchild to other musicians, (who may well think you've been scratching your ears too deep, and have dented your brain). Even when presented with scores, musicians tend to want to personalize a piece, so even if they do understand what you're raving . . . er, talking about, there will likely be something lost in the translation anyway. Secondly, it's a lot easier to go through dozens of hours of experimentation and general fooling around with a bit if you don't always have to be buying coffee for the rest of the band. Third, overdubbing is tighter than live performance, because you can

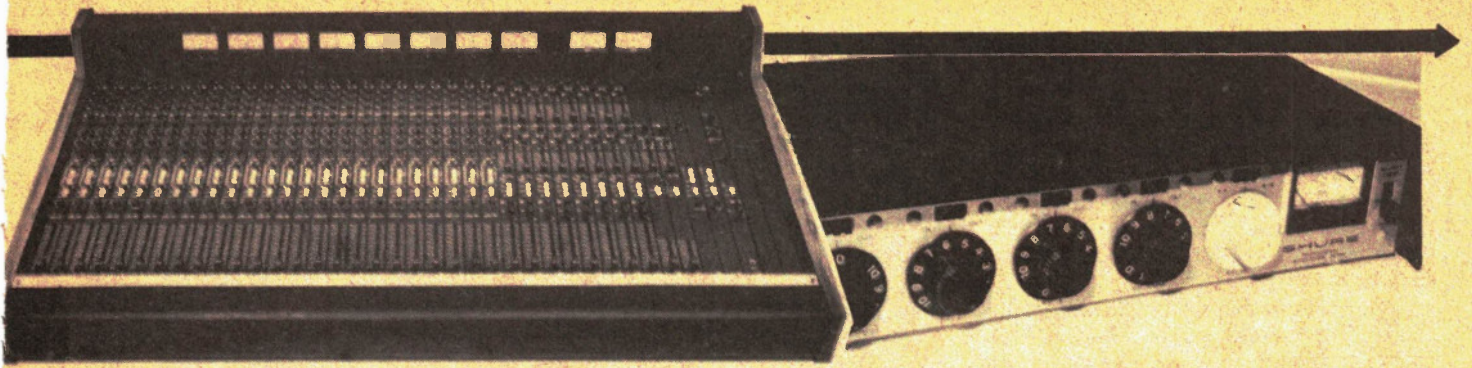

(Above) A multichannel studio mixer. This unit accepts up to 24 inputs and can place them anywhere on the stage.

(Right) A smaller professional type mixer. The Shure M67 accepts four channels, AC or battery operation, and isolated output.

play the exact same three bars over 10<sup>19</sup> times, if that's what it takes for you to know when to come in with the kazoo solo. In playing live, there is always some variation. Lastly, doing the personal studio trip requires less space, because there's only one of you, (one should hope) and less bread, because recording studio time is getting rather steep, especially if all you're doing is fooling around. Overdubbed stuff has the potential for being a lot more unusual, simply because there are no constraints or pressures about how much it's all going to cost when the Visa bills roll in.

On the negative side, the spontaneity of this type of thing is usually buried in the black somewhere, because everything gets planned and rehearsed over and over. This is a drag for pop material, but gets to be of less importance the closer you get to the neo-classicist, headspace instrumental trip.

It is, for most basement studio gnomes, in this kind of music where the personal studio really does become an instrument in itself, and thus, an extension of the performer. Most of the things we're going to look at here relate to this type of piece.

### Signals

There are two places from whence to obtain signals, these being microphones, and electronic things, like guitars, synthesizers, other tape recorders, and so on. There are several important points to consider when figuring out where your sound is going to come from.

The first rule I find myself working under is that acoustic is always best. Noises that actually exist as noises before reaching the speaker are always fraught with sympathetic resonances, overtones, formants, and such, and are therefore a lot more complex and interesting than would be electronically synthesized equivalents. Subconscious perception of what is happening in a sound, especially by someone who's been out of the Black Sabbath genre for a few years and has recovered from his deafness, can be quite detailed, and the tiny little intricacies

inherent in natural phenomena lend a lot to the listener's experience of what's coming down.

Microphones are kind of tricky. For one thing, studio quality sound dictates studio quality mikes . . . the trick with these is in affording them. Neumanns, which are really superb mikes, go for about a grand and a half. Worth every penny of it, of course, but a couple of these little mothers can make a rather large dent in the ol' piggy bank. Even the mouldy old AKGs I use go for about four or five hundred new. Sennheisers, which are fairly acceptable, are about two fifty each. Most mikes below this range are stage mikes; the econo Shures, Sonys, Electrovoices, and so on. In a hall, their imperfections can be masked by assorted room noises, a screaming Strat or two, and, hopefully, even applause. However, in the studio, where every scrap of noise and any little hiccup in the frequency response tells, cheap mikes can mortally wound the karma of the thing even before it gets rolling.

Miking an instrument requires between one and eight mikes, depending upon what instrument is in question, and exactly what sound you are after. Keep in mind that studio mikes are highly cardioid, or, at least are usually used set up in this pattern, and will only pick up what they are aimed at. Thus, a mike hung over the bass strings of a piano won't even touch the treble notes. This is actually quite an asset, for, while requiring complex mike arrangements, it permits one a great deal of control over the mix of the instrument as it hits the tape.

Miking a piano is probably one of the toughest bits. A grand isn't all that much of a drag, because you can hang down over it, and, possibly, stick a few mikes under the soundboard. An upright, however, which is what most of us poor, benighted souls are blessed with, due to spacial considerations, isn't really designed for electronic interface at all. There are a couple of approaches to the task.

The best trip is to pull the piano away

from the wall, out by at least four feet, and hang a blanket or carpet behind it, to keep the wall from causing a lot of undue liveliness. The instrument is then miked from the rear, with the mikes fairly low to the floor and a foot or two from the sound board. There are a couple of things to be overcome in picking up keys. The first is that the sound behind a piano is rather . . . hearty. Like, loud, man. We don't want anything more coming back as reflections, which will possibly overload things and, secondly, muddy up the presence. Also, because the mikes are to be lodged in rather cramped quarters, it's fairly easy to lose some of the strings, because each frequency comes from a slightly different part of the soundboard. This last is a fairly subtle gremlin, because all the notes will come through, but any that have, in fact, been missed on the first pass will be picked up as reflections and, thus, won't be as bright.

It might be necessary to use up to four mikes, depending upon the individual instrument and the scope of the piece to be played.

The other way to mike an upright piano is to suspend a few mikes in through the open top of the case, or to remove the front, and point them at the strings with booms. This technique does not avail one of the most natural sounds imaginable; in fact, it sounds a little freaky in most cases. With a bit of artificial liveliness, reverb or delay added, a very thick texture can be obtained . . . a peculiar, complex organ sound is possible, if everything is set high.

The positioning of the piano on the stereo stage, that is, how you set the pan pots on the board, can be used to indicate its importance in the piece. If it's all crowded off to a corner, it will not be perceived as being as strong as if it's dead centre. If the piano is the centre of the work, then it can be set up to cover the whole state, using a kind of interesting arrangement. The bass mike is panned all the way to the left, the treble all the way to the right and the mid range mikes set half way between. Thus, as the notes ascend on the keyboard, they also move across the stage. It sounds very spacey in headphones.

With each mike handling only a chunk of the spectrum, it's cool to turn on the EQ's and filter out the bits in which there is no sound. This will hold down the noise and increase the sense of spacial distribution, if the keyboard is set up to span across the stage.

Miking drums is similar to doing the piano. One usually has a mike on each drum and one over the cymbals. The snare presents the biggest problem, because most snares leak to some degree, which "spits" air at the mike. It is often necessary to use a highly cardioid mike some distance from the snare. Alternately, use congas and blocks, which are more interesting and far less of a hassle.

One generally sets drums up for ease of playing. However, as with the piano, their relative positions can be moved around on the stereo stage by panning the mikes. Thus, the drums, too, can pan across the room as they ascend in pitch, if so desired. If you're just banging on congas, you can have one in one speaker and one in the other. Again, the effect is really bizarre in cans.

Most other instruments aren't as much of a problem and one or two mikes will usually suffice. A pair is good when doing something like a flute, especially if you are wont to moving around a bit when playing . . . which can lead to a gently phasing tremolo every time you swing across the mike. If you are unsure as to how you want the track to sound, you can set up three or four mikes, each on its own track, and keep the track that sounds best.

Guitars, strings, and most wind instruments can be miked a different way, that is, via transducers, or Barcus Berrys. (This is actually a brand name and several other manufacturers make transducers as well). These things attach to the instrument in

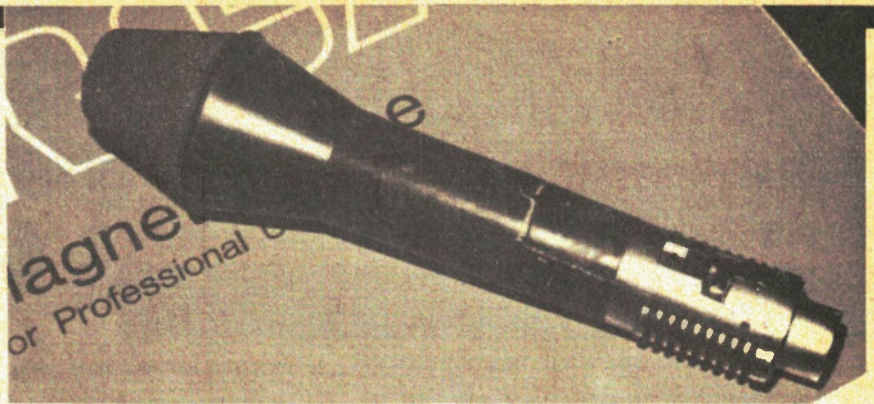

Just about everything starts with microphones, so don't cut corners too sharply here.

one way or another and proffer a perfectly miked signal at the end of a cable. The sound they produce is somewhere between wholly electronic and wholly acoustic. Flute pickups, for instance, sound almost completely natural. They're ideal if the signal is going to be processed anyway and usually acceptable if it's going to be used direct as a component of a fairly complex passage.

Electronic instruments, electric guitars, synthesizers, and such like, are the easiest to deal with . . . they simply get patched into the board. If you want to run your guitar's output directly into a mike jack, an impedance matching device, or direct box, is usually called for to keep the sound from getting heavily twangy and laying a country and western trip on your rendition of "Sheep May Safely Graze".

The Recorder

The tape recorder is the centre of things. An eight track isn't really necessary . . . as we'll see shortly, you can get eight tracks on a four track machine if you juggle things right. Noise reduction, such as dbx, is considerably more important, because multiple generations of tape are frequently employed. Obviously, selfsync is vital. Most machines have provision for remote control and this is a very useful feature, indeed. You can usually build the control unit yourself. It's rather nice, when enmired in headphones, guitar chords and mike cables, not to have to untangle one's self in order to get up and start the engines.

An alternative to this may seem to be putting the tape machine right next to you. While this is a most agreeable arrangement, it only works until you do

You can cut a lot of crosstalk by setting up your cables as shown at right. The combination of looseness and wires crossing each other (physically) reduces parallel inductance (this trick is used with car sparks plug wires to avoid misfires). If you do use cable ties don't snug them down to tightly, you might pinch the cable.

EVEN THOUGH IT LOOKS NEAT AND ORDERLY -

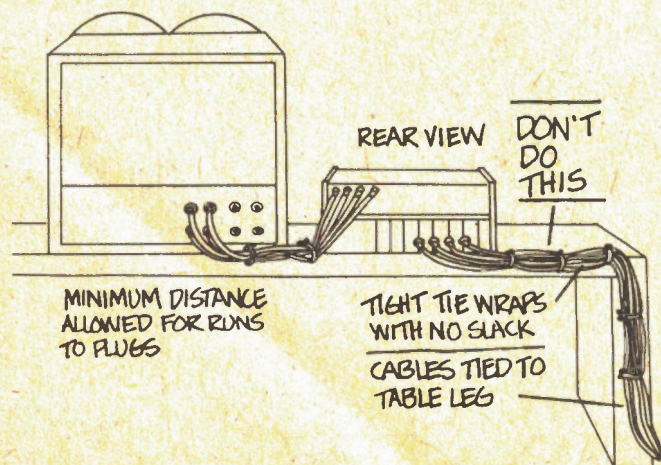

THIS IS BEST

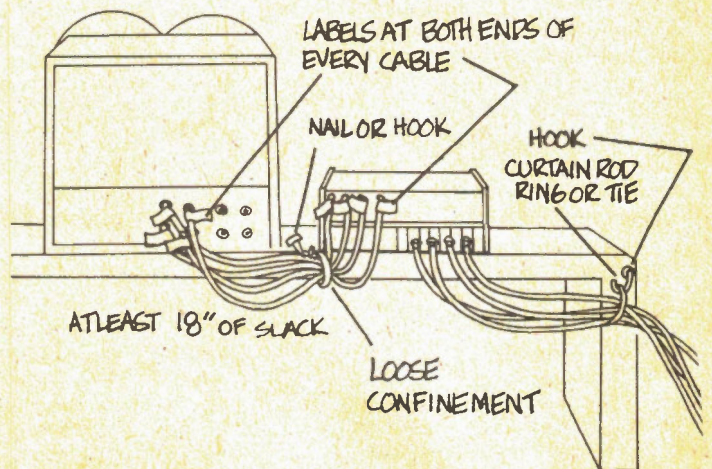

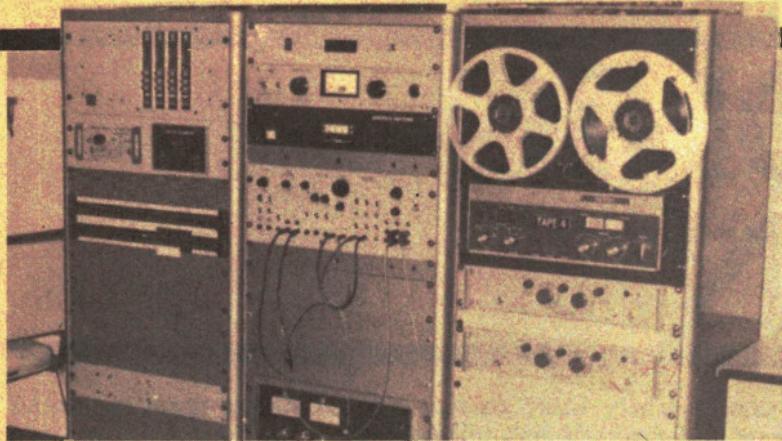

If you have a lot of equipment, you might consider rack mounting. This creates a much neater set up.

your first miked track, at which time the sound of the tape on the reels gets picked up.

Now, about that eight track business. There is a very handy technique, when you have four or more tracks to play with, called track bouncing. It allows, at least theoretically, infinite track expansion, although the noise tends to catch up with you after a two or three fold doubling. It works as follows.

Suppose we put down a piano track on track one and overdub a guitar on track two. There are three other instruments to go down, but only two tracks left. Therefore, we play tracks one and two back, mix them together in the way we want them to be in the final mix, and simultaneously record them on track four. (On most recorders, with separate playback and record heads, the mix on track four will now be unsynced from the original on tracks one and two.) This done, the first two tracks can be re-used, and, with the addition of track three, as yet left blank, there will be room to accommodate the additional three instruments.

(Below) If you're short on mikes try stretching them this way.

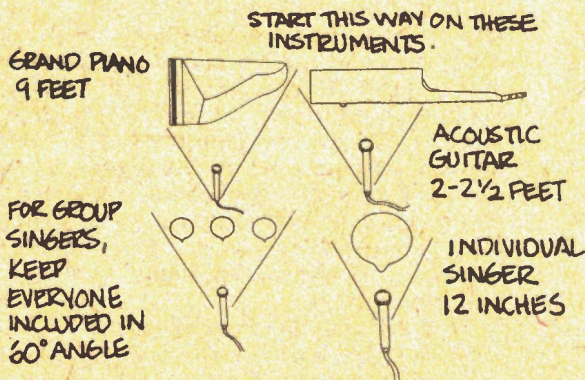

Miking drums poses some unusual problems. Use highly directional units to isolate the sound from each individual instrument.

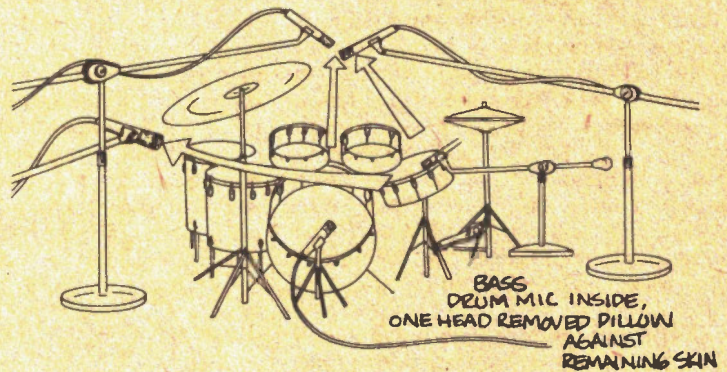

Microphone placement requires considerable care or the results will be less than satisfactory.

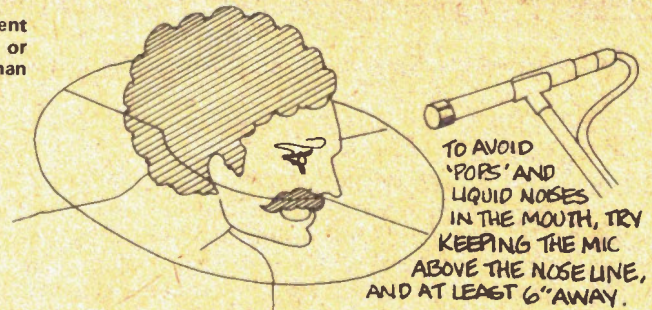

If more than three additional instruments were required, the first would be recorded on track three and then tracks three and four bounced across to track one. Four or five generations of bounce are not at all nasty given fairly high class tape, Ampex 456 or something similar, a good and properly set up recorder (calibrated for the specific tape being used) and a dbx.

There are a few intricacies of track bouncing. On some machines, it is possible to do three to one bouncing, that is, to record on tracks one, two and three and bounce down to four. For example, I've done this on a half inch Scully four track without experiencing any major hassles. All the books say you shouldn't be able to, though. You cannot do anything with adjacent tracks on a Tascam machine, like a 40-4, because of the peculiar head arrangement used with these beasts. The centre head is used for playback and record, with the third head being just for monitoring and set up. Recording and playing back on adjacent X-Y STEREO OVERHEAD PAIR

tracks produces great flapping, scathing pork barrels of feedback . . . as one well might imagine, the two head coils behaving just like windings of a transformer.

The Tascams have several redeeming features, however; due to this odd configuration, self sync is automatic, and bounced tracks are in sync with their originals.

Next month Steve Rimmer discusses multi-track recording techniques and special sound effects, all of them budget Studio Techniques.

# ELECTRONIC IGNITION

A first-class capacitor-discharge-ignition unit that can be easily fitted to any 4 or 6-cylinder negative ground car engine. The unit has built-in goodies like status and timing lights, pre-settable RPM limiting, automatic fail-safe circuitry and remote change-over switching.

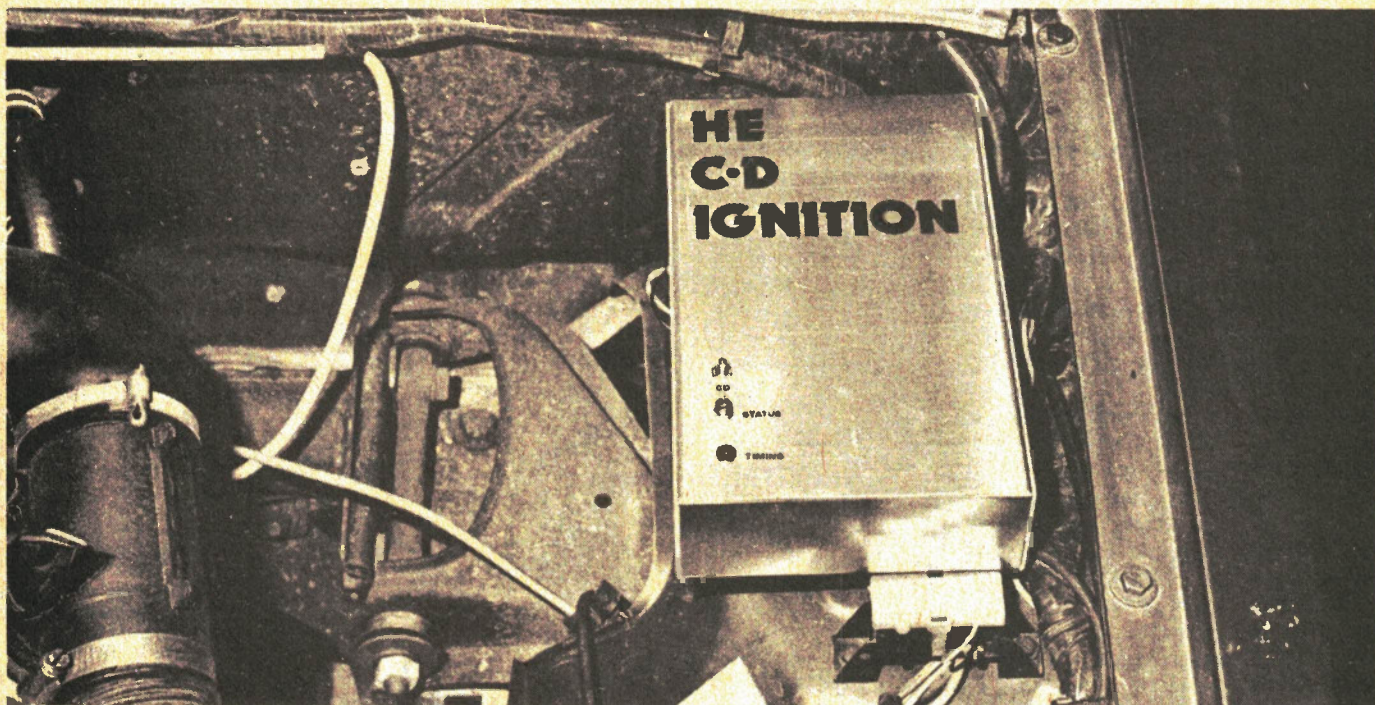

The CD ignition installed and ready for use. This system has already given many thousands of miles of trouble-free motoring.

CONVENTIONAL IGNITION SYSTEMS work by inductively storing energy in the ignition coil when the contact breaker (CB) points are closed and then releasing this energy (at a high voltage level) to the spark plug when the CB points open. These simple 'inductive discharge' systems suffer from a number of disadvantages. The available spark energy and voltage falls to low (and sometimes inadequate) levels and under cold-start conditions. The high inductor charge currents and heavy kick-back voltages cause excessive CB points burning and wear. Most important, the relatively long rise times of the ignition waveform (typically 100  $\mu$ S) make the system very susceptible to total energy loss under fouled-plug and damp-weather starting conditions.

Capacitor-discharge electronic ignition systems, by contrast, work by storing energy in a capacitor (charged to 300 volts or so) between ignition cycles. This energy is then released to the spark plugs via a 100:1 step-up transformer (the existing, conventional ignition coil) each

time the CB points open. The energy is released via a fast-acting silicon controlled rectifier (SCR), which in turn is triggered via the CB points at a 12 volt, 250mA level.

CD ignition systems offer several practical advantages over conventional systems. CB points burning is eliminated and wear reduced. Available spark energy and voltage do not degrade significantly under cold starting conditions, so cold-start performance is improved. Most important, the very fast rise time of the ignition waveform (about 5  $\mu$ S) ensures that the spark does not degrade significantly under fouled-plug and damp-weather starting conditions. The system also gives improved ignition or 'firing' characteristics and consequently gives a slight improvement (2-5%) in fuel economy.

The CD ignition system described here can be used on all 4- and 6-cylinder 4-stroke engines fitted with 12 volt negative-ground electrical systems. Our unit is

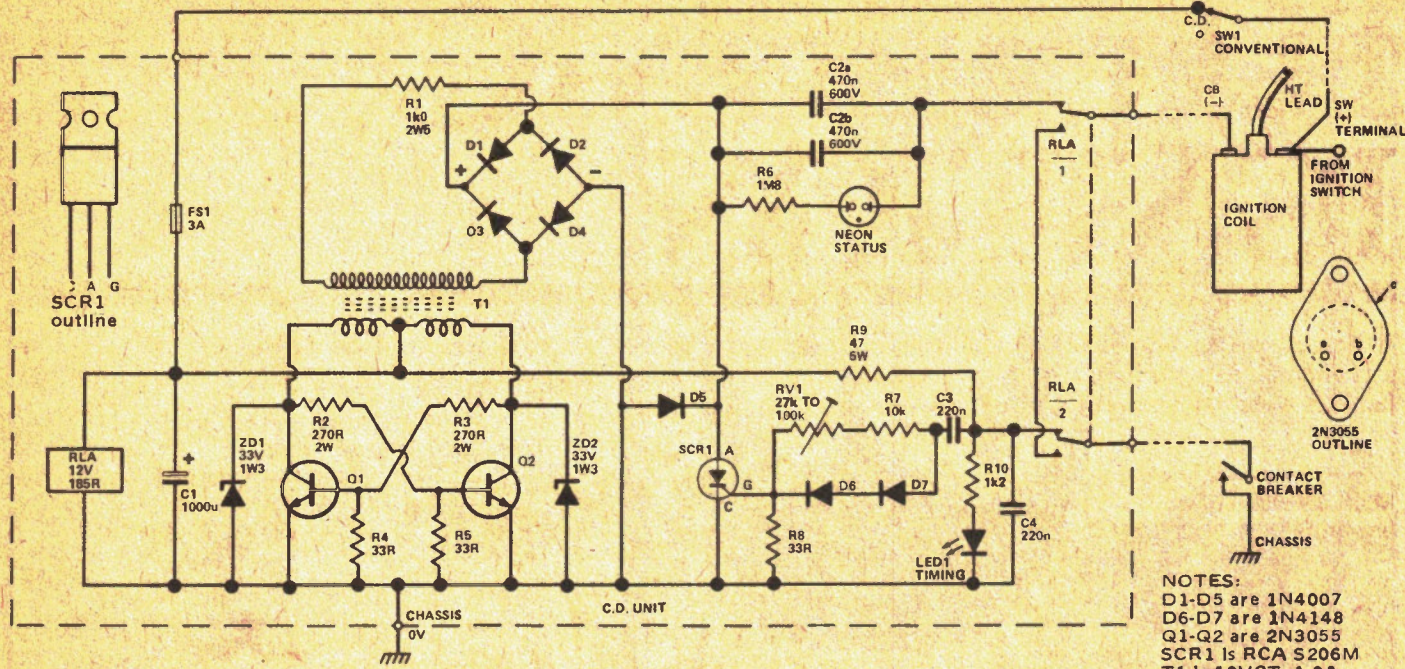

Fig. 1. Circuit diagram of the CD ignition system.

NOTES:  
 D1-D5 are 1N4007  
 D6-D7 are 1N4148  
 Q1-Q2 are 2N3055  
 SCR1 is RCA S206M  
 T1 is 10VCT, 1.0A  
 Power Transformer.

### HOW IT WORKS

The circuit can be broken down into four basic sections, a low-voltage (14 volts) to high-voltage (about 350 volts) DC-to-DC converter, an energy-storage section, a trigger/discharge section and a relay fail-safe/mode-selector section. The DC-to DC converter is used to charge the energy storage capacitor to about 250-350 volts and the trigger/discharge section is used to direct this energy to the spark plugs via the ignition coil (which is used as a simple step-up transformer) as the contact breaker (CB) points open in each cycle.

The converter section is designed around T1-Q1-Q2 and the associated components. T1 is a standard 10 VCT, 1.0A power transformer. Q1 and Q2 are connected to the T1 primary terminals and cross coupled via R2 and R3 so that they act as a high power astable multivibrator which feeds anti-phase square waves to T1 primary. The primary circuit is powered from the vehicles battery supply (typically 14 volts under running conditions) and the astable action is such that double this voltage appears alternately on the collectors of Q1 and Q2 during the astable action. The astable waveform has considerable leading-edge overshoot and zener diodes ZD1 and ZD2 are used to limit this overshoot to safe values.

The astable voltage is stepped up to about 350 volts at D1-D4 bridge. The resulting dc is used to charge energy storage capacitors C2a-C2b, which have one side effectively taken to the battery positive line via the ignition coil. Resistor R1 and the output impedance of T1 limit the peak charging currents to safe values. The neon lamp wired across the energy storage capacitors is used to indicate their status and also to slowly discharge them when the ignition unit is switched off. Note that, because of the overshoot characteristics of

the Q1-Q2 astable, the circuit is capable of producing a considerable capacitor charge even under low-voltage 'cold start' conditions.

Silicon controlled rectifier SCR1 is used to discharge the storage capacitors as the CB points open. A current of about 250mA is fed through the CB points when they are closed. As the points open a brief trigger pulse is fed to the SCR gate via C3-D6-D7 and causes the SCR to turn on and discharge C2 into the ignition coil primary. Under this condition C2 and the ignition coil form a resonant circuit and the resulting backswing is 'captured' by D5 and automatically turns the SCR off after 100 uS or so, thereby completing the operating cycle: the total ignition cycle lasts for about 200 uS.

Returning to the CB 'trigger' action, assume that C3 is fully discharged just prior to the CB points opening. As the points open C3 charges rapidly via R9-D6-D7 and feeds a trigger pulse to the SCR gate. When the CB points close again C3 starts to discharge via RV1 and R7 and R8. If C3 has not discharged by the time the CB points re-open, a new trigger pulse will not be fed to the SCR gate. Thus, RV1-R7 act as a bounce-suppression network and can also be adjusted to prevent triggering beyond a certain CB operating frequency: they thus act as an RPM limiter. Light-emitting diode LED1 illuminates when the CB points are open and can thus be used as a static timing light.

Final points to note about the circuit are that it's converter section is designed to give adequate operation up to 6000RPM on a 6-cylinder (9000RPM on a 4-cylinder) 4-stroke engine and its trigger/discharge section is designed to give cold-start triggering at battery voltages down to 6 volts.



Fig. 2. Above PCB layout for CD ignition.  
Fig. 3. Below. Overlay diagram — ensure the relay is connected the right way round.

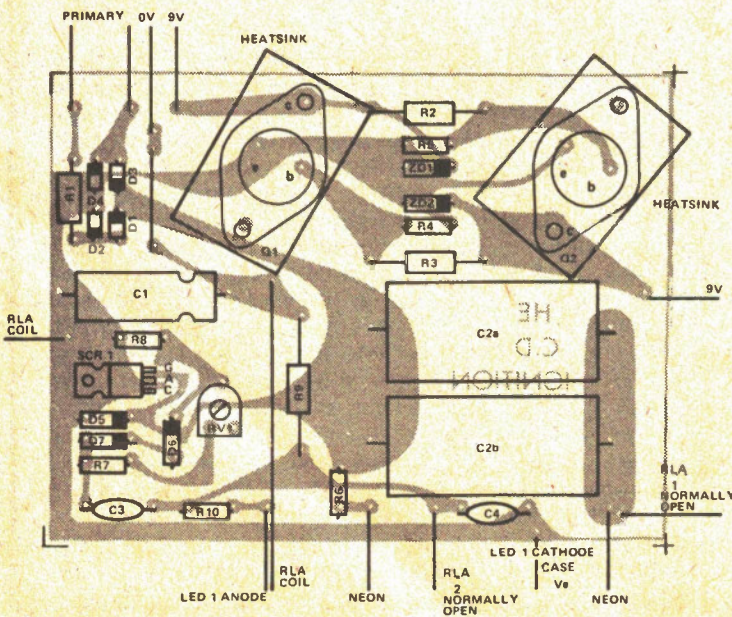

## PARTS LIST

## RESISTORS:

R1, 1k $\Omega$  2W5  
R2, 3, 270R 2w  
R4, 5, 8, 33R  
R6, 1M8  
R7, 10k  
R9, 47R 5W  
R10, 1k2

## POTENTIOMETERS:

RV1, 10k horizontal preset

## CAPACITORS:

C1, 1000u 25v electrolytic  
C2a+b, 470n 600V dubilier  
C3, 4, 220n polyester

## SEMICONDUCTORS:

Q1,2, 2N3055  
SCR1, RCA S206M  
D1-5, IN4007  
D6-D7, IN4148  
ZD1, 2, 33V 1W3  
Led 1, 0.2" dia. red LED.

## MISCELLANEOUS

T1, 10Vct 1A Hammond 166J10  
2 off heatsinks drilled for T03  
Neon  
SW1 SPDT toggle  
FS1 3A + holder  
Relay DPDT, coil 185R  
Case aluminum box, size 8½" × 5½" × 2"

designed for easy fitting and uses only four external connections. The design, which has been subjected to several thousand miles of actual and simulated road testing, incorporates a number of unusual 'goodies'. It has a built-in 'status' light to indicate correct functioning and a LED indicator that can be used as an ignition timing aid (the LED illuminates when the CB points open).

Our unit also incorporates a pre-settable RPM limiter. A relay is used to change the circuit connections from 'conventional' to 'capacitor-discharge' ignition and can be activated via a remotely mounted panel switch. The CD unit is fuse-protected and the relay automatically reverts to the 'conventional ignition' mode in the event of fuse failure, thus giving fail-safe operation.

These features should ensure many thousands of trouble free miles.

## Construction and Use

This project has been designed with ease of construction in mind and no attempt has been made to miniaturise the unit. All components except the relay and transformer are mounted on a single PCB as shown in the overlay.

When the PCB construction is complete fit the PCB, relay and transformer into a suitable metal box and complete the interconnections, taking special care to see that no short circuits occur between the circuitry and the



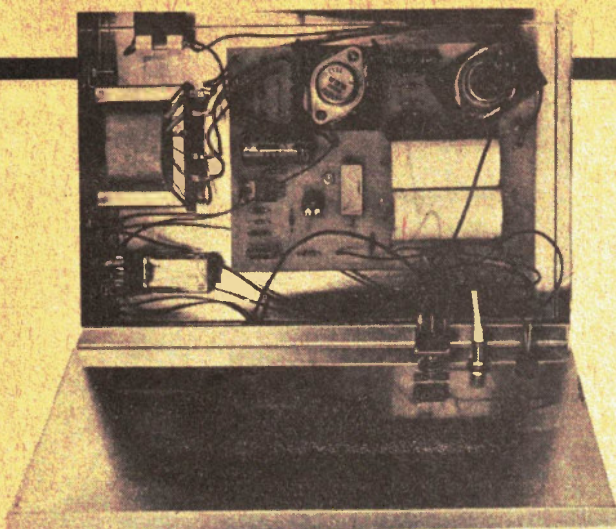

We recommend that the PCB be covered in wax or varnish to reduce the vibration damage.

case. You can then give the unit a functional check as follows, after first setting RV1 to the minimum resistance position.

Place the unit loosely in the vehicle's engine compartment, remove the existing CB-to-coil connections and then connect the unit's four output leads as shown in the diagram. One lead goes to chassis, one to the ignition coil's 'SW' or '+' terminal, one to the CB points and one to the coil's 'CB' or '-' terminal. When the connections are complete, switch on the ignition. If all is

well the neon will light and the unit will emit a whistle sound. Operate the vehicle's starter switch. The engine should start easily and run smoothly. Check that the ignition reverts to 'conventional' operation when the connection to the coil's 'SW' terminal is broken.

If everything is OK, bolt the unit into place in the engine compartment, as close to the coil as possible. Switch SW1, used to connect the unit to the coil's 'SW' terminal, can be mounted on the vehicle's instrument panel. If you wish to use the unit's 'RPM LIMIT' facility, raise the engine revs to the desired limit value and then adjust RV1 so that misfiring just starts to occur: if necessary, change the value of RV1 so that limiting occurs with RV1 at approximately mid value.

If your vehicle is fitted with a CB-activated tachometer, the tachometer will probably work perfectly well with the CD unit. ●

*PROBLEMS? NEED PCBs? Before you write to us, please refer to 'Component Notations' and 'PCB Suppliers' in Table of Contents. If you still have problems, please address your letters to 'ETI Query' care of this magazine. A stamped, self-addressed envelope will ensure fastest reply. Sorry, we cannot answer queries by telephone.*

# Designer Circuits

## LOW-POWER FLASHING LIGHT

Most integrated circuits, in fact most electronic circuits, are designed to operate with power supplies in the range 4V5 to 40V. It is quite rare to find battery-operated equipment fitted with indicator lamps, due to the unacceptable current drain. Even light emitting diodes (LEDs), which use up very little current (usually 10 to 20mA), are not used all that often. At very low voltages (below 2V) an LED will not even illuminate!

National Semiconductor have produced an integrated circuit to be used specifically for flashing an LED, even operating at voltages as low as 1V1, with an average current consumption orders of magnitude below that of an LED on its own.

The circuit achieves its very low current consumption in two ways. Firstly the LED is only illuminated 1% of the time, and only transistor Q4 is turned on for the rest of the time — drawing a current of only 50uA while on. The 300uF capacitor determines the flash rate by charging up via the two 400R resistors and the 3kΩ resistor. Q1 and Q2 are turned off until the voltage at the positive end of C1 reaches about 1V0. The exact voltage is determined by the junction voltage drop of Q1 and Q4 plus the voltage divider across Q4's base and emitter.

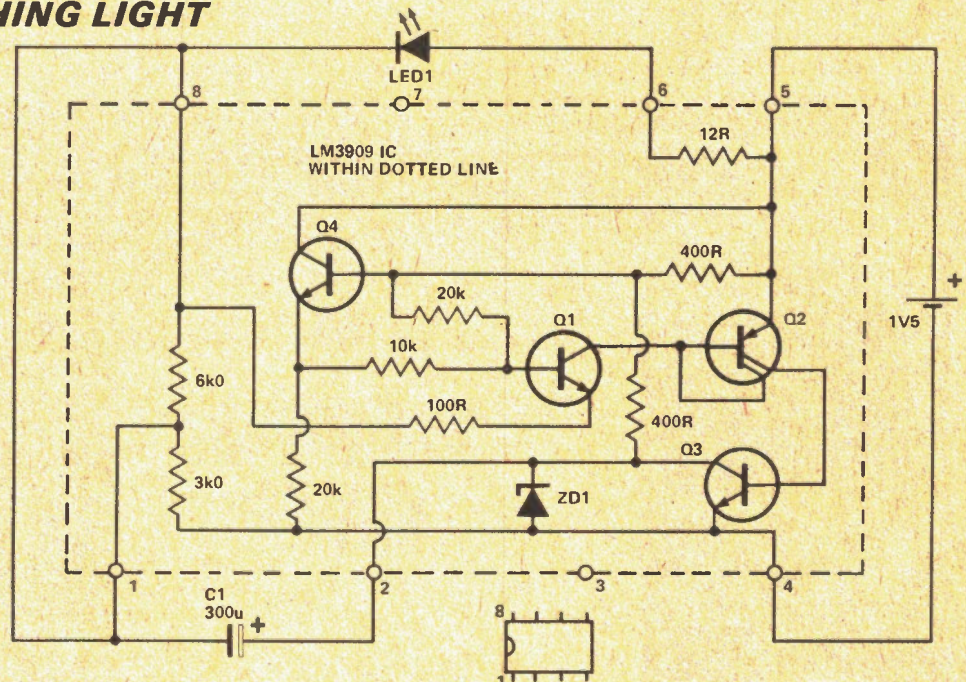

When the voltage at pin 1 is 1V0 more negative than the positive supply (pin 5), Q1 starts to turn on. This in turn switches on Q2 and Q3. The circuit then supplies a high current pulse to the LED. Q3 is a medium-power trans-

istor that can handle 100mA of current, and rapidly brings pin 2 to a voltage close to zero volts. As the capacitor has a charge it makes terminal 1 (the negative end of the capacitor) go below supply zero. At this point in the cycle the cathode

of the LED is at a higher potential than supply positive, and the current that flows through the LED is limited by the 12R resistor between pins 5 and 6. The cycle then repeats itself.

# DIGITAL FREQUENCY METER

Living by numbers? . . . do it digitally with this easy to build DFM.

WITH JUST A COUPLE of simple-to-operate controls, this project will enable you to measure and display frequencies from 20 Hz to about 2 MHz. The upper frequency limit is determined by the waveform of the input signal, the input amplifier and the performance of the particular chip used for IC3. As the CMOS chips used in this design have a better high-frequency performance with increasing supply voltage, a twelve volt supply was chosen and this can be simply provided with eight AA size cells.

99999=1

Even a few years ago, a DFM like this unit would have been AC powered with numerous boards and in-

numerable interconnections. Large scale integration, the same technology that has put microprocessors in almost everything, has changed all that and this project features a five digit readout with input amplifier, logic gating and counter all on one board. This saves you from having to worry about connecting displays and cascading discrete counter chips.

Most of the work is done by one chip which counts the input pulses and organises the display. Another chip takes the display data and drives the light-emitting-diode display while the remaining ICs provide an accurate counter "window" and gate the input signal.

The advantage of CMOS over conventional bipolar technology is low current drain and the whole unit uses less power than an ordinary flash light.. Many more



The Digital Frequency Meter.

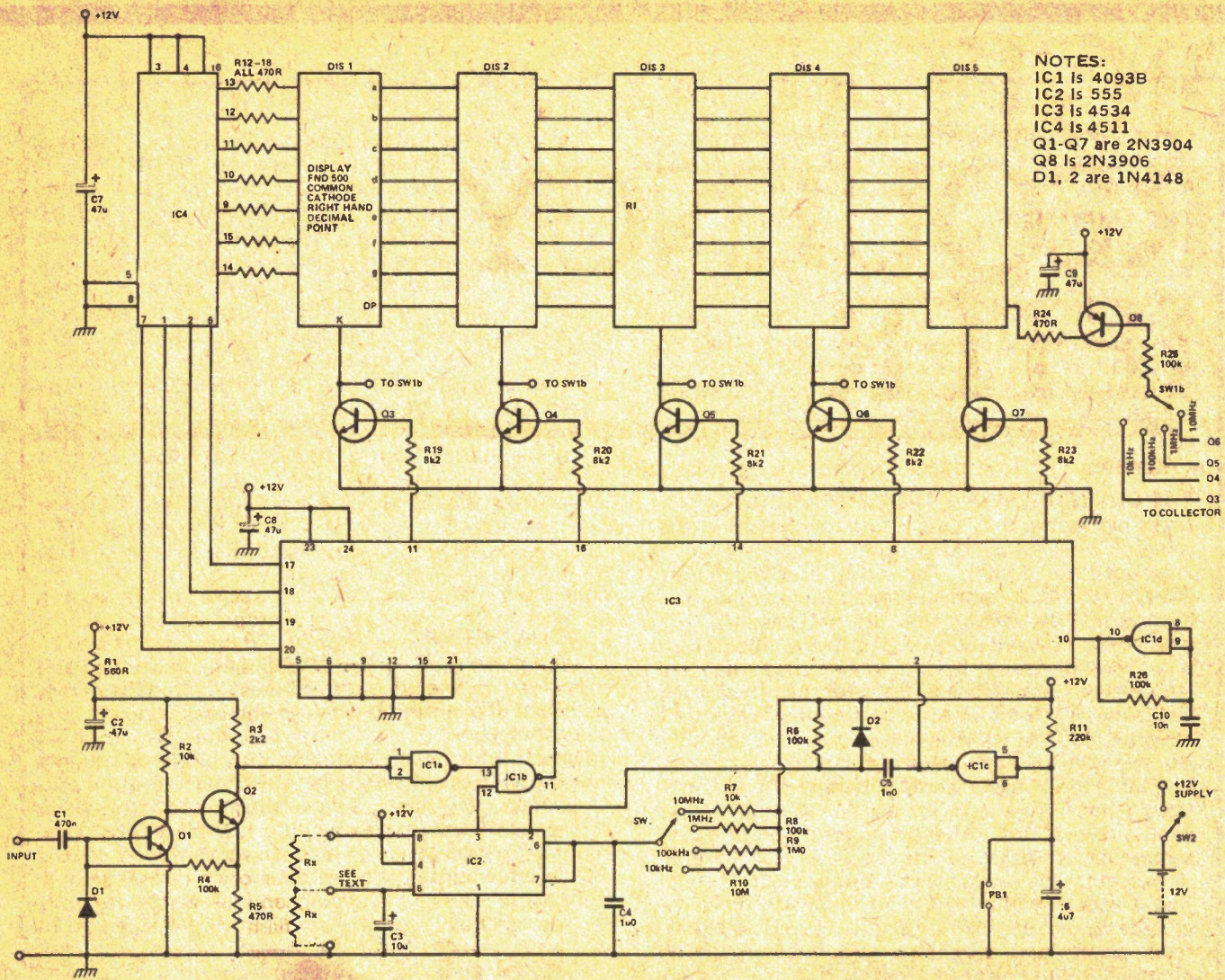

Fig. 1. Circuit diagram of the DFM. By using close tolerance components for C4 and R7 to R10 accuracy should be assured.

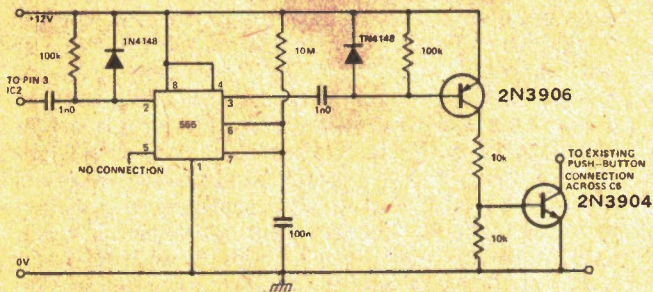
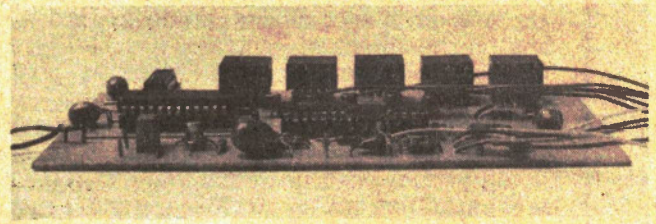

Fig. 2. Suggested additional circuitry to perform "auto update" on DFM.

sophisticated units of this type use a crystal oscillator and divider chain to provide accurate timing (just like in your digital watch). As this would have added considerably to the cost of the project an analogue technique based on the ubiquitous 555 timer chip has been used. This is not too much of a problem as the 555 is capable of providing accurate and repeatable time delays set by choice of just one resistor and capacitor and a simple technique is outlined in "how it works" for calibrating all four ranges.

#### Construction and Use

If you are confident of your ability to handle CMOS and make the many interconnections required then almost any constructional technique may be used. However, we



Above. Side view of the DFM. By keeping a low profile it's easier to mount the unit in its box.

Below. Although the layout is not critical we strongly recommend you follow ours.

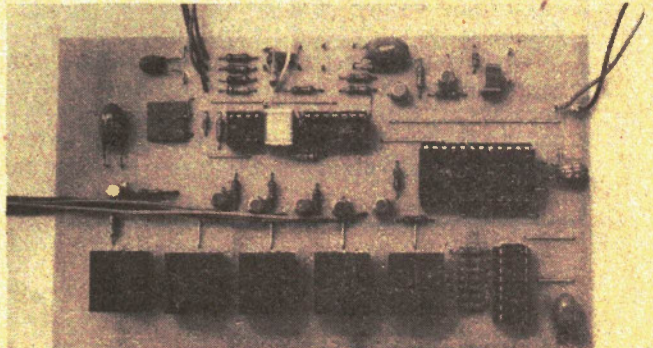

## HOW IT WORKS

Circuit operation is most easily understood by considering each section separately. This approach makes troubleshooting much simpler too.

**THE AMPLIFIER**

Transistors Q1, 2 form a simple direct-coupled amplifier. The DC operating point is set by negative feedback via R4. Input signals are capacitively coupled via C1. The value chosen gives good results between 20 Hz and 2 MHz. The amplified signal appears at Q2 collector where it is 'squared-up' by Schmitt trigger gate IC1a whose output drives one input of IC1b. Components R1, C2 provide a smooth 'decoupled' supply for the amplifier.

**THE COUNTER WINDOW GENERATOR**

Input pulses are only allowed to reach the counter (pin 4, IC3) when the other input of IC1b is 'high'; ie at about twelve volts. The input is driven from a 555 counter, IC2, connected as a monostable multivibrator. This means that upon being triggered when the voltage at pin 2 drops below about one-third of the supply voltage, the chip will generate a pulse whose length is determined by the values of C4 and one of the switch-selectable resistors R7, 8, 9, 10. This pulse provides a 'window' during which time signal transitions at the amplifier input are counted. The number of transitions (that is just another way of saying changes from one level to another) in a certain period; say a second, is expressed as the frequency of the input waveform. This means that a frequency of 50 Hz is just a way of saying that there are fifty cycles of change in one second of time. A cycle is a change from positive to negative and back again. By changing the counter window length, we can provide our frequency meter with different ranges. This circuit generates a window of ten secs., one sec., one tenth sec., or one hundredth sec. depending on the choice of resistor R10 to R7; giving a full scale measurement from 9.9999 kHz to 9.9999 MHz.

A novel feature of the 555 chip used in this design is its ability to provide a large range of output timing periods with good accuracy. Using a polyester capacitor for C4 and close tolerance resistors for R7 to R10, the timing intervals obtained will be very close to ten times multiples of each other. This means that if the circuit can be accurately set up on one range then the other ranges will fall into line automatically. Fortunately the 555 has another trick up its sleeve as the timing period, even with fixed values of R and C, can be varied considerably by use of the control input, pin 5.

With the unit set to the lowest range, a 50 Hz signal from the low voltage output of a transformer (say 6 or 9 volts) may be applied to the input via a resistor (about 1 M should do). After depressing and releasing PB1, the display should

flicker as the unit counts until a steady number is displayed. The line frequency is 60 Hz but the display will probably read 65 Hz or so. A resistor 'Rx' should now be connected between 'C' and 'N' and a new reading taken. Different values of resistance should be tried until the display indicates 60 Hz (0.0600) or at least something close. Don't be surprised if a slightly different reading is obtained even with the same value of resistance for Rx. We found a value of 56 k was about right. If a value less than 10 k is required then C4 should be replaced. In the unlikely event that the display reads less than 60 Hz then the resistor should be connected between 'C' and 'P'. Any value down to 4 k7 may be used. Once one range is calibrated, the accuracy of the other ranges will depend on the tolerance of resistors R7, 8, 9, 10. Capacitor C3 prevents noise from upsetting things at the control input.

**COUNTER AND TRIGGER**

Depressing PB1 causes the output of IC1c to go high to a logic '1' resetting the counters in IC3. When PB1 is released, C6 charges via R11 and IC1c output goes low removing the reset signal from IC3 and triggering the monostable IC2 which enables gate IC1b to pass signals to the counter input (pin 4, IC3). IC3 contains five decade counters which means that it can count up to 99,999 before 'overflowing' and starting again from zero. The output of each stage is presented in binary-coded-decimal form on pins 17, 18, 19, 20. Each stage uses all four pins but only one stage at a time is connected to them. Simultaneously, one of the digit driver outputs goes high corresponding to the stage whose value is being output. The binary-coded-decimal signals are converted to drive a seven-segment display by IC4 and the appropriate digit is enabled by Q3 to Q7 driven from the digit driver outputs pins 11, 16, 14, 8, 7. The decimal point is driven from Q8 which is turned on at the appropriate time by controlling it from the digit driver transistors via SW1b. The technique of using a few pins to carry many signals at different times is known as multiplexing. The multiplexer circuitry inside IC3 needs to be driven by an external clock and this is provided by IC1d which, with R26 and C10, oscillates at about 700 Hz. (Try using the meter to check this after you have built it!) The exact frequency is not important. Resistors R12 to R18 and R24 serve to limit current flow in the display driver and the LED displays. Do not be surprised if the resistors feel a little warm. They dissipate about 200 mW and this is quite normal.

The 47 $\mu$  capacitors dotted around the circuit help to prevent interaction between different stages and are deliberately sited close to individual chips and transistors.

## PARTS LIST

### RESISTORS (All 1/2W 5%)

R1	560R
R2	10k
R3	2k2
R4, 6, 25, 26	100k
R5, 12 to 18, 24	470R
R7	10k
R8	100k
R9	1M0
R10	10M
R11	220k
R19 to 23	8k2
Rx	See text

(Resistors R7 to R10 will effect the accuracy and stability of the DFM. Use two per cent resistors if you can obtain them. Otherwise, use whatever you can get — the circuit will still work).

### CAPACITORS

C1	470n ceramic
C2, 7, 8, 9	47μ tantalum
C3	10μ tantalum
C4	1μ0 polycarbonate
C5	1n0 ceramic
C6	4μ7 tantalum
C10	10n ceramic

### SEMICONDUCTORS

IC1	4093B
IC2	555
IC3	4534
IC4	4511B
Q1 to Q7	2N3904
Q8	2N3906
D1, 2	1N4148
DIS 1 to 5	FND500

common-cathode seven-segment LED displays.

### MISCELLANEOUS

PB1 push-button switch SW1 2 pole -- 4 way  
SW2 SPST

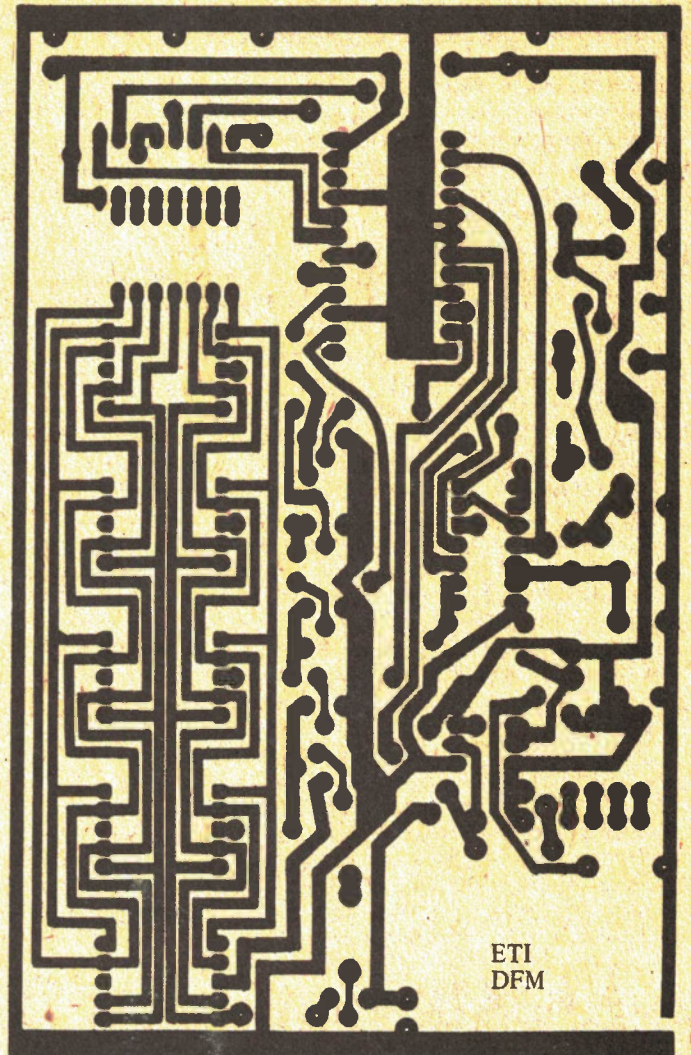

Fig. 3. PCB foil pattern for DFM.

*PROBLEMS? NEED PCBs? Before you write to us, please refer to 'Component Notations' and 'PCB Suppliers' in the Table Of Contents. If you still have problems, please address your letters to 'ETI Query', care of this magazine. A stamped, self addressed envelope will ensure fastest reply. Sorry, we cannot answer queries by telephone.*

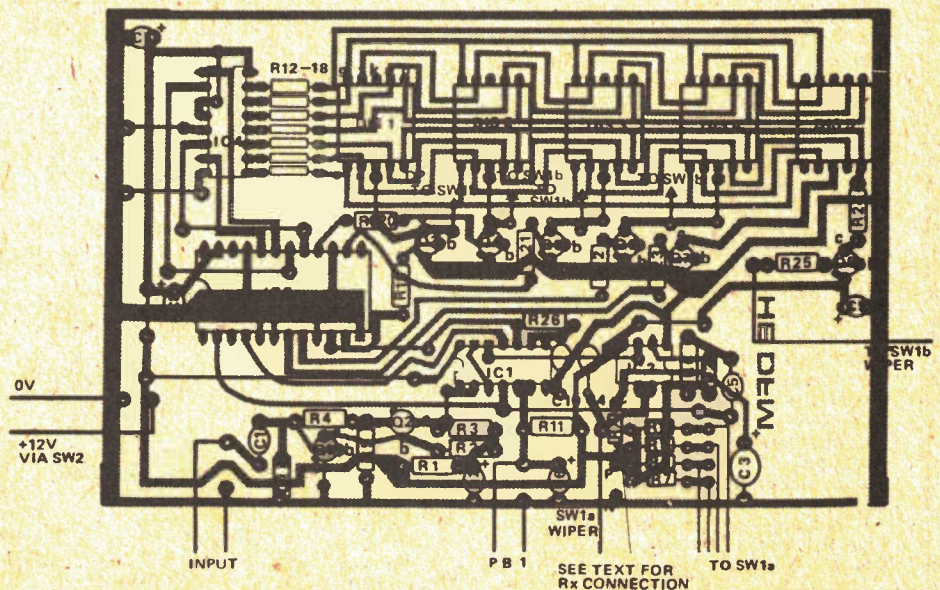
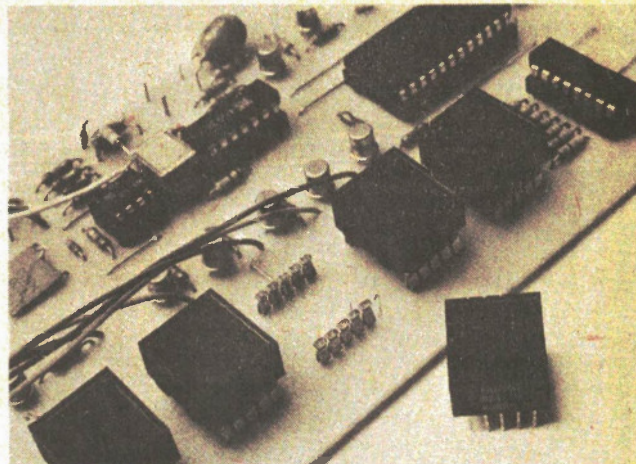

Fig. 4. Overlay diagram, we suggest you use sockets for all IC's. Note that the capacitors C2, C6, C3 are bent flush to the PCB to enable the board to fit neatly in its case.

strongly recommend that our PCB design is used as this will cut down the chance of any error creeping in.

If you do use a PCB then construction is quite straightforward. There are sixteen wire links to make and these should be inserted first as they pass beneath many of the other components. Use an insulated link for the connection between IC2, pin 3 and IC1, pin 12 to avoid a possible short circuit to C4. The other components may be inserted almost as they come to hand although it helps to have some kind of system to facilitate checking. The best course is to follow the parts list; resistors first followed by capacitors and finally the semiconductors. This technique minimises the chance of overheating the semiconductors though modern silicon devices are fairly hardy anyway. We usually use IC sockets; avoiding handling problems and enabling the chips to be re-used or replaced if they fail. The LED displays may be soldered to the PCB or "soldercon" pins can be used. These are do-it-yourself IC sockets which are supplied in strip-form. You just break off as many as you need; in this case five, solder them into the board then break off the unwanted metal carrier strip at the top of the pins by grasping it with a pair of pliers and repeatedly flexing it back and forth. The displays should be mounted so that the decimal point is facing away from the nearby edge of the board. In fact the displays will still work if you put them in back to front but you will see some pretty funny numbers!

There are few connections to make to the board and the only ones which need special care are those to SW1. These should be arranged so that when one section is connected to R7, the other section connects with the collector of Q6 and so on as the ranges are selected. This gives a display reading directly in kilo-Hertz with a moving decimal point so each range is selected and facilitates reading the display.



One of the display units removed from its socket. Note C2 and C6 mounted flush to the board.'

In use, the highest range should be used first and then lower ranges selected as required. This avoids false readings as the counter overflows. The unit is quite sensitive and will tolerate many waveforms though it becomes fussier on the highest range, preferring a sinusoidal waveform. The basic design will only update the display following a depression of PB1. Included here is a simple update circuit which you can add if you like. It works by imitating the action of depressing PB1 electronically about one second after the display has settled. Any method of construction may be used for this little circuit and there shouldn't be much difficulty in making the required connections to the main board.

Whichever way you build it, this project will provide you with an economical piece of test gear — off the shelf and made to measure.

# Designer Circuits

## A SINGLE OP AMP OSCILLATOR

An op amp can be made to oscillate generating a square-wave output. The circuit is a Schmitt trigger and integrator all rolled into one.

To understand the operation imagine the output is high; C1 is charged up via R3. The voltage at point A is +0.9 V due to the resistor divider network R1, R2. When the voltage at B exceeds this voltage, the output of the op amp flips into its negative (low) state, C1 is therefore discharged by R3. When the voltage on C1 reaches -0.9 V, the reverse process occurs and the op amp output flips back to its high state. Thus the circuit oscillates producing a square wave going from +10V to -10 V.

The frequency of operation can be obtained from the voltage changes on C1. This is the truncated section of an exponential charge/discharge curve, but we shall ignore this and assume that the curve is linear (which it almost is).

The frequency can be obtained from the formula  $F=I/\Delta V \times C$  Hz where I is the charging current

(approximately 100µA), ΔV is the charge across C1 (3.6 V) and C is the capacitance measured in Farads.

Therefore  $F=10^{-4}/3.6 \times C$  Hz. Thus, if C1 = 100nF, F = 270 Hz; if C1 is 10nF, F = 270 Hz and if C1 is 1nF, F = 27 000 Hz.

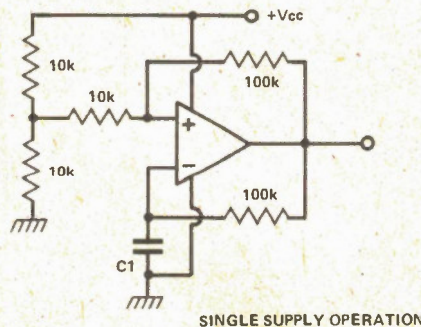
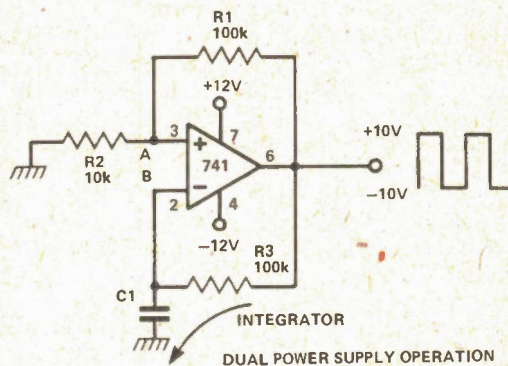
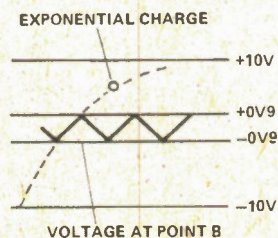

# POWER TO THE PEOPLE

We all need electricity, but how do we get it? Ian Sinclair looks at the multitude of methods we use to generate, store and use electricity today.

WHERE DO YOU GET the power to run these circuits? Do you use expensive, but convenient, batteries or cheaper, but heavy, power supplies? What sort of batteries do you use, or do you need stabilised power supplies? For the answers to your power problems — read on!

Batteries are ideal for low voltage circuits which use comparatively low currents and which have to be portable. If your circuit project uses just a few transistors, or some op-amps, or CMOS digital ICs, then chances are the current drain is so low that a dry battery is the best type of power supply. One possible exception is when there is a seven-segment LED readout — these devices can easily use 20 mA per segment when illuminated, making the life of a dry battery pretty short.

## Escape-Proof-Cells

The most common type of dry battery is based on the zinc-carbon cell (Fig. 1). The voltage is generated by the chemical action of ammonium chloride (in paste form) on the zinc case, and the hydrogen bubbles which are produced from the chemical reaction are absorbed by the manganese dioxide which is packed around the carbon rod. This action (called depolarisation) is important because hydrogen in gas form does not conduct electricity, so that a layer of hydrogen gas around the carbon rod would make the cell an open circuit. In use, the carbon rod is the positive pole of the cell and the zinc case is the negative pole. Because the zinc is being eaten away by the ammonium chloride jelly during the life of the cell, there is some risk that the jelly will start to leak from an old cell, so 'leakproof' cells use an additional casing of steel around the zinc. Always use these leakproof types in electronic equipment, because ammonium chloride can make a fair old mess of a PCB and all the components on it.

If your circuit has a very low current drain (measured in microamps rather than milliamps), a mercury dry cell may make more sense, because these types can deliver current over very long periods with a steady voltage output. Mercury cells are available in the smaller sizes, such as the AAA size of rod battery and, of course, the button type of watch or calculator battery. An alternative to mercury types for very small cells is the silver oxide cell.

If your project needs rather a lot of current and must be operated with no power cables, then a rechargeable cell or cells will have to be used. The most common type is nickel-cadmium — it's expensive and not always as reliable as its manufacturers claim. Nickel-cadmium cells and batteries are made in sizes which match the sizes of dry cells, but with rather lower voltage. For example, the

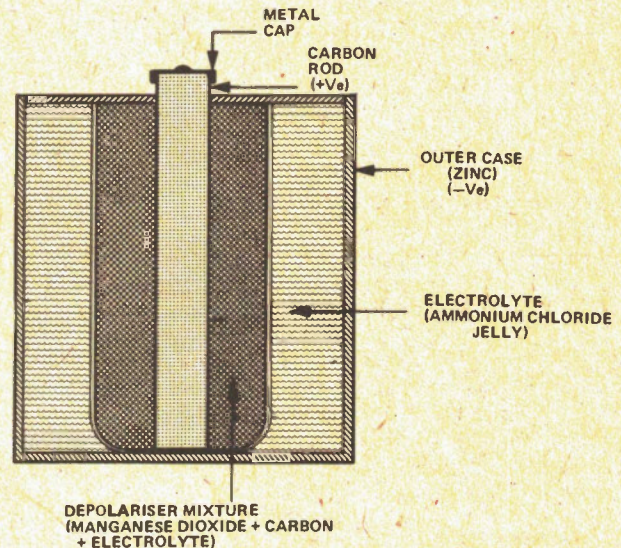

Fig. 1. A zinc-carbon cell, still the most widely used for batteries.

AAA size Ni-Cad cell has only 1.25 V output compared to the 1.5V of a zinc-carbon cell and the 9V size has only 8.4V comparison, a Ni-Cd 9V will cost anything from \$7. to \$10. depending on whether you get it wholesale price or retail, as compared to the 80¢ or so for the drycell. In addition, you need a constant current charger — a car battery charger is sudden death to Ni-Cd cells — and you have to keep the cells working. Most failures of Ni-Cad cells seem to occur when equipment is under-used. In general they thrive on hard work and last well providing that they are run right down and then immediately recharged.

## Internal Resistance

Oddly enough, the sealed construction of the Ni-Cad cell, which lets us operate these cells, like dry batteries, in any position, has now been copied to produce lead-acid cells, built along the same lines as the familiar car battery.

All batteries, wet or dry, primary or secondary, have internal resistance, which is simply the electrical resistance of the materials inside the battery. The effect of this internal resistance is to cause the output at the terminals when current is drawn to be less than the voltage which the battery generates. We can understand why this should happen by drawing a circuit in which the internal resistance is represented as a separate resistor (Fig. 2).

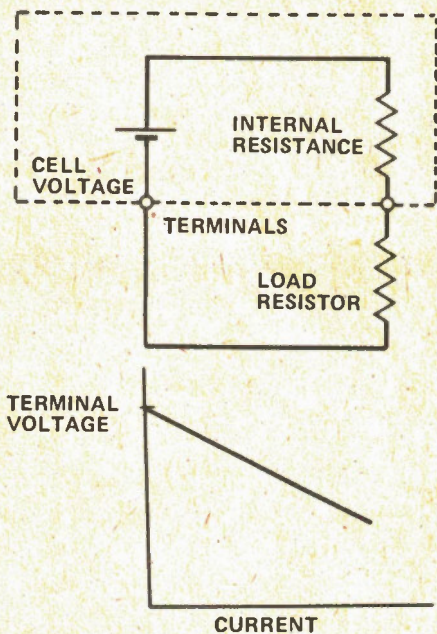

Fig. 2. Internal resistance (a) and its effect (b).

For example, if the battery has a voltage of 9 V at zero current, and the internal resistance is 4 R, then a current of 0.5 A (500 mA) drain from this battery would cause a voltage drop of  $0.5 \times 4 = 2$  V across the internal resistor. Since you can't connect across the internal resistance, the voltage at the terminals is now  $9\text{ V} - 2\text{ V} = 7\text{ V}$ , and this will drop still lower if more current is drained. Fig. 3 shows how to calculate the internal resistance of a battery from measurements of voltage across the terminals. Dry batteries have fairly small

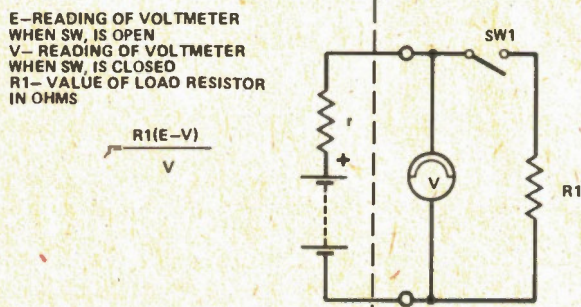

Fig. 3. Calculating the amount of internal resistance. R1 should be a 5% wirewound resistor, value about 1R5 for each volt of battery voltage (9R for a 6V battery, for example).

internal resistance values (about 0R5 or less per cell) when fresh, but the internal resistance is considerably greater when the cells are nearly exhausted. Always test the voltage of a cell when a resistor is connected across it — it's a better guide. For cells of "C" size, a suitable resistance value is around 1R5 per cell (so that 6R would be used for a 6 V, four cell battery).

Rechargeable cells have much lower internal resistance values, due mainly to the use of liquid electrolyte. The internal resistance of nickel-cadmium cells is particularly low and that's why they need a special recharging circuit which passes a fixed amount of current for any voltage of cell. The charges used for lead acid cells give a fairly constant voltage and rely on the fact that discharged lead-acid cells have a higher internal resistance than fully charged cells, so that when the cell

voltage is low, the high resistance prevents the charger passing too much current. As the cell charges, the resistance drops, but the voltage rises, so that, once again, the amount of current that can pass is limited. Ni-Cad cells have such low internal resistances at all times that a constant voltage supply would pass excessive current. The danger of exceeding the rated charging current is that the cell is sealed and the gas produced when excessive charging currents are used will build up pressure until the cell bursts, making a nasty mess of anything near it. Fig. 4 shows a simple Ni-Cad constant current charger circuit.

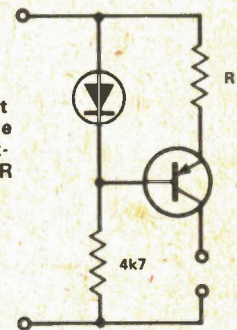

Fig. 4. A simple constant-current supply for a Ni-Cad cell. The current in milliamps is approximately equal to  $2/R$ , when R is in kilohms.

Horses and Courses

However you go about it, using batteries for anything but the simplest low-current circuits is an expensive way of buying electricity, so that the more ambitious project builder will need a line power supply unit (PSU). Such units are surprisingly inexpensive to build (less than the price of a 9V nickel-cadmium cell, for example), but will operate your circuits until the cows come home just for the price of hydro electricity — which at the moment works out at 6¢ per kWh. In case you don't realise how cheap that is, a unit using 10 W, the average consumption of a Hi-Fi set-up, can run for 50 hours for one penny. Even at 100 W consumption, you get five hours for a penny. By contrast, you would get about half a minute of use of a 276 dry battery taking 10W at a cost of around \$1. It's horses for courses here, you simply don't use batteries to deliver power of 10 W or so.

Three in One

A simple line PSU consists of three parts. There must be a transformer to step down the line voltage to the lower voltage we need, a rectifier to convert AC into current flowing in one direction and a reservoir capacitor to convert pulses of current into smooth DC. A typical circuit is shown in Fig. 5 for a nominal 9 V supply.

Because the PSU uses line voltage at its input, the usual high voltage safety precautions have to be observed.

Clamp that Cable

An additional safety requirement is that the line cord into the PSU must be well secured, so that if someone (you, perhaps) trips over the cable, the connections will not tear out. Suitable cable clamps can be obtained which are designed for this job — do not use makeshift clamps which can damage the cable. For equipment which is so heavy that the cable would pull out of any clamp, a plug/socket connection to the case of the PSU is acceptable provided that the plug and socket are of an approved type.



Remember that if your construction doesn't measure up to modern safety standards, you are responsible for any accidents that may be caused.

The action of a PSU of the type shown in Fig. 5 is something like this. When you switch on, the AC sinewave at one end of the transformer will be in antiphase to the sinewave at the other end of the winding. One pair of diodes will conduct, leading current through the load (the circuit which is powered by the PSU) and also charging up the reservoir capacitor until the peak of the voltage wave is reached. As the wave voltage drops the diodes stop conducting and the load current is supplied by the capacitor discharging. When the sinewave voltages at the transformer reverse, the other pair of diodes will conduct whenever the wave

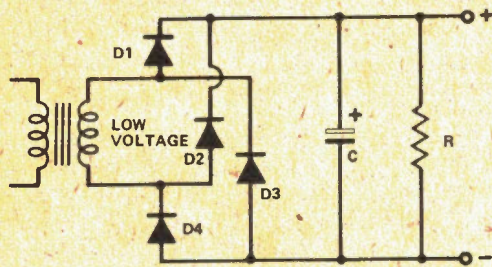

Fig. 5. A rectifier bridge power supply (mains switch and fuse not shown).

voltage is greater than the voltage across the capacitor. The capacitor is now topped up with charge once again, until the voltage across it equals the peak of the wave voltage. The way that the diodes are connected ensures that the current through the load is always in the same direction and the reservoir capacitor ensures that the current keeps flowing even when the diodes are not conducting.

If very little current is taken, the supply is almost perfectly smooth DC, but larger amounts of load current will cause the reservoir capacitor to discharge during the time when the diodes are not conducting. This causes an alternating voltage, or 'ripple', on top of the DC voltage and it is this ripple which is the cause of 'hum' from a power supply. The amount of ripple voltage, peak to peak, is approximately given by:

$$V = \frac{1000It}{C}$$

where  $I$  is the load current in mA,  $t$  is the time between peaks (10 ms for a bridge rectifier) and  $C$  is the capacitance of the reservoir capacitor in microfarads. For example, if we decide to use a 500  $\mu$ F reservoir capacitor on a bridge circuit supplying 100 mA (= 0.1 A), then the ripple voltage is

$$\frac{1000 \times 0.1 \times 10}{500} \text{ volts,}$$

which is 2 V. This isn't too good, but a capacitor of 5000  $\mu$ F will reduce the ripple to 0.2 V which is much better.

The simple rectifier bridge plus reservoir capacitor type of power supply works well providing we don't expect too much of it, but it does have a fairly large internal resistance. If the circuit needs a steady voltage, unaffected by changes in line supply voltage or in the

amount of current being taken by the load, then a stabilising circuit must be added. The effect of a stabilising circuit (stabiliser or regulator) is to reduce the output voltage to a level which is then held steady despite changes in mains voltage or load current and which has no detectable ripple voltage.

Fig. 6 shows a simple zener diode regulator. The output from the reservoir capacitor is 12 V, but the voltage across the zener diode, providing that at least 2 mA is flowing, is only 5 V. Since the ripple voltage affects only the peak of the waveform (11.5 V to 12.5 V), no ripple appears on the output from the stabiliser and the difference between the supply voltage and the stabilised voltage appears across the resistor. The resistor value is calculated so that the zener diode will still pass current even when the load demands its maximum current. For example, if the maximum load current is 50 mA, then allowing for 2 mA through the zener diode, a total of 52 mA must drop 7 V (12 V - 5 V) across R1. The value of R1 is therefore

$$\left(\text{from } R = \frac{V}{I}\right) \quad \frac{7}{52} \text{ k}$$

which is 0.135k or 135R — the nearest preferred value is 120R.

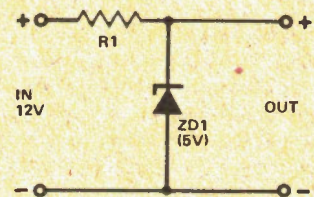

Fig. 6. A simple zener diode voltage stabiliser.

### Series Stabiliser

For larger load currents, a series stabiliser such as that of Fig. 7 is used. Q2 is a power transistor used to control the flow of current to the load so that the voltage across the load is constant. A sample of the voltage across the load is selected by resistors R3 and R4 and fed to the negative input of an operational amplifier IC1. The action of this IC is to amplify the difference in voltages at its two inputs, marked + and -, and the output voltage is always in antiphase to the - input voltage. The zener diode fixes the voltage at the + input of the IC. Now if the output voltage rises too high, making the voltage at the - input higher than the zener diode voltage, the voltage at the output of the IC will drop, causing Q1 to be biased back. This in turn will bias Q2 back so that the current fed to the load is reduced. Since this will reduce the voltage at the output, the rise of voltage has been corrected. Similarly, any drop in output voltage will cause the voltage at the - input of the IC to drop, making the output voltage rise, increasing the bias on Q1 and Q2 and so providing more current to the load. Once again, this corrects the fall in voltage, so that the stabilisation is automatic.

While a stabiliser circuit such as this one is most effective, several factors can cause the stabilisation to fail. One possibility is attempting to stabilise at an output voltage which is too close to the supply voltage, for example providing a 10 V stabilised supply from a 12 V unstabilised supply. This causes problems because the

# BATTERY TESTS

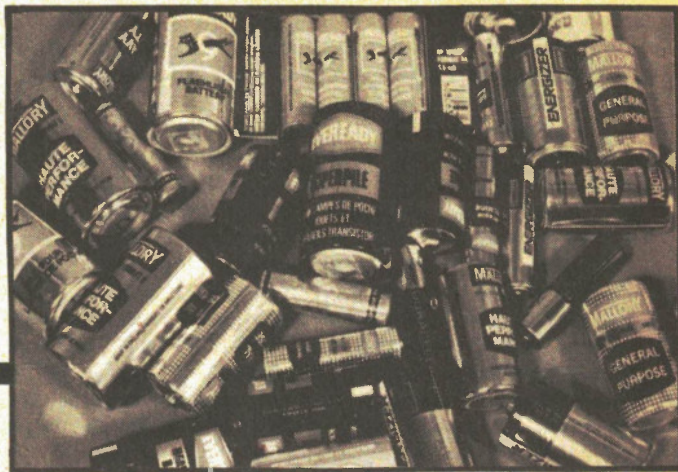

Alkaline batteries are being pushed really hard by their makers. Are they good value; we've been finding out.

'TAKE the Energiser Test'; 'No battery looks like it or lasts like it': these are the messages that bounce out at you from your TV screen. Has something dramatic happened in the battery field? Yes it has, but it happened some while ago with the introduction of Mallory's Duracell — an alkaline battery rather than the traditional zinc-carbon types. The competition has heated up because of the introduction of Eveready's Energiser. Now there's nothing very surprising nowadays when products are improved, we expect technological goods to get better. We can believe it when we are told these new batteries last up to five times longer but have you compared this to the extra cost? An Energiser D cell typically costs \$2.10 each (they're normally sold in a twin pack) while a Radio Shack General purpose type goes for 39¢ — a greater than five-fold price difference for what looks the same product.

There appears to be very strong pressure to make only the new batteries available; in a large department store near ETI's offices in Toronto they only sell Energisers — you can't buy the other batteries — this wouldn't matter if they were obviously always a better buy — but are they?

## Considerations.

More equipment than ever before requires batteries. Not many years ago transistor radios and flash lights accounted for a very high proportion of batteries sold. In the last few years calculators, digital watches, electronic flash guns and toys have been added to the products. When considering our tests we looked around and it's amazing the range of products that are battery powered — pencil sharpeners, automatic telephone books — even a blood pressure tester! Testing

batteries requires quite a bit of thought. At first you may imagine that you can hang a resistor across the terminals and plot a time voltage graph — but that's not how we use batteries. The type of load, the length of usage, the time allowed for the battery to recover, the likelihood of it being left on accidentally; all have a bearing on the test.

Battery makers *do* produce specification sheets on their products and they're a lot more complex than you'd imagine — the useful life of a battery can be five times as long as another depending on the usage.

In our tests we simulated, as close as possible, true test conditions. This presented us with a problem in a few areas. Although we began our tests six weeks before starting to write this article, it was nowhere long enough for some tests, such as electric clocks where a years operation can be expected from even the worst type of battery.

Other tests we started were not completed on account of the length of time that the batteries lasted; an example of this was a cassette recorder. This couldn't be left unattended for long periods and the alkaline batteries lasted so long that we had to give up on this part of the test.

We did however complete many others — in flashlights, flash-guns, radios and in a portable TV set. We also have some comments on battery powered toys.

## Are the claims valid?

How do the makers claims make out? Our conclusion is that not only are they substantially correct but in some cases the performance we got was *better* than the claims. In most cases this also showed greater power-per-penny with the alkaline types, but not invariably.

## Electronic Flash Guns

For our test we bought an inexpensive

Keystone electronic flash, it cost only \$10; our reason for choosing an inexpensive model was that flash tubes are supposed to last only for about 1000 flashes and we anticipated going through several units; in fact our little flash gun lasted throughout the test, over 2500 flashes in all.

In a flash gun the battery drives a tiny, but heavy current consumption, oscillator which produces a high voltage charge in a capacitor which is discharged very rapidly through the flash tube when the shutter button is pressed. There is a tiny neon which strikes to tell you when there is sufficient charge in the capacitor.

Even in a small flash gun, the initial current drawn from the battery is high. We measured 1.8 AMPS for the first charge (which fell to about 1.2A for subsequent turn ons, presumably because the electrolytics were reforming). This current falls to about 200mA when the neon strikes. Even so, nearly 2A is a lot to expect from an AA cell.

As the batteries become used up, the time taken to charge the capacitor becomes longer and longer.

Uses of a flash gun will vary but a typical programme might be 15 flashes in a 30 minute period, then nothing for another month.

Even during the first few flashes, carbon batteries took noticeably longer to charge than alkaline types and the time expanded as the test went on. However after a 'rest' they improved dramatically for a short period. Used continually, carbon batteries were good for only about 50 flashes before the time taken to charge became unacceptable (over 30 seconds).

The alkaline batteries showed no appreciable deterioration — even when used continually — until 400 flashes and they still had plenty of life left in them. They didn't show the dramatic



In our electronic flash gun tests the alkaline cells did far, far better than carbon types. They work out cheaper and have the advantages of long life.

'recovery' of the carbon batteries but they did improve slightly after a rest.

Alkaline batteries have a very extended life and in a flash gun this is a definite plus. Many of us will use a flash only a few times each year and this fits in with the advantages of alkaline batteries.

#### Toys

Radio control toys are great fun (far too good for kids). Carbon batteries are practically useless because the current drain is so high, they can't cope, even at the beginning. The car we tried with carbon batteries was so sluggish we couldn't possibly recommend them.

Alkaline batteries do the job beautifully, but there's a catch. In an ideal world the kids will always switch off their toys once they've finished playing with them. In a real world they'll lose momentary interest and leave the toy jammed against the wall in a stalled condition (which increases current drain considerably). By the time the parents find it, there's \$8 worth of batteries to throw away.

By far the greatest cause of battery discharge in toys is being left on — not useage — that's in a real world rather than an idealistic one.

#### Radios

Transistor radios don't draw much current, 20mA is typical and they're usually used for about an hour at a time with longish gaps between useage. In our tests we set three identical radios (having checked them to ensure that the current drains were similar) on at the same volume. Regular carbon batteries lasted for about 75 hours while the alkaline batteries were good for about 180 hours. We repeated these tests as on a penny-per-hour basis the alkaline types weren't so hot. The repeat test confirmed the initial results.

#### TV

We purchased a 5" screen portable TV which could be used with AC, from a car battery via the lighter socket or from dry batteries. Now no one is suggesting that you would ever use batteries for this type of equipment if there was an alternative but we gave it a go. Our model took nine D cells which cost nearly \$19 using the alkaline Energisers! To put this in perspective this is more than 10% of the cost of the TV itself. The current drain was 320mA — pretty large. Carbon batteries lasted only three hours before failing (we did two tests which gave the same results). After a couple of days these batteries were good for another hour or so but that was about it.

Alkaline batteries lasted for about 18 hours — a six-fold improvement — but

Although we have never heard of any publicity being given to it, Mallory battery packs are stamped with a date (it's embossed on the cardboard part of the pack).

Another point to look out for is that we were offered leaky batteries on two occasions (once these were on 'special'). All modern batteries are much less likely to leak than those of ten years ago (some people will remember the first improvement in batteries — leak-proof types). As most batteries are now sold in bubble packs signs of leaking are easy to spot.

#### Squeezing out the last ounce

Where batteries are required to give a lot of current, they may still have plenty of life in them for some less exacting equipment. The carbon batteries used in our



Although we ran several tests — and repeated them — the alkaline batteries did not prove good value in radios. They lasted longer but not in proportion to their cost. The flashlights last five times longer using alkaline cells.

this still works out at over a dollar an hour! (As with carbon types, we also did two tests with alkaline types).

#### Flash lights

Flashlights are one of those things that most of us keep for emergencies but when we want them, we want them to work — we're usually using the thing as an emergency anyway.

Carbon batteries — both regular and heavy duty types — gave out after about 4 hours, the alkaline types were good for 20 hours.

There's a very practical reason to use alkaline types here which doesn't apply to the other tests. The outside temperature during winter here in Canada — especially at night — make alkalines almost a necessity. Carbon batteries have a poor performance at low temperatures and even fresh ones won't be much good at very low temperatures.

#### Buying batteries

You'll do well to buy your batteries from a retailer who has a big turnover in them; you should be able to work out for yourself who this will be in your area.



TV test for instance were apparently dead after four hours (total) but they were used to fill up flash lights for Halloween and were good for at least 2½ hours more.

#### Manufacturer v Manufacturer

In all to do our tests we purchased over \$150 worth of batteries and had originally intended to compare not only carbon against alkaline but Duracell against Energiser. Both companies are spending a lot on advertising asking us to compare. Note that they don't suggest you try out one against the other,

# EPROM ERASER

A simple and inexpensive way to erase EPROMs from Marty Ing.

VIRTUALLY all EPROMs require a light source of 2537 Angstroms to erase the contents back to its original state of all outputs high or all outputs low. For a long time the only method of getting that type of light source that I knew of was to buy a commercial EPROM eraser. By the time I landed the cheapest one into Canada I was looking at over one hundred Canadian dollars. Since then I've found you can have an EPROM eraser for as low as \$27.00.

At 2537 Angstroms light does not pass through common glass or the atmosphere very well. This means ordinary mercury vapour ultra-violet sources such as the ones you use for exposing sensitized PC boards or making blueprints do not work when it comes to erasing EPROMs. Exposing to direct sunlight doesn't seem to work either because of the atmospheric absorption of light rays in this region. I can safely say this because I've tried these methods including "black lights" and plant lights.

## The Right Bulb

After searching around I finally found the G8T5 bulb (better known as germicidal lamp). The beautiful part of this lamp is that it will fit any standard desk top fluorescent lamp that uses a 12" bulb. All you have to do is replace the existing bulb with the G8T5 or equivalent. This bulb isn't cheap. At \$27.00 a bulb you better not drop it too many times. The secret to this bulb is quartz tubing instead of glass.

Placed at 3/4" away from the EPROM window it will erase the EPROM contents in about 20 minutes, even less time for 1702/4702 types. Because of varying situations, i.e. age deterioration, dust particles on the EPROM window, centering of the light source, etc., you should run a complete "read" of all the addresses on the newly erased EPROM to ensure there is not partial erase on any of the bits. It can be very frustrating to find a partially erased bit at the 1023 location after you've keyed in everything correctly up to that point.

**Warning!** Although light sources in this range of the spectrum may not look

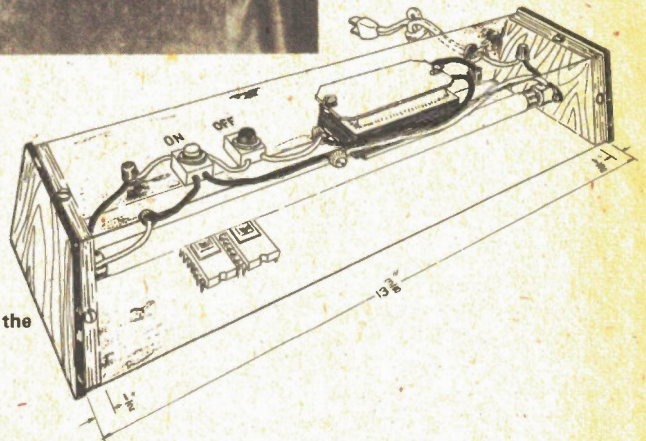
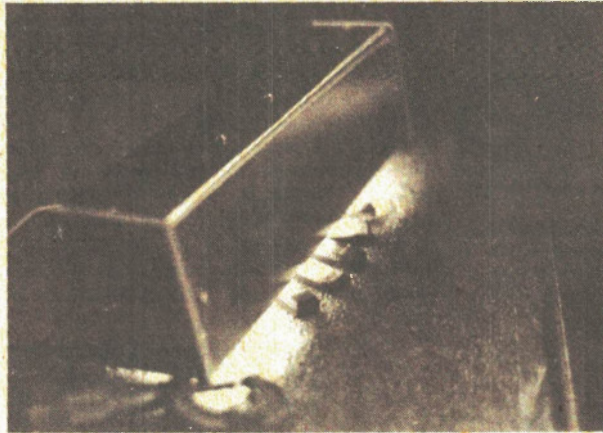

Fig. 1. Basic construction of the Eprom Eraser.

very dangerous or even very bright, it can cause skin cancer under continued exposure. At 2537A, it is well beyond the light spectrum you can see but it will still destroy the cells in your eye, eventually causing blindness. The moral of this story is to clearly label a warning on your lamp fixture and don't try to read with this bulb.

For safety reasons or if you don't have a suitable lamp fixture already you can build an inexpensive unit such as shown in the drawing. It's simply a piece of .032 aluminum folded into an

inverted trough with 3/4" hardwood plywood ends mitered as shown to keep the light from escaping at the ends. The wiring is shown in figure A. Simply centre this light source over your EPROMs, turn it on and come back after the required exposure time. If you're building from scratch, be sure to mount the lamp sockets so that there is at least 3/4" clearance between the bottom of the lamp and the base line. You can even save on the sockets by soldering the leads directly to the bulb. ●

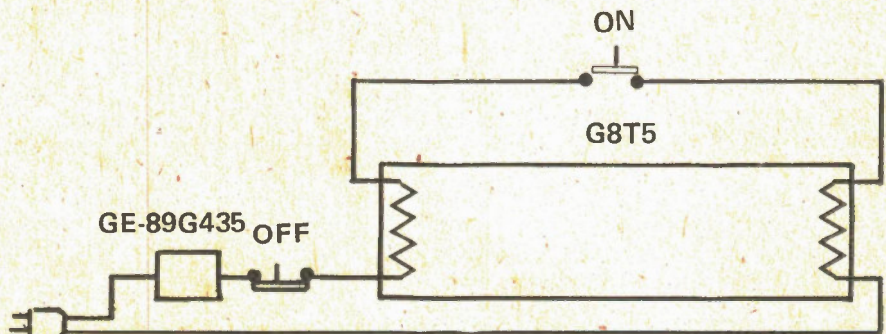

Fig. 2. The schematic.

# Everybody's making money selling microcomputers. Somebody's going to make money servicing them.

New NRI Home Study Course Shows You How to Make Money Servicing, Repairing,  
and Programming Personal and Small Business Computers

Seems like every time you turn around, somebody comes along with a new computer for home or business use. And they're being gobbled up to handle things like payrolls, billing, inventory, and other jobs for businesses of every size...to perform household functions like budgeting, environmental systems control, indexing recipes, even playing games.

## Growing Demand for Computer Technicians...Learn in Your Spare Time

Even before the microprocessor burst upon the scene, the computer industry forecast over a 100% increase in job openings for the decade through 1985. Most of them *new* jobs created by the expanding world of the computer. NRI can train you at home to service both microcomputers and their big brothers. Train you at your convenience, with clearly written "bite-size" lessons that you do evenings or weekends without quitting your present job.

## No Experience Needed

You don't need prior training in electronics or computers to take this exciting new course. NRI starts you with the basics, gives you a firm foundation to build on. And your personal counselor is always available, ready to help whenever you have questions.

## Assemble Your Own Microcomputer

NRI training also includes plenty of practical experience. You perform



meaningful experiments building and studying circuits on the NRI Discovery Lab.<sup>®</sup> Then you build your own test instruments like a transistorized volt-ohm meter, CMOS digital frequency counter...equipment you learn on, use later in your work.

And you build your own microcomputer, the only one designed for learning. It looks and operates like the finest of its kind, actually does more than many commercial units. But NRI engineers have designed components and planned assembly so it demonstrates important principles, gives you working experience in detecting and correcting problems. It's the kind of "hands-on" training you need to repair and service units now on the market.

## Rush Card for Free Catalog

Send the postage-paid card today for our 100-page, full-color catalog. It describes NRI's new Microcomputer Technology Course in detail, shows all equipment, kits, and lesson plans. And it also tells about other NRI courses...Complete Communications with 2-meter transceiver...TV/Audio/Video Systems Servicing with training on the only designed-for-learning 25" diagonal color TV with state-of-the-art computer programming. With more than a million students since 1914, NRI knows how to give you the most in home training for new opportunity. If card has been removed, write to:



**NRI Schools**  
McGraw-Hill Continuing  
Education Center  
330 Progress Avenue  
Scarborough, Ontario M1P 2Z5  
or telephone 416-293-1911

# We wouldn't dare enter the Canadian scope market if we didn't have a better product

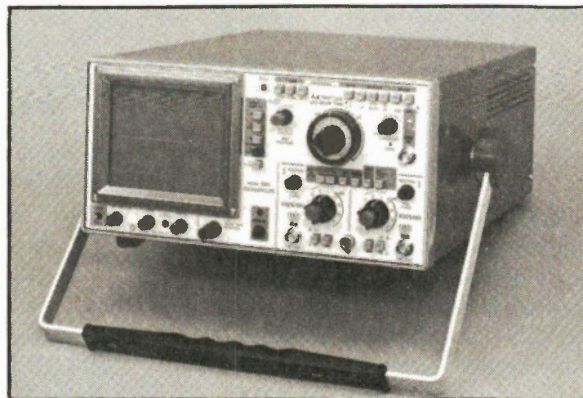
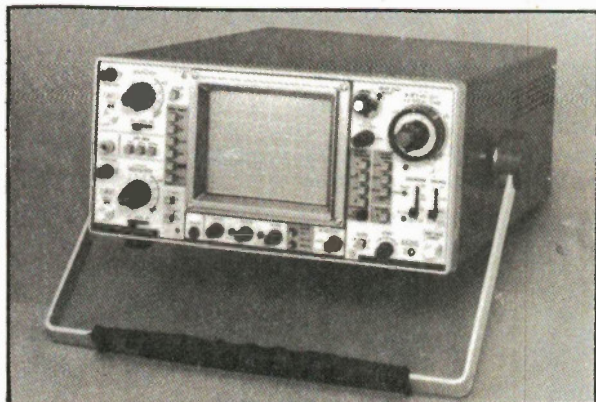

**MODEL 5630**  
35 MHz, dual trace, calibrated delayed sweep. Alternate trigger, 500KHz chop frequency, variable trigger hold off, alternate timebase viewing, 5mV @ 35 MHz, 1mV @ 10 MHz.

**MODEL 5531**  
35 MHz, dual trace, delayed sweep. Auto selection, alternate/chop (200KHz) and chop mode only, variable trigger hold-off, one touch X-Y mode, 5mV @ 35MHz, 1mV @ 15MHz.

## KIK-SCOPES

MODEL 5650	50MHz, calibrated delayed sweep.	\$2569.	5520	20MHz, dual trace . . . . .	\$1005.
5630	35MHz, calibrated delayed sweep.	\$2275.	5516ST	10MHz, storage, auto-erase . . . . .	\$2509.
5531	35MHz, delayed sweep. . . . .	\$1770.	5513	10MHz, dual trace . . . . .	\$824.
5530	35MHz, dual trace . . . . .	\$1495.	5509	10MHz, single trace . . . . .	\$663.

Price includes probes and a 2 YEAR WARRANTY.

For more information about Kik-Scopes, Circle No. 59 on Reader Service Card.

### Conditions:

Prices are F.O.B. Montreal, Quebec, duty and FST included. Payable by certified cheque or money order.

### Phone numbers of other locations:

Ottawa (613) 838-3187  
Toronto (416) 826-7080  
Montreal (514) 336-0392

# interfax

systems inc.

### MAIL ORDER ADDRESS:

INTERFAX SYSTEMS INC.  
6515 Van Den Abeele,  
St. Laurent, P.Q.  
H4S 1S1



## RESOLUTION WHEN AND WHERE YOU NEED IT

Data Precision has 3½ digit DMM's, the 935 and 936, that compete very well with other manufacturers, especially if reliability and accuracy are considered.

But at 4½ digits our competitors back off. The 245, 248 and 258, all 4½ digit portables, have 0.05% basic DC accuracy, plus the 248 and 258 have true RMS measuring capability.

The model 2480 and 2480R have 0.03% basic DC accuracy in a bench/portable package.



Model	Price	RMS	Digits	Accuracy
935	\$219	No	3½	.1%
936	\$248	No	3½	.1%
245	\$558	No	4½	.05%
248	\$504	Yes	4½	.05%
258	\$528	Yes	4½	.05%
2480	\$458	No	4½	.03%
2480R	\$489	Yes	4½	.03%

For more information on Data Precision products, Circle No. 60 on Reader Service Card.

# THE EDISON EFFECT

Many famous discoveries were made by accident or whilst investigating another field. The Edison Effect falls into this category. K.T. Wilson tells the story. . .

THOMAS ALVA EDISON (1847-1931) was called "The Wizard who Spat on the Floor." The U.S. Patent Office credits him with more patents on inventions than any other U.S. citizen before or since and it was he who coined the expression 'genius is 1% inspiration, 99% perspiration.' What it all amounts to is that even though Edison was a practical man, he was also an inventive genius. This is the story of how he discovered one of the basic principles of electronics — and then forgot it!

## Let There Be Light.

In 1878, Edison, then aged 31, along with his partner Swan, produced the first successful incandescent light bulb. That's the type of lamp bulb that we use today with a wire filament heated white-hot by electric current. It's difficult to imagine, writing this a century later, how astonishing this must have been, to have light at the touch of a switch. These early bulbs used filaments which were either of carbon, produced by charring silk or cotton threads, or of tungsten (a hard, tough metal) wire. The filaments were sealed into a glass bulb, with the wire leads made of a material which expanded to the same extent as the glass so that the glass around the wire did not crack as it all cooled. The bulbs were then evacuated, using a rather primitive air pump. The vacuum was necessary because the oxygen in the air combines with any very hot metal (or carbon) — the material, in other words, burns. Take away the air, and the filament can be heated white hot without burning. They had their problems, of course; the carbon filaments were very fragile and easily broken but astonishingly enough, a few carbon-filament lamps have survived and are still usable. Edison, however, felt that the future lay with the more robust metal filaments.

Now in those days, as now, you could arouse a lot of interest with a new invention, but it had to be pretty well sorted out before people in large numbers could be persuaded to buy. The metal-filament bulb certainly had a better chance of getting to the customer in one piece, but its working life was short. After only a few hours of running, the light level had dropped noticeably, the glass of the bulb darkened, and soon afterwards the filament melted.

At that particular time, what we now call vacuum physics was in its infancy, and very little was known about how materials behaved in a vacuum but nowadays, we can understand perfectly what was happening in these primitive light bulbs. Every substance has its own vapour around it and the pressure of this vapour can be measured. When the pressure of the vapour equals the pressure of the atmosphere around the material, the material vaporises rapidly, we say that it *boils*. The higher the temperature of any material, the greater is its vapour pressure.

## Low Pressure Problems

At 20°C (normal room temperature) for example, the vapour pressure of water is 2.34 kPa (the kilo-Pascal, shortened to kPa, is the unit of pressure), and at 100°C,

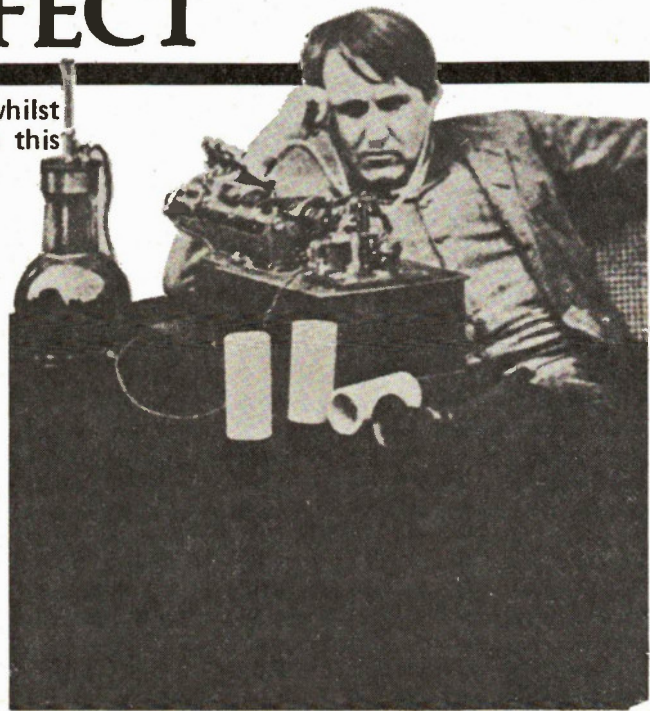

Thomas Edison was one of that rare breed — the practical inventor. He holds the US record for the number of patents filed but one of his discoveries, the diode, was not appreciated by him, or anyone else for that matter, at the time.

the vapour pressure of water is 101.32 kPa, equal to the pressure of the air about us, so that water boils at 100°C. If we put some water in a container inside a vacuum bell-jar and start to pump out the air, however, we can soon bring the air pressure inside the jar to 2.34 kPa. This is the same as the pressure of vapour around water at 20°C, so that the water inside the bell-jar will boil at this pressure, even though its temperature is only 20°C. By lowering the pressure still further, we can make the water boil even while it is busy turning into ice.

What has this to do with lamp bulbs? Well, it's just that Edison's tungsten filaments, at the temperature that was needed to give out light (well over 2000°C) had a vapour pressure which was pretty close to the pressure inside the glass bulb — so the tungsten was evaporating fast. Like any other vapour, whenever the tungsten vapour hit the cold surface of the glass it condensed, leaving a thin film of tungsten on the glass. This cut down the amount of light passing through the glass and also reflected a lot of the radiated heat back. As more and more tungsten condensed, less light was given out, and more heat was reflected, making the filament hotter so that it evaporated faster. Eventually, the inevitable happened, the filament melted.

Edison was strictly a practical man, self-educated, who had no interest in science unless he could see an answer to a problem. This was such a problem, and he browsed over some ideas. The most likely connection he could see was with electrostatics. He reasoned that the hot filament was giving off some sort of particles and that it was these landing on the glass which were causing the trouble. What could be done? According to the laws of Electrostatics, charged particles could be attracted or repelled by other charges, were the particles charged? Edison wasn't interested in speculating, he simply wanted a solution to the problem, so he devised an experiment to see if he was right.

Physical Attractions

If the particles were charged, it should be possible to attract them to a metal plate inside the bulb if the metal plate were connected to a DC supply. Edison reckoned that if the particles could be attracted to a plate, they would not fog the glass and the Edison light bulb would shine for much longer. In addition, it would be one in the eye for Swan and his carbon filaments.

Using his excellent workshop facilities (which have been preserved as a museum), he constructed his experimental light bulb, looking something like Fig. 1. The metal plate was connected to a stub of wire which was in turn sealed through the glass, and the rest of the bulb was a normal lamp-bulb which was then evacuated and sealed-off in the usual way.

Edison then set up the circuit for his experiment. The lamp filament was operated by a DC supply, and another DC supply was hooked up for the plate. How would he know if it worked? The obvious answer was to wait and see if the bulb dimmed, but Edison was much too impatient for this. He decided that if charged particles reached the plate, then an electric current would flow, and that this current could be measured. He connected a milliammeter into the supply line for the plate and fixed up a reversing switch so that one side of the supply could be connected to the plate and the other to the negative filament lead (Fig. 2).

He switched on and juggled with the controls. To his delight, he found that the milliammeter registered a current when the plate was positive with respect to the filament but not when the plate was negative with respect to the filament. This was clear evidence that charged particles were moving through the vacuum inside the bulb. He then tried varying the filament current. When the filament current was decreased, the milliammeter current (plate current) dropped greatly, and became zero when the filament was no longer glowing brilliantly, though still glowing. This was equally clear evidence that the charged particles were coming from the filament and that they were emitted only when the filament was very hot. Since they collected on a positively charged plate, the particles must be negatively charged.

It looked good to Edison and he then set about what we would call a life-test, adjusting the filament current to its normal value, and making the plate voltage positive so that the charged particles were attracted to the plate. He then turned to something else, since he always had several projects going at the same time.

Meanwhile, Back at the Lab

He returned to his bulb experiment a few days later to find the plate current still flowing merrily but the bulb clouding over in the usual familiar way. Soon afterwards, the filament melted. Edison, not quite believing it, made a second sample. He found the same action, the flow of current in the plate circuit indicating that charged particles from the filament were landing on the plate. This bulb also clouded over and then failed. Edison hated being beaten, but he didn't know what to do next. It was obvious that the clouding of the glass was not related to the flow of the charged particles. Being a shrewd man, Edison thought that he should patent the idea, just in case he thought of a use for it later. So it was that the Edison Effect was described fully in its US patent, filed in 1880. Edison was soon too busy with ideas to revive his experiments and, tragically, no-one who might have made use of the idea seems to have read

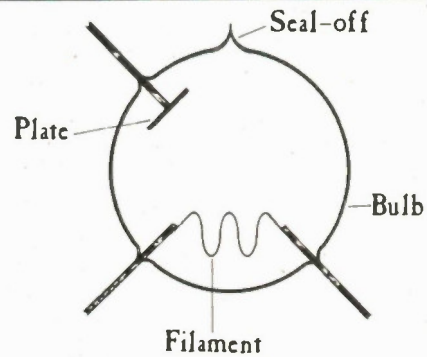

Fig.1. Edison's experiment which he set up to see if a charged plate inside his light bulb would attract the vapourised tungsten which was causing all the problems.

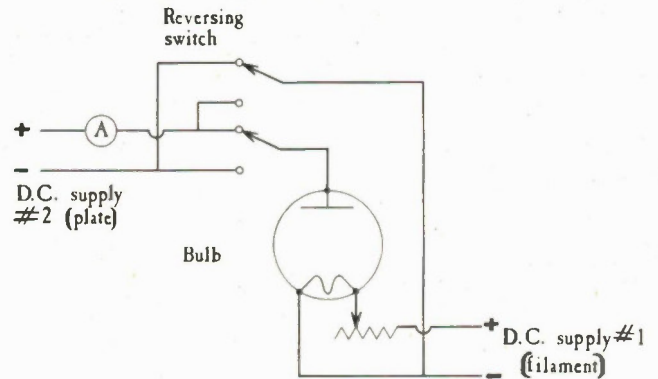

Fig.2. Being too impatient to wait to see if his arrangement in Fig.1. worked. Edison decided to measure any current to his charged plate.

the patent — there were no instant copiers in those days.

What Edison had invented, you see, was the first diode valve. With the invention of the telephone in 1876, and Marconi's first long-distance radio transmission of over a mile in 1895, the time was ripe for the birth of electronics. Poulsen in Denmark was experimenting with magnetic recording, a principle that cried out for electronic amplification; but the Edison effect was forgotten by its inventor, overlooked by the rest of the world, and the patent lapsed. Later on, Fleming had to invent the diode all over again and Irving Langmuir was then ready to add the grid that made the diode into a triode, opening the way to amplification.

The lamp-bulb problem? Swan was more of a scientist than Edison, and he soon realised that the problem was caused by the low pressure around the filament. The only reason for using such a low pressure was to remove oxygen from the bulb, and Swan devised the method that is still in use today, of allowing an inert gas (one which does not allow hot metals to burn) into the bulb after the air was evacuated out. Such gas, argon or neon, can have a fairly high pressure, so that the rate of vaporisation of the metal is very low and can help to conduct heat away from the hot filament.

If Only...

What a lot of might-have-beens we can think up, though. Suppose, for example, that the remarkable genius Heinrich Hertz, born in 1857, who discovered radio waves, but who died at the age of 37, had noticed the Edison effect? What sort of history would have been written, what sort of electronics would we know today?

Anyone out there forgotten about any old inventions? ●



10 to 30 MHz oscilloscopes with more performance and reliability than you ever thought possible.



It's easy to see why LEADER oscilloscopes are now specified more than ever. More performance and quality for less cost... with immediate deliveries from stocking distributors. They come with the best two-year warranty in the industry... backed by efficient factory service.

### A full-range of reliable, medium bandwidth oscilloscopes.

LEADER's oscilloscope line includes 11 models, single and dual trace versions, for bench or field use. All models offer comprehensive triggering controls, TTL compatible Z-axis modulation, front panel trace alignment control and convenient, color-keyed front panel layout. Probes are furnished with most oscilloscopes and options include probe pouches, carrying cases, front panel covers and rack mounting adapters.

### 30 MHz delayed sweep - NEW

LBO-515B is a compact, precision oscilloscope at a moderate price. Using a PDA 4-inch CRT with parallax-free internal graticule, it features 5 mV sensitivity and delayed sweep for viewing and measuring complex waveforms. Also has 120 ns signal delay, trigger hold-off and x-y operation at full sensitivity.

### 30 MHz with signal delay - \$1585.

LBO-520 combines a 11.7 ns rise time with 5 mV sensitivity and 120 ns signal

# The surprising leader.

delay lines. Has single shot triggering, X10 sweep magnifier and bright, sharp PDA CRT. Triggers to 50 MHz.

### 20 MHz dual and single trace - \$1100., \$865.

LBO-508A and LBO-507A give you versatility at low cost. Rise time is 17.5 ns with 1 M $\Omega$  (35 pF) input impedance. Automatic or external triggering, X5 sweep magnifier, 10 mV/cm sensitivity and add/subtract modes.

### 10 MHz with 1 mV sensitivity - \$895.

LBO-514 has both vertical and horizontal X5 magnifiers. Sensitivity is from 1 mV/cm to 10 V/cm. Sweep speeds from 0.2 s/cm to 0.1  $\mu$ s/cm. Auto or normal triggering. Z-axis modulation. (Single trace version, LBO-513, \$775.)

Circle No. 16 on Reader Service Card

### 20 MHz battery/ac portable - \$1350.

LBO-308S provides lab performance and high reliability in field service applications. Sensitivity is 2 mV with a complete set of triggering controls and 18 sweep ranges to 0.1  $\mu$ s/div. with X5 magnifier. Compact, lightweight with 3-inch rectangular, internal graticule CRT. (Optional 2 hour internal battery pack is recharged during ac operation.)

### Two-year warranty. Evaluation units.

A history of high reliability permits LEADER to provide a generous 2-year warranty... backed by factory service. Call or write for:

- an evaluation
- a catalogue
- the name or your nearest franchised distributor
- additional information

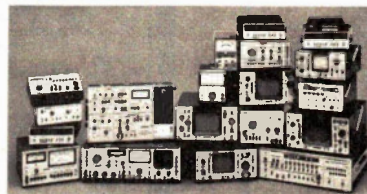

Oscilloscopes, frequency counters, function generators, video and audio instruments... a LEADER instrument for almost every need.

When Quality Counts

**LEADER**  
Instruments Corporation

REPRESENTED IN CANADA BY:

**omnitronix Ltd.**  
2056 Trans Canada Hwy.  
Dorval, Quebec.  
H9P 2N4  
(514) 683-6993  
Telex: 05-822692

Unit 7, 6295 Shawson Dr.  
Mississauga, Ontario.  
L5T 1H4  
(416) 678-7170  
Telex: 06-968653

## Hi Power Class 'A' Amplifier Kits

Now you too can afford to experience and enjoy the exciting, almost no-distortion sound of the latest Class "A" amplifiers with unique circuit designs you can only find in expensive brand name products.

### BUILD YOUR OWN AND SAVE!

No. 1000	250W maximum (85W R.M.S. per channel) Stereo Dynamic Bias Class "A" Dual Differential Fully Complementary Preamp. and Power Amplifier with Speaker Protector and Power Supply . . . . .	\$189.50
No. 920	70W R.M.S. per channel Stereo Class "A" OCL DC Preamp. and Power Amp. with Built-in Mic Mixer, Speaker Protector and Power Supply . . . . .	\$138.50
No. 7777	130W R.M.S. per channel Stereo FET Super Low T.I.M. Dynamic Class "A" Power Amplifier with Speaker Protector and Power Supply . . . . .	\$169.50
No. 100A	100W maximum (35W R.M.S. per channel) Stereo Dynamic Bias Class "A" Dual Differential Pure Complementary Power Amplifier with Speaker Protector . . . . .	\$75.50
No. 1200	120W R.M.S. single channel DC FET Super Class "A" Power Amplifier with Super Low-Noise Matching Pair FET Differential Output . . . . .	\$96.00
No. 100DP	DC Class "A" Professional Stereo Preamp. with Regulated Power Supply . . . . .	\$84.50

Add 5% for postage and handling (no charge on orders of \$200.00 or more). Ontario residents add 7% sales tax. Send cheque or money order. Master Charge or Visa accepted.

PHONE ORDER (MASTER CHARGE OR VISA ONLY): (416) 499-0401

FREE CATALOGUE:

AUDIOVISION SERVICE

P.O. Box 955, Station B

Willowdale, Ontario M2K 2T6

Circle No. 1 on Reader Service Card.

## VIDEO DISCOUNT

6 hr VHS VCR (1981 Model, Solenoid controlled) . . . . . \$999  
6 hr VHS tapes . . . . . \$19.99 min of 6 . . . . . \$20.99 for 1

COLOUR CAMERAS . . . . . from \$599 up.  
SANYO Beta video recorder . . . . . \$888  
6 hr portable with tuner . . . . . \$1299

Video accessories available:

—Dust covers (specify model) . . . . . \$22.95  
—Cleaning kits . . . . . \$9.99  
—Others available. Write for catalogue.

Movies from . . . . . \$49 + up  
Satellite Earth Stations . . . . . \$4995

Shipping Extra

Write for a free catalogue or circle the Reader Service Number (below) on the Reader Service Card.

## VIDEOLAND

LOWEST PRICES  
WE SHIP ANYWHERE.

### TORONTO

Head Office & Mail Order Address:

780 Wilson Ave.  
(W. of Dufferin)  
Downsview, Ont.  
M3K 1E2  
(416) 638-2974

582 Yonge St.  
(N. of Wellesley)  
Toronto, Ont.  
921-0264

1375 Danforth Rd.  
(N. of Eglinton)  
Scarborough, Ont.  
265-3525

1158 Queensway  
(W. of Islington)  
Etobicoke, Ont.  
255-7543

### OTTAWA

1154 Bank St.  
(at Glenn)  
236-0475

**SARNIA**  
773 Confederation  
Sarnia, Ont.  
336-8433

### NORTH BAY

1138 Cassells St.  
North Bay, Ont.  
476-0007

Other locations opening soon in Montreal, Calgary and Vancouver. Call telephone operator for phone number. Retail (non-mall order) customers must present this ad (or a photocopy) to get these prices.

(DEALERSHIPS AVAILABLE)

Circle No. 23 on Reader Service Card.

## SUCCESS WITHOUT COLLEGE 15 WAYS

ICS will prepare you at home in your spare time for one of these top pay careers.

- |   |  |
|---|--|
| <input type="checkbox"/> Accounting                         | <input type="checkbox"/> TV Servicing            |
| <input type="checkbox"/> Auto Mechanics                     | <input type="checkbox"/> Electrician             |
| <input type="checkbox"/> Aircraft Mechanics                 | <input type="checkbox"/> Interior Decoration     |
| <input type="checkbox"/> Business Management                | <input type="checkbox"/> Electronics Engineering |
| <input type="checkbox"/> Motel/Restaurant Management        | <input type="checkbox"/> Drafting                |
| <input type="checkbox"/> Air Conditioning and Refrigeration | <input type="checkbox"/> Secretarial             |
|   | <input type="checkbox"/> Adult High School       |
|   | <input type="checkbox"/> Diesel Mechanics        |

FREE CAREER BOOKLET - FREE DEMO LESSON

NO OBLIGATION

Fill out this Coupon and Mail Today, to:

### ICS

Canadian Limited

7475 Sherbrooke St. West, Montréal, P.Q. H4B 1S4

NAME \_\_\_\_\_

ADDRESS \_\_\_\_\_

CITY \_\_\_\_\_ PROV \_\_\_\_\_

P CODE \_\_\_\_\_ APT \_\_\_\_\_ AGE \_\_\_\_\_

TEL No. \_\_\_\_\_ ET 0181

## FOR PARTS O BRYAN ELECTRONICS O FOR EVERYTHING O



**WHAT A DEAL!**  
Mini-dip switches  
4-pole-\$1.49 ea.  
**UNBELIEVABLE!**  
For every one you buy, we'll give you one free!

**HELP US! WE'RE GOING TO BE BURIED ALIVE IF WE DON'T MOVE 'EM.**  
ELECTROLYTICS - RADIAL

1 mfd-50v-20¢ ea.
2.2 mfd-50v-20¢ ea.
3.3 mfd-50v-20¢ ea.
4.7 mfd-25v-20¢ ea.
10 mfd-25v-20¢ ea.
22 mfd-25v-20¢ ea.
33 mfd-25v-20¢ ea.
47 mfd-25v-25¢ ea.
100 mfd-25v-25¢ ea.
220 mfd-25v-30¢ ea.
330 mfd-25v-35¢ ea.
470 mfd-25v-45¢ ea.
1000 mfd-25v-65¢ ea.



**JANA PCB'S SAVE YOU MONEY.**  
\*Parts and instructions not included.

No. 15A-0-24v 1A power supply . . . . .	\$2.49 ea.
No. 22-Xenon strobe . . . . .	\$2.40 ea.
No. 23A-3 channel Color Organ . . . . .	\$2.25 ea.
No. 27A-Electronic Dice . . . . .	\$6.95 ea.
No. 28A-Super Roulette . . . . .	\$4.50 ea.

\* SEND FOR COMPLETE LIST \*

**TRANSISTOR BLITZ!**

2N2222-39¢ ea.
2N3055-69¢ ea.
2N3704-10¢ ea.
2N3904-15¢ ea.
2N3906-15¢ ea.
TIP29C-69¢ ea.
TIP30C-69¢ ea.
MPS6515-16¢ ea.

**DISPLAYS**  
common anode, 0.8" 7 segment-\$2.25 ea.  
9 segment-\$2.25 ea.

**GET THE "LED" OUT L.E.D.'s**  
Jumbo 5mm, Pin-point 3mm your choice.

red . . . . .	\$ .19 ea.
yellow . . . . .	\$ .29 ea.
green . . . . .	\$ .29 ea.

WHEN YOU PUT THE FAMILY NAME ON THE BUSINESS YOU HAD BETTER DO IT RIGHT - WE DO IT RIGHT

**TAB BOOKS**

No. 1100-Master Transistor I.C. Substitution Handbook . . . . .	\$13.55
No. 1053-Microprocessor Cook Book . . . . .	\$6.75
No. 856-Master Op-Amp Applications Handbook . . . . .	\$10.95
No. 938-Linear I.C. Applications Handbook . . . . .	\$7.60
No. 875-Master Handbook of Digital Logic Applications . . . . .	\$9.30

SEND FOR COMPLETE LIST

**FREE OFFER**

INTERESTED?? Tell us what page our ad appeared on in November/80 ETI and we'll give you FREE shipping on your order!!!

**THE RIPPLE BEATERS! POWER SUPPLY TYPE ELECTROLYTICS**

2,200 mfd 50v . . . . .	\$2.83 ea.
3,300 mfd 50v . . . . .	\$3.64 ea.
4,700 mfd 50v . . . . .	\$3.91 ea.
6,800 mfd 50v . . . . .	\$4.72 ea.
10,000 mfd 50v . . . . .	\$5.40 ea.
15,000 mfd 50v . . . . .	\$7.42 ea.
2,200 mfd 100v . . . . .	\$6.61 ea.
3,300 mfd 100v . . . . .	\$8.77 ea.
4,700 mfd 100v . . . . .	\$10.80 ea.
6,800 mfd 100v . . . . .	\$16.20 ea.

## ORDER & SAVE

"LIMITED QUANTITIES. IF YOU'RE GOING TO ORDER, DO IT NOW, OR YOU MAY BE LEFT OUT. THIS SALE EXPIRES MARCH 1/81."

NOTICE: This is Canada. These are Canadian prices.



**WE DARE YOU!**  
TRY AND BEAT THESE PRICES!

8040-10 color-coded clip leads . . . . .	\$1.79 ea.
7019-F59 cable connectors . . . . .	\$1.16 ea.
7009-75/300 ohm antenna matcher . . . . .	\$ .69 ea.
7012-75 ohm 2-way splitter . . . . .	\$1.69 ea.
7034-6' telephone cable plug/spade lugs . . . . .	\$1.69 ea.
7035-25' telephone cable plug/spade lugs . . . . .	\$3.69 ea.

### FINISHED PRODUCTS

Watch for this space in our upcoming ads in ETI. Our Marketing expertise is going to save you money! Shipping is extra on these items, 15 day return privilege.

I.C.C. Electronics Home Audio-Amp 160 wrms total-\$299.95

Phone Controller Automatic Phone Dialer-30 number storage, battery back-up, LED display, built in clock, elapse timer, auto-redial, hold, and more-\$129.95

Write for more details on these items.

**BRYAN ELECTRONICS**  
P.O. BOX 2068  
BRAMALEA, ONTARIO  
L6T 3S3

## "AFTER SANTA SUPER SALE"

Circle No. 7 on Reader Service Card.

# DIRECTORY OF ELECTRONIC STORES

This listing of Electronics Stores has been compiled from our own lists and with the cooperation of several subscribers to the magazine. They were asked to supply details of their local stores or any that they purchased from. We then wrote to all stores and this listing is what they supplied; the wording and the details are those given to us by stores.

## BRITISH COLUMBIA

### Kamloops

Cam Gard Supply Limited ETI  
825 Notre Dame Dr, Kamloops, B.C. V2C 5N8  
Tel. (604) 372-3338  
EC, RTV, TG, EK, MO  
National wholesaler of electronic parts and equipment including such lines as B & K, Potter and Brumfield, Jana, Belden, Hammond, semis.

### Vancouver

Active Component Sales Corp. ETI  
3070 Kingsway, Vancouver, BC, V5R 5J7  
Tel. (604) 438-3321.  
EC, CA, RTV, TG, EK, MO, CAT (Free)  
See our directory ad.

Cam Gard Supply Ltd.  
2055 Boundary Rd, Vancouver, British Columbia. V5M 3Z2. Tel. (604) 291-1441.  
EC, CA, RTV, TG, EK, MO.  
Aiphone, Amphenol, Andrew Ant, A P Products, Augat, B&K, Bach Simpson, Beckman, Belden, Cannon, Controlled Static, EZ Circuit, Gel Cell, Hammond, I T T, Jana, Lab Volt, Luxo, Mallory, Pico, Potter & Brumfield, Power One, Scotch Flex, Texas Instrument.

Conti Electronics Limited  
5656 Fraser St., Vancouver, B.C. V5W 2Z4  
Tel. (604) 324-0505  
AP Products, Armaco, Commodore Business Machines, EZ Hook, Fluke, GC, Plessey, Sanken, Silicon General, Synertek and more.  
(Line card available).

Glenwood Trading Company Limited  
278 East First St., North Vancouver, BC V7L 1B3. Tel. (604) 984-0404  
EC, CA, RTV, TG, MO, CAT (Free)  
Canada's largest mail order supplier of amateur radio equipment, accessories, antennas, books. Computers, microphones, power supplies, receivers, rotors, transceivers.

Heath Company ETI  
3058 Kingsway, Vancouver, B.C. V5R 5J7  
CA, TG, EK, MO, CAT, FREE  
Shortwave Radios, Amateur Radio Equipment, Radio, Control Equipment, Marine Equipment, Video, HI-FI, and other kits.

### KEY

ETI ETI Magazine sold here  
EC Supplies Electronic Components  
CA Sells Computers and Accessories  
RTV Sells Radio and TV parts  
TG Sells Test Gear  
EK Sells Electronic Kits  
MO Company does Mail Order  
CAT Catalogue available. The cost of this, or if it free, is shown



Intek Electronics Ltd. ETI  
10 - 8385 St. George St., Vancouver, BC V5X 4P3. Tel. (604) 324-6831.  
EC, EK.  
Electronics parts distributors handling products such as: Alpha, Beckman, C&K Dale, Exar, Harris, ITT, Littlefuse, Motorola, Opto-22, PMI, Silicon General, Teledyne Semiconductor, Robinson Nugent, Varadyne, Mallory.



R-A-E Industrial Electronics Limited ETI  
3455 Gardner Court, Burnaby, B.C. V5G 4J7  
Tel. (604) 291-8866  
EC, CA, TG, EK, MO, CAT, \$10.00  
The largest inventory in Western Canada of industrial electronic components. R-A-E stocks 150 manufacturers product lines with over 26,000 separate items to choose from.

### Victoria

Queale Electronics Ltd.  
1004 North Park Street, Victoria, British Columbia. V8Z 2E6 Tel. (604) 388-6111  
EC, CA, RTV, TG, EK, MO.  
Broad line distributors, all phases of electronics parts, equipment consumer & industrial plus audio visual.



INDUSTRIAL ELECTRONICS LTD.  
VANCOUVER - EDMONTON

R-A-E has the largest inventory of industrial electronic parts in Western Canada, representing over 150 manufacturers of active and passive components. Many hard-to-find parts are readily available from our extensive inventory of over 26,000 separate items.

Our new 1200 page catalogue is now available. It's free to industrial customers on receipt of a letterhead request. Copies for hobby or home use are \$10 each.

VANCOUVER  
3455 Gardner Court  
Burnaby, B.C. V5G 4J7  
Phone (604) 291-8866

EDMONTON  
11680 - 170th Street  
Edmonton, Alberta T5S 1J7  
Phone (403) 451-4001

VISA and MASTERCHARGE mail orders are welcome.

# DIRECTORY OF ELECTRONIC RETAILERS

## ALBERTA

### Calgary

**Active Component Sales Corp.** ETI  
5809 MacLeod Trail South, Calgary, Alberta,  
T2H 0J9. Tel. (403) 259-6408.  
EC, CA, RTV, TG, EK, MO, CAT (Free)  
See our directory ad.

**B & E Electronic Supply Limited** ETI  
442 Manitou Rd. S.E., Calgary, Alberta  
T2G 4C4 Tel. (403) 243-3177  
EC, RTV, TG, EK, MO

### Visions

329 - 8th Avenue S.W., Calgary, Alberta,  
T2P 1C4. Tel. (403) 233-2249.  
CA, RTV, MO, CAT (Free).

Visions is a speciality video, electronics and video retailer. Major lines carried: Exidy, Atari, Mattel, Magnavox, Electrohome, C.Itoh and Hitachi. Sister company Spectra Electronics is Canadian distributor for Exidy Data Products Inc.

## Medicine Hat

**Base 2 Consulting Limited**  
(formerly KS Computer Services)  
42 Rossmere Close, S.E., Medicine Hat,  
Alberta T1B 2J8 Tel. (403) 526-0594  
CA

## SASKATCHEWAN

### Moose Jaw

**Sonic Supplies Ltd.**  
Box 1265 - 111 Main St. N., Moose Jaw, SK  
S6H 0V9. Tel. (306) 692-6486.  
EC, CA, RTV, TG, EK, MO  
Stereo components, video cassette tapes  
electronic parts, amateur radio equipment,  
semiconductors, tools, wire, TV antennas,  
TV distribution equip., sound equipment.

### Regina

**Radio Supply & Service (1977) Limited**  
3033 S. Railway St., Regina, Sask. S4T 1H5  
Tel. (306) 352-8642 Telex. 071-2661  
EC, CA, RTV, TG, EK, MO  
We are wholesale distributors of radio, TV  
electronics parts and industrial components,  
serving dealers, HI-FI trade, broadcast, indus-  
trial, government, amateur radio accounts.  
We supply manufacturers' catalogues/bro-  
chures free on request. Directory of lines  
available.

### Saskatoon

**Cam Gard Supply Limited**  
1501 Ontario Ave., Saskatoon, Sask. S7K 1S7  
Tel. (306) 6424.  
EC, RTV, TG, EK, MO

### Swift Current

**G W Colortronics Ltd.**  
616 Cheadle Street West, P.O. Box 1270  
Swift Current, Saskatchewan. S9H 3X4.  
Tel. (306) 773-3672  
EC, RTV, TG, EK, MO.  
WR - VHF 2-way Radios, Leader Test  
Equipment, Sylvania Tubes and Electronic  
Parts, Satellite Earth Receiving Stations,  
Winegard TV Antennae Systems, Cable  
TV Supplies, Columbia and Cerro Cable,  
Lindsay Towers and Antennas.

## MANITOBA

### Winnipeg

**Cam Gard Supply Ltd.**  
1777 Ellice Avenue, Winnipeg, Manitoba.  
R3H 0W5. Tel. (204) 786-8481  
EC, RTV, TG, EK, CAT (Free)  
Industrial OEM and Radio Television parts  
supplier. Industrial semiconductor supplier  
representing Texas Instruments, Fairchild,  
ITT, Data Display, General Instrument, Beck-  
man, Philips and General Electric.

## Heathkit Electronic Center

1315 Portage Ave., Winnipeg, Man. R3G 0V3  
Tel. (204) 783-3334  
CA, TG, EK, MO, CAT, FREE  
Kit Televisions, Amateur Radio, Weather  
Instruments, Marine Equipment, Stereo and  
Speaker Equipment. Service of Heath Pro-  
ducts and Parts.

**J & J ELECTRONICS LTD.**

Mail order distributors of Electronics.  
Specializing in semiconductors by most  
name manufacturers. Prime quality surplus  
electronic materials. Stocking pots, resistors,  
capacitors, switches, audio amps, and  
perfboard, (VEROBOARD). Canadians  
serving Canadians since 1962.

Store at:  
310 Notre Dame Ave.,  
Mail orders to:  
P.O. Box 1437,  
WINNIPEG, Man.  
R3C 2Z4

**J & J Electronics Limited** ETI  
310 Notre Dame Ave., P.O. Box 1437,  
Winnipeg, Man. R3B 1P4/R3C 2Z4  
Tel. (204) 943-6916  
EC, RTV, EK, MO, CAT, \$1.00

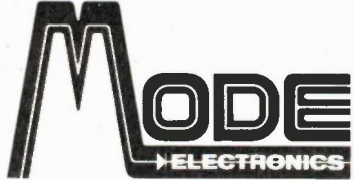

**MODE**  
ELECTRONICS

HEAD OFFICE  
1777 ELLICE AVE WPG MANITOBA

BRANCH  
88 HORNER AVE. TORONTO, ONTARIO



**WES**  
ELECTRONICS LTD.

1515 King Edward St  
Winnipeg, Man.  
R3H 0R8  
(204) 632-1260  
TLX. 07-57347

**W.E.S. Electronics Limited** ETI  
1515 King Edward St., Winnipeg, Manitoba  
R3H 0R8 Tel. (204) 632-1260  
EC, RTV, TG, EK, MO  
Wholesale industrial electronics distributor  
for: Fluke, Samtec, Magnecraft, Hammond,  
Delhi, Belden, Viz, Poweronic, Platt, Ungar,  
Diamond Tools, Eveready, Cinch Jones,  
Sylvania, Raytheon, Siemens, Semi-conduc-  
tors, B & K, Switchcraft.



## DEALERS IN:

**COMPUTER PRODUCTS**

- Atari 400 and 800 Home Computers
- Exidy Data Products
- C. Itoh Printers
- MPI Printers
- Quality Software

**VIDEO GAMES**

- Atari 2600
- Magnavox Odyssey II
- Mattel Intellivision

**VIDEO PRODUCTS**

- Electrohome Projection Televisions
- Magnavox Video Disc & Televisions
- Hitachi Video Recorders
- Accessories

Catalogues available upon request

**VISIONS**  
329-8th Ave. S.W.  
Calgary, Alberta.  
T2P 1C4  
(403) 233-2249

## Edmonton

**Cardinal Industrial Electronics Ltd.** ETI  
10630 - 172 St., Box 12000, Edmonton,  
Alberta T5J 2P4 Tel. (403) 483-6266  
10-5920 - 10th St. S.E., Calgary, Alberta  
T2H 2M4 Tel. (403) 259-6817  
EC, RTV, TG, MO, CAT, \$10.00  
Sales area - Alberta, Saskatchewan, British  
Columbia and the Territories. Hammond,  
P & B, Fluke, Amphenol, Intersil, Weller,  
B & K, Belden, Alpha, Microswitch and many  
others. Call us.

**Heath Company** ETI  
12863 97th St., Edmonton, Alberta  
T5E 4C2 Tel. (403) 475-9331  
CA, TG, EK, MO, CAT, FREE  
Shortwave Radios, Amateur Radio Equip-  
ment, Radio Control Equipment, Marine  
Equipment, Video, HI-FI and other kits.

**R-A-E Industrial Electronics** ETI  
11680 - 170th St., Edmonton, Alberta  
T5S 1J7 Tel. (403) 451-4001  
EC, CA, TG, EK, MO, CAT, \$10.00

# CAM GARD SUPPLY LTD.

HEAD OFFICE WINNIPEG 1777 Ellice Ave.

WESTERN BRANCHES		EASTERN BRANCHES
VANCOUVER	RED DEER	HALIFAX
2055 Boundary Rd.	#5 6841 - 52 Ave.	3065 Robie St.
KAMLOOPS	SASKATOON	FREDERICTON
825 Notre Dame Drive	1501 Ontario Ave.	Rookwood Ave.
EDMONTON	REGINA	MONCTON
16236 - 40 - 116 Ave.	1303 Scarth St.	15 Mount Royal Blvd.
CALGARY		TORONTO
640 - 42nd Ave. S.E.		88 Horner Ave.

## ONTARIO

### Brampton

**Bryan Electronics** ETI  
90 Kennedy Rd., S., Brampton, Ont. L6W 3E7  
Tel. (416) 457-9269  
EC, RTV, TG, EK, MO, CAT, FREE  
Suppliers of electronic parts, equipment, home and car audio, specialty items, etc., at discount. Access to more than 550 brands of manufacturers.

### Georgetown

**Inventories Unlimited** ETI  
130 Guelph Street, Georgetown, Ont. L7G 4A5. Tel. (416) 846-1759.  
EC, EK

**Computer Innovations Limited**  
70 Princess St., Kingston, Ont. K7L 1A5  
Tel. (613) 544-6830  
CA

(Branch of Computer Innovations Limited, Ottawa) Sells Apple, Commodore (PET), Crumemco and Hewlett-Packard minicomputers and Texas Instruments, Brother and Hewlett-Packard calculators.

### London

**R. J. Buckland Company**  
P.O. Box 367, Station B, London, Ontario.  
Tel. (519) 672-8390.  
CAT, FREE.

**Computer Innovations Limited**  
171 Slater St., Ottawa, Ont. K1P 5H7  
Tel. (613) 233-8413  
CA, MO

We sell Apple, Commodore (PET), Cromenco and Hewlett-Packard microcomputers and Texas Instruments, Brother and Hewlett-Packard calculators.

**Gervais Electronics Limited** ETI  
333 Cumberland St., Ottawa, Ont. K1N 7J3  
Tel. (613) 236-3101  
EC, RTV, TG, EK  
Astatic - ECG and SK Semiconductors - Tenco - Oaktron and Peerless Speakers - Thordarson - Buss Fuses - Vaco - B & K - Sencore - Leader - Tech-Spray - C.D.E. - EduKits - TDK - Ampex - Eveready - Lenline - Workman - Columbia Wire

**Heath Company** ETI  
866 Merivale Rd., Ottawa, Ont. K1Z 5Z6  
Tel. (613) 728-3731  
CA, TG, EK, MO, CAT, FREE  
Shortwave Radios, Amateur Radio Equipment, Radio, Control Equipment, Marine Equipment, Video, HI-FI, and other kits.

**Kris Electronics** ETI  
(A Division of 365781 Ontario Limited)  
1070 Morrison Dr., Unit 1-B, Ottawa, Ont. K2H 8K7 Tel. (613) 820-4986  
EC, CA, RTV, TG, EK  
ILP Amplifiers, Sinclair Instruments, Univolt V.O.M.s, Phillips and Oaktron Speakers, Ritron Equalizers, Mixers, Edukit, Transformers, Ceresist, Wire, Cable, Adaptors, Semiconductors, Resistors, Capacitors, P.C. Accessories, Motors . . .

**Videoland**  
1154 Bank St. (S. of Sunnyside), Ottawa, Ontario. Tel. (613) 236-0475  
We are the oldest and largest video specialist in Canada. We carry video recorders, video cameras, blank tapes, prerecorded movies, satellite earth stations and accessories, giant screen TV. We transfer film to video and also sell or rent all kinds of video equipment. We are inexpensive too.

**Wackid Radio**  
312 Parkdale Ave., Ottawa, Ont. K1Y 1G3  
Tel. (613) 728-1821  
EC, CA, RTV, TG, EK, MO  
We sell 232 product lines in 16 categories, including video, C.B., Ham and HI-FI etc. (Line card available - free on request).

### Owen Sound

**North Western Electronic Supply Limited** ETI  
370-2nd Ave S E, Owen Sound, Ont. N4K 5T1  
Tel. (519) 371-1071  
EC, RTV, TG, EK, MO

### North Bay

**Videoland**  
1138 Cassell St., North Bay, Ontario.  
Tel. (705) 476-0007.  
We are the oldest and largest video specialist in Canada. We carry video recorders, video cameras, blank tapes, prerecorded movies, Satellite Earth Stations and Accessories, Giant screen TV. We transfer film to video and also sell or rent all kinds of video equipment. We are inexpensive too.

## XS INVENTORY UNLIMITED

IC's  
DIODES  
RESISTORS  
CAPACITORS  
TRANSISTORS

TELEPHONES

BOOKS

ROTORS  
ANTENNAS  
AMPLIFIERS  
ACCESSORIES  
WE INSTALL

NEW SOURCE FOR ELECTRONIC NEEDS  
LARGE INVENTORY GREAT PRICING

130 Guelph Street  
Georgetown, Ontario  
(416) 846-1759

### Guelph



**Neutron Electronics Limited** ETI  
485 Silvercreek Pkwy N., Guelph, Ont. N1H 7K5 Tel. (519) 836-9220, 836-9221  
EC, CA, RTV, TG, EK  
Distributor for Hammond Xfmr's - cabinetry - power supplies, Sylvania and GE - tubes and transistors, Westinghouse - industrial tubes and semiconductors, Jana Kits, B & K, Amprobe Test Equipment, Xcelite and Weller - Ungar - solder equipment and tools, Astatic Wheelies and Cartridges, Ceresist, Panavise, OK Machine, Atlas Sound Equip.

### Kitchener-Waterloo

**K-W Surplus Clearinghouse** ETI  
327 Breithaupt St., Kitchener, Ont. N2H 5H6  
Tel. (519) 745-2661  
EC, CA, RTV, TG, EK  
Surplus electronics of every type including components assemblies, test equipment etc. Open only Wed., Thurs., Fri., 12pm to 9pm. Sat. 9am to 5pm. Store is both retail and wholesale.

**Waterloo Electronic Supply Co. Inc.** ETI  
219 Hartwood Ave., Waterloo, Ontario N9J 3Z9. Tel. (519) 745-9421.  
EC, RTV, TG, EK, MO.  
Industrial - PB Relays, Hammond, Belden, Burgess Switch, Buss, AP Products.  
Test Equipment - B&K, Leader, Beckman, Amprobe, Eico.  
Hi-Fi - Sanyo, Kenwood, Fisher, Lloyds.  
Car Sound - Sanyo, Sound Barrier.  
CB - Cobra.  
Antenna Systems - Kay Towne, Delhi, Delta, Benco.

**Forest City Surplus Ltd.** ETI  
781 Dundas St., London, Ont., N5W 2Z6  
Tel. (519) 438-0233.  
EC, CA, RTV, TG, EK.  
Surplus electronics of every description. Components, semiconductors, assemblies, test equipment, computer parts etc.

### Mississauga

**Atwater Electronics Limited** ETI  
886 Dundas Hwy E., Mississauga, Ont. L4Y 2B8 Tel. (416) 276-4550  
EC, CA, RTV, TG, EK, MO  
Suppliers and consultants of Philips speakers, Sylvania tubes and ECG semiconductors, B & K Test Equipment, Concord Car Components, TDK and Maxell Tapes, Eico and Jana Kits, Tab Books and Sam's Books, Weller and Ungar Soldering Supplies, Industrial Wire, Batteries, Plugs and Jacks, Etc.

**Heath Company** ETI  
1478 Dundas St E, Mississauga, Ont L4X 2R7  
Tel. (416) 277-3191  
CA, TG, EK, MO, CAT, FREE  
Shortwave Radios, Amateur Radio Equipment, Radio, Control Equipment, Marine Equipment, Video, HI-FI, and other kits.

### Ottawa

**Active Component Sales Corp.** ETI  
Baxter Centre, 1050 Baxter Road, Ottawa, Ont., K2C 3PA. Tel. (613) 820-9471.  
EC, CA, RTV, TG, EK, MO, CAT (Free).  
See our directory ad.

**Compumart** ETI  
(A Division of Emile State Inc.)  
411 Roosevelt Ave., P.O. Box 6132,  
Station J, Ottawa, Ont. K2A 1T2  
Tel. (613) 725-3192  
CA  
We carry Apple and Commodore microcomputers, and a large selection of books, magazines and software for the TRS-80, Apple and PET.

**Sarnia**

**Videoland**  
773 Confederation, Sarnia, Ontario. Tel (519) 336-8433.  
We are the oldest and largest video specialist in Canada. We carry video recorders, video cameras, blank tapes, prerecorded movies, satellite earth stations and accessories, giant screen TV. We transfer film to video and also sell or rent all kinds of video equipment. We are inexpensive too.

**Simcoe**

**Norfolk Electronics Limited**  
17 Peel St., Simcoe, Ont. N3Y 1S1  
Tel. (519) 426-1527  
EC, RTV

**Toronto**

**A-1 Electronics** ETI  
5062 Dundas St W, Etobicoke, Ont. M9A 1B9  
Tel. (416) 231-4331  
EC, CA, RTV, TG, EK, MO, CAT, FREE  
Mississauga and Etobicoke's largest electronics store. Product lines carried: Hammond, Texas Instrument, Fairchild, AP Products, OK Machine And Tool, Leader, Jana, National Semiconductor, Sam's Books, Ungar.

**Active Component Sales Corp.** ETI  
4800 Dufferin Street, Downsview, Ont., M3H 5S9. Tel. (416) 661-1115.  
EC, CA, RTV, TG, EK, MO, CAT (Free)  
See our directory ad.

**Active Surplus Annex** ETI  
345 Queen St W., Toronto, Ontario M5V 2A4  
Tel. (416) 368-7936  
EC, CA, RTV, TG, EK  
Large stock of electronic components. New and used electronic equipment including transformers and motors.

**Arkon Electronics Limited** ETI  
409 Queen St W., Toronto, Ont. M5V 2A5  
Tel. (416) 868-1315  
EC, CA, RTV, TG, EK, MO  
Complete industrial and hobbyist outlet. Stocking distributor of OK Machine, AP Products, Hammond, Stackpole, Chemtronics, Amp, SD Systems, Vector, OSI, RCA, Injectorall, SSM, Mullen and much, much more.

**Batteries Included**  
71 McCaul St., Toronto, Ont., M5T 2X1  
Tel. (416) 596-1405.  
CA, CAT (Free).  
We carry a complete selection of calculators as well as being authorised Commodore PET dealers. We are also the Canadian distributors for Microtechnology Unlimited (MTU) and Connecticut Micro Computer (CMC) products.



409 Queen St. W.  
Toronto Ont.  
M5V 2A5  
(416) 868-1315

## TECHNOLOGY LEADERSHIP!

### YOUR TOTAL COMPONENT SUPPLIER

WE ARE STOCKING DISTRIBUTORS OF:

**TOOLS AND PARTS:** A P Products, Global, Hammond, Injectorall, Lenline, Mallory, Noma, OK Machine, Jana, Saxton, Stackpole, Tech Spray, Chemtronics, Ungar, Xcelite, Weller, Vector, Amp, Oifa, Cramco, Kester, Omega Tools, Amphenol, Cannon, Eagle, Edsyn, Hobby-Blox.

**TEST EQUIPMENT:** Kelthley, Hitachi, Leader, Sinclair, Hioki, Univoit.

**ARKON EXCLUSIVES:** CPIO/1, FORT/80, Arkits.

**COMPUTERS AND SUPPLIES:** Ohio Scientific, Aardvark, Control Data, DCS., SSM, Mullen, RCA, Rockwell, Texas Instrument, SD Systems, Siemens, Epson, Lifeboat, Dysan.

**TELEPHONES:** GTE, Northern Telecom, Teledevices, Webcor, Teleconcepts.

**SPEAKERS AND AUDIO:** Laser, Phillips, Sanyo, Shure, Koss, Jana, Motorola, RSC, Oaktron, Sound Design, A.R.K., Scott, Peerless, Fanon.

**COMPONENTS:** Zilog, Fairchild, Texas Instrument, Signetics, Motorola, Intel, General Instrument, Hitachi, NEC.

We carry the most complete line of books and magazines in Canada.

Also, visit our sister companies: <b>M&amp;W Computer Stores Inc.</b> 407 Queen Street West Toronto, Ontario M5V 2A5 (416) 368-5705	<b>M&amp;W Computer Stores</b> 2155 Leanne Blvd. Unit 3 Mississauga, Ontario L5K 2K8 (416) 822-8080	<b>Interested Dealers</b> for Computer Accessories and magazines, call <b>MICRON DISTRIBUTING</b> (416) 363-6058
--	--	--

**Cesco Electronics Ltd.**  
24 Martin Ross Ave. Toronto, Ontario.  
M3J 2K9 Tel. (416) 661-0220  
EC, CA, RTV, TG, EK, MO, CAT, FREE.  
Cesco stocks semiconductors and components by major manufacturers including Texas Instruments, Motorola, RCA, Allen Bradley, Corning, Scotchflex, Amphenol, Cutler Hammer, Signetics, Apple, Commodore, Centronics, Mallory.

**Dominion Radio and Electronics** ETI  
535 Yonge St., Toronto, Ontario. M4Y 1Y5. Tel. (416) 922-1818  
EC, RTV, TG, EK, MO, CAT (Free).

**Efstonscience Inc.**  
3500 Bathurst St., Toronto, Ont., M6A 2C6  
Tel. (416) 787-4583.  
EK, MO, CAT (\$2.00).  
This company specializes in optics, electronic instruments and kits of educational, research and/or industrial use. A new line of high quality electronic measuring instruments, speciality tools, tool kits and cases. All available through mail order or at our retail premises. Two catalogues, Jensen Tools and EfstonScience. \$2.00 each or both for \$3.00.

**Electro Sonic Inc.** ETI  
1100 Gordon Baker Road, Willowdale, Ont., M2H 3B3. Tel. (416) 494-1555.  
EC, TG, EK, MO, CAT (\$15.00).  
Coast-to-coast service with Canada's largest inventory of semiconductors, electronic components, and equipment. Specialists in supplying the needs of the industrial and educational markets.

**Electronics 2001** ETI  
5529 Yonge St., Willowdale, Ont., M2N 5S3  
Tel. (416) 223-8400.  
CA, MO, CAT (Free).  
Dealers for Commodore computers, RCA video recorders, Computer related books and magazines. Software for Commodore, Apple, TRS-80. TV cable converters, telephone accessories, Sharp calculators, Casio calculators.

**Exceltronix Components & Computing Incorporated** ETI  
319 College St., Toronto, Ont. M5T 1S2  
Tel. (416) 921-5295  
EC, CA, TG, EK, MO, CAT, FREE  
We have exceptional stock and prices of LS-TTL and memory chips.  
Main products: digital and linear IC's, memories, transistors, passive components, computer systems, boards and software by multi-flex and Ohio Scientific. We distribute: AP Products, Jana Kits, Jana Industrial, Lenline, Ungar, OK Tools.

**General Electronics** ETI  
5511 Yonge St., Willowdale, Ont., M2N 5S3. Tel. (416) 221-6174.  
EC, CA, RTV, TG, EK, MO.  
Jana, Vero, AP Hobbyblox, Audiovision, Ceres, Surplus, Eveready, Edukit, Tenco, Accusonic, Hioki, Leader, Hameg, Injectorall, Lenline, Resistors, Capacitors, ICs, Transistors, Solder, Wire, Hammond.

**Gladstone Electronics** ETI  
1736 Avenue Rd., Toronto, Ont. M5M 3Y7  
Tel. (416) 787-1448  
2936 Eglinton Ave E, Scarborough, Ont.  
CA, TG, EK, MO, CAT, FREE  
Speakers (Phillips, KEF, JBL, Celestion, Decca, Motorola), ILP Audio Modules. Sinclair/Thandar Test Equipment, Kits (Logical Systems, Ace Audio, PAIA, Eico), Sinclair ZX80 Computer.

**Home Computer Centre**  
6101 Yonge Street, Willowdale, Ontario.  
M2M 3W2. Tel. (416) 222-1165  
CA, MO, CAT, FREE.  
Canon, PET, Apple, North Star Horizon, Atlas, T.I.

**KEY**

- ETI ETI Magazine sold here
- EC Supplies Electronic Components
- CA Sells Computers and Accessories
- RTV Sells Radio and TV parts
- TG Sells Test Gear
- EK Sells Electronic Kits
- MO Company does Mail Order
- CAT Catalogue available. The cost of this, or if it free, is shown

# ELECTRONICS 2001

COMPUTERS • VIDEO • MICRO ELECTRONICS

5529 YONGE STREET  
WILLOWDALE, ONTARIO M2N 5S3  
223-8400

## QUEBEC

### Blainville

#### SURPLUS ELECTRO QUEBEC

We buy and sell surplus  
Electronic Components

**SPECIAL No. 1:** Approximately 1000 electronics parts: capacitor - resistor relay - switch - etc, etc, for \$10. **Special No. 2:** Assortment of .50 tantalum capacitors, 1 uf to 100 uf (6 to 35 VDC) for \$10.  
All new and first quality parts with unconditional money-back guarantee. Free flyer and sample on request.

2264 Monte Gagnon  
Blainville, P.Q. J7E 4H5

**Surplus Electro Quebec**  
2264 Monte Gagnon, Blainville, P.Q. J7E 4H5  
EC, MO, CAT, FREE  
Mail Order only. Surplus from manufacturers of commercial radio (two way) in H.F. - VHF - UHF

### Longueuil

**Master Vox Ltd.**  
400 St. Jean, Longueuil, PQ, J4H 2X6.  
Tel. (514) 670-1550.  
EC, MO, CAT (\$5.00).

### Mont-Joli

**Distribution JMC Distribution Inc.** ETI  
C.P. 142, 88 Ave Laval, Mont-Joli, PQ  
G5H 3K9. Tel. (418) 775-2231.  
EC, RTV, MO, CAT (\$1.00).

One stop shopping for electronics parts, commercial or industrial. Genuine Jap parts, Transistors (2SA, 2SB, 2SC...) IC and general replacement for solid state JMC Products same as ECG. Recorder and projector belts, Tapes, Cassette, 8-Track, videocassette, reel-to-reel.

### Montreal

**Active Component Sales Corp.** ETI  
5651 Ferrier St., Montreal, PQ, H4P 2K5  
Tel. (514) 731-7441.  
EC, CA, RTV, TG, EK, MO, CAT (Free)  
See our directory ad.



Active Components is capable of serving the complete needs of the hobbyist, student, technician and professional by not only providing the latest solid-state and passive components, but a wide variety of computer parts as well.

As a division of Canada's largest franchised semiconductor distributor, Future Electronics, Active Components' extensive inventory is supported by over 80 major manufacturers.

Active Components is conveniently located in Canada's major cities (see listing). Those clients who do not have access to our current stores should use our extensive mail-order service located at our Montreal office. Ask for our Quarterly Money Saver today.

**House of Computers Inc.**  
368 Eglinton Ave W, Toronto, Ont. M5N 1A2  
Tel. (416) 482-4336  
EC, CA, MO

Jimpak, Apple Computers, CompuColor Corp, Northstar Computers, Versatile from Computer Data Systems, Commodore Business Machines, APF, Control Data, Olivetti, Centronics, Integral Data Systems. We carry a full selection of Computers, Printers and Accessories, Parts, Books, Magazines, Software. Full service department.

**M & W Computer Stores Inc.**  
407 Queen St W, Toronto, Ont. M5V 2A5  
Tel. (416) 368-5705  
CA, MO

Apple Computers, S-100 Computers, Trendcom, Anadex, Centronics Printers, Personal Software, Programa, Instant Software, Creative Software, for all Microcomputers, Dysan Disks, Mountain Hardware, and much more.

**Radio Trade Supply Limited** ETI  
490 Yonge St, Toronto, Ontario M4Y 1X5  
Tel. (416) 966-5151  
EC, RTV, TG, EK

These products are available from us:

Aiphone, B & K, Belden, Bogen, Buss, Cinch Joives, Delhi, E.C.G. Sylvania, Eveready, Hammond, Hioki, I.R.C., International Rectifier, Mallory, Memorex, Microswitch, Motorola, Photoswitch, Spectro, Sprague, Switchcraft, Tubes, Ungar, Weller, Xcelite.

### Videoland

582 Yonge St. (N. of Wellesley), Toronto, Ontario. Tel. (416) 921-0264  
1375 Danforth Rd., Scarborough, Ontario. Tel. (416) 265-3525  
1158 The Queensway, Toronto, Ontario. Tel. (416) 255-7543  
780 Wilson Ave., Downsview, Ontario. Tel. (416) 638-2974

We are the oldest and largest video specialist in Canada. We carry video recorders, video cameras, blank tapes, prerecorded movies, satellite earth stations and accessories, giant screen TV. We transfer film to video and also sell or rent all kinds of video equipment. We are inexpensive too.

**Zenith Radio Canada Limited** ETI  
1020 Islington Ave, Toronto, Ont. M8Z 5X5  
Tel. (416) 231-4171  
EC, RTV, TG

B & K Test Equipment, Jerrold Converters, Fanon Auto Sound, Record-a-Call Telephone Answering Equipment, Leader Test Equipment, Vaco Tools

### Waterford

**Copeland Electronics**  
46 Main St S., Waterford, Ont. N0E 1Y0  
Tel. (519) 443-4163  
EC, RTV, TG

Jana, Daveco, Sylvania, ECG, Principal Business - TV, stereo, auto stereo, sales and service.

**Addison Electronic Ltd.**  
8018-20e Ave., Montreal, Quebec. H1Z  
3S7. Tel. (514) 376-1740  
EC, RTV, CAT (\$1.50)

**Cite Electronique (1979) Inc.** ETI  
3185 Hochelaga, Montreal, P.Q. H1W 1G4  
Tel. (514) 525-2551  
EC, CA, RTV, TG, EK, MO  
Aiwa, Amphenol, Armaco, Astatic, Bach, Simpson, Bechman, Belden, Bishop, Graphics, Calectro, Celestion, Cornell, Dubelier, Cutler, Hammer, Daveco, Delta Wakefield, Eagle and more. Product card available.

**Cesco Electronics Ltd.**  
4050 Jean Talon St. W., Montreal, Quebec.  
H4P 1W1 Tel. (514) 735-5511  
EC, CA, RTV, TG, EK.

Cesco stocks semiconductors and components by major manufacturers including Texas Instruments, Motorola, RCA, Allen Bradley, Corning, Scotchflex, Amphenol, Cutler Hammer, Signetics, Apple, Commodore, Centronics, Mallory.

**Etco Electronics**  
183 Hymus Blvd., Pointe Claire, PQ, H9R  
1E9. Tel. (514) 695-0400.  
EC, RTV, TG, EK, MO, CAT (Free)

We publish a very interesting American catalogue available free to our Canadian customers. Also branch at North Country Shopping Center, Plattsburg, NY 12901 and 469 Mc Gill St., Montreal, PQ.

**Hamilton Avnet Electronics**  
2670 Sabourin, St. Laurent, PQ. H4S 1M2  
Tel. (514) 331-6443  
EC, CA

Distributor for AMD, Fairchild, Harris, Hewlett Packard, Intel, ITT, Litronix, Motorola, National Semiconductor, RCA, Rockwell, Signetics, Siliconix, TRW LSI, Centronics printers, Hazeltine, Novation (modems), Shugart etc.

**Heath Company** ETI  
1400 Sauve Ouest, Montreal, P.Q. H4N 1C5  
Tel. (514) 332-3666  
CA TG EK, MO CAT, FREE  
Shortwave Radios, Amateur Radio Equipment, Radio Control Equipment, Marine Equipment, Video, HI-FI and other kits.

**North American Electronics Co. Limited**  
2407 Ste-Catherine St. East, Montreal, P.Q.  
H2K 2J7 Tel. (514) 522-8422  
EC, RTV, CAT, FREE  
We can sell anything in terms of parts. However, we are well known for the following: Amidon Cores & Rods - J.W. Miller Coils & Chokes - magnet wire, etc.

**Payette Radio**  
730 St-Jacques, Montreal, Quebec.

**Radio Hovsep**  
5945 Park Ave., Montreal, Quebec. H2V  
4H4. Tel. (514) 274-0589  
EC, RTV, TG, EK, MO.

Authorized Grundig Service Depot for Canada. Also parts and accessories for European makes.

## DIRECTORY OF ELECTRONIC RETAILERS

**Produits Electroniques Ltee**  
/Electronic Wholesalers Co. Limited  
1935 Avenue de L'Eglise, Montreal, P.Q.  
H4E 1H2 Tel. (514) 769-8861  
EC, RTV, TG, EK, MO  
General line distributor with portfolio of 200 lines. Principal penetration industrial. Hammond, P & B, Amphenol, Edac, TRW, C & K, Beckman, Philips, A.P., Mallory, I.R.C., Homite, B & K, Belden, Alpha.

**Standard Electronics** ETI  
8927 Boul. Pie IX, Montreal, P.Q. H1Z 3V3  
Tel. (514) 327-3578  
EC, RTV, MO  
Semiconductor's Specialist, for radio, TV, CB, VTR, Communications Equipment, computers, industrial controls, any brand as RCA, Solid-State, Motorola, National, etc. Ask for our free price list.

**Super Electronic (Canada) Company**  
1963 Centre St., Montreal, P.Q. H3K 1J1  
Tel. (514) 932-5636  
EC, RTV, TG, EK, MO  
Electric Motors, Cables & Wires, Switches, Non Contact Voltage Detectors, Insulators, Capacitors (Computer Grade, Electrolytic, Oil, Disc, Polystyrene, Tantalum, etc.), Relays, Resistors (Precision, regular, large, medium, small), Tubes, Semi Conductors.

### St. Romuald

**Selco Electronics**  
P.O. Box 2036, St-Romuald, Quebec. G6W 3P2. Tel. (418) 839-8367.  
EC, MO, CAT, Free.  
Your mail order source for calculators, ICs, resistors, capacitors and a lot more. Ask for our free catalogue and check our prices.

### Thetford Mines

**Elektronixxe Enr.**  
276 Notre Dame Nord., Thetford-Mines, P.Q. G6G 5R9 Tel. (418) 338-2330  
EC, CA, RTV, TG, EK, MO  
We can etch any size, any kind of circuits with photoresist or silk screen. We buy electronics components from US, England, Japan, etc. - so we have unusual parts. We have optical products, chemical products etc - all for electronic projects.

### Trois Rivieres

**Matteau Electronique**  
2045 Royale, Trois Rivieres, PQ, G9A 4L3  
Tel. (819) 375-4779.  
EC, RTV, MO

### NEW BRUNSWICK

#### Moncton

**Amphion Electronics Limited**  
4 Lockhart Ave., Moncton, N.B. E1C 6R1  
Tel. (506) 855-3337  
EC, RTV, TG, EK  
We handle audio components, auto sound equipment, audio visual (video) equipment, amateur radio.

### NOVA SCOTIA

#### Halifax

**Amphion Electronics Limited**  
2411 Agricola St., Halifax, N.S. B3K 4C1  
Tel. (902) 429-7211  
EC, RTV, TG, EK  
We handle audio components, auto sound equipment, audio visual (video) equipment and amateur radio.

**Basic Computer Sales Ltd.**  
6061 Young St., Halifax, NS, B3K 2A3  
Tel. (902) 454-9600.  
CA, MO, CAT (Free).  
Stocking dealer for the following micro-computers: Texas Instruments, Hewlett Packard, Zenith-Heathkit, Atari Software and computer books.

**Cam Gard Supply Limited** ETI  
3065 Robie St., Halifax, N.S. B3K 5H6  
Tel. (902) 454-8581  
EC, RTV, TG, EK, MO, CAT, FREE  
Electronic wholesaler covering dealer, industrial, educational and dem accounts throughout Canada. Also distributors for Jana, OK Machine, Fairchild, Texas Instruments and other major semiconductor lines.

**MiniComp Systems Limited**  
5666 Stanley St., Halifax, N.S. B3K 2G1  
Tel. (902) 455-5123  
CA, MO  
Sales and service of the complete Commodore line. Specializing in small business applications. Also inventory control package for CBM systems.

### Sydney

**Fisher Electronics Limited**  
337 Welton St., Sydney, N.S. B1P 5S4  
Tel. (902) 539-3949  
EC, RTV, TG, MO  
Learjet, Jensen, Sencore Test Equipment, Belden and Columbia wire, RCA Semiconductors, Bogen, University, Bearcat, Shure, Electrovoice, Astatic, Hammond, Blonder Tongue, Mirtone, Telex, Sony, Sprague, Tenco, Lenline.

### PRINCE EDWARD ISLAND

#### Charlottetown

**Island Radio Centre Limited** ETI  
102 Queen St, Charlottetown, P.E.I. C1A 4B1  
EC, RTV, TG, EK, MO  
Bogen, B & K, Switchcraft, Basf, Belden, Cooper Tool, C.G.E., Dual, ElectroVoice, Eico, Fanon, Hammond, I.R.C., J.B.L., Lindsay, Marsland, Sams, Paco, Sylvania, Shure, Sencore, Telex, University, Ungar, Uher.

### NEWFOUNDLAND

#### St. John's

**Electronic Centre Limited** ETI  
115 Ropewalk Lane, St. John's, N.B. A1E 4P1  
Tel. (709) 579-5021  
EC, CA, RTV, TG, MO  
Astatic, Atari, Atlas, Belden, Bogen, Buss, Delhi, Electrohome, Fanon, Hammond, Midland, Raytheon, RCC, Schematics, Shure, Sylvania, ECG, TDK, Antenna, C.B., Computer, Stereo, VHF, Landmobile.

#### IS ANYONE MISSING?

Although we mailed all the companies for whom we had information, some of them twice, a few did not supply details. We are also certain that we have missed some outlets. If you know of any store that you feel should be included, please let us know. If there is any reasonable number of them, we will include a supplementary listing in a couple of months. Inclusion is quite free.



# Save up to 28% on the Newsstand price!

One Year Subscription to ETI Magazine: \$16.95  
(a 23.8% saving over the newsstand price)

Two Year Subscription to ETI Magazine: \$29.95  
(a 28.6% saving over the newsstand price)

Fill out the coupon on the reverse of the order form or send your cheque (or Visa or Mastercharge Card number and expiry date) to:

Subscription Department,  
ETI Magazine,  
Unit 6, 25 Overlea Boulevard,  
Toronto, Ont., M4H 1B1



# COIN TOSS MACHINE

Try your luck with the ETI Coin Toss Game. Heads or Tails with LED indicators, full sound effects and fingertip control.

YOU KNOW how it is. Someone flips a coin, it spins wildly in the air, you all call and the coin lands. . .on the floor and rolls under the sideboard. Frustrating, isn't it? Well, now you can banish the problem at a stroke with our great new circuit. Featuring illuminated indicators, single push-button control and exciting sound effects, the whole unit is powered from a single nine volt battery and switches itself off automatically after about twenty seconds.

Only a couple of cheap chips are used along with three transistors and a scattering of discrete passive components. Depressing the push-button causes the unit to emit a 'whooping' siren sound. Also the LEDs flash alternately, gradually slowing down until one remains illuminated. A further depression of the push-button starts the process again. If the unit is left undisturbed it will turn itself off, emitting a couple of quiet squeaks. Once the flashing display has settled and one LED is illuminated continuously, the display will remain stable until both LEDs are extinguished. This avoids any troublesome arguments!

## Construction

The unit is assembled on a single PCB with the battery, push-button switch, LEDs and loudspeaker connected via flying leads. There are two links to make on the board; from IC1 (pin 4) to IC2 (pin 4) and from IC1 (pin 3) to the junction of diodes D6, 7. Note that this is a straight wire link which passes under R11 and D6. The flying lead link is most easily made on the underside of the board after construction is complete.

Assembly is quite simple. As usual, pay attention to the orientation of the diodes, transistors, ICs and capaci-

tors. C9 may have to be bent to one side to accommodate C1. However, there is plenty of space for the other components. As IC1 is a CMOS chip, use a socket if you are worried about damage from static electricity. There are no problems with IC2 or the other components.

Layout of the unit is uncritical and any construction technique may be employed. You need two different coloured LEDs. Any size or colour of LED will do. The unit should work as soon as power is applied and again upon depressing PB1. Build one now and try your luck!

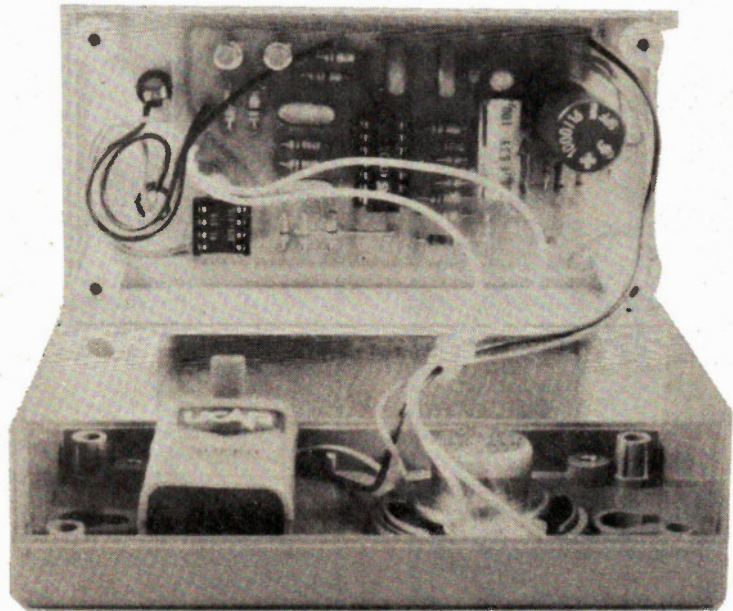

The finished coin toss machine installed in a standard Verobox.

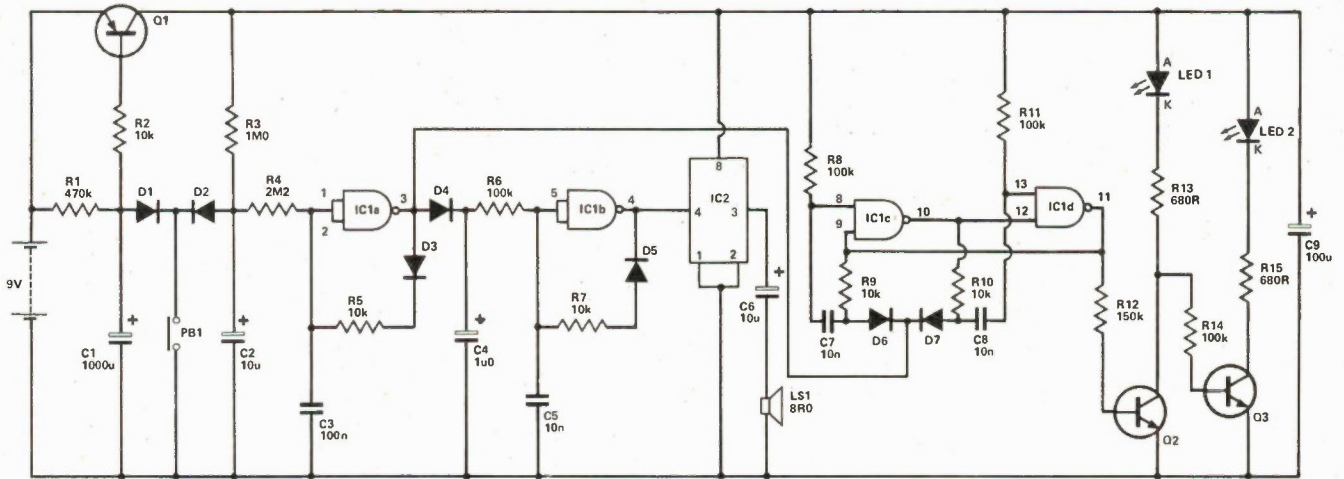

Fig. 1. Circuit diagram. We found that the circuit operated more reliably if D1 was made 1N4001

NOTES:  
 IC1 is 4093  
 IC2 is 555  
 Q1 is 2N3906  
 Q2, 3 are 2N3904  
 LED 1, 2 are any LED  
 All diodes are 1N4148

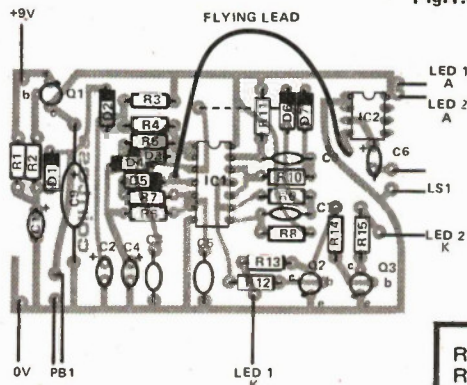
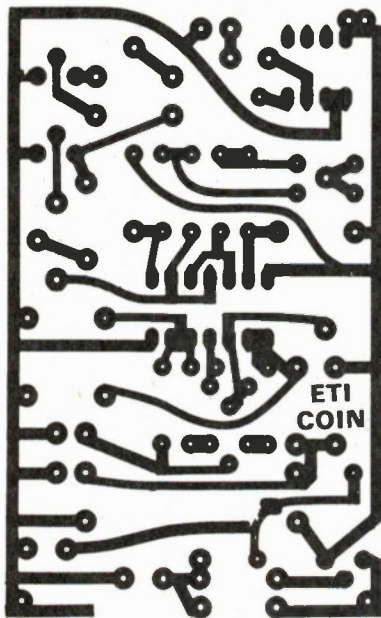

Fig. 2. Component overlay.

PARTS LIST

Resistors	
R1	470k
R2,5,7,9,10	10k
R3	1M0
R4	2M2
R6,8,11,14	100k
R12	150k
R13,15	680R
Capacitors	
C1	1000u electrolytic
C2,6	10u tantalum
C3	100n polyester
C4	1u0 tantalum
C5,7,8	10n polyester
C9	100u electrolytic
Semiconductors	
IC1	4093
IC2	555
Q1	2N3906
Q2,3	2N3904
LED 1,2	ANY LEDs
D1 to 7	1N4148
Miscellaneous	
PB1 SPST, LS1 8 ohm loudspeaker, PCB, 9V battery.	



HOW IT WORKS

The circuit has a single push-button control, PB1. When PB1 is closed, C1 is shorted to ground via D1. Current then flows through R1,2 and the base-emitter junction of Q1, turning the transistor on and providing power to the rest of the circuit. Upon releasing PB1, the charging current in C1 maintains power for about twenty seconds, after which the circuit will shut down.

A voltage-controlled-oscillator is formed around IC1a, which generates the clock for the sound-effects oscillator IC1b and bistable flip-flop IC1c, d. Depressing and releasing PB1 causes the voltage across C2 to rise exponentially from near zero volts as it recharges via R3. IC1a then produces a train of pulses which decay from about 10Hz until the oscillator stops when the voltage across C2 rises above the lower threshold voltage of the IC's input. Note that IC1 is a schmitt trigger device. Use of the specified chip is essential to ensure proper circuit operation.

Oscillation occurs as C3 is discharged below the lower threshold voltage of IC1a, causing the output (pin 3) to go 'high'. C3 then charges via D3, R5 until the voltage across it reaches the positive threshold, flipping the output of IC1a 'low'. C3 then discharges via R4 and the cycle continues until the voltage across C2 rises above the lower threshold of voltage of IC1a. A falling siren tone is generated by IC1b. Operation of this VCO is identical to IC1a except that it is configured to operate with a positive control voltage. The output of IC1b drives IC2, a 555 timer which simply acts as an amplifier driving LS1.

The slow oscillator pulses from IC1a drive the bistable flip-flop formed around IC1c, d, R9,R10,C7,8 and D6,7 provide a 'steering' network for the trigger pulse. The indicator LEDs are driven by Q2,3. Overall supply decoupling is provided by C9.

PROBLEMS? NEED PCBs? Before you write to us, please refer to 'Component Notations' and 'PCB Suppliers' in the Table Of Contents. If you still have problems, please address your letters to 'ETI Query', care of this magazine. A stamped, self addressed envelope will ensure fastest reply. Sorry, we cannot answer queries by telephone.

# Oscilloscope Probes

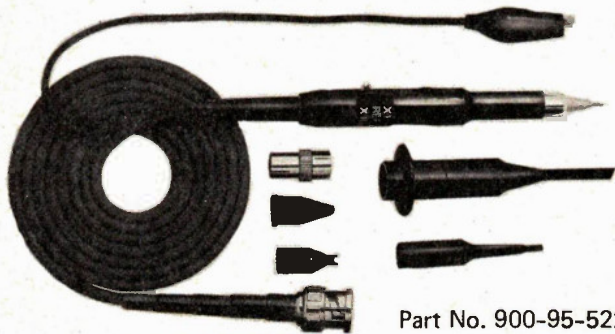

Part No. 900-95-522

## SP 100 Oscilloscope Probe Kit

This passive probe incorporates a three-position slide switch in the head and has a cable length of 1.5 metres.

### Position x1

Bandwidth: D.C. to 10 MHz  
 Input Resistance: 1MΩ (oscilloscope input)  
 Input Capacity: 40pF. Plus oscilloscope capacity  
 Working Voltage: 600 Volts D.C. (including Peak A.C.)  
 Cable Length: 1.5 Metres

### Position Ref.

Probe tip grounded via 9MΩ resistor, oscilloscope input grounded

### Position x10

Bandwidth: D.C. to 100 MHz  
 Risetime: 3.5 nanoseconds

**\$51<sup>20</sup>**

ALSO AVAILABLE ARE THE FOLLOWING

MODEL	ATTEN.	FREQUENCY	PRICE
IP20	x1	20 MHz	\$26.60
P100	x10	100 MHz	35.85
2P150	x10	150 MHz	48.10
2P250	x10	250 MHz	63.50
SP100	DUAL	100 MHz	51.20
2LCP100	x100	100 MHz	72.70
DP300	Detector	300 MHz	41.95
DP750	Detector	750 MHz	66.55
TLS2000	TEST LEAD SETS		23.50
Sprung Hook for above probes			6.90
Wire Wrap adapt. above probes			8.15

The above prices include shipping via parcel post. For other means please include additional cost. Ontario residents add 7% sales tax. Send cheque or money order to ....

Circle No. 9 on Reader Service Card.

## BCS

**ELECTRONICS LIMITED**  
 Instruments For Industry and Service

980 Alness Street  
 Unit 35  
 Downsview, Ontario  
 M3J 2S2  
 (416) 661-5585

**YOU CANNOT SKI  
 DOWN  
 OUR  
 SLOPES**



# VERO

But VERO SLOPING FRONT CASES do make attractive housings for many projects.

They are available in two sizes, made from high quality, two tone plastic, with anodised aluminium front panels. Both cases have integral circuit board fixing points in the base.

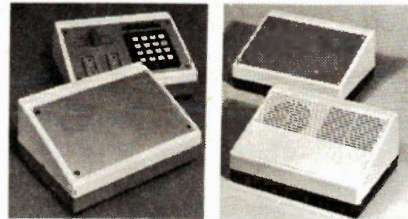

65-2523E and 75-1798K make ideal housings for test equipment, audio gear (faders, mixers, rhythm generators etc.) and control boxes.

See them at your local electronics shop and judge for yourself.

For your Free Catalogue circle No. 49 on Reader Service Card, Dealers reply on letterhead.



**ELECTRONIC PACKAGING SYSTEMS LTD.**  
 Retail Department  
 P.O. Box 481, Kingston, Ontario  
 K7L 4W5 Telephone (613) 384-1142

## INJECTORALL

## P.C. PRODUCTS

If you need:

- printed circuit boards and connectors
- drafting aids
- breadboards
- PCB chemicals
- Electronic chemicals

send for our complete catalogue today!

**CATALOG NO. 80**

**INDEX**

**INJECTORALL ELECTRONICS CORPORATION**

**P.C. CONNECTORS**

**PRINTED CIRCUIT KITS**

**ALIGNMENT TOOLS**

**ELECTRONIC CHEMICALS**

**MASS MERCHANDISER**

**SERVICE DEALER**

1980

90-100 Hwy 24, Unit 200, R.T. 11942 U.S.A.  
Tel: 914-671-0010

Please send me a copy of your Injectorall Catalogue and Price List.

Name \_\_\_\_\_  
 Address \_\_\_\_\_  
 City \_\_\_\_\_  
 Prov. \_\_\_\_\_ Postal Code \_\_\_\_\_

**omnitronix ltd.**

2056 TRANS CANADA HWY. UNIT 7, 6295 SHAWSON DRIVE  
 DORVAL, QUE. H9P 2N4 MISSISSAUGA, DNT. L5T 1H4  
 Tel: (514) 683-6993 Tel: (416) 678-7170  
 Telex: 05-822692 Telex: 06-968653

Circle No. 17 on Reader Service Card.

# AUDIO OPENING

## SPECIALS

**CAMBRIDGE** 70W.rms Air Suspension 12" Woofer 2" Voice Coil, 25Hz Resonance. 2 FOR \$65.00

**MARSLAND TRI-LINEAR** 6"x9" Bi-ampable 100W.rms Eac. 400z. magnet. 1/4 Voice Coil. 2 FOR \$39.95



## WOOFERS

## COMPLETE CABINETS

**SYSTEM I** 40W.rms 2 Way Speaker System 10" Woofer 2" Tweeter, Walnut Veneer Cabinet \$79.95PR

**SYSTEM II** 80W.rms 3 Way Speaker System 12" Woofer 5" Midrange 1" Dome Tweeter Rosewood Veneer Cabinets \$199.95PR

## EVERYTHING NOW IN STOCK

Come in and see our newly opened audio room. We are authorized Distributors of: A.R.K. Loudspeakers, Concord, Fanon, Foster, Fuji, Jana, Koss, Laser, Motorola, Daktron, Peerless, Phillips, R.S.C., Sanyo, Shape, Shure, Sound Design.

## SEE OUR FULL LINE OF AUDIO COMPONENTS

Send certified cheque, money order, **Chargex**, **Master Charge**... include expiry date, card number and signature. We process only prepaid orders. Minimum order \$10.00 Add 5% (minimum \$2.00) for shipping and handling. Ontario residents add 7% sales tax. All prices subject to change. Dealer inquiries welcome.

409 Queen Street West, Toronto, Ontario Canada, M5V 2A5. Tel. (416) 868-1315.



## TWEETERS

PHILIPS	
AD0140/T8	8ohm 20W.rms 11.95
AD0141/T8	8ohm 20W.rms 11.95
AD0162/T8/4	4 or 8ohm 40W.rms 13.60
AD0163/T8/4	4 or 8ohm 40W.rms 13.95
AD0163/T8	8ohm 50W.rms 16.05

MOTOROLA	
KSN1039A	8ohm* 100W.rms 10.25
KSN1041A	8ohm* 100W.rms 11.95
KSN1005A	8ohm* 100W.rms 12.95
KSN1016A	8ohm* 100W.rms 13.95
KSN1025A	8ohm* 100W.rms 22.50

PEERLESS	
K0100T	8ohm 70W.rms 19.95

FOSTER	
CONCAVE DOME	8ohm 40W.rms 9.95

MIDRANGE	
AD5060/SQ	4 or 8ohm 40W.rms 20.60
AD0211/SQ	4 or 8ohm 40W.rms 31.40
AD02161/SQ	4 or 8ohm 60W.rms 39.95

R.S.C.	
5" MID.	4 or 8ohm 40W.rms 9.95

OAKTRON	
BF6HMR	8ohm 18W.rms 24.55
8HMR	8ohm 18W.rms 26.45
BF8KMR	8ohm 25W.rms 38.60

PHILIPS	
AD4060/W8	8ohm 20W.rms 18.75
AD5060/W8	8ohm 20W.rms 17.30
AD70620/W8	8ohm 20W.rms 19.95
AD70650/W8	8ohm 40W.rms 26.15
AD80100/W8	8ohm 40W.rms 34.50
AD80671/W8	8ohm 60W.rms 33.25
AD10100/W8	8ohm 40W.rms 69.95
AD10200/W8	8ohm 80W.rms Coming Soon
AD10240/W8	8ohm 80W.rms 51.00
AD12200/W8	8ohm 80W.rms 72.50
AD12250/W8	8ohm 100W.rms 81.10
AD12240/W8	8ohm 80W.rms 57.70

LASER	
LA1032AS	8ohm 50W.rms 29.95
LA1254AS	8ohm 150W.rms 64.95
LA1254BR	8ohm 150W.rms 64.95
LA1554AS	8ohm 150W.rms 74.95
LA1554BR	8ohm 150W.rms 74.95

R.S.C.	
15B78	8ohm 200W.rms 105.00

OAKTRON	
FE18Y2W	8ohm 175W.rms 175.00

# NEED MORE INFORMATION?

If you would like more information on the products or services mentioned in the advertisements:

1. Fill in the attached card with your name, address, etc
2. Circle the appropriate Reader Service number for further information about advertised products.
3. Mail the card and the advertiser will send you literature free of charge. If the card has been removed, or if you want the information in a hurry, phone or write direct to the advertiser and refer to the ETI issue and page number.

**Your Company Classification (if applicable):**

- A. Manufacturer
- B. Retailer
- C. Government
- D. R&D
- E. Servicer/Installer
- F. Distributor/Representative
- G. Educational Institution

**In the field of:**

1. Computer and Related Equipment
2. Communications Equipment & Systems
3. Navigation, Guidance or Control Systems
4. Test & Measurement Equipment
5. Consumer Products
6. Industrial Controls & Equipment
7. Components & Subassemblies
8. Other (Please specify on the card)

**Your major job function (if applicable):**

- A. Buying
- B. Technologist
- C. Educator
- D. Not employed in an electronics-related field
- E. Engineering
- F. Technician
- G. Management
- H. Sales
- I. Other (Please specify on the card)

**What interests you most about ETI? (your favourite five or less):**

- A. Audio
- B. Video
- C. Ham Radio
- D. Shortwave Listening
- E. Servicing
- F. Components & Technology
- G. Reports on the Electronic Industry
- H. Microcomputers
- J. Projects
- K. News Digest
- L. Other (Please specify on the card)
- M. Tech Tips

# VOCAL "TRUTH" ANALYZER

- \* Works on TV, radio, telephone, tape recorder
- \* Immediate results — no waiting
- \* Analyzes anyone
- \* Compares with professional systems at \$3,000 — \$4,000!

The LOGICAL SYSTEMS VOICE STRESS ANALYZER KIT is an inexpensive yet elegant exploration of a stress theory that has gained prominence in recent years. The VOICE STRESS ANALYZER will analyze any voice it hears — It utilizes the harmonics of the voice, which enables detection of stress over frequency limited devices such as TV, radio, tape recorders — you can even hook it up to a telephone!

The LOGICAL SYSTEMS VOICE ANALYZER KIT comes complete with all components, hand held case, battery clip, power jack, telephone jack, and a detailed assembly and operating manual. All components are circuit board mounted, making assembly rapid and secure. This kit can be fully assembled and operational in an evening or less.

**STRESS DETECTION**  
The stress theory employed by the LOGICAL SYSTEMS VOICE ANALYZER was developed from wartime counter intelligence work. A measurable frequency of 8 — 12 Hertz was found in the voices of relaxed subjects — a frequency that disappeared under stress! This frequency, or microtremor, decreases as a person's autonomic nervous system takes control. The autonomic nervous system generates what we call the 'flight or fight' response: muscles tighten, blood rushes away from limbs, pupils dilate — and the 8-12 Hz frequency disappears from our voices!

The LOGICAL SYSTEMS VOICE ANALYZER detects this frequency and displays the presence or absence of it by lighting the NORMAL or the STRESS light. Extra lights are built into the unit so you may better monitor the degree of stress.

Phone (416) 787-1448  
**\$149.95** one unit  
**\$139.95** two-four  
**\$129.95** five or more



## VOCAL "TRUTH" ANALYZER KIT

**To: GLADSTONE ELECTRONICS**  
 1736 Avenue Rd., Toronto M5M 3Y7  
 Please send me \_\_\_\_\_ Logical Systems Voice Stress Analyzer Kits. I enclose a cheque/moneyorder/credit card number.

Visa-M/C: \_\_\_\_\_  
 Expiry Date: \_\_\_\_\_  
 Amount: \$ \_\_\_\_\_  
 Signature: \_\_\_\_\_  
 NAME: \_\_\_\_\_  
 ADDRESS: \_\_\_\_\_  
 CITY: \_\_\_\_\_ PROV. \_\_\_\_\_  
 POSTAL CODE: \_\_\_\_\_

# VOICE STRESS ANALYSER

Tired of the same old party lie detectors? John Van Lierde reviews a new type that shows considerable promise.

The logical Systems Voice Stress Analyser.

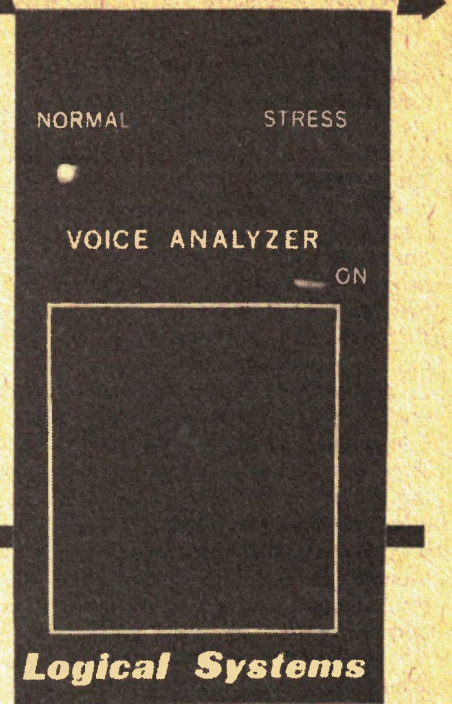

IT IS OUR experience that there are some projects that will always be of particular interest to our readers. These include metal detectors, digital dice, party games and, the topic of this article, lie detectors.

It isn't possible to detect lies directly. Rather, we look for indications of the presence of lies, usually in the form of bodily stresses. There are many things that we can observe that are directly affected by stress. A few of them are; respiration, blood pressure, pulse, galvanic skin resistance, pupil dilation, microtremors in the voice, and others.

Skin resistance is the variable most frequently employed in inexpensive lie detectors and similar party gadgets. The basic circuit is nothing more than a glorified ohmmeter. Analysis of the other bodily variables is reserved for more expensive instruments.

## The Voice of Truth?

Our attention was drawn to the Logical Systems 'Voice Stress Analyser'. For a mere \$150.00 you can join the ranks of the FBI, CIA and the RCMP. ('A hundred and fifty bucks???' do I hear you shout. Bear in mind that commercial units cost many (and I mean many) thousands of dollars.) Needless to say, the system 'detects stress by observing the microtremors in a subjects voice.

The unit itself is the size and weight of a pocket calculator. It is completely self contained, right down to its own internal microphone. In addition there are two jacks provided. One for an AC adapter (nice touch) and the other, for external voice sources (tape recorder

telephone pickups, etc.). The whole affair runs off a 9V battery. Using the VSA is simplicity itself. You simply turn the box on, point it at your subject (victim?) and make like you're Kojak.

The display takes the form of three LEDs. When the VSA picks up speech, the 'Normal' LED will light. If the VSA thinks the subject is under stress the it will illuminate one or two of the 'Stress' LEDs.

We were provided with a review model and a kit which we did not build up. From the looks of things, however, the kit can be easily built in an evening. The manual is clear and concise and includes the usual sections on soldering, tools and components. The actual assembly instructions take the constructor through step by step with separate overlays for each type of component. In addition there are section dealing with the principles of microtremors, how to detect them and how the VSA works.

The printed circuit board supplied

with the kit is superb. The copper traces are tinned, so soldering won't be a problem, and the silk screened component overlay is unambiguous. The components appear to be of high quality and are packed according to type (a bag of resistors, a bag of capacitors etc.) Unfortunately no IC sockets are provided so the constructor should take care to get it right the first time.

## Voice 'Quakes

The principles behind the device are more interesting than the actual ability to 'detect' lies. Human speech is composed of both fundamental and harmonic frequency components. It turns out also that the fundamental frequencies occur between 90 and 200Hz (This is why telephone lines get away with such a narrow bandwidth). These fundamental frequencies are in turn modulated by an 8-12Hz vibration, the so-called 'microtremors'. In the speech of a person under stress, the tremors are reduced in amplitude if not completely



A commercial Voice Stress Analyser costing \$8,000.

absent. Consequently, if we have some means of detecting these microtremors we would have a fairly effective means of detecting stress and, by implication, lies (hopefully).

Note that because the microtremors modulate the voice fundamental frequencies, they are unaffected by the narrow bandwidth of telephones and inexpensive tape recorders. This means that you are not restricted in your means of analysis.

Referring to the block diagram, it is fairly apparent how the VSA works. The signal is initially amplified and filtered to pull the voice out of any background noise. The next stage of the circuit rectifies the signal, removes the unwanted harmonics and triggers a monostable timer. The spacing of this resulting pulse train is modulated by the microtremors. The 20Hz bandpass filter changes the incoming pulses in to changing voltage levels that hopefully are in the 8-12Hz range. The next stage, the 8-12Hz bandpass filter, decides whether it is indeed looking at a microtremor and triggers the appropriate LEDs.

**Using It**

Lie detecting is a very subjective process. The prospective investigator has to monitor his subject carefully to determine just how he/she will react to a stressful situation. In order to get the most useful data from the VSA, the subject must be completely relaxed and free from any distraction. Also, because no two people are exactly identical in how they'll react to a given question, each subject should be evaluated on his/her own merits. The usual procedure in such cases is to give a series of fairly in-

**BATTERY TESTS**

*Continued from page 27*

just to compare their alkaline cells against carbon types.

To conduct such a test fairly turned out to be far more difficult than we had anticipated. First you have to ensure that both batteries are equally fresh, and then every test had to be identical. We did of course get results and differences. The Energisers gave a marginally better performance in all cases but we wouldn't like to say that this would always be so; the differences were not great and both performed vastly better than carbon types.

**Conclusions**

Think about the application for the battery before you buy.

If the equipment can be run off the power line and it is practical to do so always use this; it's hundreds if not thousands of times cheaper. Plug-in AC adaptors cost under \$10, no more than a couple of refills of alkaline cells for a radio. Most radios and tape record-

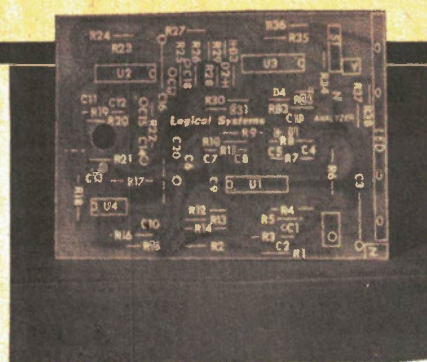

The component overlay on the pc is very clear.

nocuous questions with the 'zingers' interspersed. Therefore your questioning might go along the lines of; 'What is your name? How old are you? Are you married? Did you steal my jelly donut? What colour are your eyes?'

Theoretically questions 1, 2, 3, & 5 will keep the subject at ease while question 4 will induce a substantial amount of stress. Note that the questions require only simple one word answers. This hopefully would eliminate ambiguities. Some researchers also feel that the subject should be allowed to read through the questions and prepare for the actual test.

Testing the VSA properly proved more difficult than we thought. In an office environment you don't go around to seriously see if someone is lying—you can cause real embarrassment and/or offence. (Also, using thumbscrews tends to ruin the objectiveness of the test.)

We did however get some results. In

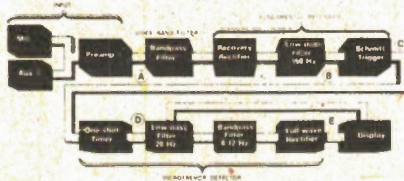

Block diagram of the VSA



The kit before it is built up.

normal conversation it is very difficult to get the 'stress' LEDs to light easily. We did test radio phone-in shows and found that the 'personality' registered 'normal' while the callers tended to give readings more in the 'stress' area. We also tried the unit on a tape where we interviewed a person that we didn't believe (we never ran the story). That person continually peaked in the 'stress' area.

We're not claiming our results demonstrate anything. Relaxed speech does sometimes show stress (especially 'ums' and 'ers'), there did however appear to be far more peaks with the radio station callers than with the person we interviewed.

The Logical Systems VSA does open the door to some intriguing experimentation. One can use it to evaluate political debates on television or screen your daughters prospective dates for sincerity.

*The Logical Systems Voice Stress Analyser is available from Gladstone Electronics, 1736 Avenue Rd., Toronto, Ontario M5M 3Y7. Send Cheque or Money order for \$149.95.*

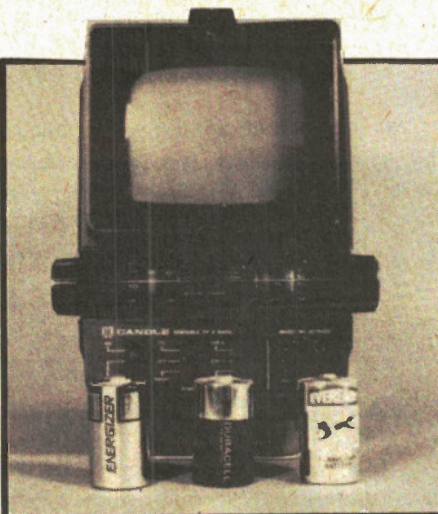

This TV drew 350mA and cost \$1 an hour using dry cells. The alkaline types lasted six times longer than the carbon cells.

ers come equipped for AC/DC operation anyway.

Consider Ni-Cads where you are using the equipment a lot. The cost of these hasn't risen as fast as the cost of disposable cells. Remember however that Ni-Cads can be destroyed unless they're properly used and recharged.

For flash lights, electronic flash guns and toys (but see the notes on this) the alkaline cells are the best bet.

Our tests with radios however, did not demonstrate any real advantage for the dearer alkaline cells.

**Finally**

We're somewhat surprised how few people take advantage of the Radio Shack Battery Club scheme. Look under the battery section in their catalogue; you get a free battery (regular type) once a month — the idea of course is to get you to visit the store every so often. Even so it's a good scheme and there's no obligation to buy.

# Special Supplement COMPUTERS

In next month's ETI we're including a bumper supplement devoted entirely to computers and computing. Those readers NOT interested in this subject will not be cheated out of the regular content as this is over and above the normal features.

## COMPUTERS FOR SMALL BUSINESSES



Our magazine isn't a particularly unusual business; we maintain books, mailing lists, raise invoices and keep check on inventories, and we're planning to instal a computer. Like most companies we've got a limited budget and have had some problems in deciding on what we need to take account of future growth. We've written about our experiences in tackling this problem.

## SINCLAIR ZX80 COMPUTER

A computer for under \$300? That's what this system costs. John Van Lierde has been trying it out.

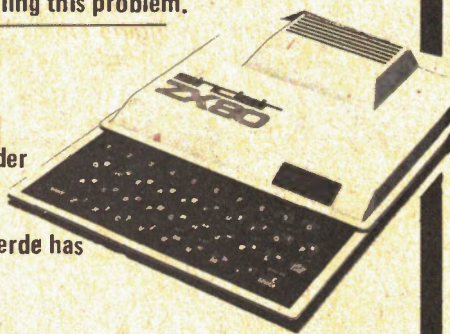

## COMPUTERS — AN OVERVIEW

A look at the forefathers of the modern computer and how they developed into today's machines and continues with a look at some of the terminology.

## ANATOMY OF A MICRO

Looks inside the microprocessor itself, at the architecture and the way that it works.

LOOK OUT FOR THIS SUPPLEMENT IN THE FEBRUARY ISSUE.

# ETI ORDER FORM

**BACK ISSUES:** Please circle issues desired.

1977	February	May	July	November			
1978	March	May	June	July	August	September	
	October		November	December			
1979	January	February	March	April	May	June	July
	August	September	October	November	December		
1980	January	February	March	April	May	June	July
	August		October				

QTY.	ITEM	AMOUNT
.....	Back Issues @ \$3 (mark choice above)	\$ .....
.....	Canadian Projects Book No. 1 @\$3.45	\$ .....
.....	ETI Circuits Book @ \$5.45	\$ .....
.....	'More Circuits' Book @ \$4.95	\$ .....
.....	Set(s) of Panel Transfers @ \$5.00	\$ .....
.....	ETI T-shirts @ \$5.50	\$ .....
	Small ( ) Medium ( ) Large ( )	
.....	ETI Binders @ \$6.75	\$ .....
	Ontario residents add 7% PST on last three only.	\$ .....
.....	Subscriptions @ \$16.95/\$29.95	\$ .....
.....	Hobby Projects @ \$3.95	\$ .....
.....	Electronic Circuit Design @ \$3.95	\$ .....

QTY.	BABANI	BABANI
..	BP1 \$2.80	No.223 \$5.50
..	BP14 \$4.80	No.224 \$4.25
..	BP24 \$4.25	
..	BP33 \$4.25	
..	BP35 \$5.50	
..	BP37 \$5.50	
..	BP39 \$5.50	
..	BP42 \$3.55	
..	BP44 \$7.55	
..	BP46 \$5.90	
..	BP47 \$5.90	
..	BP48 \$5.90	
..	BP49 \$6.25	
..	BP50 \$5.90	
..	BP51 \$5.50	
..	BP62 \$8.95	
..	BP63 \$8.95	
..	BP64 \$8.95	
..	BP65 \$6.55	
..	BP66 \$7.55	
..	BP67 \$7.55	
..	BP68 \$7.25	
..	BP69 \$7.55	
..	BP70 \$2.40	
..	BP71 \$7.70	
..	BP72 \$7.70	
..	BP73 \$8.58	
..	BP74 \$7.70	
..	BP75 \$7.30	
..	BP76 \$7.30	
..	BP77 \$12.30	
..	BP78 \$7.30	
..	BP79 \$7.30	
..	BP80 \$8.25	
..	No.205 \$3.55	
..	No.213 \$4.50	
..	No.215 \$3.70	
..	No.221 \$5.50	

QTY.	TAB
..	No.800 \$18.30
..	No.804 \$18.35
..	No.805 \$11.75
..	No.806 \$11.75
..	No.841 \$8.55
..	No.1000 \$11.55
..	No.1010 \$9.85
..	No.1015 \$9.70
..	No.1064 \$11.85
..	No.1070 \$12.35
..	No.1071 \$10.90
..	No.1076 \$11.55
..	No.1088 \$11.85
..	No.1120 \$7.75
..	No.1133 \$9.75
..	No.1152 \$11.75
..	No.1169 \$13.75
..	No.1174 \$9.75
..	No.1234 \$11.75
..	No.1241 \$11.75

QTY.	SYBEX
..	C200 \$10.75
..	C202 \$18.75
..	C280 \$20.75
..	C281 \$22.75
..	D302 \$18.75
..	G402 \$18.75
* BABANI SUBTOTAL	
<b>TOTAL ENCLOSED</b>	
BABANI SUBTOTAL \$ .....	

If we cannot complete your order, do you wish the balance refunded? YES  NO

PLEASE PUT YOUR NAME AND ADDRESS ON REVERSE SIDE OF THIS FORM.

# SUBSCRIBE NOW!

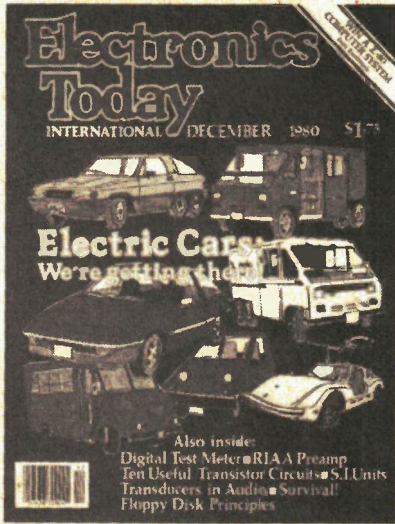

## BOOKS, BACK ISSUES BINDERS—SEE OVER

**FOR OFFICE USE**

Code \_\_\_\_\_

Electronics Today Magazine, Unit 6, 25 Overlea Blvd., Toronto, Ontario M4H 1B1.

**SUBSCRIPTIONS:**  NEW SUBSCRIPTION? OR...  RENEWAL? Please check one.  
 One year subscription (12 issues) \$16.95  Two year subscription (24 issues) \$29.95  
 Postage and handling to Canada is included, for U.S. please add \$3, other countries add \$5/yr.

**PLEASE PRINT CLEARLY**

NAME \_\_\_\_\_

ADDRESS \_\_\_\_\_

TOWN/CITY \_\_\_\_\_ PROVINCE/STATE \_\_\_\_\_

CODE \_\_\_\_\_ DATE \_\_\_\_\_

Cheque enclosed. DO NOT send cash.

Bill Mastercard. A/C No. \_\_\_\_\_

Bill Visa A/C No. \_\_\_\_\_

Signature \_\_\_\_\_ Expiry Date \_\_\_\_\_

**PLEASE ALLOW 6-8 WEEKS FOR YOUR FIRST MAGAZINE TO ARRIVE**

0181

# ETI SPECIALS

**Electronic Circuit Design** \$3.95  
 92 pages  
 A collection of major articles on various aspects of circuit design including CMOS, Audio Amps, Amplifiers, Power Supplies, SCR's, Op-Amps, Using the 3080 and Temperature Control. A large number of useful circuits are given but the emphasis is on guidance and how to tackle the design for yourself.

**Hobby Projects** \$3.95  
 100 pages  
 First published Summer 1980. Contains 25 straight-forward projects most of which have never appeared in the magazine including: Stereo Amp, Audio Mixer, Scratch and Rumble Filter, Constant Volume Amp, Graphic Equaliser, Envelope Generator, White Noise Effects, Linear Scale Ohmmeter, Intercom, Drill Speed Controller, LED Tacho, Parking Meter Timer, Electronic Organ, Touch Switch, Electronic Dice, Siren, Simple Receivers.

**More Circuits** \$4.50  
 108 pages  
 Over 150 circuits plus articles on Construction, Test Gear, a project on a Digital Panel Meter, Design notes on Crossovers, TTL pin-outs, Design notes on Crystal Oscillators.

**Canadian Projects Book No.1** \$3.00  
 100 pages  
 25 of our most popular projects from our earlier issues including: Audio Limiter, 5W Stereo, Bass Enhancer, Modular Disc, 50W/100W Amp Modules, IB Metal Locator, Touch Organ, Electronic Mastermind, Double Dice, Reaction Tester, Sound Operated Flash Burglar Alarm, Injector-Tracer, Digital Voltmeter.

**ELECTRONIC CIRCUIT DESIGN** Summer 1980  
**HOBBY PROJECTS** Summer 1980

Available from your local electronic parts store or direct from ETI (please add 45c each to cover postage).  
 Send money to:  
 Electronics Today Magazine,  
 Unit 6, 25 Overlea Blvd.,  
 Toronto, Ont.,  
 M4H 1B1



# Electronics Today

## INTERNATIONAL

At the time of going to press, the articles mentioned are in an advanced stage of preparation. However, circumstances may result in changes to the final contents of the magazine.

NEXT MONTH

### FEBRUARY

#### ELECTRONICS IN

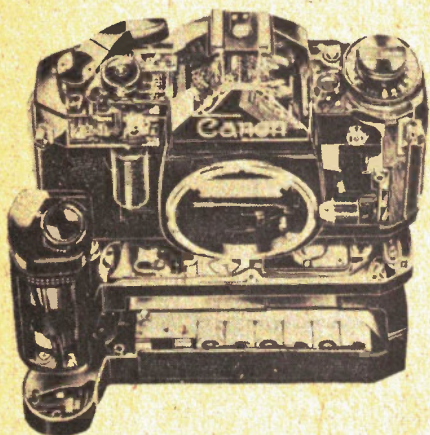

Cameras are changing fast and are becoming very sophisticated — all thanks to electronics. In next month's issue, Phil Gerring looks at the applications of electronics in the field of photography.

#### FUZZ SUSTAIN UNIT

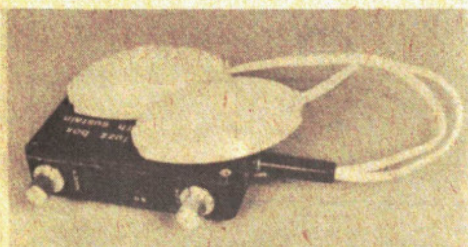

For that raunchy sound that is so beloved of electric guitarists the world over, this straight-forward project is just the thing. Using the foot switches you may select straight through operation, fuzz with sustain or fuzz without sustain.

#### COMPUTING SUPPLEMENT

A bumper extra in next month's ETI, all dealing with computers.

Features include: 'What to consider when buying a business computer for a small company'; a review of the Sinclair ZX80 computer which costs under \$300; Steve Rimmer writes on programming and we look at the development of computers.

#### ULTRASONIC BURGLAR ALARM



Ultrasonic burglar alarms offer one major advantage over contact-triggered types: they need no complex wiring. They work by 'flooding' an area with sound waves and if these are disturbed, an alarm sounds; they work by detecting movement of an intruder. Complete details next month.

#### PIEZO ELECTRICITY

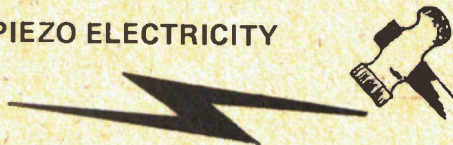

'It sparks when you hit it': well, that's not a bad description of the piezo electric effect but these crystals can do a whole lot more as Ian Sinclair will explain.

#### PROCESS TIMER



This controller has a myriad applications in electronic and photographic work. It features a LED display which 'counts down' and is visible in most light conditions. It will work over the range of 0.1 seconds to 20 minutes.

#### DESIGNING ACTIVE FILTERS

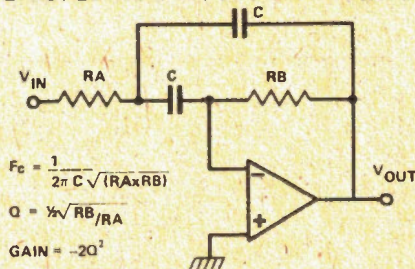

Our circuits feature in the February issue examines the different methods of separating out sound frequencies from one another. Tim Orr examines the various types and presents practical circuits with the formulae for calculating the component values.

#### SHORT WAVE AERIALS

Modern SW radios are selective and sensitive — and normally are used with a short telescopic antenna but results are staggeringly better when they are used with a properly designed aerial.

Save up to 28% on the Newsstand price by subscribing to ETI — see page 40.

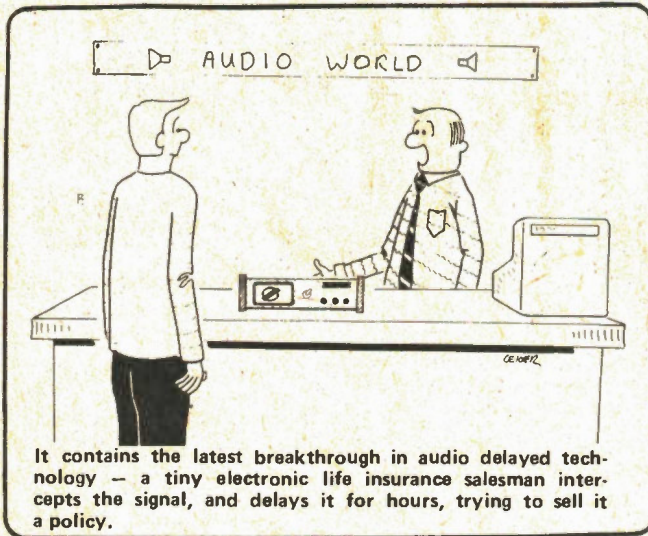

It contains the latest breakthrough in audio delayed technology — a tiny electronic life insurance salesman intercepts the signal, and delays it for hours, trying to sell it a policy.

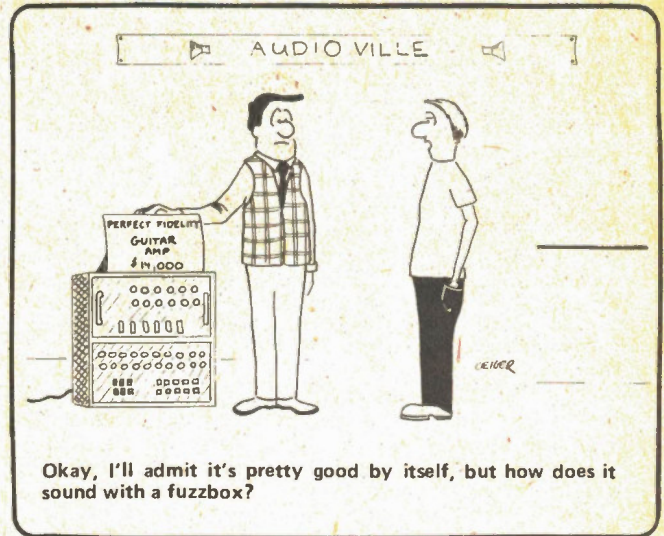

Okay, I'll admit it's pretty good by itself, but how does it sound with a fuzzbox?

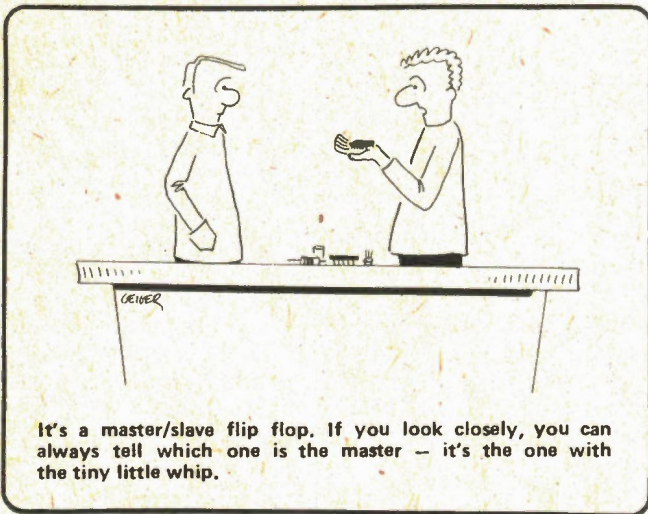

It's a master/slave flip flop. If you look closely, you can always tell which one is the master — it's the one with the tiny little whip.

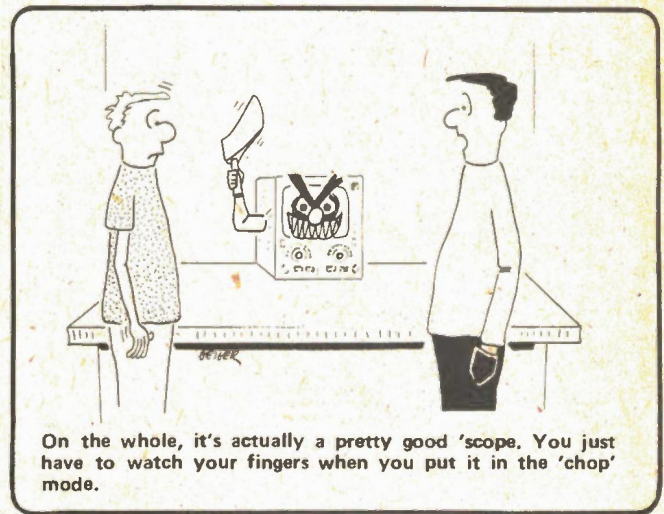

On the whole, it's actually a pretty good 'scope. You just have to watch your fingers when you put it in the 'chop' mode.

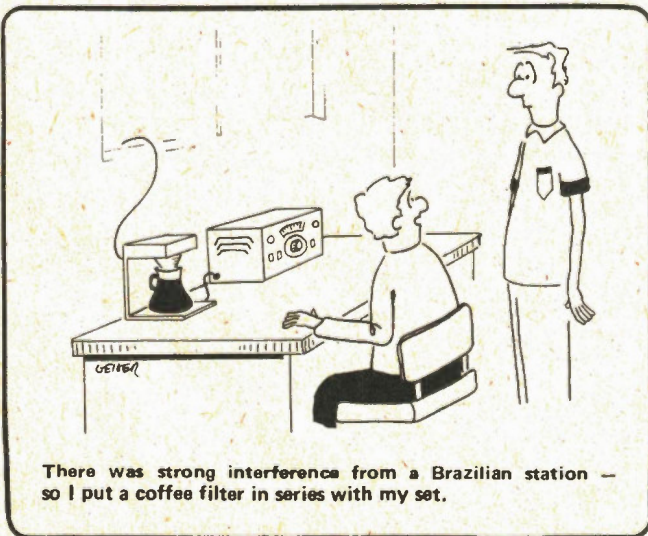

There was strong interference from a Brazilian station — so I put a coffee filter in series with my set.

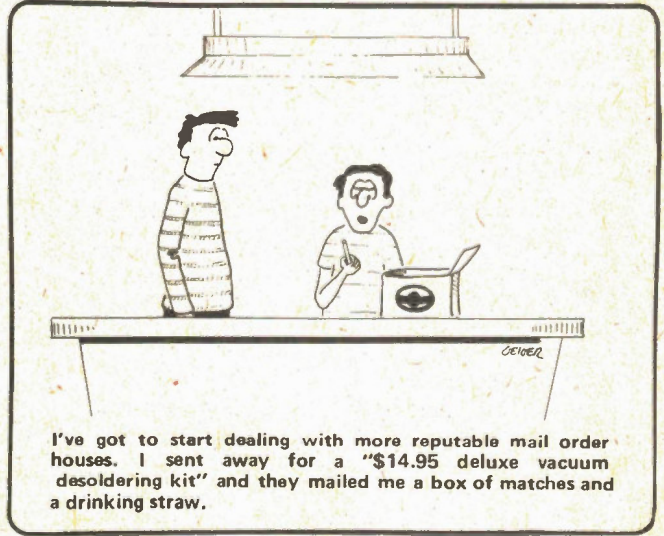

I've got to start dealing with more reputable mail order houses. I sent away for a "\$14.95 deluxe vacuum desoldering kit" and they mailed me a box of matches and a drinking straw.



# ETI INDEX

## 1980

### Projects — Miscellaneous

Egg Timer	Feb	22
General Purpose Power Supply	Feb	25
Getting Started In RTTY	Feb	28
Electromyogram — Part I	Mar	12
Electromyogram — Part II	April	9
RTTY — Part II	April	31
16K RAM Card	May	55
HEBOT — Part I	July	16
Photographic Timer	July	46
HEBOT — Part II	Aug	25
Passionmeter	Aug	53
Touch Switch	Sept	50
Metal Locator	Oct	11
6W Siren	Nov	43
Survival Game	Dec	40

### Projects — Home & Automobile

Battery Condition Indicator	Mar	18
Wire Tracer	Mar	24
Failure Monitor Indicator — Auto	April	51
Fuel Level Monitor	May	61
Soil Moisture Detector	May	40
Overspeed Alarm	June	63
Home Security System	Sept	19
Baby Alarm	Oct	65
Infra Red Remote Control	Nov	59

### Projects — Test Equipment

Logic Probe	Jan	25
Function Generator	June	21
Analogue Frequency Meter	July	50
Transistor Tester	Aug	37
Linear Scale Capacitance Meter	Oct	29
Power Supply	Oct	45
Digital Test Meter	Dec	11

### Projects — Audio & Music

Guitar Effects Unit	Jan	15
Series 4000 Stereo Amplifier	Jan	18
Series 4000 Moving Coil Preamplifier	Feb	14
Complex Sound Generator	April	59
Click Eliminator	May	13
Dynamic Noise Filter	June	38
Accentuated Beat Metronome	July	58
300W Amp	Aug	12
Speaker Protection Unit	Sept	65
Guitar Practice Amplifier	Nov	13
RIAA Preamp	Dec	37

### Science & Technology

A History Of Car Ignition	Jan	55
Calcometer 4100 Review	Mar	27
Deep Space Tracking	Apr	38
Standing Waves	May	25
Electronic Warfare	June	12
Beryllium — How Dangerous?	June	35
The Tesla Controversy	July	42
Life Out There?	Aug	56
Telidon	Sept	13
Kirlian Photography	Sept	43
Project Daedalus	Nov	53
Electric Cars	Dec	31

### General

Hams At Mississauga Madness	Jan	43
Biofeedback	Mar	36
Valdemar Poulsen	April	34
Microwave Cooking	May	33
CSA	May	45

Canadian Sound Archives	June	33
Electronics In the Studio	July	31
Introduction To Test Gear	Aug	31
Burglar Alarm Installation	Sept	24
Synthesizers	Oct	21
Electronic Fences	Oct	35
Cassette Decks and Tapes	Nov	29
SI Units	Dec	56

### Microprocessors & Computing

HP41C Review	Feb	63
Artificial Intelligence	May	54
C.L.I.P.	June	51
Getting 'Round HEX	June	48
S100 Bus System	Aug	21
IEEE Bus	Sept	62
Identimat	Nov	39
Floppy Disks	Dec	23

### Components & Circuit Theory

LM 10 — Applications	Jan	30
<i>(Part I of this feature appeared in Dec '79)</i>		
Practical Guide To Triacs — Part II	Jan	38
<i>(Part I of this feature appeared in Dec '79)</i>		
Simple Radio Control	Feb	33
Gain Control — Part I	Feb	36
Practical Guide To Triacs — Part III	Feb	54
Gain Control — Part II	Mar	40
Power Supplies	Mar	50
Self Resonant Capacitors	Mar	56
Data Sheet	Apr	15
40 CMOS Clock Circuits	Apr	21
SAWFs	Apr	43
Delay Lines	May	21
Magnetic Power Control	June	41
CA3130 Circuits	June	27
PLL Synthesis	June	18
CMOS 555	July	11
Capacitors	July	24
FET Special	Aug	45
D—A Techniques	Sept	28
Solar Cells	Oct	39
Into Electronics — Part I	Oct	53
Audio Amplifier Circuits	Oct	61
Attenuators	Nov	34
Into Electronics — Part II	Nov	65
Thermistors	Nov	71
Into Electronics — Part III	Dec	49
Ten Simple Transistor Circuits	Dec	26
Transducers In Audio	Dec	17

### Designer Circuits

Logic Lock	Sept	56
Electronic Thermometer	Sept	56
Single IC Organ	Oct	18
Water Alarm	Oct	18
HF TTL Oscillator	Nov	19
Linear Scale Resistance Meter	Nov	19
555 I.C. Projects	Nov	20
Sound Triggered Flash	Nov	21
Quick Transistor Tester	Nov	21
AF Signal Generator	Nov	22
Sine To Square Converter	Nov	22
Headphone Amplifier	Nov	23
NiCad Charger	Nov	23
CMOS Monostable	Nov	24
Two Transistor Noise Source	Nov	24
Sustain Unit	Nov	25
AC Meter Booster	Nov	25
Clipping Amplifier	Nov	26
Reaction Game	Nov	26
Car Cassette Power Supply	Dec	23

### Series 4000 Stereo Amplifier January 1980

i) The power supply pcb for this article appeared in the March 1980 issue.

ii) RL1 is a 12V relay with maximum pull in current of 100ma or minimum coil resistance of 100R.

### Minisynth April 1980

Minor error in the PCB. The trace between the cathode of D1 and the positive terminal of C14 is missing. This is Vcc for the SN-76477, solder in a short jumper.

### Click Eliminator May 1980

i) The Parts List only lists resistors for the right hand channel. You will also need C104-106 (identical to C1 to C6); RV101 (identical to RV1), and ICs 101-103 (you get the idea).

ii) C12 and C13 are 4u7 tantalums R23 (listed twice) is 10k.

iii) Two overlay problems; C10 at the top right corner should be C11. Also, the R103 that appears just to the right of RV101 is actually C103.

### Simple Intercoms Hobby Projects, Summer 1980

A 25u, 25V capacitor (C5) is specified for the power supply but does not appear in the schematic. It goes in parallel with C4.

### Hebot July, August 1980

As stated in the article, our arrangement for the manufacture of Hebot chassis fell through. We do have a source of excellent motors, write to: Isotronic Limited, 105 Scarsdale Road, Don Mills; Ontario and check availability. Further notes on mechanical construction appear in Part II, August 1980.

### 300W Amplifier August 1980

i) The note on the schematic neglects to mention Q17. It can be either a BD139 or 2N4923. The Parts List is correct in this respect.

ii) Apparently the Philips heatsink is unavailable.

### Electronic Thermometer Designer Circuits, September 1980

i) Pin numberings 1 and 2 for IC2 are reversed. The output is pin 1, the input (from B1) is pin 2.

ii) The right hand leg of C2 goes to pin 8 on IC1.

iii) RV1 and RV2 are described as R4 and R6 in the test. There are no R4s or R6s required.

### Speaker Protection Unit September 1980

The note on the schematic describing D1-D4 as 1N914 and D5-D6 as 1N4001 is incorrect. They are reversed (the Parts List is correct).

### Metal Locator October 1980

The pcb overlay gives R3 as 1M. This is incorrect, its value is as shown in the schematic and Parts List.

### NiCad Charger Designer Circuits, November 1980

C1 is incorrectly sited in the schematic. Its positive lead goes to the junction of D1,2, and its negative lead is connected to the transformer center tap. The original 'C1' is in fact the center tap connection to ground.

# INTO ELECTRONICS (PART 4)

This month Ian Sinclair looks at transistors, how they work, and how they're used.

## Double Your Junctions

IN 1948, Brittain, Bardeen and Shockley made one of the most important discoveries of all time. They managed to make two PN junctions really close together: the first **transistor**. What's so special about two junctions close together? It's like Siamese Twins, that's what, and anything that happens in one affects the other.

Imagine a very thin layer of P-type material as the meat in an N-type sandwich (Fig.1). By a thin layer we mean just a few hundred atoms thick. Now imagine one N-type layer connected to battery + and the other connected to battery -. From what we know so far there's no way this arrangement could conduct current, its like two diodes connected anode to anode. No matter which way you look at it, one diode is reverse biased and therefore can't conduct. This is where the closeness of the junctions has an effect. Suppose we start one

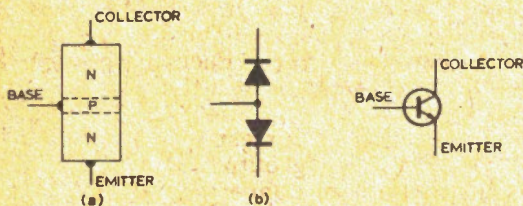

Fig. 1. The transistor. (a) Arrangement of junctions. (b) Two-diode circuit which would give the same readings on an ohmmeter. When two terminals of a transistor are found which do not conduct in either direction, the other terminal must be the base. (c) Symbol of NPN transistor.

junction conducting; the one between the P-type material and the N-type that is connected to battery negative. It won't conduct until the voltage across it is somewhere around 0.55 V (assuming a silicon device), but when it does, the junction is flooded with **carriers**. Because the junctions are so close the other junction also becomes flooded with carriers, though it is reverse biased. This turns the second junction into a conducting junction, despite the reverse bias, so that current flows between the two N-type regions. This current can flow only for so long as carriers are injected from the junction that has been deliberately forward biased.

It's time we put some names to the bits of this device, the bipolar (or junction) transistor. The meat in the sandwich is the part called the **base**, the other two regions are the **collector** and the **emitter**. The reverse biased junction is the junction between collector and base and the forward biased junction is the junction between base and emitter.

Look at it all again. With no bias (or reverse bias) between the base and the emitter, no current flows between the collector and the emitter: reason for that is

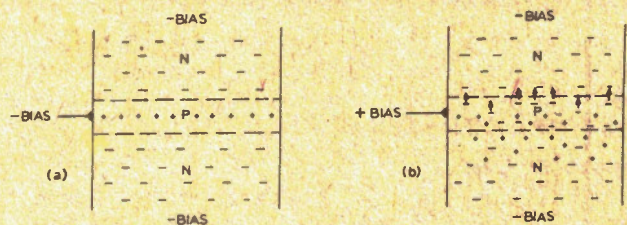

Fig. 2. Transistor effect. (a) With the base-emitter P-N junction unbiased, both junctions are depleted, no current flows. (b) When the base-emitter junction conducts, both junctions are flooded with carriers (electrons in this case) so that both conduct.

the reverse bias between the collector and the base. When the base-to-emitter junction is forward biased, though, the carriers enter the collector junction, so that it conducts. As a result, we can change the collector-emitter circuit from insulating to conducting by altering the base voltage slightly.

We can do even better than this. When we make the base-emitter junction conduct, most of the base carriers are swept across the other junction (base-collector). As a result, much more current flows between the collector and emitter than between base and emitter; a small current between base and emitter controls a large current between collector and emitter. Controls? Yes, controls, because the ratio:

$$\frac{\text{Collector to emitter current}}{\text{base to emitter current}} \text{ is fairly constant.}$$

A typical value is 100, meaning that the current between collector and emitter,  $I_c$  is 100 times the current between base and emitter ( $I_b$ ). This ratio is called the **forward current transfer ratio**, common emitter, mercifully shortened to  $h_{fe}$ . The phrase '**common emitter**' is used because both the base and the collector conduct to the same terminal, the emitter.

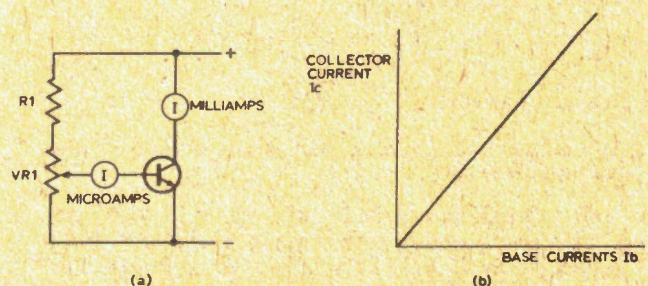

Fig. 3. Current gain (a) Circuit for measuring base and collector currents. (b) Typical graph of collector current plotted against base current.

**NPN and PNP**

Bipolar transistors can be made in two varieties, **NPN** and **PNP**. The NPN operates with its collector positive to its emitter and will conduct when the base (the P-layer) is about 0.55 V positive to the emitter. The PNP transistor

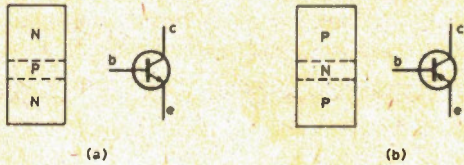

Fig. 4. Junction arrangements and symbols (a) NPN, (b) PNP.

operates with its collector negative to its emitter and will conduct when the base (the N-layer) is about 0.55 V negative to the emitter. These voltages assume that silicon devices are being used

**Gaining on the Deal**

Look at the circuit of Fig. 5a. It has a 6 V, 60 mA bulb in series with a switch and a 6k8 resistor across a 6 V battery. What happens when it's switched on? Nothing noticeable, because 6 V across 6k8 produces less than 1 mA of current, not enough for a 60 mA bulb to glow as bright as an exhausted firefly? Now try the circuit in Fig 5b. This time the switch will operate the bulb. The current through the 6k8 resistor is more than enough to make the transistor conduct, passing 60 mA through the bulb. We call this effect **current gain**, and the quantity  $h_{fe}$  measures this current again.

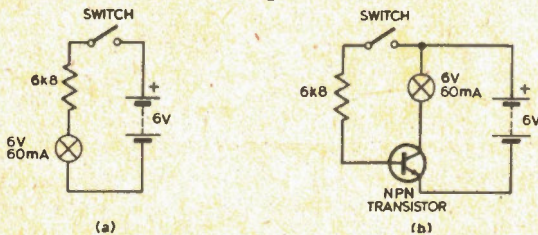

Fig. 5. Current amplification. (a) This circuit cannot pass enough current to light the bulb. (b) The bulb will light when the switch is closed because the base current of the transistor will cause collector current to flow.

Don't get carried away though. The transistor hasn't created this current, just controlled it. If the battery had not been able to supply 60 mA, no cunning tricks with transistors could make the bulb light.

Try the circuit of Fig. 6 for yourself. The bulb will

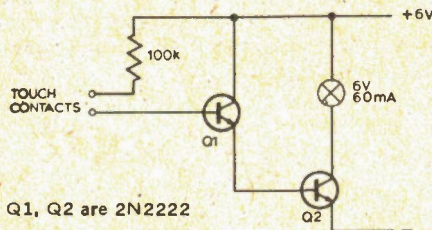
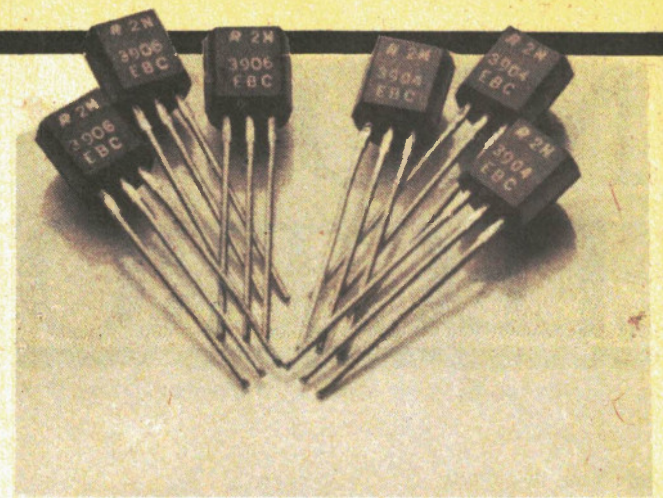

Fig. 6. A touch switch — touching the contacts with your fingers will allow the bulb to light.

light when the two terminals are touched with one finger. The tiny amount of current that flows through you causes a current many times greater to flow in Q1. (We use the abbreviation **Q** for a transistor; an alternative is **Tr**). This greater current flows into the base of Q2, and causes a greater current still, enough to operate the bulb. Suppose we put some sizes to these currents. If the



Typical small signal transistors. (R Ohm)

bulb needs 60 mA, then let's suppose, for the sake of simplicity, that Q2 has a current gain ( $h_{fe}$ ) of 60. Then just 1 mA is needed into the base of Q2 to make the bulb glow. This 1 mA is supplied by Q1. If this transistor also has  $h_{fe}=60$ , then only one sixtieth of a milliamp (16 uA) is needed into the base of Q1.

This sort of use of transistors is called **switching**. The bulb, or whatever the transistor is switching on and off, is called the **load**. The load is connected in the collector-emitter circuit, and switched on or off by charges at the base. To switch the load on:

- (a) the voltage between base and emitter must be more than 0.55 V for a Silicon Transistor (0.15 V for a germanium transistor)
- (b) the current between base and emitter must be enough to ensure that the correct current will flow through the load.

Just to illustrate these conditions, try to explain why the circuits in Fig. 7 will **NOT** work!

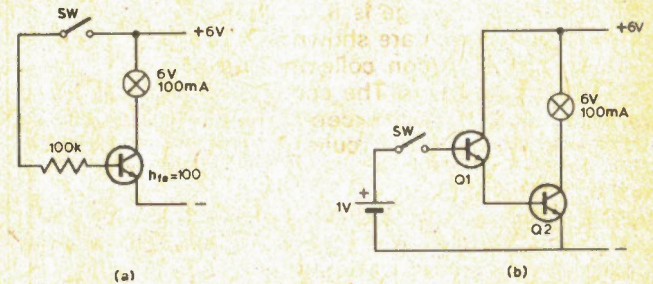

Fig. 7. Two circuits which DON'T work. Can you explain why?

**Variations on the Theme**

Figure 8 shows another circuit which needs some thought. If the load resistor is in the emitter part of the circuit, then the amount of current needed at the base is the same as it would be if the load were connected in the collector part of the circuit. The voltage needed at the base, however, has to be *more* than the normal voltage across the load. Think of it this way — for the load to operate, it needs the correct voltage across it and the correct current through it. Suppose the load is a 6 V 60 mA bulb. In this circuit, the emitter terminal of the transistor must be at 6 V when the bulb glows. For the transistor to conduct, the base voltage must be 0.6 V or so above the emitter voltage which means around 6.6 V. The shift in the position of the load in the circuit makes a

large difference to the voltage that is needed at the base. This is, in fact, a rather different type of circuit, the **common collector circuit**.

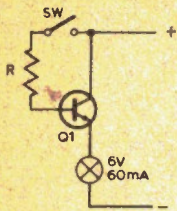

Fig. 8. The emitter-follower.

The differences between these circuits illustrate rather well differences in the behaviour of transistors. Connect as a common emitter circuit (Fig. 5b) and small *changes* of voltage at the base cause fairly large changes of *base* current. The input circuit of the transistor (base-emitter) behaves like a low resistance. Connect the transistor in a common collector circuit (Fig. 8) and much larger *changes* of voltage at the base are needed to cause the same changes of base current. Now the input circuit behaves like a large resistance. We refer to this as the input resistance of the transistor; it's important because we have to be able to supply the correct voltage to this input resistance to turn on the current.

Transistors have an output resistance too. A transistor connected in a common emitter circuit has a high output resistance. This means that changing the collector voltage has very little effect on the collector current. It's a useful feature, because a high value of output resistance means that the current flowing between collector and emitter is controlled only by the base current, not by the collector voltage. Connecting the transistor up into a common collector circuit has the opposite effect; the output resistance is now low. Any change in the emitter voltage now causes a large change in the emitter current (assuming the base voltage is fixed). These input and output resistance values are shown in Table 1, for the common emitter, common collector and also for the common base connection. The common base connection is seldom used now except in high frequency circuits or as a part of other circuits.

#### Laying it on the Line

Take a look at the graph of Fig. 9. It's a graph of silicon transistor collector current plotted against the base voltage (base-to-emitter voltage, that is). What it shows is that very small changes of base voltage will cause larger changes of collector current. We make use of this when we design voltage amplifiers.

A voltage amplifier has an AC voltage signal at its input and produces a copy of the wave, with greater amplitude at its output. The ratio voltage gain equals

$$\frac{\text{signal amplitude at output}}{\text{signal amplitude at input}}$$

How do we use a transistor as a voltage amplifier? To start with, we have to convert the collector currents into voltages. The simplest method is to use a resistor as a load. Take the example of Fig. 10. The load resistor here is a 1k resistor, and the voltage signal is at the collector of the transistor. When the collector current is zero, the voltage at the collector is 6 V, the supply voltage. When a collector current flows, there is a voltage across the resistor so that the collector voltage drops. The greatest

amount of current that could possibly flow in this circuit is 6 mA, because this amount makes the collector voltage zero. We could then get a voltage wave at the output with an amplitude peak-to-peak of 6 V, providing we had enough signal voltage at the input to cause a collector current of 6 mA peak-to-peak. That's where the graph of Fig. 10 comes in, because we can read off the base voltages for the two current limits of zero and 6 mA. Now we have the output voltage (6 V p-p) and the input voltage (0.1 V p-p); so that the voltage gain of this amplifier is 60 times. Easy!

Is the output voltage signal a good copy of the input voltage signal? It can be, but two things can go wrong. One is that the graph of  $I_c$  (collector current) against  $V_{be}$  may not be a straight line. Any curvature of this line causes a poor copy; we say that there is **distortion**. The other thing is that the base voltage must never drop

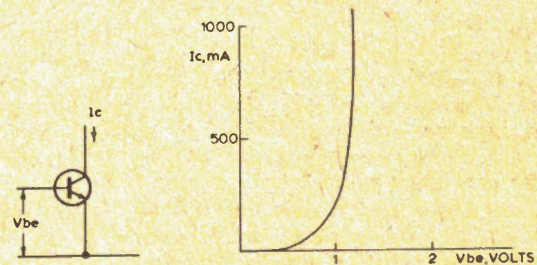

Fig. 9. Mutual conductance characteristic for a medium-current silicon transistor.

below the minimum conducting voltage of about 0.55 V. Both problems are tackled by using **bias**. In everyday language, bias is anything that tips things to one side. What we need to tip to one side is the base voltage, to make sure that it can't drop below that figure of about

TABLE 1

#### Relative sizes of input and output resistances

	Name	R <sub>in</sub>	R <sub>out</sub>
	common emitter	medium	high
	common base	low	high
	common collector	high	low

low: below 100R; medium: several k; high: above 10k.

0.55 V (again assuming a silicon transistor).

A bias circuit does just that. Two common types of bias circuits are drawn in Fig. 11. and Fig. 11a. shows a circuit using a resistor connected between the base and the collector. We can calculate the value of the resistor so that the collector voltage, with no signal present will be about half supply voltage. This way if we put an AC signal in at the base, an amplified signal will appear at the collector and its amplitude can be anything up to about half supply voltage without cutting off either peak.

Figure 11b is of another type of bias circuit. In this design, a potential divider sets the voltage at the base. This makes the transistor pass current through the emitter resistor R4 so that the voltage between base and emitter is set to the correct value, around 0.55 V. If we

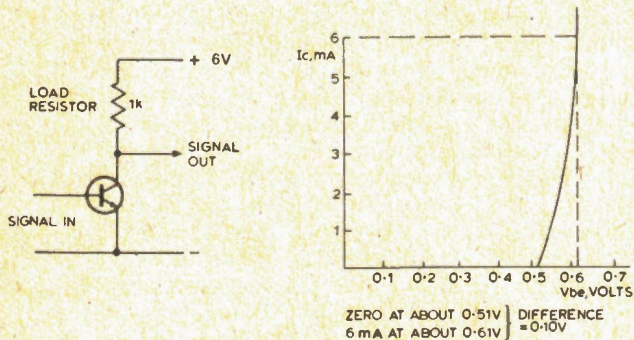

Fig. 10. Voltage amplification using a load resistor.

choose the value of the load resistor R3 correctly, the collector voltage can be set to about half supply voltage once again. The capacitor C2 is important. Unless this capacitor is connected, we do not have a true common emitter circuit for signals (because of R4) and the voltage gain will be very low — more of that later.

Both of these methods of bias are self correcting — if we change the base voltage temporarily with a signal, the voltages will afterwards always return to the value that we set. In addition, slight changes in the values of  $h_{fe}$  or resistance will not cause noticeable changes in the bias voltages when these circuits are used.

Bias is not necessarily just a method of preventing the peaks of the signal from being chopped (or clipped). Bias can also be used to ensure that the distortion is as low as we can arrange. The graph of  $I_c$  against  $V_{be}$  is not usually a perfectly straight line, but some parts of the curve may be more nearly straight than others. If we bias the transistor so that a fairly straight portion of line is used, then the distortion is low. The names 'linear amplifier'

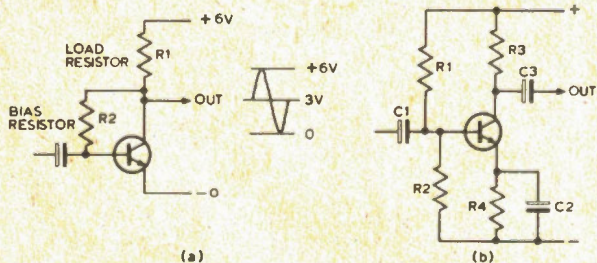

Fig. 11. Two types of bias circuit. (a) Current bias, using a single resistor. (b) Voltage bias, using a potential divider.

and 'linear operation' come from the idea that the best operating conditions are along a piece of the graph which is a straight line.

We can calculate the gain of a transistor amplifier very easily. The ratio

$$\frac{\text{change of collector current}}{\text{change of base voltage}}$$

called **mutual conductance**, symbol **gm**, is about 40 mA/V for each 1 mA of collector bias current. For a transistor biased to a collector current of 2 mA, for example, the gm value would be 80. This value of gm is also related to the current gain  $h_{fe}$  and the input resistance of the transistor  $h_{ie} = gm h_{ie}$ . Now the correct signal out for an input  $V_{in}$  must be  $gm V_{in}$ , so that the voltage signal is  $gm V_{in} R_L$  ( $R_L$  is the value of the load resistance). An even simpler method arises because the DC bias voltage across  $R_L$  depends on the bias collector current. The voltage gain of any small signal amplifier using silicon transistors is just  $40 \times$  (steady voltage across  $R_L$ ). For example, if there is 5 V across the load resistor with no signal input, the voltage gain of the transistor is  $5 \times 40 = 200$  times.

**Up and Down the Scales**

We can measure the voltage gain of a voltage amplifier at any frequency of signal we care to use, but we won't get the same results at each frequency. A simple voltage amplifier such as that of Fig. 12 will have its normal value of voltage gain (around 200) at frequencies ranging from about 100 Hz to several hundred kHz. At very low frequencies, of a few Hz, the measured gain will be less. The transistor is still doing its stuff, but the capacitors that are used in the circuit have such high reactance values at very low frequencies that the signal is potential-divided by each capacitor that is connected to a resistor or the transistor. If we use circuits that eliminate capacitors (direct coupled circuits), the voltage gain remains constant even for DC.

We cannot simply remove the capacitors in a circuit such as that in Fig. 12 because these capacitors are needed to prevent the bias voltages being shorted out or increased by the circuits to which the transistor is connected.

At the high frequencies, it's capacitors again that cause the trouble. This time they're invisible, the type we call **stray capacitance**. Every gap in a circuit is a capacitance, though of small value. In the circuit of Fig. 12 the dotted lines indicate gaps which must have some stray capacitance. The effect of these capacitances is to provide an easier route for high frequency signals than the resistors or even the transistors, so that the voltage gain is, once again, reduced. For audio amplifiers,

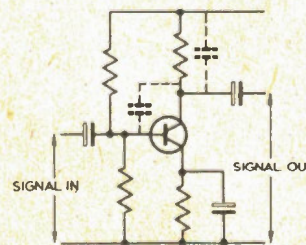

Fig. 12. A complete voltage amplifier stage. The dotted lines indicate important stray capacitances between parts of the circuit.



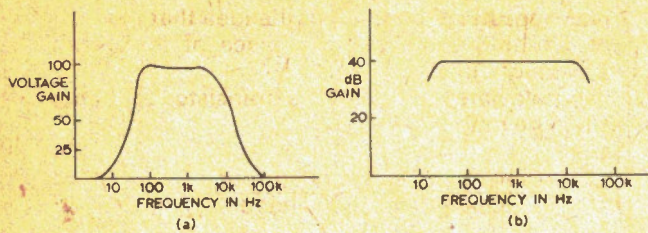

Fig. 13. Frequency response graphs. (a) Using a linear scale for gain. (b) Using a decibel scale for gain.

working with the frequency range 40 Hz-20 kHz, these frequency limits are not usually troublesome. Amplifiers intended for much higher frequencies use tuned (resonant) circuits in place of the load resistor. The stray capacitance then becomes part of the resonant circuit, so that its value does not greatly affect the frequency we can use. At really high frequencies, the transistor itself begins to give up, because the charge does not move fast enough to follow the changes of voltages of high frequency signals. Transistors of rather specialised construction are needed for frequencies of 100MHz or more.

A graph of voltage gain plotted against frequency is called a **frequency response graph**. A typical frequency response graph for an audio amplifier is shown in Fig. 13a. We have to use a logarithmic scale for frequency, with the same distance between 1 kHz and 10 kHz as we have between 100 Hz and 1 kHz. This is because a linear scale would have to be several metres long to show the same frequency points.

The frequency response of an amplifier plotted in this way always looks much worse than we expect from the evidence of our senses. The reason is that the difference between a gain of 100 and a gain of 50 is not so very great when the amplifier drives a loudspeaker or the brightness of a cathode ray tube, it certainly doesn't seem like a 2 : 1 ratio. A better way of showing

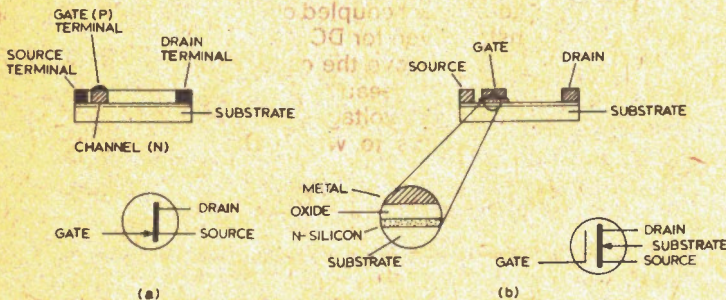

Fig. 14. FETs. (a) Junction type, N channel. (b) MOS type, N channel. The substrate is the silicon layer on which the other layers are deposited.

frequency response is the **decibel (dB)** scale. To convert a voltage gain to decibels, we use  $dB = 20 \log(\text{voltage gain})$  so that a voltage gain of 20 is 26 dB, a gain of 40 is 32 dB, and a gain of 80 is 38 dB. Note that doubling the gain figure causes the dB figure to *increase* by 6 dB, typical of a logarithmic scale.

A frequency response graph plotted in dBs is shown in Fig. 13b.

## FETS

The two-junction, or bipolar, transistor is not the only way of using a semiconductor material for switching or amplification. **Field-effect transistors (FETS)** make use of another way of controlling the movement of

electrons or holes in semiconduction without injecting carriers from junctions. The main current path in any FET is called the **channel**, it's a thin narrow strip of silicon, usually N-type. There are no junctions along the length of this channel, so that it behaves like a resistor, allowing current to flow in either direction. The current in the channel is controlled by changing the conductivity of the material, not by injecting carriers into a reverse biased junction.

Two ways of controlling the current are used. One way uses a reverse biased junction, so that the FET is a junction FET. The junction is formed around the strip at one end (Fig. 14a), but the carriers moving through the channel do not pass across the junction. Reverse biasing the junction will deplete it of carriers, so that the conductivity of the silicon around the junction becomes less, and the current in the channel becomes less.

The other type of FET is the MOSFET (Metal-Oxide-Semiconductor FET). A thin layer of silicon oxide (an insulator) is grown on the strip of channel at one end and a layer of metal deposited on top of the insulator. This arrangement forms a capacitor with the silicon of the channel as one plate and the insulated metal as the other. Connecting the metal to a negative voltage causes negative charges to be repelled from the channel, so that the conductivity of the channel becomes less.

In either type of FET, the controlling electrode is called the **gate**; the end of the channel nearest the gate is called the **source**, and the far end of the channel is called the **drain**. A voltage between gate and source controls the current between source and drain, and the ratio

$$\frac{\text{change of channel current}}{\text{change of gate voltage}}$$

is called **mutual conductance, gm**. The values of  $gm$  obtained from FETs are pretty low, 1.2-3.5 mA/V usually, as compared to values of 40 mA/V upwards for bipolar transistors. The big advantage of FETs is their very high input resistance. The MOS types have such a high gate resistance that they can be damaged by the electrostatic voltages produced by rubbing materials together! These types of FET (and the MOS types of integrated circuits) must be handled carefully, keeping the leads shorted together until they can be soldered in place in their circuit. ●

# BURGLAR ALARM CIRCUITS

Ray Marston looks at low-cost burglar-and security-alarm circuits.

BURGLAR ALARMS and home security systems are genuinely useful projects that are always popular amongst electronics hobbyists. The most important feature to look for in such alarms is their system reliability or immunity to false alarms. Most 'clever' alarm systems, such as those using ultrasonic, infra-red, or proximity-detection principles, tend to be rather unreliable and, generally speaking, should be avoided like the plague, particularly when they are amateur-designed circuits published in electronics hobbyist magazines.

The most reliable types of burglar alarm are those that use electro-mechanical devices such as microswitches, reed-and-magnet switches, or pressure mat switches, as intrusion sensors. Fig 1 shows the simplest of all types of burglar alarm. The circuit is activated via normally-open (close-to-operate) switches such as pressure mats and consumes zero standby current. When any of the switches close the relay turns on the self-latches via contacts RLA/1 and the alarm is activated via contacts RLA/2. This circuit can be used to give a reasonable degree of security to a small house.

## Break-to-Operate Alarm Systems

An alternative type of alarm system is shown in Fig 2. Here, normally, closed switches are used as intrusion sensors. Normally, with all switches closed, the base and

emitter terminals of Q1 are shorted together, so Q1 and the relay are off. If any of the sensor switches open, Q1 and the relay are turned on via R1 and the relay is self-latched via contacts RLA/1.

This basic 'break-to-operate' type of circuit has two distinct advantages. First, the alarm automatically activates if any of the sensor-switch leads are cut or broken. Second, the series-connected switches of the circuit are far easier to install in a building than the parallel-connected switches of the Fig 1 circuit. This second point is particularly important when complex switch-wiring installations are concerned. A major disadvantage of the Fig 2 circuit is that it draws a fairly hefty 'standby' current of 1 mA via hold-off resistor R1.

Fig 3 shows an improved version of the basic Fig 2 circuit. Here, IC1 is a 4-gate CMOS IC with one of its gates used as a simple inverting buffer between R1 and Q1. The use of this gate enables the R1 value to be increased to 12M, thereby reducing the circuit's standby current to an insignificant 1 uA. Note the use of C1 and R2 in this circuit. In practical installations many metres of wire may be used to interconnect the series sensor switches and this wire tends to pick up spurious pulses and signals, particularly during thunderstorms. C1 helps reject these spurious signals and R2 protects the IC against lightning-induced spikes.

Fig. 1. This simple close-to-operate self latching burglar alarm is adequate for many domestic applications.

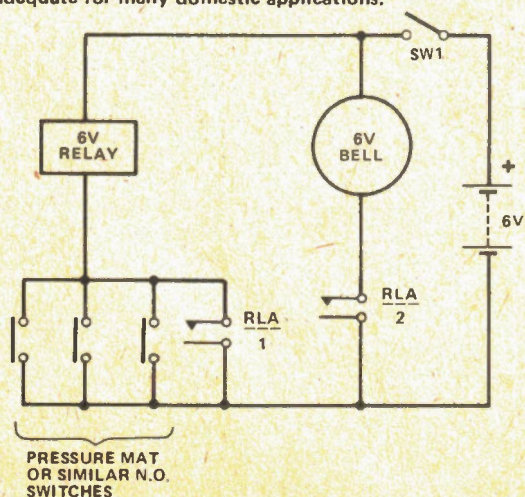
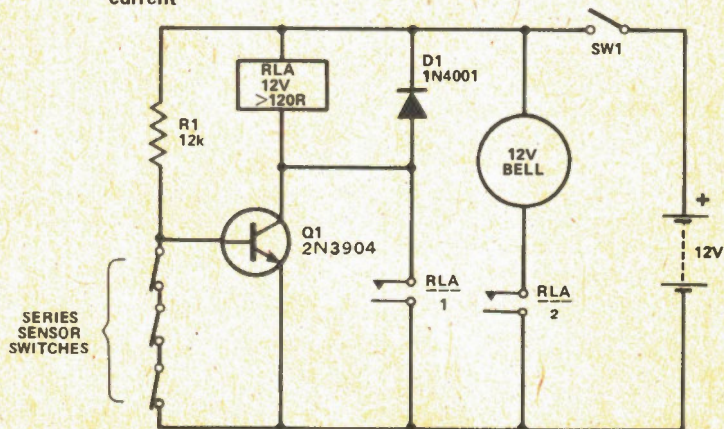

Fig. 2. This simple break-to-operate alarm consumes 1mA standby current



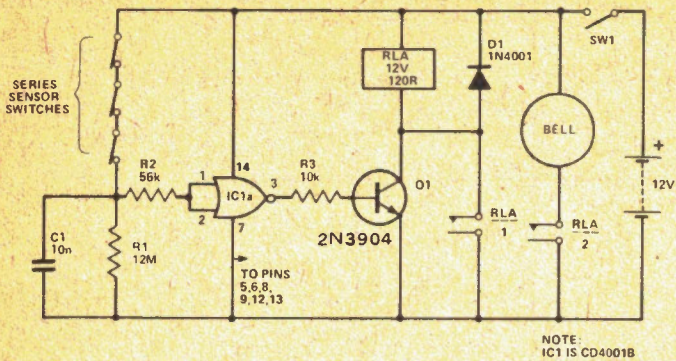

Fig. 3. This CMOS-aided alarm draws only 1mA standby current

An alternative type of break-to-operate alarm circuit is shown in Fig 4. In this case the self-latching action is performed by the IC1a-IC1b bistable circuit. C2 and R4 cause the bistable output to latch low at the moment that SW1 is closed, ensuring that the relay and alarm are off. If any of the sensor switches are activated they cause a 'high' signal to be fed to pin 2 of the bistable, which then latches into a high-output state which turns on Q1 and RLA. Relay contacts RLA/1 are used to activate an external alarm generator.

Note in the Fig 4 circuit that R2 is wired in series with the series sensor switches, thereby enabling the circuit to be activated by either the series switches or by paralleled pressure-mat switches wired across R1. The

circuit thus makes a versatile burglar alarm. The circuit is designed to activate an external alarm generator that is equipped with its own power supply.

Fig 5 shows how the above circuit can be modified to give auto-turn-off alarm action, so that the alarm sounds as soon as an intrusion is detected but turns off again automatically after four minutes or so. This action is obtained via IC1a and IC1b, which are wired together as a monostable or one-shot multivibrator that is triggered via the sensor switches.

Note in the Fig 4 and 5 circuits that Q1 and the relay are permanently connected to the power supply rails, even when SW1 is open. This fact makes it easy to add accessories such as fire detectors and 'panic' buttons, which must be permanently enabled, to the basic circuits. 'Panic' buttons are push-button switches that are placed in vulnerable intrusion areas such as halls, kitchens and bedrooms, to enable aid to be summoned via a self-latching alarm generator at any time.

Fig 6 shows a practical add-on 'Panic' and 'Fire' alarm circuit that can be used with either of the Fig 4 and 5 circuits. IC2a and IC2b are wired as a bistable latch that can be used to turn the relay on (via Q2) via any of a number of parallel-connected panic switches or fire-sensing thermostats. Note that if you decide to combine (say) the Fig 5 and 6 circuits into a single unit, it is still necessary to use two independent ICs for IC1 and IC2, since these ICs must have isolated supply connections.

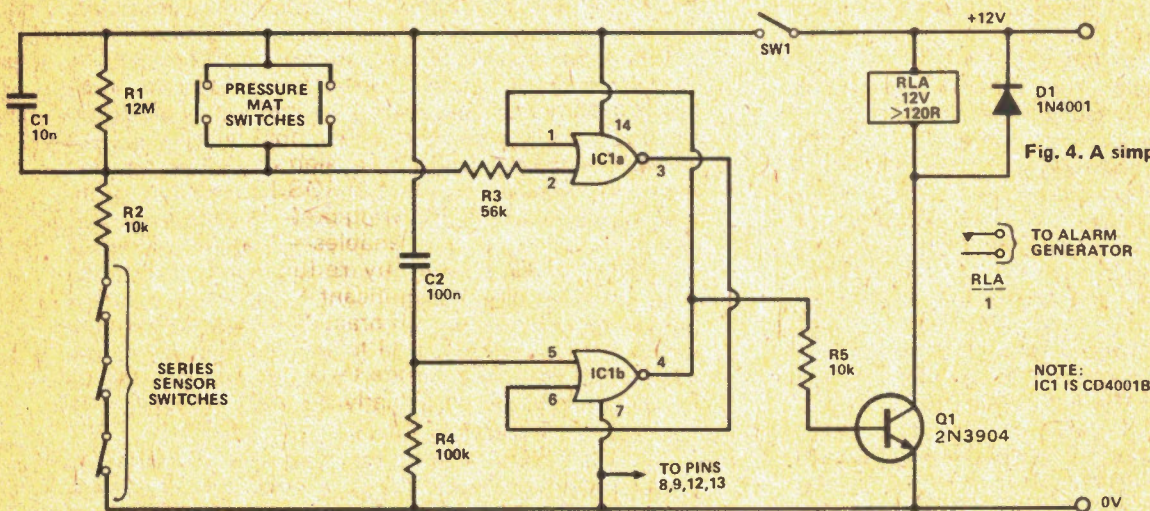

Fig. 4. A simple self-latching burglar alarm

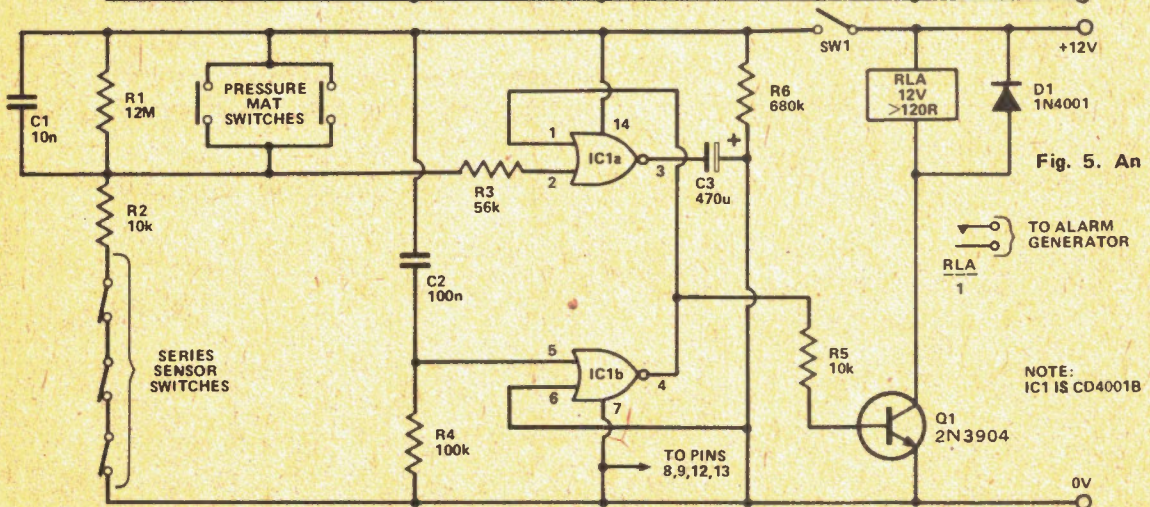

Fig. 5. An auto-turn-off burglar alarm (turn off delay = 4 min)



# Babani Books from ETI

**BP1: First Book of Transistor Equivalents & Substitutes \$2.80**

More than 25,000 transistors with alternatives and equivalents make up this most complete guide. Covers transistors made in Great Britain, USA, Japan, Germany, France, Europe, Hong Kong, and includes types produced by more than 120 different manufacturers.

**BP14: Second Book of Transistor Equivalents & Substitutes \$4.80**

This handbook contains entirely new material, written in the same style as the "First Book of Transistor Equivalents & Substitutes". The two complement each other and make available some of the most complete and extensive information in this field.

**BP24: Projects Using IC741 \$4.25**

The popularity of this inexpensive integrated circuit has made this book highly successful. Translated from the original German with copious notes, data and circuitry, a "must" for everyone, whatever their interest in electronics.

**BP33: Electronic Calculator Users Handbook \$4.25**

An invaluable book for all calculator users whatever their age or occupation, or whether they have the simplest or most sophisticated of calculators. Presents formulae, data, methods of calculation, conversion factors, etc., with the calculator user especially in mind, often illustrated with simple examples.

**BP35: Handbook of IC Audio Pre-amplifier & Power Amplifier Construction \$5.50**

This book is divided into three parts: Part I, Understanding Audio ICs; Part II, Pre-amplifiers, Mixers and Tone Controls; Part III, Power Amplifiers and Supplies. Includes practical constructional details of pure IC and Hybrid IC and Transistor designs from about 250mW to 100W output. An ideal book for both beginner and advanced enthusiasts alike.

**NO.205: First Book of HI-FI Loudspeaker Enclosures \$3.55**

The only book giving all data for building every type of loudspeaker enclosure. Includes corner reflex, bass reflex, exponential horn, folded horn, tuned port, bafflehorn labyrinth, tuned column, loaded port and multi speaker panoramic. Many clear diagrams are provided showing all dimensions necessary.

**BP37: 50 Projects Using Relays, SCR's & Triacs \$5.50**

Relays, silicon controlled rectifiers (SCR) and bi-directional triodes (TRIACs) have a wide range of application in electronics today. These may extend over the whole field of motor control, dimming and heating control; delayed, timing and light sensitive circuits and include warning devices, various novelties, light modulators, priority indicators, excess voltage breakers, etc.

The enthusiast should be able to construct the tried and practical working circuits in this book with a minimum of difficulty. There is a wide latitude in component values and types, allowing easy modification of circuits or ready adaptation of them to individual needs.

**BP39: 50 (FET) Field Effect Transistor Projects \$5.50**

The projects described in this book include radio frequency amplifiers and converters, test equipment and receiver aids, tuners, receivers, mixers and tone controls, as well as various miscellaneous devices which are useful in the home. This book contains something of particular interest for every class of enthusiast - short wave listener, radio amateur, experimenter or audio devotee.

**BP42: 50 Simple L.E.D. Circuits \$3.55**

50 interesting and useful circuits and applications, covering many different branches of electronics, using one of the most expensive and freely available components - the Light Emitting Diode (L.E.D.). Also includes circuits for the 707 Common Anode Display. A useful book for the library of both beginner and more advanced enthusiast alike.

**BP44: IC 555 Projects \$7.55**

Every so often a device appears that is so useful that one wonders how life went on before without it. The 555 timer is such a device. It is manufactured by almost every semiconductor manufacturer and is inexpensive and very easily obtainable.

Included in this book are Basic and General Circuits, Motor Car and Model Railway Circuits, Alarms and Noise Makers as well as a section on the 556, 558 and 559 timers.

**BP46: Radio Circuits Using ICs \$5.90**

This book describes integrated circuits and how they can be employed in receivers for the reception of either amplitude or frequency modulated signals. Chapters on amplitude modulated (a.m.) receivers and frequency modulation (f.m.) receivers. Discussion on the subjects of stereo decoder circuits, the devices available at present for quadrophonic circuits and the convenience and versatility of voltage regulator devices. An extremely valuable addition to the library of all electronics enthusiasts.

**BP47: Mobile Discotheque Handbook \$5.90**

The aim of this book is to give you enough information to enable you to have a better understanding of many aspects of "disco gear". The approach adopted is to assume the reader has no knowledge and starts with the fundamentals. The explanations given are simplified enough for almost anyone to understand.

**BP48: Electronic Projects For Beginners \$5.90**

The newcomer to electronics, will find a wide range of easily made projects and a considerable number of actual component and wiring layouts. Many projects are constructed so as to eliminate the need for soldering. The book is divided into four sections: "No Soldering" Projects, Miscellaneous Devices, Radio and Audio Frequency Projects and Power Supplies.

**BP49: Popular Electronic Projects \$6.25**

A collection of the most popular types of circuits and projects which will provide a number of designs to interest the electronics constructor. The projects selected cover a very wide range. The four basic types covered are: Radio Projects, Audio Projects, Household Projects and Test Equipment.

**BP50: IC LM3900 Projects \$5.90**

The purpose of this book is to introduce the LM3900, one of the most versatile, freely obtainable and inexpensive devices available to the Technician, Experimenter and the Hobbyist. It provides the groundwork for both simple and more advanced uses.

Simple basic working circuits are used to introduce this IC. The reader should set up each of these for himself. Familiarity with these simple circuits is essential in order to understand many more complicated circuits and advanced uses.

**BP51: Electronic Music and Creative Tape Recording \$5.50**

This book sets out to show how electronic music can be made at home with the simplest and most inexpensive of equipment. It then describes how the sounds are generated and how these may be recorded to build up the final composition.

For the constructor, several ideas are given to enable him to build up a small studio including a mixer and various sound effects units. All the circuits shown in full have been built by the author. Most of the projects can be built by the beginner.

**BP62: BOOK 1. The Simple Electronic Circuit & Components \$8.95**  
**BP63: BOOK 2. Alternating Current Theory \$8.95**  
**BP64: BOOK 3. Semiconductor Technology \$8.95**  
**BP77: BOOK 4. Microprocessing Systems & Circuits \$12.30**

Simply stated the aim of these books is to provide an inexpensive introduction to modern electronics. The reader will start on the right road by thoroughly understanding the fundamental principles involved.

Although written especially for readers with no more than ordinary mathematical skills, the use of mathematics is not avoided, and all the mathematics encountered is taught as the reader progresses.

The course concentrates on the understanding of the important concepts central to electronics. Each book is a complete treatise of a particular branch of the subject and, therefore, can be used on its own. However, latter books assume a working knowledge of the subjects covered in earlier books.

**BOOK 1:** This book contains fundamental theory necessary to develop a full understanding of the simple electronic circuit and its main components.

**BOOK 2:** This book continues with alternating current theory.

**BOOK 3:** Follows on semiconductor technology, leading up to transistors and integrated circuits.

**BOOK 4:** A complete description of the internal workings of microprocessors.

**BP65: Single IC Projects \$6.55**

All the projects contained in this book are simple to construct and are based on a single IC. A strip board layout is provided for each project, together with any special constructional points and setting up information, making this book suitable for beginners as well as more advanced constructors.

**BP66: Beginners Guide To Microprocessors & Computing \$7.55**

This book is intended as an introduction to the basic theory and concepts of binary arithmetic, microprocessor operation and machine language programming. The only prior knowledge which has been assumed is very basic arithmetic and an understanding of indices. A helpful Glossary is included. A most useful book for students of electronics, technicians, engineers and hobbyists.

**BP67: Counter Driver & Numeral Display Projects \$7.55**

The author discusses and features many applications and projects using various types of numeral displays, popular counter and driver IC's, etc.

**BP68: Choosing & Using Your HI-FI \$7.25**

The reader is provided with the fundamental information necessary to enable him to make a satisfactory choice from the extensive range of stereo equipment currently on the market. This should aid him in understanding the technical specifications of the equipment he is interested in buying. Full of helpful advice on how to use your stereo system properly so as to realise its potential to the fullest and also on buying your equipment. A Glossary of terms is included.

**BP69: Electronic Games \$7.55**

The author has designed and developed a number of interesting electronic game projects using modern integrated circuits. The book is divided into two sections, one dealing with simple games and the latter dealing with more complex circuits, ideal for both beginner and enthusiast.

**BP70: Transistor Radio Fault-Finding Chart \$2.40**

Author Mr. Chas. Miller has drawn on extensive experience in repairing transistor radios to design this book. The reader should be able to trace most of the common faults quickly using the concise chart.

**BP71: Electronic Household Projects \$7.70**

Some of the most useful and popular electronic construction projects are those that can be used in or around the home. These circuits range from such things as '2 Tone Door Buzzer' and Intercom through Smoke or Gas Detectors to Baby and Freezer Alarms.

**BP72: A Microprocessor Primer \$7.70**

A newcomer tends to be overwhelmed when first confronted with articles or books on microprocessors. In an attempt to give a painless approach to computing, this small book will start by designing a simple computer that is easy to learn and understand. Such ideas as Relative Addressing, Index Registers, etc. will be developed and will be seen as logical progressions rather than arbitrary things to be accepted but not understood.

**BP 73: Remote Control Projects \$8.58**

This book is aimed primarily at the electronics enthusiast who wishes to experiment with remote control and many of the designs are suitable for adaptation to the control of other circuits published elsewhere. Full explanations have been given so that the reader can fully understand how the circuits work and see how to modify them. Not only are Radio control systems considered but also Infra-red, Visible light and Ultrasonic systems as are the use of Logic ICs and Pulse position modulation etc.

**BP74: Electronic Music Projects \$7.70**

Although one of the more recent branches of amateur electronics, electronic music has now become extremely popular and there are many projects which fall into this category, ranging in complexity from a simple guitar effects unit to a sophisticated organ or synthesiser.

The purpose of this book is to provide the constructor with a number of practical circuits for the less complex items of electronic music equipment, including such things as Fuzz Box, Waa/Waa Pedal, Sustain Unit, Reverberation and Phaser-Units, Tremolo Generator etc.

**BP75: Electronic Test Equipment Construction \$7.30**

This book covers in detail the construction of a wide range of test equipment for both the hobbyist and radio amateurs. Included are projects ranging from a FET Amplified Voltmeter and Resistance Bridge to a Field Strength Meter and Heterodyne Frequency Meter.

Not only can the home constructor enjoy building the equipment but the finished project can also be usefully utilised in the furtherance of his hobby. An ideal book for both beginner and advanced enthusiast alike.

**BP76: Power Supply Projects \$7.30**

Power supplies are an essential part of any electronic project.

The purpose of this book is to give a number of power supply designs, including simple unregulated types, fixed voltage regulated types, and variable voltage stabilised types, the latter being primarily intended for use as bench supplies for the electronic workshop. The designs are all low voltage types for use with semiconductor circuits.

There are other types of power supplies and a number are dealt with in the final chapter, including a cassette supply, Nicad battery charger, voltage step up circuit and a simple inverter.

**BP78: PRACTICAL COMPUTER EXPERIMENTS \$7.30**

This book aims to fill in the background to microprocessors by describing typical computer circuits in discrete logic and it is hoped that this will form a useful introduction to devices such as adders, memories, etc. as well as a general source book of logic circuits.

An essential edition to the library of any computer and electronic enthusiast.

**BP79: Radio Control For Beginners \$7.30**

The aim of this book is to act as an introduction to Radio Control for beginners to the hobby. The book will commence by dealing with the conditions that are allowable for such things as frequency and power of transmission. This is followed by a "block" explanation of how control-device and transmitter operate and receiver and actuator(s) produce motion in a model.

Details are then given of actual solid state transmitting equipment that the reader can build. Plain and loaded aerials are then discussed and so is the field-strength meter to help with proper setting up.

The radio receiving equipment is then dealt with, this includes a simple receiver and a crystal controlled superhet. The book ends with electro-mechanical means of obtaining movement of the controls of the model.

**BP80: POPULAR ELECTRONIC CIRCUITS—BOOK 1 \$8.25**

Another book by the very popular author, R. A. Penfold, who has designed and developed a large number of circuits which are accompanied by a short text giving a brief introduction, circuit description and any special notes on construction and setting up that may be necessary.

The circuits are grouped under the following headings: Audio Circuits, Radio Circuits, Test Gear Circuits, Music Project Circuits, Household Projects, and Miscellaneous Circuits.

An extremely useful book for all electronic hobbyists, offering remarkable value for the number of designs it contains.

**NO.213: Electronic Circuits For Model Railways \$4.50**

The reader is given constructional details of how to build a simple model train controller: controller with simulated inertia and a high power controller. A signal system and lighting for model trains is discussed as is the suppression of RF interference from model railways. The construction of an electronic steam whistle and a model train chuffer is also covered.

**NO.215: Shortwave Circuits & Gear For Experimenters & Radio Hams \$3.70**

Covers constructional details of a number of projects for the shortwave enthusiast and radio "Ham". Included are: an add-in crystal filter, adding an "S" meter in your receiver, crystal locked H.F. Receiver, AM tuner using phase locked loop converter for 2MHz to 6MHz, 40 to 800MHz RF amplifier, Aerials for the 52, 144MHz bands, Solid State Crystal Frequency Calibrator, etc.

**NO.221: Tested Transistor Projects \$5.50**

Author Mr. Richard Torrens has used his experience as an electronics development engineer to design, develop, build and test the many useful and interesting circuits in this book. Contains new and innovative circuits as well as some which may bear resemblance to familiar designs.

**NO. 223: 50 Projects Using IC CA3130 \$5.50**

In this book, the author has designed and developed a number of interesting and useful projects using the CA3130, one of the more advanced operational amplifiers that is available to the home constructor. Five general categories are covered: Audio Projects, R.F. Projects, Test Equipment, Household Projects and Miscellaneous Projects.

**NO.224: 50 CMOS IC Projects \$4.25**

CMOS IC's are suitable for an extraordinary wide range of applications and are now also some of the most inexpensive and easily available types of ICs. The author has designed and developed a number of interesting and useful projects. The four general categories discussed in the book are: Multivibrators, Amplifiers and Oscillators, Trigger Devices and Special Devices.

**ALL PRICES INCLUDE POSTAGE & HANDLING**

**These books are specially imported from England by us. If someone has already used the form in this issue, please write to: ETI Magazine, Unit 6, 25 Overlea Boulevard, Toronto, Ontario M4H 1B1.**

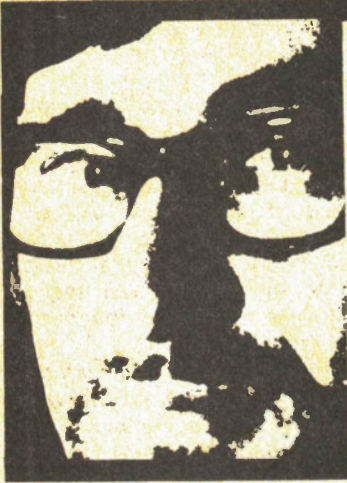

# Audio Today

What does slew rate limiting mean? Wally Parsons explains.

LAST MONTH in the letters section of *Audio Today*, your usually kind and gentle Scribe chastised a not so gentle reader over a rather acerbic letter which dealt, among other things, with T.I.M., slew rates and deep-sounding stuff like that.

Buzz-words, the latest ongoing breakthrough in high-fiddly-dum.

Generally speaking, buzz-words gain currency as a result of their improper or excessive use by advertising types, salesmen, journalists, TV commentators, and the like, in a vain attempt to make the comprehensible incomprehensible, then convert it into something as simple as the mind of a politician.

Such words abound: interface, oppression, racist, to mention a few in the areas of socio-politics; inflation, productivity, in the economic fields.

And in audio we hear about phase coherence, phase linearity, time windows, time alignment, rise time, Transient Intermodulation Distortion (T.I.M.), Slewing Induced Distortion (S.I.D.), slew rate, scanning windows. You name it.

I suppose the next term we hear will be Dynamic Tension. And if you don't know what that is, check the back covers of old comic books.

## Slewing Along

Webster defines "slew" (sometimes spelled "slue") as being originally a nautical term meaning to swing or turn around a fixed point or pivot. As a noun, it's also described as "a wet place, presumably the abode of so many people who throw the term around indiscriminately.

When applied to amplifiers, slewing can be described as a change in output voltage from a zero reference in res-

ponse to a step change in input voltage. The *slew rate limit* (a more accurate term than simply "slew rate") is the maximum rate of change of the amplifier's output voltage. If electrons travelled through semiconductors at an infinite rate of speed, and there were no time delays elsewhere in the circuit, then any amplifier would have an infinite slew rate.

But in the real world nothing is ever simple, except wishful thinking. Electrons do have a finite transit time, and transistors and interelectrode wiring (including etched conductors in Integrated Circuits) have capacitances, resulting in time delays which also produce phase shift.

Real world transistors also have non-linear transfer characteristics, resulting in distortion, so to correct this we use feedback around all or part of a circuit.

The phase shifts which result from the aforementioned capacitances can also cause instability under certain conditions of feedback, conditions which, in strict accordance with Murphy's Law, correspond to conditions usually encountered in audio design.

To compensate for this a compensation capacitor is invariably used within the feedback loop, usually in the forward gain portion, and the greater the feedback, with its attendant lower gain, the larger the capacitance.

The time required to charge and discharge this capacitor and the fact that there is only a finite amount of charging current available results in a delay in the rate of output change in response to an input step.

## Slewing Rate

In simple terms, we've seen that slew rate could be described as the maximum

possible rate of change in output in a given period of time. The degree of change is expressed in Volts and the time in microseconds, giving us "Volts per microsecond" or V/us.

Thus, the ever popular type  $\mu$ A741 can slew 0.5V/us, while an LM318 can slew 50 V/us. This does *not* mean that the  $\mu$ A741 can only put out 0.5V or that the LM318 can deliver 50V. This is determined by other factors in the design. What it does mean is that if the device had unlimited output capability, the output would swing to this level in one microsecond if the input were pulsed with a signal with an infinitely fast rise time.

It also means that if an input signal has a slope which exceeds this rate, the output will not follow it.

## Signal Characteristics

If a sine wave of 1kHz is applied to the input, the input voltage will rise to a positive maximum, fall to zero, rise to a negative maximum, fall back to zero, that is, complete one full cycle, in 1/1000th of a second, or one thousand microseconds. The output will have to follow the first quarter cycle in 250us, and each subsequent quarter cycle in the same time.

Let us suppose that an amplifier has a slew rate limit of 1V/us. Given unlimited output capability, such an amplifier would be able to deliver 250V in 250us. Thus, such an amplifier could be able to deliver its full output at 1kHz.

At 10kHz, the first quarter cycle would take 25us, so 25V would be the maximum possible output, due to slew rate limit.

At 100kHz, the quarter cycle time is 2.5us, for a 2.5V slew limited maxi-

Voltage Follower Pulse Response

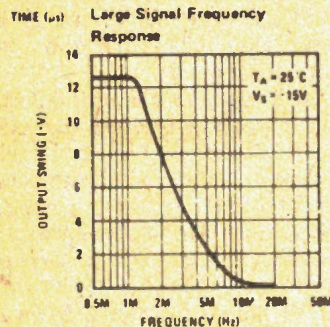
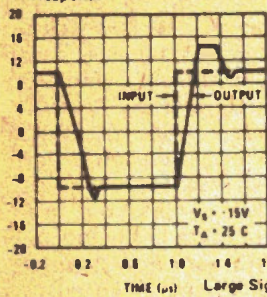

Fig. 1. a) An example of slew rate limiting. This figure shows what a typical op amp (LM 118) does to a square wave. b) Graph of an LM 118 large signal response versus frequency.

mum.

If our maximum output is specified at 2.5V then our power bandwidth is 100kHz, assuming adequate current to deliver specified power at the rated load. This is true for both power and voltage amplifiers.

If we were to double the slew rate we could double the maximum slew limited voltage at any given frequency, or double the power bandwidth for a given output rating.

If our maximum output at low frequencies is set at 10V due to supply voltage and amplifier characteristics, and we wish to maintain this capability to 50kHz, then our quarter cycle time is 5 $\mu$ s. Our output would have to swing 10V in 5 $\mu$ s, or 2V in 1 $\mu$ s, for a required slew rate of 2V/ $\mu$ s.

If this were a power amplifier, 10V output into 8 Ohms would give us 12.5W

A 50W amplifier would deliver 20V, and with a slew rate of 2V/ $\mu$ s, power bandwidth would reduce to 25kHz. To retain the full 50kHz power bandwidth would require a slew rate of 4V/ $\mu$ s.

In other words the power bandwidth varies inversely as the maximum output voltages, or the root of the power output.

For a given power bandwidth, the slew rate required varies directly as the maximum output voltage, or the root of the output power.

These are parameters which can be traded off, a fact which is used to good advantage by circuit designers. And

failure to understand this gives rise to much misunderstanding by the uninformed.

Complex Signals

So far, we have only considered slew rate in terms of the amplifier's ability to handle single sine waves.

But music and speech consist of complex wave forms whose wave fronts may be very steep.

Since we are primarily concerned with the handling of the rising wave front, it's convenient and quite proper to consider this situation by examining the rising front of a square wave. Although a perfect square wave would have an instantaneous rise time, corresponding to a step response, real square signals consist of a multiplicity of sine waves, and in the real world a square wave is considered to be adequately passed by an amplifier whose bandwidth is equal to ten times the fundamental frequency of the square wave. Thus, to handle a square wave of 10kHz would require a band-

width of 100 kHz, and to pass that square wave essentially unaltered would require a full power bandwidth of 100kHz. If full power is some high value, say 200W the slew rate would have to be quite fast, namely 16V/ $\mu$ s.

This assumes full output will in fact be demanded, but we know that the real requirements of music are such that we are not likely to demand full output of a 10kHz square wave.

More than likely our demands would be at least 20dB down from this value, if any of the analysis conducted over the years have validity. Lowering our demands by 20dB means a 10:1 reduction in voltage, and slew rate, so our requirements are no more than 1.6V/ $\mu$ s.

These figures are in line with the findings of many designers, including Peter Walker, of Quad Acoustical.

Slew rate has an effect on other characteristics than power bandwidth, which we shall consider next month. The point is, it is only one factor in a whole fistful of trade-offs.

And that's not so simple.

# Audio Today Letters

Re your comments in Audio Today Letters (Oct. '80) in respect of a speaker construction project:

I would like to see a project that would fulfill the following points:

It could be any design that would produce a high quality speaker for hi-fi use, to handle, say 100W (should satisfy most people).

Use readily available drivers, perhaps De Forest, which are reasonably priced, if they are of high enough quality. This would have to be left up to you.

The finished speaker should show good value for money. Most people able to build a speaker resent paying perhaps double the cost of the materials, for a finished speaker.

Hope I haven't confused the issue more. Speakers are my next purchase.

A F C, Niagara-On-the-Lake, Ont.

Just thought I'd write with some feedback on speaker projects. I wouldn't mind seeing a satellite/subwoofer system, perhaps organized in the following stages, to allow for different needs and ambitions.

1) Ported satellite design, with a useful response similar to or better than the available minispeakers.

2) Electronic assistance for above, on Thiele B6 alignment basis, to introduce concept and improve response further; eg., parameters easy to change to accommodate later project.

3) Subwoofer design, with passive/active alternates. Also necessary alternatives to satellites, for mid/high use.

4) Electronic crossover design for active design of subwoofer, fitting in with the use of electronic assistance and trusty 60W, low TID design amp.

Also, an overview of ported speaker theory, to give some good grounding and stimulate experiment.

Hope that this is helpful. I like your articles, especially your recent ideas on dynamic range. Thanks.

J G, Toronto, Ont.

I write again to request a speaker project (and maybe a permanent column) on speaker building. The system you were talking about in July '78 sounded interesting.

One question I do have is, what is the

efficiency of a Transmission Line speaker system? I ask, partially because I am considering the NAD 3020 Integrated Amp. Its power is only forty watts, but rave reviews, especially in *The Audio Critic* make it look like a very good deal.

Some speakers I have been considering are from Itone Audio. Their high efficiency, low distortion, and low bass cut-off make them look pretty good. There did seem to be a possibility that they were more like Disco speakers, but the near rave review in the May '80 *Audio* has nearly laid that worry to rest. What's your opinion?

By the way, I think you should put in a plug for the ORACLE turntable. After all, it is a Canadian company, and it did receive the CLASS ONE rating from *International Audio Review*.

On the subject of Canadian Audio Manufacturers, is anyone producing your Transmission Line speakers yet?

I will close by saying, thanks for your time, and keep up the great work.

Greg Erker, Address Unknown

Thanks, guys. I knew you were out there.

We have a speaker project on hand, developed in Australia, which, in my opinion, fulfills the requirement of being of good quality, and although not state of the art, of reasonable cost, which can be built from readily available parts by someone with reasonable cabinetry skills and tools.

I agree that a skilled constructor might resent paying high prices for what is really a simple well established design which he could easily duplicate. And most speakers on the market fit this description, even though there are some notable exceptions.

At the present time, the project is undergoing modification to suit Canadian parts availability, and a series of optional modifications which the builder may incorporate or not as he sees fit.

As to the satellite, etc., idea, as it happens I have plans for such a system myself which will be built after I get the new woodworking shop together, probably next spring. At present I'm building a listening room with non-parallel sound-proof walls, and internal damping, partly to prove that good acoustic design can also yield an aesthetically pleasing decor.

However, rather than a ported design, I have something else in mind which doesn't correspond to anything currently in use. On paper it looks good and preliminary tests are promising.

However, to suggest making all the parameters of a B6 alignment variable is terrifying. Do you know what you're asking, lad! Surely it must be the sudden chill of October cooling the brain too

rapidly which prompts such an idea.

Anyway, electronic assistance is appropriate only for 5th order and higher alignments, and is an integral part of the alignment, not an attempt to make it better. With a B6 alignment it allows extended bass, high mid-range efficiency, and smallish box, but demands high power from the woofer amplifier.

However, something on reflex design might be a good idea. I must admit that, outside of professional journals and an article in the August 1975 issue of *Audio*, I haven't seen anything particularly memorable on the subject.

Efficiency is not a function of the system alone, but largely magnet, voice coil, cone mass, which are related to the design. Most transmission line speakers are very insensitive. Most such speakers are also badly designed. A good design is capable of delivering the efficiency of an air suspension system with a high resonance frequency, only retaining the extended bass response. It's a matter of

balancing the electrical and mechanical Q of the driver with that of the line. Most designers seem concerned only with the total Q of the driver, ignoring its components. For moderate levels, 40 Watts can be quite adequate, although I like dynamic range, which means power.

As for the Itones, I share your misgivings, just as Bert Whyte did before he wrote the review you sent me. Remember, they were auditioned at an audio show, and might perform differently under home conditions.

I'd be glad to mention ORACLE but I hear they're getting orders so fast they're several hundred units behind. And it doesn't need a boost because it's Canadian, but because it's good. Period.

No, no one is manufacturing my speakers. I may try marketing on a custom order basis. If you want to buy a pair, or have some capital to invest, Greg, send me your address and I'll get back to you.

Adios, amigos!

## Audio Today Products

### Power Kits

Designed primarily for use with musical instruments, Celestion has made available a set of plans for use with their Power Range loudspeakers.

There are seven systems in all for use with different woofers, but what sets these systems apart from other such endeavours is that, instead of giving dimensions for sealed boxes for use with several superficially similar drivers, each system is designed in conjunction with a specific Celestion driver in a specific Thiele alignment. As a result, unless you know how to use these alignments, you can't mix and match. On the other hand, the approach promises optimum system performance.

These kits are not for people who think that manufacturers who think that published plans are merely guides, to be used as a point of departure.

Also they are for musical instrument use, not high fidelity reproduction. They are sensitive, high power units which, in the home, could probably serve double duty in demolition work.

Contact Rocelco at 1669 Flint Road, Downsview, Ontario M3J 2J7. Phone: 1-416-663-5302.





**SHARP POCKET COMPUTER**

- Programs in BASIC
- 24 character alphanumeric display
- 1424 steps, 26 memories
- Reservable and definable keys
- Optional cassette interface to store programs or data
- 1 year warranty, extensive documentation (3 manuals)



Only . . . . . \$289.

**COMMODORE PET COMPUTERS**

- 8K . . . . \$1195.00 Full keyboard.
- 16K . . . . \$1495.00 Separate numeric keypad - 25 lines
- 32K . . . . \$1795.00 of 40 characters.

- Memorex 5 1/4" Diskettes . . . 10 for \$49.95
- Memorex C-10 Cassettes . . . . \$1 each
- PET Personal Computer Guide . . . \$19.95
- Library of PET Subroutines . . . . \$24.95
- BSR System X-10 Home Control System for lighting and appliances. No special wiring needed. Starter Kit . . . \$139.95 (Includes 1 command module, 1 appliance module, 2 lamp modules)

**Scientific SHARP PRODUCTS**

- programmable (Model EL5813) . . \$59.95
- Metric Converter . . . . . \$25.95
- Sharp Talking Clock (Pocket size, digital, alarm/timer/stopwatch) . . \$99.00

We also carry Apple Computers, VCRs, video cassettes, and a vast array of other innovative products. Write or call for our **FREE CATALOGUE**. Or come in & see us.

Send Money Order, Charge, Master Charge. Include expiry date, card number bank name and signature. Add 5% for shipping (excess refunded). Ontario residents add 7% sales tax. All prices subject to change.

**ELECTRONICS 2001**

5529 Yonge St. (just south of Finch)  
Willowdale, Ontario M2N 5S3  
(416) 223-8400

Circle No. 29 on Reader Service Card.

**NORTH AMERICAN ELECTRONICS EST. 1949**

AMIDON TOROIDAL CORES, FERRITE BEADS AND RODS, POT CORES, J.W. MILLER R.F. CHOKES, COIL FORMS, OSCILLATOR COILS, TRANSISTOR I.F.s, HASH FILTER CHOKES, MAGNET WIRE, XCELITE HAND TOOLS, WELLER SOLDERING EQUIPMENT, KESTER SOLDER, BARKER & WILLIAMSON AIR COILS, R.F. SWITCHES, ANTENNA CONNECTORS, ELECTRONIC HARDWARE, WIRE AND CABLE, RADIO TUBES, SWITCHES, AND MORE.

Our 44 page 1981 catalogue, No. 18, is now being sent, free of charge. **WRITE** for it, or **CALL** us.

**NORAMEL CO. LTD.,**  
2407, STE. CATHERINE ST. E.,  
MONTREAL, QUE., H2K 2J7.  
(514) 522-8422

Circle No. 21 on Reader Service Card.

**W**hen you're making **W**out your will, you should provide, first and foremost, for your loved ones and friends. But after they're looked after, then what?

We ask you to consider leaving something to the Canadian Cancer Society.

Why? Simply, because we need it.

The funds we receive from our annual fund-raising campaign cover only approximately two-thirds of the money we are committed to spend. The rest comes from bequests, and other kinds of special gifts.

Please help us find the light at the end of the tunnel by inserting this one small sentence in your will: "I give to the Canadian Cancer Society the residue of my estate."

You will be leaving the rest to us.

Canadian Cancer Society

**CAN CANCER BE BEATEN? YOU BET YOUR LIFE IT CAN.**

**LEAVE IT TO US TO BEAT CANCER.**

**You've heard OAKTRON**



**... more than you've heard of OAKTRON**

If you've heard a lead guitar lately, ringing out a string of clear, crisp notes - or a concert organ thundering a thousand voices, you may have been hearing Oaktron loudspeakers.

Oaktron has made speakers for some of the leading names in the musical instrument field - and the Hi-Fi field. And any field where clear sound is important.

Over the past 25 years, you may have heard more Oaktron speakers than any other brand. You've heard Oaktron in studios, theaters, discos, and homes of the Hi-Fi pros. From steel mill to ballet stage, you've heard Oaktron. And you've liked what you've heard.

We'd like you to get to know our speakers. Call us for the name of your nearest dealer or drop in and hear them at:

Oaktron's M18Y2 Lead & Rhythm Speaker, 175 watts RMS.



Ask for Oaktron's speaker catalogue by circling the Reader Service Card number or by writing to:

Represented in Canada by:

**omnitronix ltd.**  
UNIT 7, 6295 SHAWSON DRIVE  
MISSISSAUGA, ONT. L5T 1H4  
TEL: (416) 678-7170

2056 TRANS CANADA HWY.  
DORVAL, QUE. H9P 2N4  
TEL: (514) 683-6993

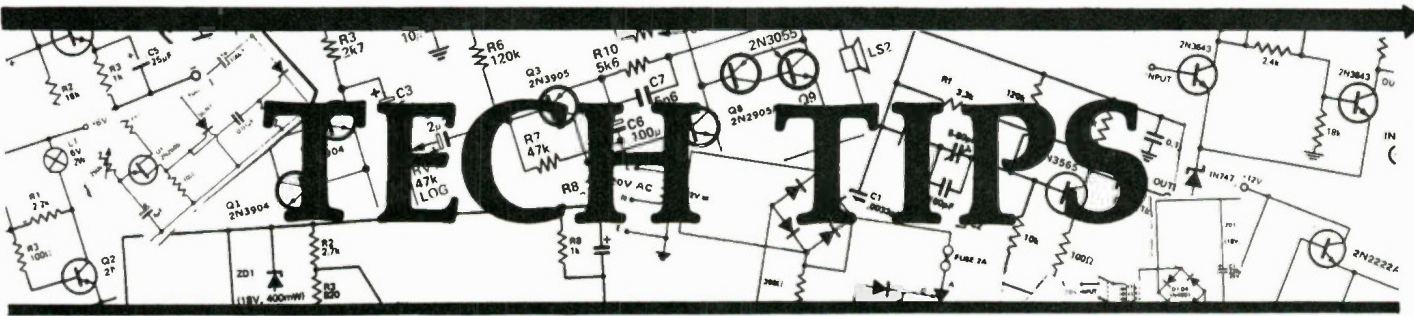

### Simple 2708 EPROM Programmer Elmer Bulman

This circuit will allow you to program 1K X 8 2708 EPROM. Contrary to what it appears to suggest in the spec sheets, you do not have to run through the full 1K during programming. Simply tie address 8 and 9 to the map location of your choice. This will conveniently allow you to program 256 bytes in one run. The procedure is to serial in your address to the address register then serial in your data to the data register. IC1a gating prevents clocking the address register while entering data. Once address and data are established strobe the programming pin as per specs. I suggest for your first attempt that you do a number of dry runs and scope each pin to check for obvious errors. If a mistake does occur, correct the fault(s) and move to a new map location. You have four chances before you will have to erase.

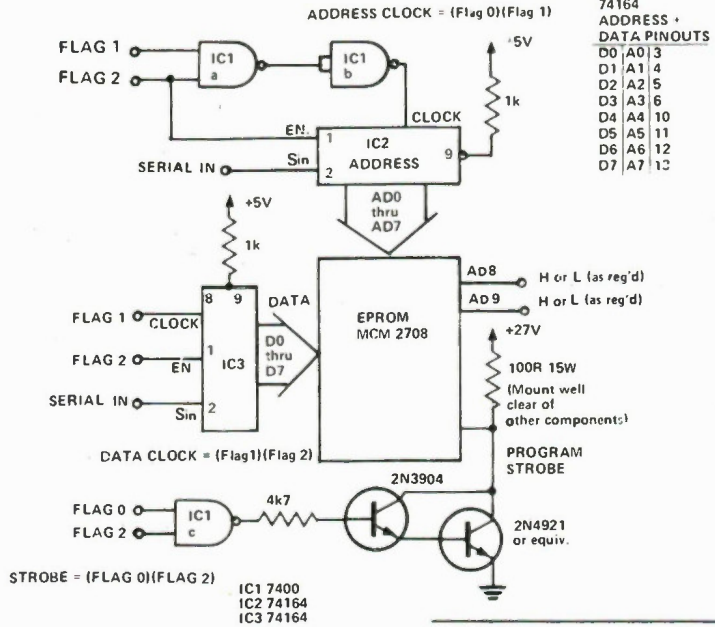

### Windshield Wiper Delay Grant Wood

This circuit works great on misty days. IC1 is wired as a monostable oscillator. C1 charges through RV1, R2 and D2, until the charge reaches two-thirds of the supply voltage, then IC1 switches and C1 discharges through D1 and R1 to pin 7. While C1 discharges, pin 3 is low and RL1 is operated. Pin 3 stays low long enough for the windshield wipers to cycle 3 times. The time between relay operations is controlled by RV1 and ranges from 15 seconds to 2 minutes. SW1 is used for continuous wiper operation. The contacts of RL1 can be wired in parallel with the car's wiper switch. The relay contacts should be rated to handle the motor current.

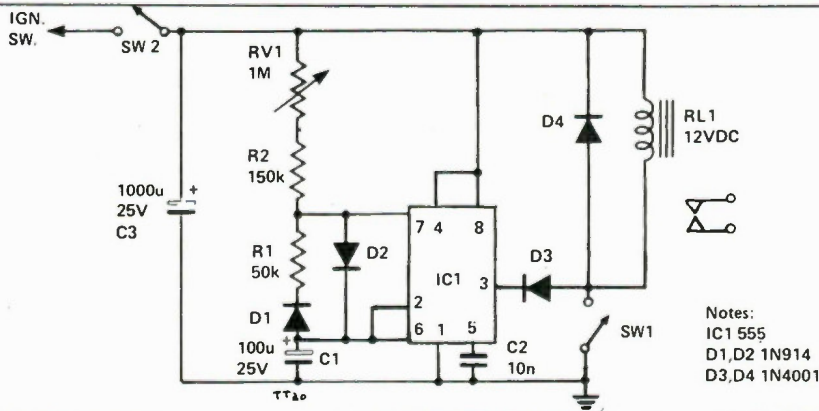

### Relay Power Saver L. Goodfriend

When power is at a premium (usually in battery circuits), this circuit can be used to save 20% or more of the power used by a relay.

Since the pull-in voltage of a relay is several volts more than its drop-out voltage, there will be no noticeable effect if a resistor is switched into circuit when the relay pulls in. This is very simple to achieve. Any contact which carries the coil voltage of the relay can be used to bypass current

limit resistor R1 until the relay is energised. When power is applied to the relay, all the necessary current flows through this contact, but when the relay pulls in, the current has to flow through R1, which reduces the power drain.

The value of R1 must be determined by experimentation; try about a quarter to a fifth of the relay's coil resistance. Bear in mind that the on-load voltage of a battery decreases with use, so while a resistor may seem to be suitable with a new battery, the relay may start to drop out when the battery ages.

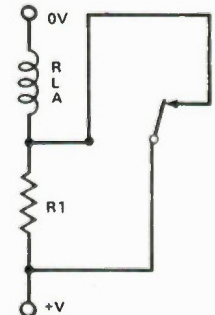

# The Best Scope Buys Available!

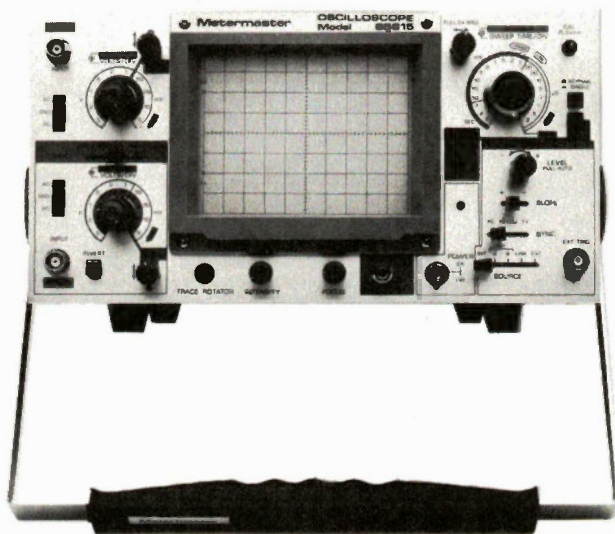

## Introducing...

Metermaster's NEW  
40MHz Dual Trace  
Oscilloscope.

### Model 65615

Featuring an Extremely  
Bright CRT Display  
(15KV acceleration voltage).

only **\$1395.**  
F.S.T. INCLUDED

#### FEATURES INCLUDE:

- Internal Graticuled 5" CRT.
- Full 40MHz Bandwidth at -3dB.
- 5mV Vertical Sensitivity for the full bandwidth, expandable to 1mV/div. utilizing the X5 Gain Multiplier below 10MHz.
- Trace Rotator.

#### PLUS:

- 50 nsec delay for viewing pre-trigger data.
- X5 Sweep Magnification.
- Supplied with AC Line Cord and an Operations and Maintenance Manual.

**Accessories:** Probes (extra).

## Look...

At the features  
of these 15MHz  
Oscilloscopes

**\$695. each**  
F.S.T. INCLUDED

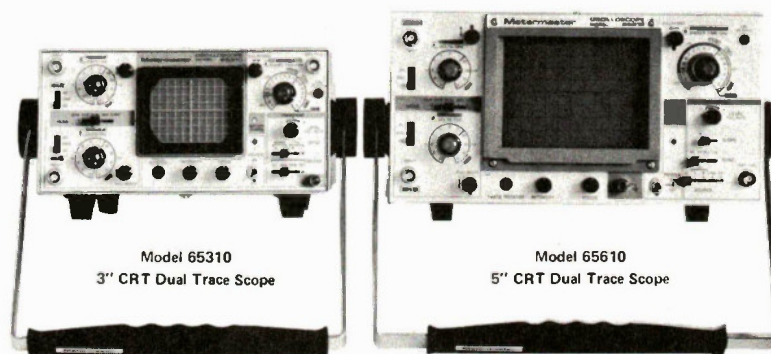

Model 65310  
3" CRT Dual Trace Scope

Model 65610  
5" CRT Dual Trace Scope

- Model 65310:**
- Operates from 3 Power Sources
    1. Rechargeable Ni Cad Batteries.
    2. 120 VAC Line (also charges batteries).
    3. 11 - 30 VDC.
  - Fully Automatic Triggering.
  - Bandwidth DC - 15MHz (-3dB).
  - Trace Rotator.
  - 2mV Vertical Sensitivity.

Accessories: Vinyl carrying case, probes (extra).

- Model 65610:**
- Operates from 2 Power Sources
    1. 120 VAC Line.
    2. 11.5 - 30 VDC.
  - Fully Automatic Triggering.
  - Bandwidth DC - 15MHz (-3dB).
  - Trace Rotator.
  - HF Rejection.
  - 5mV Vertical Sensitivity.

Accessories: Probes (extra).



**Metermaster**  
**R.H. NICHOLS**

All prices F.O.B.  
Downsview, Ontario  
subject to change with-  
out notice. P.S.T. extra  
where applicable.

TORONTO (416)661-3190 • MONTREAL (514)337-0425 • EDMONTON (403)432-7746 • OTTAWA (613)238-7007

Circle No. 4 on Reader Service Card



# INTERACT COMPUTER 16K LEVEL II



Just  
**\$595.**

Write for our  
flyer on Interact  
Computer

A powerful microcomputer with a full standard 53 key typewriter style keyboard and built-in cassette recorder for use in entering and storing programs. Utilizing the versatile Intel 8080A microprocessor, the Interact computer has 16K of RAM and 2K of ROM at its disposal. Output is in color on your own TV screen. Sound is also generated through your TV set and can consist of exhilarating computer beeps or two full octaves of music. This is truly a powerful computer capable of developing and handling a variety of programs, and with available software provides true educational stimulus (examples: Star Track, Chess, Concentration, etc.). The Interact computer offers the ideal opportunity to learn BASIC, the most popular computer language for small business and hobbyists, and with the use of the 84 page manual, you learn at your own pace.

**INSTALLATION:** Attach to antenna terminals of your color TV set and plug into 120 VAC wall outlet. Computer includes built-in RF modulator, FCC approved and UL and CSA listed.

**PROGRAMING:** Most Micro-computers start you off with an abbreviated 4K BASIC, and then later you have to relearn the more powerful language. Since this computer has 16K of RAM, we start you with Level II Microsoft 4.7 BASIC. BASIC is the most popular Micro-computer language using commands that are words we are ordinarily used to: such as, PRINT, NEW, GOTO (For go to), END, COLOR, JOY, INPUT, etc. To help you learn programming we have included an 84 page instruction manual, plus a 20 page book of program examples.

**Educational and Entertaining**

# POCKET ASCII TERMINAL

MIDGET  
DUPLEX UNIT  
WITH MAN-SIZED  
CAPABILITIES

Here's \$\$\$\$ worth of convenience for anyone working with digital systems. Carry it anywhere in a pocket, valise or toolkit to enter and retrieve data, run diagnostics, change constants, test data links, etc.



Look at its facilities:

- Transmits 128 ASCII codes
- Can display last 30 characters received
- Displays full 64-character ASCII set on clear 16-segment LEDs
- 25-line RS232/c compatible interface
- Single 5V supply required at 400mA typical
- 110 or 300 baud transmission selectable
- Parity codes, stop bits settable to your standard
- Obeys bell, cursor and data format control codes

For more information call or write to:  
**TRACKER INDUSTRIES LTD.**  
P.O. Box 1094 Stn. "A"  
Toronto, Ontario M5W 1G6 CANADA  
tel.: (416) 364-2943 or 762-8744  
telex: 06-22816

Circle No. 3 on Reader Service Card.

# ORION

Electronic Supplies Inc.

ELECTRONIC DISTRIBUTOR

INDUSTRIAL — EDUCATIONAL — COMMERCIAL — HOBBYIST

RCA

COSMAC

VIP

Authorized distributor for RCA, COSMAC VIP

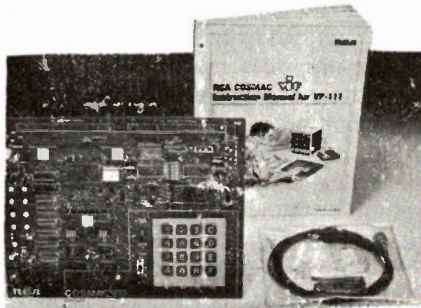

New! VP 111  
Microcomputer... **\$129.50**

- Features:
- RCA 1802 Microprocessor.
  - 1K Bytes static RAM.
  - Expandable on-board to 4K.
  - Expandable to 32K Bytes total.
  - 512 Byte ROM operating system.
  - CHIP 8 interpretive language or machine language programmable.
  - Hexadecimal keypad.
  - Audio tone generator.
  - Single 5-volt operation.

Assembled\* and tested.

- Video output to monitor or modulator.
  - Cassette interface—100 Bytes/sec.
  - Instruction Manual with 5 video game listings, schematics, CHIP-8, much more.
- Ideal for low-cost control applications.  
Expandable to full VIP capability with VP-114 Kit.  
\*User need only connect cables (included), a 5-volt power supply, and speaker.

## START WITH ORION FOR A NEW ERA IN THE WORLD OF ELECTRONICS

We have the most complete selection  
of electronic components.

Full line of TTL, CMOS, Linear,  
ICs, Computer Interface, Support Chips  
and CPUs.

## SIEMENS

### DISK DRIVE ★SALE★

FDD 100-5 Single 5"	.....	\$425.75
FDD 200-5 Double 5"	.....	\$597.75
FDD 100-8 Single 8"	.....	\$649.75
FDD 200-8 Double 8"	.....	\$1175.75

Visa/Master Charge add 3%  
 Please send more information on  
Siemens disk drives.

## AP Products

The all-new line of ACE

All-Circuit Evaluators  
WITH POWER

POWERACE 103

Triple-output power supply for prototyping both linear and digital circuits.

**\$159.00**

POWERACE 101

The general purpose model for prototyping all types of circuits.

**\$107.93**

POWERACE 102

The complete digital prototyping lab with FREE logic probe built in!

**\$159.00**

Orion Electronic Supplies Inc.

40 Lancaster Street West  
Kitchener, Ontario N2H 4S9  
(519) 576-9902

Master Charge & Visa, COD, Cheque,  
Money Orders accepted. CODs, shipping  
& insurance extra. Write for our FREE  
catalogue!

Circle No. 20 on Reader Service Card.

lets you create and  
play video games and  
generate graphics !!!!!

- Easy to operate
- Easy to program
- A challenge for the serious hobbyist
- AND it's Expandable !!!

VIP-Hobby Computer: An assembled micro-computer. Built-in cassette interface, video interface, 16-key keypad, 2K RAM, ROM operating system, CHIP-8 language and power supply. Output drives video monitor or TV modulator.  
VP-711 (COP185711) .....

**\$259.75**

VP Color Board Displays VIP output in color! Program control of four background colors and eight foreground colors. CHIP-8X language adds color commands. Includes two sockets for VP-580 Expansion Keyboards  
VIP-590 .....

**\$94.75**



MUSIC



VP-595 .....

VIP Simple Sound Board Provides 256 different frequencies in place of VIP single-tone output. Ideal for use with VP-590 Color Board for simultaneous color and sound. Great for simple music or sound effects! Includes speaker.  
VP-595 .....

**\$39.75**



VIP Super Sound Board Turn your VIP into a music synthesizer! Provides two independent sound channels. Frequency, duration and amplitude envelope (voice) of each channel under program control. On-board tempo control. Provision for multi-track recording or saving VIPs. Output drives audio preamp. Does not permit simultaneous video display.  
VP-550 .....

**\$67.50**

VIP Super Sound 4-Channel Expander: Package VP-551 provides four (4) independent sound channels with frequency duration and amplitude envelope for each channel. Package includes modified VP-550 super sound board, VP-578 two board expander, data cassette with 4-channel PIN-8 program, and instruction manual. Requires 4K RAM system and your VP-550 Super Sound Board.  
VP-551 .....

**\$99.75**



VIP Expansion Keyboard Adds two-player interactive game capability. 16-key keypad with cable. Connects to sockets provided on VP-590 Color Board or VP-585 Keyboard Interface Board.  
VP-580 .....

**\$27.98**



VIP Keyboard Interface Board Interfaces two VP-580 Expansion Keyboards directly to the VIP. Not required when VP-590 Color Board is used.  
VP-585 .....

**\$22.50**



VIP Memory Expansion Board Plug-in 4K static RAM memory. Jumper locates RAM in any 4K block in first 32K of VIP memory space.  
VP-570 .....

**\$128.70**



ASCII Keyboard Fully encoded, 128-character ASCII alphanumeric keyboard. 58 light touch keys (2 user defined). Selectable "Upper-Case-Only".  
VP-601 .....

**\$99.75**



ASCII/Numeric Keyboard ASCII Keyboard identical to VP-601 plus 16 key numeric entry keyboard for easier entry of numbers.  
VP-611 .....

**\$129.95**

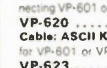

Cable: ASCII Keyboards to VP-711 Flat ribbon cable, 24 in. length, for connecting VP-601 or VP-611 and VP-711. Includes matching connector on both ends.  
VP-620 .....

**\$27.50**



Cable: ASCII Keyboards Flat ribbon cable, 36 in. length with mating connector for VP-601 or VP-611 Keyboards. Other end is terminated.  
VP-623 .....

**\$27.50**

# CLASSIFIED ADVERTISING

ETI's classified advertising section allows you to reach 30,000 Canadian readers nation-wide. For as little as \$15 (there's a 20 word min.) you can promote your business from coast to coast.

## WHAT DO YOU DO?

Send us your typewritten or clearly printed words, your permanent address and telephone number, and your money (no cash please). Make your cheque or money order payable to 'ETI Magazine'. We're

at Unit 6, 25 Overlea Blvd., Toronto, Ontario. M4H 1B1

## WHAT DO WE DO?

We typeset your words (and put the first word and your company name in BOLD capital letters). If we get your message by the 14th of the month, it will appear in ETI 1½ months later. For example if we receive it by October 14th you (and thousands more) will see it in the December issue.

**LOW-PRICED**, high quality ETI Project Boards. Glass epoxy, drilled, tinned, guaranteed. Inquire about our low-cost TRS-80 (TM) printer interface. For latest flyer send stamp to: K.S.K. ASSOCIATES, P.O. Box 54, Morriston, Ontario. N0B 2C0

**RECEIVING TUBES.** Radio & TV. Large quantity, brand new, original boxes, RCA, WE, Crossley etc. \$2 each while they last. Send your requirements to WOLVERTON ENTERPRISES, 5, South Hythe, Burnaby, BC, V5B 3H6

**INTERNATIONAL Electronics Components Exhibition, Paris, France, 3rd to 11th Apr'81.** Attend or participate. Establish Import/Export contacts around the World. Take your Family and make it a Business and Pleasure trip. For details contact VIAIR TRAVEL SERVICE (The Travel Experts), 2020 Eglinton Avenue West, Toronto, Ont., M6E 2K3. Phone (416) 783-6141.

## POWER TO THE PEOPLE

Continued from page 25.

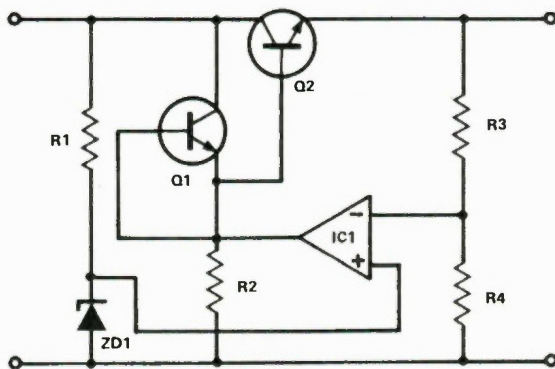

Fig. 7. A series stabiliser circuit using an operational amplifier.

12 V will drop as more current is passed, and when the unstabilised voltage becomes too low there is not enough voltage across the two transistors to keep current flowing. A second problem concerns the IC which must be a type which permits the input and output voltages to rise close to the supply voltage — the popular 741 does not do this. The third problem is that if the reservoir capacitor of the unstabilised circuit is too small, all the stabilisers in the world will not prevent ripple from appearing on the output voltage.

One final headache arises when a stabiliser works too

**J&J ELECTRONICS LTD.,** P.O. Box 1437E, Winnipeg, Manitoba R3C 2Z4. Surplus Semiconductor Specialists. Do you get our bargain flyer? Send \$1.00 to receive the current literature and specials and to be placed on the mailing list for future publications.

**PRINTED CIRCUIT BOARDS** for your favourite projects. C.D. Ignition - \$5.75; Digital Freq. Meter - \$7.50; Coin Toss - \$2.85; Digital Test Meter "A" - \$5.25; DTM "B" - \$5.85; DTM Switch Board \$3.10; RIAA Preamp -\$1.50; Survival Game -\$3.60; Guitar Practice Amp. -\$10.15; I.R. System-Receiver-\$3.25; Decoder-\$3.70; Remote Control-\$2.35; Power Supply-\$1.25 We have all Boards for Summer '80 Special Projects and Canadian Projects Book 2. Full list free. Send Cheque, Money Order or C.O.D.. Post and Pack 50¢. B & R ELECTRONICS, Box 6326F, Hamilton, Ontario. L9C 6L9.

sale! Z89/48k \$2995.00; H14 Printer \$899.00; Z87 Dual Discs \$1349.00. JRT, 80 Empire, London, NSY 1G7, (519) 451-3154

**SUPERBOARD** Machine utilities software. Disassembler, memory block move and auto-load cassette loader. Tape \$13.95. Richard van Nus. Box 9, 100 Mile House B.C. V0K 2E0

**NEW STORE! Hobbyist. Parts. Speakers. Kits. Equipment.** GENERAL ELECTRONICS, 5511 Yonge St., Willowdale, Ont. M2N 5S3, 221-6174. Please write for free catalogue. Monday, Friday, Saturday: 10:00 AM - 6:00 PM. Tuesday, Wednesday, Thursday: 10:00 AM - 8:00 PM

**COMPLETE Electronic Hobby Services.** Custom kits, circuits, technical writing, special parts, original designs. Free information. **TEKNIKIT ASSOCIATES** 301 Flora Street, Carleton Place, Ontario K7C 3M8.

**SEMI & KITS.** 1. 168W Leach power amplifier kit \$214. / 2. 80W Playmaster amplifier kit \$169. / 3. MJ15003, 15004 \$9.00 per pair. / 4. MJ502, 4502 \$8.00 per pair. Send \$1.00 for our catalogue add 5% for shipping. **KITSTRONIC INTERNATIONAL** Box 577 Station J, Toronto M4J 4Z2

**PRINTED CIRCUIT Boards** available for all ETI projects. Electronic Ignition - \$7.69; Frequency Meter - \$6.49; Coin Toss - \$2.49. No C.O.D.'s please. Get parts for your boards from our large selection during our Winter Sale. Write to: **WENTWORTH ELECTRONICS**, R.R. No.1, Waterdown, Ontario, L0R 2H0

**DYNAMIC bias Super Class A amplifiers\*** Colour LED VU and Power meters\* Versatile bench power supplies\* FM wireless Mic.\* Electronic switches and many other quality Kits. Write for your free catalog: **CLASS-A ENTERPRISES, INC** No. 104-206 E. 6th Ave. Vancouver, B.C. V5T 1J8

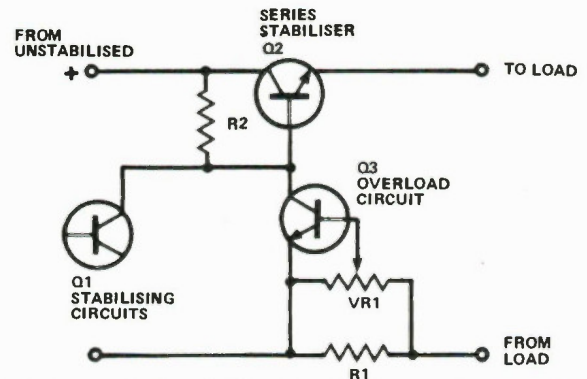

Fig. 8. An overload protection circuit. The potentiometer RV1 is used to set the current at which the protection operates. R1 is a low-value resistor, 1R0 or less.

well! If the output is accidentally shorted, the stabiliser will burn out its transistors trying to keep the output voltage constant. The addition of the circuit of Fig. 8 prevents such a situation. When the current returning from the load passes through R1, a voltage ( $V = R1 \times I$  load) appears across the base and emitter of Q3. If this voltage is sufficient to switch Q3 on, the collector of Q3 will conduct and its connection to the base resistor of Q2 will cause Q2 to switch off, so switching off the stabiliser.

# The Finkler File

An established and reliable source for electronic and electrical equipment.

Components, instruments, hand tools, production devices, printed circuit board holders, hardware, communication antennas, soldering and desoldering irons, digital equipment, breadboarding elements, etc. etc.

Eighteen different companies' product lines are represented across Canada by Len Finkler Limited. Their catalogues list thousands of products used daily by all

segments of the Canadian Electronic & Electrical Industry.

The Finkler File designed to fit into a standard filing system, is a complete set of product data and catalogues represented by Len Finkler Limited. Each company has its own file folder, which is tabbed with detailed product information and local distributors' addresses and telephone numbers.

The Finkler File is part of the commitment to the pursuit of service excellence initiated 25 years ago.

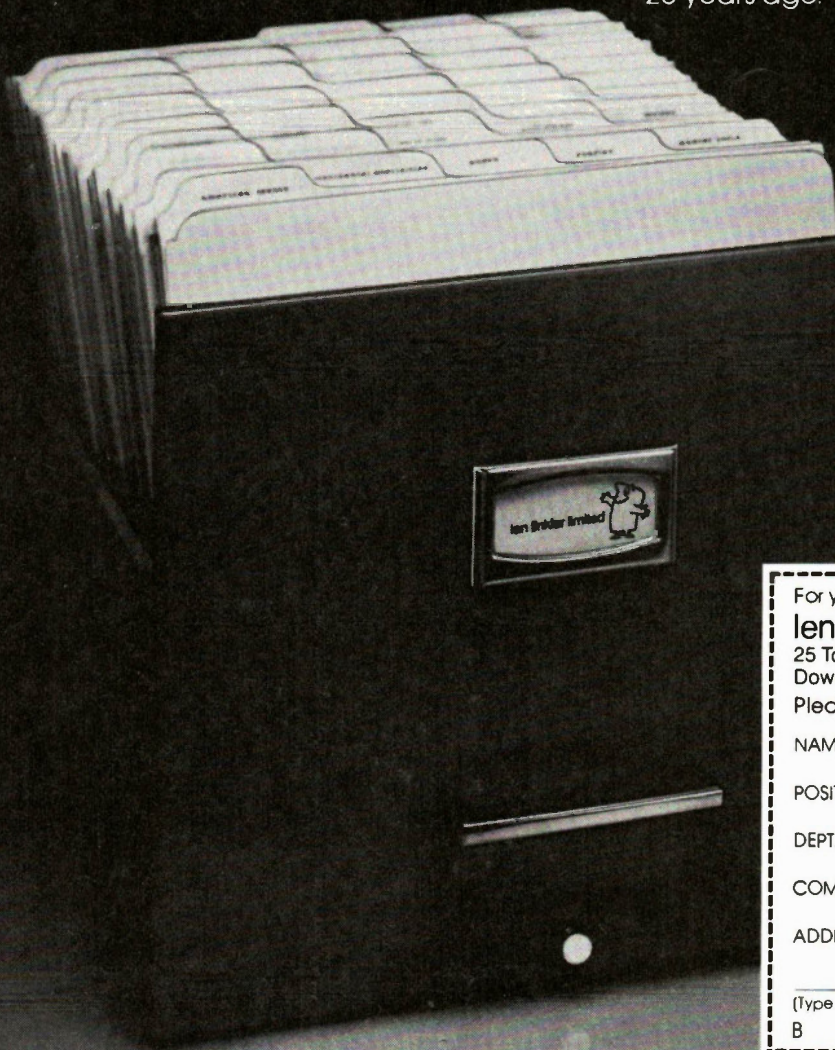

len finkler limited

25 Toro Road  
Downsview, Ontario M3J 2A6  
Telex: 065-24010 • Phone: (416) 630-9103



For your own Finkler File, please mail this coupon to:

**len finkler limited**

25 Toro Road  
Downsview, Ontario M3J 2A6

Please send my Finkler File to:

NAME \_\_\_\_\_

POSITION \_\_\_\_\_

DEPT. \_\_\_\_\_

COMPANY \_\_\_\_\_

ADDRESS \_\_\_\_\_

POSTAL CODE \_\_\_\_\_

(Type or print clearly please)

B

Circle No. 13 on Reader Service Card.

AMERICAN BEAUTY • HUNTER TOOLS • LENLINE  
• K. MILLER TOOLS • MOODY TOOLS  
• PANA-VISE • TRIPLETT

