

ETI for Electronics & Computing Enthusiasts

CP/M for the
Apple II

Electronics Today

\$2.25
MM70924

INTERNATIONAL

February 1983

**Hero: Heath's
Robo+ Kit**

**High
Definition TV
Tube Hi-Fi**

**Audio
Spectrum
Analyser**
A rainbow of
sound



**Torch Computer
Reviewed**

**Directory of
Electronic
Retailers**

**Column LS
Design**
Tall Sound

Cattle Producers 2001

Manitoba
Cattle Producers
Association

MARKET REPORT

- 1 Features
- 2 Slaughter cattle
- 3 Feeder cattle
- 4 General trade trends
- 5 Directory of information providers



Electronics in Farming

Property of Keith Summers



Exceltronix

Exceltronix Computer Division
Computers at unbeatable prices!



DISK DRIVE II W/DOS 3.3

\$795

DISK DRIVE II

\$739

Also check out our
Multiflex drives
We provide our own
120 day warranty

New Multiflex Products

for the Apple™

Special Limited Time Offer

16K RAM CARD \$75

Allows you to expand your 48K
Apple to 64K.

Assembled & Tested with 90
day guarantee

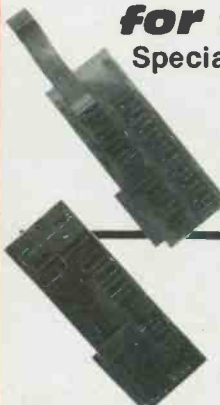

Multiflex Video Card

(80 x 24)

Based on 6845 **\$169**

Assembled & Tested with 90
day guarantee

Multiflex Wire-Wrap card for Apple \$17.95

Multiflex Disk Drives for your Apple™

SA400L Disk Drive attractively
packaged, ready to plug into an Apple
Drive Controller Card (Compatible
to Apple Drive). This month only

\$379

SA400L Packaged with Controller,
DOS and Book. Special

\$549

Apple is a registered trade mark of Apple Computers Inc.

SPECIAL DISKETTES

SYNCOM 5 1/4" Single Sided Double

Density **\$33.95** box of 10

VERBATIM Single Sided Double

Density **\$48.95** box of 10

DISK LIBRARY CASES \$3.95 ea

Also Available:

Maxell, Wabash and CDC

Monitors



Zenith Monitors complete with housing
and power supply ready-to-use with any
composite video signal 12" green
phosphorus screen switch selectable for
40 or 80 characters. 90 day warranty;
quantity discounts available.

ONLY

\$165

COMREX

ONLY

COLOUR 1 MONITOR \$499

13" Colour Monitor 90 day warranty.

RF Colour Modulators \$46.00

OSBORNE 1

The Osborne 1 computer is one of the most exciting developments in the field of
small systems in the recent times. Its low prices, combined with its small size and
large features make it in high demand all over the world. The hardware features in-
clude: * a Z80A CPU with 64K RAM * dual floppy disk drives with 90K storage * 5"
CRT * RS232 interface * IEEE 488 interface * business keyboard. The software in-
cluded is: * CP/M operating system * WORDSTAR word processor (c/w
MAILMERGE) * SUPERCALC spreadsheet * CBASIC * MBASIC.

\$2495

includes 12" Zenith
Green Screen Monitor

\$2395

without extra
Monitor

Multiflex Speech Board Kit (with 32 useful words)

Special . . . \$149 read about on page 23 in our catalogue.

Multiflex EPROM Programmer for the Apple Programs 2716, 2732, 2764 (with ZIF
socket) **\$150.**

Assembled and tested with 90 day warranty

Multiflex Z80 card for the Apple \$150 (software at extra cost)



EPSON

MX80 type III **\$759**

MX80FT type III **\$869**

MX82 type III **\$825**

MX82FT type III **\$959**

MX100 type III **\$1069**

Note: All type III printers in-
clude graphics. All printers
come with 90 day warranty.

Apple Interface card and cable
for Epson printers **\$149**

Quantity Discounts Available. Please call.

PRINTERS

OKI DATA

Okidata u82A. 80 column, pin or fric-
tion feed, 120 c.p.s., parallel or
serial. **\$795**

Okidata u83A. 132 column, friction
or tractor feed, 120 c.p.s. parallel or
serial. **\$1250**

Daisywriter-100. 132 column,
serial, daisy-wheel letter quantity
\$1795

TEC

Tec-Writer I. 80 column, tractor &
friction feed, parallel and serial
. **\$645**

STAR

PRINTERS

Gemini 10 \$629

MAIL ORDERS

Send a certified cheque or money order (do not
send cash). Minimum order is \$10 plus \$3 for ship-
ping. Ontario residents must add 7% provincial
sales tax. Visa, Mastercard and American Express
accepted; send card No., signature, expiry date
and name of bank.



PRICE POLICY

Remember that at Exceltronix, all prices are
negotiable for quantity purchases. If you cannot
afford large quantities on your own, how about
starting a Co-op.



319 COLLEGE STREET, TORONTO, ONTARIO, CANADA, M5T 1S2 (416) 921-5295
ALL PRICES ARE IN CANADIAN FUNDS, 9% FEDERAL SALES TAX INCLUDED

Circle No. 7 on Reader Service Card.

You can't beat the best!

Exceltronix

Components & Computing Inc.

Don't hesitate to contact us on our price
hotline 921-4114 for the most
competitive prices in Canada!

MULTIFLEX SUPER PACKAGE

Z80 System with 5 1/4" disk drive and CPM

\$1195.00

See it and read about it in DEC. Issue of ETI

U of T 6809 Board

Perfect as a starter

KIT PRICE **\$375**

Requires RS232 Terminal
Includes 6809, 2 (6522) parallel ports, 2 (6551) serial ports, 48K of dynamic RAM, 4K of monitor.

Optional 8K of U of T Assembler and Editor available at \$160 extra.

Read May 1982 ETI for review of this 6809 Board.

DISK DRIVES SPECIAL

This Month Only!

SA400L **\$289**

(5 1/4" SS Shugart)

SA200 **\$285**

(5 1/4" Slimline SS Shugart)

SA801 **\$669**

(8" SS Shugart)

SA851 **\$895**

(8" DS Shugart)

CONTROL DATA

CDC 9409 **\$399**

(5 1/4" DS DD)

CDC 9406 **\$595**

(8" DS DD)

Best Prices on Hameg, Hitachi and Leader 'Scopes. See pages 34-37 in our catalogue.

SPECIAL MEMORY SUPER SPECIALS

very good stock



4164—150ns **\$9.95**

(1 x 64K single (+ 5V) supply)

4116-150ns (1x16k) **\$2.50**

4116-200ns (1x16k) **\$1.95**

4116-300ns (1x16k) **\$1.75**

2114L-200ns low power **\$1.95**

TMM 2016 (2k x 8 static RAM) **\$9.00**

NOTE: 1 of these can do the job of 4 2114's but uses only one 24 pin socket

6116 (2k x8) **\$11.00**

(same as above but CMOS)

2102 CFPC **\$1.80**

5101 CMOS **\$3.85**

2708 EPROM (1k) **\$5.95**

2716 EPROM (2k) **\$5.50**

2732 EPROM (4k) **\$8.95**

2532 EPROM (4k) **\$9.95**

2764 EPROM (8K)300ns **\$17.95**

FOR QUANTITY PRICES CONTACT US FOR UNBEATABLE PRICES

NEW MULTIFLEX PRODUCTS

Intelligent Terminal Kit

Comes with keyboard and 4K of RAM, 80x24 character composite video display and RS232 output (uses Z80 as control chip). See ETI Oct. and Nov. '82 issues.

Kit **\$269**

Case **\$45.00**

TV Option **\$39.00**

Power Supply **\$45.00**

Extra 4K RAM **\$19.00**

Ass. & Tested **\$369**

(plus options)

Intelligent Terminal Kit & Zenith 12" Green Screen Monitor.

This Month Only **\$379**

(This is an unbeatable combination)

Multiflex Terminal

&

6809 Board

Includes Multiflex Intelligent Terminal (options extra) and U of T 6809 Board Kit with monitor program and 16K of RAM.

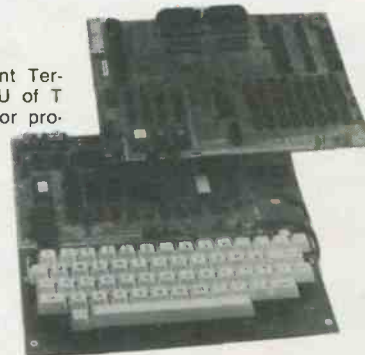

\$647

with Zenith 12" Monitor

\$645 A&T

\$797

with Zenith 12" Monitor

Multiflex Keyboard (55 key)

With connector wired in for external keypad. This keyboard uses 2716 to store the ASCII characters, therefore can be customised to suit your needs (all drawings and codes supplied in kit).

\$99

Optional case **\$35**

Static S-100 RAM Card Kit

Using 6116 (150ns). See catalogue page 20.

Special on 16K version **\$295**

Multiflex Modem Kit

(See catalogue page 30) **\$149**

New Multiflex Single Board Z80 System

See catalogue page 23. On board memory, floppy controller, video and much more.

Special with 64K RAM **\$579**

Optionally expandable to 256K RAM at \$289 extra.

For limited time only you can buy this kit (with 64K RAM) with a Zenith 12" Green Screen monitor for only \$729.

CP/M 2.2 and BIOS \$169 extra.

Logic State Analyser Kit

(See catalogue page 24)

Special. Kit with case **\$289**

Assembled and Tested **\$379**

New Improved Multiflex

Great for beginners or pros

\$369

Comes with a motherboard and a S100 CPU card. Standard features:

Motherboard

Includes 32 keypad with 16 HEX and 16 control keys; HEX display; Cassette Interface; EPROM Programmer for 2708, 2716, 2732, 2532, 2764, 27128; Wire-Wrap area (space for about fifty 14-pin chips); Parallel Port (8255); S100 Connector (with space for three more).

CPU card Includes

Z80A CPU, 2732 (EPROM with our monitor), 6116 (2K x 8 RAM) and all the circuitry. The CPU card has provision (but kit does not include the parts for) 64K of RAM, 4 sockets for EPROM/RAM (2732, 2764, 6116, 8255), parallel port and 8253 timer. Also piggyback board is available for this CPU with 2 serial ports, real time clock and much more.



Remember that at Exceltronix, all prices are negotiable for quantity purchases. If you cannot afford large quantities on your own, how about starting a Co-op.

PRICE POLICY

MAIL ORDERS

Send a certified cheque or money order (do not send cash). Minimum order is \$10 plus \$3 for shipping. Ontario residents must add 7% provincial sales tax. Visa, Mastercard and American Express accepted: send card No., signature, expiry date and name of bank.



319 COLLEGE STREET, TORONTO, ONTARIO, CANADA, M5T 1S2 (416) 921-5295
ALL PRICES ARE IN CANADIAN FUNDS, 9% FEDERAL SALES TAX INCLUDED

Circle No. 7 on Reader Service Card.

SURPLUSTRONICS

we will not be undersold

We accept Visa, Mastercard and American Express

We buy, trade and sell

ABS '6502' Cases

High Quality

\$99.00

Beautiful ASCII encoded KEYBOARD, fits above exactly and plugs directly into 6502 board

\$109



Aluminum '6502' Cases

Beige colour, similar to ABS case, with all hardware.

\$69

Super value ASCII encoded KEYBOARD in Kit form with all parts; ideal for 6502 board. **\$89**

6502 Power Supplies

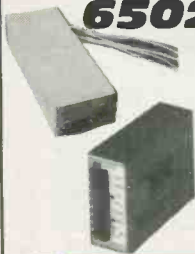

5V, 5A; 12V 1A; -5V, 0.5A;
-12V, 0.5A **\$95.00**

5V, 3A; 12V, 2A; -5V, 0.5A;
-12V, 0.5A **\$115.00**

PARTS ON SALE

2114 (450nS)	95c
4116 (150nS)	\$1.70
Special: 24 of above	\$39.00
2716	\$4.95
Special: 6 of above	\$25.95
2732	\$8.95
Special 3 of above	\$21.95
6502	\$6.89
All sockets. Super quality	1¢ per pin
(Quantity discounts available)	

112K Memory Boards

Containing (56 pieces) 4116, in sockets and control circuitry with schematics.

\$79

128K Memory Boards containing (64 pieces) 4116 (in sockets) and control circuitry. Schematics included.

New Shugart SA400L Disk Drives

5¼" Single Sided, Single or Double Density. Limited time offer. **\$265**

300 Baud Acoustic Modems

(No case or PSU) while they last **\$24**

Special

16K RAM Card (PCB only)	
Apple compatible	\$18.95
80x24 Video Board (PCB only)	
Apple compatible	\$18.95
Z80 Card, Apple compatible	\$19.95
Wire Wrap Card, Apple compatible	\$18.95
Parts Kits available for the above	
<small>Apple is a registered trade mark of Apple Computers Inc.</small>	

BRAND NEW 12"

MONITORS, (with attractive case.)

and ready to be plugged in,

SPECIAL (While they Last) **\$119.00**

TECH WRITER 1 \$529.00

NEW 6502 BOARD COMING SOON!

Has on-board provision for: 64K RAM, 80x24 Video, Floppy Controller and 6 slots for some of the above boards.

\$57.95

Mail Orders

Send a certified cheque or money order (do not send cash). Minimum order is \$10 plus \$3 for shipping. Ontario residents must add 7% provincial sales tax. Visa and Mastercard accepted: send card No., signature, expiry date and name of bank. All sales final.



ADVERTISERS' INDEX

Active Component Sales Corp	41
Active Surplus Annex	49
Audiovision	81
BCS Electronics	12
Bite Electronics	38
Classified	75
Combl Tec	83
Cyprus Products	38
Daetron	41
Dulex Electronic Inc.	84
Electronic Packaging Systems	81
Encom Inc.	81
Exceltronix	2,3
General Electronics	79
Gladstone Electronics	85,87,88
Kiltstron International Ltd.	7
McGraw-Hill	37
Metermaster	78
Nu-West Video Systems Ltd.	83
Orion Electronic Supplies	8,9
Parts Galore	77
Protec	84
PWT Computer Group	82
R.F. Systems	7
H. Rogers Electronic Instruments	7
Smith Corona	46
Stream Computers	7
Surplustronics	4
The Canadian Armed Forces	11
Toronto Small Business Computer Show	51
Trigid Communications	81

Features

Electronics in Farming 13

The day of the sixteen bit cow may be upon us.

Column Loudspeaker Design 17

The best way to keep people from putting things on top of your speakers is to make them too tall to reach.

CP/M for the Apple II 22

It may sound like a mixed basket of fruit but it serves up very well.

Electronic Stores Directory . 25

Where to get a TDA1022 in sled dog country. You had to ask.

ZX Interfaces 31

Let your Sinclair communicate with the outside world so it'll get an idea of how *really* small it is.

Hero 39

The Heath Educational Robot is unlike any other kid project. Have you ever come across an amplifier that followed you around?

Torch Computer Review 42

From the folks who brought you the Acron ATOM, here is a system heavy enough to completely crush one.

High Definition TV 47

A new standard in TV to look out for, these sets will have, in addition to 10' speakers and built in blenders, better pictures.

Membrane Switches 60

We get under the skin of these one piece immortal keyboards.

VMOS 65

Another chapter in the continuing saga of the field effect.

Into Digital IC's Part 6 70

Ian Sinclair explains J-K Flip-Flops.

Columns, News and Information

News	6
Next Month	21



Our cover: The Torch is a powerful new system with colour graphics, sound and an unusual implementation of CP/M. See page 42. Photo by Steve Rimmer. The Hero is also fairly powerful, at least as small robots go. A look at it can be found on page 39. Electronics in farming, complete with digital livestock, is on page 13.

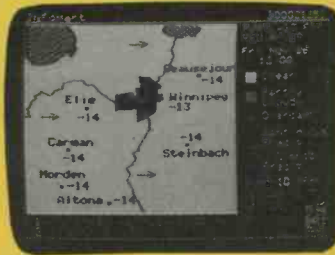

pg 13

Projects



Styrofoam Cutter 35

Make signs, sculptures and Toyotas with this handy project.

Audio Spectrum Analyser . . 52

Complete this and you'll easily convince your friends you have the all-time best hand-held video game.

Series 5000 Preamp (conclusion) 68

The masterpiece is completed at last. Framing instructions to come.

Designer Circuits	24
ETI Bookshelf	56
Order Form	61
Subscriptions	62
Computing Today	63
ETI Specials	73
Back Issues	74
Classifieds	75
Fun of Electronics	76

NEWSSTAND DISTRIBUTION:

Master Media, Oakville, Ontario

SUBSCRIPTIONS

\$18.95 (one year), \$33.95 (two years). For US add \$3/yr., other countries add 5/yr. Please specify if subscription is new or a renewal.

BINDERS

Binders made especially for ETI are available for \$8.00 including postage and handling. Ontario residents please add provincial sales tax.

BACK ISSUES AND PHOTOCOPIES

Previous issues of ETI Canada are available direct from our offices for \$3.00 each; please specify by month, not by feature you require. See order card for issues available.

We can supply photocopies of any article published in ETI Canada; the charge is \$2.00 per article, regardless of length. Please specify both issue and article.

COMPONENT NOTATION AND UNITS

We normally specify components using an international standard. Many readers will be unfamiliar with this but it's simple, less likely to lead to error and will be widely used everywhere sooner or later. ETI has opted for sooner!

Firstly decimal points are dropped and substituted with the multiplier; thus 4.7uF is written 4u7. Capacitors also use the multiplier nano (one nanofarad is 1000pF). Thus 0.1uF is 100nF, 5600pF is 5n6. Other examples are 5.6pF = 5p6 and 0.5pF = 0p5.

Resistors are treated similarly: 1.8Mohms is 1M8, 56kohms is the same, 4.7kohms is 4k7, 100ohms is 100R and 5.6ohms is 5R6.

PCB SUPPLIERS

ETI magazine does NOT supply PCBs or kits but we do issue manufacturing permits for companies to manufacture boards and kits to our designs. Contact the following companies when ordering boards.

Please note we do not keep track of what is available from who so please don't contact us for information on PCBs and kits. Similarly do not ask PCB suppliers for help with projects.

K.S.K. Associates, P.O. Box 54, Morriston, Ont. N0B 2C0

B—C—D Electronics, P.O. Box 6326F, Hamilton, Ont., L9C 6L9.

Wentworth Electronics, R.R.No.1, Waterdown, Ont., L0R 2H0.

Danocinths Inc., P.O. Box 261, Westland MI 48185, USA.

Arkon Electronics Ltd., 409 Queen Street W., Toronto, Ont., M5V 2A5.

Beyer & Martin Electronic Ltd., 2 Jodi Ave., Unit C, Downsview, Ontario M3N 1H1.

Spectrum Electronics, Box 4166, Stn 'D', Hamilton, Ontario L8V 4L5.

Dacor Limited, P.O. Box 683, Station Q, Toronto, M4T 2N5.

POSTAL INFORMATION

Second Class Mail Registration No.3955. Mailing address for subscription orders, undeliverable copies and change of address notice is: Electronics Today International, Unit 6, 25 Overlea Blvd., Toronto, Ontario, M4H 1B1.

News

MOSORBS

A free manual now available features Motorola's new zener type silicon transient suppressor product line, better known as MOSORBS.

Included in this handy reference are data sheets, applications information, a discussion of important parameters and how to pick the proper device for your application.

To order the MOSORBS manual, write to Motorola Semiconductor Products, Inc., P.O. Box 20912, Phoenix, Arizona 85036.

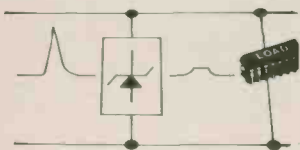

ETI Magazine Is Published by:

Electronics Today International
Editorial and Advertising Offices
Unit 6, 25 Overlea Boulevard,
Toronto, Ontario, M4H 1B1
Telephone (416) 423-3262

Publisher

and Editor: Halvor W. Moorshead
Assistant Editor: Steve Rimmer
Production Manager: Ann Rodrigues
Production: Cindy Baker
Liz Longwill

Subscription Department: Bebe Lall
Diane Neill

Accounts Department: Pirjo Dunphy
Advertising Manager: Senga Harrison
Advertising Representative: Omar Vogt
Advertising Services: Carolyn Wyatt

COPYRIGHT

All material is subject to worldwide copyright protection. All PCB patterns are copyright and no company can sell boards to our design without our permission.

LIABILITY

While every effort has been made to ensure that all constructional projects referred to in this magazine will operate as indicated efficiently and properly and that all necessary components are available, no responsibility whatsoever is accepted in respect of the failure for any reason at all of the project to operate efficiently or at all whether due to any fault in the design or otherwise and no responsibility is accepted for the failure to obtain component parts in respect of any such project. Further no responsibility is accepted in respect of any injury or damage caused by any fault in design of any such project as aforesaid.

EDITORIAL QUERIES

Written queries can only be answered when accompanied by a self-addressed, stamped envelope. These must relate to recent articles and not involve the staff in any research. Mark such letters ETI-Query. We cannot answer telephone queries.

Disk Drive

dy-4 SYSTEM INC. of Ottawa, Canada has announced availability of their new DSTD-711 Universal floppy disk controller with 64K bytes of RAM and DMA. The DSTD-711 is an STD bus card incorporating a Universal Floppy disk controller for 5 1/4" and 8" disk drives, 64K bytes of DRAM and a DMA controller. It supports up to four drives with density up to DS/DD 96 TPI, software controlled memory paging on 8K boundaries the 711 is available in both 2.5 and 4.0 MHz version.

For more information please contact: dy-4 SYSTEMS INC., Ottawa, Ontario, Canada K1Z 5M1. Telephone 613-728-3711.

Synthesizer

A number of readers have noticed that there haven't been any modules for the ETI synthesizer for the past few issues. We'd like to assure everyone that the thing hasn't been abandoned. Tightness of time and some parts hassles have conspired to delay the next installment . . . but it is on its way. Look for an output module, replete with headphone amps and the reverb/echo in issues to come.

Solid State Panel Meters

Bowmar has just released a new catalog describing their line of Solid State Analog Panel Meters.

All meters feature an LED or LCD type of Bargraph display. They are available in 3", 5" and 10" sizes, edgewise configuration, and will accept DC; AC input, as well as parallel BCD digital input. These meters are immune to shock and vibration and feature an easy to read illuminated scale. The high reliability of these meters make them ideally suited to the more demanding applications with an MTBF of 88,000 hrs.

For more information contact Metermaster division of R.H. Nichols Co. Ltd., 214 Dolomite Drive, Downsview, Ontario. M3J 2P8.

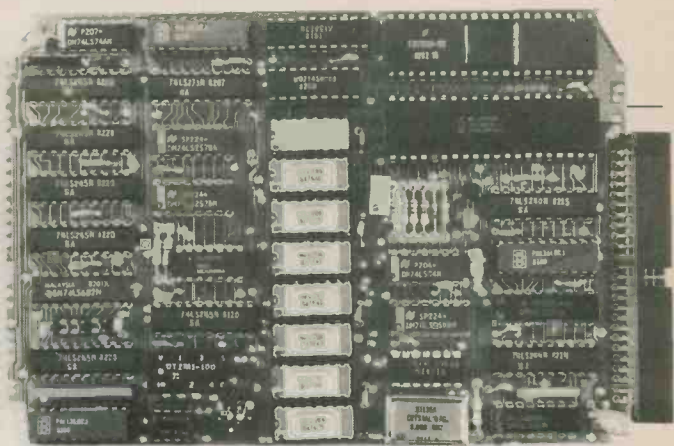
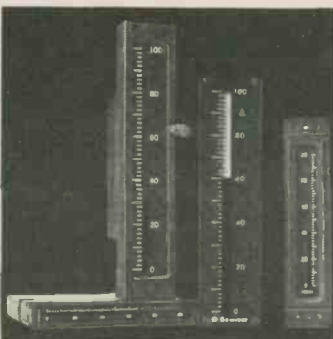

Modem

Grenadier Manual-Mini MODEM is an inexpensive, self-contained direct-connect telephone interface, allowing computer to computer

sends/receives 0-300 baud. It features easy manual originate and answer mode and 300 bps full duplex which is Bell 103 compatible. It also has power-on and carrier detector indicators. For information contact, TRIGILD Com-



communications over ordinary telephone lines. The model MM-102 has a standard RS-232-C connector for interfacing to computers and terminals, and

1631 The Queensway, #6, Toronto, Ontario M8Z 5Y4 (416) 259-7801.

New PAL Circuits

Four new programmable array logic (PAL[®]) circuits, which combine the greatest density of any PAL circuits to-date with PAL's fastest access time of 25 nanoseconds (worst case), are now available from Monolithic Memories, Inc., the originator of PAL technology.

Joining the 24-pin PAL family are PAL20L8A, PAL20R8A, PAL20R6A and PAL0R4A. These new devices have eight product terms, up to 20 inputs and eight outputs. This is in comparison to the existing PAL20L8, PAL20R8, PAL20R6 and PAL20R4 which have four product terms, twelve inputs and ten outputs.

The new PAL circuits also have 25 percent more fusible links than their predecessors (2560 fuses compared to 2048), giving the devices the equivalent of approximately 300 gates, depending on how the circuit is programmed.

Their 25 nanosecond (ns) access time is a speed improvement over 45 ns of the older devices.

Circuit development, simulation and fuse pattern generation are accomplished with PALASM[™], an easy-to-use software program, which is compatible with most operating systems. Once a circuit has been designed and verified, two additional security fuses may be blown to make copying by outsiders extremely difficult.

PAL20L8A, 20R8A, 20R6A and 20R4A are available now in plastic or ceramic .3 inch wide 24-pin SKINNYDIP[™] packages, flat packs and leadless chip carriers. Commercial versions are priced at \$14 each in quantities of 100. A military version is also available. Delivery is four weeks after receipt of order.

For more information contact Monolithic Memories, 1165 East Arques Ave., Sunnyvale, CA 94086.

Continued on page 10

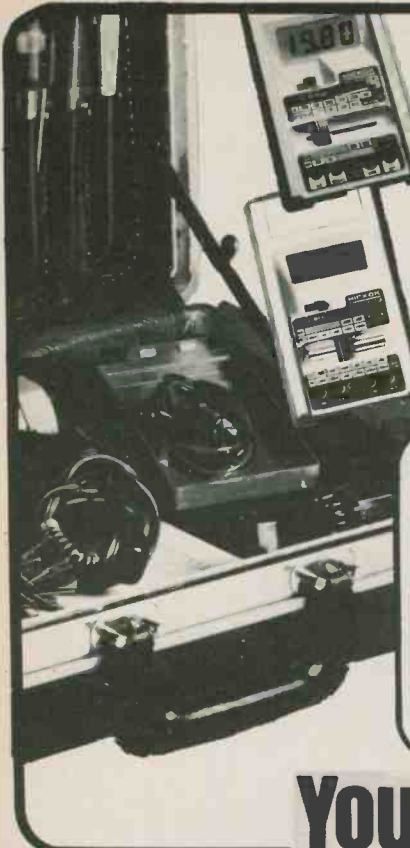

LX304 digital multimeter with automatic decimal point, built in low battery indicator and transistor testing capability. **\$138.00**

LX303 digital multimeter with easy-to-read LCD display. Only **\$110.00**



Model 216 Transistor Tester with fast, automatic switching for instant good-bad analysis of NPN's, PNP's, FET's, diodes and SCR's in or out of circuit. **\$172.00**

Model 240 Video Generator with 10 step gray scale staircase for VTR, CCTV monitor and TV applications. **\$230.00**



H. ROGERS electronic instruments Ltd.
P.O. Box 310, 595 Mackenzie Ave. Units 1&2
Ajax, Ontario L1S 3C5. Tel. (416) 683-4211
Duty and FST included. ChargeX (Visa) accepted.
Ontario residents add 7% sales tax. Shipping extra.

**FOR THOSE
ON THE GO
FROM...**
HICKOK
the value innovator
H. ROGERS electronic instruments Ltd.

Your Toolbox Test Bench

Circle No. 4 on Reader Service Card.

TIMEX SINCLAIR 1000 AND ZX-81 OWNERS

INTRODUCING WHAT YOUR ADULT HANDS HAVE BEEN WAITING FOR:

THE STABILIZER PAD \$9.95



- ELIMINATES SLIDING & MOVEMENT
- GRIPS 16K - NO PROGRAM LOSS
- ELIMINATES "FLAT PLATE" ERGONOMICS
- ELEVATES & TILTS KEYBOARD FOR LESS TIRING, MORE ACCURATE TYPING
- FEATURES CASSETTE HOLDER AND BOTTOM SLOT FOR MANUAL

THIS IS A QUALITY SOFT ELASTOMER CAST BASE WHICH MAKES THE SINCLAIR VASTLY MORE USER FRIENDLY.

TIMEX SINCLAIR 1000 2K	\$149.95
16K MODULE	\$74.95
SOFTWARE-SINCLAIR MINDWARE	\$18.95 - 27.95
	\$22.95 - 29.95

ALL SINCLAIR ACCESORIES AT LOWEST PRICES WITH FAST DELIVERY.

ATARI 800 \$899.95

Ontario residents add 7% P.S.T. Our prices include shipping.

STREAM COMPUTERS
P.O. BOX 113, AJAX, ONT. L1S 3C5
416-839-0323

Circle No. 19 on Reader Service Card.

We believe everyone should enjoy FREE SPEECH

especially during the Texas Instruments Home Computer Free Solid State Speech TM Synthesizer offer.

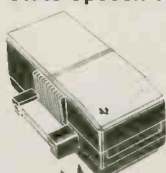

The whole family will enjoy the pleasant, very distinct, very "human" voice produced by a TI-developed breakthrough technology called Solid State Speech TM. You have to hear it to believe it. Here's how the offer works. If you buy any six Texas Instruments Solid State Software TM Command Cartridges between Jan 1st/83 and Mar. 31st/83, Texas Instruments will send you the remarkable Solid State Speech TM Synthesizer free.

Checkout our other amazing specials. Prices effective only until February 28th, 1982.

TI-99/4A Home Computer 16K RAM, 26K ROM 16-bit micro-processor	\$379.95
PHM3015 Early Reading*	64.95
PHM3059 Scolastic Spelling - Level 3*	64.95
PHM3060 Scolastic Spelling - Level 4*	64.95
PHM3061 Scolastic Spelling - Level 5*	64.95
PHM3062 Scolastic Spelling - Level 6*	64.95
PHM3053 TI Invaders	49.95
PHM3054 Car Wars	49.95
PHM3122 Parsec**	49.95

For more information on the TI-99/4A and the software packages available, call (416) 247-8897 or write to: R F Systems, P.O. Box 34 - Station "A" Toronto, Ontario M5W 1A2

Mail Orders: Send certified cheque or money-order (do not send cash) Add \$3.00 for shipping. Ontario residents must add 7% Prov. Sales Tax. VISA and MASTERCARD accepted; send card number, signature, expiry data and name of bank.

Circle No. 21 on Reader Service Card.

We can supply the following components for your 6502 project.

1. Computer Keyboard (Apple compatible) **\$129.00**



2. Switching Power Supply
A. A large open frame supply that will run the main PCB and a low current Disc drive (3 LB)
+5V 4 AMP, +12V 1.0 AMP
-5V 0.5 AMP, -12V 1.0 AMP **\$85.00**

B. THE ORIGINAL, runs 2 Disc drives plus several peripherals.

+5V 3 AMP, +12V 2 AMP
-5V 0.5 AMP, -12V 0.5 AMP **\$119.00**

3. 6502 Motherboard (bare) **\$55.00**

4. ABS Case (steel base) **\$129.00**

5. Motherboard Components (All IC sockets, TTLs, RAMs, CPU, Transistors, Capacitors, Crystal and Peripheral Connectors) **\$189.00**

6. 5 1/4" MITAC Floppy Disk Drives with controller card (100% Apple compatible, much quieter than the SHUGART DRIVES). **\$489.00**

7. SPECIAL THIS MONTH
6502 - \$6.50 each
4116 - \$1.65 each
2716 - \$4.99 each

Distributor for "FUJITECH BRAND" Audio Kits. (made by Luxman, Japan).

FREIGHT AND INSURANCE INCLUDED. Send cheque or money order. Ontario residents please add 7% P.S.T. VISA & Mastercard accepted.

DEALER INQUIRIES INVITED
KITSTRONIC
INTERNATIONAL LTD
Box 577, Stn. J. Toronto
Ontario. M4K 4Z2 (416) 667-8807 or 292-8872

Circle No. 8 on Reader Service Card.

ORION

Electronic Supplies Inc.

ELECTRONIC DISTRIBUTOR
INDUSTRIAL — EDUCATIONAL — COMMERCIAL — HOBBYIST
Circle No.6 on Reader Service Card.

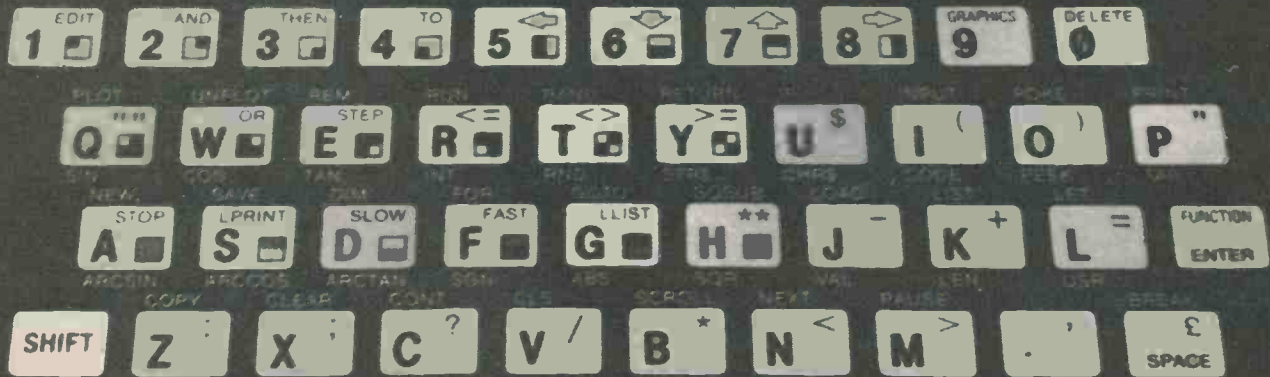

Sinclair ZX81 Computer ASSEMBLED \$129.95

The ZX81's advanced capability. The ZX81 uses the same fast microprocessor (Z80A), but incorporates a new, more powerful 8K BASIC ROM — the "trained intelligence" of the computer. This chip works in decimals, handles logs and trig, allows you to plot graphs, and builds up animated displays. And the ZX81 incorporates other operation refinements — the facility to load and save named programs on cassette, or to select a program off a cassette through the keyboard.

New, improved specification. *Unique "one-touch" key word entry — eliminates a great deal of tiresome typing. Key words (PRINT, LIST, RUN, etc.) have their own single-key entry. *Unique syntax-check and report codes identify programming errors immediately. *Full range of mathematical and scientific functions accurate

to eight decimal places. *Graph-drawing and animated-display facilities. *Multi-dimensional string and numeric arrays. *Up to 26 FOR/NEXT loops. *Randomize function. *Programmable in machine code. *Cassette LOAD and SAVE with named programs. *1K-byte RAM expandable to 16K. *Full editing facilities. *Able to drive the new Sinclair ZX Printer (to be available shortly).

If you own a ZX80... The new 8K BASIC ROM as used in the ZX81 is available as a drop-in replacement chip. (Complete with new keyboard template and operating manual). With the exception of animated graphics, all the advanced features of the ZX81 are now available on your ZX80 — including the ability to drive the Sinclair ZX Printer.

16K Memory Expansion Kit
(No P.C. Board) **\$69.95**

Sinclair's new 8K Extended Basic offers features found only on computers costing three or four times as much. *Continuous display, including moving graphics. *Multi-dimensional string and numerical arrays. *Math and scientific functions accurate to 8 decimals. *Unique one touch entry of "key words" (i.e. basic and system commands). *Automatic syntax error detection. *Randomize function. *Built-in interface for ZX Printer. *Connects to standard TV and cassette recorder. *164 page manual included. *Power supply (9V at 650 ma) optional for \$14.95. *1K of memory is included.

ZX81 Printer \$169.95

Designed exclusively for use with the ZX81 (and ZX80 with 8K basic ROM), the printer offers full alphanumeric and highly sophisticated graphics. COPY command prints out exactly what is on screen. At last you can have a hard copy of your program listing and results. Printing speed is 50 characters per second, with 32 characters per line and 9 lines per vertical inch. Connects to rear of ZX81 — using a stackable connector so you can use a RAM pack as well. A 65 ft paper roll, instructions included. Requires 9 volts, 1.2 amp power supply (option extra).

64K \$249.95

MEMOTECH 64K MEMOPAK

The Memopak is a 64K RAM pack which extends the memory of the ZX81 by a further 56K. Designed to be in the price range expected by Sinclair owners. Plugs directly into the back of the ZX81 and does not inhibit the use of the printer or other add-on boards. There is no need for additional power supply or cables. The Memopak together with the ZX81 gives a full 64K, which is neither switched nor paged, and is directly addressable. The unit is user transparent, and accepts such basic commands such as 10DIM A(9000). With the Memopak extension the ZX81 is transformed into a powerful computer, suitable for business, leisure and educational use, at a fraction of the cost of comparable systems.

Machine Language Software

ZXAS Machine Code Assembler. A full specification Z80 assembler. Standard mnemonics are written directly into your BASIC program. **\$13.95**
ZXDB Disassembler/Debugger. Perfect complement to ZXAS, also provides single step, string search, block transfer hex loader. **\$13.95**

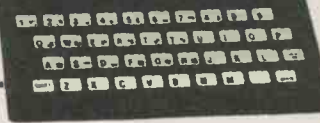

Hardware	
ZX81 Assembled	\$129.95
ZX Printer	169.95
64 K-RAM	249.95
16K RAM	99.95
16K RAM Kit	69.95
Power Supply (for ZX81 + 16k memory)	14.95
Software	
Multifile Data Storage System	\$39.95
Dictator	19.95
Constellation	19.95
ZX Chess	29.95
Star Trek	13.95
Vu-Calc	29.95
Viewtext	19.95
Books	
Not only 30 programs for the ZX81 — \$16.95	
Understanding your ZX81 ROM — 23.95	
Getting acquainted with your ZX81 — 16.95	
The explorers guide to the ZX81 — 16.95	
The gateway guide for the ZX81 & ZX80 — 16.95	
Mastering machine code on your ZX81 — 24.95	
The ZX81 pocketbook — 16.95	

Orion Electronic Supplies Inc.
40 Lancaster Street West
Kitchener, Ontario N2H 4S9
(519) 576-9902

Master Charge & Visa, COD, Cheque, Money Orders accepted. COD's, shipping & insurance extra. Write for our FREE FLYER.

Prices subject to change without notice.

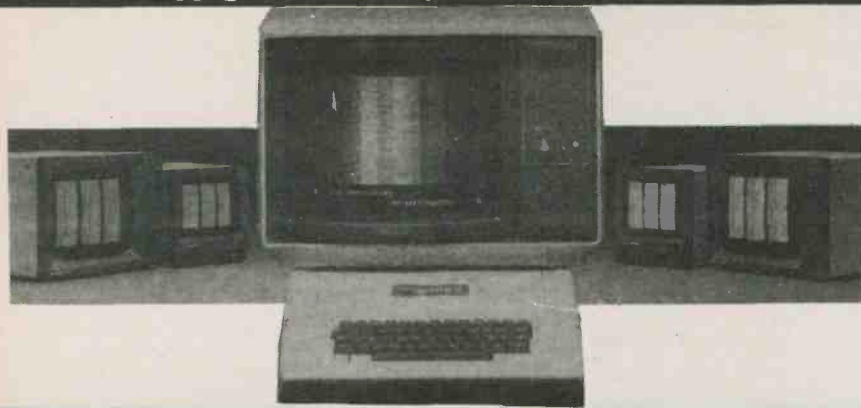

Electrohome Monitors

EDM926/B&W 9" Black & White monitor	\$159.50	ECM1302-2 13" Color RGB Monitor Hi Rez.	\$850.50
EDM926/P31 9" P31 Green Monitor	\$169.50	I-1302 NTSC Interface for ECM1302 for Apple II Computers	\$ 69.50
EDM1226/B&W 12" Black & White Monitor	\$179.50	I-1302/IBM Cable for ECM1302-3 and IBM Computer	\$ 27.50
EDM1226/P31 12" P31 Green Monitor	\$189.50	I-1302/Apple Cable for ECM1302 and Apple III Computer	\$ 27.50
ECM1302-1 13" Color RGB Monitor	\$499.50		



MP-1302-APL **\$249.50**
 RGB Card for Apple II or Franklin 100

6502 BOARDS & ACCESSORIES

AMB-1 Mother Board, APPLE II Compatible, Assembled & Tested c/w Basic ROMS, 48K RAM, Made in Japan	\$449.00
ABB-1 APPLE II Compatible, Motherboard (no components)	\$ 59.00
PDA-232C Serial interface RS232C Card for APPLE II c/w Cable & Manual, Three Operating Modes: I/O, Terminal, Remote	\$169.00
VCB-1 Versatile Communication Board for APPLE II	\$249.00
VVC-1 Videotape, Video Disc, Controller Board for APPLE II c/w Demo & Interface Software	\$499.00
AKB-1 Keyboard; replacement for APPLE II	\$139.00
KBC-1 Plastic 2-tone Beige & Brown Case for Apple-type keyboard	\$ 29.00
AC-1 Beige APPLE II Case (No keyboard)	\$145.00
APS-1 Switching Power Supply for APPLE II; +5V @ 5 amps, +12V @ 1 amp, -5V @ 1 amp, -12V @ 1 amp	\$ 99.00
APS-2 Switching Power Supply for APPLE II; +5V @ 3 amps, +12V @ 2 amps, -5V @ 1/2 amp, -12V @ 1/2 amp; c/w on-off switch & connecting wires	\$139.00
AAA-2 Low Profile Disc Drive, 5 1/4", APPLE II Compatible, Excluding Controller Card	\$599.00
AAA-1 Low Profile Disc Drive, 5 1/4". APPLE II compatible c/w Controller Card, Single Side, Single Density, Automatic Select DOS 3.2 & 3.3	\$649.00
PC-1 Printer Interface Card for APPLE II, Parallel Output	\$169.00
ZVM-121 12" Green Phosphor Data Monitor Zenith	\$189.00
ADC-1 Disc Drive Controller Card for two drives; Apple II Compatible	\$129.00
AXT 14.31818 MHz Crystal for APPLE II; HC-18/U package	\$ 5.50

APPLE II is a registered trade mark of Apple Computer Inc.

What can you honestly expect from an interactive data terminal that costs only \$475.95



Well, to begin with, color graphics. RCA's VP-3301 has unique color-locking circuitry that gives you sharp, jitter-free color graphics and rainbow-free characters.

Plus much more: Microprocessor control. Resident and programmable character set. Reverse video. State-of-the-art LSI video control. 20 and 40 character formats. RS232C and 20 mA current loop. Six baud rates. Eight data formats. ASCII encoding. Light-touch flexible-membrane key switches for reliability and long life. CMOS circuitry and a spill-proof, dust-proof keyboard for hostile environments.

The VP-3301 can be used with a 525-line color or monochrome monitor or a standard TV set through an RF modulator. It serves a wide variety of industrial, educational, business and individual applications including communication with time sharing and data base networks such as those provided by Dow Jones News/Retrieval Service, CompuServe and Source.

All this—for the low price of \$475.95. And it's made by RCA.

VP-3501 Videotex Data Terminal
 For time sharing applications via telephone. Connects to standard TV set for display. Built-in 300 baud direct connect modem. Includes: numeric keypad, color graphics, tone and noise generator, RF and video/audio outputs, expansion interface, resident and user-definable character sets, cursor control, reverse video, plus many other features. (Includes connecting cables.)

VP-3303 Interactive Data Terminal (RF & Video/Audio)
 General purpose terminal. Similar to the VP-3501. Does not include modem or numeric keypad. Six switch selectable baud rates to 19.2k. RS-232C and 20 mA current loop interfaces.

RCA PRICE LIST

58-Key Typewriter Format for Alphanumeric Entry	
VP-601 - 8-bit parallel output	\$109.75
VP-606 - Asynchronous serial output	139.75
58-Key Typewriter Format Plus Separate 16-Key Calculator-Type Keypad for Fast Numeric Entry	
VP-611 - 8-bit parallel output	\$149.75
VP-616 - Asynchronous serial output	159.87
VP-3301 - Video output & built in audio	475.95
VP-3303 - Connects directly to TV set	488.95
VP-3501 - With built in modem & RF modulator	549.95

ASCI Keyboard Fully encoded, 128-character ASCII alphanumeric keyboard. 58 light touch keys (2 user defined). Selectable: "Upper-Case-Only"	\$109.75
VP-601 ASCII/Memoria Keyboard ASCII Keyboard identical to VP-601 plus 16 key numeric entry keyboard for easier entry of numbers	\$149.75
VP-611 Cable: ASCII Keyboards to VP-711 Flat ribbon cable. 24 in. length, for connecting VP-601 or VP-611 and VP-711. Includes matching connector on both ends	\$27.50
VP-620 Cable: ASCII Keyboards Flat ribbon cable. 36 in. length with mating connector for VP-601 or VP-611 keyboards. Other end is unterminated.	\$27.50
VP-623	

START WITH ORION FOR A NEW ERA IN THE WORLD OF ELECTRONICS

We have the most complete selection of electronic components.

Full line of TTL, CMOS, Linear, ICs, Computer Interface, Support Chips and CPUs.

ORION
Electronic Supplies Inc.

ELECTRONIC DISTRIBUTOR

INDUSTRIAL - EDUCATIONAL - COMMERCIAL - HOBBYIST

Circle No.6 on Reader Service Card.

Memory Special

RAM		
4116-20	16K	\$ 1.85
4164-15	64K	\$15.00
4164-20		\$12.50
6116P	200nS 2Kx8 Static CMOS	\$12.50
2016 EPROM	NMOS 2Kx8	\$ 9.75
2708		\$ 5.95
2716		\$ 5.95
2732		\$ 8.75
2532		\$ 9.75
2764-45		\$17.50

Computer Connection

If you're frightened, intimidated, and enormously confused by computers, or just want to learn more about them, you're not alone.

More than 2,000 dauntless Ontarians have already registered (as of mid-December) in the *TVO Academy on Computers in Education* in an effort to dispel the mystique surrounding these ubiquitous, baffling electronic creatures.

Steadily growing networks of enthusiasts around the province offer some much-needed encouragement to those individuals who prefer group learning.

For example, some of TVOntario's more zealous registrants are rallying their communities in favour of computer academy support groups that offer program screenings and access to computers.

For interested participants, TVOntario is working out a "buddy system" to match registrants geographically and/or by area of interest. The academy will also provide information about computer resources, such as computer clubs, in communities throughout Ontario.

TVO Academy on Computers in Education is an at-home, step-by-step, 12-week learning opportunity combining print and electronic media, starting Wednesday, 16 February at 9:00 p.m. EST. The programme will almost certainly be broadcast in other provinces but at present dates and times are not known.

The comprehensive course materials consist of Bits and Bytes (a 12-part television series focussing on practice and theory, starring Billy Van and Luba Goy), study guides, a variety of readings,



multiple-choice questionnaires, personalized correspondence, topical newsletters, and contributions from numerous computer experts.

ETI were invited to a special showing of the program and were impressed. The style is friendly, relaxed but with a very well written script. The technical level is basic and it won't appeal to those who already have some personal computing experience but is ideal for people who are still puzzled by computer specifications.

An optional Hands-On Manual is designed as a stand-alone aid for people with access to a PET, Apple, or TRS-80 microcomputer.

On completion of the course, registrants will have learned to operate a computer, understand how it functions, select methods of educational application, and develop simple computer programs.

A certificate of completion will be mailed on request.

Registration, including the Hands-On Manual, is \$59 (without the manual, \$53).

For further information or registration, contact TVO Academy on Computers in Education, Part-Time Learning, TVOntario, Box 200, Station Q, Toronto M4T 2T1, or call 484-2614 ro 2648.

Tube Book

The Vestal Press has announced *70 Years of Radio Tubes and Valves*, by John W. Stokes.

The entire electronics industry was founded on radio's "Magic Lamp", the radio tube, or valve, in British parlance. From its invention in 1904 to its gradual eclipse beginning in the 1960's as it was replaced by solid-state devices, the electron tube reigned supreme as the cornerstone of the electronics industry.

In this new book the history of the radio tube is covered in its entirety, with emphasis on developments occurring between 1927 and 1937, the period when the 'all electric' receiver evolved to become a familiar part of our daily lives.

Mr. Stokes, a New Zealand native, has been a student of tubes and valves for many years, and he gives equal treatment to developments throughout the Western World. With over 430 pictures, drawings, and early advertisements, the book is a treat for anyone involved in electronics to see and read how this now-giant

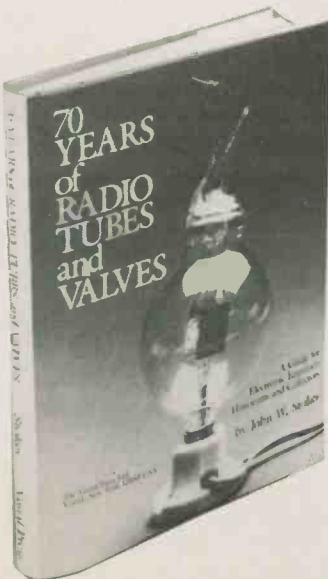

industry which permeates every aspect of today's existence grew together with inventions in the field of tubes.

All the giants of the industry, Westinghouse, General Electric, Sylvania, RCA, Raytheon and others their size were involved, as were many smaller firms, a lot of them forgotten today, as if awaiting a book like this to revive their memories for anyone who enjoys studying how our modern technical civilization has progressed. The story is thorough, from Edison's discovery that electrons would flow in a vacuum (the famed 'Edison effect') to Lee DeForest's invention of the 'grid', to RCA's "Nuvistor" that closed the era.

For more information, contact The Vestal Press Ltd po box 97 Vestal New York 13850 USA telephone (604) 797-4872

Music Processor

One of the weirdest errors ever to creep into a project has just recently been discovered in the music processor. Prior to the artwork for that article leaving our offices to go to the printer the PCB was touched up a bit with several stick on pads. As far as we can tell one of the pads was dislodged along the way and managed to fasten itself to another spot on the board. There is, thus, a short between pins five and six of IC6 which must be scraped away for the circuit to work properly. Readers who contacted us about this were informed that our prototype had turned up no difficulties as our board was, of course, made from the artwork that existed prior to the magazine's being published.

Also...

We don't do too much trumpet-blowing so readers may forgive us this once: ETI's circulation broke the 20,000 barrier for the first time with the October 1982 issue. It's too early to know final sales figures for later issues but the November and December are in very short supply indeed and both will probably set new records.

A report from International Resource Development Inc. predicts that by 1990 15 million US homes will have direct broadcast satellite receivers on their roofs. Price will probably be under \$500 as the higher frequencies expected to be used for direct broadcast will mean dish antennas of about a metre diameter.

Cooper tools have recently introduced a soldering or desoldering tool that uses hot air rather than a conventional bit to heat the joint.

Hitachi have introduced a 3" floppy disk drive which they claim is exactly similar to a 5 1/4" type, so much so that existing disk controllers can be used with it.

A follow-up to the numbers game in home computers: Future Computing, a US market research group, rank the leaders as Texas and Commodore tied at No. 1 followed by Atari then Radio Shack. The same report says sales of home computers in 1982 equaled the complete sales from the start (1977) up to the end of 1981. So now we have four contenders for No. 1: Apple, Sinclair, TI and CBM!

Binatone, a UK company who has its factories in Hong Kong have announced a home computer selling for \$100 there which is compatible with TRS-80 software and is expandable to 64K. It's expected to be available in March.

In the Canadian Armed Forces, you can be almost anything you ever wanted to be.



A Canadian Forces base is a mini-city. Every skill from dentistry to fire-fighting is needed.

We can give you most of these skills.

You could learn trades ranging from radio-technician to auto mechanic. These are skills you keep; a passport to security for the rest of your life.

But trades are not all we offer you.

In the navy, you'd be part of a team running a ship and visiting other countries.

In the airforce, you'd work with jet fighters and transports, part of the team that keeps them flying.

In the army, you'd learn all the skills of survival while living the sort of rugged, outdoor life that's impossible anywhere else.

If you qualify, you could be selected to go to school or university to further your education, which could lead to an officer's career.

The Canadian Forces have a lot going for you. Find out for yourself and decide. Get good pay while learning a valuable skill. The comradeship and chance to make lifelong friends that only comes by being part of a team.

For more information, visit the recruiting centre nearest you or call collect - we're in the yellow pages under Recruiting, or send this coupon.



THE CANADIAN ARMED FORCES.

Canada

The career with a difference.

Director of Recruiting and Selection
National Defence Headquarters
Ottawa, Ontario K1A 0K2

Name _____

Address _____

City _____

Prov. _____

Postal Code _____

There's no life like it.

N-EL

HM 204 MULTI-FUNCTION SCOPE

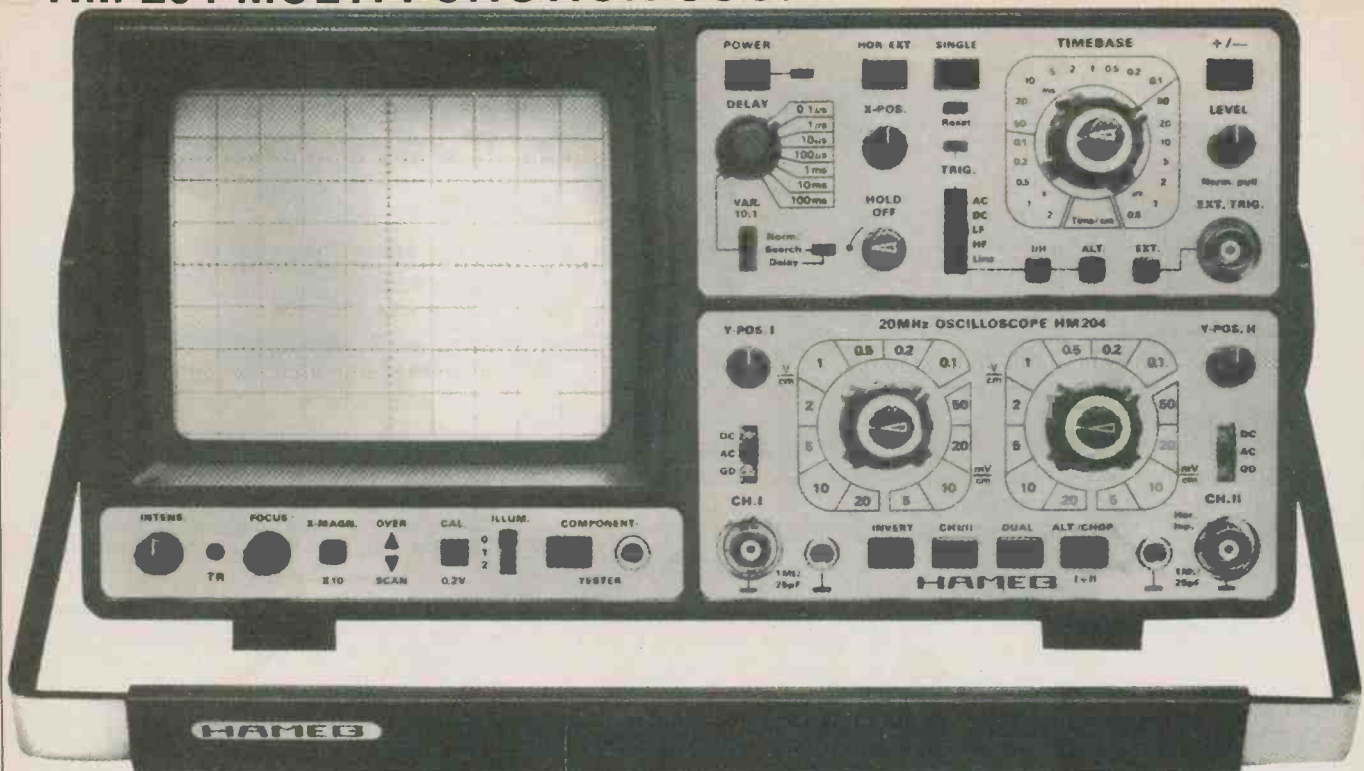

■ **2x 20MHz, max. 2mV/cm**
max. 1% Overshoot

■ **Component Tester**
One-Button Operation

■ **8x10cm, Rectangular CRT**
Internal Graticule (illum.)

The new HM204 demonstrates the exceptionally high quality and operating standards set by HAMEG, providing a multitude of features normally found only in more expensive scopes. The rectangular 8x10cm CRT has a quick-heating cathode, burn-in resistant Phosphor, and an internal graticule, which can be illuminated. Each channel is electronically switched to the vertical final amplifier in either **alternate or chop mode**.

Although the bandwidth of the HM204 is rated at 20MHz -3dB (70% of 80mm), the 50MHz bandwidth of the preamplifiers permits viewing of signals up to 40MHz at smaller display heights. HAMEG's **overscan indication** is superior to the common beam finder, as it will also show the presence of signal components or fast spikes outside the vertical limits of the CRT screen.

The HM204 may be operated as a **single or dual trace** oscilloscope. The **sum of two channels** is displayed in **Add Mode**, their difference by using the **Invert function**

■ **Timebase 20ns/cm - 2s/cm**
incl. Magnification x10

■ **Trigger Bandwidth 50MHz**
internal at 5mm

■ **Delayed Sweep 100ns - 1s**

of Channel I. In **X-Y Mode**, both channels have equal input impedance and sensitivity ranges.

The wide timebase range from 20ns/cm (incl. **Magn. x10**) to 2s/cm provides excellent resolution of all signals. HAMEG's new LPS trigger technique ensures reliable triggering even on small signal heights (5mm) up to 50MHz. Normal and fast **Automatic Peak Value Triggering** and **Variable Hold-Off** time permit stable displays of very complex or aperiodic signals. The **Alternate Trigger Mode** ensures jitter-free display of two asynchronous signals, while the **Single Sweep** facility allows the investigation of single events and accurate photography. The **Sweep Delay** is particularly useful for the analysis and expansion of complex waveforms, offering almost all the advantages of a second timebase at much lower cost. **Component Tester, Z-modulation, raster illumination, ramp output, trace rotation** and **built-in calibrator** are standard with this most versatile and competitive scope.



980 Ainess St.,
Unit 7,
Downsview, Ontario
M3J 2S2
(416) 661-5585

LIST \$1120

Electronics in Farming

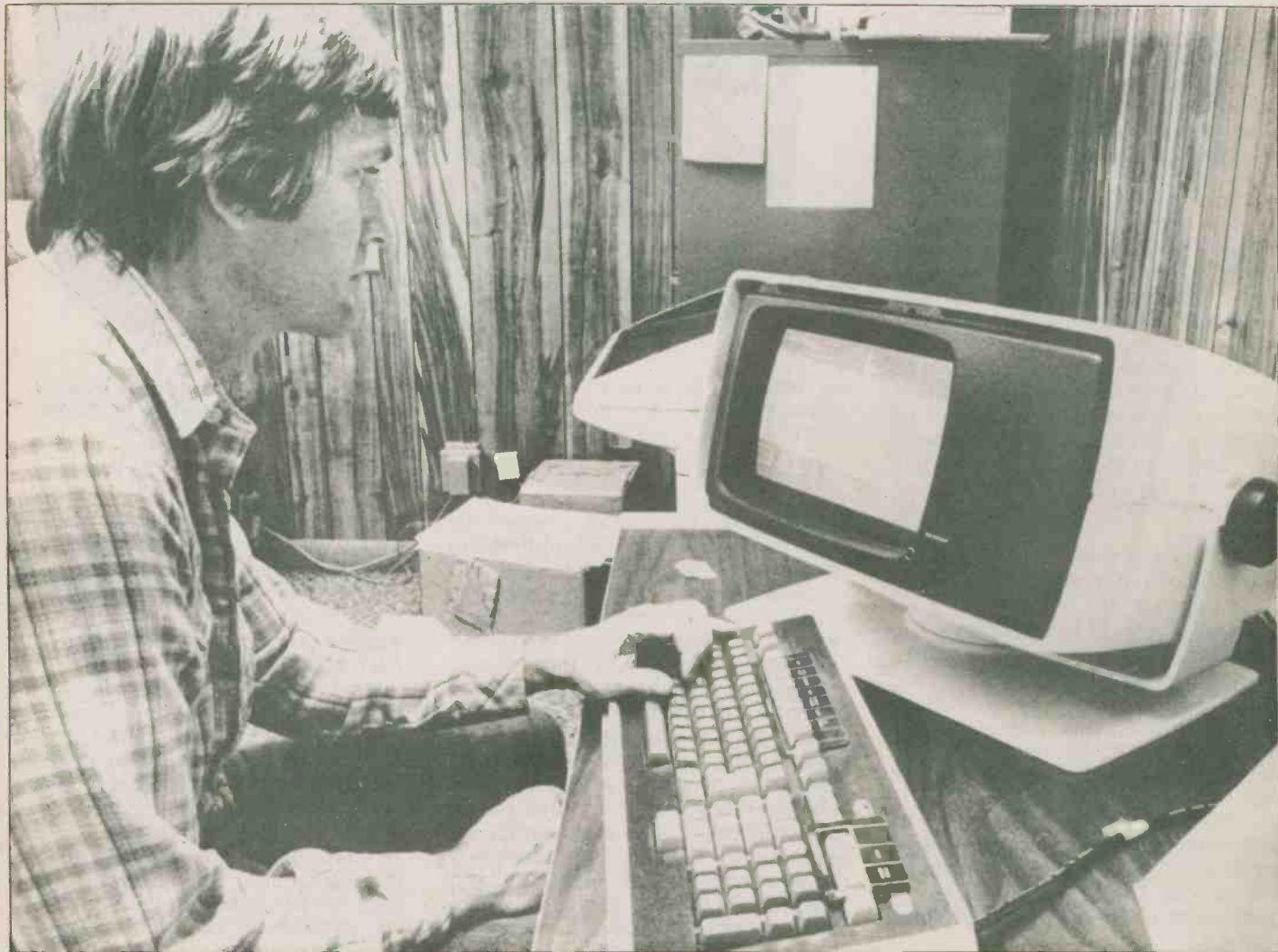

Allen Hatter uses a Data General microNOVA MP/200 microcomputer to keep track of feed consumption, cash flow and health statistics for up to a million turkeys.

The traditional views of the conservative farmer, resisting change is often wrong. Roger Allan looks at the use of computers in Canada's largest industry.

DURING THE 1950's computers found entry into agriculture through universities as a tool for scientific research and development. Scientists in agricultural schools began looking toward the computer to help analyse the large amount of data coming from agricultural research. Statistical laboratories were set up to aid the work in crop science, soil science and animal science at a very early date in the development of computers. By 1965 the situation had completely

changed. Computer programs were 'much smarter' and the results were often quite readable by the average computer user.

There is, however, a fundamental difference between corporate or academic usage of computers and the use of the computer on the farm. On the farm, the farmer is normally the organization, chairman of the board, president, personnel manager, purchasing officer, production supervisor, marketing manager, salesman

and principal stockholder. This places the generation of information and the processing of information very close together, and hence, the phenomenon of greater reliance on memory and experience rather than on written records was largely the name of the game. As such, the time was almost never available to produce the volume of documents that normally accompany corporate business. Computers have changed all that.

Electronics In Farming

Farm record keeping and accounting services have sprung up all over North America and Europe mainly at the instigation of trained farm managers who work for the local agricultural college or some governmental service organization. In Ontario, the E1 Farm system at the Ontario Agricultural College in Guelph is an example.

This record keeping automation has been a boom to cash flow analysis, tax planning and other accounting-like aspects of farm business management. During the past 20 years, many more farm management oriented concepts have been developed which draw upon scientific knowledge about farm production and marketing and merge it with the management data which the farmer keeps. Techniques for feed ration formulation, budgeting procedures for production planning, guides for fertilizer application, herbicides and pesticide strategies, herb monitoring systems and many others have been developed which are all aimed at improving farm management. Many of these farm information process techniques have been designed to use with a computer for support.

There are a number of ways in which a computer can become involved in the workings of a farm:

1. Through a small but growing group of chartered accountants and banks who make use of computer record keeping and also offer some management services. This area is pretty straight forward for readers of ETI and really needs no further explication.
2. Through farm management workshops focussing on computerized budgeting which are sponsored by the various provincial ministries of agriculture and food. Again, straight forward.
3. Through record keeping service organizations like Canfarm. This is really just a commercialized amalgam of the first two above;
4. Through government policy implementations;
5. Through information-marts, such as Grassroots;
6. By the purchase by the individual farmer of a microcomputer and either the purchase of a software program or the generation of an individualized program "on the farm."

Government Policy

The government policy makers are confronted with a series of frequently conflicting social, economic and

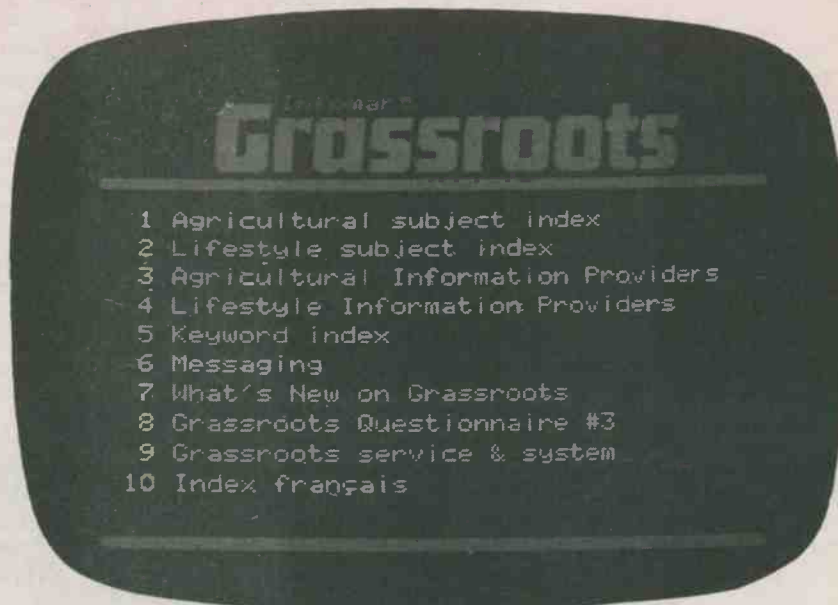

Manitoba's Grassroots Telidon system is supplying up-to-date market prices, detailed weather reports and mass of additional information to 350 subscribers in the province.

political concerns and constraints. For example, Canadian agriculture depends heavily on trade and any assessment of the trade policy implications must consider producer earning, consumer prices, foreign exchange earnings and the international trading rules. Agriculture is influenced by the non-farm sector and vice-versa through food prices and expenditures, wage costs, interest rates, energy prices and foreign exchange rates. Prices in either sector or commodity group can impinge on each other. Other policy considerations would include treasury costs, regional impacts, income distribution, number and size of firms in the farm and food industry, innovation adoption rate, environmental consequences, stability of incomes and prices, economic growth and funding of agricultural research for long run future growth. Thus, policy evaluation must consider these trade-offs and interrelationships. Models can provide estimates of some of the quantitative effects of alternative policies. They enable the consideration of a large number of factors simultaneously as well as the time path of adjustments from the existing to the new policy situation.

There are a number of examples during the past decade of these model usages within Agriculture Canada in evaluating alternative policies.

Before the national feedgrains policy was introduced in 1973 and 1974 there were a number of concerns raised about equity between regions, trade implications, stability of production and prices and transportation costs. The development of a large quantitative model of production, demand and international and inter-regional trade in the major grains and livestock classes, enabled an examination of regional prices, production and farm income for a variety of policy alternatives.

The debate on alternatives for the Agricultural Stabilization Act of 1975 raised concerns about its affect on expanding production, trade, treasury costs and stability of production and farm income. These factors were examined using quantitative models for a variety of support levels and methods of payment calculation.

The 1980 partial embargo on sales of grain to Russia required compensation to producers for the resultant price decline. Calculation of the extent of that decline and the implications for grain producers' incomes involved the use of a model to provide those estimates plus treasury costs.

Other examples where policy evaluation has involved the use of quantitative models include the Crows Nest Pass rate for prairie grain transportation, the Western Grains Stabilization Act, the Meat Import

Law and Dairy Policy for industrial milk.

Grassroots

Information marketing is another major influence of computers and electronics on the individual farm. Specifically, Infomart, in conjunction with the Manitoba Telephone System, in the fall of 1981 introduced Grassroots, a form of Telidon. The technical details of Telidon are outlined in a previous ETI edition (ETI September 1982). Specifically, Grassroots places the individual farmer in touch with a computer bank of some 10,000 pages of farm information. Currently, there are some 350 users (expected to rise to 1200 by the end of 1983) accessing some 400,000 pages of information a month, at a cost of \$50 a month for the terminal rental and five cents a minute for access time.

The use of Telidon system is believed to be even better than a simple library of information retrieval function device, as the actual computing power of the central machine

is also available to the home user. This capacity can be used to provide services such as teleshopping, telebanking and electronic mail. This capacity is also used to provide interactive programs called 'action tasks' which aid the farmer in planning crop rotations, calculating least cost feed formulations, examining chemical usage options and so on.

A major use of Grassroots on the farm is weather forecasting. Grassroots provides, for a fifty mile radius around most farms, a detailed satellite weather forecast for the next 36 hours, updated three times a day. The Telidon receiver displays detailed full colour weather maps showing storm fronts, cloud cover, probability of rain, wind speed and wind direction as well as all the more usual weather information. Further, it provides information including soil moisture content, corn heat units and growing degree days.

Another popular information package (from among the fifty currently available by Grassroots) is the direct feed from the commodities exchanges providing a regularly updated listing of future and past prices

for all major agricultural commodities, such as the Winnipeg Commodity Exchange, the Chicago Board of Trade, the Chicago Mercantile Exchange and the Mid-America Exchange — all on a ten minute delay feed.

Other major information providers to Grassroots include the government departments such as the Manitoba Department of Agriculture and Agriculture Canada, as well as regulatory agencies such as the Canadian Wheat Board and the Canadian Grain Commission. There are also many private sector agribusiness corporations providing information their services and products. All industry sectors including chemicals, fertilisers, equipment, real estate, seed, feed and grain marketing agencies are represented. The system also provides two-way capabilities for educational programs for children, computer games, messaging and soon telebanking.

Personal Computers

Perhaps the most interesting application of computers to the farm is not

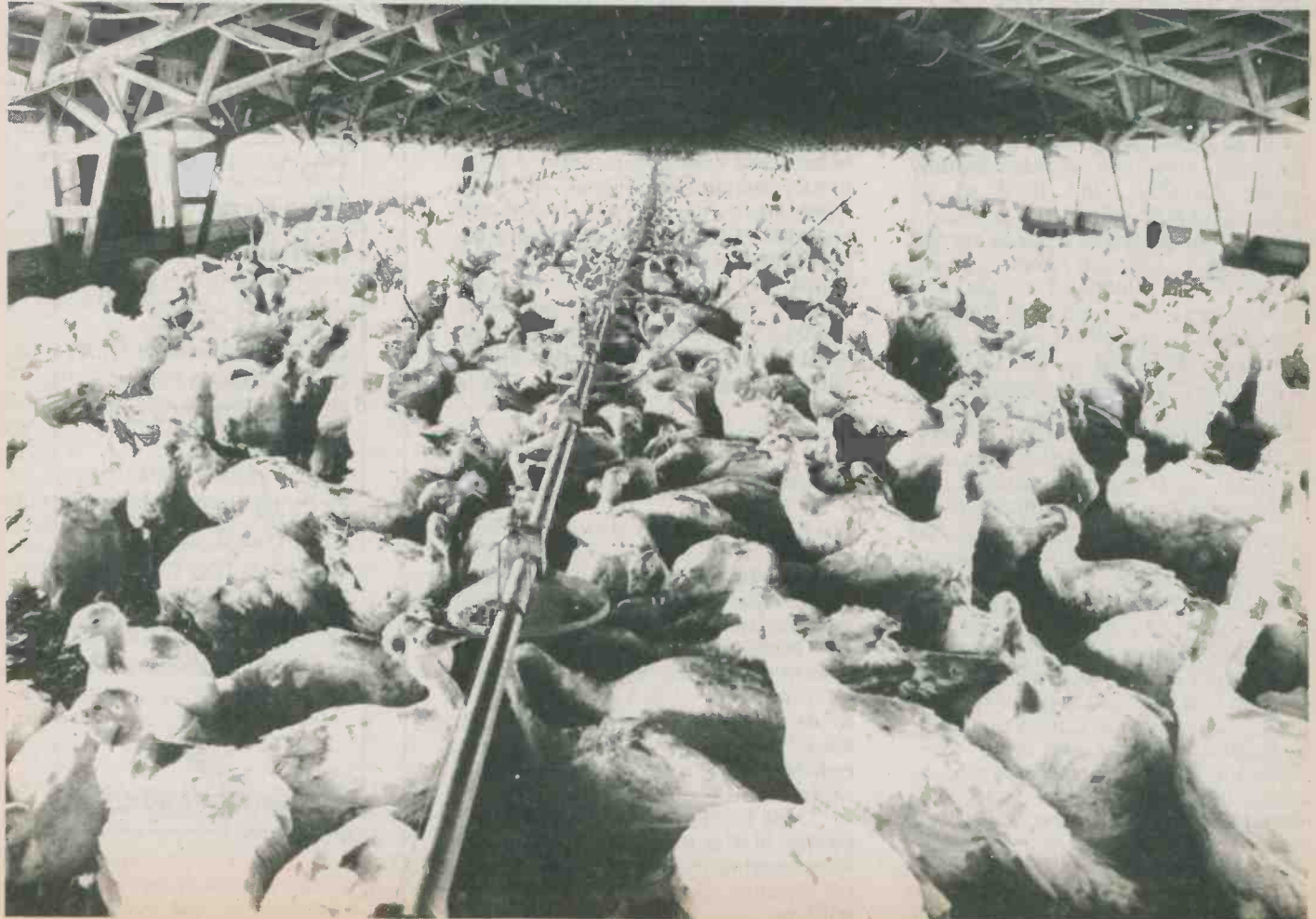

Five thousand turkeys here have their feed ration allocated daily by computer.

Electronics In Farming

the larger applications but the small individual ones created by the lone farmer to suit his own specific needs. While there are some 400 home computers reputedly being used on Ontario farms alone, information about the specific application is a little hard to come by due to the farmer's inherent conservatism and the specific nature of their individual programs. However, a number of typical examples can be cited to indicate what is being done.

One such application involves the raising of turkeys — some 1,000,000 a year where a computer keeps track of feed consumption, cash flow and a number of other factors for 50 to 100 flocks of birds at 20 different locations. The computer used is a **micro NOVA MP/200** microcomputer, with a 10 megabyte cartridge disc subsystem, two DASHER terminals and a modem for remote reporting.

Since 70 to 80 percent of the cost of poultry production is in the feed, this area has the greatest effect on profit and loss. The turkeys are fed 100,000 pounds of feed per day, with the computer making all the calculations to produce efficient turkey rations at the lowest cost. Feed cost, inflation, energy consumption and other seasonal costs are all factored into the equation. The computer monitors metabolic weight gain and feed consumption. The ratio of feed input to turkey weight gain is one of the best measures of successfully turkey farming. One third of all turkeys are sold in the holiday season with the remaining two thirds spread pretty evenly over the remaining year (primarily as luncheon meats and frankfurters). This high peak demand can result in the farm having to borrow some \$200,000 to \$300,000 per week during the holiday season. The computer is also used to keep track of major events in the flock's history, such as changes in medications, and weather, with reports printed for management at regular intervals.

A similar system, Apple based and known as the Natural Language Systems On-Line Animal Housing program (NOAH) is used at the Herbyuck Poultry Ranch. The system controls and regulates the henhouses, turning lights on and off and activating and deactivating the feeding lines. It automatically produces hourly reports on food and water consumption and can provide print-outs at 10 minute intervals. Further, the NOAH system makes the day to day care of the chickens more reliable. Whereas before the installation of the computer a manager would have to climb to the top of the feed bin once a

week and decide visually that he had used, say, two shipments of feed that week. This was not an accurate measure of how much protein each bird was consuming. With an hour by hour accounting generated by the computer, the managers can adjust each chicken's individual feed mix to provide a perfect balance of amino acids.

Another example is the 7,000 acre Lakeside Farms Industries in Brooks, Alberta, which feedlots cattle. At the feedlot, several different relations are produced, to meet different herd requirements for various stages of growth and kinds of cattle. Into each of these go a variety of growth components, silage, barley, surplus vegetable matter along with supplemental ingredients necessary to balance the rations for optimum weight gain and health. For each blend the nutritionist updates and stores ingredient and nutrient constraints applicable to the type of animal and level of performance desired. The available ingredients in response to their nutritive content and respective costs are then combined by the linear program in a least cost formula to meet the specified nutrient requirements of the animal being fed. Careful accounting is necessary in an operation of this type (the profit margin on cattle being so low) because of the nature of the feedlot operation. Cattle are bought in lots and confined to various pens to be fattened before sales and shipment. The computer used, an HP-250, provides daily reports on lot status, pen status and customer status. Daily charges for feed (depending what ration a lot is being fed) veterinary services and 'yardage' (space and handling costs) are calculated on the cattle as they are moved from pen to pen.

Marketing

But raising produce is not sufficient — it has to be sold. An example of the use of computers in the wholesale agriculture business is the meat packing and processing plants.

Perhaps the broadest use of computers in meat processing comes in customer ordering (retail and foodservice) and invoicing. Through links from sales offices to plants, orders are received and filled overnight.

One of the earliest uses of computers in the meat industry was in 'least cost formulation'. In production of comminuted sausage lines including wieners, bologna, specialty

sausage and mini-deli lines, there is usually some flexibility in raw material usage. For example, in wieners, unless labelled as 'beef wiener', the processor can use, within certain guidelines, various meat ingredients such as boneless beef, poultry trimmings and hyphenated. By developing a program of standards for the product (fat, moisture, protein) and placing limits on some ingredients to control colour, flavour, texture and binding quality to acceptable company quality control levels, it is then possible to generate the least cost formulation by feeding into the computer the availability of and price of raw meat ingredients. In the meat industry volume is the key and pennies saved in operations become dollars on the bottom line of the financial statements.

Therefore, it appears that computer use in agriculture is limited by imagination. From determining the genetics of the seed to be used, to calculating planting and harvesting time, accounting, wiener specifications and so on, the computer, while as yet owned and operated by only a small number, determines the quality and price of the food we eat.

ETI

Do You Think You Have Arthritis?

If you think you do, you're in good company. More than three million other Canadians have it too. For the facts about arthritis, arthritis research and treatment programs, contact the office of The Arthritis Society nearest you. It's listed in your phone book.



THE ARTHRITIS SOCIETY

Column Loudspeaker Design

The column loudspeaker is an example of a directional sound source which is of special use if acoustic feedback is a problem; it is most commonly found in sound reinforcement or public address applications. David Hornsby describes a novel design that can be made at a fraction of the cost of its commercial equivalent.

A STANDARD loudspeaker tends to radiate sound in all directions, both forwards and backwards. It is helpful to look at this sort of response on a polar diagram (Fig. 1); the circle round the sound source shows that the sound loudness is about the same in all directions. If the loudspeaker is now placed in an enclosure then sound is allowed to radiate forwards only and we have a 'unidirectional' source. The polar diagram for it in Fig. 2 shows a balloon-like shape for the sound radiation pattern, which now covers an angle of slightly less than 180°. The dotted line shows the response if the enclosure lets a little sound out backwards.

If polar diagrams are new to you, these two diagrams will probably have given you a fairly good feel for what they are all about. They are similar to the contour lines on a map, but instead of showing height they show the sound intensity or loudness. The further the

line on the polar diagram is from the sound source at the centre then the louder the sound is in that direction.

One-Way Sound

The unidirectional sound source is the one most of us use in our homes and cars but it's not very good for live performances where the microphone(s) is in the same area. Diffraction effects, echoes and reverberations all help to spread the sound back from the loudspeaker to the microphone so that as soon as the sound is turned up, positive feedback makes the system oscillate and howl.

There are one or two different solutions to this problem but the most common and probably the best is to use a highly directional sound source. This tends to concentrate the sound into the area where it is needed, the audience, but well away from the microphone.

One type is the horn loudspeaker which has good directional properties and is also very efficient electrically. Unfortunately it has to be physically large to be effective at low frequencies. The fog horn at your local lighthouse (you do have one, don't you) and the PA in a cinema have space for large horn units, but in the domestic scene we either have to use a folded horn design or just use tiny horns for high frequency tweeter applications.

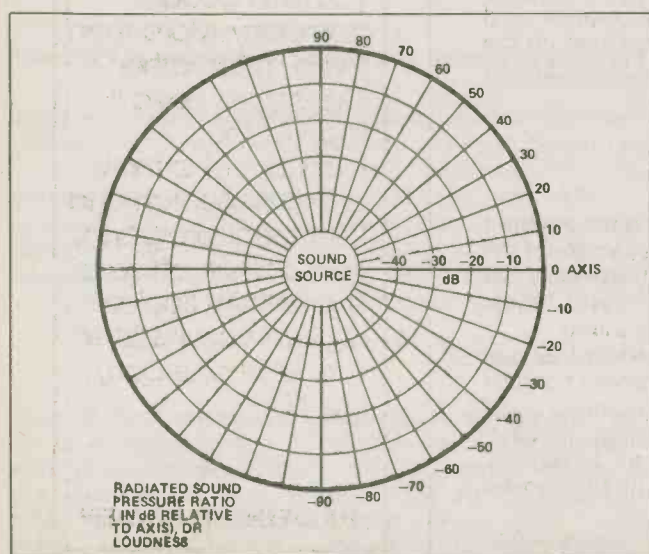

Fig. 1 Polar diagram of a sound source which radiates equally in all directions (approximated by an unmounted loudspeaker). The sound source is at the centre of the diagram.

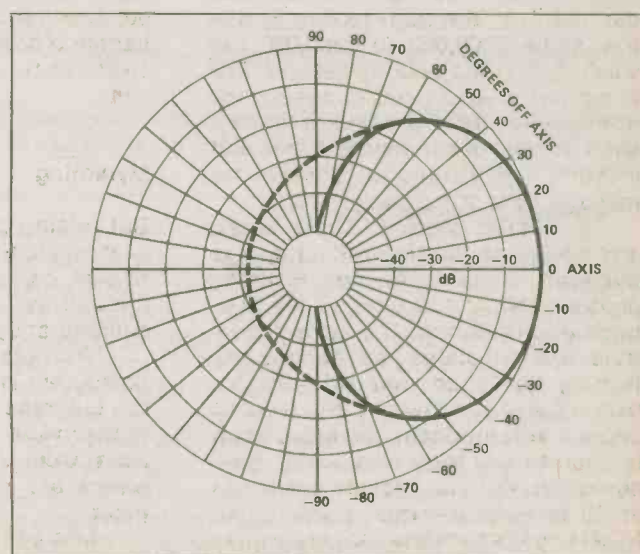

Fig. 2 Polar diagram of a sound source which radiates mostly forwards (approximated by a loudspeaker mounted on an infinite baffle enclosure). If a little sound is allowed out backwards the dotted line applies.

Column Loudspeaker Design

The other directional type of loudspeaker in common use is the 'line source' or column loudspeaker, and that's the one we're going for here. The theory tells us that all we need is a loudspeaker with a cone which is long and narrow, rather like an elliptical loudspeaker taken to the extreme. Put that in a similarly long and narrow enclosure and that should be it! We do still have the problem that unless we allow the length to be at least a few feet then we will lose the beaming effect on the low frequencies, but there's a far worse problem - how do we actually get hold of our crazily-shaped loudspeaker? Does such a beast even exist? Actually it probably could be made with an electrostatic speaker but that's not for us. Instead we can approximate a line source with several conventional round speakers stacked in a line. Commercial designs use three or more,

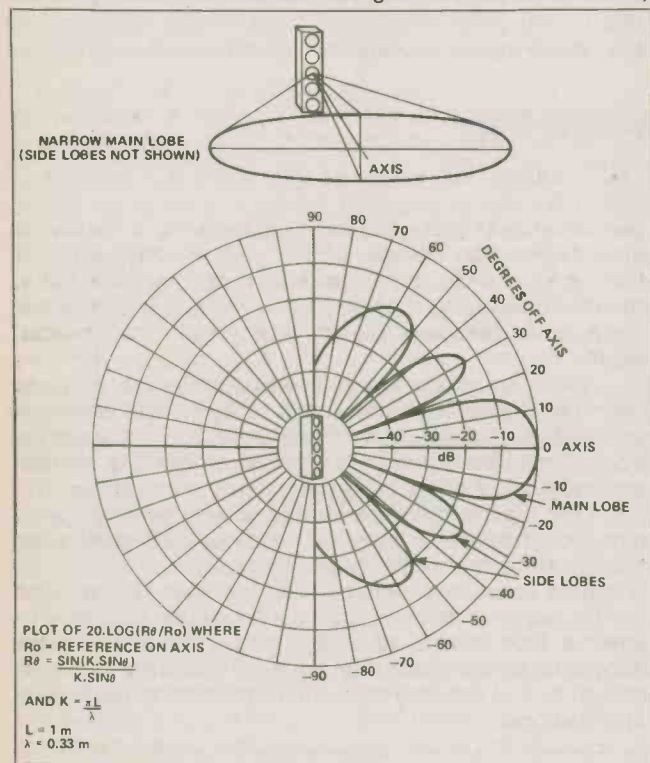

Fig. 3 Polar diagram of a column loudspeaker at 1 kHz.

often quite a few more, and this works well. Our design uses five speakers spaced evenly along an enclosure of one metre length.

Directional Characteristics

It is at this stage that we must look again at a polar diagram for our design, Fig. 3, and this is where this diagram begins to give us some useful information. The first thing to note is how the shape is drastically changed from a balloon to a series of fingers of various sizes. The largest finger is the main beam or lobe of our column loudspeaker while the smaller fingers are unwanted side lobes. If you have seen interference patterns on a ripple tank then you will probably understand the reason for this sort of pattern. To improve the directional properties of the speaker system still further, we want to reduce the side lobes and enlarge the main lobe. It would probably also be useful to have a slightly broader main lobe, since it is unlikely that we can arrange for the audience to be confined into too narrow a region.

Without going into all the math of the solution, both these aims may be reached by a process known as 'grading' or 'tapering' the aperture. This is a little trick that is used in all sorts of situations, not just column loudspeakers. Microwave dish aerial systems often do just the same, for example. In our case, tapering the aperture simply means that we must arrange to evenly decrease the power fed to each of the individual loudspeakers as we move away from the central one on the column. The effect of this is shown in Fig. 4. Note that these diagrams both apply only at one frequency, 1000 Hz. At higher frequencies the lobes are narrower and more numerous, but they become wider and less numerous at lower frequencies until below about 500 Hz, the wavelength of sound is comparable with the length of the column and the beaming effect begins to

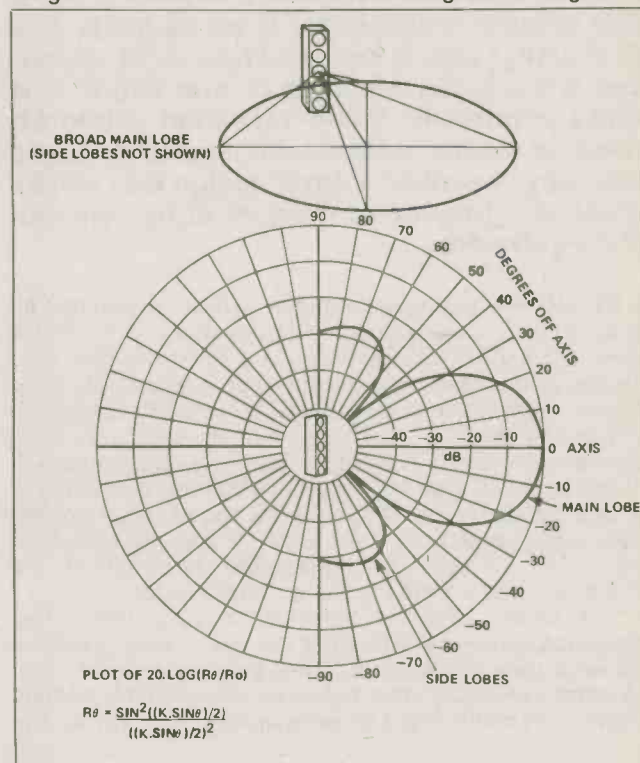

Fig. 4 Polar diagram of a column loudspeaker at 1 kHz with graded aperture.

fail. Fortunately acoustic feedback is likely to be worst at frequencies well above 500 Hz so one metre is as long as we need to make the column.

You may occasionally come across giant column loudspeakers which are also curved so that they look concave from the listener's vantage point. This produces the same effect as tapering but is not necessary except for systems much longer than one metre.

Electrical Design

So now a way of arranging the power feed to each speaker has to be devised. If series resistors of appropriate values are wired in with the speakers, then, although things work well enough acoustically and electrically, we will have an inefficient design which wastes much of the power of the amplifier as heat in these resistors. The common commercial solution is to forget about tapering altogether, or for expensive units to use a special matching transformer with tapings for each individual speaker. This not only adds to the cost

but also to the weight of the final product. Don't forget that no transformer has yet been designed which gives zero distortion, so that's yet another problem. While pondering this (in the bath — where else!) the author devised what seems to be a splendid engineering solution; that is, one that cheats the situation by winning several points at one go but without making any serious concessions. The key is to use identical speaker units but with different coil impedances. After many calculations with a range of different combinations, one design stood out as being almost ideal. It produces an effective impedance of 6.15 ohms, gives an even tapering and uses just 8 ohm and 15 ohm speaker units which are readily available.

The electrical set-up is given in Fig. 5 and for nominal 10 W units produces a speaker system of 25 W capability. The actual make of loudspeaker unit doesn't really matter provided you can get both 8 and 15 ohm units in the same style. The original design used wide-range six-and-a-half inch loudspeakers which have given reliable service for over four years now. Some may

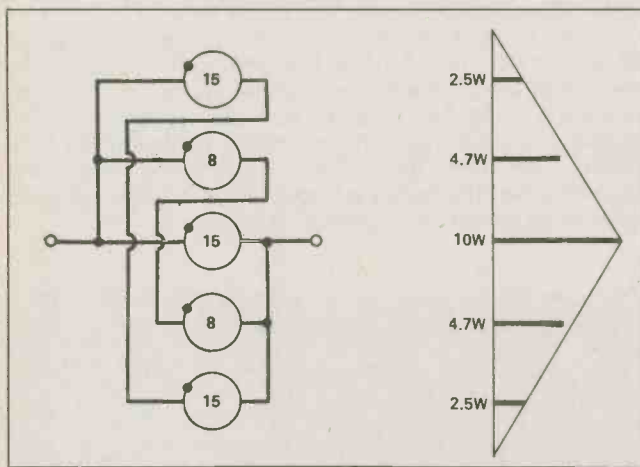

Fig. 5 The wiring diagram for the 8 and 15 ohm speakers. Note how each speaker is wired in phase. For 10 W speaker units the power handling is about 25 W (actually 24.375 W). At right is shown the profile of the graded aperture.

object that five 10 W speakers ought to give a system capable of more than 25 W. It is, of course, the tapering of the system which causes this reduced power rating, but its electrical efficiency is fair and there is no real problem. It is in fact possible to rewire the individual units so as to increase the power rating to 40 W, as shown in Fig. 6, but the tapering goes out of the window with this arrangement and it is not recommended.

Calculations show that the series/parallel combination of speaker units in our design gives an effective impedance of 6.15 ohms. This is just about ideal and suits the 4 to 8 ohm range that most power amplifiers are designed to feed. If you happen to have one which cannot drive impedances less than 8 ohms then you will need to add a 2 ohm series resistor to get things right. However, most column loudspeakers are necessarily mounted some distance from the amplifiers and the leads' resistance may provide some or all of this extra 2 ohms if you are lucky.

A Case In Point

The cabinet for the design may be made from chip-board. Three-quarter-inch thick is about the right grade for this job. If you are going to use six and a half inch

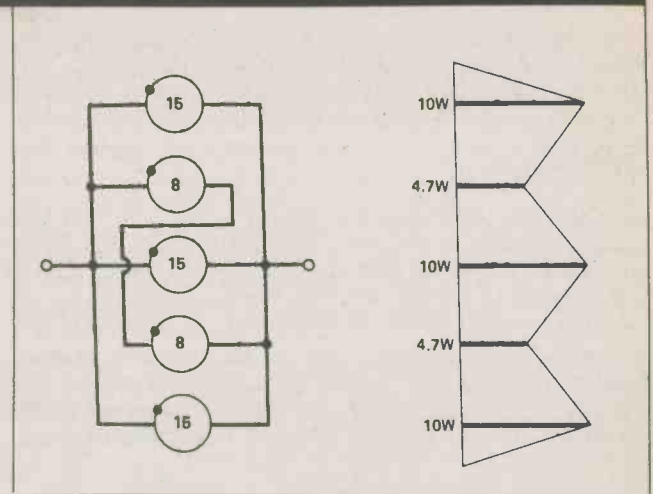

Fig. 6 An alternative way to wire the speakers. This gives a power handling of nearly 40 W but is not recommended as the aperture is not correctly graded. The profile of the aperture is irregular, as shown.

units then, provided your woodworking skills are fair, it is only necessary to refer to Fig. 7 for all the details. If you have or can gain access to a circular saw (what about woodwork evening classes?) the task is that much easier. None of the dimensions are that critical, but the overall volume has been designed to match the suspension characteristics of the speakers themselves and should be kept the same. The unusual cross-sectional shape is not an essential part of the design either but was chosen so that the column could be neatly and permanently mounted on a wall and still point-in the right direction. If your intended use is stage work then a square or rectangular cross-section giving the same volume would be easier to make.

Take care to close all joints with enough glue to make the unit reasonably airtight since this is a requirement of this type of speaker unit's cone suspension. The inside of the cabinet is filled with acoustic wool or similar sound-absorbing material so as to reduce internal sound reflections which otherwise give an unnatural colouration to the performance. I once knew a musician who insisted that internal lining of an enclosure reduced the high frequency response, but he had simply come to enjoy a particular type of distortion — don't leave it out! The best way to fix it is to tack it on lightly before the front is put on the enclosure. If it is not fixed it will soon fall to the bottom and lose most of its effect; if it is glued it tends to become compressed on to the glue which again cuts down on its absorption properties. Similarly, use a proprietary make of grille material for the front rather than any old material or again you will distort the sound. Most probably it will be the high frequencies that you lose this time if you are tempted to use the spare curtains because they are the right colour!

If the final unit is to be attached to a wall, a small screw recess can be provided near the top of one side for this. Most ironmongers stock screw-on brass plates that are ideal as a reinforcement for this. Don't forget to provide electrical connections on the back before the unit is assembled. Suitable types are available from the same sources as supply the acoustic wool and grille material (and the speakers themselves for that matter). The finish on the outside of the cabinet is obviously a matter of personal choice. If you wish to make a feature of it you can use a wood veneer or vinyl covering to

Column Loudspeaker Design

achieve a smart appearance. The original design was made to appear unobtrusive (if that's not a contradiction in terms) by simply painting it the same colour as the wall it was to hang on, and this worked very well.

Performance

In assessing how well the design works we must first decide what it is we are looking for. With a speaker system intended for hi-fi applications we might look at the frequency response and phase linearity, for instance, but this design is for sound reinforcement pur-

Judged by these standards the final product is totally effective; the beaming effect is very noticeable. When it was tested in the living room at home before installation the sound appeared to be thrown forwards towards the listener in a way that the conventional speaker cannot achieve. With a pair of speakers now hanging on side walls each side at the front of the church, their base being six feet from the floor and the axis of each speaker pointing towards the floor at the mid point of the back wall, the comparison with the old temporary single speaker units is really quite spectacular. At the front of the church the sound is beamed high over people's heads and so is not deafeningly loud. At the back, however, the beams reach down to ear level and the sound seems every bit as loud as at the front even though you are further from the speakers. What is more, the sound, particularly speech, is strangely clearer. The effect is perhaps not unlike that in the Whispering Gallery in St. Paul's Cathedral, where you might be surrounded by background noise yet can hear a whisper with startling clarity from a spot exactly opposite. The speakers do not whisper but the sound seems to surround you in the same way.

The power handling of the column loudspeaker, 25 W, is more than adequate. The two units are driven by mere 15W amplifiers but even these are never turned up anywhere near full volume. Acoustic feedback is no longer a critical problem, no mean achievement in a stone church building. The improvement is so pronounced that the music group now need to be provided with extra speakers to provide foldback.

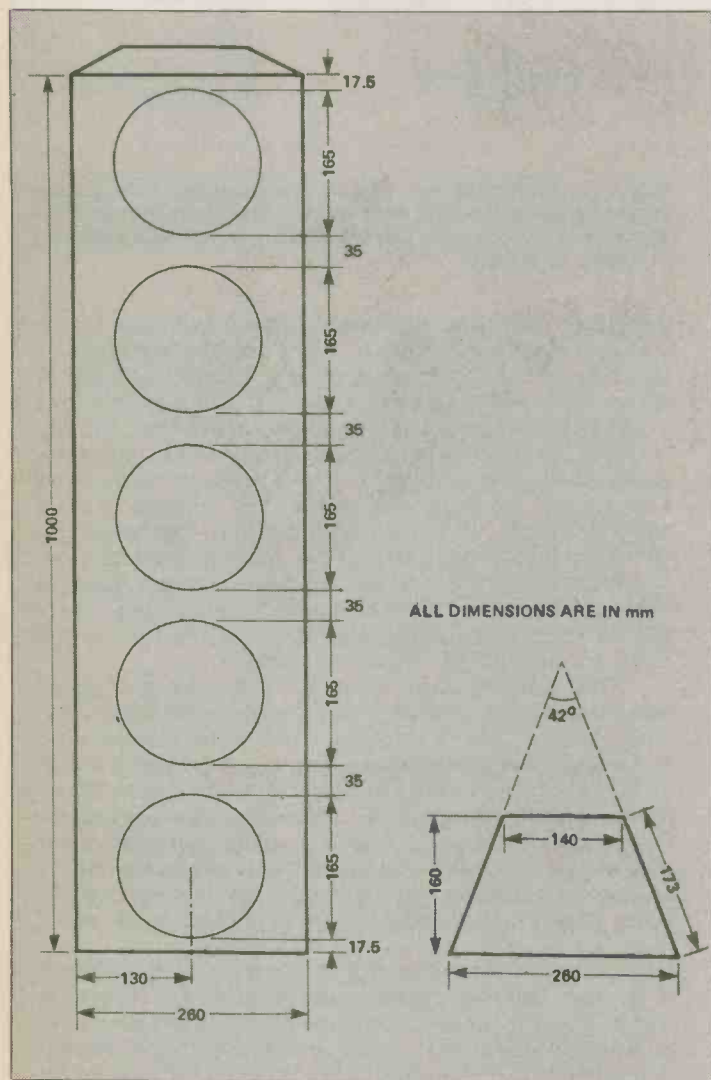

Fig. 7 Cabinet details — all dimensions are in millimetres. The total cabinet volume is 0.324 cubic metres. A suitable material to use is $\frac{3}{4}$ " chipboard and this thickness needs to be added to the dimensions shown where appropriate.

poses. The chief needs are to reduce acoustic feedback by efficient beaming of the sound and to improve the audibility of whatever is behind the microphone. The design was originally made to meet the needs of a church of moderate size (about 50 by 30 feet) for both music and singing from the music group at the front, and for speech from the pulpit (but not both at the same time!).

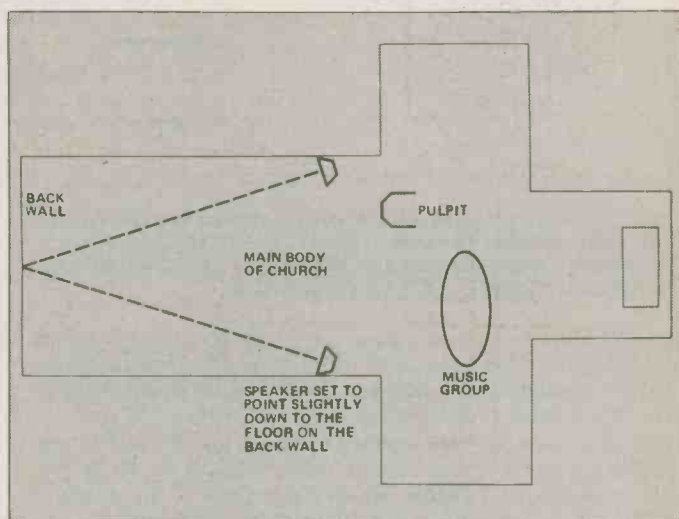

Fig. 8 The working layout of the speakers in the church.

The frequency response of the units is essentially that of the individual loudspeakers — about 70 to 16 kHz for the author's column. Purists will notice and object to the lack of the extreme high frequency element, but this is unimportant in this application. In fact a design of this type will have rather better characteristics than the straight theory predicts since the matching of the system to the air is improved with the larger surface area of many loudspeaker cones. At low frequencies in particular it appears the response goes down well below 70 Hz although no measuring

Continued on page 38



next month

Starlab

This joint Canadian/Australian project will at least get to *look* where no man has gone before. Above the haze of the Earth's atmosphere this observatory will be able to see stars never found by terrestrial telescopes. Sort of an intergalactic peeping tom, y'know?

Plus!

SuperFET!!!

Ultra Scale Project!!!

Mega Designer's Notebook!!!

Giga dbx Noise Reduction Explanation!!!

Nano Staples (just the two of them, actual)!!!



ZX81

ZX-81 Printer

Like the Sinclair computer, the ZX-81 printer is small and really rather clever. Its printouts are distinctive . . . they're silver . . . and it is very low in cost compared to other printers. A tractor feed is probably never going to be available, and no one envisions a daisy wheel version in the near future. What is happening with this little brute will be given a good scrutening next issue.

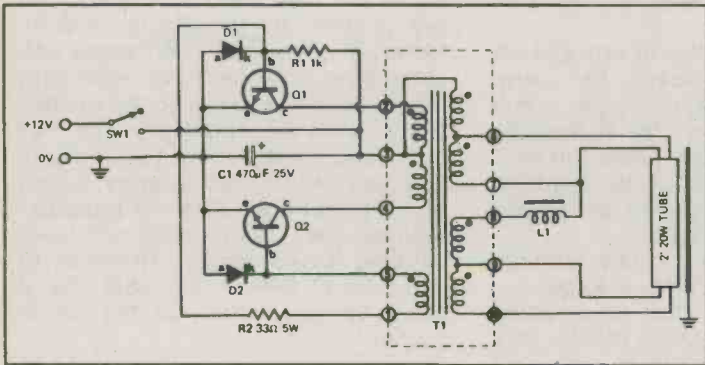

Light and Power From DC

Have you ever been out in the wilderness with nothing but your wits and a few car batteries and said to yourself "Gee, it'd sure be nice to be able to listen to my stereo before the bears eat me"? Sure, it happens to all of us. Next month we'll look at how to run line powered devices from batteries and other DC sources.

Dual Logic Probe Project

A logic probe can often tell you as much about a digital circuit as a 'scope could have. However, a logic probe doesn't cost as much as a 'scope, doesn't weigh as much as a 'scope and is much easier to use. Sadly, it doesn't have as many knobs to impress the relations, but life is full of this sort of hardship. Next month, we'll be presenting a logic probe project. There will also be 'scope ads, for those who aren't convinced.

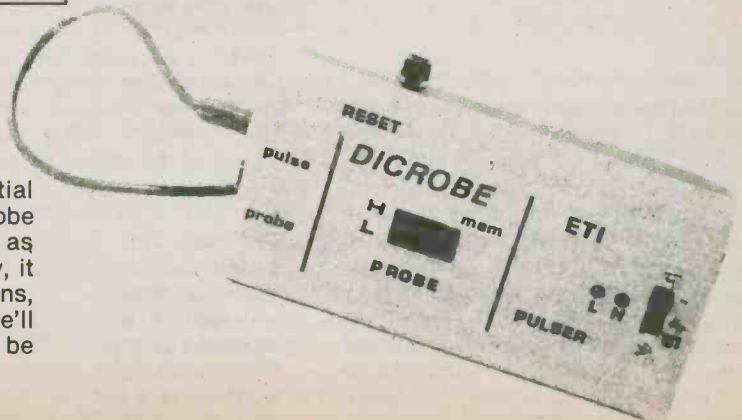

CP/M for Apple

Give your Apple II schizophrenia ... get it running DOS and CP/M. By Steve Rimmer.

THE DOS ON THE APPLE II is one of the oldest ones still extant. It's actually pretty clever in places, but there are a lot better packages around now. The same is true of Applesoft BASIC ... if you've ever worked with one of the large Microsoft disk BASICs you'll find Applesoft a bit limited. The Apple, however, is a very powerful computer, and with the advent of the Apple clones that have cropped up recently (see ETI December '82) it has become extremely approachable as a low cost system, too. However, there are these limitations.

Consider the noble Apple. It has high resolution graphics, a good sturdy hardware design, the power supply, keyboard ... everything's there. It just needs more up to date software. Well, how about something better, then, like CP/M.

Yes, you say, that's nice. However, last we heard CP/M ran under the auspices of the Z-80 chip, and the Apple is a 6502, right? This is true. At the moment, your standard Apple runs under a 6502 processor. However, it needn't always be that way. It is possible to convert the Apple into a friendly powerful dual processor system. All you need is ... the card.

Uhm, and the disk. We'll get to that.

The Card

One of the Apple pirate peripherals that has cropped up of late has been the Z-80 Softcard. Originally designed by Microsoft, it is now available in the cheap and sleazy no-name versions we've come to know and love. You can debate the ethics of this for yourself. The bare board usually costs about twenty bucks, and there is another twenty five dollars worth of parts required to stuff it. There are no EPROMs on the board ... everything's in the software.



Stuffing the card is dead easy. About the only even mildly difficult part to find for it is the four section DIP switch and this can be omitted for most normal applications of the thing. There are seventeen chips, including the Z-80 processor chip itself. The card runs at 2 MHz, so even this isn't real critical.

The card can live in any slot on your Apple II except for zero, although there seems to be some mythos concerning the favourable auspices of slot four. When the card is selected, a red LED protruding from the top will be illuminated, telling you that everything's cool.

In order to get the card running, you will require a CP/M package written for the Apple. This is available through several dealers. Please note that the legality of copying the card itself may be a hazy issue, but the CP/M is a proprietary trip of Digital Research and Microsoft, who packaged it up for the Apple. As such, if you buy it from a ROM bandit or other figure of the shadows, you are clearly violating copyright.

The CP/M is rather expensive, to be sure, but it adds unspeakable power to your system, and is unquestionably worth it.

Getting from DOS into CP/M is splendidly simple. You just put the CP/M disk into yonder drive 1 and boot. After a few seconds of whirring and clanking the Applesoft prompt

will be replaced with the familiar A► of CP/M, and you're ready to rip.

What You Get

All of the CP/M commands normally found on dedicated Z-80 packages are present in the Apple version. However, there has been some patching done to make things work with the 40 column screen, so the display is attractive and readable. The DIR command produces a two column directory in the pristine state, which is just about right. A few of the other utilities, like DUMP, have not been patched for 40 column. However, in the case of DUMP, the ASM file is given so you could do the patch yourself.

So, what you actually get is all of the following stuff:

APDOS	This program allows transferring files from DOS to CP/M ... providing you've got at least two drives.
ASM	A complete and rather superb Z-80 mnemonic assembler.
CONFIGIO	This program lets you set up the parameters of the peripherals used by CP/M. For example, if you use an 80 column card you can make the

screen 80 column wide. You can assign the CP/M peripheral calls where you want them, and so on.

COPY This program is for copying files between disks. Now, if you have two drives, PIP will do some of this for you. However, you cannot move the CP/M system around, which is a major hassle. The one thing the package does seem to lack is SYSGEN. This can be overcome with COPY. COPY A:=A: will copy the whole disk, allowing disk swapping as you go. COPY A:=A:/S will copy just the system.

DOWNLOAD Now this is civilized. It lets you transfer CP/M files between two systems. There is also an UPLOAD.

DDT A Z-80 program debugger and artificial runtime environment. It also disassembles.

DUMP Takes a file and prints it to the screen as hex numbers. It's actually not too useful, as it doesn't show you the printable ASCII characters alongside the hex. I use a public domain program called LOOK to do this.

ED This is the CP/M contextual file editor. It's a bit of a vegetable, actually, but it'll do in a pinch for editing code files if you haven't got a word processor.

FORMAT Formats disks prior to putting data on 'em.

GBASIC A Z-80 BASIC specially written to take advantage of the Apple's high resolution graphics facilities.

LOAD Takes the hex files created by ASM and makes loadable, runnable machine language programs.

MBASIC A somewhat smaller Z-80 BASIC written for the Apple but only having low resolution graphics facilities.

PIP This moves files between the system peripherals. Usually

this involves the disks, but it can also deal with ports, the printer, the screen and so on.

RW-13 Lets you get data from a 13 sector disk onto a 16 sector disk.

STAT This program basically tells you how much space is left on the disk, but if you get into figuring out what all the options mean you can find out quite a lot more with it.

SUBMIT This little fellow lets you use files of command names to batch together other programs.

In addition to all of the above splendor there are the six CP/M built in commands,

DIR Show a directory of what's on the disk.

ERA Kill a file

REN Rename a file

SAVE Make a file out of the contents of a specified number of pages of RAM.

TYPE Print a text file on the screen.

USER Move around user areas on the disk. I can't exactly say what this is good for.

Without exception, all of the commands and programs worked just as they do on dedicated CP/M systems, with the exception of the forty column-ness previously mentioned.

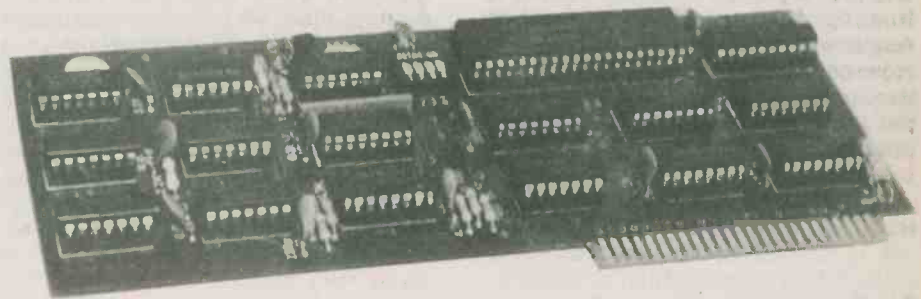

What Can You Do

The obvious advantage of CP/M is that you can run CP/M based programs. There is lot of free stuff available for this format, and the paid for material is very good . . . it's been written for a huge market. The few common programs that are a little system specific . . . MODEM7, for example, or WORDSTAR, are actually available in dedicated versions for the Apple II running CP/M.

However, the immediate advantage to the Apple user will be the incredible quantum leap in the power available for BASIC programming. The BASICs included have features like automatic line numbering and renumbering, paddle sensing without PEEKing around in RAM, CHAINing, a real live *decent* program editor, PRINT USING, which will format text on the screen without a lot of VTAB and HTAB machinations and the ever useful WHILE/WEND loop.

There will also be a few immediate disadvantages to the Apple II user . . . all of which can be overcome, but they do pose some minor hassles. The first is that these BASICs are LARGE. Truly. When you run GBASIC on a 48K Apple you get five whole kilobytes of RAM to play with. While you can, of course, do a lot of CHAINing, it is far better to get a 16K language card, bringing the system's RAM complement up to a full house and availing you of a lot more programming space. Then too, a few of Applesoft's features have been omitted, most notably those dealing with high resolution shape tables, requiring some changes in strategy when slipping from Applesoft into MBASIC.

The BASIC is extremely good, though . . . it is fairly fast for its size and exhibits no bugs or nasties. There is a lot more flexibility in accessing the disks, a serious limitation under DOS. You can even use the 6502 while running under the Z-80 . . . we'll leave just how for another day (it's tricky). However, this can avail one of a system with the advantages of two processors in one box. The rich

instruction set of the Z-80 can be combined with the speed of the 6502 for a really high powered machine.

Of course, Applesoft is still available at any time. Adding the Z-80 card involves absolutely no hardware changes aside from just plugging in the card. Deciding whether you are using DOS or CP/M is just a matter of booting with the appropriate disk . . . there aren't even any grimy toggle switches to meddle with. Under DOS, the Apple behaves like it always did,

CP/M for Apple

with no notion that the second processor is even in there.

The only serious limitation of the whole mess are the disk drives themselves. Even using a sixteen sector system, you can't get nearly as much stuff on an Apple's 5¼ inch disk as you can on a big eight inch floppy. Unfortunately, CP/M was designed to run in an eight inch environment, and, as such, its designers made it a little hungry for disk space. For example, when ASM assembles a text file it generates several other files, one of which may be bigger than the original. In the end, all of these files get erased, but you still have to have lots of headroom in the mean time. Thus, really massive files may be a problem, and you should expect to do a lot of disk swapping.

The Apple is, for most users, traditionally a one drive system. CP/M is very dependant on having two for some of its operations. It'll get by without the second one, to be sure, and you'll be able to do a great deal with a single drive Apple under CP/M. However, be prepared for a yearning for additional hardware.

If you are a dedicated Apple owner or you've just gotten into this system due to the recent availability of the much acclaimed raiders of the



orchard, adding the facility of CP/M will be a very worthwhile investment. The cost has never been lower, and the potential of it is growing all the time.

For those interested in whether all this fake hardware actually works, the following stuff was involved in this article. The Apple board itself was a converted

Eurapple. The disk drive is one of Exceltronix's house brand deals. The Z-80 card came from Parts Galore, as did the disk drive controller. Despite its varied origins everything worked right out of the box and hasn't hiccupped once. The counter dudes of both places were most helpful in getting all of this together.

ETI

Designer Circuits

A TREBLE BOOSTER circuit can be used with a guitar, and other electronic musical instruments, to boost a range of the higher order harmonics and give a more "brilliant" sound. A circuit to achieve this has a fairly flat response at the bass and across most of the middle frequencies while the upper middle and most of the treble frequencies are given a substantial gain boost.

The circuit is basically just an op-amp (IC1) used in the non-inverting amplifier mode. The non-inverting input is biased by R4 and R5 via a decoupling network which is comprised of R3 and C3. C4 and C5 give dc blocking at the input and output respectively. With SW1 open there is virtually 100% negative feedback through R1, R2 and C1, giving the circuit unity gain and a flat response. Closing SW1 brings C2 into circuit, and this decouples some of the feedback through R1 and R2 at frequencies of more than a few hundred Hz, giving the required rising response.

Feedback through C1 at high treble frequencies causes the response to fall away above about 5.5 kHz, and

prevent the very high frequency harmonics from being excessively emphasized.

As the unit has unity gain at frequencies where boost is not applied it can simply be connected between the instrument and the amplifier.

It is normal to give only a modest amount of emphasis to the upper-treble in order to get good stability and a low noise level. This also prevents the output from sounding too harsh. The frequency response of this treble booster is shown in the accompanying graph.

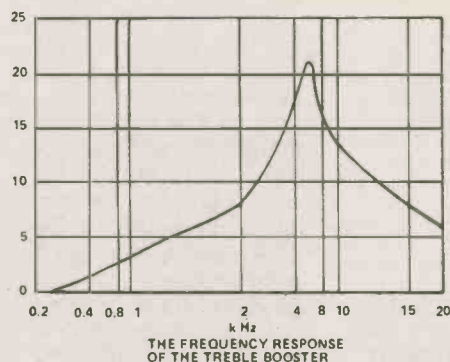

741C TOP VIEW

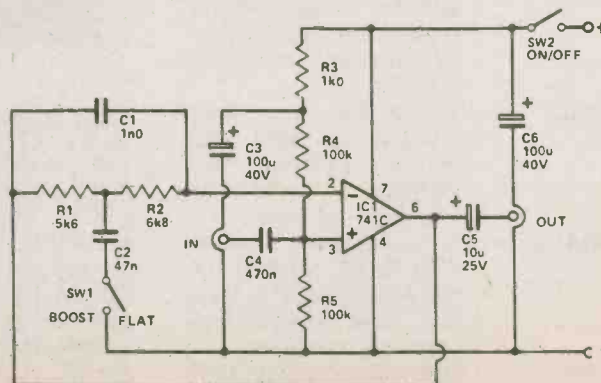

This third listing of Electronics Stores in Canada has been compiled from our own lists and with the cooperation of several subscribers to the magazine. They were asked to supply details of their local stores or any that they purchased from. We then wrote to all stores and this listing is what they supplied; the wording and the details are those given to us by stores.

Directory of Electronic Stores

KEY	
ETI	ETI Magazine sold here
EC	Supplies Electronic Components
RTV	Sells Radio and TV parts
TG	Sells Test Gear
EK	Sells Electronic Kits
MO	Company does Mail Order
CAT	Catalogue available. The cost of this, or If It Is free, is shown

BRITISH COLUMBIA

Nanaimo

Queale Electronics Ltd.

1925 Bowen Rd., Nanaimo, B.C. V9S 1H1 (604) 758-8166

EC, RTV, TG, EK, MO

Broad line distributors, all phases of electronics parts, equipment consumer & industrial plus audio visual.

Trall

IUS Electronics Ltd.

P.O. Box 81, Trall, BC V1R 4L3, (604) 364-2786.

EC, MO, CAT, Free

Specialise in Speaker Kits, Finished Speakers, and Raw Drivers. (VISA, MC, ETC.).

Vancouver

Active Component Sales Corp.

3070 Kingsway, Vancouver, BC, V5R 5J7 Tel. (604) 438-3321.

EC, RTV, TG, MO, CAT, Free

Semiconductors, Microprocessors, Microcomputer boards, Potentiometers, Switches, Knobs, Sockets, Cable and Wire, Power Supplies, Data books, Meters, Duracell, OK Tool, Weller, Xcelite, Vector, AP Products, Ungar.

Cam Gard Supply Ltd

2055 Boundary Rd, Vancouver, British Columbia. V5M 3Z2. Tel. (604) 291-1441.

EC, RTV, TG, EK, MO, CAT

National supplier of electronic parts and components. Amphenol, Beckman, Belden, Buss Fuses, Delhi (General Instrument), Hammond, ITT Components, Mallory Duracell, Philips, Potter & Brumfield, Spectro, Westinghouse, Xcelite, 3m Cable & Connectors.

Contl Electronics Ltd.

7204 Main Street, Vancouver, B.C. V5X 3J4 Tel. (604) 324-0505

EC, TG, MO

AP Products, Armaco, Commodore Business Machines, EZ Hook, Fluke, GC, Plessey, Sanken, Silicon General, Synertek and more. (Line card available), NEC, EPSON, TEC, Mannesmann Tally.

Glenwood Trading Company Limited

278 East First St., North Vancouver, BC V7L 1B3. Tel. (604) 984-0404

TG, MO, CAT (Free)

Canada's largest mail order supplier of amateur radio equipment, accessories, antennas, books. Microphones, power supplies, receivers, rotors, transceivers.

Heathkit Electronic Centre

3058 Kingsway, Vancouver, B.C. V5R 5J7

EC, RTV, TG, EK, MO, CAT, FREE.

Heath/Zenith self-instruction courses. Earth satellite receiving stations, Heathcraft Furniture line, Digital products for home, car and boat, Amateur Radio Equipment including antennas Shortwave, Radio, Control, Marine, TV and Audio equipment, Automotive test equipment. Over 400 kits to choose from.



Intek Electronics Ltd.

10 — 8385 St. George St., Vancouver, B.C. V5X 4P3 Tel. (604) 324-6831 Telex: 037-2970 TWX: 610-831-1101

EC, MO

Alpha, Beckman, C&K, Dale, Duracell, Exar, Hutson, I.E.E., ITT, Kester, Littlefuse, Mallory, Midtex, Motorola, National Semi, Opto-22, Philips, PMI, Robinson Nugent, Schroff, Sheldahl, Teledyne, Wescorp, (Visa).

ALBERTA

Calgary

Active Component Sales Corp.

5809 MacLeod Trail S., Unit 109, Calgary, Alberta, T2H 0J9. Tel. (403) 259-6437.

EC, RTV, TG, MO, CAT, Free

Semiconductors, Microprocessors, Microcomputer boards, Potentiometers, Switches, Knobs, Sockets, cable and wire, Power Supplies, Data books, Meters, Duracell, OK Tool, Weller, Xcelite, Vector, AP Products, Ungar.

B & E Industrial Electronics

444 Manitou Rd. S.E., Calgary, Alberta T2G 4C4

Tel. (403) 233-7211

EC, RTV, TG, MO

CARDINAL

Industrial Electronics

Edmonton: 10630-172 St. (Box 12000)
T5J 2P4 (403) 483-6266 Telex
037-2372

Calgary: 10-5920-11St. NE T2H 2M4
(403) 259-6817 Telex 038-27992

*STOCKING: Alpha, Agastat, Amphenol, Amprobe, B&K, Bleden, Buss, EECO, Fluke, Gen. Inst., Hammond, P&B, Microswitch, Rockwell, Siemens, Intersil, Teccor. Semis; CMOS, TTL, LS & more.

Cardinal Industrial Electronics Ltd.

10 — 5920 — 10th St. S.E., Calgary, Alberta T2H 2M4 Tel. (403) 259-6817

EC, RTV, TG, CAT, \$10.00 (Free on company letterhead requests)

Hammond, Rockwell, Intersil, P & B, Amphenol Weller, B & K, Belden, Alpha, Microswitch.

Cam Gard Supply Ltd.

640 - 42nd Ave. S.E., Calgary, Alberta. T2G 1Y6. Tel. (403) 287-0520.

EC, RTV, TG, EK, MO, CAT

National supplier of electronic parts and components. Amphenol, Beckman, Belden, Buss Fuses, Delhi (General Instrument), Hammond, ITT Components, Mallory Duracell, Philips, Potter & Brumfield, Spectro, Westinghouse, Xcelite, 3m Cable & Connectors.

Heathkit Electronic Centre

101 - 5809 Macleod TR 5, Calgary, Alta, T2H 0J9 (403) 252-2688

EC, RTV, TG, EK, MO, CAT, FREE

We sell in kit form computers, ham gear, stereos, wind instruments. (weather).

Visions Leisure Electronics

232 — 7th Avenue S.W., Calgary, Alberta, T2P 0W6. Tel. (403) 233-2249.

RTV, MO, CAT, Free

Visions is a specialty video, electronics and video retailer. Major lines carried: Exidy, Atari, Mattel, Magnavox, Electrohome, C.Itoh and Hitachi. Sister company Spectra Electronics is Canadian distributor for Exidy Data Products Inc.



R-A-E Industrial Electronics Limited

3455 Gardner Court, Burnaby, B.C. V5G 4J7 Tel. (604) 291-8866

EC, RTV, TG, EK, MO, CAT, \$12.00 (Free on company letterhead requests)

Western Canada's leading Electronics Distributor. Over 160 Product Lines, including AMD, Belden, Beckman, B&K, Hammond, Mosftek, National, RCA etc. Books, Hardware, PROM Programming, Cable assemblies.

Victoria

Queale Electronics Ltd.

1004 North Park Street, Victoria, British Columbia. V8Z 2E6 Tel. (604) 388-6111

EC, RTV, TG, EK, MO.

Broad line distributors, all phases of electronics parts, equipment consumer & industrial plus audio visual.

Directory of Electronic Stores

Edmonton

Cardinal Industrial Electronics Ltd. ETI
10630 — 172 St., Box 12000, Edmonton, Alberta
T5J 2P4 Tel. (403) 483-6266

EC, RTV, TG, CAT, \$10.00 (FREE: on company letterhead requests.)

Sales area — Alberta, Saskatchewan, British Columbia and the Territories. Hammond, P&B, Fluke, Amphenol, Intersil, Weller, B & K, Belden, Alpha, Microswitch and many others. Call us.

Cam Gard Supply Ltd.

16236 - 40 - 116 Avenue, Edmonton, Alberta.
T5M 3V4. Tel. (403) 453-6691.

EC, RTV, TG, EK, MO, CAT
National supplier of electronic parts and components. Amphenol, Beckman, Belden, Buss Fuses, Delhi (General Instrument), Hammond, ITT Components, Mallory Duracell, Philips, Potter & Brumfield, Spectro, Westinghouse, Xcelite, 3m Cable & Connectors.

Heath Company

12863 97th St., Edmonton, Alberta T5E 4C2 Tel.
(403) 475-9331

TG, EK, MO, CAT, FREE
Shortwave Radios, Amateur Radio Equipment, Radio Control Equipment, Marine Equipment, Video, HI-Fi and other kits.

Intek Electronics (Alberta) Ltd.

4616 - 99 Street, Edmonton, Alberta. T6E 5H5.
Tel. (403) 437-2755.

EC, RTV, TG, EK, MO
Motorola, Harris, Silicon General, ITT, National, Hutson, PMI, Philips, Sprague, Beckman, CTS, Dale, Mallory, Rubycon, Evox, Stetner, Piher, 3m Alpha, C&K and IEE, Littlelite and Littlefuse.

R-A-E Industrial Electronics Ltd

11680 — 170th St., Edmonton, Alberta T5S 1J7
Tel. (403) 451-4001, 1-800-661-7224

EC, RTV, TG, EK, MO, CAT, \$12.00 (Free on company letterhead requests)
Western Canada's leading electronics distributor. Over 160 product lines including AMD, Belden, Beckman, B&K, Hammond, Mostek, National, RCA, etc. Books, Hardware, PROM Programming, cable assemblies.

Red Deer

Cam Gard Supply Ltd.
#5 - 6841 - 52nd Avenue, Red Deer, Alberta.

T4N 4L2. Tel. (403) 346-2088.
EC, RTV, TG, EK, MO, CAT
National supplier of electronic parts and components. Amphenol, Beckman, Belden, Buss Fuses, Delhi (General Instrument), Hammond, ITT Components, Mallory Duracell, Philips, Potter & Brumfield, Spectro, Westinghouse, Xcelite, 3m Cable & Connectors.

Whitecourt Electronics

P.O. Box 68, Whitecourt, Alberta T0E 2L0.
MO, FLYER, \$1.00

Flyer contains 5% credit for first order. Mail order only. Surplus. Excellent service — orders shipped five days a week. All items guaranteed 60 days, except as noted.

SASKATCHEWAN

Moose Jaw

Sonic Supplies Ltd.
Box 1265 — 111 Main St. N., Moose Jaw, SK
S6H 0V9. Tel. (306) 692-6486.

EC, RTV, TG, EK, MO
Stereo components, video cassette tapes, electronic parts, amateur radio equipment, semiconductors, tools, wire, TV antennas, TV distribution equip., sound equipment.

Regina

B & E Electronic Supply Ltd.
1433 Scarth St. Regina, Sask., S4R 2G1. Tel.
(306) 522-7866.

EC, RTV, TG, EK

Cam Gard Supply Ltd.

1303 Scarth St. Regina, Saskatchewan. S4R
2E7. Tel. (306) 525-1317.

EC, RTV, TG, EK, MO, CAT
National supplier of electronic parts and components. Amphenol, Beckman, Belden, Buss Fuses, Delhi (General Instrument), Hammond, ITT Components, Mallory Duracell, Philips, Potter & Brumfield, Spectro, Westinghouse, Xcelite, 3m Cable & Connectors.

Radio Supply & Service (1977) Limited

3033 Saskatchewan Dr., Regina, Sask. S4T 1H5
Tel. (306) 352-8642 Telex. 071-2661

EC, RTV, TG, EK, MO
We are wholesale distributors of radio, TV electronics parts and industrial components, serving dealers, HI-FI trade, broadcast, industrial, government, amateur radio accounts. We supply manufacturers' catalogues/brochures free on request. Directory of lines available.

Saskatoon

Cam Gard Supply Ltd.
1501 Ontario Ave., Saskatoon, Sask. S7K 1S7
Tel. (306) 652-6424.

EC, RTV, TG, EK, MO, CAT
National supplier of electronic parts and components. Amphenol, Beckman, Belden, Buss Fuses, Delhi (General Instrument), Hammond, ITT Components, Mallory Duracell, Philips, Potter & Brumfield, Spectro, Westinghouse, Xcelite, 3m Cable & Connectors.

Swift Current

G W Colortronics Ltd.
616 Cheadle Street West, P.O. Box 1270 Swift
Current, Saskatchewan. S9H 3X4. Tel. (306)

773-3672, Telex. 071-21166
EC, RTV, TG, EK, MO.
WR — VHF 2-way Radios, Leader Test Equipment, Sylvania Tubes and Electronic Parts, Satellite Earth Receiving Stations, Winegard TV Antenna Systems, Cable TV Supplies, Columbia, Cable, Lindsay Towers and Antennas. TOA Professional Sound Systems, MATV Systems design and supplies.

MANITOBA

Winnipeg

Cam Gard Supply Ltd.
1777 Ellice Avenue, Winnipeg, Manitoba. R3H
0W5. Tel. (204) 786-8401

EC, RTV, TG, EK, MO, CAT
National supplier of electronic parts and components. Amphenol, Beckman, Belden, Buss Fuses, Delhi (General Instrument), Hammond, ITT Components, Mallory Duracell, Philips, Potter & Brumfield, Spectro, Channel Master, Westinghouse, Xcelite, 3m Cable & Connectors.

Heathkit Electronic and Computer Centre

1315 Portage Ave., Winnipeg, Man. R3G 0V3
Tel. (204) 783-3334

EC, RTV, TG, EK, MO, CAT, FREE
Kit Televisions, Amateur Radio, Weather Instruments, Marine Equipment, Stereo Kits, Speakers, Test Equipment, Computers, Electronic & Computer Home Study Courses. Service of Heath Products & Parts.



J & J Electronics Limited ETI
310 Notre Dame Ave., P.O. Box 1437, Winnipeg,
Man. R3B 1P4/R3C 2Z4 Tel. (204) 943-6916

EC, RTV, EK, MO, CAT, \$1.00
Mail order electronics distributors, specializing in semiconductors. Prime quality materials and surplus specials. Serving Canada since 1962.



HEAD OFFICE:
1777 Ellice Ave.
Winnipeg, Manitoba

BRANCH LOCATION:
88 Horner Avenue
Toronto, Ontario

Plugs, Jacks, Patch Cords, Switches, Pots, Microphones, Headphones, Speakers, Meters, Educational Kits, Telephone & T.V. Accessories

Canadian Agents for TCG Replacement Semiconductors™

Mode Electronics

1777 Ellice Ave., Winnipeg, Manitoba. R3H
0W5. Tel. (204) 786-3133.

EC, RTV, TG, EK, CAT, FREE
Plugs, Jacks, Patch Cords, Switches, Pots, Microphones, Headphones, Speakers, Meters, Educational Kits, Telephone & T.V. Accessories. Canadian Agents for T.C.G. Replacement Semiconductors.

W.E.S. Electronics Limited

1515 King Edward St., Winnipeg, Manitoba R3H
0R8 Tel. (204) 632-1260

EC, RTV, TG, EK, MO
Wholesale industrial electronics distributor for: Fluke, Magnecraft, Hammond, Delhi, Belden, Powersonic, Diamond Tools, Eveready, Cinch Jones, Sylvania, Raytheon, Siemens, Semiconductors, B & K, Rockwell Microcomputer, Phonix.

ONTARIO

Bramalea

Double-Dollar-Paks
P.O. Box 2068, Bramalea, Ont., L6T 3S3

EC, MO, CAT
Prime quality packaged parts available for \$2.00 per package. Absolutely no "fall-outs". Eventual listing of 2000 "Paks". Catalogue No. I 600 Paks \$2.00, Catalogue No. II 300 Paks \$2.00.

Kit-King

P.O. Box 2068, Bramalea, Ont., L6T 3S3.
EK, MO, CAT

Design, development, and marketing of electronic kits. P.C. Board work, prototyping, and co-op Marketing of Kits. Catalogues and bulletins available by yearly subscription, \$3.50.

Brampton

Bryan Electronics
90 Kennedy Rd, S., Brampton, Ont. L6W 3E7
Tel. (416) 457-9269

EC, RTV, TG, EK, MO, CAT
Suppliers of electronic parts, equipment, home and car audio, specialty items, etc. More than 100 catalogues available at nominal cost. Free flyers.

Brockville

Altair Electronics Enterprises Ltd ETI
223 King St. West, Brockville, Ontario K6V 3R7.
(613) 342-0885.

EC, RTV, TG, EK, MO
Electronic Parts: CPU's, Memories, TTL, CMOS, etc. Computers: TI-99/4A, Commodore, Acorn, Kay Pro II, Shamrock, OSI. Printers: Epson, Oki Data, Tec-Writer, Education: Multitech, Micro Professor, MPF-II Computer. Misc: Beeco, Vero, Chemtronics, Accessories, Books, Software.

Guelph



Neutron Electronics Limited ETI
485 Silvercreek Pkwy N., Guelph, Ont. N1H 7K5
Tel. (519) 836-9220
EC, RTV, TG, EK
Distributor for Hammond Xfmr's — cabinetry — power supplies, Sylvania transistors — IC's — tube — miniature lamps — Westinghouse — Test Equipment — B & K, Amprobe — Leader — Bach Simpson — Mallory Electronic Components — Buss — Littlefuse — Delhi Antenna systems. Satellite — Ungar — Xcelite — Weller — Auto Sound & Installation — Alpine — Sanyo — Audiovox — LearJet.



Hamilton Spectrum Electronics
P.O. Box 4166 Station D, Hamilton, Ontario L8V 4L5 (416) 387-5893.
MO, CAT, FREE
Manufacturer of printed circuit boards for hobbyists, educational institutions, and industry. Also provide custom pcb and assembly service. ETI & Elektor pcbs also available

Steel City Surplus ETI
212 King William St. (at Ferguson), Hamilton, Ont., L8R 1A9. Tel. (416) 526-8551
EC, RTV, TG, EK
Surplus Electronics of every description components, semiconductors, assemblies, test equipment, computer parts etc.

Kingston Altair Electronics Enterprises Ltd. ETI
660 Progress Avenue, Kingston, Ontario. K7M 4W9. Tel. (613) 384-3876.
EC, RTV, TG, EK, MO
Electronic Parts: CPU's, Memories, TTL, CMOS, etc. Computers: TI-99/4A, Commodore, Acorn, Kay Pro II, Shamrock, OSI. Printers: EPSON, Oki Data, Tec-Writer. Education: Multitech Microprofessor, MPF-II Computer. Misc: Beeco, Vero, Chemtronics, Accessories, Books, Software.

Kingston Electronic Supply Co ETI
147 Joseph St., Kingston, Ont., K7K 2H8. Tel. (613) 549-3773
EC, RTV, TG, EK, MO, CAT, FREE
Mode, Tenco, OK Machine, Leader, Hioki, Ceres, Hammond, Belden, Eveready, Fanon, Bogen, Philips, Vero Len line, Lloyds, Sinclair, Sylvania, Tab, Astatic, ILP, Sprague, Cornell Dublier.

Kitchener-Waterloo K-W Surplus Clearinghouse ETI
327 Breithaupt St., Kitchener, Ont. N2H 5H6
Tel. (519) 745-2661
EC, RTV, TG, EK
Surplus electronics of every description components, semiconductors, assemblies, computer parts, speakers. Also bargain priced tools, hardware, household, just about anything. Wholesale electronic flyer only on request.

Orlon Electronics Supplies Incorporated ETI
40 Lancaster Street West, Kitchener, Ontario. N2H 4S9. Tel. (519) 576-9902
EC, RTV, TG, EK, MO, CAT, FREE
Mode, Lenline, G.C. Electronics, Eico, Daveco, Cosrad, Lenbrook, Lindsay, Ceresist, Leader, A.P. Products, Sinclair, Tab Books, Sams Books, National Semiconductor, Motorola, R.C.A. Etc, General Electric, Texas Instrument.

Waterloo Electronic Supply Co. Inc. ETI
219 Hartwood Ave., Waterloo, Ontario N9J 3Z9
Tel. (519) 745-9421.
EC, RTV, TG, EK, MO.
Industrial — PB Relays, Hammond, Belden, Burgess Switch, Buss, AP Products, Vero Board, Test Equipment — B&K, Leader, Beckman, Amprobe, Eico. Hi-Fi — Sanyo, Lloyds. Car Sound — Sanyo, Sound Barrier, Lear Jet. CB — Cobra. Antenna Systems—Delhi, Lindsay, Winegard. P.A.—Bogen, Shure.

London R.J. Buckland Company
P.O. Box 367, Station B, London, Ontario. Tel. (519) 672-8390.
EC, RTV, TG, EK, CAT, FREE.
Also Surplus Electronic Equipment and Supplies.

Forest City Surplus Ltd. ETI
781 Dundas St., (near fairgrounds) London, Ont., N5W 2Z6 Tel. (519) 438-0233.
EC, RTV, TG, EK.
Surplus electronics of every description from just about everywhere. Components, semiconductors, assemblies, test equipment, our stock changes continuously. Also bargain priced tools, machinery, household items.

Mississauga Atwater Electronics Limited ETI
886 Dundas Hwy E., Mississauga, Ont. L4Y 2B8
Tel. (416) 276-4550
EC, RTV, TG, EK, MO.
Suppliers and consultants of Philips speakers, Sylvania tubes and ECG semiconductors, B & K Test Equipment, Concord Car Components, TDK and Maxell Tapes, Eico and Jana Kits, Tab Books and Sam's Books, Weller and Ungar Soldering Supplies, Industrial Wire, Batteries, Plugs and Jacks, Etc.

Heathkit Electronic Centre ETI
1478 Dundas Hwy. E, Mississauga, Ont. L4X 2R7 Tel. (416) 277-3191
TG, EK, MO, CAT, FREE.
Heath/Zenith Computer products, Amateur Radio Equipment, Radio Control, Marine & Automotive Equipment, T.V. & Hi-Fi Equipment, Test Equipment, Panasonic Shortwave, Home & Auto Alarms and other kits.

K.S.K. Associates
P.O. Box 54, Morriston, Ontario N0B 2C0, (416) 878-9721.
MO, CAT, FREE (send stamp).
Designers and consultants for micro-computers. Custom circuit design including P.C. Board fabrication. ETI Project Boards handled.

Westown Electronics Ltd.
931 Matheson Blvd., Mississauga, Ont. L4W 2R7 (416) 624-8311.
EC, RTV, TG, MO
Large stock of electronic components for industry, plus community colleges and universities. Maintenance repair overhaul electronics. RS232 interface materials and equipment. Technical and professional support staff.

Ottawa

Active Component Sales Corp. ETI
Baxter Center, 1050 Baxter Road, Ottawa, Ont., K2C 3P2. Tel. (613) 820-9471.
EC, RTV, TG, MO, CAT (Free).
Semiconductors, Microprocessors, Microcomputer boards, Potentiometers, Switches, Knobs, Sockets, Cable and Wire, Power Supplies, Data books, Meters, Duracell, OK Tool, Weller, Xcelite, Vector, AP Products, Ungar.

Gervals Electronics Limited ETI
333 Cumberland St., Ottawa, Ont. K1N 7J3 Tel. (613) 236-3101
EC, RTV, TG, EK, MO.
Astatic — ECG and SK Semiconductors — Tenco — Oaktron and Peerless Speakers — Thor-darson — Buss Fuses — Vaco — Tech Spray — Chemtronics — B & K — Hioki — Leader — C.D.E. — EduKits — TDK — Ampex — Eveready — Lenline — Workman — Columbia & Provo Wire

Heath Company ETI
866 Merivale Rd., Ottawa, Ont. K1Z 5Z6 Tel. (613) 728-3731
TG, EK, MO, CAT, FREE
Shortwave Radios, Amateur Radio Equipment, Radio, Control Equipment, Marine Equipment, Video, HI-FI, and other kits.

Kris Electronics ETI
(A Division of 365781 Ontario Limited) 1070 Morrison Dr., Unit 1-B, Ottawa, Ont. K2H 8K7
Tel. (613) 820-4986
EC, RTV, TG, EK, MO, CAT, \$1.00
Modekits, Edukits, I.L.P., Ritron Equalizers, Mixers, Hioki — Sinclair — Univolt Multimeters, Philips — Oaktron Speakers, Veroboards — Ceresist — Injectoral P.C. Boards & Chemicals, Northern Telecom Telephones/Accessories, Electronic Components, Ultrasonic Alarms.

Wackld Radio ETI
312 Parkdale Ave., Ottawa, Ont. K1Y 1G3 Tel. (613) 728-1821
EC, RTV, TG, EK, MO
We sell 232 product lines in 16 categories, including video, C.B., Ham and HI-FI etc. (Line card available — free on request).

Owen Sound North Western Electronic Supply Limited ETI
370-2nd Ave S.E., Owen Sound, Ont. N4K 5T1
Tel. (519) 371-1071
EC, RTV, TG, EK, MO

Toronto Active Component Sales Corp. ETI
4800 Dufferin Street, Downsview, Ont., M3H 5S8. Tel. (416) 661-1115.
EC, RTV, TG, MO, CAT (Free)
Semiconductors, Microprocessors, Microcomputer boards, Potentiometers, Switches, Knobs, Sockets, Cable and Wire, Power Supplies, Data books, Meters, Duracell, OK Tool, Weller, Xcelite, Vector, AP Products, Ungar.

Active Surplus Annex ETI
345 Quen St W., Toronto, Ontario M5V 2A4 Tel. (416) 593-0967
EC, RTV, TG, EK
Large stock of electronic components. New and used electronic equipment including transformers and motors. Used 12 Volt 5" and 7" Sony T.V.'s.

Arkon Electronics Limited
409-407 Queen St W., Toronto, Ont. M5V 2A5
Tel. (416) 868-1315
EC, RTV, TG, EK, MO, CAT, \$2.50
Complete industrial and hobbyist outlet. Professional Staff always on hand to answer any question and take your order.

Directory of Electronic Stores

Audiovision ETI
578 Marlee Ave., Toronto, Ont M6B 3J5. (416) 781-3263.
EC, EK, MO, CAT, \$1.00
Direct import and sale of Audio/Microcomputer/Electronic Kits, Parts and Project Cabinets. Serving, Electronic Hobbyists, Technicians, Engineers, Schools, Industries and D.J.'s.

Cesco Electronics Ltd.
24 Martin Ross Ave. Toronto, Ontario. M3J 2K9 Tel. (416) 661-0220
EC, MO,
Cesco stocks semiconductors and components by major manufacturers including Texas Instruments, Motorola, RCA, Signetics, Allen Bradley, Corning, Scotchflex, Amphenol, Cutler Hammer, Intersil, Mallory.

Cam Gard Supply Ltd.
88 Horner Avenue, Toronto, Ontario. M8Z 5Y3. Tel. (416) 252-5031
EC, RTV, TG, EK, MO, CAT
National supplier of electronic parts and components. Amphenol, Beckman, Belden, Buss Fuses, Delhi (General Instrument), Hammond, ITT Components, Mallory Duracell, Philips, Potter & Brumfield, Spectro, Westinghouse, Xcelite, 3m Cable & Connectors.

Domlnlon Radio and Electronics ETI
535 Yonge St., Toronto, Ontario. M4Y 1Y5. Tel. (416) 922-1818
EC, RTV, TG, EK, MO, CAT (Free).

Efstonscience Inc.
3350 Dufferin St., Toronto, Ont., M6A 3A4 Tel. (416) 787-4583.
EK, MO, CAT \$2.00
This company specializes in optics, electronic instruments and kits of educational, research and/or industrial use. A new line of high quality electronic measuring instruments, speciality tools, tool kits and cases. All available through mail order or at our retail premises. Canadian Distributor for; Jensen Tools of Phoenix, ARIZ. Edmund Scientific of Barrington, N.J. Two catalogues, Jensen Tools and Efston Science. \$2.00 each or both for \$3.00.

Electro Sonic Inc.
1100 Gordon Baker Road, Willowdale, Ont., M2H 3B3. Tel. (416) 494-1555.
EC, TG, EK, MO, CAT (\$25.00).
Coast-to-coast service with Canada's largest inventory of semiconductors, electronic components, and equipment. Specialists in supplying the needs of the industrial and educational markets.

Exceltronix Components & Computing Incorporated ETI
319 College St., Toronto, Ont. M5T 1S2 Tel. (416) 921-5295
EC, TG, EK, MO, CAT, FREE
We have super stock and great prices on a wide range of TTL, CMOS, Memory, Micros, and discretes. We also distribute the MULTIFLEX line of kits, VERSADIGITAL digital displays, AP Products, HAMEG and HITACHI scopes, LEADER scopes, and HIOKI test gear.

General Electronics ETI
5511 Yonge St., Willowdale, Ont., M2N 5S3. Tel. (416) 221-6174.
EC, RTV, TG, EK, MO.
Complete Hobbyist Supply House. Specializing in kits, parts speakers and equipment. Vero, Hameg, Electronakit, Mode, factory-priced excellent speakers. Ask for our free kit catalogue. We, the staff, are hobbyists - we understand your needs.

Radio Trade Supply Limited ETI
490 Yonge St, Toronto, Ontario M4Y 1X5 Tel. (416) 966-5151
EC, RTV, TG, EK
These products are available from us: Aiphone, B & K, Belden, Bogen, Buss, Cinch Joives, Delhi, E.C.G. Sylvania, Eveready, Hammond, Hioki, I.R.C., International Rectifier, Mallory, Memorex, Microswitch, Motorola, Photoswitch, Spectro, Sprague, Switchcraft, Tubes, Ungar, Weller, Xcelite.

Zenith Radio Canada Limited ETI
1020 Islington Ave, Toronto, Ont. M8Z 5X5 Tel. (416) 231-4171
EC, RTV, TG
B & K Test Equipment, Jerrold Converters, Fanon Auto Sound, Record-a-Call Telephone Answering Equipment, Leader Test Equipment, Vaco Tools

WENTWORTH ELECTRONICS

R. R. 1. WATERDOWN, ONTARIO, CANADA L0R 2H0

**CUSTOM
P.C.Bs**

**PROFESSIONAL QUALITY
WITH THE
PERSONAL TOUCH**

**E.T.I.
PROJECT
BOARDS**

PRINTED CIRCUIT BOARDS FOR ALL YOUR NEEDS

Gladstone Electronics ETI
1736 Avenue Rd., Toronto, Ont. M5M 3Y7 Tel. (416) 787-1448
TG, EK, MO, CAT, \$1.00
Speakers (Philips, KEF, JBL, Celestion, Decca, Motorola), ILP Audio Modules. Thandar & Leader Test Equipment, Kits (Ace Audio, Eico), Sinclair and Acorn Computers. Software.

**Waterdown
Wentworth Electronics**
R.R. 1, Waterdown, Ontario. L0R 2H0.
EC, MO, CAT, FREE
A mail order company with a complete selection of printed circuit boards for all ETI Projects. Custom work and quantity discounts available.

Newtronics' Engineering Inc.
208 Spadina Ave., Suite 1J0, Toronto, Ontario. M5T 2W3. Tel. (416) 368-8994.
EC, RTV, TG, EK, MO, CAT, FREE
Wholesale of Electronic Kits and Parts, Engineering of Special Projects.

**Waterford
Copeland Electronics**
46 Main St S., Waterford, Ont. N0E 1Y0 Tel. (519) 443-4163
EC, RTV, TG, EK
Jana, Daveco, Sylvania, ECG, Principal business — TV, stereo, auto stereo, sales and service.

ELECTRONICS 2001

5529 YONGE STREET
WILLOWDALE, ONTARIO M2N 5S3
223-8400

AUTHORIZED DEALERS FOR COM-
MODORE AND ATARI COMPUTERS,
RCA VIDEO RECORDERS, SHARP
AND CASIO CALCULATORS. WRITE
OR CALL FOR MORE INFORMAT-
TION.

Electronics 2001 ETI
5529 Yonge St., Willowdale, Ont., M2N 5S3 Tel. (416) 223-8400.
MO
Video recorders, books, magazines. Software, telephones, answering machines, auto dialers, TV cable converters, Sharp calculators, Casio, electronic games. Computers.

Active Components

Your One Stop Source
For The Widest Variety
of Factory Fresh Electronic
Components — No Surplus

- Semiconductors • Integrated Circuits • Microcomputer Boards
- Microprocessor & Support Circuits • Transistors • Diodes
- Capacitors • Resistors • Optoelectronics • Potentiometers
- Relays • Multimeters • Switches & Knobs • Connectors
- Sockets • Cable & Wire • Power Supplies • P.C. Boards
- Plastic Enclosures • Breadboarding Devices
- Data and Reference Books • Soldering Aids
- And much much more

**MAIL
ORDERS
SHIPPED IN
24 HOURS!**

**FREE CATALOGUE
NOW AVAILABLE.**

Write to your nearest location.

<p>MONTREAL 5651 Ferrier St. Mt. Quebec H4P 1N1 Tel.: (514) 731-7441</p>	<p>OTTAWA Baxter Centre 1050 Baxter Road Ottawa, Ont. K2C 3P2 Tel.: (613) 820-9471</p>	<p>TORONTO 4800 Dufferin Street Downsview, Ontario M3H 5S8 Tel.: (416) 661-1115</p>	<p>CALGARY 5809 MacLeod Tr. South, Unit 109 Calgary, Alta. T2H 0J9 Tel.: (403) 259-6437</p>	<p>VANCOUVER 3070 Kingsway Vancouver, B.C. V5R 5J7 Tel.: (604) 438-3321</p>
---	---	--	--	--

QUEBEC

SURPLUS ELECTRO QUEBEC

SPECIAL No. 1: Approximately 1000 electronics parts: capacitor — resistor — relay — switch — etc, etc, for \$10. **Special No. 2:** Assortment of 50 tantalum capacitors 1 uf to 100 uf (6 to 35VDC) for \$10. **Special No. 3:** 500 assorted Disc. ceramic capacitors for \$10. All new and first quality parts with unconditional money-back guarantee. Free flyer. Add \$2.00 for handling.

**2264 Monte Gagnon
Blainville, P.Q. J7E 4H5**

Blainville

Surplus Electro Quebec

2264 Montee Gagnon, Blainville, P.Q. J7E 4H5
EC, MO, CAT, FREE

Mail Order only. Surplus from manufacturers of commercial radio in H.F. — VHF — UHF. Importer of the famous LORLIN switches Manufacturer of Wide band folded dipole antenna & accessories for 1.8 to 30 mhz.

Longueil

Master Vox Ltd.

400 St. Jean, Longueil, PQ, J4H 2X6. Tel. (514) 670-1550.
EC, MO, CAT (\$5.00).

Mont-Joli

JMC Distribution Inc.

C.P. 142, 88 Ave Laval, Mont-Joli, PQ G5H 3K9.
Tel. (418) 775-2231.
EC, RTV, MO, CAT (\$1.00).

One stop shopping for electronics parts, commercial or industrial. Genuine Jap. parts, Transistors (2SA, 2SB, 2SC...) IC and general replacement for solid state JMC Products same as ECG. Recorder and projector belts, Tapes, Cassette, 8-Track, videocassette, reel-to-reel.

Montreal

Active Component Sales Corp.

5651 Ferrier St., Montreal, PQ, H4P 1N1 Tel. (514) 731-7441.

EC, RTV, TG, MO, CAT, FREE
Semiconductors, Microprocessors, Microcomputer boards, Potentiometers, Switches, Knobs, Sockets, Cable and Wire, Power Supplies, Data books, Meters, Duracell, OK Tools, Weller — 24 Hour Mail Order Turn Around Time.

Addison Electronic Ltd.

8018-20e Ave., Montreal, Quebec. H1Z 3S7. Tel. (514) 376-1740
EC, RTV, CAT (\$1.50)

Cite Electronique (1979) Inc.

3185 Hochelaga St., Montreal, P.Q. H1W 1G4
Tel. (514) 525-2551

EC, RTV, TG, EK, MO
Sony, Amphenol, Armaco, Astatic, Bach-Simpson, Bechman, Belden, Bishop, Graphics, Calectro, Celestion, Cornell-Dubilier, Cutler-Hammer, Daveco, Delta Wakefield, Eagle and more. Product card available.

Cesco Electronics Ltd.

4050 Jean Talon St. W., Montreal, Quebec. H4P 1W1 Tel. (514) 735-5511
EC, MO

Cesco stocks semiconductors and components by major manufacturers including Texas Instruments, Motorola, RCA, Signetics, Allen Bradley, Corning, Scotchflex, Amphenol, Cutler Hammer, Intersil, Mallory.

Coronet Electronics

649A Notre Dame, W. Montreal, PQ H3C 1H8.
(514) 288-6731
EC, RTV, EK, MO, CAT, \$1.00
We carry Texas Instrument, Fairchild, RCA, Nat., Exar, Armaco, Daveco. Also, Surplus Computer Terminals, Monitors, Keyboards and much more.

Etco Electronics

183 Hymus Blvd., Pointe Claire, PQ, H9R 1E9.
Tel. (514) 695-0400.
EC, RTV, TG, EK, MO, CAT (Free)
We publish a very interesting American catalogue available free to our Canadian customers. Also branch at North Country Shopping Center, Plattsburg, NY 12901 and 464 Mc Gill St., Montreal, PQ.

Hamilton Avnet Electronics

2670 Sabourin, St. Laurent, PQ, H4S 1M2 Tel. (514) 331-6443
EC
Distributor for AMD, Fairchild, Harris, Hewlett Packard, Intel, ITT, Litronix, Motorola, National Semiconductor, RCA, Rockwell, Signetics, Siliconix, TRW LSI, Centronics printers, Hazeltine, Novation (modems), Shugart etc.

Heath Company

1400 Sauve Ouest, Montreal, P.Q. H4N 1C5 Tel. (514) 332-3666
TG, EK, MO, CAT, FREE
Shortwave Radios, Amateur Radio Equipment, Radio Control Equipment, Marine Equipment, Video, HI-FI and other kits.

North American Electronics Co. Ltd.

(Noramel®) 2407 Ste-Catherine St. East, Montreal, P.Q.
H2K 2J7 Tel. (514) 522-8422
EC, RTV, MO, CAT, FREE
Toroidal Cores, R.F. Chokes, Wire & Cable, Resistors, Capacitors, Cabinets, Hardware, Semiconductors, Tubes, Switches, Meters, Ferrites, Coil Forms, Tools, Insulators, Connectors, Copperclad, and more.

Radio Hovsep Co. Ltd.

5945 Park Ave., Montreal, Quebec. H2V 4H4.
Tel. (514) 274-0589
EC, RTV, TG, EK, MO.
Authorized Grundig Service Depot for Canada. Parts and Accessories for European makes. Large stock on old and new receiving tubes.

Produits Electroniques Ltee/ Electronic Wholesalers Co. Limited

1935 Avenue de L'Eglise, Montreal, P.Q. H4E 1H2 Tel. (514) 769-8861
EC, RTV, TG, EK, MO
General line distributor with portfolio of 200 lines. Principal penetration industrial. Hammond, P & B, Amphenol, Edac, TRW, C & K, Beckman, Philips, A.P., Mallory, I.R.C., Homite, B & K, Belden, Alpha. Fluke Test Equipment, Midland Communications Equipment, Delhi Satellite Equipment, Sony.



Standard Electronics

8927 Boul. Pie IX, Montreal, P.Q. H1Z 3V3 Tel. (514) 327-3578, 327-5958, TLX. 05-828838
EC, RTV, MO, FREE
Japanese, Europeans and Americans Semiconductor's Specialist, for radio, TV, CB, VTR, Communications Equipment, Computers, industrial controls, any brand as RCA, Solid-State, Motorola, National, etc. Ask for our free price list.

Super Electronic (Canada) Company

1963 Centre St., Montreal, P.Q. H3K 1J1 Tel. (514) 932-5636
EC, RTV, TG, EK, MO
Electric Motors, Cables & Wires, Switches, Non Contact Voltage Detectors, Insulators, Capacitors (Computer Grade, Electrolytic, Oil, Disc, Polystyrene, Tantalum, etc.), Relays, Resistors (Precision, regular, large, medium, small), Tubes, Semi Conductors.

Noranda

Simtronique Inc. ETI
C.P. 365-230 Ave. Carter, Noranda, P.Q., J9X 5A9. Tel. (819) 762-1874/762-5144.
EC, RTV, TG

Bach Simpson, Astatic, Leader, Fluke, Cobra, Bogen, Mallory, Eveready, Hammond, Delhi, Amp, Sylvania Tubes, Sylvania Transistors, Chromalox, Audio Vox Intercom, Fanon Intercom, Magnavox TV & Amp, Clarostat Controls.

KEY

ETI	ETI Magazine sold here
EC	Supplies Electronic Components
RTV	Sells Radio and TV parts
TG	Sells Test Gear
EK	Sells Electronic Kits
MO	Company does Mail Order
CAT	Catalogue available. The cost of this, or if it is free, is shown

Quebec City

Pro Technique, Jean-Marc Emond Inc. ETI

383 Canardiere, Quebec, PQ. G1L 2V1. Tel. (418) 529-5793. Telex: 051-3956.
EC, MO
We stock electronic components like Amp, Belden, Hammond, Kings, Mallory, Panduit, P & B, Sylvania, Vero, Weller, Xcelite Anomure line card and catalogue available on request.

Selco Electronique

P.O. Box 2036, St-Romuald, Quebec. G6W 5M3.
Tel. (418) 839-8367.
EC, MO, CAT, Free.
Your saving place for parts and accessories. We stock a very wide range of parts and we've got the lowest price on Machine & Tool and AP Products. Don't forget to ask for your free catalogue.

Video Payette

1375, boul. Charest ouest, Quebec, Quebec. G1N 2E7. Tel. (418) 687-5050.
EC, RTV, TG, EK
Radio-communications, audio and video equipment, telephone systems. Product card available on request.

Sherbrooke

Cite Electronique (1979) Inc. ETI

918 King St. W., Sherbrooke, P.Q. J1H 1S2. Tel. (819) 569-9908.
EC, RTV, TG, EK, MO
Sony, Amphenol, Armaco, Astatic, Bach-Simpson, Bechman, Belden, Bishop, Graphics, Calectro, Celestion, Cornell-Dubilier, Cutler-Hammer, Daveco, Delta Wakefield, Eagle and more. Product card available.

Directory of Electronic Stores

Trois Rivieres

Matteau Electronique

ETI

2045 Royale, Trois Rivieres, PQ, G9A 4L3 Tel. (819) 375-4779.
EC, RTV, MO

NEW BRUNSWICK

Moncton

Amphion Electronics Limited

4 Lockhart Ave., Moncton, N.B. E1C 6R1 Tel. (506) 855-3337

EC, RTV, TG, EK

We handle audio components, auto sound equipment, audio visual (video) equipment, amateur radio.

Cam Gard Supply Ltd.

15 Mount Royal Blvd. Moncton, New Brunswick. E1C 8N6. Tel. (506) 855-2200.

EC, RTV, TG, EK, MO, CAT

National supplier of electronic parts and components. Amphenol, Beckman, Belden, Buss Fuses, Delhi (General Instrument), Hammond, ITT Components, Mallory Duracell, Philips, Potter & Brumfield, Spectro, Westinghouse, Xcelite, 3m Cable & Connectors.

NOVA SCOTIA

Halifax

Amphion Electronics Limited

2411 Agricola St., Halifax, N.S. B3K 4C1 Tel. (902) 429-7211

EC, RTV, TG,

We handle audio components, auto sound equipment, audio visual (video) equipment and amateur radio.

Cam Gard Supply Limited

ETI

3065 Robie St., Halifax, N.S. B3K 4P6 Tel. (902) 454-8581

EC, RTV, TG, EK, MO, CAT

National supplier of electronic parts and components. Amphenol, Beckman, Belden, Buss Fuses, Delhi (General Instrument), Hammond, ITT Components, Mallory Duracell, Philips, Potter & Brumfield, Spectro, Westinghouse, Xcelite, 3m Cable & Connectors.

Sydney

Fisher Electronics Limited

337 Welton St., Sydney, N.S. B1P 5S4 Tel. (902) 539-3949

EC, RTV, TG, EK, MO

Learjet, Sencore Test Equipment, Belden and Columbia wire, RCA Semiconductors, Bogen, University, Bearcat, Shure, Electrovoice, Astatic, Hammond, Blonder Tongue, Mirtone, Telex, Sony, Sprague, Tenco, Lenline.

PRINCE EDWARD ISLAND

Charlottetown

Island Radio Centre Limited

102 Queen St, Charlottetown, P.E.I. C1A 4B1. Tel. (902) 892-1291.

EC, RTV, TG, EK, MO

Bogen B & K, Switchcraft, Basf, Belden, Cooper Tool, C.G.E., Dual, ElectroVoice, Eico, Fanon, Hammond, I.R.C., J.B.L., Lindsay, Marsland, Sams, Paco, Sylvania, Shure, Sencore, Telex, University, Ungar, Uher.

NEWFOUNDLAND

St. John's

Electronic Centre Limited

115 Ropewalk Lane, St. John's, NF A1E 4P1 Tel. (709) 579-5021

EC, RTV, TG, MO

Armaco, B & K, Beldon, Simpson, Centralab, Delhi, Dynacharge, Electrohome, General Cement, Hammond, Hitachi, IRC, Midland, Potter and Brumfield, RCC Schematics, ECG, Switchcraft, Tech Spray, Ungar, Vaco, Weller, Xcelite.

ETI

YOUR PET NOT AS FRIENDLY AS IT USED TO BE?



The Tech/News Journal For Commodore Computers Vol. 4.

Maybe the colour seems to have gone out of your Vic. It's probably not something your dealer can do anything about. Your problem is simple. You've got a troll living in your computer.

Yes, we used to think that it was silly stuff like lack of documentation or poor availability of software that turned people off their systems but modern technological understanding has banished such odd notions. We now realize that after you've had your computer for a little while the mystic spirits of the nether world crawl into it between the keys on the keyboard and grow tiny trolls under the chips. As they mature they send off powerful vibrations that subconsciously make your computer resemble a plate of freeze dried asparagus. No wonder you've lost interest in it.

Most systems, when so afflicted, are doomed. However, recently a new publication has emerged for the owners of PETs, CBMs, VICs, Commodore 64's and related systems which especially caters to owners of these machines who suspect troll intervention. Called the Transactor, it is crammed full of amazingly useful software which not only makes your system eminently more useful to you but also sets up an internal atmosphere which is not conducive to troll growth. After a few issues of the Transactor your Commodore computer will be troll free and doing things you'd have never thought possible.

A year's subscription (6 issues) is just \$15.00.

The Transactor, Subscriptions Dept.
500 Steeles Avenue
Milton, Ontario
L9T 3P7.

ZX Interfaces Explained



The ins and outs of Sinclair computers. Details are given for the Spectrum as well as the ZX81. Although the Spectrum is not yet available in Canada, it is likely to be very popular when it arrives. By Mike Lord.

ADVERTISEMENTS for Sinclair's original ZX80 said that it could be used to control a power station. We doubt whether many readers will be that ambitious! On a more practical level, the ZX81 and the new ZX Spectrum can be used to control activities such as model train layouts, a robot arm or a sophisticated burglar alarm/deterrent system. And in the 'professional' world, many laboratories are now using ZX computers to control simple experiments and record the results.

The main attraction of the Sinclair machines for these applications is, of course, their low cost. But their small size can also be an advantage on a crowded workbench, as well as their ability to survive the rough and tumble of life outside the hallowed precincts of a computer room; an important feature if, like the author, you are prone to dropping pieces of equipment on the floor or

spilling cups of coffee over everything.

Input and Output

To be of any use, a computer has to be able to communicate with the outside world. It has to be able to take in data (and remember that a computer sees your program as just another form of data that it has to deal with), and it also has to be able to put out the results of its computations.

Normally, the input signal to your ZX comes from the keyboard or from a cassette recorder, and it sends outputs to the TV display or to a cassette recorder. This article will show you how to make your ZX81 or Spectrum able to accept signals from other sources, and how to make it generate signals which can be used for purposes other than driving a TV set or tape recorder.

Because the ZX is an electronic

device (and because this is an electronics magazine), we shall only be considering electrical inputs and outputs. Most real applications, however, will also have a mechanical aspect, such as how to actually move the robot's arm, or how to sense that a train is passing through the station. Solving these problems will have to be left to your ingenuity!

The Key To Input

Each key on the ZX keyboard is, electrically speaking, a normally open single pole switch. Pressing the key closes the switch and this can be detected by routines built into the computer's ROM. The function IN-KEY\$, for example, can be used in a BASIC program to detect if a single key has been pressed and to tell which key it was.

So, if we wire a normally open switch or relay contact in parallel

ZX Interfaces Explained

with one of the ZX's keys, then the operation of the switch or the closing of the relay contact will appear to the ZX exactly as if that key has been pressed, and it can be detected by your program.

You can't get at the actual switch contacts themselves on the ZX81 or Spectrum keyboards as they are sealed units, so you will have to connect your added switch(es) to the 5 and 8 way film-cable sockets mounted on the computer PCB. One contact of each keyboard switch is connected to one lead in the 5 way cable, the other contact is connected to one lead in the 8 way cable, so that the 40 keys are arranged in a 5 x 8 matrix. The actual connections for each key are shown in Figures 1 and 2, so if you wanted your added switch to appear to the computer as key '2', it would have to be connected between connector points X1 and Y2.

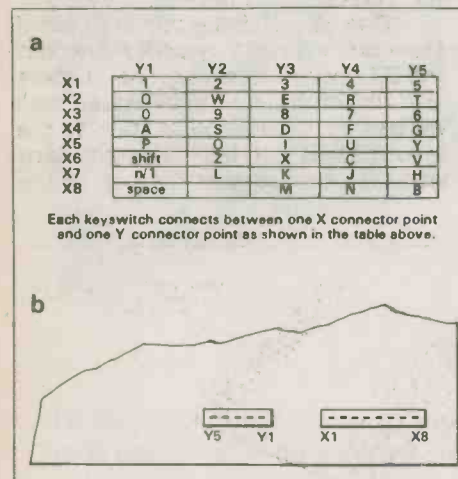

Fig. 1(a) The ZX81 keyboard connections; (b) component-side view of the ZX81 board, showing the keyboard sockets.

This technique is usefully simple, but there are a few points to watch. Any leads connected to the keyboard must be relatively short - say less than 30 cm - or they are liable to confuse your ZX by picking up stray noise. Also, INKEY\$ will refuse to recognise any of them. And, of course, you have to be sure that any contacts you may add are open-circuit whenever you want to use the normal keyboard.

A simple joystick can be made using this technique to add interest to games programs. Four normally open switches should be used, mechanically connected to the joystick so that one switch is closed when you move the stick in a particular direction. The switches could be wired in parallel with the four cursor control keys (numbered 5 to 8),

corresponding to movements of the stick as Up, Down Left and Right.

Since neither side of the keyboard switches can be connected to ground (doing so would prevent the ZX from working properly), some form of isolating device is needed if you want the ZX to sense an electrical signal. As illustrated in Figure 3, a suitable relay could be used, or perhaps a phototransistor/LED opto-isolator. If an opto-isolator is used, the emitter of the photo-transistor should be connected to the 8 way keyboard connector, and the collector to the 5 way connector.

The Rear Connector

If we want our ZX to provide outputs - for controlling motors, lights or whatever - or if we want it to be able to detect more than one input signal

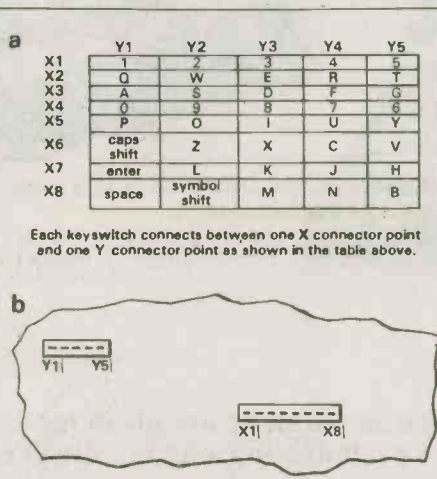

Fig. 2(a) The Spectrum keyboard connections; (b) the keyboard sockets from the component side of the Spectrum PCB.

connector has 23 contact positions on each side, the Spectrum has 28; in both cases a slot has been cut into the PCB in one of the contact positions to locate a polarising key fitted to the mating socket. Suitable sockets are readily available from a number of specialised ZX hardware suppliers.

The connector carries the computer's address, data and control signals as well as power lines and was intended for use with add-on devices such as the ZX81's 16K Rampack or the ZX printer; but, as described in the remainder of this article, it also allows you to plug on your own Input/Output interface board. One point to remember when building any add-on for the ZX is that it doesn't prevent you from adding other extensions. This means, in effect, that it should include a double sided PCB plug which is wired to carry the same signals as the actual ZX connector, and to which other extensions can be fitted. One way of achieving this is illustrated in Figure 4. Alternatively, you could make up a 'motherboard' as shown in Figure 5. This would have sockets for accepting I/O interface boards and a double sided PCB plug at the end for connecting to the ZX printer or Rampack. Again, suitable PCB plugs are available from some ZX hardware suppliers.

The signals on the ZX rear connectors are shown in Figures 6 & 7. The ones which are most useful for an Input/Output interface are:

The Power supplies; The +9 V line comes directly from the unregulated output of the ZX line adaptor. It can vary between about 7V5 and 11 V, and has 1 to 2 volts of 100 Hz ripple on it. Depending on what else is connected to your ZX, you

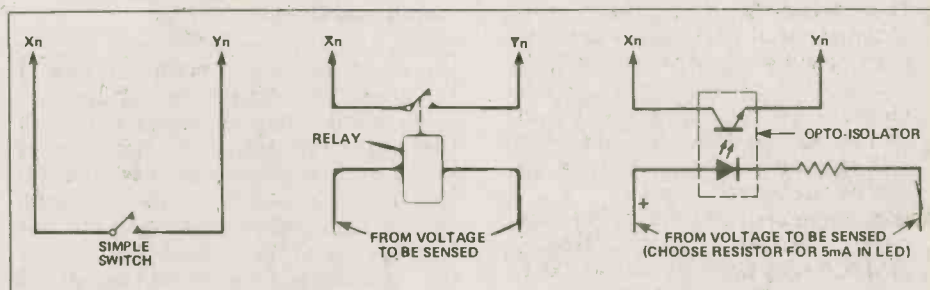

Fig. 3 Inputs to the ZX keyboard matrix.

at a time, then we have to add an interface circuit to the ZX's rear connector.

This connector consists of two rows of contact pads spaced 0.1" apart along the rear edge of the ZX's printed circuit board. Row A is on the top surface of the PCB and row B is immediately underneath. The ZX81

should be able to draw about 200 mA from this line. The +5 V line comes from the ZX's internal 5 volt regulator, which runs hot at the best of times, so don't try to take more than about 100 mA from this supply. The Spectrum also provides a +12 V output, which can supply about 30 mA, and a -5 V

line from which you shouldn't take more than a couple of milliamps. Also on the Spectrum rear connector is a point labelled '-12 V'. In fact this is not actually a negative 12 V DC supply, but rather a high frequency square wave of about 13 V peak-to-peak. It can be used to generate a low current (10 mA) negative rail of approximately 12 volts by adding a suitable rectifier circuit such as that shown in Figure 8.

Other useful lines on the connector are the signals which come from the Z80 microprocessor at the heart of the ZX computer. They are:

The Microprocessor Data Bus lines DO to D7. These carry data to and from the Z80, one 8-bit byte at a time. The voltage levels are TTL compatible, but not more than one LSTTL (Low Power Schottky TTL) input should be connected to each line. To input signals to the ZX computer, you have to put signals onto the data bus and this should be done using a device which has tri-state outputs, so as not to load the bus lines when data is not being input.

The Microprocessor Address lines A0 to A15. These carry address information from the Z80 and can each drive one or two LSTTL inputs.

The Z80 Control lines RD, WR, MEMRQ and IORQ. These are all outputs from the Z80, used to control the reading and writing of data to and from memory and I/O devices; they are all TTL compatible, capable of driving one or two LSTTL inputs. These lines are normally 'high'; the RD line goes low when the Z80 wants to read data from memory or I/O, the WR line goes low when it wants to write. The MEMRQ line going low signifies that the Z80 wants to read or write to memory, similarly a low level on the IORQ line indicates that the Z80 is reading or writing to I/O. (Note that the term 'I/O' is used in a special sense, as will be discussed later).

Finally, there are two interesting lines called RAMCS and ROMCS (RAMCS only appears on the ZX81, not on the Spectrum). These are signals generated within the ZX to select its internal RAM or ROM memories, but are brought out to the rear connector to allow an externally applied signal to over-ride this selection. For example, the ZX81's 16K Rampack uses the RAMCS Line to disable the ZX81's internal 1K RAM. As will be described later, we can use these lines to make the ZX81 com-

municate with an external I/O interface rather than with its internal memory. The levels on these lines are somewhat non-standard, being TTL output levels fed through a 680R resistor. This is illustrated in Figure 9 which shows, as an example, how the ROMCS signal is generated in a ZX81. To enable the internal ROM, the ULA chip in the ZX81 presents a 'low' output level which normally passes directly to the ROM chip-select input without being significantly affected by the 680R resistor, as the ROM input is

a very high impedance. We can, however, connect an external circuit to the ROMCS line to prevent the voltage at the ROM chip select input from going low enough to enable the ROM. We would then be free to feed signals from an external interface onto the data bus lines. Similarly, on the ZX81, we can disable the RAM memory by pulling the RAMCS line high.

Memory Addressing

If the ZX is to be able to communicate with an Input/Output interface, it must be able to select that interface when it wants to write to or read from it, but the interface mustn't interfere with the ZX's normal communications with its ROM and RAM memories or other Input/Output devices such as the keyboard and printer.

One way of doing this is to see if there are any memory addresses that the ZX doesn't normally use. If there are any such 'free' addresses, then we can allocate some of them to the Input/Output interface. The interface can then be designed to look to the

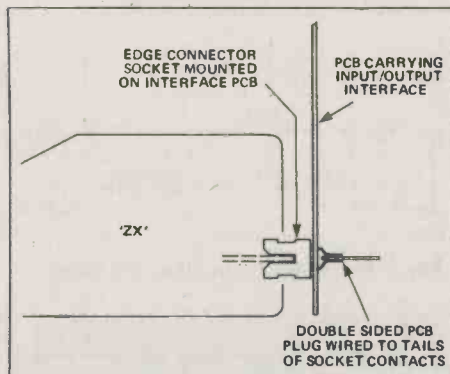

Fig. 4 An add-on board must allow access to the ZX socket contacts.

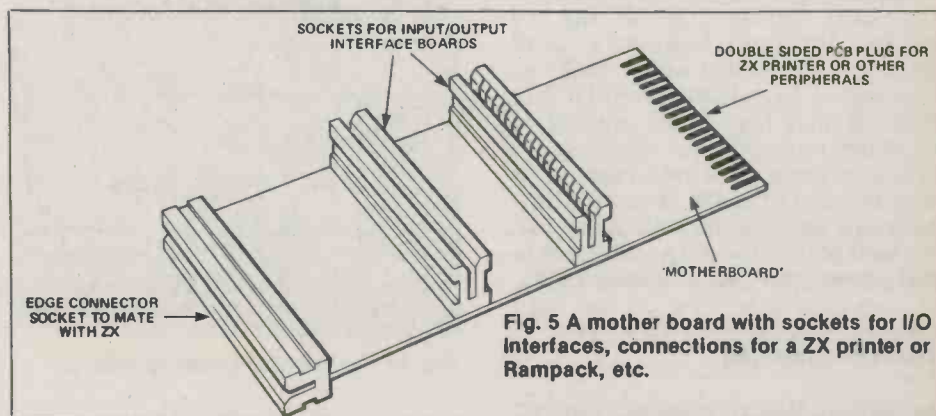

Fig. 5 A motherboard with sockets for I/O interfaces, connections for a ZX printer or Rampack, etc.

Pin No.	Signal	
	Side A (top)	Side B (bottom)
1	A15	A14
2	A13	A12
3	D7	+5V
4		+9V
5		Slot
6	D0	OV
7	D1	V
8	D2	CK
9	D6	A0
10	D5	A1
11	D3	A2
12	D4	A3
13	INT	IORQ
14	NMI	OV
15	HALT	VIDEO
16	MRQ	Y
17	IORQ	V
18	RD	U
19	WR	BUSRQ
20	-5V	RESET
21	WAIT	A7
22	+12V	A8
23	-12V	A5
24	M1	A4
25	RFSH	ROMCS
26	A8	BUSACK
27	A10	A9
28		A11

Fig. 6 The Spectrum rear connector signals.

Pin No.	Signal	
	Side A (top)	Side B (bottom)
1	D7	+5V
2	RAMCS	+9V
3		Slot
4	D0	OV
5	D1	OV
6	D2	0
7	D6	A0
8	D5	A1
9	D3	A2
10	D4	A3
11	INT	A15
12	NMI	A14
13	HALT	A13
14	IORQ	A11
15	RD	A10
16	V	A9
17	WR	A8
18	BUSACK	A7
19	WAIT	A6
20	BUSRQ	A5
21	RESET	A4
22	M1	A3
23	RFSH	ROMCS

Fig. 7 ZX81 connector signals.

ZX Interfaces Explained

computer like added memory, appearing at the otherwise free locations, and can be accessed by using the ZX BASIC's PEEK and POKE commands.

Since the ZX has 16 address lines (A0 to A15), it can theoretically handle 65536 (64K) different memory locations. The 'memory map' for the Spectrum is shown in Figure 10, and it can be seen that a fully expanded Spectrum equipped with 16K of ROM and 48K of RAM does not have any room left in its memory address space for an Input/Output interface.

The ZX81, however, is different. Normally only 8K of ROM and a maximum of 16K of RAM are fitted, which would appear to leave plenty of room for an Input/Output interface. But, because the circuits in the ZX81 which select the ROM and RAM don't decode the address lines as fully as they could, 'echoes' of the ROM and RAM appear throughout the memory map, as shown in Figure 11. Thus the 8K ROM not only occupies addresses 0 to 8191, but it also appears to occupy addresses 8192 to 16383. Similarly, multiple echoes of the RAM appear throughout the address space. In fact, one of these RAM echoes, which starts at address 49152, is essential to the circuits in the ZX81 which produce the TV display. There are, however, a lot of unnecessary echoes which could be removed — by holding the RAMCS or ROMCS lines high when required — to make room for our interface. In practice, because it interferes least with the use of really large ROM expansions such as the Memopack 64K the best address to put an interface is just above the ROM, at address 8192.

Z80 I/O Addressing

As well as 64K of memory, the Z80 processor can also handle special 'I/O' addresses. From a hardware point of view, these use the same 16 address lines (A0 to A15) as memory, but are accessed when the Z80 IORQ output goes low, whereas a normal memory access is signalled by MREQ going to a low level. We could, therefore, design an Input/Output interface so that it responded to these special 'I/O' addresses, rather than appearing in the normal memory map. From a software point of view, the Z80's I/O addresses are handled by a special class of Z80 machine code instruction. There is no equivalent instruction in ZX81 BASIC, so a special machine code routine would have to be written to handle an Input/Output interface mapped into the 'I/O' address space. Spectrum

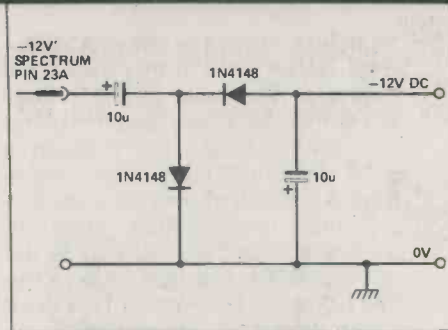

Fig. 8 Deriving a negative DC supply from the Spectrum '12V' output.

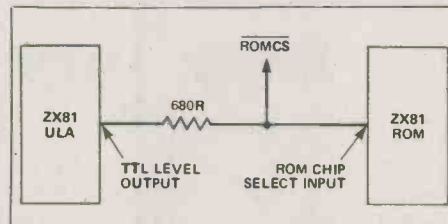

Fig. 9 The ROMCS circuit of the ZX81.

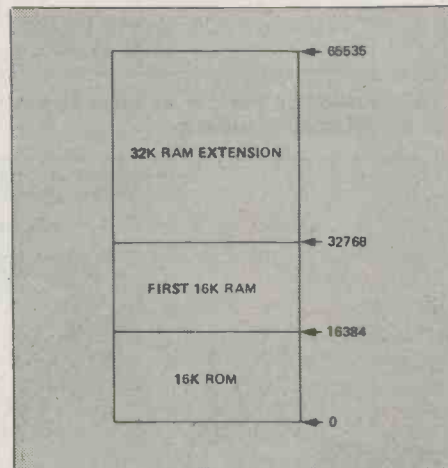

Fig. 10 The Spectrum memory map.

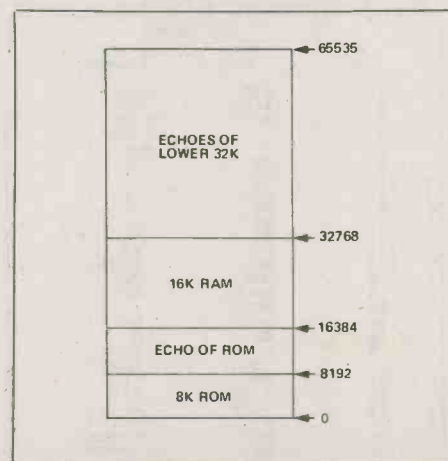

Fig. 11 The ZX81 memory map.

BASIC, however, includes IN and OUT commands which act like PEEK and POKE — but on this 'I/O' space, rather than on memory. This is fortunate because, as we have seen, there is no room in the Spectrum's memory map for an Input/Output interface.

Some of the I/O address space is already used by the keyboard and cassette ports, and other parts have been allocated to Sinclair add-ons such as the printer and the eagerly awaited Spectrum disc drive. Instead of allocating specific blocks of the I/O address space for these functions, the ZX designers have, instead, used the state of individual address lines to select individual 'I/O' functions. For example, bringing A1 low, while leaving the other address lines high, would select the ZX printer. Overall, lines A0 and A8-A15 are allocated for ZX peripherals. In all cases a 'low' level on an address line selects the function. This means that if we want to put our Input/Output interface in the 'I/O' map, we must choose an address which as A0-A4 and A8-A15 all '1'.

Theory and Practice

Many different kinds of interface have been designed for the ZX81, ranging from straightforward I/O boards for controlling relays, lights etc, through joystick controllers and full-sized keyboards to analogue-to-digital converters. No doubt similar products for the Spectrum will appear in due course. Now that we know what signals are available at the rear connector of a ZX computer, and how we can use them to communicate with the outside world, we are better able to understand how these work.

ETI

**Fight
Them All**



Styrofoam Cutter



The ETI Hotwire is just the thing to get you going. No, it's not for stealing cars, it's for modelling. Turn that waste foam packing into beautiful models with the Hotwire and some imagination. Design and development by Phil Walker.

THIS EASY-TO-CONSTRUCT project is a controller for a hot-wire styrofoam cutter. This method of cutting foam is probably better than most others as it does not create any rough edges or crumbs; it actually works by melting the material as it comes into contact with the hot wire.

The object of the controller is to maintain the wire at a fairly constant temperature sufficient to melt the styrofoam quickly but without charring. This is accomplished by using a simple type of phase controller to regulate the power applied to the wire. The circuit employs a 747 dual op-amp, both parts of which are used as comparators. Speed of operation is not critical here as the circuit is operating at line frequency (60 Hz).

Taking A Pulse

The first part of the circuit produces a 120 Hz pulse signal which synchronises the rest of the circuit to the output from the bridge rectifier. The second part generates a variable time

delay which is used to regulate the amount of power developed in the cutting wire. The longer the time delay, the less power is developed and vice versa.

The control element used in this project is a thyristor as this will withstand the high peak currents in the circuit without the necessity for large drive currents.

Construction

This is fairly simple since most of the components are mounted on the PCB. Make sure that the diodes and IC are the right way round. Bolt the small heatsink to the rectifier bridge before mounting it on the board. Allow it to stand about 6 mm away from the board to avoid thermal stress effects. The thyristor is mounted on top of the larger heat-sink, both being held by the same screw. Heat conductive paste should be used here as well. R9 will get quite

hot in operation and should be stood away from the board if possible to allow air flow around it.

When mounting the PCB in the case, it is advisable to do so with the capacitor C1 at the bottom so that it is not heated by the other components.

Fairly thick wire should be used for connecting to the transformer and output sockets as they will be carrying several amps. RV1 is wired so that minimum resistance occurs at clockwise rotation.

Some Cutting Remarks

In our prototype the cutting head was made from two short pieces of slotted aluminium extrusion of the type sold for shelving systems. These were screwed to a piece of wood to form a handle while also insulating them from each other. The steel wire was clamped with some large nuts and bolts so that it was under some tension. The wires to the control unit were also clamped to the large bolts and held in place along the arms of the head with sticky tape.

It is recommended that the ceramic insulators sold by electrical shops be used for the ends of the cutting wires in order to keep the metalwork isolated. Plastic connector block could be used but may melt under extreme circumstances.

Once everything is working correctly you can begin to exercise your creative talents on the nearest piece of styrofoam. Apart from a modelling tool, a gadget for 3-D doodling and something to keep the kids quiet during the summer holidays, you could use the Hotwire for cutting out large letters — ideal for advertising displays or exhibition stands.

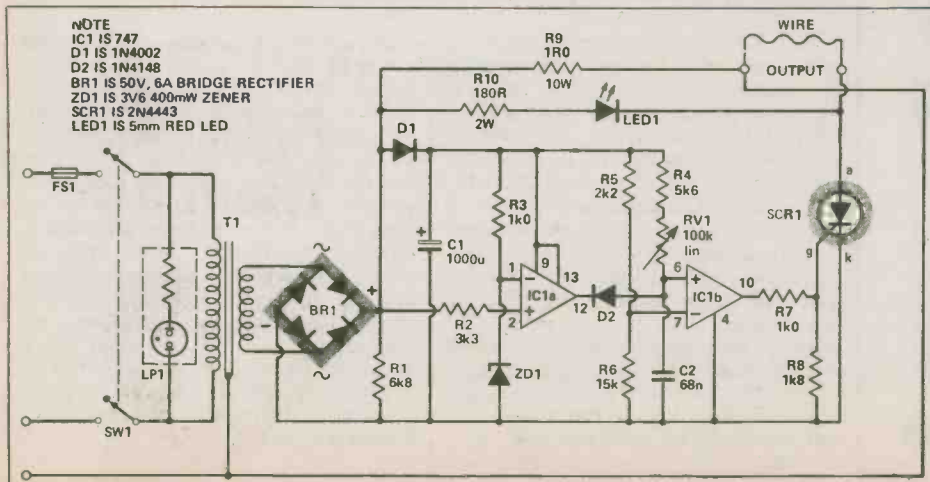
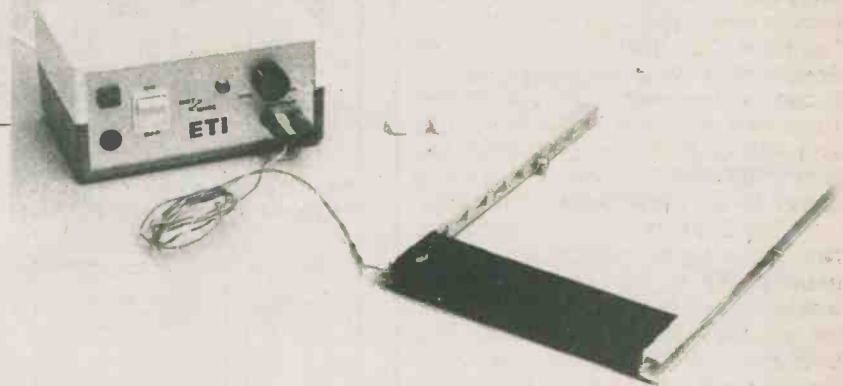

Fig. 1 circuit diagram of the ETI Hotwire.

PARTS LIST Styrofoam Cutter

Resistors (all 1/4W, 5% unless stated otherwise)

R1	6k8
R2	3k3
R3,7	1k0
R4	5k6
R5	2k2
R6	15k
R8	1k8
R9	1R0 10W wirewound
R10	180R 2W wirewound

Potentiometer

RV1	100k linear
-----	-------------

Capacitors

C1	1000u 25V axial electrolytic
C2	68n ceramic

Semiconductors

IC1	747
D1	1N4002
D2	1N4148
BR1	6 A bridge rectifier, square package, 50 V or greater
ZD1	3V6 400 mW zener
SCR1	2N4443
LED1	5 mm red LED

Miscellaneous

FS1	20 mm 1A6 slow-blow fuse and holder
SW1	Double pole rectangular mains rocker switch
LP1	Mains panel-mounting neon indicator with integral resistor
T1	15 V 60 V A mains transformer

Heatsinks (finger-style for thyristor, for rectifier); PCB; case; panel mounting socket for LED1; two off 4 mm banana sockets, grommet, wire, nuts, bolts, brackets etc; 0.010" steel wire (guitar top 'E').

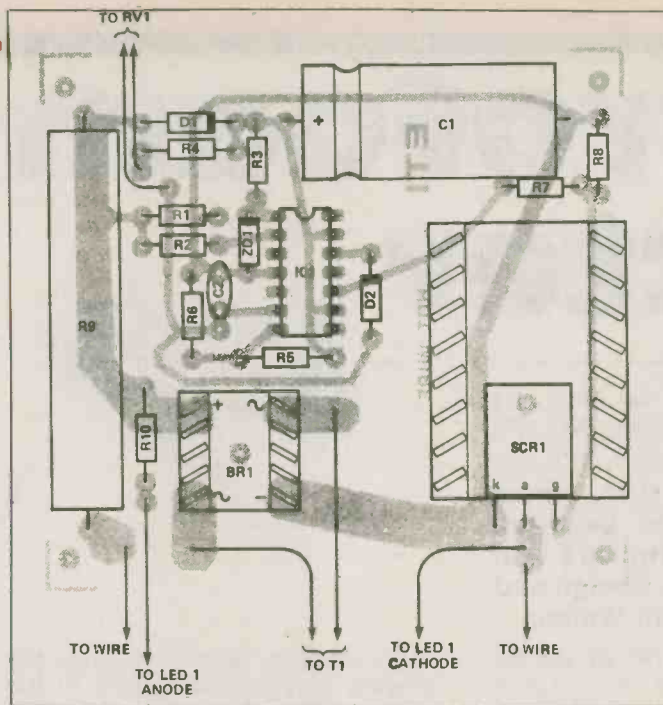
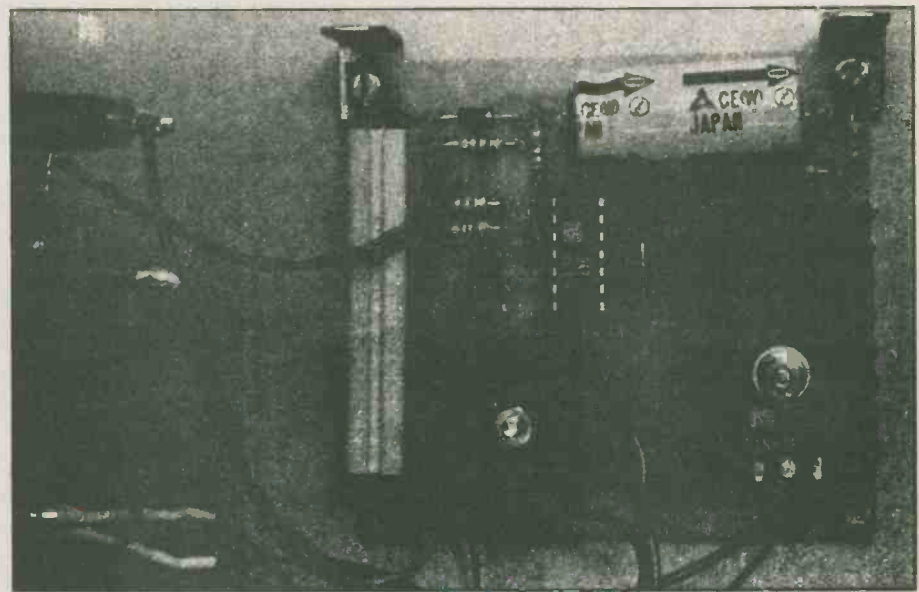

Fig. 2 Component overlay for the polystyrene cutter.



The Hotwire PCB. On the left you can see the ground connection to the pot case.

HOW IT WORKS

The 15 V AC from the transformer is rectified by BR1 to give a raw 120 Hz pulsating DC supply. C1 is charged to the peak voltage of this supply via D1 and provides the power for the circuitry. The raw DC supply is taken via R2 to IC1a where it is compared with the voltage across ZD1. The output from IC1a consists of a train of negative-going pulses which occur around the zero crossings of the AC input. These pulses are used to synchronise the variable time delay circuit by discharging C2 at the zero crossing of the AC input. The capacitor then charges at a rate set by R4 and RV1 until its voltage reaches the level set by R5 and R6. At this point the output of IC1b changes from its low to high state and switches SCR1 into conduction.

Once SCR1 has been switched on it

causes the raw DC supply to be applied across R9 and the cutting wire until the voltage falls to zero at the end of the half cycle. At this time the thyristor turns off, the variable time delay circuit is reset and starts again. The proportion of the total time for which the output is on is determined by the time delay set by RV1; hence this controls the amount of power dissipated in R9 and the cutting wire. The main function of R9 is to reduce the peak surge current which would flow in the circuit, but it will also give some protection against inadvertent short circuit (the wire itself has a resistance of a couple of ohms). LED1 is incorporated to indicate when the output is operating and gives a visual indication of the power setting.

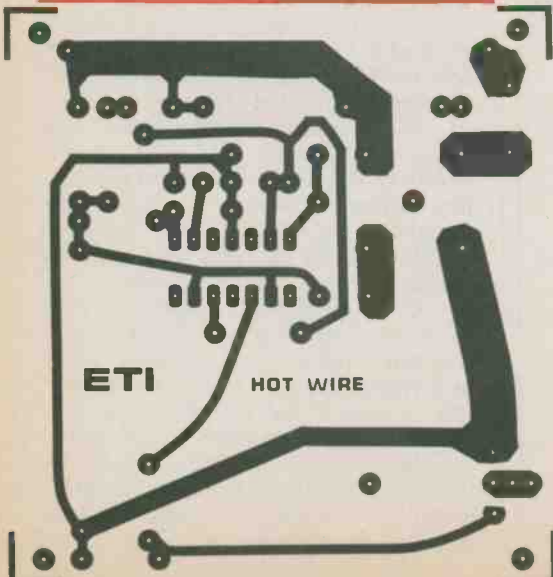

Now NRI takes you inside the new TRS-80 Model III microcomputer to train you at home as the new breed of computer specialist!

NRI teams up with Radio Shack advanced technology to teach you how to use, program and service state-of-the-art microcomputers...

It's no longer enough to be just a programmer or a technician. With microcomputers moving into the fabric of our lives (over 250,000 of the TRS-80™ alone have been sold), interdisciplinary skills are demanded. And NRI can prepare you with the first course of its kind, covering the complete world of the microcomputer.

Learn At Home in Your Spare Time

With NRI training, the programmer gains practical knowledge of hardware, enabling him to design simpler,



Training includes new TRS-80 Model III microcomputer, 6-function LCD Beckman multimeter, and the NRI Discovery Lab with hundreds of tests and experiments.

(TRS-80 is a trademark of the Radio Shack division of Tandy Corp.)

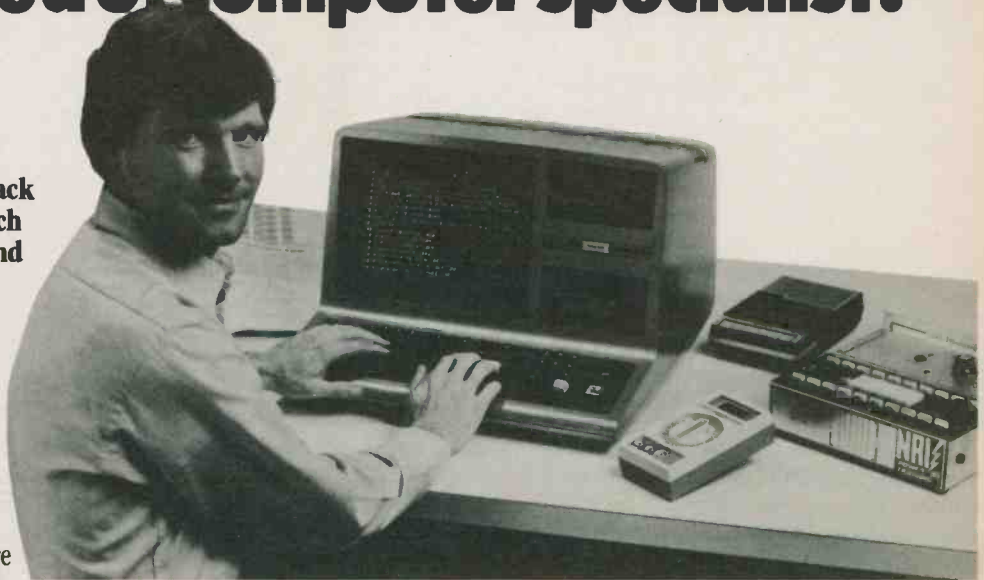

more effective programs. And, with advanced programming skills, the technician can test and debug systems quickly and easily.

Only NRI gives you both kinds of training with the convenience of home study. No classroom pressures, no night school, no gasoline wasted. You learn at your convenience, at your own pace. Yet you're always backed by the NRI staff and your instructor, answering questions, giving you guidance, and available for special help if you need it.

You Get Your Own Computer to Learn On and Keep

NRI training is hands-on training, with practical experiments and demonstrations as the very foundation of your knowledge. You don't just program your computer, you go inside it...watch how circuits interact...interface with other systems...gain a real insight into its nature.

You also work with an advanced liquid crystal display hand-held multimeter and the NRI Discovery Lab, performing over 60 separate experiments. You learn troubleshooting procedures

and gain greater understanding of the information. Both microcomputer and equipment come as part of your training for you to use and keep.

Rush Card for Free Catalog

Get all the details on this exciting course in NRI's free, 100-page catalog. It shows all equipment, lesson outlines, and facts on other electronics courses such as Complete Communications with CB, TV/Audio and Video, Digital Electronics, and more. Keep up with the latest technology as you learn on the latest model of the world's most popular computer. If card has been used, write to:

NRI Schools
McGraw-Hill Continuing
Education Center
330 Progress Avenue
Scarborough, Ontario M1P 2Z5
or telephone 416-293-1911

We'll give you tomorrow.

Column Loudspeaker Design

Continued from page 20

equipment was available to make quantitative measurements. If operation above 16 kHz is important for you don't despair: add a horn tweeter and mount it on top of the cabinet.

The overall impression of the speakers is of clean effortless performance, lacking only in that extreme high frequency content. They have been used regularly for four years now with 100% reliability. Applications have included not only the live sound sources mentioned earlier but also the playing of taped music and use for film shows. Once when playing back a taperecorded voluntary from the pipe organ, several members of the congregation admitted to me afterwards that they had to look at the organ to check that it was not live playing — quite remarkable really when you think that the organ is at the back of the church and the column speakers at

the front! This is the result obtained with directional sound: it seems to come directly to you.

One last note of caution for you: do position your column speaker the right way round, that is vertically. You will have seen from Figs. 3 and 4 how the sound beam spreads out from the system. Possibly because this spreading is the opposite of what might at first be expected or perhaps because of plain ignorance, column loudspeakers are occasionally positioned the wrong way round! In fact I know of one not many miles from my home, where, in a specially converted stable, a column speaker is attached horizontally to an old oak ceiling beam. Wild horses wouldn't drag the exact location of the stable from me (pun intended — groan); I enjoy the little theatre too much to want to upset them.

ETI

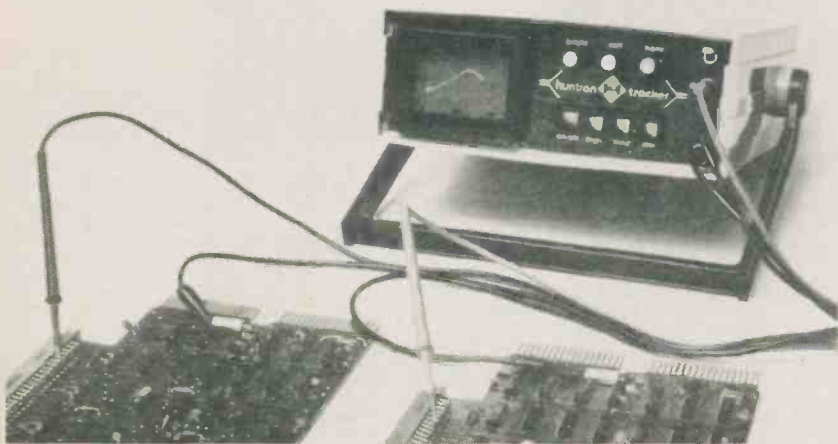

In-Circuit, Power-Off Troubleshooting

Use it to increase your service productivity.

We've redefined the problem of troubleshooting solid-state electronic circuits and components. And in so doing, given you an entirely new and highly effective service tool, the Huntron Tracker™. Now you can quickly troubleshoot digital, analog, and hybrid circuits and components with no power applied.

The Tracker is a compact, light-weight, self-contained instrument that provides both stimulus and display capabilities. The crt displays waveforms, or

"signatures," that indicate the health of a semiconductor as it responds to a current limited ac voltage from the Tracker.

The Tracker detects leakage, noise, shorts, and opens. And most of the conditions between these states which can cause intermittent failures. This makes the Tracker the first piece of general-purpose test equipment that can actually find quality faults in semiconductor devices, in-circuit and power off.

Get some leverage out of your test equipment.

The Tracker will help your field service organization become more productive.

While meter manufacturers offer more ranges and scope makers increase bandwidth or lower prices, neither approach addresses the issue of field service productivity.

Huntron's Tracker complements your existing ATE and general-purpose test equipment by helping you solve the troubleshooting problems they can't. Think about what that will do to shrink board float and increase customer satisfaction. Then, give us a call:

(604) 327-8814

We'd like to demonstrate the Tracker to you and show how power-off troubleshooting will increase the productivity of your service engineering staff.

HUNTRON

Cyprus Products, Inc.
7648 Heather Street,
Vancouver, B.C. V6P 3R1
Canada

PLEASE MENTION ETI
WHEN REPLYING TO
ADVERTISEMENTS

BITE ELECTRONICS
WE BUY, SELL AND TRADE



TV BLOCK CONVERTER

VHF 2 to 13
UHF 14 to 83
Ideal for VCRs

21.95

90 day warranty

STEREO MIXER

Work with — Two turntables
— Two tape decks
— Tuner + tape deck
— Etc.



21.95



3 CHANNEL COLOUR ORGAN

200W per channel.

21.95

— Strobe Light Kits	14.95
— Trim 1 Signal Level Meter (To check TV channels)	14.95
— 100 Asst' Resistors pkg 1 ohm to 10m	3.95
— 50 Asst' Capacitor pkg	3.95

SHIPPING INCLUDED

SEND FOR OUR LIST OF BARGAINS. FREE WITH ANY PURCHASE, OTHERWISE SEND \$1.00. MAIL ORDER ONLY. ONTARIO RESIDENTS ADD 7% P.S.T.

1515 LAKESHORE RD. EAST, UNIT 1008, MISSISSAUGA, ONT. L5E 3E3

Heathkit Hero

Robots are quite the thing these days — now you can even buy one in kit form. Steve Rimmer investigates.

OH, ISN'T IT adorable . . . such a cute little robot with its own cute little robot arm, and, oh, listen to that, it talks in cute little robot speech, look at those cute little robot lights flashing on and off and, oh, what's this, oh a cute little robot death ra . . .

(I may just be a robot but I still hate old broads that think I'm a cocker spaniel . . .)

You can't trust these things, you know. Computers are fairly tractable because no matter how much of a personality they come up with they're still basically immobile. If you walk out of the room all the silly thing can do is flash its cursor at you angrily and possibly bombard you with a few control G's. However, the boys at Heath have changed all that. They have introduced something called HERO I, and old Hero is a robot. He moves.

Or she moves. It's probably immaterial, as it can't reproduce . . . at least, not without the right software.

HEROics

The Hero is about the size of a waste basket, twenty inches high and eighteen inches in diameter. Weighing in at a trim thirty nine pounds . . . ah, the joy of specifications that aren't in metric. . . he has a tripod, or triwheelial, gate that lets him turn in a one foot radius. He is powered by 12 volt rechargeable batteries (can you comprehend the D cells a thing like this could eat?).

The robot consists of two major bits, which are comprised of a varying number of smaller bits, depending upon how many you loose during construction. The robot proper holds the batteries, drive motor, on board computer and sundry other paraphernalia. The head, which is, traditionally above the body, has the sensors, of which we shall speak anon, the programming keyboard and an ex-



perimenters breadboard area. The mechanical arm attaches to the upper half of the body.

The robot is capable of accepting sufficient programming to permit it to handle realistically complex actual world situations unattended. As such, it has a variety of sensors to permit it to figure out what exactly is happening out there. It can measure the level of ambient sound over an omnidirectional range. It can't really differentiate the location of the source, but at least it'll know if you're screaming at it to stop beating up on the cat. It can measure the level of incident light over a range of about 30 degrees across its photocell. It has an ultrasonic ranging system which can detect objects up to eight feet away. Thus, if the cat is asleep (and deaf) it will be able to sneak up on it. It has doppler motion sensing, and, as such, it can find a human being at about fifteen feet if said individual is on the go.

The robot also has a speech synthesizer. It is phoneme based, which is to say, the words are generated by concatenation of sound primitives, as opposed to being held in a ROM. This permits the robot to say anything at all, even the words they won't put in

ROMs for you. This has amazing possibilities. Imagine programming the robot to walk up to chicks on the street and say "My, but you are a fine looking primate. Can I now. Can I . . ."

But I digress.

There is also a real time clock in there, in hardware so that the computer doesn't have to do anything but read it. It is accurate to 120 seconds a year and runs for four years without any hassle.

The breadboarding area in the robot's head has a fair bit of stuff associated with it, including an I/O port to the computer, an interrupt line, CPU control lines and five and twelve volt power supplies from the batteries.

Perhaps the most interesting thing about the robot is the arm. Canada is, after all, *the* place to mess with robot arms and, when they're working, they can be shot off into outer space. This arm rotates 350 degrees horizontally along with Hero's head. A separate motor moves it up and down over 150 degrees. Its little robot hand can extend five inches. The wrist motor can move the hand through a 180 degree revolution, while the hand itself is capable of opening to a maximum gap of six in-

Hero

ches and closing with a bone crushing five ounces. Well, it doesn't actually take much effort to crush cat bones, y'know.

The arm can lift eight ounces, and carry sixteen. Pretty pointless, this latter specification from what I can see, but, no matter. It looks pretty neat anyway.

The Brain (Igor! It Lives!)

Finding no reliable way of shipping human brains after they had been out grave robbing, the Heath engineers eventually decided that Hero would have to make do with a microprocessor in his belly. He uses a 6808 chip which has its own operating system running in there... obviously, it's robot oriented. The computer can accept instructions either via its keypad or through a cassette port and can store sequences of up to 1024 separate directives. There is also a sort of remote control keypad which can be used to communicate with the beast.

Programming interface is via a LED display. A CRT would have been nicer, of course, but, then if they were going to have gone that far a printer and a couple of Winchester hard drives wouldn't have hurt any, and Hero, the eight ton robot, would have majestically descended through the floorboards.

The operating system is essentially a quasi-menu driven deal. It has seven modes, of which the menu is the first and default. Whenever the thing doesn't know what to do next it drops into this one, called the "executive". There are modes allowing the user direct access to the robots primitive functions (sounds a little base, doesn't it) to set up the arm, set the clock, change the programming and so on. There is a mode in which the functions of the robot can be completely under manual control and another wherein absolutely everything can be handled by the computer. Yet another mode allows it to receive data through its remote control. The last mode is called the "sleep mode" which is kind of quaint (do androids dream of electronic sheep?). In this arrangement, the robot can be programmed to go into a coma until its clock reaches a specified time setting, at which point it will wake up and carry on with its programming.

A Two Robot Family?

Hero appears to have been designed for the educational scene, with all manner of nifty documentation and



learning stuff. Available in either kit or fully assembled form, its construction manuals seem to be up to Heath's nit-picking thoroughness. There also appears to be tons of support documentation.

The potential of a creature such as this would, however, seem to go far beyond the classroom. Given a radio link to a larger micro it could do all manner of wonderful stuff, including guarding the house, picking up stray transistors and, yes, pro-

bably beating up on the cat if you keep Felix properly sedated. It could become one of the all time great peripherals.

Wait, yes, *that's it!* It can set type and become an unspeakably slow printer. Just give it some hot lead and a couple of those little hammers...

The robot costs \$2199.85 in kit form and \$2495.00 built up. A 1200 page course in the use of robotics and the Hero is available at \$149.00.

EDS PROFESSIONAL PRODUCTS from **VERO**

for your free catalogue circle No. 16 on readers service card

**VEROBOARD
CIRCUIT
BOARDS
ACCESSORIES
MODULE
SYSTEMS
CASES &
BOXES**

Dealers reply on letterhead

Electronic Packaging Systems Ltd.
Retail Dept., P.O. Box 481,
Kingston, Ontario K7L 4W5
Telephone (613) 384-1142

Circle No. 16 on Reader Service Card.

QUALITY SERVICE AVAILABILITY  **ACTIVE, YOUR NUMBER ONE CHOICE**

Active Components

Active Components
Your one stop source for the widest variety of factory fresh electronic components

Extensive Product Offering
Semiconductors, Integrated Circuits, Micro-computer Boards, Microprocessor and Support Circuits, Transistors, Diodes, Capacitors, Resistors, Optoelectronics, Potentiometers, Relays, Multimeters, Switches, Knobs, Connectors, Sockets, P.C. Boards, Enclosures, Data and Reference Books, Soldering Aids, AND MUCH MORE

Superior Service
Greater choice. Easier, faster ordering and more reliable deliveries. Active's all NEW comprehensive Fall/Winter catalogue is now available — **FREE OF CHARGE**. Circle No. 2 on free information card or write to: 5651 Ferrier Street, Montreal, Quebec H4P 1N1, or call: (514) 731-7441

TELEX: 05-823554 TWX: 610-421-3251

Circle No. 2 on Reader Service Card.

WHY SPEND A FORTUNE ON A DIGITAL CAPACITANCE METER?

As a matter of fact you don't have to pay \$250 to \$700 and up, anymore, for a Digital Capacitance Meter that is both dependable and rugged, with good accuracy.

The Model MC100 is manufactured by DAETRON and is sold directly to you, eliminating costly mark ups by the middle man and distributors.

Check these features:

- Portable (only 4 3/4" x 2 1/2" x 1 1/2")
- Extensive range - 50 pF to 9,999 uF
- Completely assembled (no kit to assemble)
- Basic accuracy 2% (± one count) on pF and nF ranges, 5% (± one count) on uF range
- Decimal points light up when battery is low or when capacitor is over range.
- Uses special circuitry to save on batteries (batteries not included)
- 90 Day parts and labour warranty

The meter is also well suited for the hobbyist, technician or engineer who wants to quickly sort and check out many different type capacitors, especially those that have lost their markings.

DAETRON

935 THE QUEENSWAY, BOX 641, TORONTO, ONTARIO M8Z 5Y9



\$89.95

PLEASE SEND ME

____ (QUANTITY) MC 100(s) @ \$89.95 \$

ONTARIO RESIDENTS ADD 7% PST. \$

SHIPPING AND HANDLING @ \$1.00 per instrument \$

TOTAL \$

I ENCLOSE CHEQUE MONEY ORDER BILL MY VISA

VISA CARD NO _____ EXPIRY DATE _____

SIGNATURE _____

Immediate shipping on orders with Certified cheque, money order or Visa. Personal cheques, please allow 2 to 3 weeks for clearance.

NAME _____

ADDRESS _____

CITY _____ PROV. _____ POSTAL CODE _____

ETI 0283

Torch Review

"Torch" may not be one of the all time inspired names for a computer. However, the system which wears it does have its illuminated moments. By Steve Rimmer.

WHAT DO YOU SAY to a computer with a four colour keyboard? What do you say to your computer? Have you seen a doctor about this?

The Torch is a very interesting new system with a four colour keyboard just off the designers' bench and about to fling itself onto the unsuspecting world. It is the first large system we have seen to have been designed and built in the U.K., and it is decidedly unusual. However, as we'll see, in amongst its weirdities it has an awful lot to commend it.

CPU's For All

The Torch runs with a Z-80 as its primary processor. However, it also has a 6502 to handle some peripheral functions and you can actually use this chip as the main CPU if you feel like it. We'll get to that in a second. The Z-80 uses an operating system called CPN, which is not a typo. It is, supposedly, a CP/M clone with many enhancements.

The first interesting thing about CPN is that it does not live on the disk. It is resident in firmware, and, as such, is available as soon as the machine is powered up. Its capabilities are outlined in a HELP message that can be called up from the ROM via an unmarked blue key. Most of the often used utilities, such as FORMAT, SYSGEN and most of the basic file management stuff are available in the ROM. This saves a huge amount of disk space, of course, and makes the whole works fundamentally more reliable, as disk errors can no longer trash the system tracks ... there aren't any.

The CPN equivalents to the popular CP/M transients work a little differently than most of the ones we've come to know and tolerate. PIP, for example, is banished. There is a COPY routine for moving files around, but this will not deal with peripherals at all, a handy feature of PIP. On the other hand, it's a lot easier to use and



it doesn't tie up a lot of disk space. The FORMATER is quite slow. There is a BACKUP routine which handles formatting and disk duplication all in one shot, a nice bit.

The Torch has a very interesting power up procedure inasmuch as, before it will even acknowledge your existence, it wants to run any of several sorts of files. Thus, you can write a HELLO program to do all manner of initialization and fidgeting, or leap right into a major program, all without the usual hassle of patching the CP/M CCP. This is good, actually, as, with the CCP, or CCCP, as they call it, in firmware, patching it would be all but impossible.

Characters

The file that the Torch usually runs is one called ROMAN.COM. This is, as it turns out, a character set. The Torch has a ver versatile screen display section, beginning with fully programmable characters. ROMAN is standard type. We got two other character sets, GOTHIC, which is semi-unreadable florid Olde Englishe script, and RUSSIAN, which is completely unreadable cyrillic. However, there is a program for creating your own fonts, which is quite easy to use once you get the hang of it. I created a new typestyle, called WOMBAT, which is ... there's an art to doing character patterns, y'know.

One of the weirdities uncovered by playing with the character sets is

that the Torch treats its screen in a most unusual manner. Most computers create the character patterns on the tube from either a ROM or an equivalent block of RAM which is forever being scanned by the character generator to refresh to screen. The Torch, however, effectively plots the characters on a high resolution screen. As such, there is no limit to the number of character fonts one can have on at one time. You could invoke GOTHIC, print a headline, invoke ROMAN, print some text and then invoke WOMBAT and do whatever you might want to in a typestyle where all the characters have little eyeballs. You can also have high resolution graphics mixed freely with the characters ... since the characters, themselves, are in fact high resolution graphics.

This technique does not slow down the screen in any way; it runs as fast as that of our normal old TRS-80 Model II.

The screen is, of course, capable of full colour. There are three character modes, which produce lines of 80, 40 and 20 characters respectively. The twenty character deals are gross and all but unreadable. The screen colour is set from the keyboard by typing F and a number for the foreground and B and a number for the background.

This console oriented programming is carried through most of the operating system. The baud rate on the serial port, for example, is set by typing *FX and then some

parameters. There is no need for a menu driven CONFIG utility.

The Torch also has a built in three voice sound generator which is capable of producing extremely precise pitches. There is a utility to drive it provided, called MUSIC. MUSIC plays text files which can, in fact, be created by another program, also provided. The music files we got with the system, including a three voice Bach fugue, were just excellent. I can't imagine buying a system such as this just to toodle around with beep music, but it is a very clever bit of hardware to dally over after everyone else has gone home, and speaks of the level of sophistication of the machine.

The 6502

One of the commands available from the boot ROM's HELP list is BASIC. BASIC, as it turns out, does not go scavenging across the disk for the Z-80 MBASIC, but, rather, abandons hope of the Z-80 altogether and hands control over to the 6502 chip. The 6502 in our Torch was running the mythical BBC BASIC.

A representative of Torch has, in fact, stated that "the Torch may not continue to support BBC BASIC, and anyone who really wants it should probably buy one fairly quickly."

The BBC BASIC is, as everyone has imagined, rather a trip. What it really is is a greatly enhanced and fixed up version of the BASIC found in the Acorn ATOM. It is highly non-Microsoft, and still very unusual. However, it has many interesting points to it, including the ATOM's built in machine language assembler, which still works very, very well. Its colour graphics tend to be a bit limited in regards to the number of colours they can handle at one time ... usually a maximum of four, and you can't get every combination. The colour graphics plotting commands are fairly minimal. There is MOVE, DRAW and PLOT, but no CIRCLE or PAINT bits.

The other major drawback involved in the BBC BASIC is that there does not seem to be any way to access the, ahem, mass storage devices, that is, ahem, the disk. This would seem to mean that you can't store your, ahem, programs. This is probably an oversight in either the software, or, more likely, the documentation, attributable to our Torch being a fairly early model.

The BBC BASIC does support the Torch's sound functions, and

rather well, with the capabilities of altering the pitch of the tones, setting their volumes and giving them envelopes.

When the 6502 is not running BBC BASIC, it still does all the peripheral handling for the system. This includes dealing with the keyboard and screen, the disks, the printer, serial port, sound interface and the built in modem ... which we will also get to in the fullness of time. As such, even when its existence is not immediately apparent it is still making life much easier, and considerably faster, for the main Z-80.

Running

We ran a number of the usual sorts of software packages on the system, including Wordstar, Supercalc and MBASIC. Wordstar could be configured to run in colour, which was

While not Earth shattering, it was a useful bit none the less, and I created a number of semi useless Wordstars while playing with it. (This configuration is only for use in editing C text files on Thursdays ...)

Supercalc was equally as pleasant in colour.

The MBASIC was something of a disappointment. It was, in fact, just regular old MBASIC, with no extra bits to drive any of the fancy options, like the sound and the colour graphics. In order to do this, one would pretty well have to write device drivers in ASM to be called from the BASIC ... a task which some users may not be quite up to. We were a lot more impressed with the if800 in this respect, the manufacturers of which had gone to the expense of getting a complete BASIC written for it.

Dial a Pizza

If the standard software that came



rather a trip. This sounds fairly pointless, but, in fact, it is pleasing to be able to set the thing to display text in a colour that's the least taxing of the orbs. This facility also permits Wordstar's block movement commands to use highlighting instead of block markers, making it vastly easier to see what you're doing.

In fact, this version of Wordstar came with a rather useful additional configuration program which permitted additional customizing of Wordstar. The foreground and background colours were fully programmable and the most useful initial defaults could be set. As such, it could boot up with the help level at two instead of three, a black and green screen, insert off, whatever gets you through the night.

with the Torch was not always dreadfully exciting, the custom stuff, written to use the system's particular characteristics, was a thorough trip. One of the first things one notices about the Torch is that there is a wire dangling off the back terminating in a modular telephone plug. Yes, as previously alluded to, the Torch has its own built in modem, which can run at speeds up to 1200 baud. This is a fine little gadget.

There are several software packages available to drive the modem, and, of course, more mundane ones like MODEM7 could be used. The modem can do automatic dialing, and the programs provided also incorporated directories and dial routines.

Continued on page 72

Now a major new Magazine of

Computing Now!

Canada's Personal

Canada's personal

Now there's a magazine for people who want to discover the potential of the microcomputer: **Computing Now!** It's brought to you by the same strong team who publish ETI, reinforced by new talent.

Computing Now! will appeal to a) the person **looking for a microcomputer or wanting to upgrade** and b) the person who has a system and **wants to find out its true potential**. Jargon is unavoidable in any new technology: we won't promise not to use it but we **will** explain it.

The advent of Computing Now! will not have any effect on ETI (in case you're concerned). ETI's circulation is rising **very** fast and we're not going to tamper with a proven formula! The new title will carry hardware and software reviews on the latest equipment as well as explanatory articles. The whole area of microcomputers is changing so fast that it's hard to keep track of what's happening and what's available: Computing Now! will reflect this fast moving scene.

As an ETI reader, you qualify for a special **Charter Subscriber Rate: \$18.95** — that's a **42%** saving on the regular newsstand price but **only** if we receive your payment before March 31st 1983.

We wouldn't ask you to subscribe sight-unseen without a very special guarantee: Not only may you cancel your subscription at any time for any or no reason and receive a full refund on the unexpired portion of your subscription **but** if you cancel within 5 weeks of receiving your first copy (you should have two issues, Canada Post willing!) we'll refund your **complete sum** and the first two issues will be complimentary. Any refunds will be made promptly and cheerfully.

First Issue

**zine from the publishers
ETI.**

Computing!
HOW!
Personal Computing Magazine

computing magazine.

SCHEDULED FOR FIRST ISSUE

- Specifications and survey of 50 microcomputers**
- **Introduction to Word Processing** • **A play with Prestel**
- **A look at small business printers** • **Bulletin Boards**
- **The 'C' Language** • **Update on the Apple Pirate Industry**
- **Computer Review** • **Metaprograms (such as Quick 'n Easy)**
- **Trog: a videogame listing for the Apple** • **Software Reviews**
- **Plotter Review** • **News** • **New Products.**

The final contents may vary for reasons of topicality or availability

April 1983.

Smith-Corona introduces the first printer with real character at the unreal price of \$1095.*



The Smith-Corona Daisy Wheel Printer

Until now, if you wanted to include a reasonably-priced printer as part of your computer or word processing system, you had to use a dot matrix printer. Daisy wheel printers were just too expensive.

Not anymore. Now Smith-Corona* offers a daisy wheel printer at such an incredibly low price, you can't afford *not* to include it. That means that even the smallest installation or business can now have letter quality printing capabilities at every work station.

The Smith-Corona printer operates with micro-processor-controlled daisy wheel technology, and is available with industry standard serial or parallel data interfaces.

Best of all, it produces results identical to those of our very finest office typewriters – printing with real character. So it can be used to create letters or documents that have to look perfect. As well as financial statements, inventory reports, direct mail campaigns – anything that requires quality printing.

And it's easy to use – just turn on the power, load the paper and away it goes. (It works equally beautifully with letterhead bond or fanfold paper.) There are drop-in ribbon

cassettes and a choice of easy-to-change, snap-on daisy print wheels for a variety of fonts.

So why not get your hands on a real bargain: letter-perfect printing at an amazingly low price. Because, thanks to Smith-Corona, a printer with real character is no longer expensive.

Ask for it by name.

Smith-Corona

DIVISION OF **SCM**® (CANADA) LIMITED

*suggested retail price

Please send me more information on the Smith-Corona daisy wheel printer.

Name

Title

Company Name

Business Address

City Prov. Postal Code

Type of Business

Mail coupon or call:
Education Director,
Smith-Corona

29 Gervais Drive, Don Mills, Ontario M3C 1Z1
(416) 449-0164

ETI

Circle No. 24 on Reader Service Card.

High Definition TV

The technology already exists to make our TV pictures better than the simulated ones shown in department store catalogues. Eric McMillan explains.

SOME ARE CALLING it revolutionary — an innovation on a par with the inception of television itself. Others see it as just one of a number of modifications to our TV technology that will change viewing habits over the next two decades.

But most industry insiders expect high-definition television (HDTV) to become as common in our future living rooms as the 20-inch colour console is today.

HDTV is already being used in professional and institutional settings and the large American and Japanese electronics companies are poised to introduce consumer models by the end of the 1980's.

"Every major manufacturer in the business is working on developing HDTV," an executive from the RCA head office in Indianapolis, Ind., told us. "It's definitely the coming thing."

One might wonder why it has taken so long. The technology is simple enough and experts agree the current North American TV broadcast standards have lagged far behind what is possible indeed behind what is available throughout the rest of the world.

The world is divided among three colour broadcast systems: SECAM is used by France, the Soviet Union and their respective colonies; PAL is standard in Britain, most of Europe, Australia and some underdeveloped countries; and NTSC is the system employed by North America, a portion of Latin America and Japan. "NTSC" stands for National Television Standards Committee but the system has been dubbed "Never Twice the Same Colour" by critics who prefer the PAL or SECAM standards.

Overlaid across these divisions we have two main scanning systems. With some exceptions, the NTSC countries use 525 scanning lines while almost everyone else enjoys the higher resolution of 625 lines.

Theoretically, the NTSC-525 system sends electron beams sweeping across our screens every thirtieth

of a second to complete 525 lines. Colour is activated by the picture elements, or pixels, strung out along the horizontal lines. With a 4.18 MHz bandwidth, the NTSC maximum is 330 elements per horizontal line.

In reality, most TV sets here do not produce a full 525 lines, thus displaying fewer pixels overall for each televised image.

High-definition TV on the other hand promises much more. Bearing in mind that standards have not been fixed yet and that the general public may end up with a modified version of the technology, we can marvel at figures such as over a million elements for each image.

The HDTV picture is set up by 1,125 scan lines, more than double NTSC and far more than PAL or SECAM can offer. With an anticipated bandwidth of 20 MHz, the rule of thumb of 80 horizontal elements per MHz indicates each HDTV scan can resolve 1,600 pixels — nearly five times NTSC.

Such resolution is roughly equivalent to that of 35 mm film. No wonder Hollywood is interested in the development of high-definition TV and video, both as a threat and as an aid to filmmaking. As a rival, HDTV could keep customers out of the movie theatres and at home before their sets, particularly if domestic screen dimensions begin to approximate those in the theatres. Or, at the other extreme, high-definition technology might allow producers to switch from film to the cheaper and more flexible videotape while maintaining the resolution that theatre-goers have come to expect.

Francis Ford Coppola is a movie director who is optimistic about the meeting of film and HDTV. Responsible for movie hits such as the *Godfather* epics and *Apocalypse Now*, Coppola has used video cameras to play back scenes he'd shot on film. In *One From the Heart* he went further and shot some scenes in video, later transferring the tape to film to be spliced into the movie.

With high-definition video, entire movies could be taped on video and transferred to film without noticeable

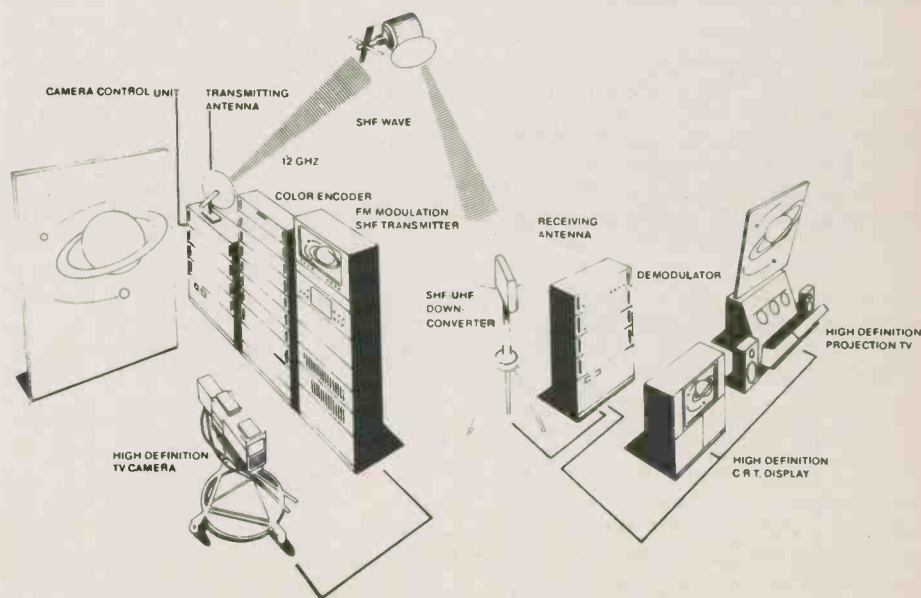

One idea of how high-definition television (HDTV) could be delivered involves a 1,125-line camera with 30 MHz bandwidth amplifiers, a super-high frequency (SHF) direct-broadcast satellite, a receiving dish with SHF/RF converter and a choice of HDTV display units. (Courtesy Matsushita Electric)

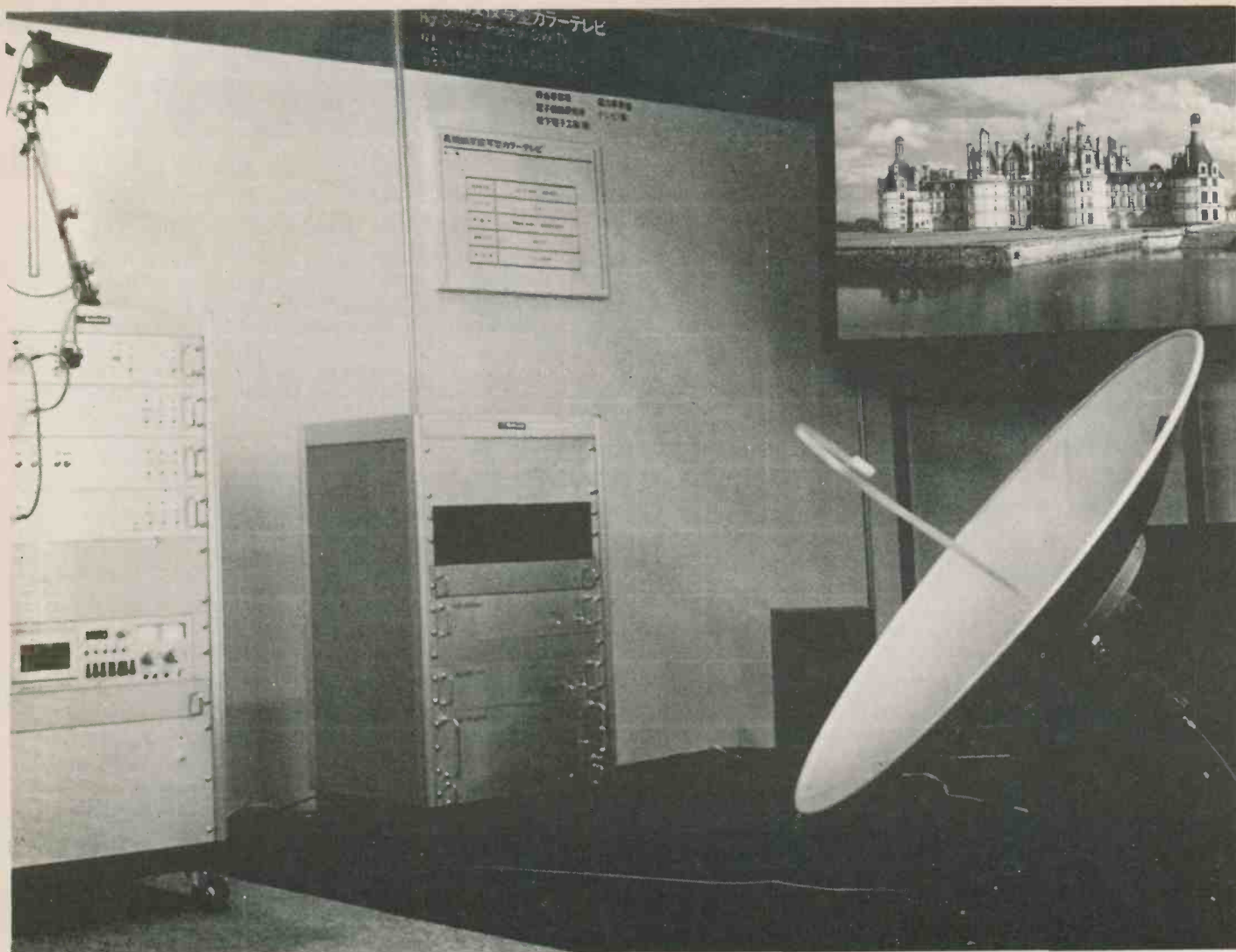

The Matsushita demonstration combining HDTV and SHF direct-broadcast satellite technologies produced an image (upper right) in the proportions of, and as sharp as, 35 mm film.

loss of resolution. The next step would be to eliminate film altogether. Coppola has been experimenting with projecting HDTV images onto theatre-size screens and witnesses have been impressed with the clarity.

Sony, Matsushita and CBS have all demonstrated HDTV equipment that would put the same experience in our homes. Although the technology has been around for years, two recent trends in home TV use have added an impetus to develop HDTV systems for consumers.

One trend is the burgeoning market for movies on television. Videocassette and videodisc rental outlets are springing up in every neighbourhood. Pay TV channels offering recent uncut films have gained millions of subscribers in the U.S. Satellite dish owners are pulling in shows from all over the world. It is reasonable to expect the public to appreciate any advance in TV manufacture that would bring them closer to

the quality they used to get at the movie palaces. These advances would include stereo sound, a more rectangular screen, higher signal-to-noise ratio (both audio and video) and, of course, better resolution.

Another trend is towards larger screens. Projection television has blown the TV image up to six feet diagonally and Matsushita is about to market a model with a screen measuring 2.5 metres high by 3.4 metres wide. But anyone with the \$2000 to \$8000 to buy a large-screen TV today will notice a major failing.

No matter how refined the workings of a projection system become, the fact remains that it is taking the same information available to a smaller set and spreading it over a wider area. The resolution has to suffer, just as a newspaper photograph loses sharpness when magnified.

Within the NTSC system we can go only so far in improving the image. Enter HDTV. The combination of high-definition technology and projection

TV could give you Coppola's next production at home with the size and picture quality you would expect at the theatre. Perhaps not Coppola's very next flick.

Ken Kewin, national product training manager for consumer video, of Sony of Canada, thinks the HDTV receiving-end hardware will be "quite pricey" when it's first introduced to the general public. "You're probably looking at about \$10,000," he says, although the costs will fall as HDTV catches on. Probably in time for *The Godfather: Part Seven!*

HDTV is not the entire answer — a number of other advances are being made in TV technology to change our expectations of the boob tube. But, strangely enough, these can also be considered part of the development of HDTV.

Digitization is an example. One of the remaining technical kinks in HDTV is high-frequency noise — a distortion plaguing any TV picture but much more pronounced with HDTV.

Continued on page 50

ACTIVE

ANNEX

SURPLUS

ACTIVE SURPLUS ANNEX
345 QUEEN ST. W.
TORONTO, ONTARIO
M5V 2A4
593-0967

THE LARGEST VARIETY OF
ELECTRONICS RELATED ITEMS
AT THE LOWEST PRICES IN
TOWN

ACOUSTIC COUPLERS NEW AND PRIME

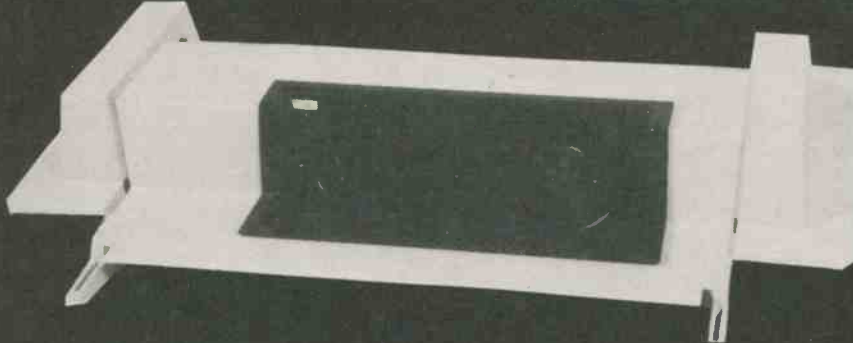

50 pc OR MORE \$24.00

300 BAUD • TTL LEVELS ON TRANSMIT AND RECEIVE LINES •
WORKS ON ANY COMPUTER WITH A SERIAL PORT • FULL
SCHEMATIC AND PIN OUT

6502 COMPUTER BOARDS

ALL CANADIAN MADE

—MOTHER BOARD	45.00
—DISC CONTROLLER	15.00
—16K LANGUAGE	18.00
—80 COLUMN	18.00
—COLOUR GRAPHIC BOARD	20.00
—TMS9918A CHIP	36.00
—RS232 CARD COMPLETE WITH MANUAL	140.00
—Z80 CARD	20.00

IC SOCKETS

TIN	14 PIN	6/\$1.00	\$13.00/100 pc
	16 PIN	6/\$1.00	\$13.00/100 pc
GOLD	14 PIN	5/\$1.00	\$14.00/100 pc
GOLD	16 PIN	5/\$1.00	\$14.00/100 pc
INLAY	18 PIN	30¢	

SPECIAL BUY!
30¢ EACH

24 PIN 28 PIN 40 PIN

CRYSTALS

14.31818 MHz	3.00 ea.
17.430 MHz	5.00 ea.
10.738635 MHz	4.50 ea.
2.000 MHz	2.00 ea.
4.000 MHz	4.00 ea.
4.433618 MHz	0.50 ea.
5.0688 MHz	3.00 ea.
10.240 MHz	3.00 ea.
16.000 MHz	3.00 ea.

WE ALSO HAVE A GOOD SELEC-
TION OF MARINE BAND
CRYSTALS \$1.00 EACH

CONDENSER MICROPHONE

WITH BUILT IN PRE-AMPLIFIER

\$1.00 EACH

USED AND TESTED FANS

4"	\$6—\$8.00
3"	\$9.00

ADAPTORS

—4.5 VOLT 5 WATT	1.00
—9.5 VOLT 9 WATT	2.00
—12 VOLT 4.8 WATT NO CAPACITOR	2.50
—12.5 VOLT 5.5 WATT	2.50

AND MANY MORE IN LIMITED
QUANTITIES

TRANSFORMERS

—12 VOLT CT 3 AMP	6.00
—12.6 VOLT 300 mA	1.25
—16 VOLT CT & 50 VOLT 300 mA	1.50
—24 VOLT CT 500 mA	1.50

AND MANY MORE

NEW MONITORS

—12" WHITE PHOSPHOR	
—12 MHz BANDWIDTH	
—WITH SYNC SEPERATOR BOARD NO POWER SUPPLY	\$68.00

SYNC BOARD	\$15.00
COLOUR MODULATOR	\$18.00

WE ALSO CARRY A WIDE AND
ALWAYS CHANGING SELECTION
OF MOTORS • SPEAKERS •
RESISTORS • CAPACITORS •
SEMICONDUCTORS • IC'S •
SWITCHES • TOOLS • ELEC-
TRONIC PARTS.

MAIL ORDERS WILL BE ACCEPTED ONLY ON THE ACOUSTIC COUPLERS
AND THE 6502 BOARDS.

SEND A CERTIFIED CHEQUE OR MONEY ORDER. ONTARIO
RESIDENTS MUST ADD 7% SALES TAX. VISA AND MASTER CARD AC-
CEPTED: SEND CARD NO., SIGNATURE, EXPIRY DATE AND NAME OF
BANK. ALL SALES FINAL. ALL MERCHANDISE WILL BE SHIPPED BY
COURIER COLLECT.

High Definition TV

Continued from page 48

Digital techniques however translate the TV signal into binary code which can then be transmitted and received without distortion.

"I don't want to say that HDTV has been shelved," says Kewin, "but some new technology has come in as far as digitizing it. You should see digital video arriving in the stores in the next couple of years." Digital components will be used first in conjunction with the present NTSC system but will smooth the way for the introduction of HDTV.

Another long-overdue, though less drastic, change to be ushered in with HDTV is the widening of TV screens relative to height. The aspect ratio of today's screens (width:height) is a squarish 4:3 or even 5:4. HDTV will bring with it an aspect ratio of at least 5:3, closer to the proportions of theatre screens. Possibly an HDTV system will be able to show any movie in its original proportions, from the more vertical older films to the super-wide films with a 2:1 aspect. This would eliminate the cropping of films for TV which often results in incomplete titles (*A*S* instead of M*A*S*H) and dialogue between characters who are off-screen.

public broadcasting corporation. Reports indicate that the images were indeed comparable to 35 mm film.

With all the advantages of HDTV over current broadcast standards, then what's holding it up? After the technical problems of making the system practical for consumers, the largest impediment may be the delivery system. The larger bandwidth of HDTV presents difficulties for current broadcasters who may have to look to Direct Broadcast Satellite (DBS) or some combination of DBS with wire or fibre-optic cable networks.

"The first use will be with DBS," says Sony's Kewin. His high estimate of the initial cost to the consumer is premised upon the necessity for both an HDTV monitor in the home and a TVRO (TV Receive-Only satellite dish) outside to pick up the signals.

Matsushita has shown how such an HDTV system could work in a demonstration that involved a high-resolution TV camera with a 30-MHz bandwidth amplifier, fiber optics transmission system, an SHF (Super High Frequency) DBS satellite, a TVRO with low-noise SHF/RF con-

So the technology is both theoretically enticing and practically possible. The question that remains is what will it take to get everyone to throw out their old TV set to buy another one, particularly in times of economic hardship? Already HDTV is being used by film and television producers but to become a mass-interest item HDTV will have to catch on with all consumers or none at all. For, like the existing broadcast systems, HDTV is incompatible with all others. You won't be able to hook up an HDTV set within the NTSC, PAL or SECAM systems. Nor will your NTSC set work in an HDTV system.

Manufacturers are counting on a gradual replacement of today's standards by HDTV. They have the precedent of Britain which upgraded its system by going through a period during which the old and the new standards still co-exist.

Kewin explains, "We won't obsolete the NTSC system right away. They will probably run parallel for about ten years, then we'll eventually drop NTSC."

And just when they've started building TVs that will last beyond then.

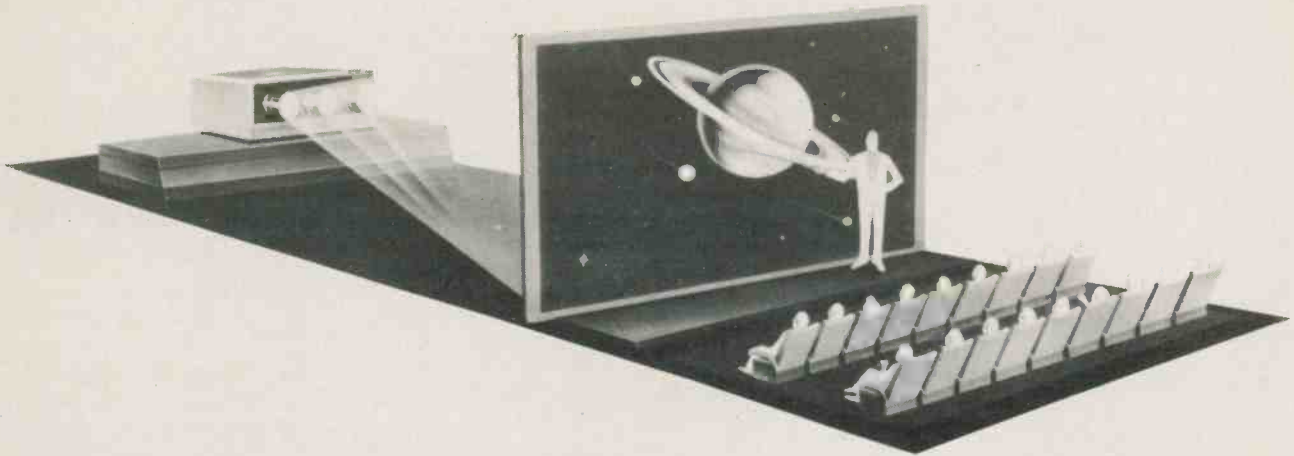

One impetus for the development of HDTV is the growing use of large-screen projection television which would benefit from greater resolution. Screens as large as 8½ by 11¼ feet are about to hit the market. (Courtesy Matsushita Electric)

And since HDTV entails a complete technical overhaul of the television broadcast system, we can expect all the other advances we've heard predicted to be thrown in as well, including stereo sound and a component approach to TV — both of which have already come onto the market in some form.

In 1981 CBS demonstrated high-definition TV with stereo sound, wide screen, and enhanced colour. The system also employed Sony digital technology, Matsushita projection TV and an HDTV camera from Japan's

verter at the receiving end and a 1,125-line TV console and projection unit.

The SHF satellite is an essential ingredient since it solves the bandwidth problem. Boosting the frequency into the gigahertz range creates room enough for channels to be reserved for the bandwidths required by HDTV, provided the national regulatory agencies agree. Observers of the Matsushita demonstration said that the resultant images were sharp enough to distinguish blades of grass and strands of hair.

ETI

**Help Fight
Arthritis now!
Be Generous
when your
canvasser calls.**



THE ARTHRITIS SOCIETY

DON'T MISS

- An automation supermarket where small business can find and compare computer products to become more **EFFICIENT** and **COMPETITIVE**.
- Computer hobbyists can compare the newest in personal computers and games.



THE TORONTO SMALL BUSINESS COMPUTER SHOWPLACE

SPECIAL EVENTS

Low - Cost often repeated workshops on how to select and use computers for small business.

QUEEN ELIZABETH BUILDING,
CNE, TORONTO

**FEBRUARY 11, 12, 13
1983**

FRI. & SAT. 10:00 a.m. - 10:00 p.m.
SUN. 10:00 a.m. - 6:00 p.m.

ATTENDANCE: \$5.00



INDUSTRIAL
TRADE SHOWS OF CANADA

20 BUTTERICK RD., TORONTO, CANADA MBW 3Z8

Audio Analyser



For creative audio applications

AUDIO spectrum analysers can be used for a variety of tasks. Their most valuable use is to set up a room acoustically, for live music or in conjunction with a graphic equaliser connected to your hi-fi. This will allow you to compensate for deficiencies in either your speaker system alone, or the system/living room combination. The procedure used involves feeding pink noise (more on this later) into the room via your hi-fi system and monitoring the sound with the Analyser. The Analyser points out the peaks and troughs in the audio so that you can get rid of them by adjusting the graphic equaliser controls

— hopefully this will produce a flat response.

Other uses for a spectrum analyser include monitoring live programme material or (let's be honest!) as a great little gadget to impress your friends.

To Sweep Or Not To Sweep

There are two main methods of performing spectrum analysis. The first uses a single tuneable filter which can have its centre frequency swept across the band of interest. When the filter output is displayed on an oscilloscope screen it constitutes a graph of amplitude against frequency for the input signal. This gives a well-

formatted and accurate display but unfortunately it has the disadvantage of not being 'real time'; if something happens at one frequency while the filter is sweeping somewhere else, it will not be recorded. Consequently, this method is normally only used where the spectral content is constant and the sweep is to be made over a small percentage of the total frequency. A typical example of this would be checking that the emissions of a CB rig were within legal limits; the rig is turned on, with no audio input, so that only the carrier wave is being transmitted; a sweep is then made either side of 27 MHz to check that there are no spurious emissions.

When the spectrum of the input is rapidly changing, as is the case with an audio signal, then we must choose a different method. For real time analysis we use several band-pass filters, with fixed centre frequencies, to chop up the frequency spectrum into several bands. The content of each band is rectified, averaged and displayed on an oscilloscope or, as in this project, on columns of LEDs. Commercial spectrum analysers are available with anything from 10 one-octave steps to 30 third-octave steps, but the cost and complexity of the filters increases dramatically as you make the bands narrower. Consequently, we have

PARTS LIST

RESISTORS (All 1/4 watt 5% carbon)

R1,2	220k
R3	2k2
R4,5,69	15k
R6-10,31-35,72	10k
R11-15,21-25	
36-40,46-50,78	1M
R16-20,41-45	220R
R26-30,51-55	
68,76	100k
R56	680k
R57	6k8
R58-67	47k
R68	100k
R69	15k
R70	430R
R71	27k
R73	4k7
R74	180k
R75	18k
R77	390k

POTENTIOMETERS

RV1	47k log carbon
PR1-10	220k min horiz preset

CAPACITORS (All metallised Polycarbonate unless noted)

C1,13,43,49,50	100n
C2,3,41	10u 16V tantalum bead
C4,5,7	1u0
C6	56n
C8,10	27n
C9,11	270n
C16-20,35-39	2u2 35V tantalum bead
C12	6n8
C14	18n
C15	3n9
C21,22	39n
C23	1n5
C24	33n
C25,32,33	2n2
C26,44	820p ceramic disc
C27	12n
C28	3n3
C29	470p ceramic disc
C30	10n
C31	180p ceramic disc
C34	100p ceramic disc
C40	22n
C42	1n
C45	2n7
C46	5n6
C47,48	220u 16V axial electrolytic

SEMICONDUCTORS

IC1	LF353 dual BIFET op-amp
IC2-6	TL064 quad lo-power op-amp
IC7	4011 CMOS quad 2-input NAND
IC8,9,10	4016 CMOS quad analogue switch
IC11	LM3915 bargraph driver
IC12	4017 CMOS decade counter/divider
IC13	4070 CMOS quad EX-OR
IC14	4006 CMOS 18-stage shift register
Q1-11	2N3904 silicon NPN transistor
D1-22	1N4148 signal diode
LED1-100	high efficiency red LED

MISCELLANEOUS

SK1	1/4" jack socket with break contacts
MIC1	electret microphone
9V battery clips (2 off); IC sockets (13 off); case; wire; solder; PCBs, etc.	

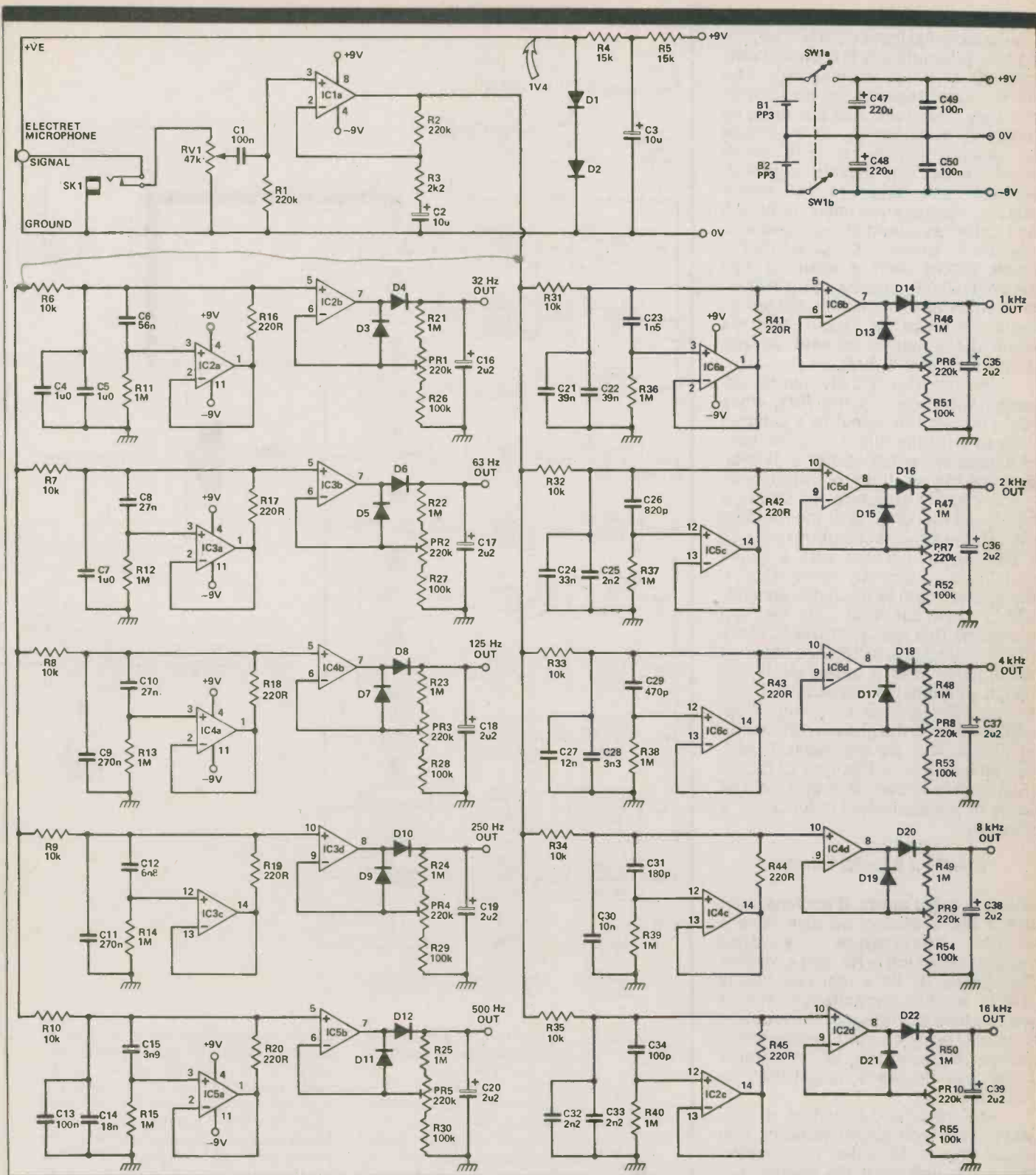

Fig. 1 The input and filter stages of the circuit.

opted for a 10 channel version, the filters' outputs being 12 dB down one octave from the centre frequency. The centre frequencies of the filters follow the standard scale; measured in Hertz they are 32, 63, 125, 250, 500, 1k, 2k, 4k, 8k, and 16k. The amplitude scale has 3 dB steps.

Admittedly, the fact that this type of analyser breaks up the frequency spectrum into octave chunks means that it isn't capable of picking out individual harmonics in the way that the sweep analyser can. Nevertheless, it does allow you to instantaneously determine the average

spectrum of a sound, which is all we require.

The Circuit

The input to the circuit (Figure 1) is either from the built-in microphone or

Audio Analyser

via the external input socket. The jack socket automatically disconnects the mic if a plug is inserted. The microphone requires a reasonably flat frequency response but must be relatively inexpensive, so we chose an electret condenser type which meets these requirements. However, electret mics require a 1V5 power supply, normally provided by an AA cell. Ours has a built-in regulated supply built around D1-D2-R4-R5-C3. Zener diodes with a value of 1V5 aren't available but, by using two ordinary diodes in series, we can get an output voltage of about 1V2-1V4 (each diode has a forward voltage drop of about 0V6-0V7).

The input sensitivity can be adjusted with level control RV1, while IC1 boosts the signal to a suitable level to drive the filter bank. The gain of IC1a is set at 101, ie, $(R2 + R3)/R3$. Each of the ten filter-rectifier blocks is identical in structure. To obtain a bandpass response with the required roll-off, the simplest solution is to use a parallel LC network with a series resistor. Unfortunately, large value inductors are both bulky and expensive, which rules out their use. We can overcome this easily, however, since the only electrical difference between an inductor and a capacitor is the phase relationship between the current and the voltage. By using an op-amp to reverse the phase relationship of a capacitor we can make it look like an inductor — this type of circuit (Figure 3) is known as a gyrator. The value of the equivalent inductance is given by:

$$L1 = C1 \times R1 \times R2 \text{ Henries}$$

where C is in Farads, R in ohms. Just like a real inductor, we also have a series resistance (winding resistance) which is R2, and a parallel resistance, R1 (in a real coil this is due to winding capacitance). Hence we can tune our filters to the required frequencies by altering the capacitor values in each one, using parallel pairs in some cases, to get the correct values.

The rectifier section is a half-wave type, with a gain variable from about four to 12, using the presets. When the output of the op-amp swings positive, capacitor C1 charges rapidly via the diode; D1; when the output falls, the capacitor can only discharge slowly via the resistor chain. The second diode D2, from the op-amp output back to the inverting input, keeps the op-amp in the linear region on the negative half-cycle.

The outputs of the ten rectifiers are multiplexed to reduce the compo-

HOW IT WORKS

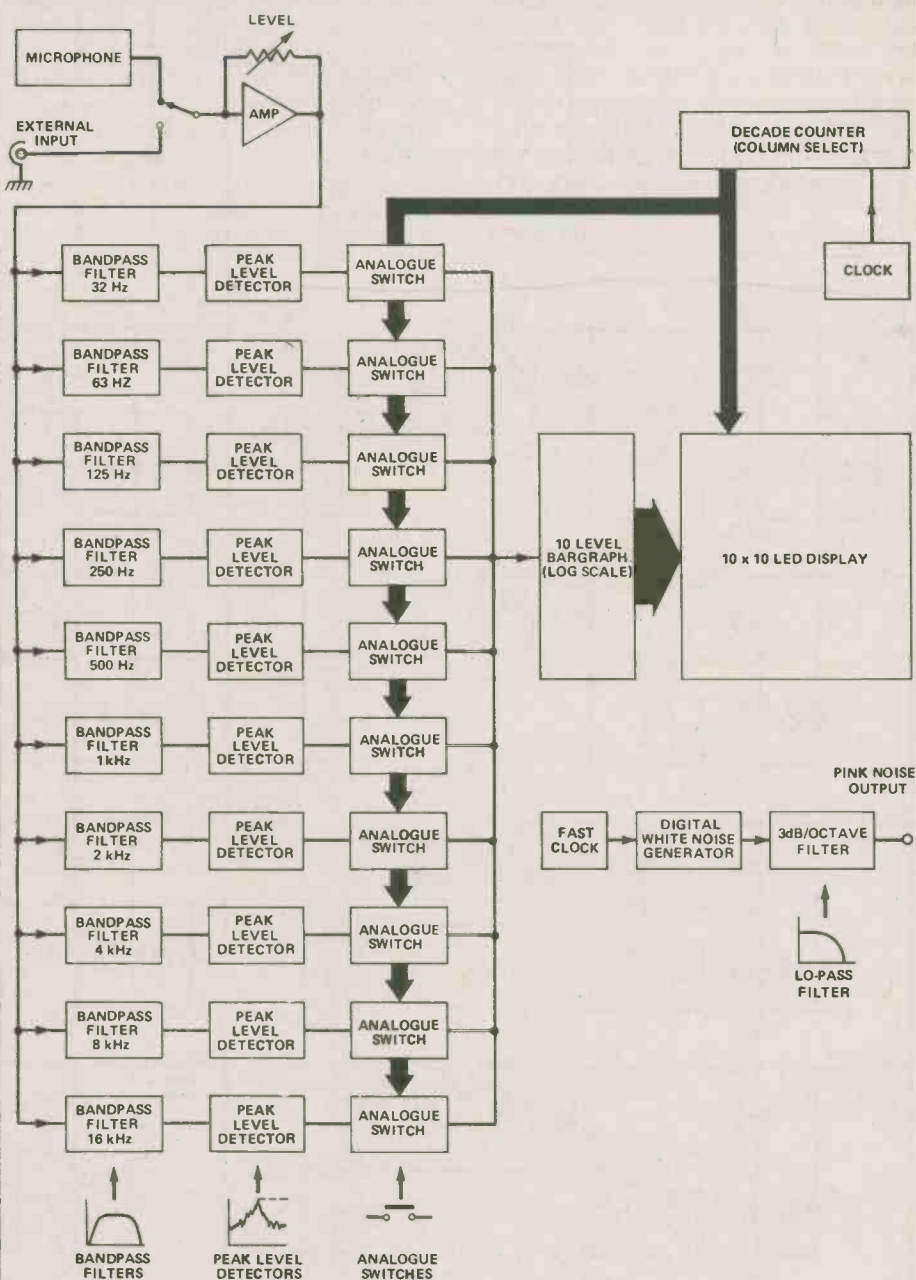

The audio signal to be analysed is taken from the microphone or external input socket to the level control/preamplifier section. This amplifies the signal to a suitable level to drive the circuitry that follows. The signal is fed to 10 bandpass filters spaced one octave apart, each of which will only allow through a small section of the signal around the centre frequency. Each filter is followed by a peak level detector which averages out the signal, responding quickly to peaks but decaying slowly so that the display is easy to read. The outputs of the 10 peak detectors are connected one at a time (by the CMOS analogue switches) to the input of a 10-level LED bargraph

driver. A logarithmic driver is used to give 3 dB steps. To reduce current consumption the bargraph operates in dot mode, so that the height of the illuminated LED up the column represents the peak level. The decade counter which controls the analogue switches also switches on the correct column of LEDs for each passband. All the columns are blanked for a short period, as the switches change over, to prevent garbage being displayed.

The white noise is generated digitally by cycling a scrambled sequence of 1s and 0s through a shift register. The white noise is passed through a filter with a slope of 3 dB/octave to produce pink noise.

nent count and cost; if we drive each column of LEDs separately we'd need ten LM3915s, which is a bit expensive! Multiplexing means that each rectifier output is switched to the input of the LM3915 (IC1) one after another, by the analogue switches IC8, 9 and 10. The switches are controlled by a 4017 decade counter (IC12) with ten decoded outputs, each

of which is high for one clock period only. These outputs also switch on one of the transistors Q1-10, connecting the required column of LEDs to the positive supply rail. Meanwhile the LM3915 has turned on one of its outputs corresponding to the voltage on its input (remember, it's wired in dot mode). Hence a current path between the supply rails exists for only

one LED of the 100 in the display, so at any moment only one LED is turned on. By clocking the 4017 at a fairly slow speed (about 500 Hz) the display cycles through all ten columns 50 times a second and the eye sees ten LEDs 'continuously' lit.

To generate an adequate light level, a red LED requires at least 4 or 5 mA continuous current. Since each

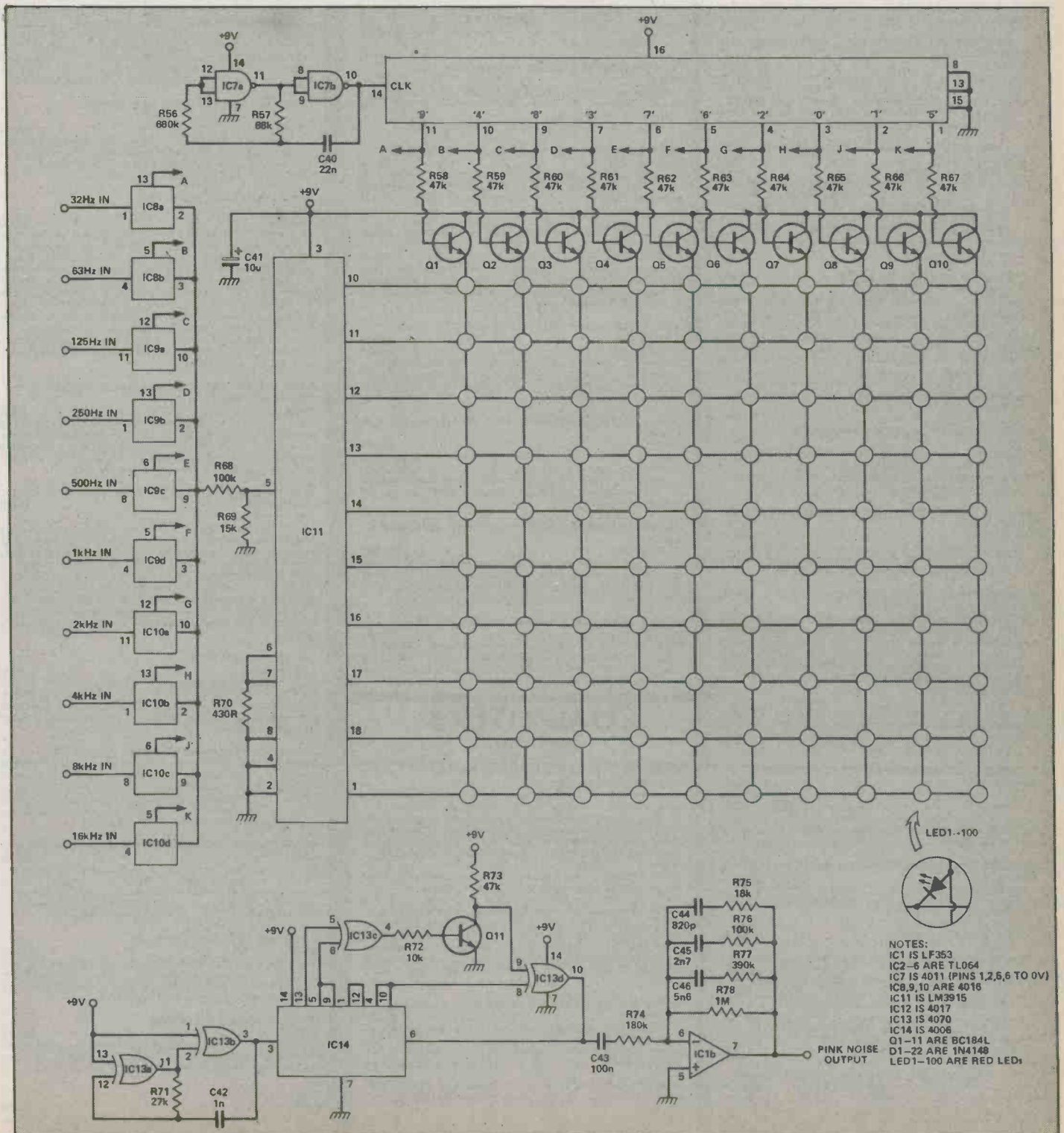

Fig. 2 The display generation circuitry.

Continued on page 79

COMPUTERS

(HARDWARE)

THE ESSENTIAL COMPUTER DICTIONARY AND SPELLER

AB011 \$10.45
A must for anyone just starting out in the field of computing, be they a businessman, hobbyist or budding computerist. The book presents and defines over 15,000 computer terms and acronyms and makes for great browsing.

A BEGINNER'S GUIDE TO COMPUTERS AND MICROPROCESSORS — WITH PROJECTS.

TAB No.1015 \$13.45
Here's a plain English introduction to the world of microcomputers — its capabilities, parts and functions . . . and how you can use one. Numerous projects demonstrate operating principles and lead to the construction of an actual working computer capable of performing many useful functions.

BP66: BEGINNERS GUIDE TO MICROPROCESSORS AND COMPUTING

E.F. SCOTT, M.Sc., C.Eng. \$7.55
As indicated by the title, this book is intended as an introduction to the basic theory and concepts of binary arithmetic, microprocessor operation and machine language programming.

There are occasions in the text where some background information might be helpful and a Glossary is included at the end of the book.

BP72: A MICROPROCESSOR PRIMER

E.A. PARR, B.Sc., C.Eng., M.I.E.E. \$7.70
A newcomer to electronics tends to be overwhelmed when first confronted with articles or books on microprocessors. In an attempt to give a painless approach to computing, this small book will start by designing a simple computer and because of its simplicity and logical structure, the language is hopefully easy to learn and understand. In this way, such ideas as Relative Addressing, Index Registers etc. will be developed and it is hoped that these will be seen as logical progressions rather than arbitrary things to be accepted but not understood.

BEGINNERS GUIDE TO MICROPROCESSORS

TAB No.995 \$10.45
If you aren't sure exactly what a microprocessor is, then this is the book for you. The book takes the beginner from the basic theories and history of these essential devices, right up to some real world hardware applications.

HOW TO BUILD YOUR OWN WORKING MICROCOMPUTER

TAB No.1200 \$16.45
An excellent reference or how-to manual on building your own microcomputer. All aspects of hardware and software are developed as well as many practical circuits.

BP78: PRACTICAL COMPUTER EXPERIMENTS

E.A. PARR, B.Sc., C.Eng., M.I.E.E. \$7.30
Curiously most published material on the microprocessor tends to be of two sorts, the first treats the microprocessor as a black box and deals at length with programming and using the "beast". The second type of book deals with the social impact. None of these books deal with the background to the chip, and this is a shame as the basic ideas are both interesting and simple.

This book aims to fill in the background to the microprocessor by constructing typical computer circuits in discrete logic and it is hoped that this will form a useful introduction to devices such as adders, memories, etc. as well as a general source book of logic circuits.

HANDBOOK OF MICROPROCESSOR APPLICATIONS

TAB No.1203 \$14.45
Highly recommended reading for those who are interested in microprocessors as a means of accomplishing a specific task. The author discusses two individual microprocessors, the 1802 and the 6800, and how they can be put to use in real world applications.

MICROPROCESSOR/MICROPROGRAMMING HANDBOOK

TAB No.785 \$14.45
A comprehensive guide to microprocessor hardware and programming. Techniques discussed include subroutines, handling interrupts and program loops.

BP102: THE 6809 COMPANION

M. JAMES \$8.10
The 6809 microprocessor's history, architecture, addressing modes and the instruction set (fully commented) are covered. In addition there are chapters on converting programs from the 6800, programming style, interrupt handling and about the 6809 hardware and software available.

AN INTRODUCTION TO MICROPROCESSORS EXPERIMENTS IN DIGITAL TECHNOLOGY

HB07: \$15.85
SMITH
A "learn by doing" guide to the use of integrated circuits provides a foundation for the underlying hardware actions of programming statements. Emphasis is placed on how digital circuitry compares with analog circuitry. Begins with the simplest gates and timers, then introduces the fundamental parts of ICs, detailing the benefits and pitfalls of major IC families, and continues with coverage of the ultimate in integrated complexity — the microprocessor.

DESIGNING MICROCOMPUTER SYSTEMS

HB18: \$15.85
POOCH AND CHATTERGY

This book provides both hobbyists and electronic engineers with the background information necessary to build microcomputer systems. It discusses the hardware aspects of microcomputer systems. Timing devices are provided to explain sequences of operations in detail. Then, the book goes on to describe three of the most popular microcomputer families: the Intel 8080, Zilog Z-80, and Motorola 6800. Also covered are designs of interfaces for peripheral devices, and information on building microcomputer systems from kits.

S-100 BUS HANDBOOK

HB19: \$22.75
BURSKY
Here is a comprehensive book that exclusively discusses S-100 bus computer systems and how they are organized. The book covers computer fundamentals, basic electronics, and the parts of the computer. Individual chapters discuss the CPU, memory, input/output, bulk-memory devices, and specialized peripheral controllers. It explains all the operating details of commonly available S-100 systems. Schematic drawings.

BASIC MICROPROCESSORS AND THE 6800

HB06: \$21.45
Provides two books in one: a basic guide to microprocessors for the beginner, and a complete description of the M6800 system for the engineer.
Each chapter is followed by a problem section.

DIGITAL INTERFACING WITH AN ANALOG WORLD

TAB No.1070 \$14.45
You've bought a computer, but now you can't make it do anything useful. This book will tell you how to convert real world quantities such as temperature, pressure, force and so on into binary representation.

MICROPROCESSOR INTERFACING HANDBOOK: A/D & D/A

TAB No.1271 \$14.45
A useful handbook for computerists interested in using their machines in linear applications. Topics discussed include voltage references, op-amps for data conversion, analogue switching and multiplexing and more.

COMPUTER TECHNICIAN'S HANDBOOK

TAB No.554 \$17.45
Whether you're looking for a career, or you are a service technician, computer repair is an opportunity you should be looking at. The author covers all aspects of digital and computer electronics as well as the mathematical and logical concepts involved.

HOW TO TROUBLESHOOT AND REPAIR MICROCOMPUTERS

AB013 \$13.45
Learn how to find the cause of a problem or malfunction in the central or peripheral unit of any microcomputer and then repair it. The tips and techniques in this guide can be applied to any equipment that uses the microprocessor as the primary control element.

TROUBLESHOOTING MICROPROCESSORS AND DIGITAL LOGIC

TAB No.1183 \$13.45
The influence of digital techniques on commercial and home equipment is enormous and increasing yearly. This book discusses digital theory and looks at how to service Video Cassette Recorders, microprocessors and more.

HOW TO DEBUG YOUR PERSONAL COMPUTER

AB012 \$13.45
When you feel like reaching for a sledge hammer to reduce your computer to fiberglass and epoxy dust, don't. Reach for this book instead and learn all about program bug tracking, recognition and elimination techniques.

COMPUTERS

(SOFTWARE)

BP109: THE ART OF PROGRAMMING THE 1K ZX81

M. JAMES AND S.M. GEE \$8.10
This book shows you how to use the features of the ZX81 in programs that fit into the 1K machine and are still fun to use. Chapter Two explains the random number generator and uses it to simulate coin tossing and dice throwing and to play pounce. Chapter Three shows the patterns you can display using the ZX81's graphics. Its animated graphics capabilities, explored in Chapter Four, have lots of potential for use in games of skill, such as Lunar Lander and Cannon-ball which are given as complete programs. Chapter Five explains PEEK and POKE and uses them to display large characters. The ZX81's timer is explained in Chapter Six and used for a digital clock, a chess clock and a reaction time game. Chapter Seven is about handling character strings and includes three more ready-to-run programs—Hangman, Coded Messages and a number-guessing game. In Chapter Eight there are extra programming hints to help you get even more out of your 1K ZX81.

BEGINNER'S GUIDE TO COMPUTER PROGRAMMING

TAB No.574 \$16.45
Computer programming is an increasingly attractive field to the individual, however many people seem to overlook it as a career. The material in this book has been developed in a logical sequence, from the basic steps to machine language.

HOW TO PROFIT FROM YOUR PERSONAL COMPUTER: PROFESSIONAL, BUSINESS, AND HOME APPLICATIONS

LEWIS \$17.00
Describes the uses of personal computers in common business applications, such as accounting, managing, inventory, sorting mailing lists, and many others. The discussion in-

cludes terms, notations, and techniques commonly used by programmers. A full glossary of terms.

PROGRAMS FOR BEGINNERS ON THE TRS-80

BLECHMAN \$13.05
HB02
A valuable book of practical and interesting programs for home use that can be understood and used immediately by the beginner in personal computer programming. You'll learn step-by-step how 21 sample TRS-80 programs work. Program techniques are described line-by-line within the programs, and a unique Martri-Dex™ matrix index will enable you to locate other programs using the same BASIC commands and statements.

THE JOY OF MINIS AND MICROS: DATA PROCESSING WITH SMALL COMPUTERS

STEIN AND SHAPIRO \$15.85
HB03
A collection of pieces covering technical and management aspects of the use of small computers for business of science. It emphasizes the use of common sense and good systems design for every computer project. Because a strong technical background is not necessary, the book is easy to read and understand. Considerable material is devoted to the question of what size computer should be used for a particular job, and how to choose the right machine for you.

USING MICROCOMPUTERS IN BUSINESS

VEIT \$14.45
HB04
An essential background briefing for any purchaser of microcomputer systems or software. In a fast-moving style, without the usual buzz words and technical jargon, Veit answers the most often asked questions.

BASIC FROM THE GROUND UP

SIMON \$17.00
HB15
Here's a BASIC text for high school students and hobbyists that explores computers and the BASIC language in a simple direct way, without relying on a heavy mathematical background on the reader's part. All the features of BASIC are included as well as some of the inside workings of a computer. The book covers one version of each of the BASIC statements and points out some of the variations, leaving readers well prepared to write programs in any version they encounter. A selection of exercises and six worked out problems round out the reader's experience. A glossary and a summary of BASIC statements are included at the end of the book for quick reference.

BASIC COMPUTER PROGRAMS FOR BUSINESS: STERNBERG (Vol. 1)

HB13 \$15.85
A must for small businesses utilizing micros as well as for entrepreneurs, volume provides a wealth of practical business applications. Each program is documented with a description of its functions and operation, a listing in BASIC, a symbol table, sample data, and one or more samples.

BP86: AN INTRODUCTION TO BASIC PROGRAMMING TECHNIQUES

S. DALY \$8.25
This book is based on the author's own experience in learning BASIC and in helping others, mostly beginners, to program and understand the language. Also included are a program library containing various programs, that the author has actually written and run. These are for biorhythms, plotting a graph of Y against X, standard deviation, regression, generating a musical note sequence and a card game. The book is complemented by a number of appendices which include test questions and answers on each chapter and a glossary.

THE BASIC COOKBOOK.

TAB No.1055 \$9.45
BASIC is a surprisingly powerful language . . . if you understand it completely. This book, picks up where most manufacturers' documentation gives up. With it, any computer owner can develop programs to make the most out of his or her machine.

PET BASIC — TRAINING YOUR PET COMPUTER

AB014 \$17.45
Officially approved by Commodore, this is the ideal reference book for long time PET owners or novices. In an easy to read and humorous style, this book describes techniques and experiments, all designed to provide a strong understanding of this versatile machine.

PROGRAMMING IN BASIC FOR PERSONAL COMPUTERS

AB015 \$13.45
This book emphasizes the sort of analytical thinking that lets you use a specific tool — the BASIC language — to transform your own ideas into workable programs. The text is designed to help you to intelligently analyse and design a wide diversity of useful and interesting programs.

COMPUTER PROGRAMS IN BASIC

AB001 \$15.45
A catalogue of over 1,600 fully indexed BASIC computer programs with applications in Business, Math, Games and more. This book lists available software, what it does, where to get it, and how to adapt it to your machine.

PET GAMES AND RECREATION

AB002 \$17.45
A variety of interesting games designed to amuse and educate. Games include such names as Capture, Tic Tac Toe, Watchperson, Motie, Sinners, Martian Hunt and more.

BRAIN TICKLERS

AB005 \$9.00
If the usual games such as Bug Stomp and Invaders From the Time Warp are starting to pale, then this is the book for you. The authors have put together dozens of stimulating puzzles to show you just how challenging computing can be.

PASCAL
TAB No.1205 \$16.45
 Aimed specifically at TRS-80 users, this book discusses how to load, use and write PASCAL programs. Graphic techniques are discussed and numerous programs are presented.

PASCAL PROGRAMMING FOR THE APPLE
AB009 \$17.45
 A great book to upgrade your programming skills to the UCSD Pascal as implemented on the Apple II. Statements and techniques are discussed and there are many practical and ready to run programs.

APPLE MACHINE LANGUAGE PROGRAMMING
AB009 \$20.45
 The best way to learn machine language programming the Apple II in no time at all. The book combines colour, graphics, and sound generation together with clear cut demonstrations to help the user learn quickly and effectively.

Z80 USERS MANUAL
AB010 \$21.45
 The Z80 MPU can be found in many machines and is generally acknowledged to be one of the most powerful 8 bit chips around. This book provides an excellent 'right hand' for anyone involved in the application of this popular processor.

HOW TO PROGRAM YOUR PROGRAMMABLE CALCULATOR
AB006 \$12.45
 Calculator programming, by its very nature, often is an obstacle to effective use. This book endeavours to show how to use a programmable calculator to its full capabilities. The TI 57 and the HP 33E calculators are discussed although the principles extend to similar models.

Z-80 AND 8080 ASSEMBLY LANGUAGE PROGRAMMING
SPRACKLEN
HB05 \$19.25
 Provides just about everything the applications programmer needs to know for Z-80 and 8080 processors. Programming techniques are presented along with the instructions. Exercises and answers included with each chapter.

BASIC COMPUTER PROGRAMS IN SCIENCE AND ENGINEERING
GILDER
HB08 \$15.85
 Save time and money with this collection of 114 ready-to-run BASIC programs for the hobbyist and engineer. There are programs to do such statistical operations as means, standard deviation averages, curve-fitting, and interpolation. There are programs that design antennas, filters, attenuators, matching networks, plotting, and histogram programs.

GAME PLAYING WITH COMPUTERS SECOND EDITION
SPENCER
HB11 \$31.25
 Now you can sharpen programming skills through a relaxed approach. Completely devoted to computerized game playing, this volume presents over 70 games, puzzles, and mathematical recreations for a digital computer. It's fully illustrated and includes more than 25 game-playing programs in FORTRAN or BASIC complete with descriptions, flowcharts, and output.

MICROCOMPUTERS AND THE 3 R'S
DOERR
HB09 \$14.25
 This book educates educators on the various ways computers, especially microcomputers, can be used in the classroom. It describes microcomputers, how to organize a computer-based program, the five instructional application types (with examples from subjects such as the hard sciences, life sciences, English, history, and government) and resources listings of today's products. The book includes preprogrammed examples to start up a microcomputer program, while chapters on resources and products direct the reader to useful additional information. All programs are written in the BASIC language.

GAME PLAYING WITH BASIC
SPENCER
HB10 \$15.25
 The writing is nontechnical, allowing almost anyone to understand computerized game playing. The book includes the rules of each game, how each game works, illustrative flowcharts, diagrams, and the output produced by each program. The last chapter contains 26 games for reader solution.

SARGON: A COMPUTER CHESS PROGRAM
SPRACKLEN
HB12 \$25.00
 "I must rate this chess program an excellent buy for anyone who loves the game." Kilobaud.
 Here is the computer chess program that won first place in the first chess tournament at the 1978 West Coast Computer Faire. It is written in Z-80 assembly language, using the TDL macro assembler. It comes complete with block diagram and sample printouts.

A CONSUMER'S GUIDE TO PERSONAL COMPUTING AND MICROCOMPUTERS, SECOND EDITION
FREIBERGER AND CHEW
HB14 \$14.45
 The first edition was chosen by Library Journal as one of the 100 outstanding sci-tech books of 1978. Now, there's an updated second edition!
 Besides offering an introduction to the principles of microcomputers that assumes no previous knowledge on the reader's part, this second edition updates prices, the latest developments in microcomputer technology, and a review of over 100 microcomputer products from over 60 manufacturers.

THE BASIC CONVERSIONS HANDBOOK FOR APPLE, TRS-80, AND PET USERS
BRAIN BANK
HB17 \$11.75
 Convert a BASIC program for the TRS-80, Apple II, or PET to the form of BASIC used by any other one of those machines. This is a complete guide to converting Apple II and PET programs to TRS-80, TRS-80 and PET programs to Apple II, TRS-80 and Apple II programs to PET. Equivalent commands are listed for TRS-80 BASIC (Model I, Level II), Applesoft BASIC and PET BASIC, as well as variations for the TRS-80 Model III and Apple Integer BASIC.

SPEAKING PASCAL
BOWEN
HB16 \$17.25
 An excellent introduction to programming in the Pascal language! Written in clear, concise, non-mathematical language, the text requires no technical background or previous programming experience on the reader's behalf. Top-down structured analysis and key examples illustrate each new idea and the reader is encouraged to construct programs in an organized manner.

BP33: ELECTRONIC CALCULATOR USERS HANDBOOK \$4.25
M.H. BABANI, B.Sc.(Eng.)
 An invaluable book for all calculator users whatever their age or occupation, or whether they have the simplest or most sophisticated of calculators. Presents formulae, data, methods of calculation, conversion factors, etc., with the calculator user especially in mind; often illustrated with simple examples. Includes the way to calculate using only a simple four function calculator: Trigonometric Functions (Sin, Cos, Tan); Hyperbolic Functions (Sinh, Cosh, Tanh) Logarithms, Square Roots and Powers.

THE MOST POPULAR SUBROUTINES IN BASIC
TAB No.1050 \$10.45
 An understandable guide to BASIC subroutines which enables the reader to avoid tedium, economise on computer time and makes programs run faster. It is a practical rather than a theoretical manual.

PROJECTS

BP48: ELECTRONIC PROJECTS FOR BEGINNERS \$5.90
F.G. RAYER, T.Eng.(CEI), Assoc. IERE
 Another book written by the very experienced author — Mr. F.G. Rayer — and in it the newcomer to electronics, will find a wide range of easily made projects. Also, there is a considerable number of actual component and wiring layouts, to aid the beginner.

Furthermore, a number of projects have been arranged so that they can be constructed without any need for soldering and, thus, avoid the need for a soldering iron.

Also, many of the later projects can be built along the lines as those in the 'No Soldering' section so this may considerably increase the scope of projects which the newcomer can build and use.

221: 28 TESTED TRANSISTOR PROJECTS \$5.50
R.TORRENS
 Mr. Richard Torrens is a well experienced electronics development engineer and has designed, developed, built and tested the many useful and interesting circuits included in this book. The projects themselves can be split down into simpler building blocks, which are shown separated by boxes in the circuits for ease of description, and also to enable any reader who wishes to combine boxes from different projects to realise ideas of his own.

BP49: POPULAR ELECTRONIC PROJECTS \$6.25
R.A. PENFOLD
 Includes a collection of the most popular types of circuits and projects which, we feel sure, will provide a number of designs to interest most electronics constructors. The projects selected cover a very wide range and are divided into four basic types: Radio Projects, Audio Projects, Household Projects and Test Equipment.

EXPERIMENTER'S GUIDE TO SOLID STATE ELECTRONIC PROJECTS
AB007 \$10.45
 An ideal sourcebook of Solid State circuits and techniques with many practical circuits. Also included are many useful types of experimenter gear.

BP71: ELECTRONIC HOUSEHOLD PROJECTS \$7.70
R. A. PENFOLD
 Some of the most useful and popular electronic construction projects are those that can be used in or around the home. The circuits range from such things as '2 Tone Door Buzzer', Intercom, through Smoke or Gas Detectors to Baby and Freezer Alarms.

BP94: ELECTRONIC PROJECTS FOR CARS AND BOATS \$8.10
R.A. PENFOLD
 Projects, fifteen in all, which use a 12V supply are the basis of this book. Included are projects on Windscreen Wiper Control, Courtesy Light Delay, Battery Monitor, Cassette Power Supply, Lights Timer, Vehicle Immobiliser, Gas and Smoke Alarm, D Depth Warning and Shaver Inverter.

BP69: ELECTRONIC GAMES \$7.55
R.A. PENFOLD
 In this book Mr. R. A. Penfold has designed and developed a number of interesting electronic game projects using modern integrated circuits. The text is divided into two sections, the first dealing with simple games and the latter dealing with more complex circuits.

BP95: MODEL RAILWAY PROJECTS \$8.10
 Electronic projects for model railways are fairly recent and have made possible an amazing degree of realism. The projects covered include controllers, signals and sound effects: striboard layouts are provided for each project.

BP93: ELECTRONIC TIMER PROJECTS \$8.10
F.G. RAYER
 Windscreen wiper delay, darkroom timer and metronome projects are included. Some of the more complex circuits are made up from simpler sub-circuits which are dealt with individually.

110 OP-AMP PROJECTS
MARSTON
HB24 \$11.75
 This handbook outlines the characteristics of the op-amp and present 110 highly useful projects—ranging from simple amplifiers to sophisticated instrumentation circuits.

110 IC TIMER PROJECTS
GILDER
HB25 \$10.25
 This sourcebook maps out applications for the 555 timer IC. It covers the operation of the IC itself to aid you in learning how to design your own circuits with the IC. There are application chapters for timer-based instruments, automotive applications, alarm and control circuits, and power supply and converter applications.

110 THYRISTOR PROJECTS USING SCRs AND TRIACS
MARSTON
HB22 \$12.05
 A grab bag of challenging and useful semiconductor projects for the hobbyist, experimenter, and student. The projects range from simple burglar, fire, and water level alarms to sophisticated power control devices for electric tools and trains. Integrated circuits are incorporated wherever their use reduces project costs.

110 CMOS DIGITAL IC PROJECTS
MARSTON
HB23 \$11.75
 Outlines the operating characteristics of CMOS digital ICs and then presents and discusses 110 CMOS digital IC circuits ranging from inverter gate and logic circuits to electronic alarm circuits. Ideal for amateurs, students and professional engineers.

BP76: POWER SUPPLY PROJECTS \$7.30
R.A. PENFOLD
 Line power supplies are an essential part of many electronics projects. The purpose of this book is to give a number of power supply designs, including simple unregulated types, fixed voltage regulated types, and variable voltage stabilised designs, the latter being primarily intended for use as bench supplies for the electronics workshop. The designs provided are all low voltage types for semiconductor circuits.

There are other types of power supply and a number of these are dealt with in the final chapter, including a cassette power supply, Ni-Cad battery charger, voltage step up circuit and a simple inverter.

BP84: DIGITAL IC PROJECTS \$8.10
F.G. RAYER, T.Eng.(CEI), Assoc. IERE
 This book contains both simple and more advanced projects and it is hoped that these will be found of help to the reader developing a knowledge of the workings of digital circuits. To help the newcomer to the hobby the author has included a number of board layouts and wiring diagrams. Also the more ambitious projects can be built and tested section by section and this should help avoid or correct faults that could otherwise be troublesome. An ideal book for both beginner and more advanced enthusiast alike.

BP67: COUNTER DRIVER AND NUMERAL DISPLAY PROJECTS \$7.55
F.G. RAYER, T.Eng.(CEI), Assoc. IERE
 Numeral indicating devices have come very much to the forefront in recent years and will, undoubtedly, find increasing applications in all sorts of equipment. With present day integrated circuits, it is easy to count, divide and display numerically the electrical pulses obtained from a great range of driver circuits.

In this book many applications and projects using various types of numeral displays, popular counter and driver IC's etc. are considered.

BP73: REMOTE CONTROL PROJECTS \$8.60
OWEN BISHOP
 This book is aimed primarily at the electronics enthusiast who wishes to experiment with remote control. Full explanations have been given so that the reader can fully understand how the circuits work and can more easily see how to modify them for other purposes, depending on personal requirements. Not only are radio control systems considered but also infra-red, visible light and ultrasonic systems as are the use of Logic ICs and Pulse position modulation etc.

BP99: MINI — MATRIX BOARD PROJECTS \$8.10
R.A. PENFOLD
 Twenty useful projects which can all be built on a 24 x 10 hole matrix board with copper strips. Includes Doorbuzzer, Low-voltage Alarm, AM Radio, Signal Generator, Projector Timer, Guitar Headphone Amp, Transistor Checker and more.

BP103: MULTI-CIRCUIT BOARD PROJECTS \$8.10
R.A. PENFOLD
 This book allows the reader to build 21 fairly simple electronic projects, all of which may be constructed on the same printed circuit board. Wherever possible, the same components have been used in each design so that with a relatively small number of components and hence low cost, it is possible to make any one of the projects or by re-using the components and P.C.B. all of the projects.

BP107: 30 SOLDERLESS BREADBOARD PROJECTS — BOOK 1 \$9.35
R.A. PENFOLD
 A "Solderless Breadboard" is simply a special board on which electronic circuits can be built and tested. The components used are just plugged in and unplugged as desired. The 30 projects featured in this book have been specially designed to be built on a "Verobloc" breadboard. Wherever possible the components used are common to several projects, hence with only a modest number of reasonably inexpensive components it is possible to build, in turn, every project shown.

BP110: HOW TO GET YOUR ELECTRONIC PROJECTS WORKING

R.A. PENFOLD
We have all built circuits from magazines and books only to find that they did not work correctly, or at all, when first switched on. The aim of this book is to help the reader overcome just these problems by indicating how and where to start looking for many of the common faults that can occur when building up projects.

CIRCUITS

BP80: POPULAR ELECTRONIC CIRCUITS — BOOK 1

R.A. PENFOLD
Another book by the very popular author, Mr. R.A. Penfold, who has designed and developed a large number of various circuits. These are grouped under the following general headings: Audio Circuits, Radio Circuits, Test Gear Circuits, Music Project Circuits, Household Project Circuits and Miscellaneous Circuits.

BP98: POPULAR ELECTRONIC CIRCUITS, BOOK 2

R.A. PENFOLD
70 plus circuits based on modern components aimed at those with some experience.

The GIANT HANDBOOK OF ELECTRONIC CIRCUITS

TAB No.1300
About as twice as thick as the Webster's dictionary, and having many more circuit diagrams, this book is ideal for any experimenter who wants to keep amused for several centuries. If there isn't a circuit for it in here, you should have no difficulty convincing yourself you don't really want to build it.

BP39: 50 (FET) FIELD EFFECT TRANSISTOR PROJECTS

F.G. RAYER, T.Eng.(CEI), Assoc.IERE
Field effect transistors (FETs), find application in a wide variety of circuits. The projects described here include radio frequency amplifiers and converters, test equipment and receiver aids, tuners, receivers, mixers and tone controls, as well as various miscellaneous devices which are useful in the home.

BP87: SIMPLE L.E.D. CIRCUITS

R.N. SOAR
Since it first appeared in 1977, Mr. R.N. Soar's book has proved very popular. The author has developed a further range of circuits and these are included in Book 2. Projects include a Transistor Tester, Various Voltage Regulators, Testers and so on.

BP42: 50 SIMPLE L.E.D. CIRCUITS

R.N. SOAR
The author of this book, Mr. R.N. Soar, has compiled 50 interesting and useful circuits and applications, covering many different branches of electronics, using one of the most inexpensive and freely available components — the Light Emitting Diode (L.E.D.). A useful book for the library of both beginner and more advanced enthusiast alike.

BP82: ELECTRONIC PROJECTS USING SOLAR CELLS

OWEN BISHOP
The book contains simple circuits, almost all of which operate at low voltage and low currents, making them suitable for being powered by a small array of silicon cells. The projects cover a wide range from a bicycle speedometer to a novelty 'Duck Shoot'; a number of power supply circuits are included.

BP37: 50 PROJECTS USING RELAYS, SCR'S & TRIACS

F.G. RAYER, T.Eng.(CEI), Assoc.IERE
Relays, silicon controlled rectifiers (SCR's) and bi-directional triodes (TRIACs) have a wide range of applications in electronics today. This book gives tried and practical working circuits which should present the minimum of difficulty for the enthusiast to construct. In most of the circuits there is a wide latitude in component values and types, allowing easy modification of circuits or ready adaptation of them to individual needs.

BP44: IC 555 PROJECTS

E.A. PARR, B.Sc., C.Eng., M.I.E.E.
Every so often a device appears that is so useful that one wonders how life went on before without it. The 555 timer is such a device. Included in this book are Basic and General Circuits, Motor Car and Model Railway Circuits, Alarms and Noise Makers as well as a section on the 556, 558 and 559 timers.

BP24: 50 PROJECTS USING IC741

RUDI & UWE REDMER
This book, originally published in Germany by TOPP, has achieved phenomenal sales on the Continent and Babani decided, in view of the fact that the integrated circuit used in this book is inexpensive to buy, to make this unique book available to the English speaking reader. Translated from the original German with copious notes, data and circuitry, a "must" for everyone whatever their interest in electronics.

BP83: VMOS PROJECTS

R.A. PENFOLD
Although modern bipolar power transistors give excellent results in a wide range of applications, they are not without their drawbacks or limitations. This book will primarily be concerned with VMOS power FETs although power MOSFETs will be dealt with in the chapter on audio circuits. A number of varied and interesting projects are covered under the main headings of: Audio Circuits, Sound Generator Circuits, DC Control Circuits and Signal Control Circuits.

BP65: SINGLE IC PROJECTS

R.A. PENFOLD
There is now a vast range of ICs available to the amateur market, the majority of which are not necessarily designed for use in a single application and can offer unlimited possibilities. All the projects contained in this book are simple to construct and are based on a single IC. A few projects employ one or two transistors in addition to an IC but in most cases the IC is the only active device used.

BP97: IC PROJECTS FOR BEGINNERS

F.G. RAYER
Covers power supplies, radio, audio, oscillators, timers and switches. Aimed at the less experienced reader, the components used are popular and inexpensive.

BP88: HOW TO USE OP AMPS

E.A. PARR
A designer's guide covering several op amps, serving as a source book of circuits and a reference book for design calculations. The approach has been made as non-mathematical as possible.

IC ARRAY COOKBOOK

JUNG
HB26
A practical handbook aimed at solving electronic circuit application problems by using IC arrays. An IC array, unlike specific-purpose ICs, is made up of uncommitted IC active devices, such as transistors, resistors, etc. This book covers the basic types of such ICs and illustrates with examples how to design with them. Circuit examples are included, as well as general design information useful in applying arrays.

BP50: IC LM3900 PROJECTS

H.KYBETT, B.Sc., C.Eng.
The purpose of this book is to introduce the LM3900 to the Technician, Experimenter and the Hobbyist. It provides the groundwork for both simple and more advanced uses, and is more than just a collection of simple circuits or projects.

223: 50 PROJECTS USING IC CA3130

R.A. PENFOLD
In this book, the author has designed and developed a number of interesting and useful projects which are divided into five general categories: I — Audio Projects II — R.F. Projects III — Test Equipment IV — Household Projects V — Miscellaneous Projects.

224: 50 CMOS IC PROJECTS

R.A. PENFOLD
CMOS IC's are probably the most versatile range of digital devices for use by the amateur enthusiast. They are suitable for an extraordinary wide range of applications and are also some of the most inexpensive and easily available types of IC.

THE ACTIVE FILTER HANDBOOK

TAB No.1133
Whatever your field — computing, communications, audio, electronic music or whatever — you will find this book the ideal reference for active filter design.

BP51: ELECTRONIC MUSIC AND CREATIVE TAPE RECORDING

M.K. BERRY
Electronic music is the new music of the Twentieth Century. It plays a large part in "pop" and "rock" music and, in fact, there is scarcely a group without some sort of synthesiser or other effects generator.

BP74: ELECTRONIC MUSIC PROJECTS

R.A. PENFOLD
Although one of the more recent branches of amateur electronics, electronic music has now become extremely popular and there are many projects which fall into this category. The purpose of this book is to provide the constructor with a number of practical circuits for the less complex items of electronic music equipment, including such things as a Fuzz Box, Waa-Waa Pedal, Sustain Unit, Reverberation and Phaser-Units, Tremelo Generator etc.

BP81: ELECTRONIC SYNTHESIZER PROJECTS

M.K. BERRY
One of the most fascinating and rewarding applications of electronics is in electronic music and there is hardly a group today without some sort of synthesiser or effects generator. Although an electronic synthesiser is quite a complex piece of electronic equipment, it can be broken down into much simpler units which may be built individually and these can then be used or assembled together to make a complete instrument.

THE MASTER IC COOKBOOK

TAB No.1199
If you've ever tried to find specs for a so called 'standard' chip, then you'll appreciate this book. C.L. Hallmark has compiled specs and pinout for most types of ICs that you'd ever want to use.

ELECTRONIC DESIGN WITH OFF THE SHELF INTEGRATED CIRCUITS

AB016
This practical handbook enables you to take advantage of the vast range of applications made possible by integrated circuits. The book tells how, in step by step fashion, to select components and how to combine them into functional electronic systems. If you want to stop being a "cookbook hobbyist", then this is the book for you.

AUDIO

BP90: AUDIO PROJECTS

F.G. RAYER
Covers in detail the construction of a wide range of audio projects. The text has been divided into preamplifiers and mixers, power amplifiers, tone controls and matching and miscellaneous projects.

HOW TO DESIGN, BUILD AND TEST SPEAKER SYSTEMS

OUT OF PRINT
This book covers a variety of speakers as well as instructions on how to design your own.

205: FIRST BOOK OF HI-FI LOUDSPEAKER ENCLOSURES

B.B. BABANI
This book gives data for building most types of loudspeaker enclosure. Includes corner reflex, bass reflex, exponential horn, folded horn, tuned port, klipschorn labyrinth, tuned column, loaded port and multi speaker panoramic. Many clear diagrams for every construction showing the dimensions necessary.

BP35: HANDBOOK OF IC AUDIO PRE-AMPLIFIER AND POWER AMPLIFIER CONSTRUCTION

OUT OF PRINT
This book covers a wide range of audio projects. The text has been divided into preamplifiers and mixers, power amplifiers, tone controls and matching and miscellaneous projects.

BP47: MOBILE DISCOTHEQUE HANDBOOK

COLIN CARSON
The vast majority of people who start up "Mobile Discos" know very little about their equipment or even what to buy. Many people have wasted a "small fortune" on poor, unnecessary or badly matched apparatus.

HOW TO BUILD A SMALL BUDGET RECORDING STUDIO FROM SCRATCH

OUT OF PRINT
The author, F. Alton Everest, has gotten studios together several times, and presents twelve complete, tested designs for a wide variety of applications. If all you own is a mono cassette recorder, you don't need this book. If you don't want your new four track to wind up sounding like one, though, you shouldn't be without it.

BP51: ELECTRONIC MUSIC AND CREATIVE TAPE RECORDING

M.K. BERRY
Electronic music is the new music of the Twentieth Century. It plays a large part in "pop" and "rock" music and, in fact, there is scarcely a group without some sort of synthesiser or other effects generator.

BP74: ELECTRONIC MUSIC PROJECTS

R.A. PENFOLD
Although one of the more recent branches of amateur electronics, electronic music has now become extremely popular and there are many projects which fall into this category. The purpose of this book is to provide the constructor with a number of practical circuits for the less complex items of electronic music equipment, including such things as a Fuzz Box, Waa-Waa Pedal, Sustain Unit, Reverberation and Phaser-Units, Tremelo Generator etc.

BP81: ELECTRONIC SYNTHESIZER PROJECTS

M.K. BERRY
One of the most fascinating and rewarding applications of electronics is in electronic music and there is hardly a group today without some sort of synthesiser or effects generator. Although an electronic synthesiser is quite a complex piece of electronic equipment, it can be broken down into much simpler units which may be built individually and these can then be used or assembled together to make a complete instrument.

ELECTRONIC MUSIC SYNTHESIZERS

TAB No.1167
If you're fascinated by the potential of electronics in the field of music, then this is the book for you. Included is data on synthesizers in general as well as particular models. There is also a chapter on the various accessories that are available.

TEST EQUIPMENT

BP75: ELECTRONIC TEST EQUIPMENT CONSTRUCTION \$7.30

F.G. RAYER, T.Eng. (CEI), Assoc. IERE
This book covers in detail the construction of a wide range of test equipment for both the Electronics Hobbyists and Radio Amateur. Included are projects ranging from an FET Amplified Voltmeter and Resistance Bridge to a Field Strength Indicator and Heterodyne Frequency Meter. Not only can the home constructor enjoy building the equipment but the finished projects can also be usefully utilised in the furtherance of his hobby.

99 TEST EQUIPMENT PROJECTS YOU CAN BUILD TAB No.805 \$14.45

An excellent source book for the hobbyist who wants to build up his work bench inexpensively. Projects range from a simple signal tracer to a 50MHz frequency counter. There are circuits to measure just about any electrical quantity: voltage, current, capacitance, impedance and more. The variety is endless and includes just about anything you could wish for!

HOW TO GET THE MOST OUT OF LOW COST TEST EQUIPMENT AB017 \$9.45

Whether you want to get your vintage 1960 'TestRite' signal generator working, or you've got something to measure with nothing to measure it with, this is the book for you. The author discusses how to maximize the usefulness of cheap test gear, how to upgrade old equipment, and effective test set ups.

THE POWER SUPPLY HANDBOOK TAB No.806 \$16.45

A complete one stop reference for hobbyists and engineers. Contains high and low voltage power supplies of every conceivable type as well mobile and portable units.

BP70: TRANSISTOR RADIO FAULT-FINDING CHART \$2.40 CHAS. E. MILLER

Across the top of the chart will be found four rectangles containing brief descriptions of various faults; viz: — sound weak but undistorted; set dead; sound low or distorted and background noises. One then selects the most appropriate of these and following the arrows, carries out the suggested checks in sequence until the fault is cleared.

ELECTRONIC TROUBLESHOOTING HANDBOOK AB019 \$12.45

This workbench guide can show you how to pinpoint circuit troubles in minutes, how to test anything electronic, and how to get the most out of low cost test equipment. You can use any and all of the time-saving shortcuts to rapidly locate and repair all types of electronic equipment malfunctions.

COMPLETE GUIDE TO READING SCHEMATIC DIAGRAMS AB018 \$10.45

A complete guide on how to read and understand schematic diagrams. The book teaches how to recognize basic circuits and identify component functions. Useful for technicians and hobbyists who want to avoid a lot of headscratching.

RADIO AND COMMUNICATIONS

BP79: RADIO CONTROL FOR BEGINNERS F.G. RAYER, T.Eng.(CEI), Assoc.IERE. \$7.30

The aim of this book is to act as an introduction to Radio Control for beginners to the hobby. The book will commence by dealing with the conditions that are allowable for such things as frequency and power of transmission. This is followed by a "block" explanation of how control-device and transmitter operate and receiver and actuator(s) produce motion in a model.

Details are then given of actual solid state transmitting equipment which the reader can build. Plain and loaded aerials are then discussed and so is the field-strength meter to help with proper setting up.

The radio receiving equipment is then dealt with which includes a simple receiver and also a crystal controlled superhet. The book ends with the electro-mechanical means of obtaining movement of the controls of the model.

BP96: CB PROJECTS R.A. PENFOLD \$8.10

Projects include speech processor, aerial booster, cordless mike, aerial and harmonic filters, field strength meter, power supply, CB receiver and more.

222: SOLID STATE SHORT WAVE RECEIVERS FOR BEGINNERS R.A. PENFOLD \$5.20

In this book, R.A. Penfold has designed and developed several modern solid state short wave receiver circuits that will give a fairly high level of performance, despite the fact that they use only relatively few and inexpensive components.

BP91: AN INTRODUCTION TO RADIO DXing R.A. PENFOLD \$8.10

This book is divided into two main sections one to amateur band reception, the other to broadcast bands. Advice is given to suitable equipment and techniques. A number of related constructional projects are described.

BP105: AERIAL PROJECTS R.A. PENFOLD \$8.10

The subject of aerials is vast but in this book the author has considered practical designs including active, loop and ferrite aerials, which give good performances and are reasonably simple and inexpensive to build. The complex theory and math of aerial design are avoided.

BP46: RADIO CIRCUITS USING IC'S J.B. DANCE, M.Sc. \$5.90

This book describes integrated circuits and how they can be employed in receivers for the reception of either amplitude or frequency modulated signals. The chapter on amplitude modulated (a.m.) receivers will be of most interest to those who wish to receive distant stations at only moderate audio quality, while the chapter on frequency modulation (f.m.) receivers will appeal to those who desire high fidelity reception.

BP92: ELECTRONICS SIMPLIFIED—CRYSTAL SET CONSTRUCTION F.A. WILSON \$7.30

Aimed at those who want to get into construction without much theoretical study. Homewound coils are used and all projects are very inexpensive to build.

REFERENCE

THE BEGINNER'S HANDBOOK OF ELECTRONICS AB003 \$10.45

An excellent textbook for those interested in the fundamentals of Electronics. This book covers all major aspects of power supplies, amplifiers, oscillators, radio, television and more.

ELEMENTS OF ELECTRONICS — AN ON-GOING SERIES F.A. WILSON, C.G.I.A., C.Eng.

BP62: BOOK 1. The Simple Electronic Circuit and Components \$8.95

BP63: BOOK 2. Alternating Current Theory \$8.95

BP64: BOOK 3. Semiconductor Technology \$8.95

BP77: BOOK 4. Microprocessing Systems And Circuits \$12.30

BP89: BOOK 5. Communication \$12.30

The aim of this series of books can be stated quite simply — it is to provide an inexpensive introduction to modern electronics so that the reader will start on the right road by thoroughly understanding the fundamental principles involved.

Although written especially for readers with no more than ordinary arithmetical skills, the use of mathematics is not avoided, and all the mathematics required is taught as the reader progresses.

Each book is a complete treatise of a particular branch of the subject and, therefore, can be used on its own with one proviso, that the later books do not duplicate material from their predecessors, thus a working knowledge of the subjects covered by the earlier books is assumed.

BOOK 1: This book contains all the fundamental theory necessary to lead to a full understanding of the simple electronic circuit and its main components.

BOOK 2: This book continues with alternating current theory without which there can be no comprehension of speech, music, radio, television or even the electricity utilities.

BOOK 3: Follows on semiconductor technology, leading up to transistors and integrated circuits.

BOOK 4: A complete description of the internal workings of microprocessor.

BOOK 5: A book covering the whole communication scene.

BP85: INTERNATIONAL TRANSISTOR EQUIVALENTS GUIDE ADRIAN MICHAELS \$12.25

This book will help the reader to find possible substitutes for a popular user-orientated selection of modern transistors. Also shown are the material type, polarity, manufacturer selection of modern transistors. Also shown are the material type, polarity, manufacturer and use. The Equivalents are sub-divided into European, American and Japanese. The products of over 100 manufacturers are included. An essential addition to the library of all those interested in electronics, be they technicians, designers, engineers or hobbyists. Fantastic value for the amount of information it contains.

BP108: INTERNATIONAL DIODE EQUIVALENTS GUIDE ADRIAN MICHAELS \$8.35

This book is designed to help the user in finding possible substitutes for a large user orientated selection of the many different types of semiconductor diodes that are available today. Besides simple rectifier diodes also included are Zener diodes, LEDs, Diacs Triacs, Thyristors, Photo diodes and Display diodes.

BP1: FIRST BOOK OF TRANSISTOR EQUIVALENTS AND SUBSTITUTES B.B. BABANI \$2.80

This guide covers many thousands of transistors showing possible alternatives and equivalents. Covers transistors made in Great Britain, USA, Japan, Germany, France, Europe, Hong Kong, and includes types produced by more than 120 different manufacturers.

BP14: SECOND BOOK OF TRANSISTOR EQUIVALENTS AND SUBSTITUTES B.B. BABANI \$4.80

The "First Book of Transistor Equivalents" has had to be reprinted 15 times. The "Second Book" produced in the same style as the first book, in no way duplicates any of the data presented in it. The "Second Book" contains only additional material and the two books complement each other and make available some of the most complete and extensive information in this field. The interchangeability data covers semiconductor manufacturers in Great Britain, USA, Germany, France, Poland, Italy, East Germany, Belgium, Austria, Netherlands and many other countries.

TOWER'S INTERNATIONAL OP-AMP LINEAR IC SELECTOR TAB No.1216 \$13.45

This book contains a wealth of useful data on over 5,000 Op-amps and linear ICs both pinouts and essential characteristics. A comprehensive series of appendices contain information on specs, manufacturers, case outlines and so on.

CMOS DATABOOK TAB No.984 \$14.45

There are several books around with this title, but most are just collections of manufacturers' data sheets. This one, by Bill Hunter, explains all the intricacies of this useful family of logic devices — the missing link in getting your own designs working properly. Highly recommended to anyone working with digital circuits.

MISCELLANEOUS

BP68: CHOOSING AND USING YOUR HI-FI MAURICE L JAY \$7.25

The main aim of this book is to provide the reader with the fundamental information necessary to enable him to make a satisfactory choice from the extensive range of hi-fi equipment now on the market.

Help is given to the reader in understanding the equipment he is interested in buying and the author also gives his own opinion of the minimum standards and specifications one should look for. The book also offers helpful advice on how to use your hi-fi properly so as to realise its potential. A Glossary of terms is also included.

BP101: HOW TO IDENTIFY UNMARKED IC'S K.H. RECORN \$2.70

Originally published as a feature in "Radio Electronics", this chart shows how to record the particular signature of an unmarked IC using a test meter, this information can then be used with manufacturer's data to establish the application.

SIMPLIFIED TRANSISTOR THEORY TRAINING SYSTEMS, INC. AND LEVINE HB20 \$10.25

This book is designed to provide a comprehensive understanding of the physical theory and operation of transistors and transistors and previous knowledge of electronics is not necessary. A clear understanding of basic principles is presented in a series of brief, logical chapters. Each section provides both a concise review and a complete reference source for future use.

AUDIO AND VIDEO INTERFERENCE CURES KAHANER HB21 \$9.05

A practical work about interference causes and cures that affect TV, radio, hi-fi, CB, and other devices. Provides all the information needed to stop interference. Schematic wiring diagrams of filters for all types of receivers and transmitters are included. Also, it supplies simple filter diagrams to eliminate radio and TV interference caused by noisy home appliances, neon lights, motors, etc.

BASIC TELEPHONE SWITCHING SYSTEMS TALLEY HB27 \$15.25

The Revised Second Edition of this book, for trainee and engineer alike, includes updated statistical data on telephone stations, and new and improved signaling methods and switching techniques. It also includes E & M signaling interface for electronic central offices and automatic number identification methods used in step-by-step, panel and crossbar central offices.

INTERRELATED INTEGRATED ELECTRONICS CIRCUITS FOR THE RADIO AMATEUR, TECHNICIAN, HOBBYIST AND CBR MENDELSON HB29 \$11.35

This book provides a variety of appealing projects that can be constructed by anyone from the hobbyist to the engineer. Construction details, layouts, and photographs are provided to simplify duplication. While most of the circuits are shown on printed circuit boards, every one can be duplicated on hand-wired, perforated boards. Each project is related to another projects so that several may be combined into a single package. The projects, divided into five major groups, include CMOS audio modules, passive devices to help in benchwork, test instruments, and games.

BASIC CARRIER TELEPHONY, THIRD EDITION TALLEY HB28 \$14.45

A basic course in the principles and applications of carrier telephony and its place in the overall communications picture. It is abundantly illustrated, with questions and problems throughout, and requires a minimum of mathematics.

ROBOTICS

THE COMPLETE HANDBOOK OF ROBOTICS TAB No.1071 \$13.45

All the information you need to build a walking, talking mechanical friend appears in this book. Your robot can take many forms and various options — light, sound, and proximity sensors — are covered in depth.

HOW TO BUILD YOUR OWN SELF PROGRAMMING ROBOT TAB No.1241 \$13.45

A practical guide on how to build a robot capable of learning how to adapt to a changing environment. The creature developed in the book, Rodney, is fully self programming, can develop theories to deal with situations and apply those theories in future circumstances.

BUILD YOUR OWN WORKING ROBOT TAB No.841 \$11.45

Contains complete plans — mechanical, schematics, logic diagrams and wiring diagrams — for building Buster. Buster is a sophisticated experiment in cybernetics you can build in stages. There are two phases involved: first Buster is leashed led, dependent on his creator for guidance; the second phase makes Buster more independent and able to get out of tough situations.

Membrane Switches

In the next few years equipment designers are likely to change from keyboards made up of dozens of individual pushbutton switches to keyboards based on the new technology of membrane switch panels. Bill Mitchell describes these panels, which should soon become available to the hobbyist.

ALTHOUGH THE contact-plate/actuator-button type of keyboard switch, with all its variations, is likely to be around for a while, it is now being replaced in some applications by a technique known as membrane switching. There is every likelihood that this will become the dominant keyboard technology during the next four to five years, with the market forecast to increase eight-fold by 1985. Principal advantages of the membrane switches are their ultra-thin profile and their ease of adaptability to domestic and professional custom design.

Keyboard Switch Panels

The most significant development in small, contact-switch technology during the past decade has undoubtedly been the miniature keyboard switches as used in calculators, electronic games and hand-held computer terminals. Although these switches are available in a wide variety of designs the principle of operation has remained unchanged; that is, with the contact layout printed onto a single-sided PCB and with three-point contact plates operated by activator buttons.

Recent variations of this basic design, have included the replacement of the individual contact plates by a single, multi-dimpled actuator plate over which is placed a flat, spill-proof and puncture-resistant overlay sheet. Limitless variations of multi-coloured panel legends to suit customers' requirements can be printed on this sheet, with the 'button' layout corresponding to the positions of the dimples in the actuator plate. Tactile feedback (the ability to feel that a contact has been actuated) is inherent in this design, and the switch layout and assembly can be easily incorporated as an integral part of a complete printed circuit panel layout. Examples include visual display unit (VDU) operator panels, point-of-sales equipment and domestic cookers.

Membranes For Custom Designs

This established contact-plate/actuator-button type of design will remain with us for a number of years, but there is every indication that membrane switching will become the dominant technology by about 1985 particularly for custom design. With this technology, custom design becomes a simple proposition and the keyboard and overlay configurations are virtually limitless.

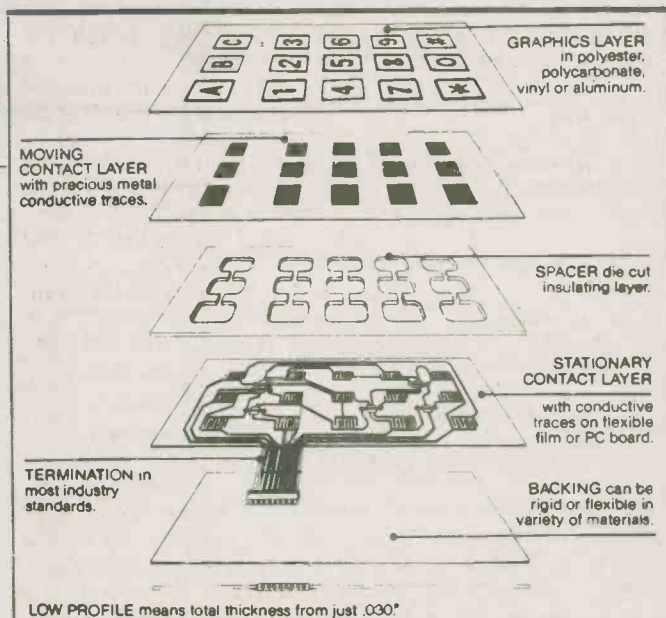

Figure 1. Cherry electrical Products' membrane keyboard, showing the five-layer laminated construction.

An established manufacturer of membrane switches is Bowmar Instruments whose 'Sensitouch' keyboard system consists of two flat sheets of polyester film with a special conductive composition circuit screen-printed onto each. These are separated by a few thousandths of an inch by a separator sheet, and as the area of the switch is touched the top sheet deforms through the separator to come in contact with the lower conductive circuit. By choice of the top surface and overlay materials, the actuation force can be varied to meet specific requirements, and the overlay itself can be made from a variety of materials ranging from metals to plastic film, onto which can be printed any chosen panel legend. Operating currents is 100 mA maximum, and operating voltage is 30 VDC maximum with a minimum operational life of 10 million cycles. Typical overall thickness is 0.05 in.

A particular advantage of this type of keyboard switch is that it can be fully sealed, and hence can be used in applications where splashing by liquids is likely to be a problem (for example, on machine tools and domestic stoves).

Once the panel has been cut to the required size and shape, connections can be made directly to the appropriate switches through their associated tracks on the reverse side of the PCB. Also, virtually any switch connection format can be obtained by the user simply by cutting and linking appropriate tracks on the reverse side of the board. A protective polyester film, already fitted, can be printed on, coloured or captioned by the user, and covered by a further protective polyester or polycarbonate film.

A development of this is Diamond H Controls' Full Travel Membrane (FTM) keyboard which includes full travel key tops as the means of switch activation. This effectively restores the keyboard feel which is absent from normal membrane keyboards.

The same company has also introduced a custom design membrane switch panel service known as TIP

THE ONLY WAY TO BE SURE OF YOUR ISSUE EACH MONTH



BOOKS, BACK ISSUES BINDERS—SEE OVER

Code

Electronics Today Magazine, Unit 6, 25 Overlea Blvd., Toronto, Ontario M4H 1B1.

ORDER Please fill out form overleaf
SUBSCRIPTIONS: NEW SUBSCRIPTION? Or... RENEWAL? Please check one.

One year subscription (12 issues) \$18.95 Two year subscription (24 issues) \$33.95. Postage and handling to Canada is included, for U.S. please add \$3 other countries add \$5/yr.

PLEASE PRINT CLEARLY

NAME _____
ADDRESS _____
TOWN/CITY _____ PROVINCE/STATE _____
CODE _____ DATE _____

Cheque enclose DO NOT send cash
 Bill Mastercard A/C No. _____
 Bill Visa/A/C No. _____

Signature _____
Expiry Date _____

PLEASE ALLOW 6—8 WEEKS FOR YOUR FIRST MAGAZINE TO ARRIVE

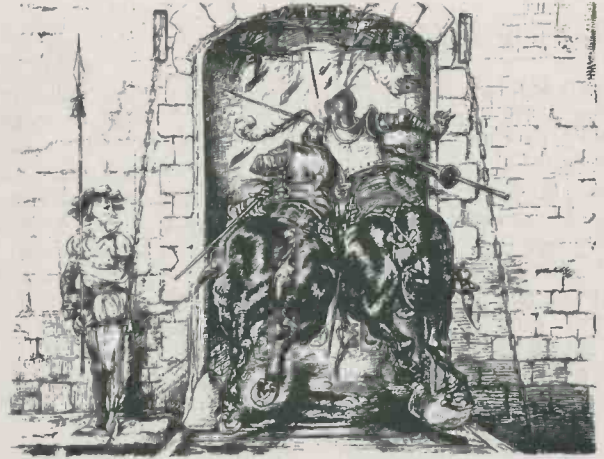

I've been the gate guard here at ETI for about seven years now and I've had about enough. If you want my job, it's yours. Oh, the standing around part's not too bad. The feet get a little sore after a while, but you learn to live with that. No, it's the little sundry things they don't tell you about that make the work a bit ... well, they call it exciting. I call it a hazard to life and limb.

Probably the worst thing about all this are the subscribers. Now when I was a knight-errant for Better Castles and Dungeons it was pretty easy living. Every so often some wizard wouldn't get his copy and lay a spell on the place, but that was the worst of it. *Here* there're these half crazed folk charging in from all directions eight hours a day, bellowing for the drawbridge to the editorial keep to be let down so they can get signed up in time to receive next month's issue. They sing loud obnoxious songs about the brilliant projects, the inspired articles and the up to the minute news. Then they start in about the money they're saving when they subscribe.

They sing like a witch being turned into a toad. If you want to subscribe, their lordships within will accept your request by *mail*. Just send \$18.95 for one year, \$33.95 for two, no chickens or sheep, and if the mail-squire doesn't drop a bag on my foot on the way in I'll thank you.

And if you want my job just let me know.

ETI Subscriptions
25 Overlea Blvd, Unit 6
Toronto, Ontario
M4H 1B1

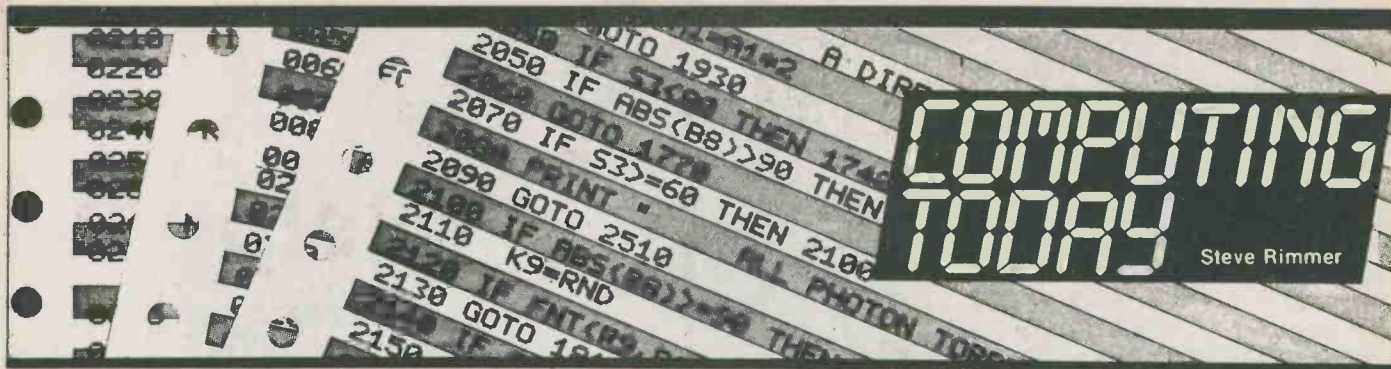

EVEN THE REALLY cheap modems aren't. Basic acoustic couplers start at around a hundred and twenty five dollars, which is a great deal of money to spend for a case that looks like it could have been made by Mattel for Barbie's lunar cottage and a tiny handful of not very sophisticated electronics. Thus it was with great interest that I found out about the magic twenty-five dollar modems that even now scamper like mad laughing trolls among us all.

The modems in question were originally used in DECwriter terminals and lived in the tops of the printers. It's hard to say what became of the printers themselves, but the tops, modems included, are cropping up at surplus places everywhere for about twenty five bucks. The modems therein are made by Novation. They are 300 baud only, with no selection of duplex or anything else. They require the addition of one RS-232 connector, or other contrivance to attach them to your system, and power in the denominations of +5, +12 and -12 volts. Then they just... happen.

The only catch in using the modems is that, whereas true RS232 signals swing at 12 volt levels, these little beasts are what is called "TTL

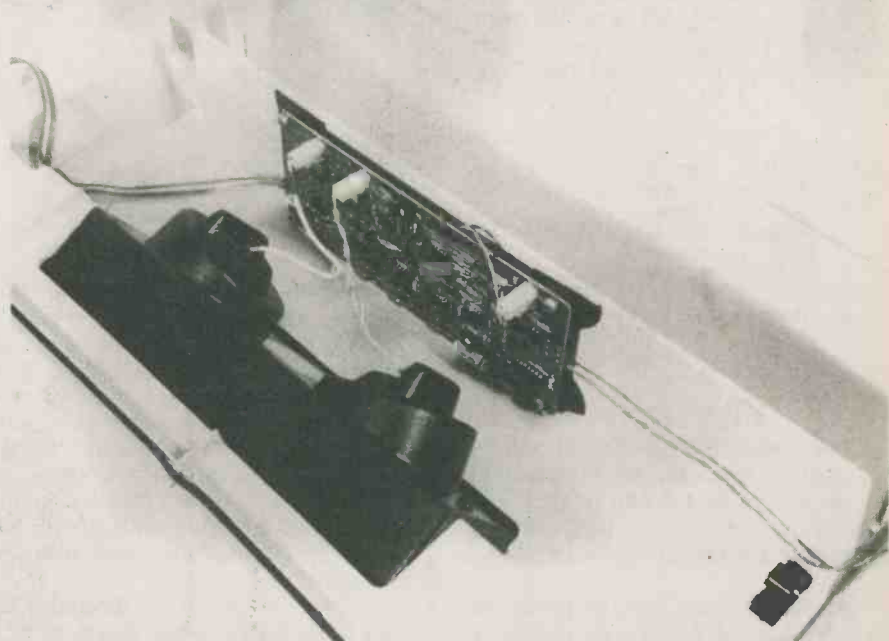

Fig. 1 The modem in its natural state.

level" deals. Thus, there is a minority of systems, such as our TRS-80 Model II, which they will not run with right out of the box. These will want some level shifting circuitry. Most hardware... we tried our modem with an Atari 800 and a couple of terminals, and there is a fellow nearby

who uses one with his PET, for starters... will be more than happy.

Attaching

The modems are available from several suppliers, a few of which have ads in this issue. Our particular one came from Exceltronix, who, in turn, got it and a hundred and ninety nine just like it from Bill Jackson of Parts Galore. I also saw a vast stock of them down at Active Surplus Annex.

Typically the modems come, complete with the top of the DECwriter, in a brand new factory type box packed for shipment to the outer galactic colonies. The white plastic top could be used as a home for the thing, but it's rather huge as modems go and looks a bit silly. The modem can be removed from the top by popping the plastic acoustic coupler out of the top... this takes some doing, and you must be careful not to crack it in the process... and then unwinding the four bolts that hold the PCB in place. There is a cable snap thing that will want undoing. At this point, the modem will be free except for the

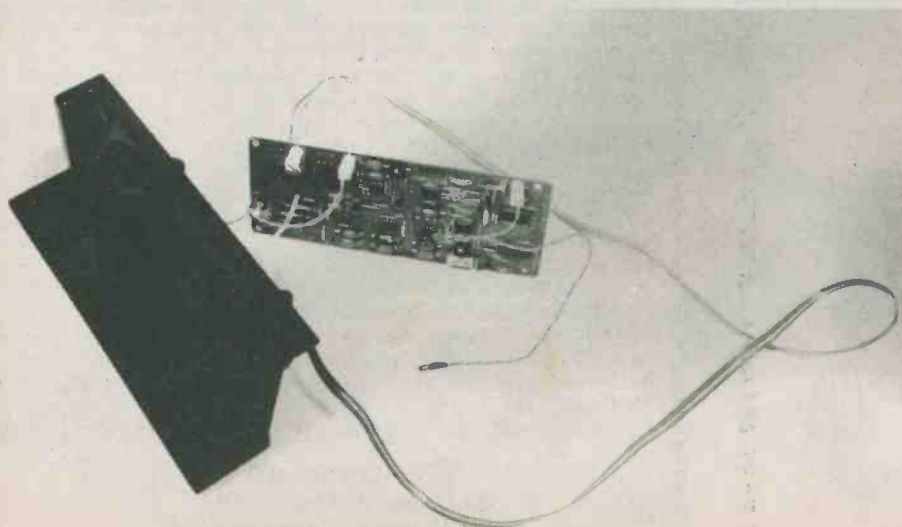

Fig. 2 The modem uncased.

Computing Today

carrier detect LED, which can be temporarily unplugged from the PCB. The rest of the modem should be put aside while the LED is struggled with ... it is a royal pain to dislodge.

The modem has a number of wires coming off it. Most go to obvious places, namely, the LED and the acoustic coupler. There is a long ribbon cable, however, which is a bit of a mystery. It is, in fact, the RS-232 lines, the power connector and a few other sundries. It is, fortunately, colour coded, and the wires emerge from a spot on the board, called J1, which is numbered. Here is what the lines do.

J1#	Colour	Function
1	Brown	Ground
2	Red	Ground
3	Orange	Received Data (RS-232 pin 3)
4	Yellow	Transmitted Data (RS-232 pin 2)
5	Green	+ 5 Volt Supply
6	Blue	+ 12 Volt Supply
7	Purple	- 12 Volt Supply
8	Grey	Break

The break line can be ignored, if you want to. However, if you attach it to a switch so that it can be momentarily grounded it can be used to disconnect the carrier if you're up for it.

As far as I can tell, the modems are a production surplus as opposed to rejected sidebands ... nobody I

Fig. 4 It works! The aluminum box is a power supply.

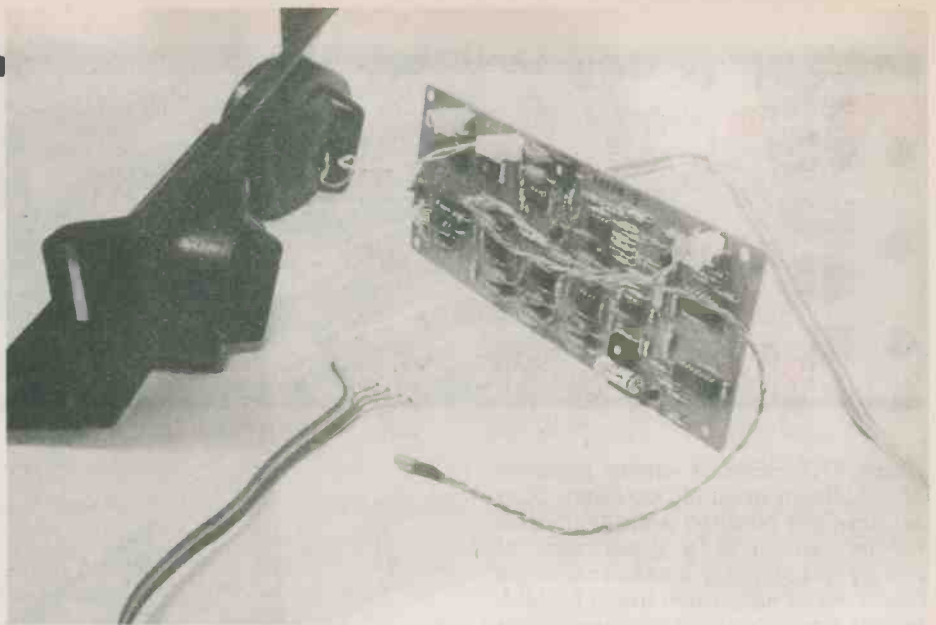

Fig. 3 A view of the board.

know of has had any hassles getting them up and running. The circuitry is dead easy ... seven 4558 dual op amps and a couple of CMOS gate chips. The power supply requirements are pretty minimal, and many proud owners of these things may be able to tap juice from inside whatever is going to be driving the modem ... anything with an RS-232 port will probably have these voltages available.

These modems will probably be sold fairly quickly, and it would be a good trip to get one about now if

you're up for doing so. Once they are gone, their extinction will probably be permanent. (Please don't contact us for additional sources of these things).

You now have no further excuse for being uncommunicative. Dial your brains out.

Wilf Steimle was one of the earliest souls to play with these modems; he has gotten several of them up and running. He has kindly offered to help anyone with questions about them. His number is 1-416-630-8660.

ETI

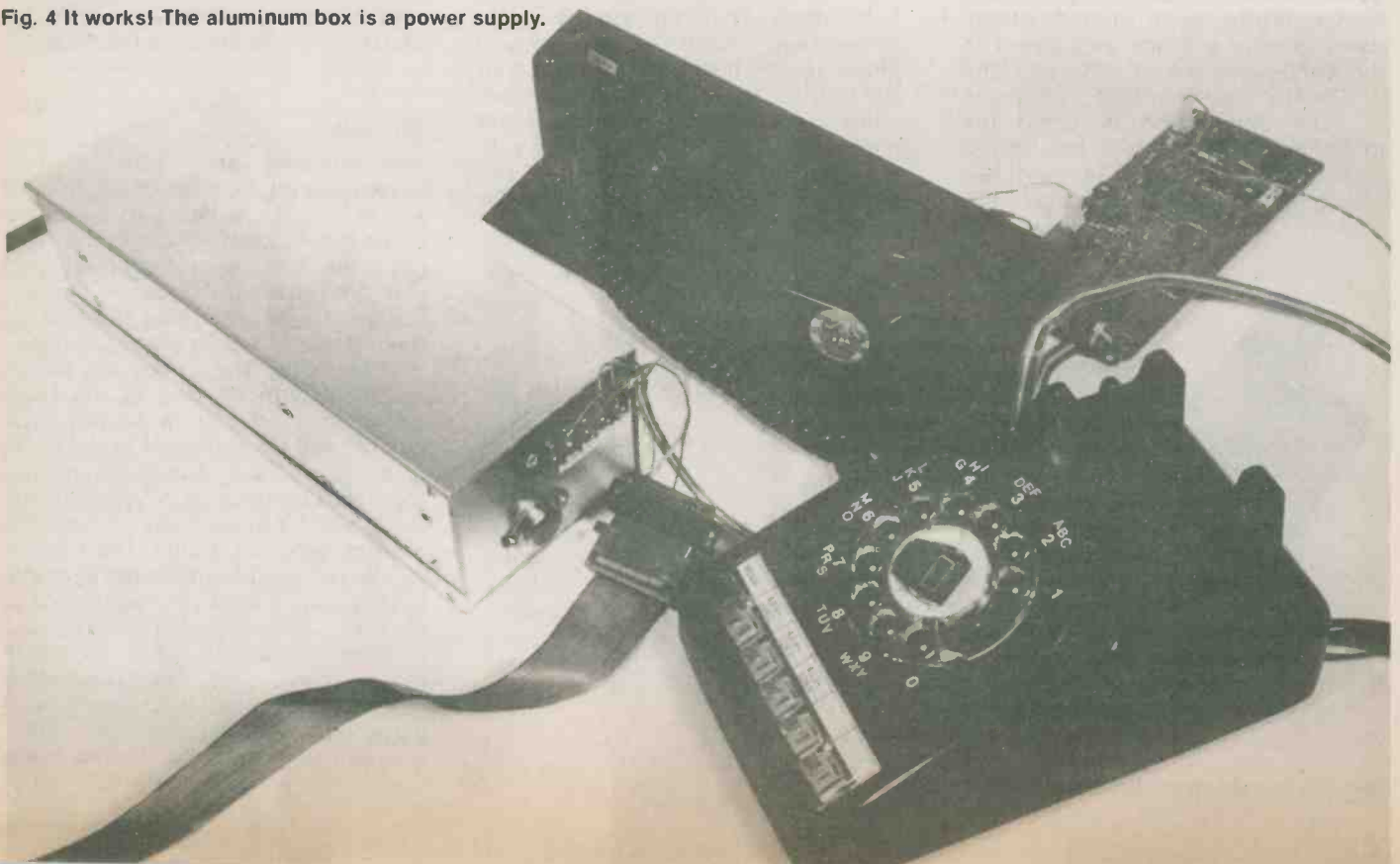

Designer's Notebook: VMOS FETS

The mysterious MOSFET demystified, by Don Keighley.

FIELD EFFECT TRANSISTORS (FETs) are peculiar brutes. If you've used them you'll know what I mean — negative bias voltages, depletion layers, pinch-off voltages and so on, ad infinitum. If you haven't used a FET before, the theory is simple enough: a FET is essentially a doped-silicon resistor (Fig. 1), much like a normal carbon resistor. The doped-silicon, however, exhibits a change of resistance if an electric field through the resistor varies. The electric field depends on the voltage present at the gate of the FET (Fig. 2), so a change of gate voltage changes the current through (and hence the resistance across) the device. Essentially a FET forms a voltage controlled resistance. In the example shown in Fig. 2 (a P-channel FET) a gate voltage of 0V will produce a resistance of approximately 100R and a gate voltage of 5V will produce a 1MΩ resistance. For a N-channel FET the opposite is true; a gate voltage of 0V will give a resistance of 100R, -5V gives 1MΩ. For low drain-source voltages and low drain-source currents, the resistance change is linearly related to the gate voltage.

FETs have two enormous advantages over bipolar transistors. First, the gate input resistance is very high, meaning that virtually no current needs to be drawn from preceding circuitry. Second, FETs can exhibit very fast switching speeds — they can be used quite easily up to frequencies of many megahertz.

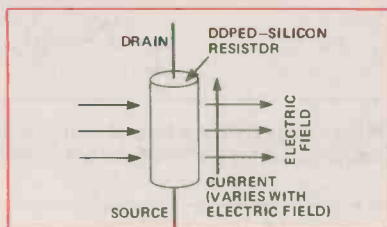

Fig. 1 A field effect transistor (FET) is a doped-silicon resistor, the resistance of which can be varied by changing the electric field through it.

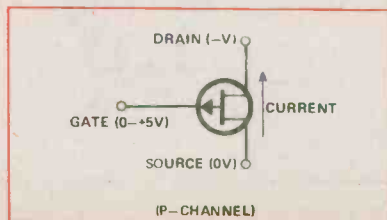

Fig. 2 The symbol for a FET. Current through the FET and hence the resistance across it is controlled by the voltage at the gate.

Problems, Problems

So, everything is fine — as long as you follow the rules. In low-power applications there is no reason why FETs can't be used anywhere a bipolar transistor can (they are, in fact, more versatile than bipolars — in low-power applications). But, therein lies the rub — power. It is very difficult (and expensive) to make a FET which can pass large currents: the main reason being the horizontal make-up of ordinary FETs. Bipolar transistors have vertical current flow and can pass larger currents because of it. Figure 3a shows the theoretical cross-section of a bipolar transistor and a similar cross-section of a FET is shown in Fig. 3b. Current flow in the bipolar is vertically upwards from collector to emitter and the large area through which the current passes allows large currents. FET current flow is from left to right (drain to source) and the small area of current flow means smaller currents than in a similar-sized bipolar transistor.

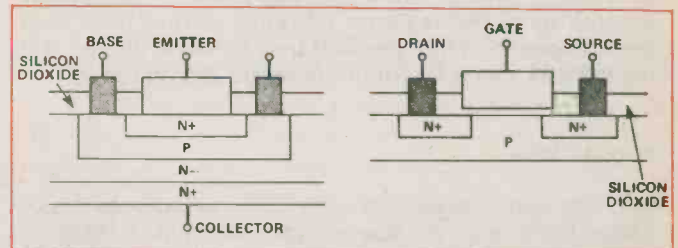

Fig. 3 Cross-sections through a) a bipolar transistor; b) a field effect transistor.

Recently, VMOS FETs have been manufactured which overcome the power problems normally associated with FETs. A typical VMOS FET cross-section is shown in Fig. 4. Current flow is now vertically upwards, from drain to source, in much the same way as in bipolar transistors. The larger chip area means large current. Hence we have transistors exhibiting all the advantages of FETs without the usual power limits. VMOS FETs also have some other very interesting advantages:

- low ON resistance — good for audio switching purposes.
- power amplification — as high as 10°.
- positive temperature coefficient on the ON resistance — as the temperature goes up the transistor passes less current, therefore remaining thermally stable.
- easily operated in parallel to increase overall current flow — due to the inherent thermal stability no 'current hogging' by one device occurs.

We'll see applications using these advantages shortly.

Designer's Notebook

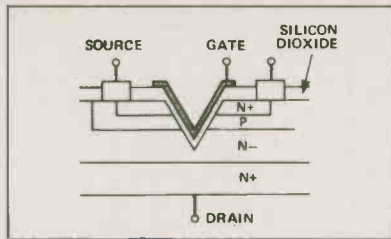

Fig. 4 Cross-section through a VMOS FET. Current flow is vertical, as in a bipolar transistor.

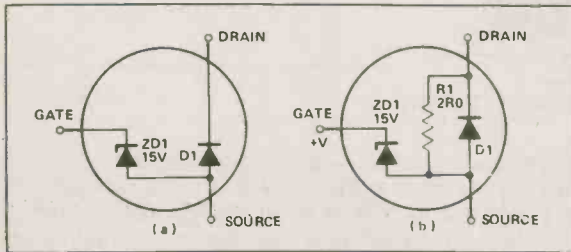

Fig. 5 Equivalent diagrams of a VMOS FET a) in the OFF state; b) in the ON state.

The equivalent circuits of a VMOS FET (such as the VN67AF) in its OFF and ON states, are shown in Fig. 5. The zener diode protects the transistor from over-voltage on the transistor gate → it is a feature on many VMOS FETs but not all! If a VMOS transistor does not have such a gate-protection zener diode, it must be handled as a CMOS IC. You must take care to avoid static build-up between connections.

In the VMOS FET's OFF state (gate is low), diode D1 is reverse-biased and no current can flow from drain to source. In the ON state the diode is effectively shorted by a $2R_0$ resistor, allowing current flow from drain to source. With gate-voltages between 0V and +V the resistor value is within the range $2R_0$ to cut in.

Applications

Low ON resistances and high OFF resistances make VMOS FETs ideal for use in audio switching networks. Figure 6 shows a simple on/off audio switch controlled by the voltage on the transistor gate: +15V turns the switch on and 0V turns it off. Audio signals can only pass in one direction, from drain to source, but any audio voltage of about $-\frac{1}{2}V$ to +5V can be switched.

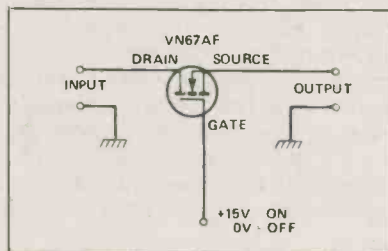

Fig. 6 A simple unidirectional audio switch formed by a single VMOS FET.

The extremely high gate-input resistance of VMOS FETs means that they can be switched by virtually any control method, such as CMOS, TTL, op-amps and so on. A four-channel audio multiplexer is shown in Fig. 7, which uses a bank of four VMOS FETs as input switches with the transistors being clocked in turn by a 4017 decade counter. The fourth output of the 4017 is con-

nected to the reset pin, giving a 1-2-3-4 count to control the VMOS FETs. As each FET is enabled by the 4017 counter the audio input at its drain is connected, via the source and a 10k resistor, to the op amp.

If TTL logic is used to control VMOS FETs, gate pull-up resistor must be inserted (Fig. 8) to ensure that the gate voltage is pulled up to +5V when on — sufficient to give about 500 mA of current through the transistor. Figure 8 also shows the principle of VMOS current control through a load, in this case an indicator lamp. The load can, however, be virtually anything requiring current e.g. relays, LEDs or loudspeakers.

When the transistor is on, its drain to source resistance is about $3R_0$ so about 1A (i.e. $V/R = 11/11$) passes through the loudspeaker. The average current (assuming a 50% duty cycle from the astable) is therefore about 500 mA. Audio output power is thus about 2W.

Paralleling two or more VMOS FETs in an output stage easily increases current-handling capacity. The siren circuit of Fig. 9 is redrawn in Fig. 10 with four paralleled output transistors. This more powerful siren will produce an output power in the region of 6W. You can see that no ballasting resistors are needed (as you would require with a similar circuit using bipolar transistors) because of the positive temperature coefficient of the drain-to-source 'on' voltage. The explanation of parallel operation is very simple: if any one of the VMOS transistors begins to conduct a larger than average current it will tend to get warmer and so current flow will reduce.

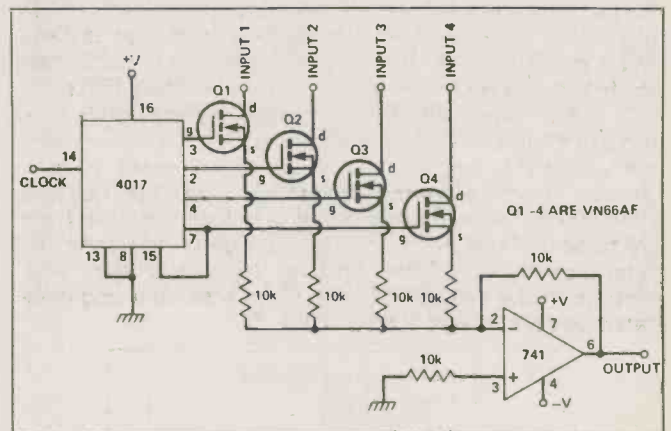

Fig. 7 Four VMOS FETs used in a four-channel audio multiplexer giving a time division multiplexed output signal.

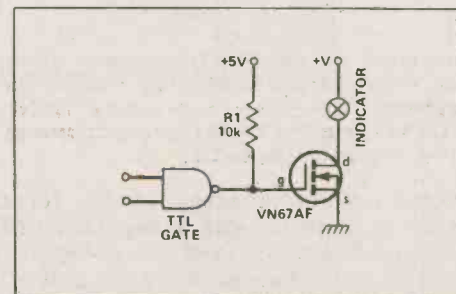

Fig. 8 TTL gate logic can be used to control VMOS FETs but a gate pull-up resistor must be used to ensure that the FET gate reaches a high enough voltage to allow sufficient current flow through the FET.

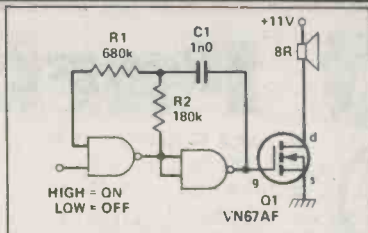

Fig. 9 Simple audio siren. An astable oscillator provides drive to switch the VMOS FET on and off at an audible rate.

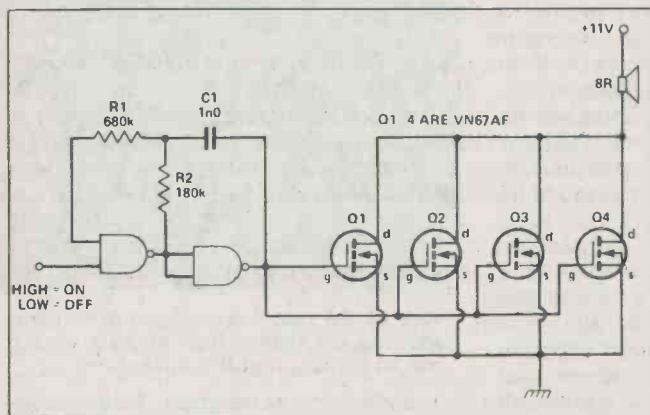

Fig. 10 Paralleling output VMOS FETs can be done simply because they are inherently thermally stable.

Linear Applications

So far we've only considered switching applications using VMOS FETs (i.e. on or off), but they can just as easily be operated in a linear mode (to act as voltage controlled resistors) in the same way as ordinary FETs.

Linear regulators in power supplies are easily constructed: such a circuit is shown in Fig. 11. An op-amp compares the output voltage with a reference voltage derived from a zener diode and parallel variable resistance. The reference voltage is thus variable from 0V to about 11V. If the output voltage is less than the reference voltage, the op-amp increases the drive voltage to the VMOS FET, and vice versa, in a negative-feedback controlled loop.

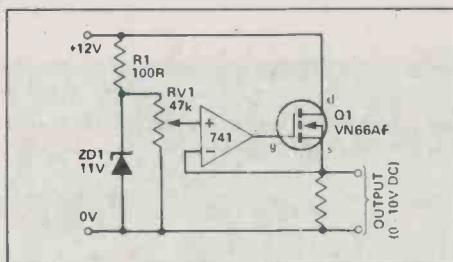

Fig. 11 A VMOS FET used in a linear voltage regulator. An op-amp is used in a negative feedback loop to provide the controlling gate voltage for the VMOS FET.

Constant-current sources suitable for charging Nicad cells can be made easily using VMOS FETs, and a simple unregulated circuit is shown in Fig. 12. The current output is defined primarily by the gate voltage of the transistor by altering the ratio of the two resistors R1 and R2. By varying the gate voltage between 0V and 5V, a range of currents of approximately 0-250 mA will be obtained. Although the high output impedance of the transistor (relative to that of a bipolar) provides a level

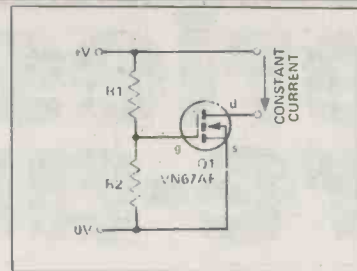

Fig. 12 Unregulated constant current source formed around a VMOS FET.

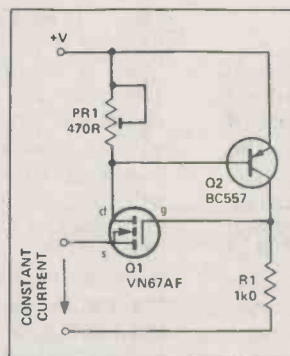

Fig. 13 Transistor Q2 holds the gate-to-source potential of the VMOS FET constant for any load. The current is therefore constant.

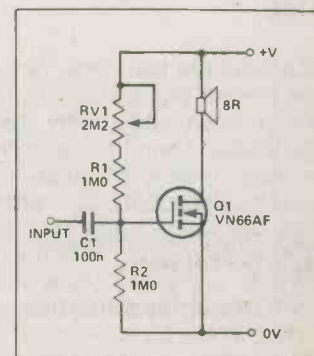

Fig. 14 A simple class A power amplifier.

of current regulation, differing loads will produce differences in current flow.

The circuit of Fig. 13 overcomes this problem with a negative feedback loop formed by Q2. This transistor holds the gate-to-source potential of the VMOS FET constant for any load. Thus the current flow is constant whatever the load.

A Class A power amplifier can be constructed with a VMOS transistor and because of the inherent thermal stability of the FET, very few precautions need be taken with the circuit (Fig. 14). The high transistor input resistance allows very high value biasing resistors. Although obviously an audio power amplifier (the transistor load is a loudspeaker!) the circuit itself will operate up to the megahertz regions.

ETI



Series 5000 Part 3 Pre-amp



In this final part we describe the finer points of construction.

SOLDER the switches, ensuring that the correct pin is closest to the top of the sub-panel assembly (see table of switches). Adjust the switches to the correct number of positions by first turning them fully counterclockwise. Remove the nut and spring washers; the remaining ring sets the number of switch positions. Now mount the switches to the sub-panel.



With all the switches mounted to the sub-panel, proceed with the interconnecting wiring. This is all done with shielded cable, as shown in detail on the sub-chassis assembly drawing. Note that all the wiring done at this stage is between the switch boards and the sub-panel. Later connections to the sub-panel assembly can then be done by soldering directly to the track sides of the switch pc boards. There are also four resistors soldered to the sub-panel assembly; it is probably wise to solder the two 10k resistors before the shielded cables.

With the construction of the front panel assembly complete, the wiring to the input switch pc board can now be done. The shielded cables run from this board to the rear panel between the low-level amp sub-chassis and the left hand side panel of the preamp. There is just enough room here to accommodate the cables, so the wiring should be neat avoiding twists or crossovers bet-

ween cables. The best way to do this is to first mount the low-level sub-chassis onto the preamp bottom plate. Use 6BA bolts through the preamp base from below and secure them with eight nuts and washers. The base plate of the low-level sub-chassis is now placed on these bolts with its open end closest to the front panel of the preamp, and secured with another eight nuts. These nuts also double as standoffs for the MM and MC pc boards. This does not leave a great deal of height between the track side of the pc boards and the base plate of the sub-chassis, so ensure that all wires on the track side are trimmed as closely as possible to the solder connections. If all is well, mount the low-level amplifiers to the eight bolts and secure with 6BA nuts. As stated in last month's issue, the MC pc board is mounted closest to the rear of the chassis with its input end against the rear. Mount the MM amp with its output end closest to the front of the preamp.

Mount the bottom two side bars to the preamp base panel. Mount the sub-panel assembly onto the bottom panel using three self-tappers through the panel in the sub-panel assembly, and with two bolts into the side bars. Position the rear panel at the back of the preamp in approx-

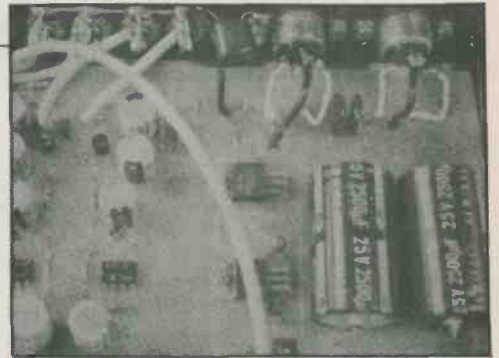

View of the rear panel and motherboard showing the output RCA sockets wiring and ac input/output DIN sockets wiring.

imately its final position. This makes it easy to estimate the necessary lengths of shielded cable to cut for the input wiring. Solder the shielded cables to the switch pc board first, run the cables down the side and behind the sub-chassis, trim and solder to the input sockets.

The next stage in the construction is to mount the main pc board to the bottom panel. Before doing this, however, pass four 1.25 inch (32 mm) 6BA bolts through the base plate from below and secure with a nut to act as pillars for mounting the LED level meters. Pass five shorter bolts through the base plate and secure with nuts. Once again these nuts act as standoffs, so ensure that wire ends on the main pc boards are trim-

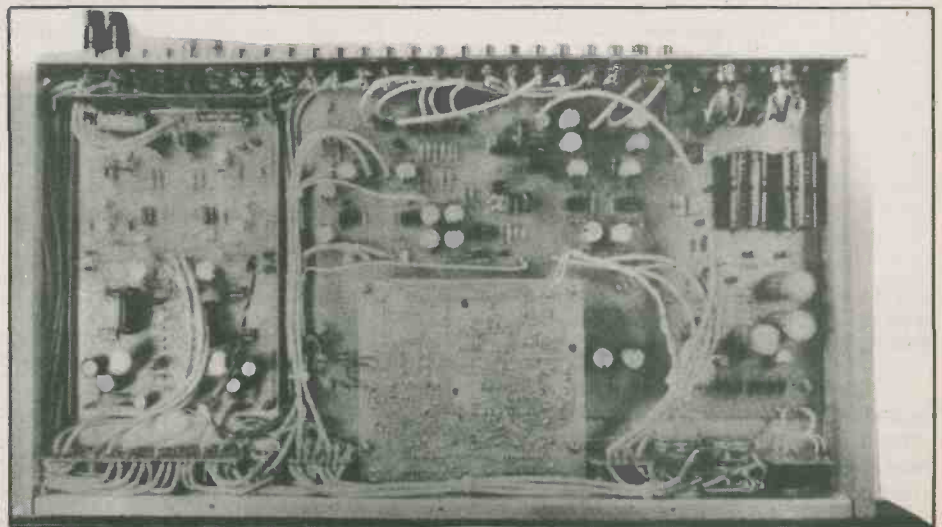

The completed project, prior to installing the low-level stages top shield cover and the cabinet cover. The wiring looks complicated, but it's not as bad as it looks! Note the holes drilled in the top LED level meter board so that the adjustments may be easily reached (see text).

med close to the solder joints. If required, a second set of nuts can be fitted to the bolts before the main board is mounted in order to space it a little further from the bottom panel, although this is probably not really necessary. With the main pc board placed roughly in position, solder the six power supply leads from the MM and MC stages to the main board, ensuring that the polarity is correct. Now secure the main board with nuts and washers. Cut and the solder the six leads from the power supply section to the three-pin DINs and the three wires to the mute section of the tape input selector, as well as from the output of the 400 Hz oscillator (see overlay diagram). Solder the leads to the power switch and the 0V connection to the output socket ground.

The remaining wiring to the pc board consists of shielded cables. Before soldering these, however, run cable from the rear panel tape input sockets to the tape monitor switch. These cables are terminated directly to the track side of the switch pc board. The connections are shown in the rear panel and sub-panel assembly, followed by the monitor amp inputs and the unity gain inverter's input and output leads. As above, all of these cables solder to the panel assembly drawings. Then solder the line amp inputs and outputs to the track side of the switch boards. Cut and solder the output leads from the main pc board to the rear panel. Pass the input leads to the MC stage through the hole in the rear of the sub-chassis, which should be fitted with a rubber grommet, and solder to the MC input sockets. With all the wiring done to the rear panel it can be bolted to the chassis, together with the top two side bars. Solder the remaining shielded cables to the low-level amps to the track side of the input switch pc boards.

The final stage in the construction of the preamp is to mount and calibrate the LED level meters. If the added holes have been drilled to allow calibration through the pc board, the first level meter can be mounted. The height of the pc board is set by four nuts and washers, which can be adjusted to the correct height on the bolts. Alternatively, screw a further three nuts and a washer onto each mounting bolt. This is close to the correct height and ensures that strain is not placed on the pc board by different-height nuts. Secure with a further four washers and nuts. The mounting holes should be drilled well oversize so that final adjustment of the position of the

LEDs can be carried out.

Now mount the front panel. If the LEDs are not in a perfectly straight line it is extremely difficult to get the front panel on, so it is well worth the effort of getting these as straight as possible. Solder the power supply wiring to the board and the input connection to the appropriate resistor on the sub-panel assembly.

Powering Up

At this stage the preamp must be powered up, so check as much as is possible. In particular check the polarity of diodes, transistors and electrolytic and tantalum capacitors. Check also the power supply connections, especially those to the MM and MC preamp stages. If all is well construct a three-pin DIN lead using

PC BOARD ARTWORK AND CABINET DRAWINGS

We do not have sufficient room to reproduce the pc board artwork and the cabinet metalwork drawings. A complete set may be obtained by sending a 300 x 250 mm stamped, self-addressed envelope to:

SERIES 5000 ARTWORK & DRAWINGS
ETI MAGAZINE
25 OVERLEA BLVD., UNIT 6
TORONTO, ONTARIO M4H 1B1

twisted hookup wire and apply power to the preamp. If you are not using the preamp with an ETI power amp, a separate 15-0-15 volt transformer must be used. Switch the tape input selector to the 400 Hz position, the tape monitor switch to the source position and the mode switch to stereo. Centre the balance pot and turn both master and monitor volume control fully on. Ensure that the three flying leads that will take power to the second level meter are not touching each other or anything else in the preamp. If the preamp is now turned on, the LED level meters should indicate the presence of the 400 Hz tone by moving swiftly to the right. If all is well, turn the monitor volume fully down and adjust the LED level meter dc offsets as described in the original article on the level meters. Ensure that the monitor level control is fully up, and by using a multimeter and adjusting the master and balance controls obtain a voltage of 1.2 Vac at the monitor output sockets. Adjust the LED level meters to read 0 dB. The preamp can now be turned off and the other level meter fitted. Once again the height of the pc board can be set by nuts on the bolt, adjusting to give the correct height. Alternatively, fit two nuts and another washer to all

four bolts. This should give the correct height. Solder the input and power supply connections. Note that this board can be difficult to get through the slots on the front panel unless the mounting holes have been drilled large enough.

Power up the preamp again, and with the master turned fully down adjust dc offsets as before. Once again adjust the master and balance pots to achieve 1.2 V at the monitor output sockets with the monitor volume control set at full. Adjust the second level meter calibration control to read 0 dB. This aligns the two level meters approximately only. If the master is now varied slowly the LEDs on each display will probably turn on at slightly different times. Adjust the top level meter calibration preset so that the LEDs come on at the same time. With the preamp set in this way the level meters indicate dB below full power when the monitor volume is set at full and the master is used as the volume control. Although this is not the usual mode of operation it is a useful feature, especially when running power amps near their maximum output powers. The usual mode of operation is to adjust the master level to give a reading on the level meters around 0 dB and then use the monitor as the volume control.

All that requires to be done at this stage is to fit the sub-chassis top panel and the preamp top panel. Don't forget to use shorting plugs on all unused low-level inputs in order to avoid thumps in the loudspeakers when the low-level input selector is switched.

Performance

The aim of this project has been to design a high-quality preamplifier suitable for home construction that will not degrade the performance of the best available power amps. To do this the conventional parameters of frequency response, noise and distortion must be good. In these respects the Series 5000 is extremely good, as can be seen from the specifications quoted last month. Of equal importance, however, are the less-known parameters such as cartridge impedance interaction. This problem is overcome through the use of a separate linear gain stage at the input to the MM amplifier.

The final test of any audio amplifier is of course subjective, but for me the Series 5000 preamplifier offers a significant improvement over many other designs, offering a detail and clarity that is seldom heard.

ETI

Into Digital Electronics Part 6

Ian Sinclair continues our educational series by looking at J-K flip-flop.

D-TYPE flip-flops have their uses, but the toggling action is reliable only if the rise-time of the clock pulse is very short. A much more versatile flip-flop has been evolved over the years, one which doesn't rely on this rise time or on the delay in the circuit. Its full name is Master-slave J - K flip-flop; just to keep your tongue from rattling to much we'll call it the J - K. It's not the sort of circuit you'd want to make up from separate transistors; even if you made it from IC NAND gates you'd need eight of them, but it can be made reasonably easily and cheaply in IC form. The one we'll use has the type number 7476, and this particular IC has two J - Ks in its 16-pin package.

The symbol for a J - K is shown in Fig. 1. It looks a lot more complicated than the flip-flop we've use so far, and it is. The reason is that the J-K can replace any other type, and ever since J-Ks have been made at reasonable prices, other types have not been needed to anything like the same amount.

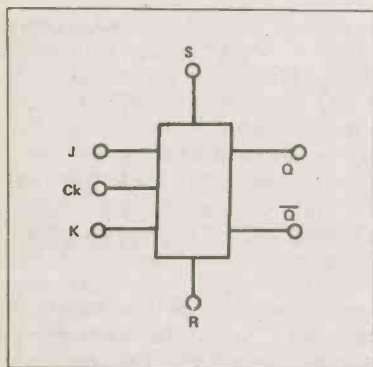

Fig. 1 J-K flip-flop symbol.

Going over the connections to a single J - K in detail, the outputs are the familiar Q and Q which we're used to by now. Three of the inputs are also familiar — the clock and the R and S inputs. A clock pulse is taken

to the clock input of the J - K, and the action of the J - K very much depends on this clock pulse. The R and S inputs are used to set (Q = 1) or reset (Q = 0) the output at anytime — there's no need to wait for a clock pulse. These inputs are called the asynchronous inputs — they are not synchronised to the clock.

The other two inputs are labelled J and K, and they are used to 'program' the flip-flop. The voltages we set at these inputs will decide what the J - K does at each clock pulse. Table 1 summarises what happens.

J	K	Q BEFORE CLOCK PULSE	Q AFTER CLOCK PULSE	
0	0	0	0	} NO EFFECT
0	0	1	1	
1	0	0	1	} FORCES Q = 1
1	0	1	1	
0	1	0	0	} FORCES Q = 0
0	1	1	0	
1	1	0	1	} CHANGES Q OVER
1	1	1	0	

S AND R
(CHANGES TAKE PLACE WHEN
S OR R TAKEN TO LOGIC 0)

S = 0, Q = 1
R = 0, Q = 0

S AND R MUST NOT BE TAKEN TO
LOGIC 0 AT THE SAME TIME

Table 1. J-K flip-flop action.

The important thing now is to try it for yourself and Fig. 2 shows a circuit diagram. We've kept the clock

generator in place, but the 7476 plugged in, with its pin 1 on line 10A and its pin 16 on line 10B. Remember that this one is a 16-pin IC! We also need to make some changes to one switch. Switch 4 is altered as shown, so that there are connections to the R and S inputs, with the switch selecting which of the two is taken low. Taking the R input to logic 0 will reset the J-K (Q = 0), and taking the S input to logic 0 will set the J-K (Q = 1). With the wiring shown, the J-K will be reset with SW4 down and set with SW4 up. SW3 is used to control the voltage used for R and S, so that we can leave them both isolated (switch 3 up) or have one of these inputs operated (switch 3 down). Table 2 summarises the action of switches 3 and 4 in this circuit.

Switches 1 and 2 are used to control the J and K inputs. These switches are wired in the same way as they were when we started, up for logic 1, down for logic 0. Switch 1 controls J, and switch 2 controls K. LED 4 indicates the state of Q.

Start with J = 0, K 50 (SW1 and SW2 both down) and reset the J - K by having switch 3 down and switch 4 down. With these settings, the clock pulse (watch LED1) should have no ef-

	UP	DOWN
SW3	NO ACTION	ACTIVATES S OR R
SW4	SET SELECTED	RESET SELECTED

Table 2. Action of switches SW3 and SW4 in Fig. 2.

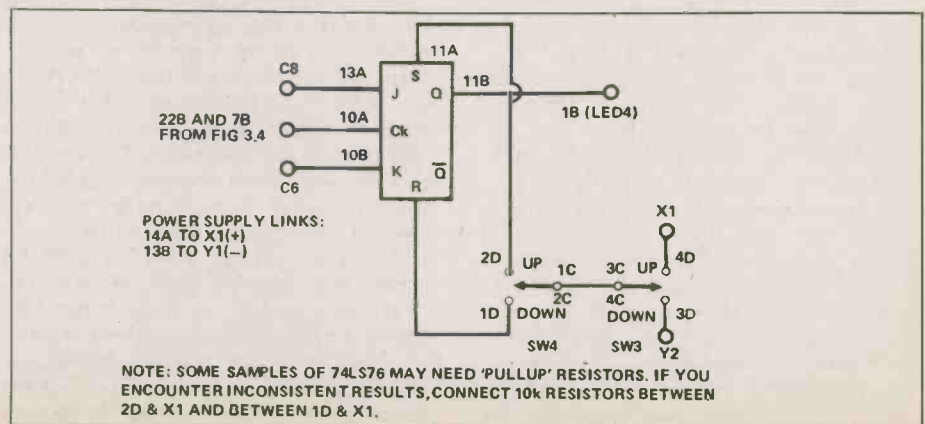

Fig. 2 Connecting the J-K flip-flop into the board, Note that the connections to switches 3 and 4 have been changed.

fect on Q (watch LED4). If you now push SW3 up just after a clock pulse, the R and S inputs are released, and whatever happens is caused by $J = 0, K = 0$.

Nothing? Don't panic — that's what is supposed to happen. With $J = 0, K = 0$, the J - K is isolated. It saves having to add a gate if we can cut off the J - K like this. Just to confirm the action, try again, but this time set switch 4 up, so that Q is set (LED 4 glows) before isolating with SW3 (up). This time the Q output remains set; the clock pulses have no effect.

What we're doing is to hold the output set or reset by using the R or S inputs, and then releasing these inputs by pushing SW3 to give logic 1. Since the set/reset inputs need a logic 0 to operate, this prevents them from acting, so that the J - K is then programmed by its J - K inputs only. With $J = 0, K = 0$, the state of the Q output is unaffected by the clock pulse.

Now set the switches so that $J = 0, K = 1$ (switch 1 down, switch 2 up). Go through the same routine again, with switches 3 and 4 down so that Q is reset, then flick switch 3 up. Is there any effect on LED4? Try again, starting with switch 4 up this time so that Q is set. Does the clock pulse cause any change after SW2 has been pushed up?

When $J = 0, K = 1$, the next clock pulse will cause the output to go to logic 0. If the output was already at 0, of course, the change will not be noticeable, but if the output was at 1, then the changeover occurs at the clock pulse.

When $J = 0, K = 1$, the next clock pulse will cause the output to go to logic 0. If the output was already at 0, of course, the change will not be noticeable, but if the output was at 1, then the changeover occurs at the clock pulse.

Now try again, with $J = 1, K = 0$ (SW1 up, SW2 down). This time you'll find that the clock pulse has the effect of setting the output to 1 after the R,S inputs have been released.

Finally, try $J = 1, K = 1$, and leave SW3 up. What effect do the clock pulses have on the output now? $J = 1, K = 1$ is the toggling connection for the J - K flip-flop. No external feedback links are needed to accomplish this (compare the D-type) and the action does not depend on having a clock pulse with a very fast rise time.

The reason for this advantage is the master-slave principle. The J - K consists of two sets of flip-flops, the master, which is affected by the J, K

inputs and the slave which is driven by the master and which in turn provides the outputs. Both of these flip-flops are operated by the same clock pulse, but the master operates on the leading edge of the clock, and the slave operates on the trailing edge. This guarantees a time difference between inputs and outputs, a time difference equal to the time of the clock pulse. At the leading edge of the clock pulse, the master flip-flop is set or reset by the J, K inputs, and its outputs are connected to the inputs of the slave. The slave does not operate, however, until the trailing edge of the clock pulse comes along, and that's when the outputs of the J - K change. By that time, no changes in the inputs can have any effect.

The J - K is such a versatile flip-flop, with so many useful operating conditions that it's seldom worthwhile using any other type. The usual TTL operating conditions apply — any unconnected input will 'float' to logic 1, and it's important not to have both set and reset inputs low at the same time, which is the reason for the connections to switches 3 and 4 in Fig. 2. These inputs are also known by the names of preset (for set) and clear (for reset).

Quick Flips And Slow Bounces

And now for something entirely different — just to tidy up a few odd points. You'll remember the clock pulse oscillator circuit which needed to use a form of NAND gate called a Schmitt gate — here's why. Most NAND/NOR gates are simply based on inverting amplifiers with a very high gain. Like any other high gain amplifier, these will oscillate if they are suitably biased, and in the course of changing between logic 0 and logic 1 (or 1 to 0) they pass through a suitable bias voltage. Now if the input pulses are so fast that the gates don't have time to oscillate, that's fine. You can't always guarantee this, though, especially when the input comes from other circuits, particularly operational amplifiers (slow little devils, these). A Schmitt trigger input to a gate has a snap-over action which never allows the gate circuit to oscillate. No matter how slowly the input voltage of a Schmitt gate changes, the output will snap over at a really high speed, and there's a fair difference in the voltage which is needed at the input to switch the output high and the voltage which is needed to switch low. This quantity is called the voltage hysteresis. Whenever a signal has to be fed into a digital circuit from circuits which are

not digital circuits, Schmitt trigger gates should be used. The symbol which is used to distinguish these gates is a miniature version of the shape of the V out/V in graph.

How does a gate like this oscillate? Imagine that the output is at logic 1, and the input is at 0. The current flowing through R charges up capacitor C, and when the voltage at the input reaches about 2.4 V, the output switches to logic 0. Capacitor C now discharges through R, until the input voltage reaches its other switching voltage at 0.8V. At this voltage, the output goes high again and the action starts all over again.

We can use the Schmitt trigger gate also for 'debouncing' a switch. Whenever a switch is closed, the contacts will bounce, so that the switch closes and opens a few times before finally closing. If you're trying to generate one single pulse, this isn't very good, and some method of 'debouncing' the switch is needed. Fig. 3 shows one circuit, making use of the Schmitt trigger NAND gate

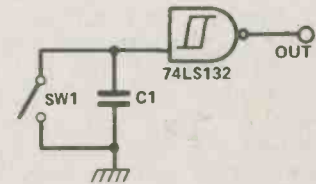

Fig. 3 Debouncing a switch, using the 74LS132.

74132. The idea is that if the switch bounces open, the voltage at the input of the gate will not change fast enough to allow the voltage to get high enough to operate the gate — the capacitor C1 ensures that. When the switch is closed, C1 is discharged.

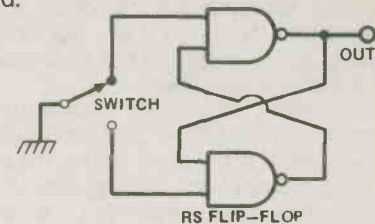

Fig. 4 Using the R-S flip-flop to debounce a switch.

Another method of debouncing a switch is the use of the R - S flip-flop (Fig. 4). If the switch has touched its contact, the flip-flop will switch-over, and any bounce simply leaves the R and S inputs both at logic 1. As you know by now, having both inputs of the R - S at logic 1 leaves the output unaffected, so the switch bounce has no effect on the output. We'll have a look at these debounced switches when we start on binary counters next time.

To be continued.

ETI

Torch Review

Continued from page 43

The first thing we got up was something called Torchtel, which is a prestel package. Prestel is the British equivalent to our beloved and laughed at Telidon. The difference is that theirs actually works. There is a Prestel system running out of Boston and its number, included in the Torchtel's directory, could be dialed automatically, and, upon attaching to the system, pages began happening.

The Prestel package for the Torch worked as well as any we've seen. (It was the first, actually.) The pages come up astoundingly fast at 1200 baud, in full colour with medium resolution graphics. The keys all do intensely logical things, and there is a special command which lets one call for a page to be retransmitted if there is a garbled character or two. The whole effect is like that of an ultra BBS running at warp factor two. Quite the game.

There were also several dedicated communications routines designed for communicating with other Torch computers running similar software. This stuff was more along the lines of a regular BBS, but all the handshaking and low level communication was done invisibly. You just sit there and watch the screen be blank until everything has hooked up. This isn't very lively, but it does work well.

We got one video game program and more ... with the system, a custom written version of Snake. The object of Snake is to manipulate a snake on the screen to go around and swallow up numbers which keep appearing. Sounds fairly stupid, of course, but it's very addictive when well written, which this one was. In fact, this program was a lovely implementation of the system, not only showing up its graphics but also how fast it could move them.

The 6502 processor, while not having the instruction complexity of the Z-80, is a lot faster. Using these two chips together has given the system a further capability, as illustrated by the Snake program. It can be programmed to talk. The Snake game calls out the numbers the snake eats and a few other words throughout the game. The speech isn't real human sounding, but it's pretty impressive for a system without a dedicated speech generator in hardware.

The Torch also came with several dedicated terminal emulator packages, which would make your Torch act like a Hazeltine, an ADM-3 and so on. These all worked well. Another package we played with a bit was the Executives' Aid, which

makes the system into a desk diary, moderate filing system and rudimentary word processor. This software was actually very well thought out for what it was intended for. It had a minimum of superfluous options and ran quite fast.

By The Book

The Torch's documentation was not quite so lavish as, say, that of the IBM PC, and, in fact, there was a great deal of the software which, we were told, was so new that there was virtually no documentation at all available for it when we got it. It should all be properly written up by the time you read this. However, what hard copy we did see was fairly good.

The books were all spiral bound deals, which is worth more than it sounds like as they lay flat and are easy to use. Some were typeset, but others were pulled right off a dot matrix printer and sent to the press. However, they weren't objectionable to read, and, obviously, manuals like this are available a lot quicker than ones that go through a mass of heavy production and fidgeting.

Most impressive of the documentation was the Torch Programmers' Guide, a beefy little tome dealing with the workings of the internals and bit-zandbytes. If all the Torch's books are of this calibre there should be no worries on the software side of things. The book details absolutely everything one could want to know about writing programs that leap about in the CCCP. All the calls are gone over in depth, with descriptions of what they do and what can be expected of them. This system has a raft of facilities, so there is a lot of calls. In fact, the full extent of the system's capabilities can only really be fathomed at this level. Neither the BBC BASIC nor any of the dedicated software we tried really run it out to its limit.

Now of the books we got, with the exception of the BBC BASIC manual, could be said to be beginners' books. Albeit, this is not a beginners' system, but the business oriented dude with an eye to it should keep in mind that once one steps beyond the bounds of the packaged software one will be in a bit of a jungle if one has not had a bit of experience with these things before. This may, of course, change with the advent of more manuals.

Reset

Mechanically, the Torch was one of the ruggedest systems we've seen, its case being made out of really

Continued on page 79

ETI FACT FILE



Manufacturer:	Torch Computers Limited
Area of interest:	Business
Processor:	Z-80 and 6502
Screen size:	11 inches
Graphics:	Up to 640 x 256 (two colour)
Sound:	Three voice programmable
Display:	Internal monitor
Mass Storage:	2 5/4 Inch DSDD disks
RAM:	68K for the Z-80, 32K for the 6502
Number of Keys:	102
Printer included:	No
Software Included:	CPN, MBASIC, BBC BASIC, MUSIC, SNAKE, EXECUTIVE'S AID, others
ROM pack facility:	No
RS-232 Port:	Yes (RS423)
Parallel Port:	Yes
Printer Interface:	Yes
DOS:	CPN
Number of units:	2
Documentation:	Programmer's Guide, some software specific manuals
Price:	\$7995

ETI'S EVALUATION

We have evaluated our sample on a scale of one (poor) to five (exceptional). In making our assessment we have taken into account the class of user to which the computer is marketed.

Mechanical Construction	●●●●●
Overall ease of use	●●●●●
Speed of Operation	●●●●●
Software	●●●●●
Suitability for beginners	●●●●●
Suitability for business	●●●●●
Manuals and instructions	●●●●●

ETI Special Publications

If you enjoy ETI, why not try some of our highly successful special publications.



Projects Book No. 2
from ETI Magazine
25 Electronic Projects
\$3.95

Contains 25 of the best projects from recent issues including the High Performance Series 4000 Amplifier (including Preamps and Power Supply), Rumble Filter, Dynamic Noise Filter, Logic Probe, Cable Tester, Function Generator, Rain Alarm, Digital Tacho, Two Octave Organ, Light Chaser, Shutter Speed Timer, Ni-Cad Charger and more. First published January 1981.

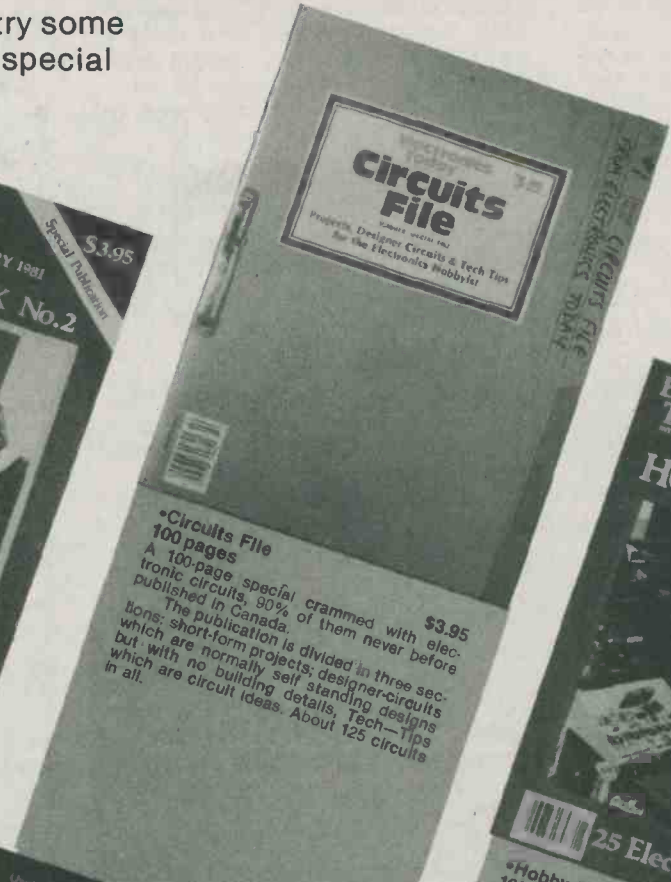

Circuits File
100 pages
\$3.95

A 100-page special crammed with electronic circuits, 80% of them never before published in Canada. The publication is divided in three sections: short-form projects; designer-circuits which are normally self standing designs but with no building details, Tech-Tips which are circuit ideas. About 125 circuits in all.



Hobby Projects
100 pages
\$3.95

First published Summer 1980. Contains 25 straight-forward projects, most of which have never appeared in the magazine including: Stereo Amp, Audio Mixer, Scratch and Rumble Filter, Constant Volume Amp, Graphic Equaliser, Envelope Generator, White Noise Effects Unit, Linear Scale Ohmmeter, Intercom, Drill Speed Controller, LED Tacho, Parking Meter Timer, Electronic Organ, Touch Switch, Electronic Dice, Siren, Simple Receivers.

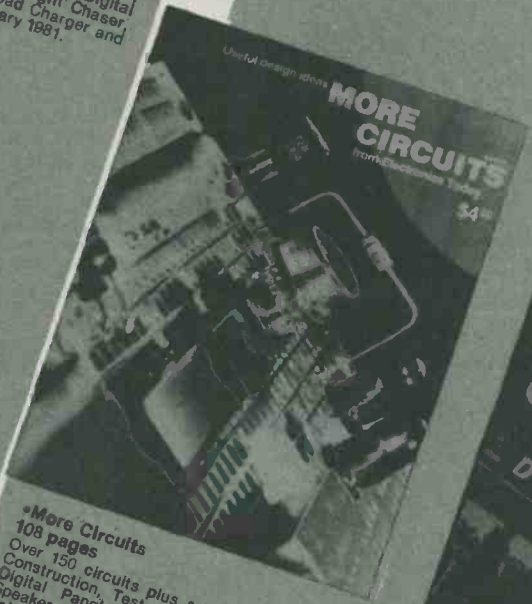

More Circuits
108 pages
\$4.50

Over 150 circuits plus articles on Circuit Construction, Test Gear, a project on a Digital Panel Meter, Design notes on Speaker Crossovers, TTL pin-outs, Design notes on Crystal Oscillators.



Electronic Circuit Design
92 pages
\$3.95

A collection of major articles on various aspects of circuit design including CMOS, Audio Amplifiers, Power Supplies, SCR's, Op-Amps, Using the 3000 and Temperature Control. A large number of useful circuits are given but the emphasis is on guidance and how to design for yourself.

Available from your local electronic parts store or direct from ETI please add 45¢ each to cover postage. Send money to: Electronics Today Magazine, Unit 6, 25 Overlea Blvd., Toronto, Ont., M4H 1B1

February 1977

Features: CN Tower, Biorythm Calculator, VCT, 555 Timer Applications, Yamaha B1 Review, Scope Test Your Car.
Projects: 5W Stereo Amp, Philips Speaker System, Reaction Tester, Patch Detector, Heads or Tail, SCR Tester.

December 1978

Features: Designing Oscillators, Ham Spectrum Chart, Principles of Video, Getting into Video.
Projects: Digital Anemometer, Tape Noise Eliminator, EPROM Programmer.

February 1979

Features: Quarks, Op-Amps, Binary to Decimal and Back.
Projects: SW Radio, Phasemeter, Light Chaser.

April 1979

Features: Designing Audio Amps, Solar Power RF Chokes, What Quad terms mean.
Projects: Differential Temperature Controller, Audio Compressor, Wheel of Fortune Game.

May 1979

Features: Space Shuttle Communications, Transducers in Measurement & Control, Research in Canada.
Projects: Light Show Controller, AM Tuner, VHF Antenna (pt.1), PCB Drill.

June 1979

Features: Op-Amps, Ultrasonic Sound, ETI Computer Catalogue.
Projects: Easy Colour Organ, LCD Thermometer, Light Show Colour Sequencer, VHF Antenna (pt.2), Bip Beacon.

August 1979

Features: Casing Survey, Smoke Detectors, TV Antennas, Reed Switches, Magnetic Field Audio Amp, Industrial Electronics.
Projects: Audio Power Meter, Shoot-out, ETI-Wet Plant Waterer.

September 1979

Features: OSI Superboard Review, Solar Power from Satellites, Reed Switches.
Projects: Field Strength Meter, Digital Wind Meter, Up/Down Counter.

October 1979

Features: SW Receiver Survey, Ultra Fidelity, Computer Speech.
Projects: Simple Graphic Equaliser, Digital Dial, Variable Windscreen Wiper, Cable Tester.

November 1979

Features: Kit Survey, Ultra Fidelity (pt.2), Using UARTS.
Projects: 60W Amplifier, Model Train Controller, Scope Curve Tracer.

December 1979

Features: LM10—the Basics, Police Radar Speed Meters, Guide to TRIACS, Fluorescent Displays.
Projects: High Performance Stereo Preamp, Development Timer, Logic Trigger.

May 1980

Features: Delay Lines, Standing Waves, Microwave Cooking, Artificial Intelligence.
Projects: Click Eliminator, Soil Moisture Indicator, Fuel Level Monitor, 16k RAM Card.

June 1980

Features: Electronic Warfare, PLL Synthesis, CA3130 Circuits, Canadian Sound Archives, Magnetic Power Control, CLIP.
Projects: Function Generator, Dynamic Noise Filter, Overspeed Alarm.

July 1980

Features: CMOS 555 Circuits, Capacitors, Electronics in the Studio, Tesla Controversy.
Projects: Hebot Robot (pt.1), Photographic Timer, Analogue Frequency Meter, Accentuated Beat Metronome.

August 1980

Features: S100 Bus System, Introduction to Test Gear, Designer Circuits, FET Special, Life Out There?
Projects: 300W Amp, Hebot (pt.2), Transistor Tester, Passionmeter.

November 1980

Features: Designer Circuits Special, Cassette Decks and Tapes, Attenuators, Project Daedalus, Thermistors.
Projects: Guitar Practice Amplifier, 6W Siren, Infra-Red Remote Control.

December 1980

Features: Transducers in Audio, Floppy Disks, 10 Simple Transistor Circuits, Electric Cars, SI Units.
Projects: Digital Test Meter, RIAA Preamp, Survival Game.

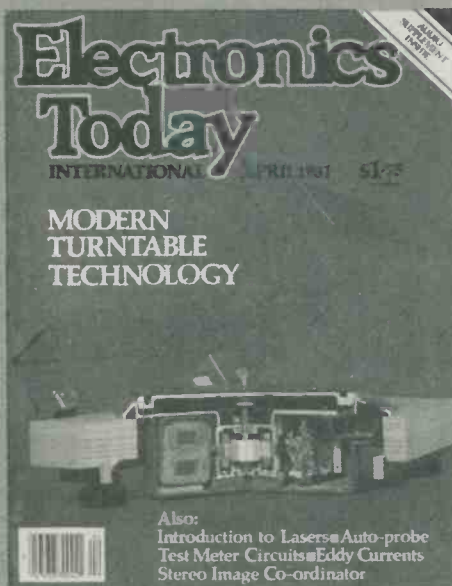

January 1981

Features: Studio Techniques, Premium Batteries, Edison Effect, Alarm Circuits.
Projects: Electronic Ignition, Digital Frequency Meter, EPROM Eraser, Coin Toss.

February 1981

Features: Electronics in Photography, Audio Filter Design, Piezo Electricity, Modems, Choosing a Printer, Selecting a Floppy Disk.
Projects: Ultrasonic Burglar Alarm, Fuzz Sustain Unit, Process Timer.

March 1981

Features: The Ubiquitous Oscilloscope, VFET Applications, Photocells, Test Gear.
Projects: Hum Filter, Drum Synthesiser, Shark Game.

June 1981

Features: Project Galileo, Story Behind Stereo, Solder, Computerese.
Projects: 1573A VCA, High Speed Cassette Interface, Double Dice, Bicycle Speedometer.

July 1981

Features: LM3914 Circuits, How to Solder, Faraday, Auto Sound Survey, Project Fault-Finding.
Projects: Universal Timer, Bargraph Car Voltmeter, Engineer's Stethoscope, Computer Motherboard.

August 1981

Features: Recording Tape and Tape Recording, Anatomy of a Micro, Holograms, Wein Bridge Oscillators, 55 Circuits.
Projects: Infra-Red Alarm, Bench PSU, Wired Sound.

September 1981

Features: Thick Film Circuits, A look at CP/M, GM Revisited, Hum Loops, Ex-OR Gates.
Projects: LED Vu Meter, Russian Roulette, LED Tacho, Emergency Light Unit.

October 1981

Features: Scope Survey, Graphic Equalizer Design, I/O Devices, Dolby C, Black Hole Theory.
Projects: Tape Optimizer, Antenna Extender, Win Indicator, Pulse Generator.

November 1981

Features: Canada in Space, Digital Design Handbook, Maxwell, POKEing the ZX80, VIC-20 Review, PWM Explained.
Projects: Alien, Attack, Headlight, Delay, Drum Machine, Computer Joysticks.

December 1981

Features: Bandpass Circuits, Tubes, Early Radio in Canada, Speaker Design (pt.1).
Projects: Universal Counter, Musical Doorbell, 4-Input Mixer.

January 1982

Features: Speaker Design (pt.2), Big Bang Theory, Acorn, ATOM Review, SLR Cameras, Micropower Circuits.
Projects: 4-Way Loudspeaker, Movement Alarm, Temperature Controlled Iron.

February 1982

Features: 50 Circuits, ATOM Review, Electronic Signs, Industrial Robots, Amplifier Class, dBx, SW Aerials.
Projects: Flash Sequencer, Enlarger Timer, Sound Bender.

March 1982

Features: Printers, Ni-Cads, ZX81 Review, Perfect Sound, Gluons, CMOS Circuits.
Projects: Music Processor, Crystal Marker, Ni-Cad Charger, Reaction Tester.

April 1982

Features: Satellite Applications, 4066B Circuits, TRS-80 Model II Review, Fessenden, Electric Pencil.
Projects: Ten Simple Projects Special.

May 1982

Features: Shroud of Turin, Faster than Light Travel, CMOS Circuits, Modems, Drone Speaker, 8809 Computer Review, Optical Disk Recorders.
Projects: AF Signal Generator, Super Dice, LED Level Meter.

June 1982

Features: Fibre Optics, Lasers in Hi-Fi, Leptons, Xerox Computer Review, Hertz, 50 More Circuits.
Projects: Phono Preamp, Roulette Game, Light Wand, Stylus Organ.

The Back Issues listed here are still available. A few others (listed on the order form) are also available but in very limited quantities. Our Back Issues are not unsold copies: each month about 500 are held in reserve for this service.

\$3.00 each or any FIVE for \$10
(Price includes shipping)

**ETI Back Issues,
Unit 6, 25 Overlea Blvd,
Toronto, Ontario,
M4H 1B1**

CLASSIFIED ADVERTISING

ETI's classified advertising section allows you to reach about 30,000 Canadian readers nation-wide for \$1.00 per word. For as little as \$20 per insertion (there's a 20 word minimum) you can promote your business from coast-to-coast.

WHAT DO YOU DO?

Send us your typewritten or clearly printed words, your permanent address and telephone number and your money (no cash please). Make your

cheque or money order payable to 'ETI Magazine'. We're at Unit 6, 25 Overlea Blvd., Toronto, Ontario, M4H 1B1.

WHAT DO WE DO?

We typeset your words (and put the first word and your company name in BOLD capital letters). If we get your message by the 14th of the month, it will appear in ETI 1½ months later. For example if we receive it by October 14th you (and thousands more) will see it in the December Issue.

FOR \$10 per kit \$ 2 handling, receive free flyer and any of the following. #1: 1000 asst'd pcs, choke - capacitor - resistor - transistor - hardware - etc. Capacitor specials: #2: 200 asst'd ceramic - #3: 100 asst'd silver mica - #4: 100 asst'd mylar - #5: 50 asst'd tantalum - #6: 50 asst'd electrolytic - #7: 50 asst'd feed-through - #8: 50 asst'd metallic silver mica (Elmenco) - #9: 25 asst'd variable. All new material. Unconditional guarantee. **SURPLUS ELECTRO QUEBEC, 2264 Montee Gagnon, Blainville, Quebec J7E 4H5.**

OKIDATA printers. 82A \$745.00 83A \$1195.00 add \$69.00 for Okigraph. 90 day warranty. **BASF** 5¼" diskettes S.S.D.D. Ten in library case. \$39.95. **J.A. MICHELL** "Focus" turntable with Linn Basik tonearm and cartridge, list \$789.00 now \$399.00. Dalesford "D" loudspeakers list \$500.00 now \$249.00 pair. Shipped Canpar FOB Montreal. Quebec residents add 9% tax. Send certified cheque or money order to **A.T.E. LTD.** Box 2392, Dorval, Quebec H9S 5N4.

EMPLOYMENT Wanted: I am a graduate of Seneca's 48-week Digital Electronics program and seek related employment, in Toronto area. Willing to "work my way up" while continuing my education through Ryerson's night school. Reply to: **F. OLSON**, 9 Lowbank Ct., Willowdale, M2M 3A5.

HYDROGEN GAS GENERATOR plans and starter kit, \$12. **PRAIRIE POWER RESEARCH AND DEVELOPMENT**, P.O. Box 8291, Edmonton, Alberta. T6H 0L0.

CORONET ELECTRONICS, 649A Notre Dame W., Montreal, Que. H3C 1H8, Catalogue IC's, Semi's, Parts, send \$1.00 to cover postage. Monthly specials at crazy prices.

ATOM OWNERS! Now available from Oak Microware: budget master, record maintenance, financial analysis, report writing. Personal and small business applications. Many options. Unlimited number of user definable accounts. Comprehensive documentation. Requires F.P. ROM and toolbox ROM. 64K and 12K versions. Send \$39.95 to **OAK MICROWARE**, 23 Brock St., Ajax, Ont., L1S 1S9. or call (416) 686-2889. Also ask about our metric master.

ALARMS. Commercial security equipment used by professional installers now available to you. Best quality only at low prices. Ask catalog #25. **POLYGRAFF**, P.O. Box 276, Sherbrooke, Que. J1H 5J1.

DISK drives for Apple™ Computers. 5¼" high quality Siemens™ technology in a handsome beige cabinet. Front panel "write protect" lock feature. Ready to install. 180 day warranty. Disk drive \$349.00, disk drive with controller \$429.00. Quebec residents add 9% PST. All orders shipped freight collect. Send certified cheque or money order. **ADV MICRO PERIPHERALS**, 763 Lajoie, Dorval, Quebec H9P 1G7. (514) 631-7672.

TEXAS INSTRUMENT 99/4A computers at lowest prices. Become a home distributor & let your computer pay for itself! No investment required. Phone or write **MIKE MATTOS**, 55 Cordella Ave., Toronto M6N 2J7 (416-763-3244)

ZX81 owners. Internal memory for your Sinclair. 2K kit-\$20, 4K-\$35. Specify computer: kit or assembled version. Instructions included, P.S.T. extra. **CANADIAN MICRO PERIPHERALS**, Box 123, Waterloo, Ont. N2J 3Z9.

MICRO-WINCHESTER easy installation in Z80 computers including Z80 Apple. 20Mb \$4,995.00, 10Mb \$3,795.00 **CANVEON SYSTEMS INCORPORATED.** (416) 226-2181. Dealer inquiries invited.

CONTRACT Bridge software for popular home computers. (Timex, Sinclair, Commodore, Texas, Shack). Details free. **ALLAN MICROCOMPUTING**, Box 313, Azilda, Ont. P0M 1B0.

ZX81 motherboard, accepts Vector and Radio Shack plugboards, plus Sinclair hardware. 2x .156, 2x 0.1 connectors, plugs into rear connector. Free hardware plans included, 16K RAM, 24 ch. in/out. \$29.95. Also ZX81 video monitor amp. Composite output. Installs easily inside case, instructions included \$9.95 **JDC** 5-14 Sentinel Rd., Downsview, Ont. M3M 2Y5.

SPECIAL priced semiconductors. 2764 -\$15.00, 2732 - \$7.00, 2716 - \$4.00, 4116 -\$1.50. Send for free list. **M.O. ENTERPRISES**. P.O. Box 2066E, Bramalea, Ontario. L6T 3S3.

1,000 liters of hydrogen for \$1! Make with ordinary household supplies! \$9.95 **NATIONAL ENERGY**, Dept. VG31, R.R.#1, Brooklin, Ont. L0B 1C0.

ACORN ATOM users! There is a thriving independent users group with members from coast to coast. An informative newsletter is published quarterly. Associate membership \$10.00 including subscription to newsletter. **ATOM USERS' GROUP CANADA**, 812 Cabot Trail, Milton, Ont. L9T 3M8.

RAECOM ELECTRONICS, 262 Evans St., Duncan, B.C., V9L 1P8., surplus!, parts, tx. tubes, power supplies, transistors, test equipment, ham gear. Send S.A.S.E. and \$1.00 for our new flyer.

J&J ELECTRONICS Ltd., P.O. Box 1437E, Winnipeg, Manitoba R3C 2Z4. Surplus and Semiconductor Specialists. Do you get our bargain flyer? Send \$1.00 to receive the current literature and specials and to be placed on the mailing list for future publications.

ZX81 Tactile Feedback Keyboard Overlay, stops missed keys, touch typing possible. \$3.95. Cassette with 4-16K programs, Astro Smasher, Birds, Typing Skills, Math Tutor, \$12.50 **P. HARGRAVE**, Site V, RR4, Nanaimo, B.C. V9R 5X9.

WSI RADIO — SWL Radios — Ham radios 18 Sheldon Avenue North, Kitchener, Ontario N2H 3M2. Tel. (519) 579-0536. Write for 1983 catalogue, \$2.00 (VE3EHC).

APPLE™ fully compatible computer boards. Mother board — \$60.00. Peripheral boards— Z80, 80 column, disk controller, 16K — \$20.00 each. All boards of high quality glass — solder — masked, silk-screened. Parts kits also available to allow you to build a fully Apple compatible and supported computer at a fraction of the original's price. Special prices for quantity and school buyers. Listed prices include shipping. B.C. residents add 6% P.S.T. Stamp brings further details. **K-K ENTERPRISES**, P.O. Box 65368, Station F, Vancouver, B.C. V5N 5P3.

PORTABLE AM antennas (540 to 1600 Khz.) for distant day and night radio reception. Instructions included. Regular model \$75. Deluxe Model \$130. Available by money order from: **ELDON ELECTRONIC ENTERPRISES**, 10653 - 137A Street, Surrey, B.C. V3T 4J7.

The Fun of Electronics



Bet it's been a while since you saw one of these old tube radios.



Dummy antenna.

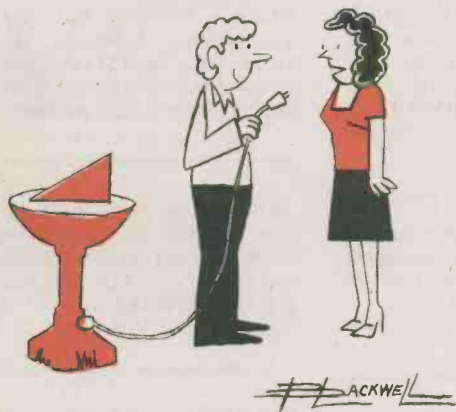

"It's wonderful, Harold, but do you really think there's a market for an electric sundial?"



Hey, what are you trying to pull here - I saw your lips move.



Of course the kit is more expensive! Do you know how long it takes me to disassemble one of these things and put all the parts in little envelopes?



"You don't seem to understand, Mr. Johnson. Your TV set isn't broken... it's been stolen."

6502 MOTHER BOARD(BARE)



This beautifully made G-10 epoxy PCB runs the ever popular 6502 CPU. Fully and clearly screened to give the precise identification and location of all parts from resistors to the CPU. This board will operate with software in these formats

(a) 6-2716's (b) 3-2732's
(c) 6-Masked ROM's (d) 3-2532's
giving you the maximum latitude possible. Upper and lower case character set is available and 3 separate prototype areas are on the board. Each board is pretested for shorts and opens and it has both color trim and crystal trim variable capacitors. (never buy a board without both of these) This board will run all 6502 software, fully compatible with Apple™ products and other peripheral boards.
6502 BOARD.....\$60.00

PARTS KITS

- For those in need we have these parts kits.
- (a) Tin IC sockets, 8,14,16,20,24,40.....\$13.00
(b) Gold IC Sockets, 8,14,16,20,24,40.....\$26.00
(c) 1/2 1/2 IC Sockets, gold, 40,24 rest tin.....\$18.00
(d) Edge connectors, set of 8.....\$25.00
(e) Resistors, all the 1/4W resistors.....\$1.00
(f) SIP resistors, 3-0.1w 1Kx8.....\$2.00
(g) Capacitors all the .1 + others.....\$7.00
(h) Transistors & diodes.....\$2.00
(i) Crystal, trimcaps, trimpot, RCA jack audio jacks, header pins, coil.....\$6.00
(j) All TTL parts.....\$34.95
(k) All linear parts.....\$4.00
(l) 6502 CPU.....\$7.00
(m) RAMS 24 4116's.....\$42.00
(n) 2716's 6 pcs.....\$27.00
(o) 2716 character gen programmed.....\$8.00
(p) 2732's 3 pcs.....\$25.00
(q) 2532's 3 pcs.....\$25.00
(r) Complete kit, no IC's.....\$57.00
(s) Complete kit, all IC's.....\$160.00
(t) Complete kit, all IC's, gold.....\$170.00
(u) Wired and tested motherboard with all parts, including blank 2732's.....\$395.00
(v) Wired motherboard, with all IC's packed separately ready to stuff.....\$325.00
(w) Wired motherboard, no IC's.....\$185.00

MODULATORS

- Those of you who have no monitor can use the following modulators to interface to a std TV set
- (a) El cheapo, a TV game modulator, OK for 40 column print in black & white but not recommended for colour.....\$6.95
(b) Medium quality unit, good for almost any uses but lacks a SAW filter for top grade colour.....\$19.95
(c) High quality unit good for all uses, has integral SAW filter for top grade colour reception.....\$29.95

ASCII KEYBOARDS



Some of you will get your PC boards running with surplus keyboards but some will not and if you want the 'original' look try one of these two keyboards. Both are ASCII and can implement all the 'original' keyboard functions.

Light grey, suitable for our Ivory enclosure. With header cable.....\$99.00
We also have a small ABS keyboard (only) box suitable for those who build their own PCB enclosure.....\$19.95

SMALL PARTS

16 Pin header.....\$2.00	14.318MHz xtal.....\$3.00
50pF trimcap.....\$0.75	17.430MHz xtal.....\$5.00
250-ohm trimpot.....\$0.50	27uH coil.....\$0.75
RCA Jack.....\$0.75	Audio jack.....\$0.75
Header pins (10).....\$0.35	Header (5 pin).....\$0.50
1K by 8 SIP.....\$0.75	Power, male.....\$0.75
1K by 9 SIP.....\$0.75	Power, female.....\$0.75
1K by 7 SIP.....\$0.75	Speaker, 3", 8ohm.....\$1.50
10K by 9 SIP.....\$0.75	Ribbon cable 8'.....\$3.00

PARTS

- An assortment of parts at really good prices so that your budget will go a long-long way.
- (a) NPN Transistors, general purpose.....100/\$6.00
(b) PNP Transistors, gen purpose.....100/\$8.00
(c) NPN Transistors, 2N2222 style.....100/\$10.00
(d) Zeners, Asstd 400 mw.....100/\$5.00
(e) 1N4003 diodes, 1A, 200V.....100/\$8.00
(f) 1N4007 diodes, 1A 1000V.....100/\$10.00
(g) MR502 diodes, 3A, 200V.....100/\$18.00
(h) Shottky, 3A, 20V switching.....100/\$50.00
(i) Power cords, 2 wire, 18g, 6'.....100/\$22.00
(j) 4 digit 1" MUX litronix LED.....10/\$10.00
(k) PL-259, pliers crimpable, 58.....10/\$6.00
(l) SPDT mini toggle switch.....10/\$15.00
(m) S-100 connector, solder tail.....10/\$25.00
(n) S-100 connector, wire wrap.....10/\$40.00
(o) 1000uH/25V Radial lytic.....100/\$30.00
(p) Modem transformer, 600-600.....10/\$20.00
(q) Infra red LEDs.....100/\$18.00
(r) Standard Jumbo red LED's.....100/\$12.00
(s) Calculator keyboard, from a TI scientific 32 key calc, matrixed.....10/\$18.00

IC SOCKETS

8 PIN LP TIN.....\$1.00	8 PIN LP G.....4/1.00
14 PIN LP TIN.....7/1.00	14 PIN LP G.....3/1.00
16 PIN LP TIN.....6/1.00	16 PIN LP G.....3/1.00
18 PIN LP TIN.....4/1.00	18 PIN LP G.....2/1.00
20 PIN LP TIN.....4/1.00	20 PIN LP G.....2/1.00
22 PIN LP TIN.....3/1.00	22 PIN LP G.....2/1.00
24 PIN LP TIN.....4/1.00	24 PIN LP G.....2/1.00
28 PIN LP TIN.....4/1.00	28 PIN LP G.....1.00ea.
40 PIN LP TIN.....2/1.00	40 PIN LP G.....1.40ea.

- August 24 and 28 pin machined contact IC sockets, the best kind.....\$1.30ea.
Loose August machined contact pins 20/1.00

PERIPHERAL BOARDS



These PC boards lack parts and need to be built up for use. All boards come with a parts layout and list but after that you're on your own.

- (a) Z-80 Bare board. This board allows you to run CPM™ on a 6502 board. You must purchase a copy of CPM™.....\$20.00
(b) 80 Character bare board, enables the user to display 80 characters on video screen. Also has light pen input.....\$25.00
(c) 16K bare board, allows for a full 64K of memory in your system.....\$20.00
(d) Floppy disc bare card, allows operation of a floppy disc drive, user must buy a DOS from dealer.....\$20.00
(e) EPROM programmer bare board, this board allows the user to program 2708, 2716, 2732, 2532, 2764 EPROMS, has its own software and is not dependent on disc.....\$25.00
(f) ROM bare board, allows an extra 16K of ROM to be switched in & out of memory in place of on-board ROM's.....\$20.00
(g) RS-232 bare board, allows serial communication to peripheral devices.....\$20.00
(h) Printer bare board, allows interface to EPSON and other printers.....\$20.00
(i) Centronics parallel interface card, lets you use a Centronics printer.....\$20.00
(j) Prototype card, all wire wrap holes no annoying power busses all over the active board area.....\$20.00
(k) Music bare board, this board allows a wide range of musical effects to be performed with a 6502 board.....\$25.00
(l) Special deal, order 10 boards from the above with a maximum of 3 of any one kind for a total price of.....\$150.00
Save \$50 to \$100, get a group together.

"ZENITH 12" GREEN SCREEN

Monitor \$135.00

ABS CASES



For those who wish to copy the 'original' as closely as possible we have the following enclosures, both fit the PCB's, power supplies, and keyboards exactly.

- (a) Belge case, ABS, all hardware, close colour match to the real thing.....\$99.00
(b) Ivory case, ABS, all hardware, to many a nicer colour for the home.....\$99.00

MUFFIN FANS



- These fans are tested units taken out of used equipment, 1000's of hours of life in 'em yet.
- (a) Standard, 4 1/4 x 4.....\$9.50
(b) Sprite, 3 1/4 x 3 1/4, Fits inside Apple(tm).....\$9.95

POWER TRANSFORMERS

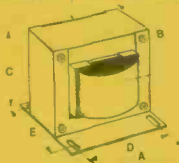

- We have had some transformers wound for the 6502 board and other projects.
- (a) 6502 board transformer, provides 8V at 5A plus 25V CT at 1.1A, this unit will run two drives and a full set of peripherals.....\$18.00
(b) S-100 board transformer, provides 8V at 8A plus 25V CT at 1.8A plus 22V at 2.5A Runs any size S-100 system with up to 4 1/2" disc drives.....\$30.00
(c) General purpose 5V power supply transformer, gives 8V at 5A for a good bench supply or what have you.....\$9.50
(d) General purpose 12V power supply transformer, gives 15V at 2.5A for a good bench supply etc.....\$8.50
(e) General purpose 24V power supply transformer, gives 25V CT at 2.5A ideal for 24V at 2A or 12V at 4A.....\$12.00

BANK KEYBOARD



- What a deal, this keyboard was originally made for a bank terminal but the standard was changed. It has an Intel 8048 CPU with 2K masked ROM on board that runs it as a serial data terminal, or you can have the 8048 address an external 2716 and run it anyway you like. There is a 6Mhz crystal on board, a numeric pad, 28 keys with lids that can hold a written legend and a bunch of standard CMOS and 74 LS IC's, an ideal low cost keyboard for classroom use
BANK KEYBOARD.....\$10.00

AMAZING QUALITY

At last, a high quality, 3 1/2 digit, LCD, DMM with all the features of the higher priced American brands at an affordable price. Check these specs.

Voltage, DC
0.2, 2.0, 20.0, 200.0, 1000.0
Voltage, AC
0.2, 2.0, 20.0, 200.0, 750.0
Current, DC
200ua, 2ma, 20ma, 200ma, 2000ma, 10A
Current AC
200 ua, 2ma, 20ma, 200ma, 2000ma, 10A
RESISTANCE
200, 2K, 20K, 200K, 2000K, 20M Ohms
ACCURACY 0.25% ± 1 DIGIT

LARGE LCD DISPLAY LOW BATTERY READOUT



HI-VOLTAGE FOR DIODE TESTING, LOW-VOLTAGE FOR IN-CIRCUIT TESTING

IN-LINE PUSHBUTTONS COLOUR-CODED FOR EASY RANGE SELECTION

RECESSED INPUT JACKS

OVERLOAD PROTECTION ON ALL RANGES

EXTRA FEATURES

- Diode test circuit
 - Lo voltage ohms, 0.5v
 - Lo battery indicator
 - Auto-Zero
 - Auto polarity
 - Overload protection, all ranges
 - ABS case (will not crack)
 - One hand push buttons. ON LY
- \$99.00**

SWITCHING POWER SUPPLIES



We have 4 power supplies that can power the 6502 PCB. They differ mainly in the total wattage available.

- (a) A bit bigger, runs more peripherals and a low power disc drive.
+5v - 3A; +12v - 1A; -5v - 1/2A;
-12v - 1/2A.....\$75.00
(b) Larger still, runs lots of peripherals and std disc drives.
T 5c - 3A; +12v - 1 1/2A; -5v - 1/2A;
-12v - 1/2A.....\$99.00
(c) The largest, runs 2 drives and lots of peripherals.
+5v - 3A; +12v - 2A; -5v - 1/2A;
-12v - 1/2A.....\$120.00

PROJECT BOARD

Have you ever tried to get an economical protoboard and had a shock? Well look at this, a good quality protoboard at a 30-40% saving. The KH-408 has 1560 holes on a std 0.1" grid for IC's and a sturdy plastic base with two binding posts for power, an excellent buy for the student.

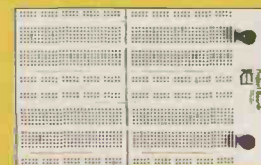

- KH-408 (as pictured).....\$38.00
KH-204 1/2 the size of KH-408.....\$20.00

PARTS ELECTRONIC COMPUTER GALORE

316 COLLEGE ST., TORONTO. M5T 1S3 (416) 925-8291

Min Order \$15.00 Visa, MC, American Express,
All Ont. Residents add 7% Sales Tax. Add 5% delivery charge; we ship Canpar or Canada Post, or Purolator

OSCILLOSCOPES!

The Best Buys Available

watch for our "NEW" 100 MHz feature packed Scope ... SOON!

Model 65310

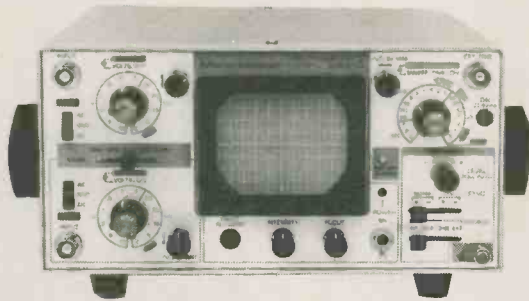

Dual Trace Portable Scope

- 15 MHz (-3dB) Bandwidth
- X5 Sweep Magnifier
- Battery, 12 VDC & AC Operation
- 2 mV Vertical Sensitivity
- Trace Rotator

\$795.00

Probes and F.S.T. included

Model 65601

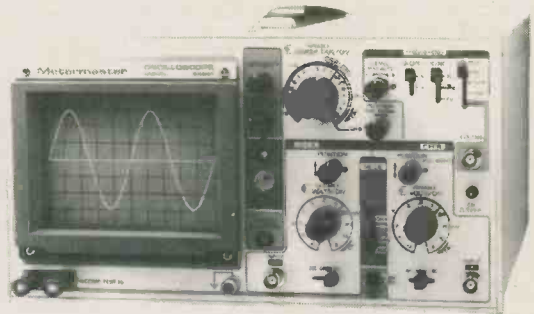

Dual Trace Bench/ Portable Scope

- 20 MHz (-3dB) Bandwidth
- 6" CRT Display
- Fully Automatic Triggering
- 'The Component Tester'
- Trace Rotator
- 2 mV Vertical Sensitivity
- HF Rejection

\$795.00

Probes and F.S.T. included

Model 65625

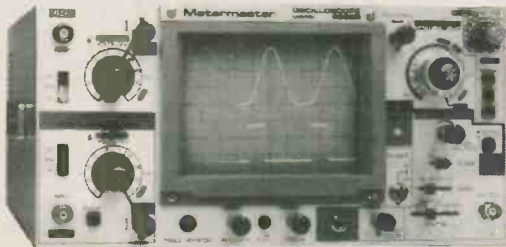

Dual Trace Bench/ Portable Scope

- 45 MHz (-3dB) Bandwidth
- Delayed Sweep (selectable)
- Single Sweep (selectable)
- Extremely Bright 5" CRT
- Illuminated Internal Graticule
- Optimal Sensitivity of 1 mV
- X-Y or X-Y-Z Operation
- 120 VAC Line Operation

\$1385.00

Probes and F.S.T. included

Model 65635

NEW!

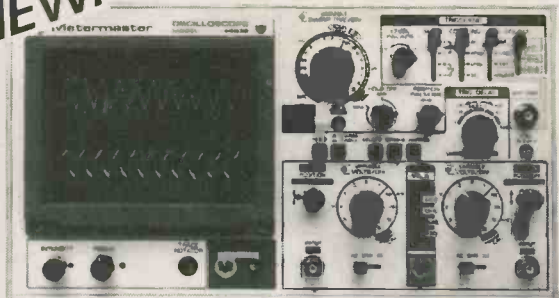

Dual Trace Bench/ Portable Scope

- 35 MHz (-3dB) Bandwidth
- Delayed Sweep (selectable)
- Single Sweep (selectable)
- 6" CRT Display
- Optimal Sensitivity of 1 mV
- X-Y or X-Y-Z Operation
- 120 VAC Line Operation
- X5 Sweep Magnifier

\$995.00

Probes and F.S.T. included

Metermaster

R. H. NICHOLS



5% Discount for Cash,
Certified Check, or Money Order

All prices F.O.B.
Downsview, Ontario
subject to change with-
out notice. P.S.T. extra
where applicable.

Head Office: 214 Dolomite Drive, Downsview, Ontario M3J 2P8

Circle no. 11 on Reader Service Card.

TORONTO (416) 661-3190 MONTREAL (514) 337-0425 EDMONTON (403) 432-7746 OTTAWA (613) 238-7007

AP II 6502 PROJECT

- * ABS LOOK-A-LIKE CASE \$139.95
- * GOLD SWITCHING POWER SUPPLY \$115.00
(+5V - 5 AMPS, +12V - 2.5 AMPS, -5V - 1/2 AMP,
-12V - 1/2 AMP.)
- * BEAUTIFUL MATCHING
ASCII KEYBOARD \$129.95
- * 6502 PROJECT BOARD \$49.95
- * DISC DRIVE LOOK-A-LIKE
WITH INTERFACE CARD \$499.00

- * ALL SMALL PARTS, IC's Capacitors, Crystal, Trim
Caps, Resistors, Sockets, Choke, etc. . . . **LOW PRICES**
- * IN CASE YOUR PROJECT HAS PROBLEMS
WE HAVE A REPAIR SERVICE . . . **LOW PRICES**
- * PERIPHERAL BOARD KITS
Z80, Floppy Disc, 80 character,
16K expansion and more coming **LOW PRICES**

SPECIAL PACKAGE OFFER: Includes Keyboard, Power Supply, Case and Motherboard **\$375.00**



general electronics

5511 YONGE ST., WILLOWDALE, ONT., M2N 5S3 221-6174

SABTRONICS • HAMEG SCOPES • PARTS, KITS • SURPLUS



Torch Review

Continued from page 72

wicked thick steel that positively sneers at injection moulded plastic. This does not lend itself to particularly attractive styling, but, then, two months after you buy a system it's usually covered with vinyl stickies and graffiti anyway. The colour monitor on ours needed a good degaussing, but was otherwise a top rank deal.

An interesting facet of the colour monitor is that it uses the British 625 line standard, opposed to the 525 lines found here. This allows it to display 32 lines of characters as opposed to twenty four or twenty five, as is usually the limit for standard monitors over here . . . and, of course, correspondingly denser graphics. However, it also means that the RGB outputs provided on the Torch will only drive a British RGB monitor.

The keyboard of the system is a detached serial arrangement, with acres of special purpose keys, including ten that can be programmed by the user. There are about a half a dozen deletes alone. This actually takes a bit of getting used to. The

general arrangement of the keyboard is quite comfortable. The numeric keypad is close to hand and all the particularly mutated control keys are grouped together in a pad.

Conclusions

The system, while moderately weird in some of the implementations of its version of CP/M, seemed to be happy running CP/M based software, so the enhancements are effectively user transparent. If you don't want to use the fancy bits they can be ignored and they won't bother you. I'm inclined to feel that some of the bells and whistles, like the built in HELP menu, will become virtually useless as soon as one gets to know the machine, but, at this point, they can just be forgotten about.

Our machine did lack most of the CP/M utilities. There was no assembler, debugger, DUMP, LOAD or disk fidgeter. There also wasn't a STAT program or indexed directory, both of which were missed. The availability of these programs . . . they're usually standard with CP/M

packages, but this one is a bit unusual . . . should be checked by both of which were missed. The availability of these programs . . . they're usually standard with CP/M anyone planning to write any ASM code. The availability of an assembler is also frequently assumed by other dedicated software packages, and things like BDS C will require one somewhere along the line.

All told, the Torch was a very powerful and well thought out machine with features that will serve a number of complex dedicated applications and enough raw boring hardware power to make it suitable for heavy duty business applications. It appears to be rugged enough to take a lot of extensive use . . . we left ours on for several days straight with nary a hiccup. It would be especially good for applications wherein a computer is called on to handle a number of diverse jobs.

And lookit this, Billy . . . it keeps the papers from blowing away as well as the PDP 11 without crushing the desk!

ETI

Audio Analyser

Continued from page 55

LED is only on for one-tenth of the total time, it requires ten times the current to give the same apparent brightness. The maximum current capability of the LM3915 is only 30 mA, so high efficiency LEDs must be used. The 4017 is even worse at supplying current, hence the use of the drive transistors.

The clock generator for IC12 is a standard configuration built round IC7a,b.

White noise is an audio signal which contains all frequencies and has equal energy per unit bandwidth. However, what we require here is

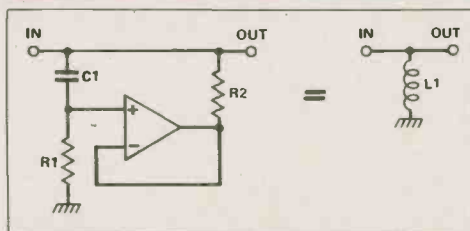

Fig. 3 A gyrator circuit 'looks like' an inductor.

equal energy per percentage bandwidth i.e. equal energy per octave). This is known as pink noise and it is obtained by passing white noise through a filter (IC1b) with a slope of 3

dB/octave. The white noise is generated digitally rather than by a Zener noise diode, which can be temperamental. IC14 is an 18-stage shift register clocked by the 30 kHz oscillator IC13a,d. Two EX-OR gates and an inverter (IC13c,d and Q11) are used to feed various outputs of IC14 back to the input (pin 6) so that a complex sequence of 1s and 0s flows through the register, repeating once every few seconds. This produces an apparently random jumble of fundamental frequencies with a vast number of harmonics, i.e. noise.

To be continued next month.

ETI

TECH TIPS

PROM Blowing by Computer L.N. Owen

Much attention has been given to EPROMs and EPROM programmers but little regard has been paid to their poor relation - the fusible-link PROM. These devices can often provide short cuts in circuit-building by replacing complete logic gate networks and thus reducing board area and power consumption. The fusible-link PROM is probably the nearest thing the hobbyist can obtain to his own design of integrated circuit.

Any type of computer can be used as long as the timing sequence is complied with — the prototype used a ZX81 and as SGS/ATES CLZ80. Only 1K of memory is required. Several types of PROM are available; this design caters for the following:
 SN74S188, SN74S288 (32 x 8 bit)
 SN74S287, SN74S387 (256 x 4 bit)
 SN74S470, SN74S471 (256 x 8 bit)
 SN74S472, SN74S473 (512 x 8 bit)

The circuit diagram is given in Fig. 1. This simple arrangement requires only one logic chip and two transistor arrays. Signals A12-A14 are decoded and inverted by the 74LS10 and thus provide the starting address of 26624 for the programming routine. The other gate is arranged as an inverter so as to produce MREQ at the base of Q1. To blow a PROM simply POKE the address (plus 26624) with the required data; to read it, have a PEEK (with +12V disconnected).

The whole process is a memory write cycle with a modified MREQ signal; the timing diagram is given in Fig. 2. The sequence is thus: the address is placed onto the address bus, then the MREQ line is taken low and inverted by the NAND gate, causing the transistors Q1 and Q2 to supply about 10V5 to the programming pin (usually V_{CC}). The data bus is then loaded, after which the WR line is activated, thus blowing the PROM at the stated address with the stated data. The transistor arrays invert the data inputs, thus providing sinks for the programming pulse — they also act as protection devices for the computer. When the PROM is in the READ mode the 12 V supply is switched to 5V.

NOTE:
 IC1 IS 74LS10
 Q1 IS 2N3905
 Q2 IS 2N3965
 Q3—10 ARE CA3046 TRANSISTOR ARRAY (TWO OFF)
 D1—3 ARE 1N4001

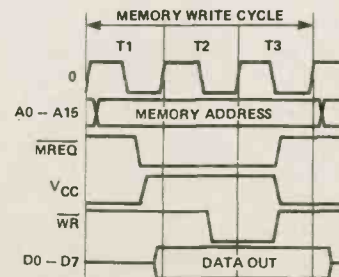
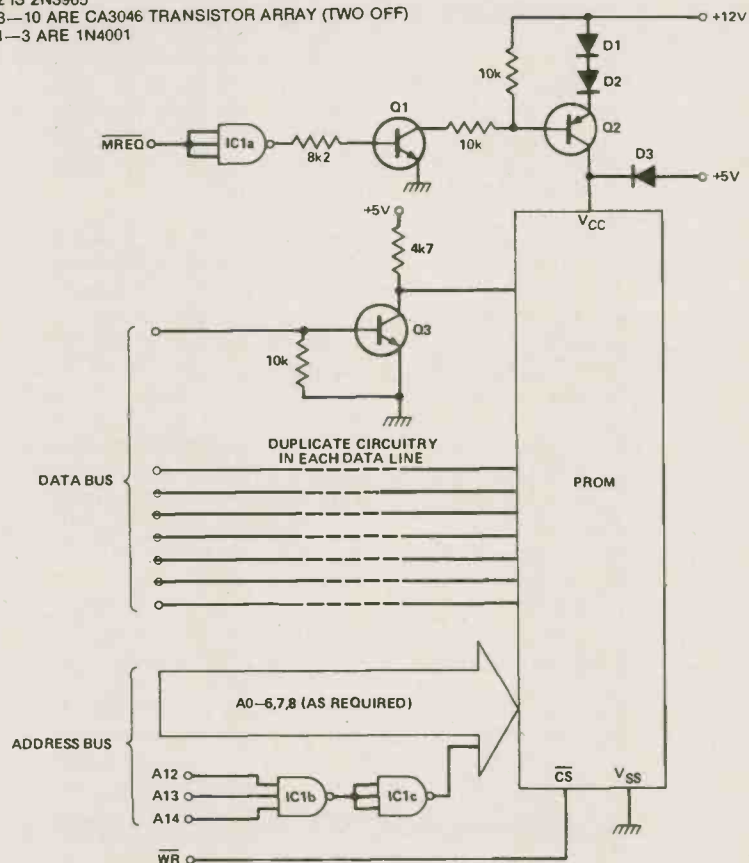

Construction is very straightforward. If you intend blowing a lot of PROMs regularly then it may well be advisable to invest in zero insertion force sockets. One word of warning — a blown PROM is a dedicated animal and there is no question of 'unblowing' or perhaps 'sucking' it.

BARGAINS ON INVENTORY CLEARANCE

Philips UHF Varactor Tuner: Cat.# ELC 1045/A3, Channel 14-83, 75 ohm input & output, 15v operation, tuning voltage 1.2-14.7v Ch3 out, same tuner as advertised in Nov/82 Radio Electronics. 3.7" x 2.2" x 1.1" Specification & schematic included

ELC 1045/A3, New\$20.00
End of production take-outs same as above, fully tested channel 2 out\$10.00

Wall Transformer: 120v AC, 22v AC/300mA, output CSA approved, 6 ft. cable 2.1" x 2.0" x 2.7" WT - 31850\$4.50

Coll: Adjustable, P.C. mtg, shielded metal can, size: 0.4" x 0.4" -0.45", TOKO RCL
KXN -K4779HM - 1 uH\$1.00
KAN -K4778HM - 15 uH\$1.00

Essential SUBSCRIPTION TELEVISION decoder information pkg. Theory & Circuits S.W., P.W.D., M.D.S. 45 pages.
ST-1\$9.50

DM 74L123N, I.C.\$0.95 • BC 547 G.P. NPN Transistor0.29 • IC Sockets 14P, 16P Low Profile0.40 • Trim Pots Philips 461 Series 5K, 50K, 500K ...0.25 • 410 Series 1K0.30 • Piher PT10V Series 1K, 5K, 500K0.33

Capacitors
Axial (47pf, 200, 270, 390pf) 63V, 390pf 500V Polystyrene. 0.18 • Electrolytic 15 uf 20V S. Tantalum1.25 • 68uf 63V, 150 uf 16V0.22 • 470uf 25V0.48 • 1000uf 35V0.85

Radials
.1uf 250V, .01uf 100V, (.1uf 200V) Film0.40 • .022uf 400V, .47 uf 250V P.V.C.0.40 • Electrolytic 4.7uf 25V0.06 • 330uf 25V, 100uf 35V0.20

Disc Ceramic (100V)
68pf0.11 • 120pf0.28 • .0010.11 • .002uf0.40 • .047uf, .1uf 25V0.60

Grommet 1/4" O.D.0.03

Columbia # C-1359-18-62 Microphone shielded 25 AWG0.10/ft • Columbia # 070503 Hook-up AWG 240.03/ft

Order by Postal Money Order or by COD. COD is accepted when accompanied by 20% (non-refundable) deposit. Shipments are insured. Cost of insurance and shipping is added to order. Add 10% for postage, insurance and handling on orders under \$25.00. Orders over \$25.00 add 5%. Minimum Order \$20.00. Ontario Residents add 7% P.S.T. Write for quantity discounts.

Encom Inc., 3044 Rushton Dr., Windsor, Ontario, N8R 1M4



AS ADVERTISED AT THE TORONTO COMPUTER SHOW

\$149.00

The Grenadier manual mini modem . . . MM102



Modem Phone Features:

- * FCC Approved
- * CSA Approved AC Adaptor
- * Asynchronous interface compatible with RS-232C
- * 300 bps full duplex
- * Bell 103 Compatible
- * Direct Connection between Microcomputer and Telephone
- * Easy Manual Originate and Answer Mode
- * Power On Indicator
- * Carrier Detector Indicator
- * Low Cost Compact Construction
- * Complete Instructions in Owners Manual

Ontario Residents add 7% PST. Please add \$5.00 Shipping and Handling. Send only certified cheque or money order, COD accepted. VISAMC accepted - Send card No., Expiry Date & Signature to:

DEALER ENQUIRES INVITED

TRIGILD
COMMUNICATIONS

1631 The Queensway #6
Toronto, Ont. M8Z 5Y4
(416) 259-7801
Telex: 06-989235

Circle No. 20 on Reader Service Card.

AUDIOVISION

EASTERN CANADA:
578 MARLEE AVE.,
TORONTO, ONT. M6B 3J5
TEL: (416) 781-3263

WESTERN CANADA:
P.O. BOX AMF23581,
VANCOUVER, B.C.
TEL: (604) 271-7539

MAIL ORDER: SEND A CERTIFIED CHEQUE OR MONEY ORDER PLUS \$5.00 FOR SHIPPING & HANDLING. ONTARIO RESIDENTS ADD 7% SALES TAX. PERSONAL CHEQUE, VISA AND MASTER CARDS ONLY ACCEPTED ON ORDERS SENT TO OUR TORONTO STORE.

6502 COMPUTER

PARTS, KITS AND ACCESSORIES. ONE STOP SOURCE.

6502 MOTHER BOARD (BARE)



- HIGH QUALITY MADE
- PRINTED PARTS LOCATION
- ON-BOARD PROTOTYPE
- COLOUR & CRYSTAL TRIM V.C
- ONE OF THE BEST BOARDS IN THE MARKET

\$55.00

SWITCHING POWER SUPPLY



CAPABLE TO RUN TWO DISK DRIVES AND SEVERAL PERIPHERALS.

+5V 3A, +12V 2A
-5V 1/2A, -12V 1/2A

\$98.50

KEYBOARD



- HIGH QUALITY MADE
- BROWN COLOR KEYS.
- UPPER & LOWER CASE
- SUITABLE FOR OUR ABS OR ALUMINUM CASE

\$140.00

LOW COST LINEAR POWER SUPPLY



-5V 1/2A, 5V 6A
-12V 1/2A, 12V 1.5A
(Up to 2.5A)

KIT \$29.50

POWER TRANSFORMER \$15.00

ABS CASE

\$95.00



ALUMINUM CASE

\$69.00



SHUGART DISK DRIVE



COMPLETE & READY TO PLUG INTO CONTROLLER CARD AND USE WITH YOUR COMPUTER.

DISK DRIVE \$399.00 WITH CONTROLLER \$485.00

12" ZENITH MONITOR



- GREEN PHOSPHOROUS SCREEN
- COMPLETE w/HOUSING & POWER SUPPLY
- READY TO USE WITH YOUR COMPUTER.
- SELECTABLE SWITCH FOR 40 OR 80 CHARACTERS.

\$159.00

JOY STICK

\$30.00



COMPLETE WITH CASE, 2 PRESS SWITCHES AND CONNECTION CABLE

MODULATOR

(CALL FOR INFORMATION)

PERIPHERAL BOARDS & KITS

(CALL FOR INFORMATION)

REPAIR SERVICE

WE REPAIR 6502 COMPUTER BOARDS AT REASONABLE CHARGES.

RACK MOUNT CABINETS



Panel size (inch)	Box size (inch)	Price
19 x 7	17 x 6.5 x 20	74.50
19 x 6	17 x 5.5 x 14	50.50
19 x 7	17 x 6.5 x 12	48.50
19 x 6	17 x 5.5 x 12	47.50
19 x 5	17 x 4.5 x 12	43.50
19 x 4	17 x 3.5 x 12	42.50
19 x 3	17 x 2.5 x 10	37.50
19 x 2.5	17 x 2 x 10	36.50
17 x 6	15.5 x 5.5 x 9	41.50
17 x 4	15.5 x 3.5 x 9	36.50
17 x 2	15.5 x 1.5 x 9	33.50
12 x 6	11.5 x 5.5 x 7	29.50
12 x 4	11.5 x 3.5 x 7	25.50
12 x 2	11.5 x 1.75 x 7	23.50

FOR OUR AUDIO/ELECTRONIC KITS PRICE LIST, PLEASE SEND SELF ADDRESS-ED & STAMPED ENVELOPE.

	PRICE	QTY	AMOUNT
1. 6502 MOTHER BOARD	55.00		
2. PACKAGE 101 = ALL IC'S, RAMs, 6502 AND BLANK 2716's	120.00		
3. PACKAGE 102 = ALL RESISTORS, CAPACITORS, DIODES, TRs, CRYSTAL, COIL AND JACKS	26.00		
4. PACKAGE 103 = ALL IC SOCKETS AND 50-PIN EDGE CONNECTORS	45.00		
5. PACKAGE 104 = SPEAKER, KEYBOARD CABLE W/HEADER, STAND OFF AND POWER SOCKET	7.50		
6. SWITCHING POWER SUPPLY	98.50		
7. KEYBOARD	140.00		
8. ABS CASE	95.00		
SHIPPING & HANDLING WHEN ORDERING ALL ITEMS (1-8), TOTAL	5.00		5.00
ONTARIO RESIDENTS ADD 7% P.S.T.			
GRAND TOTAL			

Tech-Tips

Continued from page 80

Cheap Auto-Wa Tony Allgood

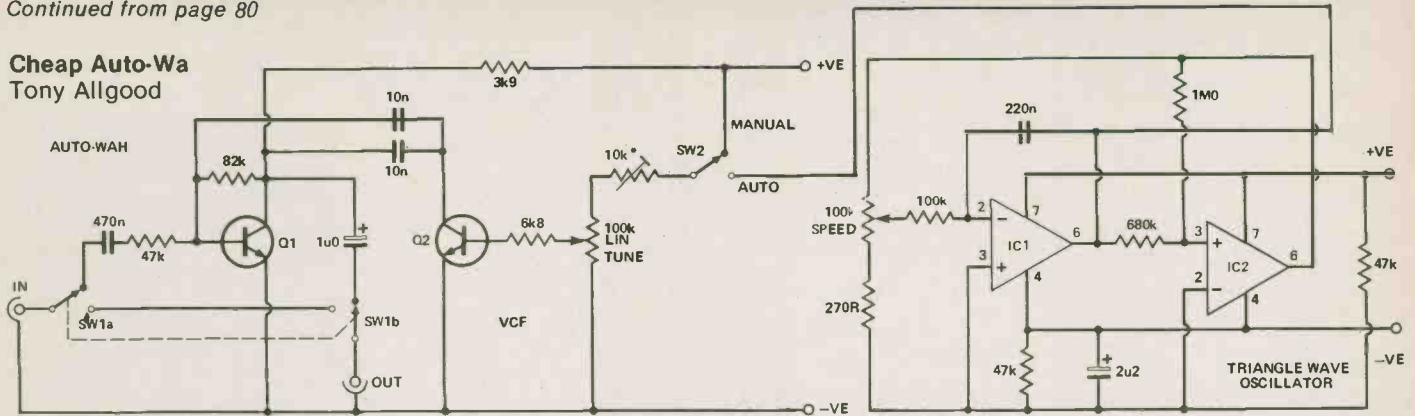

Although this unit is not capable of fulfilling the specifications of an expensive auto-wah, it has an advantage of being cheap and relatively simple.

Q2 is used as a voltage controlled resistor connected to a simple filter network based around Q1. The controlling voltage is applied to the base of Q2 and can be varied manually or automatically through the use of a triangle wave generator consisting of a standard integrator and comparator oscillator. The frequency of the sweeps is determined by the 'speed' potentiometer and can be altered from 0.5 Hz to about 10 Hz.

A 9V supply was used so the unit can be fully portable if a 9V battery is used.

Continued on page 84

Call The ETI Bull BBS

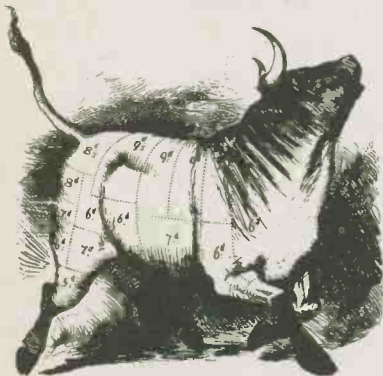

The ETI Bull can be accessed by any 300 baud terminal, and offers a growing variety of files of information, news, ETI related news and, of course, lies and falsehoods to keep you up to date in the world of creative untruths. The Bull is active from 6:00 pm to 8:00 am on weekdays and all day on weekends and holidays on (416) 423-3265.

T100 TOSHIBA

EVERYTHING YOU WILL EVER NEED FROM \$1,295.00

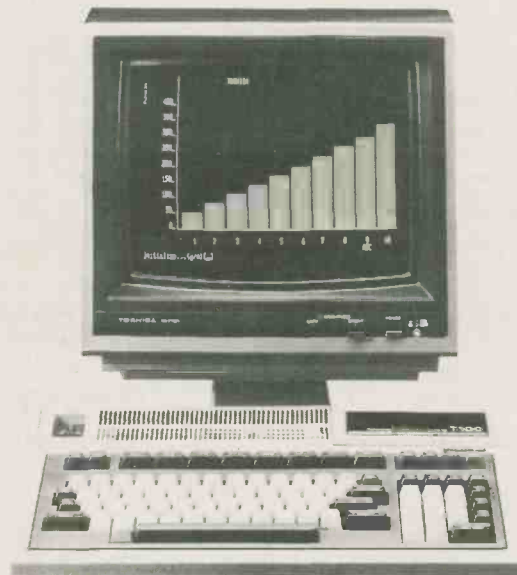

Hardware Specifications:

CPU:	Z-80A (4MHz)	Color display:	8 colors (black, blue, red, purple, green, light blue, yellow, white)
Memory ROM:	32 KB MASK ROM	Graphic displays:	640 × 200 dots (Fine graphic mode) 160 × 100 dots (Graphic mode)
RAM	64 KB (standard equipment)	Dimensions (W × H × D):	16.5" × 3.9" × 10" (420 × 99.5 × 253mm)
ROM pack	8KB - 32 KB (optional)	Environmental conditions:	Operating temperature 32°F - 95°F (0°C - 35°C) Operating humidity 20% - 80%
RAM pack	4KB - 32 KB (optional)		
Video RAM	16KB		
Keyboard:	Number of keys: 90		
Screen configuration:	80 characters horizontal × 25 lines or 20 lines vertical		
Letter configuration:	8 × 8 dots		

Design and specifications are subject to change without notice.

NOW AT AN UNBEATABLE PRICE

Call or write for a colourful brochure. Mail orders accepted. Ontario residents add 7% P.S.T. Price quoted is F.O.B. Toronto.



COMPUTER GROUP LTD.

4521 Chesswood Drive
North York, Ontario
M3J 2V6
(416) 636-7715

DEALER INQUIRIES INVITED

COMBI TEC

Microelectronics Ltd.
105-1007 Merivale Rd.,
Ottawa, Ontario K1Z 6A6
Tel (613) 722-0301

Benji III 300 baud smart modem

- * Stores 18 numbers, 14 digits long
 - * Internal micro processor
 - * Auto answer, auto dial, menu driven
- Special introductory offer **\$350.**

PDA232C CARD (Apple II serial I/O card) ONLY \$140.

- * Three versatile operating modes I/O, terminal, remote console
- * 8 user-selectable baud rates, provision for user-defined baud rates
- * Adheres to RS-232C standard for easy interface to printers, terminals and modems.

The Quentin floppy disc drive

With controller and DOS. **\$520.**
without controller **\$390.**

Quick, quiet, dependable

Turbocharge

Your APPLE* or IBM PC* with the COMBIBOX SERIES C500 WINCHESTER DISK DRIVE

- * Transfers data at a rate of .768 MS improving performance by a factor of 8.
- * Plug the interface card into any slot and the disk system "remembers" its position. allows concurrent use of floppy disk system
- * Draws on its own power supply Auto error correction-contains an internal 32 BIT ECC for burst error correction on all data field errors. In addition, the system automatically checks track integrity and bad tracks will be mapped out and replaced.
- * Users may mix DOS, PASCAL, and CP/M volumes on the same hard disk.
- * Standard DOS software utilities are usable without modification.

Introductory prices

10 MB	2950.
15 MB	3200.
20 MB	3450.

Terms and information

User hotline (613) 722-7308

- All products carry a 90 day parts and labour warranty
- Central repair depot, Ottawa
- TO ORDER! Cheque, money order, visa or Mastercard must accompany order
- All prices FST-extra. F.O.B. Ottawa ALLOW 4 WEEKS FOR DELIVERY

IBM cards expandable to 256K

64K __ \$450. ● 128K __ \$630.
192K __ \$810. ● 256K __ \$990.

Features six separate functions

- * Expansion memory (as above)
 - * With parity generation and checking
 - * Two asynchronous serial channels
 - * A real time clock
 - * A disk emulator
 - * A print spooler
- Together with it's high quality, a price-performance ratio that is tough to beat!

Apple, IBM or S-100 prototyping card

Plated through holes adds on both sides.
G-10 fiberglass
Apple — \$21.00 ● IBM — \$29.00
● S-100 — \$23.00

Circle No. 14 on Reader Service Card.

SATELLITE TV

COMPLETE SATELLITE SYSTEM

\$2,995

MINI-SAT II

- 24 CHANNEL RECEIVER
- 2 METER DISH
- 120° LNA
- TRUE POLAR MOUNT
- RF MODULATOR
- 100 FEET OF CABLES

Computer Printout — for your location for all Satellites **\$19.95**

BRANCH OFFICES: Montreal, Toronto, Winnipeg, Edmonton, Seattle

SOME DEALER AREAS STILL AVAILABLE

604 324 3303 **Nu. West Video Systems Ltd.**

6590 VICTORIA DRIVE, VANCOUVER B.C. V5P 3X9

SATELLITE HANDBOOK
— \$5.00

Circle No. 18 on Reader Service Card.

New ETI Loose Leaf Binder Punch

We here at ETI realize that money is scarce, and that there are plenty of our readers who would rather not spring for binders to preserve their copies of this precious publication. Well, that's cool, and there is always the time worn solution of digging out those filthy loose leaf binders you used in high school, the ones with the smeared anatomical renderings etched into the vinyl in greasy ball point pen, and giving over to their tender embraces your clean, shiny issues of Electronics Today. The only hassle is getting the holes punched.

Well, that need not be a problem any more, not if you use the ETI loose leaf magazine punch illustrated above. Complete with enough supplies to punch two issues, the ETI punch is guaranteed to get through even the real fat issues with the catalogs in the middle. Try that with a regular hand punch!

In addition, the ETI punch can serve as a handy vermin killing device, fly swatter, attention getter at parties, robbery implement or murder weapon. What could be more useful?

The ETI magazine punch is available to all ETI readers for the amazing low price of just \$9.45. All orders must be postmarked before July 1, 1981. Supplies are limited, so order now. (Note: if you'd prefer to use our regular ETI binders, they will, of course, still be available for \$8.00 each. . . . postmarked anytime.)

ETI Binder Punch/Funny Old Gun
25 Overlea Boulevard, Unit 6
Toronto, Ontario
M4H 1B1

Tech-Tips

Switched Guitar Volume

R.D. Pearson

It is often useful for guitarists, especially on stage, to be able to change the volume of their instrument while playing, without having to bother about twiddling volume controls. This circuit makes this possible by switching between two preset levels set by RV1 and RV2. In addition, the output level can be made to fade up or down between the two preset levels at a preset rate set by RV3. Fading is done smoothly and without any crackles and clicks since there are no mechanical controls (ie switches and pots) in the signal path. All the guitarist has to do, having set the controls, is to kick the footswitch.

The input signal, having been buffered by IC1, is fed into the electronic attenuator IC3. The gain of IC3 is dependent upon the potential at pin 2. This is determined by the voltage across C7 which is buffered by the voltage follower, IC2. The voltage across C7 is set by the potential at the wipers of RV1 or RV2, depending on the setting of the footswitch. The rate at which the voltage across C7 changes, and hence the fading speed, is set by RV3.

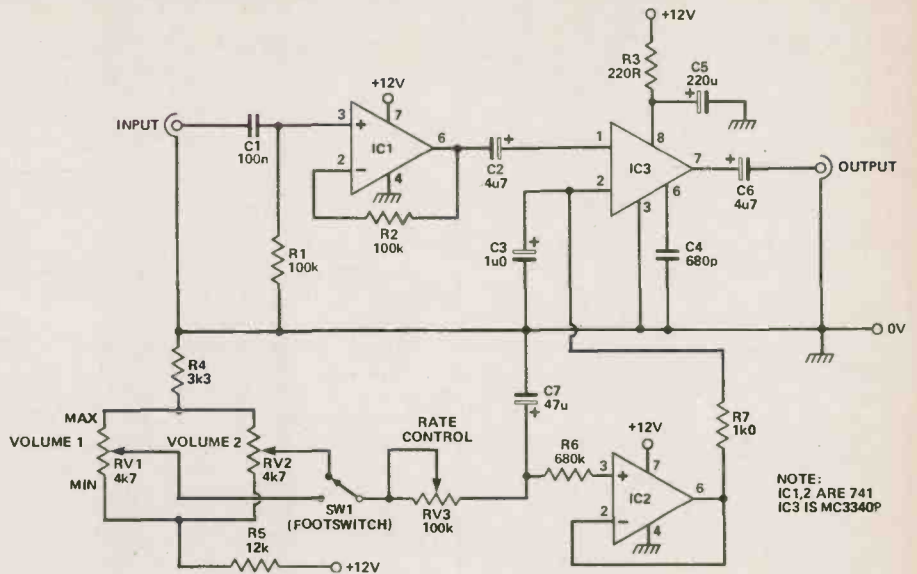

NOTE:
IC1,2 ARE 741
IC3 IS MC3340P

A $\pm 12V$ power supply is required. This should be well regulated and free of ripple if a line supply is used. The circuit is best built in a metal case as these are strong and reduce hum and RF pickup.

Continued on page 86



**A COMPLETE Z-80 BASED
MICROCOMPUTER KIT:
ONLY \$169.00**

IT INCLUDES: ● 2 parallel I/O ports ● 1K byte RAM, socket for a second K ● 1K powerful monitor ● Another Kbyte EPROM available to the user ● S-100 bus ● Wire wrap area ● Hex keyboard ● Hex digit display ● Voltage regulator ● Audio cassette interface. A detailed assembly and test manual (English or French) is also included.

Now ask for our new PRO-VIDEO expansion card that includes ● Video controller for standard colour and B/W TV ● 1K, 2K, and 4K EPROM programmer ● 8K byte editor assembler, and up to 22K byte static RAM. Prepaid orders can be mailed to:

PROTEC 725 Decarie Blvd., Suite 202
St-Laurent, Montreal, Quebec.
H4L 3L4 (514) 744-3363.

Or to our authorized distributor:
General Electronics, 5511 Yonge St., Willowdale, Ont, (416) 221-6174

Cheque, money order, visa accepted, Please print your name, visa number, expiration date and signature.



Circle No. 17 on Reader Service Card.

**Quality Boards & Kits
All Apple™ Compatible**

	PCB	Kit	A & T
Disk Controller Card	18.00	N/A	125.00
80 Column Card	18.00	134.00	N/A
Printer Card	18.00	71.00	125.00
EPROM Programmer Card	18.00	125.00	152.00
(This Card can program 25/2708, 25/2716, 25/2732, 25/2764)			
RAM Card	18.00	62.00	75.00
ROM Card	18.00	89.00	125.00
Z-80 Card	18.00	80.00	125.00
AP-2 Board (6502J)	55.00	359.00	449.00
(All Kits sold with parts list & layout)			
ASCII Keyboard			125.00
Switching Power Supply (Powerful replacement)			
5V(6A), 12V(3A), -5V(1/2A), -12V(1/2A)			125.00
5V(3A), 12V(2A), -5V(1/2A), -12V(1/2A)			99.00
Fiber Case			134.00
Metal Case			79.00
TV/Game Switch Box			2.50
UHF Modulator (Interface circuit required)			13.50
3" Speaker (With mating connector)			2.50

Terms: Send Check or Money order (Allow 2 weeks for personal check), No COD., Quebec Res. add 9% sales tax. Min. order 10.00. Do not send cash.

Freight: 10-49 \$2.00	250-499 \$ 9.00
50-99 \$4.00	500-999 \$11.00
100-249 \$8.00	1000-up Call

We service and troubleshoot 6502 boards as well as other peripherals. Please contact us for further information.

DULEX électronique inc.
electronic inc.

13092 RUE MONK ST., PIERREFONDS, QUÉ., CANADA
H8Z 1V2 TEL.: 514-620-0079

Circle No. 1 on Reader Service Card.

thandar measures up to your expectations

Performance, Reliability & Value

Counters

TF 200



- ▶ Bench/Portable
- ▶ Frequency range 10Hz — 200MHz
- ▶ Sensitivity 10mV rms
- ▶ Battery life 200 hrs. (included)
- ▶ Timebase accuracy 0.3ppm
- ▶ 8 digit Liquid Crystal Display

\$485.00

PFM 200A Led Hand-Held	\$195.00
TF 040 40MHz Freq. Meter	\$385.00
TP 600 600MHz Pre-Scaler	\$121.00
TP 1000 1GHz Pre-Scaler	\$225.00

Multimeters

TM 451

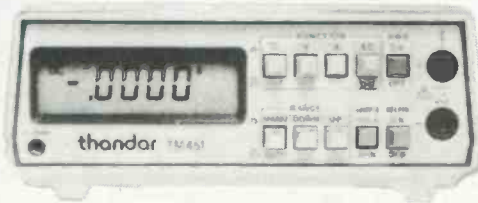

- ▶ Bench/Portable
- ▶ 4½ digit 0.4" LCD
- ▶ 0.03% basic accuracy
- ▶ Full auto-ranging or manual
- ▶ Audible continuity test
- ▶ Complete with battery and test leads

\$495.00

TM 351 LCD 3½ digit DMM	\$309.50
TM 353 LCD 3½ digit DMM	\$264.00
TM 354 LCD 3½ digit Hand-Held	\$121.00

Single Trace Bench/Portable Oscilloscope SC110 A



- ▶ 10MHz (± 3dB) Bandwidth
- ▶ Bright 2" CRT Display
- ▶ 10mV/div Vertical Sensitivity
- ▶ Economy mode
- ▶ Disposable Rechargeable Battery, 4V-10VDC & AC operation
- ▶ X-Y operation
- ▶ External triggering
- ▶ Trace Rotation
- ▶ Calibration Output

\$480.00

Generators

TG 100

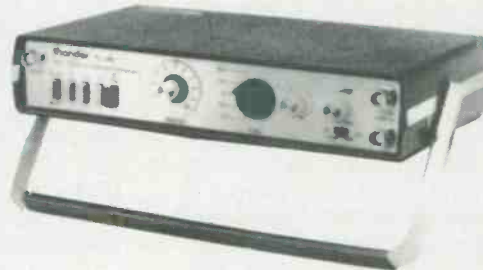

- ▶ 1Hz to 100kHz Function Generator
- ▶ Fine, square triangle waveforms
- ▶ Variable 600 output
- ▶ TTL output
- ▶ External sweep mode

\$281.00

TG 102 Function Generator	\$511.00
TG 105 Pulse Generator	\$275.00

One year guarantee
Full range of accessories available

Circle No. 22 on Reader Service Card.

Write on letterhead for FREE colour catalogue
DEALER ENQUIRIES INVITED

ALSO: LOGIC ANALYZERS, THERMOMETERS

Order direct from:

(416) 636-9404

GLADSTONE ELECTRONICS

1736 Avenue Rd., Toronto, Ont. M5M 3Y7 (416) 787-1448

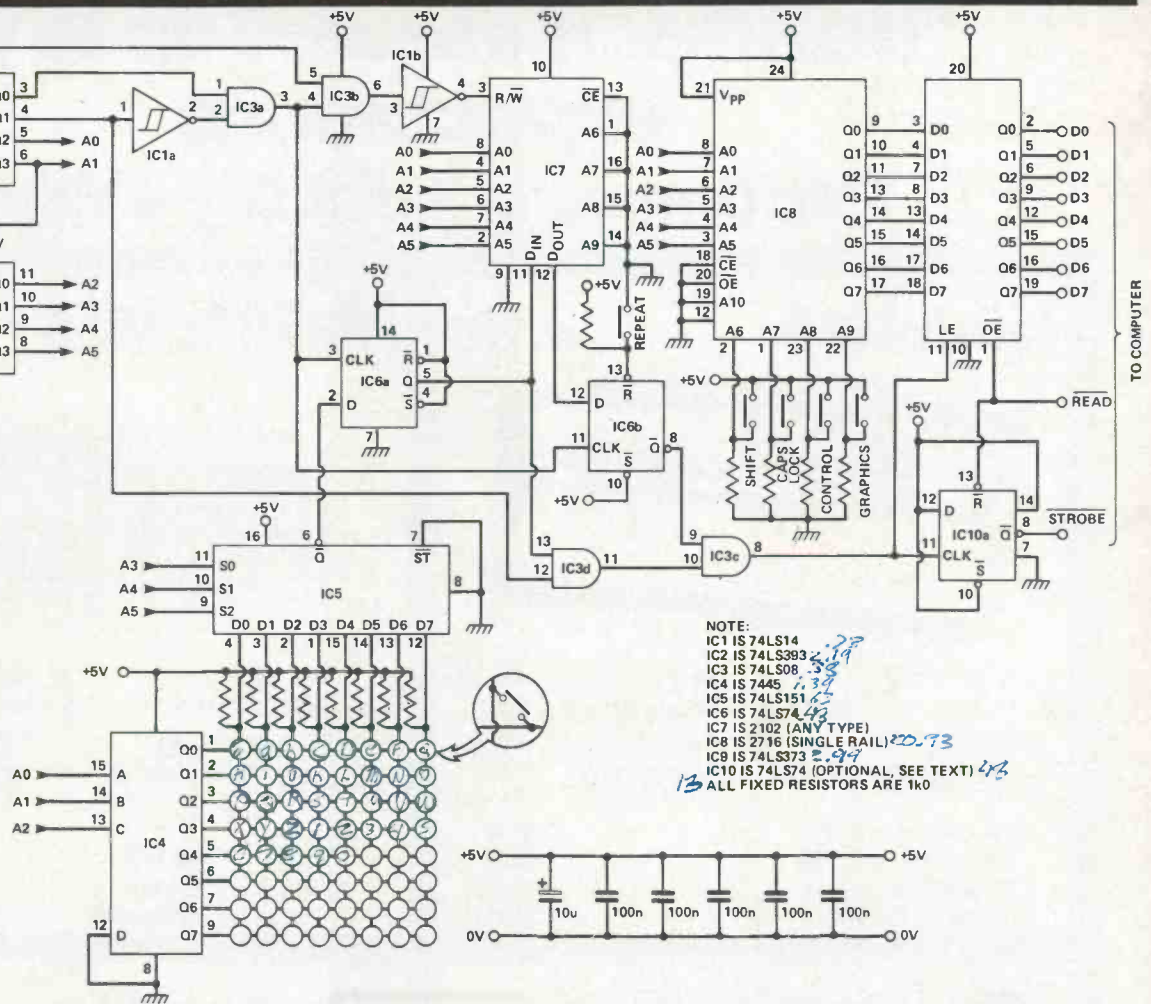

Computer Keyboard Encoder

Michael Jones

This circuit will encode a full size computer keyboard into ASCII or any other code the user requires. As it stands it handles 64 keys, plus shift, control, caps lock and graphics, although the circuit is easily expanded to cater for more. All the keys are debounced and full n-key rollover is provided. Instead of the auto-repeat found on some keyboards, this circuit provides for a separate 'repeat' key, pressed simultaneously with the required key.

Interface to the computer is via eight tri-state data lines, which may be connected directly to the computer's data bus, and two control lines. STROBE is a negative true signal output by the keyboard to inform the computer that data is available. IC10 latches it until the data is read, essential for the polling software used in most small computers; if, however, your keyboard software is interrupt-driven, IC10 is unnecessary and may be omitted, a short positive true pulse (typically 200 uS) being available on pin 8 of IC3c.

READ is a negative true signal output by the computer to activate the outputs of IC9 and clear the STROBE latch. If the data is to be continuously output to an existing buffer then pin 1 of IC9 may be tied low, but pin 13 of IC10 must still have the equivalent of the READ signal. Spare inverters from IC1 are available to invert any of these signals if required. Only a +5V supply is needed, to normal TTL specifications.

The circuit operates in four 'cycles' defined by Q1 and Q1 of IC2a; a half-cycle is also obtained from the input clock. At the start of cycle 0 the upper counter lines (labelled A0 to A5) are incremented; these are used to select a key from the multiplexed array as well as selecting a corresponding address in the RAM (IC7) and the EPROM (IC8). The RAM is used to record the status of each key, enabling rollover. The EPROM selects the code to be sent to the computer; it must therefore be programmed with the desired codes in advance. The four keys (such as 'shift') select a different block of addresses in the EPROM to give alternative codes.

At the start of cycle 1 the status of the key is latched by IC6a and the previous status, from the RAM, is latched by IC6b. During cycle 1½ the new status is written to the RAM. During cycles 2 and 3 the new and old status are compared and, if appropriate, the data from the EPROM is latched and the STROBE line activated.

The preset on the clock generator (IC1c) can be used to adjust the scan frequency which determines the maximum key bounce permissible (one scan period) and the repeat frequency.

ETI



The \$129.95 Computer!

A personal computer that grows with you.

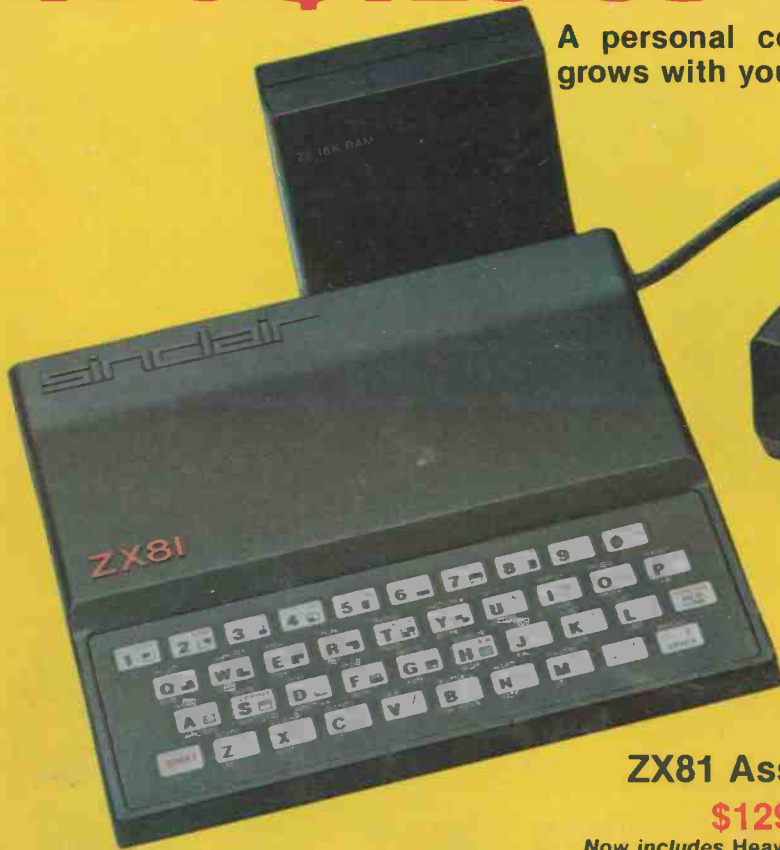

ZX81 Assembled

\$129.95

Now includes Heavy-duty AC Adaptor

Sinclair ZX81. . . .World's most popular personal computer. . . .more than 500,000 sold. . . .owned by 20% of ETI's readers!

Uses standard TV & cassette.

Your ZX81 connects directly to colour or black & white television for a 32 character x 24 line display. You can store programs on a standard cassette recorder. All the connecting cables you require for TV and cassette are provided.

Sinclair 16K RAM PACK99.95

Provides massive add-on memory in a compact plug-in module via an edge connector. Can be used for program storage or as database. Yet it costs as little as half the price of competitive memory.

Sinclair ZX Printer . . . 169.95

Designed exclusively for use with the ZX81 (and ZX80 with 8K basic ROM), the printer offers full alphanumerics and highly sophisticated graphics. COPY command prints out exactly what is on screen. At last you can have a hard copy of your program listing and results. Printing speed is 50 characters per second, with 32 characters per line and 9 lines per vertical inch. Connects to rear of ZX81 — using a stackable connector so you can use a RAM pack as well. A 65 ft paper roll, instructions included.

Lower price: higher capability.

Sinclair's new ZX81 personal computer is a tremendous advance over the highly successful ZX80. It offers far more computer capability, yet Gladstone Electronics is able to offer the ZX81 at less than half the ZX80 price!

How is it possible? Quite simply, by design. The ZX81 uses only 4 chips (as opposed to 21 in the original ZX80). The secret lies in the totally new Master chip. Designed by and custom-manufactured for Sinclair, this unique chip replaces 18 chips from the ZX80.

The ZX81's advanced capability.

The ZX81 uses the same fast microprocessor (Z80A), but incorporates a new, more powerful 8K BASIC ROM — the "trained intelligence" of the computer. This chip works in decimals, handles logs and trig, allows you to plot graphs, and builds up animated displays. And the ZX81 incorporates other operation refinements — the facility to load and save named programs on cassette, or to select a program off a cassette through the keyboard.

New, improved specification.

- * Unique 'one-touch' key word entry: the ZX81 eliminates a great deal of tiresome typing. Key words (PRINT, LIST, RUN, etc.) have their own single-key entry.
- * Unique syntax-check and report codes identify programming errors immediately.
- * Full range of mathematical and scientific functions accurate to eight decimal places.
- * Graph-drawing and animated-display facilities.
- * Multi-dimensional string and numeric arrays.
- * Up to 26 FOR/NEXT loops.
- * Randomize function.
- * Programmable in machine code.
- * Cassette LOAD and SAVE with named programs.
- * 1K-byte RAM expandable
- * Full editing facilities.
- * Able to drive the new Sinclair ZX Printer

ZX81 Professional Keyboard and Case

A full-sized, professional keyboard for the ZX81. Features 47 keys and a full-sized space bar. Connects to the ZX81 with no soldering required, via a plug-in flexible connector. You can purchase the keyboard only, or the optional metal case that holds both keyboard and ZX81. Expansion devices (i.e. RAM packs, etc) connect to the ZX81 edge-connector which extends from the rear of the cabinet.

A professional keyboard makes program entry easier and less error-prone.

Keyboard (KB-1) \$119.95
Metal case for keyboard and ZX81 (MC-1) \$29.95



32K RAM MEMOTECH

*May be used with Sinclair 16K RAM to give a total system memory of 48K RAM! Unit simply plugs into back of ZX81 and existing 16K RAM "piggy backs" on. May also be used instead of 16K. Greatly extends the capacity of the ZX81 to store masses of data and longer programmes.

Memotech Memopak 32K \$179.95

64K RAM.

The maximum the ZX81 can address. With 64K your ZX81 is transformed into an extremely powerful computer for business, leisure, and educational use, at a fraction of the cost of comparable systems.

Memotech Memopak 64K \$259.95

High Resolution Graphics. Memopak HRG \$239.95
RS232 Printer Interface. Memopak IF \$199.95

GLADSTONE ELECTRONICS

(416) 787-1448

Telephone (416) 787-1448. Use VISA, Mastercard, AMEX to order.

Circle No. 12 on Reader Service Card.

1736 Avenue Rd.,
Toronto, Ont., M5M 3Y7