

# Electronics Today

INTERNATIONAL SEPT 1980

\$1.75  
ML 70924



## TELIDON

Canada's  
Videotex System

**Build:**  
Touch Switch  
Burglar Alarm  
Speaker Protection Unit

**Also:**  
D-A Techniques  
Kirlian Photography

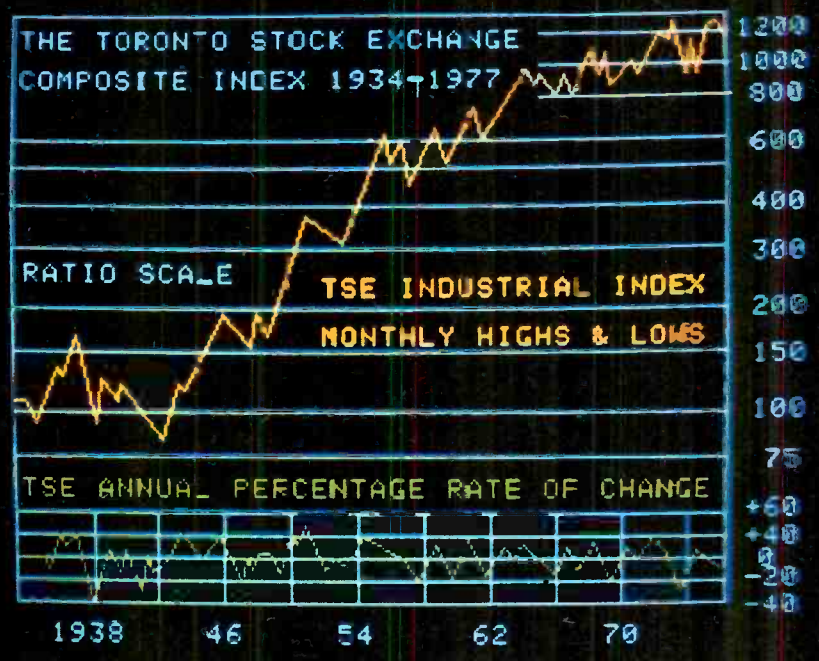

# arkon electronics ltd

# Your shopping centre for solid savings!

## CP••IO••1

An S-100 system card, wired and tested that will outperform the mass market systems in versatility, price and speed. It has all the CPU (8080) disc control (1771) and IO (8255) needed for a disc based CPM system. Interfaces, to all common 8" and 5 1/4" drives. (Shugart, Memorex, BASF, Siemens, Wang). Also features EIA RS-232 port (110 to 9600 baud), fully vectored interrupts (TMS5501), on board digital data separator, 2K bytes EPROM, 24 fully handshaked IO lines, dual mapped IO, cassette interface on board, fully buffered. \$495.00

## ASCII ENCODED KEYBOARD

RCA VP-601 keyboard with 58 key typewriter format for alphanumeric entry. Modern flexible membrane key switches offer a contact life rated at greater than 5 million operations. A finger positioning overlay combined with light positive activation key pressure gives good operator "feel" and an on-board tone generator gives aural key press feedback. The keyboard operates from a single 5 volt DC power supply and the buffered output is TTL compatible. Complete with case. \$99.00

## ASCII KEYBOARD KIT

60 key complete ASCII character set. Highest commercial quality key switches. Uses a KR 2376 ST encoder IC. Output compatible with TTL. Caps lock for upper case alpha characters. Repeat key. Parity and/or data invertible. Positive and negative keypressed and strobe signals. Requires +5V to +30V at 100mA. Complete kit all parts. \$99.95  
Power supply kit (+5V). \$7.95

## REG416 VIDEO TERMINAL

The REG416 video terminal card with excellent technological refinements! It's completely crystal controlled and displays 5x7 dot matrix characters in a format of 16 lines with 64 characters per line. Easily interfaces to most computers via serial data lines at speeds ranging from 110 to 9600 baud employing either RS232, 20mA current loop or TTL level interfaces. Also accepts parallel keyboard input with positive or negative-going key-pressed strobe. Composite video output is standard 1V peak to peak. Horizontal and vertical sync pulses also available separately. Requires +5V at 1A, ±12V at .1A (for 20mA loop or RS232).

Kit of all parts. \$169.95  
Board and manual. \$89.95  
Lower case option. \$16.95  
5V power supply option. \$16.95

## S-100 MOTHER BOARD

Exclusively ARKON's...the A6S100 6 slot mother board, designed for the system builder using modern boards where few slots are required. Provision for semi-active termination.

A6S100 \$24.95  
S-100 edge connector. \$5. ea/6 for \$25.

Fun, games, tests, helpers and more with a galaxy of ETI projects!

## JANA KITS

Auto headlight reminder \$3.95  
12 volt high power flasher \$7.30  
0-20 volt 1 ampere power supply \$25.65  
Single channel colour organ, 300W \$6.65  
Electronic siren \$4.95  
Shimmer light kit \$7.65  
Xenon strobe kit \$15.80  
3 chnl. colour organ, 300W PCB incl. \$18.95  
30 watt soldering iron kit \$8.25  
PCB's available at extra cost.

Finest quality for you from "Hammond"...transformers, power supplies, power bars, cabinets

Build creatively with "Vector" Boards and Accessories!

A rainbow of capacitors...All types in endless supply

## MULLEN EXTENDER BOARD TB-4

The best extender board made, complete with a digital probe for in circuit checkout and tracing for S-100 bus \$69.00

## SD SYSTEMS

A fully compatible line of S-100 system cards. Full data and spurs on all kits sent free on request.  
EXPANDORAM I (without RAM) \$299  
EXPANDORAM II (without RAM) \$399  
Each 16k of RAM (300 ns) See memory specials below \$72

## S-100 BOARD KITS

SBC-100 \$415. Expando Prom \$250.  
SBC-200 \$450. VDB 8024 \$520.  
Z-80 Starter Kit \$475. Versafloppy II \$350.  
MPB-100 \$350. Versafloppy II \$490.

## DOT MATRIX PRINTER BY ANADEX

Outstanding reliability! Bi-directional Anadex DP 8000. 80 columns, 112 characters per second (84 lines per minute). 100ppm characters print head life. \$1350

*Efficient test equipment... 4 outstanding "Hitachi" scopes. Also ammeters, volt meters, multi-meters.*

## SOFTWARE

For 8080 8" disc  
•CPM 1.4 \$130.00  
•CPM 2.2 \$190.00  
•SID debugger \$95.00  
•MAC macro assembler \$115.00  
•TEX text editor \$95.00  
•DES despooler \$65.00  
•CPM manual set \$30.00  
copyright Digital Research  
•FORT/80 fortran for 8080, Z80, 8085 \$99.00  
•FORT/80 manuals \$20.00  
copyright Arkon Electronics

## C-BASIC II

For OSI C1P, on cassette  
Star fighter \$8.95  
Alien invaders \$8.95  
Seawolf \$8.95  
Tank for two \$7.95  
Bomber \$8.95  
Barrierball \$7.95  
Breakthru \$7.95  
Fighter pilot \$5.95  
Killerbot \$5.95  
Lunar Lander \$4.95  
Concentration \$4.95  
Chess for OSI \$24.95  
Time Trek \$12.95  
Backgammon \$12.95

## Data Sheets

Graphic instructions \$4.00  
RS 232 for the C1P and superboard \$3.95  
Joystick instruction and plans \$3.95  
Reverse video for the C1P \$3.95  
G. T. conversion \$1.00  
Saving data on tape \$4.00  
Utilities  
C1P cursor control \$12.95  
Renumberer \$7.95  
Autoloader \$7.95

Ask for our giant list of software available for Apple II, Pet, TRS-80, by Programma Int'l, Instant Software, Creative Computing, Hayden and Sofgate.

## TX-80 DOT MATRIX PRINTER BY EPSON

A tractor feed printer featuring 100 million character head life and printing speed of 150 characters per second using 96 ASCII characters. The plug fits any Centronics type interface making this printer compatible with all types of mini and micro computers thus giving a wide range of operations. Standard paper is available at Arkon and elsewhere. Various interfaces provided as options including EIA RS 232C. This provides outstanding equipment design! It provides the business and home computer markets with an exceptionally inexpensive, sturdily built and highly reliable dot printer.  
TX80 with parallel interface. \$995.00

Replacement ribbons \$4.00  
8210 PET cable \$40.00  
8220 TRS-80 cable expansion \$57.00  
8221 TRS-80 cable bus \$40.00  
8230 APPLE II cable \$40.00  
8110 PET 2001 interface board \$83.00  
8120 TRS-80 interface board \$70.00  
8130 APPLE II interface board \$105.00  
8140 RS232 interface board \$95.00  
8160 IEEE interface board \$150.00

## ARKON GRAB BAGS

11b Capacitors \$ .75  
11b Hardware \$ .50  
2.51bs Resistors \$1.25  
50 Assorted Switches \$5.00  
21bs Potentiometers \$1.00  
100 Grommets \$1.50  
50 Trim Pots \$5.00  
30 Tantalums \$5.00

## COMPUTER POWER SUPPLY

An astounding value. Fully regulated and crowbarred with heat sink and fan. Gives +5V at 10A plus -5V at 2A plus 12V at 5A plus -12V at 2A. Each voltage separate and floating. Very compact cubic design, standard parts 16" x 10" x 7" 110/220 VAC 60/50 Hz. \$45.00.  
Mail order add \$10.00 per unit.

## ARKON KITS

All ARKON kits are complete with PCB.  
Colour Video Modulator Kit \$24.95  
Logic Probe Kit (with case) \$29.95  
555 Code Oscillator Kit \$3.95  
RS 232 to TTL Converter Kit \$9.95  
BN-9 (LM 380) Audio Amp Kit \$5.95  
TRS-80, Apple II 16K Upgrade Kit \$89.95  
VD-1 Video Modulator Kit \$8.95  
TD-1567 Tone Decoder Kit \$6.95  
FM-Wireless Mike Kit \$3.95  
FM-2 Wireless Mike w/Preamp Kit \$5.95  
Music Light Kit \$12.95  
LED Blinky Kit \$2.95  
Mad Blaster Noise Generator Kit \$4.95  
UT-1 Universal Timer Board Kit \$3.95  
MA 1003 Car Clock Module \$19.95  
MA 1023 Car Clock Module \$19.95  
MA-1008 (State 12 or 24 Hr.) \$12.95  
12V Clock Transformer \$4.95  
LCD Alarm Clock Module \$29.95  
ETI Sound Generator Kit \$44.95

## A parade of speakers and enclosures, telephones, clock modules, L C D quartz watches.

## OHIO SCIENTIFIC

SUPERBOARD II-4K Computer on-a-board \$415.00  
CHALLENGER IP - Superboard 8K in a box & P.S. \$575.00  
SUPERBOARD 8K Memory expansion (8) chips \$60.00  
SUPERBOARD memory expansion PCB (24K), data \$50.00  
CHALLENGER 4P - 8K with sound, colour, IO \$1,045.00  
CHALLENGER 4PMF - 4P with 24K mini floppy + IO \$2,559.00

## IC SOCKET SPECIALS

	# Pins	Standard	Amp	Wire Wrap
10% off for orders of 20 pieces or more	8	\$ 15	\$ 25	\$ 6
	14	\$ 25	\$ 35	\$ 9.50
	16	\$ 25	\$ 45	\$ 11.00
	18	\$ 35	\$ 60	\$ 12.25
	20	\$ 35	\$ 75	\$ 15.00
	24	\$ 40	\$ 80	\$ 16.00
	28	\$ 45	\$ 85	\$ 17.00
	40	\$ 65	\$ 95	\$ 30.00

## A supermarket of books and magazines features fabulous electronic knowledge.

## REGULATOR SPECIALS

78L05 +5V 1A \$ .65 7824 +24V 1A \$1.50  
78L12 +12V 1A \$ .65 7905 -5V 1A \$1.95  
79L05 -5V 1A \$1.75 7915 +15V 1A \$2.00  
79L12 -12V 1A \$1.50 78H05 +5V 5A \$6.00  
7805 +5V 1A \$1.65 78MG +adj. 5A \$2.00  
7808 +8V 1A \$1.40 78MG -adj. 5A \$2.00  
7815 +15V 1A \$1.50 78GU +adj. 1A \$2.00

## MEMORY SPECIALS

2102 1K 450ns static memory \$ 1.25  
2102 1K 350ns static memory \$ 1.35  
2114 4K 450ns low power static RAM \$ 7.95  
2114 4K 300ns \$ 8.95  
2114 4K 200ns \$10.45  
4116 16K 300ns dynamic memory \$ 9.95  
8 for \$72.00  
4116 16K 200ns \$12.95  
1702 256 by 8 EPROM \$ 4.00  
2708 1K by 8 EPROM \$10.00  
2716 2K by 8 EPROM \$35.00

## DISKETTES

8" Control Data or Wabash, low price. \$.65  
8" Dysan \$8.95  
5 1/4" Control Data or Dysan \$7.50  
10% off for orders of 10 or more. Attractively boxed.

A collection of trim pots ranging in value from 100 ohms to 1 meg. 35¢ each. And an array of multitrans precision pots, \$1.00 each.

Roll out the wire...electrical, speaker, telephone and hook-up wire, extension cords, ribbon and coaxial cable.

## INTEGRATED CIRCUITS

LINEAR	4011	4012	4013	4014	4015	4016	4017	4018	4019	4020	4021	4022	4023	4024	4025	4026	4027	4028	4029	4030	4031	4032	4033	4034	4035	4036	4037	4038	4039	4040	4041	4042	4043	4044	4045	4046	4047	4048	4049	4050	4051	4052	4053	4054	4055	4056	4057	4058	4059	4060	4061	4062	4063	4064	4065	4066	4067	4068	4069	4070	4071	4072	4073	4074	4075	4076	4077	4078	4079	4080	4081	4082	4083	4084	4085	4086	4087	4088	4089	4090	4091	4092	4093	4094	4095	4096	4097	4098	4099	4100	4101	4102	4103	4104	4105	4106	4107	4108	4109	4110	4111	4112	4113	4114	4115	4116	4117	4118	4119	4120	4121	4122	4123	4124	4125	4126	4127	4128	4129	4130	4131	4132	4133	4134	4135	4136	4137	4138	4139	4140	4141	4142	4143	4144	4145	4146	4147	4148	4149	4150	4151	4152	4153	4154	4155	4156	4157	4158	4159	4160	4161	4162	4163	4164	4165	4166	4167	4168	4169	4170	4171	4172	4173	4174	4175	4176	4177	4178	4179	4180	4181	4182	4183	4184	4185	4186	4187	4188	4189	4190	4191	4192	4193	4194	4195	4196	4197	4198	4199	4200																																																																																																																																																																																							
\$ .55	\$ .60	\$ .75	\$ .85	\$ 1.00	\$ 1.15	\$ 1.25	\$ 1.50	\$ 1.60	\$ 1.80	\$ 1.90	\$ 2.00	\$ 2.10	\$ 2.20	\$ 2.30	\$ 2.40	\$ 2.50	\$ 2.60	\$ 2.70	\$ 2.80	\$ 2.90	\$ 3.00	\$ 3.10	\$ 3.20	\$ 3.30	\$ 3.40	\$ 3.50	\$ 3.60	\$ 3.70	\$ 3.80	\$ 3.90	\$ 4.00	\$ 4.10	\$ 4.20	\$ 4.30	\$ 4.40	\$ 4.50	\$ 4.60	\$ 4.70	\$ 4.80	\$ 4.90	\$ 5.00	\$ 5.10	\$ 5.20	\$ 5.30	\$ 5.40	\$ 5.50	\$ 5.60	\$ 5.70	\$ 5.80	\$ 5.90	\$ 6.00	\$ 6.10	\$ 6.20	\$ 6.30	\$ 6.40	\$ 6.50	\$ 6.60	\$ 6.70	\$ 6.80	\$ 6.90	\$ 7.00	\$ 7.10	\$ 7.20	\$ 7.30	\$ 7.40	\$ 7.50	\$ 7.60	\$ 7.70	\$ 7.80	\$ 7.90	\$ 8.00	\$ 8.10	\$ 8.20	\$ 8.30	\$ 8.40	\$ 8.50	\$ 8.60	\$ 8.70	\$ 8.80	\$ 8.90	\$ 9.00	\$ 9.10	\$ 9.20	\$ 9.30	\$ 9.40	\$ 9.50	\$ 9.60	\$ 9.70	\$ 9.80	\$ 9.90	\$ 10.00	\$ 10.10	\$ 10.20	\$ 10.30	\$ 10.40	\$ 10.50	\$ 10.60	\$ 10.70	\$ 10.80	\$ 10.90	\$ 11.00	\$ 11.10	\$ 11.20	\$ 11.30	\$ 11.40	\$ 11.50	\$ 11.60	\$ 11.70	\$ 11.80	\$ 11.90	\$ 12.00	\$ 12.10	\$ 12.20	\$ 12.30	\$ 12.40	\$ 12.50	\$ 12.60	\$ 12.70	\$ 12.80	\$ 12.90	\$ 13.00	\$ 13.10	\$ 13.20	\$ 13.30	\$ 13.40	\$ 13.50	\$ 13.60	\$ 13.70	\$ 13.80	\$ 13.90	\$ 14.00	\$ 14.10	\$ 14.20	\$ 14.30	\$ 14.40	\$ 14.50	\$ 14.60	\$ 14.70	\$ 14.80	\$ 14.90	\$ 15.00	\$ 15.10	\$ 15.20	\$ 15.30	\$ 15.40	\$ 15.50	\$ 15.60	\$ 15.70	\$ 15.80	\$ 15.90	\$ 16.00	\$ 16.10	\$ 16.20	\$ 16.30	\$ 16.40	\$ 16.50	\$ 16.60	\$ 16.70	\$ 16.80	\$ 16.90	\$ 17.00	\$ 17.10	\$ 17.20	\$ 17.30	\$ 17.40	\$ 17.50	\$ 17.60	\$ 17.70	\$ 17.80	\$ 17.90	\$ 18.00	\$ 18.10	\$ 18.20	\$ 18.30	\$ 18.40	\$ 18.50	\$ 18.60	\$ 18.70	\$ 18.80	\$ 18.90	\$ 19.00	\$ 19.10	\$ 19.20	\$ 19.30	\$ 19.40	\$ 19.50	\$ 19.60	\$ 19.70	\$ 19.80	\$ 19.90	\$ 20.00	\$ 20.10	\$ 20.20	\$ 20.30	\$ 20.40	\$ 20.50	\$ 20.60	\$ 20.70	\$ 20.80	\$ 20.90	\$ 21.00	\$ 21.10	\$ 21.20	\$ 21.30	\$ 21.40	\$ 21.50	\$ 21.60	\$ 21.70	\$ 21.80	\$ 21.90	\$ 22.00	\$ 22.10	\$ 22.20	\$ 22.30	\$ 22.40	\$ 22.50	\$ 22.60	\$ 22.70	\$ 22.80	\$ 22.90	\$ 23.00	\$ 23.10	\$ 23.20	\$ 23.30	\$ 23.40	\$ 23.50	\$ 23.60	\$ 23.70	\$ 23.80	\$ 23.90	\$ 24.00	\$ 24.10	\$ 24.20	\$ 24.30	\$ 24.40	\$ 24.50	\$ 24.60	\$ 24.70	\$ 24.80	\$ 24.90	\$ 25.00	\$ 25.10	\$ 25.20	\$ 25.30	\$ 25.40	\$ 25.50	\$ 25.60	\$ 25.70	\$ 25.80	\$ 25.90	\$ 26.00	\$ 26.10	\$ 26.20	\$ 26.30	\$ 26.40	\$ 26.50	\$ 26.60	\$ 26.70	\$ 26.80	\$ 26.90	\$ 27.00	\$ 27.10	\$ 27.20	\$ 27.30	\$ 27.40	\$ 27.50	\$ 27.60	\$ 27.70	\$ 27.80	\$ 27.90	\$ 28.00	\$ 28.10	\$ 28.20	\$ 28.30	\$ 28.40	\$ 28.50	\$ 28.60	\$ 28.70	\$ 28.80	\$ 28.90	\$ 29.00	\$ 29.10	\$ 29.20	\$ 29.30	\$ 29.40	\$ 29.50	\$ 29.60	\$ 29.70	\$ 29.80	\$ 29.90	\$ 30.00	\$ 30.10	\$ 30.20	\$ 30.30	\$ 30.40	\$ 30.50	\$ 30.60	\$ 30.70	\$ 30.80	\$ 30.90	\$ 31.00	\$ 31.10	\$ 31.20	\$ 31.30	\$ 31.40	\$ 31.50	\$ 31.60	\$ 31.70	\$ 31.80	\$ 31.90	\$ 32.00	\$ 32.10	\$ 32.20	\$ 32.30	\$ 32.40	\$ 32.50	\$ 32.60	\$ 32.70	\$ 32.80	\$ 32.90	\$ 33.00	\$ 33.10	\$ 33.20	\$ 33.30	\$ 33.40	\$ 33.50	\$ 33.60	\$ 33.70	\$ 33.80	\$ 33.90	\$ 34.00	\$ 34.10	\$ 34.20	\$ 34.30	\$ 34.40	\$ 34.50	\$ 34.60	\$ 34.70	\$ 34.80	\$ 34.90	\$ 35.00	\$ 35.10	\$ 35.20	\$ 35.30	\$ 35.40	\$ 35.50	\$ 35.60	\$ 35.70	\$ 35.80	\$ 35.90	\$ 36.00	\$ 36.10	\$ 36.20	\$ 36.30	\$ 36.40	\$ 36.50	\$ 36.60	\$ 36.70	\$ 36.80	\$ 36.90	\$ 37.00	\$ 37.10	\$ 37.20	\$ 37.30	\$ 37.40	\$ 37.50	\$ 37.60	\$ 37.70	\$ 37.80	\$ 37.90	\$ 38.00	\$ 38.10	\$ 38.20</

# Exceltronix

## Components & Computing Inc.

CONTINUE TO WORK CLOSE WITH YOU .....

We have done our business in a fairly large scale that now we are able to pass more saving onto our relatively smaller buyers such as you, the hobbyists. Come and talk to us; we can match or even do better than most competitors' prices.

319 COLLEGE STREET, TORONTO, ONTARIO, CANADA. M5T 1S2. ☎ (416) 921-5295

### VOLTAGE REGULATORS SPECIAL!

78L05 ... .65	79L05 ... .99
7805 ... 1.39	7905 ... 1.85
7808 ... 1.39	7908 ... 1.85
7812 ... 1.39	7912 ... 1.85
7815 ... 1.39	7915 ... 1.85
7824 ... 1.39	7924 ... 1.85
78MG ... 1.95	78H05 ... 5.95
723 ... .69	78H12 ... 5.95

### INSTRUMENT/CLOCK CASE



Injection molded unit.  
Complete with red bezel.  
4" x 4" x 1 1/2" \$ 4.95 ea.

## MULTIFLEX TECH. INC.

### Z-80A computer kit

Simply Better

This Z-80A system operates at 4 Mhz and is S-100 Bus compatible. The unit is broken down into two boards, namely the CPU board and the MONITOR board, each of which is S-100 compatible. This unit can be used with other S-100 boards on the market and also with other MULTIFLEX peripheral system boards.

If bought alone the CPU board has the following features:-  
\* 1K Ram on board with provision for 4 K \* Memory is totally selectable in Blocks.  
\* 3K Monitor \* Provision for on board regulation from  
\* Provision for 8K EPROM if 2708s are used or standard S-100 supplies.  
16K EPROM if 2716s are used (Single supply).

When the CPU board is coupled to the MONITOR board, the system can now be used as an evaluation kit or a 'MOTHER BOARD' for starting one's own computer system. The MONITOR has the following features:

- \* A wire wrap area large enough to hold up to 40 x 16-pin DIP sockets.
- \* An EPROM programmer, with programming software included, to program 2708 or 2716s.
- \* Provision for a RS232 interface with selectable Baud Rate.
- \* A 32-key keyboard for standard functions such as: single step instruction, and so on.
- \* On board PIA using the 8255 IC.

AVAILABLE IN A KIT FORM OR ASSEMBLED AND TESTED VERSION. KIT : \$ 375.00  
A&T : \$ 450.00

YOU CAN NEVER BUY THIS GERMAN-BUILT O'SCOPE AT THIS LOW, LOW PRICE EVER AGAIN!

(SALE ENDS SEPTEMBER 30th, 1980.)

SAVE

INCLUDES : X1 PROBE



REGULAR PRICE -- \$ 449.95 NOW \$ 395.00

- LPS Triggering
- Bandwidth DC - 10MHz
- Small Dimensions
- Screen 7cm Ø

### MICRO COMPONENTS CORNER

## EXCELTRONIX INC.

EXCELTRONIX PROJECT KITS (All EXCELTRONIX kits sold are complete with PCB's.)

Kit 1. BICYCLE TURNING SIGNAL ... \$16.95	Kit 14. WINDSHIELD WIPER CONTROLLER ... \$ 4.50
Kit 2. DECISION MAKER ... \$ 4.95	Kit 15. PROGRAMMABLE L.E.D. CHASER ... \$19.95
Kit 3. CODE PRACTICE OSCILLATOR ... \$ 3.95	Kit 16. PROGRAMMABLE CHASER EXPANSION ... \$16.95
Kit 4. 2-WATT MONO AUDIO AMPLIFIER ... \$ 8.95	Kit 17. OPTO-ISOLATED TRIAC BOARD ... \$23.95
Kit 5. 3-CHANNEL COLOUR ORGAN ... \$12.50	Kit 18. LIGHTNING BOLT ... \$59.95
Kit 6. POWER FLASHER ... \$ 4.95	Kit 19. DOT/BAR L.E.D. WATTMETER ... \$22.95
Kit 7. BRITISH SIREN ... \$ 3.95	Kit 20. STORE CUSTOMER COUNTER ... \$49.95
Kit 8. AMERICAN SIREN ... \$ 3.95	Kit 21. ELECTRONIC DICE ... \$16.95
Kit 9. FLUID LEVEL DETECTOR ... \$19.95	Kit 22. ELECTRONIC SKEET GAME ... \$24.95
Kit 10. TONE DECODER KIT ... \$ 7.95	Kit 23. ADVANCED MORSE CODE PRACTICE BOARD ... \$69.95
Kit 11. FUNCTION GENERATOR ... \$19.95	Kit 24. ADVANCED MORSE CODE PRACTICE BOARD ... \$90.00
Kit 12. I.C. TIMER KIT ... \$ 3.75	(with memory capabilities)
Kit 13. RAILWAY CROSSING BLINKER ... \$ 7.95	Kit 25. AUTOMATIC KEYS ... \$ 9.95



▶▶▶▶ SPECIAL! SPECIAL! SPECIAL! SPECIAL! SPECIAL! SPECIAL! SPECIAL! SPECIAL!

### DYNAMIC RAM

4116 (16Kx1, 200ns) ... \$7.39
4116 (16Kx1, 300ns, CERAMIC) ... \$5.95

### STATIC RAM

2102LFPC (1Kx1, 350ns) ... \$1.35
2102LHPC (1Kx1, 250ns) ... \$1.75
2114 (1Kx4, 200ns) ... \$7.39
2114 (1Kx4, 450ns) ... \$4.99
P5101-45L (256x4, 450ns, LO PWR.) ... \$4.99

### EPROM

2708 (1Kx8, 450ns) ... \$ 7.95
2716 (2Kx8, 450ns, single 5 V) ... \$24.95
2732 (4Kx8, 450ns) ... \$95.00

(GOOD NEWS: Now you can program your own 2708, 2716 or 2516 EPROM's right here in our store for FREE if the EPROM's are bought from us, or for \$2.00 per PROM if bought elsewhere.)  
Note: The PROM Burner you will be using is one of the many features of MULTIFLEX's Z-80A Computer KIT. Please write for more info.

\$ 2.95 ea.

EXTRUSION IDEAL FOR BUILDING AMP'S (predrilled for 1 x TO-3 case)

\$ 2.50 ea.

V-SHAPED FINS, PREDRILLED FOR 2 x TO-3, 2 X TO-220 & 3 studs.

### BARGAIN! BARGAIN! BARGAIN!

ONE CENT PER PIN = A PENNY A PIN ✓

LOWEST PRICES - GOOD QUALITY - I.C. SOCKETS

14 PIN	.14	24 PIN	.24
16 PIN	.16	28 PIN	.28
20 PIN	.20	40 PIN	.40

(MINIMUM QUANTITY 10, YOU CAN MIX OR MATCH)

### COMPUTER GRADE CAPACITORS



'PHILIPS' 10,000 MFD/ 16V ... \$2.50
'SANGAMD' 80,000 MFD/ 20V ... \$4.95

### ANDICOM computer products

- \* Z80 cpu board
- \* 64K Dynamic memory board
- \* TRS-80 A/D Converter
- \* Floppy Disc Controller
- \* Colour Graphic board etc.

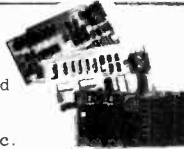

12 VDC DPDT RELAY ..... \$ 3.50 each  
(Potter & Brumfield, 800 Ohm coil, 3 Amp @120V)

GENERAL ELECTRIC POWER TRANSFORMER  
PRI: 120/240VAC SEC: 12/24VAC  
KVA: 0.25 (equiv. 20 Amp.)..... \$24.95

### DIP SWITCH 8-Pos. rockers

\$ 2.45 ea.

### WE HANDLE MAIL ORDER!

Send cert. cheque/money order (NO CASH). Minimum \$5.00 +\$1. handling.  
Ont. Res. add 7% PST  
M. Charge/Chargex accepted  
Send A/C No., signature, expiry date.

### MICROPROCESSORS

1802	13.99	8-Bit CPU, RCA COSMAC
6502	14.95	3-Bit CPU, KIM
6800	8.95	1.0 Mhz 8-Bit CPU
6802	14.95	6800 CPU + On-Chip Clock + 128 x 8 Ram, 1.0 Mhz
6809	47.95	High Performance 8-Bit CPU with 16-Bit Capability, 1.0 Mhz
8080A	6.95	8-Bit CPU
8085A	14.95	8-Bit CPU (1.3 uS)
Z80	12.55	2.5 Mhz 8-Bit CPU (MK3880, MOSTEK)
Z80A	15.50	4.0 Mhz 8-Bit CPU (MK3880-N4)

### 6800 SUPPORT DEVICES

6810P	3.95	128 x 8, 450 ns Static Ram
6820P	4.85	Peripheral Interface Adapter (PIA)
6821P	4.85	Peripheral Interface Adapter
6845P	29.95	CRT Controller
6850P	4.99	Asynchronous Communications Interface Adapter (ACIA)
6852P	5.20	Synchronous Serial Data Adapter

### 8080A SUPPORT DEVICES

8212	3.95	8-Bit I/O Port
8214	4.99	Priority Interrupt Controller
8216	3.75	Bi-directional Bus Driver
8224	4.50	2 Mhz Clock & Driver
8226	3.75	Inverting Bi-dir. Bus Driver
8228	6.50	System Controller & Bus Driver
8238	6.50	System Controller & Bus Driver
8251	8.50	Programmable Communications Interface
8253	13.95	Programmable Interval Timer/Counter
8255	8.50	Programmable Peripheral Interface
8257	13.95	Programmable DMA Controller, 4-Ch.
8259	15.99	Programmable Interrupt Controller

### 1802 SUPPORT DEVICES

1824LE	4.55	32 x 8 Static Ram
1852LE	1.95	8-Bit Byte I/O Port
1853LE	1.85	N-Bit 1 of 8 Decoder
1854LE	8.99	U.A.R.T.
1856LE	2.55	4-Bit Memory Bus Buffer/Separator
1857LE	1.75	4-Bit I/O Bus Buffer/Separator
1858LE	2.55	4-Bit Address Latch + 1 of 4 Decoder
1859LE	1.65	4-Bit Address Latch + 1 of 4 Decoder



ALL PRICES ARE IN CANADIAN FUNDS, FEDERAL SALES TAX 9% INCLUDED .....



**Editorial and Advertising Offices**  
 Unit 6, 25 Overlea Boulevard,  
 Toronto, Ontario, M4H 1B1  
 Telephone (416) 423-3262

**Publisher and Editor**  
 HALVOR W. MOORSHEAD  
**Assistant Editor**  
 JOHN VAN LIERDE

**Advertising Manager**  
 MARK CZERWINSKI  
**Advertising Services**  
 NANCY ALLEN  
**Advertising Representatives**  
 JIM O'BRIEN  
**Eastern Canada** JEAN SEGUIN &  
 ASSOCIATES INC. 601 Cote Vertu,  
 St. Laurent, Quebec H4L 1X8.  
 Telephone (514) 748-6561.

**Subscription Department**  
 BEBE LALL  
**Accounts Department**  
 SENG HARRISON  
**Production**  
 SARAH-JANE NEWMAN  
 CHERYL MAY

**Contributing Editors**  
 WALLACE PARSONS (Audio)  
 BILL JOHNSON (Amateur Radio)  
 JOHN GARNER (Shortwave Listening)  
 STEVE RIMMER (Video)  
 DICK CARTWRIGHT (Servicing)  
 DAVID VAN IHINGER (Servicing)

**INTERNATIONAL EDITIONS**

**Electronics Today International,**  
 145 Charing Cross Road,  
 London WC2H 0EE, UK

**Electronics Today International,**  
 Ryrie House, 15 Boundary St.,  
 Rushcutters Bay, Sydney, Australia.

**Elrad**  
 Kommanditgesellschaft, Bissendorfer  
 Strasse 8, 3000 Hannover 61 Germany.

**Electronica Top International**  
 Post Bus 93 Bithoven, Holland.

Published by:  
 Electronics Today International (Canada) Ltd  
 Printed by:  
 RBW Inc., Owen Sound, Ontario  
 Newsstand Distribution:  
 Master Media, Oakville, Ontario

**SUBSCRIPTIONS**  
 \$14 (one year), \$26 (two years). For US add  
 \$3/yr., other countries \$5/yr. Please  
 specify if subscription is new or renewal.

**BACK ISSUES AND PHOTOCOPIES**  
 Previous issues of ETI-Canada are available  
 direct from our offices for \$3 each; please  
 specify issue by month, not by feature  
 you require. 1977 issues available: Feb,  
 May, July, Nov. 1978 issues not  
 available: Jan, Feb and April  
 We can supply photocopies of any article  
 published in ETI-Canada for which the charge  
 is \$2 per article, regardless of length. Please  
 specify both issue and article.

Postal Information:  
 Second Class Mail Registration No. 3955.  
 Mailing address for subscription orders, unde-  
 liverable copies, and change of address notices  
 is: Electronics Today, Unit 6, 25 Overlea  
 Blvd., Toronto, Ontario, Canada M4H 1B1.

# Electronics Today

INTERNATIONAL

SEPTEMBER 1980 Vol.4 No. 9

## FEATURES

**Telidon . . . . . 13**

Soon you will be able to use your domestic TV as a VDU. Digital signals will ride the backs of TV broadcasts, come in on your phone lines and your TV cable. Read about this Canadian development inside.

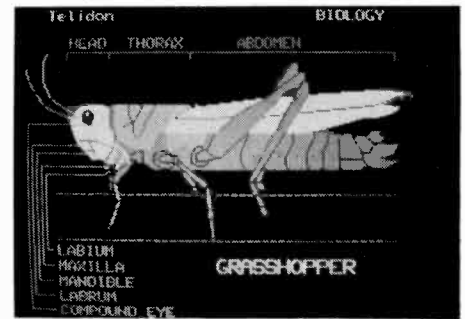

Telidon, p. 13

**Burglar Alarm Installation . . . . 24**

Our project on a Home Security System this month isn't much use unless you know how to apply it. We describe how to connect up the various intruder sensors.

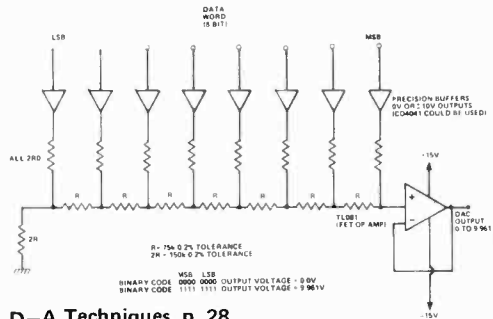

D-A Techniques, p. 28

**D-A Techniques . . . . . 28**

Digital Systems have some major advantages over analogue types but in themselves they are usually abstract and need to be converted. Tim Orr describes some of the techniques used.

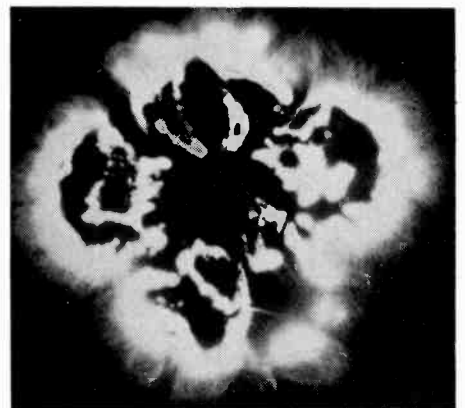

Kirlian Photography, p.43

**Kirlian Photography . . . . . 43**

A fascinating, but as yet unexplained phenomena, which shows an 'aura' around living material is investigated by Peter Sydenham.

**IEEE Bus . . . . . 62**

This computer bus system, as used on the PET, is examined in detail.

## PROJECTS

**Home Security System . . . . . 19**

A well thought-out project incorporating intruder and fire alarm facilities plus a number of other features making it a state-of-the-art design.



Home Security System, p. 19

Cover Photo: Telidon, the advanced videotext and teletext system developed in Canada, is capable of displaying significantly higher resolution and a broader range of colours than other systems.

This Canadian West-Coast Indian mask was designed on the Telidon information provider terminal by a student at the Ontario College of Art for the Bell Canada field trial.



ISSN 0703-8984

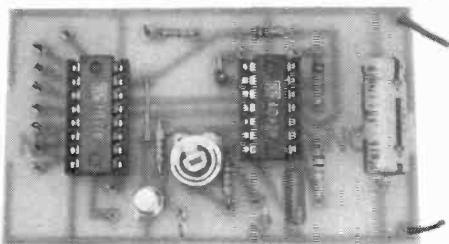

Touch Switch, p. 50

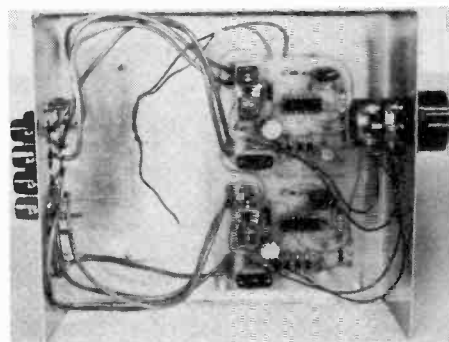

Speaker Protection Unit, p. 65

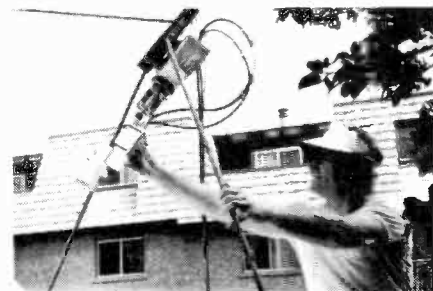

What's On, p. 58

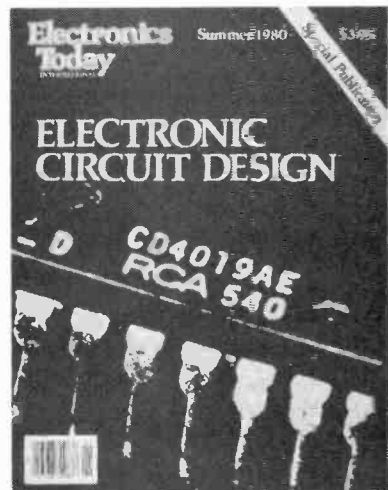

Another Special From ETI, p. 27

### Touch Switch . . . . . 50

Using the capacity of your finger tip you can switch either on and off or use the circuit to act as a rotary switch.

### Speaker Protection Unit . . . . . 65

Modern amplifiers are good but if something goes wrong they can disintegrate your speakers in a few milliseconds. Our unit automatically disconnects your drivers under amplifier fault conditions.

### Audio Today . . . . . 35

Wally Parsons

### Short Wave World . . . . . 54

John Garner

### Designer Circuits . . . . . 56

### Fun of Electronics . . . . . 57

Paul Geiger

### What's On . . . . . 58

Steve Rimmer

### Service News . . . . . 61

David Van Ihinger

### Tech-Tips . . . . . 71

## NEWS / INFO

### News . . . . . 6

### T-Shirts . . . . . 17

### Next Month's ETI . . . . . 18

### ETI Specials . . . . . 27, 75

### ETI Book Service . . . . . 38

### Reader Service Card . . . . . 48

### Panel Transfers . . . . . 53

### Babani Books . . . . . 64

### Order Form . . . . . 69

### Subscriptions . . . . . 70

### Back Issues . . . . . 76

## ADVERTISERS' INDEX

A-1 Electronics (Catalogue) . . . . .	39-42
Active Surplus Annex . . . . .	68
Active Component Sales Corp . . . . .	80
Alberta Audio . . . . .	48
A P Products . . . . .	8
Arkon Electronics . . . . .	2
Atlas Electronics . . . . .	72, 74
Audiovision . . . . .	74
Batteries Included . . . . .	77
BCS Electronics . . . . .	34
Bryan Electronics . . . . .	73
Robert J. Buckland Co. . . . .	53
Classified . . . . .	78
H. W. Cowan Canada Limited . . . . .	72
DCB Electronics . . . . .	74
Edukit Limited . . . . .	10
Electronic Packaging Systems . . . . .	69
Electronics 2001 . . . . .	72
Exceltronix . . . . .	3
Len Finkler Limited . . . . .	48, 74
Heath Company . . . . .	11
Kitstronic International . . . . .	72
McGraw-Hill . . . . .	33
Metermaster . . . . .	79
Melco Sales . . . . .	9
Omnitronix . . . . .	7, 17, 37, 68
Orion Electronics . . . . .	11
H. Rogers Electronic Instruments . . . . .	12
Royal View Electronics . . . . .	37
Paccom . . . . .	69
Spectrum Electronics . . . . .	77
Tuner Service Co. of Calgary . . . . .	72

#### COPYRIGHT

All material is subject to worldwide copyright protection. All PCB patterns are copyright and no company can sell boards to our design without our permission.

#### LIABILITY

Whilst every effort has been made to ensure that all constructional projects referred to in this magazine will operate as indicated efficiently and properly and that all necessary components to manufacture the same are available, no responsibility whatsoever is accepted in respect of the failure for any reason at all of the project to operate efficiently or at all whether due to any fault in design or otherwise and no responsibility is accepted for the failure to obtain component parts in respect of any such project. Further no responsibility is accepted in respect of any injury or damage caused by any fault in the design of any such project as aforesaid.

#### EDITORIAL QUERIES

Written queries can only be answered when accompanied by a self-addressed, stamped envelope. These must relate to recent articles and not involve the staff in any research. Mark such letters ETI-Query. We cannot answer telephone queries.

#### BINDERS

For ETI are available for \$6.75 including postage and handling. Ontario residents add 7% PST.

#### SELL ETI

ETI is available for resale by component stores. We can offer a good discount and quite a big bonus, the chances are customers buying the magazine will come back to you to buy their components. Readers having trouble in buying ETI could ask their component store manager to stock the magazine.

#### COMPONENT NOTATION AND UNITS

We normally specify components using an International standard. Many readers will be unfamiliar with this but it's simple, less likely to lead to error and will be widely used everywhere sooner or later. ETI has opted for sooner!

Firstly decimal points are dropped and substituted with the multiplier, thus 4.7uF is written 477. Capacitors also use the multiplier nano (one nanofarad is 1000pF). Thus 0.1uF is 10C, 5600pF is 566. Other examples are 5.6pF=566, 0.5uF=0p5.

Resistors are treated similarly: 1.8M ohms is 1M6, 56k ohms is the same, 4.7k ohms is 4K7, 100 ohms is 100R and 5.6 ohms is 5R6.

#### PCB SUPPLIERS

The magazine does not supply PCBs but these are available from the following companies. Not all companies supply all boards. Contact these companies direct for ordering information.

B&R Electronics, P.O. Box 6326F Hamilton, Ontario, L9C 8L9

Spectrum Electronics, Box 4166, Stn 'D', Hamilton, Ontario, L8V 4L5

Wentworth Electronics, R.R. No.1, Waterdown, Ontario L0R 2H0

Danocntis Inc. P.O. Box 241, Westland, MI 48145, USA.

Exceltronix Inc., 319 College St., Toronto, Ontario, M5T 1S2

Arkon Electronics Ltd., 405 Queen St. W., Toronto, Ontario, M5V 2A5.

A-1 Electronics, 5062 Dundas St. West, Mississauga, Ontario M9A 1B9, (+16) 231-4331.

# NEWS

## Win A Computer

If you've been waiting for the letter saying you won our May contest, wait no longer. You lost. Our winner is A. Danko of Mississauga, Ontario. He is shown shaking hands with Eugene Hutka (on the right) of Exceltronics Limited. Our twenty-five second prize winners were:

K. Humphrey	B. Bea
A.D. Lightstone	H. Edwards
B. Compson	K. Anderson
D.R. Tower	P. Bylsma
B. Bourgeois	P. Kohl
M. Van Humbeck	G. Adair
A. Grice	B. Compson
A. Rochford	S. Loh
G. Signorelli	D. Rejean
P. O'Connor	J. Nobel
G. Balding	R. Van Vliet
P. Stoneman	C. Remme
D. Bourget	

You should all have your T-shirts by now.



The winning answers were:  
(A) toggle switch, (B) alligator clip, (C) rotary switch contact, (D) speaker frame, (E) phono plug, (F) compact cassette.  
That wasn't so hard, was it??

## New OSI Machine

The C8P HD incorporates several new concepts and features in small computers including a nearly unlimited voice output capability, a voice recognition capability of several hundred spoken words, and 10 megabytes of disk storage capacity for language parsing and home information applications. The C8P HD incorporates several previous Ohio Scientific innovations to complement its voice I/O capability. This includes the ability to remotely control lights and appliances in a home without any wiring and the ability to monitor security and activity in rooms by ultrasound detectors and door/window contacts.

The system incorporates the state-of-the-art in voice recognition including the capability to recognize up to 100 distinct words simultaneously.

The system's initial high price of approximately \$10,000 depending upon options,



limits the system to advanced computer hobbyists and experimenters. The systems advanced features provide a preview of consumer electronics of the '80s. For more information contact the dealer nearest you or write to Ohio Scientific, 1333 Chillicothe Road., Aurora, Ohio 44202. (216) 562-3101.

## More Cat News

Advanced Computer Products, Inc. announces the 1980 edition of its worldwide mail order catalog. Containing a comprehensive listing of electronics, computers, hardware, software and intelligent computer products and gadgets, this year's 144 pages includes everything from Apples to Z8000 16-Bit Microprocessors.

To get a copy just send \$2.00 with your name and address to Advanced Computer Products Inc., 1310 E. Edinger, Santa Ana, California 92705.

## Cat News

Supreme Electronics 1980 Catalogue is now available for \$1.00. It contains 32 pages of ICs, transistors, capacitors and more. A useful book for hobbyists who do their buying by mail. Write to Supreme Electronics Inc., P.C. Box 6370, Stn. C, Victoria B.C. V8P 5M3.

## Slim DMM

From the land of the slim LCD calculator now comes a slim digital multimeter.

The Hioki 3207 Digital Pocket Hi Tester is an auto ranging DMM that's only 12.5 mm (less than 1/2") thick. It has all the usual DMM specs, 10M AC/DC impedance, AC and DC current and voltage measurements, as well as resistance and diode checking. A buzzer is included to indicate overrange and continuity conditions.

The meter, with test leads, case, and fuse, is available for \$174.95. Additional accessories include a 30kV high voltage probe and 10A external shunt.

To find out more, write to: RCC Electronics, 243 College St., Toronto, Ontario M5T 2Y1.

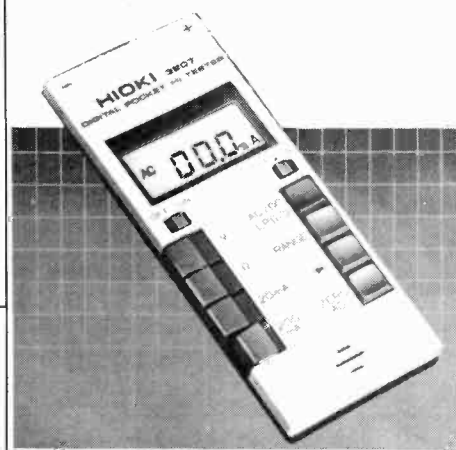

## Keeping Track

OK Machine and Tool Corporation is now offering low cost item used to identify pin numbers on wire-wrapping sockets. Consisting of a socket sized plastic panel with numbered holes in the pin location, the Socket Wrap - ID is simply slipped onto the socket before wrapping. You can also write on them for easy identification of location, IC part number, function, etc. These unique items greatly simplify both initial wire-wrapping and subsequent troubleshooting or repair. A great help to hobbyists, technicians and production facilities alike.

For further information contact, Len Finkler Limited, 25 Toro Road, Downsview, Ontario M3J 2A6.

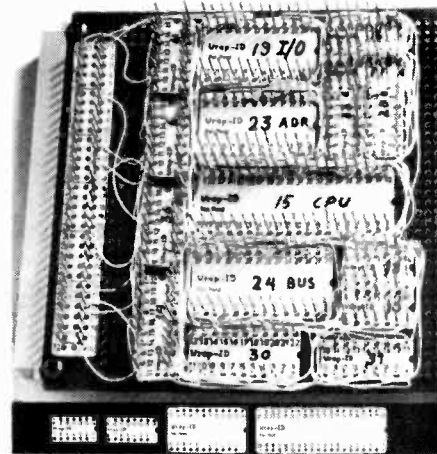

## A Logical Extension

New from Hickok Electrical Instrument Company is the MX Series of Digital Multimeters. Designated the MX 331 and MX 333, both provide 0.1% basic accuracy, 10 megohm input impedance, and overload protection.

The premium version, the MX 333, contains two features designated as Vari-Pitch, a built-in audible signal that changes frequency proportionate to digital readings, and Logi-trak, a self contained logic testing capability that combines the features of a high performance logic probe and voltmeter in one function.

Vari-Pitch functions on all voltage, current, resistance, and diode test ranges. Audio response is instantaneous, proportionate, and accurate for rapid indication on repetitive measurements. Wide range audio output on each selected range provides excellent audible resolution. Thus, with a little practice, the operator can, literally, "troubleshoot by ear" without taking his or her eyes off the probe or waiting for digital readings to settle.

On resistance measurements lower readings (eg. continuity) produce the highest pitches. On volts and current ranges higher inputs produce higher pitches.

Logi-Trak is a built-in logic testing capability that combines the features of a logic probe and voltmeter in one convenient function. It is activated by pressing a logic button on the MX 333. Any 10:1 high frequency scope probe may be plugged into

the safety insulated BNC input for measurement of all logic signals and DC voltages from 10mV to 20V. It is also used to find logic pulses as narrow as 5nsec.

Contact H. Rogers, P.O. Box 310, 595 MacKenzie Avenue, Units 1 & 2, Ajax, Ontario L1S 3C5.



## Expose Yourself

News digest is a regular feature of ETI Magazine. Manufacturers, dealers, clubs and government agencies are invited to submit news releases for possible inclusion. Submissions, or questions about material, should be sent to: News Digest, c/o ETI Magazine, Unit 6, 25 Overlea Boulevard, Toronto, Ontario M4H 1B1.

Audio products news will be directed to Audio Today's product department. Sorry, submissions cannot be returned.

## More On Test Equipment

Unfortunately our directory of test gear representatives in last month's issue was not as complete as we had hoped. To set things right, here are some more.

The four categories are:

- (O) oscilloscopes
- (M) multimeters
- (G) generators
- (F) frequency meters

### Len Finkler Limited

25 Toro Road, Downsview, Ontario M3J 2A6  
(416) 630-9103

Brands: Triplet, Global Specialties (formerly Continental Specialties), Lenline  
Categories: F, G, M

### Allan Crawford Associates Limited

6503 Northam Dr., Mississauga, Ont. L4V 1J2  
(416) 678-1500

Brands: Fluke, Gould, Wavetek  
Categories: O, M, G, F

### Guildline Instruments Limited

P.O. Box 99, 21 Gilroy Street,  
Smiths Falls, Ontario K7A 4S9

Brands: Guildline  
Categories: M

# 4 GREAT NEW BABANI BOOKS!

## Electronic Household Projects

R.A. PENFOLD

## A Microprocessor Primer

E.A. PARR B.Sc., C.Eng., M.I.E.E.



## Remote Control Projects

OWEN BISHOP

## Electronic Music Projects

R.A. PENFOLD



BP71: Electronic Household Projects \$7.70

Some of the most useful and popular electronic construction projects are those that can be used in or around the home. These circuits range from such things as '2 Tone Door Buzzer' and Intercom through Smoke or Gas Detectors to Baby and Freezer Alarms.

BP72: A Microprocessor Primer \$7.70

A newcomer tends to be overwhelmed when first confronted with articles or books on microprocessors. In an attempt to give a painless approach to computing, this small book will start by designing a simple computer that is easy to learn and understand. Such ideas as Relative Addressing, Index Registers, etc. will be developed and will be seen as logical progressions rather than arbitrary things to be accepted but not understood.

BP 73: Remote Control Projects \$8.58

This book is aimed primarily at the electronics enthusiast who wishes to experiment with remote control and many of the designs are suitable for adaptation to the control of other circuits published elsewhere. Full explanations have been given so that the reader can fully understand how the circuits work and see how to modify them. Not only are Radio control systems considered but also infra-red, Visible light and Ultrasonic systems as are the use of Logic ICs and Pulse position modulation etc.

BP74: Electronic Music Projects \$7.70

Although one of the more recent branches of amateur electronics, electronic music has now become extremely popular and there are many projects which fall into this category, ranging in complexity from a simple guitar effects unit to a sophisticated organ or synthesiser.

The purpose of this book is to provide the constructor with a number of practical circuits for the less complex items of electronic music equipment, including such things as Fuzz Box, Waa-Waa Pedal, Sustain Unit, Reverberation and Phaser-Units, Tremolo Generator etc.

To order use the form on page 69, or send your cheque or money order to ETI Magazine Unit 6, 25 Overlea Blvd., Toronto, Ontario M4H 1B1.

All prices include postage & handling.

# INTRODUCING HOBBY-BLOX™

The new modular circuit building system designed especially for electronic hobbyists.

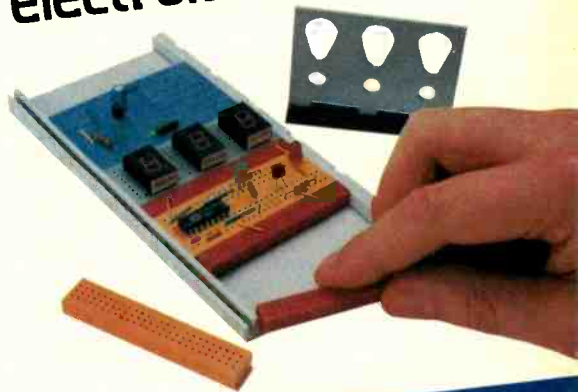
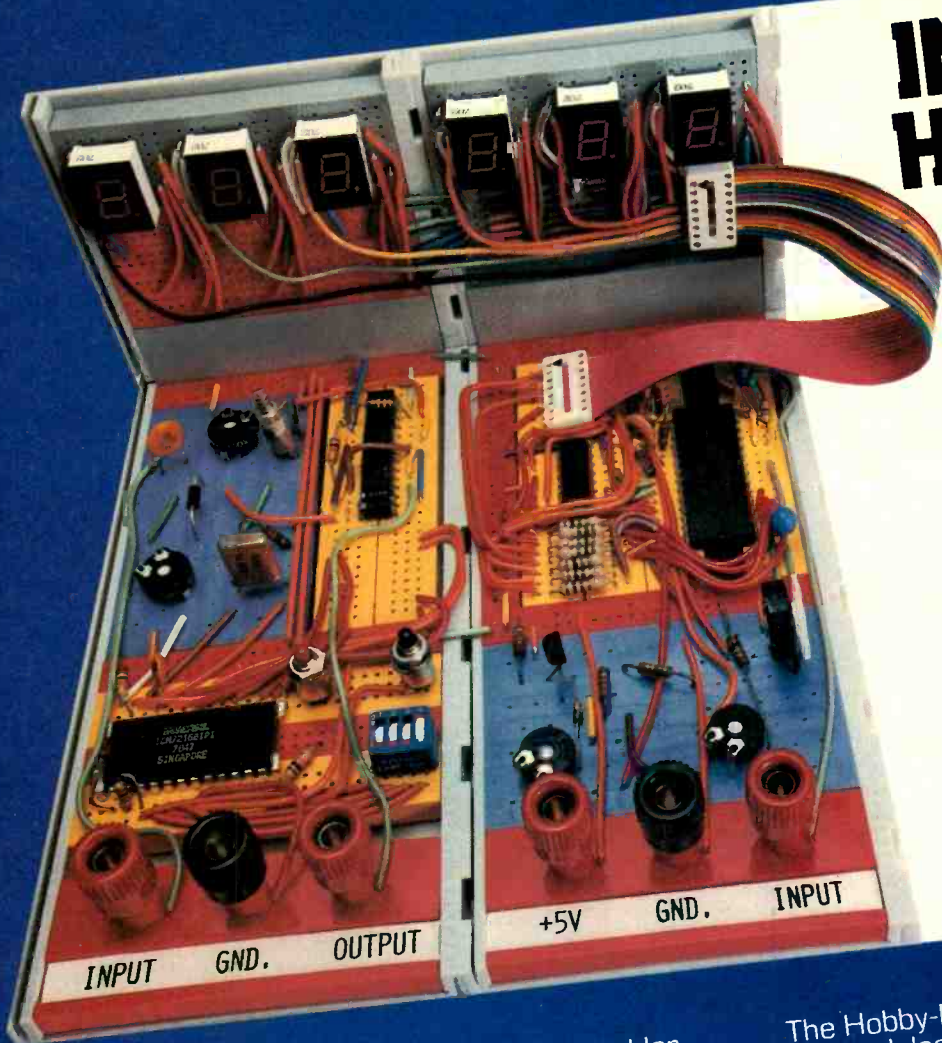

Until now, you had to buy "professional" solderless breadboards for your projects and pay "professional" prices. Now there's Hobby-Blox, a totally new circuit-building system that's not only economically priced but offers many more advantages to the hobbyist.

At the core of the system are two expandable starter packs, one for discrete component projects, the other for integrated circuit projects. Each comes with a number of Hobby-Blox modules that fit into a tray and an illustrated project booklet. In addition, the system includes 14 separate component packs you can purchase individually — terminal, distribution and bus strips, speaker panels, binding posts, etc.

The Hobby-Blox system is easy to use because the modules are color-keyed and letter/number indexed. It's time-saving, because they're solderless. It's compatible with DIP's of all sizes and a wide variety of discrete components. And you save money, because the parts can be reused again and again.

How far can you go with the Hobby-Blox system? Take a look at the example above. Then you'll know why we say, "your only limit is your own imagination!"

Patents Pending  
© A P PRODUCTS INCORPORATED 1980

For a free catalog, contact your local HOBBY-BLOX™ dealer:



A P PRODUCTS INCORPORATED  
1359 West Jackson Street  
Painesville, Ohio 44077  
(216) 354-2101

Calgary, Alberta	(403) 287-0520
Edmonton, Alberta	(403) 453-6691
Red Deer, Alberta	(403) 346-2088
Kamloops, B.C.	(604) 372-3338
Vancouver, B.C.	(604) 324-0505
Vancouver, B.C.	(604) 291-1441
Vancouver, B.C.	(604) 324-6831
Vancouver, B.C.	(800) 663-9408
Victoria, B.C.	(604) 385-2411
Winnipeg, Manitoba	(204) 786-8481
Winnipeg, Manitoba	(204) 786-1471
Winnipeg, Manitoba	(204) 683-1260
Armdale, Nova Scotia	(902) 876-2920
Downsview, Ontario	(416) 663-5563
Downsview, Ontario	(416) 663-5650

Dresden, Ontario	(519) 683-6147
Kitchener, Ontario	(519) 576-9902
Ottawa, Ontario	(613) 820-9471
Ottawa, Ontario	(613) 746-4413
Thunder Bay, Ontario	(807) 345-7334
Toronto, Ontario	(416) 868-1315
Waterloo, Ontario	(519) 745-9421
Montreal, P.Q.	(514) 731-7441
Montreal, P.Q.	(514) 769-8861
Quebec, P.Q.	(418) 647-4422
Rimouski, P.Q.	(418) 724-6800
St. Jean, P.Q.	(514) 348-4961
Trois-Rivieres, P.Q.	(819) 378-5457
Regina, Saskatchewan	(306) 525-1317
Saskatoon, Saskatchewan	(306) 652-6424
Mail Order	(416) 921-5295
Mail Order	(514) 731-7441
Mail Order	(519) 432-8625
Mail Order	(519) 886-9105



**From Polaroid**

Polaroid Corporation of Canada Limited has announced that it will begin to market an improved version of a wafer-thin six-volt battery for commercial applications. The battery was originally designed and manufactured for the Polaroid SX-70 photographic film pack.

The carbon-zinc Polapulse P100 battery is highly reliable and stable and has an expected shelf-life of three years. It weighs less than 30 grams, measures 9.5 X 7.8cm, and is only 0.5cm thick. It has two contacts which are located on the same side of the battery for ease of insertion and device design.

To help design engineers determine how Polapulse batteries can be incorporated into their company products, Polaroid is offering a Polapulse Design Kit for \$15 US that includes five Polapulse P100 batteries, a molded battery holder with external connections, and a detailed specification booklet.

But, what's really exciting is that Polaroid has also begun marketing for non-photographic applications the unique sonar transducer developed by the Company for its automatic focusing cameras.

Manufactured by Polaroid, the transducer may be incorporated into a variety of range-

finding and object detection devices. Its ranging capability, compact size, and light weight make it ideal for measurement needs in applications such as robotics, instrumentation, and fluid and bulk inventory control.

A Designer's Kit is available for product engineers so they can familiarize themselves with the capabilities of the sonar transducer. It includes two instrument-grade Polaroid transducers, a modified Polaroid ultrasonic circuit board, two Polaroid Polapulse 6-volt batteries, a battery holder, a wiring assembly, and a technical manual. Price: \$180 US.

More information on these products can be had by writing to Business and Technical Products Division, Polaroid Corporation of Canada Limited, 350 Carlingview Drive, Rexdale, Ontario. Tel: (416) 675-3680.

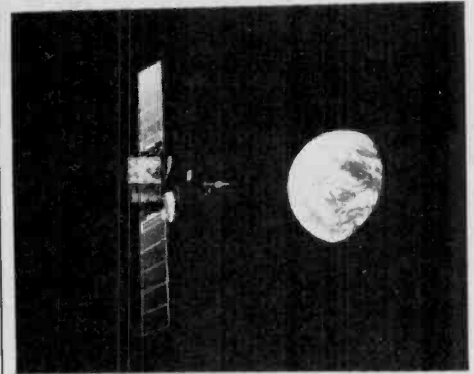

**International Electronic Mail**

Canada Post and Teleglobe Canada have established satellite transmitted mail service between Toronto and London, England.

Called INTELPOST, the new service is a joint venture of Canada Post and Teleglobe Canada. At a basic cost of \$5.00 per page, it allows businesses such as banks, stock brokers, importers and exporters, etc., to send facsimiles of letters, photo-

graphs, drawings and charts to their correspondents in England.

A ceremony launching the satellite mail service was held in Toronto at Canada Post's Front Street Office. INTELPOST service will be provided between this site and the Stock Exchange Branch Post Office in London, serving the metropolitan areas of both cities. Facsimile copy will be transmitted and received via Teleglobe Canada's international satellite facilities.

If you want to know more, talk to Canada Post at (613) 998-8682.

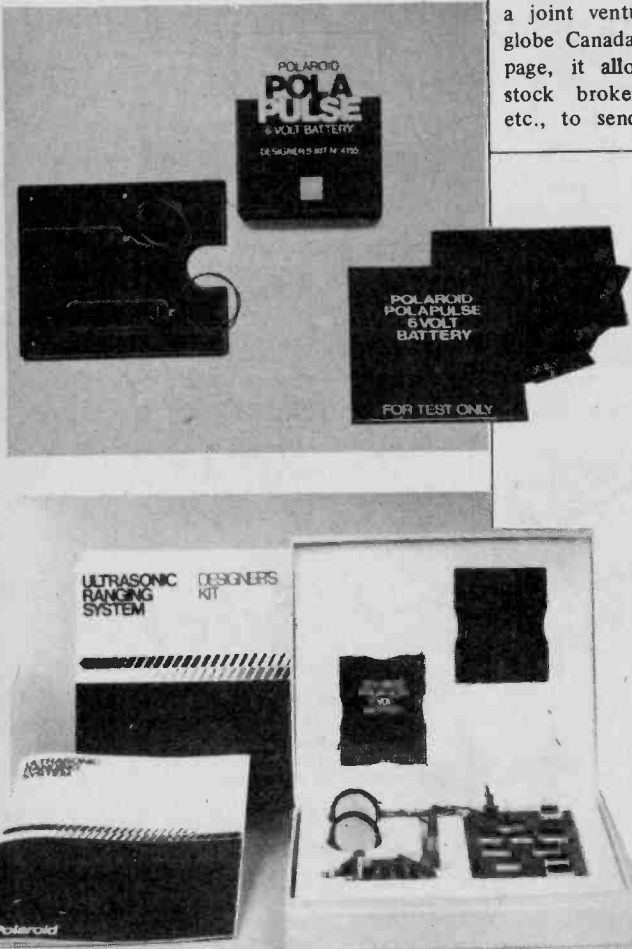

**Lend us 17 cents and we'll tell you why MITSUBISHI AUDIO SYSTEMS are for you!**

It would take a lot of space to try and tell you why you should consider Mitsubishi Audio Products for your home and your car. Mitsubishi, one of the new names on the Canadian audio scene, but an old name in Japan. A name that stands for integrity, value and state-of-the-art technology.

Mitsubishi Electric Corporation, a company that makes everything in electronics from very simple transistors to the most complicated earth satellite station. A company that has a tremendous background in electrical and electronics manufacturing for over 58 years. With 4 major research centres and 36 factories in Japan, you can be sure that they are in the forefront of electronics technology.

The only way to really tell you about our products is to send us our catalogues. Send us your name and address and we'll send you our catalogues, our price lists, the names of our dealers in your area — and we'll even return your 17 cent stamp!

Expect more from Mitsubishi.

To: Melzo Sales Canada Inc. 900C Denison Street, Markham, Ontario L3R 3K5 (416) 495-7728

Name \_\_\_\_\_ Address \_\_\_\_\_ Postal Code \_\_\_\_\_

(your business card will do)

# Announcing

EduKit LTD.

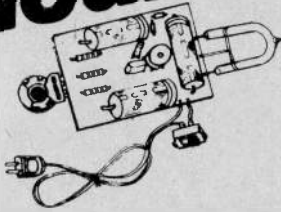

## STROBE LITE KIT

Fantastic for special effects. Variable speed Xenon flash gives you a "STILL MOTION" effect. A real attention getter.

Model # EK80SL001

PRICE: \$21.95

## 16 CHANNEL LED CHASER KIT

A very familiar sight seen at discos, department stores, and on neon signs. 16 LED's flash in sequence up-down or alternate. Adaptable to 120 vac. (Extra)

Model # EK80LC016

PRICE: \$22.95

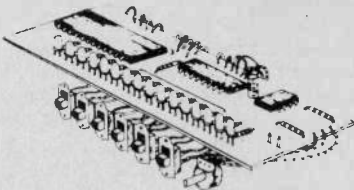

## 16 CHANNEL MULTI-MODE LED CHASER KIT

We're proud to add this to our line. It's similar to our 15 channel led chaser but with many extra features. There are over 60 selectable modes. A few are: Up, Down, Skip, Pulse, Scramble, Single Pulse, Multi Pulse and many more. An optional 120 vac board is available (Extra)

Model # EK80LCM16

PRICE: \$32.95

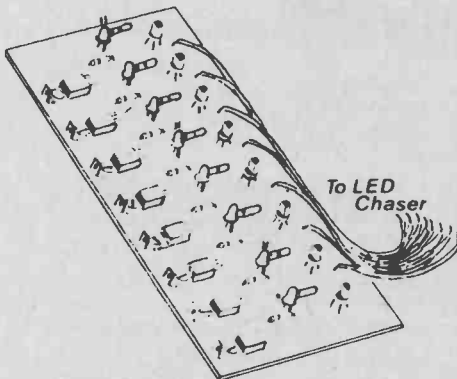

## POWER SUPPORT 120

A 120 volt power board which allows you to connect regular lamps to our LED Chaser Kits. 8 channels are supplied per board with 150 watts per channel. They can be easily interfaced for 16 channels.

Model # EK80PLC120

PRICE: \$24.95

•ALL KITS COMPLETE WITH DETAILED INSTRUCTIONS & PCB.

•DEALER & EDUCATIONAL INQUIRIES INVITED.

535 Yonge St., Tor., Ont. M4Y 1Y5

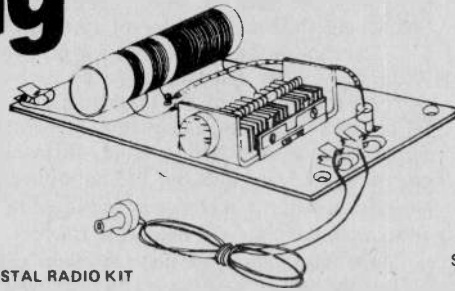

## CRYSTAL RADIO KIT

A self powered radio which uses a resonant circuit and detector for AM radio reception. An ideal project for the beginner.

Model # EK80CR001

PRICE: \$8.95

## STEREO AUDIO MIXER Kit

MODEL EK80AM001

\$49.95

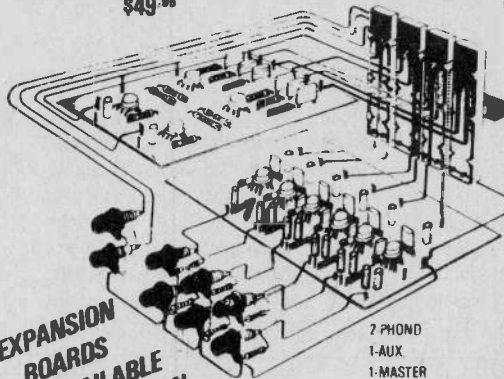

EXPANSION  
BOARDS  
AVAILABLE  
SOON

2 PHONO  
1-AUX  
1-MASTER  
EXPANDABLE  
RESP. 20Hz - 20KHz  
5V OUTPUT  
.01% DIST.

## 0-28 VOLT POWER SUPPLY KIT

A true 0 to 28 volts capable of delivering 1 amp continuous. Full wave rectification, filtering and capacitance multiplication provides a clean dc source for sensitive audio and digital work. An ideal supply for the experimenter.

Model # EK80PS028

PRICE: \$39.95



## 1.5 to 24v POWER SUPPLY KIT

A variable Power Supply suitable for many digital and linear applications. Delivers an output current of 100ma. from 1.5v to 15v and 500ma. from 16v to 24v.

MODEL # EK80PS024

PRICE \$24.95

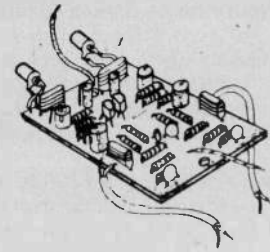

## STEREO PHONO PREAMP KIT

Anyone with a ceramic input receiver can enjoy the quality of a magnetic cartridge with this simple but very effective Stereo Phono Preamp.

Specifications:  
Frequency Response:  
Input Sensitivity:  
Maximum Output:  
Input Overload:  
S/N Ratio:

Standard RIAA  
20Hz to 2KHz + 1.5dB  
5mv input for 500mv output  
700mv rms  
100mv rms  
Greater than 60dB

Model # EK80SP001

PRICE: \$11.25

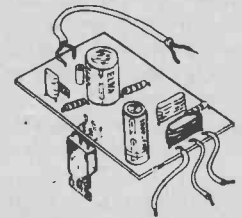

## 5 WATT IC AUDIO AMPLIFIER KIT

A general purpose 5 watt amplifier with Thermal Overload and Short Circuit Protection. Because of its low operating voltage and high power output, it allows the user to use it as an add-on amplifier for car stereo.

Specifications:  
Frequency Response:  
Power Output:

40Hz to 15KHz B(-3dB)  
5 watts at 4 ohms  
7 watts at 2 ohms  
5% at 7 watts at 2ohms  
2 to 16 ohms  
12 to 15vdc

Model # EK80A005

PRICE: \$19.95

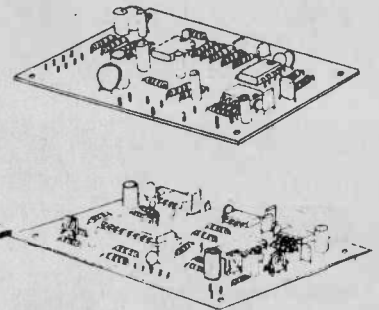

## BBD AUDIO DELAY LINE KIT

A unique Special Effects Unit which gives a variable or fixed delay of Analog Signals. Reverb, Echo and Flanging.

### Specifications

Maximum Input . . . . . 2.0v rms  
Delay Time . . . . . 6 to 30ms. (int. osc.)  
Distortion at 1v at 1KHz . . . . . 0.3%  
S/N at 2v input . . . . . 67dB  
V supply . . . . . +5vdc and -15vdc

MODEL #EK80BBD01

PRICE: \$69.95

Circle No.49 on Reader Service Card.



**LCD Matrix**

Liquid Xtal Displays Operation, a part of General Electric Company's Electronic Components Division, announces the availability of their 32 character 5x7 dot matrix LCD display, configured for conductive, elastomeric connection.

The GE-LXD reflective display consists of 2 rows of 16 characters .3" high. Overall dimensions of the display are 1.3" X 4.8". This new display (designated 95E) expands the GE-LXD product line, which includes 8- and 16- character dot matrix displays, and a complete series of 7-segment 2 to 8 character LCDs.

If you're interested in the 95E or other GE LCDs, write to General Electric Co., 24500 Highpoint Road., Cleveland, Ohio 44122.

**Lab Power Supply**

A new fully adjustable laboratory power supply, the 1200 series has been introduced by Anatek Electronics Limited and is available exclusively from Allan Crawford Associates Limited.

Designed and manufactured in Canada, the new 1200 features high power density in a small package, excellent serviceability, conservative heatsink design, independent metering of voltage and current, and voltage mode and current mode LED indicators.

Four models are available each with dc voltage and current adjustable from 0 to full output. The models are rated maximum outputs of: 15V @ 6.5A; 30V @ 4A; 60V @ 2A; and 120V @ 1A.

For more information please contact Mr. Steve Dineen, Allan Crawford Associates Limited, 6503 Northam Drive, Mississauga, Ontario L4V 1J2. (416) 678-1500.

**The Last Word**

Dear Editor: July 18, 1980  
My wife Eleanor and I were delighted to open up the August issue of ETI and find a photograph of our graceful hot air balloon at the North Pole.

We would like to answer the question asked by your caption "But what does it have to do with electronics?"

Mounted and playing in our balloon basket as we passed in free flight over the Pole was a Jensen R402 automotive radio-cassette recorder with Jensen coaxial loudspeakers. We used a superb Luxman XM-11 90 minute cassette.

We had expected the Jensen to operate for a short time at the top of the world on the ice, but we were astounded when it still played at the end of the 4th hour at -38°C with 18 knot winds. Although our battery packs were warned, the Jensen wasn't.

We had 6 other electronic units along as well, including navigation and flight instruments, video pack and camera, recorders, etc. They all performed flawlessly. I am happy to report.

Sidney Conn, LEADER  
JOY OF SOUND - POLAR BALLOON EXPEDITION

P.S. We re-worded the Jensen slogan to "The Chill of Being There".

**WHAT'S NEW  
IN HOME  
ELECTRONICS?**



Find out in the latest Heathkit Catalogue. It's filled with exciting kits in every price range, all easy to assemble, all at build-it-yourself savings.

Discover the fun you and your family can have building your own home computer, stereo system, color TV. Discover the pride of saying, "I built it myself." It's easier than you think.

Send today for your FREE Heathkit Catalogue.

**Heathkit®**

If coupon is missing, write Heath Company, 1480 Dundas Highway East Mississauga, Ontario L4X 2R7

**Send For FREE Catalogue Today!**

Send to: Heath Company, EV0980  
1480 Dundas Highway East  
Mississauga, Ontario L4X 2R7

Send my free Heathkit Catalogue now. I am not currently receiving your catalogue.

Name \_\_\_\_\_

Address \_\_\_\_\_

City \_\_\_\_\_ Prov. \_\_\_\_\_

Postal Code \_\_\_\_\_

Circle No. 12 on Reader Service Card.

**ORION**

**Electronic Supplies Inc.**

ELECTRONIC DISTRIBUTOR  
INDUSTRIAL — EDUCATIONAL — COMMERCIAL — HOBBYIST

**RCA**

COSMAC  
**VIP**

Authorized distributor for RCA, COSMAC VIP



New! VP 111 **\$129.50**  
Microcomputer ....

- Features
- RCA 1802 Microprocessor
  - 1K Bytes static RAM
  - Expandable on-board to 4K
  - Expandable to 32K Bytes total
  - 512 Byte ROM operating system
  - CHIP-8 interpretive language or machine language programmable
  - Hexadecimal keypad
  - Audio tone generator
  - Single 5-volt operation

Assembled\* and tested.

- Video output to monitor or modulator
  - Cassette interface—100 Bytes/sec
  - Instruction Manual with 5 video game listings, schematics, CHIP-8, much more!
  - Ideal for low-cost control applications.
  - Expandable to full VIP capability with VP-114 Kit
- \*Users need only connect cables (included), a 5-volt power supply, and speaker.

**START WITH ORION FOR  
A NEW ERA IN THE WORLD  
OF ELECTRONICS**

We have the most complete selection of electronic components.

Full line of TTL, CMOS, Linear, ICs, Computer Interface, Support Chips and CPUs

VP-601 58-Key Typewriter Format for Alphanumeric Entry



**VP-601 \$98.50**

VP-611 74-Key, Typewriter Format Plus Separate 16-Key Numeric Keypad for Fast Entry



**VP-611 \$114.50**

128 character, fully encoded, ASCII, alphanumerics. Positive light touch keys — two user-definable. Operation from single +5 Volt supply.

**ORION ELECTRONIC  
SUPPLIES INC.**

40 Lancaster Street West  
Kitchener, Ontario N2H 4S9  
(519) 576-9902

Master Charge & Visa, COD, Cheque, Money Orders accepted. CODs, shipping & insurance extra. Write for our FREE catalogue!

# DMM+VARI-PITCH+LOGI-TRAK=MX333

## World's fastest troubleshooter

### A DMM SO UNIQUE... SO VERSATILE... SO SUPERIOR WE WERE TEMPTED TO CALL IT SOMETHING ELSE

We believe the MX333, with the VARI-PITCH™ and LOGI-TRAK™ functions, to be the greatest time saving tool in electronics today. It has all the functions, ranges and accuracy you expect from the best along with the two additional features which will save enormous amounts of troubleshooting time. And the MX333's 20Ω range gives you 10 milliohm resolution for those critical low resistance tests. Both MX series DMM's have 0.1% basic accuracy plus a 10A range, plus the intelligent case styling that has the size of a hand held, but the shape of a better idea. With either unit you get more performance per dollar than with competitive models. And the MX333 gives you more, much more, than you ever thought possible! *Effort cutting innovations that will save you hours by the second!*



### ACCESSORIES

- SP-7 10:1 DIVIDER PROBE for Logi-trak input (100 MHz scope probe) **\$50.75**
- TP-20 TEMPERATURE PROBE: Measures temperature from -55°C to 150°C (TP-20C) or -67°F to +302°F (TP-20F); ACCURACY: ±1.4°C, 2.3°F; BATTERY LIFE: 500 hrs., 9V battery **\$72.50**
- VP-14 RF PROBE: For RF voltage measurements of 0.25V to 40V rms; ACCURACY: ±1dB from 100 kHz to 500 MHz, -3dB from 500 MHz to 750 MHz; DC BLOCKING VOLTAGE: 200V. **\$50.75**
- VP-40 40KV DC PROBE: VOLTAGE RANGE 0 to 40 KVDC, INPUT RESISTANCE 1000 MΩ; ACCURACY ±1% rdg @ 10KV; VOLTAGE COEFFICIENT—1ppm/V. **\$56.00**
- CC-4 DELUXE PADDED VINYL CARRYING CASE with room for leads and small accessories **\$23.00**
- RC-3 AC ADAPTER for powering MX and LX Series DMM's from 115V ±10% AC lines. Fits into jack on side. (Model RC-4 for 220 VAC). **\$12.50**

### EXCLUSIVE VARI-PITCH

Not just a beep... not just instant ohms. MX333's VARI-PITCH audible tone changes frequency proportionate to the reading so you can literally troubleshoot by ear! The higher the pitch, the higher the reading. No need to take your eyes off the probe or wait for a read-out to settle. VARI-PITCH responds instantly, proportionally and accurately in all voltage, current, resistance and diode test ranges. It even provides analog-like audible response to variations for quick and easy adjustments and nulling.

### FAST LOGI-TRAK (5 nsec fast)

Combines the features of a high performance logic probe and voltmeter in one convenient function. Use any standard 10:1 high frequency scope probe to find high and low logic levels and positive or negative pulses as narrow as 5 nsec without taking your eyes off the circuit! The VARI-PITCH output tells it all. And, unlike ordinary logic probes, LOGI-TRAK spots ground shorts, supply shorts, opens, marginal or ambiguous logic states and infrequent pulses instantly! Then, without changing anything but the direction of your glance, it's easy to verify actual voltage on the digital readout!

### NEW UNIVERSAL SIZE AND SHAPE

MX333 and MX331 are the first digital multimeters designed from the ground up for LCD technology. The display's 45° angle is easy to read at any viewing point; from directly above to straight on. Powered by a single 9 volt battery, their compact size and unique shape make them ideal for all portable applications.

No matter how you use a multimeter; in your hand, clipped to your belt or on a shelf, no other DMM is as convenient as the Hickok MX333 or MX331! And, with VARI-PITCH, MX333 is *really out of sight* in performance.

**MX331**  
**\$249<sup>00</sup>**



**MX333**  
**\$295<sup>00</sup>**

Duty and FST included.  
Chargex (Visa) accepted.  
Ont. res. add 7% sales tax.  
Shipping Extra.

**ROGERS** electronic instruments Ltd.

P.O. Box 310, 595 Mackenzie Avenue Units 1 & 2.  
Ajax, Ontario L1S 3C5. Tel. (416) 683-4211

# TELIDON

An example of a bit encoded picture. While the resolution isn't as good as regular TV pictures, you can still identify the famous person shown here.



The television is already a central part of our lives, much to the chagrin of sociologists and other watchdogs of our society's health. But now Canadian researchers are coming up with new uses for the boob tube.

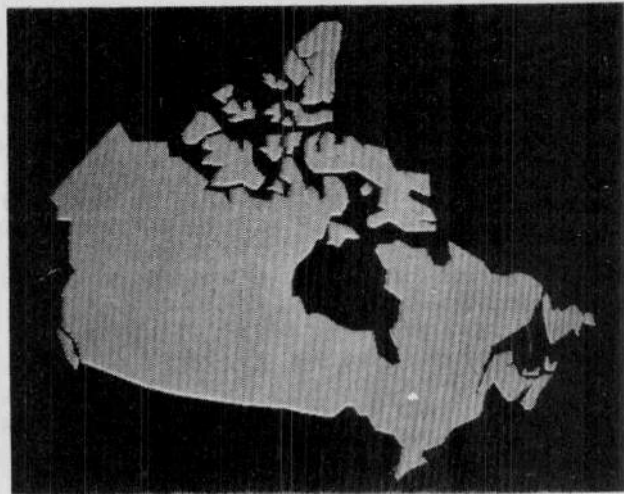
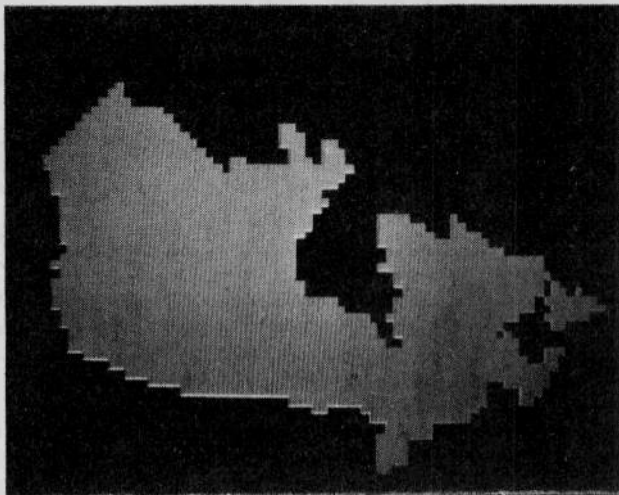

A comparison of first generation videotex technology and Telidon. The picture at left is at its utmost limit of resolution. Further refinements would require hardware and software redesign before we would see Vancouver Island and P.E.I.

ETI READERS who read the papers closely will have noticed a growing excitement in the Canadian Telecommunications industry. It has to do with something called Telidon and it's supposed to be a major coup for Canadian researchers.

Well, it is. Telidon is perhaps the most significant technological development in the communications industry since the invention of the pencil and paper. Its range of applications is enormous. It can replace newspapers, magazines and those cable TV weather reports you find on unused channels. For the business man, it provides a communications medium as versatile as the mails and as fast as the telephone. Telidon brings us one step closer to the 'wired city', a society where public information is available instantaneously, any time of day or night.

## Videotex

Telidon is part of a larger family of display techniques generically called 'Videotex Systems'. While they all differ in technologies, the principle and end result are the same, the digital transmission and display of visual and textual information.

Development of videotex systems has been going on for more than ten years now.

The most well known work has been done in Britain. There are in fact three major systems operating right now.

The first of these is the BBC's CEE-FAX, initially announced in 1972. This was shortly followed by the IBA's (Independent Broadcast Authority) own system, ORACLE.

The two organizations combined efforts and in 1974 announced a unified specification, which was significantly more advanced than either of the two earlier systems.

Essentially, the systems allow a user to access several hundred 'pages' of information. These can be news bulletins, weather reports, (including maps), sports results or anything else. The information is transmitted continuously on the vertical blanking pulses of a standard television picture. When a user selects the page he wants, the hardware waits for the appropriate page to be transmitted, stores, and displays it.

The other system currently in use is The British Post Office's PRESTEL. PRESTEL is an interactive system that makes 250,000 pages available to subscribers. A user selects the page he wants via phone lines and a central computer sends the information back and bills the appropriate account. Private companies and individuals can lease PRESTEL pages and set whatever

charges they see fit.

At present, these systems are not in wide use, there are only several tens of thousands of users; however their numbers are growing rapidly.

It would seem logical that if Canada were to implement a Videotex system, our best bet is to import the British system. The cost would be minimal and the system could be put in place with very little trouble. There is one drawback however; PRESTEL, CEE-FAX and ORACLE are for all practical purposes, obsolete.

## A Picture Is Worth How Many Characters?

To realize how advanced Telidon is, an understanding of the British and Canadian systems is required.

In the British system, each page is comprised of 24 lines of 40 characters. A character could be a letter or it can be divided into mosaic elements (2 rows by 3 columns). A character can be black or white or one of six colours. For purposes of displaying text this is quite adequate, for displaying graphics, however, it is somewhat limited. A person programming CEEFAX graphics is limited to a matrix of 48 rows by 80 columns, or 5760 mosaic elements. This means that curves must be approximated by steps and that shapes are

limited to integral numbers of pixel dimensions (see picture).

Ah! you say, increase the number of characters on screen and you increase the resolution. Clever, but self defeating and not very feasible. Remember that CEEFAX was born in the early seventies, a time when CMOS was mysterious, TTL ruled that market and any worthwhile quantity of memory ICs cost an arm and a leg to think about.

Each character required one byte of memory and British designers were forced to optimize graphics resolution against system cost. At the time, the necessary equipment to decode CEEFAX data cost something on the order of \$1,000 in 1975 dollars. Mass production has since cut this cost substantially, but in 1972, it was still a costly proposition.

Another problem inherent with increasing resolution is that you would have to transmit more data, and it costs more than it would appear at first glance. To double the resolution of the CEEFAX system you would have to double both the rows and the columns, which means you'd have to transmit four times the number of characters, 3840 instead 960. Tripling the resolution would require 9 times the number of characters and 9 times the memory.

**A Better Way**

Today, hardware designers can avail themselves of much more advanced technology. The cost of memory is no longer a major consideration, dynamic memory devices can save both space and money. The substantial reduction of microprocessor costs allow terminals to be allot smarter than they have been.

As early as 1969 the Department of Communications had been experimenting with computer graphics for space satellite applications.

During the seventies, Canadian researchers set about developing the basic philosophy of the Telidon system. Anticipating further refinements in semiconductor technology, they realized that such a system should be independent of the display technologies that carried it. It was decided that the terminal should have its own intelligence (ie; resident microprocessor) and that the picture coding software take full advantage of that fact.

The final result, Telidon, was announced August 1978. You've probably guessed by now that the name Telidon is derived from Greek roots. It is, in fact, compounded from the Greek 'tele' meaning far and 'idon', a form of the verb 'horao' meaning 'I saw' or

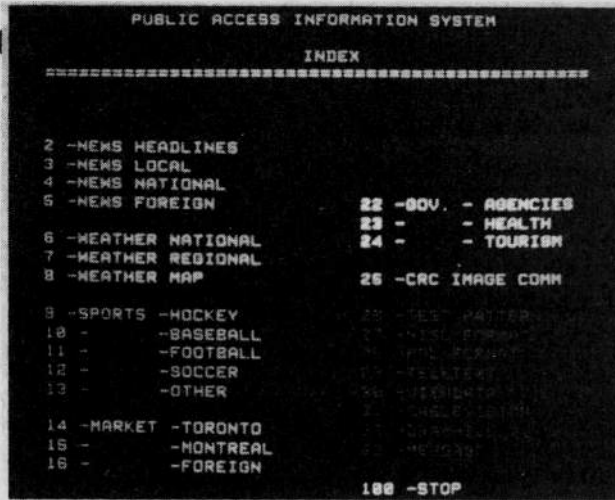

A typical index or 'menu' that you see as a user might see when accessing a videotex data base.

'I know' (this leads one to wonder that if Greek is such a great language, why don't we all speak it?)

Telidon used three methods of image description: text encoded (using ASCII); bit encoded; and picture description instructions (PDIs).

Text encoded is, as its name implies, the direct display of transmitted characters. This is perhaps the most efficient means of transmitting information.

Bit encoding involves getting back to the first principles of graphic display. The image is made up of individual picture elements (pixels), each of which occupies an individual location in memory. The byte value of each pixel gives information on grey scale tone and colour hue.

Bit encoding requires the least intelligence from a terminal. All it has to do is scan its memory and paint each pixel on its appropriate location on screen. Character encoding requires that a terminal be capable of identifying and displaying individual characters. Character encoding can be described as higher level language than bit encoding.

PDIs are in fact a high level language that embody the latter two techniques. There are at present seven instructions: TEXT and BIT we already know and five graphic primitives: POINT, LINE, ARC, RECTANGLE, and POLYGON. These last instructions are the secret of Telidon efficiency. Rather than transmit the individual characters, Telidon tells the terminal *how* to build up the picture. In this way, one instruction can replace many characters.

**Getting It Together**

In addition to the graphic primitives there are a number of control instructions to facilitate terminal and display control.

The CONTROL op code has four uses. Two are used to define terminal options. The other two, VALUE and

STATUS are used to extend the set of sub-commands used for display manipulation.

The VALUE option is to define colour for subsequent graphic and character instructions. For example, a user can specify red and subsequently draw a circle. The result would be a red circle on screen.

Colour values are specified in triplets of Green-Red-Blue in order of decreasing significance (see Fig 1). One eight bit data word can specify 64 grey scale values or 64 combinations of Green-Red-Blue. In this way Telidon can accommodate terminals with increasing degrees of resolution.

The STATUS option provides a larger range of instructions for controlling the display.

The CLEAR status sub-command, as its name implies, will clear the entire screen, as well as resetting all other states in the terminal.

The FILL Control allows the user to fill areas with solid colours, cross-hatching or broken lines.

Other subcommands are used to enhance the terminals capability. A TRANSPARENT command allows one to mix captions with conventional broadcasts (useful for deaf viewers). A WAIT command can cause the terminal

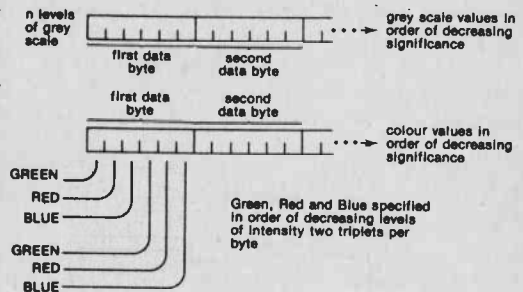

Fig.1. How colours and grey scales are specified. Note that the resolution of the system can be increased by adding more data bytes.

to pause and wait for a response (ie: display  $2 + 2 = ?$ , WAIT for user to key in 4). There are still more commands to control character display, markers and more. Note that all these commands as well as the PDIs require that the terminal possess some computational capability. By having a smart terminal on the receiving end, transmitted information can be of a denser nature than other forms of displays. This is why Telidon is so efficient.

### The Hardware Part

Having looked at how Telidon works, we next turn to how it is used and what one can expect to see Telidon on in the home.

Quite simply, there are no restrictions on how Telidon is implemented. Fig. 2 shows four possible interactive systems.

System i is perhaps the simplest you can get. Communications is accomplished via modem and telephone lines. The decoder/display generator applies its output directly to the G-R-B drive circuitry. A keypad is supplied so the user can select whichever pages he wants, answer displayed questions etc. The disadvantage of this is that circuit modifications are required to the television set (maybe someday manufacturers will provide isolated inputs for Videotex users). One way around this is system ii, which uses a channel modulator to apply the signal to the tuner. Of course, nothing is free in this world and the user would have to put up with some loss of picture quality.

System iii gets its programming from the cable TV service. System iv is a hybrid system that lets the user have access to both phone and cable services.

Using telephone allows two way operation between the users terminal and the data base. In this way the user can select the page he wishes and have it transmitted to him immediately. Depending on the size of the data base, any number of pages can be made available to the user. Complete random access is also possible.

If cable TV is used, then the data must be transmitted repeatedly. If one is using a dedicated cable channel, a substantial number of pages can be transmitted without making the user wait too long for his selection to appear. An alternative method is to transmit the information on vertical blanking interval\* of regular network programming. This is useful for captioning regular network broadcasts. The disadvantage is that the wait for the appropriate page to appear restricts the number of pages available to only a few hundred.

*\* A TV picture is created by having an electron beam paint a picture on the luminous phosphor face of a picture tube. During one picture of a transmission the beam scans from top to bottom. When it reaches the bottom it is 'blanked' (ie: doesn't paint a picture) and sent back to the top. During this time picture lines are still being transmitted. Since no video information is being transmitted, it is a relatively simple matter to transmit digital information during this time.*

Anyone with a computer can generate his own Telidon pages, given the proper software and enough memory any home computer could probably do the job. Schools could put together learn at home courses. Department stores could maintain complete catalogues in a database, altering pages for specials. Shoppers could phone up, browse through the various specials. The shopper could then order by phone. No more waiting for Thursday's paper to catch the sales.

Ultimately individuals and small business will be able to afford their own systems. People may never talk to each other again!

### And Now . . .

Since its announcement in 1978 allot has been going on behind the scenes. There are now over 200 companies, ranging in size from private individuals to large newspapers, interested in supplying Telidon programming.

Since its unveiling in 1978 there have been countless demonstrations of the Telidon system, both at home and abroad. Notable among these are transmissions to Switzerland via trans-Atlantic telephone cable and one to Australia via the Canadian-American Hermes satellite.

The program is now moving into its second phase of development with a series of field trials across Canada. These are not wholly government sponsored, but rather joint ventures between the Department of Communi-

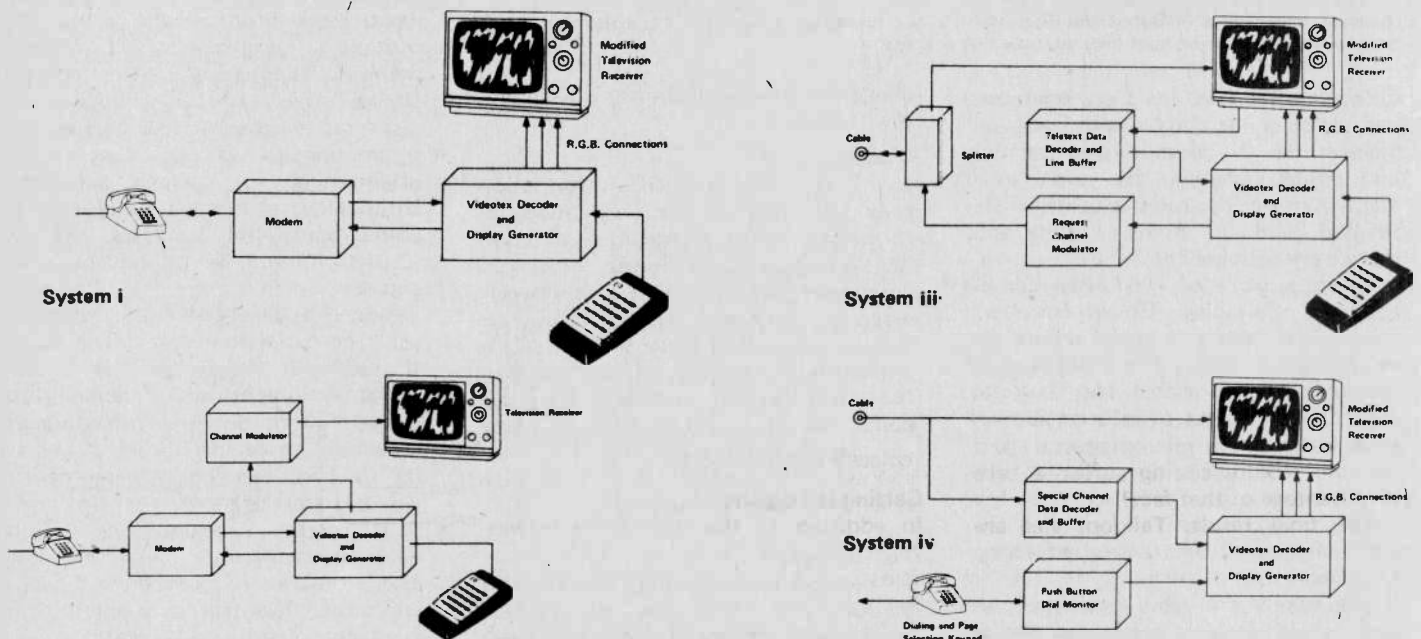

Fig.2. A few simple ways that Telidon can be utilized.

cations and local interests.

These trials are:

- The disposition of 55 terminals throughout schools and homes in Ontario to familiarize educators with the benefits of the system. The program started in January of this year and is sponsored by the Ontario Educational Communications Authority.

- In May of this year, the Manitoba Telephone System installed 37 cable fed terminals in South Headingley, Manitoba. By the end of 1980 over 150 terminals will be in place, providing several thousand pages of news, weather and sports news as well as video games, recipes and local entertainment.

- Calgary will get 120 terminals. This project is sponsored by Alberta Government Telephones.

- This fall St. John will get 20 terminals. The New Brunswick Telephone Company will spend \$800,000

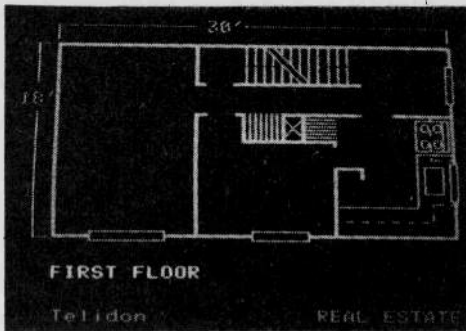

While originally intended for a videotex system, Telidon is also useful to engineers and designers for preparing, processing and storing graphics. A usual approach is to layout the diagram on paper (usually with grid) and transfer the coordinates to the screen using light pen, keyboard or a joystick.

over the next two years on what they call 'Project Mercury'. Additional services such as computerized medical and police signalling, fire and burglar alarm monitoring, remote utility meter reading and a home maintenance service are anticipated.

- In January of 1981, Bell Canada and the Canadian Government will spend \$10 million on trial comprising of 1,000 terminals. The trials will be conducted in Montreal and Toronto. Over 100,000 pages of information will be available.

- In mid 1981, the town of Elië, Manitoba will get 150 user terminals. What's unique about this system is that information will be transmitted via optical fibres.

Ultimately the fibre optic network will provide private telephone service, FM radio, and multi channel television.

- A Montreal cable TV company will

start its own system in late 1981. The system, sponsored by Télécable Vidéo-tron, will use packet-switching and multiplexing techniques to produce a fast, interactive, two-way system. A full range of services is to be provided.

### Telidon Goes South

What's really encouraging is that Telidon has been selected for the first major videotext field trials in the US.

The trial is being conducted at PBS station WETA in Washington, DC and is being sponsored by the Corporation for Public Broadcasting, the National Telecommunication and Information Administration and the Department of Health, Education and Welfare.

The system will consist of 60 terminals manufactured in Canada by Norpak Limited. In addition, TV Ontario a major educational network has offered



A typical Telidon Information provider (I.P.) terminal. This unit was manufactured by Norpak Ltd., who have been in on Telidon since it was announced. As the system grows you can expect to see I.P. and user terminals from such manufacturers as Electrohome and Northern Telecom.



incorporated. In fact, by the time Telidon comes into general use, probably around 1986, you can expect to spend around \$300 for a terminal, or sets may even be sold with the terminal incorporated in them.

By the time Telidon hits the average consumer keyboards will be remote instead of wire connected to the terminal by wires. Response time will be quicker and animation capabilities will be greatly improved.

Already there is a new generation of Telidon information provider terminals to take advantage of these capabilities as well as increase the ease with which the videotex pages can be created.

### And Finally . . .

Telidon is a remarkably flexible system. Its software structure allows the introduction of a higher resolution terminal without obsolescing older terminals. Unlike other systems, Telidon is not restricted in the number of characters it can display, or how they may be oriented or even appear on screen. Ultimately, as terminal resolution and colour capability increases, the only restrictions will be a publisher's imagination.

Telidon has generated a lot of interest at an international level. The CCITT (Consultative Committee on International Telegraphy and Telephony) has placed Telidon on an even footing with older and more established systems in its deliberations on an international videotex standard.

If Telidon is adopted as an international standard, it means that Canadian industries and services will have an enormous advantage in supplying hardware and software to the world.

And you thought TV was bad for the kids . . .

educational material already prepared in the Telidon format.

### VISPAC

In 1979, 20 potential information providers formed the Videotex Information Service Providers Association of Canada. As mentioned some 200 companies are interested in supplying videotex services. These firms are becoming involved either because of the opportunity involved or because they fear their present mandates (as cable companies etc.) will be eroded. Many are working closely with field trial sponsors to establish their data base structures as early as possible.

### To The People

At present, a user terminal costs about \$1,000 plus. This cost will drop as production volume increases. Expect even greater decreases when VLSI (Very Large Scale Integration) technology is



### Interested?

If you're interested in the various field trials around the country, here are a few addresses you might want to check out.

**Elie Project**, T. Phillips, Manitoba Telephone System, Area B 301, P.O. Box 6666, Winnipeg, Manitoba R3C 3V6. (204) 947-8479

**Project Ida**, T. Phillips, Manitoba Telephone System, Area B 301, P.O. Box 6666, Winnipeg, Manitoba R3C 3V6. (204) 947-8479

**Project Mercury**, A.C. Pendleton, Project Manager, Advanced Services, New Brunswick Telephone Company, P.O. Box 1430, St. John, New Brunswick E2L 4K2. (506) 693-6719

**Project Vista**, J. Campbell, Bell Canada, 5th Floor, 25 Eddy Street, Hull, Quebec J8Y 6N4. (819) 776-7633

**Project Vidon**, D. Klappstein, Alberta Government Telephones, Floor 30 F, 10020-100 Street, Edmonton, Alberta, T5J 0N5. (403) 425-3688

**Telecable Videotron**, Jean-Charles Dagenais, 3700 boul. Losch, Saint Hubert, Quebec J3Y 5T6. (514) 656-2111

**Telidon Project**, Maria Cioni, Ontario Educational Communications Authority, P.O. Box 200, Station "Q", Toronto, Ontario M4T 2T1. (416) 484-2930

### Bibliography

Bown, H.G., O'Brien, C.D., Sawchuk W., Storey, J.R., **A General Description Of Telidon: - A Canadian Proposal For Videotex Systems**. CRC Technical Note No. 697-E (French version No. 697-F), December 1978.

Bown, H.G., O'Brien, C.D., Sawchuk, W., Storey, J.R., **CRC Technical Note No. 699-E (French version No. 699-F)**. November 1979. *(An excellent software reference for anyone who wants to build their own system).*

Parkhill, Douglas F., Assistant Deputy Minister (Research), **An Overview Of the Canadian Scene**. Department Of Communications. Viewdata '80, 26-28 March 1980.

Information Services, **Telidon Information Kit**. February 1980. *(A collection of informative press release blurbs.)*

These publications can be obtained by writing to: Telidon Program, Room 2000, Journal Tower South, 300 Slater St., Ottawa, Ontario K1A 0C8. ●



Two young patrons of Cedarbrae District Library, Scarborough, Ontario, are given a demonstration by a staff member during the first North American field trial of Telidon, a joint project of the federal Department of Communications and the Ontario Educational Communications Authority. Present experiments are being conducted to explore potential Telidon applications for public access through both a broadcast mode and interactive mode for computer based learning systems and consumer information. Telidon is now being telecast to Ontario viewers via the OECA's educational television network, TV Ontario.

IT FEELS GREAT!!!

affix  
your  
picture  
here



Everyone has a favourite T-shirt. It's the one that's always at the top of the shirt drawer and always fits just right.

If you don't have a favourite, get an ETI T-shirt.

The shirt itself is a poly-cotton knit and Canadian made. Sizes are small, medium and large.

Send \$5.50 (postage & handling included) to:

ETI T-SHIRTS, Unit 6, 25 Overlea Blvd., Toronto, Ont. M4B 1B1.

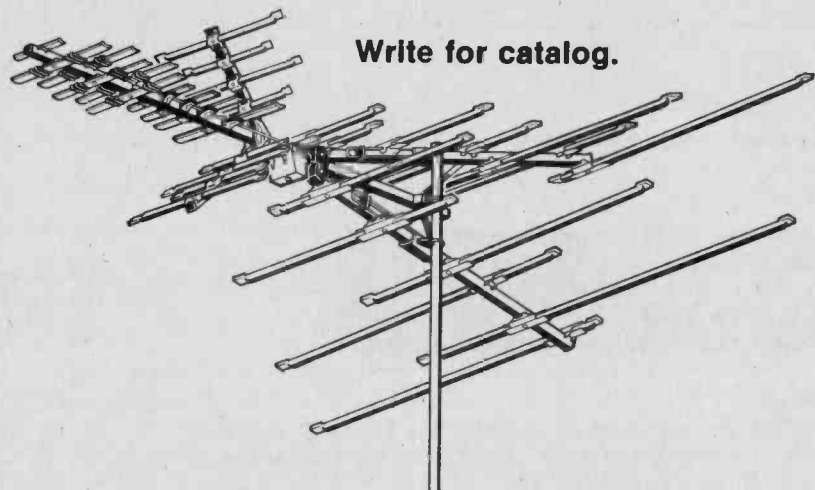

Write for catalog.

High performance, high quality  
**WINEGARD® ANTENNAS**  
TELEVISION SYSTEMS  
**AND PREAMPLIFIERS**

Stocked in Canada by

**OMNITRONIX LTD./WINEGARD**  
2056 S. Service Road  
Dorval, P.Q. H9P 2N4

# Electronics Today

INTERNATIONAL  
OCT 1980



NEXT MONTH

### Metal Locator

Whether you're a veteran beach-comber, or you're just lost your car keys in the high grass, you need a metal locator. If this is the case, then have we got a unit for you. Next month, a simple yet reliable BFO unit without difficult coil winding.

### Audio Amps

Finding the right audio amplifier circuit for a given application can be a problem. Next Month all your problems will become trivial with this sound feature.

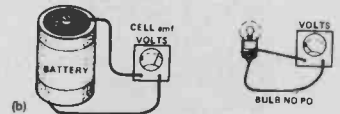
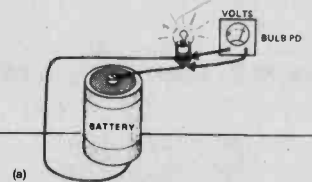
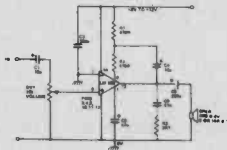

### Into Electronics

The first part of our new major series for the neophyte.



### Synthesizers

The theory behind the sounds; Tim Orr presents the basic principles and problems behind music synthesis.

### Solar Cells

Solar Cells are one of the most efficient forms of direct conversion of the sun's energy. Next Month we look at the principles behind their operation.

### Linear Scale Capacitance Meter

Another easy to build piece of test gear. This one measures up to 10u in 6 ranges.

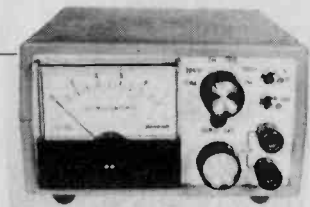

### Baby Alarm

Save on Junior's lung power with this simple yet sensitive remote amplifier. Fill the house with the sound of your loved one!

# HOME SECURITY SYSTEM

Protect your private castle against fire, thugs and thingies with this anti-disaster unit.

THE HOME SECURITY UNIT forms the heart of a general-purpose house or office protection system. When it is coupled to suitable input sensors (microswitches, pressure mats, window foil, thermostats, etc) and an output sound generator (a siren or bell) it gives a high degree of protection against burglars and frontdoor thugs, as well as giving fire protection.

The unit is designed around a single low-cost CMOS chip, and draws a very low quiescent current from its 12 volt battery power supply. Particular care has been taken to ensure that the design has good operational reliability, and consequently it has a high degree of immunity against false alarms from lightning strikes, radio interference, etc.

## The Basic Unit

The basic unit incorporates the system's power supply and all the electronic circuitry, including two siren-driving relays, and is intended to be used in conjunction with a number of external sensors and a siren or bell. The unit uses a 12 volt battery as its power supply, and the battery should be capable of powering the system for about one year if the siren is not activated. The unit is designed to give self-latching alarm operation, so once it is activated it continues to sound until it is turned off by the owner or until the supply battery runs flat.

The siren can be activated via either of two relay circuits. One of these is associated with the 'burglar alarm' side of the home security unit, and is only active when the unit is turned to the full ON mode. The other relay is permanently enabled, i.e., when the unit is in either the STANDBY or the ON mode, and can be activated via either thermostat FIRE sensors or via push-button PANIC switches scattered around the house. These panic buttons give a high degree of protection against front door thugs, etc.

Among the many features of the unit are a STANDBY/ON keyswitch on the front panel, a siren test button, a battery test button and lamp, a reset button, and a LED sensor-fault indicator.

Another important feature is a 50 second delay facility, which ensures that the anti-burglar system does not become fully enabled until 50 seconds after initial switch on, thus giving the owner plenty of time to check that there are no sensor faults via the panel-mounted

LED, and then walk over pressure mats or through *armed* doors without sounding the alarm. The system becomes fully enabled at the end of the 50 second period, and the alarm then sounds and self-latches instantly if any sensor is subsequently activated. The system can be temporarily disabled for another 50 second period, to facilitate building re-entry, etc., by momentarily operating a remote RE-ENTRY switch, which can take the form of either a key or a concealed push button.

## Sensors and Sirens

The Home security Unit can be used with a variety of types of input sensors, which can be coupled into the system via terminal strips mounted on the rear of the unit. The anti-burglary sensors can take the form of normally-open parallel-connected devices such as pressure mats, and normally-closed series-connected devices such as microswitches, magnetically-activated reed relays, and window foil strip, etc. Fire protection can be obtained by wiring normally-open thermostats in parallel, and thug protection can be obtained by wiring normally-open push-button PANIC switches in parallel.

The system's output sound generator can be any 12 volt electro-mechanical or electronic siren or bell. Figure 2 shows the practical circuit of an electronic siren that produces a warbling sound similar to that of an ambulance or police car, and which generates about 4 watts into an 8 ohm speaker or 12 watts into a 3 ohm speaker.

The systems siren or bell must be mounted external to the main unit, and can be tested at any time by pressing a non-latching SIREN TEST button mounted on the main unit.

## Construction

The major part of the electronic circuitry, including the two relays, is assembled on a single PCB, and construction should present few problems so long as care is taken to observe polarities of the electrolytic capacitors and the semiconductor devices. The two relays, which are miniature plug-in 'continental' types, are mounted on the board via 0.1 inch PCB mounting sockets. The relays are 12 volt types with coil resistances greater than 120R (185R on our prototype).

The completed PCB must be mounted in a suitable case, together with the 12V supply battery that measures 5 1/4 x 5 1/4 x 2 1/2 inches. We built our prototype unit

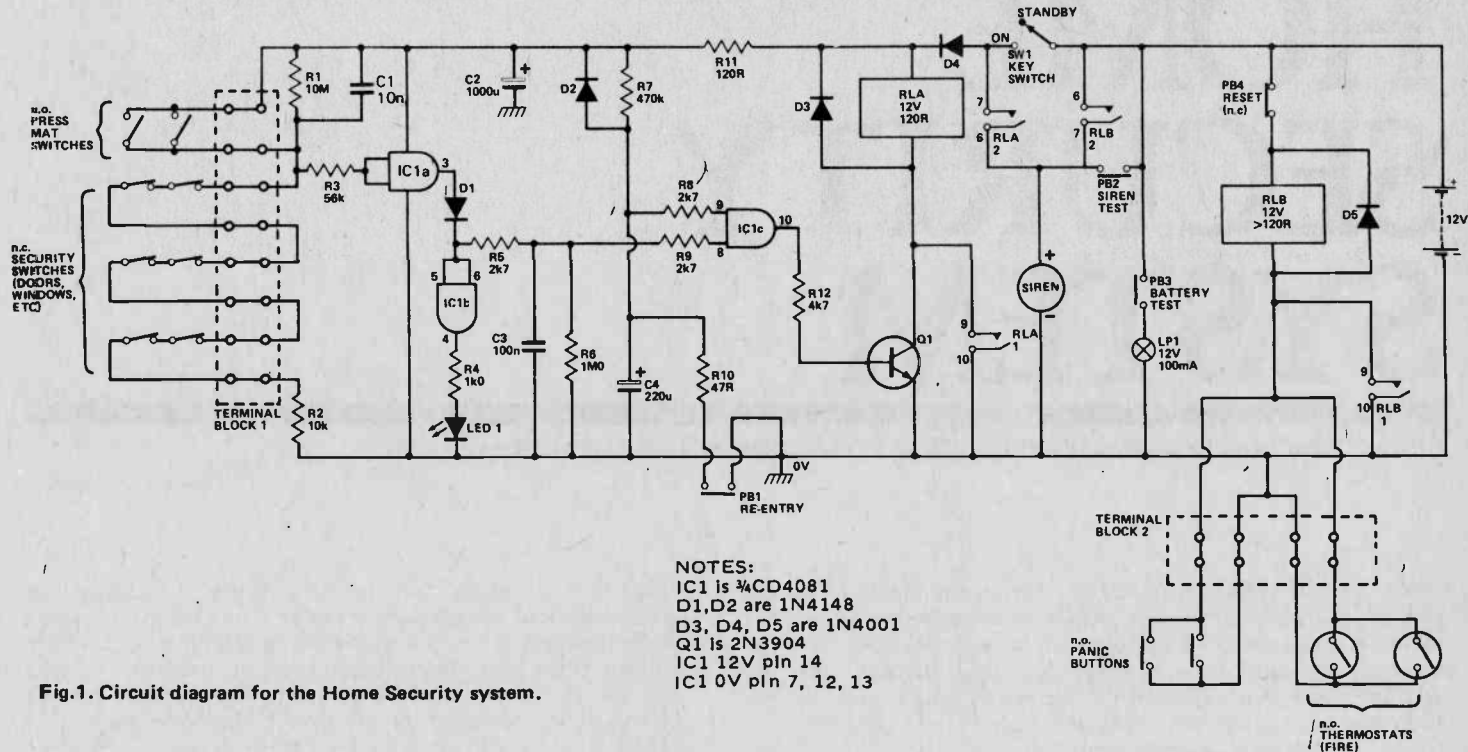

Fig. 1. Circuit diagram for the Home Security system.

## HOW IT WORKS

The circuit of the unit can be broken down into two discrete sections, with the PANIC and FIRE alarm circuitry to the right of SW1, and the burglar alarm system to the left. The panic and fire section of the unit is permanently enabled, and basically comprises relay RLB and the parallel-connected normally-open fire and panic 'switches', which are wired in series with the coil of RLB across the power supply. If any of these switches become closed the relay turns on and is self-latched via contacts RLB/1, and activates the siren via contacts RLB/2. Relay RLB can be unlatched and turned off again, provided that all sensor switches are open, by momentarily opening normally-closed RESET switch PB4. The siren can be given a non-latching test at any time by closing PB2, and the battery condition can be roughly checked via LP1 by closing PB3.

The anti-burglar section of the unit is designed around IC1-Q1 and relay RLA, and is supplied with power via the D4-R11-C2 decoupling and smoothing network, which ensures that the circuit is not adversely affected by large supply line transients generated by the siren. IC1 is a CD4081 quad 2-input AND gate CMOS chip. Only three of the available gates of the IC are used in this application.

IC1a is used as a high-impedance non-inverting input buffer. Its input (and output) is normally held at near-zero volts via R1-R2 and the normally-closed security switches, but is pulled

high via R1 if any of the NC switches go open circuit, or is pulled high directly if any NO input switches are closed. The output of IC1a is fed to LED 1 via D1 and IC1b, and is also fed to one of the input terminals of AND connected IC1c via D1 and the R5-R6-R9-C3 network. The other input of IC1c is derived from a simple time constant network formed by C4 and R7, which disables IC1c for the initial 50 seconds after turn-on of the unit. The output of IC1c is fed to the relay via Q1. The complete sequence of operations is as follows.

At the moment of system turn-on IC1c and the relay are disabled via the C4-R7 network, but IC1a and IC1b are enabled. If any of the input sensors are defective at this time, the input and output of IC1a go high and LED 1 is driven on via IC1b. If no sensor faults are present, the owner has 50 seconds in which to pass through 'protected' areas before the alarm will sound. If, at the end of this period, any sensor is activated, the input of IC1a will go high and drive relay RLA on via IC1c and Q1. Once it is activated, RLA self-latches via contacts RLA/1 and activates the siren via contacts RLA/2. The siren then continues to sound until the supply battery runs flat: this mode of operation is considered to have considerable practical advantages over the time-controlled auto-turn-off systems adopted in some commercial alarm units.

Note in the circuit that R1-C1 and R6-C3 are used as simple transient-suppressing networks, and protect the circuit against false-triggering.

into a case with overall dimensions of 6 x 11 x 3 inches. Components SW1, PB2, PB3, PB4, LP1, and LED 1 are mounted on the case front panel, and two screw-type terminal strips or blocks are mounted on the rear to facilitate connections to the systems sensors, etc.

Pay special attention to the circuit interwiring, taking care to relate the component overlay to the circuit diagram. When construction is complete, wire a suitable siren or bell in place, and give the unit a functional check by turning key switch SW1 to the ON position, with no anti-burglar sensors in place. LED 1 should illuminate, but extinguish when a short is placed between R2 and the junction of R1 and R3. The alarm should operate and self-latch approximately 50 seconds after initial switch-off if this short is removed. This timing period is determined by the C4 value.

With the key switch SW1 in the STANDBY position, the alarm should operate and self-latch when a momentary short is placed across the PANIC BUTTON or THERMOSTAT connections of the sensor terminal strip, and turn off again when PB4 is momentarily opened. When the above tests are satisfactory the unit is ready for installation in the home.

If you want to build the electronic siren circuit of Fig 2, do so at this stage. Construction of this circuit should present no problems.

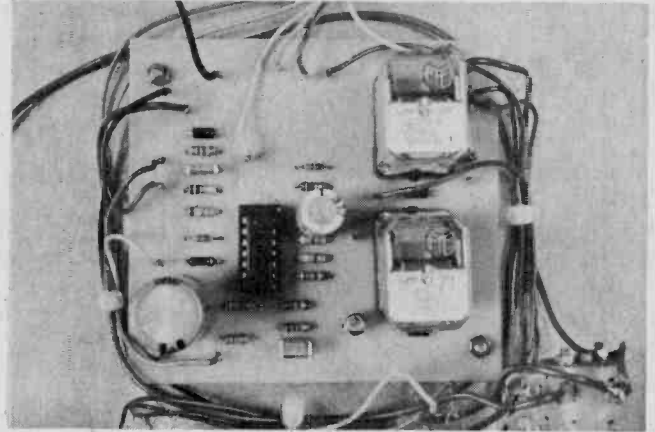

Close up of the electronics. In circuits of this type always use the best quality components, false alarms are both irritating and embarrassing.

### Installation and Use

The installation of a home security system is a fairly major undertaking, with many fine points to consider and individual decisions to be made regarding the degree of protection that is required and the types of sensors that are to be used, etc. An article outlining the

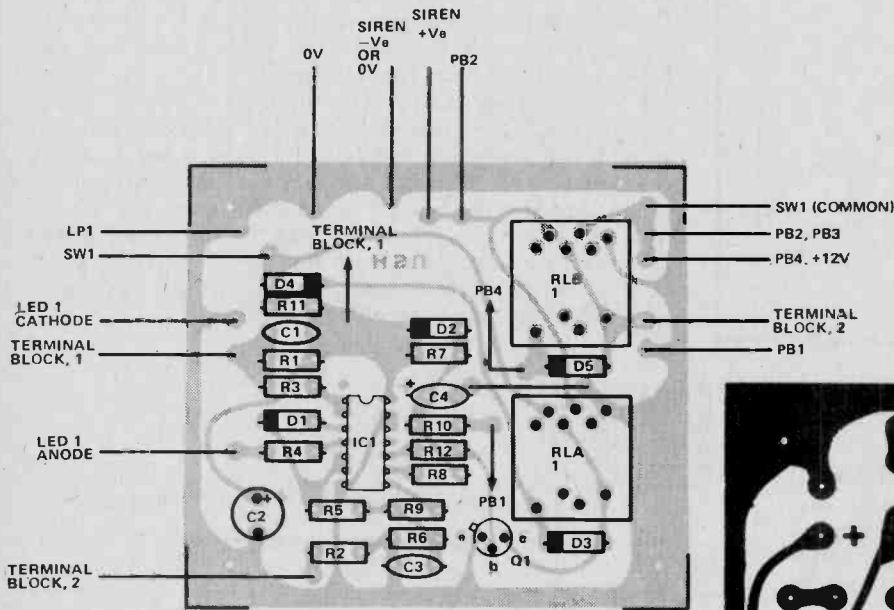
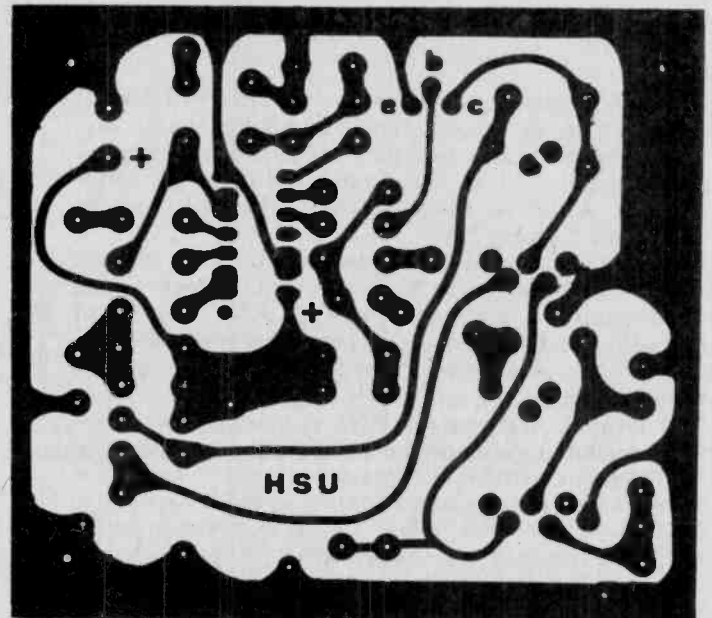

Fig.2. PCB overlay for the Home Security System, note the position of all polarised components.

Fig.3. PCB foil pattern for the Home Security System.



## PARTS LIST

## HOME SECURITY UNIT

## RESISTORS (All 1/4W 5%)

R1	10M
R2	10k
R3	56k
R4	1k $\Omega$
R5, R8, R9	2k7
R6	1M $\Omega$
R7	470k
R10	47R
R11	120R
R12	4k7

## CAPACITORS

C1	10n polycarbonate
C2	1000 $\mu$ Electrolytic (PCB mounting)
C3	100n polycarbonate
C4	220 $\mu$ electrolytic (PCB mounting)

## SEMICONDUCTORS

IC1	CD4081
Q1	2N3904
D1, D2	1N4148
D3, D4, D5	1N4001

## MISCELLANEOUS

Siren (see text)

2 off — RLA, RLB, 12V 200R coil resistance

SW1 — Key switch.

PB1, PB2, PB3, push button switches (momentary action)

PB4 push button switch (normally closed contacts)

12V battery.

8 way + 3 way terminal blocks.

Case to suit.

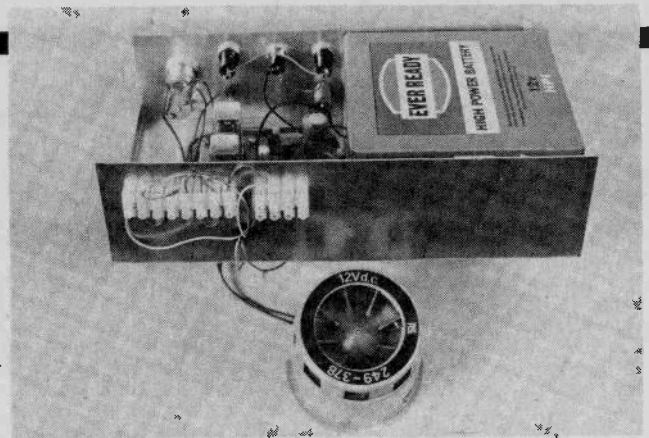

The Home Security System connected up to motorised siren.

generator super-secure, however, since the system will already have failed in its prime purpose if an unauthorised person is able to get close enough to disable its heart.

If a re-entry switch is mounted on the front door of the house, the wiring between the switch and the main unit should be carefully concealed. If required, a number of re-entry switches can be wired in parallel so that, for example, the system can be temporarily disabled from either the front door or the main bedroom.

The alarm system is very simple to use. The PANIC and FIRE alarm side of the circuit is permanently enabled, and can be operated at any time. The anti-burglar section is enabled only when the main key switch is moved to the ON position. If the panel-mounted LED lights at the moment of turn-on it means that part of the sensor system is either open or closed when it should not be, possibly due to an open door or a chair resting on a pressure mat, etc. The fault must be rectified before the system is put to full use.

If you leave the house or pass through a protected area after turning the system on, remember to use the re-entry facility before returning to the unit, or you'll sound the alarm and annoy the neighbours.

## NOTES:

D1 is 1N5401

D2 is 1N4001

Q1 is TIP3055

Q2 is 2N3906

IC1 is NE555

principles of installation is presented after this project and should be read in conjunction with the present story. In short, however, it is up to the individual reader to work out the details of his own sensor and alarm generator networks, and then couple those networks up to the main Home Security Unit.

The anti-burglar sensors must be coupled to the unit via terminal block 1, and the fire and panic sensors must be coupled via terminal block 2. Any number of normally-open (NO) sensors can be wired in parallel; and any number of normally-closed (NC) sensors can be wired in series.

The main unit is best mounted in a central part of the home, such as on a landing or at the foot of the stairs, so that it can be operated with maximum convenience. The alarm sound generator should be mounted fairly close to the unit, to minimise power losses in the connecting leads, and these leads should either be concealed or mounted in armoured sleeving so that they can not be readily cut. Excessive attention does not need to be given to the matter of making the unit and the sound

Fig.4. Circuit diagram for the optional electronic siren.

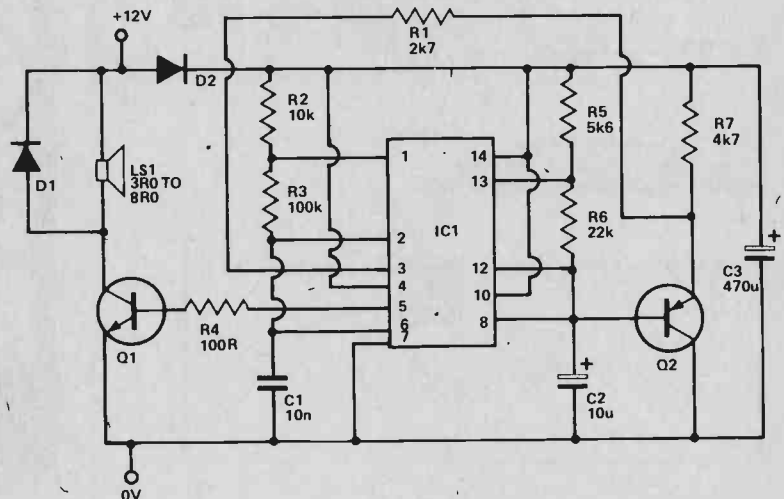

## HOW IT WORKS

IC1, an NE555, contains two so-called 'timer' circuits of the 555 type. One of these timers is available via pins 1 to 6 on the left side of the IC, and the other is available via pins 8 to 13 on the right side of the IC. Pins 7 and 14 are the supply ground and supply positive terminals respectively of the IC.

In the electronic siren circuit, both timers are configured as free-running astable multivibrators. The left hand astable is used as a square wave generator, using timing components R2-R3-C1. It oscillates at a centre frequency of about 950 Hz, and has its output fed to the speaker via R4 and power transistor Q1.

The right hand astable is used as a triangle-wave generator, using timing components R5-R6-C2, and oscillates at about 2.5 Hz. The triangle-wave output is taken from across C2 via emitter follower Q2 and is fed to 'control voltage' pin 3 of the left hand astable via R1, where it modulates the frequency of the left hand astable and causes its frequency to sweep through the range 800 Hz to 1100 Hz two and a half times per second. The resulting output sound of the speaker resembles that of an ambulance or police siren.

The speaker used in the circuit can have any impedance in the range 3Ω to 8Ω. The circuit output power depends on the speaker impedance, and is about 4 watts on 8Ω or 12 watts on 3Ω. Diode D1 is used to damp the back EMF of the speaker, and protects Q1 against possible damage. D2 and C3 ensure that the main oscillator circuitry is not influenced by the speaker transients.

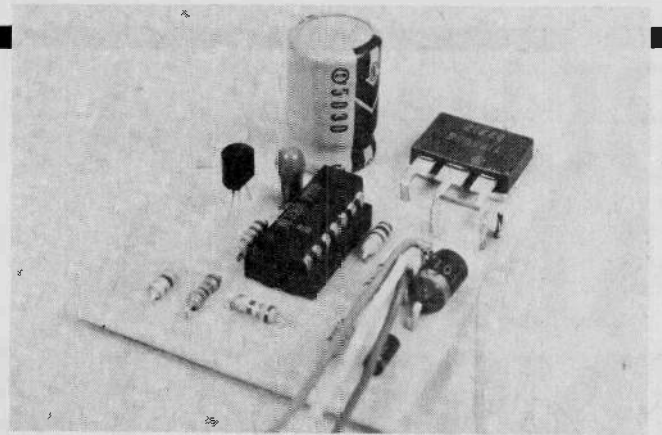

The assembled siren board, it will either fit in the case or in a remote location with the speaker.

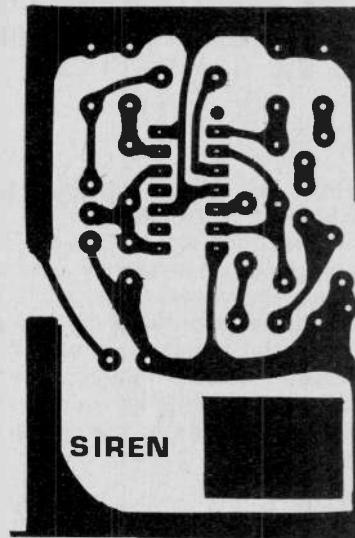

Fig.6. PCB foil pattern for the optional electronic siren.

## PARTS LIST

### SIREN

#### RESISTORS (All 1/4W 5%)

R1	2k7
R2	10k
R3	100k
R4	100R
R5	5k6
R6	22k
R7	4k7

#### CAPACITORS

C1	10n Polycarbonate
C2	10μ Tantalum
C3	470μ Electrolytic

#### SEMICONDUCTORS

IC1	NE555
Q1	TIP3055
Q2	2N3906
D1	IN5401
D2	IN4001

#### MISCELLANEOUS

LSI	3R0-8R0
-----	---------

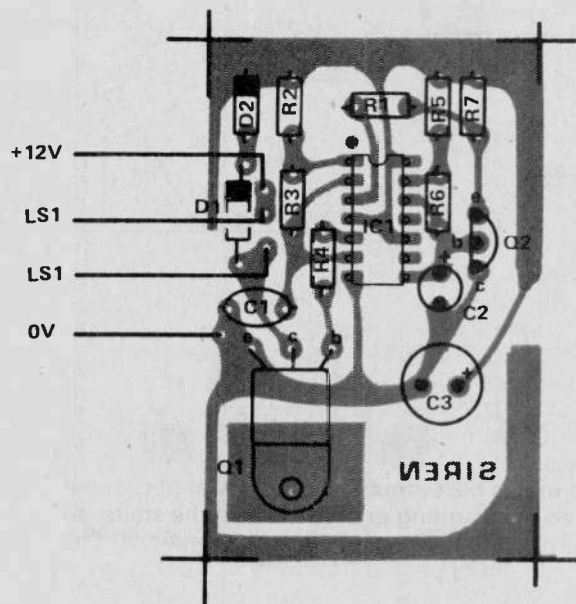

Fig.5. Overlay diagram for the optional electronic siren.

# BURGLAR ALARM INSTALLATION

If you decide to build this month's Home Security Unit project, you'll need to learn the basic principles of security system installation. Ray Marston explains in the next few pages.

STATISTICS SHOW THAT the average Canadian has a one-in-four chance of being burgled, beaten up, or burnt in his own home at least once in his lifetime. The chances of such disasters occurring can be greatly reduced by taking a few simple security precautions, such as fitting good locks on all external doors and closing all windows at night and when the house is empty. The chances can be reduced even more by installing a well thought out home security system. With the latter option in mind, let's look at some of the basic principles of home security system installation.

## Don't Get Your Fingers Burnt

stupid things like lighted cigarettes, falling onto the rugs, overheated electrical appliances, and carelessly placed tea cosies or towels igniting from the heat of gas pilot jets, etc.

The first line of defence against fire is common sense, and the second line is a fire alarm system. The fire alarm system can be a sophisticated affair, including smoke

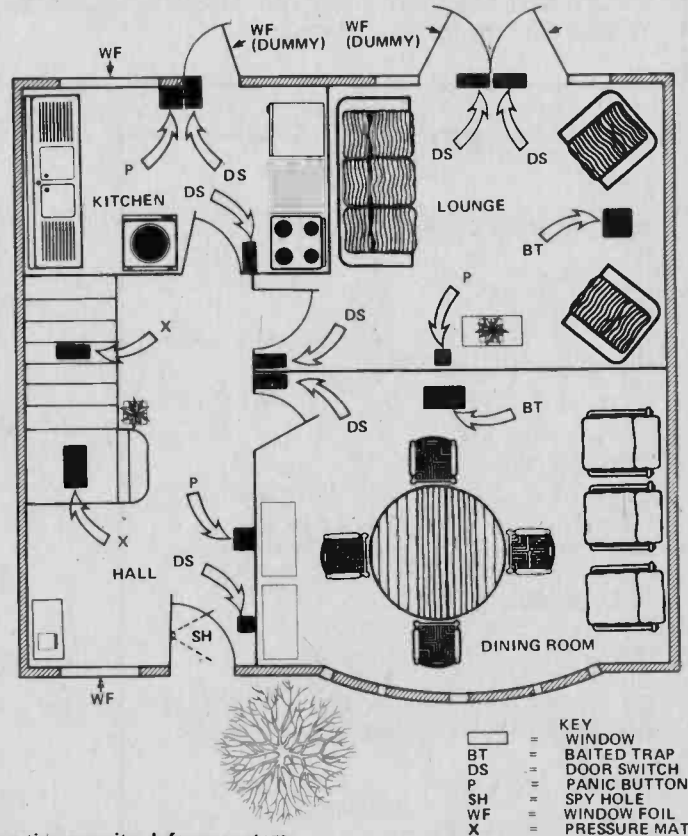
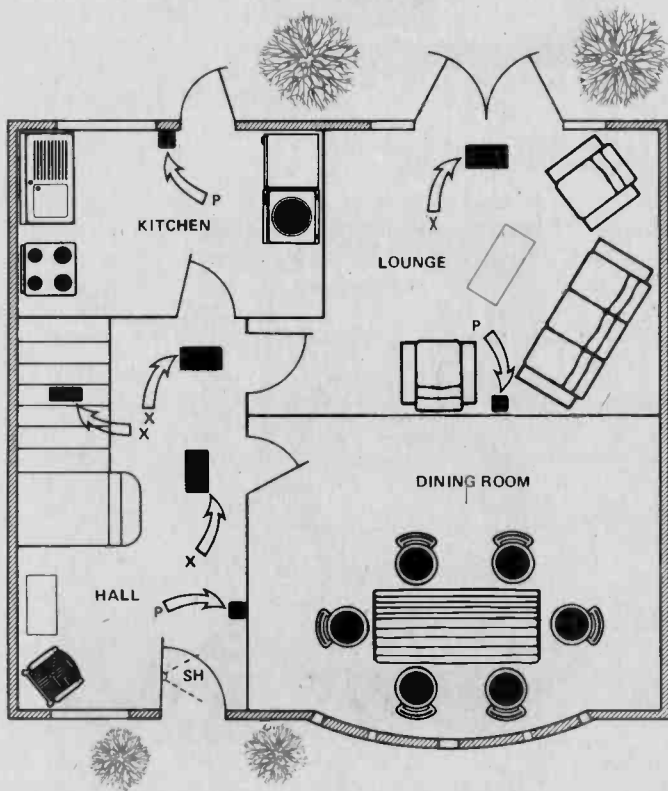

Fig. 1. Ground-floor plans of a medium-sized mid-terrace house with two alternative security defence systems. (a) House with minimal 'SPOT' and 'PANIC' defences. (b) House with a high level of 'PERIMETER' and 'SPOT' defences, plus minimal 'PANIC' defences.



and gas detectors, or a simple outfit consisting of a number of normally-open thermostats, all mounted at ceiling height and connected in parallel, and arranged so that they complete an alarm circuit if any of them close. Any type of fire alarm system is better than none at all, provided that the system is reliable. The Home Security Unit has a fire alarm facility, and is designed for use with any number of parallel-connected thermostats.

### Look Out, Look Out, There's a Thug About

Thuggery is a very real menace to the householder. It normally occurs when one or more males attack the occupier as he (or she) either opens the front door in response to a call, or occurs shortly afterwards when the strangers have gained entry to the house on the pretext of reading a gas meter or selling insurance, etc. Occasionally, the attacks occur late at night following a break-in.

The first line of defence against the thuggery menace is common sense and possibly a 'spy hole' device and a security chain fitted to the front door. An excellent second line of defence is a permanently armed system of PANIC buttons positioned close to likely attack points (front and rear doors, the TV lounge, and the main bedroom) and arranged to activate a self-latching alarm when they are momentarily activated. The Home Security Unit is designed for use with any number of parallel-connected normally-open PANIC button switches (ordinary push-button switches).

### System Reliability

The most important parameter of any security system is its reliability, or immunity to false alarms. Ninety-nine percent of all burglar alarm soundings are false alarms. Systems that frequently give false alarms tend to be ignored by both the police and their owners.

'Sophisticated' systems, such as radar, ultrasonic, and light-beam types, tend to be significantly less reliable than the 'cruder' types that depend on the activation of microswitches and reed-relays, etc., for their operation. Many alarm systems can be false-triggered by electrical interference from lightning flashes, near-by electric motors, or electric lighters operated close to their sensors. The Home Security Unit has been designed to have a high reliability factor.

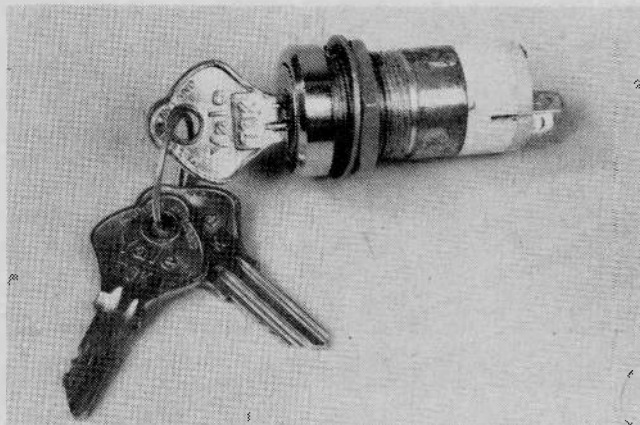

Fig.2. A good quality key switch is an essential item in any home security system.

### Protecting Your Castle

So let's assume that you've decided to instal the super wonderful Security Unit in your home, and have formed some idea of the degree of protection that you need. How do you go about planning the layout of your security switches and sensors?

Any building can, for our present purposes, be regarded as a box that forms an enclosing perimeter around a number of interconnected compartments. This perimeter 'box' is the shell of the building, and contains walls, floors, ceilings, doors and windows. To commit any crime within the building the intruder must break through the perimeter, which thus forms the owners first line of defence.

Once an intruder has entered the building he can move from one room or 'compartment' to the next only along paths that are pre-determined by the layout of internal doors and passages. In moving from one compartment to the next he must inevitably pass over or through certain 'spots' in the building, as is made clear in Figure 1a, which shows the ground-floor plan of a medium-sized mid-terrace house. Thus, to move between the kitchen (a likely break-in area) and the lounge he must pass through three 'spots' comprising the kitchen door, adjacent point 'X', and the lounge door. These typical 'spot' points form the owner's second line of defence.

The house owner can thus obtain protection by using full or partial 'perimeter' defence, or by using 'spot' defence, or by using a combination of these two methods.

'Perimeter' defence sensors include microswitches or reed-relay / magnet combinations which can be fitted to external doors and windows, and window foil which can be fitted to the glazing on external doors, windows, and skylights. 'Spot' defence sensors include pressure mat switches that can be fitted under rugs or carpets, microswitch or reed-relay / magnet door switches, and 'baited traps' comprising an attractive item (such as a clock) placed on top of a concealed microswitch that activates when the item is removed.

When planning the installation, the house owner must try to think like a burglar. Normally, the burglar enters a house from an easy access point that is obscured from the view of the neighbours, ie, a back door or window. Often, he breaks in using tools 'borrowed' from the owner's shed or garage, so these two places should

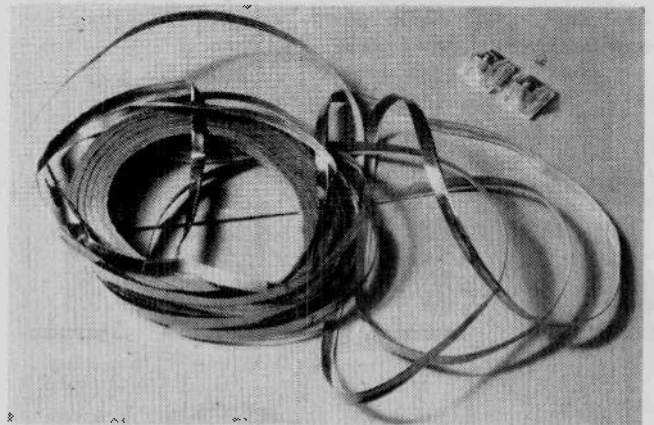

Fig.3. Self-adhesive window foil can be fixed to most types of glazing. It hooks into the security system via special connector blocks.

be included in the owner's defence system. Invariably, the burglars first action on entering the property is to secure a rapid escape route, ie, to open the back door. He then starts hunting for stealable goodies.

**Two examples**

Figure 1 shows two alternative ways of installing security defence systems in the ground floor of a medium-sized mid-terrace house. In both cases anti-thuggery protection has been obtained by installing a 'spy hole' device in the front door, and by fixing PANIC buttons at three likely attack points. The houses differ considerably, however, in their methods of burglary protection.

In the case of Fig 1a the owner has reasoned that a burglar is most likely to enter the house via the French windows of the lounge, or via the kitchen door or window. If he enters via the French windows he will be detected via a strategically placed pressure mat, but if he enters via the kitchen he will find nothing worth stealing so will open the kitchen door into the hall, where he will subsequently be detected via another pressure mat. In the unlikely event that the burglar enters the house from the front, he will eventually be detected via a pressure mat located in the hall, adjacent to the dining room door, or via a small pressure mat placed on the stairs. Note that this house owner has made no attempt to keep the burglar out of the house, but has used 'spot' defences to detect him once he has entered. This simple type of installation is highly cost-effective, and gives a reasonably high degree of protection.

By contrast, the house in Fig 1b uses an extensive perimeter and spot defence system. It's owner has decided to try to scare off potential burglars by fixing clearly visible window foil to selected areas of glazing at the front and rear of the house. Some of this foil is genuinely connected into the alarm system, and some is 'dummy'. All external and internal doors are protected by door switches, and two pressure mats are placed on the stairway. Additionally, baited traps are placed in the lounge and dining room. This house has excellent protection.

**Hints and Tips**

Pressure mats are excellent 'spot' defence devices, easily hidden under rugs and carpets. Both standard and stair types are available. Note, however, that they are fairly sensitive, and can easily be set off by large cats and dogs, and by very small elephants. If you own any of

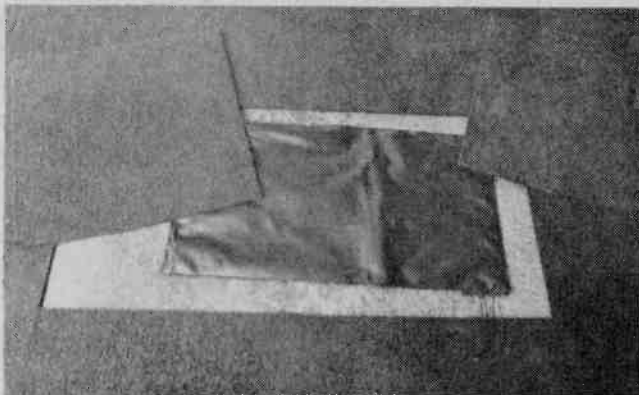

Fig.4. Pressure mats can be hidden under rugs and carpets.

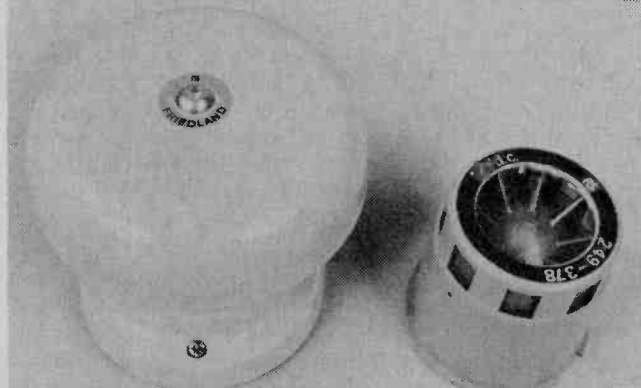

Fig.6. A powerful alarm bell or siren is an essential part of any home security system.

these creatures, make sure they are confined to sensible areas when the mats are enabled.

Window foil is an adhesive-backed aluminum strip that bonds to glazing. It couples into the alarm system via special connector blocks. The strip breaks when a window is shattered.

Door/window switches usually come in the form of a reed-relay/magnet combination. The magnet is installed in the door or the opening window, opposite the reed-relay that is installed in the frame. Most commercial units of this type have two sets of output wires in the reed-relay unit, one set giving normally-open operation, and the other giving normally-closed operation.

When you plan your installation, don't forget to make some provision for by-passing the front door protection system, so that you can re-enter the house without sounding the alarm: this facility is provided in our unit by the BY-PASS switch.

Don't forget to protect your shed and/or garage.

When you install your system, try to keep all wiring neat and concealed. Thoroughly test each section of the wiring as it is installed.

If possible, fit your system with both internal and external alarm bells or sirens. The external unit should be mounted in a prominent position at the front of the house, where it will act as an excellent burglar deterrent. Special weather-proof housings are available. ●

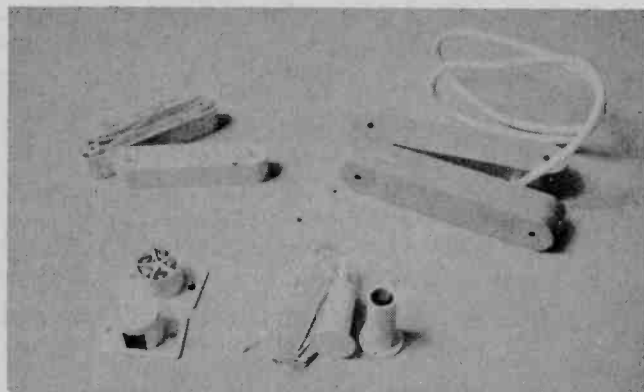
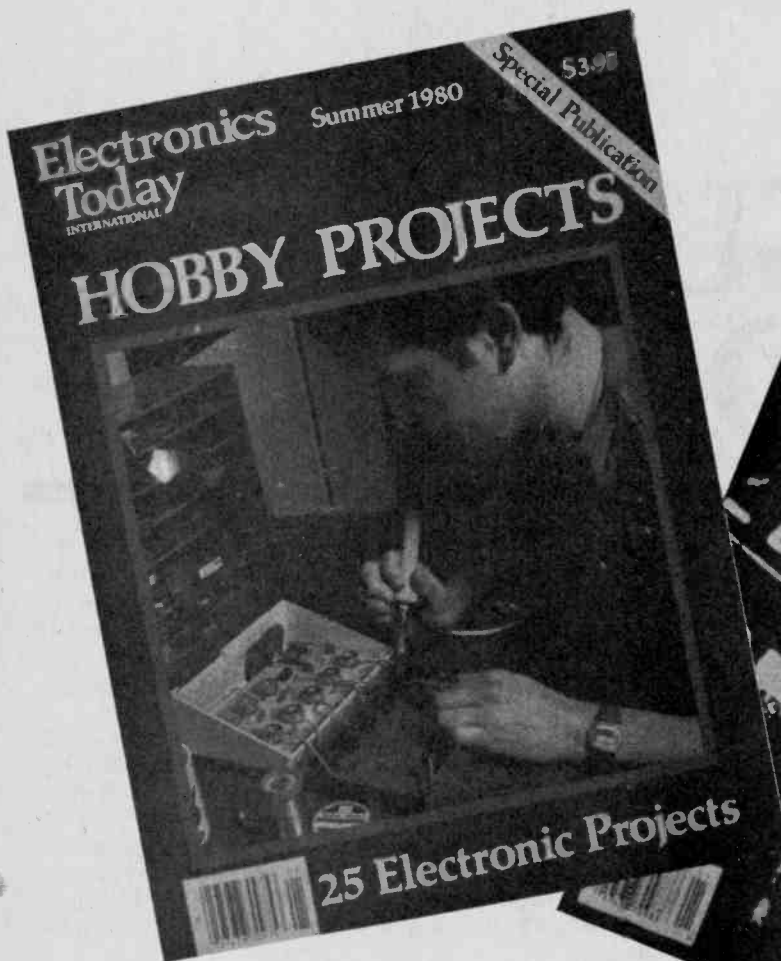

Fig.5. Reed-relay/magnet combinations, or door/window switches, are available in a variety of sizes. The smallest can be used on windows, the largest on garage doors.

\*\*\*\*\*

# Specials From ETI, Specially For You



## Hobby Projects

**\$3.95**

A compendium of over twenty-five projects that we've never published in the magazine. All Hobby circuits use readily available components, making these the ideal project for the novice and experienced constructor alike. Projects include Tantrum preamp control unit, Starburst light show, Shark game, LED Tachometer and 21 more!

## Electronic Circuit Design

**\$3.95**

Why be a slave to someone else's circuit design when you can design your own? Electronic Circuit Design contains over twelve articles covering such diverse topics as digital electronics, op amps, temperature control, SCRs and more! A 'must' for anyone interested in Electronic Circuit Design.

Send your money today to Specials, ETI Magazine, Unit 6, 25 Overlea Blvd., Toronto, Ont., M4H 1B1.  
Also available at your local components store or at your local newsstand.

# ON YOUR NEWSSTAND NOW

# DIGITAL TO ANALOGUE TECHNIQUES

Digital to Analogue conversion (DAC) is a fast growing section of electronics. Tim Orr explains some of the more practical applications.

ELECTRONICS HAS CHANGED enormously in the past ten years, having swung away from tubes, germanium transistors, even from discrete devices themselves. The trend is towards more and more complex integrated circuits, complete systems in a chip, large scale integration (LSI). Also the trend has swung heavily towards digitally based systems rather than analogue ones, partly because the IC manufacturers can get a greater success rate from making digital devices and partly because there are very many applications which can only be contemplated with a digital device. Such examples as pocket calculators and microprocessors spring immediately to mind. However there are several areas where analogue techniques present the only realistic solution (at this moment in time), such as tone controls in an audio amplifier. In fact, good cases can be made out for both analogue and digital systems and there are many examples where both are needed. In these it will be necessary to change from the analogue to the digital world or vice versa and to do this, some sort of conversion process has to be practised.

## Digital to Analogue Conversion.

The job of a digital to analogue converter (DAC) is to convert a binary code (a digital data word) into an analogue voltage. The data word is a digital representation of that analogue voltage. Thus if we presented the DAC with a digital word that was linearly increasing in magnitude, the output would be a linearly increasing analogue voltage. This digital word would be the output of a binary counter driven by a constant clock frequency. The analogue output is a linear ramp, or rather a linear staircase where the step size is controlled by the "size" of the DAC. If the DAC is an 8 bit device, ie it can accept data words 8 bits wide, then it can generate a possible  $2^8$

discrete output level. Now  $2^8$  is 256, so therefore an 8 bit DAC could generate a staircase with 256 steps in it. The resolution of the DAC is thus 1 part in 256, or rather a change of one LSB (least significant bit) in the data word will make the output voltage change by  $1/256$ th of the full scale output.

To get really fine resolution then a high performance DAC is needed. DAC prices seem to be almost linearly proportional to their resolution. I have got several DAC's amongst my collection of bits. There is an 8 bit DAC costing about \$10 a 12 bit DAC costing about \$90 and a 16 bit DAC costing just over \$360!. It is now possible to buy a monolithic (a single IC) DAC with a bit size of 6, 8, 10 and 12, but above this the devices are usually modular.

## Size And Resolve

Fig 2 shows the relationship between DAC size and resolution. Notice that a 16 bit DAC with a 10 V full scale output is made up of a staggering 65,536 discrete

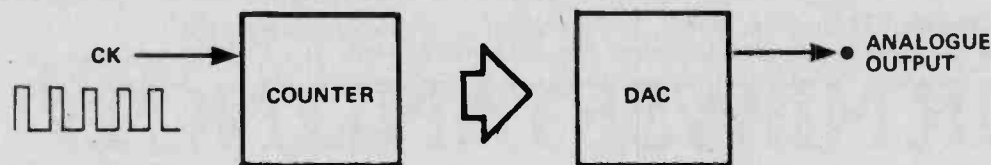
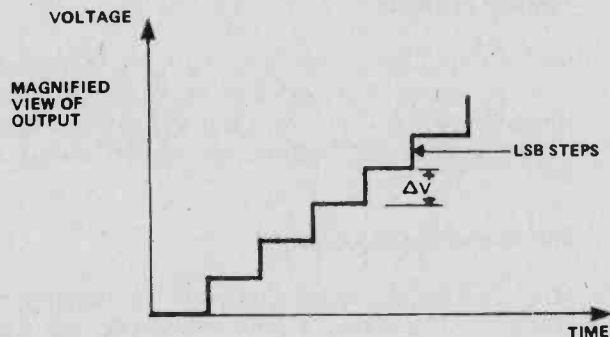

Fig 1. Converting binary code to analogue voltage.

WORDLENGTH n	RESOLUTION 1 PART IN 2 <sup>n</sup>	MAXIMUM THEORETICAL DYNAMIC RANGE	BIT SIZE ASSUMING FULL SCALE = 10V
1	2	6dB	5.0V
2	4	12dB	2.5V
3	8	18dB	1.25V
4	16	24dB	0.625V
5	32	30dB	0.312V
6	64	36dB	0.156V
7	128	42dB	78.1mV
8	256	48dB	39.1mV
9	512	54dB	19.5mV
10	1024	60dB	9.7mV
11	2048	66dB	4.8mV
12	4096	72dB	2.4mV
13	8192	78dB	1.2mV
14	16384	84dB	610uV
15	32768	90dB	305uV
16	65536	96dB	152uV

Fig 2. Relationship between size and resolution.

levels each 152  $\mu$ V in size. (There is also available an 18 bit device, costing a small fortune. The larger the bit size of the DAC, the larger is the dynamic range (best signal to noise ratio) of its output. This increases by 6 dB per bit. Thus a 10 bit DAC can give a best range of 60 dB.

The human anatomy has developed over the last few million years to respond to its environment. This has resulted in the following performance figures. The sensitivity of the eye to colour is not that good. Colour television transmission doesn't give much of its bandwidth to the colour part of the signal. Have a look at a TV and see how well defined the colour is; it is usually just "sort of smeared around" the subject. Thus it is possible to get quite good digital video using only 4 bits for the colour. The eye sensitivity to resolution is somewhat better, but even so an 8 bit oscilloscope memory will look fairly continuous, giving little indication that it is made up of discrete steps.

#### Ear Lead

However the ear can still outperform present day technology. Using a 16 bit high quality audio system a trained ear can still detect the difference between the digitally processed sound and the original. Thus, when using DAC's in professional audio equipment great care has to be taken to eliminate all types of aberrations in the system. These digital aberrations don't just worsen

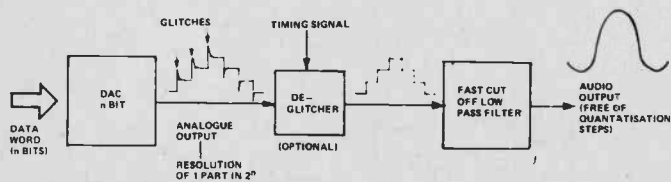

Fig.3. A DAC system in operation.

the signal to noise ratio as an analogue system might), but they produce discordant harmonic distortion, sidebands like those obtained from ring modulation and other little funnies.

Figure 3 shows a DAC system in operation. The output of the DAC is meant to produce nice clean square wave steps, but the leading edges of these steps always have small spikes (glitches), caused by the switching times associated with the DAC's internal workings. These glitches are not regular in nature and so filtering cannot eliminate them. The glitches give the sound a "dirty" quality, or, if the system is an oscilloscope display it produces fuzzy pictures.

The glitches can be removed with a little module called a DEGLITCHER, Fig 4. This is a logic controlled sample and hold which holds during the glitch period, but otherwise tracks the signal from the DAC. Thus the glitches are ignored. The output from the deglitcher then passes through a low pass filter and this removes the "stepped" quality of the signal and produces a smooth analogue output. The cut off frequency of this filter is very important and is related to the data rate of the DAC. The rule of thumb is that the filter cut off frequency should always be less than half of the data rate frequency.

#### Buying And Building

DAC's can be bought fairly cheaply as complete IC's or they can be constructed out of generally available parts, Fig 5. This circuit uses precision buffers (a CD4041 will do), E24 resistors and a FET op amp. The buffers are run from a +10 V supply and their purpose is to provide high (+10 V) and low (0 V) output with low source resistance.

They are driven by a 6 bit data word, the MSB (most significant bit) thus drives the 7k5 resistor, the LSB (least significant bit) the 240k resistor. So, when the MSB changes, the output of the op amp will move by a large amount (5 V), but when the LSB changes the output will only change a little (0V156). Going from the MSB down to the LSB, each bit has only half the effect of its predecessor. This is obtained by doubling the resistor values (7k5, 15k, 30k, 60k, 120k, 240k).

A 6 bit DAC can produce 2<sup>6</sup> discrete output levels. Now 2<sup>6</sup> is 64 and so the overall resistor tolerance should be  $\pm 1$  part in  $2 \times 64$ , which comes out at  $\pm 0.8\%$ . This type of DAC is known as a resistance ladder DAC, but in its presented form it is rather limited. For instance, a 10 bit device would require a resistor range of 1024 to 1 and a tolerance of 0.05%.

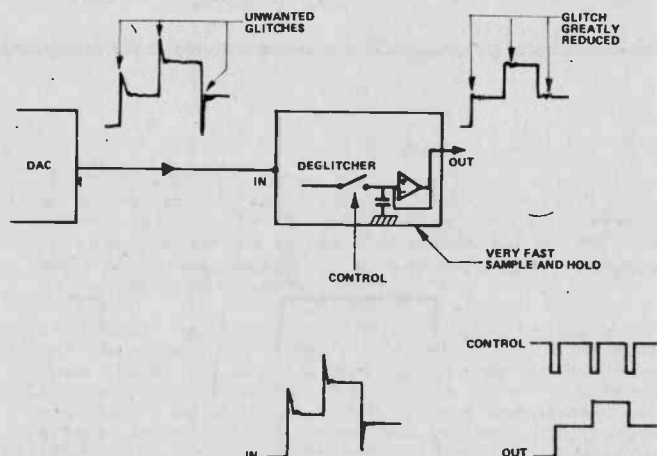

Fig.4. A deglitcher system in operation.

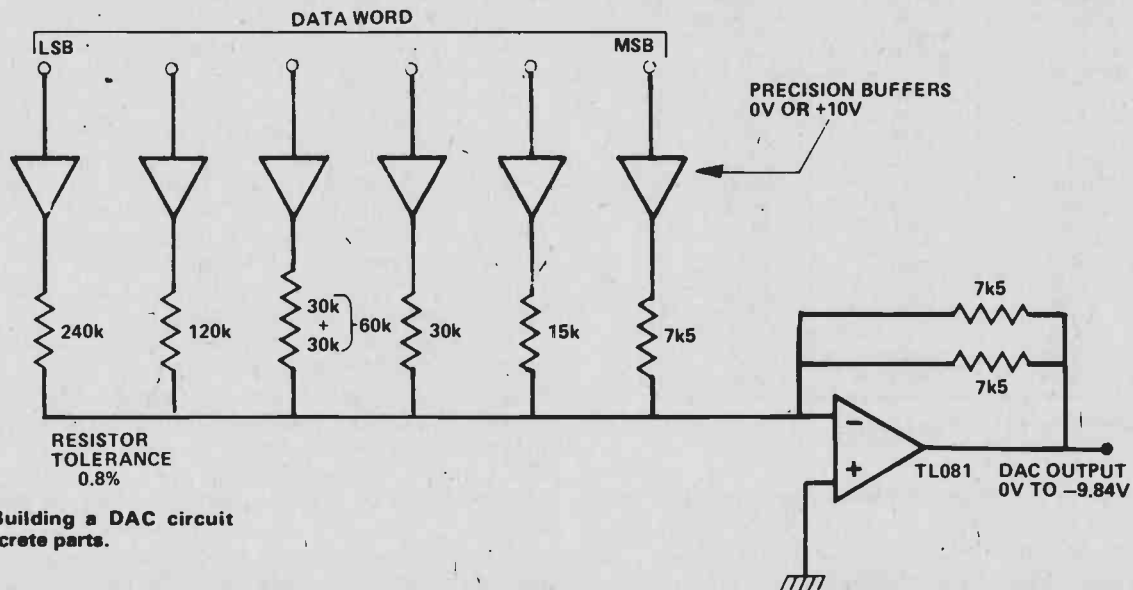

Fig 5. Building a DAC circuit from discrete parts.

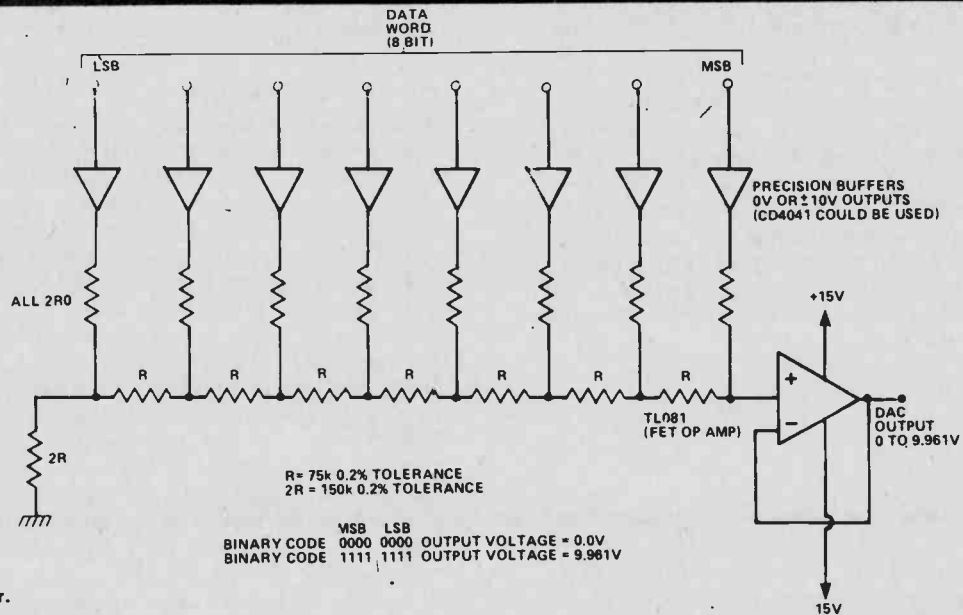

Fig 6. An R-2R ladder.

### Multiple Choice

The DAC shown in Fig 6 overcomes the problem of multiplicity of resistor values; only two are needed. The resistor tolerance

still applies. Also the ratio between the resistor value and the buffer ON/OFF resistance is important. The 2R resistors connected to the buffers should ideally be 2R — (the buffer output resistance).

### Multiplexed Sound System

Next time you are on an aircraft with a multichannel music system, it is quite possible that the sound you are hearing via your stethoscope is digitally generated. The sounds are usually stored on a multichannel tape player and each channel is connected to a multiplexer. This is a digitally controlled rotary switch and it is continually scanning all the audio channels. The output of the multiplexer is then fed to the ADC. Thus each channel is converted to a digital code. This digital code is then transmitted in serial mode and mixed with a sync pulse. The transmitted information is a series of serial data words, each representing a small piece of the eight music channels, plus some synchronisation data which passes down a two wire system to each receiving unit. This saves wire weight, there is less crosstalk and low pickup due to the high noise immunity of digital systems.

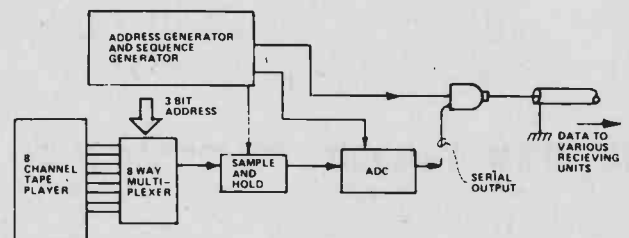

## Counting On This

A "counting" type ADC is composed of a fast comparator, a gate, a counter and a DAC. This is why ADC's always cost more than DAC's, the ADC uses a DAC to do the conversion. Assuming that the analog input is positive, and the DAC produces a positive output, the conversion operation is as follows:

- 1) The signal "start conversion" is generated. This resets the counter to all zero's, the DAC output goes to zero, the comparator output goes high and so the clock is allowed to enter the counter. Thus the count proceeds and the DAC generates a positive going staircase.
- 2) When the DAC output exceeds the level of the analog input the comparator output goes low, the counter stops. This is the end of the conversion, and the data that is held on the counters output is the data output. It would then be transferred to some latches, and held there until the next conversion is finished.

This data word describes as precisely as is possible the magnitude of the analogue input. Although simple to operate, this method has a major disadvantage, it is slow. Imagine that the ADC is a 10 bit device and the clock frequency is 500KHz,

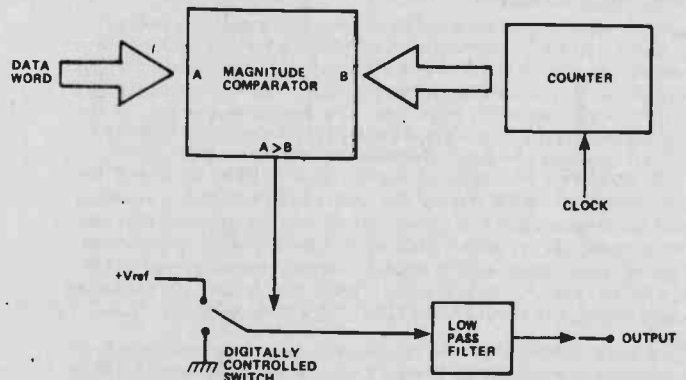

then the longest conversion time will be 1024 counts at 2 $\mu$ Sec per count which is 2.048mSec, this means that the conversion rate will be less than 500 per second.

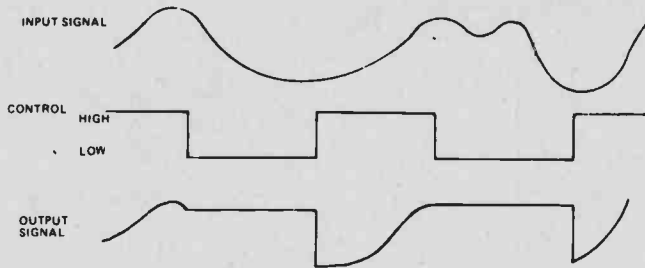
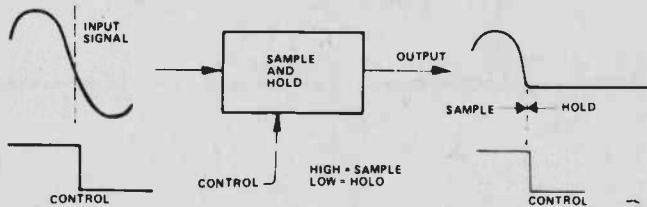

## Data Lining

Another method of generating data is to convert analogue information into digital words. The signal must first be passed through a low pass filter, the cut off frequency of which must be less than half of the conversion frequency. The signal is then "held" in a sample and hold unit so that the ADC can do its conversion on a static signal. Control logic sends commands to the ADC giving it various instructions. The sequence of events is:

- 1) Tell sample and hold to HOLD.
- 2) Tell ADC to start conversion (SC).
- 3) Conversion finished, generate end of conversion signal (EOC).
- 4) Tell sample and hold to SAMPLE.

The process then repeats itself. The sample and hold mechanism is shown below. Generally, in one period and the input signal several ADC conversions will be done. The data generated is then stored, processed or transmitted.

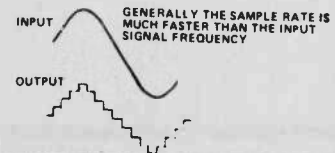

## Mark Time

Yet another type of DAC, a mark space modulation DAC is shown above. The data word is presented to one side of a magnitude comparator, the output from a fast running counter to the other. When the counter is greater than the data word the  $A > B$  output goes low. The output is a mark space waveform the ratio of which is linearly proportional to the magnitude of the data word. The mark space signal operates a precision switch, the output of which is lowpass filtered, providing a smoothed DC output. This type of DAC requires a fast running counter, but gives a relatively low bandwidth output signal. It is a good solution for a system where lots of slow moving outputs are required, because the counter can be common to all the DAC's.

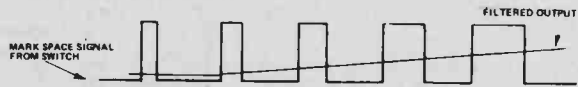

## Memory Planning

The data that drives DAC's can come from several sources. It could be generated by computation or read from a programmed memory as shown. In this example a ROM (read only memory), has been programmed with the data necessary to produce a sine wave. An updown counter provides the address for the ROM and the data is converted into an analog output by the DAC. The clock frequency divided by the size of the counter determines the sine wave frequency.



## FEATURE

### Digital Echo Chamber

There are several professional echo chambers that are all digital. The audio input is converted into a digital word and then put into a parallel set of shift registers. A 10 bit system would use 10 sets of registers. The clock that starts the ADC conversion also shifts the data along the shift registers. The data coming out of the shift registers is then converted back into an analogue voltage by the DAC. It is then filtered and mixed with the original signal.

The echo can be made to repeat indefinitely by using the digital recirculate path around the shift registers. The amount of digital storage required is rather large. Let us assume that we want a good quality echo. This would be a 10kHz bandwidth, 60 dB dynamic range which implies a clockrate of about 25kHz and a 10 bit system. Thus to store 1 second of sound (to give one second delay), we would need  $10 \times 25,000$  bits of memory, 0.25 Mbits!

The usual solution to this dilemma is to get longer delays at the expense of bandwidth. Thus a 1 second delay would be 1kHz bandwidth, a 0.1 second delay would be 10 kHz bandwidth. This would only require 25K of memory.

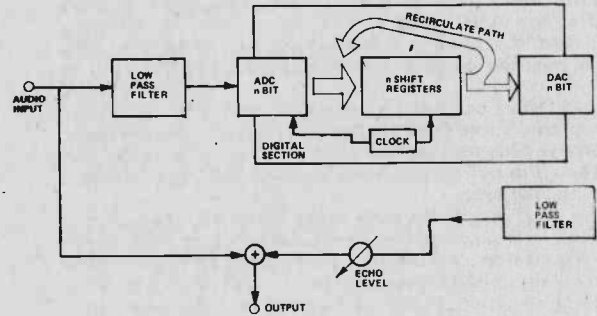

### Digital Memory for an Oscilloscope.

There are several products on the market that enable an ordinary oscilloscope to store waveform information. This is particularly useful if you are trying to capture non-repeating events. The system is very similar to the digital echo unit, there is an ADC, a memory and a DAC. Also there is a trigger circuit so that one shot events can be captured and a ramp generator to produce the Xsweep. The output of the DAC is rather interesting, because it is not low pass filtered, but it uses a linear point interpolation device. Basically, what this does is to join up the dots, so that a waveform that is represented by only a few points, can be made to look like the original signal. The visual results of interpolation are very good indeed.

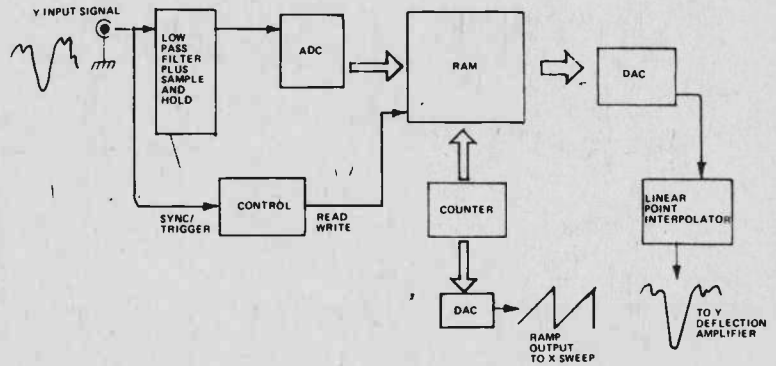

### Laser Light Show

Many laser light shows use a digital tape recorder to store the data for the show. Two outputs are produced which are converted into control voltages by DAC's. These voltages are then used to manipulate the X and Y Co-ordinates of the laser. Thus it is possible to draw pictures and cartoon characters with a moving laser beam.

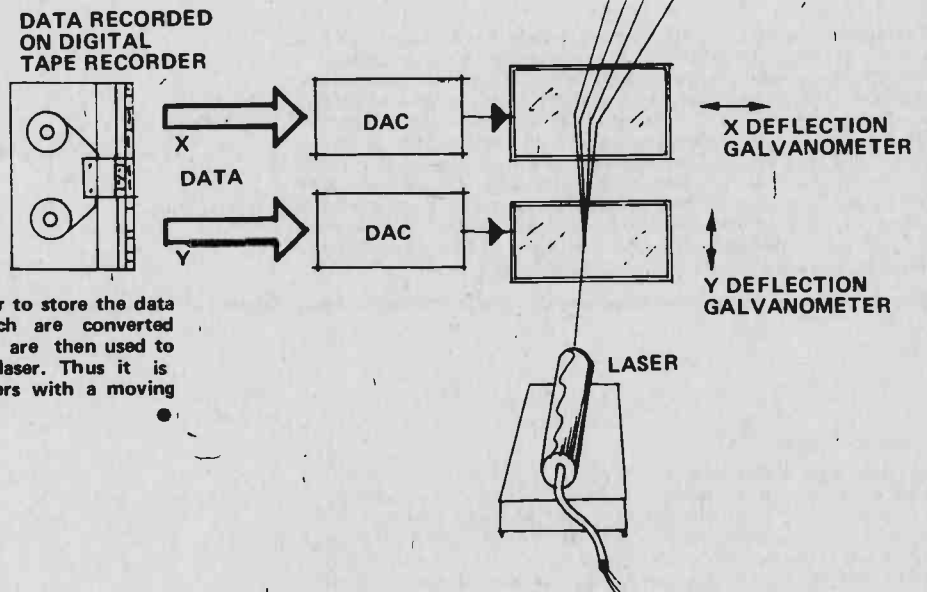



# Everybody's making money selling microcomputers. Somebody's going to make money servicing them.

New NRI Home Study Course Shows You How to Make Money Servicing, Repairing,  
and Programming Personal and Small Business Computers

Seems like every time you turn around, somebody comes along with a new computer for home or business use. And they're being gobbled up to handle things like payrolls, billing, inventory, and other jobs for businesses of every size...to perform household functions like budgeting, environmental systems control, indexing recipes, even playing games.

## Growing Demand for Computer Technicians... Learn in Your Spare Time

Even before the microprocessor burst upon the scene, the computer industry forecast over a 100% increase in job openings for the decade through 1985. Most of them *new* jobs created by the expanding world of the computer. NRI can train you at home to service both microcomputers and their big brothers. Train you at your convenience, with clearly written "bite-size" lessons that you do evenings or weekends without quitting your present job.

## No Experience Needed

You don't need prior training in electronics or computers to take this exciting new course. NRI starts you with the basics, gives you a firm foundation to build on. And your personal counselor is always available, ready to help whenever you have questions.

## Assemble Your Own Microcomputer

NRI training also includes plenty of practical experience. You perform



meaningful experiments building and studying circuits on the NRI Discovery Lab.<sup>®</sup> Then you build your own test instruments like a transistorized volt-ohm meter, CMOS digital frequency counter...equipment you learn on, use later in your work.

And you build your own microcomputer, the only one designed for learning. It looks and operates like the finest of its kind, actually does more than many commercial units. But NRI engineers have designed components and planned assembly so it demonstrates important principles, gives you working experience in detecting and correcting problems. It's the kind of "hands-on" training you need to repair and service units now on the market.

## Rush Card for Free Catalog

Send the postage-paid card today for our 100-page, full-color catalog. It describes NRI's new Microcomputer Technology Course in detail, shows all equipment, kits, and lesson plans. And it also tells about other NRI courses... Complete Communications with 2-meter transceiver...TV/Audio/Video Systems Servicing with training on the only designed-for-learning 25" diagonal color TV with state-of-the-art computer programming. With more than a million students since 1914, NRI knows how to give you the most in home training for new opportunity. If card has been removed, write to:

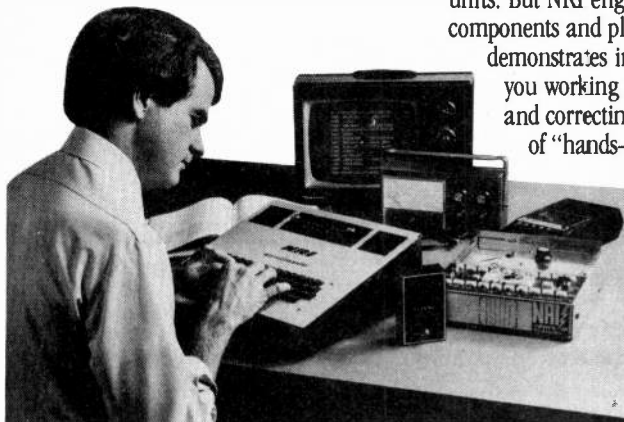

**NRI Schools**  
McGraw-Hill Continuing  
Education Center  
330 Progress Avenue  
Scarborough, Ontario M1P 2Z5  
or telephone 416-293-1911

From  
**HAMEG...**

**HM307**

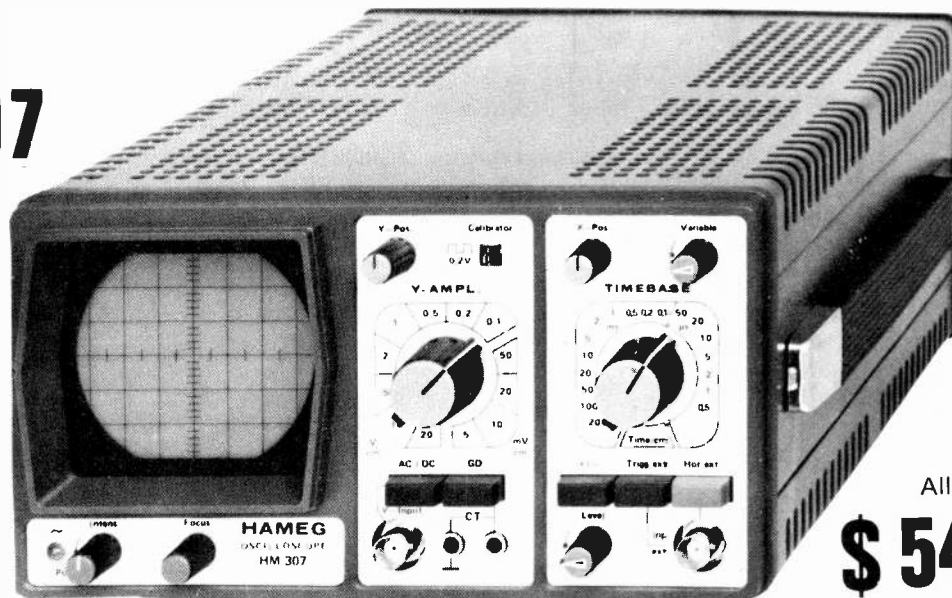

All probes included  
**\$ 549.95**  
FST included

## The only portable scope with a component tester.



Capacitor 33  $\mu$ F

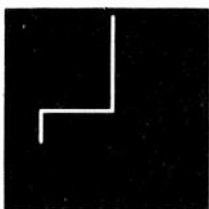

Transistor B-E

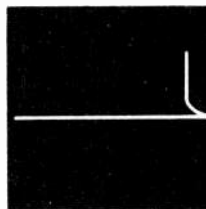

Transistor E-C



B-E 1 $\mu$ F+680 ohms

### OSCILLOSCOPE SPECIFICATIONS:

#### Y Deflection

Bandwidth: DC - 10 MHz (3 dB)  
Overshoot: Less than 1%  
Sensitivity: 5mV - 20 V/cm  
Input Imp: 1 M ohm//25 pf

#### X Deflection

Timebase: 0.2s - 0.2  $\mu$ s/cm  
Triggering: 2 Hz - 30 MHz (3mm)  
Auto + level control  
Bandwidth: 2Hz - 1 MHz

#### General Information

Component Tester: For single components and in circuit  
Calibrator: 0.2V  $\pm$  1% for probe alignment  
Power Supplies: Regulated including high voltage

A.C. Input: 110, 127, 220, 237, V.A.C., 50 - 60 Hz  
Weight: 8-1/4Lbs.  
Size: 4-1/2" Hx8 3/8" Wx10-7/16" D

For further information on HAMEG's full line of top performance oscilloscopes, contact:

**HAMEG**  
IN CANADA DISTRIBUTED BY

**BCS**  
ELECTRONICS LIMITED  
Instruments For Industry and Service

980 Alness Street  
Unit 35  
Downsview, Ontario  
M3J 2S2  
(416) 661-5585



# Audio Today

When you're trying to get the sound you want, do you really know what you're asking for?

IN THE PAST two issues we examined the matter of dynamic range with particular attention to the dbx approach to its reproduction. So far we've examined the technology both in general terms and from the standpoint of disc cutting and pickups.

This month the quarterly meeting of the Cassandra Society will come to order, and the first business on the agenda will be a consideration of the problems encountered in dealing with this greatly expanded dynamic range after delivery to the electronic and electro-acoustic system.

For new readers who may not be familiar with the Cassandra Society, this is an association of all the wise and perceptive regular readers of this department who have come to realize the truth of the Society's first dictum: in the world of audio, as in all technologies, there ain't no free lunch.

Members who have been following the past discussions of dbx in these pages as well as in other publications which readers say they don't buy anymore, have probably been wondering what the catch is.

Well, there's no catch really, but if you think that all you have to do is go out and buy a little gizmo and plug it into your system, and it's "Nirvana, here I come", you may find it a little more complicated than that.

## Maximum SPL

Obviously, if we intend to reproduce maximum dynamic range we will want to achieve the highest sound level likely to be encountered in any music we might wish to reproduce. If your tastes are limited to chamber music where a real fortissimo might reach a room shaking 90 dB there should be no great difficulty.

If you prefer the more traditional forms of folk music, what Anna Russel

once referred to as "the uncouth utterances of the masses" rather than the modern urban amplified stuff, couth or otherwise, life is even easier, with a maximum of about 80 dB, unless you get off on sounds louder than life.

However, in order to handle the maximum level of a full symphony orchestra, plus chorus, with or without an organ and/or cannons and the bells of St. Petersburg (or is it now Leningrad, I can never remember) a system should be capable of reproducing a level of at least 110 dB, and preferably 120 dB. And this does not allow for additional headroom.

## Flying Cones & All That

'Tis a sad fact of life that speaker manufacturers, on the whole, are still living in the dark ages when it comes to providing useful and honest specifications of their products. It's bad enough that so many, when they supply any information at all, give specifications as to frequency response and distortion which are meaningless, optimistic, and sometimes clearly fraudulent; to compound our difficulties an absence of standards as to sensitivity and output level capabilities has brought about the situation in which the only way you can tell whether or not a speaker is satisfactory, is to try it. If neither the amplifier nor the speaker blow, you're all right.

So let's look at some speaker ratings, as supplied by the manufacturers. These are taken from the Canadian Audio Directory, 1979.

Clearly the most ubiquitous type of speaker is the air suspension, as exemplified by the Acoustic Research line. In this line, the lowest sensitivity is claimed for the AR15, a two-way unit, with an 8" woofer, and a 1" dome tweeter.

Sensitivity is claimed to be 85 dB at a distance of 1 Meter with 1 Watt input. In an enclosed room of ordinary dimensions the greater listening distance of 2 or even 3 Meters will not have a significant effect unless the room is very heavily damped.

To achieve a sound level of 115 dB will require 30 dB more power. 30 dB represents a power ratio of 1000:1. Thus, a full kilowatt would be required. For two speakers this can be divided by two, giving us 500 Watts.

Since the woofer also handles the midrange fundamentals as well as the bass range, a fortissimo tutti could conceivably result in cone excursion, with such a small woofer, which would be measured in inches. A full power peak with heavy bass components might well separate the cone from its basket causing it to take flight around the music room like an electric frisbee. Even if most of the energy over a period of time were concentrated in the lower midrange, around middle C, the cone might at least remain attached to its moorings. But how long would it survive?

It's only rated for a continuous power handling of 50 Watts, RMS, at 400 Hz. Presumably it can handle higher peaks, but if you're listening to the Berlioz Requiem with a wide-open throttle, it won't be long before an overheated voice coil yells "Uncle", and falls over dead.

And if your tastes runs more to Punk Rock or some other modern day "uncouth utterances of the masses" you might be excused if you mistake the voice coil for a fuse.

We are not considering some unknown brand speaker, or one of the junky boom boxes which seem to fill the dealers' showrooms. This is an excellent speaker offered by a highly reputable manufacturer, complete with

five year warranty.

Even the AR9 only offers an extra 2 dB sensitivity, but will handle 400 Watts.

As for some of the mini-boxes, including the "BBC Monitor" types, forget it. Even with ordinary program programme sources some of these already have trouble reaching audible levels without getting a hernia.

#### As For Amplifiers . . .

All right, so you part with a couple of grand and get a pair of AR9's or something else in the same class, or you devote the time, effort, and Tender Loving Care needed to build a comparable system, you still have to drive it.

Last time I looked, the number of amplifiers available with this kind of power output could be counted on the fingers of a printer's hand. As for price, with the speakers included, better forget about that new car.

Even building your own gets expensive; the 300 Watt job I'm contemplating is working out to around \$1.50 per Watt.

Forget about trying to get away with considerably less power, figuring that the occasional peak clipping won't be

to bad. It will occur more frequently than with uncompressed material for the simple reason that the programme is uncompressed. Even the demonstration I heard, with Bang and Olufsen speakers and an Amcron DC300A amplifier, rated at 155 Watts per channel, with considerable headroom produced some audible amplifier clipping. And these speakers are quite a bit more sensitive than your average, or even above-average bookshelf speaker.

#### Another Way

Clearly, until the day comes when amplifiers are free and rooms are made of stretchable rubber, the days of the bookshelf speaker and the 50 Watt amplifier are numbered.

Happily, a Klipschorn costs little more than some of the best air suspension types, will handle well over 100 Watts, and can easily attain sound levels of over 120 dB with this power. Such amplifiers may not be free, but you may not have to mortgage your home to manage it.

Or, if the idea of sitting practically on top of (or inside) a pair of horns in a small study doesn't exactly thrill you with delight, there are several good re-

flex designs around, such as the Jensen System B. At 150 Watt rating, and 90 dB sensitivity, this'll do a bit over 112 dB if you use an infrasonic filter, which is a good idea anyway, especially with reflex and transmission line speakers. The design follows some of the principles which I've advocated in the past, including cross-over points which are somewhat along the lines which I suggested in June, and, I think, reinforces many of these points.

And, of course, there's always the Bang and Olufsen/Amcron combination I mentioned earlier. It may have clipped in the hotel auditorium, but in a living room should encounter no difficulties.

#### Other Choices

This isn't the only kind of equipment available, of course; nor is there a lack of good designs for the home constructor. The point is, you don't have to settle for a boom-box speaker designed by and for jerks who are impressed by volume, in order to get sensitivity, and you don't have to buy an amplifier from a travelling rock band to get power.

But suppose you're neighbours won't stand for such dynamic range. That's for the next meeting.

Same time, same pages.

## Audio Today Products

### The Turntable Song

When the late Jimmy Durante said "Everybody wants ta get inta d'act" he certainly coined what must be an eternal verity.

Today, the act is "Linear Tracking Arms", sometimes known as straight line tracking, now usually incorporating servo mechanisms.

At one time this was quite an exotic thing, as exemplified by the Rabco which sold for \$350.00 when that was a lot of money for an arm. (Why am I writing in the past tense? Is inflation really that bad?)

Anyhoo, everybody is getting into the act, so herewith a couple of entries from Mitsubishi, plus a conventional offering from the same company.

MODEL LT-30 features the use of oxide-free copper wire throughout (!), tonearm height adjustment capability of  $\pm 3\text{mm}$ , a detachable hinged dust-cover, acoustic insulator feet, as well as the usual automation features including cue prevention in the absence of a record.

Drift and temperature, load and voltage dependence are claimed to be

The Mitsubishi audio system (LT-5V) vertical linear tracking turntable.

less than 0.001%, while wow and flutter is (that's what it says here) 0.025%. There is no indication of the value of each. S/N ratio is said to be 78 dB, although this is not explained. The units' outstanding speed accuracy is said to be an indication of overall merit. Unfortunately, except as indicated above, the degree is not stated. The arm is straight (natch!), and gimballed supported. I wish some explanation were given as to why, since it should only be pivoted in one plane. Maximum tracking error is said to be  $0.05^\circ$  assuming no one mismounts the pickup.

Of special interest is the MODEL

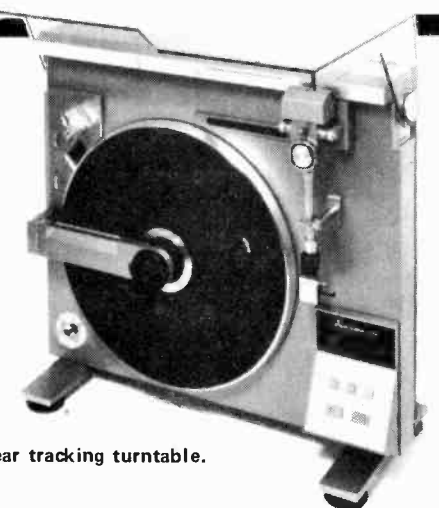

LT-5V, which appears to be the same turntable, only it's mounted in the vertical plane, and has a device for holding the record on the turntable.

The only explanation for this novel arrangement is that the model is exactly the same height as the four Mitsubishi micro components when stacked.

Naturally, the wow level increases because of this arrangement, and combined wow and flutter are claimed to be 0.045%. S/N is reduced to 76 dB.

The LT-30 carries a suggested list price of \$1200.00, while the more complicated LT-5V is only \$670.00.

MODEL DP-5, on the other hand, is more conventional, in that it is horizontally mounted and uses a conventional pivoted arm. It's nice to see that someone got the vertical pivot right, minimizing azimuth error on warped records.

The usual automatic features are included, and it will operate automatically with non-standard formats, such as 12", 45 rpm, and 7" 33-1/3 rpm. Nice touch. Suggested retail price is \$330.00. Also a nice touch.

The control layout of all three units looks as if someone did his homework and put some thought into it, but it would have been nice if the linear tracking units also had their controls arranged for operation with the lid closed, as the conventional unit does, but then, with records playing vertically, who listens to the music.

Anyway, if you think that's something, I remember one turntable manufacturer who used to demonstrate his product *upside down*. Worked, too. Mind you, it didn't work very well right



On the right the Mitsubishi DP-5 turntable. Above the Mitsubishi LT30 Linear tracking turntable.

side up, not even with his own pickups, but upside down you didn't care how it worked as long as it worked.

If you would like more info, contact Melco Sales Canada Ltd. (Mitsubishi EElectronics COporation) 900 C Deni-

son St., Markham, Ontario L3R 3K5, phone (416) 495-7728. You can also Telex 06-966536.

Ask about the micro series of components, too. All kidding aside, it's really a nice line. ●

**Panasonic**  
just slightly ahead of our time



**LIGHT SCOPE  
FF 393E  
30 POWER**

Illuminates subject. Uses 2 "AA" batteries (included).

**FOR**

- Science
- Hobby
- Experimenter
- Fun!!

**\$ 24.95**  
+ \$2.00 for shipping costs.

Chargex (Visa) accepted. Include expiry date, card number, bank name and signature on all card orders. Ontario residents add 7% PST. Or mail money order to:

**ROYAL VIEW ELECTRONICS**  
2327 Bloor St. W.  
Toronto, Ontario M6S 4W1  
Phone: (416)762-8655

**You've heard  AKTRON...**



**...more than you've heard of  AKTRON**

Over the past 25 years, you may have heard more Oaktron speakers than any other single brand — without knowing it. If you've added a custom sound system to your car, you may be hearing Oaktron every time you drive. Oaktron has made speakers for most of the well-known U.S. manufacturers and installers of audio products. You've heard Oaktron in cars, living rooms, airports and theaters — and you've liked what you heard.

We'd like you to get to know our speakers. Call us for the name of your nearest dealer or drop in and hear them at:

**omnitronix ltd.**  
2056 TRANS CANADA HWY.  
DORVAL, QUE. H9P 2N4  
TEL: (514) 683-6993

**Oaktron's popular 5 1/4" CO-AX CAB33K**



Ask for Oaktron's latest catalog.

Represented in Canada by:

**UNIT 7, 6295 SHAWSON DRIVE  
MISSISSAUGA, ONT. L5T 1H4**

For further information circle No. 2 on Reader Service Card.

Dealer inquires invited.

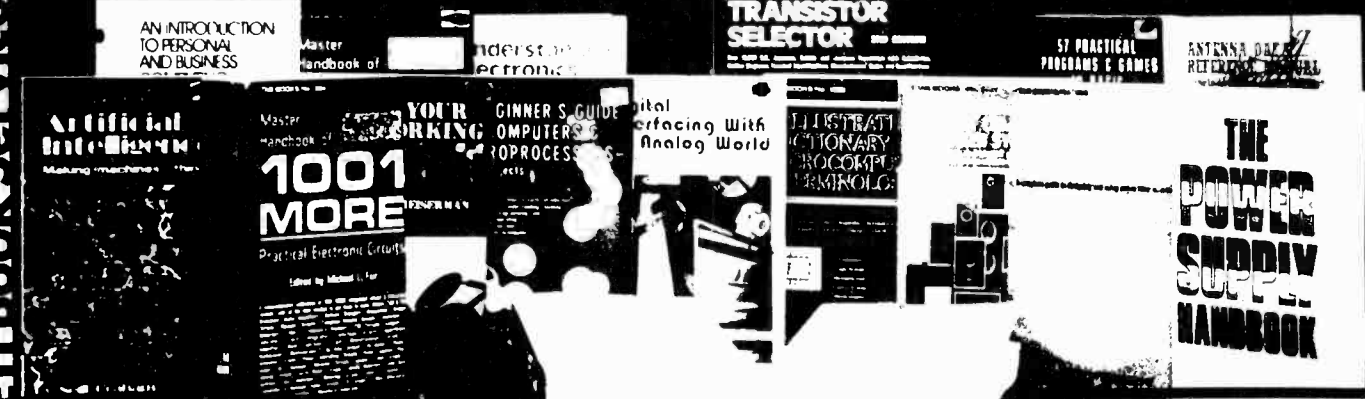

**SPECIALLY SELECTED TAB & SYBEX TITLES BROUGHT TO YOU BY THE ETI BOOK SERVICE**

To get yours, fill in the order form in this issue or write to ETI Magazine, Unit 6, 25 Overlea Boulevard, Toronto, Ont. M4H 1B1.

**Master Handbook Of 1001 Practical Circuits**  
TAB No. 800 \$18.30  
**Master Handbook Of 1001 More Practical Circuits**  
TAB No. 804 \$18.35

Here are IC and transistor circuits for practically anything and everything — with ALL the data needed to put them to work. The ideal schematic source-book for all active technicians, engineers, experimenters, amateurs — for anyone who must occasionally or regularly construct or adapt electronic circuits for any purpose whatsoever. You'll find any circuit you're ever likely to need in the pages of this rich volume. The schematics are classified according to general application, and the Sections themselves appear in alphabetical order.

**99 Test Equipment Projects You Can Build**  
TAB No. 805 \$11.75

Here's the A to Z guide you need to build all sorts of electronic test equipment — from a simple signal tracer to a sophisticated modularized 50 MHz counter — and virtually everything in between. Includes meters and ammeters, capacitance meters, resistors, inductance meters, frequency standards, signal generators, frequency counter, logic analyzers and many of RF test equipment. The variety is incredible and almost endless — virtually every test instrument you could possibly want to build for yourself. It's perfect for the hobbyist — and indispensable for the professional because you can incorporate each one — or a combination of several — into your work bench setup or other gear.

**The Power Supply Handbook**  
TAB No. 806 \$11.75

A complete one stop source for the hobbyist and engineer. Contains high and low voltage supplies, transformer and solid state. Everything you need to keep your project powering with the right volts and amps.

**Build Your Own Working Robot**  
TAB No. 841 \$8.55

Here are complete instructions — plans, schematics, logic circuits, and wiring diagrams — for building Buster. Not a project for novices, Buster is a sophisticated experiment in cybernetics. You build him in phases, and watch his personality develop as you add progressively more advanced circuitry to his mainframe. The first of this three-phase robot, Buster I, is "leash-led" and dependent on his master for decision-making; you create the "animal" and give him wheels, steering capability, and the capacity to "understand" your basic commands. Phase II makes Buster more independent. Now he has a basic brain he can use to decide when he's in need of a battery charge, or trapped into a physically binding situation he can't get out of.

**57 Practical Programs & Games In Basic**  
TAB No. 1000 \$11.55

From arithmetic progression to statistical permutations to one-arm bandits, here are 57 practical, useful and fun programs designed to help you readily put your minicomputer to work!

Game programs include blackjack, one-arm bandit, craps, and two space war games. Math and accounting programs include compounding, straight-line depreciation, statistical permutations, instant derivatives, and solutions for integrals — even a whole section of geometric solutions for modern-day Euclids. For history buffs, there is a Day-of-the-Week program for any date back through 1753.

Each program begins with an introductory paragraph describing its capabilities, and continues with a typical program sequence and flowchart. All programs will run on any floating point BASIC.

**Tower's International Transistor Selector**  
TAB No. 1010 \$9.85

Here are transistor substitutions, outline diagrams, terminal identifications, manufacturers' codes and specs for more than 13,000 devices made in the U.S., Japan, Europe, and England. This ultra-complete reference guidebook is an absolute MUST for anyone who deals with transistors or the equipment in which they're used. . . . makes it as easy to locate transistor substitutes for Japanese and European imports as for mass-market U.S. consumer electronic products. Contains info on device ratings, characteristics, case and terminal identification, applications, manufacturers and addresses, and voltage ratings — collector-to-base, collector-to-emitter, and emitter-to-base.

**A Beginner's Guide To Computers & Microprocessors — with projects**  
TAB No. 1015 \$9.70

Here's a plain-English introduction to the fascinating world of the microcomputer — its capabilities, parts, functions, and programming . . . and how you can have one in your own home. Numerous projects, using actual computer parts, demonstrate the operation of a computer and lead to the assembly of a working minicomputer capable of performing many useful functions around the home and office.

A typical family-sized computer, with video screen, printer, and keyboard, is fully described.

**How To Design, Build & Test Complete Speaker Systems**  
TAB No. 1064 \$11.85

If you've always wanted to build your own speaker system, here's a book crammed with everything you need to know to do it right. . . . The first time! Contains info on device ratings, characteristics, case and terminal identification, applications, manufacturers and addresses, and voltage ratings — collector-to-base, collector-to-emitter, and emitter-to-base.

This clear guide shows you exactly how a speaker works, how its power and resonance are attained, and how speakers may differ from one another. It's as thorough a book as you'll find on the complete subject of speakers, speaker systems, and enclosures.

**Digital Interfacing With An Analog World**  
TAB No. 1070 \$12.35

Are you looking for ways to really put your microcomputer to work? This book tells you how to go about it — how to convert energy produced by pressure, force, position, temperature, etc. into an electrical voltage or current that your microcomputer can deal with. It's for the user who views the microcomputer as a bit of hardware to be applied, and who views software as either a simple set of instructions to make the machine go or, more importantly, as a valid substitute for hardware. It presents information, in handbook style, for users of microcomputers who want to design a device or system with a microcomputer at its heart.

Very simply, this book is for the microprocessor/computer user who wants to use the machine to measure certain conditions, or to control external devices.

**The Complete Handbook Of Robotics**  
TAB No. 1071 \$10.90

Create your own robot? All the information you need to build a walking, talking friend and companion or a helpful servant appears in this book!

Your robot can take on many forms and operate in any way you choose. Every possible option is covered in minute detail — including light, sound, heat, and proximity sensors, minicomputer "brains" and more.

Whether you want a robot for a experimenting, for a security application or to perform some task suitable for a "smart" machine, all the ideas you need are packed into this book.

**Artificial Intelligence**  
TAB No. 1076 \$11.55

Artificial intelligence is the branch of computer science devoted to programs mimicking computers to carry out tasks that, if carried out by human beings, would require intelligence. Here is a book that deals with the entire subject of artificial intelligence. It describes what we consider intelligence where computers are concerned, and presents an interesting summary of the step-by-step advancement of computer complexity toward the rudiments of human-type intelligence.

**Illustrated Dictionary Of Microcomputer Terminology**  
TAB No. 1088 \$11.85

This reference book contains clear and detailed explanations for nearly 4000 terms currently used in the exploding field of microcomputers.

Anyone having trouble understanding the "buzz" words, the jargon, the technical language for the computer crowd — and the domain of the personal computer in particular — will find this authoritative reference book of terminology absolutely indispensable.

**OSCAR: The Ham Radio Satellites**  
TAB No. 1120 \$7.75

If you want to get in on one of the hottest new frontiers in amateur radio, this book is for you! It's your guide to satellite communications via the Orbital Satellite Carrying Amateur Radio (OSCAR) satellites. If you think amateur radio is fun now, wait till you see what can be done with satellite communications. This easy-to-read manual will cover, in one of the latest trends in ham radio, and at the same time show you all the details you need to start your own amateur earth station.

**The Active Filter Handbook**  
TAB No. 1133 \$9.75

A designer's and users' guide to the theory and applications of active filter circuits.

For anyone interested in making the most of one-stop guide to modern filter technology will make the difference between filters and their purpose, compares different filter types, and discusses their operation, op amps, Butterworth filters, Chebyshev filters, low-pass filters, high-pass filters, etc. This all-inclusive manual offers coverage of electronic math and basic electronic theory also. Cannot be beat for a complete and practical discussion and examination of filter techniques.

**Antenna Data Reference Manual**  
TAB No. 1152 \$11.75

Since the antenna system has a large influence on what you get out of a ham or CB station or get into a short range VHF receiver, best results are obviously achieved with the right antenna. This book will show you how to make and install horizontal, vertical, and half-wave dipoles, inverted vees, verticals, yagis, and helical antennas, and CB antenna and transmission line, plus limited space and hidden antennas. Included are precise specifications for a huge variety of different designs tuned to work on most amateur, marine, international broadcast, AM/FM broadcast and CB bands.

**The Giant Handbook Of Computer Projects**  
TAB No. 1169 \$13.75

If microcomputers have captured your imagination, you've been through the ready-made hardware route. You need this book. It's a huge collection of ready-to-use information designed for the hobbyist who wants more flexibility — and practicality — than that offered by systems assembled for the mass market.

**Model Radio Control — 3rd Edition**  
TAB No. 1174 \$9.75

This all new and complete revision will thoroughly acquaint you with everything you need to know about model radio control — how it works, how to design a system, how to install it, and how to operate model airplanes, cars, boats, toys or virtually anything by radio control. Starting out with fundamental RC concepts, the author takes you through the intricacies of modern equipment, including coding and code breaking, servos, receivers, decoders, power control circuits, servo motors, and elaborate proportional control systems and much more!

If you want to keep up with the changes in radio-controlled modeling, or if you want to get in on the ground floor of the hobby, this lucid guide should be part of your library.

**21 Custom Speaker Enclosure Projects You Can Build**  
TAB No. 1234 \$11.75

If you really want to get some truly great sounds out of your audio system, this unique new book shows you 21 projects — from simple closed-box systems to complex ones — that will make your system sound better. . . . virtually every kind of audio speaker you could want. You can pick and choose your own project — from the simplest to the most advanced . . . for home or car, stereo or quad . . . even for a van or RV.

**How To Build Your Own Self-Programming Robot**  
TAB No. 1241 \$11.75

This is a straightforward how-to book about machine intelligence — a practical guide that shows you how to build a robot capable of learning how to adapt to changing circumstances in its environment. The unique little creature described in this book, named Rodney, can pick up signals and stimuli from his environment and develop responses that are different from other animals do. Yet Rodney is fully trainable and can be programmed, altered and molded by human intervention. All in all, Rodney is a self-aware, self-learning, and is most remarkable and fascinating machine that can program himself to deal with the problems of the moment and devise theories for dealing with similar problems in the future. Yes, Rodney is self-programming, and as a result no two Rodney's behave exactly the same way. In fact, if you wipe out his self-generated memory, he'll develop another one that's somehow different from the first.

**An Introduction to Personal & Business Computing**  
SYBEX C200 \$10.75

This is a basic introductory text on microcomputers. Its main goal is to answer the question: "What do I need for . . ." in specific detail. No previous technical background is assumed. The author addresses progressively all the essential topics of interest to the microcomputer user (as proposed to the designer). How a system works. What it can do. What its function. How much memory is needed. What peripheral equipment is needed. The cost. The software. Differences between the various types of microcomputers. The real cost of a business system. Its limitations. Can you really manage a mailing list on a floppy disk? Packages and other programs. The traps for the hobbyist. Application techniques. New systems and facilities.

The book is designed to educate the reader in all the aspects of a system, from the selection of the microcomputer to the required peripherals. No computer background is required.

**Programming the 6502**  
SYBEX C202 \$18.75

An educational text designed for the beginning programmer from the ground up. Already one of the most successful programming books ever published, it has been revised and expanded to cover the entire high end of the spectrum. The range of programming concepts and techniques oriented is such that it addresses the needs of virtually every programmer interested in using the 6502 microprocessor, from beginner to expert.

**Programming the Z80**  
SYBEX C280 \$20.75

This book has been designed both as an educational text and as a self-contained reference book. As such, it can be used as a complete introductory book on programming, ranging from the basic concepts to advanced data structures manipulations.

It also contains a comprehensive description of all the Z80 instructions as well as its internal operation. It should be a comprehensive reference for the reader who is already familiar with the principles of programming, but wishes to learn the Z80. All concepts are explained in simple yet precise terms, building progressively towards more complex techniques.

**Programming the Z8000**  
SYBEX C281 \$22.75

This book was designed as both an educational text and a self-contained reference manual. This book presents a thorough introduction to machine language programming from basic concepts to advanced programming techniques. Detailed illustrative examples are included to show the reader how to write clear, well-organized machine language programs for the Z8000.

With over 113 illustrations, diagrams, and appendices, Programming the Z8000 is an indispensable text for engineers, students, PDP-11 users and anyone interested in learning machine language programming skills.

**6502 Applications Book**  
SYBEX D302 \$18.75

This book presents practical applications techniques for the 6502. You will build a complete home alarm system, a musical synthesizer, as well as an electronic piano, a motor speed controller, a motor speed controller, a simulated traffic control system, and a Morse code generator. You will also design an industrial control loop for temperature control, including analog-to-digital conversion, and your own simple peripherals from paper-tape reader to microprinter.

Truly the "input-output" book for the 6502, it includes more than 50 exercises designed for testing yourself at every step.

**6502 Games Book**  
SYBEX G402 \$18.75

This book is designed as an educational text on advanced programming techniques. It presents a comprehensive set of algorithms and programming techniques for common games. The algorithms and programs are developed for the 6502 at the assembly language level.

The reader will learn how to create a variable for the solution of complex problems, typically those encountered in games. He/she can also use all the resources of the 6502, and sharpen his/her skills at advanced programming techniques. All the games presented in this book can be played on a real board (the SYM), and require a very small amount of additional components.

## LEADER TEST EQUIPMENT

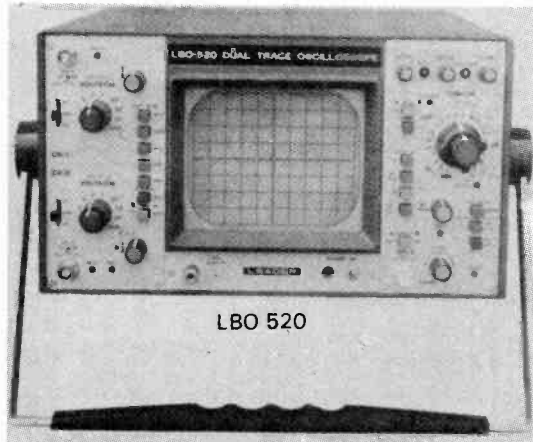

LBO 520

LSG-16RF Signal Generator	\$169.00	LBO50BA 20 MHz scope	\$999.00
LAG26-Audio Generator	\$199.00	LBO310 4 MHz scope	\$315.00
LBO520-30 MHz Dual Trace Oscilloscope	\$1,485.00	LTC906 Transistor Checker	\$245.00

- Accepts DIP packages, without adaptors or damaging component leads
- Accepts diodes, transistors, IC's, resistors, capacitors, etc. with leads between 0.01" (0.25 mm) and 0.035" (0.85 mm) diameter on a 0.1" (2.54 mm) matrix.
- Maximum temperature rating of 85°C.
- Interlocking lugs and slots allow you to connect additional Bimboards as required (each board is 6" x 2") (150 x 50 mm)
- Contacts are double sided, nickel silver current carrying capacity of 1 Amp with less than 10 milliohms contact resistance.
- Total of 550 sockets identified by a letter and number matrix for recording experiments.
- *Breadboard Section* has 47 horizontal rows of five interconnected sockets set each side of the central channel
- *Bus Strip Section* runs up each side of the Bimboard for carrying ground and Vcc etc.
- *Component Bracket* (included with each Bimboard) will fit on any of the four edges or down the centre.

## BIMBOARD BREADBOARD KIT

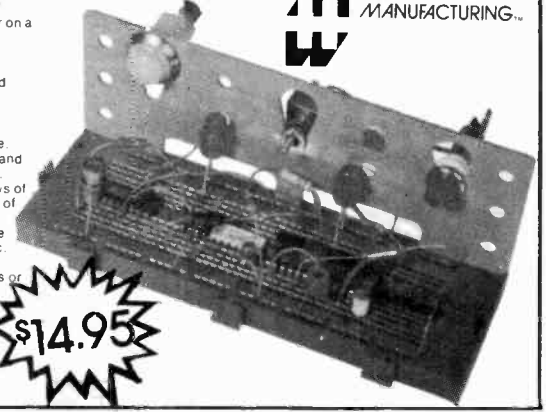

**\$14.95**



HAMMOND MANUFACTURING™

## CABINETRY

### PLASTIC DESK CONSOLES

- 3 sizes, each in four colours: blue, black, grey, and orange.
- Case moulded in ABS plastic which provides good electrical insulation and easy punching or drilling.
- Comes with four slot head screws threaded into integral brass bushings which hold recessed panel into sloping front of case.
- Rated for 85°C (185°F) temperatures.
- 1 mm (0.04") thick grey painted aluminum panel.
- Internal slots 1 mm (0.4") deep x 1.8 mm (0.7") wide for 1.5 mm (0.062") p.c. cards

- 5 mm (0.20") dia. Stand-off bosses in the base for supporting various sub-assemblies.
- 4 self adhesive rubber feet are supplied

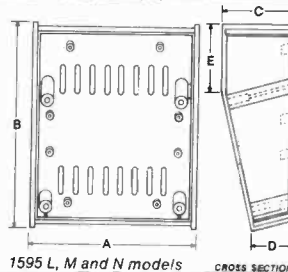
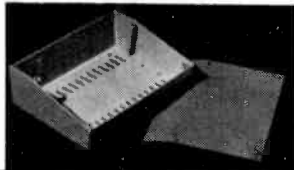

1595 L, M and N models CROSS SECTION

CAT. NO.	DIMENSIONS					PRICE
	A	B	C	D	E	
1595L	mm 105	143	55.5	31.5	37.5	\$7.10
	Ins 4.14	5.63	2.19	1.24	1.48	
1595M	mm 170	143	55.5	31.5	37.5	\$9.75
	Ins 6.70	5.63	2.19	1.24	1.48	
1595N	mm 170	213.8	81.8	31.5	58	\$13.50
	Ins 6.70	8.42	3.22	1.24	2.28	

Average Wall Thickness .08" (2 mm)  
When ordering specify colour with suffixes OR (orange), BK (black), BU (blue) or GY (grey).

### POWER BARS

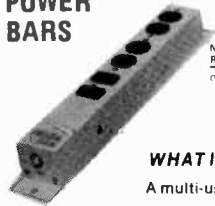

No. of Receptacles	6" cord	Price
4	1584 H4A	\$23.75
6	1584 H6A	\$25.40
8	1584 H8A	\$26.80

(ON OFF Switch, pilot light & circuit breaker)

#### WHAT IS A POWER BAR?

A multi-use device to distribute electricity safely

Power Bars are CSA approved and have up to eight receptacles. The 15 amp circuit breaker prevents overloading

As well as being safe, it comes in an attractive beige metal case with mounting tabs for permanent or portable use.

### HEAVY DUTY ALUMINUM CHASSIS

Spotwelded construction for heavy duty service Bottom edges flanged inwards providing added strength and a fastening surface for bottom.

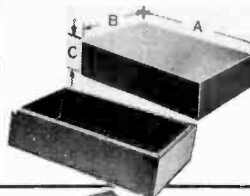

Cat. No.	A	B	C	Price	Cat. No.	A	B	C	Price
1444-6	4	4	2	\$2.18	1444-20	17	4	3	\$6.04
1444-8	6	4	2	\$2.85	1444-22	12	8	2	\$5.26
1444-9	8	4	1	\$2.18	1444-24	12	8	3	\$7.19
1444-10	8	4	2	\$3.19	1444-26	16	8	2	\$7.05
1444-12	7	5	2	\$3.19	1444-28	16	8	3	\$9.35
1444-14	9	5	2	\$3.52	1444-29	12	10	2	\$6.72
1444-15	10	6	1	\$3.19	1444-30	17	10	2	\$8.33
1444-16	10	6	2	\$4.31	1444-32	17	10	3	\$10.69
1444-18	13.5	5	2	\$4.41	1444-33	7	10	4	\$12.97

Dimensions are in inches.

### MINI BOXES

Economical two piece construction permits installation of more components than possible in more conventional designs.

All cases are made of .040" aluminum. Four self-tapping screws supplied. Finished in ASA 61 grey baked enamel.

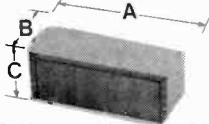

Dimensions are in inches.

Cat. No.	A	B	C	Price	Cat. No.	A	B	C	Price
1411 B	2.7	2.1	1.6	\$2.13	1411 N	5.2	3.0	2.1	\$2.87
1411 C	3.2	2.1	1.1	\$2.23	1411 P	6.0	5.0	4.0	\$3.98
1411 D	3.2	2.1	1.6	\$2.13	1411 Q	7.0	5.0	3.0	\$4.52
1411 F	4.0	2.0	2.7	\$2.23	1411 R	8.0	6.0	3.5	\$5.67
1411 G	4.0	2.1	1.6	\$2.23	1411 S	8.0	3.5	2.0	\$4.91
1411 H	4.0	2.2	2.2	\$2.23	1411 T	10.0	2.0	1.6	\$3.11
1411 J	4.2	2.2	1.5	\$2.23	1411 U	10.0	6.0	3.5	\$6.85
1411 K	5.0	2.2	2.2	\$2.56	1411 V	12.0	2.5	2.2	\$4.31
1411 L	5.0	4.0	3.0	\$3.22	1411 W	12.0	7.0	4.0	\$8.88
1411 M	6.0	2.5	3.0	\$3.11	1411 Z	17.0	5.0	4.0	\$8.88

### PLASTIC CASES WITH PANELS

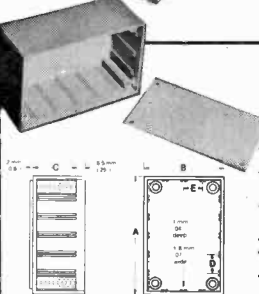

- Three sizes, each in four colours: blue, black, grey and orange.
- Case moulded in ABS plastic which provides good electrical insulation and easy punching or drilling.
- Comes with four slot head screws threaded into integral brass bushings which hold panel recessed into front of case.
- Rated for 85°C (185°F) temperatures.
- 1 mm (0.04") thick light grey painted aluminum panel.
- Internal slots on all four sides for holding 1.5 mm (0.062") p.c. cards

CAT. NO.	DIMENSIONS					PRICE
	A	B	C	D	E	
1591 L	mm 75	95	28.5	11.8	13.8	\$3.22
	Ins 3.35	2.20	1.12	.55	.55	
1591 M	mm 111	75	41.5	19.8	19.8	\$4.09
	Ins 4.37	2.95	1.63	.78	.78	
1591 N	mm 161	96	52.5	20.8	15.8	\$5.43
	Ins 6.33	3.78	2.06	.82	.63	

Average Wall Thickness .08" (2 mm)  
When ordering specify colour with suffixes OR (orange), BK (black), BU (blue) or GY (grey).

### PLASTIC (ABS) HANDY CASES

- Five sizes, each in four colours: blue, black, grey and orange.
- Moulded in ABS plastic which provides good electrical insulation and easy punching or drilling.
- Comes with 3 mm slot head screws, counter sunk into the lid and threaded into brass bushings.
- Rated for 85°C (185°F) temperatures.
- Interlocking flange on the lid
- Internal slots on 0.2" (5 mm) centres hold .062" (1.5 mm) p.c. cards
- Cat. No. 1591 E has a removable centre brace

CAT. NO.	DIMENSIONS			PRICE
	A	B	C	
1591 A	Ins 4.00	2.00	1.44	\$2.13
1591 B	Ins 4.40	2.44	1.06	\$2.51
1591 C	Ins 4.75	2.54	1.40	\$2.83
1591 D	Ins 6.00	3.15	1.64	\$3.27
1591 E	Ins 7.50	4.33	2.22	\$5.56

Average Wall Thickness 0.062 (1.6 mm)  
When ordering specify colour with suffixes OR (orange), BK (black), BU (blue) or GY (grey).

### MINIATURE CONSOLES

- Deep enough for standard keyboard modules and still low enough for comfortable operation of controls.
- 30° slopes offer the same display visibility as most calculators.
- All aluminum construction will not affect sensitive instruments. Panel is .064" and case is .081".
- Convection ventilation provided by .12" X .87" slots in the bottom (at front) and the rear (at top).
- 4 self adhesive rubber feet and four self-tapping screws are supplied with case.

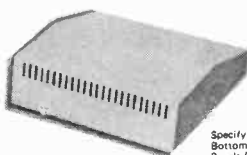

Specify your choice of colours. Bottoms: Blue, Green or Gold. Panels (Top): Off-white, Sand or Black

30° SLOPING PANELS	Dimensions					COMPLETE CASE Part No.	Price
	A	B	C	D	E		
4.0	5.5	3.0	1.1	3.7	2.2	1456 CE3	\$8.72
6.5	5.5	3.0	1.1	3.7	2.2	1456 FE3	\$9.37
6.5	7.2	4.0	1.1	5.7	2.2	1456 FG4	\$10.25
10.0	5.5	3.0	1.1	3.7	2.2	1456 KE3	\$11.34
10.0	7.2	4.0	1.1	5.7	2.2	1456 KG4	\$12.21
10.0	10.2	4.0	1.1	5.7	2.2	1456 KK4	\$13.30
14.0	7.2	4.0	1.1	5.7	2.2	1456 FG4	\$14.17
14.0	10.2	4.0	1.1	5.7	2.2	1456 FK4	\$15.04

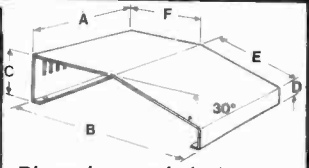

Dimensions are in inches.

### 7400 TTL

SN7400N \$ .40	SN7474 \$ .70	SN74164 \$1.78
SN7401N \$ .40	SN7475 \$ .98	SN74165 \$1.78
SN7402N \$ .40	SN7476 \$ .70	SN74166 \$2.50
SN7403N \$ .40	SN7480 \$1.00	SN74167 \$3.90
SN7404N \$ .50	SN7482 \$1.98	SN74170 \$3.18
SN7405N \$ .40	SN7483 \$1.38	SN74173 \$2.50
SN7406 \$ .58	SN7485 \$1.78	SN74174 \$2.00
SN7407 \$ .58	SN7486 \$ .70	SN74176 \$2.00
SN7408 \$ .40	SN7489 \$3.50	SN74177 \$1.58
SN7409 \$ .40	SN7490 \$ .75	SN74178 \$1.58
SN7410 \$ .36	SN7491 \$1.30	SN74179 \$3.90
SN7411 \$ .50	SN7492 \$1.04	SN74180 \$1.58
SN7412 \$ .50	SN7493 \$ .98	SN74181 \$3.90
SN7413 \$ .80	SN7494 \$1.30	SN74182 \$1.58
SN7414 \$1.40	SN7495 \$1.30	SN74184 \$3.90
SN7416 \$ .50	SN7497 \$6.00	SN74185 \$3.90
SN7417 \$ .50	SN74100 \$2.50	SN74188 \$7.90
SN7420 \$ .40	SN74107 \$ .70	SN74190 \$2.50
SN7421 \$ .58	SN74109 \$1.18	SN74191 \$2.50
SN7422 \$ .78	SN74116 \$3.90	SN74192 \$1.58
SN7423 \$ .50	SN74117 \$ .70	SN74193 \$1.58
SN7425 \$ .58	SN74122 \$ .78	SN74194 \$1.78
SN7426 \$ .58	SN74123 \$1.18	SN74195 \$1.38
SN7427 \$ .50	SN74125 \$ .98	SN74196 \$1.78
SN7429 \$ .78	SN74126 \$ .98	SN74197 \$1.78
SN7430 \$ .40	SN74128 \$1.18	SN74198 \$2.98
SN7432 \$ .50	SN74132 \$1.50	SN74199 \$2.98
SN7437 \$ .50	SN74136 \$1.50	SN74221 \$2.79
SN7438 \$ .80	SN74139 \$1.90	SN74251 \$1.98
SN7439 \$ .50	SN74141 \$1.58	SN74273 \$2.10
SN7440 \$ .40	SN74142 \$5.90	SN74279 \$1.58
SN7441 \$1.78	SN74143 \$5.90	SN74283 \$4.50
SN7442 \$1.18	SN74144 \$5.90	SN74284 \$7.90
SN7443 \$1.50	SN74145 \$1.58	SN74285 \$7.90
SN7444 \$1.50	SN74147 \$3.90	SN74290 \$2.50
SN7445 \$1.50	SN74148 \$2.58	SN74298 \$1.90
SN7446 \$1.38	SN74150 \$2.50	SN74365 \$1.38
SN7447 \$1.18	SN74151 \$1.18	SN74366 \$1.38
SN7448 \$1.58	SN74152 \$1.18	SN74367 \$1.38
SN7450 \$ .40	SN74153 \$1.18	SN74368 \$1.38
SN7451 \$ .40	SN74154 \$3.00	SN74390 \$3.90
SN7453 \$ .40	SN74155 \$1.58	SN74393 \$3.90
SN7454 \$ .40	SN74156 \$1.58	
SN7459A \$ .50	SN74157 \$1.30	
SN7460 \$ .40	SN74160 \$1.78	
SN7470 \$ .58	SN74161 \$1.78	
SN7472 \$ .58	SN74162 \$3.90	
SN7473 \$ .70	SN74163 \$1.78	

### DIODES

Zener diodes . . . . . \$ .34  
(all voltages and wattages up to 1W).  
Bridges:  
1.5 Amp 200V . . . . . \$ .59  
6.0 Amp 200V . . . . . \$1.65  
25.0 Amp 200V . . . . . \$3.25

### POTENTIOMETERS

Values Available Types Available  
50r 20k Mono . . . . .49¢ ea.  
500r 25k Stereo . . . . .95¢ ea.  
1k 50k Control with on-off switch . . . . .95¢ ea.  
2k 100k  
5k 250k  
10k 500k  
1M

### CMOS

CD4000 \$ .50	CD4024 \$1.58	CD4051 \$2.38
CD4001 \$ .45	CD4025 \$ .46	CD4052 \$2.38
CD4002 \$ .45	CD4026 \$5.90	CD4056 \$5.90
CD4006 \$1.90	CD4027 \$1.38	CD4059 \$12.90
CD4010 \$ .98	CD4028 \$1.78	CD4060 \$2.98
CD4011 \$ .70	CD4029 \$2.98	CD4066 \$1.58
CD4012 \$ .50	CD4030 \$ .98	CD4068 \$ .78
CD4013 \$ .98	CD4035 \$1.98	CD4069 \$ .90
CD4014 \$2.78	CD4040 \$2.78	CD4070 \$1.10
CD4015 \$2.38	CD4041 \$2.98	CD4071 \$ .98
CD4016 \$1.18	CD4042 \$1.98	CD4072 \$ .98
CD4017 \$2.38	CD4043 \$1.78	CD4076 \$2.78
CD4018 \$1.98	CD4044 \$1.78	CD4081 \$ .78
CD4019 \$ .98	CD4046 \$3.58	CD4082 \$ .78
CD4020 \$2.38	CD4047 \$5.00	CD4093 \$1.98
CD4021 \$2.78	CD4048 \$2.70	CD4098 \$2.38
CD4022 \$2.38	CD4049 \$ .98	MC14409 \$29.50
	CD4050 \$1.38	

### LINEAR

/8MG \$3.50	LM320T-12 \$2.50	NE565N/H \$2.50
LM106H \$1.98	LM320T-15 \$2.50	NE566CN \$3.50
LM300H \$1.60	LM320T-18 \$2.50	NE567V/H \$1.98
LM3001CN/H \$ .70	LM320T-24 \$2.50	NE570N \$9.90
LM302H \$1.50	LM323K-5 \$11.90	LM703CN/H \$1.38
LM304H \$2.00	LM324N \$2.98	LM709/H \$ .58
LM305H \$1.20	LM339N \$1.98	LM710N \$1.58
LM307CN/H \$ .70	LM340K-5 \$2.70	LM711N \$ .78
LM308CN/H \$2.00	LM340K-6 \$2.70	LM733N \$2.00
LM309H \$2.20	LM340K-8 \$2.70	LM739N \$2.38
LM309K \$2.50	LM340K-12 \$2.70	LM741CN/H \$ .70
LM310CN \$3.90	LM340K-15 \$2.70	LM747N/H \$ .78
LM311N/H \$1.80	LM340K-18 \$2.70	LM747N/H \$1.58
LM312H \$3.90	LM340K-24 \$2.70	LM748N/H \$ .78
	LM340T-5 \$2.50	LM1310N \$3.90
LM318CN/H \$3.00	LM340T-6 \$2.50	LM1458CN/H \$1.98
LM319N \$2.60	LM340T-8 \$2.50	MC1488N \$3.90
LM320K-5 \$2.70	LM340T-12 \$2.50	MC1489N \$3.90
LM320K-5-2 \$2.70	LM340T-15 \$2.50	LM1496N \$1.90
LM320K-12 \$2.50	LM340T-18 \$2.50	LM1556V \$3.50
LM320K-15 \$2.70	LM340T-24 \$2.50	MC1741SCP \$6.00
LM320K-24 \$2.70	LM358N \$2.00	LM2111N \$3.90
LM320T-5 \$2.50	LM370N \$3.90	LM2901N \$5.90
LM320T-5-2 \$2.50	LM373N \$6.50	LM3053N \$3.00
LM320T-8-2 \$2.50	LM377N \$8.00	LM3065N \$2.98
	LM380N \$2.50	LM3900N \$2.98
	LM380CN \$1.98	(3401) \$1.18
	LM381N \$3.58	LM3905N \$2.98
	LM382N \$3.58	LM3909 \$2.50
	NE555V \$ .78	MC5558V \$1.18
	NE556N \$1.98	80388 \$9.90
		LM74545ON \$ .98
		75451CN \$ .78
		75452CN \$ .78
		75491CN \$1.50
		75492CN \$1.78
		75493N \$1.78
		75494CN \$2.50
		RC4136 \$7.90
		RC4151 \$9.90
		RC4195 \$8.98

### 74C00

74C00 \$ .78	74C85 \$4.98	74C164 \$4.98
74C02 \$ .78	74C90 \$3.90	74C173 \$5.20
74C04 \$ .90	74C93 \$3.90	74C192 \$4.98
74C08 \$ .98	74C95 \$3.90	74C193 \$4.98
74C10 \$ .78	74C107 \$2.50	74C195 \$4.98
74C14 \$3.90	74C151 \$5.80	74C922 \$15.90
74C20 \$ .78	74C154 \$6.00	74C923 \$12.50
74C30 \$ .78	74C157 \$4.30	74C925 \$17.90
74C42 \$3.90	74C160 \$4.98	74C926 \$17.90
74C48 \$4.98	74C161 \$4.98	80C95 \$3.00
74C73 \$1.78	74C163 \$4.98	80C97 \$3.00
74C74 \$1.78		

### 74LS00 TTL

74LS00 \$ .70	74LS90 \$1.42	74LS160 \$2.30
74LS01 \$ .70	74LS92 \$1.80	74LS161 \$2.78
74LS02 \$ .70	74LS93 \$1.80	74LS162 \$2.50
74LS03 \$ .70	74LS95 \$1.98	74LS163 \$2.78
74LS04 \$ .84	74LS96 \$2.30	74LS164 \$3.00
74LS05 \$ .84	74LS107 \$1.08	74LS175 \$2.50
74LS08 \$ .70	74LS109 \$1.08	74LS181 \$4.98
74LS09 \$ .84	74LS112 \$1.08	74LS190 \$2.78
74LS10 \$ .70	74LS123 \$3.00	74LS191 \$2.78
74LS11 \$1.50	74LS125 \$2.10	74LS193 \$2.78
74LS13 \$1.18	74LS132 \$1.98	74LS194 \$2.78
74LS14 \$2.50	74LS136 \$1.18	74LS195 \$2.78
74LS15 \$ .70	74LS138 \$2.10	74LS253 \$2.50
74LS20 \$ .70	74LS139 \$2.10	74LS257 \$2.10
	74LS138 \$2.10	74LS258 \$3.50
74LS21 \$ .70	74LS139 \$2.10	74LS260 \$1.66
74LS22 \$ .70	74LS151 \$2.10	74LS279 \$1.80
74LS26 \$ .70	74LS155 \$2.10	74LS367 \$1.50
74LS27 \$ .70	74LS157 \$2.10	74LS368 \$1.50
74LS28 \$ .70		74LS670 \$4.98
74LS30 \$ .70		
74LS32 \$ .84		
74LS37 \$ .90		
74LS40 \$ .70		
74LS42 \$2.10		
74LS47 \$2.10		
74LS51 \$ .58		
74LS54 \$ .58		
74LS55 \$ .58		
74LS73 \$1.08		
74LS74 \$1.08		
74LS75 \$1.42		
74LS76 \$1.08		
74LS78 \$ .98		
74LS83 \$2.10		
74LS85 \$3.00		
74LS86 \$1.08		

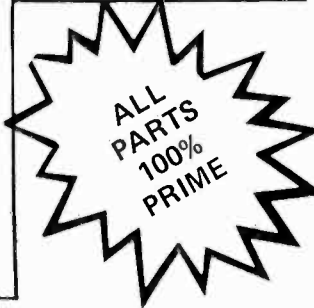

### JANA KITS

KIT No.	Description	Price
1	Auto Headlight Reminder	\$4.49 ea
2	Battery Operated Fluorescent Light Kit	\$15.95 ea
3	"Bug Shoo"	\$5.49 ea
4	Code Oscillator	\$7.49 ea
5	Crystal Radio	\$5.99 ea
7	Curiosity Box II	\$8.49 ea
8	Daily Lighter	\$6.59 ea
9	Decision Maker	\$5.49 ea
10	Fish Caller	\$6.49 ea
11	12V Hi Power Flasher	\$8.49 ea
12	Solid State Night Light	\$7.95 ea
13	6V Power Supply	\$13.79 ea
14	9V Power Supply	\$13.79 ea
15	0-24V 1A Power Supply	\$29.95 ea
16	Single Channel Color Organ 300 Watts	\$8.49 ea
17	Electronic Siren	\$5.89 ea
1	Shimmer Light Kit	\$9.95 ea
1/2	Tone Generator	\$6.69 ea
20	5 Transistor Amp Kit 1W RMS	\$13.75 ea
21	Tube & Continuity Checker	\$3.89 ea
22	Xenon Strobe	\$19.95 ea
23	3 Channel Color Organ	\$24.95 ea
24	Loudmouth Siren	\$13.75 ea
25	Roulette Wheel	\$15.95 ea
26	Electronic Skee	\$37.95 ea
27	Electronic Dice	\$33.95 ea
28	Super Roulette	\$28.95 ea
29	FM Mini Broadcaster	\$29.95 ea
31	Electronic Shoot-out	\$13.75 ea
32	Road Runner Sound Effects Generator	\$13.75 ea
33	Love-O-Meter	\$18.95 ea
34	30W Soldering Iron Kit	\$9.95 ea
35	Audio Power Watt Meter	\$21.95 ea

### TRANSISTORS

MPSA05 \$ .45	2N3823 \$1.49
MPSA06 \$ .30	2N3903 \$ .29
TI897 \$ .25	2N3904 \$ .29
TI898 \$ .25	2N3906 \$ .29
2N918 \$ .35	2N4013 \$ .39
2N2219A \$ .75	2N4123 \$ .39
2N2221 \$ .39	2N4249 \$ .39
2N2222 \$ .38	2N4250 \$ .39
PN2222	2N4401 \$ .39
Plastic	2N4402 \$ .39
2N2369 \$ .35	2N4403 \$ .39
MPS2369 \$ .35	2N4409 \$ .29
2N2484 \$ .39	2N4499 \$ .29
2N2906 \$ .35	2N5086 \$ .39
2N2907 \$ .25	2N5087 \$ .39
MJE2955 \$1.90	2N5088 \$ .29
2N3053 \$ .85	2N5089 \$ .29
2N3055 \$1.29	2N5129 \$ .29
2N3392 \$ .35	2N5134 \$ .29
MJE3055 \$1.39	2N5138 \$ .29
2N3392 \$ .35	2N5139 \$ .29
2N3392 \$ .35	2N5210 \$ .29
2N3398 \$ .35	2N5449 \$ .39
PN3567 \$ .49	2N5951 \$ .39
PN3568 \$ .39	
PN3569 \$ .39	
2N3704 \$ .29	
2N3705 \$ .29	
2N3706 \$ .29	
2N3707 \$ .29	
2N3708 \$ .29	
2N3724 \$1.09	
2N3725 \$1.52	
2N3772 \$3.60	

### RESISTORS

1r	68r	2.2k
1.2r	75r	2.7k
1.5r	82r	3k
2.2r	91r	3.3k
2.7r	100r	3.6k
3.3r	110r	3.9k
3.9r	120r	4.7k
4.7r	130r	5.1k
5.1r	150r	5.6k
6.8r	160r	6.8k
7.5r	180r	6.2k
8.2r	200r	8.2k
9.1r	220r	9.1k
10r	240r	10k
11r	270r	12k
12r	300r	18k
15r	330r	22k
15r	360r	24k
16r	430r	27k
18r	470r	30k
20r	510r	33k
22r	560r	39k
24r	620r	47k
27r	680r	51k
30r	750r	56k
33r	820r	62k
36r	910r	68k
39r	1k	82k
43r	1.2k	91k
47r	1.3k	100k
51r	1.5k	120k
56r	1.8k	150k
62r	2k	180k

### IC SOCKETS

Low Profile (Tin) Sockets

	1-24	25-49	50-100
8 PIN LP	.34	.32	.30
14 PIN LP	.40	.38	.36
16 PIN LP	.44	.42	.40
18 PIN LP	.58	.56	.54
20 PIN LP	.68	.64	.60
22 PIN LP	.74	.72	.70
24 PIN LP	.76	.74	.70
28 PIN LP	.90	.88	.86
36 PIN LP	1.20	1.18	1.16
40 PIN LP	1.26	1.24	1.22

### Discrete LEDs

**RED JUMBO LED SALE!**  
20¢ each  
10 for . . . \$ 1.90  
100 for . . . \$ 18.00  
1,000 for . . \$150.00  
GREEN . . . \$ .32  
YELLOW . . \$ .32

### CLOCK CHIPS

MM5309	\$ 9.90
MM5311	\$ 9.90
MM5312	\$ 9.90
MM5314	\$ 9.90
MM5316	\$13.90
MM5369	\$ 7.20
MM5387	\$ 9.90
CT7001	\$ 6.95

### SCRs & TRIACs



**ORDERS OVER \$75.00 SHIPPED PREPAID**

### Ohio Scientific Boards, Books & Accessories

SAMS C1P. Systems Maintenance and Repair Manual for Superboard, C1P and C1PMF. Complete Schematics etc.	\$10.00	810-8K. 8K Expansion Ram. Expandable to 24K, contains a Dual Mini-Floppy controller.	\$ 430.
SAMS C4P. System Maintenance and Repair Manual for C4P Systems.	\$25.00	CA-9. Parallel interface complete with cable and connectors.	\$ 250.
BASIC & PERS. Basic Language Primer covering Beginning, Intermediate and Advanced Programming, 438 Pages.	\$15.00	CM9. 24K, 2MHz Static Ram Board (for C4P systems).	\$ 650.
GETTING STARTED WITH YOUR C1P. 94 Pages.	\$10.00	620. Board allows C1PMF (600 and 610) to expand onto OSI BUS.	\$ 145.
8K in BASIC - Reference Manual.	\$ 3.00	CD2P. Dual 8" Floppy Drives with power supply, cable & interface.	\$2125.
65V PRIMER. Intro to 6502 Machine Language Programming through OSI 65V Machine Monitor.	\$ 9.00	CD3P. Single 5" Floppy Drive ("B" Drive expansion for C1PMF).	\$ 600.
		CD3AP. Single 5" Floppy Drive ("B" Drive expansion for C4PMF).	\$ 630.

### Ohio Scientific C4P Series.

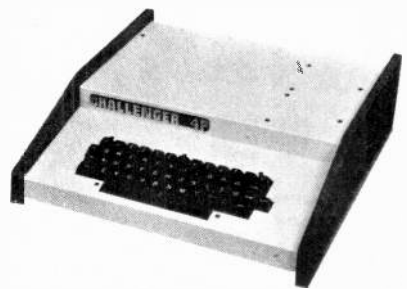

**THE CHALLENGER 4P.** A 4-slot computer with one open slot. Highly sophisticated 16 colour video display, 32 rows X 64 columns, upper and lower case, 8K BASIC-in-ROM 8K RAM, 200-20KHz programmable tone generator, AC remote interface, Expandable to 32K RAM and two mini-floppy drives. **\$1030.**

**THE CHALLENGER 4P MF.** Mini Floppy version of the 4P. Two to three times faster than others in its class. 24K RAM, Real time clock, Modem interface, Printer interface, Foreground/Background operation & much much more. **\$2540.**

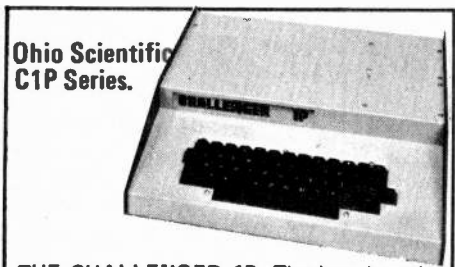

**THE CHALLENGER 1P.** The best bargain in personal computer anywhere! 8K BASIC-in-ROM, 4K RAM, Cassette based with 53-key keyboard, B&W video display, 30 rows X 30 columns. Upper and lower case. C1P with 8K RAM ..... **\$550.**  
C1P with 4K RAM ..... **\$499.**  
**OHIO SCIENTIFIC C1P MF.** Mini-floppy version of the C1P. 8K BASIC-in-ROM. Fully expandable. C1P MF with 20K RAM and OS-65D software **\$1799.**

### Ohio Scientific Accessories

AC3P - 12" B&W Monitor	\$ 200.
AC15P - 12" Colour Monitor	\$ 650.
AC17P - Home Security	\$ 360.
AC11P - Modem	\$ 275.
CA14A - Votrax	\$ 575.
CA15 - Univ. Tel/Interface	\$ 725.
CA15V - UTI & Votrax	\$1150.
AC16P - Joysticks	\$ 55.
AC12P - AC Remote Control	\$ 250.
AC18P - Line Printer	\$ 925.
AC9TP - Centronics 779	\$1650.
AC14 - Nec Spin Writer	\$3700.

### Ohio Scientific Superboard II Microcomputer

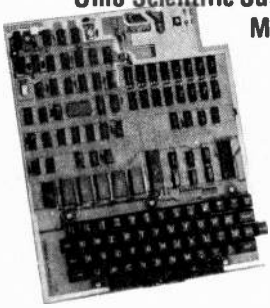

★ only ★  
**\$410.**

The first complete microcomputer system on a board. Features:

- Many special graphics characters
- Audio cassette interface built-in
- 8K Microsoft BASIC-in-ROM
- 4K RAM on board expandable to 8K
- Full 53 key keyboard with upper/lower case
- Fully assembled and tested
- Requires +5V at 3 Amps and a video monitor or TV set with RF modulator.

RF Modulator Kit ..... **\$7.95**

### Ohio Scientific 8P Series.

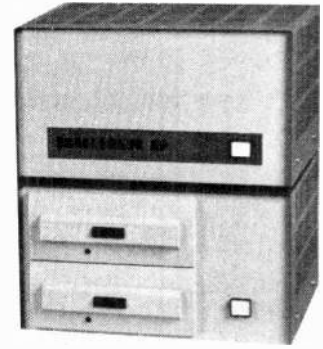

**CHALLENGER 8P.** Ohio Scientific's main-frame class. Personal computer. 8 slots with 6 open, Cassette based with 8K BASIC-in-ROM, 8K static RAM, expandable to 32K RAM, and dual 8-inch floppy disk drive. **\$1300.**

**CHALLENGER 8P DF.** A top of the line personal and small business computer. 32K RAM, expandable to 48K Features dual 8" floppy disk drives, Audio output 200 20KHz, DAC for voice generation. Keypad interfaces, Joystick (2) interfaces, AC Remote, Real Time Clock, Printer & Modem interfaces. And more. **\$4100.**

### Hobby Software

	Retail
Othello 8K	6.95
Tank Attack 4K	6.95
Computank 4K	7.95
Indy 500 4K (machine code)	4.95
Meteor Shower 8K	5.95
Star Wars 4K (machine code)	5.95
Golf 8K	7.95
Lunar Lander 4K	4.95
Aircraft Carrier 4K	5.95
Midway 4K	4.95
Mastermind 4K	4.95
Graphic Implementation Package 8K	7.95
Tiny Extended Monitor 4K	4.95
Machine Code Save 4K	5.95
Morse Code Sender 4K	4.95
3D Tic Tac Toe 8K	4.95

**Universal ASCII Keyboard**  
**LOW COST!**

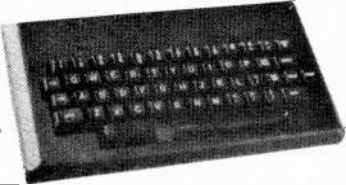

- 53 Typewriter Keys
  - Tri-mode MOS Encoding!
  - Two-key Rollover!
  - MOS/DTL/TTL Compatible!
  - Data and Strobe Inversion
  - Selectable Parity
  - Standard Parallel Interface
- Keyboard Kit (with case) ..... **\$99.95** Assembled Keyboard (with case) . **\$119.95**  
*Without case, subtract \$10.*

# A-1 ELECTRONICS

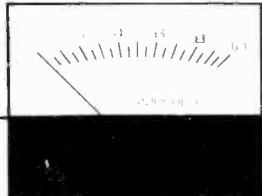

## CAPACITORS

**Mylar** — all rated at 100V or more.

001 uF	15¢	027 uF	20¢
0012 uF	15¢	033 uF	20¢
0015 uF	15¢	039 uF	20¢
0018 uF	15¢	047 uF	25¢
0022 uF	15¢	056 uF	25¢
0027 uF	15¢	068 uF	25¢
0033 uF	15¢	082 uF	25¢
0039 uF	15¢	1 uF	30¢
0047 uF	15¢	12 uF	30¢
005 uF	15¢	15 uF	35¢
0068 uF	15¢	18 uF	40¢
0082 uF	15¢	22 uF	45¢
01 uF	15¢	33 uF	45¢
012 uF	15¢	47 uF	50¢
018 uF	20¢	68 uF	50¢
022 uF	20¢	10 uF	50¢
027 uF	20¢	22 uF	50¢



**Disc** — all rated at 100V or more.

2.2 pF	39.0 pF	001 uF	0039 uF
3.3 pF	43.0 pF	0015 uF	0047 uF
3.9 pF	47.0 pF	002 uF	005 uF
5.6 pF	56.0 pF	0022 uF	0068 uF
7.2 pF	68.0 pF	0033 uF	.01 uF
8.2 pF	91.0 pF		
10.0 pF	100.0 pF		
15.0 pF	150.0 pF		
22.0 pF	390.0 pF		
27.0 pF	470.0 pF		
33.0 pF	680.0 pF		

**5¢ ea**

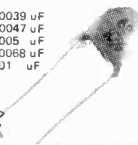

## Electrolytic

uF	VV	PRICE
1.0	63	20¢
2.2	63	20¢
3.3	63	20¢
4.7	63	20¢
10	16	20¢
10	25	20¢
10	63	25¢
22	16	25¢
22	25	25¢
22	63	30¢
33	16	25¢
33	25	30¢
33	63	30¢
47	16	30¢
47	25	30¢
47	63	30¢
100	16	30¢
100	25	35¢
100	63	45¢
220	16	30¢
220	25	35¢
220	63	55¢
330	16	35¢
330	25	45¢
330	63	60¢
470	16	40¢
470	25	30¢
470	63	40¢
1000	16	30¢
1000	25	65¢
1000	63	52.50
2200	16	65¢
2200	25	90¢
2200	63	53.50
3300	16	90¢
3300	25	11.25
3300	63	55.30
4700	16	11.43
4700	25	11.70
4700	63	55.20
6800	63	58.40
10000	63	52.50

## Tantalum

.22	35	35¢
.33	35	35¢
.47	35	35¢
.68	35	35¢
1.0	35	35¢
1.5	35	35¢
2.2	35	35¢
3.3	35	35¢
4.7	16	35¢
4.7	35	40¢
6.8	16	35¢
6.8		40¢
10		45¢
15		50¢
15		90¢
22		55¢
22		1.45
33		65¢
33		2.20
47		1.40

## AMP MODULES



**SANKEN**  
 10W RMS \$12.34  
 20W RMS \$13.50  
 30W RMS \$17.50  
 50W RMS \$29.87  
*Use 2 for stereo*

**ILP**  
 HY50  
 30W RMS \$29.95  
 HY120  
 60W RMS \$58.40  
 HY200  
 120W RMS \$81.50  
 HY400  
 240W RMS \$99.00  
 HY5  
 Mono Preamp \$22.80

## PREAMPLIFIER

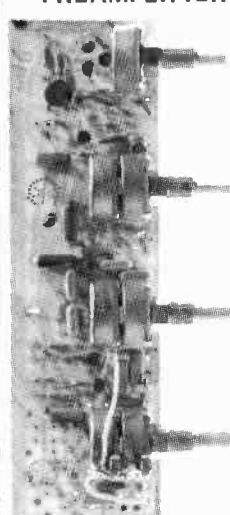

Preamp with Bass, Treble Volume, and Balance controls. Very low distortion. Requires 12V DC. Will work with ILP AMPS and other amplifier modules.  
**Assembled . . . . \$26.95**

## SPEAKERS

Pioneer - Mid range . . . . .	\$14.95
Pioneer Tweeter . . . . .	\$10.95
Crossover 75W RMS . . . . .	\$14.95
8" 20W RMS Bass . . . . .	\$16.20
8" 40W RMS Bass . . . . .	\$24.50
10" 60W RMS Air suspension . . . . .	\$32.62
12" 60W RMS Air suspension . . . . .	\$39.95
15" 100W RMS Air suspension . . . . .	\$62.50
15" 300W RMS Bass . . . . .	\$129.37
18" 300W RMS Bass . . . . .	\$199.95



## PANEL METERS

All meters are 2", 5% Accuracy

DC Volt Meters	AC Volt Meters	DC Milliamp Meters	DC Amps
<b>\$13.06</b>	<b>\$13.63</b>	<b>\$12.18</b>	<b>\$12.40</b>
0 - 5	0 - 10	0 - 1	0 - 30
0 - 10	0 - 15	0 - 2	0 - 50
0 - 15	0 - 25	0 - 3	0 - 100
0 - 50	0 - 50	0 - 5	0 - 200
0 - 100	0 - 150	0 - 10	0 - 300
0 - 150	0 - 300	0 - 20	0 - 500
0 - 300		0 - 25	

## SOLDERING IRONS

**Unreg 3-WIRE \$20.20**

7365 is an excellent soldering iron for beginners and occasional hobbyists. A variety of replacement tips are available.

**\$6.95**

**Unreg 1-WIRE \$13.13**

This sturdy iron is an excellent soldering iron for students and the more serious user. A variety of elements and tips available.

**\$13.13**

The 145K is a high quality, 3 wire soldering iron that is a must for the professional. Tips and elements are available.

**Unreg 2-WIRE \$15.27**

7365 is an excellent soldering iron for beginners and occasional hobbyists. A variety of replacement tips are available.

**\$15.27**

**Solder (1/2 kg roll, 1.1 lb, 60/40 rosin core 1 mm dia.) . . . \$15.27**  
**Lenline Dri-Wick Desoldering Braid (60 inches) . . . . . \$2.60**

**PC BOARDS** now available for all ETI Projects! Write for price list.

**SURPLUS PUSHBUTTON SWITCH \$1.85**

5, 6 or 7 Buttons

## AM-FM STEREO TUNER

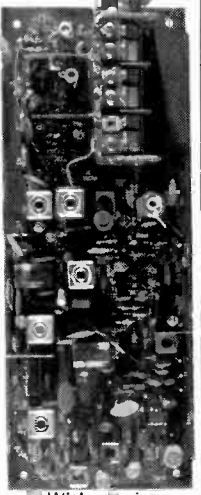

With tuning meter & AM antenna  
 •Requires 12VDC  
 •Assembled (Noresco factory surplus)  
 •With schematic  
**\$19.95!**

## GEL CELL

**OPAL**  
 MODEL NO KB-380  
 6V - 3.6AH  
 KOREA

**\$6.00!**  
 •Surplus Gel cell  
 •Rechargeable!  
 •6V, 3.6 amp hours

## EVEREADY NICAD BATTERIES

**1.2 Volt**  
 (AA size) . . . \$4.50  
 (C size) . . . \$5.07  
 (D size) . . . \$5.17  
 9 Volt . . . \$14.90  
 ACC50: Charger (Does 4AA 2C or 2D size cells at a time) . . . \$10.95  
 N88C: 9 Volt Charger . . . \$6.35

## AUTOMOTIVE CLOCK MODULE \$23.95

**CLOCK MODULE**

- Ideal for automotive applications
- Operates from 12VDC supply
- Internal crystal timebase
- 0.5 second/day accuracy
- Complete—just add switches
- Low standby power consumption

## SWITCHES

<b>SPST</b> \$1.88 DJ4030 6A	<b>SPDT CENTRE OFF</b> \$2.31 DJ4032 10A
<b>SPDT</b> \$2.01 DJ4031 10A	<b>DPDT</b> DJ4034 10A
<b>2 pole 3 position ROTARY SWITCH</b> 50¢	<b>DPDT CENTRE OFF</b> \$3.02 DJ4033 10A
<b>6 pole 2 position ROTARY SWITCH</b> 50¢	<b>6 pole 6 position ROTARY SWITCH</b> 50¢

## ORDERING INFORMATION

Clearly print out order. Ont. residents add 7% PST. Add 5% shipping charge on orders less than \$75. Excess refunded. Pay by certified cheque, Charge or Mastercharge (include signature, expiry date and card number). All orders shipped within 24 hours. All prices subject to change without notice. A-1 Electronics, 5062 Dundas St. W. Islington, Ont. M9A 1B9 (416) 231-4331

# THE KIRLIAN EFFECT

Is it a real phenomena, or a contrivance? The various 'explanations' range from the mystic to the pragmatic. In this article, Dr. Peter Sydenham, explores the history and phenomenon of radiation field photography — which may yet become a branch of the biophysical sciences.

IN THE 1850's James Clerk-Maxwell became interested in the "lines of force" (demonstrated by sprinkling iron filings on magnets) concept established by Faraday.

In 1855, when Clerk-Maxwell was twenty-four, he read the first of two papers at Cambridge reporting how he had applied mathematical expressions to Faraday's ideas. This apparently surprised Faraday who wrote, "I was at first almost frightened when I saw such mathematical force made to bear upon the subject, and then wondered to see that the subject stood it so well". At that time this must have seemed just another case of an esoteric mathematician apparently taking things beyond reason. But that was only the beginning of a most significant train of events.

From 1868 onward Clerk-Maxwell again became interested in electricity and magnetism. He sought mental models to explain how action could take place between two separated bodies, as had been stated much earlier by Newton. He developed ideas of a system of whirling vortices that helped him, mentally and pictorially, to visualise the action in magnetic fields.

Knowing, from the work of such people as Cavendish, Oersted and Faraday, that electricity was related to magnetism he tried out his ideas of vortices for electric fields. After some necessary modification he came up with a combined theory relating electricity and magnetism. His abstract visualisations included molecular vortices, whirling wheels, idle wheels and their interaction. He translated his images into drawings. (Fig. 1.)

From these mechanical models came his celebrated theory of electro-magnetism, published in 1873. Although based on a visual model it was expressed in mathematical form — the Maxwell equations.

The most surprising result of Maxwell's work was that his visual models suggested that under certain conditions there would be created a wave motion,

electro-magnetic in nature, that could be radiated through the electro-magnetic medium of space. He had discovered electro-magnetic radiation — at least, in theory.

Although he predicted that electro-magnetic radiation was feasible he was unable to prove this by experiment. And though he wished to verify his theory, it is doubtful he realized the importance of his findings.

Many people then took up the hunt for a practical method to generate and detect the elusive electro-magnetic waves. Over the years 1886 to 1889 Heinrich Hertz, in Germany, was the first to succeed in assembling apparatus (Fig. 2.) that transmitted the radiation, received and detected it. In the event, his apparatus turned out to be extremely simple. Hertz is said to have declared that, whilst interesting, this knowledge had no real value!

The world had then, for the first time, practical knowledge of an energy regime that was, as such, unknown to man beforehand. Within a decade Marconi had radio systems working and electro-magnetic radiation became an accepted phenomenon of great value.

Previous to the Hertz demonstration, many people had observed unaccountable effects that may well have been naturally generated electro-magnetic radiation — light, of course, is one. The circumstances of these 'strange' observations were varied and no explanation could be placed on them.

Bearing in mind that today, man has collected many well-documented experiences of other inexplicable happenings it seems reasonable to assume that there may well be other energy fields, or like concepts, yet to be discovered and formalised. Because we cannot sense (that is, detect) a given phenomenon with our natural sense organs, even when aided by sophisticated measuring technology, does not constitute positive proof that it does not exist. Perhaps much of the recorded data of psychical phenomena will one

day be explained by the discovery of new physical principles. Certainly the wealth of documented evidence suggests there are many such principles. The 'closed-mind' approach will not make the phenomena go away.

## Electro-photography — the Kirlian effect

Two groups of phenomena that have become closer to explanation than most are first the observations and photographic records of mysterious lights and radiations around people and objects — called variously, radiation field photography, electrophotography, Kirlian effect, Human aura, St. Elmo's fire plus other names — and second acupuncture.

The Kirlian effect and acupuncture would seem as related as monkeys to stones but, as will be shown, they do seem to be complementary concepts. First the Kirlian effect.

Belief in the existence of the human aura is very ancient. Mediaeval people distinguished four kinds of aura: 'Nimbux' and 'Halo' that stream from the head, 'Aureola' that issues from the whole body and 'Glory' which is both kinds combined. These were often featured in paintings; Fig. 3. is an example. Others divide the aura into health, vital, Kharmic, aura of character and aura of spiritual nature.

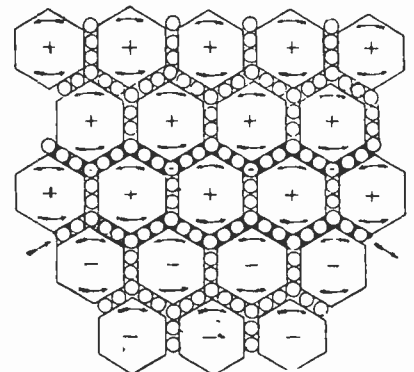
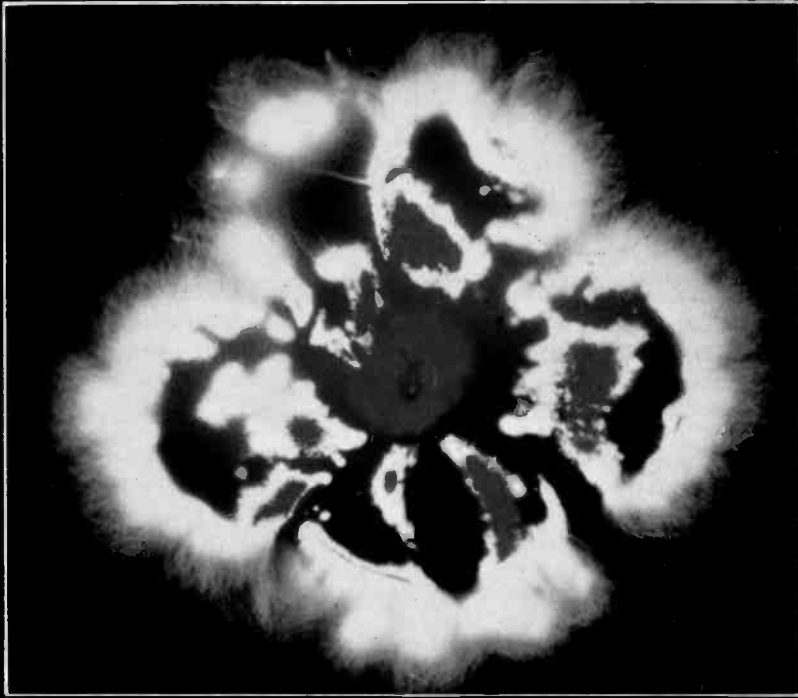
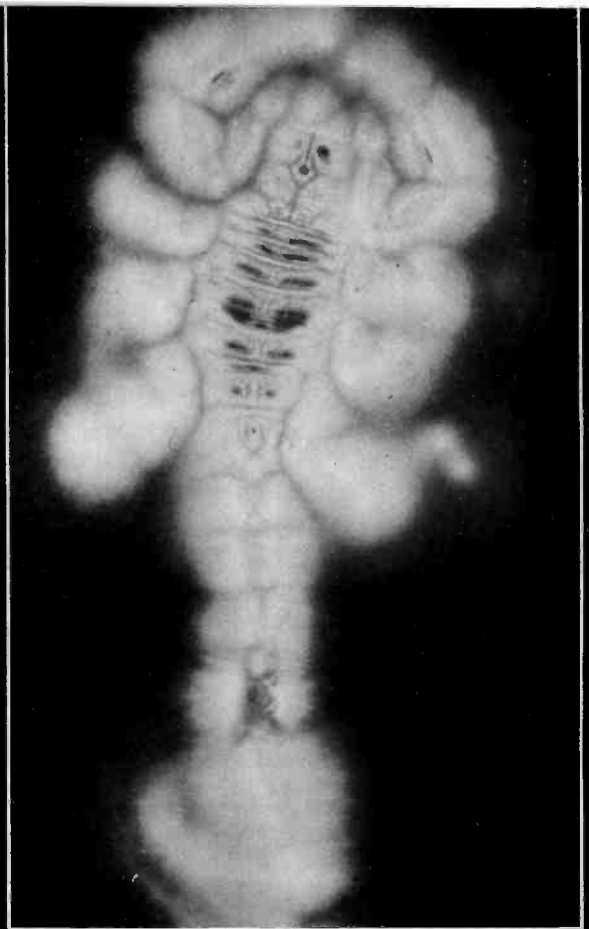

Figure 1. Maxwell used this sketch of whirling wheels and vortices to aid his thinking about the theory of electromagnetism.



Kirlian photograph of an oleander flower. The flesh of the flower in contact with the photograph film is indicated by the dark portions.



Above: the Kirlian aura of a live scorpion. The dark parts in the centre of the outline are portions of the arachnid's abdomen in contact with the photographic plate.

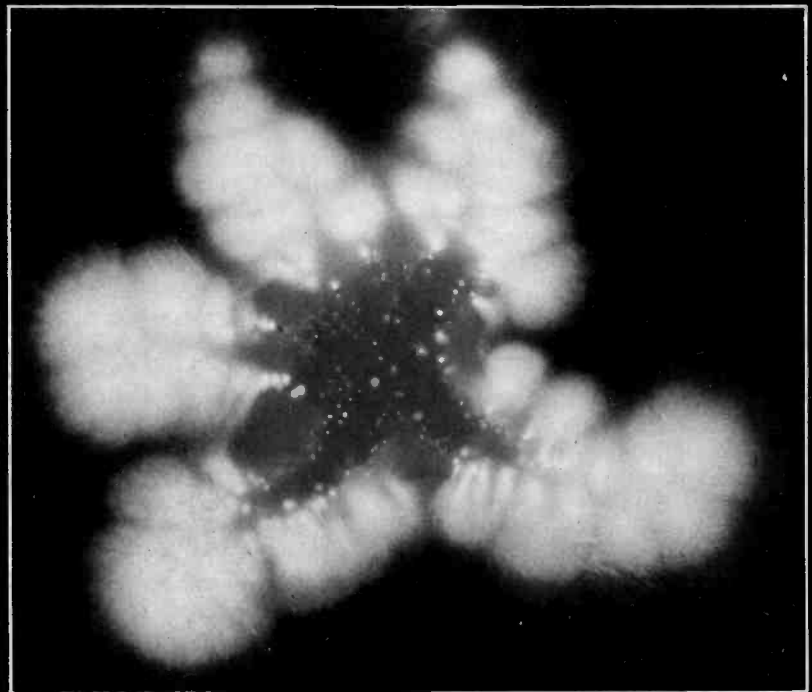

'Radiation field' of a 'Jewel of the Ocean' starfish. Fine structure of the field is evident at the extremities of the creature.

At left: the Kirlian 'aura' of a seafern.

Some people (clairvoyants particularly) claim to be able to see these effects without aids, the colours of the aura indicate the person's emotional and physical state.

The Old Testament bible relates how Moses was involved with a burning bush. Similar flames appeared as the "tongues of fire" that came upon the twelve apostles on the day of Pentecost.

Sharp ends of extended objects — ships masts, yard-arms, church steeples, airplane wingtips — in free air often exhibit this mysterious fire. This became known as St. Elmo's Fire after the martyred Italian bishop who became patron saint of sailors. Other names used include Castor and Pollux, Dioscuri, Corpusant and Fermie's Fire.

Recently this is said to be static electric discharge — corona discharge. A bluish glow was photographed around Pete Conrad the astronaut, when he landed on the Moon from Apollo 12 in 1970.

We all have, no doubt, experienced being charged-up on dry days. There are recorded instances of people who have the ability to deliver powerful electric charges who also have electro-magnetic properties enabling them to suspend magnetic materials.

Electrical storms have been known to produce images, (a rainbow in one case and pictures of people in others) semi-permanently formed in glass window panes. This is called lightning photography.

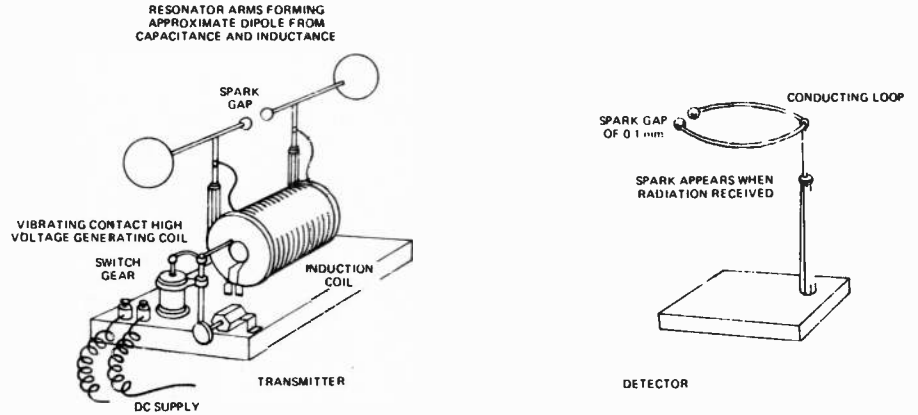

Figure 2. The apparatus used by Hertz to generate and detect electromagnetic radiation was quite simple. The 'classic' illustration is shown here.

In psychic photography, photographs of people — sometimes of people long departed have appeared on plates. It is suggested that there exists another energy form to electro-magnetic radiation. It is usually called bio-energy, the name coined by Czechoslovakian parapsychologists.

**Electro-photography**

Electro-photography is as old as the availability of photographic emulsions that could record the existence of radiations. A case dated 1842 is the oldest — see "The probability of the impossible", by T. Moss published by T.P Tarcher, 1974.

Yakov Narkevich — Todko showed photographs taken using electrical discharges in 1898.

Figure 4 from a 1926 book by C. Hall "Triumphs of Invention", carries the caption "A photograph of the Eiffel Tower taken during the dispatch of wireless time-signals. The ultra-violet radiations, although invisible to the naked eye, appear luminous on the photographic plate".

This kind of detection has become known as Kirlian photography after release of the work, in 1958, of the Russians Semyon and Valentian Kirlian. At first, interest in the Western World

**Psychic Phenomena — a group of unexplained experiences.**

Psychic science takes in phenomena such as apparitions (manifestation in image and presence form of the living and dead), apports, (solid objects unaccountably brought into closed-rooms), clairvoyance (supernormal mode of perception, resulting in a visual image in the mind), levitation (people and objects floating, in defiance of gravity), materializations (phantoms built-up from an unknown substance in sensitive persons), predictions (of future events), telekinesis (movement of objects without apparent contact), telepathy (thought transference) plus many more.

These experiences go under such names as psychical phenomena and spiritualism which include medium-

ship, extra-sensory perception (ESP) and parapsychology. They include such specific events as automatic writing of messages, spirit photographs and the appearance of poltergeists.

In early times these experiences were accepted as part of life and, presumably to help peoples' peace of mind, they were interwoven into their environment, usually as part of the religion. Witches were those with these paranormal powers.

In the 19th century a general trend was to denigrate these experiences because the highly-developing physical science of these times could not explain them. Rather than undermine the scientific method it was easier to dismiss this area of human experience.

In the late 19th century there began to appear many organised and creditable societies for the furthering

of knowledge in this fringe-science area.

Serious collecting of case-histories began. Several established scientists joined those interested, examples being Lodge, Crookes and Huxley. Many renowned physical scientists and engineers have developed interests in psychic events in their mature working years.

In this century the universities (in the Western World, that is) have become involved. A laboratory for parapsychology was established at Duke University, North Carolina in 1937. The University of Utrecht in the Netherlands had a Chair inaugurated in 1953. The Russians have had an active interest for many years.

But there still is lacking a "plausible theoretical framework" that can be used to explain the observed events.

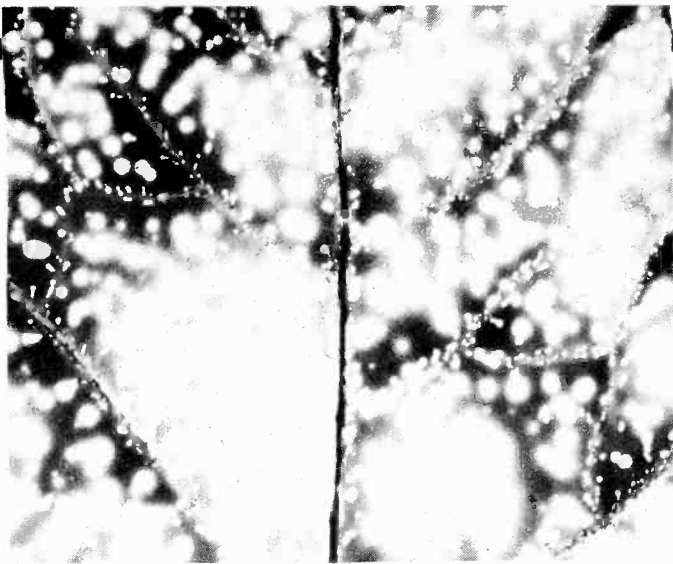

Figure 5. Kendall Johnson's first radiation field photograph was of this leaf. He made it in 1971 using surplus electrical parts in his apparatus.

Figure 3. Right: haloes are one of four forms of human aura. In early times these were shown in many paintings. Shown here is a work called "The Transfiguration" by Fra Angelico (1387 - 1455).

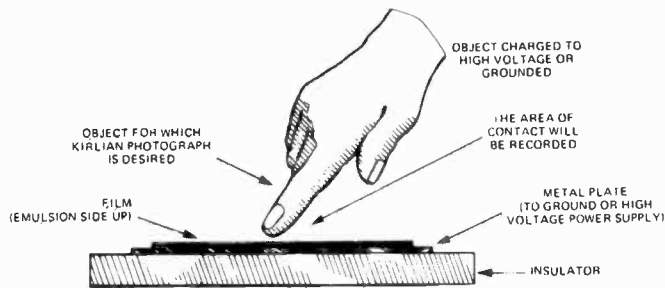
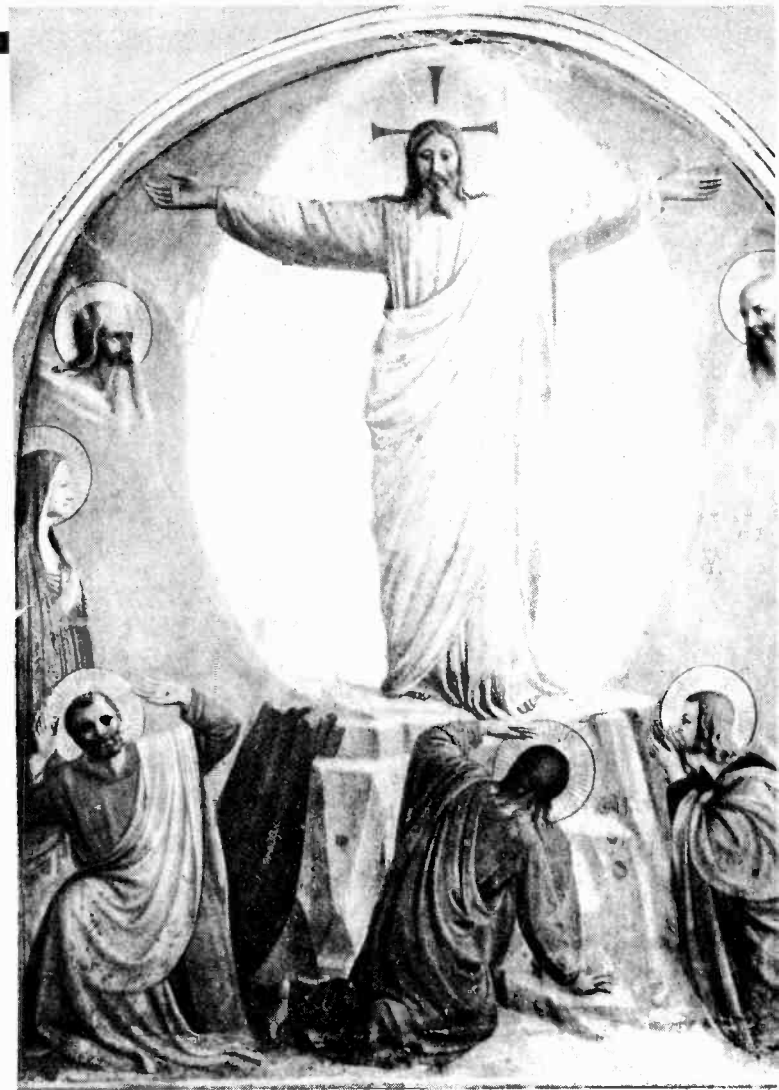

Figure 6. Simple method for making Kirlian photographs of fingertips using static charge built up on the body.

was minimal but it gained followers especially from 1970 onward.

In the West one man responsible for assisting this interest to flourish is Kendall Johnson, who it seems, was the dominant person in the US to obtain Kirlian pictures, (Fig. 5.), of objects. ("The Living Aura" by K. Johnson, Hawthorn Books, New York, 1975, is a *must* to read.) There were some earlier accounts of success in the US — one was published in 1938.

Having accepted that there is little mysterious in Kirlian photographs, researchers are now concentrating on trying to resolve whether or not the pictures have recorded more than mere electro-magnetic radiation effects. Do they contain evidence of bio-energy? Does some new form of energy exist to be explained?

#### The Practice of Kirlian Photography

In the simplest form of electrophotography an unexposed photographic film is placed on top of an electrode plate with the emulsion uppermost. Onto this is placed the subject to be photographed

— a coin, leaf or person's finger or hand. High voltage is applied to the top of the object and discharged through the object and photo-emulsion to the other plate (Fig. 6.). Clearly the high voltage source must not be of lethal extent if used directly on the body.

Body-part photographs can be made using the static charge built up on a person who shuffles around on a synthetic carpet in a dry room. The use of any other active voltage source for body-part pictures can be a most dangerous practice. It is strongly advised that you experiment with objects such as leaves, coins, flowers, metal shapes and liquid drops, unless you know about the safe use of electrical sensing equipment in electro-medical applications.

Photographs can be obtained using DC charge, a burst of audio frequency high voltage or a single short pulse. Just about every combination appears to have been tried.

Finding the right combination of film type and speed and source characteristics apparently can be time con-

suming as each object will need different settings. Results have been obtained using Tesla coils without and with spark-gaps (in which case RF is generated), Van de Graaf generators, charged capacitors and the charge of a person.

Wei, in a paper in the Journal of Applied Physics, Volume 47, p. 4437-4441 reported using a proprietary electric photography set made by Edmund Scientific. This provides voltages up to a maximum of 20kV in the frequency range 3-50kHz. The set allows the user to vary voltage, frequency, pulse width, pulse repetition and time. He also found that a spring-release piezo-electric generator, which supplies a 10 usec pulse of 19kV, was suitable as a source for his work with metal grids. It is likely that the larger style piezo-electric gas lighters might suffice. Wei uses ASA 3000 film (Polaroid 87) in his work.

Boyers and Tiller (J.Appl.Phys., Vol. 44, 3102-3112, 1973) typically used 100 usec pulses of bipolar 1 MHz signal having amplitudes varying from 20 to 100 kV. They derived this by driving an

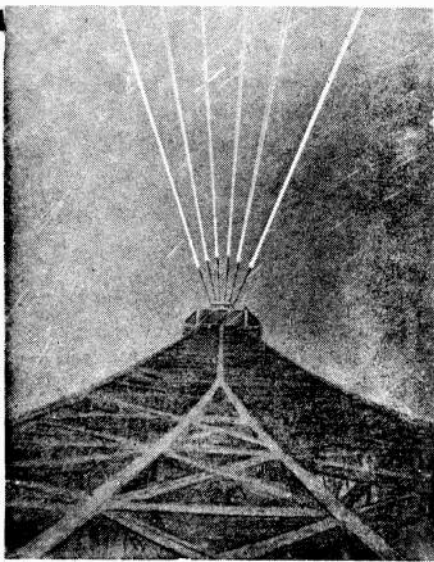

Figure 4. Ultra-violet radiation photograph looking up to the top of the Eiffel Tower — see text for explanation.

Oudin resonator coil (details given in their book) from a modified radio transmitter. They found that each pulse produced different streamer configurations, these tending to expose the film uniformly when a string of pulses was used as excitation. They also established

that the surface composition, smoothness, topography, inter-electrode spacing and parallelism of electrodes bearing on the results obtained. They also experimented with colour films, effects produced depending very much on the method of use and the type of film used.

A description of how to build a simple set of equipment is given in Johnson's book "The Living Aura", mentioned above. Another work "High-voltage photography" by H.S. Dakin, published by Edmund Scientific Company, Barrington, New Jersey, USA in 1975 provides circuitry details.

Many different arrangements of film and object position have been used. Fig. 7. shows a few variations. The film speed rating is assessed. Different films produce different results.

#### Defined Effects

Many variables exist to alter the characteristics of a Kirlian effect photograph. Even so certain effects appear to

have been established giving electrophotography an intriguing nature.

It is said that live leaves and small animals produce a much clearer image, of higher contrast, than when they are dead — the energy image is said to reduce as the leaf loses its life.

Another claim is that a piece torn from a leaf still shows as present in a photograph of the remainder. This is termed the phantom or cut-leaf effect. (This is not to be lightly dismissed for in the image storage method of holography the hologram plate can be broken and any piece from any position will still produce the same 3-D image.)

It is also said that psychic healers' finger pads produce a more brilliant image when healing is in process compared with when it is not. As Johnson states: "Do the images show an energy transfer between healer and subject? Is there some informational exchange going on, resulting in the different energy representation of the finger pads".

This also is quite plausible for we accept that information can only be

Figure 7. Various arrangements used in radiation field photography.

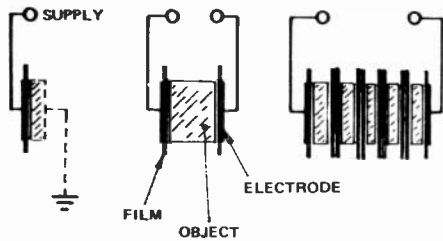

Various techniques used by the Kirlians in Russia.

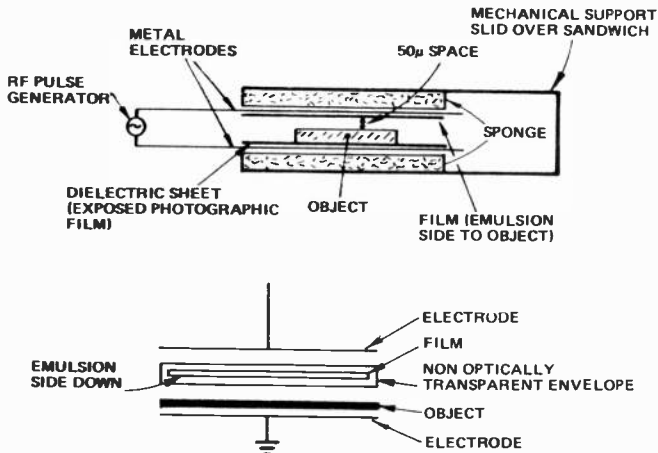

The two diagrams above show various ways of devising an envelope for the production of Kirlian photographs in a lighted room.

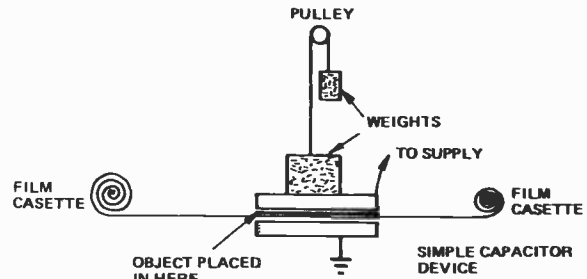

Use of roll film to record a Kirlian image. This method requires complete darkness to make the exposure.

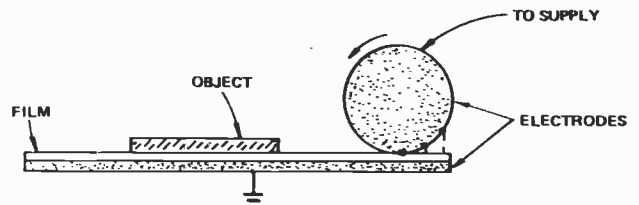

A method for producing Kirlian photographs using a rolling electrode.

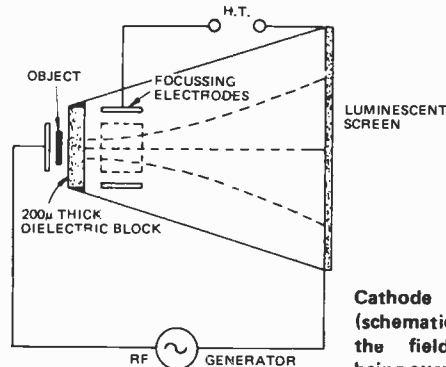

Cathode ray tube arrangement (schematic only) for picturing the field around the object being examined.

# JENSEN

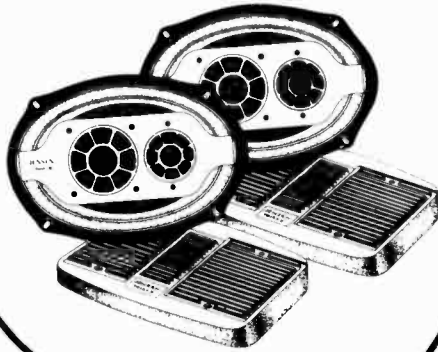

-- best prices --  
-- speakers - decks --

PAY NO SALES TAX.

## Alberta Audio

1107 73rd. Ave. S.W., Calgary, Alberta T2V 0R9  
(403) 252-1038

Circle No. 18 on Reader Service Card.

# Now Available!

OUR ALL NEW  
LENLINE  
ELECTRONIC  
COMPONENTS  
CATALOGUE.

60 pages contain  
ing more than  
400 items, all  
fully illustrated  
and described.

SEND FOR  
YOUR FREE  
COPY TODAY!



Please send me your LENLINE Electronic Components  
Catalogue and the name of my nearest LENLINE Dealer.

NAME \_\_\_\_\_

ADDRESS \_\_\_\_\_

CITY \_\_\_\_\_

PROV. \_\_\_\_\_ CODE \_\_\_\_\_

**len finkler ltd**

25 Toro Road, Downsview, Ontario M3J 2A6 • 630-9103



Circle No. 21 on Reader Service Card.

# Reader Service Information

If you would like more information on the products or services mentioned in the advertisements:

- 1 Fill in the attached card with your name, address, etc.
- 2 Circle the appropriate Reader Service number for further information about advertised products.
- 3 Mail the card and the advertiser will send you literature free of charge. If the card has been removed, or if you want the information in a hurry, phone or write direct to the advertiser and refer to the ETI issue and page number.

### YOUR COMPANY CLASSIFICATION (IF APPLICABLE):

- A. Manufacturer
- B. Retailer
- C. Government
- D. R & D
- E. Servicer/Installer
- F. Distributor/  
Representative
- G. Educational  
Institution

### IN THE FIELD OF:

1. Computer and  
Related Equipment
2. Communications  
Equipment and  
Systems
3. Navigation, Guidance  
or Control Systems
4. Test & Measurement  
Equipment
5. Consumer Products
6. Industrial Controls  
& Equipment
7. Components and  
Subassemblies
8. Other (Please  
specify on the card)

### YOUR MAJOR JOB FUNCTION (IF APPLICABLE):

- A. Buying
- B. Technologist
- C. Educator
- D. Not employed in an  
electronics-related  
field
- E. Engineering
- F. Technician
- G. Management
- H. Sales
- I. Other (Please  
specify on the card)

### WHAT INTERESTS YOU MOST ABOUT ETI? (YOUR FAVOURITE FIVE OR LESS):

- A. Audio
- B. Video
- C. Ham Radio
- D. Shortwave World
- E. Service News
- F. Components and  
Technology
- G. Reports on the  
Electronics Industry
- H. Microcomputers
- J. Projects
- K. News Digest
- L. Other (Please specify  
on the card)
- M. Tech Tips



transferred in a physical system when an energy (or mass) carrier exists to convey the data.

Evidence, in the form of Kirlian photographs, has been obtained implying that people with "green-thumbs" have properties that assist repairing damaged plant tissue.

Electro-photographs are certainly artistic and often pleasing to behold. Perhaps they do demonstrate some form of energy unknown to man.

**Kirlian Photography & Acupuncture**

What in the world have electro-photography and acupuncture in common? Why stage an international conference on this joint theme? The first Western Hemisphere Conference on Kirlian Photography, Acupuncture and the Human Aura" was held in New York City in 1972. Papers were read by authors from the Soviet Union, Canada, France, Japan, United Kingdom, Eire and the United States. Letters were received from Czechoslovakia and other countries.

Kirlian photography is concerned with the properties of objects to modify and transmit energy fields — which are certainly of electro-magnetic kind — but may also be of some other, yet unexplained, information-linking nature.

Acupuncture is a Chinese art of healing, using needles inserted into the body at certain places called acupunc-

ture points. It is a very ancient art and has been continuously practised, with effect, in the Asian regions.

The Western attitude to medicine and healing has, until recently, been skeptical towards acupuncture because it cannot be adequately explained by Western science. Considerable evidence now proves that there is much about the body that can be controlled. Yogis are able to perform quite amazing variations of bodily function. Somehow the insertion of needles, in various numbers, places and depths can cure many ailments.

Biofeedback is an apparently 'understandable' technology, Brendan O'Regan, of the Design Science Institute, Washington DC., wrote in 1973:

"Presumably, we in the West believe our senses only as their impressions are verified by the machines we create". It is in this light Kirlian photography relates to acupuncture as well as to many other subjects — see Fig. 8. for a chart of how the Russians have organised their work on psycho-energetics.

Several workers have reported that Kirlian effects are especially intense over known acupuncture points. Furthermore some people have built probes — called tobiscopes — that indicate their position.

It is claimed that acupuncture can be established by moving electrodes over the body and observing the signal

processed by an electro-physiological high-gain amplifier. The extent of the reading is said to also indicate the energy level of that particular acupuncture energy circuit. A 1971 Russian tobiscope, by Adamenko, detects skin resistance changes that are claimed to drop from around the normal 1M down to 50-100 kilohm at an acupuncture point.

**Related Reading**

Additional to the books and papers already mentioned, the following provide accounts concerned with electro-photography of electrical phenomena.

"*Psychic discoveries behind the Iron Curtain*". S. Ostrander and L. Schroeder, Prentice Hall, 1971.

"*Galaxies of life — the Human Aura in Acupuncture and Kirlian photography*". S. Krippner, Interface, New York, 1973.

"*Photography records electrical phenomenon*". Electrical Construction and Maintenance, Volume 75, 86, 1976.

"*Instant imaging of electric, radio and acoustic fields*". W.G. Hyzer, Optical Engineering, Volume 17, SR-3, 1978.

"*Handbook of Unusual Natural Phenomena*". W.R. Corliss, Sourcebook Project, Glen Arm, USA, 1977. ●

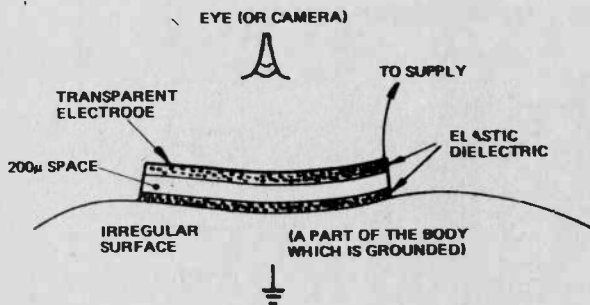

Direct viewing of the state of the 'aura' of a living object using a transparent electrode.

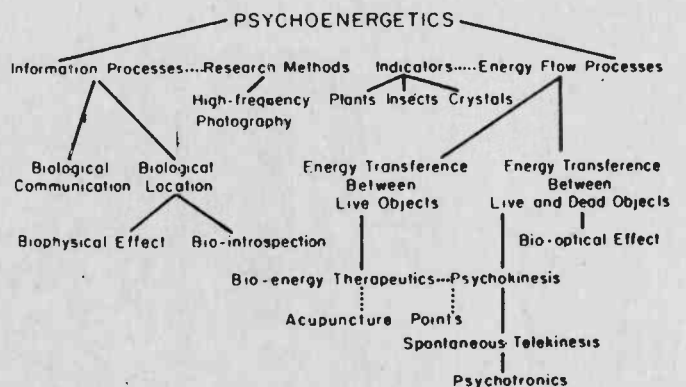

Figure 8. Chart showing how Russian work on psycho-energetics is classified and organised.

# TOUCH SWITCH

Bet you'll think this project's a touch of genius. Ten sequential outputs, or build it like a bistable. All under perfect, personal, fingertip control.

TOUCH SWITCHES have begun to appear in all kinds of places: elevators have them, TVs have them; even personal computers have them. Well, now you can have one too, for the price of a couple of chips and a handful of discrete components.

Now is your chance to get the world under your thumb. Featuring up to ten sequentially selected outputs and an overriding reset input, the project is a cinch to build. Make one for fun or control your radio, Hi-Fi, goldfish, etc.

Many commercial touch sensors rely on the electrical lines for an energising field. This circuit can be powered from a single nine volt battery, as it has low current consumption, uses only a few cheap components and is simple to construct. Also, above all, it is safe.

## Construction

To avoid the introduction of stray circuit capacitances and ensure reliable and repeatable operation, we strongly recommend that our PCB design is used. It is very small and should be quite easy to make or cheap to buy. There is only one link to make on the board. Make sure you get the diode and electrolytic capacitor the right way round. That goes for the integrated circuits too. It is quite okay to use sockets, in fact we would recommend it. That way you can always use the chips again and anyway, sockets make substitution easy if (horror of horrors!) the project fails to work first time.

You can try different layouts for the touch sensors. We made up a special board. At its simplest, a touch sensor could consist of a piece of unetched PCB split

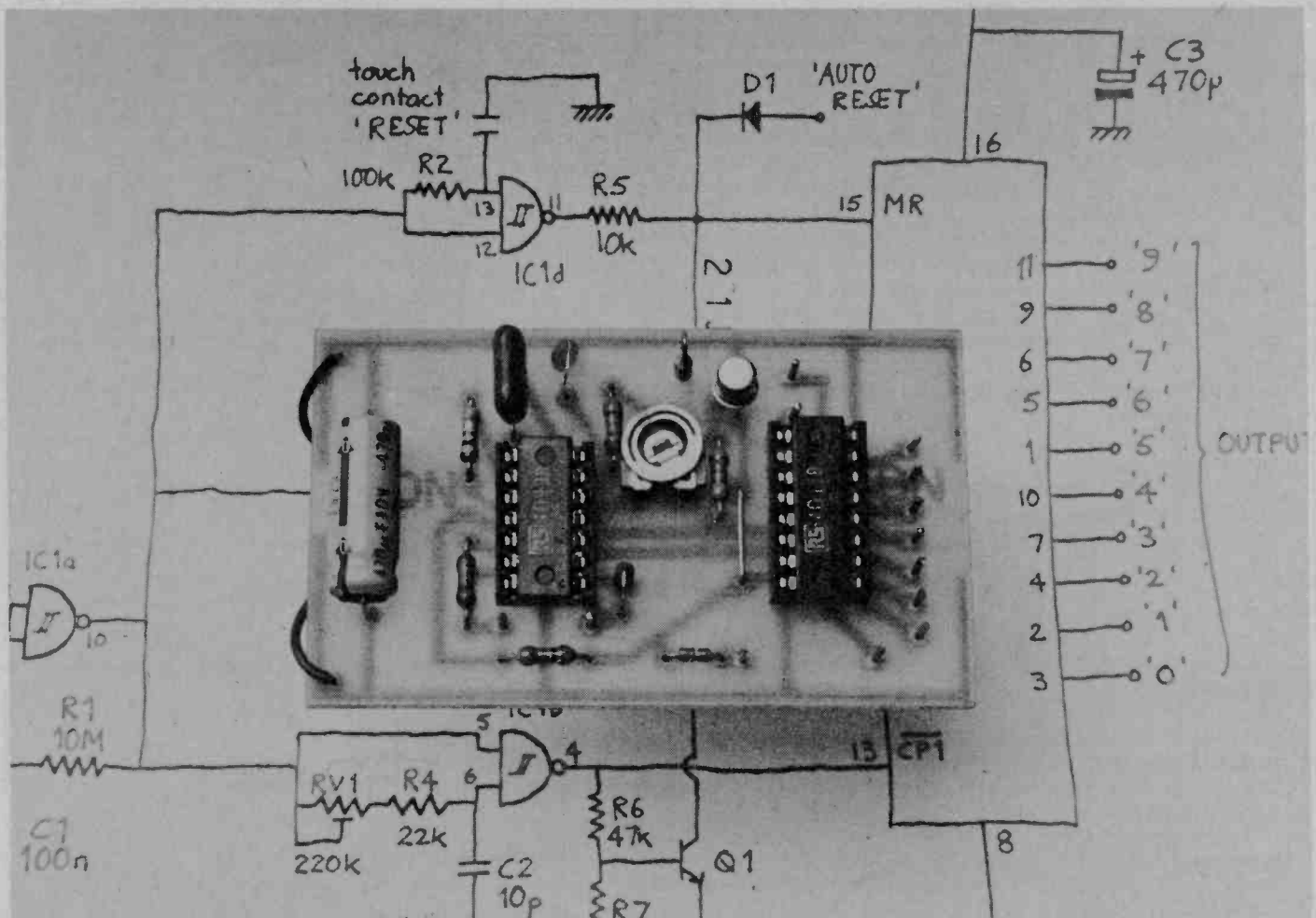

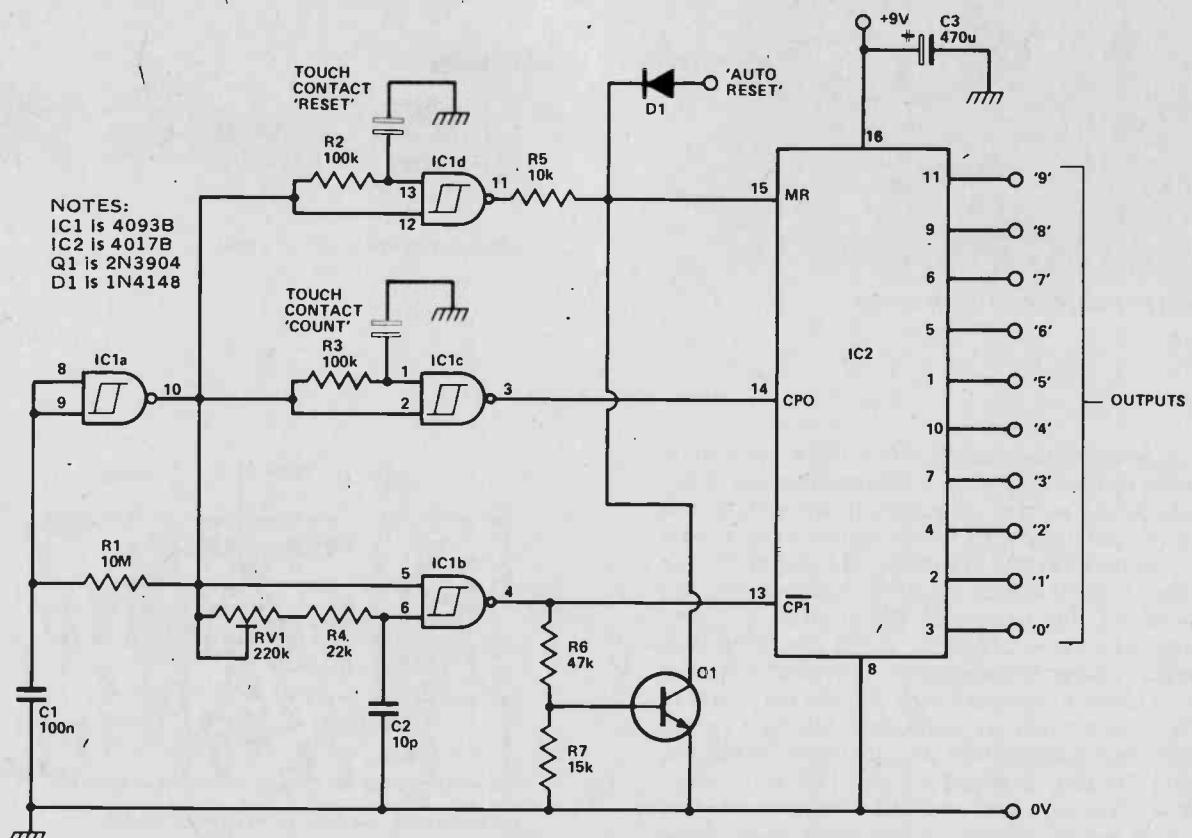

NOTES:  
 IC1 is 4093B  
 IC2 is 4017B  
 Q1 is 2N3904  
 D1 is 1N4148

Fig.1. Circuit diagram of the Touch Switch.

## HOW IT WORKS

The circuit operates by using the hand as part of a capacitor in a critical timing circuit. When the detector contacts are touched, the extra capacitance introduced has the effect of delaying the transmission of a clock edge. The circuitry is driven by one single phase clock generated by IC1a whose output consists of a continuous stream of pulses at about one Hertz with a nominal fifty percent duty cycle. A delayed and inverted clock is generated from this signal by IC1b whose output drives one of the clock inputs of decade counter-decoder IC2.

This chip does all the work of decoding the clock signals and provides a reset input which can be controlled from the touch circuitry or driven directly by one of the outputs of the chip. For example, to reset to zero after the 'fifth' count has been reached, just connect output 'six' (pin 5, IC2) to the 'auto reset' input at the anode of D1. If no connection is made to D1 then the circuit will cycle through all ten outputs. By connecting output 'two' (pin 4, IC2) to 'auto reset' and taking an output from 'one' or 'zero' (pins 2, 3 IC2), the circuit will operate as a bistable: one touch turning the output on; another touch resetting the output to off. The 'reset' touch contact may be left disconnected in this case.

A certain delay will always be introduced by IC1c, due to stray capacitance from the circuit board and connecting leads. This may be nulled out by adjustment of RV1 which should be set to

minimum resistance consistent with reliable operation.

Two suggested output circuits are shown. The first lights a LED when the appropriate output is selected, the other circuit will drive a small relay whose contacts may be used to switch more power.

The touch 'reset' circuit operates in a similar manner to the 'count' circuit. A glance at the timing diagram should make things clear.

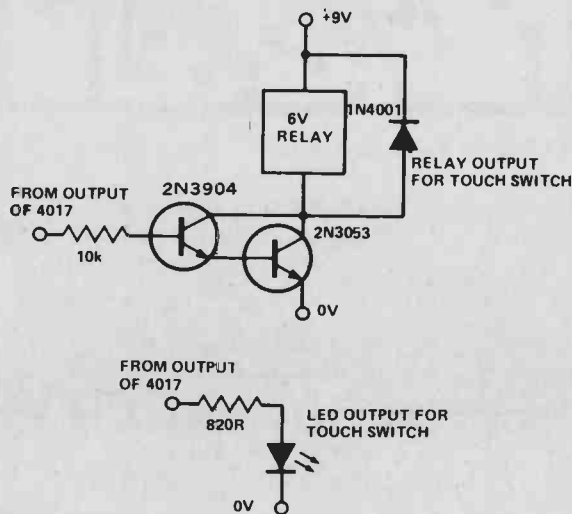

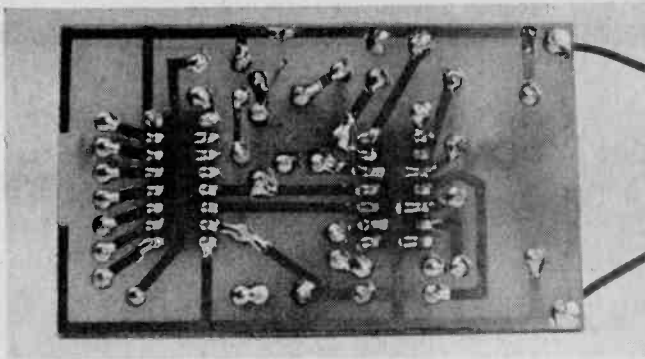

Good soldering pays off. Practice makes perfect.

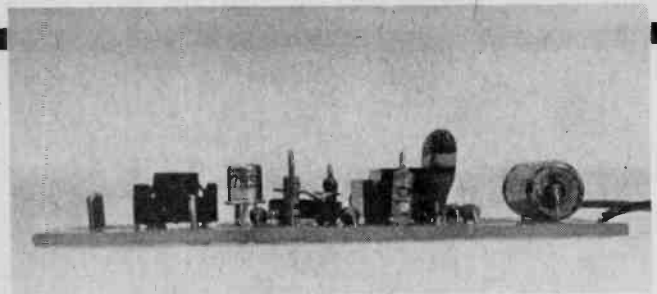

Use a PCB makes construction a snap!

into two copper lands by scoring or filing a line down the middle breaking the copper, but leaving the insulating board intact. Make sure no copper whiskers remain to bridge the copper lands as these would prevent the circuit from working at all. Sensitivity will depend to an extent on the physical size of the touch contacts and the area covered by, for example, the thumb or palm. Reliable operation was obtained using the prototype with the touch contacts covered by a layer of adhesive plastic film. Use of a coloured film like the sort used to cover books could make an attractive addition to the project. Use your imagination and do not be afraid to experiment. Finally, a word of caution to anyone thinking of controlling line powered equipment. This is okay so long as you make sure you use a relay whose contacts are rated for the job and keep all line wiring away from the rest of the project. Build one now and give your projects a little touch of class!

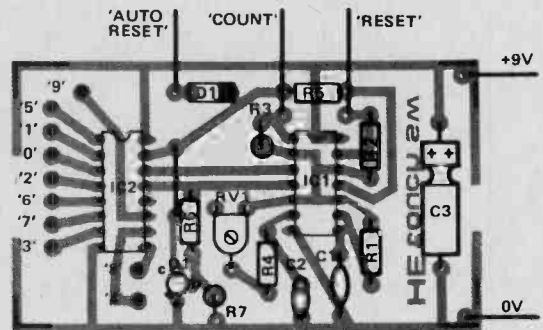

Fig.3. Overlay diagram for the Touch Switch.

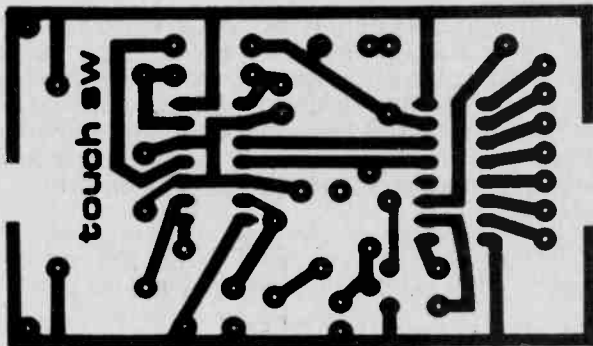
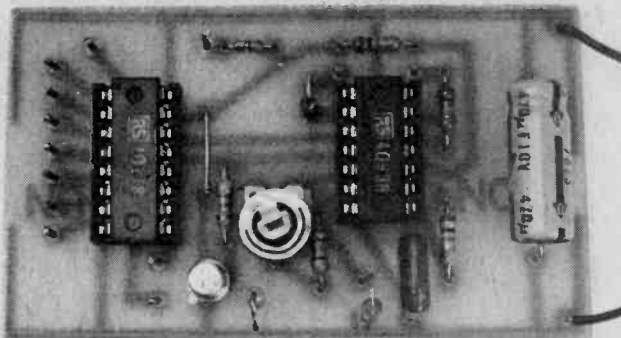

Fig.2. PCB for the Touch Switch



The assembled board, clean and compact.

## PARTS LIST

### RESISTORS (All 1/4W, 5%)

R1	10M
R2, 3	100k
R4	22k
R5	10k
R6	47k
R7	15k

### POTENTIOMETER

RV1	220k submin. horiz. preset
-----	----------------------------

### CAPACITORS

C1	100n polyester
C2	10p polystyrene
C3	470 $\mu$ electrolytic

### SEMICONDUCTORS

Q1	2N3904
IC1	4093B
IC2	4017B

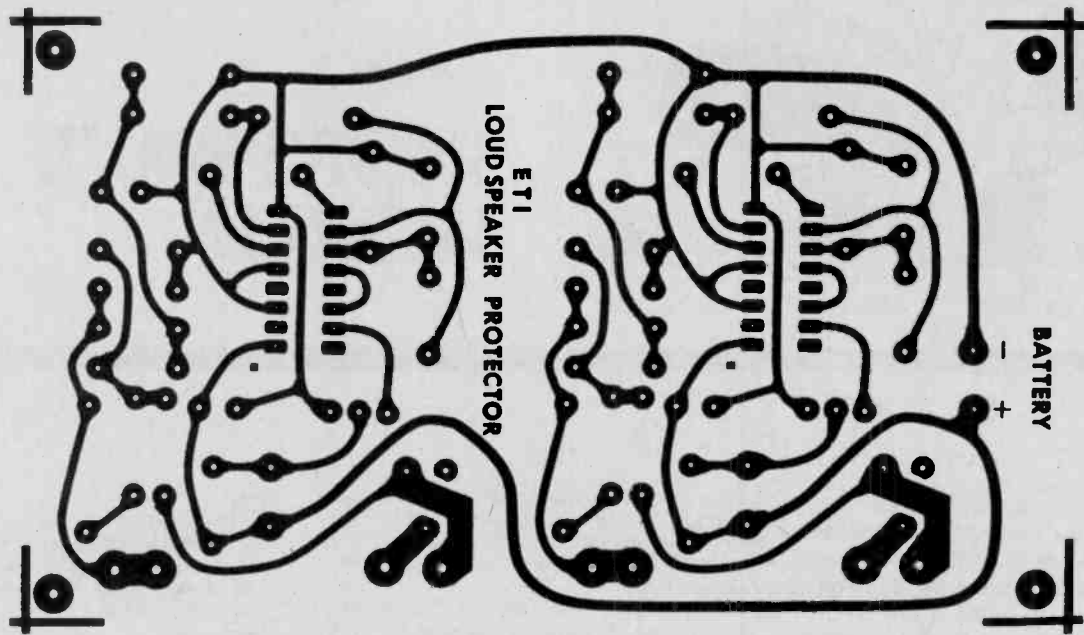

Fig.4. The PCB pattern for the Speaker Protection Project; this of is for two channels.

**No you're not finished!!!!**

no 1

Rapitape

**eti PANEL TRANSFERS**

MOO MAGS 1978 NO 1

A box with knobs and switches is by no means a complete project. You need ETI Panel Transfers.

ETI Panel Transfers are a really high quality system for finishing off your projects. The sheets include a mass of lettering and control scales for both rotary and linear pots. The markings are on two sheets (a full-sized one cut in half for easy postage) and contain sufficient lettering for dozens of projects. Send \$5.00 (postage included) to

**ETI Panel Transfers**  
Unit 6, 25 Overlea Blvd.,  
Toronto, Ont. M4H 1B1

*Ontario residents add PST.*

## ROBERT J. BUCKLAND CO.

SURPLUS ELECTRONICS  
LONDON, ONTARIO

You are invited to our 11th year celebration of successful operation as a leader in electronics surplus merchandising at our new location: 123 St. George St., at Picadilly Street, London (1 block west of our old location).

The new warehouse will have the old atmosphere but many new products and surplus items to catch the interest of the hobbyist, industrial, educational and dealer markets.

We put out regular flyers. To get on our mailing list come in and see or just drop us a line at:

Robert J. Buckland Co.

P.O. Box 367, Station B

London, Ontario

N6A 3E3

Phone (519) 672-8390

**BUYERS & SELLERS OF ELECTRONIC SURPLUS  
INVENTORIES & EQUIPMENT**

Bob Buckland VE3AQE

Dan Robinson VE3ICN

Circle No.8 on Reader Service Card.

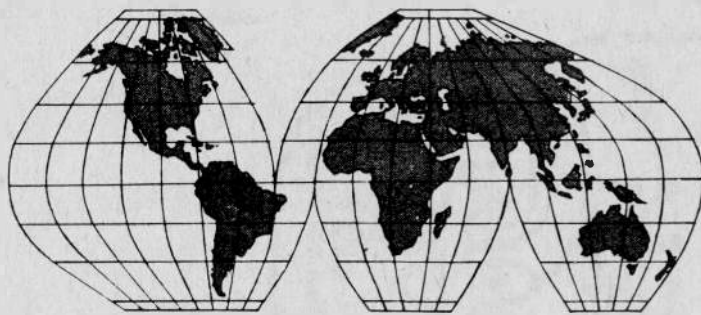

# SHORTWAVE WORLD

TWO MONTHS ago we began our discussion of the exciting area of the Tropical Bands. At that time we listed some stations in these bands from Central and South America and from Africa. We will continue this month with some stations from the rest of the world. Since these stations are about half way around the world they will be somewhat more difficult to log than the South American stations. Remember that these low frequencies propagate best over a nighttime area or darkness path so the best time to hear these will be just before sunrise or just after sunset. Of course, since the nights are longer in winter that will be the best time for many of these stations.

## Near and Mid East

**Afghanistan** — Radio Afghanistan is on 4773 kilohertz with 100 kilowatts of power from 0130 GMT to 0330 in Pushto/Dari; 1130 to 1200 in Nurestani; 1200-1300 in Turkmani; 1300-1400 in Ozbake; 1400-1530 in Urdu; 1530-1600 in English; and from 1600 to 1630 in Baluchi. I would be interested in hearing from any of our readers who can understand some of these languages!

**Cyprus** — The BBC operate their East Mediterranean Relay station from Cyprus on 3989, 5990, 6010, 6050 and 6070 kHz. Regular BBC World Service programs are broadcast from here at various times throughout the day.

**Iraq** — The Broadcasting Service of the Republic of Iraq operate on 3240 (50 kW) from Hurriyah from 1030-1400 in Turkuman and 1400-1600 in Assyrian; from 0730-1030 in Persian; 1600-1900 in Persian and from 1900-2100 in Turkish. Also from Hurriyah on 3960 with 50 kilowatts from 1300-1600 and from 1930 to 2330 in Arabic.

**Lebanon** — Radio Lebanon has a station listed on 5980 kHz with 100 kilowatts of power from 0355 to 0805 and 1620-1805. Programming is in Arabic.

**Oman** — Radio Oman has two low power frequencies in the Tropical Bands — 4886 (10 kW) and 6174 (50 kW). Programs are in the Arabic language. The BBC Eastern Relay also operates from here on 6030 with their World Service.

**Saudi Arabia** — The Broadcasting Service of the Kingdom of Saudi Arabia in Riyadh is listed on 5875 kHz from 0300-0730 and 1000-2300 in Arabic.

**Yemen Arab Republic** — Radio San'a operate on 4853 (25 kW) and 6050 (50 kW) from 0300-0700 and 1000-2130; also on Friday from 0700-1000. This is their Home Service in Arabic.

**Yemen (People's Dem. Rep.)** — The Democratic Yemen Broadcasting Service has two frequencies in the Tropical Bands — 5060 (7.5 kW) and 5970 (100 kW) from 0300-0530 and 1100-2200 (Friday 0300-2200). This is the Home Service in Arabic.

## South and East Asia

**Bangladesh** — Radio Bangladesh has a 7.5 kilowatt transmitter on 3965 kilohertz from midnight GMT to 0400 and 1330 to 1730; and a 100 kilowatt station on 4890 from 0000-0305. They broadcast in the Bangla language with some English at 0145, 1530 and 1705.

**Bhutan** — A 300 watt station is operated in Bhutan by the Radio National Youth Assoc. of Bhutan (NYAB) on 4690 kilohertz on Wednesday between 1230 and 1330 GMT in Dzonghka for the first three quarters of an hour and in English for fifteen minutes. The extremely low power will make this a very difficult one to log.

**Burma** — The Burma Broadcasting Service have three 50 kilowatt transmitters operating in the Tropical Bands — 4725 from 1030 to 1545; 5040 and 5985 from 0930 to 1600. Burmese is used until 1430 and the remainder is in English.

**China (People's Rep.)** — The Central People's Broadcasting Station (CPBS) broadcast the First Program in Standard Chinese on the following frequencies and times: 4180 from 2000-2300 and 1500-1735; 4905 from 2000-2300 and 1100-1735; 5320 from 2000-2300 and 1400-1735; 5860 from 2000-0100 and 1100-1735; 5880 from 2000-0100 and 1100-1735.

The Second Program also in Standard Chinese is on the following: 5075 from 2100-2330 and 1330-1600; 5163 from 2100-2400; 5990 from 2100-2400 and 1330-1600.

The Minority Language Service operates as follows: 3900 in Mongolian from 2230-2325 and 0500-0555 and in Uighur from 1300-1355; 4035 in Tibetan from 1100-1155; 4068 in Mongolian from 0500-0555; 4895 in Mongolian from 0500-0555; 4952 in Mongolian from 0500-0555; 4970 in Kazakh from 1400-1455; 5440 in Kazakh from 1400-1455; 6080 in Mongolian from 2230-2325 and 0500-0555.

Broadcasts to Taiwan from the mainland in Standard Chinese, Amoy and Hakka languages are carried on these frequencies: 3360 from 2000-0130 and 1000-1900; 4770 from 1501-1900; 5125 from 2000-2200 and 1401-

1900.

The Fujian Front Station (People's Liberation Army) also broadcasts to offshore islands and Taiwan on these frequencies: 2430 from 1525-2100; 2490 from 1530-2230; 2600 from 1500-2100; 3200 from 1430-2100; 3400 from 1330-2100; 3535 from 1700-2144; 3900 from 1526-2100; 4130 from 1500-2100; 4330 from 1400-2314; 4380 from 0400-2100; 4840 from 0400-2100; 5170 from 0400-2100; 5240 from 1000-1659 and 2145-0500; 5265 from 1000-0500; 5770 from 0400-1459; 5900 from 1000-0500; and 6000 from 0400-1459. The language used by the Fujian Front Station is mostly Standard Chinese with some Amoy.

There are also a number of Regional stations operating in the Tropical Bands in China. These broadcast in Chinese languages: 2200 from 2120-1600; 2310 from 2155-2400 and 1100-1540; 2340 from 2050-0530 and 0930-1600; 2350 from 2105-1513; 2415 from 2050-0740 and 0850-1520; 2460 from 2215-0600 and 0920-1605; 2476 from 2100-0500 and 0855-1505; 2960 from 2050-0540 and 0920-1520; 3245 from 2120-0100, 0250-0630 and 0920-1505; 3260 from 2130-0020, 0150-0620 and 0850-1605; 3310 from 2050-0540 and 0855-1430; 3340 from 2040-0635 and 0825-1430; 3900 from 2150-0605 and 0920-1400; 3917 from 0430-0500 and 1000-1545; 3930 from 2230-0540 and 1000-1500; 3940 from 2100-0100, 0300-0740 and 0855-1605; 3950 from 2150-0100 and 0930-1525; 3970 from 2145-0100, 0305-0555 and 0900-1525; 3990 from 2300-1730; 4010 from 0900-1520; 4035 from 2230-0645; 4068 from 2130-0050, 0230-0555, 0900-1350, 1400-1455, 1500-1800; 4110 from 2300-1730, 1800-1900 and 2000-2055; 4195 from 2330-1545; 4220 from 2330-0555, 1100-1730 and 1800-2055; 4500 from 2300-0710, 1000-1730 and 1800-2055; 4525 from 2150-0100, 0255-0500 and 0830-1400; 4750 from 2230-0645 and 1000-1545; 4759 from 2150-0600 and 0920-1600; 4735 from 0950-1400, 4787 from 2230-0800 and 0950-1555; 4830 from 2040-0100, 0250-0540 and 0900-1500; 4840 from 2040-0600; 4865 from 2120-0100, 0330-0600 and 0920-1600; 4895 from 2130-0050, 0500-0555, 1400-1455 and 1500-1755; 4905 from 2000-2300 and 1100-1735; 4915 from 2105-0005 and 0845-1605; 4925 from 2040-0635 and 0825-1445; 4940 from 2150-0100 and 0930-1525; 4952 from 2155-0100 and 1000-1500; 4970 from 2330-1730 and 1400-1455; 4980 from 2100-0100, 0300-0600 and 0855-1610, 4990 from 2105-1600; 5010 from 2130-2350.

0950-1530 and 1300-1400; 5020 from 0855-1600; 5040 from 0730-0930 and 1000-1600; 5060 from 2330-0555, 1100-1730 and 1800-2100; 5261 from 1000-1545; 5440 from 2330-0630, 1100-1730, 1800-1855 and 2000-2055; 5935 from 2230-0645 and 1000-1545; 5950 from 2040-0635 and 0825-1445; 5960 from 2155-2400 and 1100-1540; 5970 from 2120-0100, 0330-0600 and 0720-1600; 6000 from 0850-1510; 6005 from 1215-1600; 6045 from 0945-1400.

Radio Peking's External service also operates a few Tropical Band stations — in Cantonese on 5420 from 2300-2330; in Czech on 4620 and 5220 from 1900-2000; in French on 5420 from 1830-2230; in Hausa on 4020 and 5295 from 1900-1930 and on 4620 and 5220 from 2100-2130; in Hindi on 4035 and 5935 from 1600-1800; in Indonesian on 5420 from 1400-1430; in Japanese on 3960 and 4960 from 2130-2200 and 0930-1530; Korean on 4620 and 5975 from 1100-1500; Laotian on 5220 from 1430-1500; Mongolian on 5145 and 5850 from 1100-1300 and 1400-1500; Nepali on 5220 from 1500-1600; Polish on 4020 and 5295 from 2000-2100; Portuguese on 4620 and 5220 from 2000-2100, and on 4020 and 5295 from 2200-2300; Russian on 5145 from 1500-1555; Serbo-Croat on 5295 from 2100-2200; Swahili on 5420 from 1600-1730; Standard Chinese on 5420 from 2230-2300, 1500-1600 and 1730-1830; Tagalog on 5420 from 1430-1500; and in Thai on 5220 from 2330-0030.

**Republic of China (Taiwan)** — The Central Broadcasting System broadcast to Mainland China on the following: 3230 (10 kW) from 2045-0100, 0344-1000, 1045-1915; 3335 from 2045-0345, 1600-1915, 1045-1600 (in Hakka); 6040 from 2045-0700, 1045-1915. Except where indicated all programs are in Chinese.

The Voice of Free China (International Service) operates on 5980 kHz with 3.5 kW of power in Amoy from 0000-0100; in Cantonese from 0500-0700; in Hakka from 0300-0400; Indonesian from 0200-0300; and in Mandarin from 0400-0500.

The Voice of Asia also broadcasts on 5980 in English from 1030-1200; Indonesian from 1200-1300, 1600-1700 and 1730-1800; Mandarin 1300-1500, 1700-1730; and in Thai from 1500-1600 and 1800-1900.

Apparently China not only has a large number of people, they also have a large number of Tropical Band stations.

**India** — India Radio also operates quite a few frequencies in the Tropical Bands — 3205 (10 kW), 3223 (2.5 kW), 3235 (10 kW), 3268 (2 kW), 3277 (7.5 kW) from 2300-0330 and 1030-1830; 3295 (10 kW) 2300-0330; 3305 (10 kW), 3315 (10 kW), and 3345 (10 kW) from 2300-0330 and 1030-1830; 3355 (10 kW) from 2300-0330 and (20 kW) from 0030-0400; 3365 (10 kW) and 3375 (10 kW) 2300-0330 and 1030-1830; 4760 (2.5 kW) 2300-0500 and 0930-1245; 4775 (10 kW) 2300-0430 and 0930-1230; 4800 (10 kW) and 4820 (10 kW) 2300-0330 and 1130-1830; 4840 (10 kW) from 2300-0430 and 1030-1830; 4850 (2 kW) 2300-0400 and 0930-1300; 4860 (7.5 kW) from 2300-0500; 4880 (10 kW) 2300-0500 and 1030-1215; 4895 (20 kW) 2300-0930; 4920 (10 kW) 2300-0215 and 1030-1900; 4940 (10 kW) 2300-0400 and 0930-1130; 4950 (10 kW) 2300-0445 and 0930-1215; 4960 (10 kW) 2330-0430; 5960 (10 kW) 0230-1215; 5970 (10 kW) 1130-1215; 5990 (2.5 kW) 2300-0430; 6020 (100 kW) 0215-1115; 6035 (2 kW) 0125-0300. The language used on the

above broadcasts are mostly vernacular with some English news.

The External Services of All India Radio also operate on a couple of Tropical Band frequencies: in Arabic on 3905 from 1745-1945 and in Urdu on 3295 from 1430-1930.

**Indonesia** — There are about 200 stations in the Tropical Bands in this country but many of them are of very low power so I will just list some of those over 5 kilowatts. They all broadcast in Indonesian with a few English transmissions. Radio Republik Indonesia operates on these frequencies: 2332 (5 kW) 2200-0100, 0500-0800 and 1000-1600; 2452 (5 kW) 2200-0030 and 1000-1700 (English 1130-1200); 3120 (10 kW) 2155-0030, 0455-0730 and 0855-1520; 3205 (10 kW) 2200-0100 and 1000-1600; 3215 (10 kW) 2100-0300, 0330-0630 and 0830-1530; 3225 (10 kW) 1000-1500; 3232 (10 kW) 0500-0715 and 1100-1600; 3250 (10 kW) 2200-0100 (Sun. 2300-0715) and 0900-1515; 3265 (10 kW) 2300-0130 (Sun. 2330-0330), 0500-0715, and from a different location from 2100-2200 and 0830-1520; 3325 (10 kW) 0900-1520; 3345 (10 kW) 0800-1415; 3345 (5 kW) 2200-0100, 0400-0700 (Sun. 2300-0700) and 0900-1515; 3375 (7.5 kW) 2200-0000, 0200-0500 and 1000-1500; 3385 (10 kW) 2200-0015 (Sun. 2200-0600), 0400-0615 and 0900-1515; 3395 (10 kW) 2155-0130, 0455-0710; and 0855-1600; 3935 (10/5 kW) 2200-2300 and 1000-1600 (Sat. 1000-1700); 3945 (10 kW) 2200-2330 and 0957-1600; 3960 (10 kW) 2200-2230 and 0900-1520; 3975 (10 kW) 2200-0100, 0500-0700 (Sun. 0000-0700) and 0958-1600; 3995 (10 kW) 2200-0100, 0400-0700 (Sun. 2300-0700), 0900-1520 (Sat. 0900-1600 (Sun. 0900-1500); 4000 (5 kW) 2130-2345 and 0900-1530; 4005 (10 kW) 2330-0100, 0945-1620 (Sat. 0945-1700), (Sun. 0000-0400 and 1000-1600); 4719 (50 kW) 0830-1330; 4753 (20 kW) 2130-0030 and 1100-1500; 4764 (50 kW) 2300-0200, 0500-0800 and 1000-1700 (Sun. 2300-0800); 4774 (50 kW) 2200-0200 and 0830-1600; 4805 (20 kW) 2155-0100; 4845 (10 kW) 2100-0015, 0400-0600 and 0800-1400; 4855 (10 kW) 2230-0115 (Sun. 2230-0700) and 0900-1600; 4875 (10 kW) 2100-2330, 0800-1400 (English 1230-1258); 4927 (7.5 kW) 2230-0600 and 0858-1600 (Sun. 2350-0700); 4932 (10 kW) 1000-1700; 4955 (10 kW) 2300-0015 (Sun. 2300-0600) and 0800-1600; 5047 (20 kW) 0100-0300, 0455-0800 and 0955-1700 (English 1130-1145); 5970 (20 kW) 0400-0700; 6045 (120 kW) 2200-0100, 0500-0800 (Sun. 2200-0800) and 1000-1600.

**Korea (Republic of Korea)** — The Home Service of the Korean Broadcasting System is on the air in Korean from 2000-1800 on 2510, 3930 and 5975. These are 5 or 10 kilowatt transmitters.

There is also a private station in Seoul in Korean on 3985 or 3995 from 1400-1700.

**Laos** — National Radio of Laos broadcasts in Laotian languages on 4285 from 1000-1115; on 4658 from 2300-0100, 0330-0530, 1000-1155 and 1255-1425; and on 4757 from 2300-0130, 0400-0600 and 1000-1400.

**Malaysia** — The Home Service of Radio Television Malaysia (RTM) in Peninsular Malaysia have the following transmissions: on 4845 Mon. to Fri. from 2130-0130, 0540-0630, 0830 to 1530, Sat. from 2130 to 0330, 0545-1530 and on Sun. from 2130-1530 in Bahasa Malaysia and Indian languages; in Bahasa Malaysia and English on 4985 Mon. to Fri. 2230-0130, 0545-0630, 0930-1630, Sat. 2230-0130, 0530-1630 and Sun. 2230-

1630; in Bahasa Malaysia on 5965 from 1630-2130 (except Mon.); in Bahasa Malaysia and Chinese on 6025 Mon. to Fri. from 2250-0130, 0330-0545, 0830-1630, Sat and Sun. from 2250-1630.

**Radio Malaysia** — Kota Kinabalu in Sabah operate 4970 kilohertz from 2130 to 1600 in Bahasa Malaysia.

**Radic Television Malaysia** — Sarawak also broadcast on a few Tropical Bands in several Malaysian languages: 3385 from 2200-2300, 0400-0500, 0935-1500; 4835 from 2200-0130 and 0830-1600; 4895 from 2200-2300 and 1000-1500; 4950 from 2200-0100 and 0800-1600 (there is some English on this frequency); 5005 from 2200-2300, 0400-0500 and 1000-1500; 5030 from 2200-2400 and 1030-1500.

**Maldives** — Radio Maldives broadcasts in their local language on 4754 (7 kW) from 0100-0315 and 1200-1730.

**Monogolia** — The Home Service of Ulan Bator Radio in Mongolian is carried on the following frequencies: 3960, 4762, 4830, 4850, 4995 and 5055 from 2200 to 0100; on 4850, 4995 and 5055 from 0100-1030; on 3960, 4082, 4762, 4830, 4850, 4995 and 5055 from 1030-1500; and on 5960 from 0830-1050.

**Nepal** — Radio Nepal operates in Nepali with

The BBC Far Eastern Relay may also be heard from Singapore on 3915, and 6050 with their World Service.

a little English on 3425 and 5005 from 0020-0350 (Sat. 0020-0450), 0720-1050 1150-1435 and 1520-1720.

**Pakistan** — The Home Service of the Pakistan Broadcasting Corporation is on the air in Urdu on 5060 from 0130 0230 and 0615-1800. Regional Services are carried on 5010 from 0130-0430 (Fri. 0130-0500) and 1500-1800; on 5760 from 0130-0430 (Fri. 0130-0445) and 1430-1800; and on 5980 from 0130-0430 (Fri. 0130-0345) and 1400-1600.

**Philippines** — The Philippine Broadcasting Service is on 3286 in vernaculars from 2100-1500. The Far East Broadcasting Co. (FEBC) have a station on 6030 from 0230-0430 and 1300-2030.

**Singapore** — Radio Singapore broadcast in English on 5052 (20 kW) from 2230-1630 and in Chinese on 6000 kHz from 2230-1630.

Quite a few frequencies this month for you to try. Most of these will be quite difficult but they are there and are heard from time to time here in North America. Good luck logging some of these.

WHY DOES IT SMELL LIKE A FARMYARD?



MUST BE ALL THOSE FIELD EFFECT TRANSISTORS....



# Designer Circuits

## LOGIC LOCK

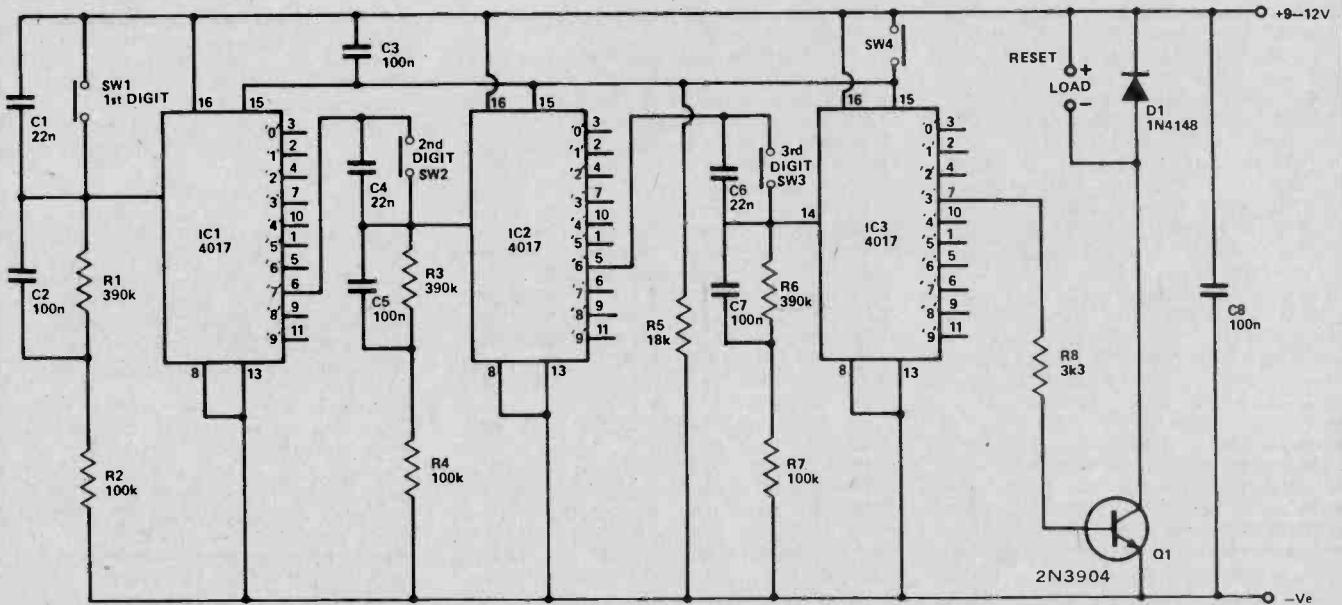

This electronic combination lock can be used instead of a keyswitch as the on/off switch for a burglar alarm or other equipment, or it can be built for its novelty value. It is unusual in that it has three push button switches which are fed with the combination, the number of times each switch has to be pressed corresponding to its combination number. The switches must be operated in the correct order, and in practice they would not be arranged so that they had to be operated starting with the left hand switch and working across to the right hand one. Thus it is possible that someone knowing the

correct combination number would still be unable to "crack" the unit. SW1 is the first switch, and a clock pulse will be fed to IC1 each time it is operated. C1, C2 and R1 are needed to prevent contact bounce from giving faulty operation (even the cheapest of push button switches will be reliable enough). IC1 is a 1 of 10 decoder, and when power is initially applied to the circuit it is reset to zero by the positive pulse generated by C3 and R5. In other words the '0' output will be high and the other nine will be low. As pulses are fed to IC1 using SW1, outputs '1', '2', '3', etc. will successively be the single

output that assumes the high state. The next stage is identical to the first, but is driven from the '7' output of IC1, and so seven pulses must be fed to IC2 before IC2 can be clocked using SW2. The third stage is fed from the '6' output of IC2, and so six pulses must be fed to IC3 before IC3 can be clocked using SW3. After three clock pulses, IC3 output '3' will go high, switching on Q1 and applying power to the load. This can be a solenoid, a relay, or any DC load requiring 9 to 12 V. at no more than 100mA. If an error is made when entering the combination, the circuit is reset using SW4

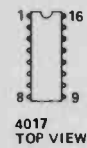

and the combination is entered from the beginning. Of course, as shown the circuit has a combination of 7-6-3, but by using the appropriate outputs of ICs 1 to 3 any three digit combination can be obtained. The circuit has a standby current consumption of only about 3uA., rising to about 3mA. (plus the load current) when it is switched to the on state.

## ELECTRONIC THERMOMETER

This thermometer covers a range of 0 to 50 degrees Centigrade with a linear scale so that the temperature can be read directly from the scale of the 50uA. meter. A range of 0-100 degrees Centigrade can be obtained by substituting a 100uA. meter.

The unit uses silicon diodes D1 and D2 as the temperature sensors, and these would normally be mounted in some form of probe which can be positioned many metres away from the other circuitry if necessary. C1 filters out any noise picked-up in the connecting cable. D1 and D2 are given a small forward bias by R1, and this is made only small so that there is no significant self heating of the diodes. The voltage produced across the diodes is nominally 1.2 V., but it actually varies by about 2mV. per degree C. per diode, or about 4 mV. across both diodes. This voltage is fed to the input of an op. ap. inverting amplifier which

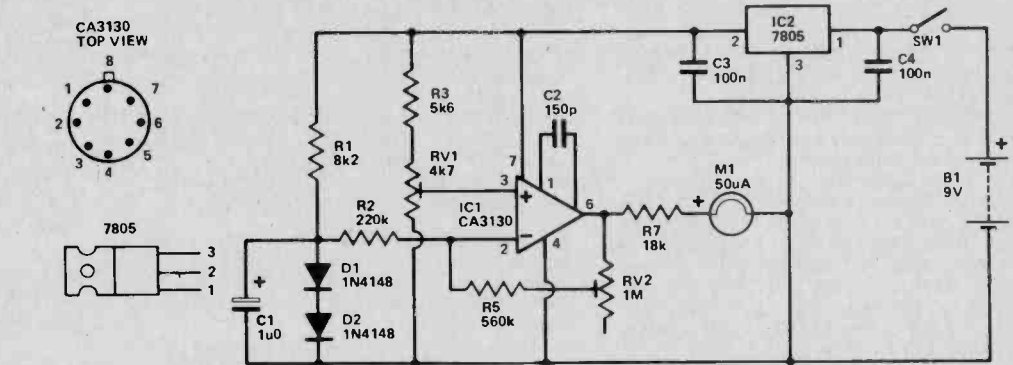

utilizes IC1. With the probe at 0 degrees C. (which can be achieved by immersing the probe in ice) R4 is adjusted for the highest voltage at IC1's non-inverting input that gives zero output voltage. This compensates for the quiescent voltage across the diodes, and gives zero reading on the 1 V. FSD voltmeter circuit which consists of R7 plus M1 and is connected across the output of the amplifier. If the diodes are now heated to

50 degrees C., the voltage across them will fall by approximately 200 mV. (4 mV. x 50 degrees C. = 200mV.), and this is amplified by a factor of 5 by the amplifier to give about 1 V. at its output and roughly full scale deflection of the meter. In practice R6 is used to adjust the gain of the amplifier so that precisely full scale deflection is produced, and the unit functions as an accurate thermometer. Of course, R6 can be given the correct

setting with the probe at any known temperature which corresponds to a reasonably substantial meter deflection, and the unit does not have to be calibrated at 50 degrees C. The circuit requires a very stable supply of about 5 V., and this is obtained from a 9 V. battery using a 5 V. monolithic regulator (IC2). C3 and C4 should be mounted close to IC2 in order to prevent instability.



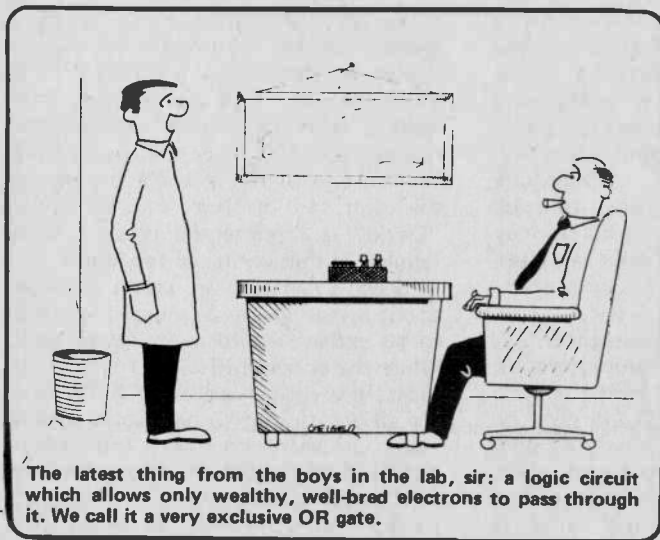
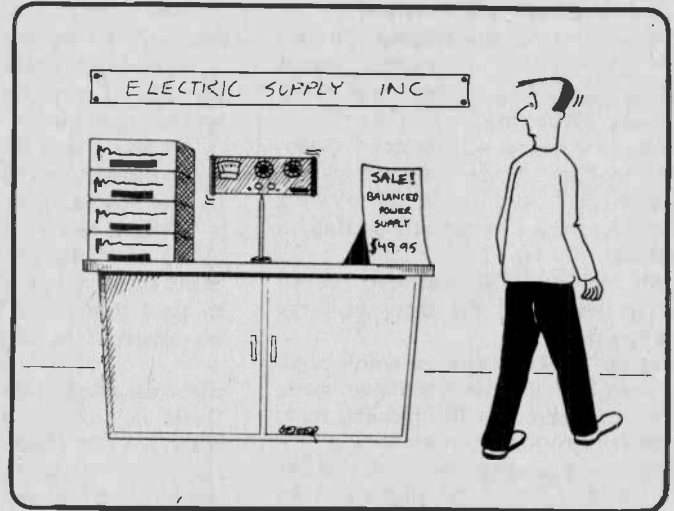
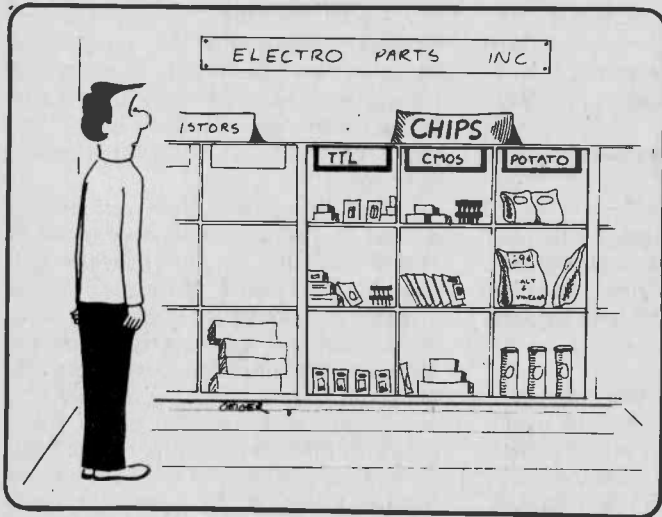
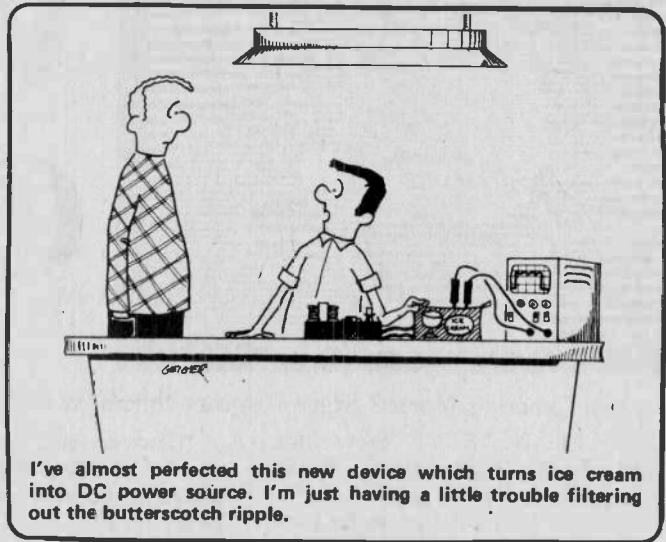
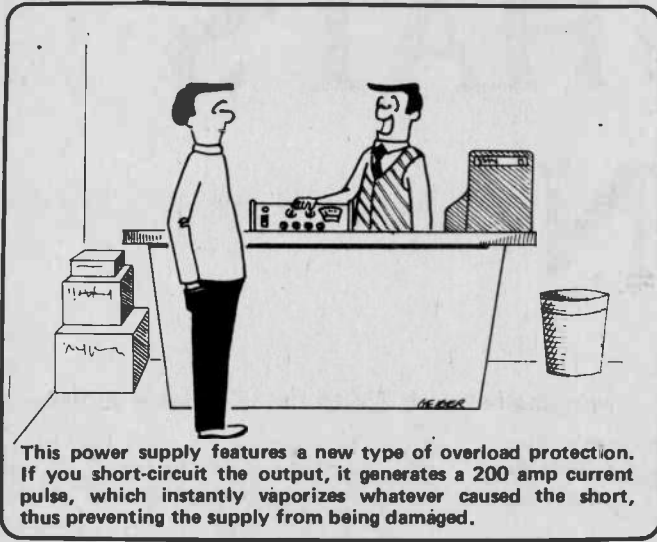

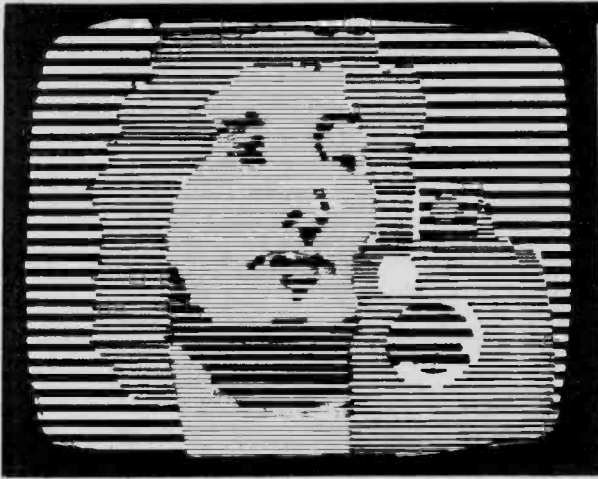

# WHAT'S ON

Pirate's in Canada's North? Steve Rimmer tells how one man is bringing network TV to the Northern audience.

"ARRGH, ME HEARTY," growls the old party in the freaky duds. "Would ya be knowin' who ya be speakin' to?"

"I dunno." I would like to go back to sleep. I was getting a fine tan before Sinbad the Sailor showed up. "Lemme guess. You're Long John Denver."

"Arrgh, I'd be Greenbeard, The Pirate o' Pickle Lake." He strikes a maniacal pose, resembling Ian Anderson doing Aqualung. "What thinks ya o' that?"

"Gee, are you a real pirate? I mean, you're the first pirate I've ever seen in a speedboat." And could ya move a bit to the left? . . . I'm really getting no sun at all.

"Ah, me ship. We captured her on the high seas. Had the crew walk the plank, we did."

Dig it. Pickle Lake is landlocked. He's been into the martini shaker again. "Hope you gave 'em life jackets, man, or the Red Cross'll be on your case."

"We gave 'em the chance t' die like men, we did. Shiver me timbers, hoist the tattersal, hard a'starb'ard . . ."

"About two more steps and you're gonna put your JC Penny pirate boots right through the picnic basket. Listen, man, like, this is a private dock. Could you kinda weigh anchor?"

"Arrgh, if ya might just direct me t' the nearest town where I'd be findin' meself a fair young wench 'r two . . . I'll tell ya, the secret of a happy pirate is a little girl in every port and a little port in every girl . . . Yo; ho; ho."

"You check into town in your present state they're gonna let ya sleep it off in the jug, Jack."

He manifested an air of disbelief. "Ain't a lubber what has the nerve t' lay a hand on ol' Greenbeard."

"Tell 'em that an' you'll get thirty days." There went the picnic. He didn't seem to notice. "Look, man, you ain't a real pirate. You just did some stuff, checked out an old flick on the box . . . You'll come down in a couple o' hours."

"Sixteen men on a dead man's chest" . . . No wonder he's dead. Probably couldn't breathe with all those guys sittin' on him.

"Look, you don't even sound like a pirate."

"And what might a pirate be soundin' like, me bucko?"

"I dunno." Great, he's gotten out of the sun at last. Ah, those rays. "Say something in pirate!"

He was silent for a moment. "Have ye ever been t' sea, Billy?"

"No, Captain Highliner."

Well, I really did come across the pirate of Pickle Lake, although the circumstances were a bit different. For one thing, I think he'd left his peg leg and his cutlass in his other pants.

## Electronic Squashbuckler (Me Hearties)

David Brough got into doing television several years back, for reasons that might not occur to the common, sun-baked mind huddled upon the American border. In most of the large urbs in Canada, there are between ten and twenty channels of electronic valium to pacify the restless evenings and drain the brain for a good night's kip . . . it may be hard to imagine living in a remote, Northern community where even the CBC does not shine. However, despite the Corporation's ubiquitous mandate, or perhaps its threat, to bring TV to one and all, and all our money sunk into things like the Anik satellites, there are still dozens of towns where Mork and Mindy are just names.

Thus it was that our protagonist . . . you remember what a protagonist is, don't you . . . set out, awhile ago, to right this grievous wrong, and light up the screens of all those lonely lumberjacks and oil drillers. He began videotaping programmes at his digs in Toronto, and "bicycling" the tapes to several of the more isolated hamlets of Northern Ontario. There, the tapes were played through Brough's teeny,

tiny TV transmitters, and, suddenly, there was something to watch. It was all done without the blessing of the Government, although the glowering nasties in Ottawa did not seem likely to descend upon someone who was doing that which they has thus far neglected. However, even with this measure of security, the technical illegality of David's situation did have its pitfalls. Some journalist dubbed him "The Pirate of Pickle Lake." Not a pretty outcome.

David Brough's current residence is a small Scarborough townhouse, one of several dozen in its development. Townhouses would seem to impose a degree of anonymity upon their occupants; they all look pretty much the same, and there isn't much one could do with one to get it looking unique. This one is an exception, though. It has a parabolic satellite downlink on the front lawn. Better Homes and Gardens never features this kind of landscaping. There is also a dish in the back yard, and further inspection disclosed, a third, similar structure on the roof. The place looks like the aftermath of the invasion of the microwave creatures of Monrovia. As I approached the door, leading with my trusty camera, and feeling like a Yankee tourist in Guatemala, one of the kids playing around the dish ran in front of me, calling "David". I suppose the press is fairly familiar in that corner of the jungle.

David's interest in satellites began about a year ago, as a natural outgrowth of his expanding Northern TV network. While the communities he provides with tapes, presently numbering thirty-nine, are all just tickled to have some tube to watch, he seems to regard this type of distribution as somewhat intermediate. The tapes, once they are recorded, get passed from community to community, until they've made the complete circuit. There are numerous problems of logistics involved. The recent widespread

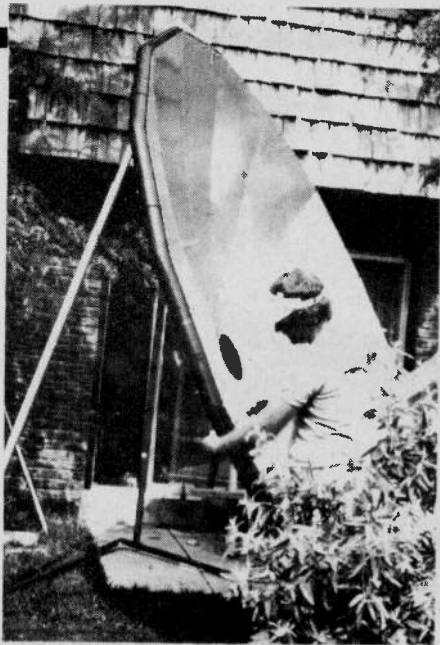

The prototype for what will eventually become a commercially available antenna.

forest fires, he mentioned, caused a few hassles. Red Lake, one of "his" towns, had to be evacuated, tying up its tapes and breaking the chain. Then there are the trolls of the tapes themselves. The machines he uses are rather unique. He takes standard Beta video cassette recorders, and removes the case tops and the cassette handling mechanisms. He then attaches his own tape handling hardware. The resulting cybernaud runs half inch tape from EIAJ seven inch reels across the Beta format drum, resulting in an incredible fifteen hours of running time. However, this leaves the tape in a rather exposed position, vulnerable to scrunching, and it requires that consumer type machines be employed all through the system. "Damn machines keep wearing out".

For all these reasons, plus that of the ongoing drudge of having to programme and run the video machines, David is looking towards satellite technology to provide "his" towns with fully autonomous, self-contained TV stations. Tied up in this are also his designs on the Southern part of the country. By the time this column goes to press, he hopes to have his system available for sale. It will be, as he says, the first practical satellite downlink available for under five thousand. That's dollars.

#### Smoking Chair

The dish in the back yard is the prototype of his commercial system. It consists of a hoop, made of one inch tubing, some eight feet in diameter, with sixteen aluminum wedges bolted around it to form the parabola. I was wondering if it would be an accurate enough parabolic shape, given the lightness of the metal, and such. David grinned. "I was working on it the other day, out in the sun. I had this chair

sitting out in front of it, and I went around back to tighten a bolt. When I got back the chair was just smoking". The glare in front of the dish is blinding. On a clear day you could roast weinies with it.

The eventual manufactured dish will be extremely simple. The outer hoop will be made in four sections, and the reflective wedges can all be pop-riveted together. This is an improvement over bolts, which can come loose in time. The dish, and its feed, will be adjustable by motorized servo systems. This is one of the fundamentals of David's consumer system. While it is fun to tinker with the downlink hardware, he realizes that the average viewer wants to regard it as just another black box providing him with signals. You can't expect the pilot of an easy chair to go outside in twenty below weather and start manhandling a dish around, climbing on a crate to adjust the polarization of the feed horn, all the while screaming back toward the house (above the howling wind) to see when the picture's right . . . just to change channels. Thus, the adjustments will be taken care of by remote control. The control will resemble a pocket calculator.

Have you noticed just how much stuff is beginning to resemble a pocket calculator? New, improved . . . the first digital toothbrush . . . well, never mind.

The system's receiver looks like a small CB. It costs a bit more, though, contributing about two grand to the total bill for the system. David had it custom-built to his specs. Come upon when it was unsuspecting, we discovered it attached to the fiberglass dish in the front yard, displaying the image of a deserted board room on a nearby TV, sitting on the grass. It all looked a bit rustic. "This is a video conference," he explained. "There'll be another channel with the other end of the conference. "You'd think that with satellite time going for a thousand bucks an hour, they could do better than that," David remarks, eyeing the static scene. He twists the receiver's tuning knob, rotates the dish feed, and the image changes to become the video for the PBS network. Further scanning uncovers a few movies, some sports, and a bit of fire and brimstone on the PTL channel. That runs twenty-four hours a day . . . although they rotate the preachers.

The receiver will actually be in two pieces. The bit that sits on top of the TV set is actually just a control box. For reasons of attenuation and just because the microwave cable is rather huge, the rf creatures of the tuner will be housed separately, in a box to be mounted as close to the actual feed as

possible, just inside one's house, tent, cave or rusty old car. This is probably the only receiver designed specifically to be used by people with no more technical background than the average TV channel knob operator. "There's a lot of unsuspecting people buying these things," David remarks, holding a commercial receiver. It seems that there's one rather large downlink manufacturer to the South who advertises a "frequency agile" receiver. This would sound like it's tuneable over the whole band of interest. And so it is, if you want to buy twenty-four crystals. The little black box on the front lawn is, in fact, one of the few sets around that is actually continuously tuneable.

David hands me a rather fat magazine. "Ever seen this before . . . the Sat-Guide?" The satellite industry seems to publish a new periodical every month. I wonder what this one will be. "It's like TV Guide," he explains. It is, except that it's three times the size, and it's wall to wall listings. There are more movies on one page than a regular viewer, huddled before the 1954 Roger's Majestic, might check out in a week. Things like "Grease", "Escape from Alcatraz", "Bound for Glory" . . . like, Godzilla does not attack Tokyo even once . . . even at four in the morning. "You mean you can get all this stuff?" Oh, yes, and it turns out that this guide only covers one satellite. "We pretty well never watch regular TV anymore," he remarks, perhaps unnecessarily.

#### Up on Twelve

David hands me a dull, aluminum box that resembles a TV antenna booster. This, as it turns out, is not too far wrong; it's the feed mounted LNA for a twelve giga-hertz downlink. "That thing's worth about six thousand," he notes. I place it gently upon the table.

There has been a great deal of interest in North America regarding the Japanese satellite system, which runs at twelve giga-hertz, instead of our four and a half. The higher frequency per-

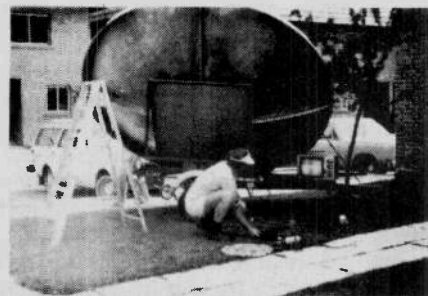

A fiberglass dish. The black thing at David's feet is his tuner.

mits smaller dishes, and antennas the size of dinner plates are quite satisfactory. More important, though, is the transmitter power situation. The transmitters of most of our satellites, David explains, run about five watts. One of the ANIK's is up around ten now. This is not due to any technical limitation; up in space juice is free for the absorbing in almost unlimited quantities. The hassle is that large, powerful downlinks could interfere with terrestrial microwave services. This is not a problem up on twelve, and signal power levels of two hundred watts are quite usual. This further simplifies the requirements of the downlink receiving hardware.

There is a little activity on twelve giga-hertz in this part of the world. One of the ANIKS has a transponder running in this band. As we head toward the backyard for a closer look at the commercial prototype antenna, David points out a hitherto unnoticed four foot parabolic leaning against a fence, the favourite child of some impending experiments.

#### Up on the Roof

We're back at the front of the townhouse, observing the progress of the video conference. There seems to be a bit more activity in the rather drab boardroom. A woman seems to be walking back and forth for the benefit of the cameraman, who is panning lazily around the room. The speaker produces only a rush of atmospheric noise. "They've probably got the audio secure," David explains. "It's likely running over phone lines."

"How do you get the signal from the dish inside the house?" I inquire. There doesn't seem to be any way to run the massive cable from the feed inside, and there would appear to be some drawbacks involved in watching TV out on the front lawn. Especially in winter when one's feet could easily become frost-bitten while sitting through "Star Wars".

"We usually watch the spherical up on the roof," David explains. We make for the roof.

According to David, the spherical antenna, as opposed to a true parabolic, is ideal poor man's approach to picking up satellite transmissions. While it has a few drawbacks, chief among which is its rather awesome proportions . . . about double the diameter of a solid parabolic, it has a number of characteristics which make it ideal for a personal, quasi experimental (works most of the time if the mice haven't been at it) installation. To begin with, it's real, real cheap.

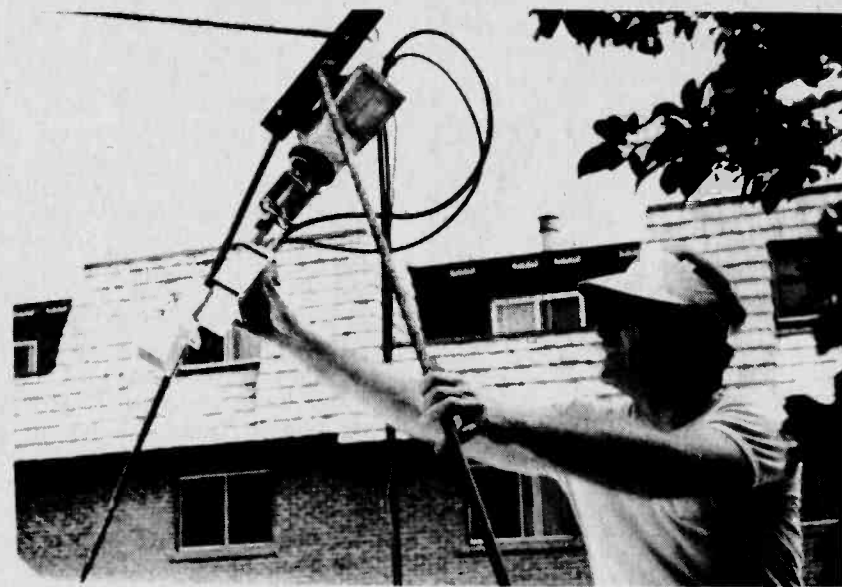

David's spherical antenna is made of redwood and window screen. The lumber frame is quite simple, having just enough sections to allow positioning the screen reflector into a true spherical segment. It is adjustable via a series of bolts. The screen reflector is stapled on. The actual nature of the screen is determined largely by whatever Canadian Tire has on hand. Anything from 1/16" window screen to 1/4" fence mesh will do about as well. The only thing that can't be used, for obvious reasons, is fiberglass.

The spherical is the only type of antenna that can be adjusted in the field without any heavy test equipment. The dish is set vertically, i.e.: sighting parallel to the surface of the planet, facing a tree or phone pole thirty feet away. A thirty foot rope is strung from the tree, at a point half the diameter of the dish above the ground. The dish will be a perfect spherical segment when any point on its surface is equi-distant from the point where the rope is tied to the tree. Thus, the rope is stretched out towards the dish surface, and the adjusting bolts twiddled until the end just touches on all points. A quarter-inch error is considered to be acceptable.

This type of dish is extremely light, and offers very little wind resistance . . . no small bonus, if you don't want your antenna to come unstuck in the next high breeze and start another round of UFO sightings. However, the finer aspects of this design are more subtle.

The principal of the parabolic dish is probably quite well understood by now. It concentrates all the radiation that impinges upon it at one point. A feed located at this point, the focus, will encounter the maximum field strength.

The spherical, as one might expect, is somewhat different. It has no focus, per se. If a feed horn is hung in front of it, it will pick up any signal striking the dish at a given angle. Thus, the positioning of the feed, and not the dish itself, determines which satellite is to be picked up. This quickly eliminates the howling eight-armed metallic marsh troglodyte of the polar mount. The thing does not have to be steerable; you can set it in concrete, and never move it again, unless there's an earthquake. Even at that, it would have to be a fairly wicked one, as the alignment of a spherical is extremely lax. Several feeds, or several mounts for a single, mobile feed, if you are putting this on the Mastercharge card, can be erected before the dish, one for each "bird" of interest.

The interesting point about the spherical dish is that it is not, by all proper physical laws, supposed to work. The nature of a parabola is such that, no matter where the signal is coming from, the distance between it and the feed will be the same across the dish. Hence, there are no phase errors. This is not the case with a spherical, and, as you may have already begun wondering, it would seem like there would be numerous signals hitting the feed, after various delays, for each one sent out. This is true, and it would look like a mess, except that the feed horn is designed to undo the phase errors that the dish lays on it. It generates errors of its own, in the other direction . . . and if the gods are placated, everything works out. It's your own fault if you haven't kept up to date with your sacrifices and chants.

The cost of all this, you cry mournfully in the night . . . David suggest that anyone with an electric drill and a skill

saw should be able to commit several zoning by-law infractions with one of these things for about a hundred and fifty dollars . . . not including miscellaneous sundries, such as the feed, horn, cable, low noise simplifier or receiver. Still, it's better than building another bookshelf.

#### Bidding a Fond Farewell

Shortly after I rolled away from David Brough's little oasis of technological mayhem, in the uncivilized jungle of Eastern Scarberia, he too would be pulling out. The dish in the front yard had been mounted on a trailer. It would be tooling on up into the Northerns to demonstrate to what might, shortly, be another of "his" towns. It would also be eyed by a number of individual tube junkies, possible customers for the downlink packages he will shortly be selling. As I stepped through the front door, the phone rang. It had been doing

so all afternoon . . . not unusual for phones, I suppose, and David began talking about some wrinkle in installation somewhere.

Yes, that's another nice thing about satellites. You can shut them off when you have had enough, whereupon they stay shut off, without complaining.

Next month, "What's On" will deal with a new topic. We will look at active television viewing, ie: how the poor clod who rots his mind with the trash on the tube can now get involved in making the decisions that determine what he sees. We'll look at things like kidnapping stars of shows you don't like, sawing through the camera cables at hockey games, and blowing up small, noisy UHF stations that run too many commercials during the movies. "Terrorism!" you say. You'll probably wish you hadn't. Stay tuned. ●

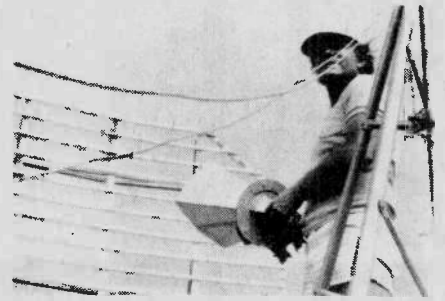

Opposite and above two LNAs. The one above in David's hand is intended for 4.5 GHz operation with his spherical antenna. The one on the left is a lower gain version for use with the fiberglass dish.

# Service News

## Beware! Behind every job lurks a possible intermittent . . .

ONE OF THE drawbacks of writing a news column for a magazine is the delay from the time of writing to the time of publication. This article, for example, is being put together at the beginning of summer, to be published at summer's end.

Right about now, all is quiet on the service front. Many shops are on short hours. Owners of one-man shops are finding time to spend in the sun, and items of news are as scarce as snow. On the other hand, when this article arrives on the stands, the holiday will be over, and the electronic service industry will be inundated with the heaviest workload of the year. Yes, the end of summer marks the re-awakening of the need for home entertainment products, when sales and service soar out of sight.

Which brings us to the point of this article, that this is a seasonal business, with predictable highs and lows that repeat annually, almost to the week.

I have found the highest month usually to be September, while February has been lowest, followed by June. From the last weeks of August to the middle week of January, I have always been running full-out with absolutely no time to relax. Help has always been hard to find during that period, and every shop seems to have more

work than it can handle.

This is the time that service operators appreciate the help of parts suppliers, be they original manufacturers' depots, or wholesale jobbers of replacement parts.

This is when you appreciate up-to-date cross-references on foreign parts, (they all seem to be foreign these days), and knowledgeable parts countermen to help select the exact replacement without delay. Isn't this the time you cross your fingers every time you try a replacement module in a set and hope it's not a dud, or worse, a recycled intermittent dog that will cost you a recall or two before you realize you have been burned again?

Speaking of intermittents, don't you wish they would go away? They are the curse of the electronic industry, the killers of giants, the destroyers of goodwill and the greatest single source of wasted time and lost profit, not to mention the bad name they have ended up giving to anyone caught in their web.

That's what an intermittent is, a web. You start out to repair a simple fault in a product and end up with a dirty intermittent after you have quoted for the job, or worse, after you have completed the work and returned the item to the customer. Who pays?

You know! One way or the other, either you fix it or lose a customer or both.

Almost all the complaints received on our association phone are about concealed intermittents, which were not evident to the technician at the time he repaired the set. I recently had a call from a person whose TV was repaired in January by a well-known and reputable service shop, and which had developed an intermittent fault immediately afterwards.

This set has been brought into the shop four times since then, and five other house calls have been made, yet the fault persists — intermittently. The customer wanted to know what could be done to the company! Aside from the small original bill for a part and housecall fee, the company had not charged the customer a single penny more for the nine visits and four shop jobs, albeit that they could not find the fault.

I only hope they fix it before this article goes to press, because they surely won't need the aggravation during the peak season following.

Have heart. The storm will be over mid-January, if my figures are the same as yours, and you can then relax, as I am doing now during this break. ●

# IEEE BUS

The workings of the PET IEEE 488 bus explained

THE FAMILIAR PET home computer possesses one of the real oddities in the microcomputer world. The user is presented with not a true bus but a version of the all singing, all dancing IEEE-488 instrumentation data bus. The original PET manual was very vague on the structure and use of this, we have set out to try and clear up some of the mysteries. The very fact that the PET is provided with a user port at all means that it must be useable, and indeed there are several commercial interface adaptors available, but the average amateur's response seems to be one of panic when hardware design is suggested.

The one vital phrase that is buried in the manual is as follows, "as implemented on". A rather better wording for this is "as adapted for" because the IEEE-488 bus on PET is a subset of the original standard. Armed with this vital piece of information we will now try to give you the rest of the information you will need.

## The Bus Structure

The bus can be divided into three sections, to make it simpler:-

1. Data bus
2. Transfer bus
3. Management bus

These three sections all interact with one another in specific ways, and it is the understanding of these interactions, handshakes as they are often called, that allows interfaces to be designed.

The data bus is an eight line bi-directional highway. The lines are designated DI01 to DI08, and are active low. The normal status of the line is therefore high and any device which grounds a line puts data onto it. The data is transferred in bytes and the most significant bit is on data line DI08.

The Transfer Bus performs all the handshaking and thus controls the transfer of data on the bus. The handshaking sequence is devised so that the slowest device will always complete a transfer once it has been initiated, if it tried to do it without controls data would be lost. There are three lines in the transfer section, NRFD, DAV and NDAC. The order of handshaking is shown in Fig 1. We will have to take a closer look at each. NRFD (Not Ready For Data) is only high when all "listeners" are ready, if any device is not ready the line is low. This allows a slow device to hold everything up, protecting its data integrity. The line is used for devices that send on the bus "talkers" in IEEE jargon. DAV (Data Valid) is put low to enable "listeners" to take data from the bus. The line can only be put low when NRFD is high, in other words all "talkers" must wait for "listeners". NDAC (Data Not Accepted) is held low by a "listener" until it has taken the data off the bus. When this goes high a "talker" can change the data on the bus.

The Management Bus consists of five lines, only two of which are fully implemented on the PET. These two are

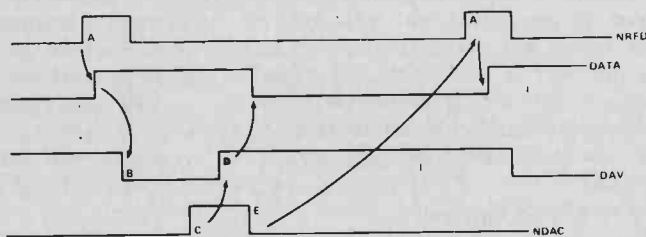

Fig 1. The handshake timing diagram.

ATN (Attention) which is set low for device assignment. If it is low then the bus is carrying addresses of peripheral devices and control messages, if high only assigned devices may transfer data on the bus. The second line is EOI (End Or Identify) and can be optionally set low by a "talker" at the end of a data transfer. However the controller always sets EOI low during the last byte transferred. The other three management lines are SRQ (Service Request), IFC (Interface Clear) and REN (Remote Enable), and are not really of interest to us.

We have summarized all the controls and interface lines in Table 1 along with their connections.

## Handshaking Routines

Because the IEEE bus was primarily designed for instrumentation rather than for home computers the handshake signals are fairly easy to use. Figure 1 shows a typical handshake taking place, the timings are relative and not drawn to scale. At "A" NRFD is set high to signal the listener that the talker or talkers on the bus are ready to send data. This line will normally be set at switch on. The talker will now place data

Pin	Designation	Function
1	DI01	Data 1 (LSB)
2	DI02	Data 2
3	DI03	Data 3
4	DI04	Data 4
5	EOI	End or Identify
6	DAV	Data Valid
7	NRFD	Not Ready For Data
8	NDAC	Data Not Accepted
9	IFC	Interface Clear (optional use)
10	SRQ	Service Request (optional use)
11	ATN	Attention
12	Chassis Ground	
A	DI05	Data 5
B	DI06	Data 6
C	DI07	Data 7
D	DI08	Data 8 (MSB)
E	REN	Remote Enable (optional use)
F		
H		
J		
K	Ground	
L		
M		
N		

Note:- polarization slots occur between 2 and 3, 9 and 10.

Table 1. Bus lines and edge connector terminations.

on the lines, when it is ready to do so. At point "B" the talker will set DAV low to indicate to the listener that the data on the lines has settled and is valid to read. As soon as one listener has accepted the data that listener sets its NRFD line low. If there is more than one listener the slower ones set their NDAC high, when all have taken their data NDAC is then asserted high. This occurs at point "C" on the timing diagram. The talker now sets DAV high, point "D", indicating that the data is no longer valid. The listeners respond to DAV going high and set NDAC low, point "E", and NRFD may now be reset high ready for the next handshake. There are only two timing constraints for the PET, if it is acting as a listener then it expects DAV to go low within 64 mS of it setting NRFD high. When PET is acting as a talker it then expects NDAC to go high within 64 mS of it setting NRFD high. In other words the data should be read from the lines within 64 mS in either direction.

There are several other observations to be made about the handshake. We have not covered the ATN line at all, this is set high for data information on the bus, low for address information. We will obviously have to take care of this in any interface we design as we are not interested in any addresses or control signals.

### Using The Bus

Most of you who have the PET will have become familiar with LOAD and SAVE commands for the cassette and will be wondering how to use the bus for these purposes. The bus actually looks like a data file to the PET BASIC and one has to use file commands to access it. The following commands are used:—

OPEN, CLOSE, PRINT#, INPUT#, GET#, CMD and ST.

To output from the PET one has to open a file and this is done in the format:—

OPEN (Address), (Device), (Secondary Address), "Filename"

The Address is within the region 1 to 255 and must be referenced by the CLOSE, PRINT#, INPUT# and GET# statements.

The Device is the address of the physical device on the bus and must be in the range 4 to 15. A Secondary Address is only sent on the OPEN and CLOSE commands and is normally ignored. The command PRINT# sends ASCII characters to the bus, INPUT# receives characters from the bus under BASIC rules, GET# "gets" a character or digit from the bus. It should be noted that all these commands refer to the Address specified by the OPEN statement. Using the CMD command allows output from BASIC to be sent to a device specified in a previous OPEN command. This allows program listings to be obtained and also leaves the bus active, hence allowing more than one "listener" on the bus. Access may be obtained to the status of the bus by inspecting the BASIC variable ST. The bits and their mask codes and interpretation are to be found in Table 2. A command of the form:—

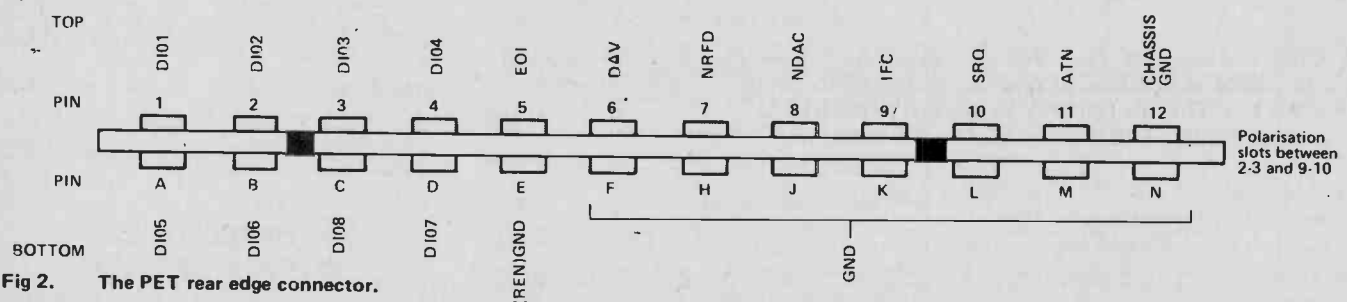

Fig 2. The PET rear edge connector.

Bit	Mask	Status
0	1	Time out on data transfer, response longer than 65mS
1	2	Read error, DAV not sent within "time out"
6	64	EOI
7	128	Device not present, return to BASIC

Table 2. Status word codes and interpretations.

IF (ST) AND MASK THEN. . . (Where MASK is either 1, 2, 64 or 128)

This test should be done immediately after the I/O operation that the user is interested in.

### Getting On The Highway

The hardware details of the bus are very simple, as rather than put a flashy IEEE connector on the back of PET an edge connector is used. This can be seen in Photo 1 and also in Fig 2. It is a 12 position 24 contact (ie double-sided) edge connector with 0.156" pitch and can be obtained from most PET stockists. Typical manufacturers are AMP, CINCH and Sylvania but at a pinch you can cut down a larger type.

There are some electrical limitations which must be observed, or else you may have problems. The cable should be no longer than 20 metres, devices should be spaced less than 5 metres apart. The number of devices on the bus should be limited to 15 and the data transfer rate kept to below 250kHz, although with tristate drivers you can push it up to 1MHz. As a design recommendation all bus lines on your interface should be buffered, this solves a lot of those inexplicable problems that tend to arise.

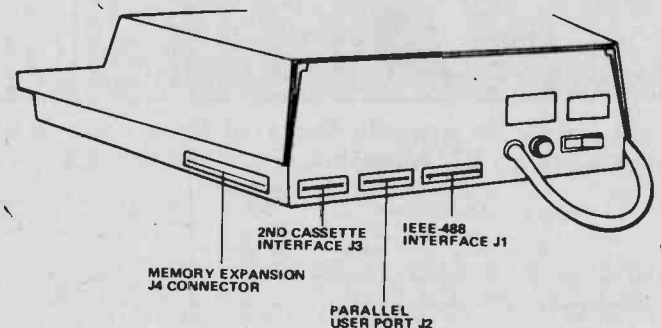

What goes where behind PET.

# Babani Books from ETI

**BP1: First Book of Transistor Equivalents & Substitutes \$2.80**

More than 25,000 transistors with alternatives and equivalents make up this most complete guide. Covers transistors made in Great Britain, USA, Japan, Germany, France, Europe, Hong Kong, and includes types produced by more than 120 different manufacturers.

**BP14: Second Book of Transistor Equivalents & Substitutes \$4.80**

This handbook contains entirely new material, written in the same style as the "First Book of Transistor Equivalents & Substitutes". The two complement each other and make available some of the most complete and extensive information in this field.

**BP24: Projects Using IC741 \$4.25**

The popularity of this inexpensive integrated circuit has made this book highly successful. Translated from the original German with copious notes, data and circuitry, a "must" for everyone, whatever their interest in electronics.

**BP33: Electronic Calculator Users Handbook \$4.25**

An invaluable book for all calculator users whatever their age or occupation, or whether they have the simplest or most sophisticated of calculators. Presents formulae, data, methods of calculation, conversion factors, etc., with the calculator user especially in mind, often illustrated with simple examples.

**BP35: Handbook of IC Audio Pre-amplifier & Power Amplifier Construction \$5.50**

This book is divided into three parts: Part I, Understanding Audio ICs; Part II, Pre-amplifiers, Mixers and Tone Controls; Part III, Power Amplifiers and Supplies. Includes practical constructional details of pure IC and Hybrid IC and Transistor designs from about 250mW to 100W output. An ideal book for both beginner and advanced enthusiasts alike.

**BP47: Mobile Discotheque Handbook \$5.90**

The aim of this book is to give you enough information to enable you to have a better understanding of many aspects of "disco gear". The approach adopted is to assume the reader has no knowledge and starts with the fundamentals. The explanations given are simplified enough for almost anyone to understand.

**BP48: Electronic Projects For Beginners \$5.90**

The newcomer to electronics, will find a wide range of easily made projects and a considerable number of actual component and wiring layouts. Many projects are constructed so as to eliminate the need for soldering. The book is divided into four sections: "No Soldering" Projects, Miscellaneous Devices, Radio and Audio Frequency Projects and Power Supplies.

**BP49: Popular Electronic Projects \$6.25**

A collection of the most popular types of circuits and projects which will provide a number of designs to interest the electronics constructor. The projects selected cover a very wide range. The four basic types covered are: Radio Projects, Audio Projects, Household Projects and Test Equipment.

**BP50: IC LM3900 Projects \$5.90**

The purpose of this book is to introduce the LM3900, one of the most versatile, freely obtainable and inexpensive devices available to the Technician, Experimenter and the Hobbyist. It provides the groundwork for both simple and more advanced uses.

Simple basic working circuits are used to introduce this IC. The reader should set up each of these for himself. Familiarity with these simple circuits is essential in order to understand many more complicated circuits and advanced uses.

**BP51: Electronic Music and Creative Tape Recording \$5.50**

This book sets out to show how electronic music can be made at home with the simplest and most inexpensive of equipment. It then describes how the sounds are generated and how these may be recorded to build up the final composition.

For the constructor, several ideas are given to enable him to build up a small studio including a mixer and various sound effects units. All the circuits shown in full have been built by the author. Most of the projects can be built by the beginner.

**BP69: Electronic Games \$7.55**

The author has designed and developed a number of interesting electronic game projects using modern integrated circuits. The book is divided into two sections, one dealing with simple games and the latter dealing with more complex circuits. Ideal for both beginner and enthusiast.

**BP70: Transistor Radio Fault-Finding Chart \$2.40**

Author Mr. Chas. Miller has drawn on extensive experience in repairing transistor radios to design this book. The reader should be able to trace most of the common faults quickly using the concise chart.

**BP71: Electronic Household Projects \$7.70**

Some of the most useful and popular electronic construction projects are those that can be used in or around the home. These circuits range from such things as "2 Tone Door Buzzer" and Intercom through Smoke or Gas Detectors to Baby and Freezer Alarms.

**BP72: A Microprocessor Primer \$7.70**

A newcomer tends to be overwhelmed when first confronted with articles or books on microprocessors. In an attempt to give a painless approach to computing, this small book will start by designing a simple computer that is easy to learn and understand. Such ideas as Relative Addressing, Index Registers, etc. will be developed and will be seen as logical progressions rather than arbitrary things to be accepted but not understood.

**BP 73: Remote Control Projects \$8.58**

This book is aimed primarily at the electronics enthusiast who wishes to experiment with remote control and many of the designs are suitable for adaptation to the control of other circuits published elsewhere. Full explanations have been given so that the reader can fully understand how the circuits work and see how to modify them. Not only are Radio Control systems considered but also Infrared, Visible light and Ultrasonic systems as are the use of Logic ICs and Pulse position modulation etc.

**BP74: Electronic Music Projects \$7.70**

Although one of the more recent branches of amateur electronics, electronic music has now become extremely popular and there are many projects which fall into this category ranging in complexity from a simple guitar effects unit to a sophisticated organ or synthesizer.

The purpose of this book is to provide the constructor with a number of practical circuits for the less complex items of electronic music equipment, including such things as Fuzz Box, Waa-Waa Pedal, Sustain Unit, Reverberation and Phaser-Units, Tremolo Generator etc.

**NO.205: First Book of Hi-Fi Loudspeaker Enclosures \$3.55**

The only book giving all data for building every type of loudspeaker enclosure, includes corner reflex, bass reflex, exponential horn, folded horn, tuned port, klipschorn labyrinth, tuned column, loaded port and multi speaker panoramic. Many clear diagrams are provided showing all dimensions necessary.

**NO.213: Electronic Circuits For Model Railways \$4.50**

The reader is given constructional details of how to build a simple model train controller, controller with simulated inertia and a high power controller. A signal system and lighting for model trains is discussed as is the suppression of RF interference from model railways. The construction of an electronic steam whistle and a model train chuffer is also covered.

**NO.215: Shortwave Circuits & Gear For Experimenters & Radio Hams \$3.70**

Covers constructional details of a number of projects for the shortwave enthusiast and radio "Ham". Included are: an add-in crystal filter, adding an "S" meter in your receiver; crystal locked H.F. Receiver; AM tuner using phase locked loop; converter for 2MHz to 8MHz; 40 to 800MHz RF amplifier; Aerials for the 52, 144MHz bands; Solid State Crystal Frequency Calibrator, etc.

**NO.221: Tested Transistor Projects \$5.50**

Author Mr. Richard Torrens has used his experience as an electronics development engineer to design, develop, build and test the many useful and interesting circuits in this book. Contains new and innovative circuits as well as some which may bear resemblance to familiar designs.

**NO. 223: 50 Projects Using IC CA3130 \$5.50**

In this book, the author has designed and developed a number of interesting and useful projects using the CA3130, one of the more advanced operational amplifiers that is available to the home constructor. Five general categories are covered: Audio Projects, R.F. Projects, Test Equipment, Household Projects and Miscellaneous Projects.

**NO.224: 50 CMOS IC Projects \$4.25**

CMOS ICs are suitable for an extraordinary wide range of applications and are now also some of the most inexpensive and easily available types of ICs. The author has designed and developed a number of interesting and useful projects. The four general categories discussed in the book are: Multivibrators, Amplifiers and Oscillators, Trigger Devices and Special Devices.

**BP37: 50 Projects Using Relays, SCR's & Triacs \$5.50**

Relays, silicon controlled rectifiers (SCRs) and bi-directional triodes (TRIACs) have a wide range of application in electronics today. These may extend over the whole field of motor control; dimming and heating control; delayed, timing and light sensitive circuits and include warning devices, various novelties, light modulators, priority indicators, excess voltage breakers, etc. The enthusiast should be able to construct the tried and practical working circuits in this book with a minimum of difficulty. There is a wide latitude in component values and types, allowing easy modification of circuits or ready adaptation of them to individual needs.

**BP39: 50 (FET) Field Effect Transistor Projects \$5.50**

The projects described in this book include radio frequency amplifiers and converters, test equipment and receiver aids, tuners, receivers, mixers and tone controls, as well as various miscellaneous devices which are useful in the home. This book contains something of particular interest for every class of enthusiast - short wave listener, radio amateur, experimenter or audio devotee.

**BP42: 50 Simple L.E.O. Circuits \$3.55**

50 interesting and useful circuits and applications, covering many different branches of electronics, using one of the most expensive and freshly available components - the Light Emitting Diode (L.E.D.). Also includes circuits for the 707 Common Anode Display. A useful book for the library of both beginner and more advanced enthusiast alike.

**BP44: IC 555 Projects \$7.55**

Every so often a device appears that is so useful that one wonders how life went on before without it. The 555 timer is such a device. It is manufactured by almost every semiconductor manufacturer and is inexpensive and very easily obtainable.

Included in this book are Basic and General Circuits, Motor Car and Model Railway Circuits, Alarms and Noise Makers as well as a section on the 556, 558 and 559 timers.

**BP46: Radio Circuits Using ICs \$5.90**

This book describes integrated circuits and how they can be employed in receivers for the reception of either amplitude or frequency modulated signals. Chapters on amplitude modulated (a.m.) receivers and frequency modulation (f.m.) receivers. Discussion on the subjects of stereo decoder circuits, the devices available at present for quadrophonic circuits and the convenience and versatility of voltage regulator devices. An extremely valuable addition to the library of all electronics enthusiasts.

**BP62: BOOK 1. The Simple Electronic Circuit & Components \$8.95**

**BP63: BOOK 2. Alternating Current Theory \$8.95**

**BP64: BOOK 3. Semiconductor Technology \$8.95**

Simply stated the aim of these books is to provide an inexpensive introduction to modern electronics. The reader will start on the right road by thoroughly understanding the fundamental principles involved.

Although written especially for readers with no more than ordinary mathematical skills, the use of mathematics is not avoided, and all the mathematics required is taught as the reader progresses.

The course concentrates on the understanding of the important concepts central to electronics. Each book is a complete treatise of a particular branch of the subject and, therefore, can be used on its own. However, latter books assume a working knowledge of the subjects covered in earlier books.

**BOOK 1:** This book contains fundamental theory necessary to develop a full understanding of the simple electronic circuit and its main components.

**BOOK 2:** This book continues with alternating current theory.

**BOOK 3:** Follows on semiconductor technology, leading up to transistors and integrated circuits.

**BP65: Single IC Projects \$6.55**

All the projects contained in this book are simple to construct and are based on a single IC. A strip board layout is provided for each project, together with any special constructional points and setting up information, making this book suitable for beginners as well as more advanced constructors.

**BP66: Beginners Guide To Microprocessors & Computing \$7.55**

This book is intended as an introduction to the basic theory and concepts of binary arithmetic, microprocessor operation and machine language programming. The only prior knowledge which has been assumed is very basic arithmetic and an understanding of indices. A helpful Glossary is included. A most useful book for students of electronics, technicians, engineers and hobbyists.

**BP67: Counter Driver & Numeral Display Projects \$7.55**

The author discusses and features many applications and projects using various types of numeral displays, popular counter and driver ICs, etc.

**BP68: Choosing & Using Your Hi-Fi \$7.25**

The reader is provided with the fundamental information necessary to enable him to make a satisfactory choice from the extensive range of stereo equipment currently on the market. This should aid him in understanding the technical specifications of the equipment he is interested in buying. Full of helpful advice on how to use your stereo system properly so as to realise its potential to the fullest and also on buying your equipment. A Glossary of terms is included.



These books are specially imported from England by us. If someone has already used the card in this issue, please write to: ETI Magazine, Unit 6, 25 Overlea Boulevard, Toronto, Ontario M4H 1B1.

ALL PRICES INCLUDE  
POSTAGE & HANDLING

Prices subject to change without notice.



# SPEAKER PROTECTION UNIT

An expensive speaker system can be readily destroyed by a 20 watt amplifier. Carelessness with a high power amplifier can melt voice coils like cheese on toast. We know . . .

MODERN TRANSISTOR power amplifiers use the technique of dc coupling between the low level amplifier stages and between the output stages and the loudspeaker. This has the advantage of removing coupling capacitors from the signal path, decreasing parts count and improving performance at low frequencies.

Older transistor amplifiers used a single supply rail so the transistors operated between the supply voltage and ground. Since an ac signal has both negative and positive excursions the power amp was designed so that a dc voltage was present on the output stage. Positive excursions would cause an increase of this dc voltage while negative excursions decrease the voltage. Since dc cannot be applied directly to a loudspeaker it was necessary to insert a capacitor, called a blocking or output capacitor, between the output stage and the loudspeaker. The load impedance of the loudspeaker is around eight ohms so the capacitor has to be 5,000uF to 10,000uF before an acceptable low end performance can be obtained.

The solution to these problems was dc coupling. The power amp is run from a 'split supply' so that the output transistors are supplied from a positive and negative supply voltage. The average of these supply rails is zero volts, so the output can be connected directly to the

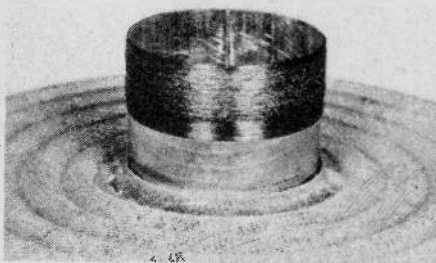

What happens without the speaker protector.

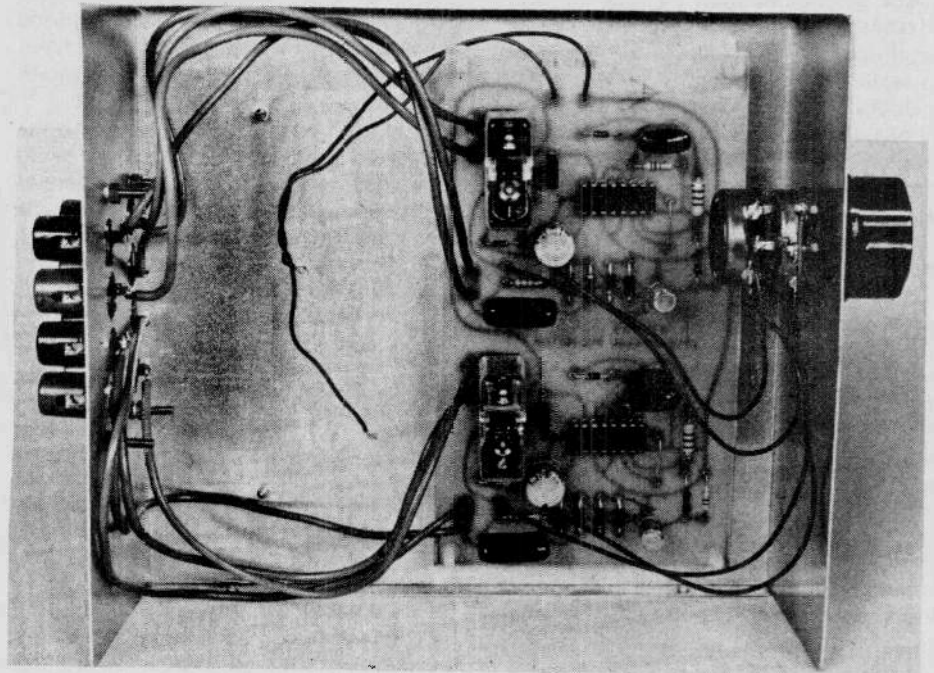

Internal view of the speaker protector.

loudspeaker. Both positive and negative excursions are possible due to the split power supply.

Unfortunately, dc coupling also has its disadvantages. The biggest of these is the possibility of damage to the loudspeakers in the case of power amp failure. Since all the stages are dc coupled, a fault anywhere in the power amp can cause the output stage to swing hard against one of the supply rails. The most common power amp fault is a condition in which one or several of the output or driver transistors is destroyed, and this almost always causes the full dc voltage from one of the supply rails to be applied directly to the loudspeaker. The loudspeaker cone is slammed against the suspension and the power dissipation in

the voice coil causes a rapid increase of voice coil temperature. In this condition most woofers will survive for only a few seconds. The most dramatic example of this fault I have seen was in a very expensive pair of three-way loudspeakers. They had been connected to a high power tuner-amplifier (150W/channel) when the output stage had gone faulty. The entire inside of the speaker was one charcoal mass (much to the horror of the owner). The temperature increase in some of the crossover components had set fire to the stuffing inside the box, totally destroying the crossover and drivers.

This type of fault is all too common and is the most expensive fault likely to occur in a modern stereo sys-

tem. Some top line amplifiers have built in protection circuits with relays that disconnect the loudspeakers should this condition occur, but these are the minority.

This project is an attempt to remedy this situation. The circuit 'looks' at the loudspeaker wires and protects the loudspeakers in two ways. The presence of any dc automatically trips the relay and disconnects the loudspeaker. The protector also looks at the amount of power applied to the loudspeaker. It allows high power transients but will disconnect the loudspeaker if the applied power exceeds the loudspeaker rating for more than about 50 milliseconds. In this way the advantage of the improved high power amplifiers is not lost but the loudspeaker is still protected. The circuit includes a two-second monostable delay circuit so that the loudspeaker is automatically reconnected approximately two seconds after the 'fault condition' has been removed.

The project is designed around two standard CMOS ICs. This ensures a very low current consumption and obviates the need for a power switch. This is important since a fault with an amplifier could well occur at the moment of turning on and it is essential that the loudspeaker protector is already on. When the relay trips, the circuit pulls around 50 mA for each relay so it is important that the battery is capable of supplying 100 mA during relay operation. For this reason, the battery specified for this project is an Eveready or the equivalent. There should be no problem with the battery lasting for its shelf life, providing the relays are not tripped more than very occasionally.

### Construction

Start the construction with the pc board. Solder the resistors capacitors, diodes and relay first. The diodes and electrolytic capacitors must be inserted the right way round as shown on the pc board overlay. Lastly solder the transistors and ICs on the board. Again, these devices must be oriented correctly.

The prototype was constructed in a general purpose steel box but this is not critical. The front panel is fitted with a stereo 100k potentiometer. This sets the trip point of the protector so that it can be adjusted for your particular loudspeakers. The rear panel holds the terminals for the wires from the amplifier and loudspeakers. I used two four-way spring terminals. The wiring to the rear panel and to the front potentiometer is shown in the wiring diagram.

Finally, make the connection to the battery. Probably the best way to do this is to screw two self-tapping screws into the battery terminals and solder the wires between these and the pc board. The pc board should be mounted on spacers in the case. Plastic pc board stand-offs are ideally suited for this project as the pc board is small.

### Testing

Check the orientation of all polarised components including the transistors and ICs. If all is well cut two short lengths of speaker cable and connect the output of the amplifier to the input of the loudspeaker protector. Connect the speaker cables to the output of the protector. Now switch on the system. Choose music with reasonably even amplitude for this test. Turn the front panel level control on the loudspeaker protector for the lowest power

## HOW IT WORKS

The signal voltage from the amplifier is rectified by a full-wave bridge consisting of diodes D1, D2, D3 and D4. The potentiometer RV1 and the resistor R1 and capacitor C1 form a potential divider that determines the sensitivity of the circuit. At normal signal frequencies C1 has a relatively low impedance and the resistance across the diode bridge becomes that of resistor R1, ie: 15k. As the frequency approaches dc however, the impedance of this capacitor increases - increasing the sensitivity of the circuit. If a dc voltage is presented to the input C1 acts as an open circuit and the protector is therefore at its most sensitive.

Signal voltages from the full wave rectifier are averaged by the capacitor C2 and R2, and then applied to a Schmitt trigger. The Schmitt trigger is formed from the resistors R3, R4, IC1c and IC1d. This circuit will only respond to a voltage level greater than a preset amount. When this voltage is exceeded (around 6.5V in this case) the output goes positive charging C3 through diode D5. This diode prevents C3 from being discharged by the Schmitt trigger when its output goes low again so the capacitor can only be discharged by the 10M resistor R5. This takes about two seconds so this circuit is in reality a simple and effective monostable. Another two stages of the IC drive the transistor, which is in series with the relay coil. Diode D6 protects the transistor which is in series with the relay coil. Diode D6 protects the transistor from large back EMF voltage spikes produced when the relay is turned off.

and slowly increase the amplifier volume. When the power to the loudspeakers exceeds that set by the potentiometer the protector should trip in and disconnect the loudspeakers.

Turn the amplifier down, and the loudspeakers should be reconnected after about two seconds. Since loudspeaker power figures are a rather dubious quantity, it is probably best to establish the correct setting for the

Fig.1. Suggested front panel layout.

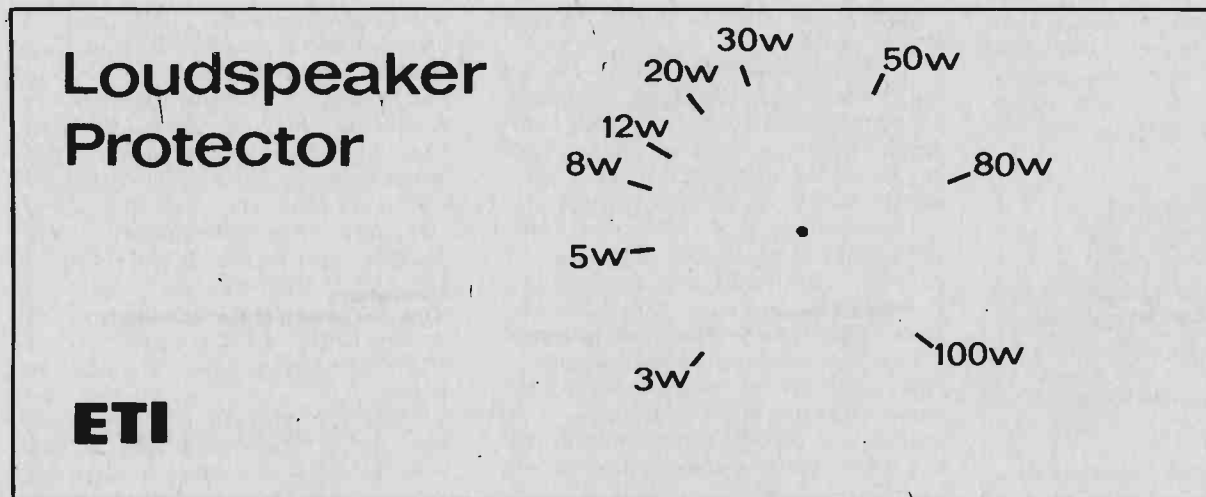

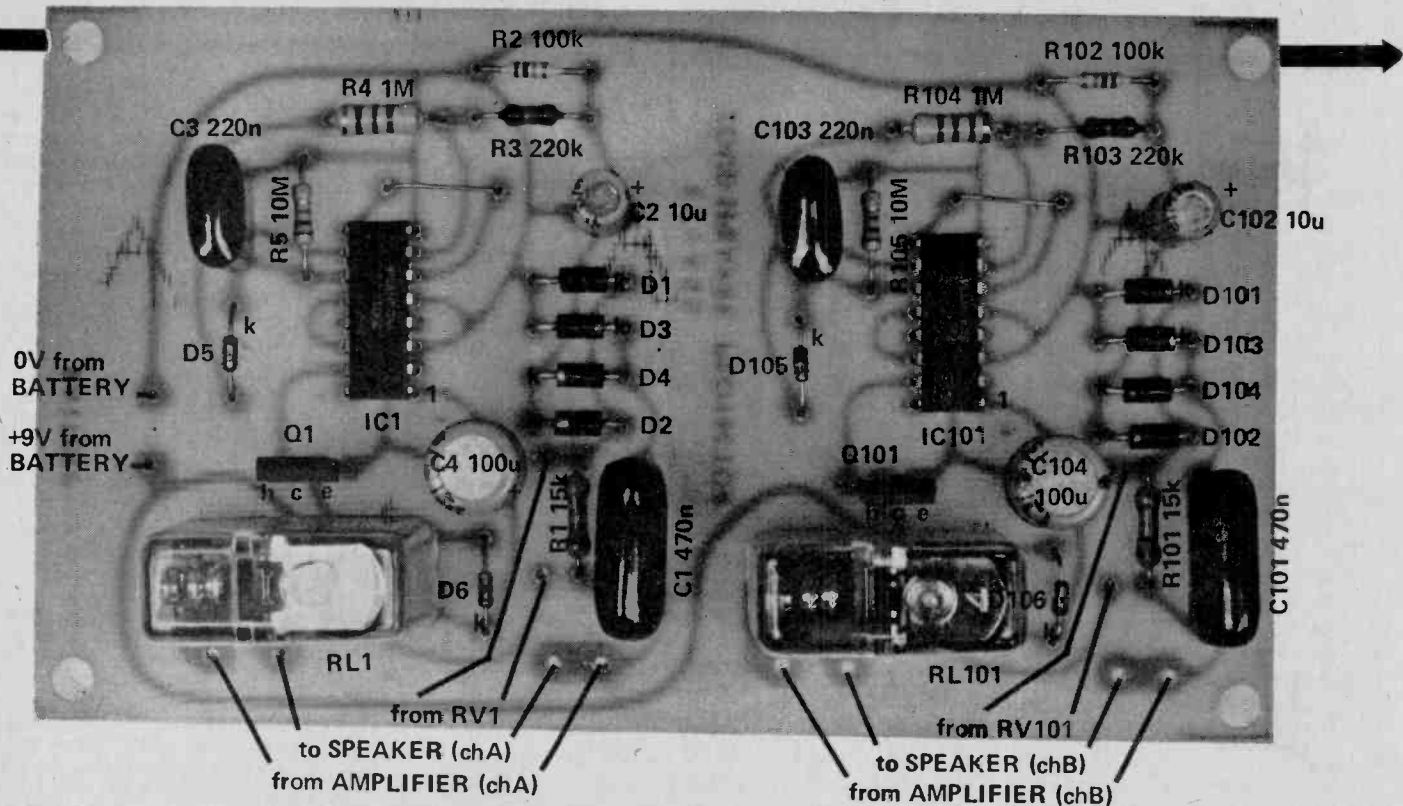

Fig. 2. The components overlay. Note that the PCB is designed for stereo operation. The components for channel B are numbered as R101 etc.

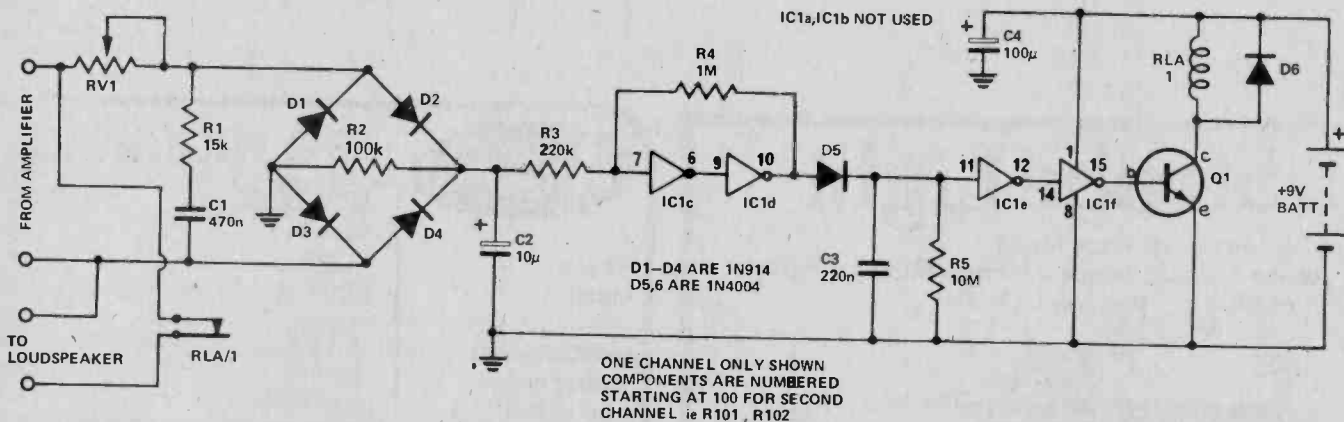

Fig. 3. Circuit of one channel of our Speaker Protection Project.

loudspeaker protector experimentally rather than just setting it to the rated power handling of your loudspeakers. Your ears are the best indication that the system is being strained. Set the loud-speaker protector so that it trips just below that volume where distortion starts to occur.

We have done extended test on the protector, even to the point of connecting expensive loudspeakers and inducing power amp faults that would otherwise destroy a loudspeaker in seconds. In all of these tests the loud-speaker protector has performed well and it is a comforting thought that should a power amp fault occur, it will not take your loudspeakers with it. ●

## PARTS LIST

Two of each of the following is required for stereo.

**Resistors** all 1/4W, 5%  
R1 ..... 15k  
R2 ..... 100k  
R3 ..... 220k  
R4 ..... 1M  
R5 ..... 10M

**Potentiometers**  
RV1 ..... 100k lin. (dual for stereo)

**Capacitors**  
C1 ..... .470n polyester  
C2 ..... .10u 25V electrolytic  
C3 ..... .220n polyester  
C4 ..... .100u 25V electrolytic

### Semiconductors

Q1 ..... .BD139, 2N4923  
D1-D4 . . . .1N4002 or similar  
D5, D6 . . . .1N914 or similar  
IC1 ..... .4049B Hex inverter

### Miscellaneous

Only one of each of the following is required.

ETI 455 . . . .pc board  
12V relay, four terminals, case, knob(s), screws, nuts, pc board, spacers.

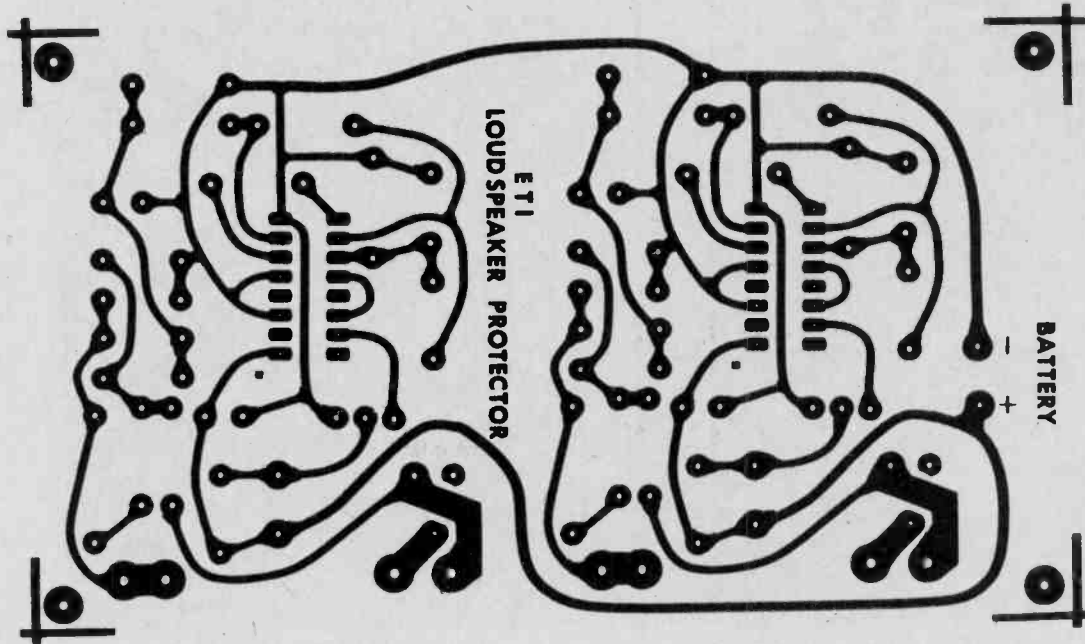

# Strobe Light

Now in complete kit form!  
**Active Surplus Annex's Mighty Midget Flasher**  
 Model FNN

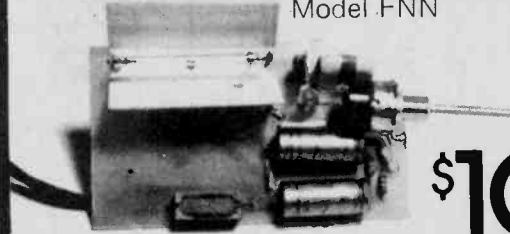

ONLY  
**\$10.50**

(Complete kit)

- Powerful Xenon Tube Flasher.
- Variable rate with On/Off switch.
- 115 Vac Neon Triggered.
- Including a horizontal beam reflector to concentrate and direct light for psychedelic effect for fun & parties.
- Perfect use for emergency warning lights, etc.
- For serious experimenters.

We also sell electronic components.

Printed Circuit Boards for all ETI projects are available.

*Sorry, no mail order.*

**ACTIVE SURPLUS ANNEX**  
 345 Queen Street West  
 Toronto, Ontario  
 (416) 368-7936

## P.C. PRODUCTS

**CATALOG NO. 80**

**INJECTORALL ELECTRONICS CORPORATION**

P.C. CONNECTORS  
 PRINTED CIRCUIT KITS  
 ALIGNMENT TOOLS  
 ELECTRONIC CHEMICALS

75c

1980

INDEX

MASS MERCHANDISER

SERVICE DEALER

**INJECTORALL ELECTRONICS CORP.** 99-100 Glen St. Glen Cove, N.Y. 11542 U.S.A.  
TEL. 516-431-0909

**If you need:**

- printed circuit boards and connectors
- drafting aids
- breadboards
- PCB chemicals
- Electronic chemicals

**send for our complete catalogue today!**

Please send me a copy of your Injectoral Catalogue and Price List.

Name \_\_\_\_\_

Address \_\_\_\_\_

City \_\_\_\_\_

Prov. \_\_\_\_\_ Postal Code \_\_\_\_\_

**omnitronix ltd.**

2056 TRANS CANADA HWY. UNIT 7, 6295 SHAWSON DRIVE  
 DORVAL, QUE. H9P 2N4 MISSISSAUGA, ONT. L5T 1H4  
 TEL: (514) 683-6993

Circle No. 33 on Reader Service Card.

68

# 8085 MICROPROCESSOR KIT



CPU Board can be expanded into a stand alone microcomputer system or used by itself as a dedicated controller for OEM applications. Includes a complete step-by-step instruction manual on 8085 operation and architecture. 8085 based CPU board is expandable with 1K eprom, 1K read/write memory, one serial port and three programmable parallel ports. 44 pin CPU edge connector can be configured for any buss structure. Area on CPU board for custom wirewrap design or user defined interface circuitry.

**8085A COOKBOOK** Basic concepts, system control, memory systems and types, interfacing. 8085A--family-compatible chips. You design several completely operational 8085A-based microcomputers. No. 21447 \$10.50

**8080/8085 SOFTWARE DESIGN** A detailed approach to assembly language programming for 8080 or 8085-based computers. Including complete, tested programs. No. 21541 \$9.50

**TRS-80 INTERFACING** Use basic language to control external devices and sense external events. Level II basic and 4K available memory required. No. 21633 \$8.95



14905 NE 140TH, DEPT. ET9,  
REDMOND, WA 98052 (206 883-9200)  
Add \$2.50 postage and handling



ENCLOSED IS \$ \_\_\_\_\_ FOR \_\_\_\_\_ EACH

KIT  COOKBOOK  SOFTWARE DESIGN  TRS-80 INTERFACING

NAME \_\_\_\_\_

ADDRESS \_\_\_\_\_

CITY, STATE, ZIP \_\_\_\_\_

CARD NO \_\_\_\_\_ EXP \_\_\_\_\_

SIGNATURE \_\_\_\_\_

SEND FOR OUR **FREE** 8-PAGE CATALOG  VISA  MSTC/D

Prices are in U.S. dollars  
Circle No. 53 on Reader Service Card.

## Vero

### For the Professional Amateur

Vero can offer a complete package to help you build your product to a truly professional standard. Full range of veroboards, accessories and housings. For your free catalogue circle no. 14 on Reader Service Card.

**ELECTRONIC PACKAGING SYSTEMS LIMITED**  
Retail Department  
P.O. Box 481, Kingston, Ontario K7L 4W5  
Telephone: (613) 384-1142  
Dealers invited - Circle no. 26 on Reader Service Card

# ETI ORDER FORM

**BACK ISSUES:** Please circle issues desired.

1977	February	May	July	November			
1978	March	May	June	July	August	September	
	October	November	December				
1979	January	February	March	April	May	June	July
	August	September	October	November	December		
1980	January	February	March	April	May	June	July
	August						

QTY.	ITEM	AMOUNT
..	Back Issues @ \$3 (mark choice above)	\$ .
..	Canadian Projects Book No. 1 @ \$3.45	\$ .
..	ETI Circuits Book @ \$5.45	\$ .
..	'More Circuits' Book @ \$4.95	\$ .
..	Set(s) of Panel Transfers @ \$5.00	\$ .
..	ETI T-Shirts @ \$5.50 (mark size below)	\$ .
..	ETI Binders @ \$6.75	\$ .
	Ontario Residents add 7% PST on last three only.	\$ .
..	Subscriptions @ \$14/\$17/\$19/\$26/\$32/\$36	\$ .
..	Hobby Projects @ \$3.95	\$ .
..	Electronic Circuit Design @ \$3.95	\$ .

BABANI		TAB	
QTY.		QTY.	
..	.BP1 \$2.80 \$ .	..	.No.205 \$3.55 \$ .
..	.BP14 \$4.80 \$ .	..	.No.213 \$4.50 \$ .
..	.BP24 \$4.25 \$ .	..	.No.215 \$3.70 \$ .
..	.BP33 \$4.25 \$ .	..	.No.221 \$5.50 \$ .
..	.BP35 \$5.50 \$ .	..	.No.223 \$5.50 \$ .
..	.BP37 \$5.50 \$ .	..	.No.224 \$4.25 \$ .
..	.BP39 \$5.50 \$ .	..	.No.800 \$18.30 \$ .
..	.BP42 \$3.55 \$ .	..	.No.804 \$18.35 \$ .
..	.BP44 \$7.55 \$ .	..	.No.80 5 \$11.75 \$ .
..	.BP46 \$5.90 \$ .	..	.No.806 \$11.75 \$ .
..	.BP47 \$5.90 \$ .	..	.No.841 \$8.55 \$ .
..	.BP48 \$5.90 \$ .	..	.No.1000 \$11.55 \$ .
..	.BP49 \$6.25 \$ .	..	.No.1010 \$9.85 \$ .
..	.BP50 \$5.90 \$ .	..	.No.1015 \$9.70 \$ .
..	.BP51 \$5.50 \$ .	..	.No.1064 \$11.85 \$ .
..	.BP62 \$8.95 \$ .	..	.No.1070 \$12.35 \$ .
..	.BP63 \$8.95 \$ .	..	.No.1071 \$10.90 \$ .
..	.BP64 \$8.95 \$ .	..	.No.1076 \$11.55 \$ .
..	.BP65 \$6.55 \$ .	..	.No.1088 \$11.85 \$ .
..	.BP66 \$7.55 \$ .	..	.No.1120 \$7.75 \$ .
..	.BP67 \$7.55 \$ .	..	.No.1133 \$9.75 \$ .
..	.BP68 \$7.25 \$ .	..	.No.1152 \$11.75 \$ .
..	.BP69 \$7.55 \$ .	..	.No.1169 \$13.75 \$ .
..	.BP70 \$2.40 \$ .	..	.No.1174 \$9.75 \$ .
..	.BP71 \$7.70 \$ .	..	.No.1234 \$11.75 \$ .
..	.BP72 \$7.70 \$ .	..	.No.1241 \$11.75 \$ .
..	.BP73 \$8.58 \$ .		
..	.BP74 \$7.70 \$ .		

SYBEX		SYBEX	
QTY.		QTY.	
..	.C200 \$10.75 \$ .	..	.C281 \$22.75 \$ .
..	.C202 \$18.75 \$ .	..	D302 \$18.75 \$ .
..	.C280 \$20.75 \$ .	..	G402 \$18.75 \$ .

SUBTOTAL \_\_\_\_\_ \$

\* Prices shown include postage and handling.

T-Shirt Sizes

No. of: Small  Medium  Large

Price is \$5.50 each

TOTAL  
Enclosed

PLEASE PUT YOUR NAME AND ADDRESS  
ON THE REVERSE SIDE OF THIS FORM.

# SUBSCRIBE NOW!



## BOOKS, BACK ISSUES BINDERS - SEE OVER

Code \_\_\_\_\_

Electronics Today Magazine, Unit 6, 25 Overlea Blvd., Toronto, Ontario M4H 1B1.

**SUBSCRIPTIONS:**  NEW SUBSCRIPTION? OR...  RENEWAL? Please check one.

One year subscription (12 issues) \$14     Two year subscription (24 issues) \$26  
 Postage and handling to Canada is included, for U.S. please add \$3, other countries add \$5.

NAME \_\_\_\_\_

ADDRESS \_\_\_\_\_

TOWN/CITY \_\_\_\_\_ PROVINCE/STATE \_\_\_\_\_

CODE \_\_\_\_\_ DATE \_\_\_\_\_

**PLEASE PRINT CLEARLY**

Cheque enclosed. DO NOT send cash.

Bill Mastercharge. A/C No. \_\_\_\_\_ Signature \_\_\_\_\_

Bill ChargeX. A/C No. \_\_\_\_\_ Expiry Date \_\_\_\_\_

# ARE YOU IN THE DARK?



Thirty eight years of relentless struggle with his home made television. The 12AX7s finally deliver. The picture is 3" by 4" and bright green!

# SUBSCRIBE TODAY!

The progress of electronics these days is truly astonishing. What's commonplace today, would have been miraculous ten years ago. Today's dreams will be tomorrow's reality.

Electronics Today focuses on the current electronics scene in Canada. You can buy ETI on the newsstand every month, or you can take out a subscription.

12 ETI's (one year) will cost you \$14.00, you can save \$7.00 over the regular newsstand rate! Use the convenient order form or send cheque or Money Order to:

Electronics Today International  
 Unit 6, 25 Overlea Blvd.  
 Toronto, Ontario, M4H 1B1





# See the logic of it all

## with B&K-PRECISION logic and pulser probes

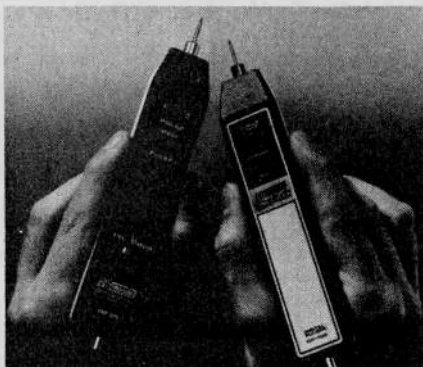

DP-50 \$89.95

DP-100 \$139.95

Armed with only two portable instruments, you can now trace logic levels through the most popular types of logic circuitry... TTL, MOS, CMOS, even HTL and HiNIL.

The new B&K-PRECISION DP-100 is a digital pulser probe that's a great aid to fast analysis and debugging of integrated circuit logic systems. Simple to operate, the DP-100 can be used alone or with a logic probe or oscilloscope. It generates a "one shot" pulse train at a 5 Hz rate and senses circuit conditions to pull an existing high state to a low or a low state to a high.

The B&K-PRECISION DP-50 is the digital probe that offers more than logic. In addition to logic status, it actually displays pulse presence to 50 MHz. The intensity of its PULSE LED reveals the duty cycle of the signal observed.

Both the DP-50 and DP-100 are well protected against overload and accidental polarity reversal. You can see the logic of it all today! Contact your B&K-PRECISION distributor for immediate delivery.

**BK PRECISION**  
**DYNASCAN**  
**CORPORATION**

ATLAS ELECTRONICS LIMITED  
50 Wingold Avenue  
Toronto, Ontario M6B 1P7  
Tel: 416-789-7761 Telex 065-24140

Circle No. 16 on Reader Service Card.

# SEMIS + KITS

MJ15003, MJ15004 . . . \$ 9.00 PER PAIR!  
MJ4502, 802 ONE PAIR . . . \$ 8.50  
TMS 4116 (30ns) each . . . \$ 7.50  
8 FOR . . . \$54.95  
2716 each . . . \$19.00

DC 12V 40W + 40W Power Amplifier Kit  
(FOR CAR, OR BOAT, ETC.)  
6 Variable Controls: Volume, Mic Volume, Bass,  
Treble, Balance & Midrange Control.  
Input Sensitivity: 2mV. Frequency response: 100KHz  
Input Impedance: 50Kohm. Voltage supply DC12V  
DC-12 KIT: \$89.95

84W + 84W LEACH Power Amplifier Kit  
KIT: INCLUDES 2 POWER SUPPLY  
TRANSFORMERS, CASE, CONTROLS AND  
SPEAKER PROTECTION CIRCUIT.  
Frequency Response: 0.5Hz-150KHz. THD 0.05%  
AT 1000Hz. Damping Factor 250 FROM 20Hz  
TO 20,000Hz.  
LEACH KIT: \$214.00

70W + 70W →  
O.C.L. DC Preamp  
and Amplifier Kit

— with Bass, Mid-  
range, Treble and  
Balance Controls. (R.M.S.) Frequency Response:  
0Hz-100KHz. I.M.D.: 0.05% or less. Input Sensi-  
tivity 1mV Voltage Supply ±28-32V. (Speaker  
Protection Circuit Included) KIT A70 \$84.95  
Class A RC 4739 Pre-amplifier with volume, tone,  
bass, and balance controls. Complete with case and  
transformer \$69.95

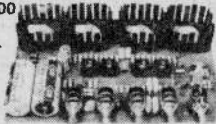

Send cheque/money order. Add 5% for handling.  
Ontario residents add 7% PST. Send \$1.00 for our  
catalogue (refundable with order).

**KITSTRONIC INTERNATIONAL**  
BOX 577 STATION J  
TORONTO, ONT. M4J 4Z2



Serving The  
Technician  
Since 1971

— Tuners are  
our only  
business.

Tuners are cleaned ultrasonically, checked on new Wavetek sweep equipment for gain, bandwidth, oscillator tracking and AFC divergence. Shaft repairs a specialty. Affiliated with Tuner Service Corporation, Bloomington, Indiana. Only new parts are used, meeting manufacturer's specifications.

**\$16.95 VHF UHF Varactor**

Same day service.

One year warranty on workmanship and materials on tuner repairs.

Please do not send mounting brackets.

**TUNER SERVICE Co. of CALGARY**

P.O. Box 5823  
Station "A"

Calgary, Alberta T2H 1Y3  
(403) 243-0971

Circle No. 11 on Reader Service Card.

## INNOVATION!

Fanon Message Centre  
— Computer controlled  
answering machine  
— Screen your calls  
— Remote message retrieval  
— Status display  
— Compact size . . . \$269.95



**COMMODORE PET COMPUTERS**  
8K . . . \$1195.00 Full keyboard.  
16K . . . \$1495.00 Separate numeric  
32K . . . \$1795.00 keypad — 25 lines  
Cassette Deck, \$99.00 of 40 characters.

Osborne's PET and the IEEE-488 Bus  
Book . . . \$19.95  
Webcor ZIP phone (with memory  
redial) . . . \$89.95

Sharp Metric  
Converter/Calculator . . . \$25.95  
BSR System X-10 Home Control System  
for lighting and appliances. No special  
wiring needed.

Starter Kit . . . \$139.95  
(Includes 1 command module, 1 appli-  
ance module, 2 lamp modules)

We also carry the APF Imagination Mac-  
chine and Apple Computers, Dictograph  
Phone Controller, and a vast array of other  
innovative products. Write or call for our  
**FREE CATALOGUE**. Or come in & see us.

Send Money Order, Charge, Master  
Charge. Include expiry date, card number  
bank name and signature. Add 5% for  
shipping (excess refunded). Ontario resi-  
dents add 7% sales tax. All prices subject  
to change.

**ELECTRONIC 2001**

5529 Yonge St. (just south of Finch)  
Toronto, Ontario M2N 5S3  
(416) 223-8400

Circle No. 9 on Reader Service Card.

NEW!

**EICO**®



274  
3½ DIGIT  
LCD  
DMM  
ONLY

**\$134.95**

### FEATURES

- Auto Polarity/Zero
- Large 0.5" LCD Digits
- Accuracy Better than 1.0% DCV
- 10 Megohm Input Impedance
- Full Overload Protection
- Over Range Indication "1"
- Low Battery Indication "BT"
- Complete with Battery, Deluxe Probes, Spare Fuse & Carrying Case

### RANGES

DC VOLTS: 0.2-2-20-200-1000  
(Maximum measurement 1000 Volts)  
AC VOLTS: 0.2-2-20-200-700  
(Maximum measurement 700 Volts RMS)  
DC CURRENT: 0.2-2-20-200mA-1A  
AC CURRENT: 0.2-2-20-200mA-1A  
RESISTANCE: 200ohm-2 20 200 2M 20M

Circle No. 22 on Reader Service Card for more information about this product. Available for immediate delivery at your local distributor. EICO is represented in Canada by:

**H.W. COWAN CANADA LTD.**  
P.O. Box 268, 99 Coons Road  
Richmond Hill, Ontario L4C 4Y2  
(416) 773-4331

Circle No. 46 for EICO catalogue.



## 2-Chip Electronic Dice

P. Adams

This electronic dice produces a true dice display using only two IC's — a 74132 and a 7495. The 7495 is a 4-bit parallel-access shift register. It can either operate as a shift-register or be parallel (broadside) loaded at inputs A-D. Control over these two functions is by a mode control input. When the mode is high data is loaded into Qa — Qd from inputs A - D on the next negative-going clock edge. When the mode is low data is shifted on Qa — Qd on the next negative-going clock edge.

By connecting the mode control to Qa so that the register alternates between load and shift and making the input word a function of the existing output word, with some simple logic, the register can be made to execute a count that will drive LEDs in a dice display. Note LEDs are lit when outputs are low. IC1a is connected as a conventional Schmitt oscillator providing clock pulses to the register. SW1 stops the oscillator and halts the count. On switch-on the register may start on an invalid count, but in a couple of clock cycles it will produce a valid count and then remain in that sequence.

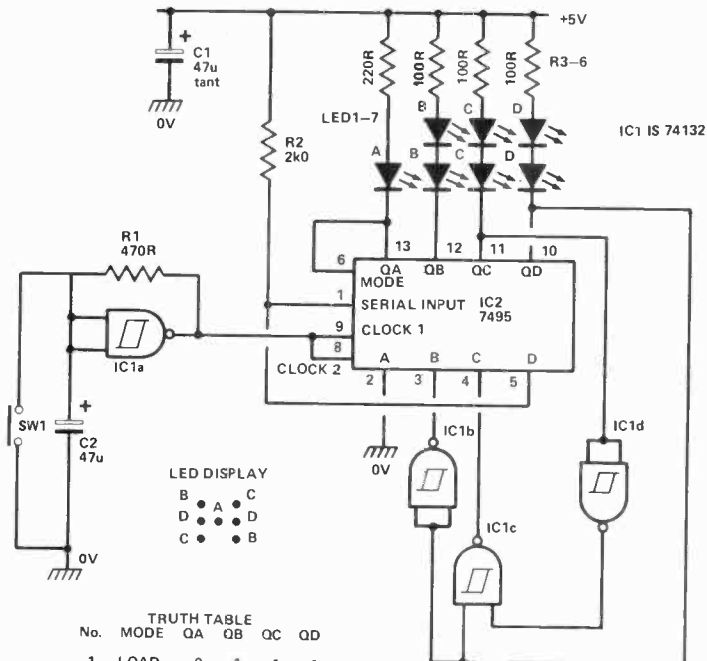

LED DISPLAY

```

    B   A   C
    D   .   D
    C   .   B
  
```

No.	MODE	QA	QB	QC	QD
1	LOAD	0	1	1	1
2	SHIFT	1	0	1	1
3	LOAD	0	0	1	1
4	SHIFT	1	0	0	1
5	LOAD	0	0	0	1
6	SHIFT	1	0	0	0
1	LOAD	0	1	1	1
ETC					

○ SALE ○

# BRYAN ELECTRONICS

○ SALE ○

KITS!  
ALL NEW

## THE X-LIGHT CONTROLLER

FANTASTIC!

DIGITAL CONTROLLED, AUDIO  
ACTIVATED, S.C.R.  
POWERED

10 CHANNEL LIGHT  
DISPLAY CONTROLLER

DESIGNED EXCLUSIVELY FOR  
BRYAN ELECTRONICS

by UTRONIX  
(available Sept. 1/80)

COMPLETE KIT WITH P.C.B. — \$69.95

AC RECEPTACLES  
CHASSIS MOUNT

STANDARD — \$.39 ea. 10/ \$2.99  
U GROUND — \$.99 ea. 10/ \$8.95

### RESISTOR SPECIALS

STOCK UP NOW

PHILIPS — 1/4w 5% \$1.89 per hundred  
— 1/2w 5% \$2.99 per hundred  
— 1w 5% \$5.49 per hundred

REED SWITCHES  
standard \$.49 ea. 10/\$3.99  
heavy duty \$.59 ea. 10/\$4.99

SUPER DEAL!  
AC LINE CORDS  
2-WIRE \$.39 ea. 10/ \$2.99  
3-WIRE \$1.19 ea. 10/ \$10.95

IF WE DIDN'T HAVE 'EM  
WE'D BUY THEM AT THIS PRICE!

1 3/4" O.D. SPEAKERS  
0.1 W 8ohms \$.99 ea 10/\$8.95

ONLY 400 IN STOCK, SO HURRY

BARGAIN BASEMENT PRICES!!

—POTENTIOMETERS—  
LINEAR, 5K, 10K, 50K, 100K,  
AUDIO, 5K, 10K  
\$.89 ea. 10 assorted \$7.95

GREAT BUY!  
MICRO SWITCHES

STANDARD — \$.89 ea. 10/ \$7.95  
WITH LEVER — \$.99 ea. 10/ \$8.95  
MINIATURE — \$.79 ea. 10/ \$6.95

EXPERIMENTERS!

6-12 v.d.c. fluid pumps  
GREAT FOR —ETCHANT BATHS  
—PHOTOGRAPHIC  
CHEMICALS  
—WATERFALLS ETC.  
BUY 2 GET ONE FREE! . . \$4.95 ea.

HERE'S AN OFFER!!!

20% off all semiconductors listed in our  
current catalogue until September 30,  
1980—NOW THAT'S A GOOD DEAL!!

### MINIATURE TRANSFORMERS

-output — 500ct to 8 ohm  
-output — 1.2K ct to 8 ohm  
-drivers — 10K to 1K ct  
\$.99 each

LED's  
MIL31-RED \$.28 ea. 10/\$1.99  
MIL31-GREEN \$.40 ea. 10/\$2.99  
MIL31-YELLOW \$.46 ea. 10/\$2.99  
HARDWARE-MIL31 \$.12 ea.  
MIL51-RED \$.28 ea. 10/\$1.99  
MIL51-GREEN \$.40 ea. 10/\$2.99  
MIL51-YELLOW \$.46 ea. 10/\$2.99  
HARDWARE-MIL51 \$.12 ea.  
LED IN CHROME BEZEL  
RED \$.99 ea. GREEN \$1.20 ea.

YOU CAN'T  
AFFORD TO  
PASS ON THIS  
ONE!!!

Miniature push  
button switch  
—S.P.S.T.  
—1A 125VAC  
—momentary  
\$.49 ea. BUY 10,  
GET 5 FREE!!  
BUY 20, GET  
15 FREE!!

TOGGLE SWITCHES — 3A/125 v.a.c.

S.P.S.T. - \$1.39 ea. 10/\$9.95  
D.P.D.T. - \$1.49 ea. 10/\$10.95  
D.P.D.T. centre off - \$1.89 ea. 10/\$14.95

### ODDS 'N' ENDS

Empire MK IV Cartridge ..... \$15.00  
145 Thermal Breaker ..... \$ .80  
Microtemp fan hair blowers ..... \$ .40  
9 section swivel antenna ..... \$1.20  
365pf tuning condensers ..... \$ .30  
Cassette tape spacers ..... \$1.49  
4.5v 200ma AC adaptor ..... \$1.99  
6v 100ma AC adaptor ..... \$1.99  
9v 100ma AC adaptor ..... \$1.99  
4 amp AC filter ..... \$1.00  
2 amp photo cell ..... \$2.20  
T066 transistor sockets ..... \$ .15  
T0-3 transistor sockets ..... \$ .15  
T0-5 transistor sockets ..... \$ .15  
Illuminated slide switch ..... \$ .99

### MORE KITS!

Stereo phono pre-amp ..... \$ 9.95  
1 watt amplifier ..... \$16.95  
5 watt amplifier ..... \$19.95  
15 watt amplifier ..... \$24.95  
Crystal radio ..... \$ 6.95  
Stereo mixer ..... \$49.95  
CCD driver ..... \$79.95  
Frequency shifter ..... \$79.95  
16 ch. multi-mode chaser ..... \$29.95  
Strobe light ..... \$19.95  
1 channel colour organ ..... \$ 6.95  
3 channel 300w colour organ ..... \$19.95  
3 channel 1500w colour organ ..... \$29.95  
Morse code oscillator ..... \$ 9.95  
0-24V power supply ..... \$29.95  
16 channel LED chaser ..... \$19.95

Add \$2.00 for shipping & handling. C.O.D.  
orders \$2.00 additional. Ontario residents  
add 7% sales tax. Mastercard, Visa, Money  
Orders, do not send cash; be sure to sign  
your order.

BRYAN ELECTRONICS  
P.O. Box 2068, Bramalea,  
Ontario, L6T 3S3

○ HURRY — SALE EXPIRES OCT 15/80 — DEALER INQUIRIES INVITED ○

**Generate virtually  
any wave  
shape  
with famous  
B&K-PRECISION  
cost-effectiveness!**



Model 3010/\$245.85

Model 3020/\$447.85

The B&K-PRECISION Model 3020 sweep/function generator is the most versatile signal source in its price range. This instrument alone can replace a function generator, sweep generator, pulse generator and toneburst generator. Frequency coverage spans 0.02Hz to 2MHz in seven ranges, each with linear 1000:1 frequency control.

A low-distortion, high-accuracy signal source, the 3020 can generate almost any waveform, including sine waves, square waves, TTL square waves, toneburst, pulses and ramps. All can be inverted. Internal linear and log sweep capability is also featured. Both modulation and carrier levels can be varied so even a double sideband suppressed carrier test signal can be generated.

For applications requiring standard signals, the Model 3010 low distortion function generator is offered. The 3010 generates sine, square, TTL square and triangle waveforms from 0.1Hz to 1MHz in six ranges. An external VCO input is provided for sweep frequency tests. Variable DC offset is included.

The 3020 and 3010 are available for immediate delivery at your local distributor. A ten day free trial is available at many locations.

**BK PRECISION**

**DYNASCAN  
CORPORATION**

ATLAS ELECTRONICS LIMITED  
50 Wingold Avenue  
Toronto, Ontario M6B 1P7  
Tel: 416-789-7761 Telex 065-24140

Circle No. 17 on Reader Service Card.

## CHALLENGER 1P SERIES 2

Ohio Scientific Microcomputer

- \* NEW program selectable 24X24 character display or 12X48 character display (Up to 32X32 or 16X64 with video monitor)
- \* NEW sound, music and voice output via a D/A converter.
- \* NEW switch selectable audio cassette, 300 baud modem and printer interface included.
- \* NEW easy expansion to colour display, joy sticks, AC remote control and much more.
- \* NEW durable high impact shell over a solid aluminum RF shielded chassis.
- \* Self contained personal computer style keyboard, video display interface, BASIC in ROM and large system expansion capability.
- \* 18K total RAM/ROM with 8K of program workspace, expandable to 32K.

CIP SERIES 2 . . . . . \$697.00  
CIP SERIES 2 with 32K RAM  
and Mini floppy . . . . . \$1,890.00  
CIP8K . . . . . \$560  
NEW COLOUR DISPLAY COMPUTER  
C4P 8K RAM . . . . . \$1,040  
C4P MF 24K RAM, MINIFLOPPY  
. . . . . \$2,550  
C8P 8K RAM, 8 SLOT BACKPLANE  
. . . . . \$1,340  
C8P DF 32K RAM, DUAL 8" FLOPPIES  
. . . . . \$4,250

\* Ontario residents add 7% Sales Tax. Prices subject to change without notice. Master Charge or Visa accepted. Shipped collect by any method you specify.

**D.C.B. ELECTRONICS**  
333 Denison St. Unit 3, Markham,  
Ontario L3R 2Z4 (416) 495-1599

## S.E.A. FREQUENCY LEVEL DISPLAY

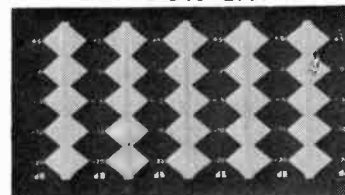

- Display frequency response of your pre-amp. or power amp. on 5 bands of LEDs.
- 5 Frequency bands: 100Hz, 300Hz, 1kHz, 3kHz and 10kHz.
- See frequency response at a glance.
- Adds exciting sight to your Hi-Fi system.
- You can use one or two units on your stereo system.
- Simply connect to the output of your pre-amp or power amplifier (with proper attenuator, just a resistor).
- Operates on DC 9V-12V (power supply section included on p.c. board). Transformer extra.
- Each kit includes: 2 pieces of drilled p.c. board, 50 LEDs (4 colours), all electronic parts, one 4-colour silkscreen printed plastic front panel.
- Front panel size approx. 4 1/2" x 2 1/2".  
LD-01 Kit . . . . . \$69.00

15 Step Power Level Indicator. 30 LEDs in 4 colours with floating or gradual display. Adjustable sensitivity control. Indicates from -36dB to +5dB. Front panel size approx. 9" x 2 1/2".  
SAD-03 Kit . . . . . \$56.00

Add 10% for postage and handling. Ontario Residents add 7% sales tax. Send cheque or money order. Master Charge or Visa accepted.

**AUDIOVISION SERVICE**  
P.O. Box 955, Station B,  
Willowdale, Ont. M2K 2T6

Circle No. 7 on Reader Service Card.

## NEW ISO-TIP®

**cordless  
soldering iron  
completely recharges  
in 60 minutes.**

**MAKES CORDLESS SOLDERING  
PRACTICAL FOR  
HEAVY-USE APPLICATIONS.**

The Iso-Tip 60 can make up to 125 electronic joints or more per charge. When completely discharged, the iron can be recharged and used in a few minutes or fully recharged in an hour. Low voltage, battery powered, ground free isolated tip design.

**WAHL CLIPPER CORPORATION**  
ORIGINATORS OF PRACTICAL CORDLESS SOLDERING

16 snap-in  
tips to fit  
any job

plus a  
PC Drill.

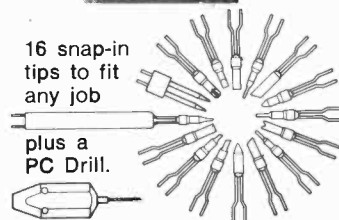

See your Electronics Distributor, or write for Free Lenline Catalogue.

**len finkler limited**

25 Toro Road, Downsview, Ontario M3J 2A6  
Telephone (416) 630-9103 Telex 065-24010



Circle No. 24 on Reader Service Card.

ETI-SEPTEMBER 1980

## Stereo VCA

J. Macaulay

The circuit shown is of a stereo VCA whose gain can be varied over a 90 dB range by the application of a control voltage between 0-15V.

Maximum gain is limited to 20 dB and occurs when the control voltage is 0V. Minimum gain occurs with the application of +15V at the control input.

The circuit works as follows. IC1/2 are 741 op amps operated in the virtual ground mode with R1, R5 determining the input impedance at 1M, regardless of gain. The feedback loop from the output of the IC's are completed by the resistors R4, R6. A pair of MOSFETs, internal to IC3, are connected in parallel with these resistors and the control voltage is applied to their gates, pins 3 and 10.

When zero volts are applied to the gates the resistance across the feedback loop is some  $10^9$  ohms in all with R4-6. In consequence these latter components determine the gain of the stage. When the control voltage is increased in a positive direction the impedance across the FETs decreases and the gain of the amplifier decreases in sympathy. Once the voltage is increased to 15V the impedance across the FETs lowers to roughly 300R.

The frequency response of the amplifier extends from approximately 5 Hz-100 kHz at the -3 dB points whilst the distortion at maximum gain is about 0.1% at 1 kHz. If the feedback resistors are close tolerance types, 2%, the gain will be found to be within  $\pm 1$  dB between channels due to the closely matched characteristics of the FETs within IC3.

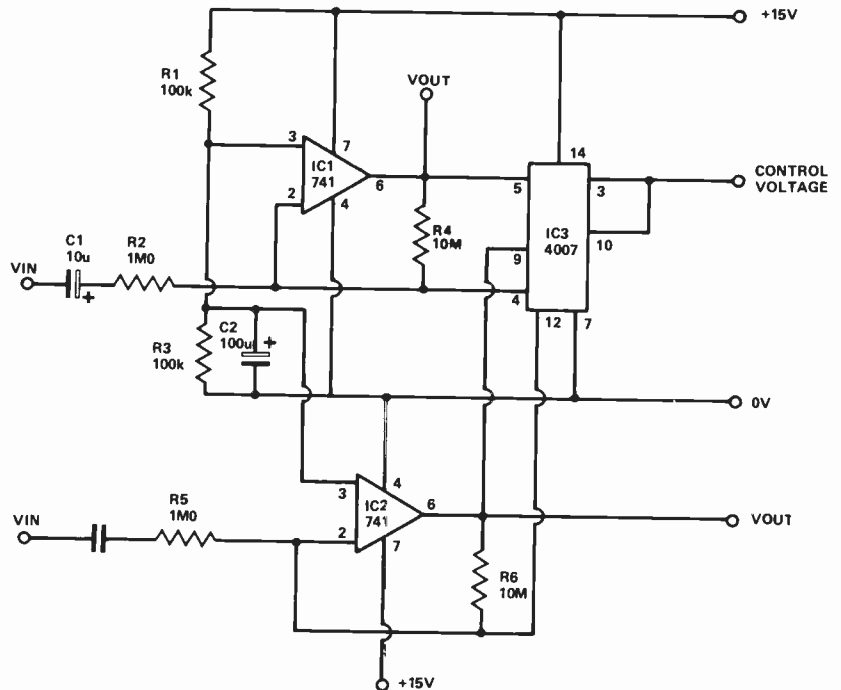

## Special Publications from ETI

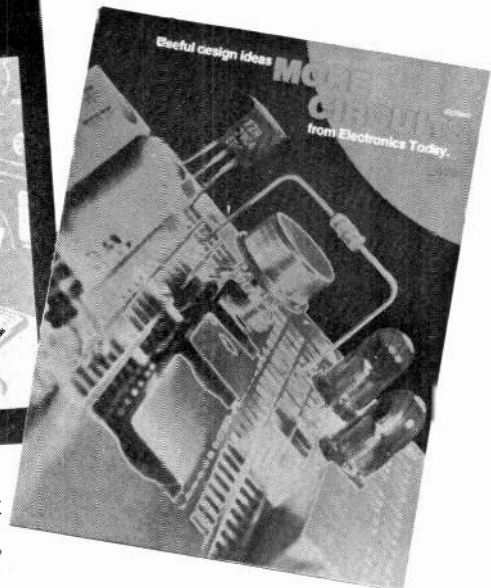
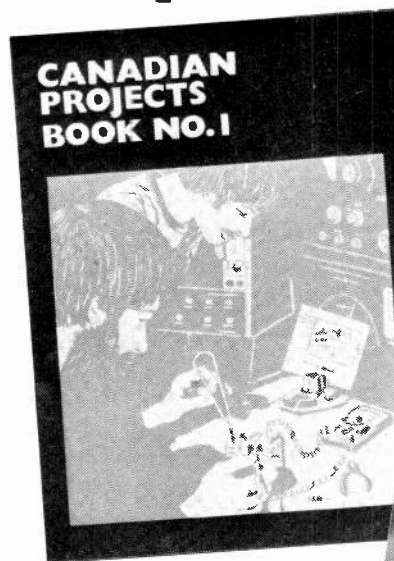

25 of the most popular projects from our earlier issues including: Audio Limiter, 5W Stereo, Bass Enhancer, Modular Disco, 50W/100W Amp modules, IB Metal Locator, Heart Rate Monitor, Phaser, Touch Organ, Electronic Mastermind, Double Dice, Reaction Tester, Sound Operated Flash, Burglar Alarm, Injector-Tracer, Digital Voltmeter. 100 pages.

**\$3.45 (inc postage)**

To order, use the card facing page 48 or send money to: ETI Magazine, 25 Overlea Blvd., Unit 6, Toronto, Ontario M4H 1B1

Over 150 circuits plus articles on Circuit Construction, Test Gear, a project on a Digital Panel Meter, Design notes on Speaker Crossovers, TTL pin-outs, Design notes on Crystal Oscillators. 108 Pages.

**\$4.95 (inc postage)**

Tech-Tips is an ideas forum and is not aimed at the beginner; we regret that we cannot answer queries on these items. We do not build up these circuits prior to publication.

ETI is happy to consider circuits or ideas submitted by readers; all items used will be paid for. Drawings should be as clear as possible and the text should be preferably typed. Anything submitted should not be subject to copyright. Items for consideration should be sent to the Editor.

# Back Issues From ETI



February 1977

Features: CN Tower, Biorythm Calculator, VCT, 555 Timer Applications, Yamaha B1 Review, Scope Test Your Car.  
Projects: 5W Stereo Amp, Philips Speaker System, Reaction Tester, Patch Detector, Heads or Tail, SCR Tester.

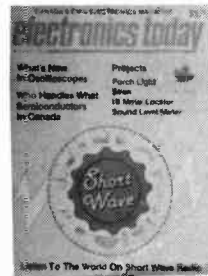

August 1978

Features: Getting into Shortwave, Using a 'Scope, Semiconductor Guide, Intro To Amateur Radio 2.  
Projects: Sound Level Meter, 2 Chip Siren, Induction Balance Metal Locator, Porch Light.

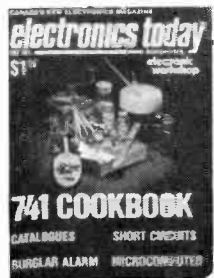

May 1977

Features: Projection TV, 741 Cookbook, Easier Way to Make PCBs, Choosing a Microcomputer.  
Projects: Burglar Alarm, Ceramic Pre-amp, Ni-Cad Battery Charger, Power Supply, Fuzz Box, Stereo Rumble Filter.

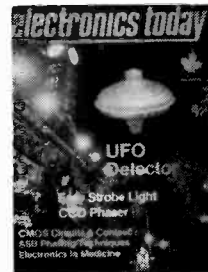

October 1978

Features: Personal Computing Commentary, CMOS Quickies, SSB by Phasing, History of Electronics in Medicine.  
Projects: UFO Detector, CCD Phaser, Strobe.



July 1977

Features: A Generation Away, I<sup>2</sup>L Explained, CB Supplement, Intro to Computers.  
Projects: Mastermind, DVM, Overled, Turn Indicator Canceller.



June 1979

Features: Op Amps, Inside Info From Ultrasound, Computer Catalogue.  
Projects: Colour Organ, LCD Thermometer, Colour Sequencer, VHF Antenna, Bip Beacon.



May 1978

Features: Tools Catalogue, Data Sheet Special on Memory Chips, Microbiography.  
Projects: White Line Follower, Add-on FM Tuner, Audio Feedback Eliminator.



August 1979

Features: Casing Survey, Smoke Detectors, TV Antennas, Reed Switches, Magnetic Field Audio Amp, Industrial Electronics.  
Projects: Audio Power Meter, Shoot-out, ETI-Wet Plant Waterer.

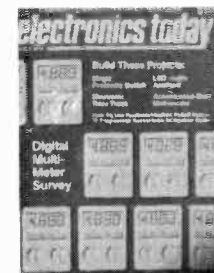

July 1978

Features: Digital Multimeter Survey, Pinball Machines, Intro to Amateur Radio, TI Programmer.  
Projects: Real-Time Analyser, Electronic Race Track, Proximity Switch, Accenuated-Beat Metronome.

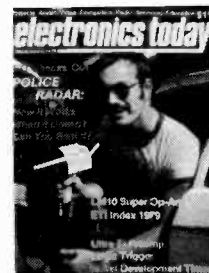

December 1979

Features: LM10 Circuits, Police Radar Speed Meters, Practical Guide to Triacs, Fluorescent Displays.  
Projects: High Performance Stereo Preamp, Photographic Development Timer, Logic Trigger.

The back issues shown and described above are available direct from us. Please order by Issue, not by feature. They are \$3.00 each or 5 for \$10.00. Use card facing page 48, which lists other back issues available, or just send to:

BACK ISSUES  
ETI Magazine  
Unit 6,  
25 Overlea Boulevard  
Toronto, Ontario  
M4H 1B1



**'SATISFACTION'** - the kind of feeling you get from working with SPECTRUM pcs  
 Write today for a free price list. - P.O. Box 4166 Stn. D, Hamilton, Ontario, Canada, L8V 4L5

Circle No. 5 on Reader Service Card.

## CALCULATOR ORDERS SHIPPED WITHIN 24 HOURS!!!

Free shipping anywhere in Canada! We take advantage of our retail operation to offer low mail order prices. In many cases, these are 15% below our retail prices!

**Canon LC-61T \$39.95**

Regular \$59.95



8 digit liquid crystal display. Features independent memory, time, calendar, alarm, stop watch. Credit card size.



**CASIO FX-81**

- 8 digit, or 6 digit mantissa with 2 digit exponents
- 30 scientific functions, independent memory, 6 level parenthesis, true algebraic logic.
- Auto power off.

**\$25.45**

FX 310. Similar to FX-81 but with 50 scientific functions including standard deviation and random numbers

**\$44.95**



**TEXAS INSTRUMENTS INCORPORATED**

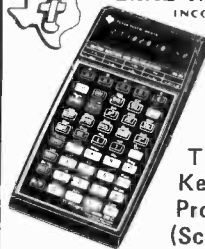

**\$143.95**

**TI 58C Keystroke Programmable (Scientific)**

TI 59	Fully Programmable	\$332.95
TIPC-1000 Printer for TI 58/59		\$224.95
TI 57	Keystroke Programmable (Scientific)	\$71.95
TI 55	Keystroke Programmable (Scientific)	\$53.95
TI MBA	Keystroke Programmable (Scientific)	\$89.95
TI BA I	Preprogrammed Financial	\$26.95
TI BA II	Preprogrammed Financial	\$53.95
TI Business Card	Preprogrammed Financial	\$53.95
TI 50	Preprogrammed Scientific	\$53.95
TI 35	Preprogrammed Scientific	\$35.95
TI PROGRAMMER	Preprogrammed Scientific	\$71.95

**HEWLETT PACKARD**



**AMAZING MACHINE, AMAZING PRICE!**

**\$420.75**

**HP-41C**

HP 41C Magnetic Card Reader	\$335.00
HP 41C Thermal Printer	\$625.00
HP 41C Memory Modules	\$73.95
HP 34C Keystroke Programmable (Scientific)	\$224.00
HP 33C Keystroke Programmable (Scientific)	\$170.95
HP 33E Keystroke Programmable (Scientific)	\$134.95
HP 38C Keystroke Programmable (Financial)	\$224.00
HP 38E Keystroke Programmable (Financial)	\$179.95
HP 92	Preprogrammed Financial \$625.50
HP 37E	Preprogrammed Financial \$112.50
HP 32E	Preprogrammed Scientific \$107.95
HP 31E	Preprogrammed Scientific \$71.95



**Canon Card FC-42**

Metric conversion calculator. Independent memory.

**\$24.95**

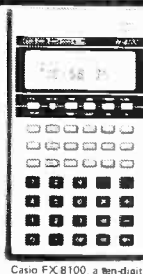

**CASIO FX-8100**

**\$71.95**

Casio FX 8100, a 16m-digit wallet type scientific calculator featuring scores of advanced functions such as hyperbolics, fractions, standard deviation, rectangular to polar coordinates and five levels of parenthesis. The FX 8100 also reveals the time, date, AM/PM and serves as a stop watch. The unit has two countdown timers and an hourly chime



**CASIO MUSIC MAKERS!**



The ML-831 is an 11 note melody calculator. 8 digit display. Independent memory. Auto power off. Function indicator. Long battery life

ML-720 (C) instant memory. Credit card size	\$44.95
ML-71 (C) clock, calendar, alarm, stopwatch	\$59.45

We accept certified cheque, money order or Charge/Master Charge. Include bank name, expiry date, card no. & signature on all card orders. Ontario residents add 7% P.S.T. All prices subject to change.

**BATTERIES INCLUDED**

Village By the Grange  
 71 McCaul St. (Just North of Queen St.)  
 Toronto, Ont. M5T 2X1 (416) 596-1405

P.S. We carry Commodore PET Computers & related products, too!  
 Write or call for details.



# CLASSIFIED

**You can write for ETI**

**75¢ per word**

ETI's not-so-new classified advertising section allows you to reach 30,000 readers nationwide. For as little as \$15 (there's a 20 word min.) you can promote your business from coast to coast.

**WHAT DO YOU DO?**  
Send us your typewritten or clearly printed words your permanent address and telephone number, and your money (no cash please). Make your cheque or money order payable to 'ETI Magazine'. We're at Unit 6, 25 Overlea Blvd., Toronto, Ontario. M4H 1B1

**WHAT DO WE DO?**  
We typeset your words (and put the first word and your company name in BOLD capital letters). If we get your message by the 14th of the month, it will appear in ETI 1½ months later. For example if we receive it by October 14th you (and thousands more) will see it in the December issue.

HIGH quality amplifier kits and power supply kit. Lowest price in Canada. For free information, please write AUDIO CONCEPT P.O. Box 2653, Thunder Bay, Ontario.

**SPECIAL No. 1:** Approximately 1000 electronics parts: capacitor - resistor - relay - switch - etc, etc, for \$10. **Special No. 2:** Assortment of 100 tantalum capacitors, 1 uf to 100 uf (6 to 35 VDC) for \$10. **Special No. 3:** 500 assorted ceramic capacitors for \$10. All new and first quality parts with unconditional money-back guarantee. Free flyer and sample on request. **SURPLUS ELECTRO QUEBEC**, 2264 Montee Gagnon, Blainville, Quebec, Canada J7E 4H5.

**SUPREME ELECTRONICS INC.** P.O. Box 6370, Stn. C., Victoria, B.C. V8P 5M3. **QUALITY PARTS** at wholesale prices. Send \$1.00 to receive our new 1980 catalogue.

**EPROMS PROGRAMMED.** 2716, 5V version. \$20, will supply EPROM if needed. Truth table and/or 300 baud cassette to **KS COMPUTER SERVICES** 42 Rosemere Close SE, Medicine Hat, Alberta T1B 2J8

**QUALITY PRINTED CIRCUIT** boards available for all ETI Projects. Loudspeaker Protector - \$5.79 Home Security System - \$3.99; Siren - \$1.99; Touch Switch - \$1.99. Please send all orders prepaid. Also a large selection of parts: Resistors, Capacitors, TTL, CMOS, Linear IC's and more. Write for complete information to: **WENTWORTH ELECTRONICS**, R.R. No. 1, Waterdown, Ontario Canada L0R 2H0.

**K-W SURPLUS** Visit us while in Kitchener. Bargains in electronic surplus for the hobbyist, manufacturer and educator. 327 Breithaupt Street, Kitchener, Ontario N2H 5H6. Open Wednesday to Friday - 12:00 to 9:00 PM; Saturday - 9:00 AM to 5:00 PM.

**WSI RADIO** - SWL Radios - Ham radios 18 Sheldon Avenue North, Kitchener, Ontario N2H 3M2. Tel. (519) 579-0536. Write for giant catalogue, free of course!! (VE3EHC).

**PRINTED CIRCUIT** boards from your sketch or artwork. Affordable prices. Also fun kit projects. Free details. **DANOCINTHS INC.** Dept. ETI, Box 261, Westland MI. 48185. U.S.A.

**FOREST CITY SURPLUS LIMITED**, Everything in electronic surplus for the hobbyist, manufacturer, educator, and bargain hunter. Don't miss visiting us while in London. 781 Dundas Street, London, Ontario (519) 438-0233.

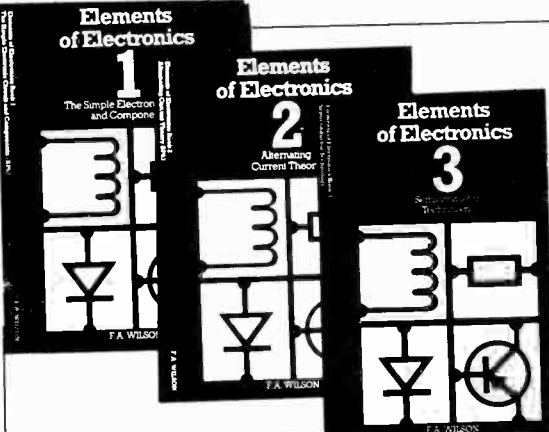

**Book 1 (BP 62)** introduces the reader to the nature of electricity, it's sources and simple electronic circuitry. Additionally there are chapters on components, electrical safety and electronic math.

**Book 2 (BP63)** delves into the secrets of AC current theory. Attention is paid to resonance and Q-factors, impedance, phasor diagrams and transformers. Includes ample mathematical appendices.

**Book 3 (BP64)** centres on semiconductor theory. Chapter 1 starts at the physics and applications theory of semiconductors. Other subjects include diodes, transistors and FETs. Applications studied include rectifiers, amplifiers, oscillators, switching and IC techniques.

To order please use the card facing page 44 or send to:  
ETI Magazine,  
Unit 6, 25 Overlea Boulevard,  
Toronto, Ontario, M4H1B1

**NEW STORE!** Hobbyist. Parts. Speakers. Kits. Equipment. **GENERAL ELECTRONICS**, 5511 Yonge St., Willowdale, Ont. M2N 5S3, 221-6174. Please write for free catalogue. Monday, Friday, Saturday: 10:00 AM - 6:00 PM. Tuesday, Wednesday, Thursday: 10:00 AM - 8:00 PM

**J&J ELECTRONICS LTD.**, P.O. Box 1437E, Winnipeg, Manitoba R3C 2Z4. Surplus Semiconductor Specialists. Do you get our bargain flyer? Send \$1.00 to receive the current literature and specials and to be placed on the mailing list for future publications.

**Blood is needed  
Be a RED CROSS  
Blood Donor today**

# The Best Scope Buys Available!

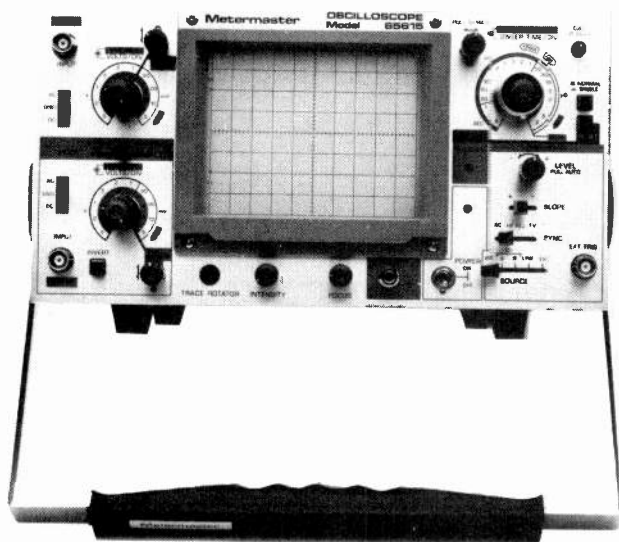

Introducing...

Metermaster's NEW  
40MHz Dual Trace  
Oscilloscope.

**Model 65615**

Featuring an Extremely  
Bright CRT Display  
(15KV acceleration voltage).

only **\$1395.**  
F.S.T. INCLUDED

**FEATURES INCLUDE:**

- Internal Graticuled 5" CRT.
- Full 40MHz Bandwidth at -3dB.
- 5mV Vertical Sensitivity for the full bandwidth, expandable to 1mV/div. utilizing the X5 Gain Multiplier below 10MHz.
- Trace Rotator.

**PLUS:**

- 50 nsec delay for viewing pre-trigger data.
- X5 Sweep Magnification.
- Supplied with AC Line Cord and an Operations and Maintenance Manual.

**Accessories:** Probes (extra).

**Look...**

At the features  
of these 15MHz  
Oscilloscopes

**\$695. each**  
F.S.T. INCLUDED

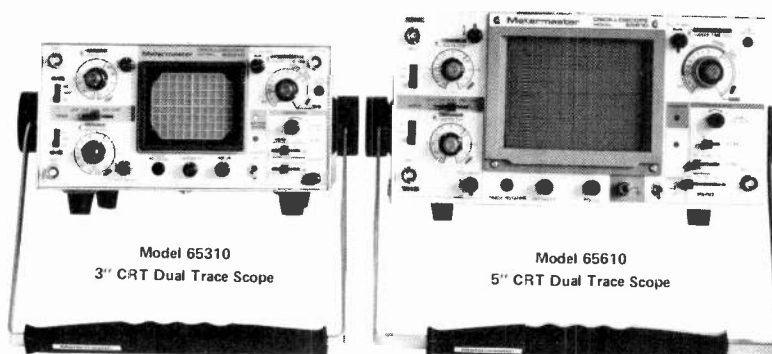

- Model 65310:**
- Operates from 3 Power Sources
    1. Rechargeable Ni Cad Batteries.
    2. 120 VAC Line (also charges batteries).
    3. 11 - 30 VDC.
  - Fully Automatic Triggering.
  - Bandwidth DC - 15MHz (-3dB).
  - Trace Rotator.
  - 2mV Vertical Sensitivity.

**Accessories:** Vinyl carrying case, probes (extra).

- Model 65610:**
- Operates from 2 Power Sources
    1. 120 VAC Line.
    2. 11.5 - 30 VDC.
  - Fully Automatic Triggering.
  - Bandwidth DC - 15MHz (-3dB).
  - Trace Rotator.
  - HF Rejection.
  - 5mV Vertical Sensitivity.

**Accessories:** Probes (extra).



**Metermaster**  
**R.H. NICHOLS**

All prices F.O.B.  
Downsview, Ontario  
subject to change with-  
out notice. P.S.T. extra  
where applicable.

TORONTO (416)661-3190 • MONTREAL (514)337-0425 • EDMONTON (403)432-7746 • OTTAWA (613)238-7007

Circle No.4 on Reader Service Card.



Z8001 \$253.50 16 Bit CPU with segmented address space to 8 Megabytes  
 Z8002 \$195.00 16 Bit CPU with non segmented address space to 64K bytes

All Products Stocked in Depth  
 Largest Zilog Inventory

Z80-CPU 2.5 MHz	13.52	Z80-SIO/0 2.5 MHz	39.65
Z80A-CPU 4.0 MHz	14.46	Z80A-SIO/0 4.0 MHz	47.71
Z80-PIO 2.5 MHz	7.98	Z80-SIO/1 2.5 MHz	46.80
Z80A-PIO 4.0 MHz	10.40	Z80A-SIO/1 4.0 MHz	57.33
Z80-CTC 2.5 MHz	7.98	Z80-SIO/2 2.5 MHz	57.33
Z80A-CTC 4.0 MHz	10.40	Z80A-SIO/2 4.0 MHz	57.33
Z80-DMA 2.5 MHz	29.06		
Z80A-DMA 4.0 MHz	36.40		



BY POPULAR DEMAND  
 QUANTITY DISCOUNT OFFER EXTENDED  
 10% QTY DISCOUNT ON 100 PCS PER  
 DEVICE TYPE NOW VALID UNTIL  
 SEPTEMBER 30, 1980.

"ACTIVE IS AGGRESSIVE"

"FALL STOP SPECIAL"

1980 IC MASTER  
 over 2700 PAGES

Complete integrated circuit data selector.  
 Master guide to the latest I.C.'s including  
 microprocessors and consumer circuits.  
 45,000 device types listed. 5,000 new  
 device types added. Complete new  
 section on MPU boards & Systems.



"VERY SPECIAL \$49.95"

TTL ALL CIRCUITS IN STOCK FOR GUARANTEED IMMEDIATE DELIVERY

74LS00N .38	74LS20N .38	74LS55N .35	74LS95N .88	74LS137N .90	74LS161N 3.19	74LS191N 3.25	74LS245N 6.29	74LS279N 1.85	74LS348N 3.84	74LS379N 3.24
74LS01N .29	74LS21N .44	74LS73N .70	74LS96N 1.09	74LS138N 1.22	74LS162N 2.54	74LS192N 1.11	74LS247N .90	74LS280N 5.53	74LS328N 1.76	74LS390N 3.24
74LS02N .77	74LS21N .89	74LS74N 1.16	74LS107N .77	74LS139N 1.22	74LS163N 3.19	74LS193N 2.15	74LS248N 2.20	74LS280N 2.30	74LS328N 3.21	74LS393N 3.58
74LS03N .35	74LS27N .70	74LS75N .90	74LS109N 1.25	74LS145N 1.79	74LS164N 1.27	74LS194N 3.19	74LS249N 1.29	74LS280N 2.21	74LS328N 15.54	74LS395N 3.19
74LS04N .77	74LS30N .31	74LS76N 1.61	74LS112N .62	74LS147N 3.24	74LS165N 3.82	74LS195N 1.22	74LS251N 3.00	74LS280N 1.51	74LS365N 6.10	74LS447N .48
74LS05N .90	74LS32N .90	74LS78N .59	74LS122N .75	74LS148N 3.19	74LS166N 7.37	74LS196N 6.36	74LS253N 1.09	74LS280N 1.09	74LS366N 1.89	74LS490N 3.19
74LS08N .49	74LS38N .51	74LS83N 1.22	74LS123N 1.55	74LS151N .83	74LS169N 10.21	74LS197N 1.42	74LS257N 1.25	74LS280N 1.11	74LS367N 2.57	74LS630N 143.00
74LS09N .77	74LS40N .31	74LS85N 1.74	74LS124N 1.94	74LS153N .64	74LS170N 2.54	74LS221N 1.61	74LS258N 1.11	74LS280N 6.38	74LS368N 2.39	74LS631N 143.00
74LS10N .38	74LS42N .75	74LS86N 1.68	74LS125N 1.16	74LS155N 1.66	74LS173N 1.11	74LS240N 1.92	74LS259N 6.19	74LS320N 6.44	74LS373N 2.51	74LS669N 6.44
74LS11N .64	74LS47N 1.14	74LS90N .70	74LS126N 1.63	74LS156N 2.28	74LS174N .74	74LS241N 1.55	74LS260N 1.30	74LS320N 5.02	74LS374N 2.51	74LS670N 6.07
74LS12N .25	74LS48N 1.14	74LS91N 1.09	74LS132N .62	74LS157N 1.53	74LS175N .74	74LS242N 2.28	74LS266N 1.89	74LS322N 6.44	74LS375N 5.72	
74LS13N .44	74LS51N .44	74LS92N 1.55	74LS133N 3.71	74LS158N 1.89	74LS181N 3.84	74LS243N 1.26	74LS273N 1.94	74LS323N 6.44	74LS377N 1.98	
74LS14N .87	74LS54N .36	74LS93N .51	74LS136N 1.29	74LS160N 2.28	74LS190N 1.89	74LS244N 2.28	74LS275N 9.01	74LS324N 3.19	74LS378N 2.54	

MICROPROCESSOR  
 CHIP SETS

Part No.	Price	Part No.	Price	Part No.	Price
8080A	\$ 7.74	6800	\$ 8.45	6502	\$12.94
8085	15.54	6802	15.54	6504	12.94
				6505	12.94
8212	3.58	6810	4.88		
8214	5.14	6820	6.44	6520	9.04
8216	3.84	6821	4.88	6522	12.95
8224	4.49	6850	5.14	6532	18.14
8226	3.84	6582	4.88	6551	18.14
8228	6.47				
8238	6.47				
8251	9.04				
8253	14.24				
8255	9.04				
8257	14.24				
8259	16.84				

BONUS!  
 RETURN THIS AD WITH YOUR ORDER  
 AND RECEIVE FREE SAMPLE —  
 ONE 9" x 19" DOUBLED SIDED COPPER  
 PRINTED CIRCUIT BOARD.

SCR's and TRIAC's

C106D	.44	SCR	5 amp 400V TO-220
TIC116B	1.26	SCR	8 amp 200V TO-220
TIC126B	1.42	SCR	12 amp 200V TO-220
TIC216B	1.29	Triac	8 amp 200V TO-220
TIC226D	1.24	Triac	8 amp 400V TO-220
TIC236D	1.89	Triac	12 amp 400V TO-220
TIC246D	1.89	Triac	15 amp 400V TO-220

Bi-Fet OP AMPS

TL064CN	3.58	Quad low power	TL081CP	.64	J-FET input
TL071CP	.77	Low noise	TL082CP	1.29	Dual J-FET input
TL072CP	1.55	Dual low noise	TL084CN	2.54	Quad J-FET input
TL074CN	3.06	Quad low noise			

MOS MEMORIES

MOS Static RAM's

Part No.	Price
2102-25	2.28
P2111-35	5.14
1K (1K x 1) 250NS 16 PIN	
1K (256 x 4) 350NS 18 PIN	5.14
P2112-35	4.49
1K (256 x 4) 350NS 18 PIN	
2114L	9.04
Low Power 4K (1024 x 4) 300NS	
2147	25.94
4K (4K x 1) 55NS	
2147	19.44
4K (4K x 1) 70NS	

UART's

AYS-1013A	5.14
0 to 40K BAUD 40 PIN	
COM8017	Special 5.14
40 KHz Single 5V Supply	

"Memory Specials"

EPROM'S

C2708	\$ 9.04
1K x 8 450 ns	
TMS2532	\$ 90.94
32K (4096 x 8) 450 ns	
TMS2716	\$ 25.94
16K (2K x 8) 450 ns	
(3 power supplies) T.L. Version	
C2716/TMS2516	\$ 19.44
16K (2K x 8) 450 ns	
(Single 5V supply — Similar to Intel version)	
TMS2564	\$513.50
64K (8K x 8) 450 ns	

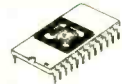

16K MOS DYNAMIC RAM'S (16 PIN)

416-3 (200ns) Ceramic	7.74
416-5 (300NS) Ceramic	6.44
4K MOS DYNAMIC RAM'S	
TMS4060-30	Special 3.84
4K (4K x 1) 300NS 22 PIN	
TMS4060-20	5.14
4K (4K x 1) 200NS 22 PIN	

LINEAR I.C.'s

LM301AN-8	.44	LM324N	.77	LM741CN-8	.51
LM304CH	1.16	LM339N	.77	LM747CN-14	.77
LM307N-8	.38	LM348N-14	1.29	LM748CN-8	.51
LM308N-8	1.16	LM358N-8	1.03	LM1458N-8	.64
LM308CH	1.24	LM555N-8	.51	LM1488N-14	.90
LM309K	1.68	LM556N-14	.64	LM1489N-14	.90
LM310HC	1.94	LM723CN-14	1.16	LM3048N-14	1.29
LM311N-8	.77	LM723CN-14	.64	LM3302N-14	.72
LM317T	1.94	LM725CN-8	2.28	LM3403N-14	1.16
(TO-220)		LM733CN-14	2.07	LM3900N	.64
LM318N-8	1.89	LM739CN-14	1.68	LM4138N-14	1.29
LM318CH	2.28	LM741CH	.85	ULN2003AN	1.29

DUAL-IN-LINE — LOW PROFILE — I.C. SOCKETS

CONTACTS	PRICE	CONTACTS	PRICE
8 PIN	.11	22 PIN	.33
14 PIN	.17	24 PIN	.36
16 PIN	.20	28 PIN	.42
20 PIN	.27	40 PIN	.61
20 PIN	.30		

• LOWEST PRICES ANYWHERE FOR THE HIGHEST QUALITY. AN  
 UNBEATABLE COMBINATION

OPTO SALE

L.E.D. LAMPS

LED209	T-1 2 mm Red	.12
LED211	T-1 3 mm Green	.25
LED212	T-1 3 mm Yellow	.18
LED220	T-1 3/4 5 mm Red	.14
LED222	T-1 3/4 5 mm Green	.31
LED224	T-1 3/4 5 mm Yellow	.21

DISPLAYS

FND357	375' Common Cathode	1.29
FND500	500' Common Cathode	1.29
FND507	500' Common Anode	1.29
DL704	300' Common Cathode	1.68
DL707	300' Common Anode	1.68
DL747	630' Common Anode	2.98
DL1416	4 digit, 16 segment alphanumeric display 16' ht.	38.94

ISOLATORS

ILD74	Dual Opto Isolator	1500V	1.68
ILQ74	Quad Opto Isolator	1500V	5.14
ILCT6	Dual Opto Isolator	1500V	1.68
TIL111	Opto Coupler	1500V	.70
4N26	Opto Isolator	2500V	.70
4N33	Opto Isolator	1500V	.85

CMOS

CD4000BE	.38	CD4021BE	.96	CD4046BE	1.16	CD4082BE	.30	CD4527BE	1.91
CD4001BE	.51	CD4022BE	1.55	CD4047BE	1.09	CD4085BE	.81	CD4528BE	1.22
CD4002BE	.30	CD4023BE	.68	CD4049BE	.85	CD4086BE	1.03	CD4531BE	1.16
CD4003BE	1.55	CD4024BE	.68	CD4050BE	.57	CD4093BE	1.22	CD4532BE	1.50
CD4007BE	.51	CD4025BE	.38	CD4051BE	1.07	CD4099BE	2.57	CD4539BE	1.09
CD4008BE	1.09	CD4026BE	2.33	CD4052BE	1.55	CD4104BE	2.59	CD4543BE	1.94
CD4009BE	.70	CD4027BE	.64	CD4053BE	1.55	CD4508BE	2.46	CD4553BE	3.87
CD4010BE	.77	CD4028BE	.74	CD4054BE	2.59	CD4510BE	1.09	CD4556BE	.96
CD4011BE	.44	CD4029BE	1.22	CD4066BE	1.29	CD4511BE	.96	CD4556BE	.90
CD4012BE	.38	CD4030BE	.59	CD4068BE	.38	CD4512BE	1.14	CD4581BE	2.54
CD4013BE	.64	CD4033BE	2.33	CD4069BE	.35	CD4514BE	3.06	CD4582BE	1.14
CD4014BE	.90	CD4034BE	3.63	CD4070BE	.51	CD4515BE	2.73	CD4584BE	.70
CD4015BE	.98	CD4035BE	1.48	CD4072BE	.30	CD4516BE	1.68	CD4585BE	1.29
CD4016BE	.57	CD4040BE	1.29	CD4073BE	.51	CD4518BE	1.16	CD4702BE	11.56
CD4017BE	.94	CD4041BE	2.03	CD4075BE	.44	CD4519BE	.77		
CD4018BE	.77	CD4042BE	.87	CD4076BE	1.09	CD4520BE	1.00		
CD4019BE	1.63	CD4043BE	1.29	CD4078BE	.44	CD4522BE	1.29		
CD4020BE	1.29	CD4044BE	1.03	CD4081BE	.35	CD4526BE	1.29		

PLASTIC POWER TRANSISTORS

TIP29	.51	NPN	1 AMP 100V
TIP30	.51	PNP	1 AMP 100V
TIP31	.55	NPN	3 AMP 100V
TIP32	.56	PNP	3 AMP 100V
TIP41	.77	PNP	6 AMP 100V
TIP42	.83	PNP	6 AMP 100V
TIP115	.77	PNP	2 AMP 60V
TIP120	.83	PNP	5 AMP 60V
TIP122	.96	NPN	5 AMP 100V
TIP125	.96	PNP	5 AMP 60V
TIP127	1.11	PNP	5 AMP 100V
TIP2955	1.08	PNP	15 AMP 60V
TIP3055	.91	NPN	15 AMP 60V
FT3055	.77	NPN	10 AMP 60V

"ANNOUNCING THE OPENING OF OUR NEW CALGARY LOCATION"



MINIMUM MAIL ORDER \$10.00  
 Add \$3.00 to cover postage and handling.  
 PRICES ARE IN CDN. FUNDS. F.O.B. CANADA  
 Federal Sales Tax Incl.  
 Provincial Sales Tax Extra

LARGE INVENTORY AT ALL LOCATIONS

STORE HOURS:  
 Monday to Wednesday 9:00 am — 6:00 pm  
 Thursday and Friday 9:00 am — 9:00 pm  
 Saturday 9:00 am — 5:00 pm

VISA AND  
 MASTER CHARGE  
 ACCEPTED

5651 FERRIER ST.  
 MONTREAL, QUEBEC  
 H4P 2K5  
 Tel.: (514) 731-7441

BAXTER CENTRE  
 1050 BAXTER ROAD  
 OTTAWA, ONTARIO  
 K2C 3P2  
 Tel.: (613) 820-9471

4800 DUFFERIN ST.  
 DOWNSVIEW, ONTARIO  
 M3H 5S9  
 Tel.: (416) 661-1115

5809 MacLEOD TRAIL S.  
 UNIT 109  
 CALGARY, ALBERTA  
 T2H 0J9  
 Tel.: (403) 259-6408