

Radio News of Canada

20

CENTS

Vol. 4, No. 5

TORONTO

NOVEMBER, 1925

20

CENTS

The "STRAD" of LOUD SPEAKERS

AMPLION

Amplior
Dragon
AR-19
\$45.00

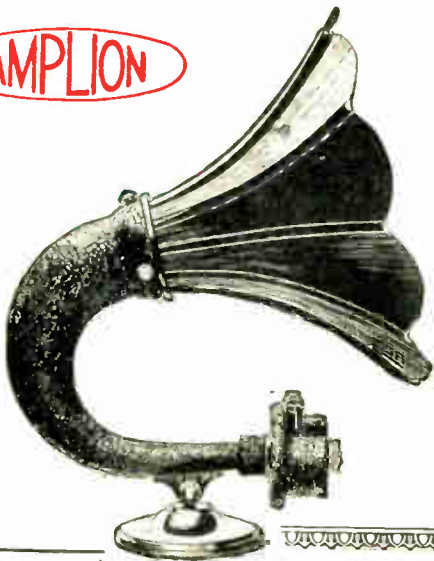

The beautiful Mahogany flare on the Amplior, not only enhances its beauty, but in conjunction with the exclusively - Amplior full-floating diaphragm, gives that pleasing soft tone which music lovers so admire in the Stradivarius violin.

Just as Stradivarius gave a violin of unsurpassable tone to the musical world, so has "The House of Graham" given a Loud Speaker of the highest quality and performance—the Amplior—to the radio musical world.



Antonio Stradivari passed on to mankind instruments of amazing purity and richness of tone. His violins are with us still, but his secret he carried to the grave.

THE AMPLION CORPORATION OF CANADA LIMITED

Sole Canadian Distributors:

BURNDEPT OF CANADA LIMITED, Head Office: 130 RICHMOND W., TORONTO

Other Burndept announcements on pages 13, 14 and 37 of this issue.



Model H2 De Luxe—\$20.00

Brown

Makers of the First Loud Speaker
Ever Used for Radio

Beauty and purity of tone with satisfying volume
makes the Brown Loud Speaker the
finest in the world.

SOLE CANADIAN DISTRIBUTORS

PURSER, BULL & CO., LIMITED

445-447 King St. West

Toronto 2, Canada

FADA Radio



Selects with
precision the
one Station
you wish to
hear ~ ~ ~ ~

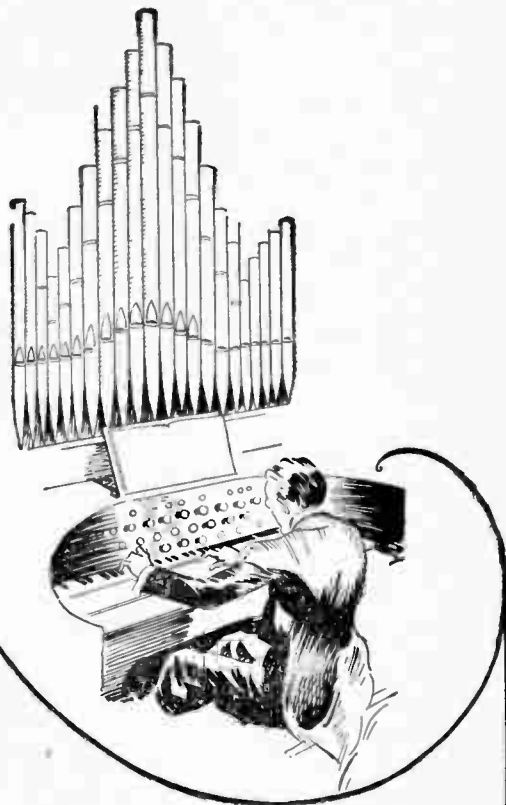

AN organ recital from New York—the latest fox-trot from Chicago—a symphony orchestra or grand opera—whichever you want—a simple turn of the dials on your Fada and the one station you have chosen comes in clearly and distinctly.

A Fada Neutrodyne assures you that perfect reception of individual stations so essential to the full enjoyment of radio. Faithful reproduction of both music and speech, ample volume on distant stations and beautiful cabinets are recognized features of Fada Radios.

There's a Fada dealer near you. Ask him for a demonstration. And remember, you may purchase a Fada with reasonable assurance that no essential changes in radio invention for years to come will render it obsolete or less desirable.

DEALERS—Write the Fada Distributors covering your territory for special Fada Franchise Offer.

- Mechanics' Supply Limited - - Quebec, P.Q.
- McLagan Phonograph Corp. - Stratford, Ont.
- Singer & Elliott, Limited - - Toronto, Ont.
- Canada Cycle & Motor Co. Ltd. - Winnipeg, Man.
- Radio Specialties, Limited - Vancouver, B.C.

FADA RADIO LIMITED

821-827 Queen Street East, Toronto

F. A. D. Andrea Inc.,
New York City

Fada Radio Limited,
London, Eng.

Manufacturers of TUNED RADIO FREQUENCY receivers using the highly efficient NEUTRODYNE principle.

Licensed under Hazeltine Patents Nos. 238128 and 238894

There is a Fada Radio Model for every purse, prices ranging from \$60.00 to \$335.00. Illustrated is the Fada Canadian at \$125.00.

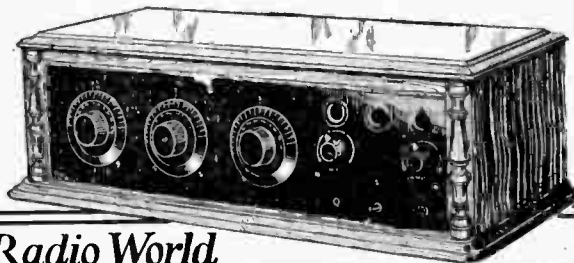
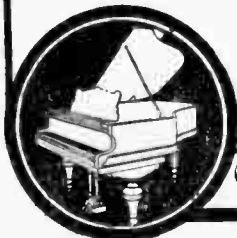

The Grand Piano of the Radio World

Tell Them You Saw It In "Radio News of Canada"

Everyone Interested in RADIO Should Write for this FREE Radio Book

90 PAGES OF RADIO VALUE

The finest and most complete radio value book published is yours free. A post card brings you your copy—send for it Now—TO-DAY!

When you buy from WRS, you save the jobbers' and retailers' double profit! In addition, it is "chockful" of interesting data every fan wants to know: Trouble Shooting Chart, Revised and Complete List of Broadcasting Stations, Log Chart, etc. ALL MERCHANDISE GUARANTEED. You MUST be satisfied or your money will be refunded. 24 hours' service—orders shipped on same day received!



McLAUGHLIN

SINGLE CONTROL SUPERHETERODYNE

WRITE FOR SPECIAL PRICE
Kit, Complete, \$79.95

GUARANTEE: All parts exactly as specified by Mr. McLaughlin.

- 2 Precise No. 750 Syncrodensers, .0005 mfd.
- 1 Precise No. 744 Coupler.
- 2 Precise Aluminum Brackets.
- 1 Precise No. 1900 filtoformer.
- 1 Precise No. 1700 super-multiformer.
- 1 Precise Audio-frequency Transformer.
- 1 Precise AF. Transformer No. 480 2½ to 1.
- 1 Marco 4" vernier dial Clockwise.
- 2 Carter Imp jacks. Loopwire plus.
- 1 Hammarlund Jr. Midget Cond.
- 1 Carter double-circuit holdtite jack.
- 1 Carter single-circuit holdtite jack.
- 1 Benjamin No. 9050 8 gang socket shelf.
- 1 Benjamin battery switch.
- 1 Weston No. 301 Voltmeter, 0 to 7 volts scale.
- 1 Weston No. 301 milliammeter, 0 to 25 milliamperes scale.
- 1 N.Y. Coil Mica Fixed Cond. .006.
- 1 N.Y. Coil Mica Fixed Cond. .00025.
- 2 Dubilier 1 mfd. bypass cond.
- 1 Dubilier No. 640 mica fixed condenser .00025 mfd. with grid leak clips.
- 1 Daven Grid Leak, 2 megohms.
- 1 Precision Inducto-Coupler No. 260.
- 1 General Radio Rheostat, type 214A, 2-ohm, 2½-amp.
- 1 General Radio Potentiometer, type 214A, 400-ohm.
- 1 Bakelite panel, black or mahogany, 10"x 14½" x 3/16", drilled, engraved.
- 1 Set Popular Radio Blueprints.
- 40 ft. Tinned Bus Bar Wire.
- 1 Book, complete, detailed instructions for building this remarkable set.
- Stranded Wireloop for coupling oscillator to circuit.
- 1 "C" Battery.



Complete Information On Any Technical Problem and ANY STANDARD Approved Circuit!

OUR MONEY BACK GUARANTEE
YOUR SATISFACTION
INSURANCE

Your money is still YOUR MONEY until you are thoroughly satisfied. Money refunded without question or quibble.

BROWNING DRAKE
FOUR TUBE RECEIVER

- One Panel—7x24", Drilled and Engraved.
- One baseboard—8½x23½".
- One National tuning unit B-D 1.
(This contains one .0005 mf. National DX condenser with 4" Velvet Vernier dial and one antenna coil mounted as a unit.)
- One National unit B-D 2.
(This contains one .00035 mf. National DX condenser with 4" Velvet Vernier dial and one National Regenaformer, also mounted as a unit.)
- One Rathbun 3-plate vernier condenser for balancing.
- Four standard Benjamin tube sockets.
- One General Radio 6-1 audio Transformer Type 285A.
- One SERCO Audio Transformer 3½ to 1 ratio.
- Two SERCO Rheostats, New Type of 30 ohms resistance.
- One 25-ohm fixed resistance.
- One Hoyt 2" voltmeter with a scale reading of 0 to 60 volts.
- One .0001 mf. fixed condenser.
- One .001 mf.
- One .00025 mf. fixed grid condenser.
- One Electrad variomh for variable grid leak.
- One BMS double circuit jack.
- One BMS single open circuit filament control jack.
- One filament switch.
- One 1 mf. by-pass condenser.
- Nine binding posts.
- Twenty feet of wire for connecting parts.
- One box of assorted screws, nuts, etc.
- One book of instructions and blue prints.
- One binding post strip.
- Two brass brackets.

Kit Price - \$44.95

Raythdeon Plate Supply Unit.
Complete Parts in Stock.
Write for Special Price.

Complete Parts for the NEW

Hammarlund
Roberts
RECEIVER

ENDORSED BY TEN
LEADING ENGINEERS

The ONE non-radiating receiver with the sensitivity of the superheterodyne. Razor blade selectivity, even in crowded areas. Tuning reduced to the simplicity of two major controls. Automatic filament control, superb tone plus the entire elimination of distortion.

The parts listed below are exactly as specified by the originators of this circuit.

- 2 Rauland Lyric Transformers.
 - 1 Hammarlund Midget Condenser.
 - 2 Hammarlund .0005 mfd. Straight Line frequency Condensers.
 - 1 Set Hammarlund Roberts Coil.
 - 2 Alden "Super De Luxe" Sockets.
 - 5 Alden De Luxe Sockets.
 - 1 Alden K-3843 1¼" Dial.
 - 4 Amperites No. 1-A.
 - 5 Prs. Union Phone tip jacks.
 - 1 Carter 25-ohm "Imp" Rheostat.
 - 1 Carter Single circuit No. 101 "Hold-tite" Jack.
 - 1 Carter "Imp" Battery Switch.
 - 1 Dubilier Type 640-G .00025 mfd. Grid Condenser.
 - 1 Dubilier Type 640 .002 mfd. Fixed Condenser.
 - 1 Dubilier Type 640 .006 mfd. Condenser.
 - 1 Durham Resistor.
 - 1 Hammarlund-Roberts Foundation Unit, consisting of drilled and engraved panels, sub-panels, brackets, screws, nuts, lugs, wire, etc.
- This Cabinet FREE. Fine mahogany finish, fancily grooved cabinet with sloping panel front, exactly as specified by circuit builders.

WRITE FOR SPECIAL PRICE

IMMEDIATE DELIVERY

Mr. Laurence Cockaday's
NEW LC-26

Broadcast Receiver

ALSO

All Radio News
Circuits and Hook-Ups

WE SPECIALIZE

In EVERY circuit approved by the technical engineers of "Radio Broadcast," "Radio News of Canada," "Popular Radio" and Mr. Cockaday. Cockaday Super, Cockaday DX, Ultradyne, Superdyne, Pressley Reflex, Reflex, etc.

W R S PRICES ARE LOWER
SERVICE IS BETTER
VALUES ARE HIGHER

FREE!

A copy of our radio Guide Book and Catalog should be in every fan's library. It's chockful of interesting data and hundreds of exceptional radio values. A postal brings it. Be sure to mention "Radio News of Canada."

DO IT NOW!

WHOLESALE RADIO SERVICE CO.

Manufacturers and Wholesale Distributors of Radio Apparatus

Be sure to address DEPT. CR 11

6 CHURCH STREET

NEW YORK CITY



A "Room-ful"
of Tone
for only

\$15⁰⁰

LIFELIKE, beautiful tone, loud and clear in every part of the room. Such tone quality and volume as only high-priced speakers have approached in the past. An unusual, artistic, space-saving shape, **all-directional** in principle. And a price that any set owner can afford. That's the story in a nutshell of this latest invention of the famous European scientific instrument makers who gave us the well-known N & K Imported Phones. Ask your dealer to let you hear this new Model S. It's an experience worth while.

9½ inches high on 6½-inch square base. Built of burtex, a **non-chattering material** that eliminates false tone vibrations. Finished in black, suggesting leather. Diaphragm unit adjustable to variations in local broadcasting and in set construction.

NEUFELDT & KUHNKE DIVISION
Th. Goldschmidt Corporation
Dept. RC 11 41 Common St., Montreal, P. Q.



The New

Imported

LOUDSPEAKER

MODEL S



N & K Imported Loudspeaker. Type W.—Unusual in volume and in tone quality. Its handsome, artistic appearance wins it welcome place in the finest home. 14 in. high. Made of burtex, finished in black, mottled in gold, also several special finishes. Unit adjustable. Price \$22.50.



N & K Imported Model D Phones.—The favorite phones of professional operators long before radio became the universal pastime. Famous for clearness and naturalness of tone, 4,000 ohms. Unusually comfortable to wear. Handsome leather-covered head bands. Price \$8.50.



The N & K Imported Phonograph Unit transforms any Victrola or any other standard phonograph into a loudspeaker of highest quality. No screws or attachment devices necessary. Adjustable to broadcasting conditions and set construction. \$7.50



DEALERS: N & K Loudspeakers and Phones SELL.
Write for the N & K PROFIT PROPOSITION.

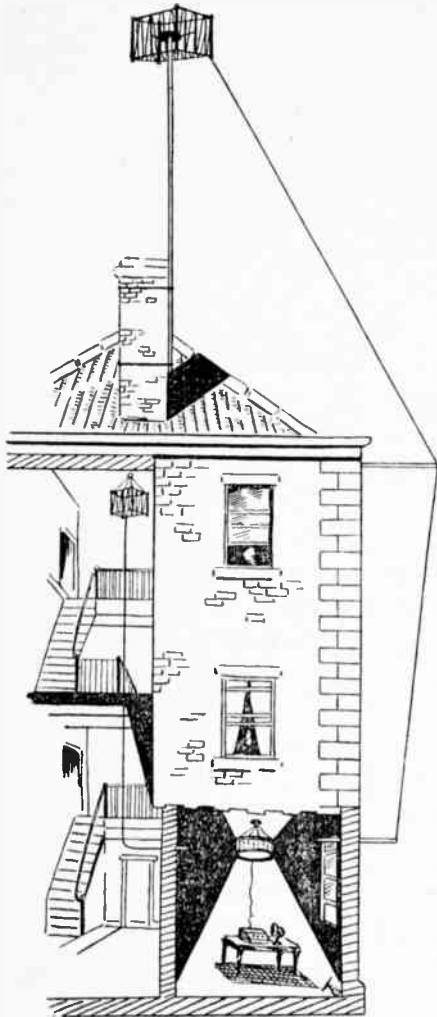

NON-DIRECTIONAL PERFEX AERIAL

Patented in Canada and abroad

INCREASES—
RANGE
VOLUME
SELECTIVITY
PURITY

It Will Improve
Reception With Any Set

Easily Erected, Only One Pole
Required, No More Interference
From Other Aerials.

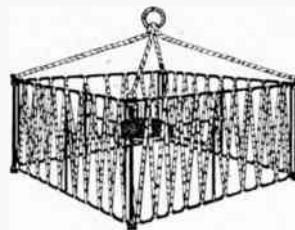

INDOOR

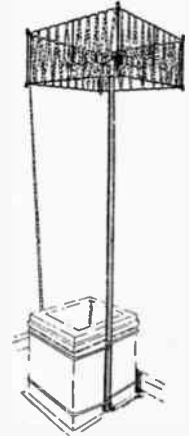

OUTDOOR

An aerial being the **first source of wireless reception**, it is of the **utmost importance** that the maximum intake is received in order to obtain full results from the set.

Three Methods of Erecting the Perfex Aerial

\$15.00

WITHOUT MAST

several can be erected on the same roof. This is of particular advantage to those living in apartments or congested areas.

It is a proved fact that a **vertical wire collects a greater amount of wireless energy** than a horizontal one. Consequently, the Perfex Aerial gives **more volume**.

The **effective height** of the aerial differs from a T-aerial, in that the height above the set itself counts, instead of the height above the roof only, hence greater volume is obtained.

The aerial folds flat, so that it can be readily used as a **portable aerial**, or if it is impossible to erect it outside, it may be suspended in the attic, hallway, or in the same room as the set.

This aerial has been tested and proved by numerous experts in Canada, who all agree that the **Perfex aerial is unquestionably the best aerial hitherto invented**.

FEDERAL RADIO COMPANY, LTD.

57 COLBORNE STREET - TORONTO 2

Phone Adelaide 1885

Cables FEDRAD, Toronto



OUTSIDE ADJUSTMENT

A FULL SIZE SPEAKER

Good Volume
Height 19"
2,000 Ohms

\$15.00

Requires Less Current
to Operate Than Any
Other Loud Speaker

The Jewel Radio Co. Ltd.

12, UPPER CAMDEN ST. - DUBLIN, IRELAND

The above Company has been formed in order to manufacture Wireless Sets and Components in Ireland, and to carry on a Mail Order business in connection therewith.

The new Broadcasting Stations in the Free State will be opened next month, and we expect a big boom in the sale of Radio goods. The highest class of cabinet work can be turned out here, so as to avoid the heavy Import duty.

The Technical Department will be under the supervision of a well-known expert, and only the highest class work at moderate prices will be produced. We want to get busy to meet the demand on the spot. This will open a new field of industry and give employment to many hands.

Just consider that in the short space of three years, over 1,400,000 licences for wireless sets have been taken out in Great Britain. It is estimated that the sales of wireless apparatus in America this year will reach the extraordinary total of £100,000,000.

The Capital is £1,250 (One thousand two hundred and fifty pounds), divided into 25,000 shares of one shilling each, the principal cash provided by the issue of 250 ten-year Notes of £100 each, bearing Interest at 5%, such Notes being issued at the price of £95, and being repayable at £100 (\$500). The purchaser of each note is intended to have the right to apply for and be allotted one hundred shilling shares in the Company at par. A person contributing £100 will, therefore, receive 100 shilling shares and one Note of £100.

It is not intended to have any preference shares, debentures, or founders' shares and, assuming that the £100 Notes are repaid at maturity in ten years' time, this would mean that the Subscriber would then receive all his capital back and would retain his full interest in the share capital of the Company afterwards.

The Company is a private Company, with not less than two, nor more than five Directors. The Directors' fee is not to exceed £100 to the Chairman and £60 per annum to each of the other Directors. A few notes are now for sale. If you are interested and desire to subscribe to the Capital and Note issue of the Company, I should be glad if you will fill up the Form below and return to me with a remittance for 1% of the amount which you are prepared to invest.

Subscribers will be notified in due course as to when the balance of their capital is to be paid.

Yours faithfully,

J. BYRNE, Secretary.

THE JEWEL RADIO CO. LTD.

I, the undersigned, hereby agree to take up and pay in cash for (a).....Notes of the above-mentioned Company for £100 each, repayable in ten years, bearing interest at 5% per annum and issued at £95, (b)..... shares of one shilling each in the said Company. I enclose my cheque for 1% of the total amount to be found by me and I agree to find the balance of the money, as to 24% on request, and as to the remaining 75% by three equal monthly payment, at intervals of not less than one month, as may be requested by the Company.

Signature

Address

Date

Cheques or International Money Order payable to J. BYRNE and crossed a/c Munster and Leinster Bank, Ltd., Dublin.

Be a RADIO EXPERT

Earn \$50 to \$250 a week in Radio—most fascinating work on earth



Learn Quickly And Easily At Home This Practical Way ~ ~ ~ ~ ~



GOVERNMENT SPENDING MILLIONS ON RADIO

U.S. Government now spends millions developing, using Radio. Ex-Postmaster - General Hays said: "Probably the biggest part in the future postal service will be played by Radio." Photo above sending out time signals at Arlington, great Government Radio station at Washington. Radio is filling new needs never dreamed of before.

SEND COUPON NOW

Get out of the low-pay rut, get into the most fascinating, easiest, big-pay profession on earth. Free Book tells you how. ACT AT ONCE!

Train At Home For A Big-Pay RADIO JOB

Radio to-day is urgently in need of trained men—Radio Experts. Astonishing opportunities—thousands of them—have been opened up by enormous strides of the Radio Industry. That's why it's easy to make big money in Radio—\$50 to \$250 a week. Here's a field that is teeming with opportunities and room for expansion—a brand-new, wide-awake and uncrowded industry. If you're earning a penny less than \$50 a week, clip coupon now for Free Book and proof.

Your Satisfaction Guaranteed

Master Radio Engineers will show you how to qualify, quickly and easily at home, for Radio's fine jobs. We guarantee to train you successfully. You don't risk a penny, for we will gladly return every cent paid in tuition, if upon completion of course, you aren't absolutely satisfied. Back of this guarantee stands all the resources of the National Radio Institute, U.S. Government - recognized and the oldest and largest Radio home-study school in the world.

Age or Lack of Experience No Drawback
You don't need experience before taking this course, and common schooling is enough. Our tested, practical methods make learning clear and easy—the most natural thing on earth.

Famous Course That "Pays For Itself"

Spare time earnings are easiest in Radio-receiving sets everywhere nowadays. In every neighborhood there are scores of jobs you can turn your hand to in an hour or so after supper. Right at the start of your course we give you practical money-making lessons which teach you how to do this work, then how to get it—so by our practical plan you can make your course pay its own way while you're studying.

GET ALL THE FACTS AT ONCE

Astonishing facts on the marvelous new industry of golden rewards—Radio—the fastest-moving, live-wire line. Free Book puts all the facts before you. No obligation. Send coupon for it now.

NATIONAL RADIO INSTITUTE
Dept. 115NB - - - Washington, D.C.

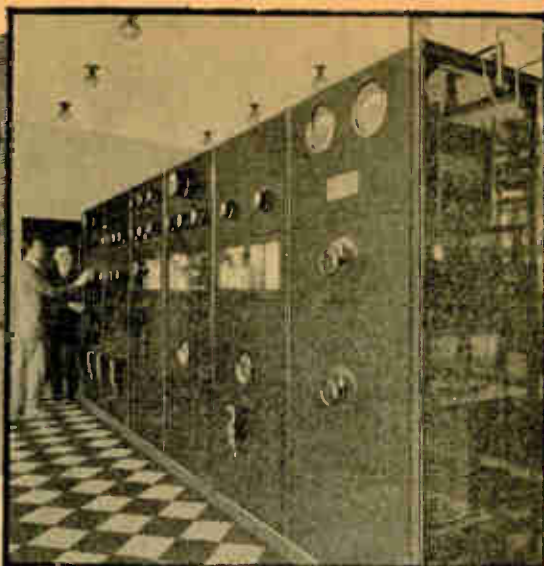

INSTRUMENTS GIVEN WITH COURSE

Receiving sets, from simplest kind to thousand-mile receiver, included without extra charge in your course. Other apparatus given to help you learn. An UNEQUALLED OFFER. Many other big features for limited time only.

GET THIS BOOK

"Rich Rewards in Radio"—most amazing book concerning Radio ever written—will be sent to you promptly when you send the coupon. ACT NOW.



Radio Needs Trained Men

You Can Do What Others Have Done
Why go alone at \$15 or \$25 or \$35 a week, when thoroughly-trained Radio Experts earn a hundred or more in the same six days? What this training has done for others, it can do for you.

N.R.I. TRAINED MEN ARE SUCCEEDING BIG



OPERATES WMAQ
"Accepted a position with Chicago Daily News—Station WMAQ. My income practically doubled, thanks to your fine course."—Keith Kimball, Chicago, Ill.



GETS BIG JOB
"Just been made Sales Manager of this Radio concern—a big raise in pay. Regret I did not take course sooner."—R. E. Jones, Bay City, Mich.

"Your course so completely covers Radio, it is worth \$40 a week more to anyone in the electrical line."—Preston Fowler, Gordon, Nebraska.



The N. R. I. Course has been worth \$2,500 a year to me, \$3,500 in another year."—Andrew Shurie, Latrobe, Pa.



"My charge for consultation now is \$2.50 per hour. The course is worth to me at least \$50,000."—R. W. Blackhill, Brooklyn, N.Y.



"Your course is worth \$2,500 a year to me—Radio a gold mine. All my success due to your splendid course."—A. R. Herke, Winnipeg, Canada.



MAIL THIS COUPON

National Radio Institute,
Dept. 115NB, Washington, D.C.

Without obligating me in any way, send your Free Book "Rich Rewards in Radio"—also full information on your practical, home-study Radio course.

Name

Address

Town..... State.....

LARGEST RADIO SCHOOL IN THE WORLD

ORIGINATORS OF RADIO HOME-STUDY TRAINING



YAXLEY Radio Products Improve Reception

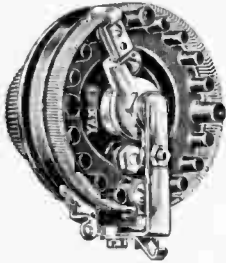

Rheostat

Operates at constant co-efficient of conductivity. The many turns, with an unusually long contact surface permits filament voltage to be built up slowly and held at just the right point to facilitate tuning and develop perfect reproduction. Quarter-inch shaft fits same size hole as jack and requires a single nut mounting. Air-Cooled Coil; Adjustable Contact Sliding Lever; Bakelite Base; Coil Exposed on All Sides; No Vernier Required.

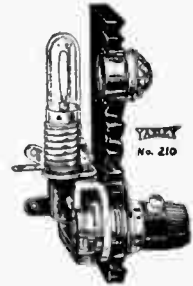

Pilot Light Switch

A combination of Pilot Light and Midget Battery Switch. Constantly indicates whether the radio set is "on" or "off." The pilot light bulb-eye is furnished in a choice of red, green or amber.

Ask your dealer, or send his name with your order to

Eastern Representative

A. C. SIMMONDS
311 King St. East
TORONTO 2

Western Representatives

STERLING SPECIALTIES
412 Duncan Bldg., VANCOUVER, B.C.
301 Travellers' Bldg., WINNIPEG

The GREBE SYNCHROPHASE

UNLIKE sets made of assembled parts, where the maker has no control over their design and quality, every detail of the Synchrophase is designed and built in the Grebe factory. They are thus able to control rigidly the design and construction of all parts so that they will co-ordinate perfectly. This makes possible the unsurpassed performance of the Synchrophase.

List Price - \$230.00



Features It Has

- 1. Binocular Coils**—to keep the set balanced against outside interference. When you have tuned in one station, even a distant one, you should not be annoyed by other stations "breaking in." With these coils, you are assured of extreme "selective sensitivity."
- 2. Low-Wave Extension Circuits**—giving a tuning range of from 550 meters down to 150 meters. The average receiver only tunes down to about 240 meters. Between 240 meters and 150 meters more than 100 existing stations are broadcasting. Besides, a majority of the new stations will be assigned to the lower wave lengths. The Synchrophase has an automatic switch which enables one dial to cover two distinct ranges. The operation is easy and without any loss of simplicity.
- 3. "Colortone"**—by which the timbre of voice, instrument or orchestra is altered to suit the individual taste, irrespective of the influence of the loud speaker. This also greatly reduces static disturbances.

- 4. Protective Fuse**—to guard B batteries against any possible injury from defective vacuum tubes.
- 5. Flexible Unit Control**—allowing the operation of one, two or three condensers from a single dial, combined or separately. This gives an added ease of operation to all local and distance reception.
- 6. S-L-F Condensers**—(Straight Line Frequency) distributing the wave bands so that all stations have equal spacing on the dials with no crowding of low-wave stations onto the lower end.
- 7. Volume Control**—giving a complete range of volume without distorting, in the slightest, the true character of all sounds. In the Synchrophase, this is accomplished without any abrupt stages of differentiation.

- 8. Dial and Pilot Light**—which serves two purposes. First, it illumines the center dial with a soft glow, sufficiently bright to read numerals and markings in dark corners. Second, it acts as a warning against leaving current on, since the light is extinguished when the vacuum tubes are turned off.

- 9. Tangent Wheel Verniers**—so "microscopic" tuning is possible. It is far easier to tune accurately with a short horizontal motion of the thumb than to use the whole hand.

All of these features are means to an end. They all contribute to the seven main requirements you have a right to demand in your set:

- (1) Selectivity; (2) Sensitivity; (3) Ease of operation; (4) Quality of tone reproduction; (5) Complete volume control; (6) Local and distance reception with equal quality and volume; (7) Handsome and dignified appearance.

If your dealer cannot supply you, write direct. We are the Ontario Representatives for the Distributors.
Wesley Electric & Radio Supply Co. WINDSOR, ONTARIO
Dealers, Write For Discounts.

The World Expected a Supreme Radio Set from **KELLOGG** *and here it is!*

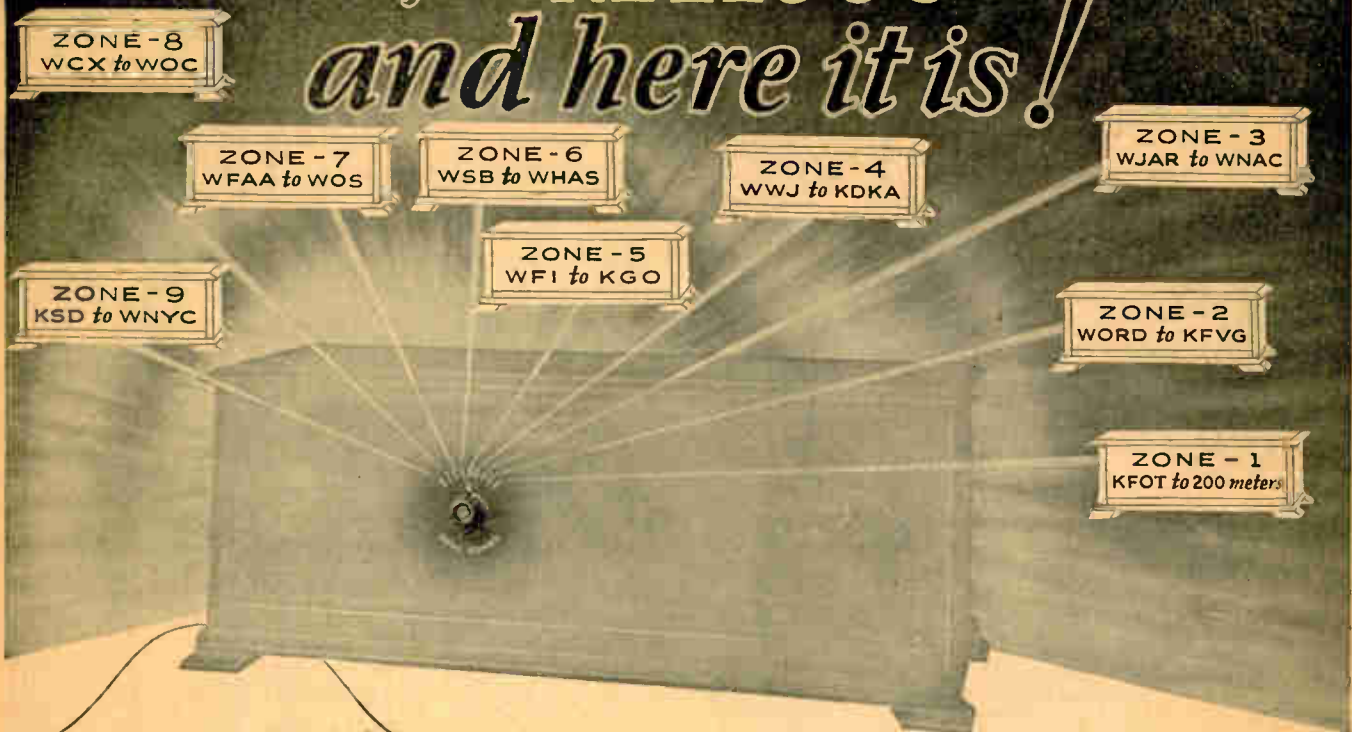

WAVE-MASTER
Standard Model



WAVE-MASTER
Brown Walnut Console
with inbuilt horn

A Separate Circuit for Each 40 Meter Wavelength Band!

Kellogg — for 28 years makers of precision telephone instruments and equipment — producers of quality parts since radio began — Kellogg has perfected a radio receiver worthy to bear the Kellogg name.

In the illustration we visualize this wonderful engineering achievement.

In the new **WAVE-MASTER** there are nine separate circuits—one for each 40 meter wavelength band. Each circuit gives that maximum efficiency heretofore found only in one short section of the dials of ordinary radio frequency sets. Each circuit brings within the range of the tuning dial a *different group of stations.*

How wonderfully simple tuning becomes! Merely set the pointer to the wave zone in which you are interested and bring in the desired station with the single Selector dial.

This remarkable tuning dial actu-

ally has a tuning range of 540 degrees—equal to $1\frac{1}{2}$ times around a complete circle — over three times the station finding range of any other set.

All other radio frequency sets have variable capacity which must be tuned, usually with three different dials, to balance with their inductance coils.

The **WAVE-MASTER'S** inductance is not fixed but variable and is easily and quickly tuned, with the one Station Selector dial, to balance the fixed capacities.

Write for full description and complete technical explanation of the Wave Master circuit. Please mention your radio dealer's name.

The J. H. Ashdown Hardware Company, Limited

MANITOBA

Exclusive Distributors in
SASKATCHEWAN

ALBERTA

STANLEY A DUVALL,
Factory Representative
308 McKinnon Building,
19 Melinda Street, Toronto, Ont.

KELLOGG
WAVE MASTER
SWITCHBOARD & SUPPLY CO.

ATWATER KENT RADIO

IS THE
MOST DESIRED OF ALL
Every survey proves it

WHEREVER people have been asked to specify the Radio they intend to buy, more of them have answered "Atwater Kent" than any other name. For example:

The Meredith Publications, owned by E. T. Meredith, former Secretary of Agriculture, asked 100,000 readers throughout the United States what make they intended to buy. Atwater Kent led.

The Capper Publications, owned by Senator Capper of Kansas, asked the townspeople and farmers in Ohio, Kansas, Iowa and Texas what make they intended to buy. Again Atwater Kent led.

Disregard, if you wish, our own national survey, although it was impartial and extended from Maine to Oklahoma—and had the same result.

Disregard, if you wish, the fact that owners of Atwater Kent Radio are so well satisfied that they hold our Re-

ceiving Sets at the highest re-sale value in the market.

Disregard, if you wish, everything except the one question so vital to dealers and prospective dealers: The people who have no Radio now, and those who expect to replace their present sets—what Radio do most of them intend to buy?

More of them, we repeat, intend to buy Atwater Kent than any other Radio. *Every survey proved it.*

Atwater Kent Radio is the most desired of all. Its reliability, simplicity, good looks and sensible price make

it the Radio which most people want to buy and most dealers want to sell.

Hear the Atwater Kent Radio Artists every Sunday evening at 9:15 o'clock (Eastern Standard Time) through stations—

- | | |
|-----------------------|---------------------|
| WEAF . New York | WCAE . Pittsburgh |
| WJAR . Providence | WGR . . . Buffalo |
| WERI . . . Boston | WOC . . Davenport |
| WCAF . Washington | WCTS . . Worcester |
| WSAI . Cincinnati | KSD . . . St. Louis |
| WCCO . Minn.-St. Paul | WWJ . Detroit |
| WFI } Philadelphia | |
| WOO } alternating | |

Write for illustrated booklet of Atwater Kent Radio

ATWATER KENT MFG COMPANY

A. Atwater Kent, President
4762 Wissahickon Avenue
Philadelphia, Pa

Model 20 Compact, including battery cable, but without tubes, \$112

Phonograph Attachment, with 9' flexible cord, \$11.25

Model L, with 9' flexible cord, \$24

Model 20, without tubes, \$112

Model 24, without tubes, \$140

Model H, with 9' flexible cord, \$31

Model 10, including battery cable, but without tubes, \$112

Model 12, built on special order, including battery cable but without tubes, \$140



Designed in early Colonial motif; handsomely veneered in two-toned walnut. Circuit is 5-tube concentrated radio frequency. Batteries are all housed within the cabinet. All wires are beneath sub-panel. Price, including built-in loud speaker, \$235.

*The
Radio
Receiver
Women
Want*



ONE of the outstanding features of the Radio World's Fair recently held in New York City was the unusual reception given the American Wireless Console Receiver. Praise came not only from consumers and dealers, but also from radio manufacturers who readily appreciated that the American Wireless Console Receiver is a Radio Receiver that Women Want.

The American Wireless Corporation had a definite purpose in mind when they de-

signed the American Wireless Console Receiver—to produce a receiver that would appeal to women as well as to men; to combine the cabinetmaker's art with the most advanced radio engineering.

Broadcast reception with the American Wireless Console Receiver always wins the approval of the most particular radio fan, and its installation never fails to lend a charm to the home that every woman notices.

Dealers—Write now for terms and details of the American Wireless Protective Sales Policy of Chartered Dealerships.

GOVERNOR RADIO SPECIALTY CO., LTD.

36 Alexander St.

Montreal

Canada

DISTRIBUTORS OF

American Wireless Console Receiver

Tell Them You Saw It In "Radio News of Canada"



Talk is cheap—especially radio talk. What you want is PROOF.

And the one certain proof is PERFORMANCE.

If you are using URECO Radio Tubes on your own set, you are already selling URECOS because you've had all the proof you need. Otherwise make this test. Tune in on any station you wish. Listen closely. Then change to URECO tubes and listen again. Note the amazing improvement in power and tone.

That's because URECOS are made to pass the severest of all tube tests in the factory.

And try the new URECO GOLDENTONE Power Tube in your last stage. It kills every last trace of distortion and increases range marvelously.

The Canadian Pearson Radio Company Limited

374 Pape Avenue

Toronto, Ont.

You'll prefer URECOS in your own set

“As Efficient as Radion Panels”

The best recommendation for these Radion low-loss parts



THE very latest developments in radio are embodied in the complete line of Radion low-loss parts—*moulded of Radion, the insulation made to order for radio purposes exclusively.*

Leading set manufacturers and thousands of amateurs know by experience that Radion Panels are most effective in reducing surface leakage and leakage noises. This means lowest losses and greater efficiency, especially noticeable in super-sensitive circuits. All the Radion low-loss parts have the same high-resistant characteristics of Radion Panels.

You can now get Radion Sockets, Dials, the new Radion Loud Speaker Horn, Tubing, Binding Post Strips, Insulators, etc. Radion Panels in black and Mahoganite come cut in standard sizes for whatever set you wish to build.

Send for booklet, “Building Your Own Set.” Gives wiring diagrams, front and rear views, shows new set with slanting panel, lists of parts and directions for building circuits. Mailed for 10 cents.

AMERICAN HARD RUBBER COMPANY
Dept. W4, 11 Mercer St., New York City

Distributors for Western Canada:
Sterling Specialties, 301 Traveler's Building, Winnipeg, Canada

NEW!

Practical types of low-loss Radion sockets for the new tubes and a collar adapter, if you like, for the old style bayonet type tube.



No. 2 Socket for new UX tubes with collar adapter for old type tubes.



No. 4 Socket for new UX tubes.

RADION

The Supreme Insulation

Made to order for radio purposes exclusively.

AMERICAN HARD RUBBER COMPANY,
Dept. W4, 11 Mercer St., New York City.

Please send me your booklet, for which I enclose 10 cents in stamps.

Name.....

Address.....

MILLIONS OF TRANSFORMERS

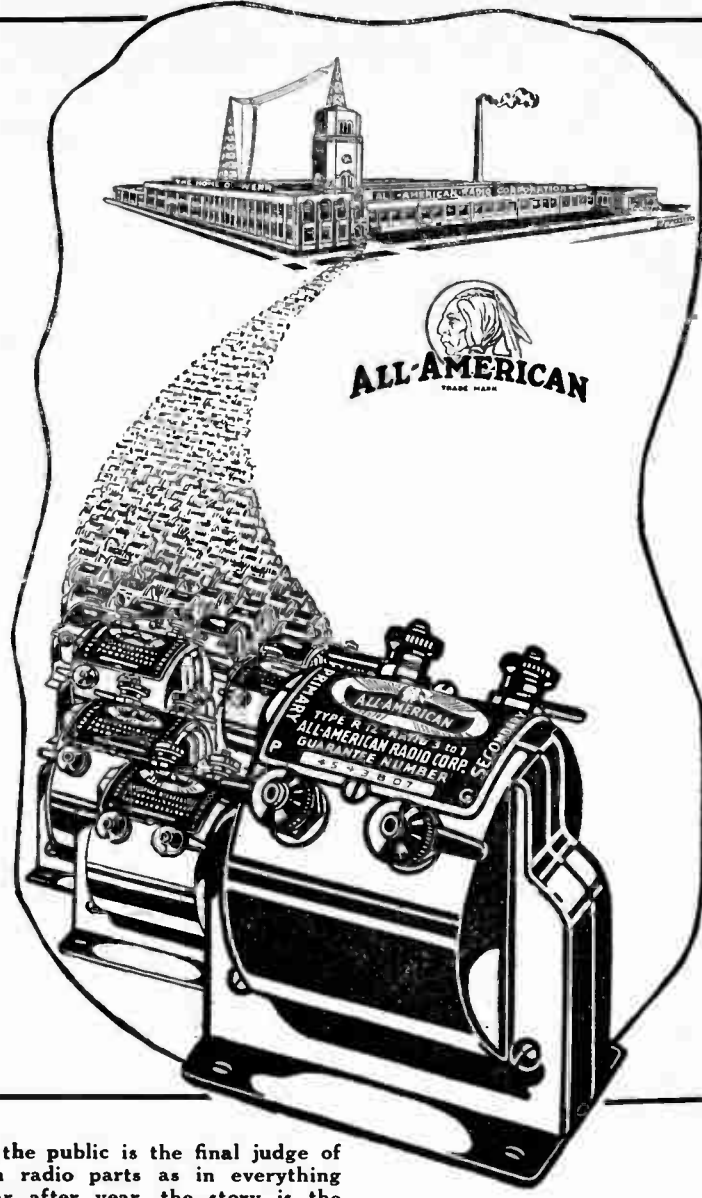

After all, the public is the final judge of quality, in radio parts as in everything else. Year after year, the story is the same—more people go into stores and buy ALL-AMERICAN Transformers than any other make. *Precision manufacture*, insuring *reliability* of operation, is the reason for this unequalled demand.

Every ALL-AMERICAN Standard Audio Transformer is individually guaranteed in writing under a serial number stamped upon the metal. Look for it and know that you are buying *satisfaction*.

Largest Selling Transformers in the World

Western Distributor
STERLING SPECIALTIES
 301 Travellers Bldg., Winnipeg
 73 Davis Chambers, Vancouver

Eastern Distributor
BURNDIPT OF CANADA LIMITED
 130 Richmond St. West, Toronto
 335 St. James St., Montreal

MEMBER **RMA** OWNING AND OPERATING STATION WENR—266 METERS

ALL-AMERICAN

Pioneers in the Radio Industry

Tell Them You Saw It In "Radio News of Canada"

JUNIOR
with Loud Speakers
SENIOR
performance



JUNIOR AR-111
 \$24.00



JUNIOR DE LUXE
 AR-114 \$27.50

JUSTLY POPULAR BECAUSE

their popularity is due not only to the fact that they are moderately priced, but that they incorporate all the patented—and therefore exclusive—features embodied in the design and construction of the Amplion standard Dragon model.

By experience and comparative tests, they have proved supreme in every respect.

The Junior AR-111 flare is metal finished in crystalline enamel to match the elbow and unit.

Handy in size; beautiful in appearance and superlative in performance, they uphold to the full the world-wide reputation of the

GUARANTEED —
 TO SATISFY

AMPLION

HEAR THEM —
 IN COMPARISON

For Better Radio Reproduction



DRAGON
 AR-19
 \$45.00

The Dragon model AR-19, which is much larger and, therefore, capable of handling more volume than the Junior models, meets the most exacting requirements. The highly finished nickel base and beautiful mahogany flare of the Dragon and Junior De Luxe make them not only one of the best Loud Speakers, but very handsome pieces of furniture suitable for the finest homes.

There are also phonograph attachments at \$17.50 and \$25.00, thus making the Amplion line complete.

DEALERS—Ask your jobber for literature or write direct to us.

Sole Canadian Distributors

BURNDEPT OF CANADA LIMITED

335 St. James Street
 MONTREAL

HEAD OFFICE: 130 RICHMOND WEST
 TORONTO

216 Bannatyne Avenue
 WINNIPEG



Radio News

Eastern United States Representatives:

DAVIDSON & HEVEY,
17 West 42nd Street, New York City
Phone Longacre 1698

Western Representatives:

MACINTYRE & SIMPSON,
14 W. Washington St., Chicago, Ill.

OF CANADA

W. J. HEVEY,
Business Manager

H. LEWIS, Editor

S. F. PEARSON, Advertising

Radio Press of Canada, Limited, Publishers, 257-261 Adelaide Street West, Toronto, Canada

Applicant for Membership in Audit Bureau of Circulations

"The Radio News of Canada" is not responsible for any statements made, other than those which appear on its editorial page.

WE LEAD, OTHERS FOLLOW

VOL. 4

TORONTO, NOVEMBER, 1925

No. 5

TORONTO RADIO SHOW

The third annual Radio Show opened at the King Edward Hotel, Toronto, on Monday, November 2nd, and continued throughout the week. It was well attended and the exhibits proved to be very interesting and worth looking at, showing as they did the very rapid strides made in radio during the past year.

Practically every important manufacturer of radio sets has an exhibit, as well as many prominent jobbers and distributors.

Hon. W. H. Price, Provincial Treasurer, formally opened the show on Monday evening. He was introduced by Mr. R. H. Combs, president of the Canadian Radio Trades Association. "Radio," Hon. Mr. Price said, "had long since passed the experimental stage and had ceased to be a wonder and novelty. It was now a very necessary adjunct to the social life of the people. The Ontario Government had early realized its possibilities and were probably the first Government in the world to make use of radio for publicity purposes. Last Summer, they had broadcast to the people of the United States the advantages of Ontario as a tourist centre and Summer resort, and the results had been highly satisfactory."

Hon. Mr. Price also made an appeal for the fund that is being raised to supply radio sets to the hospitals where war veterans are confined, still undergoing treatment for their wounds and disabilities. He was sorry that only \$3,000 had so far been received. It was expected that \$10,000 would have been received by the time Armistice Day had arrived. However, there was still hope that the money would be forthcoming. The Ontario Government's contribution to the show was one of the features. It is an educational moving picture film of seven reels explaining the operations of radio and was shown every afternoon from 3 to 3.30 o'clock. The American Relay League

had an historical radio exhibit which was very interesting. In the Pickwick Room of the hotel, a studio was fixed up and an entire concert program, with a sixteen-piece orchestra, was broadcast by Stations CKNC and CHIC. This is the first time these two stations have ever broadcasted outside of their own studios.

On Thursday, it was announced that wireless connection with London, England, had been established during the afternoon by the Ontario Wireless Association. This body, composed of Toronto amateur radio enthusiasts, is in affiliation with the American Radio Relay League, and has a transmission station at the show.

THE HAMFEST AT THE ISLAND

The amateurs at the recent hamfest of Central Ontario brasspounders, held at Toronto Island, were the guests of Mr. W. Y. Sloan, 9BJ, at that time the A.D.M. for Central Ontario, and now the Ontario Divisional Traffic Manager. Mr. Sloan has, rather unfortunately, been in ill health for a number of years, and has consoled himself in his fervent application of radio telegraphy. He has been in the game about ten years, has grown with it, graduating from spark to CW, from a five-watt set to a fifty, and this winter he has a 250-watt tube running smoothly and reaching out to every corner of the globe. This was the third hamfest Mr. Sloan had staged, and he hopes to be able to see the fellows back again for another next summer.

CORRECTION RE KELLOGG SWITCHBOARD & SUPPLY COMPANY

We wish to draw our readers' attention to the Kellogg advertisement on page 8 of this issue.

Our reason for doing this is because in our last issue the prices quoted are incorrect. We wish to express our regret for any inconvenience caused, and can assure our readers that the Kellogg Company will be only too pleased to send any information desired regarding their products.

AMPLIONS BROADCAST ELECTION SPEECHES

On the evening of October 26th, loud speakers were used with great success for broadcasting the Conservative meeting at Massey Hall, Toronto, at which the Right Hon. Arthur Meighen was the main speaker.

Vast crowds were turned away once the hall was filled, and, despite the heavy rain, these gathered to listen to the speech as being broadcast through the large loud speakers which were placed on the roof over the sidewalk in front of Massey Hall. Later the greater part of this crowd was accommodated in overflow meetings in nearby halls, but throughout the whole meeting, there was always a great number following every word of the speakers as rendered to them by the loud speakers.

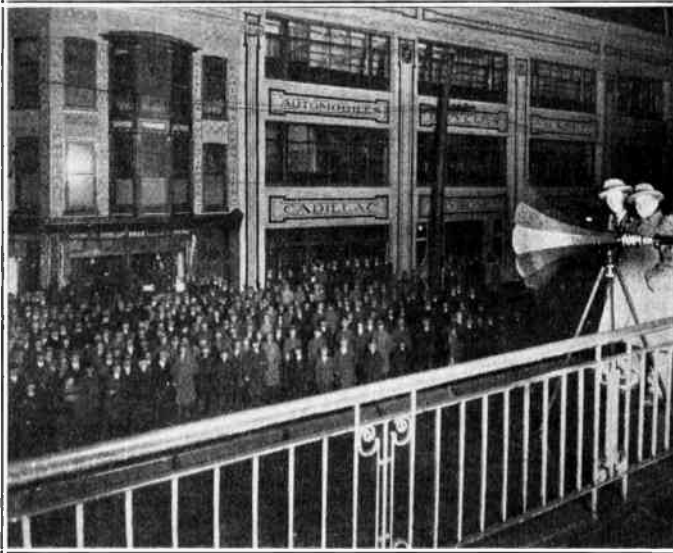

Reception in this case was made by radio from CFCA by one of H. M. Kipp's Mercury Super-Tens, with special resistance-coupled amplifier. The photograph shows one of the large speakers, an Amplion, in action. Every word came through with perfect clarity, and a member of the Committee was heard to remark that he thought it was clearer to the crowd in the streets than it was actually in the hall itself.

DO NOT BE ALARMED!

Information has reached us which would indicate that a certain law firm has been circularizing the radio industry in a manner which we can only interpret as tending to alarm the trade and curtail their activities in featuring the sale of Fada radio receivers.

Not only throughout the Dominion of Canada, but throughout the United States, England and other foreign countries as well, there are such a large number of seemingly conflicting patents pertaining to the radio industry that many, if not all, of the leading concerns are burdened with law suits, some of which are, no doubt, promoted by a conscientious belief that patents are being infringed, others perhaps involving ulterior motives.

We urge that you continue to sell Fada radio receivers, which are based on designs which have been the subject of careful research by our own engineers and patent attorneys, and which from best advice available, both in the Dominion of

Canada and the United States, are basic in design and are free from infringement on the alleged patents which have been the subject of recent circularization.

It has been the policy of F. A. D. Andrea, Inc., of New York City, who own the controlling interest in Fada Radio, Ltd., of Toronto, to retain the best legal talent for the protection of its interests and those of its distributors, dealers and customers.

Not only the full assets of both firms involved form adequate backing for this defence, but as members of the Independent Radio Manufacturers, Inc., an organization of fourteen licensed Neutrodyne manufacturers, the funds of that organization, together with the combined assets of these fourteen companies, aggregating well into millions of dollars, establish a strategic basis for defense which will unquestionably sustain the position of F. A. D. Andrea, Inc., and of Fada Radio, Ltd., as leading factors in the radio industry and free from patent infringement, and thus hold the trade fully immune from loss.

"BH" VIVAPHONIC AUDIO AMPLIFYING TRANSFORMER

The "BH" Vivaphonic (life-like sound) as its name implies, amplifies with uniform volume across the whole musical scale.

The above curve, which was made at McGill University Electrical Measurements Laboratory, proves that the amplifying power reaches its full value at the lowest frequencies and maintains its maximum height right across the chart, indicating uniform amplification of all sounds, harmonies and overtones.

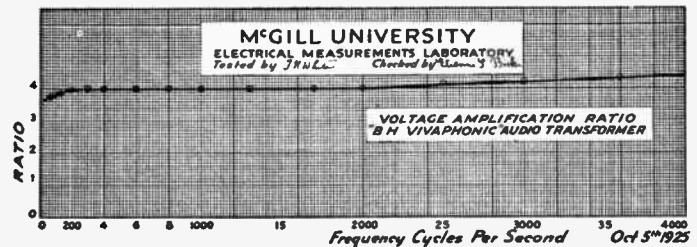

Model AA2

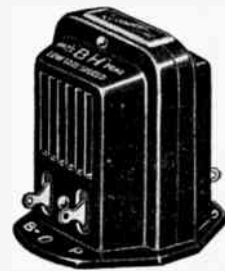

The curves of ordinary transformers start very low on the scale and do not achieve their highest point under 1,000 frequency. They form a "Hump" and drop very rapidly down again, indicating non-uniformity and accordingly distorted amplification, resulting in unnatural voice sound and musical reception. Transformers like this make beautiful, full toned piano music sound like the thin, stringy tones of a banjo.

The "BH" Vivaphonic amplifies all frequencies equally—low tones—middle tones—high tones—and the many harmonics and overtones of all audible sounds, thus giving pure, natural undistorted musical reception, making it delightfully pleasing to listen to.

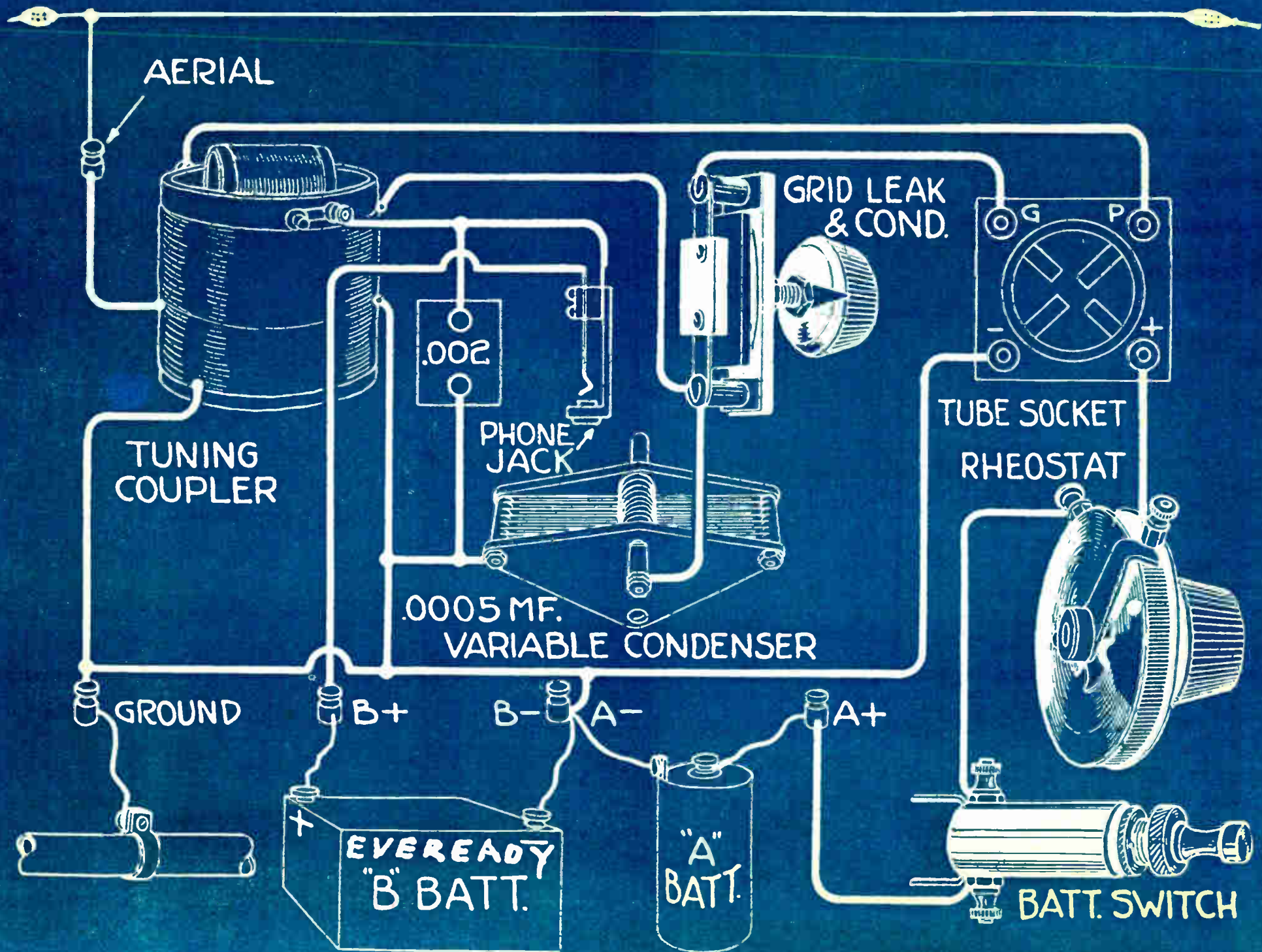

A GOOD SET FOR THE BEGINNER TO BUILD

By Carlton E. Butler

(Member, American Institute of Electrical Engineers, and Institute of Radio Engineers)

See Blue Print on reverse side

Superhetrodynes and tuned radio-frequency receivers are the eventual goal of most set builders in radio. For the beginner, the usual start should be with a one-tube set, amplification coming later. One of the encouraging things about radio for the novice is that the ultimate set may be built on the instalment plan, yet give entertainment from the moment that the initial unit with a single tube is assembled.

In the realm of one-tube sets, the foundation for the big set later on, there are many freak or trick circuits, each having a following of boosters. The little points of difference between the majority of these circuits usually rests in the manner in which regeneration is secured. The best circuits use regeneration, without which it is next to impossible to tune through interference, or bring in distant stations.

The ultra-audion circuits, known under a variety of names and very popular a few years ago, secure regeneration by the direct method, but as this is used with single-circuit receivers as a rule, it is not selective enough for present-day needs. The variometer in the plate circuit method is good, but requires additional space, and the purchase of additional apparatus. The capacity feed-

back method is good, but also requires an additional instrument.

The tickler method of regeneration is very popular and can be secured by the use of small rotating coil inside of the tuning inductance. The three-circuit tuners, of which there are a number of popular makes on the market, use this form of securing a regenerative feedback. This type of receiver is by far the easiest and cheapest to build, when selectivity and DX reception are taken into consideration.

The three-circuit couplers make use of an aperiodic or untuned primary. The secondary winding is without taps, being tuned by a variable condenser. The rotor, or tickler winding, is connected in the plate circuit of the detector tube. Two controls tuned the circuit, making it convenient for the beginner to obtain results.

To construct a set of this kind, the following apparatus will be needed:

One three-circuit tuner of any good make.

One 23-plate, .005-mfd. variable condenser of good low loss construction.

One centralab rheostat (6 ohm for the WD-11, WD-12, UV-200 and C-300 type of tubes; 30 ohm for the UV-201-A and C-301-A, UV-199 and C-299 types.

One fixed mica condenser of .00025-mfd. capacity.

One centralab variable grid leak.

One centralab filament cut-off switch.

One detector tube (WD-11 or WD-12, shown in the diagram).

One 22½-volt "B" battery. A battery for the tube to be used (1½ volt for WD-11 or WD-12).

Wire, binding posts, headphones, etc.

The receiver will take up but little room and can easily be assembled on a baseboard 6 x 12 x ¾ ins. After the set is working satisfactorily, it may be assembled on a bakelite or hard rubber panel and inserted in a cabinet. As it is usually desirable to add further amplification, it is best to purchase a cabinet and panel that will accommodate additional apparatus needed.

The value of the grid leak required depends on the individual tube used for a detector. This value can be secured best through the use of a variable grid leak, which will also be of considerable assistance in tuning.

Remarkable long distance records have been made with receivers using this circuit, and it can conservatively be called the best one-tube receiver for the beginner to try.

Please read the Government Circular on pages 28 and 29 of this issue. It will help you and the other fellows, if you follow the advice given. None of us want to annoy our neighbors, so let's all be good fellows, and help Commander Edwards in the work he is attempting to do.—Editor.

COMBINED WIRELESS AND SUBMARINE SIGNALLING IN SHIP NAVIGATION

The Fessenden Oscillator Helps the
Navigator Locate the Position of His
Vessel in a Fog

By *A. Dinsdale*

Member of the Radio Society of Great Britain.

Throughout the history of navigation, men have endeavored by every means in their power to counteract the dangers of navigating near coasts by installing warning devices at or near the most dangerous points. Thus, we have lighthouses and lightships all round our coasts.

In foggy weather, however, a light cannot be seen, so for centuries it has been the custom during the prevalence of such weather to sound some form of fog horn. Now, it has been found that sound waves travelling through air are subject to all sorts of freakish variations, and have proven thoroughly unreliable, particularly when it comes to estimating in fog the true direction from which the sound comes.

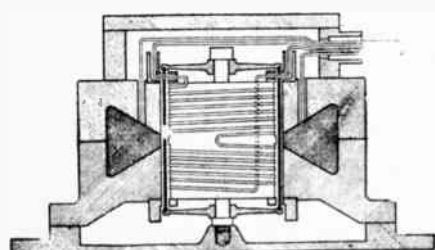

Cross Section Diagram of the Fessenden Oscillator

Faced with such a situation, inventors, long before wireless was thought of, devised, or attempted to devise, some method of projecting sound waves through the water. Not only is water a more stable and reliable medium for the transmission of sound waves, but it transmits sound many times faster than does air.

Submarine signalling, as the projection of sound waves through water is called, has continued to be developed till at the present time it is fairly highly perfected. By means of it ships in the vicinity of lightships may listen for the submarine signals sent out by it and roughly determine their position. This is done by fitting one sound receiver, or pick-up device, on each bow of the ship, and by comparing the relative strength of signals received from each side, some idea of the bearing of the light-vessel can be obtained.

This method is only very approximate, however, and can only be used at a range of a few miles. Some idea of distance can also be obtained, but only by rough estimate.

The Radio Compass

Such was the position when the wireless direction finder, or radio compass, was invented. This instrument is undoubtedly one of the greatest aids to navigation that has ever been invented since the discovery of the magnetic compass. By its use, it is possible to determine accurately, and without any other means, the position of a ship in the densest fog, and that at ranges of 100 miles or more.

This is done by taking bearings of two or more coastal stations whose positions are known. Lines representing these bearings are then drawn on the chart, through the positions of the coastal stations made use of, and where these lines intersect is the position of the ship concerned.

This is only one of the uses to which the radio compass may be utilized. When in mid-ocean, in fog or other bad weather conditions which might give rise to a collision, a ship can locate other vessels which, owing to the strength of their wireless signals, are suspected of being too close.

Similarly, in the case of a ship in distress which has sent out the wrong position, it is a simple matter to swing the radio compass on her, and steer straight up to her, thus saving much valuable time which, prior to the invention of the direction finder, was wasted in searching for the distressed vessel in the vicinity of the position given.

Ships heading for seaports frequently have to make turns round headlands or shoals in the vicinity of the coast, and it is at such points that lightships are usually placed. Besides being fitted with submarine signalling apparatus, such vessels are now being equipped with low-power wireless transmitters, and when a fog comes up, these transmitters are caused to transmit continuously and automatically some characteristic signal, or group of signals, so that ships fitted

with radio compasses can take bearings at any time, and find out if they are steering the proper course.

Submarine and Wireless Signalling

Like submarine signalling apparatus, the radio compass has the disadvantage of not being able to tell exactly the

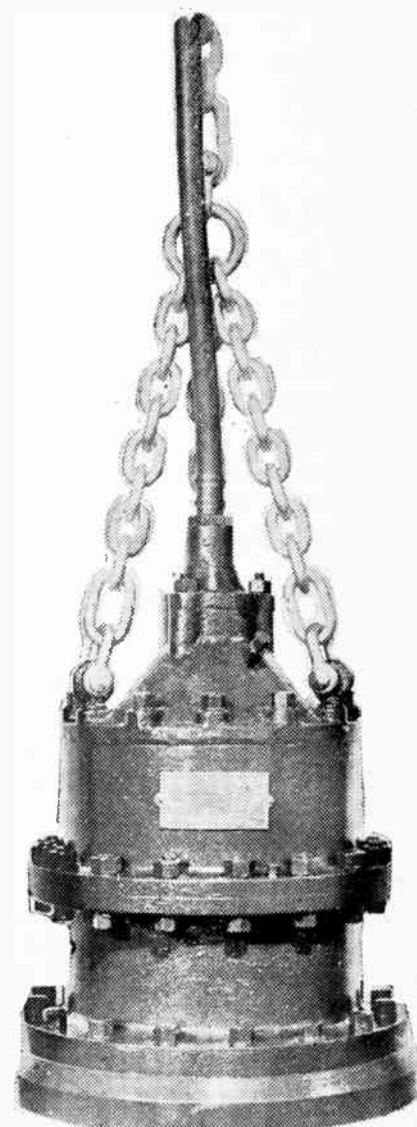

A Lightvessel Oscillator

distance between the ship using it and the wireless transmitter of which bearings are being taken. A skilled operator can, however, form a very fair idea

of the distance, provided he is familiar with the particular transmitter under observation.

An approximate idea is better than none at all, but wireless engineers have been engaged for some time in trying to find some way of measuring distance **exactly**, and no doubt this problem will be solved some day. Meanwhile, in an effort to still further assist mariners, a plan has been evolved whereby wireless and submarine sound signals are used simultaneously and in conjunction with each other for the purpose of measuring distance.

Readers are well aware that wireless, or radio, signals travel with the speed of light, which, for all practical purposes, is instantaneously. Sound signals in sea water, on the other hand, take 1.3 second to travel one mile, so that, as a mariner can hear the arrival at his ship of the submarine signal, all that is necessary is to provide some means of informing him precisely when it left the lightship. By dividing the time interval (in seconds) between the transmission and reception of the signal by 1.3 the distance in miles may be determined.

Wireless signalling is the method employed to inform the mariner of the time of departure of the submarine signal, the method being known as synchronous signalling. Simply defined, synchronous signalling is the simultaneous transmission of the same signal through two or more different conducting media, the media in this case being the ether and the sea.

Method of Operation

The method employed for determining both the bearing and distance from a lightship is for the latter to transmit, first, a series of pre-arranged signals, which serve not only to identify the transmitter, but also for simultaneous bearing observations to be taken by both the navigator and the wireless operator.

The navigator's bearings are, of course, only approximate, and, with a radio compass on board, serve little useful purpose. When the operator has completed his observations, he informs the navigating bridge to that effect, and both navigator and operator listen together on their respective instruments for the succeeding signals, which take the form of a series of about twenty dots, sent at intervals of 1.3 seconds.

The operator naturally begins to hear the series first, and he counts the number of dots he hears. Immediately the navigator hears the first dot of the series, he signals the operator, who then informs the navigator how many dots he heard before receiving the signal from the bridge. This number of dots represents, in miles, the vessel's distance from the lightship.

Thus the bearing of the lightship and the distance from it are both known and the exact position of the incoming steamer may be plotted on the chart. Subsequent observations can be made at frequent intervals and the ship's course checked to see if it is being affected by tide or ocean currents.

The importance of such observations will be readily appreciated when it is realized that steamers generally have to alter course after passing a lightship,

Lightvessel, anchored off the entrance to the river of that name, in Holland.

On the American side of the Atlantic, there is only one lightship fitted so far, and that is the Nantucket Lightvessel. As Nantucket is the first fixed point to be made for by trans-Atlantic shipping, its special importance will be readily understood.

Readers are more or less familiar with radio transmitters in general, but it may be of interest to outline briefly the

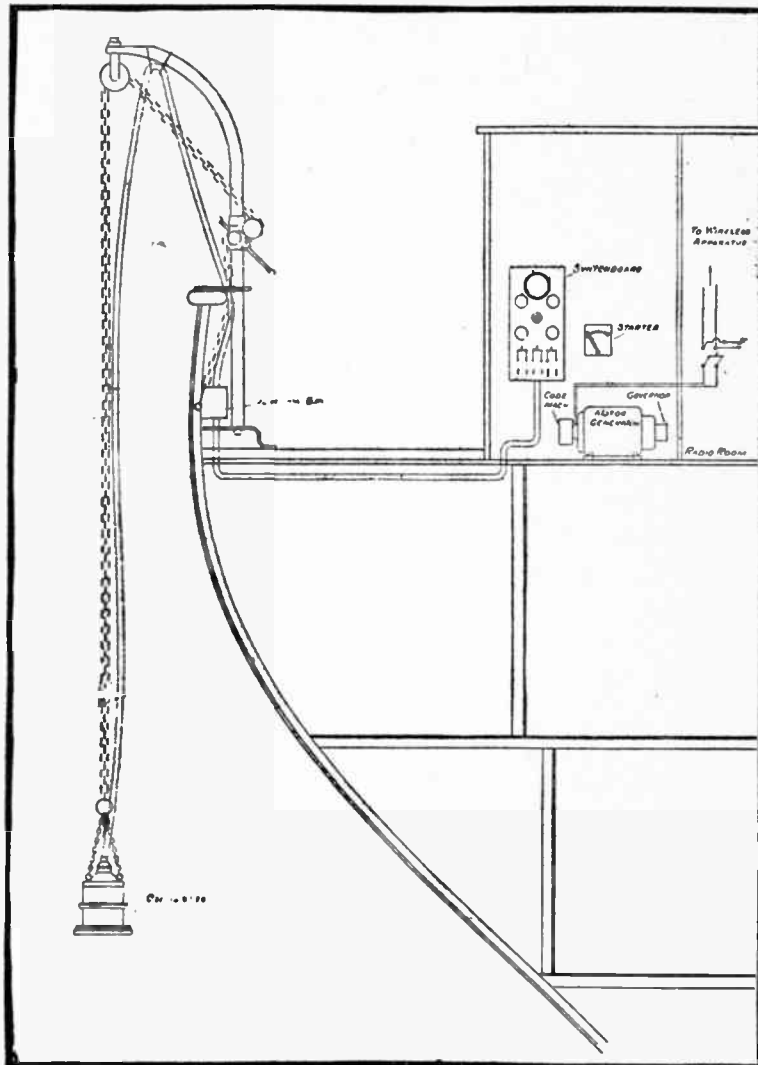

A Complete Lay-out of Apparatus Showing the Controlling Units

and in clear weather the necessary observations are made visually. Those readers who have ever driven an automobile in a thick fog and missed that vital turning off the main highway will understand the position thoroughly.

Progress of the System

These latest developments in combined wireless and submarine signalling have been adopted mostly in Europe, where the following four lightships have been equipped: The Gydsler Rev. Lightvessel, off the Baltic coast; the Graa Dyb Lightvessel, off the North Sea coast of Denmark; the Borkum Riff Lightvessel, off the entrance to the River Ems, Germany, and the Maas

history of submarine signalling, and the state of its development to-day, particularly as it owes a great deal of its present success to the genius of an American inventor, Professor R. A. Fessenden.

The first experiments in submarine signalling were made nearly 100 years ago by Colladon and Sturmi. These gentlemen succeeded in hearing the striking of a submerged bell across Lake Geneva, but, until comparatively recently, little advance was made over this method of communication.

One of the greatest difficulties in the way of long-range submarine signalling lies in the fact that water is practically incompressible, but in order to propagate

sound waves through any medium, it is necessary to set up compressional waves or strains. To do this in water requires a vast amount of power, which was not available in convenient form till electricity became available in practical form, and modern developments in its application enabled Fessenden to solve the problem successfully.

The principle followed by all inventors who have tackled the problem electrically is to arrange for some form of submerged diaphragm to be vibrated by the intermittent magnetic field of a powerful electromagnet fed with alternating current of chosen frequency.

Devices operating along these lines are known as oscillators, and the general form taken by the Fessenden oscillator is shown in the figure. A powerful ring-shaped electro-magnet is mounted around a central core, and in the annular space between the magnet and the core is located the moving part, or diaphragm, which in this case is a copper tube. Owing to the particular design and arrangement of these parts, the tube acts as a closed secondary to the core winding.

The ring magnet, when energized, produces an intense magnetic flux, amounting to over 15,000 lines of force per square centimeter. The magnetic circuit is from one pole to the ring magnet across the air gap (which contains the upper part of the copper tube diaphragm), through the central fixed armature, across the other air gap to the lower pole face of the ring magnet, and back to the upper pole face through the yoke of the magnet.

In operation, direct current is continuously applied to the winding of the ring magnet from a 4-kw. dynamo, and signalling is accomplished by switching on to the winding of the central stationary armature a powerful alternating current having a frequency of about 500 cycles.

This alternating current induces a similar current in the copper tube, which, being free to move, vibrates in the field set up by the ring magnet. This vibration transmits a rapid in-and-out motion to a metallic diaphragm which is attached to the tube. This latter diaphragm is made of steel, five-eighths of an inch thick, and forms the base of the oscillator.

The whole apparatus is lowered in the water to a depth of 25 or 30 feet on the end of a chain, and with it goes an armored cable which carries the current supply.

Considerations of Operation

The complete apparatus weighs about 100 lbs., which is comparatively light when the power applied to it, which is necessary to overcome inertia of parts and, particularly, the strain of transmit-

ting compressional strains to the water is taken into consideration. To construct heavy apparatus of this type so that it will respond to alternating currents having a frequency of 500 cycles is no simple task.

A frequency so high as this is necessary in order that the signal as received by listening ships may have a distinctive high note, which can be easily identified through interference from extraneous noises, and particularly the wash of water against a ship's side. Observations of submarine signals are always taken with the ship going full speed, unless she is slowed down for some reason or other, and the noise made by water passing over the receiving diaphragms is surprisingly loud.

These receiving diaphragms consist of circular plates fitted one on either bow, well below the water line, and connected up, through a sensitive detecting device, to the navigating bridge. The navigator listens for the signals with a pair of telephone receivers, one being connected up to the diaphragm on the port bow, and the other to that on the starboard bow.

If the ship is heading direct for the source of the signals, they will be equally strong in each phone, but if she is inclined at an angle to the source, the signals will be received louder in that phone which is connected to the receiving diaphragm nearest to it.

The detecting apparatus is very similar to the oscillator, only it is built on a lighter scale. The sound waves striking the pick-up diaphragm cause it to vibrate, and these vibrations are transmitted to the copper tube. The vibrations of the latter within the magnetic field set up currents in the central core winding which may be heard in a pair of telephones. Considering the heavy nature of the parts, it is indeed surprising that they will respond to such minute sound vibrations.

Besides being of value for warning ships of their approach to dangerous spots and its value in conjunction with wireless for measuring distance, submarine signalling has other valuable uses.

For the two purposes mentioned above, pre-arranged signals are sent out at regular intervals of a few minutes, automatically, but the apparatus can also be used for intercommunication between ships by means of the Morse code, the operating key being placed for this purpose in the A. C. circuit.

The ordinary average range of the Fessenden oscillator, with a ship going full speed, is between twenty and thirty miles or more if the ship is stopped, thus silencing interfering noises from the wash of the waves, the throb of the propellers and the beat of the engines.

Another use to which the submarine oscillator is put by the United States Navy ice patrol ships is that of locating icebergs which drift down annually on to the Atlantic steamer lanes. For this purpose oscillator impulses are sent out and immediately listened for. If such impulses should strike an iceberg, the sound waves will be reflected back to the transmitting source again, and the listener, by timing the interval between the emitted signal and its return to the origin, may calculate the distance between himself and the iceberg.

In addition to its adaptability to telegraph communication, the submarine oscillator can also be used, at very short ranges, for telephonic communication. The method is not nearly so perfect or satisfactory as the radiophone, of course, but intelligible speech can be transmitted and received.

In conclusion, it is interesting to note that, although the practical range of submarine oscillators is not very great, the French Hydrographic Service, in the course of experiments, proved that the explosion of a depth charge weighing one kilogram can be heard under water at a distance of over 200 miles.

Thus it may not be long before ships, by combining submarine signalling with radio compass bearings, will be able to determine their position when still more than half a day's run from land.

AMERICAN VIEWS ON BRITISH WIRELESS INDUSTRY

An encouraging report from the point of view of the British wireless manufacturer has been issued by the American Government trade experts. This report, addressed to the American radio industry, declares that the development of the wireless industry in Great Britain has reached such a high state of efficiency that American manufacturers cannot hope to compete in the British market.

Next to the United States and Canada, the report adds, Great Britain has the most highly developed wireless market in the world.

HIGH POWER FOR MILAN

A further field for long-distance listeners will soon be available when the new broadcasting station at Milan is opened. This station is being erected by Marconi's Wireless Telegraph Co., Ltd., and is of the same type and power as the new 2LO station. The power used is 12 kw. Details of the call sign and wavelength are not yet available.

ANTICAP WRITES AGAIN

Our old-time correspondent, Anticap, has come to the surface after a long immersion in oblivion. What he wants, we don't know with certainty, but, apparently, he has come up for AIR. We print his communication in its original spelling.—Ed.

Winnipeg, Man.

Dear Mister Editor,

The subjick of my letter this time is hogging the air, which my meaning is that some broadcasting stations get on the air, stay on the air and refuse to be shook off the air, even when some fans in the same town gets up in the air and shoots a lot of hot air to the newspapers about it. My Pa came back the other day from a trip all over the American continent and Montreal island, and he ses wherever he went the fans was calling there local stations a lot of bad names on act. of them making it hard to here the long distants ones. For in-stants, take the case of two cities which

shall be incog. I will call them X and Y, like the two comick fellers in the Algebrer books which cant never be found. At least there whereabouts always remained a mistery to me. In the X city they was broadcasting a dog fight which the fans in the Y city was busting to here. At the same time they was broadcasting the soop course at a banquit in Y and the folks in X wanted here it in the worst way because it was about the only sound left which hadn't been put on the air. You can imagin how mad the fans in X was when the banquit was ruined by the locul dog fight and how wild they was in Y on act. of the dogs being entirely drowned by the soop stunt. Pa was in both places within a few days of each other and he ses the people at X was threatening to have there local station closed down and ditto at Y. Pa ses the only cure for this kind of thing is to have all local stations abolished by act of

parlement, or else fans must get sets which is capable of percolating through the home product and which won't take no notice of low-down harmonicks and such like. Pa's idear may be all right, but if they elemonade the local stations, how is the five and ten cent stores going to keep in the radio business, and what's a lot of fans going to do when they ain't nothing left to kick about? Well, to change the subjick. The other night I was listening to a dozen stations pumping out news about a earthquake. When they stopped talking and let loose the jazz again, I didn't blame poor old Ma earth for trying to shake them off. I'd do the same thing if I was revolving in space with six hundred buzzing at once. If I was the earth, I'd have a til like a comet and swing it back and swat some of them. That's swat I'd do!

Yours truly,

ANTICAP.



C. E. Bodley's Dance Orchestra, Well Known to the Friends of Station CKNC, Toronto

The Wireless Association of Ontario has again commenced its meetings. At the first meeting of the season, c-3VH gave a talk on crystal-controlled transmitters and the plans were laid for a Canadian convention. The following meeting will take the place of a bowling meet.

Talking about luck. g-2NM and NRRL held two-way phone conversations every morning on 40-meters, while NRRL was stationed at Sidney, Australia. Certainly does sound nice, eh? Perhaps some day you and I will be as lucky. Perhaps.

The news of the Chicago convention was sent by radio to Toronto through the services of u-9APY and c-3CK. Although the results were not as successful as expected, nevertheless the news came through in time to get in last month's number. Static seemed to be worse than ever during the convention.

HOW ELECTRICAL TERMS USED IN RADIO RECEIVED THEIR NAMES

Units of Standard Value Called After
Prominent Experimenters; Joseph
Henry Responsible for Founda-
tion of Present-day Radio

By Sidney Elbert

Ask any radio fan if he ever heard of the words "volt," "ampere," "ohm," "farad" and "henry," and he will immediately respond with "Sure; what radio bug who reads a radio publication hasn't?" Ask him if he ever heard of gentlemen by the names of Alessandra Volta, Andre Ampere, George Ohm, Michael Faraday and Joseph Henry, and he will look you blankly in the face and shake his head in negation. If given a moment or two to compare the words and the names, he will forthwith appreciate that there is some connection between the two apparently irrelevant questions.

The history behind the derivations of these five units of electrical measurement, so commonly employed in radio practice of all kinds, is but infrequently recounted, yet it invariably proves interesting to the radio enthusiast because he probably has been frequently puzzled by them. It incidentally brings to light some little known facts about the very earliest scientific knowledge of wireless communication and of certain phases of other epoch-making accomplishments.

Encyclopediac research yields the fact that the "volt," the unit of electrical pressure, was designated in honor of a famous Italian physicist named Count Alessandra Volta, who was born in 1745 and died in 1827. The Count, who received his title from the illustrious Napoleon Bonaparte because of his discoveries, was one of the earliest experimenters with electricity as the inventor of the electric cell. This device, first called a "voltaic battery," he announced to the Royal Society of England early in the year 1800, and following shortly thereafter a learned member of that erudite organization voiced the conviction that the "voltaic battery was an alarm bell to experimenters in every part of Europe." It was more than that: it supplied the electricity for many of the startling inventions that changed the entire life of the civilized world. Volta's original battery in its fundamental aspect has survived through a century and a quarter of time, and even now high school sophomores immerse plates of zinc and copper in beakers of sulphuric

acid as their first physics experiment in the generation of electricity.

Volta's Experiments

As an interesting sidelight, it might be mentioned that Volta was the first man to burn gases in a closed chamber by means of an electric spark. This he succeeded in doing just at the very time a handful of British colonists in a far-off land known as America were signing a brazen document called the Declaration of Independence; he little realized that he was giving unborn automobile engineers a dependable ignition system for self-propelling vehicles that would not appear for 125 years.

A contemporary of Volta was Andre Marie Ampere, a distinguished French scholar and physicist, for whom the "ampere," or unit of electric flow, is named. Radio is indebted to Ampere for his observations on the relation of magnetism and electricity, and science in general for his theories on terrestrial electricity. He was the inventor of a device on which the construction of practically all modern electrical meters is founded.

"Ohm's law," familiar to every man who passed through high school, is named for Georg Simon Ohm, a German scientist who followed slightly after Volta and Ampere. He evolved the law while experimenting with various metals to determine the ease with which they carried electricity, and it now serves as the basis for all electrical theory and measurement.

In the German's memory, the "ohm" was adopted in 1881 as the unit of the resistance of electricity-conducting materials. The unit "mho" (pronounced "moe"), so frequently seen in connection with vacuum tube ratings, is simply "ohm" spelled backward, and mathematically is the reciprocal of the ohm. The latter term is in everyday use as a designation for rheostats, potentiometers and grid leaks; for the last named, the "megohm," or million-ohms, is more convenient for the rather high values encountered.

Life of Faraday

The "farad," and its hybrid, the "microfarad," or "mfd.," is a shortening

of the name of Michael Faraday, probably the most brilliant scientific experimenter of all time. The son of a humble London blacksmith, Faraday started his career as an assistant in the great laboratory of the world-renowned Royal Society, and displayed such genius that he finally rose to the exalted position of director. His achievements in the field of chemistry alone were prodigious, but he is best known for his discovery that a magnet moving inside a coil of wire produces a current of electricity in that coil and for his measurement of the effects of electricity on non-conducting mediums; in other words, the measurement of condensers. The period of his work was about 1831. Faraday also is responsible for the electric arc and for a substance which is the base of aniline dyes.

The most interesting story is that of Joseph Henry, for whom the "henry," the unit of coil size, is named. Henry, an unpretentious native of Albany, ranks with Faraday as a founder of this age of electricity, yet he is comparatively unknown. He certainly did more to develop the science than any other American, Franklin and Edison not excluded.

It was Henry who developed the electro-magnet, improving greatly on the fundamental idea of an earlier Englishman. He wound bars of iron with copper wire insulated with strips of silk his wife tore from her wedding gown, and he obtained magnets stronger than any ever dreamed of. In 1831, he sent a current of electricity through a mile of wire and caused an electro-magnet to actuate a signal bell, thereby creating the first telegraph. Morse is generally regarded as the inventor of the great boon to humanity, but it was Henry who really was responsible for it. Morse had an idea, but he made no headway on it until he read of the inventions of Henry and applied the latter's electro-magnets. Henry, furthermore, was the inventor of the telegraph relay, without which long-distance telegraphy would not have been possible.

Henry Responsible for Motor

Henry's greatest contribution was his discovery of a system of producing elec-

tricity with the aid of magnetism, in this labor antedating the famous Faraday by several years. All the generators and transformers employed in electrical and radio practice operate on the principles he set forth. Henry also is authoritatively credited with the first electric motor, in which his brave wife's nuptial finery again figured.

The biggest surprise revealed by an investigation of this great American's fertile life is the fact that it was he, in 1842, who discovered that the electrical discharge of a Leyden jar (a large fixed condenser) was oscillatory, and also that it could induce similar discharges in circuits a considerable distance away; this, in a word, is the basic, underlying principle of wireless telegraphy. Henry did not seem to realize the tremendous importance of his disclosure, but at any event he anticipated a similar discovery on the part of the better-publicized Hertz by at least thirty years. With his other work on electrical induction and this on oscillatory discharge, he naturally laid the rock-bottom foundation for radio as we have it to-day.

EVENTS OF INTEREST

Another Canadian record was recently made when c-4GT, of Calgary, got in touch with Ch-9TC, Major Raven-Hart, in Chile. This was the first time a Canuck had two-way communication with a Chilean and thus adds another country to the fast-growing list. c-4GT has been doing some good work of late and it is to be hoped that during the coming winter he will make some more records.

Low-powered sets can reach out and here is a fact to prove this statement: c-9CK on a houseboat on Lake Alberni, in British Columbia, was QSO with Australia recently on 40 meters and he was using a 201-A tube with 10.1 watts input! With this low power, he was able to hold the Aussie for over half an hour. Now, you folks who have been holding off getting a transmitter on account of tubes, better build one and stick in a 201-A and see if you can beat this record.

c-3AA at Galt, Ont., has worked some four or five Aussies and Zedders during the last little while, on 40 meters. He is the only Ontario station to have done so, and we are safe in saying that outside of Halifax and Vancouver, he is about the only Canadian to have been in touch with the Antipodes. He uses either a fifty or two fives and most likely only the latter. Well, boy, keep up the fine work.

MORE INFORMATION ON THE SEVEN-TUBE SUPER-HETERODYNE

By *Herbert N. French*

Due to the widely varying reports received by me relative to results obtained on the seven-tube receiver, I described in "Radio News of Canada," August, 1925, I feel that a few remarks are in order.

Some builders of this set state that it far surpasses any claims, and others that they can barely get locals. No one yet has reported merely indifferent results.

Some of the complains are as follows: No distance. No volume on locals. Uncontrollable squealing. No squealing. Condensers do not tune. One neophyte was sure his tuner oscillated all night, but couldn't make it squeal!

My first and most important suggestion is to disconnect the two ends of the primary, or small winding, of the tuner (the secondary of which discharges to the detector tube), and connect them to the antenna and ground. We thus have an ordinary three-circuit tuner with two steps of audio-frequency amplifications, and trouble will be much more readily located. If the spiderweb form of tuner is used, or one in which the tickler moves only through a right angle, the tickler can be connected only through a right angle, the tickler can be connected only one way—the right way. If the detector refuses to squeal, reverse these leads. With such tuners, in which the tickler can be continuously rotated, the tickler can be connected either way. Audio-frequency difficulties have been too frequently discussed to necessitate my going into them here.

If this connection works satisfactorily, and the condenser covers the wavelength range, reconnect the tuner primary as shown in the original diagram, and disconnect the primary of the second spiderweb coil, connecting antenna and ground to its loose ends. The builder should now read carefully the operating instructions I gave in my article. If the last three tubes have been checked as above, and are working satisfactorily, a local should be heard. In tuning the spiderweb's condenser for maximum squeal, swing it smartly back and forth, moving it less and less each time until the best setting is obtained. Then release tickler, at the same time readjusting the tuner dial, until clear reception is obtained.

If, on the other hand, no station can be heard, it is possible that the builder has connected the spiderweb wrong, an easy mistake to make, as it is difficult to distinguish the leads from the inside of this coil. Possibly the fixed condensers

are shorted. Test in the usual manner. Check socket contacts and turn bulbs way up. As I stated in my article, it is almost impossible to go wrong, as fixed condenser, variable resistance and choke-evil values are not at all critical, and the wiring may be done any convenient way.

If your detective work has been successful up to this point, reconnect the primary and try all seven tubes.

Undoubtedly most difficulties are caused by wrong spiderweb values for condenser sizes used. Also poor tubes or not burning them bright enough. The man who complained of uncontrollable squealing had, no doubt, too much tickler coil, with the result that his detector oscillated continually. The R.F. tubes cannot oscillate, so don't look there.

It will save a lot of time and trouble to buy, ready wound, inductances designed expressly for the size condensers you are using. That element of uncertainty is eliminated and other possibilities of trouble are few and easily met.

Let me repeat: This set is worth the trouble. Check up your wiring and parts carefully, and tune per instructions, and you will not regret the time spent.

WHT TO MAINTAIN STAFF OF RADIO REPORTERS

A staff of radio reporters, or expert receptionists, located in every large city in America, is being organized by station WHT through its engineering research department, in charge of Chief Engineer Reeve O. Strock, for compilation of technical data to aid in correcting faulty transmission and to insure uniform quality of reception throughout the dominant broadcasting range of the station.

Each WHT reporter will forward a weekly report to the research department and these reports will be checked one against the other at the weekly conference of the WHT operators and it is believed that much valuable information will be obtained.

AMATEUR MAKES RECORD

Gerard Marcuse, an amateur radio operator in Caterham, England, says he has talked from his home with a radio operator on board the United States cruiser Seattle while the vessel was approaching Australia, virtually half way around the world.

A TWO-TUBE REFLEX RADIO RECEIVER WHICH WILL NOT HOWL

By Adding Audio-frequency Amplification, Loud-speaker Volume May Be Obtained

By Peter Mombello

Most reflex sets have failed to give satisfaction because no provision had been made in the design of the coils to prevent howling when the set was in resonance. In cases where more than one tube was used, necessitating more than one circuit, the usual type of coils caused feedbacks, due to their stray fields. Naturally if it is possible to design coils having a very concentrated field, then interstage coupling, feedback and such troubles can be done away with. This is accomplished by the coils used in this set, the forms of which will make a very efficient radio-frequency set if two stages of RF. are used. The constants, of course, will not be the same as those given for this set, but the windings will be identical.

The astatic windings are used, the simple form of which is shown in Fig. 1. This may be used if desired and a cardboard tube used as the form with a slot cut at the proper place. But for the most efficient results, a combination of the basket weave and astatic windings is used, as shown in Fig. 2. The coils in that case will be of the best low-loss type for this receiver.

The coil winder used to make these coils must have an even number of pegs, preferably fourteen. This insures the same number of pegs on each side, so that it will be the same as the basic winding using the slot in the cardboard tube. The winder should have an inside diameter of $3\frac{1}{2}$ inches.

Method of Winding

The method of winding is clearly shown in Fig. 2, but a little explanation is necessary. Start the wire at Point 1 and wind in the direction of the arrows. The method of winding is over two, under one, over two, etc., until the Point 2 is reached. Then the wire is passed to Point 3 and the process repeated, over two, under one, over two, etc., until Point 4 is reached, at which the wire is passed to Point 1, thus completing one turn. At this point, the second turn must not coincide with the first, so that the wire is passed over only one peg, then under one, then followed by the regular process until the wire is stretched to 3. At this part, there must not be any coincidence, so that the wire goes over only

one peg instead of two, like the turn under it. This may sound complicated, but it can be very easily explained. When the corners 1 and 3 are reached, the builder should notice the previous turn. If the wire passes over two pegs in the previous turn, then he must make the next turn go over only one peg. Conversely if the wire goes over only one peg in the previous turn, then the next turn must go over two pegs. This principle is carried in every turn of the coil. If the wire inevitably coincides at

coil has sixty-five turns No. 20 DCC, there being only one winding.

The relation between the secondary and the primary on the coils will depend entirely on the location in which the set is operated. If great selectivity is not needed, the primary may be interwound with the secondary. The No. 18 and No. 20 wire are held together in the hand and wound simultaneously. When the required turns for the primary are wound, the wire is brought down temporarily to the bottom of the coil winder,

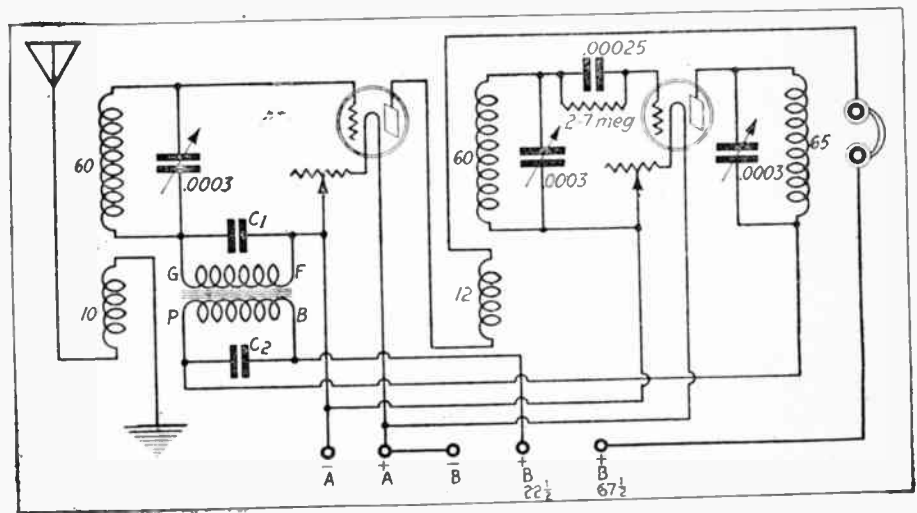

Fig. 3—The Wiring Diagram for the Receiver Herein Described.

the corner, then a mistake has been made in the round part of the coil in the last turn. This method immediately checks up mistakes in the winding as soon as they are made. Even without practice, this winding procedure is easy once the principle is grasped.

These coils have all the advantages of low-loss coils and they have the added advantage of a concentrated field so that no leakage can take place through several coils of this type when used in a set.

Constants of Coils

For use in this receiver, three such coils must be made having the following constants, as shown in the diagram in Fig. 3. The first coil has ten turns No. 18 DCC wire on the primary and sixty turns No. 20 DCC on the secondary. The second coil has twelve turns No. 18 DCC on the primary, same number as the first coil on the secondary. The third

and the secondary wire is continued by itself until its required turns are completed. This is the best method of winding, but for selectivity, the primary and secondary must be wound by themselves and then separated by one-half inch or more to obtain the required degree of selectivity. In this latter case, a few wooden pegs are left in the windings to give them support and maintain the separation. These pegs should be long and even, so that the coils may be made to stand upright on the baseboard.

The set as shown was designed for earphone reception, but a loud speaker may be used, provided the necessary amplification is first added.

The following parts will be needed to make the tuner alone. The best pieces of apparatus should be used throughout:

One pound No. 20 DCC wire, one-half pound No. 8 DCC wire.

Three low-loss .0003 variable condensers.

One audio-frequency transformer, 6:1 ratio.

Two rheostats to fit tubes used.

One panel, 7 x 18 inches; one baseboard, 8 x 16 inches.

Three medium ratio dials.

Two .002 fixed condensers. One grid condenser and leak.

Nine initial binding posts. Two sockets.

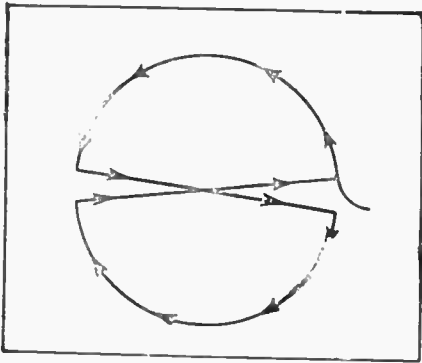

Fig. 1—Simple Form of Astatic Winding

The panel arrangement may be made next by putting one of the variable condensers in the centre and the other two on the extreme left and right of the panel. The two rheostats come on a lower level near the baseboard between the condensers. The coils are placed upright behind their respective condensers and as far apart as possible from one another. Care should be taken to see that the so-called "slot" in the astatic windings is in the same line for all the coils running from left to right, parallel to the plane of the panel. The two sockets are placed in a plane behind the coils and in a line with the rheostats. The audio transformer is mounted behind the first rheostat. The binding post strip is placed in the back centre with the post pointing outward through the back of the cabinet.

When wiring the set, either large enameled copper wire or bus bar may be used. All battery connections should be made first. The grid and plate wires should be as high up as possible and at right angles to each other. To avoid hand-capacity effects, connect the rotor of the condensers to the low potential or filament.

If there is sufficient capacity effect between transformer windings, the removal of condenser C2 may sometimes improve reception. This should be experimented with. Condenser C1 is usually necessary.

On the question of tubes for this set, the UV-199 are recommended because of their slight tendency to oscillate, due to their small internal capacity.

When tuning the set, put the condenser across the plate coil at a reading between 0 and 5 and slowly rotate the

other two condensers simultaneously until a station is found. Then the value of the plate condenser is increased. Station may be logged on the first two dials. The last dial need not be logged, since this controls the volume.

Using only a detector and one small power tube, loud speaker signals can be obtained which will be audible 100 yards away or more, for a modulated output of seven milliamps or more can be obtained. The crystal purity of the reproduction given by this unique circuit is truly remarkable, and will surprise those who have become used to the imperfections of iron-core transformer coupled A. F. amplifiers.

The absolutely complete absence of distortion when receiving from a high-

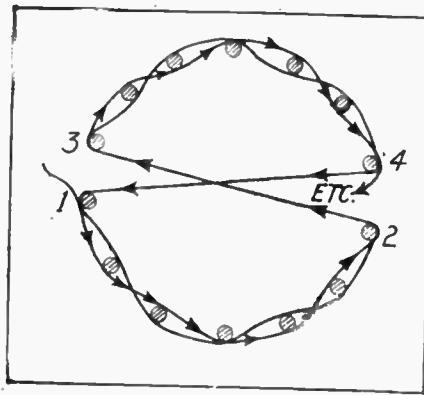

Fig. 2—Method of Winding the Combination Astatic and Basket-weave Coils.

class broadcasting station is almost uncanny, and will serve to prove to doubters that the modern loud speaker is by no means so imperfect as it is generally made out to be.

A NOVEL DEVICE

A new novel time-finding device has recently been devised by George B. Gardner, a Brooklyn printer. It consists of a black dial, calibrated in hours, the same as an ordinary clock. On the black clock dial is a smaller rotating dial calibrated in the times of the various parts of the United States, as well as London, Hawaii and Alaska. To determine how time in any of the above-mentioned places compares with that of any part of the United States, the rotating dial is set at standard time in the time zone it is being used. By looking at the rotating dial, it is possible to tell the hour at any other point in the world. Inasmuch as the minutes are the same in all zones, it is possible to tell the exact minute of the hour at a place on the opposite side of the globe.

How Body Capacity Effects May Be Reduced in Sets

Every radio fan has heard of "body capacity" until he is tired of it, and it is safe to say that nearly every fan has had his own troubles with it. Most of them would have better luck if they had a better understanding of what it really is. What is this mysterious force that often upsets the finest tuning with unruly squeals, and what is the best way to prevent its effects?

Body capacity, or hand capacity, is the term applied to the property of the human body which makes it act as an electric condenser. Your body is not a good condenser. Compared to the variable condensers in a receiving set, it has an extremely small capacity. The trouble is that even an extremely small variation in either capacity or inductance of a set can throw fine tuning out of adjustment.

Each time the operator's hand takes hold or lets go of a knob in the process of tuning the capacity of the set varies by a small amount, because some of the body capacity is communicated to the set while the hand is in contact with it. Then you know too well what happens.

A very fine adjustment of the total capacity of a set can be obtained with modern vernier knobs for rotating the parts of the condensers, which supply practically all of the capacity of the circuit. In the same way, a very fine adjustment of the total inductance is obtained by rotating the parts of the coils which supply nearly all of the inductance in the circuit. Thus these two elements in the set itself can be very closely controlled. Body capacity, while small enough in itself, is quite beyond control.

Some radio enthusiasts, who can build anything from a pocket crystal set to a superheterodyne, do not know just why this adjustment of capacity and inductance values is so important in its effect on reception. The reason, technically, is that when these values are properly related to each other for any given wave length, the equivalent resistivity, or total equivalent resistance, of the circuit is reduced to the minimum. As the voltage supplied to the set by batteries or lighting circuit is constant, minimum resistance means maximum current. With the maximum current flowing through the set, you have reached the point of resonance—the point at which signals are strongest.

Attempts have been made to eliminate body capacity by various methods, but

the most effective has been the protection of the panel, or, in some cases, with a metallic shield.

In order to make shielding thoroughly effective, care must be used in making connections in the circuit. The grid and plate terminals are most sensitive to body capacity effects. Keep the parts of the coil or apparatus to which the grid or plate is connected as far as possible from the panel. The filament circuit must be properly grounded.

With a variometer in the secondary circuit, the stator end is connected to the grid; in the plate circuit, the stator is connected to the plate. Where a tickler is at the end of an inductance, which is the case with many variocouplers, the end of the coil farthest from the tickler end should be connected to the grid.

In locating the sockets, keep the grid and plate terminals farthest from the panel and place the filament leads toward it, as they are not affected by body capacity. It is helpful to shunt the phones with a fixed condenser of .001 or .002 mfd. capacity, or, if amplification is used, to connect a fixed condenser across the plate terminal of the detector tube and the negative side of the "B" battery. In neutrodyne circuits, it is very desirable to shield the neutroformers to avoid intercoil coupling.

There are several ways in which a panel may be shielded to prevent body capacity. One is by placing small metal disks on the rear of the panel directly in back of each of the tuning dials. These disks may be cut from aluminum and should be about 4 inches in diameter. It is also important that they be connected either to the ground or to the negative of the "B" battery. For more complete protection against body capacity effects, the entire panel may be shielded with a metal plate or an "anti-capacity" panel, which is a hard rubber panel with a metal shield vulcanized in place, may be used.

When any of these methods are used, it is essential that none of the parts of the set come in direct contact with the metal of the shield, and also, if best results are to be obtained, the shield must be grounded.

ENTERTAINMENT FOR SICK

By running a wire from the receiving set to headphones in another room, it is possible for persons some distance from the set to enjoy concerts. When confined to bed by illness or permanent injury, this is an excellent means of bringing entertainment to the bedside.

NATIONS MAY DISCUSS WIRELESS PROBLEMS AT PARIS THIS FALL

The International Telegraph Conference
at Paris and the Washington Inter-
national Radio Conference Both
to Discuss Same Problems

By P. E. D. Nagel*

The United States Government accepted the invitation of the French Government to attend the International Telegraph Conference now in session at Paris, and the following information has been prepared to show the relation this conference has to radio:

The Paris Conference is a regular meeting of the International Telegraph Union, of which nearly all of the principal countries of the world and most of the smaller countries are members. The United States is not a member of the Union and is attending only on the direct invitation of the French Government.

The International Telegraph Convention is a general treaty which has been enforced in one form or another since 1879 throughout nearly all the world, except, as I have said, in the United States. The treaty itself provides for further conferences to be held at intervals to make the necessary modifications, but due to the war, there was no meeting between 1908, which was held in Lisbon, and the coming Paris meeting.

In general, the treaty is designed to provide standard methods for the exchange of cablegrams and telegrams throughout the world. The delegates are always government officials; that is, representatives of the signatory governments, but private operating companies are requested to attend and to make suggestions or recommendations, although the United States, not being a member of the Telegraph Union, is not bound by the treaty and its private cable and telegraph companies are not obliged to comply with it. The general provisions of the treaty are followed as a matter of business practice by the American companies themselves. It is obvious that there must be some recognized international standard so that a message originating in the United States will be treated the same way in any distant foreign country as would a message originating in any other part of the world, and conversely messages filed abroad must be treated in some standard method in the United States. This is the general purpose and the chief value of the telegraph treaty.

*Assistant Chief Transportation Division; Chief Communication Division, Bureau of Foreign and Domestic Commerce, United States Department of Commerce.

Now in regard to radio, at the time that the Lisbon conference was held—that is, 1908—the use of radio on a commercial basis was limited to messages between ship and shore to very few ships. In 1912, the first International Radio Conference at London produced an International Radio Convention along the lines of the telegraph convention and quoted verbatim many of the provisions of the telegraph convention. This radio agreement, however, related only to ship to shore communication, trans-oceanic radio telegraphy being then non-existent and radio telephony being unknown except as a laboratory undertaking.

Transoceanic radio telegraphy and radio telephony in all its forms have really come into existence only since the war. An attempt was made in 1920 to combine the radio and telegraph conventions into a single document with the title of the Universal Electrical Communication Union. For various reasons, however, unanimity of opinion could never be accrued among the nations, and it was finally decided to hold the telegraph conference in Paris in accordance with the provisions of the telegraph convention and later to hold an international radio conference at Washington.

The decision to hold a telegraph conference, however, was reached considerably in advance of the arrangement for a radio conference, so that many nations in replying to the invitation submitted proposals for the modification of the telegraph convention which included various phases of radio. The handling of international messages at the present time involves the use of cables, telegraph lines and radio telegraph stations for the same message in so many cases that it is difficult to make distinct rules for each part of the service.

In general, any world-wide treaty to govern either telegraph or radio telegraph separates itself naturally into three parts—the first being governmental, political and economic interests, etc.; the second, matters of general policy and standard methods for the exchange of business, and the third, purely technical operating questions. The third section of a technical nature would be very limited in a telegraph convention, but very extensive in a radio convention.

As examples of regulations to these three different classes, I might say that in the first class would come such a provision as "The government's signatory to this treaty agree to take all means within their power to provide for secrecy of messages." Under the second section would come such an article as "The sender of any message may prepay the reply in which case the letters RP followed by the number of words prepaid shall be placed at the head of the message before the address." In the third section under a radio convention would appear the provision that stations engaged in international telegraph service between fixed points shall use frequencies of less than 100 kilocycles (wave lengths in excess of 3,000 meters).

There is every reason to believe that the telegraph conference at Paris will deal only with those questions in regard to radio which require an international understanding similar to that in force on cables and telegraphs. The method of counting and charging for words and the meaning of the different symbols and abbreviations placed on messages, and arrangement for prepaid messages, collect messages, repeat messages, etc., are in the nature of standard international rules applicable for the greater part to radio messages as well as cable messages.

Regardless of any action taken at Paris, it is probable that everything in any way connected with radio will be taken up at the International Radio Conference at Washington, the date for which has been tentatively set for the spring of 1926.

THE NEW GENEVA STATION

The new broadcasting station at Geneva opens its regular transmissions early in September. Frequent tests have already been carried out successfully, usually at 8.30 in the evening, and have consisted principally of instrumental and vocal items. The power of the station is $1\frac{1}{2}$ kilowatts, whilst the wavelength is 1,100 metres.

Reports on reception are warmly welcomed by the directors, and should be addressed: "Radio-Geneve, Hotel de la Metropole, Geneva."

BUDAPEST TESTING

Test transmissions on 565 metres are now being made by the Budapest broadcasting station, using a power of 1 kilowatt. The Hungarian postal authorities, who would be pleased to acknowledge reports of reception, request that communications should be addressed: "Ung. Postdirektion, Versuchabteilung, Budapest 1X, Gali ut 22."

The Relation of Air and Atmosphere to Radio Waves

Radio Signals May Possibly Rise to Great Heights Above the Earth Before They Are Picked Up by the Antenna

By Howard G. Lapsley

Power of Radio Impulses

It is fair to assume that their course is usually vertical and not horizontal. It is true that radio impulses will penetrate practically anything. In coal mine experiments, radio signals have been distinctly heard through fifty feet of coal strata, but the audibility has fallen off rapidly as this distance was increased. Also there is little or no directional control of radio signals, and, while they will penetrate, they also pick their own route. Some radio signals sent from Nauen, Germany, to Australia have apparently gone by way of the North Pole, while other signals have apparently gone by way of the South Pole.

Clear spots and dead spots of reception are of common occurrence, but the whys and wherefores are more or less suppositious. The regularity with which the signals from certain stations surge and fade away causes one to wonder if all the messages and music we receive on our machines does not travel a long, arcing route through the high spaces before it reaches us.

The more one ponders on science, either pure or applied, the more one hesitates to make a statement with any air of finality, but it does seem to some listeners who have spent many hours at the midnight radio vigil, with acutely sensitive ears, that radio signals may possibly rise to great heights above the earth before, describing a parabola, they come down on our antenna, like a drop of dew, which we must magnify in our machines until we hear a recognizable splash of sound.

In this supposition may lie part of the answer to static and its tendency to be purely local. A careful study of your barometer may indicate 29.86, with severe static interference. The barometer near the sending station may indicate 30.06—a difference of 20 points. Another receiving set in an area where the barometer reads 30.04 may have no static disturbance. A close study of the barometer may give us more knowledge than we now possess about atmospheric electricity. The difference between midday and midnight reception may be accounted for by the theory that the heat of the sun's ray stretches the elastic belt

Radio reception tests in New York and nearby vicinity have demonstrated the notably local characteristics of static. Broadcast programs that have been literally smashed to pieces have been received with but slight static disturbance in adjacent towns, and programs which were practically impossible of reception in these nearby towns were reported as being well received in New York. These contrary conditions obtained, not for short periods of three or four minutes, but for an hour or two. As these tests were made twenty to twenty-five miles apart by air line, and as the broadcasting was from New York City stations, two conditions have been demonstrated: First, that static disturbances are sometimes definitely localized; second, that static interference apparently affects reception from the air, rather than delivery into the air, of radio messages or music.

It is always easy to wander from the realm of physics into the realm of metaphysics and to turn from a page of definite data to a mystic dream of indefinite hypothesis, so we must wander off into the indefinite, when we ask: Where does the radio message or music go, when it leaves the antenna of the broadcasting station, before it comes home to us on the headphones or loud speaker? Does it reach heaven before it reaches our ears? Of course, the advertising illustrators picture the radio flashing from antenna to antenna, in direct and short courses. Maybe the impulse does take the short, straight course, but it is unlikely.

The path of least resistance is natural to electricity as well as man, so we may assume that radio impulses follow this course, and instead of zooming along the earth's surface, fly up into the thin, high ether, where there is little or no resistance.

Air is reasonably heavy on the surface of the earth and very, very light above it. Now, the question is: Will radio impulses spend their slight strength, in piercing the thick surface stratum, or will they follow the line of least resistance and rise into the light air and free space above?

of air around the earth's surfaces to twice its nightly proportions, forcing the radio signal to reach twice the height that it reaches during the night before descending to us. On this assumption, the average receiving set would get about half the distance during the daytime which it is capable of at night.

If we accept the theory that radio signals start up vertically into space, the question arises: What brings them back to earth and our earthly antenna? To every action there is an equal and opposite reaction, so there is some ethical reaction which brings these man-made impulses back to earth. This reaction may be gravity, but it is difficult to conceive of gravity affecting either man-made or atmospheric electricity.

Air has the electro-chemical power to divide liquids and solids into the most minute particles. Air has the additional power to hold these particles in suspension almost indefinitely. Moisture may be in the air months before it descends as rain. Volcanic dust has been known to fall a year or two after the eruption which created it. Radio impulses are minutely divided forms of electricity to start with, and possibly they are still more minutely divided by the air or atmospheric electricity which they pass through. Electricity inherently resists all confinement and restriction. It seeks immediate action, whether controlled or uncontrolled. Electricity may not be life, but it is the antithesis of death, for life spells expansion.

Man produces electricity generally by means of heat. The air produces electricity by means of cold. Air resents the escape of heat from the earth.

Cause of Static

In June, July and August—our hot months—the air, becoming warmer and warmer, rises to unknown heights. The frigid upper spaces resent the intrusion of this warmth into the domain of coldness, and it is driven back to earth forcibly, by lightning and thunder. Three-quarters of our thunder storms occur in these three hot months. Sometimes the sullen, sultry summer air is hotter than before the electrical storm, and sometimes it brings to earth, as spoils of the atmospheric battle, a little of the coolness of the upper regions. However, the so-called vacant spaces above us always appear to win the argument, and the hot defeated air vents its vengeance by undignified spittings and splutterings in the ear of the radio listener.

The sea of air at the bottom of which we live rises in sharp peaks and descends in deep valleys of high and low pressure. The radio signal, if our con-

ception of its rise is correct, having reached its maximum ascension, is forced back to earth. In the downward descent, it must sink readily into these valleys of low-pressure space with little resistance, resulting in a strong signal, or, penetrating through a high peak of air with greater resistance, deliver to us a weak signal. A low barometric condition would indicate an air valley immediately overhead and a high barometer would indicate an air peak.

Diving toward earth in a parabola, the radio signal would pass through vortices of low resistance and peak areas of high resistance, mixing in its course with atmospheric electricity which may entirely demolish or render unrecognizable the original electrical sound impulse.

When these peaks and vortices of air are fairly regular in area and alternate high and low resistance, the radio signal comes through with what appears to be a definite, recognizable beat.

How high the arc may be which the radio impulse traverses before it fulfills its mission in our machines, it is hard to ever, present day broadcasting depends for success on a happy union of atmospheric conditions as demonstrated by the barometer and thermometer.

MUSIC AS A RADIO SALES ASSISTANT

A radio program, coming in at the moment a set is being demonstrated, has a lot to do with making the sale, according to a prominent San Francisco radio dealer in a letter to KGO.

"When a customer comes to my store to buy a receiver," he wrote, "I always size him up to see if he is a 'jazz hound' or not, and when demonstrating a set, I try to tune in the thing he likes. I have found that the man who dislikes jazz may refuse to buy if jazz happens to come along at a moment when he is still in doubt. A woman's talk on fashions or cosmetics may ruin the sale to a man, whose wife would be just as much upset by a man's talk on banking or sales psychology. 'I don't want any of that stuff in my house,' is just as likely as not to be the verdict.

"The best radio feature from a sales point of view to which customers may tune in is undoubtedly music, and music that is neither too highbrow nor too low. Music is not only pleasing in itself, but has the merit of being non-controversial and universal. It hurts no one and gives a certain amount of pleasure to everybody.

SHORT WAVE TRANSMITTER WITH LOW PLATE VOLTAGE MAKES GOOD RECORD

Can a five-watt transmitting tube equal the results produced by a fifty-watt? Amateur radio experimenters throughout the United States are deeply interested in comparisons because many of them cannot afford the accessories necessary to operate the fifty-watt tube. The first announcement of the results of short wave tests carried out at the Garden City Laboratory, where the special Radio Broadcast-Eveready experiments are being made, showed that, under somewhat unfavorable conditions, a five-watt tube with only 200 volts of dry "B" battery on the plate was good for a communication range of about 1,000 miles.

Tests were conducted by the Garden City laboratory with amateur station 4JR, Gastonia, North Carolina, from the Radio Broadcast-Eveready experimental station, 2GY. A five-watt tube, with 200 volts on the plate, was used and it drew 4.8 watts. 4JR is approximately 500 miles from 2GY. Then the input to the tube was reduced and communication established with Station 4KW at Jacksonville, Florida. When the input read only 1.2 watts, 4KW reported that the 2GY signals were R4 to R5, which means "fair to moderately strong," at a distance of 983 miles.

It is a common practice of transmitting amateurs to pile on all the plate voltage possible in order to attain great distance, but the first of the short wave experiments conducted at the Garden City laboratory would point to that practice as unnecessary. The experiments also show that the dry cell "B" battery can be used for transmitting as well as receiving.

C.G.S. "ARCTIC" ON THE AIR

The outstanding event is the fact that VDM, the C.G.S. Arctic, is again on the air and on the low wave bands. She has worked c-9AL and has been heard by several other Canadians, among them c-3EN of Ottawa, who is a blind chap. She has worked 6AWT of San Francisco, and is reported in the states of Washington and Texas. So it appears as if the old boat is reaching out, even though rather late in her trip.

There was some trouble about the motors just after the ship left Quebec and this took time to fix. Then when the Arctic met the MacMillan expedition, with Reinartz aboard, they got together and fixed up the transmitter, with the result that now she purrs along at a fine old rate.

RADIO BRANCH

DEPARTMENT OF MARINE AND FISHERIES

CIRCULAR LETTER TO CANADIAN BROADCAST LISTENERS

Interference from Regenerative Receiving Sets

The following note appears on the back of your Radio Receiving License:—

"When using a receiver of the regenerative type for the reception of radiotelephone programmes, please avoid increasing regeneration to the point at which the receiver begins to oscillate, otherwise you will cause interference with neighbouring receiving equipments."

—ARE YOU DOING YOUR BEST TO OBSERVE THIS?

* * * * *

A recent departmental survey of radio broadcast reception conditions in the more populated centres in the Dominion indicates that approximately fifty per cent. of the "preventable interference" which prevails is caused through the incorrect operation of regenerative receiving sets by the broadcast listeners themselves.

The survey further indicates that most of this interference is due to a lack of knowledge of correct methods of adjusting a regenerative receiving set, and it is accordingly hoped that a material reduction in the same may be effected if the broadcast listeners can be persuaded to co-operate in an endeavour to clear the air of regenerative whistles, and with this end in view, the following instructions for operating this class of receiving set have been drafted.

What is Regeneration?

The principle of regeneration, as used in radio receiving sets, is that the part of the output of the detector vacuum tube feeds back into its own input and thus greatly increases the volume of the signal.

The electric waves reaching the receiving set from the transmitting station travel down the aerial wire through the primary coil in the set and so to earth down the ground wire. The weak electric current resulting from this influences the vacuum tube in such a way as to set it functioning.

There sulting output from the plate circuit of this tube is fed back in such a manner as to set up a "field," or influence, in the part of the circuit connected to the input (the grid) of the tube. This "field" induces in the input circuit a current of electricity of the same frequency as that of the received electric waves. The energy, therefore, which comes down the antenna wire is automatically strengthened by an impulse from the output of the detector tube.

What is Oscillation?

Unless controlled, this action will continue until the saturation point or climax is reached, the tube being then said to be in a state of oscillation. When a receiving set is in oscillation, it causes howling and squealing in your own and your neighbour's receiving sets. Regeneration should, therefore, never be allowed to proceed to this point, as it then constitutes a public nuisance.

What Oscillation Does

On commercial receivers, regeneration is not always described by this name and the dial which controls this feature of the equipment may be designated by any of the following terms:—

Regeneration	Re-action	Tickler	Feed-back
Amplification	Varind	Sensitivity	

When a radio receiving set in a state of oscillation is being tuned to a broadcast station:—

- (1) It causes whistles in radio receiving set, of all types, which are tuned to the same station; this interference may be heard up to a distance of several miles.
- (2) It distorts the quality of your own music.
- (3) It uses more "B" battery power and, therefore, the life of the "B" battery is reduced.
- (4) It tends to reduce the life of the detector tube.

Zero Beat

When a radio receiving set, in a state of oscillation, is exactly tuned to a broadcast station, it is said to be in the state of Zero Beat. This distorts the broadcast reception and also interferes with neighbouring receiving sets which are tuned to the same station.

In a word, regeneration carried to oscillation causes great annoyance to your neighbours, poor reception and expense to yourself, and has no advantages whatever.

Does Your Radio Receiving Set Cause Interference?

The interfering whistle which you hear in your receiving set may originate in your own set or it may be interference caused by your neighbour. In order to determine this point, you may make the following test:—

Leave the regeneration control in a fixed position, slowly rotate the tuning dial, and note particularly the change in sound of the whistle. If the whistle rises and lowers in pitch sympathetically with the movement of your tuning dial, it indicates that your receiving set is in a state of oscillation and probably causing interference to other sets. On the other hand, if the whistle does not change in pitch corresponding to each movement of your tuning dial, but simply varies in volume, the whistle is not caused by your receiving set, but is interference produced by some other oscillating receiving set in the neighbourhood.

Many so-called non-radiating receivers will, under certain conditions, radiate and thus cause interference. Make it your business to see that your set is not causing trouble.

If you are in doubt as to whether your set can cause interference, you can check the same by making the following test, but be careful to do so at a time when only a few people are listening in, so as not to cause annoyance:—

Call a neighbour on the telephone and ask him to listen in on a particular station at a pre-arranged time and then tune your own set to the same station. Turn up your detector tube filament to normal and put the regeneration control to its maximum; move your tuning dial five times slowly across the point corresponding to the tuning of that station, then telephone your neighbour and ask him if he heard the interference corresponding to these five movements of the dial on your receiving set. If he heard your interference, the probability is that hundreds of others have also been annoyed at times by radiation from your receiving set. You should, therefore, learn how to operate without causing this interference.

How to Adjust a Regenerative Radio Receiving Set

If you will take the trouble to observe the rules which follow, you will obtain greater satisfaction and enjoyment from your radio receiving set, and at the same time cause minimum annoyance to your neighbours.

- (1) Practise on tuning **powerful stations first** and do not try to pick up weak distant stations until you become expert.
- (2) **Use both hands**, one hand for the regeneration control and the other hand for the tuning control.
- (3) Keep the regeneration control always just **below** the point of oscillation, your set is then in the most sensitive condition. This is the reason for using your two hands for tuning.
- (4) If your set then accidentally breaks into oscillation, turn **back** the regeneration control at once.
- (5) Do not try to **find** a station by the "whistle." If your set is tuned just below the whistling point, the signals will come in **clear** and your regeneration control can then be tuned a **little** further to increase the volume.
- (6) Do not force regeneration in an attempt to obtain loud speaker volume from a set not designed for the purpose.
- (7) Do not force regeneration in an attempt to hear stations beyond the range of your set; be content with those you can really hear.

The fact that you once heard a distant station on your receiving set is no indication that you can hear this station regularly, for occasionally a radio broadcast from a distant station is received with extra strength due to some freak condition. When you have tried to tune in a station in the correct manner for a minute or two and are not able to hear it, do not unduly increase your regeneration and persistently wiggle your dials, for in so doing, you may be causing annoyance to some other broadcast listener who would otherwise be able to receive this distant station on a multi-tube receiving set.

You can accordingly assist in eliminating these whistles by:—

- (a) Learning to operate correctly yourself.
- (a) Not allowing children who are not old enough to understand the correct method of operation, to cause interference from your set. **(A crystal receiving set causes no interference.)**

All Radio Receiving Sets in Canada are required, by law, to be licensed. Licenses are issued yearly and are required to be renewed on the 1st of April each year. They may be obtained for \$1.00 from local Radio Inspectors, many Post Offices, many Radio Dealers, or from the Radio Branch, Department of Marine and Fisheries, Ottawa.

The proceeds of the license fees are used to maintain an inspection staff for the administration of Radio and for the improvement of Radio conditions in the Dominion.

Additional copies of this pamphlet are available, on request, from your nearest Radio Inspector, or from the

RADIO BRANCH
DEPARTMENT OF MARINE AND FISHERIES,
OTTAWA, ONT.

SOMETHING NEW IN AUDIO-FREQUENCY AMPLIFICATION FOR RADIO RECEPTION

The Author Claims Complete Absence of Distortion When Receiving From a High-class Station

By A. Dinsdale*

In the early days of broadcasting in this country, the craze among broadcast listeners was all for noise, and yet more noise, the quality of reproduction receiving no attention at all. Happily, these days are over. Nowadays, every one strives to improve the quality of his reception, so that the output of his loud speaker shall resemble as faithfully as possible the input sounds at the microphone end of the circuit.

In an endeavor to achieve this end, all sorts of corrective devices have been applied to the usual forms of transformer-coupled A. F. amplifiers, and tubes have been worked well within their limits—i.e., volume has been reduced. Extensive use has also been made of resistance and capacity as a means of coupling A. F. stages, for, as is well known, this method of coupling introduces no appreciable distortion if properly arranged and handled.

Resistance-capacity coupling, however, suffers from the disadvantage, from the point of view of the impecunious, that the same degree of amplification per tube cannot be obtained as with transformer coupling, and a higher value of "B" battery voltage is necessary.

In view of the above remarks, it is strange that no particular effort seems to have been made by manufacturers of A. F. transformers to produce a distortionless instrument, or by designers to produce some alternative means of amplification which will combine purity with great volume, using a minimum of tubes.

Great advances have been made in England, both in the matter of improved transformers and in alternative methods of amplification, and in the present article, the writer will endeavor to describe a very promising A. F. amplification circuit.

Pierce's Trigger Circuit

The underlying principles of the new circuit are covered by two British patents—one being due to G. W. Pierce and the other to E. W. B. Gill. Pierce's original circuit is shown in Fig. 1, and Gill's modification of it in Fig. 2.

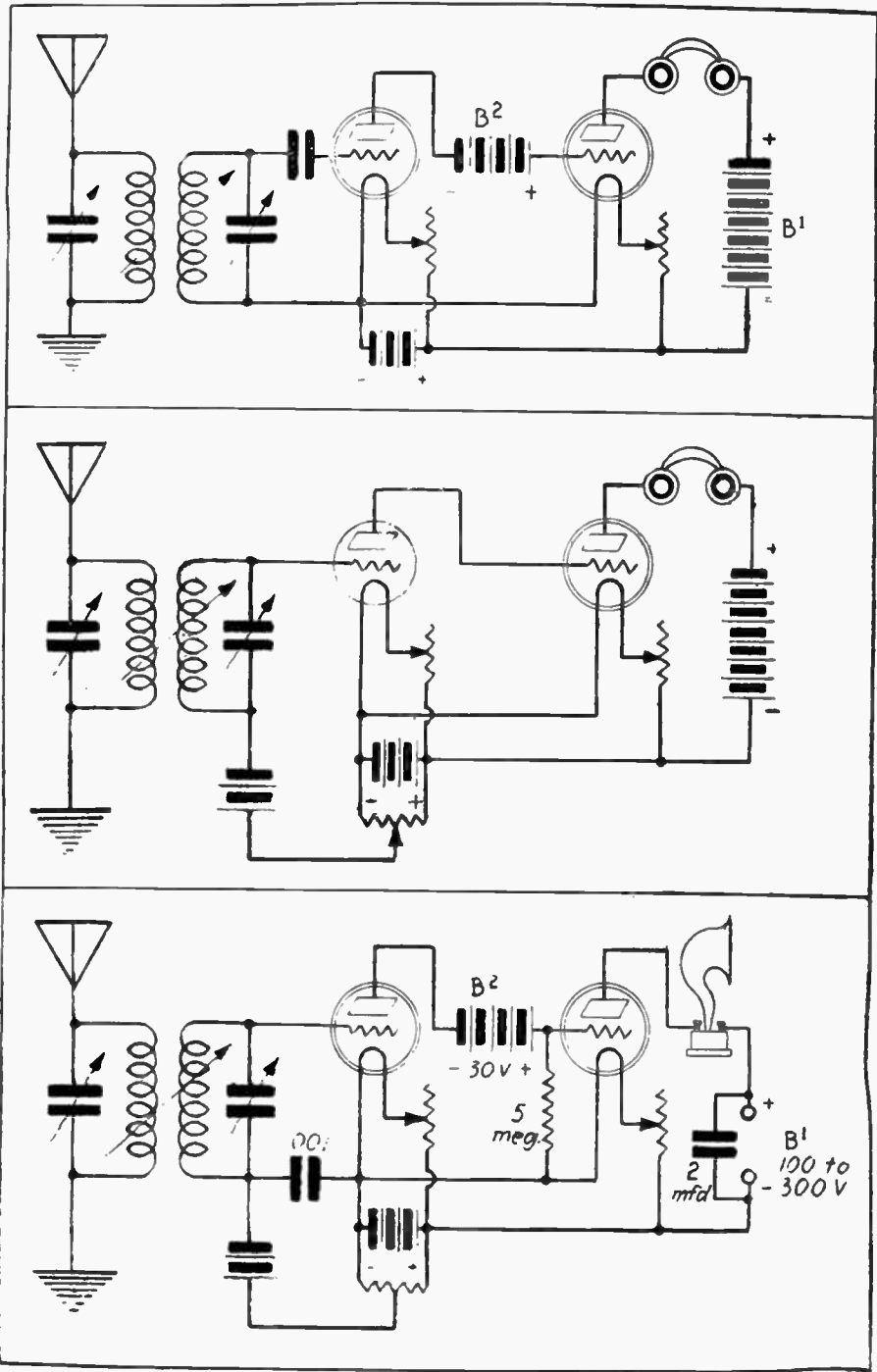

Fig. 1—Top: Pierce's original circuit. Fig. 2—Middle: Gill's modification of the circuit in Fig. 1. Fig. 3—Below: The circuit combining the trigger action with the limiting action.

*Member, Radio Society of Great Britain.

Referring to Fig. 1, it will be seen that the method of coupling the two tubes is by means of a battery, the positive terminal of which is connected to the plate of the first tube, while the negative terminal is connected to the grid of the second tube. Since the completed circuit of this battery goes through the plate-filament path of the first tube, the actual voltage applied to the grid of the second tube depends upon the conductivity of the first tube.

Thus, as signals arrive on the grid of the first tube, varying its conductivity, so the potential applied to the grid of the second tube is varied, and corresponding changes of plate current occur in its plate circuit, and, consequently, in the telephones connected

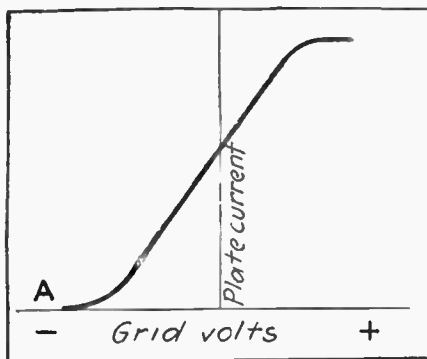

Fig. 4—Point A on the curve shows the condition of the first tube when the grid is negative before the reception of a signal.

therein. In this way, therefore, it will be seen that a kind of trigger action results, the incoming signals impressed on the grid of the first tube producing effects which cause great changes in the plate current of the second tube.

Gill's circuit, shown in Fig. 2, is very similar to Fig. 1, the only differences being that the battery between the plate of the first tube and the grid of the second has been eliminated, and potentiometer control of the grid of the first tube has been added.

The important point in connection with this circuit is that as the voltage on the grid of the first tube is increased, so the plate current of the second tube is reduced. This follows because, as the conductivity of the first tube is increased, so the plate current of the second tube is reduced. This follows because, as the conductivity of the first tube is increased, so the grid of the second tube becomes more negative, and all users of negative grid bias know that increasing the biasing voltage results in reducing the plate current.

Prince's Modification

A circuit combining the trigger action of Pierce's circuit with the limiting action of Gill's circuit is due to Major C. E. Prince, and is shown in Fig. 3. This

circuit has been used on telephony with considerable success, and is, therefore, of interest to all readers of an experimental turn of mind. The theoretical considerations of the circuit are as follows:

We will assume that the grid of the first tube (Fig. 3) has been made sufficiently negative by means of the potentiometer and grid bias to render the tube non-conductive. This means that the battery B2 is open circuited. The grid of the second tube is, therefore, to all intents and purposes, free and will have impressed upon it some fairly high and steady value of negative potential, the exact value of which will depend upon the characteristics of the tube in use.

Under such conditions, prior to the arrival of any signal, a certain value of steady current will flow through the plate circuit of the second tube, and this is really the "normal" plate circuit.

Upon the arrival of a signal, the grid of the first tube is made less negative, and if the signal is sufficiently strong, the tube will be made conductive, as far as the battery B2 is concerned. A current from B2 will flow through the circuit, and the effect of this will be to greatly increase the negative potential on the grid of the second tube. This large increase in negative bias will cause a correspondingly large reduction in the plate current of the second tube.

The action of the two tubes is shown graphically in Figs. 4 and 5. In Fig. 4, the point "A" on the characteristic curve shows the condition of the first tube when the grid is initially made negative prior to the arrival of any signal.

Fig. 5 shows the characteristic curve of the second tube, "B" being the operating point at the negative potential obtaining on the grid prior to the arrival of a signal. When the first tube is made conductive by the application of signal voltage to its grid, an increase of "C" volts in the negative bias impressed on the grid of the second tube will cause the plate current to drop to zero, as shown.

Choice of Tubes Important

The trigger action of the circuit can easily be comprehended when it is considered that with the normal currents carried by the first tube (i.e., when no signal is arriving) the plate-to-filament resistance is comparatively low in comparison to the filament-to-grid resistance of the second tube. Thus, as soon as the first tube becomes conductive, practically the full voltage of the battery B2 is applied between the filament and grid of the second tube and its plate current falls to zero.

It is, therefore, possible by this means to arrange for a reduction in plate current which will be many times greater

than any plate current change could be effected by applying the original signal voltage directly to the grid of the second tube.

It necessarily follows, then, that in order to obtain maximum results, the normal plate current of the second tube should be as large as possible. It follows also that since at the end of each signal impulse, the grid of the tube will be left with an excessive negative charge upon it means of escape must be provided, so that the grid shall immediately return to a fit state to deal with the next signal impulse. This may be arranged by introducing a grid leak, as shown in Fig. 3.

It will be apparent that much of the success of the trigger action will be dependent upon a sharp and sudden change in the first tube from a non-conducting to a conducting state. This requirement can be met by employing a tube with a sharp bend at the bottom of the characteristic, and any tube designed to act as a detector answers this requirement. Naturally, the sharper the bend of the characteristic the better, and the sharpest bends can be obtained from soft tubes. A soft tube, therefore, is recommended for carrying out this particular function, while a small power tube (say, 5 watt) is recommended for the amplification stage.

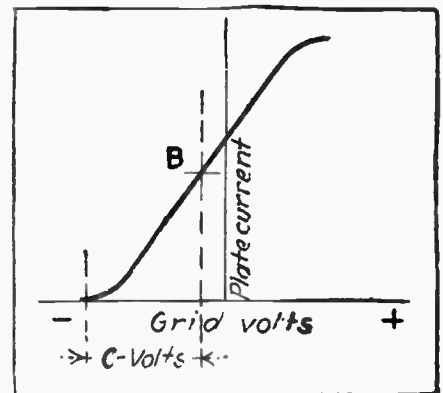

Fig. 5—The characteristic curve of the second tube prior to the arrival of a signal. Point B is the operating point at a negative potential on the grid.

As the trigger of a rifle requires a certain definite minimum amount of energy to pull it off and release the enormous power contained in the cartridge, so does the circuit under consideration require a certain minimum amount of signal energy to operate it.

As a rough guide to requirements, if a circuit similar to Fig. 3 is used without any regeneration or R. F. amplification, the signals delivered by the detector alone must equal in strength what may be termed "loud and clear" headphone reception on a crystal detector.

If signals are of a strength which make it possible to just distinguish

speech without straining the hearing, then it will be necessary to add one stage of some form of R. F. amplification before the detector.

Signals which are barely audible on the detector alone will require probably two stages of R. F. to render them sufficiently strong to operate the trigger. It will, therefore, be seen that it is a good idea to arrange a phone jack so that phones may be plugged into the detector circuit as a guide in tuning, the grid of the second tube being temporarily shorted to the filament through the telephone windings.

Once the requisite minimum signal energy has been arranged for to operate

tubes will give a very good indication of what is required, and small experimental variations on either side of these values will soon clear up these points. In the case of the power tube, the voltage required depends greatly upon the volume desired and the depth of the experimenter's pocket.

An important matter requiring serious attention is the position and insulation of the battery B2.

This battery, it must be remembered, is in the grid circuit of the power tube, and on broadcasting wavelengths, the capacity of this grid to ground, and also strap capacities from the battery B2, may cause paralyzation of the power

Considerable experimentation may be necessary at first in order to find the correct adjustments of all the circuits and component values, but, once these have been found, they need never be altered, and the set will henceforward be foolproof.

CANADIAN AMATEUR BREAKS WORLD RECORD

According to a despatch received from Port Alberni, British Columbia, Clair Foster, operating Canadian Radio Amateur Station 9CK, broke all world's records when on the morning of August 11th, he exchanged messages for over an hour with Australian Station 3YX, of Victoria. The extraordinary feature of Foster's record is that his transmitting outfit is a small home-made equipment utilizing only a single small receiving vacuum tube powered by "B" batteries of a type used in broadcast reception. The total power input of this diminutive transmitter is only 10 watts, a fraction of that used by the ordinary electric light bulb. The vacuum tube is of the familiar 201-A style and the batteries a standard make of heavy duty type. The transmitter employed a wave length of 39 meters, establishing the trans-Pacific low power record. Experimental work on such low wave lengths has recently been begun on a wide scale and this feat is a revelation to the engineers investigating the possibilities of short wave transmission.

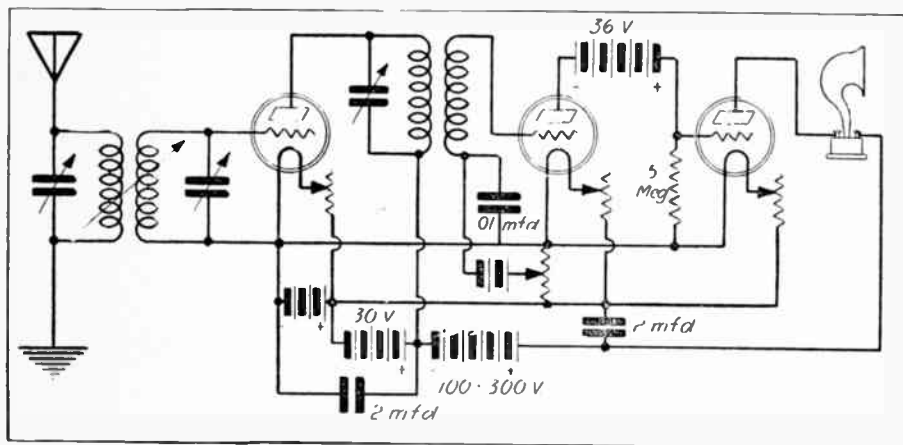

Fig. 6—A three-tube circuit which has one stage of R. F. amplification.

the trigger, practically the only limits to the degree of A. F. amplification obtainable are the capacity of the power bulb used and the value of the "B" battery potential.

This method of A. F. amplification may be applied to almost any existing receiver possessed by the reader. It is only necessary to cut out the A. F. portion, leaving the R. F. circuits as they are. In the detector circuit, the grid condenser and leak should be eliminated or short-circuited during experiments, and a suitable type of detector tube substituted for the one in use.

As pointed out above, the detector tube has to operate at, or very near, the lower bend of the characteristic, and this bend should be sharp. To bring the operating point to the lower bend, negative grid bias may be applied, but a tube possessing a grid of very fine mesh will require less bias and will function better.

As a general guide to the method of arrangement, a three-tube circuit is given in Fig. 6, which has one stage of R. F. amplification, coupled in the orthodox manner. With a suitable detector tube, the grid bias should not be more than 2 or 3 volts.

The potentials of the "B" batteries will also depend on the types of tubes used. The makers' stated requirements for the

tube before full advantage can be taken of the enormous amplification obtainable. Efforts to eliminate capacity effects should, therefore, be made, and also, in view of the unique position of the battery in the circuit, it should be well insulated from ground and connected to both tubes by as short leads as possible.

If, in operation, it is found that signals are so strong that paralyzation of the power tube results, this may be corrected by reducing the output energy from the detector circuit. De-tuning or dimming the detector filament will accomplish this.

Another way out is to alter the value of the power tube grid leak till a value is found which prevents paralysis. Alteration of the potential of B1 will also assist in achieving the same result.

If the circuit is switched on for the first time with a loud speaker in circuit, it will very likely appear to be quite dead, and nothing will alter this condition till some station providing the correct amount of signal strength to operate the trigger is tuned in. For this reason, it is advisable to tune in first with head phones in the detector circuit.

Once the correct adjustments have been found, the circuit will suddenly jump to life in a most startling fashion.

SERVICE FOR QUEENSLAND FARMERS

A special service of market reports for the benefit of farmers will be a permanent item in the programmes of the Brisbane broadcasting station (4QG), which has now practically reached completion. Owned by the Queensland Government, 4QG will work on a wavelength of 385 metres, with a power of five kilowatts.

HEAD PHONE OHMS

Many people have the mistaken notion that the resistance of head phones is a measure of their quality. Actually, radio head phones of 2,500 ohms resistance may be much better than others of 5,000 ohms resistance. The resistance is determined by the length, size and kind of wire used in their construction. Their performance is a matter of proper engineering design and the use of good materials.

A SINGLE-CONTROL SUPER-HETERODYNE RECEIVER

Simple to Construct and to Operate

By Harry J. Marx

The popular aim this season appears to be the reduction to one control of all tuned radio-frequency circuit receivers. All the old three and four dial circuits have appeared anew with a single control disguise. Certainly no one begrudges the attempt to reduce controls, but if it is going to be done, why not take it step by step?

The logical procedure is to take two of the controls and convert them to one. Obviously when three controls are reduced to one, the problem becomes more complicated. There must always be some form of compensation in design or mechanical adjustment to make up for any variations in the unified control from the original. It is easily seen that only one compensation or adjustment is necessary when a double control has

(Continued on page 36)

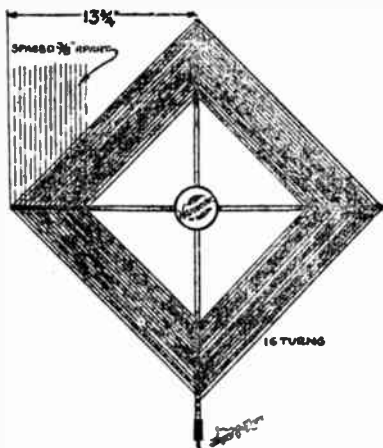
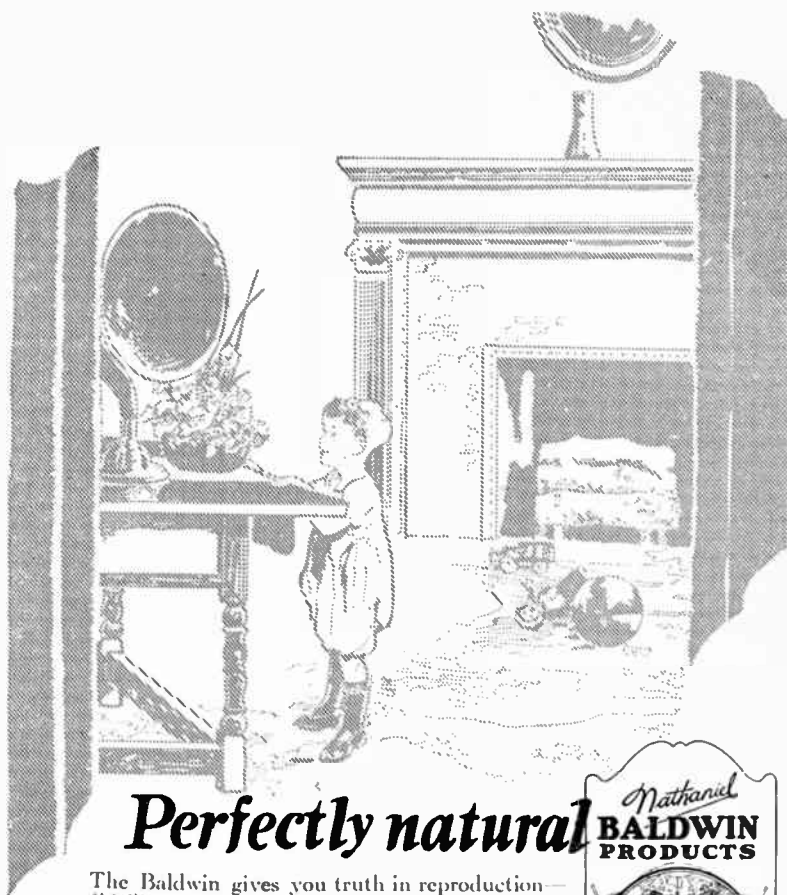

Fig. 3, Part 2



Perfectly natural *Nathaniel* **BALDWIN PRODUCTS**

The Baldwin gives you truth in reproduction—fidelity.

The Baldwin needs no one to adjust it—it needs no adjustment—there is no adjustment.

There's a Baldwin to meet your needs—horn or cabinet model, or built as standard equipment into many of the best radio sets.

Before you decide, hear the Baldwin.
BALDWIN INTERNATIONAL RADIO OF CANADA, LIMITED
Toronto Ontario

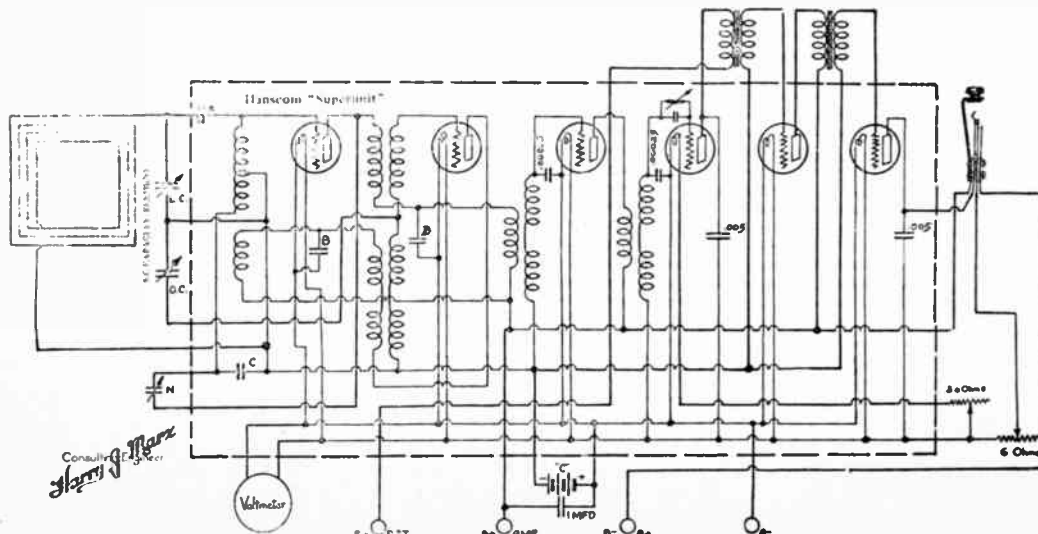
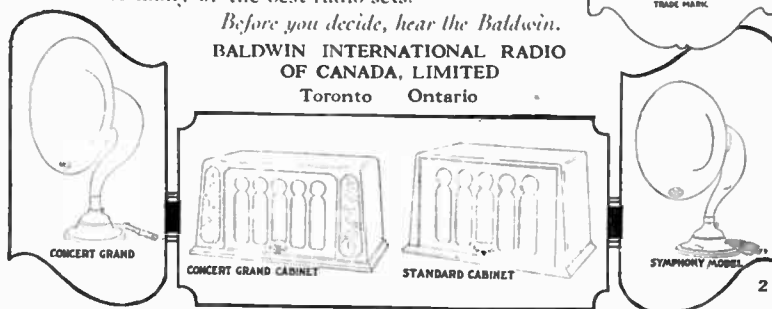

Fig. 1, Part 1

CAN'T WRITE WITHOUT HER RADIO

Daughter of London Dramatic Critic
Tells How She Composes Novel

"I can't write unless there's a noise somewhere near, and the radio is the noise I prefer," says Miss Micheline Keating, the 18-year-old author of "Fame," already in its fourth printing.

"I'm working on my second novel now and have my third planned. Sometimes I write in town while my big radio is on, but I often go outside of New York to do a few chapters. When I leave, I take my portable set with me, for I'd be lost out in the country with no sounds but owls hooting and waves lapping. Until I got the notion of using my small radio, I used to dash back into the city just to hear a few friendly noises."

Miss Keating is a tall blonde girl of English parentage, her mother formerly an actress, now a motion picture editor; her father dead many years, a dramatic critic on the "London News."

"I suppose I sound like a flighty flapper, having this distaste for quiet and repose, but that isn't true. I'm not a flapper."

This young author is convent-reared, doesn't smoke cigarettes or drink cocktails and never goes out to an evening party without a chaperone. Her rather advanced views of life have come to her mostly through books she has been reading since the age of twelve and also from her close contact with men and women of the stage and screen.

"It's the only atmosphere I know," she said, "and so it's all I can write about."

This sudden bursting into fame is not the result of any outside effort. Miss Keating's flight into authorship was quite an accident. She began to write for the sheer joy of amusing herself, and it was only when someone read the first half of her novel and showed it to a New York publisher, that she had any idea it would ever meet other eyes than her own.

"How did you come to do it?" she was asked.

"Well, you see, my mother was an actress in England, and I spent two years with Belasco, acting with the Lionels—Barrymore and Atwill. Being young, I had only a small part. In 'Laugh, Clown, Laugh,' my job for the evening was over ten minutes after the curtain went up, but I couldn't go home then for I was understudy to the leading lady and I had to stay until the last curtain was rung down. At first, I couldn't endure it, having nothing to do and being made to stay around, but soon I got the idea of writing a book. I used to

sit out in the wings, scribbling away. I remembered at school in France, they had told me I could write, but I never took it seriously. In fact, when I started this novel, I did it just for amusement, but Mr. Putnam got hold of it when I

doing theatre stories. But, of course, I can't say I'm exactly pleased with my first novel. 'Fame' has many faults. For one thing, it's uneven, but then, I suppose, I had to begin somewhere, and so it's not altogether wasted effort."



Miss Micheline Keating, 18-year-old author of "Fame," a novel already in its fourth printing. Miss Keating is a real radio fan, and says she cannot work without her radio going. "To me the stillness is oppressive, and I write best when there are friendly noises about. The radio makes the most pleasant sound of any, and so I keep it going when I'm writing. I think it is all but human."

was part way along, and told me if the last half was as good as the beginning, he would publish it. Maybe I didn't get to work in earnest then. I came home and told Mother I was giving up the stage for a writing career."

"Are you glad or sorry?"

"Well, of course, I like to write best of all. I'm doing a few short stories now, theatre background, but when I come home from a good dramatic performance, the spell of the thing is so on me I can't sit still. 'Baaa!' I tell mother, 'what's the good of writing when one can act? That's the real art!'"

"Are you always going to write about stage people?"

"Well, first, we try the things we know most about. I suppose I'll go on awhile

Miss Keating leaned across from the arm chair in her little writing room.

"I suppose you'd call it a good 'young' book, and I've had many letters from authors who have 'arrived,' telling me so."

"I'll see what we can get in," she said. "I always do about this time every day."

"How did you happen to get interested in a mechanical thing like the radio?"

"Well, one of the girls in our company out in Chicago used to go around to the broadcasting stations and sing. She often took me with her, and I never got over the thrill of watching her through the window of the studio. I used to sit out there and tell myself that it was her

(Continued on page 38)

Of all the Radio Sets
and Parts Manufacturers
95% use
BAKELITE
PANELS
TUBES
RODS
MADE IN CANADA



The radio manufacturers who set the pace for the industry are relying not only on inventive genius, but on a most careful choice of materials. They realize that the cleverest ideas for improving radio reception deserve and require the kind of construction that makes the most of those ideas.



The Genuine **BAKELITE** Radio Panels are sold only in the **golden-rod and black** package as shown above.

There is sound sense in accepting the judgment of the leading radio manufacturers and engineers, whose business it is to know all the facts as to the respective merits of radio insulation materials. Based on this knowledge and experience, they have chosen **BAKELITE**.

These reliable panels can be worked with ordinary tools. Sold by all good dealers at the same low prices as in the U.S.A.

BAKELITE RADIO PANELS

MADE IN CANADA

Sheets, Panels, Tubes and Rods
ELECTROPLAX LIMITED
163 Dufferin Street
TORONTO 2



A SINGLE-CONTROL SUPER-HETERODYNE RECEIVER

(Continued from page 33)

been converted to a single, but three and more controls when converted require two or more adjustments. Naturally, such adjustments are eliminated, if possible, but when this is done, it means a sacrifice in selectivity, volume or quality of reception.

The most popular two tuning control set has been the old super-hetrodyne, not only because of the ease of operation, but also because of its higher degree of selectivity. This, then, is the most natural circuit for use in a single control receiver.

The S-C Capacity Element

The S-C capacity element consists of two condensers mounted in such a manner that their capacities may be simultaneously varied with a single dial reading through 180 degrees. In addition, one of the condensers may be varied through 20 degrees of dial movement without disturbing the setting of the other. At the mid-point of the compensating adjustment, both condensers have equal capacity at any dial reading, and this compensator gives a plus or minus variation sufficient to cover any inequalities of tuning.

Super-heterodyne Application

Although this S-C capacity element can be used in connection with any receiver where a double condenser can be substituted for two single ones, we are only concerned with its application to the super-heterodyne circuit. This circuit consists essentially of two tuning controls—one to adjust the loop and the other to vary the oscillator frequency in order to produce the proper beat for the intermediate amplifier. This unit lends itself in wonderful manner to this type of circuit because the proper value of loop inductance may be obtained by using a loop of estimated size and number of turns. To do this, it is only necessary to vary the loop turns until a point is reached where the wavelength range can be covered with the least variation of the compensator adjustment. For the construction of this set, the required loop dimensions have been carefully estimated and checked. The details will be given later.

The super-heterodyne is different from tuned radio frequency in the respect

that it depends for its proper action on the constant difference of frequency between two tuned circuits. It is, therefore, only necessary to provide the same tuning range in each of the circuits and the compensator can be set so that one condenser will always provide more capacity than the other, thereby giving the desired beat frequency. It is possible to compensate for either the upper or lower oscillator setting.

units and in addition the problem of local oscillations.

Instead of using a potentiometer with its losses, Mr. Hanscom biased the grids of all tubes except the detector with a negative charge of 4½ volts. In this way, the plate current consumption is cut down to 10 milliamperes or less against an usual consumption of 25 to 40 milliamperes. Mr. Hanscom's ingenious method of transformer adjustment and

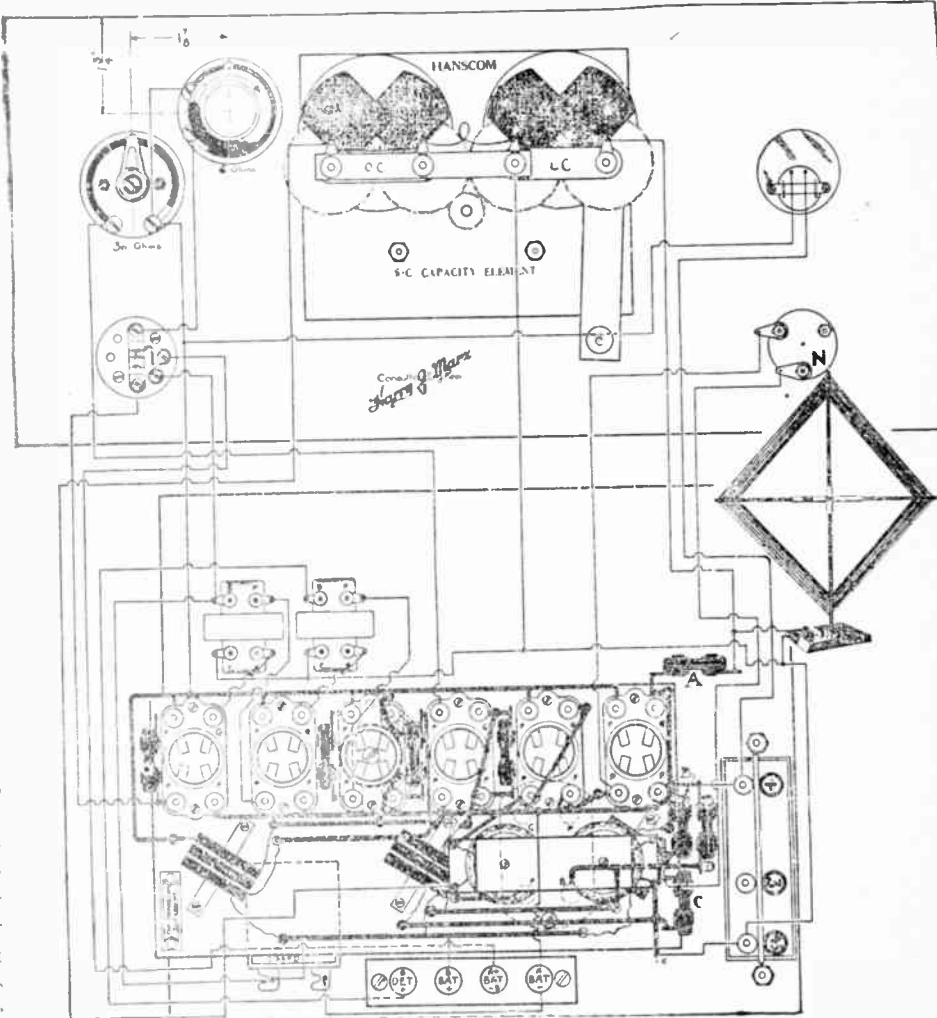

Fig. 4-Part 2

The Super-Unit

It remained for Mr. Allan T. Hanscom, an experienced radio engineer, to devise a simplified circuit in which the most efficient kind of amplification possible was obtained through sharply tuned intermediate frequency transformers. Greater efficiency can be obtained from sharply tuned air core transformers than the untuned iron core type. The difficulty, of course, has always been in properly matching such sharply tuned

neutralization makes it possible to eliminate all oscillation tendencies.

Very few home set builders have the means of making the necessary adjustments for checking the matching of the transformers, the balancing of capacities and the proper neutralization of all oscillation tendencies. Because of this, the popular and efficient super-units were evolved. In these, all the intermediate transformers, filters, oscillator coupler and balancing condensers with

EUREKA SALES COMPANY
 3 Home Investment Bldg. - Winnipeg
 WE DISTRIBUTE
AKRADYNE RECEIVING SETS
 WRITE FOR OUR PROPOSITION

EUREKA SALES COMPANY
 3 Home Investment Bldg. - Winnipeg
 WE DISTRIBUTE FOR
CARTER RADIO CO.
 WRITE FOR OUR CATALOGUE



tube sockets have been assembled in one compact unit. All the delicate, yet vital, balancing, matching and checking has been done in a well-equipped laboratory, where each man is an expert in such measurements. The unit then goes into the hands of the constructor all ready for assembly in the set with the least important wiring yet to be added. The super-unit is made in both four-tube and six-tube types, but a six-tube super-unit is used in building this set.

Parts Required

- One front panel, 8 x 18.
- One base panel, 10 x 12.
- One binding post panel strip, 7/8 x 4.
- Two panel strip supports, 1 1/2 ins. long.
- Four binding posts.
- One "C" battery, 4 1/2 volts.
- One Hanscom S-C capacity element.
- One Hanscom super-unit, type B-2, for 199 tubes.
- One midget condenser.
- One panel voltmeter, 0-6 volts.
- One rheostat, 6 ohms.
- One rheostat, 30 ohms.
- One filament control jack.
- Two audio-frequency transformers.
- One by-pass condenser, 1 mfd.
- One loop aerial (see Fig. 3).
- One cabinet to suit.
- Necessary wire, screws, terminal lugs, etc.

Both the S-C capacity element and the super-unit are made by the Hanscom Radio Devices, of Woonsocket, Rhode Island. These are the two all-important items of the receiver and on them depends the performance of the set.

In the circuit diagram, Fig. 1, the super-unit part of the circuit is enclosed in the heavy dotted line. Other parts are shown outside. All connections from the other parts to the super-unit are shown outside. All connections from the other parts to the super-unit are shown with a slightly heavier line. The capacities of the different condensers are given, with the exception of the four marked "A," "B," "C" and "D." The two marked "A" and "B" are put in during an assembled test, their value is very critical and must be determined by test. Condensers "C" and "D" are not

The Balkite Trickle Charger



for continuous charging—\$15

Charges both 4 and 6-volt radio "A" batteries at about .5 amperes. May be used in 3 ways:

(1) With a low-capacity battery of the type leading manufacturers are offering this fall for sets now using dry cells. Makes possible a most economical installation. (2) With a regular storage battery for sets of few storage battery tubes. It furnishes more current than is used by 6 dry cell or 2 storage battery tubes, so that if used while the set is in operation it need be used at no other time. (3) As a "trickle" or continuous charger for sets of as many as 8 dry cell or storage battery tubes.

Like all other Balkite Radio Power Units the Balkite Trickle Charger is entirely noiseless in operation, is a permanent piece of equipment, with no bulbs or moving parts, and nothing to replace, break or get out of order. 5 1/2 in. long, 2 3/4 in. wide, 5 in. high—fits in your dry cell compartment. Operates from 110-120 AC 60 cycle current. Special model for 50 cycles.

Sold by leading radio dealers everywhere.

Distributed by

SPARLING SALES, Ltd.

276 Smith Street, Winnipeg

RADIO SPECIALTIES, Ltd., 179 Pender St. W.

Vancouver, B. C.

BURNDIPT OF CANADA, Ltd., 130 Richmond St. W., Toronto
335 St. James St., Montreal



Balkite

Battery Charger

For charging radio "A" 6-volt batteries. Entirely noiseless. If your battery is low you merely turn on the charger and operate the set.

Price \$27.50



Balkite "B"

Replaces "B" batteries and supplies plate current from the light socket. Has no bulbs. Fits any set requiring not more than 20 milliamperes at 90 volts—practically all sets of 5 tubes or less, and most 6 tube sets. Fits in the usual dry cell compartment.

Price \$49.50



Balkite "B" II

Same as Balkite "B," except it will fit any set including sets of 8 tubes or more.

Price \$75

FANSTEEL
Balkite
Radio Power Units

BALKITE BATTERY CHARGER BALKITE TRICKLE CHARGER BALKITE "B" BALKITE "B" II

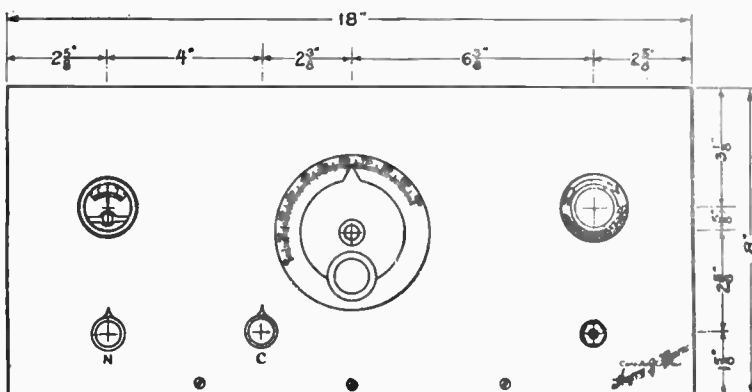

Fig. 2—Part 1

so critical, but will vary so no value is given.

The panel layout is shown in Fig. 2. The small knob and pointer marked "C" is the compensator adjustment of the S-C capacity element, while "N" is the midget condenser for controlling oscillation of the first tube. The rheostat shown is the 30-ohm, the 6-ohm is in the rear.

The S-C capacity element and the super-unit are clearly shown in Fig. 4.

(Continued on page 40)

CAN'T WRITE WITHOUT HER RADIO

(Continued from page 34)

voice coming through wood and glass over some wiring I didn't understand, and I could hear her just as though there weren't any walls or glass or wire between us. I don't really know much about radio. It's so vast, but I'm waiting till this winter when I can get the concerts to do a little experimenting. I'll be too busy, I suppose, to take much time to go out, but I can hear them over the air. Before this, I've always felt the radio has made nice sound harmonies, but they didn't seem real. I mean a voice sounded pleasant, but not like a human being, and hearing a piano solo was a long way from hearing the same thing played right in the room. But radio to-day, it seems to me, is like a bridge over which sounds pass, and when we get used to a bridge, of course, we seldom actually think of it. We walk across, but all we really see is the bank of the river. I think it's that way with radio. Some day, I expect, I'll be sitting here in my room, absorbed in my writing, and suddenly I'll hear singing. I'll look up, expecting to find an opera star at my elbow. For a moment, I won't quite know what it's all about, and then I'll suddenly remember I've left the radio tuned in and the voice is coming to me without distortion over this mechanical bridge of sound."

"And it's really only four years old, this broadcasting," someone suggested.

"Yes," said Miss Keating with a far-away look. "I think you'd call it a good 'young' art."

LOOP AERIALS

From the experience of radio engineers throughout the country, it has been found that the average loop aerial is about 5 per cent. as efficient as the average outdoor aerial. Indoor aerials are from 10 to 15 per cent. as efficient.

PREVENTING SHORTS

If there is a possibility of the rheostat shorting on the shield on the panel, cut a piece of mica and place between the rheostat and the metal shield.

MacMILLAN'S 40-METER WAVES PENETRATE TO ONLY ONE STATION IN THE EAST

A peculiar phenomenon has been observed by radio amateurs in the Eastern sections of the United States as a result of attempts to communicate by short wave radio with the MacMillan Arctic Expedition. With very few exceptions, all transmission east of the Allegheny Mountains has been carried on extremely short wave lengths in the neighborhood of seventeen meters. At the same time in the Central West, the 40-meter wave length has proved most effective. Scientists are at a loss to explain this peculiar condition. The one notable exception has been the successful exchange of messages between the Polar Expedition and that of the Radio Broadcast-Eveready short wave experimental station, 2GY, located at Garden City, Long Island. Using very low power, that station transmitted and received messages for over an hour on the 40-meter wave length, although other stations of greater power located in the East at approximately the same distance from the expedition's base are compelled to use the 17-meter wave length to accomplish the same feat.

The instrumental support which supplements the work of the Eveready group, a feature of the program of Station WEAJ and its associated chain of ten stations scattered through the East and Central West, has invariably attracted favorable comments from competent critics for its finished artistry. Max Jacobs is responsible for the excellent work of the symphony orchestra which is featured in most of the Eveready programs. As evidence of his experience, Mr. Jacobs organized a string quartet in 1910, which appeared in a series of subscription concerts for presenting new work for the first time. In 1915, Max Jacobs was appointed conductor of the New York Orchestra Society, which presented programs at Carnegie and Aeolian Halls, Metropolitan, Manhattan and Lexington Opera

Houses. Appearing with him were such world-renowned artists as Thibaud, Bonci, Amato, DeLuca, Zewla, Rappold, Fitzin, Namara, DeCisneros, Hinshaw, Seidel, Jacobson, MacMillan and others.

He was appointed conductor of the Brooklyn Philharmonic Orchestra in 1916 and conductor of the MacDowell Symphony in 1918. Recently, he organized the Chamber Symphony Orchestra, in order to provide cultured and sophisticated music lovers with symphonic novelties which seldom find a place on the programs of major orchestras. The instrumental artists selected for the Eveready Hour have all appeared previously with one or another of the major musical organizations of the country.

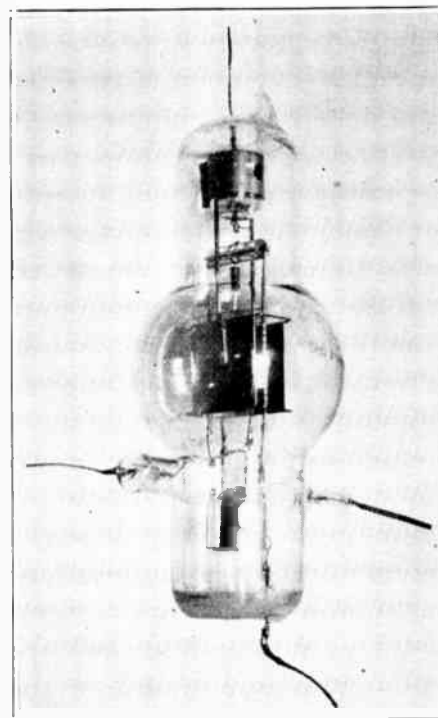

The new De Forest "H" tube for amateur sending, which is the farthest departure from the conventional transmission tube yet to be offered. In this tube, for the first time, the leads have been placed as far from one another as possible, one at either side and one top and bottom. This arrangement makes possible the use of extremely high voltages, with no chance of flash over, not only increasing the tube's efficiency, but reducing the danger of breakdown or burn-out.

We Are Distributors For
Brown
Loud Speakers
TORONTO RADIO CO.
LIMITED
64 King St. West - Toronto

We Are Distributors For
Carter Products
TORONTO RADIO CO.
LIMITED
64 King St. West - Toronto

We Are Distributors For
Baldwin
Loud Speakers
TORONTO RADIO CO.
LIMITED
64 King St. West - Toronto

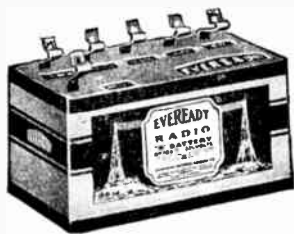
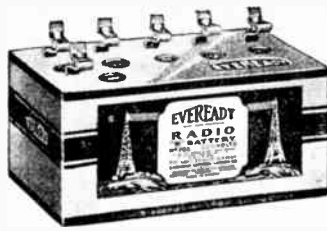

Eveready Batteries Increase Your Radio Pleasures

To fully enjoy your radio receiver, you must have good batteries. Eveready Radio Batteries are designed to meet every radio purpose and to give the longest possible service.

Evereadys are the most satisfactory and economical batteries you can buy. Every battery is subjected to many inspections and tests and comes to you ready to give many hours of steady, faithful service.

To get the best results—clear tones, ample volume and long distance reception, use Evereadys with your set. The Fahnestock clips on every radio "B" and "C" battery make installation easier and provides positive connections.

Your radio dealer will advise you the size of Evereadys you need for your Receiver—ask him!

CANADIAN NATIONAL CARBON CO. LIMITED
MONTREAL TORONTO WINNIPEG
Warehouses: Toronto St. Boniface, Man. Montreal

EVEREADY

Radio Batteries

—they last longer

A SINGLE-CONTROL SUPER-HETERODYNE RECEIVER

(Continued from page 37)

The heavy lines on the super-unit indicate the connections that are already made, while the lighter lines indicate the wiring that must be made to the balance of the apparatus. This corresponds to the connections as shown in Fig. 1, the hook-up diagram.

On the right side of the S-C capacity element will be seen a rectangular piece that projects below it. At the lower end of this piece there is a circle marked "C." This is the eccentric bearing actuated by the knob and pointer, and rocks the right condenser assembly, thus permitting proper compensation for any variations.

The arrangement of the different parts on the base panel is clearly shown, no dimensions are needed, as there is ample room. The "C" battery is clamped down on the right side. The binding post panel strip is mounted above the base panel, making use of the 1½-inch panel strip supports. This keeps the level of the strip the same as the super-unit. The super-unit has two legs and the transformer mounted on the under side, permitting a level setting of the unit for fastening to the base panel. The two audio transformers and the by-pass condenser are also fastened to the base panel in the positions shown.

The instrument on the upper right side of the front panel, Fig. 4, is the voltmeter. Below it is the midget condenser "N" corresponding to the same marking on the circuit diagram, Fig. 1. On the left side, the filament control jack is shown in the lower corner. This type of jack may not be so well known to some, but the type shown in the circuit diagram can be used. Above it are the two rheostats. The six ohm is the master rheostat for controlling all the tubes and can be mounted directly on the front panel or to an extension of the face plate of the capacity element, which can be obtained with a special larger size plate for use in this receiver. The 30-ohm rheostat is mounted on the front panel in the position shown in the panel layout, Fig. 2. This rheostat controls the filament current of the second inter-

mediate stage and acts as a throttle valve on the input of the detector which allows a perfect control of the volume without sacrificing quality. As it is connected in series with the main rheostat controlling all the tubes, it may be turned on full, except where signals are too loud. The base panel can be fastened to the front panel by means of metal angles or by passing machine screws into tapped holes in the base panel.

The actual wiring in the set has been reduced to such a minimum that it hardly appears necessary to devote much time to instructions on the subject. Keep all wiring as far away as possible from the coils on the super-unit. This is of the utmost importance in order to avoid trouble. Naturally, leads should not be made any longer than necessary and be sure of a good soldering job. If in doubt about terminals, a comparison of the circuit diagram and the picture diagram should easily solve the difficulty. Be careful not to break any delicate wires of the coils of the super-unit.

The super-unit is tagged, showing exactly to which wire each connection is to be made, so there is no reason for making any mistake in wiring. The loop aerial was pivoted in a bushing in the top of the cabinet, so the loop leads were passed through a hole in the cabinet and fastened directly to the proper terminals. If desired, two more binding posts can be added.

In order to have the proper inductance value in the loop, so that the tuning range of the condenser will check closely with that of the oscillator circuit, it becomes important that the loop be built to the specifications shown in Fig. 3. About one hundred feet of lamp cord or other insulated flexible wire is required. No specific instructions are required relative to the construction of the four arms, as any builder will possess sufficient ingenuity to make the frame. It will be found convenient to have the loop mount and pivot on the top of the cabinet. This will allow the use of short flexible leads direct to the set. Two binding posts on the lower upright are required in order to make connections. The loop can be made in the collapsible style if so desired.

The ends of the four arms should be of bakelite or hard rubber, so as to avoid any losses which would be detrimental to selectivity. The loop is directional in its effect and in tuning this will be found of decided advantage in improving the selectivity where interference is bad.

After the batteries have been connected, the tubes inserted, the loop leads attached, and the loud speaker plugged in the jack, then turn the 30-ohm rheostat on the front panel full on, now turn

the 6-ohm rheostat on the inside until the voltmeter reads about 3½ volts. The best setting can be found after the set is in operation. Once this is adjusted, it need not be touched any further with the exception when the battery may be in run-down condition. The 30-ohm rheostat in front can be used for regulation of volume. These adjustments cannot be made until the plug is inserted in the jack, as this closes the circuit and lights the tubes.

It should now be possible to tune in a signal by rotating the dial slowly throughout the entire wavelength range. For this preliminary tuning, the small midget condenser "N" should be set at maximum capacity. For local stations, this will not be found critical, but for long distance work, the adjustment will be very important. After the signal has been tuned in, the small compensator knob "C" should be turned until the signal is at maximum intensity and the loop may be rotated for the best receiving position.

Very often the volume may be materially increased, particularly on long distance work, by connecting a ground wire or antenna to the filament end of the loop. This end is the one which is connected to the "C" battery and is the terminal which may be touched with the finger with but little effect, if any, on the signal strength.

The plug for the loud speaker connection automatically shuts off the filament current when withdrawn from the jack, so no battery switch is necessary. The rheostats need not be turned off.

As the voltage of dry cells, if used, decreases with age, it will be necessary to adjust the inside rheostat from time to time in order to keep the voltmeter reading up to the mark.

Grid Leak

In the centre of the fourth tube socket from the right, Fig. 4, there is a hole through the base panel of the super-unit and the slotter shaft of the variable grid leak can be seen. By shaping a small piece of wood like a screwdriver and inserting it in the slot, the grid leak may be adjusted. Do not use a metal tool. A counterclockwise movement increases the resistance. Each unit is adjusted, but it may require slight readjustment after testing.

We Are Distributors For
Amplion
Loud Speakers
TORONTO RADIO CO.
LIMITED
64 King St. West - Toronto

We Are Distributors For
Westinghouse
Radiolas
TORONTO RADIO CO.
LIMITED
64 King St. West - Toronto



Ask the Splitdorf Merchant to Demonstrate for You

He will welcome an opportunity to let you hear the Splitdorf Inherently Neutralized Receiver in your own home.

Because he knows the Splitdorf Receiver eloquently tells its own story of pure, rich and mellow tone—of unequalled selectivity and sensitivity—of unprecedented ease of operation and unrivalled performance.

Splitdorf Receivers win in Demonstration.

Priced from \$75 to \$535.



Write for the name of your nearest Splitdorf Merchant

SPLITDORF ELECTRICAL COMPANY LIMITED
TORONTO - CANADA

BARTLANE PROCESS OF PICTURE TRANSMISSION

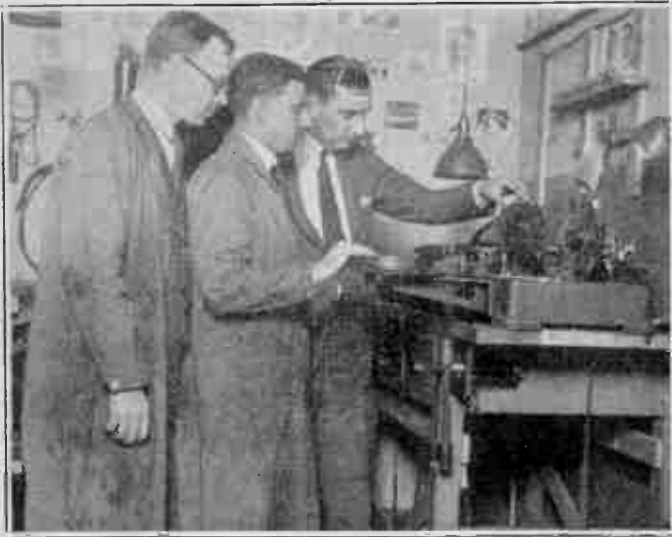

In connection with the accompanying pictures, the above photo shows, left to right: C. F. Willis and Capt. M. D. McFarlane, Bartlane experts of P. & A. Photos, and Frank S. Millar, of the Western Union Cable Company, receiving the picture of Princess Mafalda and Prince Philip.

American rights to the Bartlane process are controlled exclusively by Pacific & Atlantic Photos, Inc. The marvellous machine is an invention of Capt. M. D. McFarlane, of Pacific & Atlantic Photos, and H. G. Bartholomew, of the London Daily Mirror.



The above photo of Princess Mafalda, of Italy, and Prince Philip of Hesse, was cabled from London to New York by means of the marvellous Bartlane process of picture trans-

mission. It was taken at Racconigi, Italy, Wednesday, Sept. 23rd, immediately following the royal wedding, rushed to London by train and airplane and cabled to New York.

The Bartlane process is a method of picture transmission whereby a perfect picture is punched on an ordinary telegraphic or cable tape and transmitted over ordinary telegraph or cable lines. At the receiving station, the tape is run through a light projector, producing on a film an accurate reproduction of the original photograph.

Capt. M. D. McFarlane, of Pacific & Atlantic Photos, Inc., and H. G. Bartholomew, of the Bartlane Process, which is controlled exclusively in the United States by P. & A. Photos.

The above photo is from a slightly retouched reception. The faces have not been retouched at all, the only retouching being in the background.

ATWATER KENT ARTISTS SIGN CONTRACTS



Leaders in the musical world signing up with A. Atwater Kent, of Philadelphia, to broadcast in the Sunday night radio concerts. About forty artists will broadcast the series from WEA, New York, and the twelve connected stations. Left to right: Louise Homer, Reinald Werrenrath, A. Atwater Kent, Toscha Seidel, Anna Case (signing) and Hulda Lashanska.



**YANKEE
VOLTMETERS
AMMETERS
VOLT-AMMETERS**

Guaranteed Accurate.
Ask Your Jobber.

Manufactured by
LUNDQUIST TOOL & MFG. CO.
144 GREEN ST. - WORCESTER, MASS.

Tower



Scientific

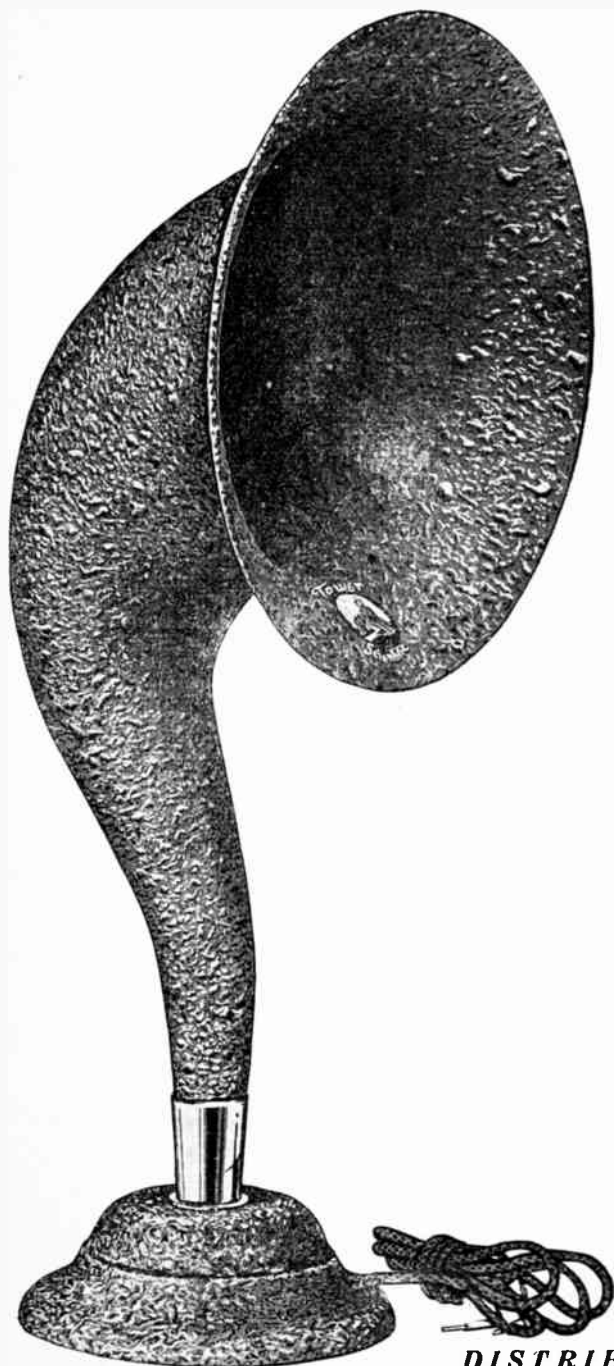

☞ This speaker fills the need for a medium priced speaker, with all the tone, quality and volume of the most expensive makes.

☞ The Reproducer is the famous Tower adjustable unit, with polished aluminum case, and 5-foot tinsel cord.

☞ Horn is of fibre, 11-in. bell, finished in black crystalline lacquer.

☞ Ferrule is burnished nickel plate.

☞ Compare it with any other speaker, regardless of price.

☞ Tests will prove it to be the finest speaker with list price of less than \$25.00.

Equipped with Adjustable Unit

Price \$12.⁰⁰

DISTRIBUTED BY

Radio Specialties, Ltd.,
Vancouver, B. C.

A. F. Smith Electrical Distributors, Ltd.,
Regina, Sask.

Imperial Radio Co.,
Sault Ste. Marie, Ontario
John Millen & Sons, Ltd.,
Montreal, Quebec

Western Radio Distributors, Ltd.,
Edmonton, Alberta

Consolidated Distributors, Ltd.,
Winnipeg, Manitoba

Emerson & Fisher, Ltd.,
St. Johns, N.B.

RADIO WAVE BOOSTING MAKES REBROADCASTING POSSIBLE

Boosting, or the amplification, of radio waves without changing their form or frequency was accomplished for the first time in the history of radio communication recently by two stations of the Westinghouse Electric & Manufacturing Company.

The achievement, which is considered as great an accomplishment in radio telephony as the inauguration of broadcasting, was recorded in a test conducted by Westinghouse stations KDKA, East Pittsburgh, Pa., and KFKX, Hastings, Nebraska.

High-frequency waves, the so-called short waves, carrying a spoken message and a musical program, from station KDKA, Pittsburgh, Pa., were received by a special receiving antenna at Station KFKX, Hastings, Neb., and there amplified many times and put on the air again at exactly the same frequency or wavelength, and at approximately the same strength at which they had been radiated from KDKA.

"The development of the radio booster system for radio makes reliable repeating or relaying feasible, as the development of the telephone "repeater" made possible long distance telephony," declared H. P. Davis, Vice-President of the Westinghouse Company and internationally known as the "Father of Broadcasting," in announcing the success of the test. "While our short wave transmission was very successful, reaching as it did all parts of the world, it could not always be depended upon, I have felt there was need of a repeater or booster system whereby it would be possible to send dependable transmissions by radio to great distances without loss of signal strength free from static and other sources of interference by amplifying the signals at stated intervals. Our efforts have been directed to the perfecting of this problem for some time.

"The result of this test shows that we have accomplished this and it is a real milestone in radio achievements. It provides the radio engineer with the thing he has been searching for to further his dream of making radio a practical, dependable method of communication over long distances which could not be accomplished even with the use of so-called super-power."

"The application of the new booster system to broadcasting will mean an amplification of program work far beyond that possible to-day. Programs emanating from a central source may be repeated by many hundreds of broadcasting stations; in fact, one program may service the entire world. All that is necessary is a sufficient number of booster stations to repeat and reactivate the signals. It is the possibility of this system to provide a radio service so much greater than that available to-day that makes it such an outstanding radio achievement."

The chief difficulty in boosting a radio wave, and one that hitherto has prevented it, lies in the fact that the receiving antenna at the booster station ordinarily would pick up signals from both the original sending station and the booster station itself, since both are radiating on the same wavelength. This "feedback" of the booster station into its receiving antenna would cause the system to oscillate and thus produce a howl that would defeat the desired purpose.

To prevent this "feedback," Frank Conrad, assistant chief engineer of the Westinghouse Company, devised a special selective receiving antenna that would not pick up signals from a certain direction. An antenna of this type was constructed about a mile north of Hastings and in such a position that it would not pick up signals coming from Hastings, but would pick up those coming from Pittsburgh.

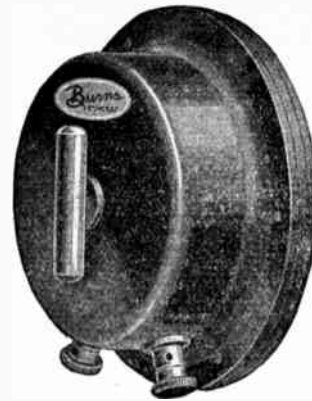

Burns

LARGE CONCERT UNIT

THE HEART OF THE SPEAKER

Large size in this unit gives great range of volume with tone of most pleasing qualities, which, combined with the special amplifying properties of the BURNS horn, produce remarkable results. The Horn is of distinctive design with pyralin flare in several handsome finishes.

It pleases the eye as well as the ear

Ask for full data and interesting trade prices
on a live line.

MANUFACTURERS

American Electric
COMPANY

State and 64th Sts. Chicago, U.S.A.



SOS HYDROMETER

FOR RADIO "A" AND AUTOMOBILE BATTERIES
SIMPLE - DURABLE - ACCURATE
EASY TO READ AND READY TO USE



Leading Battery manufacturers use the **Chaslyn Balls** as **Charge indicators**.

These Patented Balls show the condition of your battery.

Swim All **THREE**,
Charged **FULLY**

Sinks the **WHITE**,
Charge still **RIGHT**

Sinks the **GREEN**,
Charge is **LEAN**

Sinks the **RED**,
Charge is **DEAD**.

The **SOS Hydrometer** can
be purchased at your dealer.

CANADIAN REPRESENTATIVE:

302 RIDOUT ST., S. **THE D-H WILLIAMS CO.** LONDON ONT.

THE CHASLYN COMPANY

3843-45 RAVENSWOOD AVE. - CHICAGO, U.S.A.

Radio Patents Issued During September, 1925

- 253,157 Variable Electric Condenser—Frederick K. Crowther—September 1st, 1925.
- 253,233 Vacuum Electric Tube—Ernest Y. Robinson—September 1st 1925.
- 253,250 Vacuum Tube—Edna P. Stewart—September 1st, 1925.
- 253,311 Radio Apparatus—The Herzog Radio Corporation—John H. Herzog—September 1st, 1925.
- 253,364 Signalling System—The International Western Electric Company Incorporated—Western Electric Company Limited—Raymond A. Heising—September 1st, 1925.
- 253,365 High Frequency Signalling—The International Western Electric Company Incorporated—Western Electric Company Limited—Burton W. Kendall—September 1st, 1925.
- 253,463 Inductance Coil Control—George A. Turner—September 8th, 1925.
- 253,490 Electric Discharge Device—The Canadian General Electric Company, Limited—Ernest E. Charlton—September 8th, 1925.
- 253,492 Signalling System—The Canadian General Electric Company, Limited—August Schmidt, Jr.—September 8th, 1925.
- 253,493 Electron Discharge Apparatus—The Canadian General Electric Company, Limited—Albert W. Hull—September 8th, 1925.
- 253,495 Method of and Apparatus for Signal Reception—The Canadian General Electric Company, Limited—Wendell L. Carlson—September 8th, 1925.
- 253,497 Vacuum Tube Circuit—The Canadian General Electric Company, Limited—Glenn W. Carpenter—September 8th, 1925.
- 253,694 Cold Plate Vacuum Tube—Hovey B. Stoneman—September 15th, 1925.
- 253,695 Electron Discharge Device—James Henry Thompson—September 15th, 1925.
- 253,720 Dry Cell Terminal—The Canadian National Carbon Company Ltd.—Homer W. Jones and Carl H. Strohl—September 15th, 1925.
- 253,721 Spring Clip for Electrical Conductors—The Canadian National Carbon Company, Ltd.—Ralph J. Smith and Jay R. March—September 15th, 1925.
- 253,752 Means for Neutralizing Capacity Couplings—The Hazeltine Corporation—John F. Dreyer and Harry W. Dreyer—September 15th, 1925.
- 253,834 Variable Resistance Device—Lester Lawrence Jones—September 22nd, 1925.
- 253,918 Space Current Device—The Canadian Westinghouse Company Limited—C. Kirwer—September 22nd, 1925.
- 253,919 Space Current Device—The Canadian Westinghouse Company Limited—D. Ulrey and C. Kirwer—September 22nd, 1925.
- 253,963 Means for Supporting the Diaphragm of Telephone Transmitters or Receivers—The Marconi Wireless Telegraph Company—Henry J. Round—September 22nd, 1925.
- 253,969 Electric Discharge Tube—N. V. Phillips' Gloeilampenfabrieken—C. Bol and Balthasar van der Pol—September 22nd, 1925.
- 254,160—Rheostat—September 29th, 1925—The Central Radio Laboratories—Erwin R. Stockle—September 29th, 1925.

Westinghouse

Makes this

RADIOLA

Model III-A

with

Complete Outfit
Storage or Dry Batteries



Only \$5⁰⁰
Down

What an unequalled opportunity! Think of it—a genuine 4 tube Radiola, made by the great Westinghouse Company—with complete outfit all ready to use—delivered to your home for only \$5 00 deposit. Everyone knows that Westinghouse builds the “last word” in radio sets. Radiolas include the latest developments. They are the most reliable of all sets. Yet, our prices on Radiolas with complete outfits are surprisingly low. Our guarantee is the most liberal. Our terms are the most favorable. Write to us today for our big free catalog and full details of the exceptional offer now open.

2 Weeks Free Trial Easy Monthly Payments!

On a well known set like the Radiola, a free trial may seem hardly necessary. Even so, we make you this offer. Let us send you this complete outfit. Use it for two weeks in your own home. If you are not perfectly satisfied in every way, return it at our expense, and your “Good Faith” deposit will be cheerfully returned to you. Such an offer could scarcely be made on unknown merchandise. But we are safe in making it on Radiolas made by Westinghouse and you are protected against any possibility of disappointment. Our free catalog gives you all details of this great offer, including the terms of our monthly payment plan. Write for it today. See how easy it is to own and enjoy a genuine Radiola.

Send Quick for Special Offer

Even the great Westinghouse Plant cannot keep up with the demand for Radiolas. When our contracted supply is exhausted, future deliveries are uncertain. Prompt shipment is certain on orders placed early. Don't risk disappointment. Send the coupon at once. Get our big catalog.

**This Coupon
Will Do—
Send It
TODAY!**

**BABSON BROS.,
of Canada, Ltd.
Dept. R-218
110 Princess Street,
Winnipeg, Man.
321 King Street
Toronto, Ont.**

**BABSON BROS. of Canada Ltd., Dept. R-218
110 Princess Street, Winnipeg, Man.
321 King Street, Toronto, Ont.**

Gentlemen: Please send me your free book telling all about the wonderful Radiola 3-A, and about your special price offer, terms, and easy monthly payment plan! I understand that this request places me under no obligation.

Name _____
Address _____
Province _____

PARLOR MAGIC WITH YOUR RADIO SET

By *Hugo Gernsback*

(Member, American Physical Society)

Using your radio outfit for parlor magic and novelty stunts is a brand new idea. In this article, the author shows how your set can be used to entertain your friends in an entirely novel manner.

Those of you who think that a radio receiving set is good only for listening to the various broadcast programs are mistaken. Aside from giving its customary entertainment, a radio outfit, under certain circumstances, can become an excellent entertainer of the parlor magic variety. The stunts which are



Fig. 1—The "Radio Kiss." This photograph shows how this mysterious experiment is performed. Every time the performer kisses the lady's hand, music issues from the horn. A most astonishing and amusing experiment. Fig. 1A shows the connections clearly.

described below are all original, so far as I am aware, and have not been described before. Many variations may be made, and we now have a new source of entertainment from our versatile radio set.

In order to perform any of the experiments and entertainments herein described, it is necessary to have at least a 3-tube, or, better, a 5-tube set. The first stunt, which never fails to evoke surprise, might be termed "The Radio Kiss," although this may not be an exact name for it.

In the first entertainment, it is necessary to have for the surprise element a metallic chair.

This iron chair is of the garden variety, and while it is not so evident in cities, most country houses boast several of them. In order to make the experiment, it is necessary to have a metallically conducting chair. Should it not be possible to get a metallic chair like the one pictured, then the next best thing would be to get an ordinary wooden arm chair, and fit it with metallic handles, arm rests, or otherwise wrap tin—or copper-foil—around the arm rests, although this is not quite so good, because such a chair will always arouse the suspicion of the party to be initiated.

If a metallic chair is used, one wire from the loud speaker is run to one of the chair legs and connected with it. This may be done under a rug or carpet, so the connection will not show. In this manner, there will be no possible suspicion and the surprise effect is consequently heightened. The other end of the cord from the loud speaker goes to the 'phone plug, as shown, while the other pole of the plug connects to a cord or wire, which may be wrapped around a spoon or other metallic object, in order to make good contact with the performer's hand. It will now be seen that if the performer kisses the lady's hand, providing the radio set is turned on and there is a station going, the instant he touches the hand, the music, or whatever program there is from that station will issue from the horn.

In this experiment, the current flows through the performer's body, thence through the lady's hand and arm, while her other hand or arm is grounded on the chair, from which part of the current goes back to the loud speaker, thereby completing the circuit. It will be noted that music can issue from the horn only so long as contact is made between the performer and the one entertained, nor is the music or sound weakened, as a rule. So long as a good contact is made, the high frequency currents pass readily through the body, almost as if there were a solid metallic connection throughout.

As a rule, the lady being entertained will be skeptical that it is the contact between mouth and hand that causes the music. If she is, just ask her to touch your face or your hand herself. At the every contact thus made, music will, of course, be heard.

An added interest is given the experiment by touching a sensitive part of the subject's face, such as, for instance, her ear, or her lips, lightly with the finger. If a 3 or 5 tube set is used, a slight tingling sensation will be experienced, which, if a set is powerful enough, will sometimes be left as harmless little shocks, such as are given off by a weak shocking machine. **This occurs only if the touch is very light.** If the finger is pressed solidly against the skin, this effect will not be noticed.

Of course, the entire success of this experiment hinges upon the "victim's" not seeing the one wire running to the performer's body. Variations of this can be made as follows:

The performer may have a few short nails run through his shoes, in which case a hole has to be cut from the sock, so that his foot makes contact with the heads of the nails. Then metallic plate



Fig. 2—A variation of the "Radio Kiss," which might be entitled "The Touchdown." Here we have a chain of girls touching various portions of each other's skin. Music comes from the radio horn only when the chain is unbroken and when the girls actually touch each other. Fig. 2A shows how the connections are made.

may be put under the rug and connected with the one end of the loud speaker cord. The performer has then only to step upon the plate, and the nails will pierce the rug and make good contact with the brass plate. This will be very mysterious and afford an opportunity for quite a good deal of fun.

There are, of course, many other variations that will readily suggest themselves to any clever performer. If a

wooden chair with metallic arms is used, it is, of course, necessary to run the wire up to these metallic arm-rests, and I need not state here that the lady always has to make contact with the arm rests, otherwise the horn will remain silent.

Illustrations 2 and 2A show another variety of the same idea. Here we have a number of persons connected in a chain in series with a loud speaker and a set. In order to have sound come from the loud speaker, it is necessary that a complete, unbroken chain be established. Any number of players may join in this, but the more there are, the weaker the sounds will be. It will be noticed in this experiment that the sounds can be made to vary from very loud to weak, simply by having some one in the chain make a light contact, such as touching the skin lightly on the back of the hand. Also, it will be found that some parts of the body have higher resistance than others and consequently cut down the volume of sound. Thus, for instance, men, as a rule, providing their hands are dry, if five or six are in the chain, will practically kill all sounds from the loud speaker. This is due to the high resistance of the skin of the hands. If, however, the hands are slightly moistened, the loud speaker will come on with full strength as a rule.

In the chain experiment, as shown in illustrations 2 and 2A, lots of amusement will be created by the operator asking one of the girls to stick out her tongue and having the next partner

'SPARTA' FULL TONED SPEAKERS

*Your dealer will tell
you more about
these products*

MAKE
THE
ARTISTS
YOUR
GUESTS

*Liquid resonant tones,
volume in plenty, its
mellow throat brings in
the voice and music in
its original beauty
of expression.*



Dealers, write for particulars.

Fullers' Electric (Canada) Ltd.

93 King Street East
TORONTO

144 Craig St. West
MONTREAL

Obsolete

Take the "GUESS" Out of Tube Control

Ask Your Dealer

AMPERITE—the Self-Adjusting rheostat, takes care of tube current better than any expert operator could regulate it. No more hand rheostats or filament meters necessary. Brings the most out of each individual tube automatically. Simplifies wiring, doubles tube life, lowers set cost. Approved by all leading laboratories. Used in every popular construction circuit.

RADIALL COMPANY
Dept. C.M.1, 50 Franklin St., New York City

Write for **FREE** Hook-ups

AMPERITE
REG. U.S. PAT. OFF.
"means right amperes"

touch it with the tip of her finger. The tongue, being very sensitive and moist, will naturally carry a high amount of current. If the set is of the 5-tube variety, I can vouch that the same girl will not try it twice. Although the shock is not at all serious, it is somewhat disagreeable when experienced for the first time. This particular experiment, by the way, does not work unless the polarity is right. You may have to reverse the connections at the plug in a previous experiment to find out which is the correct polarity.

The next is a most interesting experiment, as interesting as it is surprising. Even your average radio engineer, if told that you can make a perfectly good head set with a pair of gloves, will prob-

ably laugh at you. Nevertheless, the following shows how to do it:

As shown in illustrations 3 and 3A, it requires two performers and one person to be entertained. The two performers must put on kid gloves (cotton or silk gloves do not work). One pair of gloves will do, namely a right and a left. The gloves should be put on the usual way, buttoned up, so that the palm of the hand and the stretched part of the glove become a diaphragm, which, when held with a spread hand, will be stiff.

The two performers now grasp leads or wires leading to the plug of the radio set. No loud speaker is connected in this case. The two hands with the gloves are put over the ears of the listener. Be sure that the gloves actually touch the

(Continued on page 50)

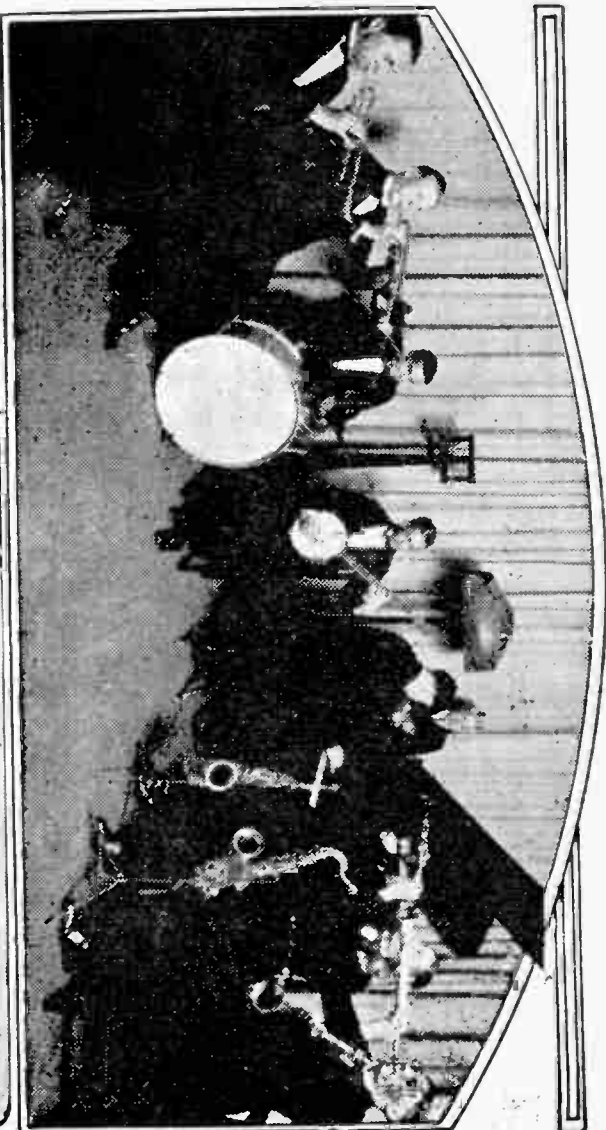

Above: Interior of the studio of Station WHAZ with an orchestra playing.

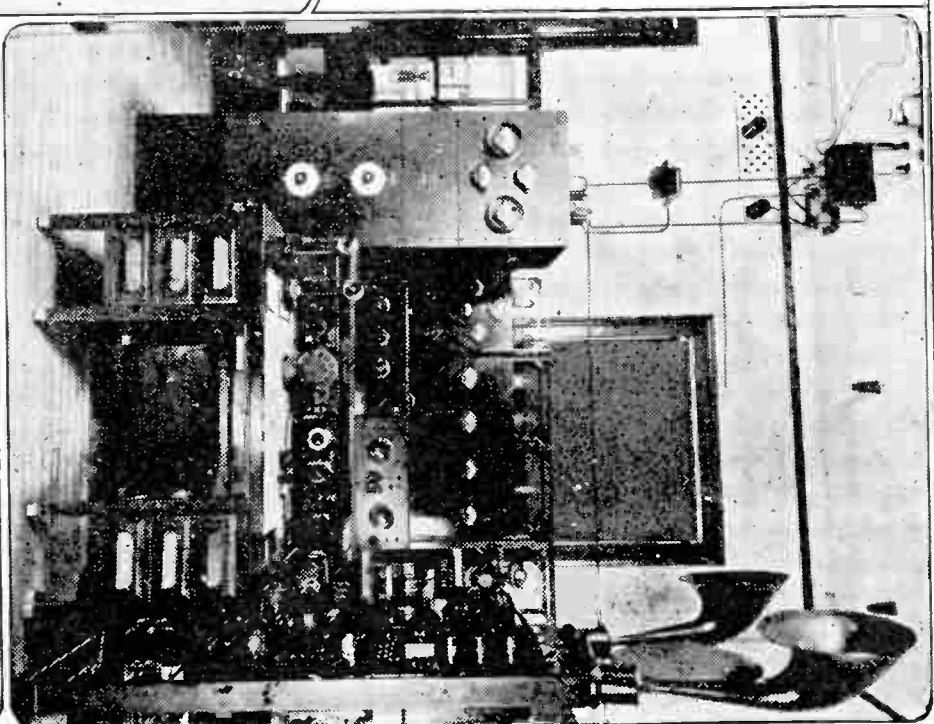

Right: The transmitting equipment. The panel on the left is the main transmitter.

Below: The antenna system on the roof of the engineering building of the college.

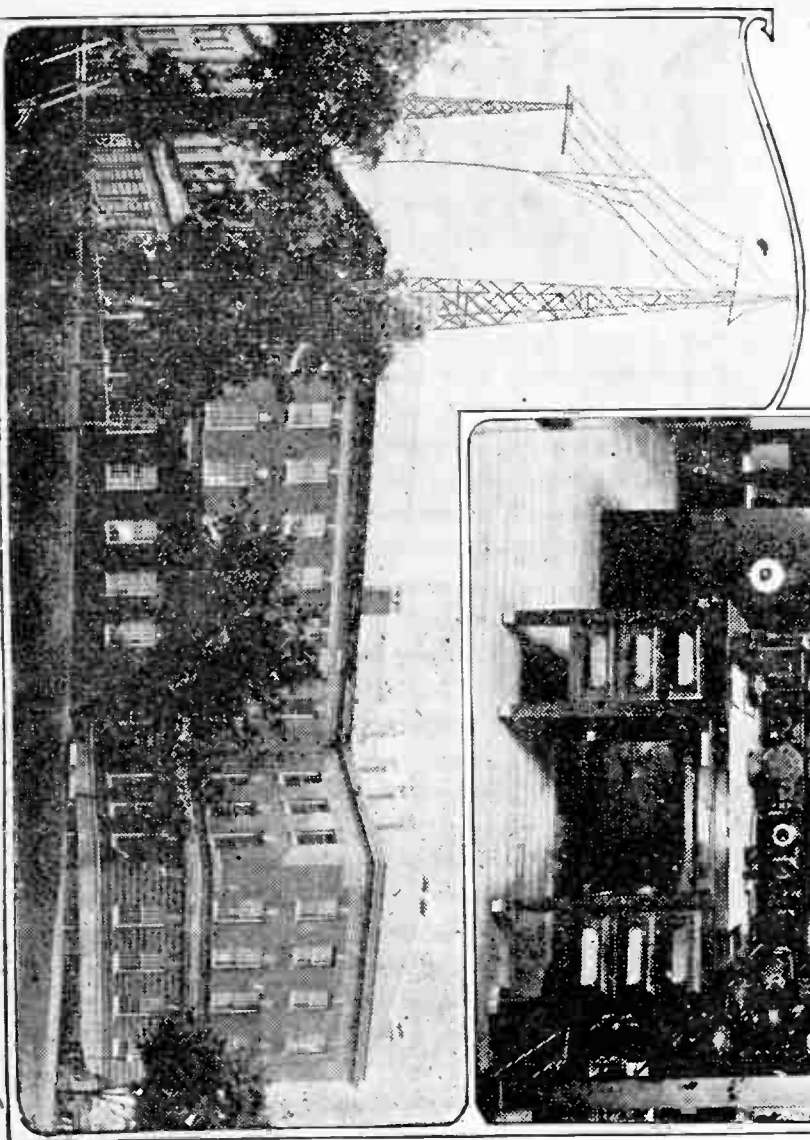

POPULAR AMERICAN BROADCASTING STATIONS

WHAZ, Troy, N.Y.

Unique among American broadcasting stations is radiophone WHAZ at the Rensselaer Polytechnic Institution, Troy, N.Y., the first of the Class B stations established in a college, which observed its third anniversary Monday evening, September 14th. It is unique not alone from the fact that it established in the early days of general broadcasting, February, 1923, the long distance transmission record of more than one-third the way around the earth, nearly 10,000 miles to New Zealand, accomplished under every regular Class B broadcasting condition at its regular wave length of 379.5 meters and with only 500 watts power, but through a long series of unusual radio tests carried out by the electrical communication department of the oldest college of engineering and science in America, which celebrated its centennial last October. Although regularly "on the air" only from two to four hours every Monday evening, aside from its elaborate experimental work, this station has earned the title of the "Transcontinental and International Radiophone" from the fact that its broadcasts have spanned the continent for approximately forty weeks a year for the last three years. This station has been heard with great fidelity and regularity, as more than 30,000 letters and messages attest, from coast to coast, from Alaska to Panama, and frequently in the Pacific Islands, West Indies, South America, England and Continental Europe.

This station has not been on the air many weeks when it became one of the first in America to be heard in continental Europe, France and Belgium, in November, 1922, and in Hawaii, at four points simultaneously, in December following. Two-way radio telephone communication more than 2,000 miles overland, a feat not duplicated, was carried at the will of the operators between WHAZ, Troy, and CFCN, Calgary, Alberta, Canada, in January, 1923. The program director has always sought un-

usual programs and unique features in radio, as becomes a college experimental station, and by dint of numerous experiments has introduced many novelties, some now become regular features of radio programs. The first minstrel show broadcast was in the WHAZ studio, first Boy Scouts program, first program of old-time songs, one of the earliest radio plays and introduced the "Hearies," in which the play was re-written and adapted for radio as it is for the "movies," first all-Spanish program by Latin-American students which was heard as far south as Peru, first Far East program by Chinese, Japanese and Siamese students, first concert by all blind performers, the ringing before the microphone of the same bell with which Professor Joseph Henry in 1831 first transmitted signals at a distance by means of the electro-magnet, forerunner of the telephone, telegraph and radio, and the first radio pageant on the sesqui-centennial of the Revolution were among many others.

Program for Indians

Long distance transmissions from WHAZ are not mere chance "pick-ups," in which the call letters were made out laboriously and the rest an unintelligible jumble. Four successive broadcasts were heard in New Zealand. Chief Lone Eagle, of Eagle Bar Ranch, at Winnett, Mont., requested a special program by the Campus Serenaders, students' dance orchestra, and sixty Indians danced to the music at the ranch. A college fraternity at Hotel Atwater, Catalina Islands, danced to music from the Troy studio, and at another time a group of cowboys in western Nebraska. One graduate of the institute makes it a point to entertain the public of his native city, San Salvador, Central America, with student programs from his alma mater by means of a loud speaker. A Harry Lauder imitator notified relatives in Scotland that he would sing on a cer-

(Continued on page 52)



Trumpets

Timbre of brass and thunder of trombone! Out over mountain and prairie, through storm and sunshine, it is carried on the waves of the air from the steel towers of the broadcast station. And in your home it rings out clear and strong — held fast to all the purity of the original by the marvelous power of Rauland-Lyric.

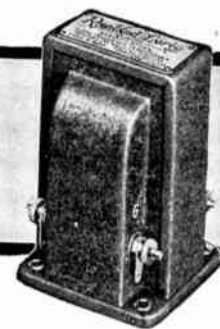

Rauland-Lyric is a laboratory-grade audio transformer designed especially for music lovers. The price is twelve dollars.

Western Distributor
BURNDIPT OF CANADA LTD.
130 Richmond Street, West, Toronto
335 St. James Street, Montreal

Eastern Distributor
STERLING SPECIALTIES
301 Travellers Building, Winnipeg
73 Davis Chambers, Vancouver

Rauland-Lyric
AN
ALL-AMERICAN
TRADE MARK
TRANSFORMER

The Choice of Noted Music Critics

We Are Distributors For
Brandes Head Phones
and Table Talkers
TORONTO RADIO CO.
LIMITED
64 King St. West - Toronto

We Are Distributors For
Northern Electric Peanut
Tubes and Sets
TORONTO RADIO CO.
LIMITED
64 King St. West - Toronto

PARLOR MAGIC WITH YOUR RADIO SET

(Continued from page 47)

ears. In the case of a girl, the hair must be pushed aside, as the experiment will not work well over the hair. If the



FIG. 3

Fig. 3—When kid gloves become a radio head-set. In this experiment, the performers grasp the two bare wires coming from the radio set, while their gloved hands are held over the listener's ears. She will hear the sounds as well as with a regulation head-set. Fig. 3A shows how to make the connections.

station is tuned in, she will hear the selections as loud as with a good head-set. This may seem surprising, but it is



FIG. 4

Fig. 4—Here we have a variation of the experiment shown under Fig. 3. Perhaps you do not believe that two sheets of letterhead paper may become a good radio head-set, but hearing is believing, and if you don't believe it, try it and you will have the surprise of your life. Here we have the two performers grasping the two wires coming from the radio set, while their bare hands rest against two letterheads pressed tightly against the young lady's ears. Evidently she is enjoying it, because the sounds are coming through loud and clear with no distortion, and fully as well as with a good head-set. The principle, by the way, is that of Dolbear's Condenser Telephone. Fig. 4A indicates the connections.

simply a variation of the good old condenser telephone, invented by Professor Dolbear in 1876. In this case, the hands of the performers form the two plates of the condenser, while the gloves are the dielectric. The head of the listener becomes the third plate. The leather diaphragm vibrates under the influence of the high-frequency currents, and the sounds are heard. This is a very pretty experiment and one that always arouses considerable astonishment, not only from the layman, but also from those who know something about electricity.

A clever variation of this experiment is shown in illustrations 4 and 4A. This is a duplicate of the preceding one, except that in this, no gloves are used, merely two pieces of stiff bond paper, such as used for letterheads. The two pieces of paper are pressed with the bare hands against the listener's ears, while the performers grasp the metallic ends of the wires coming from the phone plug in the two free hands, as in the glove experiment. If the choice of the paper is right, the listener will hear the sounds as loud as with a good head-set.

In both of these experiments, it is assumed that the strength of the signals is good. If they are weak, as, for instance, those coming from a distant station, the results will be very poor. The louder the signals received, the better the results.

SIEMENS

LOUD SPEAKERS

GIVE PERFECT REPRODUCTION OF EVERY NOTE AND EVERY WORD.

TO get the maximum of enjoyment, your Loud Speaker must be a good one. Amongst those of the highest class, the Siemens Loud Speaker occupies a pre-eminent position. It is just the right size for an ordinary living room, and the price is right. Needless to say, the workmanship and finish are first class, the appearance artistic and refined, and the quality of reproduction unsurpassed.

The Siemens Loud Speaker is manufactured in England by Siemens Brothers & Co., Limited. Each instrument carries a one-year guarantee.

Ask your dealer for a demonstration.

SIEMENS BROTHERS (CANADA) Limited
 281 McDERMOT AVENUE . . . WINNIPEG, MAN.

PRICE \$22.50

NEW VALLEY BATTERY CHARGER

The Valley Electric Co., St. Louis, Mo., pioneers in the mechanical rectifier field, has added the 96-volt series charging of "B" batteries to its type ABC charger, materially increasing its all-around usefulness. The advantages of this have long been recognized, but in accordance with its established policy, no apparatus is built by them that will not meet with the full approval of the National Board of Fire Underwriters, and the Hydro-Electric Power Commission of Ontario. Heretofore, the underwriters have refused approval on any apparatus that has an exposed voltage in excess of 25 volts. But with these regulations being broadened this year, the Valley Electric Co. has changed its former parallel charging arrangement, to the one shown in the illustration, where in 24, 48, 72 or 96 volts of "B" batteries may be charged in series, utilizing the front panel switch to secure the desired voltage. In addition, the taps for charging 2 volt, 6 volt and 12 volt batteries, are retained.

This high "B" battery voltage has given another advantage to the machine, a condenser across the contacts being found to give added smoothness to high voltage charging. This condenser is of sufficient capacity to entirely smooth out any interference that might be experienced by a receiving set in the neighborhood of a charger in operation.

The usual Valley high standard of construction has been maintained throughout, and it will be noted that this new machine is almost identical in appearance with the machine that has been so popular during the last two seasons. The same speedy 6 amp. charging rate has been maintained on the 6-volt tap, and the 3-amp. rate on the 2 and 12 volt taps. And in all voltages, there is an



RADIO AGENTS WANTED
5 Tube Demonstrator FREE!

Earn \$25 to \$100 a week, part or full time. Everyone a prospect. Complete line standard sets and accessories, \$5 to \$90. Write to-day for illustrated catalog and exclusive selling plan for live dealers and community agents. 20TH CENTURY RADIO CO., 1331 Coca Cola Bldg., Kansas City, Mo.

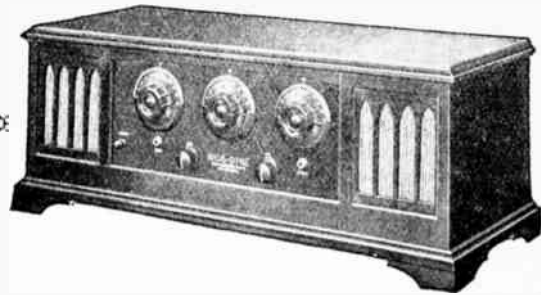

RICO-DYNE "De Luxe"
With Built-in Loud Speaker Price \$97.50

Nothing in Canada within Dollars of its Price or Value.

COMPARE THIS DESCRIPTION

No matter what price you pay, you cannot buy a better-built instrument than the Rico-Dyne. Imagine a five-tube straight line tuned radio-frequency receiver, handsome in appearance, marvellous in performance, with built-in loud speaker and compartments for batteries selling at this price! You must see and hear it in operation—no printed description can do it justice.

RICO-DYNE "Standard"

Similar to Rico-Dyne De Luxe, but without loud speaker or battery compartments. Gives the same distortionless reception; most selective and sensitive.

Price \$65.00



"Headset of Merit"

A Matchless Product at an Impressive Price... \$3.50



CANADIAN DISTRIBUTORS

ANGLO-AMERICAN RADIO DISTRIBUTORS

374 ANNETTE STREET - Phone Junct 3779W - TORONTO, ONT.

DEALERS—Write at once for our Proposition; it's Liberal.

MELOTONE PHONOGRAPH UNIT
(Adjustable)

\$9.50

MELOTONE CABINET SPEAKER

\$32.00

MELOTONE LOUD SPEAKER
(Horn Type)

\$15.00

Superfine—that's the RICO Line.

automatic tapering charge, so that it is quite impossible to overcharge a battery. The carbon-silver combination of contact point materials prevents any possibility of contacts sticking, and in every way the charger is as fool-proof as eleven years of battery charger building experience can make it. It is built in a black enamel case, with genuine black bakelite panel, and moulded glass top, the operating mechanism being exposed to view.

The Canadian Electrical Equipment Co. Ltd., Toronto, are Canadian distributors for the Valley lines of motors, battery chargers, "B" eliminators and Valteone receiving sets.

**GRINNELL BROS., OF WINDSOR,
SECURE ROGERS' RADIO
AGENCY**

The well-known Music House of Grinnell Bros., Windsor—a branch of the famous Detroit music institution—gave a great deal of consideration to the radio franchise which they felt was the best to offer to the public, and, in keeping with their reputation for quality, they chose the batteryless super A. C. sets. It was through the interest created by separate heading of the Long & Wilson exhibit at the Radio Show, Windsor, that convinced Grinnell Bros. of the possibilities of the Rogers' agency.

"DISTANTONE" FIVE

The Finest for Reception
Long Range, Selectivity,
Tone Superiority
Model "A", List\$49.50
Mahogany Finish
Model "B" 65.00
3-Tone Cabinet

FLORENCE SPECIAL

3,000-ohm Headsets, List..... \$3.50

A Special Canadian Made Head Set
FINEST QUALITY AND WORKMANSHIP

Florence Transformers —
High-grade Only,
.....\$3.25 and \$3.50

American Tubes—Guaran-
teed \$3.00

Eastern Coils — Newest
Types

Harkness, Roberts, Browning-Drake, RX-1
and T.R.F.

The BURNS Loud Speaker

Perfect in Tone
All Ranges

A Reproducer for Music
Lovers

List: Black,\$27.50
Mahogany 35.00
White 40.00

The "Selfish" Set— Martian Beauty

One Tube (6 volt), One or
More Head Sets

1,500 Miles—One Dial,
Very Selective

Use a Hotspot Battery and
a 45-volt "B"

Very Small—Compact—
Low Loss

"Cam-Fish" Co. Ltd.

70 King West - Toronto (2)

POPULAR AMERICAN BROAD- CASTING STATIONS

(Continued from page 49)

tain night, and they heard him. Receivers in the British Isles reported hearing WHAZ programs on seven successive Monday nights last winter, and sixteen listeners in different English towns reported fairly complete logs of the programs on the same night. A Boy Scout commissioner on a steamship en route to Cuba listened to a program he arranged before he sailed. A sea captain reported a complete program heard on shipboard in the South Seas, 5,000 miles from Troy. The postmaster at Wailuku, Hawaii, and a graduate with his family in the Hawaiian capital have entertained friends on more than one occasion with programs from WHAZ. Navy vessels often report concerts heard while passing through the Caribbean Sea, and on occasion the program has been reported from every state and territory of the Union, seven provinces of Canada, Cuba and Bermuda. "Personality" is put into the station by the program and participants rather than the announcer, who merely tries to make what is going on in the studio intelligible to the audience, and the programs are made as continuous as possible.

Student Broadcasts

Naturally the programs by the students of the Rensselaer Polytechnic Institute on the last Monday evening of each month, with a midnight program on the second Monday, have become a popular feature of WHAZ broadcasts, with the Symphony Orchestra, Campus Serenaders' Dance Orchestra, Glee Club and individual students participating. While the purpose of this radiophone is not merely to entertain, it has done that so well as to receive the commendation of every type of radio listener through its always varied and unusual programs. Educational features find an important place in the broadcasts in a way that make them interesting as well as instructive. Members of the faculty contribute practical and non-technical talks on subjects of current interest in the scientific and engineering field, and prominent speakers are frequently heard on topics of the day. The station furnishes no regular news, sports or market services.

Of the broadcasting apparatus, it is sufficient to state that it is the standard Western Electric 500-watt outfit, complete in every detail, and was installed through a gift of the Roebblings, graduates of the Troy Tech, famous as builders of the Brooklyn Bridge. WHAZ is under the direction of Professor Wynant J. Williams, associate professor of electrical engineering in charge of the

course in communication engineering, with a corps of instructor-operators, Harry B. Mimno, Hiram B. Harris and Bertram H. Cramer jr., each of whom has been engaged in radio experimentation from boyhood. In physical equipment, station WHAZ is similar to many other leading broadcasting stations of the country. Its ideal location on the top of the big Sage Building, one of the largest college electrical and mechanical laboratories in the country, at the crest of the beautiful hilltop campus, overlooking the Hudson River at the head of tidewater navigation, 150 miles from New York, is most advantageous. The remarkable success of the station is credited chiefly to the superior skill of the engineering experts in charge of its operation. The studio is attractive and in excellent taste, its walls being covered with soft gray draperies, floor heavily carpeted and ceiling with a double perforated covering, preventing reverberation. It is furnished with a fine piano and other necessary musical and pick-up devices. Rutherford Hayner has been the sole program director and announcer since the station was opened.

As an engineering college in which electrical and communication engineering is one of the major courses, Rensselaer Polytechnic Institute radio department has a remarkable equipment embracing practically every variety of apparatus. There are numerous long and short wave transmitters and receivers. Transmission and experimentation is almost continuous. The equipment includes the first wireless telephone equipment ever sold—an old De Forest set—by means of which Professor Williams delivered a lecture to students as far back as 1910, long before the general public knew anything of radio broadcasting. There is a Marconi wireless telegraph set of 1902, including a coherer of the original type, a German Telefunken system wireless outfit, and all the infinite variety of apparatus that has been developed in the intervening years down to the very latest improved devices. Many radio amateurs both in this country and abroad are familiar with the call letters of the institute stations, 2XAP, 2SZ and 2CDC.

LONG & WILSON, WALKERVILLE, DISPLAYED ROGERS' SETS AT WINDSOR SHOW

Long & Wilson, Walkerville, are having splendid success with the Rogers' agency, having already sold a number of sets ranging in price from \$260.00 to \$370.00. The Rogers is proving to be a money maker for dealers handling this latest radio invention.

MERCURY SUPER-TEN



A Canadian Achievement !

The **MERCURY SUPER-TEN**—in every feature that makes radio worth while—will gain by comparison with any set in the world, but what is even more important, it was designed and built for long distance reception especially to meet Canadian conditions, and under all circumstances will give uniformly satisfactory reception.

The **MERCURY SUPER-TEN** is the only commercial set of its kind on the Continent. Ten Northern Electric Peanut Tubes used in a new and exclusive **MERCURY** combination, give extraordinary distance on loop aerial, and selectivity that is "Knife-edged."



Outstanding Features of Mercury Super-Ten

- Employs 10 Northern Electric Peanut tubes in a new way.
- Gives phenomenal distance on loop aerial—2,500 miles.
- Will work the largest loud speaker to full capacity.
- Has four stages of Radio Amplification.
- Selective as your telephone.
- Simplicity itself to operate.
- Panel measures only 6¼ x 18". Set is 7" deep.
- Uses Push-Pull type Transformers in balanced Power Amplifier.
- Remarkably economical in operation—only ½ amp. per hour from 6v. Storage Battery.
- Can be supplied either in "KIT" form or completely assembled.

PRICES

Complete Kit (less cabinet and tubes)	\$110.00
Walnut-finish Cabinet, Model D	15.00
De Luxe Solid Walnut Cabinet, Renaissance Design.....	30.00
Complete Set, built and tested, with tubes and Cabinet, Model D	195.00
Peanut Tubes, each	3.00

Despite its enormous power and the number of its tubes, it is remarkably economical in operation. The **TEN** tubes require just 45% more current than **ONE** standard tube in the average set.

The tonal qualities of THE **MERCURY SUPER-TEN** are in keeping with its range and selectivity. Over twenty-five different makes of Audio Transformers were tested and rejected before one was finally found good enough to become a part of this truly wonderful set.

Do not buy a set at any price until you have read "The Story of THE **MERCURY SUPER-TEN**." This booklet is yours for the asking. Drop us a Post Card to-day.

*A Wonderful Opportunity
For Enterprising
Dealers*

H. M. KIPP COMPANY
LIMITED
447 Yonge St. - Toronto, Ont.

NEW WESTINGHOUSE RECEIVING SETS NOW READY FOR DISTRIBUTION



Westinghouse 55

Price \$150.00
Including 5 Tubes

OUR NEW ILLUSTRATED CATALOGUE, SHOWING OUR NEW LINES OF HIGH-CLASS RADIO SETS AND PARTS, MAILED UPON REQUEST

DEALERS, WRITE FOR
CATALOGUE
AND DISCOUNT SHEET

These two new Westinghouse Models stand supreme in the radio market, and cannot be equalled for volume, tone selectivity and ease in operation. Dealers should protect themselves by having these sets in stock when they are asked for.

A. CAREY and SONS

274 KING STREET E., HAMILTON, ONT.

Phone Regent 8579

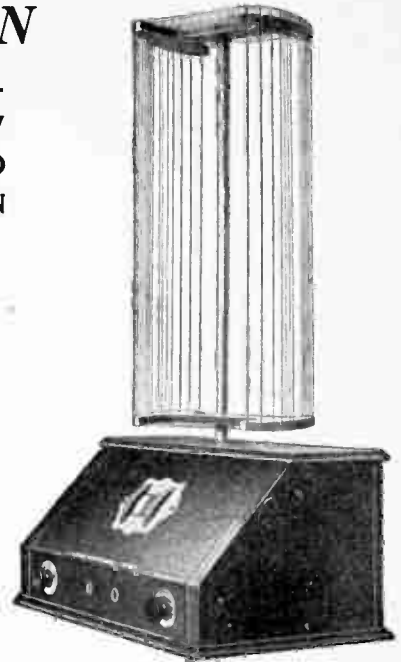

Westinghouse
8-Tube Superheterodyne
Price \$330.00
Including 8 Tubes, Loop
and Loud Speaker

BABY TRANSMITTER OF 9EX-9XH

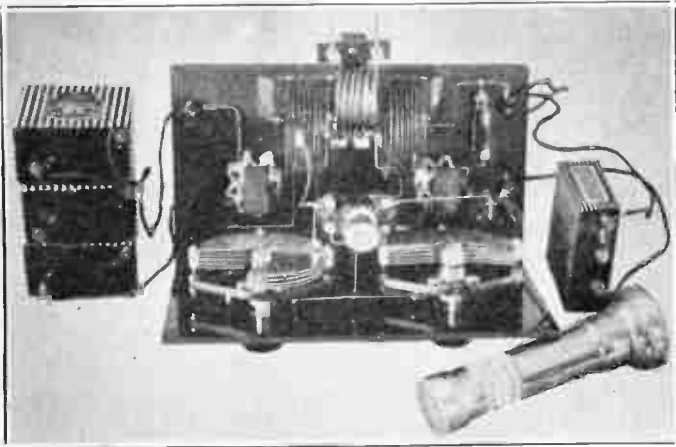

This is a picture of the Baby Transmitter of 9EK-9XH, Burgess Station, Madison, Wisconsin, and its "A" and "B" batteries with which communication is carried on up to 1,800 miles on the 40-meter band and with only one UV-199 tube.

The flashlight is shown for comparison. The power input into the set may be less than that taken by the flashlight.

The input to the tube is the total of the filament and plate watts. Some records which were made with this set are:

Auburndale, Massachusetts, 1,000 miles.....	0.98 watts
Mexico City, Mexico, 1,800 miles	2.00 watts
New York City, New York, 800 miles	0.41 watts

On the last test, the input was:

Filament, 3.0 volts, 0.06 ampere=	0.18 watts
Plate, 54.0 volts, 0.0044 ampere=	0.237 watts

Total	0.417 watts
-------------	-------------

The transmitter weighs five pounds and the parts can be bought for less than \$20.00. The batteries weigh four pounds and would cost about \$5.00.

The Famous Browning Drake Receiver

The highest development in tuned radio frequency sets combined with super power Daven Resistance Amplifier.

All Parts Carried in Stock Kit, consisting of

One National Tuning unit B.D. 1 (This contains one 0005 National condenser with 4-inch Velvet Vernier Dial and Tuning Coil mounted as unit).

This contains One National Unit B.D. 2 (00035 National condenser with 4-inch Velvet Vernier Dials and one National Regenerator also mounted as a unit).

*Send for Circular and Our Catalogue.
Workmanship and Efficiency Unexcelled.*

RADIO LIMITED

497 Phillips Square

Montreal

THE "LEAKANDENSER"

One of the few notable improvements in radio devices brought out this season is the new Daven "Leakandenser," an unique device which combines in a most attractive form a grid leak and a grid condenser. The Leakandenser attracted considerable attention at the recent New York Radio Show and many wondered why it was not thought of before. It is similar in size and shape to the conventional cartridge type of grid leak, with metal end caps, and may be mounted conveniently in the set by means of two spring clips supplied with the unit.

The Leakandenser is manufactured by Daven Radio Corp., 160 Summit St., Newark, N.J.

STONE & FOX, RADIO CONTRACTORS

Messrs. Edgar J. Stone and Charles Fox have formed a partnership to carry on the business of providing service for the radio trades. To the dealers in Toronto and the territory adjacent thereto, this should prove an important announcement.

Since 1912, Mr. Stone has been a radio enthusiast and has made it a specialty from the technical and practical standpoint. Returning from war experience, during which he was a lieutenant of the R.N.V.R., and saw stirring times in patrol service in the North Sea, he formed the Lyric Radio Company, and which he recently wound up.

Mr. Fox has also had extensive technical experience in the radio field, and is a member of the Radio Institute of Engineers. During the war, he was a special operator with the Navy.

The field Messrs. Stone and Fox have entered is one whereby they can give manufacturers, wholesalers, retailers and radio users service, including repair work, the erection of aerials, etc. They are equipped with motor truck, extension ladders, tree climbers, etc., for outside work, as well as shop and equipment for repairing sets, testing and adjusting.

The firm style is Stone & Fox, Radio Contractors, and premises have been leased at 331 Gerrard St. East. They are not and do not intend going into the business of selling sets, but believe that the dealers will welcome into the field reliable men capable of taking over the service worries that so frequently follow the sales receiving sets. Their telephone number is Main 4923.

VIMY SUPPLY CO. LTD. WILL DISTRIBUTE SAMSON ELECTRIC PRODUCTS

D. M. Fraser, Limited, announce that they have appointed the Vimy Supply Company, Limited, 14 Temperance St., Toronto, as distributors in Ontario for the radio products of the Samson Electric Company. "Samson" helical-wound transformers are gaining in popularity on account of their exceptionally low distributed capacity and since they have practically no distortion at any frequency.

Besides audio and radio transformers, the Samson radio products consist of a super-kit; a small neutralizing condenser, a radio-frequency choke coil, antenna coupler and double rotor R. F. transformer. These four products make up the essential parts in the "Samson" TC Assembly.

A high-grade R. F. variable condenser of very small size will also be placed on the market shortly.

On account of the growing demand for these products, it was felt that better service could be given the trade by having a large stock carried by the Vimy Supply Company. D. M. Fraser, Limited, are also the representatives for the Jewell Electrical Instrument Company, Chicago.

"B" Eliminators
Assured Success With New Type Tubes



TRANSFORMERS

CHOKES

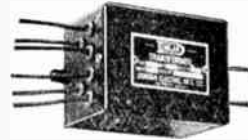

Designed especially for operation with the new Filament and Non-Filament Tubes, Dongan Transformers and Chokes are most essential parts of the remarkable new B Eliminators. These new Eliminators are thoroughly endorsed by Cockaday and other authorities.

TRANSFORMERS

- No. 509 Full wave
- No. 537 Full wave
- No. 537 Full wave
- No. 538 Half wave
- No. 538 Half wave

- For Raytheon Tubes
- For R.C.A. UX-213 Tubes
- For Cunningham CX-313 Tubes
- For R.C.A. UX-216-B Tubes
- For Cunningham CX-316-B Tubes

CHOKES

- No. 514 20 henry
- No. 506 30 henry
- No. 539 50 henry

DONGAN ELECTRIC MANUFACTURING CO.

WALKERVILLE - - - ONTARIO

Represented by
TORONTO—W. F. Kelly, 104 Richmond St.
MONTREAL—I. D. Livinson, 5335 Park Ave.
WINNIPEG—T. W. MacKay, 807 Electric Ry. Chambers

TRANSFORMERS OF MERIT FOR 15 YEARS

SOMETHING NEW

BENJAMIN ENSEMBLE

A complete 5-Tube R. F. Receiver of Benjamin Quality Products Built in One Hour

Front panel 8" by 24", walnut Celoron, gold engraved, all parts mounted, including 3 dials, 2 rheostats, 3 condensers, jack and battery switch.

Sub panel, black Celoron, all parts mounted, including coils, transformers, sockets, brackets, fixed condensers, grid leak and marked terminals. Also ten feet of wire.

Four screws attach sub base to panel—**JUST A FEW WIRES** and you have a **QUALITY RECEIVER** at **MINIMUM COST**.

SIMPLIFIED DIAGRAM makes it **IMPOSSIBLE** for the most inexperienced **TO GO WRONG**.

IMMEDIATE DELIVERIES—JOBBERs AND DEALERS, SEND FOR PROPOSITION ON THIS SNAP SELLER WITHOUT DELAY

Benjamin Electric Co. of Canada, Limited
Toronto - - - Ontario

CONTROLLING OSCILLATION IN R.F. SETS

When all of the better grade models of receiving sets are brought out this Fall by the leading manufacturers, it will be found that one of the principal improvements in the tuned radio-frequency circuits will be the introduction of a 200,000-ohm variable resistance, such as the centralab radiohm. Orders for more than a million of these radiohms from set manufacturers indicates the extent to which this method of controlling oscillation in radio-frequency sets will be used.

With this improvement being made in the manufactured sets, there is no reason why the home set builder shouldn't take the same advantage. The accompanying diagram shows how the radiohm can be connected in series with the "B" battery lead to the plates of the radio-frequency tubes. A bypass condenser of from one-half to one mfd., indicated by "C," is necessary between the negative filament lead and the primary of the radio-frequency transformer.

The purpose of making this change is to give perfect control of the tubes on all wave lengths. This tube control is vitally important. It has long been known that a set which will not whistle or squeal under certain conditions will not produce volume or distance.

This whistle is actually caused by the carrier wave of an incoming signal combining with the high-frequency wave generated in the set when the tubes are operated in a state of oscillation. For clear reception, the tubes should be just below this point. In addition to causing whistles and squeals, the music or speech received will be mushy and distorted when the tubes are oscillating.

Many types of receivers, of which the neutrodyne and tuned radio-frequency types predominate, oscillate readily and require some means of control. Attempts to make receivers non-oscillating by means of small fixed condensers or by reducing the number of turns in the transformer primaries, are successful only at a sacrifice of volume and range. Over certain portions of the dial, the set may operate satisfactorily, but over the whole range, additional control of the tubes is necessary.

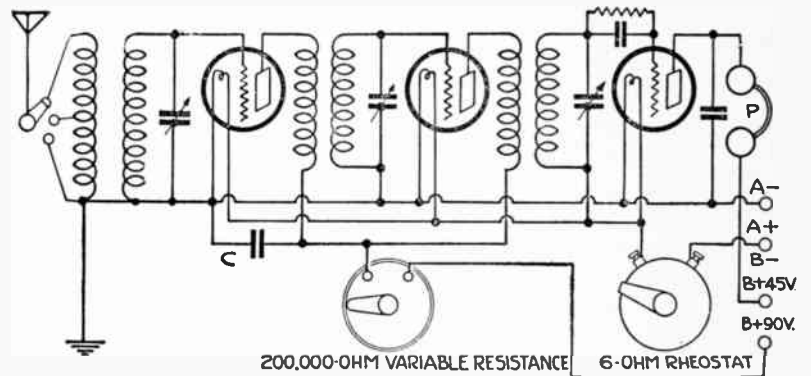

The majority of receiving sets are improperly neutralized or balanced. Faint signals can be brought in by turning up the rheostats, a poor and critical method of control, at best. By the use of a radiohm, the receiver can be controlled on all wave-lengths with the noiseless variable resistance.

The Crystal with  *Valve Power*

NEUTRON

THE WORLD'S GREATEST RADIO CRYSTAL
CONCERT TESTED AND GUARANTEED
 Acclaimed by every Radio user as by far the best Crystal on the market to-day.

PURITY AND TONE UNEQUALLED.
SENSITIVE ALL OVER AND THROUGHOUT.

Buying Agents of good standing who are desirous of taking up this famous crystal are requested to communicate at once with the Sole Producers.

PRODUCED BY
NEUTRON LTD.
 SENTINEL HOUSE - SOUTHAMPTON ROW - LONDON W.C.1

"RELATIONSHIP BETWEEN THE RADIO MANUFACTURER AND THE AMATEUR"

Extracts from Mr. Frost's speech, given at the New York Radio Show

By Herbert H. Frost

(President, Radio Manufacturers Assn.)

Mr. Toastmaster, Ladies and Gentlemen:

It is indeed an unusual honor and pleasure to appear before you to-night and greet you on behalf of the Radio Manufacturers' Association of the United States.

A great deal has happened in the last few years in the radio world, and as I stand here, I see many familiar faces of old-time amateurs who attended your convention and Radio Show at the Broadway Armory in 1921. Looking back over the years, it is amusing to recall the type of apparatus exhibited at that show. I am sure that visitors coming to the Armory were under the impression that the best exhibit was the one having the largest rotary spark gap, capable of making the most noise and that the most successful transformer was the one that would blink the lights until they were almost out. I remember a great amount of discussion about the Armstrong circuit. Small groups of A.R.R.L. men could be seen most anywhere about the Armory engaged in discussion of the values and voices of this particular hook-up, which at that time was conceded to be the last word in radio.

The American amateur does not have to make place in the sun, as there is no greater organization in radio than the A.R.R.L. and certainly no organization can claim the brilliant

record of past performance that is a matter of A.R.R.L. history. The peace-time achievements of your organization are apparent to everyone connected with the radio industry and the radio manufacturers in particular.

But far greater than peace-time work is the brilliant record of the American amateur in the world war. When the call to arms came in 1917, our nation was caught in a state of unpreparedness, which will always be a black page in American history. Realizing his duty, the American amateur enlisted in the Signal Corps of the Army and the Radio Communication Section of the Navy. I cannot tell you how much this meant to your country at that time.

Communication in military forces represents the nerves of the Army. Take away this communication and you effect a state of paralysis, the same as would be experienced by loss of nerves in the human body. Therefore, our military forces were able to grow no faster than our communication service could be expanded and brought to a state of high efficiency.

The American amateur furnished the nucleus of trained specialists and their radio knowledge made it possible for the Signal Corps and the Navy to train thousands of men to be military operators within the shortest possible time.

(Continued on page 60)

THE "BULLPHONE" NIGHTINGALE

BRITAIN'S BEST

Let "BULLPHONES" do the talking and they'll sell themselves!

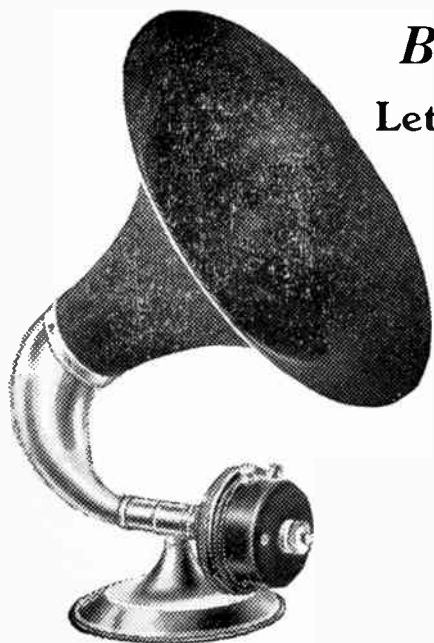

*NIGHTINGALE
Model De Luxe*

Unequaled for volume of sound and clarity. Crystal Black Bell, N. P. Arm and Stand.

Height, 21 in.
Bell Mouth, 14 in.

\$28.50

*NIGHTINGALE
Concert Grand*

This Model, owing to its great volume, is most suitable for Large Halls and Outdoor use.

Height, 26 in.
Detachable Bell, 14 in.

\$32.50



BULLPHONE GRAMOPHONE ATTACHMENT
Made in 2000 ohms **\$15.00**

INSIST on hearing a "BULLPHONE"

Canadian Distributor:

J. H. WALKER,

Jobbers, write for Territory

28 WELLINGTON ST. WEST
TORONTO

Manufactured by W. BULLEN, 38 Holywell Lane, Gt. Eastern Street, London, E.C.1, Eng.

IMPROVING SELECTIVITY OF SETS

For Tuned Radio-frequency and Neutrodyne Receivers

By Harry J. Marx

One of the most popular questions of the day is the one of the best method of improving the selectivity of the many five-tube tuned radio-frequency and neutrodyne types of receiving sets. It would be rather difficult to estimate the actual number of these types of receivers in use at the present time. In rural and suburban sections, they give fairly satisfactory results, but in large cities and especially where broadcasting stations are numerous, there is much cause for dissatisfaction.

The trouble can be easily remedied, but, unfortunately, most people seem to go about it in the wrong way. There is no reason for scrapping the present set and buying a new one. Before explaining just how it can be done, it might be well to just make a diagnosis of the trouble.

In practically all of these sets, the tuning unit consists of a radio-frequency transformer with a secondary winding that is tuned by means of a variable condenser. The primary or antenna winding usually consists of but a few turns in a fixed inductance relation to the secondary. This means that the

is often asked that if by loosening the coupling, the energy of the interfering station is cut down, but does it not at the same time reduce the energy of the station that it is desired to receive. Sometimes it does and then again it may not, depending entirely upon the wavelength difference between the two stations. The reduction in the station tuned in, compared to the reduction of the interfering station, is small enough to be negligible. Besides the sacrifice of a slight reduction of volume is well worth the compensation of good clear reception of the desired station.

In order to obtain complete resonance for various wavelength ranges, it would really be desirable to vary the coupling between the primary and secondary circuit. In a tuned radio-frequency transformer, this variable coupling is not so important, but in the tuning unit in front of the first tube, it becomes very valuable. When a station is tuned in and the coupling has been adjusted for resonance between the two circuits, then the energy transfer from the antenna to the



Fig. 1

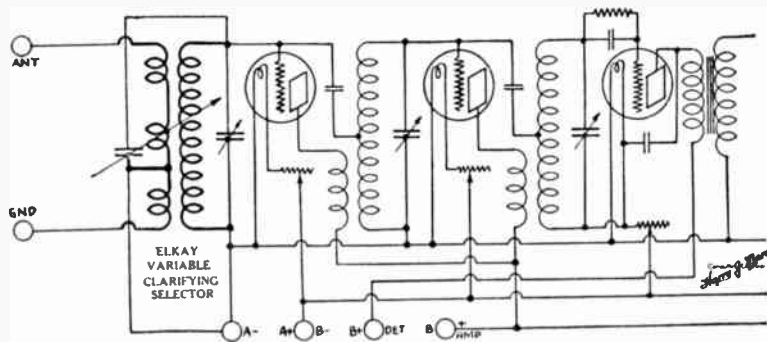

Fig. 2

coupling between the two circuits remains fixed. In some cases the primary and the secondary are both grounded and in others, there is no primary winding, a tap on the winding providing for the antenna connection.

In a tuning unit of this type, where the coupling remains fixed, or where there is just a single circuit arrangement, the selectivity of the receiver is limited because the energy transfer from the antenna to the grid of the first tube has a fixed value. If the incoming signals which are collected by the antenna were all of the same intensity, then there would be no difficulty in separating them. Unfortunately, there are in many places powerful local stations which, because of proximity, send out an excessive amount of energy, which when collected by the antenna because of the fixed coupling relation, is passed on to the grid. Although the secondary may be tuned to a different wavelength, still this excessive energy forces its way through, creating the interference and spoiling the reception from stations of nearby wavelengths.

What is necessary, then, is some control or what may be called an "electrical valve" which will control the amount of energy or power, which is passed on to the grid of the tube.

Variable Coupling

Variable coupling is the natural solution to this part of the problem. This, however, again creates some further difficulties that will be taken up and discussed later. The question

secondary will be considerably weakened for an interfering wavelength over the transfer that would take place if there was a fixed coupling. In other words, there is a decided loss of energy of any frequency except the one to which the circuits have been tuned to resonance.

Disadvantages of Variable Coupling

A disadvantage was mentioned above. This is the fact that every time the coupling between the primary and the secondary is altered, it immediately effects the adjustment of the variable condenser that tunes the secondary circuit. This coupling is a factor in the inductance value and if the inductance is altered, the wavelength of the circuit is changed. This makes it difficult to log the dial setting of the condenser and has been the main objection to a variable coupling control.

If this difficulty can be overcome, then it is easily seen that a variable coupling unit becomes not only an advantage, but in fact is a vital necessity to good selectivity. Each circuit will then have an "electrical valve" that stands at the door and keeps guard to see that only the desirable wavelengths get through, while undesirables are barred.

Variable Clarifying Selector

This instrument consists of a fixed secondary winding that is tuned with a separate .0005 microfarad variable condenser and a two-part primary or antenna winding—one part fixed coupled to the secondary and the other part on a rotor which

(Continued on page 62)

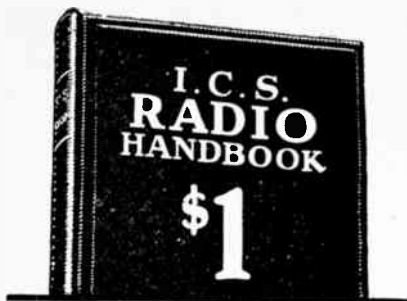

This
RADIO BOOK
will save you money!

Compiled by HARRY F. DART, E.E.
Formerly with the Western Electric Co.
and U. S. Army Instructor of Radio

Technically edited by F. H. DOANE

NEW edition off the press! The greatest book on radio ever written. Price only \$1. Filled with sound, practical, tested information for every radio fan, from beginner to hard-boiled owl. Written, compiled and edited by radio experts of national reputation.

Every page tells you something useful. And there are 514 pages! More than 150 illustrations and diagrams!

You may dip into this I. C. S. Radio Handbook at random, or hunt up special information you want, or read it right through. Different types of receiving and sending hook-ups are explained; interesting experiments; definitions; codes and symbols; technical data and thousands of suggestions for getting more pleasure out of radio. Will save you from wasting money on things that won't work. 100,000 already sold.

Send \$1 to-day and get this 514-page I. C. S. Radio Handbook before you spend another cent on parts. Money back if not satisfied.

—TEAR OUT HERE—

International Correspondence Schools
Canadian, Limited
Dept. 1613C Montreal, Can.

I enclose One Dollar. Please send me—post-paid—the 514-page I. C. S. Radio Handbook. It is understood that if I am not entirely satisfied I may return this book within five days and you will refund my money.

Name.....
Address.....
Check here and enclose \$1.50 if you wish the de luxe edition, bound in Leatheroid.

THE BULLPHONE

This popular British loud speaker is now on the Canadian market and is creating a good deal of interest in the trade. It is a nice looking instrument, and has a very natural tone and good volume.

It is being distributed in Canada by J. H. Walker, 28 Wellington St. W., Toronto, Ont.

CONNECT IN SERIES

Several speakers may be used at one time by connecting them in series. In this way, dance music may be received sufficiently loud to be heard all over a dance hall of considerable size.

5 TUBE PEARSON

(Tuned Radio Frequency)

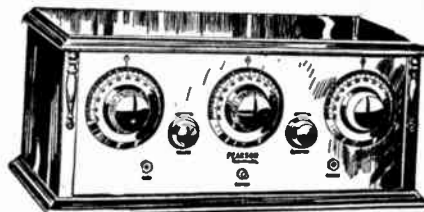

The Set that has startled the Radio World in Tone, Volume and Price

Quantity production has enabled us to quote this low price on a set of this great selectivity, range, volume and fine tone—a real sales leader. It is a marvel at any distance, and for positive easy control cannot be beaten. The magnificent cabinet is a model of the cabinet maker's art and the finish is in keeping with the high quality of the working parts of the set.

A demonstration will prove its leadership.

List price without batteries or tubes... **\$86.90**

What a User Said :

"I tuned in on twenty-one stations in two hours with two high-powered locals going full blast less than one and a half miles away." Order a demonstrating set to-day.

New 1926 Line Now Ready

A few territories still open for authorized dealers.

Canadian Pearson Radio Company

374 Pape Avenue - - Toronto, Canada

Do you believe in Names? Look for the initials R.V.C.

EVERY Radiotron manufactured by the Radio Valve Company, who have been manufacturing radio valves in Canada for several years, is marked R.V.C.

R.V.C. Radiotrons are distributed to the trade exclusively by the Canadian General Electric Company and the Canadian Marconi Company, which is your guarantee of quality.

For Sale by Dealers Everywhere. **U.V. 199 \$350**

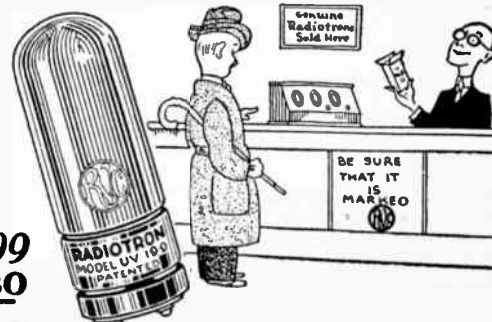

Radiotron

Canadian MARCONI Co & Canadian General Electric Co Ltd

R10

Sangamo Mica Condensers



In reflexing ~ ~

where accuracy brings results

Because of their high accuracy, Sangamo Mica Condensers give perfect results in reflex circuits, where exact capacity is necessary to success. Any receiver, whatever the circuit, is improved by the use of Sangamo Condensers.

They *are* accurate, and they *stay* accurate. The accuracy of these condensers is not affected by heat or cold, moisture or acid fumes, soldering or electrical surges.

They are solidly moulded in brown bakelite, which will not chip or crack. The edges are rounded, and substantial ribs increase their mechanical strength.

All in all, Sangamo Condensers are as fine condensers as money will buy, not only on account of their sustained precision, but because their workmanship and finish is in harmony with the beautiful construction of the highest quality of radio parts on the market.

All standard capacities. Your dealer should have Sangamo Condensers. If not, insist and he'll get them for you.



Sangamo Electric Company of Canada, Limited

Radio Division, TORONTO Head Sales Office, MONTREAL

"RELATIONSHIP BETWEEN THE RADIO MANUFACTURER AND THE AMATEUR"

(Continued from page 57)

In the early part of 1917, I was assigned to the command of a radio company of one of the Regular Army Field Signal Battalions and found that out of a total strength of 76 men in this company, 52 of them were licensed amateur operators who had enlisted at the first call, and I know of one town in Pennsylvania that gave 11 amateurs to the Signal Corps out of a total of 13 licensed members who were residents of that city. So you can see, gentlemen, that the American amateur and the A.R.R.L. have made their bid for fame and stand before us to-day richly endowed with a past record in both peace and war.

What is the present and future status of the American amateur and how is he related to the radio manufacturer? Speaking for the radio manufacturers, I can assure you that our interest in the radio amateur is great. It cannot be otherwise. Every radio manufacturer knows that every amateur radio station is a laboratory and that the radio stations of the A.R.R.L. members make the radio laboratories of the world.

If you will search the records and go back far enough, you will find that most of the great things in radio had their inception in some amateur station about 2 a.m., and to-day we find an ever-increasing number of serious-minded amateurs experimenting with the unknown quantity of radio. Certainly from all this we can expect to draw a great measure of advancement and development.

The radio manufacturer realizes the value of the amateur and it is the desire of the members of the Radio Manufacturers' Association to draw from the ranks of the amateurs men who can qualify in technical or sales capacities.

Your organization has been unusually honored during this year. You have been asked by the Navy Department to work with the Pacific fleet; you have been asked by the Signal Corps to handle the training camp communications of the National Guard and the Organized Reserves; you have been asked to extend your services in keeping communication with that heroic band of explorers under command of Donald B. MacMillan, now located within the Arctic circle.

Let me assure you, young gentlemen, that the radio manufacturer will always welcome a visit from an amateur, and that the members of the Radio Manufacturers' Association stand ready and anxious at all times to help the amateur in planning his career as an individual and also in furthering the interests of the American Radio Relay League.

It has indeed been inspiring to appear before you to-night and I am sure the local members of your organization have planned many interesting things for your benefit while in our city. I thank you.

UNITRON BATTERY CHARGERS

Two sizes: No. 00, charges at 2½ amps.; No. 0, 6 amps. No. 0 also charges "B" batteries up to 110 volts in series.

Complete with bulb and connections for socket and battery, price, No. 00, \$25.00; No. 0, \$35.00.



Great West Electric Co. Ltd. - Winnipeg, Man.

VARIOMETER COUPLED R.F. RECEIVER

By **Carlton E. Butler**

Member, American Institute of Electrical Engineers
and Institute of Radio Engineers

Properly constructed, with good parts and workmanship, the variometer coupled radio-frequency receiver is surpassed only by the super-heterodyne for efficiency and range. Selectivity is remarkable and the set will not radiate energy while the tubes are controlled at their proper operating point by the potentiometer.

It has been repeatedly demonstrated that tuned radio-frequency amplification is essential to provide sufficient selectivity to tune through the maze of broadcasting stations now on the air, and to give sufficient volume to operate a loud speaker on distant stations. At the present time, the majority of radio receivers incorporate tuned radio-frequency in some form or other.

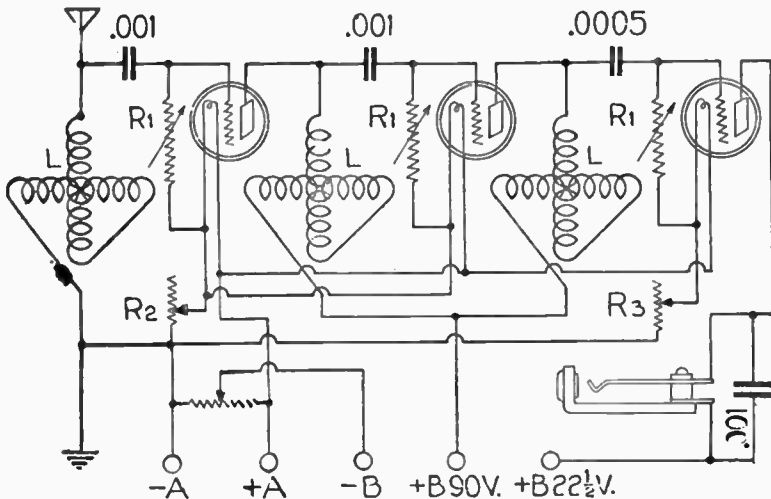

Three-tube inductively tuned radio-frequency receiver. With two stages of audio-frequency, this circuit will equal or surpass any of the five-tube sets for volume and range.

The circuit described in this article uses a combination of fixed condensers and inductive tuning, in place of the usual arrangement of fixed transformers and variable condensers. Variometers are used instead of condensers for tuning, and the receiver is stabilized with a series of variable resistances from the grids of the tubes to the negative filament lead. The following parts will be needed:

- Three variometers, capable of tuning from 200 to 550 meters.
- Three .001 mfd. mica fixed condensers.
- One .0005 mfd. mica grid condenser.
- One 200,000-ohm non-inductive variable resistance.
- Two centralab non-inductive variable grid leaks.
- One 400-ohm centralab non-inductive noiseless potentiometer.
- One each 30-ohm and 6-ohm rheostats of centralab type.
- One telephone jack.
- Three sockets.
- Binding posts, wire, etc.

The resistances are very important, the one on the first tube should be capable of going below 10,000 ohms. For this purpose, the 200,000-ohm radiolohm, as manufactured by the Central Radio Laboratories of Milwaukee, is recommended for the first R₁.

For noiseless reception, it is essential that the non-inductive variable grid leaks be used for R₂ on the second and third

tubes. Once the leaks have been adjusted so that oscillation does not occur at any setting of the dials, further adjustment will not be required except with the potentiometer, which controls volume and will be found very helpful in tuning in distant stations.

As the first two tubes are controlled by a single rheostat, it need be but half of the resistance required for operating a single tube. A 30-ohm rheostat will control the first two tubes if they are of the UV-199, C-299, UV-201-A or C-301-A type. A 6 ohm will be the proper size for the detector if the one ampere UV-200 or C-300 detector is to be used. A 30 ohm is best for the other types of tubes.

Stations will generally come in over the first part of the first variometer dial and over the latter half of the second and third dials.

EBY PATENTED BINDING POSTS

**Standard Equipment on
150 Manufacturers' Sets**

Unvarying built-in superiority made them select EBY posts. They are your logical choice, too. You can find whatever markings you need for your hook-up among the twenty-five in which EBY posts are furnished. The tops don't come off. Identify the genuine article by the name on the base.

Canadian Representative:

Trade Mark Registered

EUREKA SALES COMPANY

3 Home Investment Bldg. - Winnipeg

WE DISTRIBUTE THE

Baldwin Line of Loud Speakers

DEALERS, WRITE FOR PROPOSITION

PATENTS - - -

Procured in all Countries

TRADE MARKS AND DESIGNS
Special Attention given to Patent Litigation
Pamphlets sent free on application

RIDOUT & MAYBEE

156 Yonge Street - - - Toronto, Ont.



WRIGHT SUPER-5

Priced at \$60.00 and \$70.00

Startling new results are obtained with this new set. The WRIGHT SUPER-5 is the outstanding set of the 1925-26 Radio season.

- No more interference from local stations!
- No more crowding together and overlapping of low wavelength stations.
- No more trouble in receiving those distant favorites.

See the new Battery contained Model at your dealers.

Write us for literature and your dealer's name.

WRIGHT RADIO LIMITED

Offices and Factory - MONCTON, N.B., CAN.

RUSSELL'S HERTZITE

*The CRYSTAL
for the CONNOISSEUR*

Two Grades in
Sealed Boxes. Price 50 Cents

STILL A FEW DISTRICTS
OPEN FOR SOLE AGENTS

WRITE

The L. G. RUSSELL LABORATORIES
1-7 Hill Street, Birmingham, England



IMPROVING SELECTIVITY OF SETS

(Continued from page 58)

can be turned to permit any degree of inductive coupling. In fact, as it is rotated, a variometer effect is created giving wide coupling range which is not critical in operation.

On the end of this instrument is attached a small compensating condenser which is automatically controlled by the rotor shaft. As the rotor shaft is turned and the coupling altered, this compensator adds capacity as required in order to make up for any alteration of inductance value due to the changing of the coupling. Fig. 1 shows the Elkay Variable Clarifying Selector with the compensating condenser mounted on the end. It is made by the Langbein-Kaufman Radio Co., of New Haven, Connecticut.

It is obvious, too, since this device controls the amount of energy passed through to the tube, it may also be used as a means of controlling the volume of sound produced by the receiver.

Using the Clarifying Selector

The impression may be gained that this is a complicated instrument and difficult to add to a set. This is far from being the case. Fig. 2 shows the hook-up diagram of a neutrodyne, in which the clarifying selector has been substituted for the first neutrodyne coil. This instrument requires a .0005-mfd. variable condenser to tune the secondary, so the capacity of the variable condensers used in the set should be checked up. Of course, this creates an extra control, but it is one that is to be desired since it performs two functions—controlling selectivity and volume. The radio amplifier stages are not shown in the hook-up, as that is not affected. Where plain radio-frequency amplifiers are used, the addition of the clarifying selector is the same as shown for the neutrodyne.

When using this instrument, the logging of the condenser dial is unaffected by the setting of the selectivity control.

This device may also be added to a three-coil system where a tickler is used to increase regeneration in the circuit. The inductive reaction may be compensated by the addition of this device to the tickler shaft.

HAMILTON RADIO SHOW

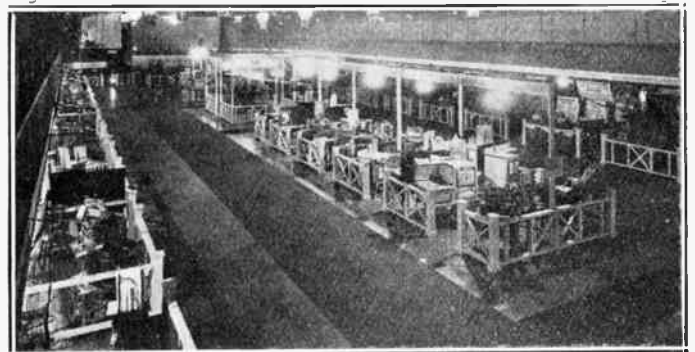

The Radio Show at Hamilton, Ont., was a complete success and many thousands attended during the week.

RADIO NEWS OF CANADA IS
YOUR BEST ADVERTISING
MEDIUM



Powel Crosley, Jr., prominent radio manufacturer, has been appointed Chairman of International Radio Week. During this week, beginning January 24, tests will be conducted in broadcasting between Europe and America. The new American super-power stations should result in better reception than has ever before been attained in transoceanic broadcasting. Crosley was recently elected Vice President of the National Association of Broadcasters.

FANS TO HEAR ENGLAND THIS YEAR, SAYS CROSLLEY

American radio listeners as a whole will be able to hear England and enjoy the special programs broadcast from that side of the Atlantic during International Radio Week, according to Powel Crosley, Jr., of Cincinnati, chairman of the committee in charge.

"We recognize the fact that thousands were disappointed last year," said Mr. Crosley, "but success is now assured. We have made tremendous plans for complete co-operation between the British Broadcasting Company and all broadcasting stations in the United States, Canada and Mexico. If promises are kept, not an American station will be on the air during the British broadcasting hours. Moreover, due to the tremendous power which English stations will have at their disposal by January 24th, when the tests commence, almost any good receiving set in America should pick up their programs.

"We are also satisfied with the magnitude of these tests that we are asking artists who have never broadcast to give their services, and we feel certain they



QUALIDYNE

The Superior Set

5 Tube Tuned Radio Frequency

Accuracy—This is the key-note of the Qualidyne success. No set can be truly efficient unless every unit is perfectly matched and is accurately made. All Qualidyne major units are built by us—each one is subjected to a rigid test. Combined with a unique application of the tuned radio-frequency principle, this gives you the Qualidyne—a Custom Made Receiver. Complete with batteries and phones, \$195.

A new standard of radio reception will be yours with the Qualidyne—reception so far in advance of what you have received that you will never be satisfied with less than the Qualidyne offers. Our production is limited—we cannot make the Qualidyne on a quantity basis. Get the clear-cut proofs of Qualidyne performance at once.

C & G Superior Condenser

This Condenser is a perfect straight line frequency—the principle that has superseded the old type of instrument. Insulated shaft—no body capacity, adjustable rotor shaft, special attachment to operate cut-in condenser—these and many others are features of the C. & G. For sheer efficiency, it cannot be approached.

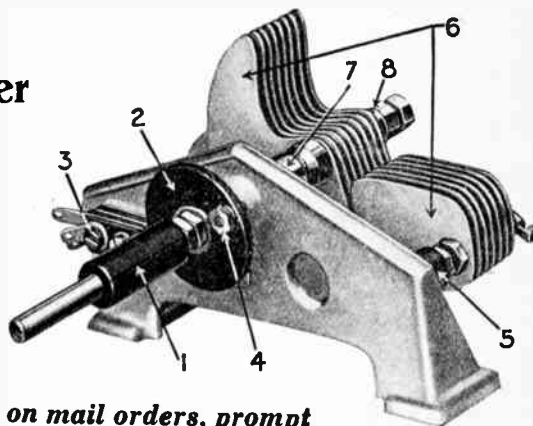

We specialize on mail orders, prompt service and right prices.

C. B. GIBSON & COMPANY

826 YONGE STREET

TORONTO

will accede to our requests. The same thing will be done in England. American artists who are there at the time will be asked to give special broadcasts for their friends on this side of the water.

"It is safe to say that the American people will be astonished at the features they will hear from their own local stations during the week. Once the programs are made known, those thousands who have never owned a set will acquire one because they will realize what they will miss if unable to listen in."

BRUNO SHORT WAVE COIL

This coil is the latest word in the low loss design of 3-circuit tuners for short wave reception. A special feature is the method of winding the primary and

secondaries with flat rolled copper and aluminum wire, which is spaced by a special method, thus eliminating to a great extent the detrimental distributed capacity losses, which are so harmful on short wave work. When tuned with a .00025 condenser, a range of from 20 to 110 meters is obtained, which will endeavor the listener to receive the benefits of both regular transmission and C. W. reception. A special feature of this coil is the design of the tickler which enables the regeneration to be controlled without any noticeable loss of the desired wave length. A single mounting screw is all that is necessary to fasten this coil to the panel.

Manufactured and guaranteed by Bruno Radio Corp., 221 Fulton St., New York City.

CANDIDATES SUCCESSFUL IN EXAMINATIONS FOR RADIO CERTIFICATE

The Radio Branch of the Department of Marine and Fisheries announce that eleven (11) candidates were examined during the month of September, 1925, of which the following were successful and obtained Certificate of Proficiency in Radiotelegraphy:

Commercial

First Class—F. R. Graesser, Toronto, Ont.

Amateur

F. V. Burgess, Glace Bay, N.S.; W. H. Gillard, Hamilton, Ont.; W. E. Fenn, Kitchener, Ont.; P. A. Boissineau, Sault Ste. Marie, Ont.; I. J. Armstrong, Saskatoon, Sask.; P. Socolofsky, Loreburn, Sask.

Q.R.S. MUSIC COMPANY APPOINTED DISTRIBUTORS FOR HERBERT H. FROST PRODUCTS

The Q.R.S. Music Company, Eastern distributors for the Rogers batteryless and battery radio receiving sets, have been appointed exclusive Canadian distributors for the well-known Frost line of radio accessories, including the famous Musette speaker, first prize winner at the Radio Worlds Fair.

Herbert H. Frost Inc. is well known to experienced radio dealers and jobbers throughout the Dominion. They also make a complete line of parts besides their plugs and adaptors.

Already the demand for the Musette speaker and plugs is proving that this year's dealers should anticipate their requirements in advance to prevent the shortage of last year.

RADIO ADVERTISERS' DATA BOOK

The 1925-1926 Radio Advertisers' Data Book, a volume of rates and other information for national advertisers, has just been issued by its publishers, Arthur Rosenberg Co. Inc., New York.

Several features which were not in the 1924 issue have been included in the current edition. The contents include advertising rates, circulation and other data regarding radio consumer and trade publications, as well as of all the periodicals of the allied trades, including automotive, electrical, hardware, music, talking machine and sporting goods.

The radio dealer and jobber sales situation and the radio manufacturer's merchandising and advertising problems are treated both editorially and graphically.

MARCONI COMPANY APPOINT DISTRIBUTORS

Messrs. Marks, Clavet & Dobie, of Port Arthur, Ont., have recently been appointed Marconi dealers for that city and are carrying the well-known and popular lines of Marconi radio receivers, Marconi loud speakers, Marconi straight line frequency condensers, headsets and Marconi ideal distortionless audio-frequency transformers.

Messrs. Marks, Clavet & Dobie are the largest sales organization between Winnipeg and Sudbury and are a very old established firm.

They are to be congratulated on securing the valuable "Marconi" franchise and should find this line an exceedingly profitable addition to an already stable and carefully chosen range of merchandise.

The illustrations herewith serve to show a portion of the large interior of the Port Arthur store.

**HELP THE
DISABLED SOLDIERS
RADIO FUND**

MADE IN CANADA

PACENT



AUDIOFORMER

Perfectly designed for the A.C. Circuit. High amplification, with no single high peak or distortion. Beautifully finished in satin nickel. Ratio, 3½ to 1. Binding posts permit short leads. If your jobber cannot supply you, write direct.

WHITE RADIO, LIMITED

*Exclusive Licensed Manufacturers of
Pacent Products in Canada.*

41 West Avenue North Hamilton, Ont.

DON'T IMPROVISE—PACENTIZE

NEW

Valley Battery Charger



You can't do without it

Charges 96 volts *in series* as well as 2-volt, 6-volt and 12-volt batteries.

You can't get along without a battery charger, if you want to enjoy radio to the utmost. A charger with your set means that you need never miss a programme because of a run-down battery.

And when you choose your charger, you might as well get the best—a Valley Battery Charger.

DISTRIBUTED BY

CANADIAN ELECTRICAL EQUIPMENT CO. Ltd.

TORONTO

Valley
Battery Chargers

Valley
B-Eliminators

Valleytone
Receiving Sets

THE ROGERS "BATTERYLESS" RADIO

is not only a Master Development
— it is a **PROVEN SUCCESS!**

No
"A" or "B"
Batteries



No
Aerial

"Just plug in - then tune in"

So great is the public interest in this newest advance in radio (the invention that utilizes electric current instead of storage batteries) that we have prepared a pamphlet explaining in the most simple manner the "WHY" of the Rogers Batteryless Set—how it operates and why its construction makes it so economical. Every intending owner of a radio set should get this pamphlet. Among other valuable information, this pamphlet tells why—

—the A/C Tubes in the Rogers Set have longer life than ordinary tubes in sets operated from batteries.

—why line voltage fluctuations cannot affect the operation of the Rogers.

—why the power required from your electric light system is less than the addition of a 60-watt lamp and the cost of current is less than 5c a week.



What About the Rogers Performance?

As the pamphlet explains the "WHY" of the Rogers Set, these remarkable testimonials tell about its success in operation:

- (a) A letter from the Maritime says: "While our local broadcasting station was operating, we picked up 25 other stations on loud speaker without any interference. One was CKCL, Toronto. The first time this year that this station has been heard here."
- (b) A Government Engineer, after severe tests, states: "Without hesitation, I would recommend this apparatus to the most exacting radio enthusiast."
- (c) "In August last, under worst atmospheric conditions, secured trans-continental stations seldom heard in summer."
- (d) A dealer writes: "The elimination of battery and tube troubles is a blessing both to the public and dealer. We have had wonderful results in tone quality, volume and selectivity. I can furnish you with names of many customers who are great Rogers boosters."

This New Pamphlet Answers All Your Questions -- Write for FREE Copy.

Whether you now own a radio set or not, you will want to read this specially prepared pamphlet, which covers in complete and concise terms every feature of this latest development in the science of radio reception. Write for your copy to-day. Address nearest distributor.

Rogers Radio Receiving Sets are manufactured under the DeForest Canadian Radio Patents, the E. S. Rogers Radio Patents, and the Canadian McCullough A/C Radio Patents by

STANDARD RADIO MANUFACTURING CORPORATION LIMITED, TORONTO

Owners of the De Forest Canadian Radio Patents.

DISTRIBUTORS -

Q.R.S. Music Co. Canada, Ltd., 590 King St. West, Toronto - - for Ontario and Quebec
Radio Corporation of Winnipeg Limited, 290 McDermott Ave., Winnipeg - for Manitoba
Canada West Electric, Limited, Regina - - for Saskatchewan and Alberta
Radio Corporation of Vancouver Limited, 605 Dunsmuir St., Vancouver - for British Columbia



RADIO PROGRAMS FOR SHUT-INS

Broadcasting Station Directors Are
Herein Advised by a Shut-in as to
the Type of Entertainment Best
Suited to Those Who Live
Within Four Walls

By *Mary Louise Howden*

Illustrated by the Author

If that new wonder-child of the air—Radio—were to be taken from us tomorrow, were to suddenly vanish, to become only a dream, the people who undoubtedly would suffer most from this disaster would be chronic invalids and shut-ins. They would lose everything, where as other people would still retain their points of contact with the outside world.

Radio, to persons who are doomed to spend the rest of their lives in institutions, who are blind, who are chronically helpless, whose horizons are bounded by the four walls of a room, is the most wonderful thing that ever happened. It is the opening of a magic casement through which the shut-in spirits can fly at will to seek sunlight and companionship hitherto denied them. It transports them on magic crutches to places they will never see. It brings the world of sport, of travel, of music and art and books to bedside and wheelchair. It does

patients and home shut-ins. If there is one fact more than another which shows how completely they have failed to envisage these needs, it is that the very best things on the day's program are put on the air late in the evening, at 9 and 10 o'clock, or later, whereas hospital wards are silenced for the night and wrapped in darkness by 9 or 9.30.

Then again very few programs are fitted for sick people in their entirety. It would be difficult to find an hour's program that would be quite suitable. Most stations change their programs every fifteen minutes. Stations offering a steady hour of any one group of artists generally make this hour straight classical music or straight jazz, and an uninterrupted hour of either is apt to be too much for an invalid whose powers of concentration, owing to his physical condition, are not high.

The writer is a shut-in. Radio has provided her with an entirely new outlook

getting ideal, the operator should be one with a very clear idea of the sort of entertainment that sick bodies and sick nerves need—some one, preferably, who knows what it is to be sick himself—and even then he will have a hard time pick-



ing a program suitable for his constituency from the combined offerings of the available stations.

Where the patient has an individual radio set, and is not strong enough to be out of bed, he may very easily get tired with the constant tuning out and in necessary to find something he can enjoy. And take, for instance, the case of a ward to which has been donated a radio set with a loud speaker. Presuming that most of the patients in this ward are not well enough to be out of bed, and that those that are, are not familiar with a radio set, what happens? The

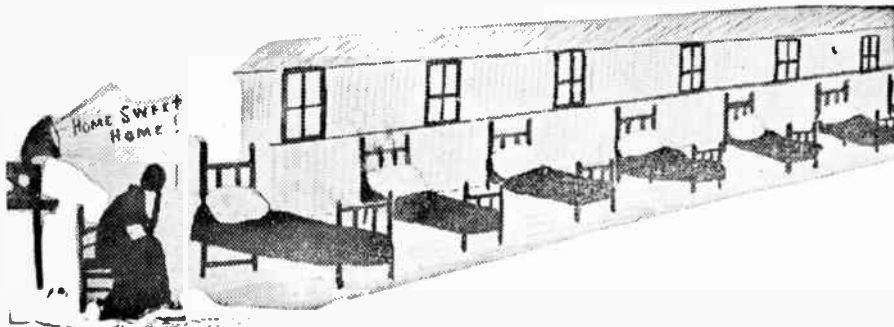

away with the tedious and lonely hours that once were theirs.

Surely radio was intended for shut-ins and invalids. It seems to belong especially to them.

Yet it is a strange fact that this class of people, who most need radio, and who benefit most by it, are generally ignored by the broadcasting stations. Managers of stations do realize, of course, that radio programs are of great pleasure and benefit to invalids. Individual artists realize this keenly because of the letters they receive from such sufferers. Many of them are laudable in their efforts to provide brightness and cheer for sick people. But not being handicapped in that way themselves, broadcasters and program directors fail to realize and to meet the radio needs of institution

on life. But in this case, there is privacy, an individual radio set, and sufficient health and strength to sit up in front of it and tune, and pick out programs that are helpful and amusing. In the case of patients who cannot do this, radio is handicapped. It cannot give the invalid all that it was meant to give him.

All veterans' hospitals now have radio equipment, we are told, and in other hospitals radio is in very much more general use than was the case a couple of years ago. Some hospitals, I believe, have a central receiving set with a radio operator in charge, with wires to each bed, where the patients are supplied with ear-phones. The patients do not disturb one another and each can plug in or not as he feels like it. This is very nearly an ideal arrangement; but to make it alto-



nurse, of course, tunes in and sets the thing going, but a busy nurse—and all institution nurses are busy—can't leave her work even ten or fifteen minutes to

(Continued on page 70)

ELECTRAD LAMP SOCKET ANTENNA

"A Foe to Old Man Static"

This demon of the ether, with his hammer and tongs, his crashes and rattles, will be a stranger in your home when you use the "Electrad" Lamp Socket Antenna.

It replaces an outdoor aerial and is ideal for apartment houses or other locations where the aerial problem is bothersome. Makes every lamp socket an aerial. No danger of fire or shock. Perfectly safe and approved by underwriters. Uses no current. Can be used in any room of the house. Instantly removed when necessary. Price \$1.10.

At all good radio stores, together with other handy "Electrad" Guaranteed Radio Essentials—Variohms, Audihms, Lead-ins, Grid Leaks, Six Point Pressure Condensers, Aerial Outfits, Royalty Variable Resistances, etc.

Canadian Sales Representatives: G. S. WHITAKER, LTD., 8 Colborne St., Toronto

ELECTRAD, Inc.

428 BROADWAY - NEW YORK CITY



Price
\$1.10

ELECTRAD SIX POINT PRESSURE CONDENSER

Electrad Certified Fixed Condensers. Ingenious rigid binding and firm riveting fastens parts securely at six different points. Guaranteed to remain within 10% of calibration. Price 45c to \$1.10.

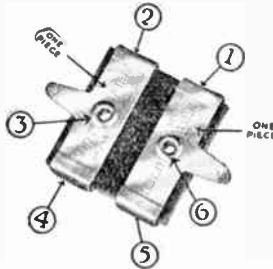

Electrad Variohm—A variable grid leak; perfect in operation. A positive control, adjustable to every tube requirement. List, \$1.75, unmounted; \$2.00 mounted.



Ethovox

REG. CAN. PAT. OFF.

Made in LONDON, England

The Most Sensitive, Tonal,
Perfect Reproducer

\$45.00

The graceful swan neck and flare are distinctive of the Ethovox horn. It is made of a special non-resonant alloy metal and is neither "tinny" nor "raspy." Its reproduction is perfectly natural.

It is finished in a heavy, durable, baked enamel; rich mahogany in color.

"The World's Finest Reproducer"

Write to-day for open territory.

ACCEPTED FOR ITS QUALITY BY 28 NATIONS

ETHOVOX is absolutely guaranteed for one year.

SOLE CANADIAN DISTRIBUTORS:

THE GOVERNOR RADIO SPECIALTY CO. Limited

46 St. Alexander Street

MONTREAL, Canada

Fisher Transformer and Condenser Kits



Fisher Transformer Kit



Fisher Condenser Kit

The Fisher 5-Tube Tuned Radio Frequency Circuit - A Canadian Achievement

Advantages

In the Fisher R. F. Low-Loss Circuit, oscillation has been controlled without building up resistance. The Fisher Low-Loss Transformers with their unique construction give marvellous results. Without going into technicalities, it suffices to say that the Fisher circuit gives a degree of sensitivity and selectivity few sets possess; and for distant reception, it brings in the stations clearly and with volume. It is absolutely the last word in radio and is the highest attainment in radio design.

Every Man's Kit

Now comes a kit that any average man may build EASILY and obtain perfect results from the finished receiver.

There is nothing intricate about the Fisher Circuit, with Fisher Transformers and Condensers plus the simple, easy-to-understand directions with every kit, the building of this circuit is simplicity indeed. And its fun, too—especially when you know that the final result will be perfectly satisfactory.

Prices and Description

For the man who wants an inexpensive yet efficient set, these Fisher prices will appeal.

Kit 1—3 Air Core Transformers **\$10.00**

Kit 2—3 Low-Loss Straight Line
Wave Length 13 Plate,
250 mmf. Condensers **15.00**

With complete instructions for building.

The Keynote of the Fisher is Simplicity

The Fisher Condenser (Low-Loss)

EFFICIENT

DURABLE

SIMPLE

SINGLE HOLE MOUNTING

ADJUSTABLE BEARINGS

STRAIGHT LINE
WAVE LENGTH

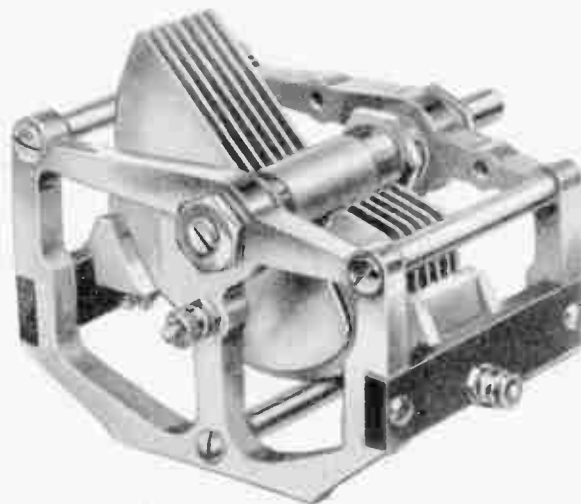

150 mmf. - 7 plate

250 mmf. - 13 plate

520 mmf. - 23 plate

DEALERS—Write for our proposition to-day. Fisher kits are becoming increasingly popular because of their ease of construction and efficiency. Feature them for Christmas gifts, many of your customers will welcome your suggestion for solving their gift problems.

FISHER MOTOR CO. LIMITED

ORILLIA

CANADA

\$100.00**\$100.00**

This is the Fisher Set

— A set built by expert workmen, using the highest grade parts obtainable, and embodying the most advanced circuit in use.

In this set, we offer you expert assembly of component parts by the following manufacturers—specialists in their respective lines:

Insulation	Bakelite	Electroplax Ltd., Toronto
Panel Art Work	Day Name Plate, Toronto	
Audio Transformers ...	Splitdorf	Splitdorf Electric Co. Ltd., Toronto
Inductances	Fisher	Fisher Motor Co., Ltd., Orillia
Variable Condensers ...	Fisher	Fisher Motor Co., Ltd., Orillia
Fixed Condensers	Splitdorf	Splitdorf Electric Co. Ltd., Toronto
Sockets	Mazda Double Contact.	Mazda Radio Mfg. Co., Cleveland
Jacks	Mazda	Mazda Radio Mfg. Co., Cleveland
Battery Switch	Mazda	Mazda Radio Mfg. Co., Cleveland
Cabinets	Walnut	Ideal Mfg. Co., Listowel
Dials	Two piece	Mazda Radio Mfg. Co., Cleveland

We honestly believe that in this FISHER set we offer you the most advanced 5-tube set now before the public, a set that will bring consistent distance; that will give you selectivity beyond anything you have yet experienced, and a set that will give volume and purity of tone beyond your expectations.

This Fisher set is built with no thought of economy in parts, as evidenced by our specifications, yet it sells to you at a price much less than that of sets in the same class.

We will allow you ten days' examination of this set and if you are not perfectly satisfied that it meets your every requirement, we will cheerfully refund your money.

C. L. MURRAY

514 YONGE ST.

TORONTO

Randolph 5289

RADIO PROGRAMS FOR SHUT-INS

(Continued from page 66)

re-tune the receiver. The loud speaker emits pleasant music for the allotted fifteen minutes; and then switches to a financial talk, or a health talk, or something else utterly and ludicrously unsuitable. Indeed, if nervous and irritable patients were obliged to listen to some of the talks given over the air, one wouldn't blame them a mite if they suddenly became destructive and violent!

The remedy for all this is for some of our leading broadcasting stations in different parts of the country to put on once or twice a week an hour's program especially adapted to the needs of invalids.

"But what sort of programs would be suitable?" I think I hear the stations say, "and at what hours?"

For evening programs, 7 to 8, in places where they don't allow evening visiting, is the ideal time, with 8 to 8.30 a rather poor second. The earlier the better in hospitals. The time from 8.30 to 9 is

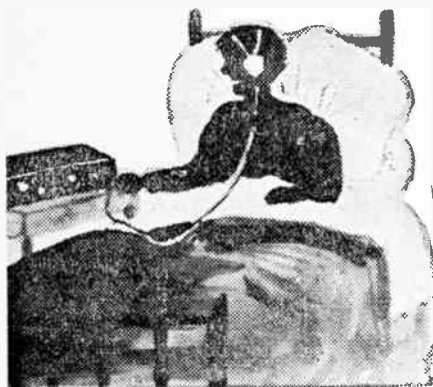

occupied by the nurses in getting the patients settled for the night, and by 9 the lights are out and the patients are supposed to go to sleep—if they can!

As to the afternoon, 4 o'clock is a good hour. The time from 2 to 4 p.m. is "visiting hour" in most hospitals, and patients would rather visit with their home folks than listen to any program, however enchanting. But the hour from 4 to 5, when the excitement of visitors is over, and before the supper trays make their appearance to break the monotony of the day, is a flat, stale and unprofitable one, and might very well be enlivened with a good program. Those who have had visitors are sufficiently tired to feel pleasantly relaxed and in a mood to enjoy music. Those who haven't had visitors are probably feeling pretty blue about it and need cheering up. And right here we come to the type of program needed. "Cheerful by Request!" Very much so. For the music, lightness, cheerfulness and rhythm; not all heavy classical pieces, not necessarily all jazz, either. Light opera is ideal here, and Roxy did a real service to suffering

humanity when he put Gilbert and Sullivan on the air.

However, "highbrow" a patient's musical education may have been, when he is sick, he will crave something light. The writer was educated in a school that made a point of sending all its musical girls in for the examinations of the London Royal Academy of Music. The school made a specialty of its concerts, we practiced for hours every day and were never allowed to hear much less to play a popular air. The first time I ever heard jazz, I was horrified. But I was still more horrified later on to find out that I was beginning to like it, and cherished this as a guilty secret until I found out the reason, which was a very simple one. It was the rhythm.

A catchy tune with a clearly defined rhythm is more soothing to sick nerves than anything else that can be offered; which explains perhaps why Vincent Lopez and Paul Whiteman are so popular with those of us who will never dance again, and why in a hospital ward, even among patients who appreciate classical music, they are likely to be enjoyed more than a symphony orchestra or concert ensemble.

The Colonial Aces with their tunefulness and splendid pep would be a good feature on a program like this, and I can imagine no more welcome entertainers in a ward program than Goldie and Dustie, who really do "brighten the corner where they are"—the Old Timers' Hour from W.E.A.F.—a short edition of it, anyway—would be a great joy to any hospital or home for the aged.

But here I should like to point out that too much insistence should not be placed on the "home and mother" motif. Most of the inmates of institutions either haven't got homes, or, if they have, are never going to see them again. I have in mind one black night last winter when a popular Sunday evening hour of studio music finished up with the announcer's reading "Home, Sweet Home," while a violin in the background softly played that heart-breaking tune. There must have been a good many homesick hearts among his hearers that night and a good many tears shed quietly into the recesses of the pillow after the nurse had put the ward lights out. You can't expect us invalids to be Pollyanna-ish all of the time, and a thing like that hits us hard.

No Talks for Sick Folks

Talks should be omitted from a hospital program. The talks now given over the air, interesting and excellent as many of them are, are in no way fitted for sick folks. If talks must be given—and they should not be a regular feature on the program—let them be given by some one who has actually been there, some one who knows what it is to be sick and up against it himself. Any one

else is not likely to be able to offer anything but platitude to such an audience; unless, of course, you are going to offer some well-known speaker of proven sympathy, insight and power.

The best is none too good for sick people. And for goodness sake—and this can't be too strongly emphasized—cut out the Pollyanna stuff! Professional cheerfulness is something invalids can get in large doses every day from doctors and nurses; and the inmates of our institutions could often give lessons in patience, cheerfulness and humor to those who talk to them so glibly about it.

A friend of mine told me that she once visited an institution for incurables with the special idea of being an uplift and a little sunbeam. She said she hadn't been in the place twenty minutes before she felt like crawling out of it on her hands and knees. The people she came to see



taught her so infinitely more than she could ever have taught them. If talks must be included in such a program, they shouldn't be more than five to ten minutes long and should be given by someone who knows the problem of the institution inmate from the inside.

A word to the directors of orchestras. Any orchestra broadcasting for the special benefit of sick people should choose its selections with special reference to the weather. The reader may smile at this, but all invalids are extraordinarily susceptible to weather conditions. I have in mind a certain trio broadcast by one of our leading stations at the noon lunch hour, which plays music of a high order superlatively well. But these good people always seem to choose a grey day of fog and dripping rain to broadcast selections in wailing cadences and a minor key; and if they could only hear how it comes across! Indeed, "Elegie" and "Melancholia" and "Valse Triste" do not go well with the patter or rain on the windowpanes and the howling of the wind. Neither, for that matter, do the "Down and Out Blues."

Speaking of "blues," dance orchestras on such a program should be of the best type, both as regards their execution and the quality of their instruments. I have spoken before of the beneficial effect of rhythm. A dance orchestra playing with

perfect rhythm and a noticeable absence of blaring, squawking saxophones is really a soothing thing and an appropriate "Good-night" touch on an invalid's program, particularly if the volume is softened to where it can just be heard agreeably. The writer knows whereof she speaks, as she uses such an orchestra for a lullaby nearly every night!

Stations willing to put on programs for shut-ins could consult with superintendents and floor supervisors of hospitals and homes known to have radio receiving equipment, as to hours, etc. But, generally speaking, the hours from 4 to 5 p.m. are likely to be the most suitable. The programs should be well balanced and very cheerful—dance music, banjo and mandolin selections, light opera, some of the lighter classical pieces, and old-time songs. Such a program could be widely advertised as being intended for hospitals and shut-ins; and it could not fail to be very popular.

Broadcasting stations, please take notice!

"ROXY AND HIS GANG" RETURN TO WEA F

"Roxy and His Gang" has returned to radio via WEA F, New York.

Requests for information as to what his type of program would be have met with Roxy's characteristic answer: "All I know now is—Hello, Everybody!" Whatever has followed that in former days has depended upon the time, the place, the artist, and, of course, Roxy. He has recently returned from a short trip to Europe and has been busily occupied grouping "His Gang" for broadcasting.

The "Gang" has now been formed and includes several artists who are well known to radio listeners. Following is a list of those who will participate in these weekly programs from WEA F: Duke Yellman and Orchestra; Douglas Stanbury, baritone; Jack Oakley, baritone; Joseph Wetzel, tenor; Adrien Da Silva, tenor; Frank Moulan, singer-comedian; Max Terr, accompanist; Olive Cornell, coloratura soprano; Phoebe Crosby, soprano; Jessica Dragonette, soprano; Frederic Fradkin, violinist; Joseph Stopack, violinist; Florence Mulholland, contralto; Geoffry O'Hara, noted singer and composer, and others.

PRACTICAL COSTRUCTIONAL DATA ON A SIMPLE FOUR-TUBE RADIO RECEIVER

This Set Employs the Four-circuit Principle With the Idea of Economical Operation

By R. C. Hitchcock

A present day radio set must be economical to be popular. Any set which is sparing of its A and B batteries and tubes is bound to succeed. Yet this economy must not be carried too far; every fan wants to receive distant stations and desires to be able to operate a speaker on them. In Fig. 1 and 2 is shown a four-tube set which has proved very efficient, hearing stations several hundred miles away on the loud speaker during summer evenings. In winter its range would be easily three or four times as great. A few of the considerations in

the audio load becomes so great that the tube cannot carry its two loads efficiently, and distortion results. The present five-tube neutrodyne is a fine example of engineering, and will give as good reception as is wanted by an average fan. But if the question should be asked: "Does each tube work up to its limit of capacity?" the full answer would have to include an explanation that the first radio tube and even the second radio tube seldom work at their maximum possible output.

From this typical set, a generalization

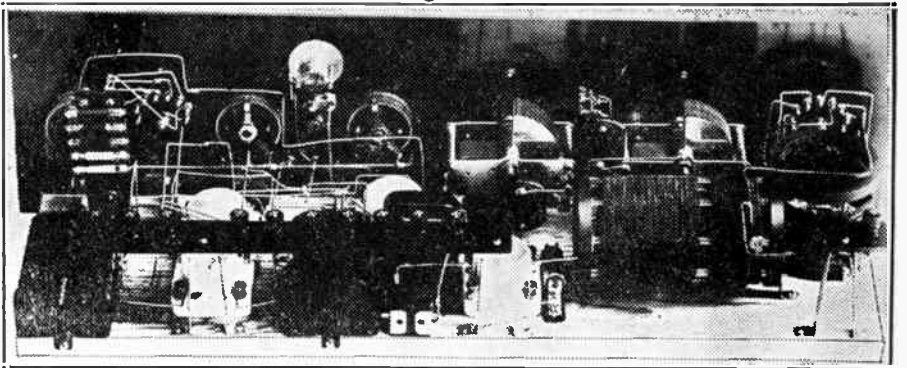
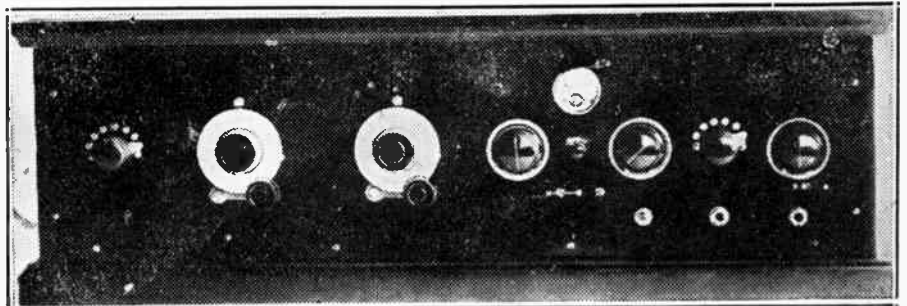

the design will be discussed before describing the set itself. There are nearly as many kinds of radio sets as there are different manufacturers making them, and those which operate a loud speaker range from two-tube sets up to any number under ten.

A really effective radio set should use its tubes economically. That is, each tube should have demanded from it all the work that it can do well. A two-tube reflex set which will operate a speaker is said to be economical in a certain sense. Let this be considered briefly. A reflex set makes a tube carry a double load at all times—audio and radio energy. When this is done, often

can be made. Radio-frequency amplifiers seldom handle sufficient energy to make their tubes work anywhere near their maxima. Of course, the radio-frequency amplifier brings up a very weak signal to a strength sufficient to be detected successfully, and in so doing, it, no doubt, brings in some signals that otherwise would have been audible. This point, however, is becoming less and less applicable to present-day broadcasting. Stations are increasing their power and radio-frequency amplifiers are becoming less necessary. And, from what has been said, it is almost a foregone conclusion that a radio amplifier is uneconomical; the tube simply does not

PATENTS
 Promptly Procured.
 Send a sketch of your invention.
FREE INVENTION RECORDING BLANK
 Name
 Address
MAIL TODAY

Z. H. POLACHEK
 PATENT ATTORNEY
 CONSULTING ENGINEER
 70 WALL ST.
 NEW YORK

have power enough to make it do its utmost. Having determined to make a set which demands the utmost from each tube, yet not going so far as to overload a tube, what set should be selected? Reflexes and neutrodynes will not be considered, neutrodynes because their radio-frequency tubes are underloaded and reflexes because their tubes are likely to be overloaded.

The Detector

Having found that radio-frequency amplifiers are apt to be uneconomical, the next step is to consider only sets that do not have this form of circuit. Let the detector be considered. Is there a

more output than one with an ordinary low ratio, and would, therefore, be economical, but in choosing such a high ratio instrument, great care must be taken to select one that has an even amplification—one that amplifies all frequencies to nearly the same degree. There are a few high ratio transformers on the market which are guaranteed by their manufacturers to have even amplification. So far, in the set there are two tubes working at maximum output, a regenerative detector and a high ratio audio amplifier. A set so equipped will furnish satisfactory volume on local stations, with no further additions. But

Volume Control

In some sets resistances are put across the speaker connections to control the volume. This performs the desired result, but it wastes B battery energy. If a resistance could be inserted in some part of the circuit before the B battery has been reached, the loud speaker results would be the same, but the means would be more economical. For this set resistances are placed in the grid circuit of the first amplifier tube and a selector switch provided to give the adjustment desired. Energy arriving from the detector circuit, at the grid terminals of this transformer is allowed to leak through the resistance, thereby making a weaker signal for the tubes to amplify. This arrangement affords a considerable saving of amplifier B batteries. An analogy may serve to make the arrangement clearer. Compare the current which flows through the speaker to an automobile being driven along a road at a speed of forty miles an hour. Suppose this speed is too fast to be safe on the road, comparable to the current being too great for the speaker to handle. The auto could be slowed up by putting on the brakes, still leaving the engine in gear; this would correspond to the putting of a resistance in the speaker circuit, a very wasteful procedure. If, however, the speed of the auto is decreased by reducing the engine speed, then the car should go slower with no power wasted; this corresponds to putting in resistances in the grid circuit before the amplifier B batteries are reached. In Fig. 3, the switch marked "volume control" is connected to these resistances. At the left of Fig. 2 the grid leak type resistance units may be seen. For use with the high ratio transformer T1, five of the resistances are used and are put on a narrow hard rubber strip. The resistance values for each are the same, 50,000 ohms. This value is sometimes rated in megohms, and manufacturers make them 1-20 megohm or .05 megohm, which is exactly the same as 50,000 ohms.

Voltage

The filament voltmeter included in this set is not an expensive one, and yet it is really economical. This is explained by remembering that the expensive meters that are designed for continuous service, use very little current. Cheaper instruments use quite a lot of current, and the set builder has this situation to face—he wishes to keep his tubes at the voltage best suited for their economical operation—should he buy an expensive meter and conserve A battery current or buy a cheap meter which continually wastes a lot of current? The problem is somewhat simplified and a solution reached more easily when it is considered that once the tube voltage has been set at

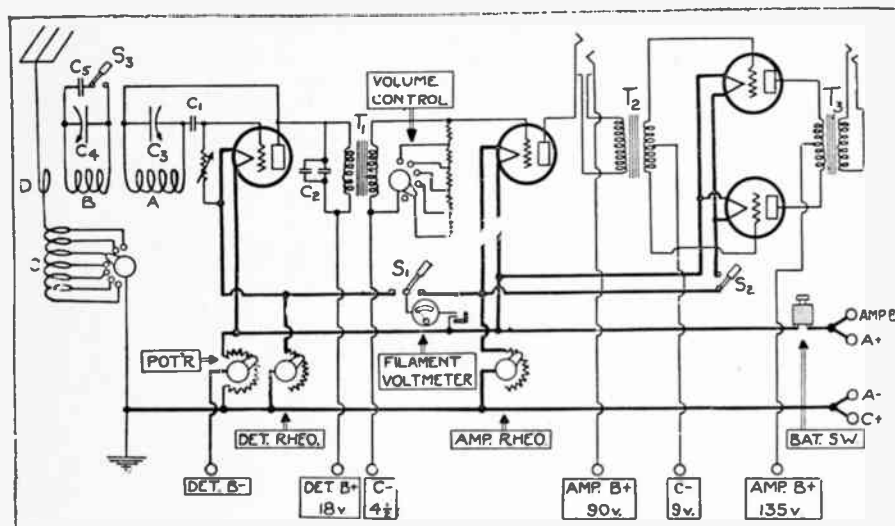

form of detector which is efficient? The regenerative detector is considered good, although the circuit chosen should be one that makes the minimum interference. The very simplest regenerative set is a bother to its owner as well as to the neighbors. The neighbors will object to the tendency for radiation and the owner probably will find that stations will come in "two at a time," due to the poor selectivity afforded by most receivers of this type. A three-circuit tuner would prove satisfactory, but a four-circuit tuner, with its incorporated wave trap, was finally chosen as being more selective and being little, if any, harder to tune. Regular Cockaday units may be used for the coils, but in the set here described, a home-made set of coils was used. A few changes were made in the mounting of the coils, which will be made clear by looking at Figs. 2 and 4. Details will be given later in the article on how to make and connect the coil. A separate B battery for the detector makes for clearer operation; this is shown in the wiring diagram, Fig. 2, and the binding post connections in Fig. 5.

Audio Amplifiers

Having chosen the detector circuit, the amplifier should be picked out. Our keynote is economy. A high rate transformer, say, 6:1, would certainly give

distant stations will not be loud and distinct, and further amplification is necessary to hear them. A second high ratio audio amplifier would not prove satisfactory because it would overload a single tube. Another reason why two similar transformers should not be used is that they tend to bring out the worst points in each. For example, even though theoretically the amplification is even, there will be certain frequencies that are amplified slightly more than others. Suppose such a point to be at 2,000 cycles. Two similar transformers, used one after the other, would distort signals badly—making the 2,000-cycle notes stand out more than their original intensity would justify.

Still keeping in mind that the set has a fairly strong output from the first audio transformer, it will be seen that a push-pull amplifier is ideal for the second step. The power is easily handled by two tubes, and with the connection used, an even balance and faithful reproduction are secured. This completes the main units in the set—all four tubes are working at their peaks. Several features will now be described which have been incorporated to add to the ease of obtaining the desired volume and the device for making each tube work at its best voltage point.

Here It Is!



Just What You Are Wanting The Portable Radio Pole

that can be carried under your arm, and will put up your aerial 30 ft. without ladders or climbing. It is easily attached to the side of a building or to a stake driven in the ground. This pole is so trussed and tentioned that it will stay straight and strong. Its neat and slender appearance is in keeping with the surroundings of the finest homes.

For further particulars ask your radio dealer, or for descriptive literature write

HAROLD PRICE
15 YORK ST., MONCTON, N.B.

Dealers, write for proposition.

Manufactured only by
Harold Price, Moncton, New Brunswick
Patent Applied For

any particular time, it will remain there, so a meter is really needed for just a short time. With this consideration, a switch may be included for connecting the meter while the rheostat is set, and then the meter can be cut out of the circuit. This saves the A battery as only a small amount of power is wasted while the meter is being read, and allows a cheap meter to be used. In this particular set, there are two rheostats, a separate one for the detector and amplifiers, so the voltmeter has two circuits to measure. It is, therefore, put on a double throw selector knife switch, S1 in Fig. 3, in addition to the "off and on"

coils to be described, C3 and C4 were variable low loss condensers of .00035 mfd. capacity each. The coils shown in the photograph, Fig. 2, were home-wound on coil forms having hard rubber end rings and glass rod supports. These were strictly low loss coils and proved effective. Seventy turns on the (3-inch diameter) form, of green double silk No. 20 copper wire made up coil A and 35 turns of the same wire comprised coil B. Green silk thread is tied around the completed windings to keep them from sliding on the glass rods. Forty-five turns of either No. 20 or 22 wire is used on coil C, and taps are taken at the fol-

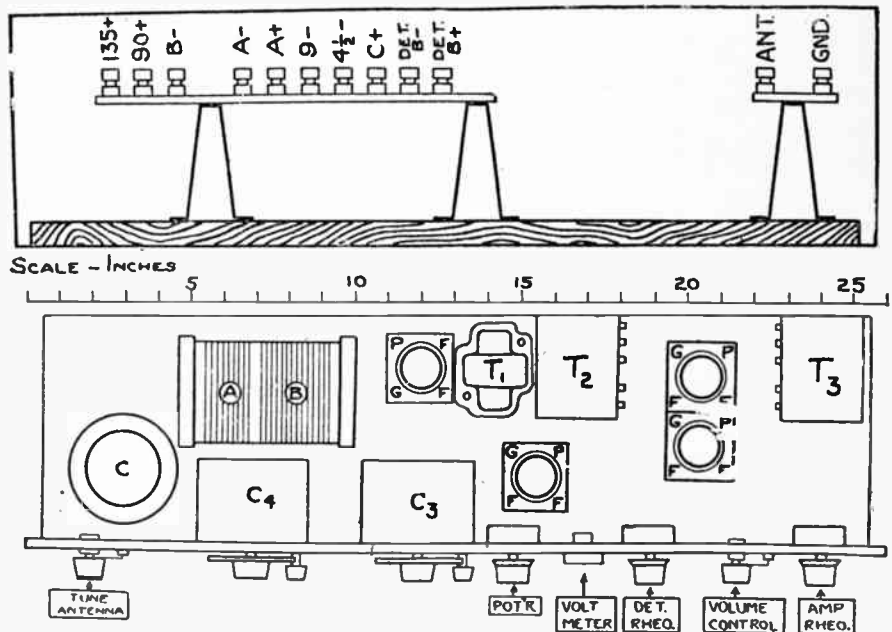

lowing turns: 1, 3, 7, 15, 45. Coil B in the original circuit is inductively coupled to coil C, so that these tune together for the longer wave lengths. In the set shown, these coils are kept separate, allowing closer tuning. To allow coil B to tune to the longer waves, a small mica grid condenser, C5, is wired behind the panel to increase the capacity of the condenser, which tunes coil B—making the set easy to tune by spreading out the stations on the dial and permitting tuning to higher waves by increasing the capacity by throwing switch S3 and beginning on the first part of the dial again. An antenna series condenser, not shown, of .00025 mfd. capacity, or a variable condenser of greater capacity, may be used if extreme distance is wanted with a long antenna.

one, the second switch changing the voltmeter from the detector to the amplifiers, these voltages being set separately by their respective rheostats. A small knife switch, S2 in Fig. 3, allows the cutting of the current from the push-pull amplifier tubes, so that the set can be used with two tubes, with the plug in the first jack. When using the full set of four tubes, three of them are controlled by the amplifier rheostat, when using two tubes only, one tube is on the amplifier rheostat, so that the amplifier rheostat should be reset whenever switch S2 is pulled, so that the one amplifier tube does not receive the battery energy through a rheostat set to serve three tubes. The voltmeter is used, of course, to set the rheostat correctly. The volume control obviates the necessity of using two tubes except in the case of powerful locals. But keeping strict economy in mind, the A battery is saved when two tubes are used; hence, the inclusion of this feature in the set.

Coils

The coils may be the regular ones of a factory-made unit, and .0005 mfd. condensers used for C3 and C4. For the

A one-turn coil, D, over coil B is made of bus wire covered with spaghetti. This one-turn coil is connected as shown in Fig. 3. Tinned copper bus wire is used throughout for wiring, connections being kept apart as much as possible, crossing at right angles when necessary, and junctions being soldered with resin flux.



Sold under a positive guarantee—you take no chances when you buy **EMPIRE-TRONS**—no finer tube made. Retails in Canada at \$3.00. If your dealer cannot supply, write us.

EMPIRE SPEAKERS

Beautiful in design; scientifically constructed; acoustically correct. Made in all popular models and crystalline finishes.

Retails at \$13.50 up.

EMPIRE LOUD SPEAKER UNITS

Phono-Speakers

Equal to any Unit on the market.

Retails—\$6.50.

We supply Fibre Horns to manufacturers of Loud Speakers. Inquiries solicited.

Write for Illustrated Folder "C"

Distributors Wanted—Write for Prices.

AMERICAN INTERNATIONAL TRADING CO.

24-28 Stone St., New York

Factory: 132-134 Greene St.

Cable Address "Stanmarks"



Patents Pending

NO BACK LASH

SMOOTH, EASY ACTION
SEND FOR LITERATURE

BREMER-TULLY MFG. CO.

532 S. CANAL ST. - CHICAGO, ILL.
Eastern Canadian Distributor:
Carter Radio Co. of Canada, Ltd.
Toronto, Canada

Outside Connections

Horizontal narrow hard rubber panels are used for connections. These are shown clearly in the photograph Fig. 2 and in the back view of Fig. 5. The cabinet is not shown, but a slot should be cut in the back to allow wires to run to these binding posts. If a keyhole saw is not available for cutting the slot, separate holes may be bored for each binding post wire. The panel of the set, as shown in 7 x 26 inches, but a 7 x 30 size could be used, and the wiring would be slightly less crowded. For simplicity in Fig. 4, some instruments are not shown; the voltmeter selector switch S1 is under the voltmeter, the battery switch is under the detector rheostat, the first amplifier jack is under the volume switch and the second amplifier jack is under the amplifier rheostat. These instruments are shown in Fig. 1. If the set is to be made exactly as the one in the photograph, the inch scale of Fig. 4 will aid in placing instruments.

Operation

The potentiometer provides a fine adjustment of the regeneration, and is especially effective when a 200 type tube is used as a detector. When the arm is near the negative side of the potentiometer, regeneration takes place with difficulty, and when near the positive post regeneration is easy to obtain. Try several B voltages to find the one which operates most easily on all wave lengths. A 201A tube used as a detector will use more voltage than a 200 tube. This type of circuit has no ground in the grid circuit, and it will prove sensitive to body capacity. Long vernier handles will make the set do its best, but even without these aids to tuning, the set will work well, and with this added feature, sensitivity is marvellously increased.

The main tuning is with the condenser connected to coil A, but the wave trap, coil B, has to be kept along with it to hear stations at all clearly. To tune stations having long wave lengths (above 400 meters), the auxiliary condenser, C5, should be connected by using the knife switch provided, S3.

Maximum volume is, of course, obtained when the volume switch is placed on the off tap, with no resistance in circuit, and if this should prove too strong for the speaker, the control is easily set

to the desired place. This is a neater and more satisfactory way of reducing volume than by detuning or reducing regeneration, with the accompanying re-tuning.

SOMETHING EVERY FAN SHOULD HAVE

A volt-ammeter is essential to every one owning a radio set. It tells you instantly the condition of your batteries,

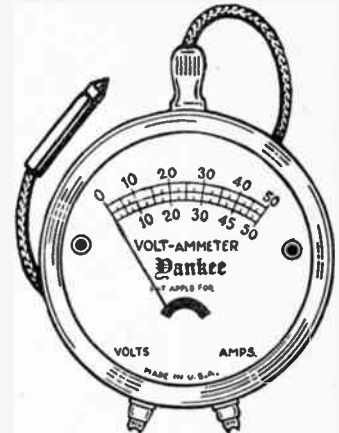

and saves the endless trouble usually brought about by guessing what voltage your batteries are delivering.

FEDERAL RADIO COMPANY INCORPORATED

The Federal Radio Co. Ltd. of Toronto, incorporated last month with a share capital of \$40,000. Mr. Benno



MR. B. HETHEY

Hethey is vice-president and general manager of the new company.

This company manufactures the new Perfex aerial and distributes the Ultra loud speaker and other lines. The offices and warehouses of the company are at 57 Colborne St., Toronto, Ont.

Help the Disabled Soldiers' Radio Fund

We Are Distributors For Marconiphones

TORONTO RADIO CO. LIMITED

64 King St. West - Toronto

"ELECTRAD" CERTIFIED MICA CONDENSERS

"The Six Point Pressure Condenser"

"Electrad" Certified Condenser, Standard "S" type. Soldering lug and binding strap in one piece.

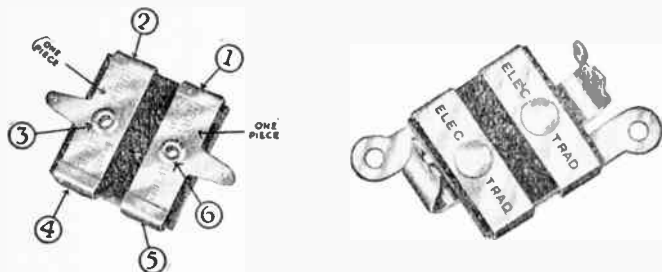

"Electrad" Certified Condenser. "G-S" type is especially convenient for attaching directly to the socket terminal. Saves time and worry on sub-panel work and is particularly adapted for sub-panel resistance coupled amplification.

THE PEARSON RADIO RECEIVER

W. N. Banfield & Sons, Toronto, who are operating the Canadian Pearson Radio Co. Limited, have certainly broken into the radio field with a strong, well-balanced line.

The Pearson radio receivers, of which we show a cut, have exceptional merit, appearance, performance and every factor that goes to make a finished receiver.

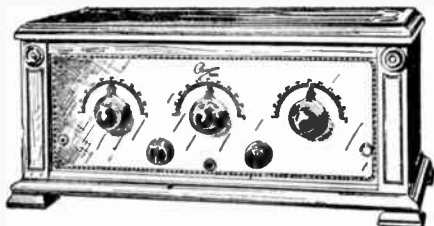

The Ureco tubes and Utah loud speakers, both are too well known to need much comment from us, though the small Utah speaker surprised us with its volume and clarity; its unique shape should also prove attractive to the buyer. We might add that all Pearson radio receivers, with built-in loud speaker, are equipped with Utah units.

It is a mighty healthy sign for the radio trade when firms like The Canadian Pearson Radio Co. Limited, of undoubted prestige, engages in the radio field.

THE BULLPHONE LOUD SPEAKER

The new British loud speaker, "Bullphone," distributed by J. H. Walker & Co., 28 Wellington St. W., Toronto, Ont., has found favor in the eyes of the Canadian fan. It has remarkably good tone and its appearance is all that can be desired. Having heard it under various conditions, we have no hesitation in recommending it to the Canadian radio trade and fans.

NEW MARCONI APPOINTMENT

R. M. Brophy, for several years on the sales force of the Canadian Marconi Company, Montreal, has been appointed Assistant Sales Manager.

Mr. Brophy is widely known in the radio trade throughout Canada, having covered all sections of the country and being thoroughly conversant with radio merchandising and conditions.



CLEARTRON

GUARANTEED



RADIO TUBES

WHY take a chance of marring the reception of the broadcast programs with inferior tubes, when Cleartron guaranteed radio tubes cut variation to the minimum, better the tone quality of your receiver, and materially increase its volume and ability to bring in the distant stations?

Perfect workmanship and rigid adherence to the most careful inspection system ever adopted by any factory; account for Cleartron quality and make it possible for us to back each and every Cleartron tube with our iron-clad guarantee.

At All Reliable Dealers

Write to-day for FREE six page folder giving valuable information regarding radio tubes.

IRON-CLAD GUARANTEE

All Cleartron tubes are guaranteed to deliver positively perfect service, and we authorize our distributors to make replacements of any Cleartron tube which proves unsatisfactory to user. The only requirement is that the tube must not be burned out.

The Following Types \$3.50

C-T 201 A; C-T 199 Standard Base; C-T 199 Small Base; CTX 120; C-T 400 Rectron Tube for "B" Battery Eliminators; C-T 101 A The original Hi-Mu tube for Resistance-Coupled Amplifiers.

CTA 112 Power Tube \$7.50

All types equipped with Genuine Bakelite Bases

THE CLEARTRON VACUUM TUBE COMPANY

Executive Offices:
28 W. 44th Street - New York, N.Y., U.S.A.
Canadian Offices and Warehouse:
8 Colborne Street - Toronto
England: Cleartron Radio, Ltd., 1 Charing Cross, London
Factories:
West New York, N.J., U.S.A. Birmingham, England

FOR BETTER RECEPTION

THE FISHER 5-TUBE SET

The "Fisher" 5-tube set embodies the conventional two stages of radio frequency, detector, and two stages of transformer coupled audio frequency. The control of oscillation in a radio receiver is, of course, of the utmost importance, as the nearer we can approach the point of oscillation, the more sensitive the set and the greater the selectivity. There are three well-used methods of controlling oscillation in a set. The power loss method using a potentiometer, the voltage loss method using a non-inductive variable resistance, and the capacity method using a variable condenser in conjunction with a third winding of the R. F. transformers. The power loss method impairs the all round efficiency of the set, the voltage loss method is with the ordinary form of R. F. transformer inherently hard to control. Of all methods, the capacity in conjunction with specially wound R. F. transformers would seem to be the most efficient and all things considered, the easiest to control.

The Fisher set employs three R. F. coils. The first, the usual two-circuit coil coupling the antenna to the set through a primary and secondary. The second coil has a third circuit as has also the third coil and the three-plate control condenser in series with these third coils by controlling the negative feedback permits one to approach the oscillation point smoothly and so build up signal strength.

The success of this set depends on the low loss "Fisher" coil and the low loss "Fisher" condenser, both items necessary for the correct operation of this circuit. In a later issue, we shall publish this circuit in detail with complete construction instructions and specifications.

BENJAMIN DEVELOPS NEW LINE

The Benjamin Electric Mfg. Co. of Canada have recently developed a new and novel means of using their radio products to best advantage. They are placing on the market the Benjamin Ensemble, which consists of the two panels and all parts necessary for a complete five-tube R. F. receiver. The front panel is of walnut Celoron measuring 8 x 24 inches, on which is mounted three 4-inch black dials, two rheostats, three variable condensers, battery switch and phone jack.

The sub panel is of black Celoron, and the following parts are mounted thereon: Five sockets, three coils, fixed condensers, two audio transformers, marked terminals, grid leak and the usual brackets for mounting the whole panel.

A special simplified diagram is supplied with each ensemble and is so arranged that even the most inexperienced person can wire the receiver without difficulty. The wiring should take about an hour to accomplish and the result will be a high-class receiver from which results can be fully assured in view of the fact that the complete ensemble is constructed of all fully guaranteed Benjamin products.

This is an excellent proposition for the radio fan who gets as much interest from the building of his receiver as from the actual results obtained, and also is a great money saver, the cost being considerably less than half the price of a completed receiver of any type in the same class, now obtainable from either the Canadian or American markets. Jobbers and dealers will do well to get in touch with the manufacturers immediately, as this line is already going over in a very big way, and will undoubtedly prove a big money maker to all in the radio business.

John Duncan & Co. Ltd. will distribute Benjamin electric lines in Montreal and district, and are offering their services to dealers in this connection.



THE KURZ-KASCH ARISTOCRAT LINE

"Aligns rite - Holds tite"

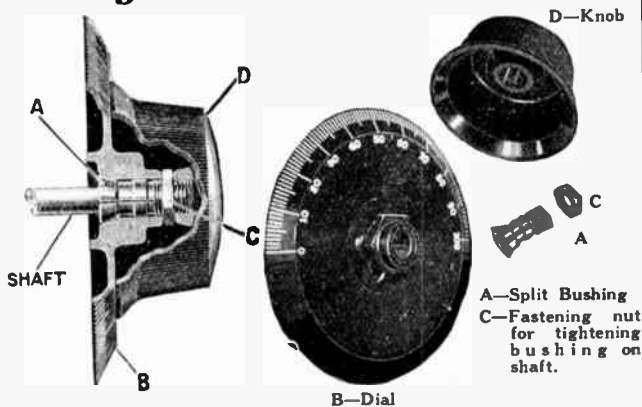

The Kurz-Kasch patented split bushing method of mounting at once became popular. Over two hundred Radio manufacturers and thousands of set owners, appreciating these products, have purchased them in ever-increasing quantities. The high quality and workmanship have earned for Kurz-Kasch products the position of leadership. They are the acknowledged best.

KURZ - KASCH ARISTOCRAT E-Z-TOON
(EASY TUNE)

"The Key to Simplified Tuning"

The Kurz-Kasch Aristocrat E-Z-Toon gives that close vernier adjustment so essential and desirable, greater distance, closer selectivity, simpler tuning. Used as standard equipment by some of America's best set manufacturers.

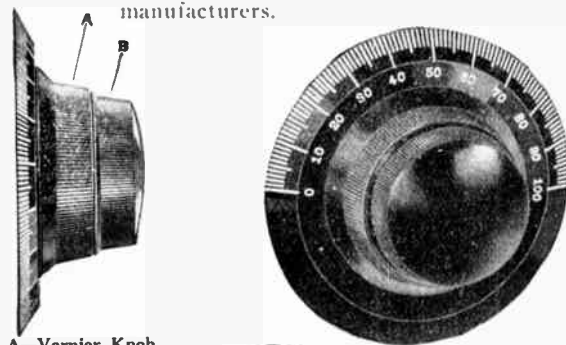

A—Vernier Knob
B—Dial—Knob

Kurz-Kasch
bear this
Insist on



Products
Trademark
the genuine

Write for illustrated literature on complete Kurz-Kasch line.
Dials, Knobs, Sockets, Potentiometers, Rheostats, etc.

Eastern Canada Representative:
SCOTT SALES COMPANY, REG'D.,
332 St. Catherine Street W. - - - Montreal, Canada

THE KURZ-KASCH COMPANY
Largest Exclusive Moulders of Bakelite
Factory and Main Office: - - - Dayton, Ohio

PREMIUMS

New Radio Books given as Premiums with Subscription to RADIO NEWS OF CANADA or books can be purchased outright if desired at advt. prices

HENLEY'S WORKABLE RADIO RECEIVERS

An Authoritative Book on Practical Receiving Sets of Modern Design with Complete and Explicit Directions for Building Them

THIS new book contains complete and detailed descriptions of many types of receivers which, by long experience, have proved to be the most satisfactory from the viewpoints of selectivity, convenience and economy of operation, dependability and quality of reproduction. It gives in greatest detail circuit and wiring diagrams, panel and baseboard layouts and drilling templates, so that any amateur may build a successful receiver from the directions given.

In order to help the Workable Radio Set builder, who may not be familiar with the conventional symbols used in hooking up a set, **most of the receiving sets are illustrated by complete full page diagrammatic drawings**, showing just where to attach the wires, location of condensers, rheostats, transformers, vacuum tubes, plugs, jacks, etc. 216 pages. 106 diagrams and illustrations specially made for this book. Price **\$1.00**

CONSTRUCTION OF A MODERN SUPER-HETERODYNE TYPE RECEIVER

Designed by a Staff of Radio Engineers of Wide Practical Experience and Thorough Theoretical Training

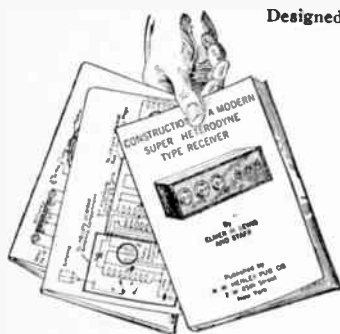

THE SUPER-HETERODYNE TYPE RECEIVER is the most sensitive receiver it is possible to build. This booklet, together with the working drawings, give the most detailed information on the complete construction of a modern type of Super-heterodyne which is extremely sensitive, selective and non-radiating and at the same time insures excellent quality of reproduction when used with a high-quality loud speaker. Very complete information on the testing of all parts of the circuit as well as the complete receiver are given. The directions for operating the set are also very complete. Directions are included for slightly altering the wiring of the receiver to accommodate dry cell tubes, instead of the standard types which require storage batteries. The design may be altered for the use of a loop instead of an open antennae in accordance with the instructions given. **This receiving set has actually been built and operated by a novice from directions given.**

Price \$1.00

HENLEY'S 222 RADIO CIRCUIT DESIGNS

A Complete and Up-to-date Collection of Modern Receiving and Transmitting Hook Ups

THIS new book treats the subject in an entirely different and novel way, as it is the only book that illustrates the complete electrical design of the circuits, showing the electrical values of inductances, capacities and resistances, with the name of each element on the diagram of the circuit.

It surpasses all other books in the scope of its subject matter, in the simplicity and novelty of presentation, and in thoroughness of detail. 271 pages, 284 diagrams.

Price \$1.00



Publishers of "Radio News of Canada,"
257 Adelaide St. West, Toronto, Can.

Please enter my subscription to the "Radio News of Canada" for six months (and thereafter until cancelled) and in payment for first six months' subscription, I hereby remit you \$1.00.

Name.....

Street and No.....

City.....

A copy of either of the above three books will be given to all readers who fill in this form and mail it to us not later than December 30th, 1925.

The book will be mailed immediately we receive your Dollar. Your subscription will commence the month following.

IMPROVING THE "SUPER"

The super hetrodyne set is the most sensitive and select type of set we have to-day, but with these two outstanding qualities there sometimes is the drawback—a small 199 type of valve. When you purchase such a set, you get six valves taken from stock, and while the valves are all right in that they will light, detect and amplify, all of them may not do all of these things as well as some others.

When you get six valves that are "equally matched," you have a super that will work better than any other type of set. But getting matched valves is sometimes quite a proposition.

Those of you who have the supers using this type of valves know from practical experience (if you have had the set a year) that at some time or another all your valves seem to go bad at one time. When you complain to your dealer, he will tell you the valves were burned too brightly, and they were. But you had to burn them brightly to get any results, and you probably have wondered why.

The reason is as follows: You have six valves, and if one of them is not as good as the others, either as amplifier or detector or oscillator, the set is not working properly, and you have to give this defective valve more "juice" than the others need, and as you only have one filament control, the others get more current than they need, which is overloading them, with the result they soon become paralyzed and in a short time the set will not respond to distant stations and others will not be strong as they formerly were, with the result you complain the set is not what it used to be or they claimed it was.

Upon examination, it will be found you have one or more valves defective. By "defective" is meant not as good as the rest, although they will work after a fashion. The remedy for such things is to have a filament voltmeter connected across the filament circuit, in order to be positive you are not putting more than the three volts required to operate these valves. The set you have does not use such a voltmeter, and it is practically impossible for you to instal one yourself, due to the thickness of the three-ply panel and the large hole necessary for the voltmeter.

The installation of such a voltmeter of the high-grade type would soon pay for itself in the detection of a poor valve by the set not working, when three volts were applied to the filaments. It is always best to have one or two spare valves on hand for just such emergencies. The voltmeter is used this way. When it is connected across the filament leads, it registers the voltage impressed on the filaments, which should be three volts or less. The rheostat is turned up until this reading is obtained, regardless of where you formerly had the rheostat set. As your battery runs down, the rheostat is advanced until the voltmeter reading is three volts or less. If signal strength drops off at this reading, you either have a defective valve or valves; "B" battery low or the "C" battery is low. The high-grade voltmeter should have a scale reading of from 0 to 5.

INCREASING LOOP SETS' RANGE

People owning radio sets using a loop aerial read where so and so picked up XYZ, but they are unable to with their set, and want to know if an aerial cannot be used in connection with or without the loop.

They can very easily; but a set designed for loop reception is really too sensitive for outdoor aerial use. It is so sensitive, the noise level will be considerably above the signal strength, with the result you have a very noisy set on your hands. For example: There is a limit to the strength of signal which a radio-frequency amplifier can feed to the detector, and this limit is very often reached with loop aeriels, and when you add the outdoor aerial, or even indoor one, the energy gathered is

Carter Products

*Used by all the
Leading Manufacturers*

Examine the leading receiving sets built on this continent—notice how Carter Products are standard with the great majority. Nothing but sheer merit influences these manufacturers to use Carter Products—no matter what unit it may be, Carter builds it better.



**CARTER
LOOP AERIAL
\$15**

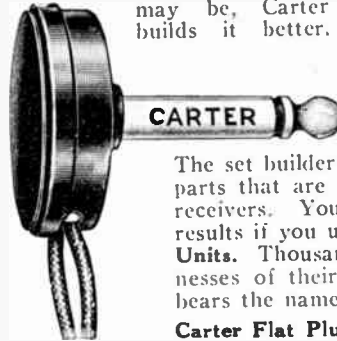

CARTER

**For the
Set Builder**

The set builder cannot go wrong in using parts that are built into America's finest receivers. You are certain of excellent results if you use high-grade units—**Carter Units**. Thousands of set builders are witnesses of their efficiency. Make sure it bears the name **Carter**.

Carter Flat Plug..... 85c. each

"There is no substitute for a CARTER Product"



Trade Mark Registered

**Ever growing
in popularity**

Every day, increasing sales afford fresh proof that the "HAMILTON" Radio Reproducer is fast growing in popularity. The "Loud Speaker with the Human Throat design" has lived up to all its claims and then some. Never was there more perfect radio reproduction. Hear it and judge for yourself.

*Ask your "Hamilton" Dealer for
a demonstration.*

**NATIONAL SALES & DISTRIBUTION
COMPANY LIMITED**

Corner Adelaide and Sheppard Streets, Toronto

Controlled by

DOMINION ELECTRIC PROTECTION CO.

Western Distributors:

Canada Cycle & Motor
Co. Ltd.,
48 Ross Ave., Winnipeg

Montreal Office:

J. C. LEROUX,
Manager,
119 St. Henri Street



**HAMILTON
RADIO
REPRODUCER**

Beautifully finished in mottled gold or green—an artistic creation that will harmonize with any furnishings. Fully guaranteed.

such that the noises from atmospheric disturbances, arc lights and other man-made disturbances are greater than the signal level.

There are, no doubt, some of our readers who operate a super hetrodyne, and who often connect it to an aerial (other than the loop), and think they are not annoying their neighbors. You certainly must know you have a continuously oscillating tube as the oscillator, which is controlled by your right-hand condenser. When you have this set connected to an aerial, even though it is inductively coupled, you are continually interfering with those around you who are tuned to stations slightly above or below the wave-length you are listening to, depending how you have your hetrodyne circuit adjusted. It sets up a continuous whistle similar to one station hetrodyning another.

There are two methods of coupling to a loop set. First and simplest is to wind one or two turns of wire on the same form as the regular loop is wound, but keep this turn several inches from the regular loop. The extra turn or two is connected in series with the regular aerial and ground. The other is to make up a kind of vario-coupler. This can be wound on a 3½-inch form similar to the standard tuning coil and using No. 20 cotton-covered copper wire, wind 20 turns for the secondary and leave a space of 1½ or 2 inches, then wind on 10 turns for the primary. The aerial and ground are connected to the 10-turn winding and the terminals; the loop was formerly connected to go to the 40-turn coil.

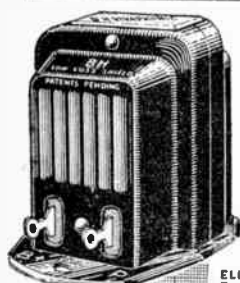

FAMOUS "BH" TRANSFORMERS

The BH VIVAPHONIC is a scientific achievement. Proved by scientific test to be a Straight-Line-Frequency Distortionless Transformer. Our efficient methods, backed by quantity production, enable us to offer the Radio Public this wonderful Transformer at \$3.50 each.

MCGILL UNIVERSITY
ELECTRICAL MEASUREMENTS LABORATORY
Tested by J.R. Lee Checked by W. J. Smith

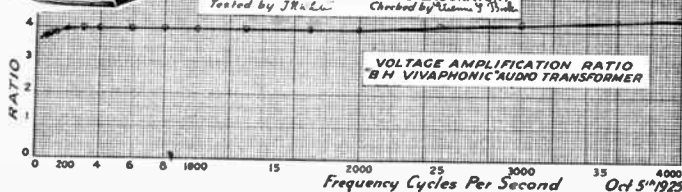

The only transformer made having a low loss shield structure (patents pending).

ASK YOUR DEALER FOR OUR LITERATURE OR WRITE US
BENJAMIN HUGHES ELECTRIC CO.
298 LAGAUCHETIERE ST. W., MONTREAL, CAN.
TRANSFORMER BUILDERS SINCE 1910

"F.A.W." BY-PASS CONDENSERS -

They are renowned for their accurate and constant capacity, and there are no better on the market

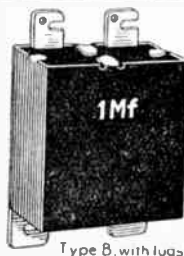

Type B, with lugs

Supplies promptly from stock
Write for detailed quotation and samples today to:

F. ARNO WOLF, BERLIN-CHARLOTTENBURG
BISMARCKSTRASSE 97/98 - TELEGRAMS. ELECTROWOLF, BERLIN

THE SUMMIT OF PERFECTION

**WILLARD
Radio Batteries**

Large Capacity "A" Battery in Beautiful Movable Rubber Case.

"B" Batteries that will give years of service.

Storage Batteries Improve Your Reception.

DYSON BATTERY SERVICE LIMITED

Alberta Distributors:

Cor. 6th Ave. and 1st Street East, Calgary
10154 102nd Street, Edmonton

Bestone SuperTube Company
of New York

*Desire
Canadian
Distributors*

Bestone Products are favorably known throughout the United States. We are now ready to discuss selling in the Dominion of Canada.

We require a distributor who feels sure of his ability to get business and who will look after our interests, as if they were his own.

For such a man, we have an interesting proposition.

Mail All Replies to Our
New York Office

Bestone SuperTube Company
131 West 39th St. New York City

Your Radio License For 1925 FREE!

With a Yearly Subscription to

RADIO NEWS OF CANADA

YOU must have a license to operate a receiving set—the penalty for the non-observance of this law is \$50.00, plus confiscation of your set. Here is our offer:

**Radio License for 1925 . . . } BOTH FOR
Radio News for 12 months } \$2.00**

A radio license costs \$1.00, and the regular subscription price of "Radio News" is \$2.00 per year.

If your present subscription has not expired, you can take advantage of this offer by mailing coupon and \$2.00, and we will mail your license at once, and have your subscription start at expiration of your present one. Agents who are soliciting subscriptions to "Radio News" have no authority to give you the above offer.

You Must Send Your \$2.00 Direct To This Office

You Get Your License Absolutely Free!

FEATURES OF RADIO NEWS :

Valuable Blueprints in every issue.
Latest information on all radio matters.
Editorial Articles that are up to the minute.
75% of all articles are copyrighted in the Dominion.

"Radio News of Canada,"
257 Adelaide St. W., Toronto.
Gentlemen:

Please enter my subscription to "Radio News of Canada" for 12 months, same to include Radio License for 1925, for which I enclose herewith the sum of Two Dollars.

NameAddress

. . . For the . . . Discriminating

Marco Vernier Dial

is the most perfect instrument for precise tuning. It is non-microphonic, it has no backlash, no gears to wear out, no rubber to decay. Its movement is smooth as velvet. Its self-logging feature precludes the necessity of reference to logs once you have tuned in on any station. A good set equipped with Marco Dials leaves nothing to be desired. Price \$3.60—and worth it.

Marco Switch Plug

enables one to switch from Phones to Speaker without disturbing a wire, plug or anything else. This will prove one of the most useful adjuncts to your set. Price is only \$1.45.

Marco Sta-Put Jr. Plug

has the well-known Marco quality built into it and yet its price is but 45c.

Marco Switch

Push-Pull type, for battery, etc., is another example of the fact that quality can be built into a dependable accessory and yet the price, due to the large demand, kept within the reach of everyone. Only 45c.

Marco Tape Aerial

will prove itself worth many times its cost. Its receiving surface is equivalent to that of 400 ft. of stranded aerial wire, consequently will pick up even weak signals. Price 90c.

The above and all other Marco quality products can be obtained from any Dealer who believes that it pays to pay for quality.

Martin-Copeland Co.
Providence, R.I.

WRIGHT RADIO CO.

Sole Canadian Distributors
OVERBROOK, OTTAWA, CANADA

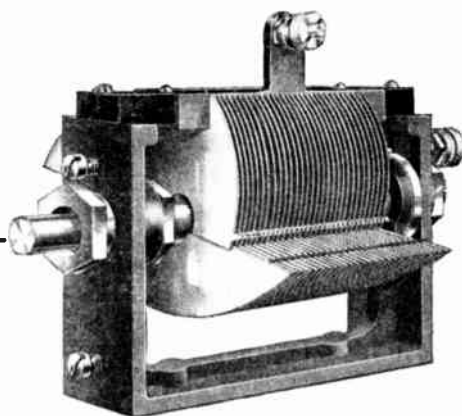

Smallest Uniform Frequency Condensers made, easily fit into present sets

They are half to a third the size of others, are only 2¼" in diameter with plates fully extended, so will easily go into your set.

Do away with crowding of station readings—85 out of 100 come below 50 on dial with ordinary condensers—by using

Samson
Uniform Frequency
Condensers

These condensers are built to 1/1,000 inch tolerance, silver plated all over and—in addition—have gold-plated plates to prevent oxidization. Grounded rotor type—minimum capacity 12 mmf.—losses lower than most laboratory standards. .500 mmf., \$7.00; 350 mmf., \$6.75; 250 mmf., \$6.50.

SAMSON ELECTRIC COMPANY
CANTON - - MASS.

B.M.A.

Manufacturers of Quality Electrical Products Since 1882

Canadian Sales Representatives: D. M. Fraser, Ltd.,
24 Adelaide St. East, Toronto, Ontario, Canada;
Sparling Markle, Ltd., 276 Smith St., Winnipeg,
Manitoba, Canada.

The Winding Trail to True Amplification



Practically uniform high amplification over entire audible range with minimum distortion is obtained by using Samson Helical Wound Transformers. Ratios 6:1, 3:1, \$5.00.

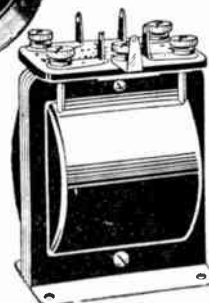



Brandes Speaker,
Type H \$25.00
West of Ft. William
\$26.00



Dubilier By-Pass
Condensers
\$.90 to \$5.00



Brandes Cabinet
Speaker \$45.00
West of Ft. William
\$41.00



Brandes Audio
Transformer
\$6.00



Brandes Photograph
Attachment, \$11.00



Brandes Adjustable
Table-Talker \$13.00
West of Ft. William
\$13.50



Dubilier Micadons
Type 640 and Type 640-G
\$.45 to \$1.40



Brandes Superior
Matched Tone Headset
\$6.25



Brandes Table-Talker
\$10.00
West of Ft. William
\$10.50

Brandes

Brandes—Experts
in radio acoustics
since 1908.
Canadian Brandes Limited
Factory and Office
243 Church Street
Toronto



The Durham Metallized
Resistor
\$.50

Westinghouse



Brandes Products exclu-
sively distributed in Canada
by Canadian Westinghouse
Co. Limited
Hamilton Ontario