



BRISTOL LOUD SPEAKER "AUDIOPHONE"

Multiplies the Pleasure of Radio

It will make your radio outfit a source of entertainment for the entire household—for all your family, and for the friends who join you. Its rich, full tones carry from room to room—clearly audible and with no blurring of sound. The "Audiophone" is complete in itself—needs no separate storage battery for magnetizing current—and can be used with all types of two or three stage power amplifiers. Its graceful lines and dull bronze finish adapt it for even the finest interiors.



Distinguished by its NATURAL Tone and Perfect Articulation

The "Audiophone" reproduces either voice or instrument with fidelity and with a remarkable freedom from all mechanical distortion. It has a natural tone—clear and strong and round, with ample carrying power. It is the outgrowth of years of development in sound reproduction by an established engineering firm. It is for those who must have the best.

*A new single stage power amplifier for use with the usual two-stage amplifier can now be furnished, which will greatly increase the range of the "Audiophone" where desirable.
List Price \$35.00—write for the circular.*



"AUDIOPHONE" SR. complete, 15-inch bell. List price..... \$45.00
"AUDIOPHONE" JR. complete, 11-inch bell. List price..... 31.50

Ask your dealer for a demonstration. If he hasn't the "Audiophone" in stock, write us. We will see you are supplied.

THE BRISTOL COMPANY, Waterbury, Conn.

R A D I O

This Name Plate on a Radio Set is all ~ Important

Northern Electric Company
LIMITED

A consistent advertiser stands behind his goods with a guarantee of their sound worth. His name plate is his word, his word his bond. Products which do not live up to their name

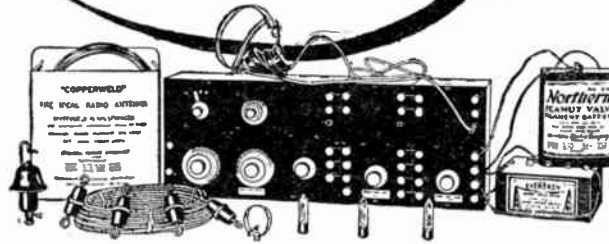

plates cannot stand the test of consistent advertising.

For many years the Northern Electric Company has spread its goods across Canada through the medium of sound advertising. Its name plate has been a guarantee of perfection.

"Whats in a name!" was never better demonstrated than in a Radio receiving set bearing a trade mark of reliability and sound composition. Years of consistent endeavour in every form of electrical enterprise makes it possible to offer the public a Radio set bearing the name plate of the Northern Electric Company.

Manufactured in Canada by

Northern Electric Company
LIMITED

Montreal
Halifax

Quebec
Ottawa

Toronto
Hamilton

London

Windsor
Winnipeg

Regina
Calgary

Edmonton
Vanconver

For sale by Branch Houses and Reputable Dealers.

CONDENSITE CELORON

STANDARD RADIO PANEL



The package speeds the sale

CELORON Radio Panels in standard sizes enable you to give the radio set-builder immediately the panel he needs. Each panel makes a separate package wrapped in glassine paper to protect the surface.

Stock Celoron Radio Panels in standard sizes and you carry a packaged article that turns rapidly and brings substantial profit. Furthermore, you give a service that can easily lead to the sale of other parts the set-builder needs for completing his set.

This material is a leader among radio insulations used by leading manufacturers of radio equipment. It is easily worked, machined, drilled, and tapped, and will engrave evenly without feathering.

The following panel sizes have been selected only after thorough investigation as to the needs of set-builders and the requirements of many dealers:

- | | |
|-----------|------------|
| 1.—6 x 7 | 5.—9 x 14 |
| 2.—7 x 9 | 6.—7 x 21 |
| 3.—7 x 12 | 7.—12 x 14 |
| 4.—7 x 18 | *8.—7 x 46 |

Thickness $\frac{1}{8}$ or $\frac{3}{16}$.

**This strip for cutting special sizes. Not wrapped in glassine.*

While we feature these standard sizes, Celoron comes in full-size sheets and we can supply special sizes if desired.

Advertising is spreading the story of Celoron Standard Radio Panels and sending radio fans into your store.

Send in your order, designating by number the sizes you sell most. We will gladly supply you with dealer material for your counter and window.

Diamond State Fibre Company

of Canada, Limited
TORONTO - CANADA

At Any
Authorized Starr Dealer

STARR

At Any
Authorized Starr Dealer

The Universal Detector and Amplifier

Long Distance
Detector
using
Honeycomb Coils

\$18.00

(as illustrated)
Without Tube and Coils.



Amplifier
Matches Detector
2 Stages
Audio Frequency

\$24.00

Without Tubes.

Size of Condensite Panel 7 x 7 $\frac{1}{4}$ inches

STARR METAL PRODUCTS CO.,

Temporary Address: 630 Pape Avenue,

TORONTO, ONTARIO

CRYSTALS Unconditionally GUARANTEED



STANDARD BRAND

Standard Brand Special Radiocite

Crystals are unconditionally guaranteed
to give satisfaction—we tie no strings to
our offer, they must be right.



Packed in neat Containers
Samples and Prices Upon Request

STANDARD MINERAL COMPANY

216 Market Street,

NEWARK, N. J.

Standard Radio Equipment

(De Forest Patents)

Radio Transformers



Price \$6.25

For maximum of amplification with minimum amount of distortion our A-10 Audio Frequency Transformer is a Leader. This transformer has made us a reputation for transformer design. If you want better reception install our A-10—the results will surprise you.

Real Radio Frequency at Last!



Price \$6.00

You can now obtain our R.F.-12 Radio Frequency Transformer. This transformer is a decided improvement over other makes. It may be used with any "hard" tube and was purposely designed on a narrow wave band extending from 325 to 450 meters for greater efficiency.

Radio Frequency is simplified by the use of the R.F.-12 Transformer and complete instructions, with a simple effective circuit, is supplied with every unit.

If your Dealer cannot supply these transformers, do not take a chance on other makes but send your order direct to us.

CANADIAN INDEPENDENT TELEPHONE CO., LIMITED

212 KING STREET WEST, TORONTO, ONT.

WESTERN DISTRIBUTORS:

Radio Corporation of Winnipeg, Limited, Winnipeg, Man. Radio Corporation of Regina, Limited, Regina, Sask.
Radio Corporation of Vancouver, Limited, Vancouver, B.C. Radio Corporation of Calgary, Limited, Calgary, Alta.

RADIO

EVEREADY RADIO BATTERIES



THE current from Eveready "A" and "B" Batteries is steady and powerful. Through their use you get freedom from battery noises and clearer receiving. They are the choice of experienced wireless operators.

Fahnestock Clips on Eveready "B" Batteries save time and worry in hitching up and operating the outfit.

Get Eveready "A" and "B" Batteries from your Radio Supply Dealer. If he has not the right sizes in stock, write us direct.

CANADIAN NATIONAL CARBON CO. LIMITED
MONTREAL - TORONTO - WINNIPEG

FRESHMAN PRODUCTS Accurate and Dependable

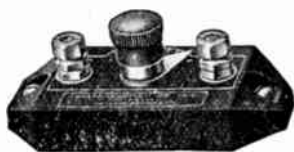

Variable Resistance Leak

With .00025 Mfd. Micon Condenser Combined **\$1.00**

Without Condenser **.75**

Unbroken range—Zero to 5 Megohms. Clarifies signals, lowers filament current, increases battery life, eliminates hissing.

"Micons"

Tested Mica Condensers

Size	Price
.00025	\$0.35
.0005	.35
.001	.40
.002	.40
.0025	.50
.005	.75
.006	1.00
.01	1.50



Assure absolute noiselessness—clarity of tone—accuracy—constant fixed capacity.

.006 Micons and Variable Resistance Leaks, especially adapted for New Flowelling "Super" Circuit.



Antenella

No antenna or serial needed. Eliminates all the inconveniences in radio, operates from any light socket.

Price only... **\$2.00**

At your dealers—otherwise send purchase price plus 30% duty charge and you will be supplied postpaid.

Chas. Freshman Co., Inc.
106 Seventh Ave., New York City

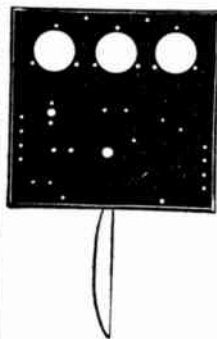

CONDENSITE
CELORON

Standard Size Panels

Always in Stock.
Prompt Service on
Special Sizes.

We are Distributors for the following firms—

F. A. D. Andrea; Grebe; Westinghouse; Murdock; Northern Electric; Atwater-Kent; Kellogg; S. E. A. R-Dee; Radio Corporation; Diamond State Fibre Co. of Canada; Marconi.

Kellogg all-wave coupler—180 to 3000 meters. Used for single circuit receivers.

Price \$14.00

Dealers! Write for Our Proposition

Salisbury Electric Co.

LIMITED

112 King St. West, . . . TORONTO
Toronto's Leading Radio Supply House

TUNE-IN ON THE NATIONAL

WAVE LENGTH AND SAVE MONEY ON YOUR PURCHASES

Lowest Prices on Standard Radio Goods in the U.S.A.

FREE A HYDROMETER (Battery Tester) with **FREE**
each purchase of \$1.00 or over

Have You Entered Our Advertising Prize Contest?

- FIRST PRIZE** \$250.00 Radio set Free—Six tube Radio
-Audio Frequency set.
- SECOND PRIZE** \$150.00 Radio set Free—Four Tube set,
Detector and 3 stage Amplifier.
- THIRD PRIZE** \$100.00 Radio Set Free—Three Tube
set, Detector and 2 stage Amplifier.

To advertise our business we will give the above prizes to the three persons sending us a list of five or more names of Radio fans and who compose the best slogan or phrase of words we can use for our advertising matter. We are interested in sending our catalogue and price lists to Radio fans.

If you are interested in Radio and in its future possibilities don't overlook this opportunity to get acquainted with us, secure low prices on your purchases and an opportunity to win one of the above prizes free of charge. In the event of two or more persons submitting the slogan judged the best, second best, or third best, each will receive the full amount of the prize tied for. All entries must be received by us not later than March 31, 1923.

OUR PEANUT TUBE DOES THE WORK OF WD-11

For Detector and Amplifying uses. Can be used on 1½ volt dry cells or regular 6 volt A Batteries. Fits standard V.T. socket. Uses about 1/10 ampere, on two 1½ volt dry batteries. Price of tube, \$2.50, includes adapter.

1½ VOLT TUBE (not WD-11, but for same use). For detector and amplifying uses.
Used on 2 Dry Cell Batteries (1½ volt) \$5.00

THIS WEEKS SPECIALS

- 1,000 HEADSETS, \$6.00 Value \$2.99 each
Biggest Radio Bargain Ever Offered—Order Promptly
- 200 RADIOLEAN CRYSTAL SETS, \$12.50 Value \$6.50 each
Includes Receiving Set and All Antenna Equipment

VACUUM TUBES

- U.S. Navy (Pilotron) used as a De-
tector, Amplifier and Transmitting
Tube, all in one. Type V.T. 14..... List \$8.00, now \$4.00
- U.V. 200 Detector 4.25
- U.V. 201 Amplifier 5.25
- U.V. 201A Amplifier 8.50
- WD-11 1½ Volt 6.50
- Cunningham Detector 4.25
- Cunningham Amplifier 5.25
- Myers Audion High-Mu 4.50

Vacuum Tubes Repaired. Broken and burned out tubes repaired. Mail them parcel post insured. Price, \$2.75 each, cash with your order. Tubes returned by Parcel Post, prepaid. We guarantee them to burn equal to new tubes.

VERNIER CONDENSERS

- 11 Plate List \$4.00, now \$3.00
- 23 Plate List 5.00, now 4.00
- 43 Plate List 6.50, now 5.00
- Freshman Grid Leak and Condenser
for Flewelling Circuit List 1.00, now .75

TRANSFORMERS

- Thordasen List \$4.50, now \$3.00
- Atwater Kent List 5.00, now 3.75
- Acme List 5.00, now 3.75
- WD-11 List 5.00, now 3.75

- BUSS BAR WIRE, 6 two-foot lengths \$0.25
- DX TRANSFORMERS, \$9.00 Value, Special 6.50

HEADSETS

- 2200 Ohm, equals best \$8.00 phones on market, now... \$4.50
- Brandes—2000 Ohm 5.50

- Dictograph \$5.80
- Federal 5.30

How to Order

All goods forwarded by Parcel Post. Send Money Order with order, and include the following rates with same for postage:

- On Purchases \$1.00 to \$ 5.00, 6 Cents Postage
- On Purchases 5.00 to 10.00, 15 Cents Postage
- On Purchases \$10.00 to \$20.00, 20 Cents Postage
- On Purchases 25.00 to 50.00, 35 Cents Postage

Space being limited, we are obliged to omit other money-saving items. Write for quotations or ask for our latest Price Sheet Catalog.

National Radio Products Corporation
Mail Order Dept., 509 FIFTH AVENUE, NEW YORK

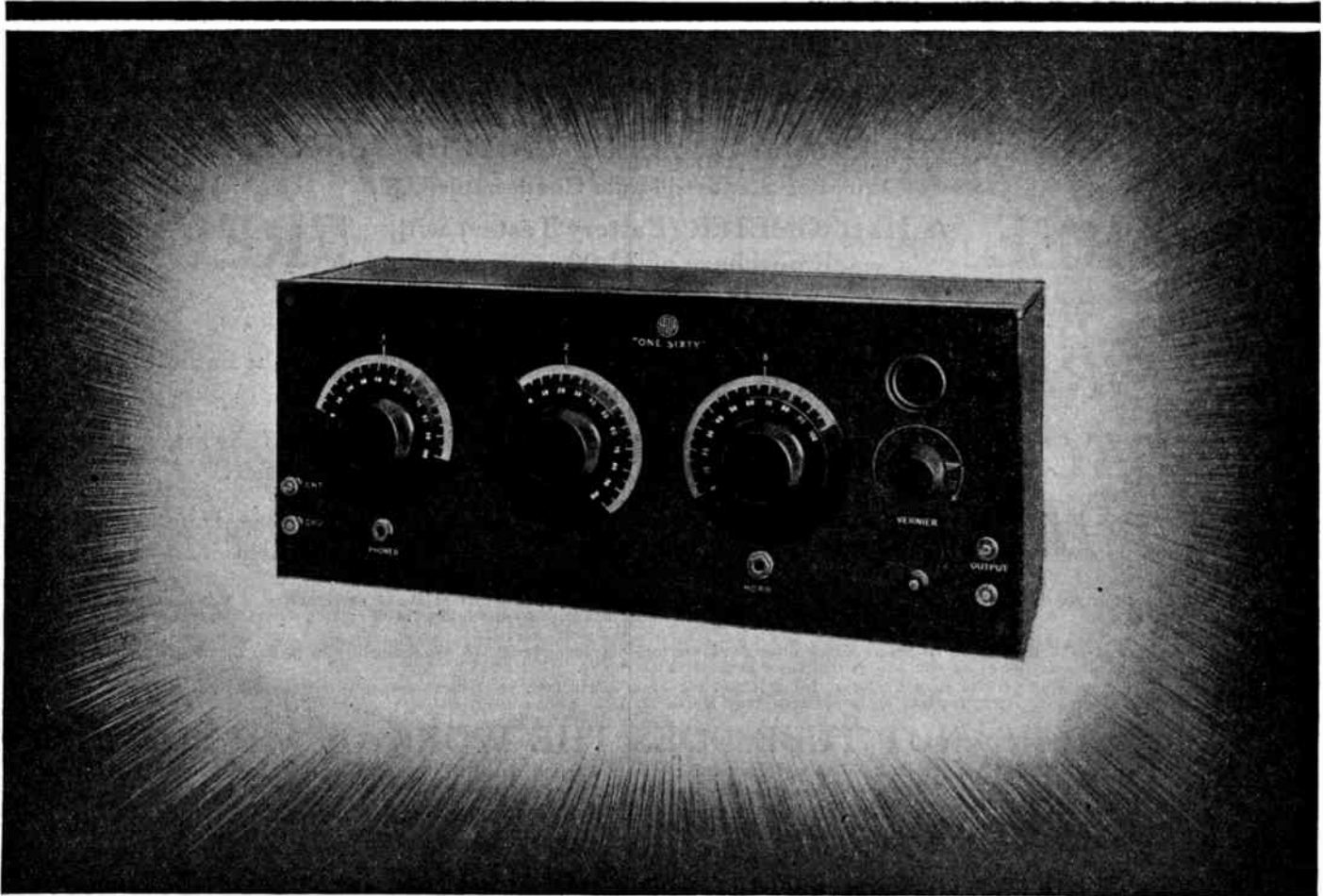

The famous FADA "ONE SIXTY" with the NEUTRODYNE circuit—

NEUTRODYNE—

Is the name given to a marvelous new radio receiver circuit invented by Professor L. A. Hazeltine, of Stevens Institute of Technology, Hoboken, N.J., and used in the FADA "ONE-SIXTY" receiver.

Only four vacuum tubes are used. The selectivity is remarkable and yet the dials can be easily adjusted to receive distant stations.

The FADA "ONE-SIXTY" will receive broadcasted concerts from the Atlantic to the Pacific and with loud speaker intensity.

Denver, Colo.; San Antonio, Tex.; Havana, Cuba, and Los Angeles, Calif., are some of the far distant stations listened to from New York City, using only a small indoor antenna.

The FADA "ONE-SIXTY" is the ideal receiver—the cost \$120.00]

F. A. ANDREA, INC. - 1581-P Jerome Ave., New York City

The **FADA "ONE SIXTY"**
 ~ WITH THE NEUTRODYNE CIRCUIT ~



Federal

Is a Large User of Formica

THE Federal Telephone and Telegraph Company of Buffalo is a large factor in the radio industry and has an excellent reputation for the quality of its product.

It is a very extensive user of Formica insulation not only in the complete sets which it produces but in the radio parts, variometers, variocouplers, head sets of which it is a large manufacturer.

A list of users of Formica reads like a directory of the leading independent radio manufacturers. So many of the best informed radio men in America cannot be mistaken in their opinion that Formica is most uniform, the best looking, the most efficient radio insulation.

Dealers and Amateurs can safely follow these great concerns in selling or using Formica

THE FORMICA INSULATION COMPANY

Canadian Office and Warehouse:— 47 West King St., Toronto, Ont.

FORMICA

Made from Anhydrous Redmanol Resins
SHEETS TUBES RODS

When writing to Advertisers please mention RADIO



**RADIOTRON
UV 201A**



**List Price
\$7.50**

The most efficient Vacuum Tube ever placed on the market for amateur, experimental and broadcast reception.

This new and improved Radiotron is a high vacuum tube suitable for Detection, Radio and Audio Frequency Amplification. It contains a new Tungsten Filament, the characteristics of which are Long Life, Low Power Consumption and Low Operating Temperature. It consumes only one-quarter of an ampere.

**Electrical
Characteristics :—**

Filament Potential5 Volts
 Filament Current0.25 Amps.
 Plate Potential20-100 Volts
 Plate Impedance16,000 Ohms
 Amplification Constant 6.5

**Descriptive Literature
Upon Request.**

The Marconi Long Range Receiver

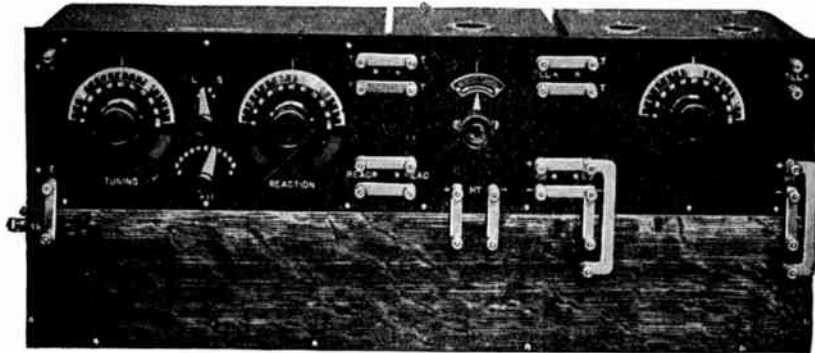

A set of proved ability and consistent performance that is giving universal satisfaction in thousands of Canadian Homes.

It is stocked by all High Grade Dealers who are supported to the fullest extent by the Marconi Service Department.

Individual Units:—

Tuner	\$45.00	Amplifier	\$40.00
Detector	20.00	Battery Cabinet	5.00

Receiver complete with the following accessories:—

- | | |
|----------------------------------|------------------------------------|
| 1 Detector Valve. | 4 Aerial Insulators. |
| 2 Amplifier Valves. | 1 Earthing Switch. |
| 1 pair "Radio Blue" Telephones. | 25 ft. Earth Wire. |
| 1 80 Amp. Hour Storage Battery. | 20 ft. No. 20 Rubber Covered Flex. |
| 3 "B" Batteries, 22½ volts each. | 1 Earth Clamp. |
| 200 ft. Stranded Aerial Wire. | 1 Set of Bus Bars. |

\$175.00

Detailed specifications together with much interesting matter contained in our new twenty-page booklet entitled "About Radio." May we mail you a copy?

The
**MARCONI WIRELESS TELEGRAPH COMPANY
 of CANADA Limited**

MONTREAL

Vancouver - Toronto - Halifax - St. Johns, Nfld.

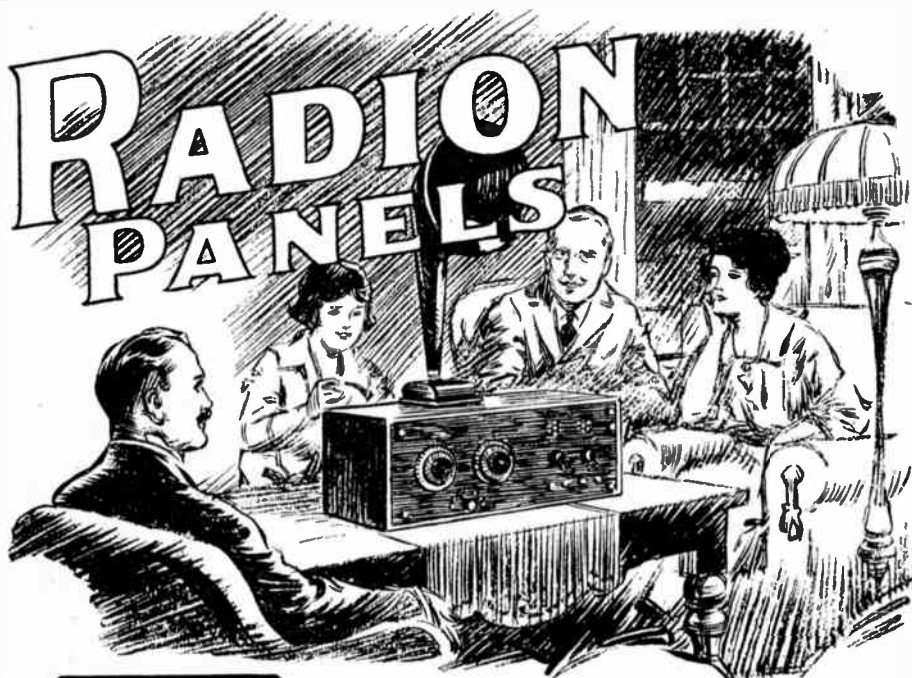

More
Economical

Better
Results



RADION Panels, both black and mahoganite, are made in 18 stock sizes—a sufficient range to meet every need WITHOUT waste. Nothing to cut off and throw away, hence Radion is economical. Each panel is packed in a heavy manila envelope to protect the beautiful finish, and complete directions for use are printed on the outside.

Radion is a superior grade of insulation, developed exclusively for radio use.

Radion excels all other insulations in the four most important characteristics required for radio use, viz.: (1) low phase angle difference, (2) low di-electric constant, (3) high resistivity, and (4) moisture, gas and acid repelling properties. Tests by competent authorities establish these claims beyond question.

Radion is mechanically better than other insulations, because it will not warp under normal conditions, and because it is so easily sawed, drilled, countersunk, sanded and engraved with simple tools at home. It will not chip or crack when being worked.

Radion is made in two colors—black and mahoganite. The latter resembles fine old mahogany. Both colors have a beautiful satin-like finish comparable to the finest ever put on hard woods.

Radion costs no more, in most cases less, than the ordinary insulation materials.

Radion is also furnished made up into dials, knobs, sockets, antennae insulators, condenser ends, etc.

Radion panels and parts are marked Radion to protect you against inferior substitutes.

Radion is procurable at most dealers, where the better class of radio products are sold. In case your dealer cannot supply you, write us direct, giving us his name. We shall also be pleased to forward descriptive folder to all who request it.

American Hard Rubber Co.

11 MERCER ST.,

NEW YORK.

Sales Agents:

For Western Canada: Sterling Specialties, 213 Somerset Bldg., Winnipeg, Manitoba
For Quebec: Daniel Devienne, 251 St. James St., Montreal



RADION Panels



Inductance Switch

AMSCO

Inductance Switch,
Rheostat,
Potentiometers,
Variable Air
Condensers,
Vernier Air
Condensers.

**SPECIFICATIONS OF
RHEOSTATS AND
POTENTIOMETERS**

BASE—Genuine Condensite.
RESISTANCE—Nickel, chrome.
Steel, "Ideal."
CONTACT—Phosphor Bronze.
KNOB—Attractive Taper Type.
ACTION—Smooth, noiseless.
POINTER—Highly nickeled.
RHEOSTAT—6 ohms, 1½ amp.
POTENTIOMETERS—250 ohms,
2 amp.

**2 NEW
ZONES**

**DURHAM VARIABLE
GRID LEAKS
MULTIPLE PHONE
CONNECTORS List 60c**

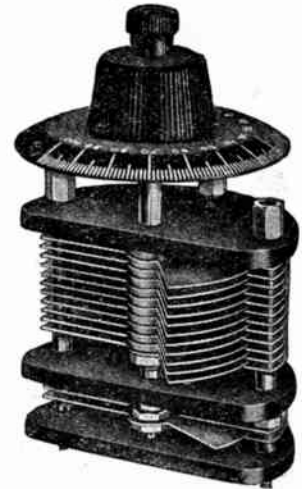

Vernier Variable Condenser

Also **NATIONAL DISTRIBUTORS** for
Raven Radio—Pacent Essentials—Burgess Batteries
Condensite Panels—Crystal Mines

SCOTT BROTHERS LIMITED R.R. Phones
332 St. Catherine St. West, - - - MONTREAL Fada
Wholesale Only

A THOUSAND MILE SET USING NO STORAGE BATTERY

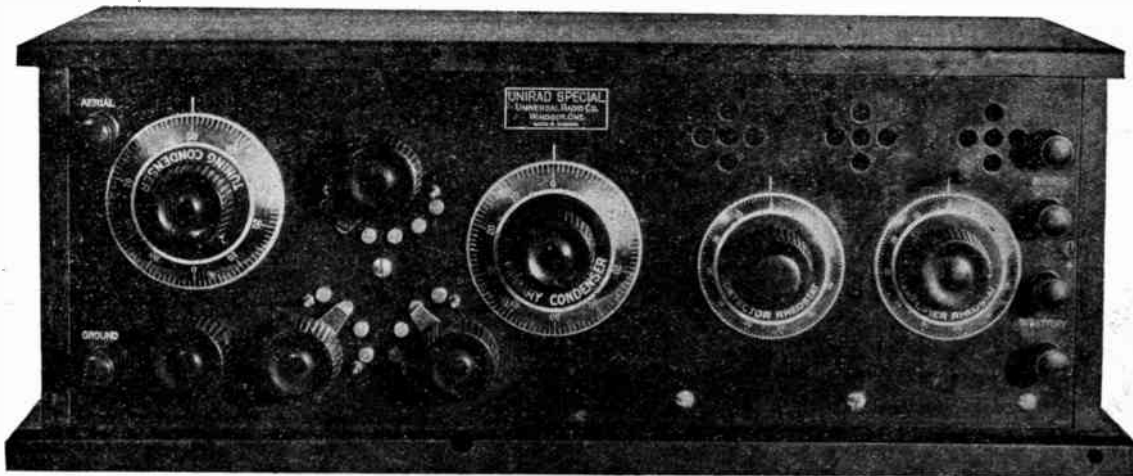

We will give a written guarantee that this set will operate over distances of 1,000 miles. It has received over 2,000 miles on a loud talker, using a single wire aerial 150 ft. long. This set is equipped with REINARTZ tuner, WD11 1½ volt tubes (three), EBY posts, genuine BAKELITE panel, VERNIER condensers and rheostats, BURGESS "B" batteries, and other exclusive features. In size it is 6 x 17 x 6 in. and the cabinet holds the "B" batteries.

SPECIAL

Grebe CR9 \$150. R3 Magnavox \$40. UV201A Tubes \$7.50 Splitdorf 3000 ohms Headset \$6.50
600 watt Acme Power Transformer CW with rectifying jars complete for 25 cycle supply \$65.00
10 watt phone or CW set complete \$285.00

We carry a complete line of all makes of goods at all times. We have the most complete and varied stock in Canada and ship the same day order is received. Catalogs sent on receipt of ten cents in coin or stamps.

UNIVERSAL RADIO AND ELECTRIC COMPANY - 26 Ferry Street, WINDSOR, Ont.

There Is Practically No Competition with the
BRACH
 VACUUM
RADIO PROTECTOR

It Has Dominated Its Field For Over 17 Years

**FOREMOST ENGINEERS GIVE IT PREFERENCE
 DEALERS EVERYWHERE FEATURE IT**

Because it requires no argument to sell it—because it is so universally recognized as the best radio protector in the market, dealers find the Brach Arrester an active seller throughout the year and especially during the season when static interference is greatest and lightning storms most frequent.

Approved by the National Board of Fire Underwriters



OUTDOOR TYPE



**SELL SOLDERALL
 TO YOUR RADIO FANS**

IT IS A METAL IN PASTE FORM—great for soldering radio wires and joints, insuring perfect reception. All you need is a tube of this paste solder and a match to heat it. Results guaranteed equal to bar or wire solder. **IT'S A BIG SELLER EVERYWHERE.**

L. S. BRACH MFG. Co.,

NEWARK, N.J.

Distributed by Perkins Electric Limited, Montreal

RADIO BARGAINS

Type R3 MAGNAVOX (New Style) - \$40.00

Celeron Panels, cut any size, per sq. inch - $\frac{1}{8}$ "—.02; $\frac{3}{16}$ "—.03; $\frac{1}{4}$ "—.04

Star Rheostats	.75	Amsco 23 plate Vernier Condensers	5.50
Cutler-Hammer Vernier Rheostats	1.75	Amsco 43 plate Vernier Condensers	6.50
“ “ Non Vernier Rheostats	1.25	Esco 3 plate Condensers	.75
Chelsea Transformers	4.00	Eveready “B” Batteries 22½ V. (Large)	2.00
UV 201A Radiotrons .25 amp.	7.25	Burgess “B” Batteries 22½ V. (Large)	2.75
Westinghouse WD 11 Tubes 1½ volt	7.50	Complete Crystal Sets	2.00
Pemberthy 2500 ohm Receivers (double)	5.75	Rotary Switch Levers	.25
Amsco 13 plate Vernier Condensers	4.50	Bakelite Sockets	.50

Crystal Detectors (Glass protected) .50

All orders over \$10 prepaid.

Wesley Electric & Radio Supply Co.

25-27 Chatham Street W.

Windsor, Ontario, Canada

QUALITY—SERVICE AND SATISFACTION

When writing to Advertisers please mention RADIO

Paul F. Godley's Amazing Experience With **BURGESS** RADIO BATTERIES

PARAGON RADIO PRODUCTS
GENERAL OFFICES & FACTORY
UPPER MONTCLAIR, N.J.
November 29, 1922

Mr. Duncan Keith, Vice-President,
Burgess Battery Company,
Chicago, Illinois.

Dear Mr. Keith:

In reply to yours of the 21st of November,
I am always pleased to recommend a first-class article.

A year ago this month I received a shipment
of Burgess Batteries for use in conjunction with my re-
ception of American amateur signals in Scotland. These
batteries were taken to Scotland, used for ten days while
actually setting in the mud underneath a rough table which
carried the apparatus. They gave entire satisfaction dur-
ing all this time. Some of them were brought back to the
United States and purposely left outside my home all dur-
ing the summer in sun and rain. Last night I connected
them into circuit connection with the regenerative receiv-
er and two-stage amplifier. They functioned perfectly. I
am sending one of these batteries to you by parcel post
and should be glad to have you take it and place it in
your "museum".

Knowing "B" batteries as I do, I consider this
as a very remarkable one.

I am,

Yours very truly,
Paul F. Godley
Paul F. Godley

PEG:15

TWICE across the stormy Atlan-
tic, engulfed in oozing mud, and
exposed for months to the destruc-
tive action of the elements, Paul God-
ley's set of BURGESS Radio Batteries,
wind-swept, rain drenched and sun-
scorched though they were, responded
instantly and powerfully, with the vital
energy necessary to the perfect opera-
tion of his delicate receiving set.

While it is seldom that a radio battery
is required to function under the stress
of conditions a fraction as difficult as
these, Paul Godley's experience stands
out as a remarkable and heretofore un-
heard-of example of the long life, high
capacity, tenacity of power and inde-
structible construction of Burgess Bat-
teries—*enduring qualities that are built in.*

BURGESS BATTERIES, Ltd.

Engineers—DRY BATTERIES—Manufacturers

Offices and Warehouses at:

WINNIPEG 701 Wellington Ave.
TORONTO 8 Colborne St.
MONTREAL 285 Beaver Hall Hill

In United States: BURGESS BATTERY COMPANY
Chicago, Ill. New York, N. Y. Boston, Mass. Washington, D. C.
St. Paul, Minn. Kansas City, Mo. Madison, Wis. New Orleans, La.



"ASK ANY RADIO ENGINEER"



When writing to Advertisers please mention RADIO



A. F. PENTON & Co.,
Publishers.

(Member Canadian Business Publications Association)

60-62 ADELAIDE ST. EAST, TORONTO, CANADA.
R. F. BUILDER, Bus. Mgr.

C. LINCOLN-MITCHELL,
Publication Manager.

Volume 6.

TORONTO, APRIL, 1923.

No. 1

PROPER ANTENNA FOR TUNING

By Frank Conrad, Assistant Chief Engineer, Westinghouse Electric and Manufacturing Co.

The ability to hear a desired station alone, or "selectivity," as it is called, depends in part on the receiving apparatus and in part on the antenna system to which it is connected.

Many believe that the better the antenna, the better the signals. This is true, but it does not necessarily mean that the best antenna is the largest. The function of the antenna is to transfer to the receiving apparatus the electric forces which are set up by the waves being transmitted through space. This receiving apparatus must discriminate between the electric forces due to the radio wave it is desired to receive, and the forces due to the undesired waves, among which are the waves from "Nature" herself, or "static" as they are called.

The selective receiver is one that offers a high resistance to the flow of current which would be set up by the electric forces from undesired waves, and offers a low resistance path for the flow of current due to the electric forces from the waves it is desired to receive. In other words, it permits you to hear the stations you wish to hear, and to tune out those you do not wish to hear.

The receptive ability of an antenna is, in general, determined by the height of its horizontal portion above the ground, or, stated differently, the strength of the electric forces induced in an antenna by the radio waves is proportional to the height of this antenna. Therefore, to tune out or discriminate between different waves, the selectivity or resisting power of the receiver to interfering waves would have to be increased as the antenna height is increased, while to receive an equal signal from a desired wave, the resistance in the receiving set to this desired wave, would have to be decreased as the antenna height is decreased.

Experiments have shown that when the antenna height is increased and a receiver, such as a crystal-detector set or a tube set not using regeneration, is used, the signal at first increases but soon reaches a maximum strength, which can not be exceeded by further increase of antenna height. This height is such that the electric forces set up by the incoming wave is sufficient to drive through the receiving apparatus the full current strength which is equivalent to the received signals. To express it in another way, this maximum current is that which would itself set up the same strength of radio wave around the re-

ceiving antenna as is induced by the transmitting antenna sending out the signals it is desired to hear.

A vacuum-tube receiving set, in which the principal of regeneration is employed, tends to reduce the resistance to the flow of current from a wave corresponding to that for which it is tuned. Therefore, if a regenerative receiver is used, an antenna in an ideal location, it will be found possible to maintain the maximum strength of signal, even with a reduced antenna height. However, as the same resistance will be maintained by this receiver against undesired waves the reduction of height will therefore give a greater selectivity. Of course, in general practice it usually will not be possible to obtain quite the same strength of signal with the low as with the high antenna, as there is a certain amount of absorption or loss near the ground which tends to reduce the possible signal strength.

Should the location be such that the antenna is perfectly clear and free from surrounding objects, the low one will be found to be practically equal to the high one, when a regenerative receiver is used. But should the antenna be located where it is considerably shielded, as where it is surrounded by high buildings, it is possible that the signal strength will be greatly influenced by height. In this latter condition, it will probably be necessary to make up for the poor selectivity of the high antenna by using a somewhat elaborate receiving apparatus. Under the conditions surrounding the average residence district, it usually is possible, with care in the location of the antenna, to maintain good signals, even though the height is considerably less than with the scheme generally employed of attaching the horizontal wire to some point near or on the roof of a two-story house.

The actual selectivity required divides itself into two classes or conditions of service; one in which it is desired to discriminate between two relatively nearby stations of approximately equal signal strength but separated by some interval of wave length, the other where it is desired to discriminate against a nearby station and receive from a distant one, the signal from which would, of course, be very much weaker than that from the nearby station. For the first condition, it will be found that with the average regenerative receiver ample strength will be obtained from an antenna which is not over ten or fifteen

feet high, or it may even be entirely within an ordinary living room. The second condition, however, is a much more severe one and requires either a location where an antenna of not over fifteen or twenty feet high will

not be unduly shielded, or where the lesser selectivity of a high antenna will be counterbalanced by a more elaborate and selective receiving set.

Hints on Antenna Construction

By F. Conrad, Assistant Chief Engineer, Westinghouse Electric and Manufacturing Co.

If your antenna were erected in an open space clear of any obstruction, the problem would be comparatively simple but as it is we usually have to make the best of the conditions as we find them. The element of the antenna which determines its ability to pick up or give off signals is its effective height. The term of effective height does not mean the height from the ground connection to its topmost point, but is more nearly the average height from ground connection to the center of its exposed area. For an antenna consisting only of a straight vertical wire, the effective height is about two-thirds its actual height while for an antenna having a large horizontal top structure the effective height is very nearly the actual height. The only purpose of the horizontal top element of a receiving antenna is to give a greater effective height for a given actual height.

When a regenerative vacuum-tube receiver is used the extent to which the signal can be built up by regeneration is independent of the antenna height if all parts of the antenna were equally exposed to the incoming signal. However, the amount of interference which is picked up will be proportionate to the height, and we must, therefore, endeavor to select a location which will permit of minimum height.

As the lower part of the antenna will usually be more or less shielded it is necessary to make some compromise between signal strength and selectivity and for installation in cities a height of 20 feet with a horizontal top of the same length will usually be found ample for reception of distant signals. For use when interference is slight or in country districts the height may be increased to 30 feet. It is of course assumed that for strictly local reception the antenna will be an indoor one.

It is unnecessary to use more than one wire for any part of the antenna and the size of this wire is unimportant. It should be well insulated at the supporting points and be spaced as far as possible from conducting

objects. If the outer end of the top wire is attached to a tree, a break insulator should be placed in the wire well top wire over or near any objects such as a metal roof, outside the branches. We should also avoid running this as the effective height of the antenna will probably be about the height of this top wire above the metal roof. If a supporting structure is available, a straight vertical wire without top horizontal part will be satisfactory or it may extend in a diagonal direction from the side of the building near the receiving set to a point some twenty or thirty feet above on an adjoining building or other support with clear space between.

For the best results the ground connection should be made to some conducting area on about the same level as the receiver. A steam or hot water heating system gives a good ground. Avoid a long ground wire as this gives height and lack of selectivity without compensating additional signal strength. This is an important point when the receiver is installed in an upper floor of a building such as an apartment. In this latter case the piping system of the building will furnish a good ground. Never run a separate wire down to the ground floor. The wires from antenna and ground where they approach the receiver should be separated as much as possible and the receiver should be placed as near as possible to the point where the antenna wire enters the building. The ground connection should be made to the nearest part of the conducting system which is to form the ground and it is often an advantage to connect to more than one conductor—such as the heating and water or gas pipes.

If your receiving set is not giving the results you think it should, look over your antenna structure to see how it meets the conditions I have just outlined. Thus it is possible that by a change in the height you can obtain the selectivity desired or by a change in its location you can improve the strength of signals from those distant stations.

How to Save Your Tubes

Paul McGinnis.

When it comes to "burning money" there are, perhaps, few methods which can compare in neatness and dispatch to that of connecting a "B" battery across the filament of a vacuum tube. A tiny flash and there the tube stands silent and imperturbable, the grim reminder of money which has gone forever.

The sudden demise of tubes must be guardad against in a number of ways and there are other precautions in the matter of minor ailments which must be taken if tubes are to have long and useful lives.

A fundamental mistake which is made sometimes by the experienced operator as well as by the novice is that of connecting parts of the apparatus or changing connections

without first disconnecting the batteries. There may seem to be no danger. Perhaps it is merely the connections of the tickler coil which need to be reversed. Such a change, as most anyone knows, could not burn out a tube, but there are other things to be considered.

When a wire is taken from the tickler coil it may, like all wires, have a tendency to spring from your hand, and if it should fly loose, it could easily touch another wire in such a manner that the high voltage of the "B" battery would flow through the filament of the vacuum tube and burn it out.

It is worth while, therefore, to remove your tubes when making connections, to connect your batteries after all

other connections have been made, and to make tests of the circuits.

The beginner is not apt to have a voltmeter or other instrument for testing, and he sometimes relies upon the short circuit sparks of his batteries to guide him unless he understands a handy use of his head phones.

Although the wire with which phones are wound is delicate, it will not burn out when the phones are used as a voltmeter for testing purposes because of the great length of wire wound in the little coils and because of its resulting high resistance. The tips of the phone cord can be touched to any part of the set without danger of injury, and the resulting clicks of the diaphragms will positively identify the low and high voltages used and avoid all danger of burning out the tubes.

Most sockets are marked with the letters F, G and P, which stand for filament, grid and plate. Some sockets for "peanut" tubes are not marked, but since one hole into which the prongs of the tube fit is larger than the others, the terminals are easily identified; the large hole is the plate, the one opposite is the grid and the other two are the filament terminals.

A moderately loud click should be heard in the phones when they are connected across the two filament terminals. When connected between the plate and either of the filament terminals, a much louder click should be heard. A click of medium intensity may be heard when connection is made to the grid and plate terminals. As the only danger to the tube comes through placing high voltage on the filament, the phones make an efficient testing instrument.

The intensity of the spark which is given off when connections are made and broken, for the spark of the "B" battery is much brighter than that of the "A" battery. Where such testing forms a short circuit, however, it takes

considerably energy from the battery and shortens its life.

When the current of the "A" battery is turned off by means of the filament rheostat, the current from the "B" battery also ceases to flow, as there is no connection between the elements inside the tube without the stream of ions given off by the lighted filament. All current can be turned off in this manner. The tubes can be harmed by turning the current on suddenly, and for this reason the rheostat should always be turned slowly. If your phone jacks control your tube current, the rheostats should be turned off when changing from one stage to another, so that the insertion of the phone plug will not light the tubes suddenly.

While the ions flowing from the filament form the only path for the "B" battery current, the tubes can be damaged if this current is too high. It is possible to use as much as 90 volts with some tubes, but when the high voltage causes a blue glow inside the tube, it should be reduced.

The plate voltage must be determined for each detector tube. It will be something less than $22\frac{1}{2}$ volts, and when it is once found, the tube can be operated on it without appreciable change. The adjustment of the filament voltage is a delicate matter, especially when amplification is used, and vernier rheostats are often useful.

It is possible to buy fuses to protect your tubes, and where temporary hook-ups are used such fuses are often valuable. If your connections are not soldered, they should be made by looping the wire entirely around the binding post, so that it can not come unfastened unless the thumb screw is removed from the post.

Tubes are made to be mounted in an upright position, and if they are mounted horizontally the filaments will sag, so as to shorten their length of service if they do not actually make a short circuit, and the function of the tube will be impaired.

The Neutrodyne Circuit Receiver

By Kimball Houton Stark,
Chief Engineer, F. A. D. Andrea, Inc.

Possibly the newest development in radio is the neutrodyne circuit invented and developed by Professor L. A. Hazeltine, professor of electrical engineering at Stevens Institute of Technology, Hoboken, N.J.

Professor Hazeltine recently disclosed his circuits before a meeting of the Radio Club of America at Columbia University, New York City.

The object of the neutrodyne circuit is the neutralization of the capacity coupling between two or more portions of a given circuit. When used for the improvement of radio receiver circuits it eliminates the capacity coupling existing between plate and grid, thus preventing regeneration. This condition of neutralization is brought about by the adjustment of specially designed condensers placed in the circuit.

The fundamental circuit illustrating the neutrodyne principle is shown in Fig. 1. In the diagram, circuits A and B are coupled through the direct connection at the bottom and through the coupling capacity C1. To neutralize this capacity coupling two closely coupled inductances L1 and L2 and the neutralizing capacity C2, are arranged as shown, L1 being connected between one terminal on C1 and the common connection, and L2 being connected in series with C2, between the other terminal on C1, and the common connection. Terminals of L1 and L2 which are connected together

are of unlike polarity. If circuit A has a source of alternating current, the alternating potential at its upper terminal (marked disturbing potential) will send a current through C1 to circuit B, which current in flowing through the impedance of circuit B will set up a voltage between the terminals of this circuit, power thus being transferred from A to B.

Now if the neutralizing circuit L1, L2 and C2 be introduced and so adjusted that the current through L1 magnetically balances the current through L2, no voltage will exist across either of these coils nor across circuit B, which is the condition desired to eliminate the transfer of energy.

As directly applied to vacuum tube circuits, Fig. 2 illustrates the application. In this figure, the capacity C2, being correctly adjusted, neutralizes the grid-plate capacity, represented by C1.

In actual practice inductance coils L1 and L2 may be respectively the primary and secondary inductances of air core radio frequency transformers. The secondaries of these transformers are preferably tuned by variable air condensers. A distinct advantage of the neutrodyne circuit is the fact that radio frequency transformers may be employed having a step-up ratio of windings of the order of one to four.

The adjustable neutralizing capacity in both Figs. 1

and 2 is designated as C2. In actual practice this capacity is adjusted in such a manner that the capacity coupling between circuits is reduced to a minimum, if not to zero. The neutralizing capacity may have a capacitance of from 1 to 5 or 6 micro-micro-farads.

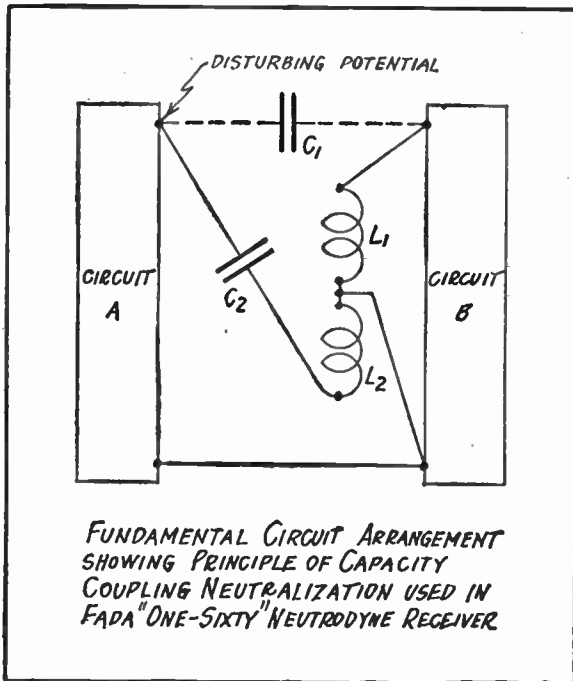

Such a very small adjustable condenser is unusual even in radio. A condenser of this kind may be readily constructed as shown by the drawings in Fig. 3. It consists of an insulated sleeve in which are inserted two pieces of wire with about 1/8 inch space between them at the centre. A metal tube is then adjusted lengthwise from the ends of the two wires, the result-

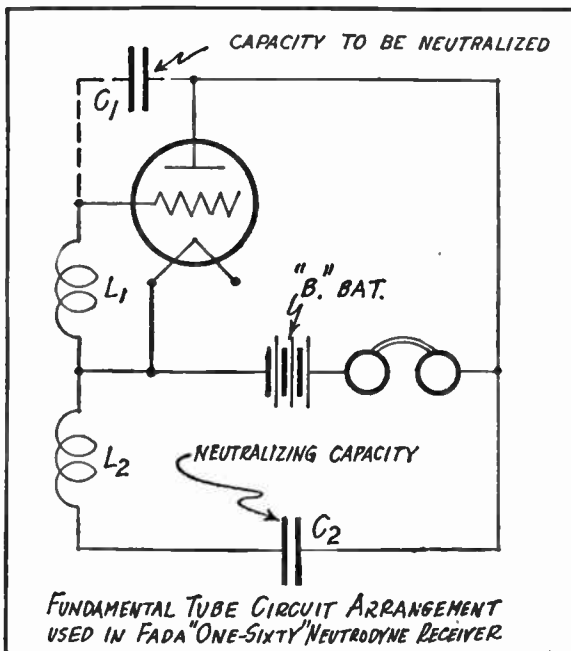

tant capacity being the series capacity of the metal tube and both wires. During tests this neutralizing capacity is adjusted and then sealed.

In making this initial adjustment, the receiver circuits are tuned to a strong buzzer signal, the filament

of the tube whose capacity is to be neutralized is turned out, but the tube left in its socket. When the neutralizing capacity is properly adjusted under these conditions there will be no capacity coupling on either side of the tube and no buzzer signals will be transferred. If the tube, however, is taken out of the socket altogether signals will come in strong, being again neutralized when the tube is placed in contact with the grid and plate contact springs.

Such a method of adjustment illustrates that the neutrodyne circuit operates to eliminate capacity coupling and is not just a method for opposing the effects of regeneration, because the adjustment is made with the filament cold, and, therefore, under conditions when the tube could have no regeneration.

The front of the panel has only four controls. Three of these are large dials for tuning control and the fourth knob is that of a vernier rheostat for the detector tube. A switch is placed at the lower right hand end of the panel for tuning on and off the filament current to all tubes.

In the interior, the radio frequency transformer units are mounted at such an angle to each other that no transfer of electro-magnetic coupling can take

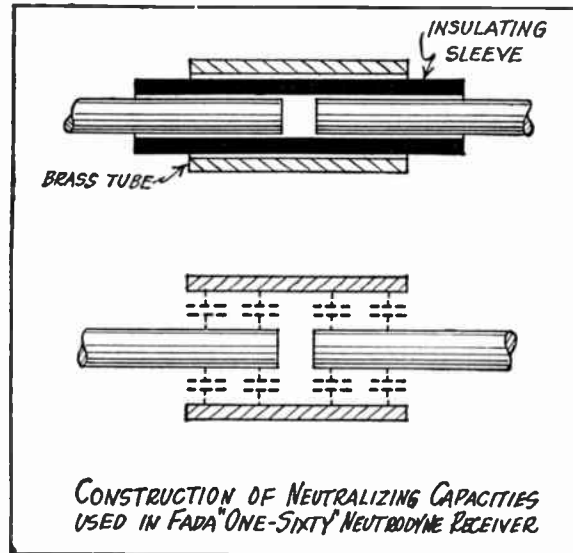

place. The neutralizing or balancing capacities are above and between the transformer units.

Fig. 4 shows a complete schematic wiring diagram of the receivers. The table of constants beneath the wiring diagram will explain the various parts of the circuit. This circuit using only four tubes actually does the work of five tubes, as the first tube is used as both a radio and audio frequency amplifier.

It seems to be human nature for every one who owns any kind of a radio receiver to want to pull in long distance signals. To get stations a thousand miles away isn't enough, and we are continually staying up nights twisting dial after dial in an effort to bring in that station 1,500 or 2,00 miles away.

From this point of view receivers utilizing the neutrodyne circuit are certainly ideal. There being only three simple adjustments, nearly any one can learn to operate the receiver in a few moments and with exceptional results. In such a receiver, there being no regeneration and no re-radiation, obviously there will be no squealing and howling and interference will not be caused in passing over various carrier waves.

It will be found when a station is actually tuned in

that Dials 2 and 3 will read nearly the same, Dial 1 varying in setting with various antennae used.

Once a station is logged and notations made of the settings of all three dials the same station can be listened to at any later time by simply readjusting the dials to the given setting.

WGM	Atlanta, Ga.	38.2	65	64	10:56
CFCA	Toronto, Canada	47.2	72.2	71.2	11:00
WLAG	Minneapolis, Minn.	38	58	57	11:15
WAAP	Wichita, Kan.	20	52.2	51	11:30
WHN	New York, N.Y.	19	47	45	11:45
					A.M.
WSB	Atlanta, Ga.	35	62	61	12:02

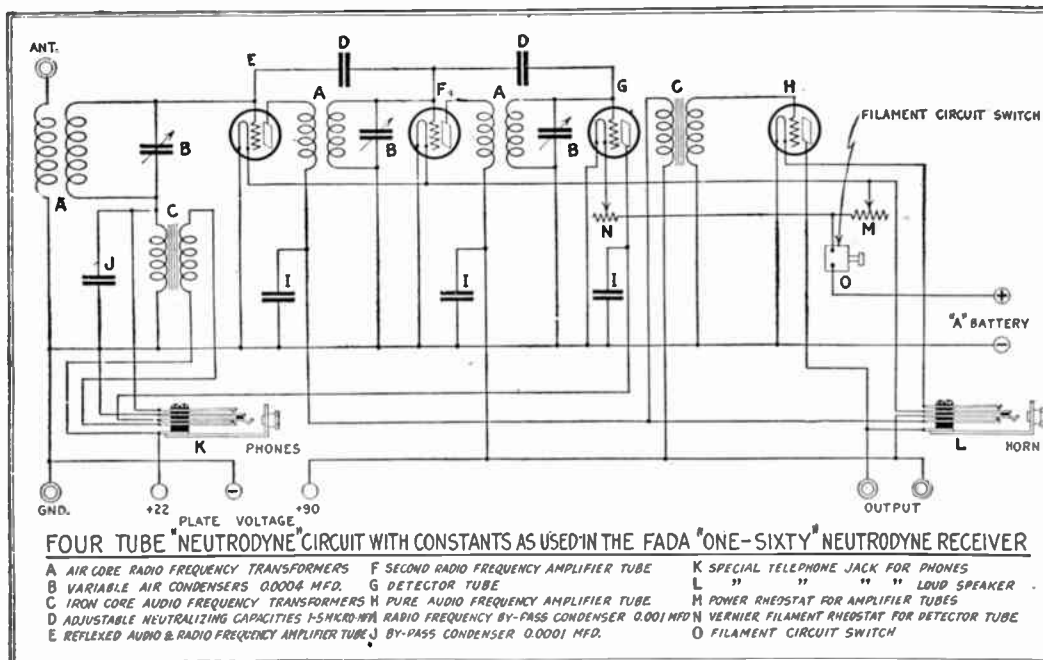

Some of the broadcasting stations heard from New York using only a 50-foot indoor antenna around the picture moulding of a fourth floor apartment are noted below, together with dial settings. This reception was on the evening of March 8, 1923.

STATIONS HEARD FROM NEW YORK ON RECEIVER USING HAZELTINE'S NEUTRODYNE CIRCUIT

Stations	Dial 1	Dial 2	Dial 3	Time P.M.
WBZ Memphis, Tenn.	40	67	66	9:35
WOO Philadelphia, Pa.	36	63	62	9:35-10
WEAF New York, N.Y.	30	56	57	9:35-20
WGY Schenectady, N.Y.	23	49	48	9:35-30
WJZ Newark, N.J.	10	42	41	9:35-40
WHB Kansas City, Mo.	31.2	60	59	10:50

WDAP	Chicago, Ill.	17	48	47	12:12
WDAJ	College Pt., Ga.	17	45	44	12:15
WLW	Cincinnati, Ohio	38	41	40	12:17
WDAF	Kansas City, Mo.	32	63	62	12:35
WSD	St. Louis, Mo.	27	57.2	56	12:52
KFI	Los Angeles, Cal.	49	71.3	70

WGY, Schenectady, N.Y., was received without aerial or ground and with very good intensity on a simple loud speaker.

Surely any receiver as simple to operate, which does not cause interference by re-radiation, and which has the ability to bring in long distance stations such as are shown above, is an ideal receiver.

Hardly a day goes by that enthusiastic letters are not received from all over the country telling of exceptional results obtained with this circuit—results that did not require an expert to obtain.

WHAT HEINIE HEARS

Nothing But Market Quotations Being Broadcasted in Berlin.

Only one station in Berlin has obtained a broadcasting license. There are several receiving stations, but mainly for business purposes only, and the lone broadcasting station deals solely with market and exchange quotations and fluctuations. Its service is confined to subscribers who pay for a license to erect a receiving apparatus, also a monthly subscription varying from one thousand to seven thousand five hundred marks. Subscribers can either do this, or else hire a receiving set from the post office department, which costs them 2,500 marks every month.

CHANGE NAME TO RADIO

The name of the Wireless Society of London has now been officially altered to the Radio Society of Great Britain.

Washington.—Public houses in England have been forbidden to instal radio sets and regale their customers with concerts and beer simultaneously. The information came semi-officially to Washington for use of United States manufacturers of radio apparatus, whose market is to be thus circumscribed.

Radio sets in public houses, the law justices at Manchester ruled, according to the reports, turn them into a different type of entertainment places than the liquor selling license allows the owner to maintain. He must either get a special license, the decision ran, or quit selling intoxicants. Lawyers for the publican at the trial of the test case introduced an ancient precedent, which allows a clarionet player to stick his horn through a public house door and play without the publican having a special entertainment permit, but the court ruled it out.



A Boon to Canadian Radio Enthusiasts and to the Trade

DEMAND in the United States for Michigan Radio Receivers and parts has been so heavy that we have refrained, up to now, from entering the Canadian markets, for fear we should not be able to render the prompt service which is so necessary in this business.

Recent enlargement in our facilities, however, enables us to extend to Canadian friends the privilege of enjoying what has come to be recognized as the highest development of radio reception anywhere in the world. The line includes:



"SENIOR" SET

Michigan Regenerative Radio Receivers

"Senior" and "Junior" Types



"JUNIOR" SET

licensed under the Armstrong U. S. patent, 1,113,149 and pending letters patent No. 807-388 and rendering a long-distance service which has no parallel in the art.

Michigan Two-Stage Amplifier, Michigan Variometers
Variocouplers, Variable Condensers, Rheostats
Etc. Each the top of its class.

RADIO EQUIPMENT & SUPPLIES, LIMITED

Canadian Distributors

18 Adelaide Street West, - - - TORONTO

DEALERS: Write for particulars about the exclusive MRC Franchise — the biggest business asset any radio dealer can possess. If you can measure up to our requirements, we will make you the *dominant* radio distributor in your territory.

MICHIGAN RADIO CORPORATION

GRAND RAPIDS, MICHIGAN

MICHIGAN RADIO PRODUCTS

Now Ready for Canadian
Distribution

Dealers—Write us re exclusive
MRC FRANCHISE and what it
means to you.

A Revelation in Radio Quality.

Canadian Distributors for
Dayton Fan and Motor Co.
Michigan Radio Corp.

Ontario Distributors for
Marconi Sets
Splitdorf Phones
King Chargers

Dealers: Write us for information
on these lines.

A Complete Stock of
QUALITY RADIO PRODUCTS

Radio Equipment & Supplies

Limited

CANADIAN DISTRIBUTORS

18 Adelaide St. West, TORONTO, Ont.

Amateur Section

The Construction of a Long Distance Peanut Valve Receiving Set

By Alex. V. Polson, E.E., Assoc. Member, A.I.E.E.

The details for the construction of the apparatus described in this article are the result of four months experimenting with peanut valve detectors and amplifiers, and apply in practically every detail to a set which is now in operation and delivering the goods.

Before proceeding further, it may be well to mention that the set referred to, with a single wire aerial thirty feet high and a hundred and twenty feet long, including lead-in and ground connection, has received clearly between fifty and sixty broadcasting stations, located from New York to British Columbia and Los Angeles to Havana, Cuba. These results have been consistent, and such stations as KHJ, Los Angeles; WSB, Atlanta; WBAP, Forth Worth, and others twelve hundred to two thousand miles away, can be heard almost every night. Further, several of these stations as far as Fort Worth have been clearly heard without any aerial connection. Local stations can be heard satisfactorily with a six-inch aerial and no ground connection. The methods for operating the set under each of these conditions will be dealt with later.

The parts necessary to construct this set are as follows:

- 1 vario coupler, with dial.
- 1 23 plate vernier condenser, with dial.
- 1 vernier rheostat.
- 2 plain rheostats.
- 3 peanut tubes and sockets.
- 1 variable grid leak and .00025 M.F. condenser.
- 1 .001 M.F. telephone condenser.
- 2 audio amplifying transformers.
- 2 switch levers.
- 12 contact points.
- 2 2-circuit telephone jacks.
- 1 single circuit telephone jack.
- 1 telephone cord tip plug.
- 1 nickel-plated bezel for tube peep-hole.
- 7 binding posts.
- 1 panel, 8½ in. x 20 in.
- 1 woden box to suit, approx. 9 in. x 10 in. x 20 in.
- 1 sq. ft. of tin foil for shielding rear of panel.
- 2 1½ volt cells Eveready flashlight batteries.
- 3 No. 6 dry cells for A battery.
- 1 22½ volt B battery, with tops 16½ to 22½ volts.
- 1 22½ volt B battery, without tops.

The panel that was used in the set was mahogany wood, 8½ in. x 20 in. x 5/16 in., and was laid out as shown in Fig. 1. The exact layout of hole spacing will vary somewhat with the apparatus purchased, but if the general arrangement shown is followed, the connecting wires between the various pieces of apparatus will be about as short as possible. This panel is held to the baseboard by means of small angle pieces of brass, which can be procured at a hardwood store.

The three peanut tube sockets are carried on a little shelf, as shown in Fig. 1. By this means the amplifying transformers can be conveniently located on the baseboard, as shown. The "B" batteries are arranged one above the other in order to save floor space, the upper battery being supported on a shelf.

The variocoupler used, when purchased had fifty-six turns on the stator and twenty-eight on the rotor. Previous experiment showed that there were advantages to be gained by having seventy or eighty turns on the stator and about sixty on the rotor, this later being used as a tickler coil. In order to obtain the desired number of turns, two pieces of cardboard tubing—one 3 in. in diameter by 1½ in. long and one 3½ in. in

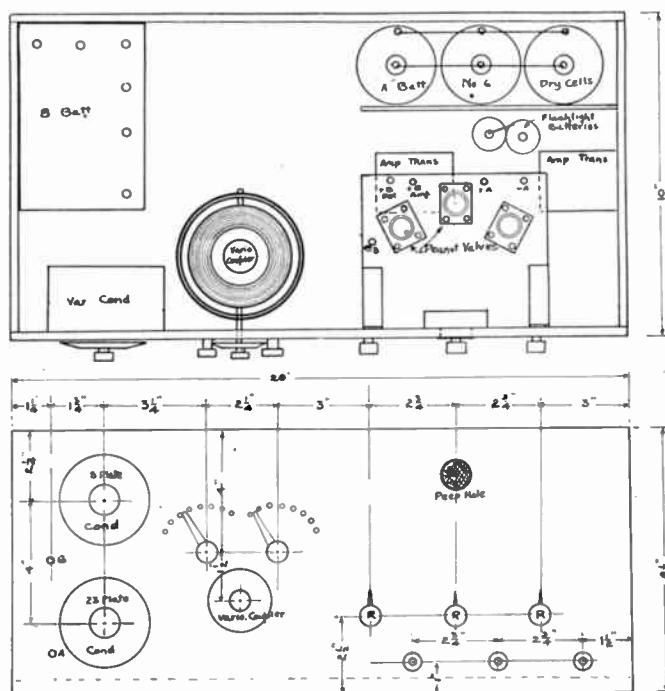

FIG. 1. GENERAL LAYOUT

diameter and 1½ in. long, are each wound with twenty-eight turns of No. 24 S.C.C. copper wire. The larger coil has tops taken out at every seventh turn and the smaller coil has no tops. These two coils are connected so that the larger coil is a continuation of the stator of the variocoupler and the smaller coil is connected in series with the rotor. The direction of the winding should be continuous, i.e., in the same direction as the original stator. The coils are placed concentrically in the lower part of the stator tube and held in place by wooden wedges or spacers. The variocoupler thus altered may be mounted behind the panel and the tops soldered to the contact points, as shown in the diagram of connections. If a variocoupler can

be procured with fifty or sixty turns on the rotor and seventy or eighty on the stator no alterations will be necessary.

The variable condenser used should have 23 or 43 plates, with a vernier of 3 or 5 plates for best results. The writer used one 23 plate and one 5 plate condenser, connected in parallel, but the use of a single vernier condenser would have saved space.

The detector rheostat should be of the best vernier type, as the filament adjustment is quite important in tuning. The other two rheostats are plain, and do not require any verniers.

A grid leak condenser of .0005 or .00025 M.F. capacity and an adjustable pencil mark leak are used, although the set will operate with a fixed grid leak of about one megohm. It will be found that reception of weak signals will be affected very noticeably by a close adjustment of the grid leak.

The audio amplifying transformers used were Jefferson No. 41, although any good transformer with a ratio of $4\frac{1}{2}$ or 5 to 1 should be satisfactory.

The apparatus described above may be arranged as shown in Fig. 1, and should be connected according to Fig. 2.

The two small $1\frac{1}{2}$ volt cells of flashlight battery are connected in series, and are located as shown in the wiring diagram. Before deciding on the best value for this "C" battery a potentiometer was used, and it was found that about 3 volts was very satisfactory. It may be well to mention here that the centre pole of the flashlight cell is positive and the outer zinc casing negative.

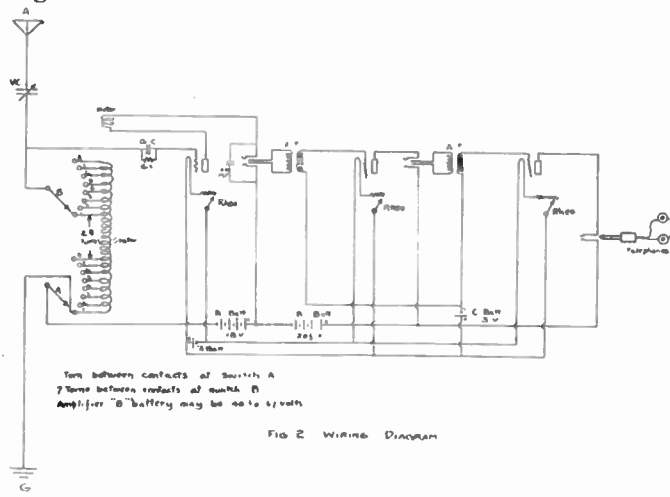

When using peanut valves I have always made a practice of inserting a short piece of resistance wire between each filament and the A battery. This is merely a safety measure to lessen the danger of filament burnout when the batteries are new. It is good practice to use three No. 6 dry cells connected in parallel when using three tubes.

A few notes on tuning this set under the following conditions may be of value: In the first place, with the aerial mentioned in the first paragraph; in the second place, with a lamp plug aerial; in the third place, with no aerial, but with a ground connection; and lastly, with a loop aerial, and no ground connection.

First, switch A is put on the 3rd contact, switch B on the 3rd or 4th contact. The tubes are lighted to a dull red and the variable condenser adjusted until a "whistle" is heard. The detector rheostat should be turned back slowly until the whistle disappears and the music comes through clear. A closer adjustment

of the condenser vernier, the tickler and the detector rheostat may then be made to strengthen signals. The amplifier rheostats require very little adjustment.

In using this set with a lamp plug aerial it will be found that switch "A" should be placed on the seventh or eighth contact, and switch "B" will have to be on the seventh or eighth point. This has held true in every case tried out, and signals are almost as good as with an outdoor aerial.

If no aerial is used, the ground wire should be connected to the aerial terminal on the set and the adjustment of switches A and B will be as mentioned in the preceding paragraph. The tuning will be found to be extremely sharp, and careful tuning is necessary for distant stations. Several stations over a thousand miles away have been heard in this way.

Local stations have been heard with various loop aerials from three inches in diameter to three feet square. The tuning is very sharp when a loop aerial is used, and the condenser must be rotated slowly or the "whistle" will be passed by unnoticed.

AMERICAN AMATEURS HEARD IN NEW ZEALAND

A radio amateur in far-off New Zealand, with a home-made single tube receiving apparatus, has succeeded in hearing dots and dashes from a number of amateur transmitting stations in the United States, it was reported recently in a letter from R. Slade, the New Zealand amateur, to the American Radio Relay League. This came as a surprise, since it was not known generally that New Zealanders were interested in radio.

As far as it is known, this is the first authentic reception of American amateur signals in New Zealand linking that island up with other distant corners of the world, where low power apparatus of U. S. amateurs is reaching out in an ever-widening circle. The letter, signed by three other amateurs who witnessed this feat, stated that a number of amateur radio clubs were being formed in New Zealand.

The first station heard was that of Thomas E. Nikirk, of Los Angeles, Cal., and his signals were picked up repeatedly on several nights. Other stations heard at distances ranging up to 8,500 miles were the following:

- C. Tipton, 200 Clark Ave., Fort Worth, Texas.
- C. Foresan, 1714 Alameda Ave., Alameda, Cal.
- Leslie B. Essington, 4412 Farlin Ave., St. Louis, Mo.
- Roy W. Weisbach, 6727 Yale Ave., Chicago, Ill.
- C. C. Brown, Volta Power House, Manton, Cal.
- Albert P. Upton, 2547 Ulyses St., Minneapolis, Minn.
- Gray & Gray, Orange, Texas.
- L. Mott, Avalon, Cal.
- H. A. Duvall & O. Esler, 4963 Wadsworth St., Los Angeles, Cal.
- Lloyde V. Berkner, 117 E. Summitt St., Sleepy Eye, Minn.

"In New Zealand we are much restricted by the government," Slade stated. "We have to get special permits to receive, and no sending is allowed at all. Instruments are also very hard to obtain here, and the prices are extremely high." Interest in radio in New Zealand, he said, was stimulated by the American Radio Relay League's trans-Atlantic tests. He expressed the desire that amateurs in his vicinity will have an opportunity to take part in long distance amateur tests.

On Some Experiments with a Hazeltine Circuit

By F. K. Crosbie.

Having been much troubled with the interference caused by the use of the narrow band of wave-lengths in vogue to-day by the general run of broadcasting stations, I happened to think of a circuit, named after its originator, used in England during the latter days of 1918-1919.

I decided that I would build a set, incorporating this particular circuit, and make some experiments with it for the purpose of finding out, if possible, some simple method of eliminating undesirable stations.

It has been recommended by Scott-Taggart as a highly selective circuit, embodying the principle of non-regeneration and absorption of all wave lengths differing in but a few meters on either side of the wave length which it was desired to receive, and regenerating to its maximum degree the desired wave length.

The set was assembled in a quarter-cut oak cabinet, finished in the natural color, the parts being mounted on a Formica panel, 6 in. x 21 in. x 3/16 in.

The usual list of parts required may be compiled from the following diagram:

In this diagram, regeneration is effected by means of the magnetic coupling between the coils L-1 and L-2.

The plate oscillatory circuit L-2, C-2, is connected across the plate and grid, and not across the plate and filament, which is the more usual connection.

Both the grid and plate circuits are tuned to the desired wave and the regenerative amplification will be confined to that wave length.

The valve has a strong tendency to reduce interference, as it absorbs energy from oscillations of other frequencies than the one to which it is tuned.

Using the tube in this way for combined regenerative and absorbing action precludes its use as a detector, because its grid circuit is connected to the aerial circuit L-1 C-1.

In the diagram which shows a detector and one stage amplifier, we have that circuit loosely coupled to the circuit L-2 C-2, by which interference may be still further minimized.

One may of course insert one stage of radio-frequency, or one may use variometers in the grid and plate circuits of the detector valve.

It is necessary to use separate A and B batteries for really satisfactory working, C batteries being used in both amplifier valves.

The ratios between L1-L2-L3 are found by experiment, L1 having a value in turns of half L2, while L3 has approximately from 50 to 80 turns.

The condensers C1-C2-C3 may be of the value .001, .0005, or .0006.

The condenser C1 was a Dubilier Variodon, which is singularly accurate and smooth-working, and takes up no room.

These are highly recommended, as they get away from undesirable inter-capacity effects between condensers.

The valves used were two English Marconi R's for the amplifiers, using .85-160 volts with a C battery voltage of approximately 10% of B1 and B2.

The detector was a D1, others being also tried.

A potentiometer of 220 ohms was used as a grid bias on the detector, and made quite a difference to the valve used in different cases.

This circuit is not difficult to tune, and the results to me were quite in accord with Hazeltine's claims. It was a pleasant surprise to me when I tuned in

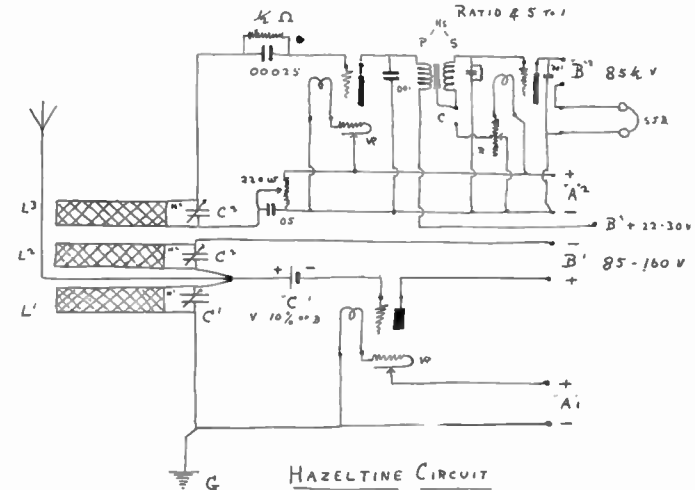

WGY, WEAJ, and WDAE, among others, in absolute silence produced by the successful elimination of all interference from other sources.

Our friend the Star, roaring in with its usual clarity, and what may be termed the pristine beauty of its carrier wave, could be, if desired, tuned out by a 3 millimetre movement of the dial controlling C3.

This is not by way of cheap sarcasm, for I have a sneaking affection for our local "Music Box," having enjoyed many an excellent programme broadcasted by them, and I may say enjoying it more since working with this circuit.

I am carrying out a further series of experiments with this circuit, which I hope in due course to disclose at some future date through the pages of this magazine.

Lastly, I would mention that for short wave-lengths large diameter Groves coils are the best to use in this circuit.

Save time distributing papers

Kleradesk

Automatically sorts and routes mail, memos, orders, etc., for all to whom mail is distributed. It holds reference papers immediately at hand when needed. Very convenient.

A Steel Sectional Device

Add compartments as required. Sections 75 cts each. Fifteen-compartment Kleradesk illustrated below only \$12.00 Indexed front and back. Write for free, instructive folder, "How to Get Greater Desk Efficiency."

Ross-Gould Co., 433 N. 10th—St. Louis
New York. Chicago (5)

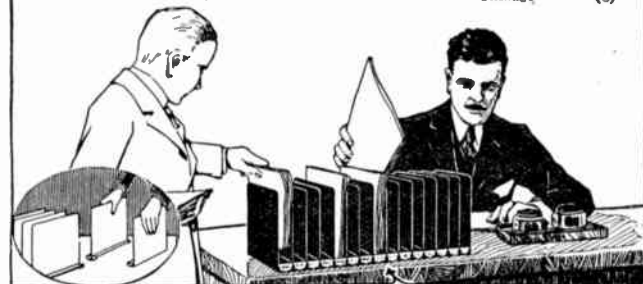

EVERYONE IS INTERESTED IN RADIO

Are all of the citizens in the United States interested in radio? Nearly all of them are, and the majority actively, according to Hiram Percy Maxim, president of the American Radio Relay League, in an address read before the Second Michigan Convention of the A.R.R.L.

It appears so when you know there are about 600 broadcast stations in America, when you hear radio talked about at every turn, that it is common ignorance not to know about the functioning of a vacuum tube, that any number of listeners in Newark, N.J., go to bed with receivers over their ears, and that thousands upon thousands of amateurs in every part of North America and foreign countries listen to each other's signals by means of short wave transmission on low power.

One can hardly walk a city block nowadays without finding someone who is interested in radio, whether manufacturing, selling, buying, or using radio apparatus. Outside the joy of reassembling a certain low-priced automobile, it is the only game verging on the technical which has widespread popularity. Thousands who had previously never shown the least enthusiasm in electricity are not burning midnight oil, but running up their light bills until 3 a.m. figuring out a new hook-up for their receiving sets.

Recently an automobile, loaded with headsets, was mobbed on arriving in a town where radio material was short, and they were carried away before the retail dealers were aware of their loss. Radio is not only in the air, but in the system, and Mr. Maxim, who is the best known amateur in America, divides the U. S. into four classes—the amateur telegrapher, expert broadcast listener, broadcast listener, and the interested citizens. Mr. Maxim says in part:

"Until the present time our conventions all over the country have been for one kind of people—amateur telegraphers. The conventions were organized by and for the amateur. We called each other by our call letters. We discussed our transmitting problems, our traffic organization, importance of co-operation, and questions that surround only dot and dash communication.

"But to-day our conventions must go beyond these things. We must consider others who are in radio, and who must use the same air with us. They are interested in radio, as we are, but from a different angle. The tremendous number of them mean purchasing power and influence. These two things will do more to advance the radio science in our country than all of the others combined.

"The expert broadcast listener is much the same kind of clay as we, but he happened to come into the game via the broadcast instead of the code telegraphy. He studies radio, and he knows what there is in receiving. Now this sort of person, with his technical bent and his appetite whetted, is not going to remain satisfied with concerts and crop reports, and the minute he tastes the sweet of long distance communication he is lost and becomes one of us."

W. A. O. O.

The last meeting of the Wireless Association of Ontario was held in Room 25, Electrical Building, University of Toronto.

The first speaker of the evening was Mr. Thatcher, who spoke of some very interesting experiments with synchronous rectifiers. Mr. A. L. Ainsworth sup-

plemented this paper with some remarks upon the practical operation of this type of rectifier. Considerable discussion followed.

Mr. W. C. C. Duncan, Canadian traffic manager, announced that since the last trans-Canada tests had apparently failed, similar tests would be held on April 13, 14 and 15.

It was suggested by Mr. C. A. Lowry that separate listening stations work in connection with transmitting stations during the tests. The work of organizing these "listening stations" was given to the city manager, Mr. W. Choat.

The last speaker of the evening was Mr. R. A. H. Galbraith, who spoke on the operation of "reflex" receiving circuits. This paper concluded the evening's program.

CHANGE IN SERVICE COMMITTEE

Broadcast listeners are requested to note that Mr. F. A. Burgess has been appointed to the Service Committee of the Wireless Association of Ontario, to fill the position left vacant by the departure of Mr. Ross Young from Toronto. Mr. Burgess' address is 3 Glebe Road, and his telephone number is Hudson 10.

Broadcast listeners unfamiliar with the purpose of the Service Committee are referred to the Wireless Association's announcement in the last issue of this magazine.

CANDIDATES SUCCESSFUL IN EXAMINATIONS FOR RADIO CERTIFICATE

The Department of Marine and Fisheries announce that nineteen (19) candidates were examined during the month of February, 1923, of which the following were successful and obtained "Certificate of Proficiency in Radiotelegraphy":

First Class—Commercial.

Name.	Address.
Messiter, W. F.	Vancouver, B.C.
Withrow, P. G.	Halifax, N.S.
Watt, G. E.	Vancouver, B.C.

Second Class.

Mennie, J.	Vancouver, B.C.
-----------------	-----------------

Amateur.

Best, J. G.	Toronto, Ont.
Coleman, G. S.	North Sydney, N.S.
Crowell, G. D.	Sydney, N.S.
Dusky, W. A.	Windsor, Ont.
Hartley, F. W.	Toronto, Ont.
Lanskail, R. B.	Vancouver, B.C.
Miles, F.	Toronto, Ont.
Rigney, W. H.	London, Ont.
Rowland, A. E.	Montreal, P.Q.
Smith, C. H.	Windsor, Ont.
Southam, W. G.	Westmount, P.Q.

HOTEL RICHMOND

70 West 46th St.
(Between Fifth Ave. and Broadway)

NEW YORK

Convenient Location At Moderate Prices

SAY IT IN "RADIO" !

The Advertising in this Magazine is a safe index to reliable business.



RADIO IN THE HOME

INTEREST TO FANS



The Problems of Radio Broadcasting

By H. P. Davis, Vice-President, Westinghouse Electric and Manufacturing Company.

Has it occurred to you what a curious relation there is between the broadcasters and the listeners, and how little there is to let us know what the other think of us? The artist appearing before an audience is almost immediately aware of the success or failure of his effort; the theatre manager has a barometer in his box office; the newspaper or the magazine can tell by its circulation to what extent it is meeting public appreciation. Public utility service companies can readily sense the public's attitude. But in this undertaking of ours—which in a way is also a public service—we have not yet found an effective means to sense the feelings of those who make use of this broadcasting service.

Now, KDKA is anxious to change this situation and wishes in some way to obtain a closer touch with you. Besides, we would like you to have a better understanding of radio matters in general, and the problems that must be solved in an undertaking of this kind.

With a full appreciation of the situation, and realizing the serious nature of the difficulties now confronting broadcasting, I am giving this talk as a sort of opening chapter of a series of talks, which will follow at short intervals, on the various phases of radio broadcasting transmission and reception, and it is hoped to cover every angle of the subject.

These talks will be given by some of the foremost radio engineers and broadcasting program managers.

The broadcasting problem really divides itself into three major divisions, the first of which is that of regulation.

When KDKA started to broadcast it was the only broadcasting station in existence. It offered a service entirely new and of a most fascinating and mysterious character. It, therefore, had no difficulties with interference, nor did it have to meet any criticism from its comparatively small audience.

During the period of somewhat over two years that we have been operating, however, this situation has materially changed. Receiving stations have been established at an almost inconceivable rate, so that now they number in the millions all over United States and Canada, and radio service has become actually a public necessity.

Unfortunately, however, this growth is not confined to the receiving or listening public, but the number of broadcasting stations also has increased by leaps and bounds, until now there are in the neighborhood of 600 broadcasting stations in the United States, all bunched on two wave lengths.

This huge but miscellaneous bunch of broadcasters and listeners is now confronted with a condition of chaos. There is no existing or proposed plan to correct this chaotic condition or to prevent interference. Action must soon be taken in some way to restrict the number of stations broadcasting if there is to be any hope of enjoying non-interfering reception, so essential to worth-while broadcasting.

Further, there must be supervision and regulation that will require both quality and service of the broadcasting stations.

In the range of wave bands allotted by the Government for broadcasting there are comparatively few available for that purpose, and even if all of them were made use of it would not permit more than 30 or 40 stations throughout the country, and location and wave length would have to be very carefully allotted and adhered to, to permit these to operate at the same time without interference.

The problem of accomplishing this with six hundred or more stations now operating, and possibly as many more starting in the near future, will make it plain for you to see that the situation is out of control.

Pending such time as there is proper organization and proper federal regulation to remedy this situation, there have been many suggestions made to improve existing conditions, and the one which has most frequently appeared, and has been the most urged, is that of a silent night to permit of long distance reception.

Have you realized how difficult this will be? Suppose that in the Pittsburgh territory all the stations closed for one night to allow local listeners to receive distant programs. In the selection of the nights, it would, of course, be out of the question to select nights in advance when reception conditions would be favorable.

Next, if all the rest of the world were operating, even though the local stations were closed, the interference would still be uncontrolled and satisfactory reception would be very uncertain.

It appears that the better suggestion would be to have one night a week in which a few selected stations properly picked throughout the country would operate, and these only. This selection of stations, of course, could be changed from week to week.

These stations should operate on such wave lengths on that night so that they would not interfere with each other, and selection and regulation of the stations and allotment of wave bands would have to be done from Washington.

In addition to the selection of the stations, the hours during which each station would broadcast should also be arranged, so that they could not conflict—thus giving the listeners for that evening opportunity to listen to the broadcasting of each station separately.

This also assumes, of course, that all amateur sta-

CANADA RADIO STORES

KINGSTON, ONTARIO

Largest Dealers and Distributors of Standard Equipment in Eastern Ontario

Wholesale and Retail Radio Exclusively

ALL MAIL ORDERS PREPAID—FREE INSTRUCTION SERVICE—WRITE US

tions which are operating on interfering wave lengths would be closed on that night.

If this arrangement were possible, it would give the listening public an opportunity to compare these various stations. In my opinion it would lead to the solution of some of these problems, thus testing the desirability of limiting the number of stations permitted to broadcast, and of selecting those most capable for such service.

But the problem is not merely one for the legislators, although their problem is one that we must all support and urge to the end of organized regulation and limitation of the stations that are permitted to broadcast. In a later talk this phase of the problem will be discussed at length and suggestions made as to how you can exert your influence to bring this about.

The second division of our problem is that of program quality and development.

Now, in the matter of programs we are all vitally interested. Have you ever thought what a task it is to provide a daily program, hours in length, seven days in the week, each of which will be pleasing and satisfactory? Especially when it is recognized that the service given is gratuitous by those who appear in these programs?

KDKA is especially anxious to give programs that

are pleasing to the larger number of its listeners. We ask your co-operation. This co-operation can be given by suggestions, and by encouragement to the artists who appear. A small effort on your part may mean a great deal in our success, and words of praise to the performers will make our task easier in stimulating the desire of performers to appear.

Nothing discourages an artist so much as a cold audience, and I think we must all admit that there is nothing colder than a radio audience unless we will each of us recognize that we have a duty that exists beyond the mere listening of the programs.

There are hundreds of thousands—yes, millions—of listeners to the nightly programs of the broadcasting stations. At the present time this is a gratuitous service, and as far as I can personally see it is likely to always remain so.

But even recognizing this, what is the attitude of the listeners? Are you always to remain passive and take what is offered by the broadcasting stations, or will some way be found to correct this?

I appeal to you, therefore, for help. Write to KDKA, KYW, WJZ, WLW, WGR, WCY, CFCA, CKAC, CFCF, etc.—whichever is nearest to you—and give criticisms or suggestions. Thousands have done this, but the number is only a small fraction of the vast

THE RADIO RUSH HAS STARTED

The man behind the counter as well as the road salesman will find the

EBY SILENT SALESMAN

(as illustrated) indispensable in making quick sales, as it enables the customer to wait on himself.



One in your bulk window brings in the customer.— One in your show case completes the sale.

Price to Jobbers and Manufacturers \$1.75 each
Price to Dealers \$2.00 each
Net f.o.b. Hamilton.

Sole Canadian Distributors — THE WALLACE BARNES CO., LTD. - - HAMILTON, ONT.

THE NAME IS



A Guarantee



No. 56.

Murdock Head Receivers
Murdock Variable Condensers

Are sold by Progressive Canadian Dealers.

WM. J. MURDOCK CO.
100 CARTER STREET - CHELSEA, MASS, U. S. A.

Quality Radio Supplies

We stock only the most reputable lines such as—

- | | | |
|------------|--------------------|-----------------------|
| Frost | Magnavox Co. | Homecharger |
| Brown | Atwater Kent Co. | Valley Charger |
| Pacent | Howard Radio Co. | Canada Wire Co. |
| Brandes | Hart "A" Batteries | Northern Elec. Co. |
| Chelsea | Burgess Batteries | Westinghouse Sets |
| U. S. Tool | Reliable Batteries | Marconi Wireless Co. |
| Murdock | Eveready Batteries | Federal Telephone Co. |
| Precise | Condensite Celoron | Can. indept. Tel. Co. |
| | Durham & Company | |

Write for Our Illustrated Catalog.
Discount Sheet to Dealers.

TORONTO RADIO CO.,
62 Yonge St. Arcade, - TORONTO, ONT.

Our New Price List is Ready—Listing all Standard Radio Apparatus at Attractive Prices

Brandes Matched Headsets \$8.00. Triple Coil Mounts \$3.00. Holland 1½ volt Peanut Tubes, Standard Base \$8.50, Fore Battery Chargers \$27.50.

Write for Price List.

THE J. D. FORD RADIO EQUIPMENT CO.
974 BLOOR ST. WEST, TORONTO, ONT. Ken. 2416 W

BUY DIRECT

MINIMAX RADIO BATTERIES

6 Volts 60 Amp. hrs.	\$13.00	Built specially for Radio, finished in Mahogany to match the set, with portable handle and Rubber mat. Positively guaranteed.
6 Volts 85 Amp. hrs.	18.00	
6 Volts 110 Amp. hrs.	23.00	

The MINIMAX STORAGE BATTERY CO.
323 Third Ave., Maisonneuve, MONTREAL, Que., Phone: La Salle 1797

unknown and unseen audience. We promise you our best efforts to follow the will of the majority, if you will respond.

The third division of our problem belongs to the radio engineer.

I want you to realize that this service of radio broadcasting is only a little over two years old.

Obviously, with so young an undertaking, much has to be done in the way of improvement and development, which is bound to occur if those who have the ability, means and facilities to accomplish it are encouraged and permitted to do so.

There are only a relatively few individuals and organizations so situated that they can accomplish this necessary and desirable end. This work must be done by those who can do broadcasting and who can make the receiving apparatus.

I have already indicated how few wave bands are available in the limits permitted by the Government for broadcasting. With the apparatus now available for transmitting and receiving, this limits the number of broadcasting stations that can operate without interference to a relatively small number of widely separated points.

The radio engineers, therefore, have the problem of devising apparatus for transmitting that will permit sharper tuning, and thus allow more broadcasting stations; and similarly, receiving apparatus that will be more selective to allow a desired station to be tuned in without interference from other stations that may be broadcasting at the same time. This is possible, and in due course much will be accomplished along these lines.

To make the program interesting, speech and music must be so transmitted and received as to allow the listener to receive the true tone qualities. A good deal has been accomplished in two years in this respect, but a great deal is still left to be done.

These problems are being worked upon with intense activity in the research laboratories of the large electrical organizations, for the problem is essentially electrical, and by those organizations, and by them only, is the solution possible. None of this development work is possible by other organizations not so situated. Please do not forget this.

I have not said anything about the cost of broadcasting. There has been much said about this, however, and a great deal of worry has existed as to the permanency of broadcasting because of the lack of revenue to those who are doing the broadcasting.

Personally, I believe this is one of the least of the worries you should indulge in. Rather than worry about the expense to those who are broadcasting, you should be more concerned about the confusion to which I have referred, and the failure of the authorities to show inclination to correct it, which is discouraging to those who have development, quality and service in mind. Results along these lines are impossible to obtain under conditions as they exist at the present time.

I believe the solution is in your hands, and in yours only. This situation will be rescued only when you, the great public, take organized action to bring your wishes before those who make the laws, and to the attention of those who are doing the broadcasting.

Loudspeakers

By A. Nyman, Radio Engineer, Westinghouse Electric and Manufacturing Company.

"Loudspeaker" is a new word which came into popular use about the same time as the word "Radio."

The loudspeaker is really the voice of the radio, converting the radio set into a musical instrument. Like any voice, it may be good or bad, and a careful selection of a loudspeaker should be made with regard to its quality, volume, and purpose, in order to be sure that the sound it gives will correspond to the sound sent out from the radio station.

It is a well-known fact that any sound can be regarded as vibration in air. Some sounds are vibrations at a definite rate, or pitch; others are vibrations at an irregular rate of rising or falling magnitude. You can distinguish between a pure sound of a definite and continuous pitch, such as the sound of an organ pipe or a flute; a complicated sound, which may consist of a blending of a number of pitches, as the voice of a person; or an abrupt sound, like the sound of a piano. It is evident that a complicated or an abrupt sound is much more difficult to reproduce than a pure sound.

The loudspeaker which is to reproduce all the musical instruments, and also all the voices that may be transmitted over the radio, must contain the qualities of all the different voices and instruments to be able to reproduce all sounds without any of its own characteristics. So far no loudspeaker has fully achieved this perfection. Any instrument possessing a horn, a diaphragm, or a reed, will have its own characteristic sounds, which may be suppressed to a certain extent, but not entirely eliminated. It remains with the listener to decide which loudspeaker is most capable of reproducing the largest

number of instruments and voices with the greatest fidelity.

Almost all loudspeakers will reproduce a pure note with a fair degree of accuracy. If a pure note gives a rattling or scratching sound, it is certain that the loudspeaker cannot reproduce a complicated sound; but, on the other hand, the fact that a pure note comes through clearly does not necessarily mean that a complicated sound will be faithfully copied. The same loudspeaker may reproduce a low-pitched note much weaker than a high-pitched note. A complicated sound, which contains both these pitches, will appear distorted because its low pitched component will be weak compared to its high pitched component.

This shows two qualifications necessary in a good loudspeaker. The first is clearness of pure sound at different pitches; the second is equal loudness of sound at different pitches. But even these qualities are not sufficient to reproduce all complicated sounds correctly. A third necessary qualification is that in a complicated sound the individual pitches should get through in the same proportion that they have in the original sound. A fourth qualification is that the natural sound of the loudspeaker should be eliminated as much as possible. The natural sound of the loudspeaker is dependent on the horn more than anything else. The longer horn gives the effect of a lower and a more pleasing pitch. By a suitable design this effect can be reduced to its correct proportion.

A person desiring to choose a loudspeaker with the best qualities possible should make the following tests:

First.—Listen for a pure sound, such as that from an

organ or a flute, or from a clear voice singing a sustained note; or if such tones are not available, the usual kind of "Howl" on the radio set may be used. If you run this howl through the full range, you can tell fairly well if any particular pitches come through unusually loud, or if other pitches are somewhat weak. If the loudspeaker gives all pitches without a rattle, and at a fairly even volume, you may expect this loudspeaker to give a rather good reproduction of all kinds of music. If one or two notes are particularly prominent, you will find that in reproducing music these notes will always ring too loud, and if the voice happens to strike these notes they will distort the quality of the voice. However, if one or two notes are missing, the quality is not impaired to any great extent. It is only when a range of notes is missing (for instance, all the low notes, or all the high notes) that the quality of both music and speech will be impaired considerably.

This test by means of the "howl" of the set will, as a rule, show you better than any particular selection of music or voice whether a loudspeaker can reproduce all kinds of music and voice satisfactorily.

The second test is made with piano notes. The piano gives a very abrupt sound, generally consisting of a blending of several pitches which are known in music as the fundamental and its overtones. In order to reproduce this sound correctly, the loudspeaker must have superior qualities. Sometimes the low notes of the piano seem to come through very clearly but, somehow, a musician would not think that the piano is reproducing correctly. He would speak of it as sounding "tinny." This would give a fair indication that these low notes miss their fundamentals and only reproduce their overtones, or high pitches.

A third test, and probably the most important, is the test of the voice. The voice, and particularly the speaking voice, is an extremely complicated sound. It consists, generally, of a blending of a number of pitches. Sometimes as many as twenty or thirty pitches are necessary to produce the quality and the inflection of the voice.

An increase or decrease in any one of these pitches will change the quality or inflection. Personal judgment is, of course, the only way to determine the quality of the loudspeaker. If you hear a person, whose voice you know, talking by radio, you can judge the quality of the loudspeaker by the naturalness of the voice, particularly by its inflections. The pitch of your friend's voice may appear lowered or raised a certain amount, due to characteristics of the horn, but that would not necessarily impair the quality. If you do not know the person talking, the best test you can make is to get far away from the loudspeaker and try to understand what is being said. With a good loudspeaker it is possible to go to a different part of the house, shut the door, and yet understand clearly.

In addition to clearness, another quality of speech should be considered also. A loudspeaker may give very clear speech, but with an accent on some particular sound, as the "ah" sound. Although this does not necessarily make the loudspeaker undesirable, yet the effect of this accent during a long talk will probably be annoying and cause some of the listeners to beg to have it shut off.

In testing the loudspeaker, and also in using it, it is essential that the radio station, the radio set, and the amplifier with which it is used all give good quality. A poor amplifier, or a radio set improperly adjusted, will make the best loudspeaker sound like the worst. It is sometimes difficult to get a distant station on the loudspeaker to sound clear. The usual effect is to accentuate

the low notes and suppress the high ones. All voices are pitched low, and the music seems to consist of the booming of drums and the low notes of the piano or orchestra. This effect is due to the closeness of adjustment of the set and can be corrected only by the use of a more powerful set which does not require such close adjustment.

In conclusion, let us consider the place where the loudspeaker is to be used. In an ordinary living room of a small house, it is not necessary to have a loudspeaker that gives a large volume of sound. Quality is far more important, and a weak loudspeaker with a good quality will be found far superior and more pleasing. A loudspeaker capable of an enormous volume has its uses for outdoor demonstrations, dance halls, or auditoriums. A house with large rooms, where the loudspeaker may be used for dancing, requires a fairly large volume from the loudspeaker. As a rule, dance music must be made louder than speech or purely artistic value.

A person desiring a loudspeaker for any particular use will find in almost any radio store one that will satisfy his need. It will pay him, however, to choose one according to its merits for the particular use for which he desires it, since the same loudspeaker may be suitable for one place and very unsatisfactory when used in another.

RADIO REACHES OUT-OF-THE-WORLD PLACES

The Indian Lake Lumber Co., Ltd., have a camp at Osaquan (via Ignace, Ont.), not found on any of the published maps of the world. Until radio came along they were "on the edge of the Aurora Borealis—many miles from any town of importance."

Now they consider themselves the centre of the world. On February 17 Mr. Appleton wrote: "Last night we listened to two concerts between 9.30 and 11 p.m. Both Schenectady, N.Y., and St. Louis Post Dispatch were broadcasting between these hours. With the dials all set, we listened to both sets by simply moving the tuner from 51 (W.G.Y.) to 58 (K.S.D.); the intervals of one concert being taken up by the selections of the other, and we had a three-hour concert in the space of one hour and a half, every piece of which came through the loud speaker as loudly as if the performers were in the building with us.

"One of the most beautiful and perfect concerts we got was on December 4th last, when we had a fierce blizzard from the north, which piled up most of the snow we now have. We heard 'The Flower Wreath' programme from Fort Worth, Texas, every selection clearly through the loud speaker. In fact, we seem to get better results when there is the opposition of a wind. Clear, still and intense cold nights, and results are not so good.

"I am satisfied we have a set as nearly perfect as can now be obtained, and that this perfection is due to the careful selection which was made of the component parts of the set, and which included Burgess 'B' batteries."

Those who are talking pessimistically about the future of radio should think of the vast good humanity in the isolated places receives. Think of the wonderful mission we who are interested have in spreading the good word to these people and showing them what radio can do for them. And from indications as to the type of men who have allied themselves with the industry there is every reason to believe a good job, well done, will be the final outcome.

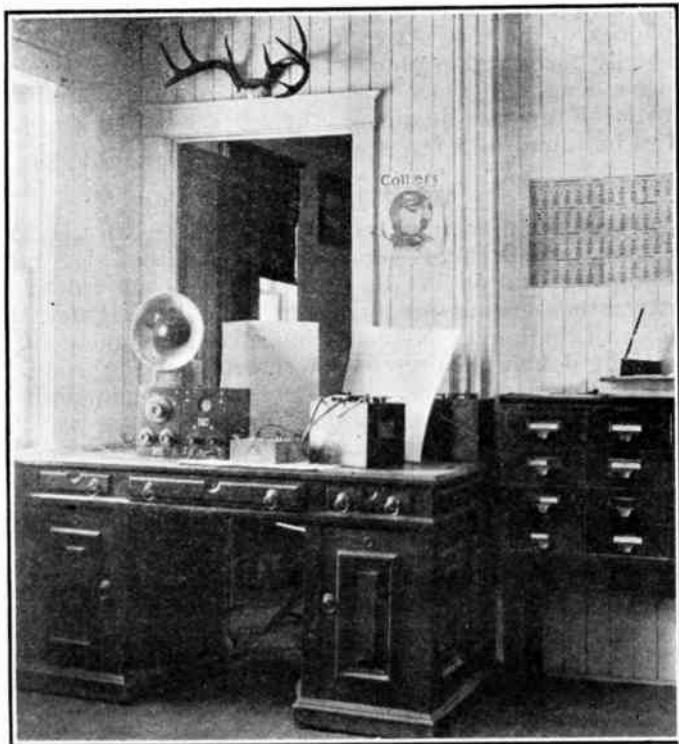

Mr. Appleton's set in his office.

TOO MANY SIZES OF BASES

Nothing could better illustrate the lack of organization back of radiophone development in this country than the unstandardized system of making certain component parts for use in receiving sets, and of this the vacuum tube is undoubtedly the most striking example.

At the present moment there are receiving tubes on general sale which have three different types of bases, each of which requires a special socket of its own. Now a fourth type is about to be placed on sale. In addition to these, there is the original "Peanut" or "N" tube (which at the present time can only be bought in Canada), that has still a different sized base from all the others. As there is every possibility that reconsideration of existing agreements may shortly release this tube for general sale, the resulting confusion can easily be imagined.

It is not only in the matter of bases, however, that confusion exists—the tubes themselves are so arranged that each type requires a different voltage on its filament, and consequently a rheostat of special resistance value to care for it and eliminate the possibility of burning out the filament.

BROADCASTING REACHES 30,000 ISLANDS

From one of the 30,000 islands of the Georgian Bay, Ontario, has been received one of those letters which help radio station personnel, and artists feel that their efforts are relieving the sum total of loneliness in the world. L. E. Monck, on Wahsouné Island, Sans Souci, Ontario, Canada, writes:

"We are all very much attached to the entertainments being broadcasted by the different stations. These take us back to the cities and bright lights, and for the duration of the programs forget we are alone on one of the 30,000 islands of Georgian Bay, and for weeks at a time cut off from all communication with the rest of the world.

"Our nearest winter post office is Parry Sound, eighteen miles away, and when the ice is too thick to use a boat and not thick enough to walk on, we just stay here and hope for good ice, so as to be able to get out either with dog team or horse to get our mail. Just now the ice is good, and we make the trip every eight or ten days, but soon now the ice will start to break up, and then we are marooned until clear enough for a motor boat."

Another lonely radio fan in the Middle West is J. W. Morton, of Tofield, Alberta. He wrote: "I live on a farm 200 miles north of Calgary, and have been getting concerts off and on all winter, and when I do get them they are very distinct. I have a one-tube, home-made affair."

RESERVOIRS OF ENERGY ARE RADIO CONDENSERS

Condensers are a very necessary part of any radio set. They are reservoirs of electrical energy, in which the oscillations from the antenna circuit are stored up before they are passed on to devices that detect, amplify and throw out the music of speech in the form of sound waves.

Condensers may be so grouped that the total capacity of the unit is larger than that of any one condenser, or so that it will be less. Sometimes it becomes necessary to change the capacity of a circuit containing fixed condensers. This can be done by connecting the condensers in the required fashion.

The capacity of condensers is measured in a unit called "farad." As this unit is very large and the capacity of condensers used in radio work is so very small, it is customary to take a unit which is a millionth part of the farad, and is, therefore, called a "microfarad." This is abbreviated mfd. for short and the standard in radio apparatus.



The Gilliams Service

RADIO FOR YACHTS

As sailing days come near yacht owners are equipping their palatial crafts with the newest pastime, Radio apparatus, as a new aid to add to the pleasures of cruising, and to such an extent that it is reaching the proportions of a fad. Photograph shows a fair yachter off the Pacific coast, where yachts cruise all the year round, listening in on the radio with which her yacht is equipped.

RADIO A BOOM IN THE HOME

A woman, recently asked what was the greatest modern invention, said: "The radio—it keeps the old man home nights." A man, asked the same question, said: "The radio; it keeps the old girl quiet while I read the paper after supper."

But seriously the radio seems like a God-sent agency to restore and keep intact the family circle and the home life of our city that was being torn apart by so many other diversions, appealing as they did to the overwrought nerves of our people to be ever on the move. From an address on radio by Rev. Lyman R. Hartley, pastor of Fort George Presbyterian Church, New York City.

NO RIGID INSPECTOR PLANNED FOR RADIO

Bill Proposed by Hydro Would Only Safeguard Erection of Aerials.

In the proposed bill before the Legislature to give the Hydro-Electric Commission control of all radio installation, there is nothing to indicate that the Commission is planning a house-to-house canvass to inspect homes in which radio sets have been installed. The Hydro Commission has for a number of years had control over all electrical installations, and the proposed bill merely seeks to extend its safety regulations to include radio.

In this respect, the utmost to which owners of radio receiving sets could be affected would be in a few requirements regarding outside aerials, which are already observed by nine out of ten radioists. For instance, that the aerial be free from risk of coming into contact with power wires, and that a lightning arrester or switch be used in every case. The principal effect of the bill would be to provide inspection of amateur and commercial broadcasting stations.

This explanation is made for the benefit of those who may have views similar to a reader, signing himself "Radialis," who wrote in protest against the proposed bill, mention of which was made on this page last Wednesday.

"How will the boys like to be supervised in their attempts by some authority clothed with official power to interfere and suggest 'improvements' and 'necessities?'" he asks. "It will be the beginning of the end for many, if adopted."

"It would seem unnecessary to state the impertinence of the proposal on grounds of safety," he goes on, "except possibly in cases where the set is plugged into the small percentage, no doubt. The less control the industry receives, consistent with public safety, the better. Proposed installers will certainly resent it."

NO TECHNICAL KNOWLEDGE NEEDED TO INSTAL A SET

If a person has no knowledge of radio terms, symbols and hook-ups, it will be less expensive in the end if he buys a good set outright instead of trying to construct it himself. In building a set one learns more about radio theory, construction and operation than if he purchased a set. However, the practical experience of building a set will be found more expensive than buying unless the builder is familiar with radio theory and practice.

No technical knowledge of radio is necessary to instal a complete receiver. The binding posts are marked so that by following directions it requires but a few

minutes to connect the antenna, ground, batteries and phones to the set. After the connections are made it is only necessary to tune the instruments to the proper wave length. Once the operator becomes familiar with the tuning adjustments the different wave lengths can be found in a few seconds.

WGR TO MOVE

Through an arrangement between the Statler Hotel Company and the Federal Telephone and Telegraph Company, station WGR, Buffalo, will be moved to a new studio being prepared for it on the eighteenth floor of the hotel. New and improved equipment furnishing double the present power will be used throughout. Two large pipe organs, one in the main dining room, the other in the ballroom of the hotel, as well as the orchestra under the direction of Vincent Lopez, of Pennsylvania Hotel, New York City, will easily be broadcast by means of a permanent cable connection with the set upstairs.

RADIO PATENTS

No. 228,573. Secret Signalling.—The International Western Electric Company, Incorporated, assignee of Burton W. Kendall, both of New York City, New York, U.S.A., 6th February, 1923. Filed 8th July, 1921.

Claim.—1. The method of secret signalling which comprises modulating a wave by currents of signalling frequency, suppressing the unmodulated components of both the signalling frequency and the wave, transmitting only one side band of the modulated wave, modulating a second wave by the transmitted band and transmitting to the distant station only one side band of the second modulated wave, the frequency of one of said waves being continuously varied.

11. A system for producing a pure modulated high frequency wave and for suppressing currents of all frequencies incident to the production of said wave except those comprised in a single side band, said system comprising means for producing an unmodulated wave, means connected thereto for modulating said wave, a filter for selectively passing frequencies lying to one side of said unmodulated wave frequency, but preventing the transmission of said unmodulated wave and currents of all frequencies to the opposite said of said unmodulated wave frequency, means for modulating a high variable frequency wave in accordance with current of the frequencies passed by said filter and a filter for selecting for transmission only those currents comprised in a single side band resulting from the modulation of said high variable frequency wave which lacks the component representing either of said different high frequencies.

25. The method of transmission which consists in producing waves of signalling frequencies lying within a predetermined range extending from near zero frequency, modulating by said signalling frequency waves, a carrier frequency wave displaced in the frequency spectrum from said modulating frequencies by an amount sufficiently small so that the resultant side bands due to modulation will encompass a relatively large portion of the total range of frequencies extending from zero up to the upper limit of the upper band, selecting one of said side bands and transmitting energy corresponding thereto to a distant joint, receiving said transmitted energy, and reproducing therefrom the waves of signalling frequencies lying within said predetermined range.

Claims allowed, 52.

Air Line Distance, between Winnipeg, Canada and the following Cities, with Map and Key

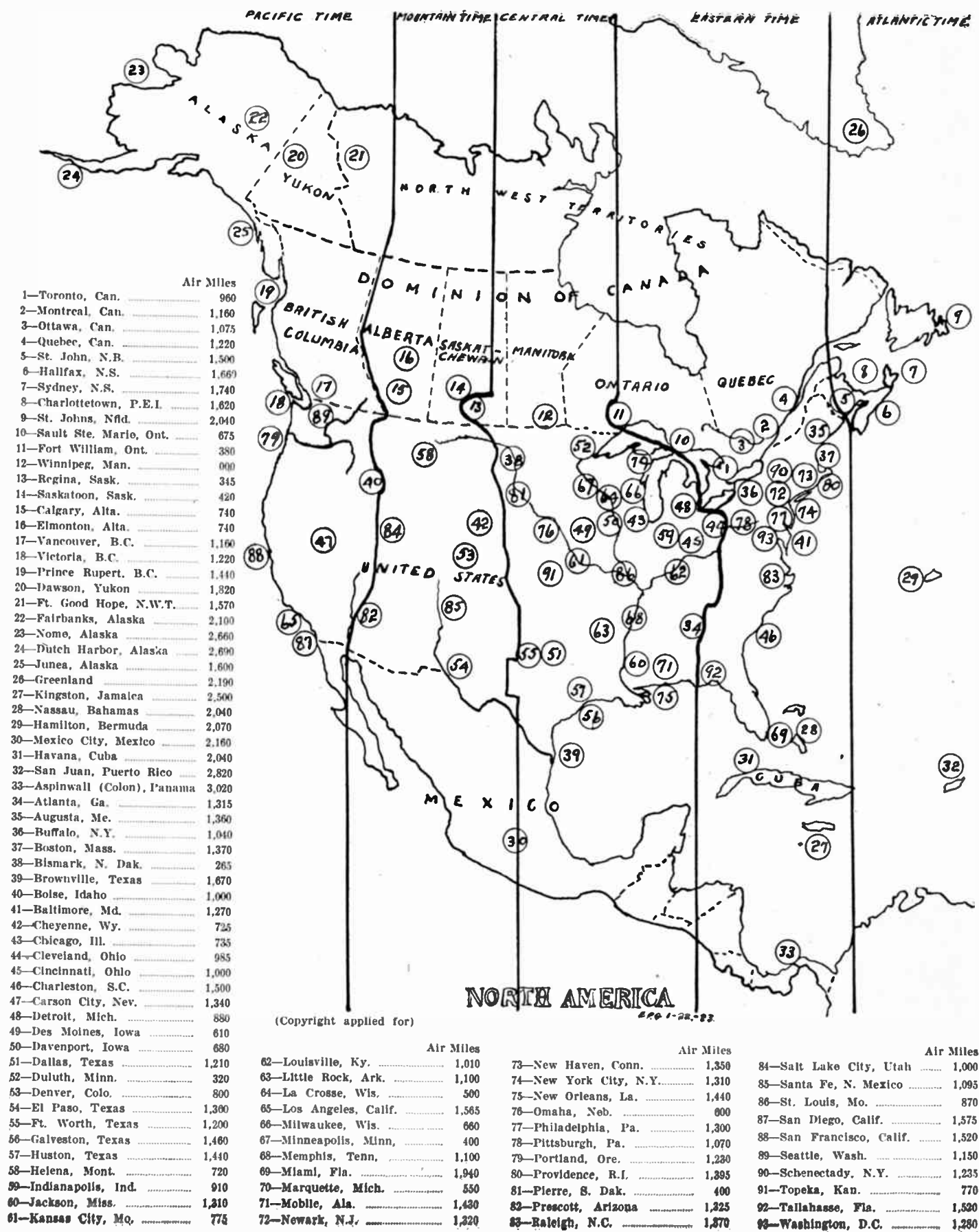



Radio's World Wide News

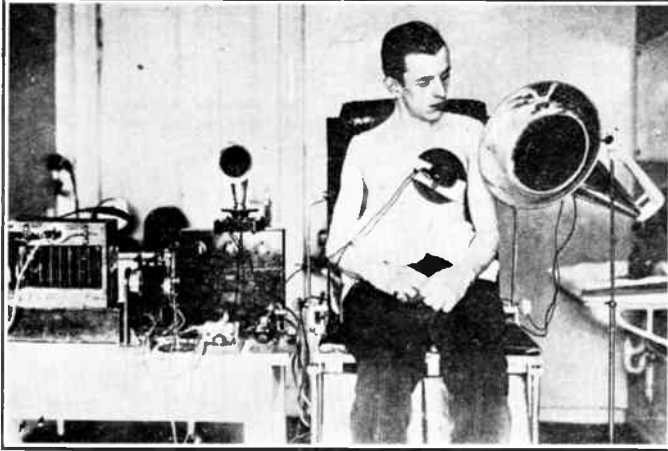
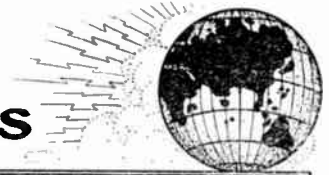

The Gilliams Service

RADIO TO HELP IN HEART DIAGNOSIS

One of the most unique and promising of the new uses of radio is that just introduced by Dr. Leo Jacobsohn of Charlottenburg, Germany, a famous heart specialist who has devised a unique and remarkable radio instrument which amplifies the sound of the beating heart enormously and has resulted in the discovery of new data on the human heart in general. Photograph shows this remarkable appliance in operation in Dr. Jacobsohn's office.

LEPER COLONY BRIGHTENED BY RADIO

At Porto Rico's leper home on Cabras Island, there is now installed a radio receiving set complete with loud speaker. After long dreary years and silent nights this isolated spot has at last been able, through modern science, to obtain entertainment for its lonely and unfortunate patients by means of radio.

Few installations of radio receiving sets have been watched by a more eager and interested group of spectators than this one. The thirty-six lepers now find life on this island, where the sun beats fiercely and the surf pounds ceaselessly, a little more pleasant.

Heretofore there has been absolutely nothing to break the awful monotony of existence. Thus radio again comes to the fore in aiding humanity, and the shut-in ones, keeping them in touch with what is going on in the world.

COMMERCIAL BROADCASTING IN GERMANY

Eight Hundred Scattered Subscribers Getting News From America Through the High Power Station at Nauen.

After four months of experimenting, the Express Service Company (Eildienst Gesellschaft), Berlin, has begun a daily service of financial and commercial news, broadcasting to subscribers in various parts of Germany, according to a report to the Department of Commerce from Consul E. V. Richardson, Berlin. This company is financed by German capital, and is purely a private undertaking. Having arranged with the National Government for the use of the radio station at Koenigswusterhausen on a limited basis for a definite period, a regular service of financial news is

received from the United States, Switzerland, Sweden, and other countries, via the high power station at Nauen, Germany.

This information is broadcasted immediately by radio telephone to subscribers of the company. These number at present about 800, and are mostly banks and industrial institutions located in some 200 towns and cities. It is expected that New York quotations handled by this service will be available generally to subscribers within ten minutes of their despatch from New York.

Each subscriber rents from the company the necessary receiving apparatus, paying for the service itself an annual fee of 300,000 marks, and for the apparatus an annual rental of approximately 200,000 marks. There are 2½ hour schedules daily, beginning at 9.30 a.m. and 5.00 p.m. The Express Service Company is represented in New York by a large American news agency.

QUEEN MOTHER BROADCASTS HER GREETINGS TO THE NATION BY RADIO

Queen Alexandra, on the occasion of the 60th anniversary of her arrival in England, celebrated by broadcasting a message to the nation in the following words:

"I am very glad upon the 60th anniversary of my arrival in England to send my affectionate greetings to the British people through the broadcasting service.

"From the day when I received such a magnificent welcome upon landing upon these shores in 1863, up to the present time, I have always experienced the greatest kindness and consideration from all classes, and I shall ever remember with gratitude the loyal and devoted sympathy shown to me in both my joys and sorrows.

"With a full heart, I sincerely thank them.

"ALEXANDRA."

In her 79th year, Queen Alexandra is as beloved as she was when she came to England as the bride-elect of the heir to the throne at the age of nineteen.

During the war she was a tireless worker in the Red Cross, and many Canadians who fought overseas will always remember her visits to the hospitals in which they were confined in and around London. She always had a smile and a word of cheer for everyone.

Owing to the unfavorable weather, her Majesty spent the day indoors at Marlborough House, and, although there was no special celebration, there was a continuous stream of callers at the Lodge in Pall Mall to sign the visitors' book, and thus express their affection and good wishes. The buildings in London were bedecked with flags.

The Mayor, aldermen and burgesses of Margate sent their greetings, for it was at this port that the then Princess Alexandra of Denmark landed on March 6, 1863, on board the Royal yacht Victoria and Albert, and the Mayor and several aldermen went to sea in a lugger to meet her and present an address of welcome. Thus they were the first Englishmen to greet her.

AMATEURS IN CANADA STIR UP INTEREST IN HOLLAND

Of late there has been a remarkable increase in the popularity of radio throughout Holland. Several large broadcasting stations have been planned, and they now are broadcasting directly from The Hague, on a 2,600-metre wave length. This interest has sprung up rapidly, and is a direct result of the reports of the American and English transatlantic tests, in which amateurs from this continent did such remarkable work.

London.—William Marconi is on the track of wireless directional control. The inventor revealed to-day that he hoped soon to perfect a device by which radio messages would be received only by the person for whom they are intended.

This problem, long one of the greatest difficulties in wireless development, has occupied Mr. Marconi's attention for some time, and, while declining to divulge his secret, he asserted he was confident he could overcome the obstacle.

Mr. Marconi has made numerous experiments to this end already. The chief tests of his device, however, will be made in April on his yacht *Electra*. The yacht is now at Southampton, and will leave shortly for a cruise along the coast of Spain and Western Africa.

"The entire matter is only in the experimental stage; it will at least point the way for a successful device of this kind, which may be improved later. If successful it will revolutionize wireless telegraphy."

Privacy to be Assured.

Mr. Marconi explained that the greatest difficulty with regard to wireless is the listening-in by strangers to private communications. Under the new method, it would convert the radio to a sort of telephone as far as privacy is concerned.

If the new device accomplishes its purpose, it will be possible to send radio messages from one station to another across the Atlantic without anyone listening in.

Both Mr. Marconi and his associates are maintaining a close guard over his new secret, which will be continued until the invention has proved itself. It is understood here, however, that the plan follows somewhat the lines of receiving instruments, whereby stations can tell the point of the waves' origin to a small fraction of a second or arc.

The air waves' origin has long been the problem of those seeking a method of directional wireless. If Mr. Marconi succeeds in this, it will mean reducing the sending of radio messages to the simplicity of telephone calls—and they would be equally private.

The inventor is also experimenting with other ends of wireless development, and hopes to increase transmission, as well as to improve accuracy.

Regulating Air Waves.

If this new device is successful, as regards controlling the air waves which carry messages, it will prevent waves spreading as they do now. Details cannot be gone into yet, but the hope is expressed that it may be practical to regulate air waves, even as far as across the Atlantic. On the trip going south, so as to be near port, instead of in mid-ocean, they will try the tests on the far countries.

Messages will be sent to the yacht from Carnarvon, Wales, and they can cruise about and tell exactly over how wide a space the messages can be received.

RADIO CONTROLLED AIRCRAFT

Rear-Admiral William A. Moffett, chief of the bureau of aeronautics of the United States navy, pointed out in his recent talk on the subject of naval aeronautics, delivered from the Waldorf-Astoria through WJZ, that the United States now has planes which can be controlled entirely through the medium of radio. This is the more impressive when it is understood that no pilot, observer or single person need be in the aircraft thus controlled.

SWEDISH FIRM CAPITALIZED AT \$170,000

A stock company has been formed in Sweden, with a capital of \$170,000, to broadcast news, market reports and entertainment from Stockholm. Remarkable interest has been shown in the new science, as evidenced by the generous purchase of radio goods throughout the kingdom.

NEW STATION IN SWEDEN

The Department of Commerce, Washington, D.C., announces plans for the establishment of a transatlantic commercial station at Gothenburg, Sweden, which is expected to be in operation by the end of the year. A direct circuit will be established with the Rocky Point station of the Radio Corporation of America, thus providing the first direct radio communication between the two countries.

SIGN OF THE TIMES

Here in Canada, when the street piano makes its appearance on the streets and fills the air with music played by handle, it seems to tell us that spring has come. With this new radio street broadcasting barrel organ making its appearance on the streets of old London, it not only tells us spring has come, but that radio has come to make itself felt as a real power throughout the entire world. Burndept, Limited, London, here show again their leadership in wireless by being the first to replace the old barrel organ so well known throughout England, with the radio broadcasting

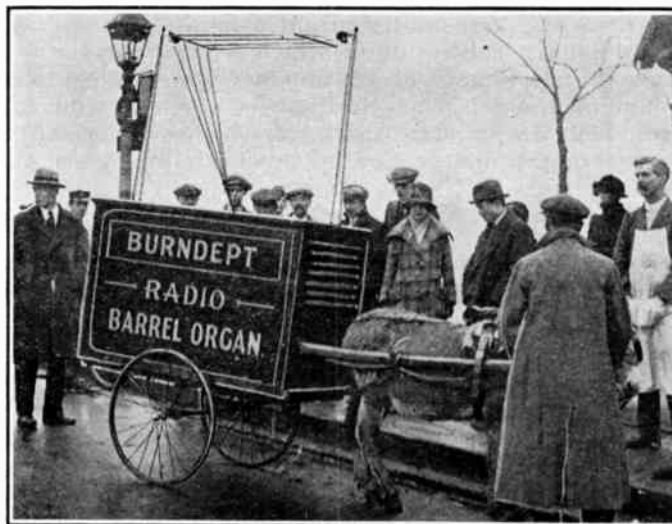

barrel organ shown in the illustration. Burndept have also accomplished, by experimental work, the new feat of receiving in an aeroplane concerts broadcasted by land stations. Burndept are now established in Canada at 172 King St. W., Toronto, Ont., where high grade British-built products can be seen and demonstrated.

GIGANTIC RADIO SET ON BOARD LEVIATHAN

The radio installation aboard the Leviathan, which re-enters the trans-Atlantic service some time in June, will be the most powerful and elaborate steamship equipment of its kind in the world. The contract to equip the Leviathan with a super-power marine radio installation has just been signed, and work in connection therewith is now in progress.

The Leviathan's radio equipment will enable her passengers to exchange messages with two continents, regardless of her position on the high seas. With equipment six times as powerful as that carried by the average ocean greyhound, uninterrupted communication with points 3,000 miles distant is assured. Upon leaving her berth in New York harbor the Leviathan's radio officers will be able to link the huge vessel with various marine centres in Europe, and to communicate with America when leaving European ports.

In addition to telegraph service, a radio telephone installation, which will provide voice contact with other vessels and shore stations, is also to be installed. While it is not expected that a commercial telephone service will be inaugurated immediately upon the Leviathan going into commission, it is quite probable that shore stations will in the no distant future be erected to handle wireless telephone traffic from ships in mid-ocean to points inland over the conventional land line system.

A special emergency set will also be installed, so that if one or two sets become useless due to a mishap, the third or emergency set may be relied upon to summon assistance. Furthermore, two of the lifeboats are fitted with emergency radio apparatus.

The principal transmitter consists of a high-power vacuum tube outfit which will deliver to main antenna about six times as much power as the apparatus now used on the average steamship. A rapid transfer switch will enable the operator to shift the wavelength of this transmitter in an instant. The second is a duplex telephone outfit which will permit simultaneous telephone and continuous wave telegraph communication. The third or emergency sending equipment is a standard spark set, which will normally operate on 600 metres. Several super-sensitive vacuum tube receivers will be used for reception.

CUBAN STATION HEARD BY SEVERAL AMATEURS

Following the announcement that a Toronto amateur had picked up a Cuban station which he could not identify, several fans have written to report that they have received concerts from the same station on different occasions.

W. A. Smith, of Orillia, and Dr. G. H. Field, of Cobourg, both identify the station as that of Frank H. Jones, Tumiboo, Cuba, a sugar plantation 200 miles east of Havana.

"This station has not been assigned a call number," Mr. Smith writes, "but it is a regular licensed station. It is on 315 meter wave length, 100 watt output."

"I frequently hear this station," said Dr. Field, "but I think Mr. Milton did very well to get it with no amplification."

Letters have also been received from F. B. Hummel,

Omaha, Nebraska; Donald Kay, Peoria, Illinois; J. A. Taylor, Rensselaer, N.Y.; Virgil Hepp, Gladbrook, Iowa; W. J. Hans, St. Louis, Mo.; F. G. Smith, Sarnia; Miles Kaltwasse, Wooster, Ohio; S. J. Mahuring, Brookfield, Mo.; W. C. Haines, Clarksburg, Ontario.—Toronto Daily Star.

RADIO BROADCASTING IN NORWAY

The Norwegian Telegraph administration, says Vice-Consul H. E. Carlson, Christiania, has recently made public a memorandum to the effect that the company to which a license for broadcasting is to be issued must be a stock company in which only Norwegian capital is represented, and in which Norwegian radio manufacturers, Norwegian press, and local amusement syndicates must have an interest. Material to be broadcasted will be limited to entertainment, general information and news.

RADIO REPLACES ORCHESTRA IN FRENCH CAFES

The Minister of Finance recently increased the tax on orchestras in France. Several cafe and dance hall proprietors let their orchestras go and installed radio receiving sets. Customers may now listen to music or dance with their meals at a cheaper rate than before.

According to the Under-Secretary of Posts and Telegraphs, owners of more than 50,000 private radio installations are now listening in to the concerts passing through the ether lanes over France.

UNDERGROUND RECEPTION

Radio has now yet another new feat to its credit. Experiments made at the Baggeridge Colliery (England) resulted in successful communication between the deepest section of the working (some 700 yards down) to the mouth of the mine.

NEW WEST INDIES STATION

Station WKAQ, the second broadcasting station in the West Indies, is now in operation at San Juan, Porto Rico. Programs are supplied on Thursday and Saturday evenings, starting at 7.30 o'clock, Eastern standard time. The station is an exact duplicate of PWX, Havana, a 500-watt type.

PAMPHLETS ISSUED BY SIGNAL CORPS

The United States Signal Corps is issuing a series of radio communication pamphlets describing the principles and operation of radio apparatus, with particular reference to the types of apparatus employed in the radio service of the Signal Corps.

ENGLISH FAN PAYS FINE

With the object of making it known that wireless apparatus cannot be installed or operated without first securing a license from the Postmaster-General, an action was taken against a radio fan in Royton, Lancashire, England, lately, and a fine of forty shillings imposed. He was also ordered to pay five shillings on two additional charges of unlawfully operating his set.

The English Government is enforcing this law in their usual thorough manner.

RADIO RESEARCH CLUB OF CANADA

The Audion as a Morse Telegraphic Relay

Chas. A. Culver, Ph.D., Chief High Frequency Engineer, Canadian Independent Telephone Co., Limited.
Lecture delivered before the Radio Research Club of Canada on January 5th, 1922.

Among the various problems which present themselves to telegraph engineers are those connected with the failure of Morse operated lines, due to excessive leakage, and the difficulty experienced in the use of high resistance lines. Since in certain radio uses of the audion it is employed as a potential operated device, it was thought that possibly one might combine the audion with an ordinary relay, in such a manner that Morse operation might be effected by means of potential applied to the line, rather than by the current in the line, and thus overcome certain troubles which result from wet weather, and also from high line resistance. The fact that the audion, when operated as a relay, functions without inertia, is an advantage in this connection. Work was begun on the problem

In developing this new device, advantage was taken of the well known characteristics of the audion. If, for example, one selects a tube having static characteristics of the character shown in Fig. 1, it will be apparent that when operated at its normal anode voltage of 500 and zero grid potential, the plate current will be of the order of 40 milliamperes. If, however, the tube be operated at an anode potential lower than normal, say, 125 volts, the space current will be only 6 milliamperes, or less, when the grid potential is zero. If then, under the latter condition, we impress upon the grid a potential of 40 volts positive, the plate current will increase from 5 milliamperes to something of the order of 80 milliamperes. A current of this order is sufficient in magnitude to operate a standard 150-ohm relay. It will thus be evident that we have in the audion a device which will function as a potential operated mechanism for ordinary telegraphic purposes.

In Fig. 2 is shown two typical circuits, which may be used for Morse traffic—one a full metallic circuit and the other a circuit having an earth return. From an examination of the figures it will be obvious that the audion when functioning as a Morse relay operates on "open circuit." Conditions could obviously be arranged so that such an electron relay would operate on "closed circuit," the signalling being done by reducing the voltage applied to the grid to zero. Such an arrangement would, however, possess little advantage over existing electro-mechanical relay operation.

Again referring to Fig. 2, it will be seen that upon closing the key at station "A," for example, there will be impressed upon the grid of the audion relay at that station a definite predetermined positive potential, and the space current will instantly rise to a value which will give positive operation to the Morse relay in the plate circuit of the electron or audion relay. This procedure simultaneously impresses upon the grid of the audion at the distant station "B" a like potential (except for the slight fall of potential due to the resistance of the line), and the distant audion relay will function in a manner similar to that at station "A." At both terminals the local Morse relay in the plate circuit may be adjusted so that they will be operated as "closed" or "open" organizations, as convenience dictates.

Since in using this device the line current is of extremely low value (only 1 to 5 milliamperes), and since the resistance of the signalling circuit is chiefly due to the grid-to-filament resistance of the tubes, the resistance of the physical line itself is of secondary importance.

Laboratory tests over artificial lines and actual field tests have demonstrated that we have in this device a means by which one may successfully operate a

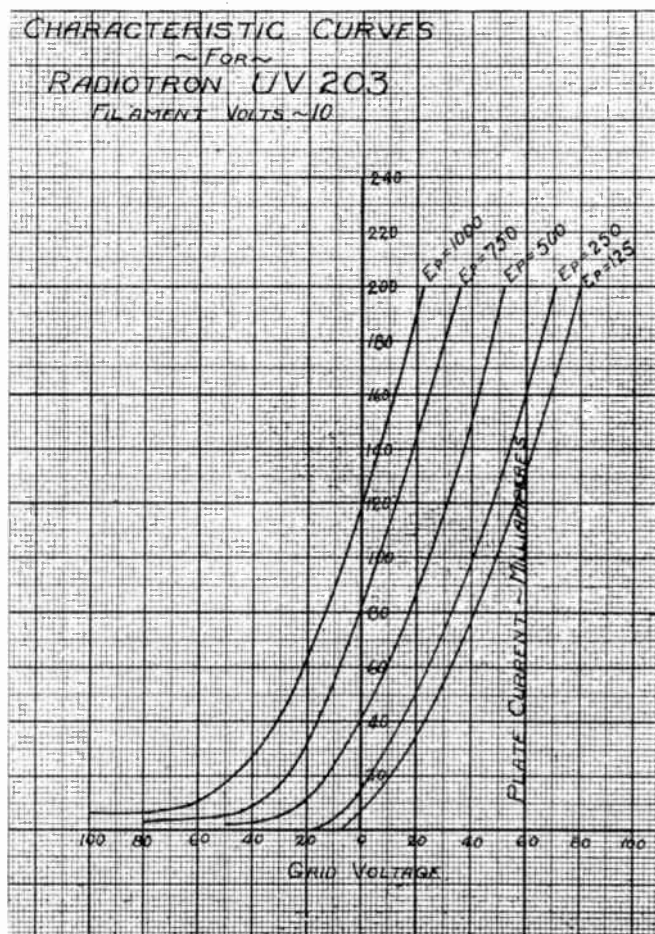

early in 1921, and has now progressed to the point where there is considerable promise of a practical operating organization being available.

Courtesy of "Telephone & Telegraph Age," New York City, U.S.A.

Morse relay circuit over lines of high ohmic resistance, and also over lines showing comparatively low insulation resistance. It would appear that lines of iron wire will function satisfactorily. Tests over artificial and actual lines appear to indicate that the audion relay when operated over standard copper lines will give satisfactory commercial service over lines up to 800 and possibly 1,000 miles without repeaters. The magnitude of the energy consumed in the line is extremely low, and hence the magnetic field set up by signalling is of very small value, hence the interference with adjacent telephone circuits is reduced to a negligible

lines, telephone relays were operated while conversation was in progress, and practically no sound could be detected in the telephone circuit.

While the audion has certain marked advantages over the ordinary relay, as outlined above, this device may also prove to have certain limitations, due to the fact that it is a potential operated mechanism. Positive potentials induced in the lines from extraneous sources may tend to result in abortive operation of the relay. However, so far as the writer has tested the audion as a signalling device over actual lines, this phenomenon has not presented itself. Only by extended practical operation can these limitations be

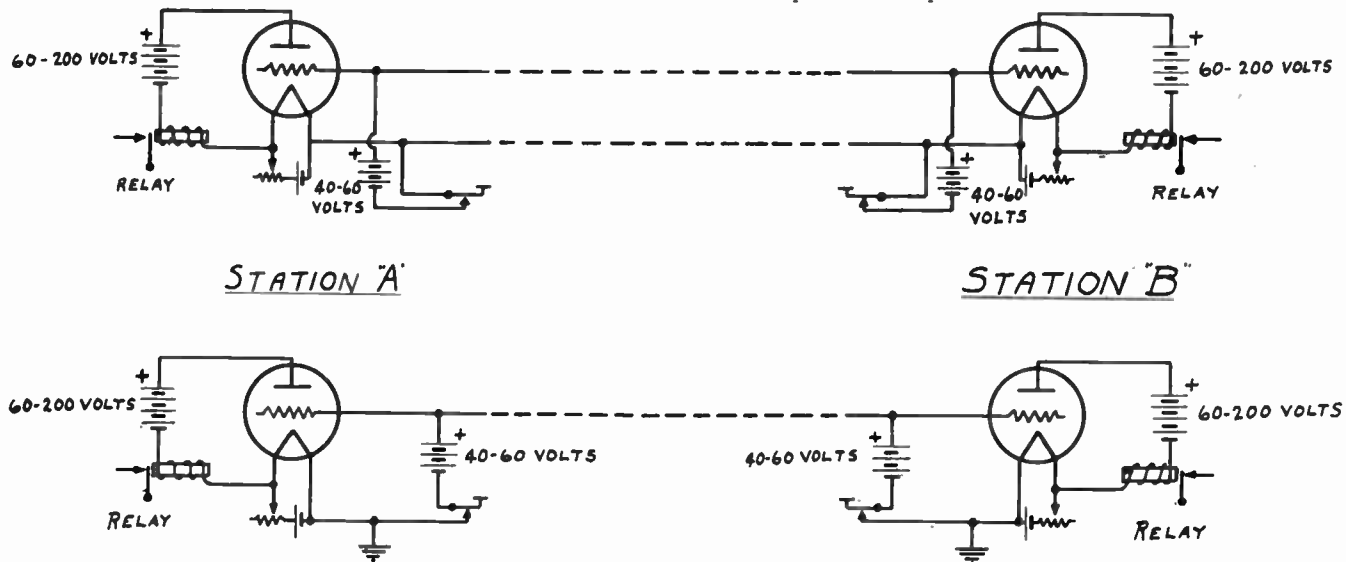

quantity. For the same reason it is also possible, by means of this device, to establish either a simplex or composite circuit, without the use of the usual retardation coils and condensers. In a trial over actual

determined. However, notwithstanding such possible limitations, we have in this new application of the audion a device which will undoubtedly assist in the improvement of Morse operations.

Counterpoise System of Reception

Now that the static season will soon be upon us, we are looking around for substitutes for aerials that will bring in the desired stations without static.

Then again there is the summer time vacation set. The peanut tube has hepled a whole lot in this direction with the battery problem and portability, but there is the aerial which is not such a great problem in the camp outside of static until it comes to the canoe, car or a location devoid of trees for aerial supports. There you turn to radio frequency, reflex and super regeneration to serve your aerial problem. Here's where you kill the portability of your set. It will be of rather large proportions to contain any of the above circuits and then again none of these circuits are really universal. They don't work as well as they did on their original aerials or in their original locations, so their operating characteristics combined with bulk and number of controls in my opinion kill their vacation possibilities.

With static and the summer time vacation set problem in mind, I have succeeded in producing a circuit that should meet with approval of both the radiophone fans and the telegraphy amateurs, and you relay workers will sure appreciate it when the Q.R.N. is heavy.

Fig. 1 shows a honeycomb coil circuit, the departure from the usual circuit being in the common battery

connection which, instead of going straight to ground as is customary, it first passes through an inductance which is placed in inductive relation with the aerial or primary coil.

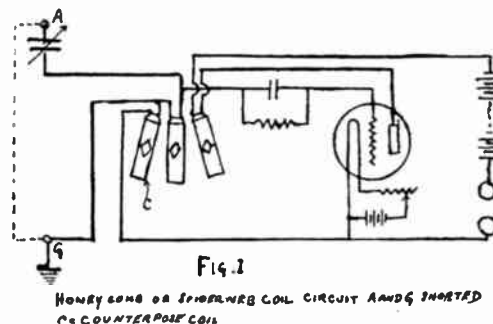

The A battery connection may run straight to ground as usual with the negative lead of the B battery only passing through this counterpoise coil before joining the A battery, or the negative of the B battery may pick up the ground connection with the A battery lead passing through the counterpoise coil, results being obtained with either arrangement although both battery leads passing through the coil appear to give the best results, but it is advisable to try each arrangement and choose the

one that gives the best results for your particular conditions.

This counterpoise system is absolutely universal and is adaptable to any circuit. It is not necessary that you have to make any radical changes in your present existing set and a further advantage it may be made as a separate external attachment to any set, the only material required being a variometer or the usual standard coupler.

Keeping in mind that you already possess a receiving set I will attempt to make the counterpoise attachment applicable to your particular set. The three coil honeycomb or spider web being the most popular will be tackled first. Fig. 1 shows the three coils, primary coils and tickler are left intact, the change being made in the secondary or middle coil. The drawing pretty well explains itself, the only precaution being to reverse the connections to the middle coil. The counterpoise coil is here shown on the left, although any combination may be adopted. Counterpoise in the middle, primary on either one side or the other, tickler coil in the middle.

Fig. 2 shows another popular circuit using the vario-

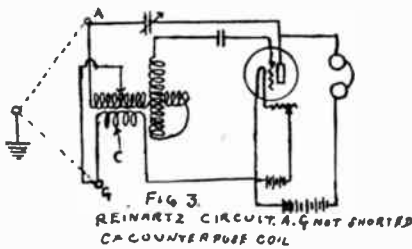
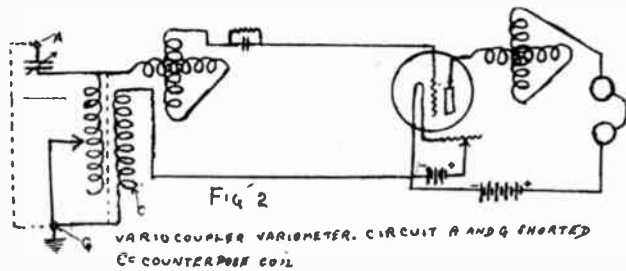

coupler and two variometers, the changes being made only in the coupler, the dotted lines showing suggested changes and should not be used as a combination, that is, try one of the dotted connections first, then disconnect and try the other.

Fig. 3 is the typical Reinartz circuit, the addition being the counterpoise coil which if desired may be arranged to slide inside the primary coil, keeping in mind to reverse the connections to the counterpoise coil. There are many users of the Reinartz circuit who have made a slight departure from the circuit shown on Fig. 3, but the counterpoise coil is still applicable as shown.

Fig. 4 is the now popular Flewelling circuit and is the last circuit I have tried out with the counterpoise. The addition being here in the additional coil which is shown in the circuit after the condenser bank. This calls for a triple coil mounting, and as some of you have already a triple coil mounting fitted to your "Flew" you will be able to make a quick change. The same combination as in Fig. 1 may be tried out by placing the counterpoise coil either in center or opposite ends. I have tried the counterpoise coil in various positions in the "Flew" circuit such as before the condenser bank and after on the ground side and in the common battery leads before they pick up the condenser bank, this arrangement appears to

give the best results, as it permitted the tuning in of stations without the carrier wave.

I will now show how this counterpoise system may

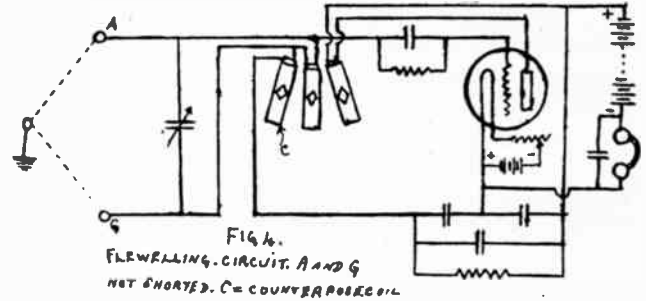

be used as an external attachment so that the wiring of your set may not be disturbed.

In Fig. 5 is shown the imaginary set, no matter what the circuit may be. Obtain a variocoupler or a variometer (which should be split to function as a coupler), connect it as shown in Fig. 6.

Another method is to wind a coil of about 30 to 50 turns on a form that will either slide inside or over your primary coil, connecting your battery lead to one side and the other side to the primary on the ground side. If a series condenser is in use in your circuit your A and G binding post should be shorter.

As I have already mentioned, I was chasing up a portable set for vacation use, so I confined my experiments on the counterpoise system to peanut tubes, resulting in a cabinet, 7 x 7 x 7, containing detect and two steps and all batteries, all tuning being done with a 23-platt condenser (single control). No rheostats were used. To those who have the vacation set in mind a few suggestions will be quite in order. If you have used peanut tubes, especially the Northern Electric (Canadian), you have noticed that the adjustment on the rheostat is not critical and requires a very low adjustment. This being evident, I decided I could work the tube with a fixed resistance, same applying to the amplifier tubes, so I divided the resistance element of a rheostat into three equal por-

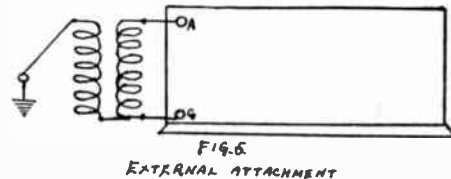

tions, placing one in each leg of the three tubes. A cheap rheostat will answer this purpose, as only the element is needed. To obtain the single control I tried out several single circuit arrangements, choosing the circuit that gave the largest range of control with the condenser only, the inductance kept in a mean fixed position. The circuit decided upon, the counterpoise coil was introduced, and was arranged to pick up the mean position, that is, with a suitable range on either side. This position was about at right angles to the primary; in this position the counterpoise coil was fixed. Two honeycomb or spider web coils will answer the same purpose. This is the vacation outfit for use in car, canoe or camp.

Would state that the various circuits submitted in this article have all been tried with the counterpoise attachment, and are not merely suggestions. Each circuit in turn came up to the decided standard. On detector alone using the variocoupler, variometer



RADIO TRADE REVIEW



What is Formica ?

The newcomer in radio is almost sure to ask that question. The exact nature of the shiny, highly polished material of which radio panels are made is a mystery. It looks like rubber, and yet it doesn't. It's a question that needs explaining.

Formica is now almost universally used in the radio sets manufactured by the makers of complete sets and by a great many of the parts manufacturers. It is one of the standard and staple radio articles that figures practically wherever radio is used.

The base material in formica is a fibrous product somewhat akin to paper. This material is soaked in and impregnated with a varnish or resin called redmanol. The varnish is produced under the patents of the General Bakelite Company.

Then it is cut in sheets and the sheets arranged in piles, according to the thickness of the piece of formica that is to be produced. On each side of the sheet is placed a burnished plate of metal. Then the piles are put into a great press and subjected for some time to great heat and pressure.

The fibrous sheets are vulcanized or welded during this process into a solid insoluble sheet of formica. The effect of the burnished metal is like that of a squeegee plate on a photographic print. It imparts a high polish to the surface, which is one of the characteristics that is highly valued in formica panels for use in high quality receiving sets where appearance is an important consideration.

After the formica comes from the press it is finished except for trimming the edges of the sheet on a saw and sawing up large sheets of formica into smaller ones of suitable size for use in radio panels.

Formica is almost universally used in radio, and is very widely used in all sorts of electrical manufacture. In these uses it has largely replaced hard rubber and vulcanized fibre, older materials that were once generally used.

With relation to hard rubber, formica has the advantage of greater tensile strength and less likelihood of cracking and breaking when it is worked on with tools, or when it is accidentally dropped. Formica does not soften under heat, nor does sunlight discolor it. The dielectric strength, which is high when the material is new, improves with age and does not deteriorate.

As against vulcanized fibre formica has the advantage of not absorbing moisture, and so remains a perfect insulator in humid weather or damp climate. It has the tensile strength and same working qualities with tools as vulcanized fibre.

An important quality in insulating material for radio purposes is uniformity in dielectric strength, and it is one that requires great care in manufacture

to obtain. The resin is composed of two substances, which react on each other, and to secure a uniformly good product it is essential that the reaction should have progressed to the same extent in each case in which the resin is used.

To secure this perfect uniformity the Formica Insulation Company buys these substances separately and mixes them in their factory, so that it is certain

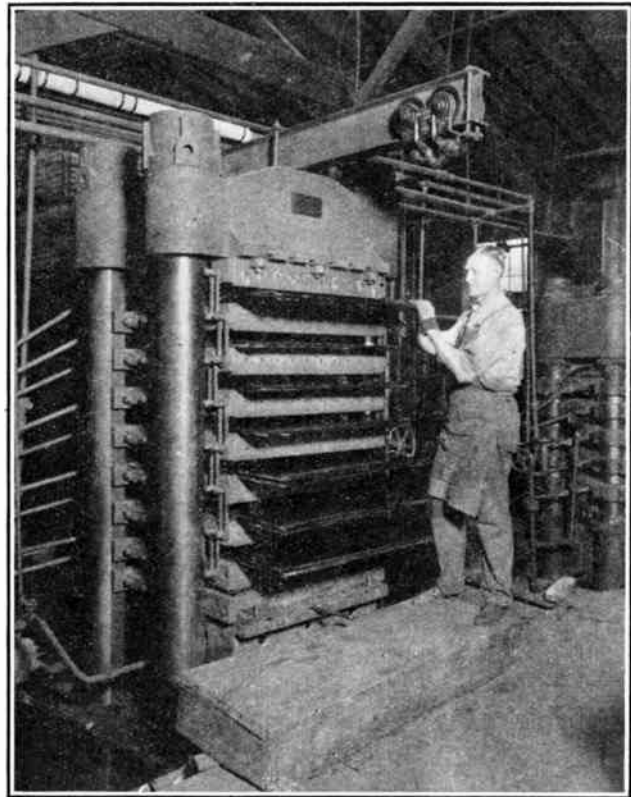

that the resin will be the same each time. The special fibre base is also manufactured accurately to formica specifications.

Formica is a highly useful material made for a wide range of purposes in a number of grades. The dielectric strength of the material is determined by the percentage of resin used in its manufacture. Some electrical purposes require higher dielectric strength than others. Radio demands the best possible insulators.

To secure greater mechanical strength formica is made with a base such as cotton duck, which is used in gears and pinions where silence and ability to absorb shocks is required. Formica is also used for pump valves.

The Second Annual Radio Convention

The Second District Annual Radio Convention and exhibit, held at Hotel Pennsylvania, New York City, March 1st to 3rd, was a marked success. Much that was new in the way of radio equipment and many novel stunts were features of this show.

The exhibit starting on Thursday noon consisted of twenty-five of the most representative manufacturers. The Radio Corporation had a large display board, some ten to twelve feet square, with their initials R. C. A. spelled by use of over three hundred audion bulbs of their manufacture. The Bristol Company, manufacturers of loud speakers and other units, had a powerful 10-step amplifier connected up to 10 speakers, 6 of which were in the exhibit room and the others at various points. The tremendous volume produced by these speakers was such that anyone on the floor was

exhibit. This company, recognizing the need for standardization of panel sizes, have, after much study and investigation covering many months, adopted seven sizes, which cover over 90% of the demand. These panels are carefully cut to size, cleaned and wrapped in glassine bags, on which is printed directions for working. This method of putting out panels represents an improvement over the old method of merchandizing whereby one had to order a panel and then wait for a half-day or more until it was cut. The high quality of these condensite celoron panels was particularly noted, especially the freedom from surface blemishes and other defects commonly noted. This company also exhibited a large amount of radio equipment manufactured by representative manufacturers, showing applications of the panel material. Sets from



enabled to hear plainly and distinctly all announcements, lectures and broadcasting. This arrangement was also used to page wanted persons.

Another feature of the show was the use of large models of radio parts and equipment.

The Adams-Morgan Company of Upper Montclair, N.J., featured a model of the well known "Paragon" receiver built on a three to one proportion. Its panel, made from condensite celoron, measured 57 in. long by 19½ in. wide. The dials, one foot in diameter, were made the exact image of the smaller dial, the lines being all carefully engraved and the dial machined from a solid piece of condensite celoron. Even to the binding posts and contact points the exact proportion was carried out.

Along the line of new equipment the Reflex receiver, manufactured by the DeForest Radio Telegraph and Telephone Company, and the Neutro-Dyne receiver, manufactured by the Freed-Eisemann Radio Company, and the F. A. D. Andrea Company, had the centre of attraction. Many possibilities are claimed for these types of sets, and they no doubt represent a distinct advance in the radio industry.

The booth of the Diamond State Fibre Company, manufacturers of condensite celoron, was especially attractive. Standardized panels was the feature of this

the Clapp-Eastham Company, Adams-Morgan Company, New York Coil Company, Freed-Eisemann Radio Company, condensers from the U. S. Tool Company, Heath Radio & Electric Mfg. Company, Eisemann Magneto Company, and many other machined specialties from condensite celoron and vulcanized fibre.

The convention ended with a banquet in the ballroom of the hotel. This banquet, a strictly amateur affair, was attended by many prominent men in the radio field. The younger set were supplied with whistles, which made the place sound like a boiler factory. One novel feature of the show was pulled off by the Adams-Morgan Company, who had their large model receiving set, mentioned above, placed up in the balcony. A Bristol loud speaker was placed on top of it, and the hall listened to sweet strains from a young lady's voice. It was apparently radio music, for Mr. Paul Godley, of radio fame, was tuning the instrument. After a few selections, the lid over the cabinet was raised and out came the lady. After much applause, speeches were enjoyed from Mr. H. P. Maxim, Mr. Schnell, Mr. Warner, and many others of note.

From the observations of one who attended last year's show, one could honestly say that radio has made a distinct advance during the preceding year.

THE NEW FILKOSTAT

In the Filkostat, a new filament control just perfected by S. R. Hipple, well known as an inventor of apparatus for the control of electrical currents, there is at last presented an instrument which is distinctly designed to utilize the great tuning possibilities of the vacuum tube itself. Radio set builders, amateurs and manufacturers have been looking forward to the advent of just such a device. They have realized that all rheostats, and other so-called filament regulators, are merely adaptations of pre-radio day devices, not capable of adjusting the infinitesimal graduations of filament Heat which adjustments are essential to perfect tuning.

Perfect Tube Control.

The Filkostat permits perfect regulations of filament heat. Since the heat emitted varies as the square of the current, fine current regulation becomes extremely necessary to accomplish. This governs the flow of electrons. Proper control of the electronic flow in the tube permits the very finest tuning conceivable. The fine adjustment of the Filkostat starts slightly before the tube begins to function. With other filament controls, what minute adjustment there is, starts when the filament is almost at maximum heat—the Filkostat control is so fine that increases of temperature are fractions of a degree, with corresponding variations of electronic flow from the filament to the plate, are obtainable.

Longer Tube Life; No Noises.

The initial inrush of current prevents the crystallization of the filament which so many experts claim occurs when the current is fed too slowly at first as is done in other forms of filament controls. This means considerable increase in tube life. Furthermore the extreme degree of fineness in increase and decrease of electronic flow by infinitesimal variations, makes the Filkostat control ideal.

The perfection of design including ample internal contact is the cause of this new instrument being non-microphonic, absolutely silent, and free from all noises.

Proven Best by Laboratory Test.

The Filkostat superiority has been proven by tests made on Bureau of Standard, instruments. Comparison was made of the area of fine adjustment control of the wire rheostat, all other well known filament controls and the Filkostat. In case the gradual and perfect increase and infinite adjustments which the Filkostat permits was clearly indicated.

The area of the fine adjustment line on the graphs for the Filkostat is 19 times that of the line for the wire rheostat and more than twice that of the next best filament control. However while one can visualize the difference in area of those lines, the actual difference in area of fine adjustment is far greater—by reason of the nature of the resistance element in the Filkostat.

The WDIP'S curve the graph is eloquent testimony as to the Filkostat's adaptability to any dry cell tubes. These tubes using only a fraction of an ampere demand an instrument that is so finely adjusted that this fractional current can be perfectly regulated. This the Filkostat accomplishes.

Other Filkostat Features.

The Filkostat has a definite off. It is so designed that the filament extinguishes abruptly indicating that the A battery supply is completely disconnected.

At full on the Filkostat resistance is practically zero.

The Filkostat consists of a hollow cylinder containing the special resistance material placed between two large adjustable contacts controlled by turning the knob.

The resistance element is so finely divided that no further division is possible. There are no disks to break or chip.

The resistance remains constant at any position eliminating current variations once set. Such variations are not apparent to the person tuning excepting in "fading out" of stations, and noises. But in the laboratory where such a test as that shown on the graph mentioned above can be made by anyone, this feature and all the other points of superiority of the Filkostat are immediately apparent.

Carter Improved Radio Products Now Available

Until Canadian Representation is Established,
Orders will be filled direct

Prices include duty F. O. B. Chicago

New Carter Automatic Plate and Filament Control Rheostat

Eliminates use of first and second stage Jacks, change-over switches and filament control jacks; simplifies operation, and improves efficiency (pig-tail connections used).

Code No. 3—6 Ohm Rheostat. Price each...\$3.00

Code No. 3-C—20 Ohm Rheostat. Price ea.. 3.35

New Carter Vernier Control Rheostat

No scraping or jerking; no friction bearing connections; 1½ Ampere capacity (pigtail connections used).

Code No. 1—6 Ohm Rheostat. Price each...\$2.00

Code No. 1-C—20 Ohm Rheostat. Price ea.. 2.35

Carter Universal "Tu-Way" Plug



Takes from 1 to 4 headsets; any kind of cord terminals can be easily attached without tools by means of large, knurled screw heads.

Price each.....\$2.00

Carter Universal "Hold-Tite" Jack

New design; heavy tapered phosphor-bronze springs; the polished nickle-plated frame is tapered and so shaped that the usual high insulation stackup is eliminated. No spacer washers needed in mounting on panels of varying thickness. (Insulation, Westinghouse "Micarta.")

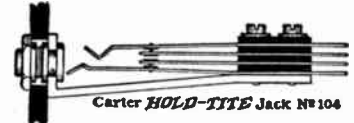

Carter HOLD-TITE Jack No. 104

Price Each

Code No. 101—Open circuit.....\$0.95

Code No. 102—Closed circuit..... 1.05

Code No. 103—Single filament..... 1.20

Code No. 104—Double circuit..... 1.35

Code No. 105—Double filament..... 1.50

"Imp" Cord Tip Jack

Replaces binding posts; provides quick and sure means of making connections; will take any standard phone cord tip.



Price each.....\$0.50

"Imp" Cord Tip Plug

Can be attached to tinsel cord or wire without soldering. Price each.....\$0.20

Carter Jack Switch

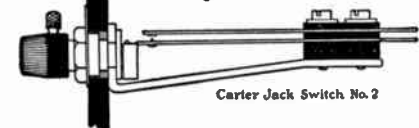

Carter Jack Switch No. 2

For opening and closing the "A" battery circuit; mounts same as a jack.

Code No. 2—Jack Switch. Price each...\$1.35

Begin Standardizing Now on Carter Improved Radio Products

Manufactured only by



(All Illustrations One-half Actual Size)

The Filkostat which will retail for \$2.00 is being manufactured by the DX Instrument Company of Harrisburg, Pa. The entire international distribution is in the hands of Radio Stores Corp. of New York. An extensive advertising campaign to reach the dealer and consumer has been planned by the Arthur Rosenberg Co. Advertising Service.

WANTED—Radio Engineer to travel extensively. Must be capable of highest type of sales and service work in demonstrating and introducing line of patented radio equipment for well known manufacturer of thirty years standing. Write stating experience, education, age and salary desired. Dept. "Y" RADIO, 60 Adelaide St. E., Toronto.

THE VIMY SUPPLY CO., LIMITED.

It is with a feeling of pride that we can say a few words about the firm who signed the first radio advertising contract for the Aviation News and are still with us. This firm was one of the first to realize what service and quality meant to the budding amateur, and served their requirements well in the old spark days.

Customers of those days are customers now. Apparatus made by reliable manufacturers only is stocked. Their mail order service stretches from coast to coast, both to dealers and amateurs.

An item of interest just added to their stock is the McTighe storage "B" battery, 22½V, using Edison plates. The cost of upkeep is very low, and also the great disadvantage of a noisy "B" is eliminated. Acid and oil are supplies for charging.

Keep up the good work, Vimy.

THE DICTOGRAND RADIO LOUD SPEAKER



The Dictograph Products Corporation, 220 West 42nd Street, New York City, has placed on the market the new Dictogrand Radio Loud Speaker. This new loud speaker is mounted in a mahogany finished hardwood cabinet. By referring to the accompanying illustration, it can be seen that an adjusting dial in the front of the cabinet increases or decreases the air gap or distance between the pole shoes and an especially made secret alloy diaphragm. The ad-

justing mechanism operates through a shaft, pinion and gear. Changing the air gap varies the pull of the magnet upon the diaphragm, thus enabling the loud speaker to be tuned up in complete harmony and resonance with the receiving set.

The unit is an entirely new and novel arrangement, consisting of laminated pole shoes, with special dictograph coils wound with No. 44 magnet wire. The harsh, jarring sounds, the noises and overtones, defects common to all other loud speakers, have been overcome in the dictogrand. It creates the illusion that the artists are in the very room with the listener.

The new wonderfully effective design and mechanical arrangement for adjusting the air gap of the Dictogrand Loud Speaker regulates the magnetic flux as simply as the flow of water is controlled through a faucet.

The diaphragm is of special composition, restricted solely to Dictograph Loud Speaker production. The entire unit is subjected to a rigid inspection and test both during sub-assembly and final completion, and is guaranteed against all mechanical and electrical defects for a period of one year.

The horn is of spun copper, handsomely finished in

mahogany. The tone-arm is a die casting, especially designed for resonance and lack of vibration. Each loud speaker is equipped with five feet of flexible silk cord, with standard terminals.

The Dictogrand Radio Loud Speaker is designed to operate on any vacuum tube receiving set, using two stages of amplification, but good results are often secured on sets employing but one stage of amplification, dependent upon the type set used and the distance from the broadcasting station. This loud speaker required no external batteries. In its design and construction is concentrated 20 years' leadership in the art of sensitive sound transmission. Dictograph experience in the manufacture of the Accousticon for the deaf, the Secret Service Dictograph, and the Dictograph System of Interior Telephones, has enabled the production of this perfected radio loud speaker.

RUSSEL RADIO SET

Illustrated in the advertising columns of this issue is a complete radio receiving set, now in production by the Russell Gear & Machine Company, Limited, Toronto.

The circuit arrangement is that which experience has shown to be most satisfactory for reliable everyday service—honeycomb coil tuner, detector, and two stages audio amplifier. Such a circuit is selective, easily operated, and is the only simple means of efficiently receiving all waves used for radio communication. This latter point is of considerable importance in view of the inevitable change of wave length by many broadcasting stations in the near future. It also makes possible reception of other than the ordinary broadcasting stations and of telegraph signals on all waves.

The layout of the set makes for convenience of operation. All parts are mounted on a celoron panel, 7½ in. high x 20 in. long, thus bringing all controls to the proper level for operating with the arm resting on the table. Filament control jacks are, of course, provided.

This set is supplied complete with aerial equipment, batteries, tubes and phones, and the stamp of a reputable manufacturer assures that all parts are of the highest quality. It is supplied unwired, the accompanying blueprint showing in detail exactly how connections are made. The few hours required for this work will not only reduce the cost of a set, but will amply repay the user by giving him an insight into "what is in the box."

A. Carey & Sons have now moved into their new location, 274 King Street E., Hamilton, where they have a large showroom for demonstrating purposes, also large stock rooms.

They are now handling extensively a complete line of high-class radio products for both wholesale and retail trade

They are distributors for the Canadian Westinghouse Co., Dictograph Products Corporation of America, Burgess Batteries, Ltd., Bremer-Tully Radio Co., Radio Corporation of America, Dyer Radio Co., Chelsea Radio Co., and many other high-class manufacturers' products.

They have now every facility for handling all orders promptly, and will be pleased to send price lists on application to any legitimate radio dealer

LATEST F-F RECTIFIER CHARGES "B" STORAGE BATTERIES ONLY

Charging "B" storage batteries of 22 to 100 volts from alternating current can be easily, economically, and cleanly done with the type TB mechanical rectifier, recently added to the line of F-F battery boosters made and marketed by the France Manufacturing Company, Cleveland, O.

The manufacturer states: "We developed this low-priced equipment to overcome the uncertainties of electrolytic rectifiers, with their attendant muddiness, short life, and great voltage loss. Type TB is always ready for instant use. It has no parts to get out of order or to deteriorate."

Any group or Lead or Edison cells equivalent to 22 to 100 volts can be charged in series at the same time. The current rate is regulated by an ordinary tungsten lamp screwed into socket shown on rectifier. Usually a 60-watt lamp meets the requirement.

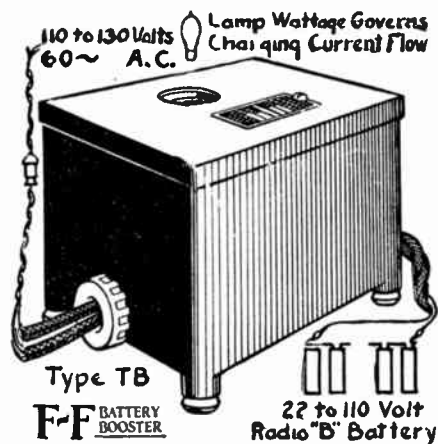

A "B" storage battery is charged by first disconnecting it from the receiving set. Clips supplied on ends of battery cords coming from rectifier are snapped on battery terminals—positive to positive, negative to negative—no chance for reversed currents. The extension cord is then plugged into any convenient A.C. lamp socket.

Size is 5 in. x 5 in. x 3 in.

Shipping weight, 4 lbs.

For full details address the manufacturer.

A GUARANTEED CRYSTAL

Standard brand crystals are made of mineral radiocite by the Standard Mineral Co. of Newark, N.J. They think so much of this product that each and every crystal is guaranteed unconditionally to give satisfaction. This means a great deal to the reliable dealer who is doing business with the amateur, and must give quality merchandise if he expects to hold their trade.

WILL THIS BE A RADIO SUMMER?

The belief that radio is a one-season hobby is surely losing ground. Reports show that the demand for radio material is on the increase, and both manufacturer and dealer are looking for a real good summer.

J. V. Elliot Company of Hamilton claim that the vacation and other usual summer attractions will in no way interfere with radio this summer. Whether they go motoring, canoeing, fishing, hiking or camping, their radio set is going right along with them.

This statement is strengthened owing to the increased demand for peanut tubes, which suggests vacation sets.

Mr. Elliot goes on to say that the market for portable sets this summer will be exceptionally good, and with this in mind he will, in all probability, be handling a "no aerial set" at a reasonable price.

STARR 3,000 OHM RECEIVERS

This is a new product of the Starr Metal Products Co. Due to not having space available to devote to the making of their receiver, they are manufactured in the plant of the Automotive Products Co. under their supervision.

These are a high-grade phone. Among the many features are forged magnets, matched coils, and the phone terminals cannot short on the head band, head bands being of spring steel, nickel-plated, is most sanitary, and are very comfortable fitting, not having too much spring tension, and easily adjusted.

These phones may now be purchased from any Starr dealer for \$7.50 per set, and are sold with the regular Starr guarantee.

NEW RADIO WHOLESALE HOUSE

C. R. Fraser & Co. have opened offices at 8 Colborne Street, Toronto, and are distributors for the following high grade lines: T. A. D. Andrea, Bilts & Bilts, Radiolo Co., Northern Electric Co., Ltd.

These lines need no introduction to our readers in Canada, except possibly the new T. A. D. A. "One Sixty" set, full description of which is found in this issue.

Samples can be seen at above address, or full description, dealers' prices, etc., will be gladly submitted upon request. These lines are all well worth investigating.

The list price is 25c, and the dealer gets a very attractive discount. Write to-day for full particulars.

COUNTERPOISE SYSTEM OF RECEPTION—Concluded from page 37

circuit, Memphis, Tennessee, was picked up. I don't suggest that the variocoupler, variometer set, is the most efficient of these tried out; it just happened that conditions atmospherical and otherwise were ideal for transmission when this particular circuit was being experimented with.

With the counterpoise system the rheostats are in a tuned circuit, and any adjustment of the rheostat will affect the tuning, for this reason, non-inductive rheostats, such as the Bradley rheostats, are recommended; this will permit bringing the tube to its best operating point without weakening signals due to detuning. Of course, where the filament adjustment is fixed the tuning effects of the rheostats need not be considered. Theory:—The reception of signals without the use of an aerial would suggest super-regeneration or super-sensitivity; but no super-effects are present, for when the aerial is used no unusual increase in signal strength is noted. With this counterpoise system some value other than the collector value of the aerial is being substituted.

The relation of the counterpoise coil to the aerial circuit is very similar to the outside counterpoise aerial, and the same theory appears to be applicable. With the counterpoise coil system we can obtain the counterpoise effect right inside the cabinet, which is a decided advantage when the cost and labor of the outside counterpoise is taken into consideration.

To fully appreciate this circuit it should be tried out on a night that static is bad, and you relay hams will need it.

S. HAMILTON.

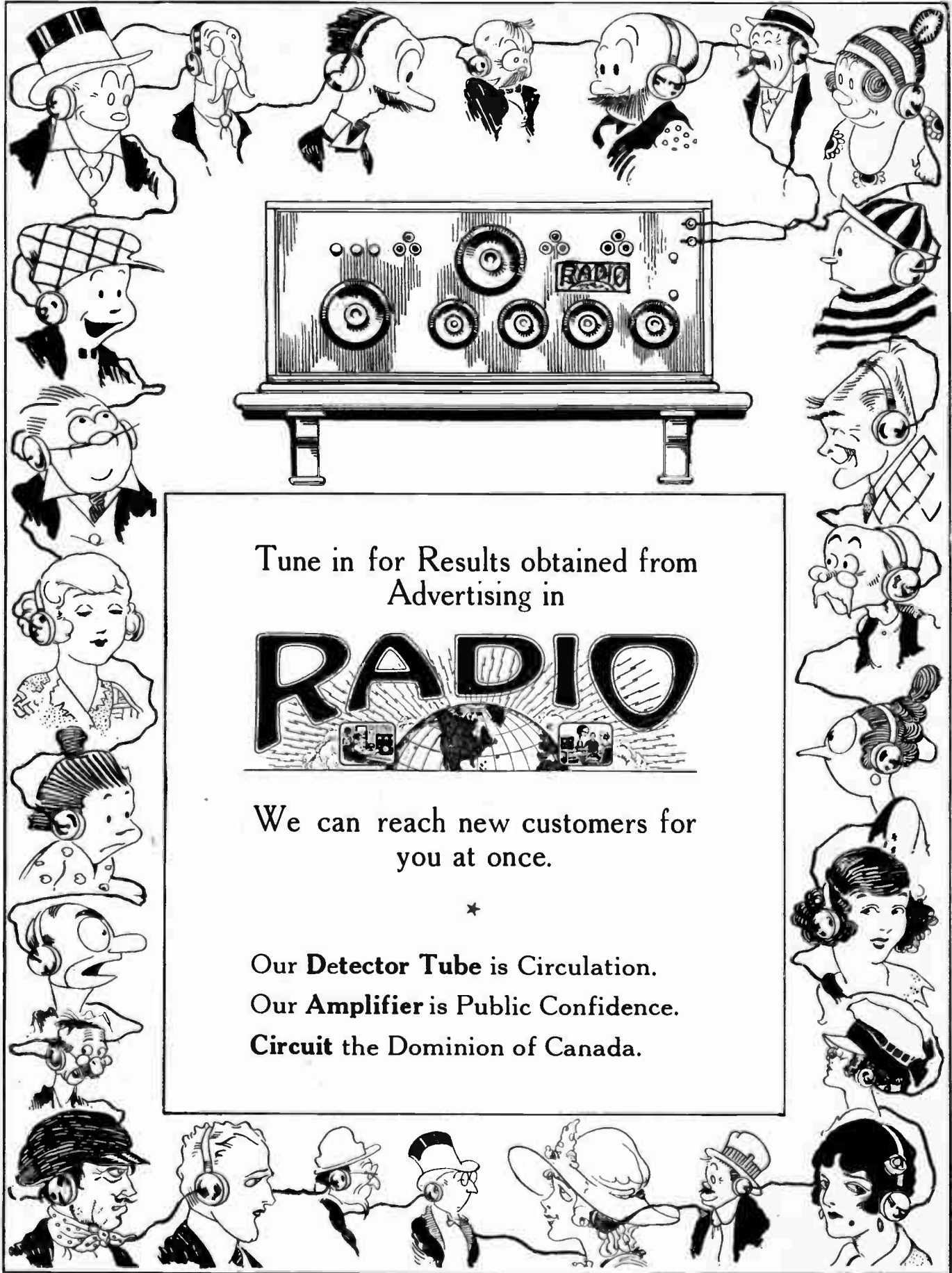

Tune in for Results obtained from
Advertising in

RADIO

We can reach new customers for
you at once.



Our **Detector Tube** is Circulation.
Our **Amplifier** is Public Confidence.
Circuit the Dominion of Canada.

When writing to Advertisers please mention RADIO



Western Canada

STATION CKY, WINNIPEG, CANADA, OPERATED BY THE MANITOBA TELEPHONE SYSTEM

Station CKY was equipped on September 26th, 1922, as an experimental telephone station and was operated for some months as a telephone experiment and incidentally broadcasting concerts as requested. A series of concerts two evenings a week were broadcasted for a period of seven months for one of the local newspapers. The station was, at that time, equipped with 100 watts power, two 50-watt tubes being used for modulation and two 50-watt tubes were used in the oscillating circuit. The Western Electric Company's speech amplifier was also used.

On March 17th of this year, the Manitoba newspapers ceased broadcasting operations by mutual arrangement and the Manitoba Telephone System continued to broadcast regular concert programs, news items, etc. The station CKY was re-equipped with larger tubes, and music room re-fitted. This station is now the only broadcasting station operating in the Province of Manitoba and has a power output of 500 watts.

The equipment consists of a speech amplifier containing three stages of amplification, the radio high frequency transmitter being equipped with two 250-watt oscillator tubes and two 250-watt modulator tubes and one 50-watt additional amplifier connected between the speech amplifier and the radio transmitter.

The power supply is furnished from the commercial power operating one 5 h.p. motor, mounted on the same shaft as the generator which supplies 44 amperes at 18 volts for filament current. On the same shafting is mounted the high tension generator supplying 5 amperes at 1600 volts. The power plant is automatically controlled from the operating room by means of a power switchboard. All of the operating room equipment is enclosed in metal casing making it fireproof and preventing accidental contact with high tension circuits by the operator.

The currents used in the tubes are as follows:—

- Plate voltage (oscillating and modulating), 1600 volts.
- Filament voltage, 14.3 volts.
- Oscillator plate current, 650 milli-amperes.
- Modulator plate current, 195 milli-amperes.
- Oscillator grid current, 95 milli-amperes.
- Antenna, 7.3 amperes.

The speech amplifier is equipped with 3-stage amplification. The currents in these tubes are as follows:—

- Filament current (first 2 stages), 1.25 milli-amperes.
- Filament current (3rd amp. tubes), 1.30 milli-amp's.
- Plate voltage, 130 volts.
- Grid voltage, 9 volts.
- Plate current (first and second), 2 milli-amperes.
- Plate current (3rd amplifier), 6 milli-amperes.

The current in the fourth amplifier tube is as follows:—

- Plate voltage, 1600 volts.
- Filament current, 3.7 amperes.
- Plate current, 250 milli-amperes.
- Filament voltage, 10.5 volts.

This last tube controls the large 250-watt modulator

tubes which are connected in parallel thus modulating 500 watts of power furnished to the antenna circuit.

The antenna circuit is primarily responsible for the radio frequency; it consists essentially of a large variometer in series with the capacitance of the antenna and the frequency is adjusted by changing the inductance in the variometer; the antenna circuit is coupled to a tuned plate circuit to receive the output of the oscillator and coupled to an untuned grid circuit for supplying the oscillator input.

Modulation is accomplished by what is known as the constant current or Heising method. In this system, the modulator and oscillator plate currents flow through a common choke coil, the inductance of this choke coil is large enough so that the current through it cannot change with the changes that occur at and above voice frequency. As a result when the modulator plate current increases, the oscillator plate current must decrease and vice versa, since the sum cannot change; thus the radio frequency output of the oscillator is forced to change in accordance with the changes in the modulator plate circuit, and this in turn is controlled by the modulator grid voltages. By connecting the speech input to the grid of the modulator, voice modulation of the radio frequency is obtained.

The speech input is supplied from the speech amplifier controlled by a special type of microphone into which, the music is sung and in front of which, the speaker stands.

The whole of this equipment was supplied by the Northern Electric Manufacturing Company of Montreal, Canada, and the new tubes were manufactured by this company at Montreal, Canada.—H. E. Brockwell, Chief Engineer Manitoba Telephone System.

RADIO LINKS TWO CONTINENTS

The government has decided to erect a wireless station for communication with the Dominions, so Premier Bonar Law announced in the House of Commons. The government has also decided to license the erection of private wireless stations in Great Britain for world-wide communication, the Premier stated.

An Empire wireless policy has long been urged upon the government, as well as the encouragement of private wireless enterprise.

The Times has been one of the strong advocates of an Empire wireless chain under central control, and it recently said: "At present it is often a matter of comment that more news of the Dominions does not appear in the newspapers here. A substantial part of the reason for any dearth there may be of news from overseas lies in the high cable rates. One of the first results that it is hoped to reap from a co-ordinated wireless system is a cheap news service."

RADIO COLLEGE

The State College at Pullman (Washington) is erecting a radio station, with which it is proposed to send out complete educational courses for the benefit of ranchers.



Western Canada

Western Canada Radio Co.
of WINNIPEG

Offices Factory
Suite 846 Somerset Block 61 Heaton Ave.

REPRESENTATIVES
in the
PRINCIPAL CITIES and TOWNS
of WESTERN CANADA

Write for illustrated and descriptive catalogue containing full particulars regarding our Receiving Sets, Plan and Locations for Broadcasting Stations, and valuable information regarding Aerial Erection and Operation of Radio Receiving Sets. This catalogue will be sent to any address upon request, with the name and address of our representative in your district.

WESTERN CANADA RADIO CO.
846 Somerset Block,
WINNIPEG, Manitoba

We Give

SERVICE

A Complete Stock of Sets and Parts
'NOORDERTOOSMALL'

AMRAD
WESTINGHOUSE
MARCONI
BRITISH COM—

Exclusive Agents for Leading American
and English Radio Firms

Complete Sets Sold on the Instalment Plan
Dealers and Jobbers Write for Quotations

WHOLESALE ∴ RETAIL

EUREKA SALES CO.

5 HOME BANK BLDG., - WINNIPEG

STERLING SPECIALTIES

213 Somerset Bldg. - - WINNIPEG, Man.
FACTORY REPRESENTATIVES

Representing:—

Howard Radio Co.	True-Tone Radio Mfg. Co.
Electric Mfg. & Sales Co.	Bremer-Tully Radio Co.
American Hard Rubber Co.	Standard Crystal Co.
Mitchell Band Mfg. Co.	Eastern Electrical Precision.
Stay-Ot Mfg. Co.	United Specialties Co.
Emeloid Co. Inc.	Radio Engineering Co.

ENQUIRIES FROM JOBBERS SOLICITED

Specializing Everything Radio

Mail Orders Solicited. Write for Price List.

AUTHORIZED DEALERS **AMRAD** PRODUCTS

INDUSTRIAL RADIO STORE

Industrial Bureau, Chas. D. Floria WINNIPEG, MAN.

Manufacturers and Jobbers of

RADIO SUPPLIES

Cummings Brass & Wire Works
310 Good Street, WINNIPEG, Man.

FREE ADVICE
Send Stamped Addressed Envelope

RADIO EQUIPMENT & SUPPLIES

VINCENT THOMAS,
Radio 4-C-E 535 Somerset Block - WINNIPEG, MAN.

RADIO SUPPLIES

COMPLETE SETS and PARTS
Quality Goods Only

ACME MAGNETO & ELECTRICAL CO., LTD.
148 Princess Street, WINNIPEG

The **AMPLION**

Loud Speakers
DOMINATE THE BRITISH MARKET

because—
 No other loud speakers can give such amplification with clarity of tone and no tinny distortion.

They are designed and produced by the world's original and largest manufacturers of loud speakers, telephones, and signalling devices.

The construction of the Amplion is based on the Loud Speaking Naval Telephone, which is used exclusively by the British Navy.

It has been adopted by the leading wireless manufacturers in England.

The AMPLION will perfect your Radio reception, and give true tone to your set.



Aluminum Bell
 Perfect Tone at low cost.
NO POWER AMPLIFIER REQUIRED.

Made by
Alfred Graham & Co.
 LONDON, Eng.

Canadian Agents—
BURNDEPT OF CANADA LTD.
 172 King West, - Phone: Adel. 919 - TORONTO

BURNDEPT

British Wireless Apparatus

BURNDEPT build the sets to receive concerts broadcasted over the ocean and to receive concerts from **EARTH to AEROPLANE.**

The Burndept Ethophone is famous
 Burndept Waterproofed Coils
 Burndept Interval Transformers
 Burndept Coil Holders

NOW IN CANADA

HEADQUARTERS also for
Marconi-Osram Valves
 Low Voltage—Economical.

BURNDEPT OF CANADA LTD.
 172 King St. W. - Phone Adel. 919 - TORONTO, CAN.

Ask
 Your Dealer For
THE
NEW BROWN
FEATHERWEIGHT
HEAD SET



The Lightest Phone on the market. Weighing only 6 ounces.
 Complete with Cords
 4000 Ohms

\$10.00

STOCK IN TORONTO

Canadian Distributors
H. M. PURSER
 624 Empire Bldg., - - - TORONTO
 Phone: Adel. 6484

Qualitone

Popular Radio Horns
 With **DOUBLE TONE CHAMBERS**

Marvelously sweet toned horns that have taken the American radio enthusiasts by storm—now ready for distribution to lovers of high quality radio reception in Canada. Made of fibre and hard wood, stained and grained in beautiful dark mahogany and gloss finish.

If your dealer has not stocked the Qualitone, ask him to order one for trial. You will both be pleased with it.



PATENTS PENDING

Illustrating
 Type No. 1. Holds two phones of any make.
 Canadian price, \$5.50

Also Type No. 1R. Holds one phone of any make, Canadian price..... \$5.50

Merchandising opportunity for radio distributors.
 For details please address

THE DUAL TOOL COMPANY
RADIO DIVISION CLEVELAND, O.

Magnavox prices are the result of Magnavox quality

IN the long run, the price of the really successful and satisfactory product is set by the purchaser—not by the maker or the dealer.

Because when the manufacturer and dealer charge too much for a product, they destroy its market; and when they charge too little they destroy its quality—which results in the something—loss of market.

Magnavox Radio products are of the highest quality—and their prices bring them within reach of every serious radio user.

R2-18 Magnavox Radio (With 18-inch horn)

This instrument is intended for those who wish the utmost in amplifying power; for clubs, hotels, dance halls, large audiences, etc. It requires only .6 of an ampere for the field.

R3-14 Magnavox Radio (With 14-inch horn) *As illustrated*

The ideal instrument for use in homes, offices, amateur stations, etc. Same in principle and construction as Type R-2.

AC Magnavox Power Amplifier *As illustrated*

For use with the Magnavox Radio and insures getting the largest possible power input.

2 and 3 stage.

Magnavox Radio, can be used with any receiving set of good quality. Ask your dealer to demonstrate it with the Magnavox Power Amplifier, as illustrated. This combination produces the most satisfactory results.



*What matters bad weather
when Radio entertains?*

RADIO'S "every-hour-every-where" broadcast schedule is the most stupendous organization of the means of entertainment the world has ever witnessed.

So responsive have people been to the opportunity of enjoying these programs at their best that Magnavox equipment has become synonymous with the full enjoyment of radio music and speech for an ever-greater circle of satisfied users.

Magnavox Products can be had from good dealers everywhere. Our interesting new booklet will be sent on request.

The Magnavox Co., Oakland, California
New York: 370 Seventh Avenue

MAGNAVOX
Radio
The Reproducer Supreme



AMATEURS NEED Radio Broadcasting Program

Published Every Week
Subscription Price (Postage Paid) \$2.00 per year

Attention Amateurs !

THE "RADIO BROADCASTING PROGRAM"

Was established at Toronto as a permanent weekly publication by the publishers of "RADIO" the National monthly Radio Magazine, at the request of a great number of radio fans who are regular readers of "RADIO" but who required up to the minute information regarding the weekly changes of the programs of the principal Canadian and American Broadcasting Stations.

The popularity of "RADIO BROADCASTING PROGRAM" is the finest tribute to its success and usefulness to the owners of radio receiving sets.

The subscription price of two dollars per year enables you to have the leading broadcasting schedules placed in your home or office every week for fifty-two weeks.

COMBINATION OFFER

Radio fans will find it a great advantage to receive regularly both "RADIO" Canada's National Radio Monthly Magazine, with its fund of valuable and carefully selected information and news of the developments in radio communication—and "RADIO BROADCASTING PROGRAM" containing the schedules you need for "Listening In." The publishers have therefore decided to announce to take effect at once the following combination offer—

<p>"RADIO" Monthly for One Year (\$1.50) and - - - "RADIO BROADCASTING PROGRAM" } Fifty-two Weeks (\$2.00)</p>	<p>For a Total of</p>	<p>\$3.00</p>
--	---------------------------	----------------------

Subscribe today for yourself and friends and put it down as your best 1923 investment. Remit to the publishers—

Penton Publications

60-62 Adelaide Street East,

TORONTO - CANADA

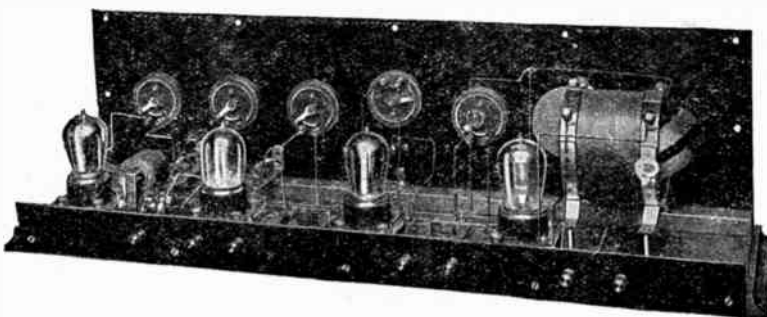

Illustration shows interior of Cabinet.
It is housed in a beautifully finished Mahogany Cabinet.

GILBERT'S 4023 Radio Frequency Set

*THE LATEST
INVENTION.*

Making way for the new Gilbert Radio Sets, it is our intention to clear out all Sets and Units such as DeForest, Tresco, Receiving Sets, Amplifier Units, Tuners, etc., as well as separate parts. We are clearing out at less than cost, demonstration sets other makers Head Phones, every description of Horn and Loud Speaker.

The A. C. GILBERT-MENZIES Co.,
LIMITED
439 King St. W., TORONTO

HART RADIO "A" BATTERIES

YOUR DEALER CAN SUPPLY YOU
AT A PRICE THAT'S RIGHT

Or Write to us Direct

HART BATTERY CO. Limited
Montreal Toronto Winnipeg

PATENTS

HERBERT J. S. DENNISON

Mechanical Engineer and Registered Attorney

Expert in Patents, Trade Marks, Designs, Copyrights and Infringements.

Over 20 Years' Experience in Patents and Practical Engineering.

KENT BUILDING,
YONGE and RICHMOND STS.,

TORONTO

RADIO MERCHANDISE

WHOLESALE ONLY

All Standard Lines. Send for Price List No. 4

F. D. PITTS CO. INC.

219 Columbus Avenue,

BOSTON, MASS., U.S.A.

We have developed additional Parts and Units of RADIO Equipment which are now in production in our factory.

G. R. C. Radio Sets & Supplies

ARE OF HIGHEST QUALITY

Write to-day for our Illustrated Catalogue giving full particulars of our G. R. C. 11 Long Range Tuner, G. R. C. 12 Detector-Capacity Unit, G. R. C. 13 and 14 Audio and Radio Frequency Amplifiers.

General Radio Company,

Affiliated with

THE COX-CAVENDISH ELECTRICAL CO., LTD.

Twyford Abbey Works, Acton, Harlesden, London, N.W. 10

When writing to Advertisers please mention RADIO



**Dictograph
HEADPHONE
DICTO - GRAND
LOUD
SPEAKERS**
*Best for
Real
Results.*

Wholesalers
and Retailers
Famous
Westinghouse
Receivers

*For Real
Results—
They Can't
Be Beat!*

CANADIAN DISTRIBUTORS:
The Mullard Radiovalve Company, Ltd., England



RECEIVING - AMPLIFYING - TRANSMISSION
Write for prices, discounts, etc., to

POWLEY & MOODY, Limited
TORONTO — CANADA
Vancouver, B.C. Edmonton, Alta. Saskatoon, Sask. Montreal, Que.

PHONE:
Main 6875



COIL MOUNTS **COIL PLUGS**
The preference for Formica is not confined to any one class. Manufacturers of the highest grade apparatus use it, so do skillful amateurs and dealers everywhere prefer to sell it because of its high standing with the trade. We carry a large stock of all sizes in Black and Natural. See our Coil Mounts genuine Formica throughout.

FORMICA PANELS **LATERAL COILS**
TOMLINSON & FORBES
MANUFACTURERS "T & F" HIGH GRADE RADIO PARTS
28 Duke Street, Room 22, TORONTO

RADIO WORKERS
—USE—
"Imperial" Rosin Core Solder
CLEAN AND QUICK for all Fine Work
Ask Your Jobber And Specify "Imperial"
The Canada Metal Co. Limited
TORONTO

MALCOLM and HILL
Limited
KITCHENER, ONT.
Manufacturers of
Radio-Cabinets
Special designs and prices on application



\$7^{List}
3000 ohms.

Backed by a Positive Guarantee of Quality.
Concealed Cord Connections. Super Strength Magnets.
Noiseless Tinsel Cords. Maximum Wire Turns.

JOBBERS *Write or Wire — NOW* DEALERS
For "TRUE TONE" Discounts

TRUE-TONE RADIO MFG. CO.
190 No. La Salle St. Chicago, Ill., U.S.A.



**AK - 2 stage
Amplifier**
\$19.60

**ATWATER-KENT MAGNAVOX
QUALITY RADIO RADIO**
**UNITS
and
—SETS—**

New Prices
R2 Magnavox \$82.50
R3 Magnavox \$48.00
AC-2 2 stage \$75.00
AC-3 3 stage \$105.00

Distributed by
JOHN MILLEN & SON, Limited
TORONTO 71 WELLINGTON ST. W.
MONTREAL 321 ST. JAMES ST.
QUEBEC 96 CROWN ST.



R-2 Magnavox

“WORKRITE” REDUCES PRICES

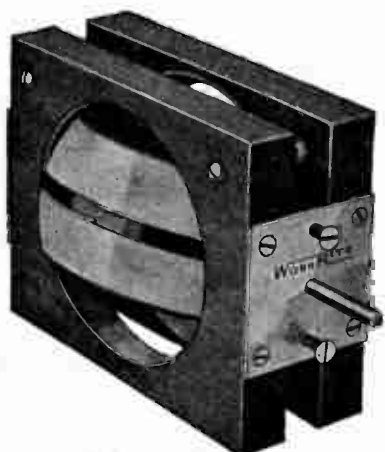

**WorkRite
Super Variometer**

NOW

\$3.50 Each

*Last Spring
they sold
for \$6.00 each*



**WorkRite 180°
Super Variocoupler**

The “WorkRite” Variometer is made from the finest quality mahogany, oil rubbed—a beautiful instrument. Brass parts nicked. Sixty wire turns on stator and sixty on rotor. Rotor wound with green silk. No shellac used. A perfect Variometer both technically and mechanically.

The “WorkRite” Variocoupler is being used the world over because it represents the last word in a coupler. Tunes twice as sharp as the ordinary 90 degree coupler. Made from moulded Bakelite. Sixty wire turns on primary, forty-five on secondary. Both wound with green silk. Twelve taps. Double springs at each connection. There is no better on the market at ANY price.

THE FAMOUS “WORKRITE TUNER TEAM”

Two WorkRite Variometers and one WorkRite Variocoupler make a Tuner Team that cannot be beat for selectivity and long distance records. Concerts have been heard across the entire continent with them. Local concerts can be tuned out and long distance brought in.

PRICE: Due to our enormous production, we have been able to reduce prices gradually from \$6 each down to the present price of \$3.50. You have long wanted to build a high grade set with WorkRite Products—now is your chance at prices that will probably never be lower. Order yours now!

Write for list of complete line of WorkRite Radio Parts and Hookups—Free

THE WORKRITE MFG. CO., 5504 Euclid Ave., CLEVELAND, Ohio
BRANCH OFFICE: 2204 S. Michigan Ave., Chicago, Ill.

The World's
Most Popular
Home Battery
Charger.

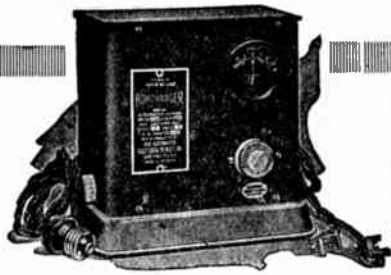

**THE
HOMCHARGER**

is NOW safely established as the World's Most Popular Battery Charger. Over 100,000 have been sold the first year—an unprecedented record.

The name HOMCHARGER has become a "buy-word" in the Radio market. Set owners specify it as a "matter-of-fact." They take for granted that it is the only real battery charger—they recognize it as the STANDARD, because they see it advertised everywhere, and hear their friends boast of its performance.

A GOOD PRODUCT THAT'S MERCHANDISED

Therein lies the secret of the HOMCHARGER'S ever-increasing popularity—it is the only rectifier on the market combining all of these necessary features and advantages:

1. Nationally advertised in over 35 leading publications.
2. Dealer helps and dealer co-operation to the limit.
3. SELF-POLARIZING.
4. HIGH CHARGING RATE.
5. Approved by INSURANCE UNDERWRITERS everywhere.

Retail Price, \$25.00, complete with Ammeter, etc.

Write TO-DAY for FREE booklet, "Best by Test," showing why the HOMCHARGER is the only rectifier you can afford to purchase.

Manufactured by
THE AUTOMATIC ELECTRICAL DEVICES CO.
149 West Third Street, CINCINNATI, OHIO.
Largest Manufacturers of Vibrating Rectifiers in the World.

**Westinghouse
RADIO RECEIVING SETS**

We announce a two-stage audio frequency amplifier, using WD11 Bulbs for ready attachment to the Aeriola Senior Receiving Set.

For delivery beginning March 10th.

Place Your Order Now!

**Canadian Westinghouse Company
LIMITED
HAMILTON, CANADA**

District Offices:

- | | | |
|----------|-----------|--------------|
| TORONTO | CALGARY | FORT WILLIAM |
| MONTREAL | VANCOUVER | OTTAWA |
| WINNIPEG | EDMONTON | HALIFAX |

Radio Specials

BAKELITE PANELS (smooth edge)

- | | | |
|----------------------------|-----|--------|
| 6 in. x 6 in. x 3/16 in. | - - | \$1.00 |
| 10 in. x 12 in. x 3/16 in. | - - | \$3.00 |
| 10 in. x 12 in. x 1/4 in. | - - | \$4.00 |
| 10 in. x 15 in. x 1/4 in. | - - | \$5.00 |

BAKELITE TUBING

- | | | |
|-------------------------------------|-----|--------|
| 4 in. dia. x 1/16 in. wall, per ft. | - - | \$1.80 |
| 5 in. dia. x 1/16 in. wall, per ft. | - - | \$2.00 |

MAGNAVOX Reg. \$62.50 Spec. Price \$40.00

- | | | | |
|-----------------------------|-----|--------------|--------|
| 3000 ohm phones | - | Reg. \$12.50 | \$7.50 |
| .001 mf. Chelsea Condensers | - - | | \$4.60 |
| .005 mf. Chelsea Condensers | - - | | \$4.15 |

BROCK RADIO CO.
B.L. SILVER RADIO ENG.
357 S^W CATHERINE S^W. MONTREAL. PHONE-UP668

KIC-O RADIO

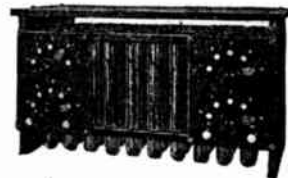

**Storage
"B" Batteries**

FOR EFFICIENCY

THINK over the following FACTS about KIC-O "B" Batteries before making your next "B" battery purchase.

1. Not an ACID battery. Alkaline Type.
2. They eliminate noises caused from "Bs" that are rapidly deteriorating.
3. The first storage "B" battery in the market with panel control. This feature permits single cell variations from 12 volts and up. (A critical plate adjustment is essential in the detector circuit for C.W. and Radiophone reception.)
4. Rechargeable from your 110 volt A.C. line in connection with the rectifier supplied with each battery.
5. NOT an experiment. All batteries are sold with the privilege of receiving your money back if unsatisfied within a 90-day trial.
6. No discharging while idle. One charge lasts from three to six months in the detector plate circuit.
7. Neat, efficient and compact.

	(Plain)	(With Panels)
16 cell, 22 volts	\$ 6.50	
24 cell, 22 volts	8.00	\$12.00
36 cell, 48 volts	10.00	14.00
50 cell, 68 volts	12.00	17.00
78 cell, 100 volts	16.00	21.00
108 cell, 145 volts	21.00	26.00

KIMLEY ELECTRIC CO.

1355 Fillmore Ave.,

Buffalo, N. Y.

**National Airphone
Model G.**

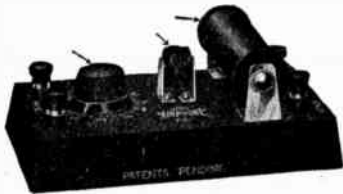

Canadian Price
\$16.50

HIGHEST TESTIMONIALS

Awarded Certificates of Merit by the Laboratories of "Radio News," "The Evening Mail" and "New York Tribune." Pronounced by Radio Engineers as the Best Ever.

"Puts the Joy in Radio"

**NATIONAL
AIRPHONE
CORPORATION**

REG. U.S. PAT. OFF.

16-22 HUDSON STREET
NEW YORK

Dealers—Write for Discounts.

Distributors—for Terms of Exclusive Distribution.

**"Gold-Grain" Detector
National Airphone**



SIZE
2-1/16" x 3 3/8"
Mounted
With
Binding Posts

Canadian Price
\$3.50

**CANADIAN WESTINGHOUSE
"RC" RECEIVING SETS**

**IMMEDIATE
DELIVERY**

This set is now being manufactured in Canada and is the last word in Broadcasting reception.

We are Distributors for the following High-Class Manufacturers:

- Canadian Westinghouse Co., Ltd., Hamilton, Ont.
- Chelsea Radio Co., Chelsea, Mass., U.S.A.
- Dyer Co., Cambridge, Mass., U.S.A.
- Bremer Tully Radio Co., Chicago, Ill., U.S.A.
- Electral Dealers Supply Co., Chicago, Ill., U.S.A.

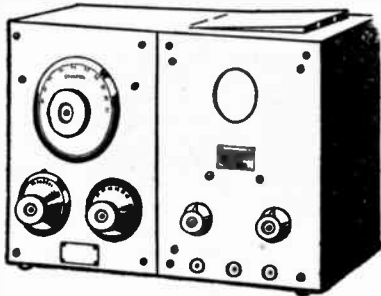

Price \$145.00

Bremer Tully Vernier Condensers and Dyer Moulded Bakelite Variometers and Variocouplers (including Bank Wound Coil) now in stock, and many other high-class Radio Products.

Dealers: Write us for Territory, Price Lists and Discounts.

Mail Orders Receive Prompt and Careful Attention

A. CAREY & SONS, 274 King Street East, HAMILTON, Ont.

Phone: Regent 8579

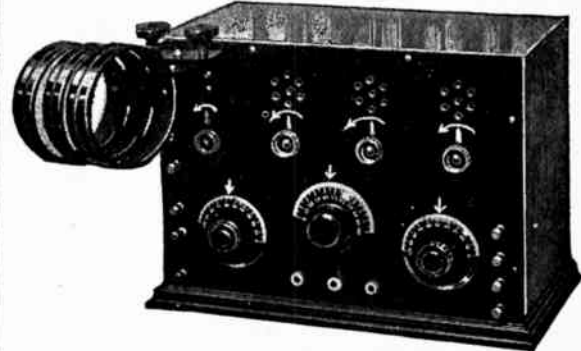

ASSEMBLED—BUT NOT WIRED.
**MULTI-WAVE TUNER DETECTOR
AND TWO-STEP AMPLIFIER,
\$55.00**

Here is a new way to buy reliable Radio Equipment—a cheaper way. You do the wiring yourself in accordance with the diagrams and instructions.

SEND FOR OUR NEW PRICE LIST.

J. M. PAQUIN
THE ELECTRICAL SHOP
787 Queen St. W. TORONTO, Ont.

Up-to-Date & Popular RADIO BOOKS

Covering details on—How to Operate a Set. How to Build a Set.
Principles of Vacuum Tubes. Radio Hook-up, etc., etc.

EXPERIMENTAL WIRELESS STATIONS—



By P. E. Edelman.

Tells how to make apparatus to not only hear all telephoned and telegraphed radio messages, but also how to make simple equipment that works for transmission over reasonably long distances. The first and only book to give all the recent important radio improvements, some of which have never before been published. 392 pages, 167 illustrations. Price, \$3.00.

HOW TO MAKE COMMERCIAL TYPE RADIO APPARATUS—By M. B. Sleeper.

This book describes in detail many commercial types of spark and vacuum tube telephone transmitting and telegraph and phone receiving equipment of all kinds. The experimenter will be able to get a world of ideas for the design and construction of his next piece of radio equipment from the very clear descriptions and the 98 clearly illustrated figures. Price, 75c.



RADIO HOOK-UPS—

By M. B. Sleeper.

A book that gives you not only clear diagrams for all kinds of telephone and telegraph receiving and transmitting sets, but simple descriptions of each circuit shown and spaces for notes of results obtained. Price, 75c.

WIRELESS TELEGRAPHY AND TELEPHONY SIMPLY EXPLAINED—By Alfred P. Morgan.

One of the most complete and comprehensive treatises on the subject ever published. A study of its pages will enable one to master all the details of the wireless transmission of messages. The author explains in simple language the theory and practice of wireless telegraphy and telephony. 154 pages, 156 engravings. Price, \$1.50.

THE A.B.C. OF VACUUM TUBES USED IN RADIO RECEPTION—By E. H. Lewis, Radio Instructor.



Written particularly for the person who "knows nothing about radio," but who would like to gain an understanding of the elementary principles of operation on vacuum tubes and various circuits in which they are used for the reception of radio-telegraph signals and radio-telephone music and speech. Illustrated. Price, \$1.00.

CONSTRUCTION OF NEW TYPE TRANS-ATLANTIC RECEIVING SETS—By M. B. Sleeper.

There is a peculiar fascination about receiving radio messages from the high-power stations of England, France, Germany, Russia and Italy, as well as those located in the Pacific Ocean and the Oriental countries. Several types of simple receiving sets for this purpose are described with detectors and amplifiers to accompany them. Suggestions are also given for operating relays and reproducing the signals on a phonograph. Schedules of operating time for high powered stations are given. In addition there is some valuable data on home-made wavemeters for testing and experimenting. Price, 75c.

THE RADIO EXPERIMENTER'S HANDBOOK—By M. B. Sleeper.



Throughout the preparation of this book, one purpose was kept in mind—Answer the Practical Questions of the "Novice," of the "Beginner," and the more advanced "Student." This book will help in the selection or construction of simple apparatus for the transmission and reception of radio telegraph and telephone signals. In the chapters on radio receivers the simplest crystal, the simple audion, and the regenerative types, are described in quite some detail. The question of antennas, both for transmitting and receiving, are taken up.

A good many helpful suggestions are given which will be of considerable aid to the experimenter. 16 chapters, fully illustrated. Price, \$1.00.

CONSTRUCTION OF RADIOPHONE AND TELEGRAPH RECEIVERS FOR BEGINNERS—By M. B. Sleeper.

The man who wants to feel the real thrill to accomplishment, and who is not satisfied in the merely making use of what others have done for him, builds his own radio apparatus. Radio men can follow the data in "Radio Phone and Telegraph Receivers" with full confidence, because each piece of apparatus described was first made, tested and found efficient before the final design was accepted. Special receivers, both crystal and audion, are shown in detail. Regenerative circuits as well as audio and radio frequency amplifiers are described with clear photos, diagrams and working drawings prepared especially for the novice and the man who wants to receive the radio telephone broadcast. A special feature is the phonograph type radio set and the loud speaker. Fully illustrated. Price, 75c.

IDEAS FOR THE RADIO EXPERIMENTER'S LABORATORY—By M. B. Sleeper.

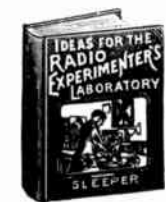

The science of radio communication has developed with astonishing rapidity, and the advance of the art has resulted in the offering for sale of varied apparatus by the many manufacturers, which may cause confusion to the beginner.

His little volume tells in simplified form the "How" and "Why" of Radio Apparatus.

He accomplished and experienced amateur, as well as those of an experimental turn of mind,

will find much information on experiments and tests which are of great value to them, while the novice will discover a wealth of information which will assist him in the designing, constructing and testing of his set, a special feature being a complete table of Inductance Capacity and Frequency, corresponding to wave lengths of from 100 to 39,000 meters. Comprehensive data is given on such necessary laboratory instruments as the Oscillator, Wavemeter, Direction Finder, Radio Compass, V. T. Characteristic Measuring Set, and detailed advice is given on the winding of the various kinds of standard Inductance Coils, including Rules and Regulations on Fire Protection.



RADIO DESIGN DATA—

By M. B. Sleeper.

The only book that gives tables and data for designing, receiving and transmitting apparatus so that you need no knowledge of mathematics. It's the first book a beginner buys after he has learned the use of his phone receiver. Price, 75c.

Copies of any of these books sent prepaid to any address, on receipt of price

A. F. PENTON & Co., 60-62 ADELAIDE ST. E., TORONTO, CANADA



No. 57 RADIO RECEIVER.

LONG DISTANCE RADIO RECEPTION Now a Reality

Through the use of the

Federal

No. 57 RADIO RECEIVER

RADIO SIGNALS MAY BE RECEIVED OVER EXTRAORDINARY DISTANCES with a pureness of tone and beauty of reproduction *unrivalled* by any receiving apparatus that has yet been built.

FOR FURTHER INFORMATION WRITE FOR
BULLETIN No. 119-W

IT IS AN EDUCATION IN RADIO FREQUENCY AMPLIFICATION.

Century Telephone Construction Co., Inc.
BRIDGEBURG, ONT.

Canadian Branch—Federal Telephone & Telegraph Co., Buffalo, N.Y.



All Wave Receiving Set

HONEYCOMB COIL TUNER, DETECTOR
AND TWO STAGE AUDIO AMPLIFIER.

All parts necessary for the user to assemble this set
can be supplied.

Blueprint of detail layout and hookup furnished.

By
RUSSELL GEAR & MACHINE CO., Ltd.
1209 KING ST. WEST, - - TORONTO



Ask Any Radio Operator

THE RELIABLE PEANUT VALVE FILAMENT BATTERIES are specially constructed and designed to give the very best Service.

1. For the DETECTOR CIRCUIT use RELIABLE NO. 6 RADIO BATTERY or RELIABLE P.V. 121 (which is two cells connected in multiple), has a capacity of 1½ volts.

2. For ONE STAGE OF AMPLIFICATION use either RELIABLE P.V. 122 OR P.V. 222, which has a capacity of 3 VOLTS and an extra tap brought at 1½ volts.

3. For TWO STAGE OF AMPLIFICATION use RELIABLE P.V. 123 OR P.V. 223, which has a capacity of 4½ volts.

NOISELESS, LONG LIFE,

HIGH VOLTAGE MAINTENANCE
are assured when you use

RELIABLE RADIO B. BATTERIES



Manufactured only by
THE DOMINION BATTERY CO. LIMITED
Toronto - Montreal - Winnipeg - Calgary - Vancouver

When writing to Advertisers please mention RADIO

Talk
Number
4

SIGNAL

Facts from the Factory

YOUR first consideration in selling Radio Apparatus is the responsibility of the manufacturer. Has it the years of the peculiar kind of experience which the production of efficient and dependable Radio Equipment demands? *Does it keep pace with the progress of the science of Radio?*

SIGNAL stands that test. We've been making Telephone and Telegraph equipment over thirty-five years. We've developed as "wireless" developed. We know Radio from its beginning. SIGNAL Radio Equipment is made by men who've been making that kind of apparatus ever since it was discovered.

And our force of Radio Engineers is constantly engaged in research work which insures that every SIGNAL item represents the latest Development in Radio.

Sell SIGNAL Radio Equipment and you sell Radio Service and Satisfaction!

Besides Radio Equipment the SIGNAL line includes:
Bells and Buzzers
Bell Ringing Transformers
Medical Batteries
Telegraph Instruments
Battery Charger (for Radio and Auto Batteries)

SIGNAL Electric Mfg. Co.

Factory and General Offices:
1920 Broadway, Menominee, Mich.

Atlanta Cleveland Pittsburgh
Boston Minneapolis San Francisco
Chicago Montreal St. Louis
Toronto

You'll find our local address in the Telephone Directory.

(2243B)



**SIGNAL
Vernier Rheostat**

Your customers will surely approve of this SIGNAL Vernier Rheostat. It has the fine appearance and will give the Exceptional Service which characterizes every SIGNAL item. It's the first successful vernier using a single knob for control. Fine adjustment easily obtained. Furnished with or without knob and pointer, so dial to match others of set may be used.

**INFORMATION
COUPON**

Signal Electric Mfg. Co.
1920 Broadway,
Menominee, Mich.

Please send catalog and bulletins giving complete information about SIGNAL Radio equipment to name and address written in margin of this page.

DURHAM Variable High Resistance



Get Better Results This Summer

Radio entertainment may be greatly improved during the coming months—if you take every precaution to have the vacuum tubes as efficient as possible. And the first step is adjusting grid resistance. No two tubes are alike, so the resistance *must* be variable.

This is the reason why sets equipped with DURHAM Variables produce such remarkable results. Fullest advantage is taken of the tuning possibilities of the tubes themselves. Hissing noises are eliminated and, naturally, greater distances are covered.

Listen Through the Static

Without DURHAM Variables greater distance might mean more static. But the exclusive DURHAM plugger control permits such fine adjustment and such sharp tuning that the static nuisance is reduced to a minimum.

These convenient DURHAM units come in three values—variable between wide limits. And they can be used in your present resistance base, the special DURHAM base, or with Dubilier Micadons.

No. 201A—2 to 10 megohms special for W201A tube
No. 101 — 100,000 to 5 megs, for other tubes
No. 100 — 1,000 to 100.00 ohms for general use.

Durham & Co.

Radio Engineers

Philadelphia

Distributed throughout the Dominion by

Toronto Radio Co. Scott Brothers Ltd. Consolidated Distributors
Toronto Montreal Winnipeg

Canada's Leading House for Amateur Radio Supplies

Recognized from COAST to COAST for SERVICE and QUALITY

BAR CHAS. COILS for Rheinart Circuit - \$2.95	SERIES PARALLEL SWITCH For Panel Mounting - \$1.25	Burgess, Eveready, Reliable Ontario "B" Batteries
--	---	--

McTIGUE "B" STORAGE BATTERY 22½ VOLTS - - - \$5.90	BRANDES SUPERIOR - - \$8.00 PEN SPECIAL 2000 - - \$5.85
---	--

Freshman Variable Grid Leak and Condenser, .00025 mfd., 5 meg.	\$1.25
Freshman Variable Grid Leak only, 0-5 meg.95
Freshman Condensers, .0001, .00015, .00025, .00035, .000545
Freshman Condensers, .0008, .001, .002, 50c; .0025, 63c; .005, 95c; .006, \$1.15; .01, 1.90	
Vario Coupler Parts, with wire.	1.75
Radiotrons U.V. 200, \$6.00; U.V. 201, \$7.50; U.V. 201A	7.50
White Dials, Black Knob, Brass Insert, 3/16 and 1/415
Tuner and Detector, in Oak Cabinet, using Bar Chas. Coil	23.50
Tuner, Detector, and One Stage ditto.	32.50

DEALERS—WE CAN SUPPLY YOU
AMATEURS—OUR MAIL ORDER SERVICE IS THE BEST

THE VIMY SUPPLY CO., Ltd., 567 College St., Toronto

PHONE: COL. 9074

Premier

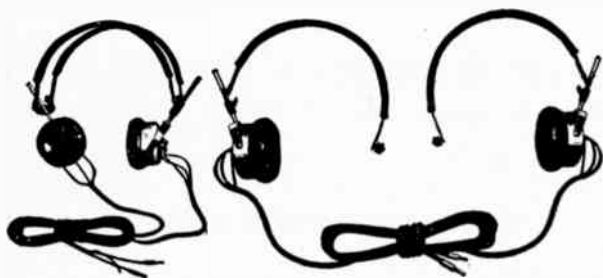

Guaranteed Radio Phones

Made of the best of materials, by men who know how. Correct in Design and intended to give Real Service. Carefully Tested to Insure Clearness and Volume, unusually sensitive to very weak signals.

The Magnets are Tungsten Steel, Hammer Tested and will not lose their Magnetic strength. The intensity and tone of each Cup is the same. Coils are Enamelled Copper Wire thoroughly Insulated.

The efficiency of Radio Reception depends largely on the Head Set. Premier Phones increase efficiency. They are sold on an Absolute Guarantee and will stand any comparative test.

The Head Band is novel. It splits into two parts, each having an overhead strip so that two persons may listen in comfort. They are sold by reliable dealers or direct at

2000 ohms **\$6⁵⁰** 3000 ohms **\$8⁰⁰**

Premier Accessory and Specialty Corp.

28 CONGRESS STREET, NEWARK, N.J., U. S. A.

HEAD SETS THAT SATISFY



These instruments have a remarkable degree of sensitivity and trueness of reproduction, making them exceedingly popular for receiving local and long distance broadcasting.

Army and Navy Type:
2500 ohms, per pair **\$10.00**
3200 ohms, per pair **12.00**
Swedish-American Type:
2200 ohms, per pair **8.00**
Victor Type:
Single coil, double magnet.. **6.00**
Keystone Type:
Single coil, double magnet.. **5.00**

Jacks, Plugs, Microphones and other Radio Parts.

ASK FOR OUR LIBERAL TRADE PRICES.

American Electric Company

State and 64th Streets - CHICAGO, U. S. A.

When writing to Advertisers please mention RADIO

A Complete Set of RADIO BOOKS

AMATEURS!

There is a complete set of seven books on Radio, written by some of the highest authorities in this science:

“A GUIDE TO LISTENERS IN,” by Abby Morrison.

“RADIO SIMPLY EXPLAINED,” by Waldemar Kaempffert.

“TUNING AND WHAT IT MEANS,” by John V. L. Hogan.

“THE ALLADIN LAMP OF RADIO,” by Prof. J. M. Morecroft.

“BRINGING THE MUSIC TO THE EAR,” by R. S. Ould.

“HOW TO MAKE YOUR OWN PARTS,” by Raymond Francis Yates.

“INSTALLING THE HOME SET,” by Pierre Boucheron.

They are just 5 in. x 6½ in., handy size for the pocket and come in a heavy cardboard binding decorated in colors to grace any drawing room table.

The set complete for only \$3.00, or with a year's subscription to Radio \$4.00; with Radio Broadcasting Programme, \$4.50.

Remit to-day to the Book Department.



Penton Publications,
60-62 Adelaide St. E. Toronto, Canada

R A D I O

Proof!

Graphic proof of FIL-KO-STAT superiority as shown here can be had in any laboratory equipped with Bureau of Standards Instruments.

Practical proof of FIL-KO-STAT superiority is evident the moment you put FIL-KO-STAT'S in place of the devices you now use to regulate filament action.

Here's the Comparison of Fine Adjustment Control Range of FIL-KO-STAT with Rheostats and Other Filament Controls Clearly Indicating How FIL-KO-STAT Excels and Showing Wherein it Permits Perfect and Gradual Current Increase With Infinite Adjustments

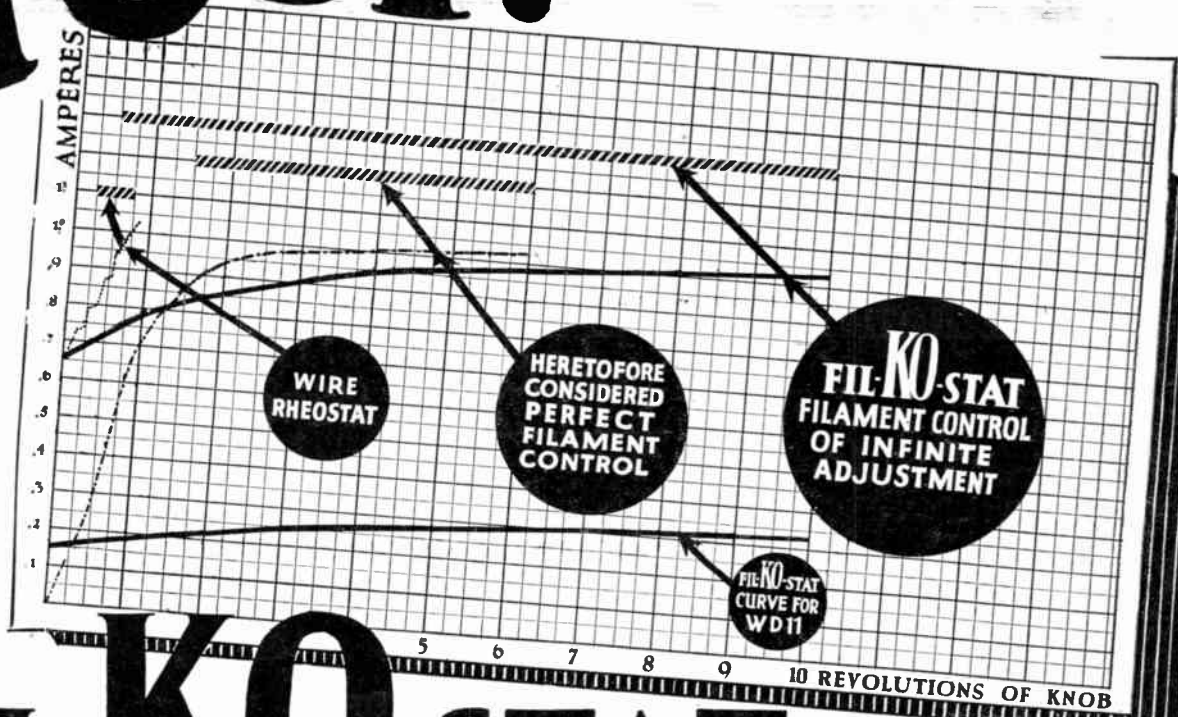

FIL-KO-STAT Best Filament Control



- Infinitesimal Control** of Electronic Flow
- Definite Off** indicating complete "A" Battery disconnection.
- Fine Adjustment** starts where tube begins to function.
- At Full On** Resistance practically zero.
- Absolutely Silent** Non-microphonic, free of all noises.
- No Current Variations** Resistance constant at any setting.
- No Disks to Break or Chip** Resistance element so finely divided further division impossible.

GUARANTEED

The FIL-KO-STAT is to all purposes "fool proof". Each instrument is packed with the maker's guarantee that it will be replaced if broken within one year.



You have been eagerly waiting for just this instrument Mr. Set Builder, amateur or manufacturer. It marks a step forward in Radio. It is not an adaptation of some old method of current control. It is not a rheostat. IT IS A FILAMENT CONTROL, distinctly designed to utilize the great tuning possibilities of the vacuum tube itself.

Its superiority is proven by every test. It regulates the FILAMENT HEAT. It gives absolute control of the ELECTRONIC FLOW and consequently permits THE FINEST TUNING POSSIBLE.

Perfect and gradual increase of filament heat assures longer life to the tube. Fine adjustment of fractional currents makes it ideal for use with Dry Cell tubes.

And infinitesimal control of electronic flow gives a corresponding control of fine detection so absolutely essential in DX tuning.

The time to replace all other filament control devices with FIL-KO-STATS is now. Say "FIL-KO-STAT" to your dealer today. If he has none in stock send his name and your remittance direct to

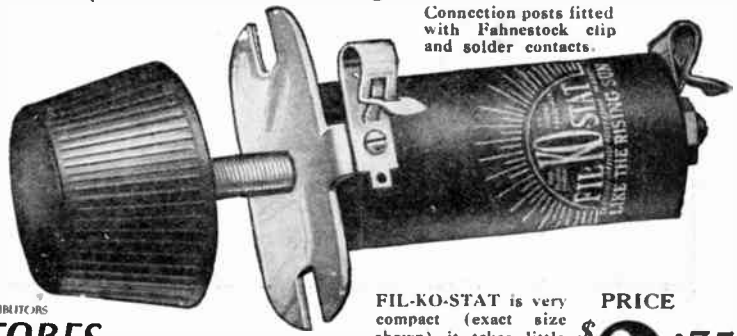

Connection posts fitted with Fahnestock clip and solder contacts.

SOLE INTERNATIONAL DISTRIBUTORS
RADIO STORES CORPORATION
 218-222 West 34th St.
 NEW YORK

WIRE ORDERS FILLED TO JOBBERS AND DEALERS

FIL-KO-STAT is very compact (exact size shown) it takes little space on the panel. So mountable it can replace any other control without redrilling.

PRICE \$ **2**·75

Dept. CR

R A D I O

QUALITY RADIO ONLY

The following Manufacturers for whom we are Canadian Distributors produce Quality Radio Only :—

Canadian Brandes Limited

PRODUCE---

Brandes
"Matched Tone"
TRADEMARK REG.

Superior Headsets

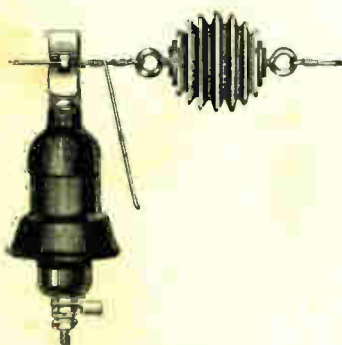

OUTDOOR TYPE

L.S. Brach & Co.

**Vacuum Gap
Lightning Arresters**

APPROVED BY BOARD OF
FIRE UNDERWRITERS



INDOOR TYPE

Canadian Westinghouse Company

Westinghouse Receiving Sets and WD11 Tubes

Canadian National Carbon Co.

Eveready Radio Batteries



American Radio and Research Corporation

Amrad Sets and Parts.

AND MANY OTHERS

Address Nearest Office

PERKINS ELECTRIC LIMITED

347 Bleury St.,
MONTREAL, Que.

11 Temperance St.,
TORONTO, Ont

217 McDermott Ave.,
WINNIPEG, Man.



When writing to Advertisers please mention RADIO