

MAY 1957 A Maclean-Hunter publication: five dollars a year

COLLINS RADIO CAN LTD
2 W PRESTON PROJ ENG
11 BERMONDSEY RD
TORONTO 16 ONT
33
3-1

ELECTRONICS ENGINEERING

OF CANADA

Atoms create new jobs for electronics

The Human Operator — what is the limit?

Methods of waveform analysis

Improved transistor biasing

New AM transmitter design

IRE National convention

full contents inside



Computers: what next?

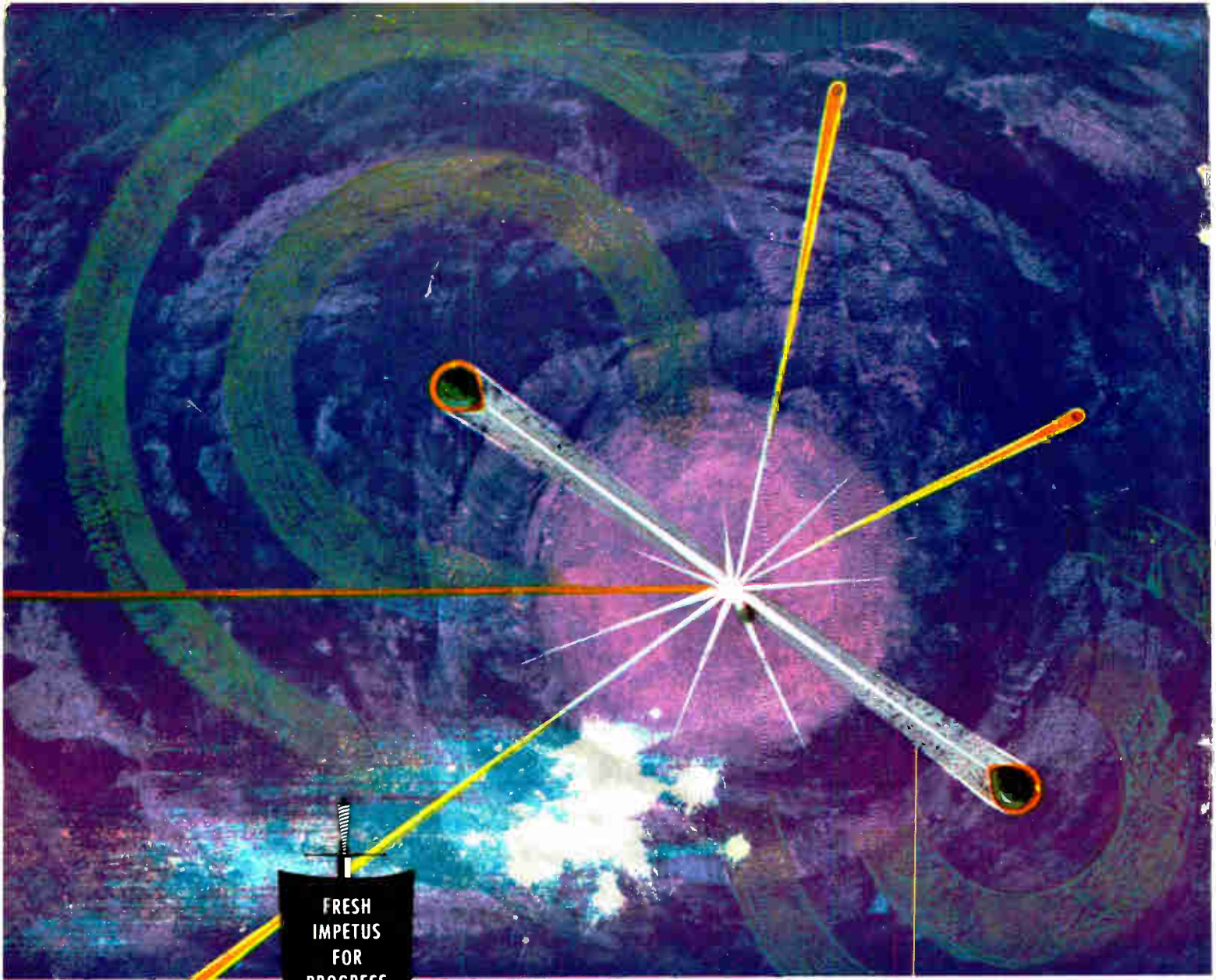

FRESH
IMPETUS
FOR
PROGRESS

THE DYNAMIC RELEASE OF NEUTRONS AND FISSION PRODUCTS AS THE ATOM SPLITS.

Unleashing the Atom's Power-for Canada

Partner with Atomic Energy of Canada Limited in developing nuclear programmes, and designer and builder of specialized research equipment of considerable size and complexity . . . Canadair is helping Canada unleash the atom's power for peace.

The experienced Canadair team of nuclear physicists is available for consultation with scientists or industries to study or specify how nuclear knowledge can be applied in any field;

generation of heat and power — medicine — agriculture — metallurgy or general industry.

Inquiries are particularly invited from universities, laboratories and industries. Write to the Nuclear Division, Canadair Limited, for the booklet: "Canadair in the field of Nucleonics".



CANADAIR
LIMITED, MONTREAL

- Aircraft
- Research and Development
- Guided Missiles
- Nuclear Engineering

ELECTRONICS ENGINEERING

What we think	<i>Electronics—Canada's challenge</i>	27
*Computers: what next?	<i>A survey of digital and analog computers; new designs and uses</i>	28
Atoms create new jobs for electronics	<i>The part electronics has played in atomic development; new instruments</i>	32
The Human Operator — what is the limit?	<i>The problem of how to fit the human into complex control systems</i>	36
Methods of waveform analysis	<i>Theory and principles of waveform analysis and the instruments used</i>	40
Improved transistor biasing	<i>Problems of transistor output stage stability at critical temperatures</i>	44
New AM transmitter design	<i>Modern design work on a new 50 kw AM transmitter for broadcasting</i>	46
Special section: IRE National Convention	<i>Over 50,000 electronics engineers meet in New York. News and picture story</i>	52



Departments:	People in the industry	5
	Reports from industry	7
	Quotes from everywhere	58
	What's new in view	60
	For your library	62
	New products	64
	Round-up: coming events	84

***our cover design** *To symbolize our feature on computers we portray the intricate flow and pattern of perforated computer tape in action. Photogram by Tom Schell, one of Canada's leading graphic designers.*



Magnet Wire at its finest comes from **FEDERAL**

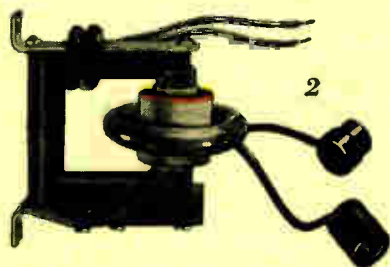

2



3



4



5

- 1 Deflection Yoke
—Federal Bandel
- 2 Horizontal Transformer
—Federal Formel
- 3 Width Control
—Federal Formel

- 4 Blocking Oscillator
—Federal Formel
- 5 Horizontal Stabilizer
Coil—Federal Formel
- 6 i.f. coils with traps
—Federal Formel



6



FEDERAL Wire and Cable Company Limited

Head Office and Factory: GUELPH, ONTARIO
Sales Offices and Warehouse Stocks: St. John's, Nfld., Truro, Montreal, Winnipeg,
Regina, Saskatoon, Calgary, Edmonton, Vancouver.

staff

HAROLD PRICE, BSc. (Eng.), P.Eng., *Editor*
 KENNETH W. LINES, *Managing Editor*
 IAN R. DUTTON, BSc., P.Eng., *Associate Editor*
 ANTHONY BRIAN, *Montreal Editor*
 ROBERT E. SWAN, *Advertising Representative*
 ROSS C. MACDONALD, *Eastern Advertising Representative*
 FRANK DAVIES, *Editorial Art Director*
 JOHN F. FOY, *Circulation Manager*
 J. W. SARGENT, *Sales Promotion Manager*
 J. LESLIE, *Production Manager*
 R. G. SCOTT, *Research Manager*
 W. A. WEIR, *Advertising Service Manager*
 C. A. KING, *Manager*
 GEORGE W. GILMOUR, *Group Manager, Industrial Publications*
 J. L. CRAIG, *Director, Business Publications*

contributors and special articles in this issue:



Editor Price



Lines



Author Price



Dutton



Rybb

Editor **Harold Price**, B.Sc. (Eng.), P.Eng., who takes a good look at computers in his article "Computers—What Next?" has been employed by Canadian Westinghouse since 1953. He started as a design engineer becoming, respectively, project engineer and section engineer. From April of last year he was a section manager supervising work concerned with anti-aircraft fire control, anti-submarine fire control, sonar, torpedoes and magnetic amplifiers. Mr. Price took his B.Sc. at Durham University, England, in electrical engineering and radio. His positions in England included that of design engineer with English Electric Co. at Stafford.

How does the human operator fit into electronic control systems? Managing Editor **Kenneth W. Lines**, who set out to find an answer in his article, has worked in London on the Daily Mirror and the News Chronicle, writing feature articles, sub-editing and originating typographical make-up and design. He has traveled extensively in Europe and Africa on writing assignments and spent some time in Africa as general manager of a newspaper group. During the war he worked on radar and predictor equipment and at the end was engaged for a period on radar and electronic research.

Electronics and atomic physics are inseparable says Associate Editor **Ian R. Dutton**, BSc., P.Eng., in "New Jobs for Electronics." After three years with the

Canadian Army during World War II as a radar technician and instructor, Ian Dutton entered the University of Toronto to obtain a degree in electrical engineering. On graduation he joined the Electronic Equipment Department of Canadian General Electric Co. Ltd. to establish and supervise their Technical Publications Group. He was recently with J. A. Wilson Lighting and Display Ltd.

From Witwatersrand University, South Africa, comes **Maurice Price**, P.Eng., who describes some original design work in "Improved Transistor Biasing." After five years with South African railways he moved to England in 1953 where he was with the British Thomson-Houston Co. and Smith's Aircraft Instruments Ltd. as an electronic designer. He came to Canada in 1955 and has been associated with Computing Devices of Canada Ltd. since then as a product design engineer, working mainly in the field of aircraft instrumentation.

Measurement is the main interest of author **S. A. Rybb**, P.Eng., (Methods of waveform analysis). Of Polish origin, he graduated from London University in electrical engineering in 1949 and joined Dawe Instruments Ltd. He came to Canada in 1954 to work with the company's newly formed division and is now their chief engineer. During the war he served with the Allied Armed Forces as a technical officer.

a Maclean-Hunter publication

Authorized as second class mail, Post Office Department, Ottawa.
 Printed and published by Maclean-Hunter Publishing Company Limited, Editorial and Advertising Offices: 212 King Street West, Toronto 2, Canada. Address all correspondence: P.O. Box 100, Toronto, Canada.
 Horace T. Hunter, Chairman of the Board; Floyd S. Chalmers, President; Donald F. Hunter, Vice-President and Managing Director; Thomas H. Howse, Vice-President and Comptroller.
 Publishers of National Magazines in Canada; Maclean's, Chatelaine, Canadian Homes and Gardens, Business newspapers in Canada; Canadian Hotel Review; Fountains in Canada; Heating and Plumbing Engineer; Bus and Truck Transport; Canadian Advertising; Canadian Automotive Trade; Canadian Aviation; Canadian Grocer; Canadian Machinery; Canadian Packaging; Canadian Paint and Varnish; Canadian Printer and Publisher;

Canadian Shipping; Canadian Stationer; Civic Administration; Drug Merchandising; Electronics Engineering; L'Epicer; The Financial Post; Hardware and Metal; Marketing; Men's Wear; Modern Power; Painting and Decorating Contractor; Plant Administration; Le Prix Courant; Electrical Contractor; Style; Office Equipment & Methods; Home Goods Retailing; Photo Trade; Building Supply Dealer; Business newspapers in U. S. and U. K.; Inland Printer, Rock Products, Concrete Products, British Printer.
 OTHER SERVICES: The Financial Post Corporation Service; Canadian Press Clipping Service; Commercial Printing Division.
 Offices at 1242 Peel Street, Montreal; Maclean-Hunter Limited, 125 Strand, London (Eng.).
 Subscription rates: Canada \$5.00 per year, two years \$9.00, three years \$13.00. Single copy price, \$1.00. Other countries \$8.00 per year.



New stacked ceramic receiving tubes that can withstand heavy shock and vibration

2CL40A A new, small ceramic high vacuum rectifier or clipper diode that can be air or liquid cooled



3CX100A5 A premium quality ceramic and metal 100 watt triode



4CX300A General purpose tetrode with 300 watts plate dissipation up to 500 MC

EIMAC FIRST
with ceramic tubes
that can take it...

In recent years equipment manufacturers and users have been introduced by Eimac to a series of ceramic tube firsts unequalled in the industry: klystrons, negative grid tubes, rectifiers and receiving tubes.

Clean, and rugged... these tubes can stand up to shocks and temperatures no glass tube can. Design and production advantages are a boon to equipment manufacturers and users alike.

As first in the field, Eimac has developed ceramic tube manufacturing techniques that have evolved into well established processes.

For further information contact our Eimac Canadian representative.

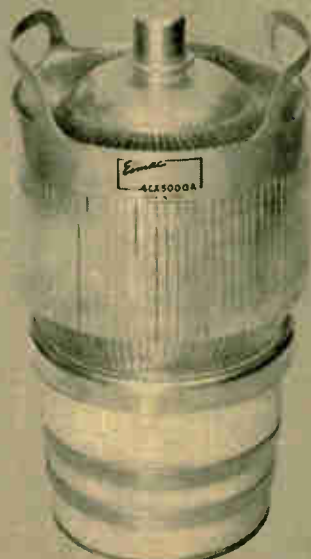

4CX5000A High power radial-beam tetrode especially suitable for single sideband operation



4K50,000LQ Four cavity klystron that delivers 10,000 watts of power at frequencies of 700 to 1000 MC

EITEL-McCULLOUGH, INC.

SAN BRUNO

CALIFORNIA

The World's Largest Manufacturer of Transmitting Tubes



REPRESENTED IN CANADA BY

THE AHEARN AND SOPER COMPANY LIMITED

P.O. Box 715

Ottawa, Ontario



New AGM for Ontario Hydro

Two are named for new positions

Mr. H. J. Sissons has been appointed new assistant general manager of Ontario Hydro. Mr. Sissons, a 1937 graduate of the University of Toronto in Political Science and Economics, will be responsible for a newly established Services Branch comprising the information, research, property and supply divisions, the A. W. Manby service centre at Islington and building management functions in the Toronto area. Tremendous expansion of Hydro's operations has made the change necessary, says Chairman James S. Duncan, C.M.G.

Another Hydro appointment: Mr. H. P. Cadario as Assistant Director of Engineering. He has been head of the Stations Department of the Engineering Division since 1953.

Two Canadians awarded I.R.E. Fellowships



Field



Horner

Awards of Fellowships in the Institute of Radio Engineers were made to two Canadians at the IRE annual banquet, held in the Waldorf-Astoria Hotel, New York. They were Dr. G. S. Field and S. G. L. Horner.

Dr. Field, who is chief scientist of the Defence Research Board, received his award for contributions to ultrasonics and to the defence research program of the Royal Canadian Navy. Mr. Horner's work with the Radio Division of the Hudson's Bay Company's Fur Trade Department led to his award, the citation reading, "for contributions to radio communications in Canadian Northern and Arctic regions."

Measurement Engineering sales post

New member of the staff of Measurement Engineering Limited is Mr. A. C. Perkins who becomes their Central Ontario sales representative. During his association with Canadian

General Electric Mr. Perkins was responsible for the technical efficiency of heavy radar units which formed part of the "Pinetree" defense system.

During his 15 years' experience in the electronic and communications field Mr. Perkins has received training at American factories and laboratories on products handled by his firm in Canada.

Leaves RCAF to join T.M.C. (Canada)

In one of three new appointments to T.M.C. (Canada) Ltd. Mr. A. G. Sheffield becomes Executive Assistant/Managing Director following his retirement after 16 years in the Telecommunications Branch of the RCAF. Squadron Leader Sheffield's prewar experience as a member of the Canadian Broadcasting Corporation engineering staff involved the installation and maintenance of 50kw broadcast stations together with being a member of the technical crew covering the royal visit in 1939. He is a radio amateur — VE3EB.

In the other two T.M.C. appointments Mr. Shelley M. Presentey, P.Eng., is made assistant chief engineer and Mr. Dieter Lohr, P.Eng., joins the staff. Mr. Presentey graduated from the University of Sofia and studied at the Sorbonne in Paris. He was head of the electronics division of the Le Havre Port Authority in France and has been with Canadian Marconi in Montreal.

Electronic revolution — in 25 years

Mr. K. R. Patrick, president of Canadian Aviation Electronics Ltd., believes that electronics will have as great an effect in the next 25 years as the industrial revolution in the last 250 years.

As well as opening new frontiers for industry electronics will liberate mankind for the "accomplishment of great intellectual advancement." In the days of the Greek philosophers, there were five slaves for every free citizen and free citizens enjoyed time for thought and plenty of it. Electronics would provide tomorrow's "slaves."

Mr. Patrick was on a speaking tour across Canada.

Two new IRE fellows

M.E. sales post

RCAF officers move

Electronic revolution

Founder is made chairman

Military consultant at Westinghouse

Group Captain C. B. Limbrick has been appointed as military consultant to the Canadian Westinghouse Company's electronics division. Former special weapons and communications expert at RCAF headquarters, Ottawa, G/C Limbrick will serve as consultant on technical requirements for military electronic equipment. He will also assist in long-range Westinghouse planning for military development projects.



Limbrick



McGregor

Mr. B. H. McGregor, P.Eng., has been appointed sales engineer in the electronics division of A. C. Wickman Ltd. Mr. McGregor graduated from the University of Toronto in 1947 and has worked with Northern Electric, Rogers Majestic Electronics Ltd. and most recently with R. H. Nichols Ltd. In his new position he will specialize in the application of Brush direct writing recording systems and allied products.

Appointments, changes

Annual meeting of Allanson Armature Manufacturing Co. Ltd. elected Mr. H. E. Allanson chairman of the board of directors. Mr. Allanson founded the company in 1928. Mr. Ray Jameson was elected president, retaining the position of general manager.

* * *

Canada Wire and Cable Co. Ltd. have made the following appointments: J. H. Pryce, general sales manager; O. W. Francoeur, sales manager, Eastern region; W. N. Herod, sales manager, Central region; E. W. Johnson, sales manager, Western region.

* * *

Canadian Westinghouse have appointed Mr. K. J. Farthing general advertising manager. He joined the company in 1914.

FIRST silicon transistors meeting NAVY SPECS

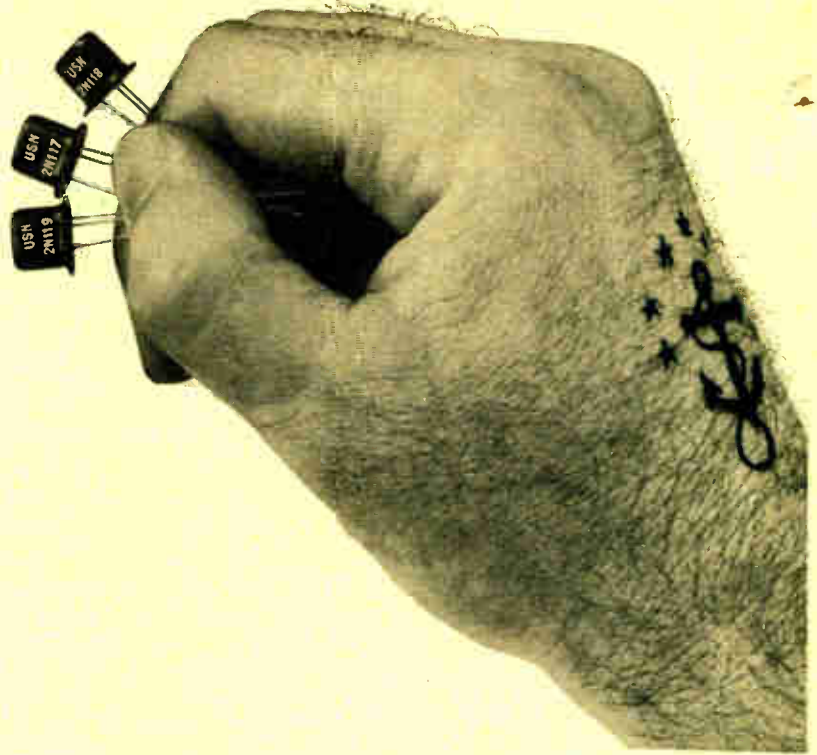

For *reliability* under *extreme* conditions... design with Texas Instruments military silicon transistors... built to give you high gain in small signal applications at temperatures up to 150°C. Made to the stringent requirements of US MIL-T-19112A (SHIPS), US MIL-T-19502 (SHIPS), and US MIL-T-19504 (SHIPS) – these welded case, grown junction devices furnish the tremendous savings in weight, space and power you expect from transistorization... *plus* close

parameter control that permits you to design your circuits with confidence.

Through the new Texas Instruments Ottawa office you can now choose from the broadest line of semiconductor devices available from a single source... germanium and silicon transistors and tiny silicon rectifiers built for rough duty. TI is the world's major supplier of high temperature transistors to industry for use in military and commercial equipment.

degradation rate tests for TI's USN-2N117, USN-2N118, and USN-2N119

test	condition	duration	end point at 25°C
lead fatigue	three 90-degree arcs	—	no broken leads $I_{CO} = 2\mu A$ maximum at 5V $h_{ob} = 2\mu mhos$ maximum $h_{fb} = -0.88$ minimum (USN-2N117) $h_{fb} = -0.94$ minimum (USN-2N118) $h_{fb} = -0.97$ minimum (USN-2N119) no mechanical defects interfering with operation
vibration	100 to 1000 cps at 10 G	3 cycles, each x, y, and z plane	
vibration fatigue	60 cps at 10 G	32 hours, each x, y, and z plane	
shock	40 G, 11 milliseconds	3 shocks, each x, y, and z plane	
temperature cycle	-55°C to +150°C	10 cycles	
moisture resistance	MIL-STD-202	240 hours	
life, intermittent operation	$P_c = 150 mW, V_c = 30V$	1000 hours, accumulated operating time	
life, storage	150° C, ambient	1000 hours	
salt spray	MIL-STD-202	50 hours	

**LOOK TO TI FOR: SILICON HF, MEDIUM POWER, POWER, AND SMALL SIGNAL TRANSISTORS
SILICON DIODES AND RECTIFIERS • GERMANIUM VHF, POWER, RADIO, AND GENERAL PURPOSE TRANSISTORS**

**pioneer producer of
silicon transistors**



**TEXAS INSTRUMENTS
INCORPORATED**
53 QUEEN STREET OTTAWA 4, CANADA

Half CBC programs in colour by 1963

Steady expansion — says Fowler

The Royal Commission on Broadcasting report did not go far enough, in the general opinion of the electronics industry, particularly in its pronouncements on the introduction of color TV into Canada.

The commission recommended some change in the set up of the governing body, possible competition in present one-channel TV centres and foresaw 50 percent of CBC's TV programs in color by 1963. Radio, said the report, has a new role in the light of television.

It was suggested that there should be a Board of Broadcast Governors representing a broad public interest and experience, which would be responsible for control and supervision not only of the public broadcasting agency but of all private broadcasters as well. The Board should be directly representative of all the provinces.

On color TV: This is one American influence we will be unable to resist for very long. It costs about \$15,000 to \$25,000 to equip an existing station for color; operating costs are about 25 percent higher than for monochrome programs. Color would cost the CBC about \$6 million in 1963.

The commission asked the CBC to submit a plan to raise TV coverage from 80 to 90 percent of the population. In the current year the net operating expenditure for the CBC (after deducting commercial revenue) will be over \$38 million. Estimated net cost in 1963 would be nearly \$75 million.

Record sales level for CGE

Canadian General Electric Company Ltd. achieved a record level in sales during 1956 and set records in employee earnings and payments to suppliers, says President James H. Goss.

Sales reached \$248,168,551, an increase of 14 percent over 1955. Net income for the year totaled \$10,822,183 representing 4.4 cents on the sales dollar compared to 2.8 cents in 1955.

The work force total 16,700 at the year-end, up 1,500 from 1955. Payrolls were up \$11,000,000 to a new high of \$66,000,000.

Dividends in 1956 totaled \$2,327,052 and the sum of \$8,495,131 was added to earned surplus, making the balance in that account \$72,479,501. Thus almost 80 cents of each dollar of earnings in 1956 was reinvested in the company.

Powerlite discontinue a division

Powerlite Devices Ltd., with head offices in Toronto, has discontinued its instrument division. President Dudley S. Young, P.Eng., says the company will concentrate its entire facilities on the design, manufacture and marketing of its long established lines of cable terminating and sectionalizing equipment, switchgear and street lighting.



Young

The new Powerlite manufacturing plant in Toronto, according to Mr. Young, is operating at full capacity and it is felt that the new policy of concentration on Canadian manufactured items and those represented products more closely allied to them is in keeping with the growing trend toward specialization in the electrical field.

ROR will handle Computers

ROR Associates Ltd. announce their appointment as representatives for the Berkley Division of Beckman Instruments Inc. ROR will cover the Eastern Canadian provinces. Products handled include EASE analog computers and decimal counting and scaling instru-

Record CGE sales

Change by Powerlite

ROR to handle computers

Move for technicians

New line for MEL

ments. ROR will also handle Canadian sales for the Systems Division of Beckman Instruments.

The Beckman Systems Division produces data reduction and handling devices, special purpose digital computers and high speed tele-metering equipment. ROR Associates will move into a new building at 1470 Don Mills Rd., Don Mills, Ontario. Facilities will include a display room and service department. A mobile laboratory will be available to provide on-the-spot demonstrations and trial of ROR Instrument lines.

Certificates for technicians

Ontario's rapidly growing force of engineering technicians, estimated at 30,000, can now receive certificates under a voluntary program started by the Association of Professional Engineers of Ontario.

Under the program engineering technicians who apply for certification will be examined by a special panel and classified in one of five grades determined by their educational qualifications and technical experience.

A quick look around

Measurement Engineering Ltd., Arnprior, Ontario, have been appointed Canadian representatives for Keithley Instruments Inc., Cleveland, Ohio. MEL have set up repair facilities for the instruments.

Dawe Instruments, Bank Street, Ottawa, are now Canadian representatives of a British line of ceramic and silvered mica capacitors.

Canadian Marconi will supply CHUM, Toronto, with two Gates Radio Company BC-5 P transmitters. They will also supply a Gates TV transmitter for a new Twin Cities TV station in Kamloops, B.C.

Statement by the Workmen's Compensation Board of Ontario says that in 1955 620,580 cheques were processed and mailed. This total reached 666,337 in 1956. Increased volume of paper work has resulted "in the trend toward more extensive use of electronic aids."



SALT SPRAY AND HUMIDITY CHAMBER has a working space 48x36x26 in. The Engineering staff of ARL is available to laboratory customers.

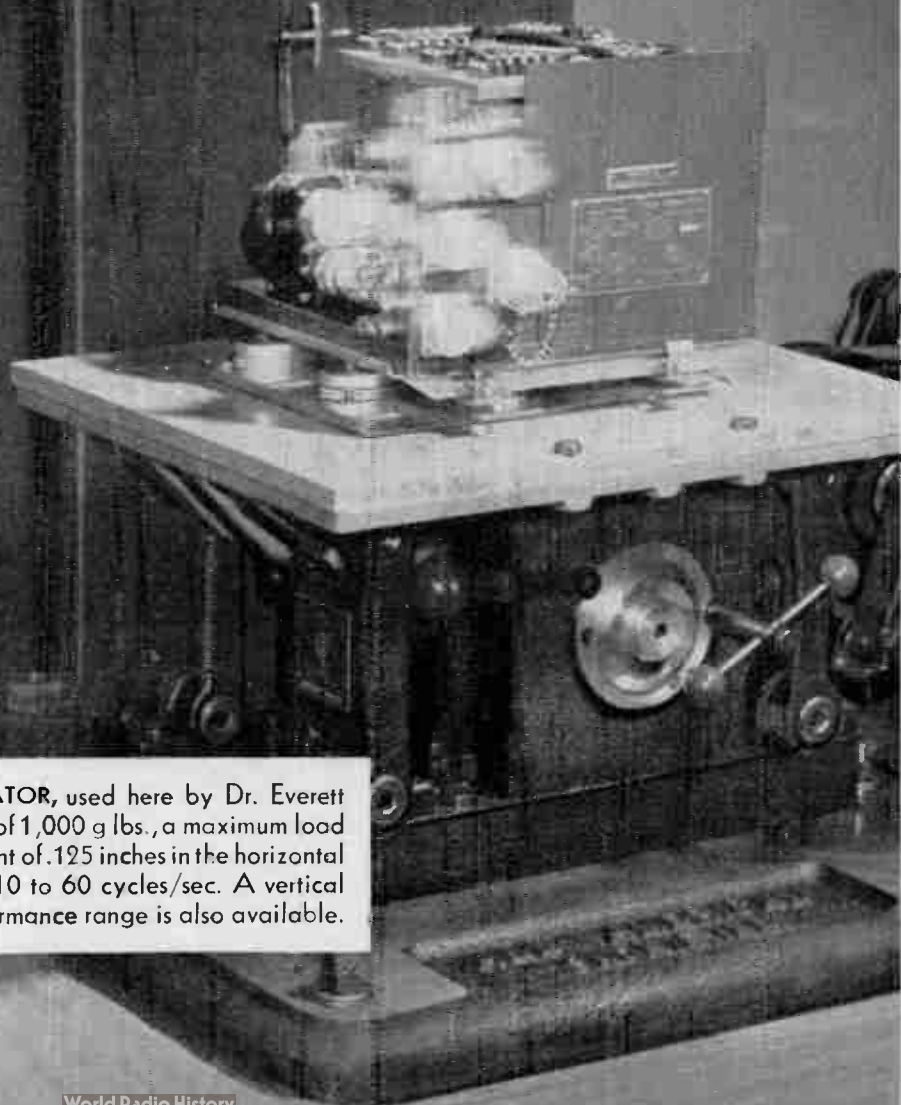

HORIZONTAL MECHANICAL VIBRATOR, used here by Dr. Everett Braaten, test lab chief, has a capacity of 1,000 g lbs., a maximum load of 150 lbs. and a maximum displacement of .125 inches in the horizontal plane within the frequency range of 10 to 60 cycles/sec. A vertical mechanical vibrator of the same performance range is also available.

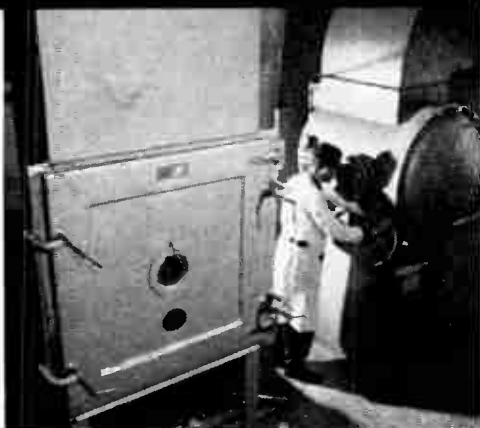

SAND AND DUST CHAMBER, left, and Explosion chamber, right, have working spaces of 3x3x3 feet, and 3-ft. diameter x 4-ft. length, respectively.



ICING WIND TUNNEL, with present 24 h.p. motors, has a maximum indicated airspeed in excess of 400 f.p.s. Work space cross section is 12x12 in.



TEMPERATURE ALTITUDE CHAMBER has a 27 cu. ft. capacity. Tests from -100°F. to 300°F., at altitudes from sea level to 100,000 ft.

TAILORED FOR TORTURE

Equipment takes its worst punishment at new PSC Applied Research test lab

FOR their own highly specialized purposes, engineers and researchers can now, practically speaking, fly around the world without leaving 3,000 square feet of floor space at PSC Applied Research Ltd.'s environmental test lab in Toronto. Moisture congealing Arctic temperatures; buffeting, shock and strain of severe air turbulence; corroding heat and humidity in the tropics; icing and air pressure at high altitudes—these are the facts of world flight most interesting to design engineers. They are among conditions now duplicated in detail at ARL's new lab—the first private enterprise establishment of its kind in Canada. Entire facilities of the laboratory are being offered to industry and government on a commercial basis.**

Tests available: low and high temperature, altitude, humidity, shock, vibration, salt spray, sand and dust, radio interference, explosion, fungus, wind tunnel.

Literature is available on request, giving full details of each test facility.

**Canadian Aviation magazine,*



PSC APPLIED RESEARCH LTD.

1500 O'CONNOR DRIVE
TORONTO 16, ONTARIO, CANADA
PLYMOUTH 5-3371



World Radio History

Member: A. V. Roe Canada Limited & Hawker Siddeley Group

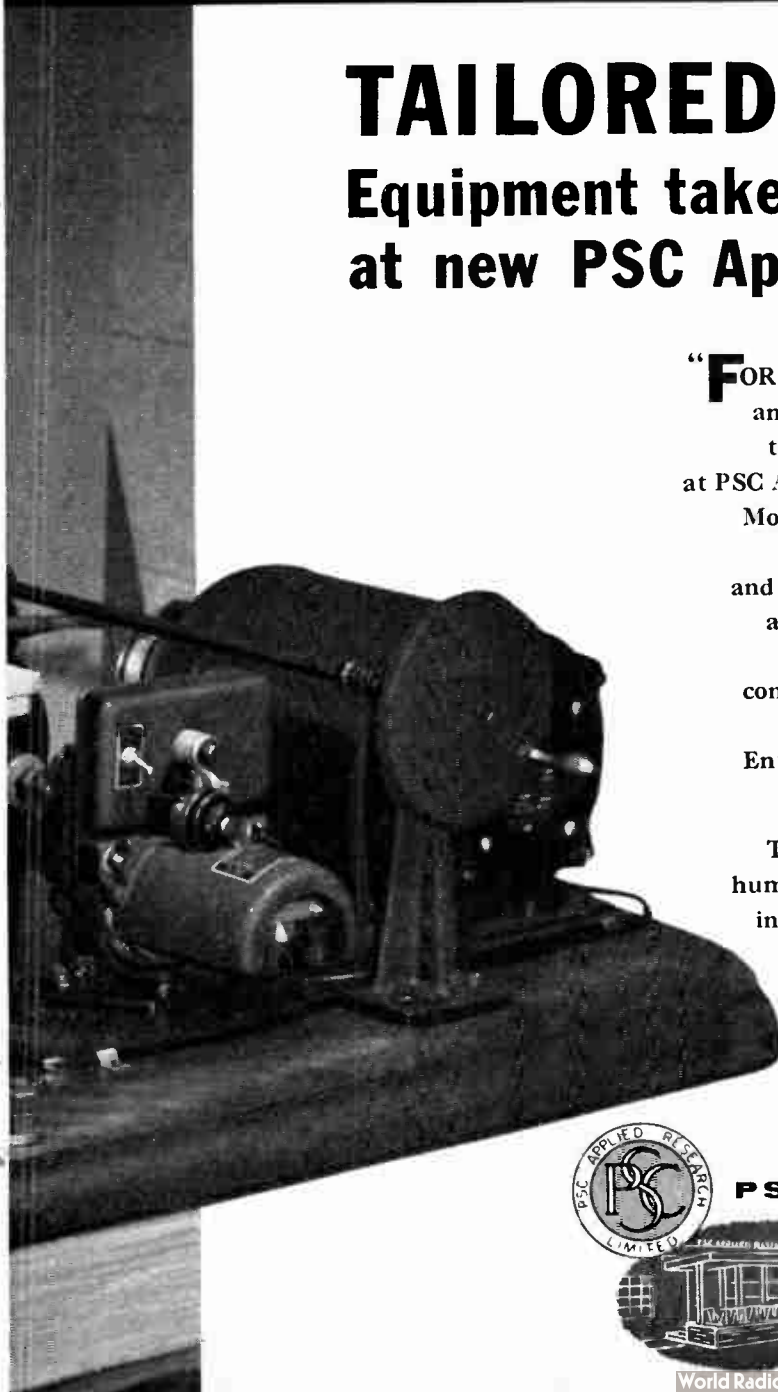



a comprehensive
**Telecommunication
Engineering Enterprise**

The largest telecommunication manufacturing organisation in the British Commonwealth **Standard Telephones and Cables Limited** covers the whole waterfront of telecommunication engineering and is engaged in the research, development, manufacture and installa-

tion of all types of communication and control systems.

The Company is in an unrivalled position to undertake, within its own organisation, the co-ordinated systems-planning of complete communication projects involving inter-dependent systems of various types.

'Standard' productions include:—

**Telecommunication Line Transmission
Equipment**
Radio Broadcasting Equipment
Radio Communication Equipment
Air Radio Navigational Aids
Supervisory and Remote Control Systems
Railway Communication Apparatus
Railway Control Equipments
Telephone Cable
Sound-Reinforcement Systems
Public and Private Telephone Systems
(Automatic and Manual)



**Standard Telephones & Cables
Mfg. Co. (Canada) Ltd.**

9600 ST. LAWRENCE BLVD., MONTREAL 12. P. Q.

signal generators

10 to 21,000 MC!

EASIER TO USE • MORE ACCURATE • MORE STABLE

11 TO CHOOSE FROM

With *-hp-* signal generators, frequencies are directly set and read on one dial. Output voltage is directly set and read. No calibration charts are required. Most *-hp-* generators offer internal pulse, FM or square wave modulation; some include external pulsing and FM'ing. New *-hp-* 626A (10 to 15.5 KMC) and 628A (15 to 21 KMC) offer 10 mw output, SWR 1.2.

-hp- signal generators outsell other signal sources by approximately 2:1. Engineers report the reasons are simpler operation, versatility, trouble-free performance, and exceptional value.

Instrument	Frequency Range	Characteristics	Price
<i>-hp-</i> 608C	10 to 480 MC	Output 0.1 μ v to 1 v into 50 ohm load. CW, pulse or AM mod. Direct calibration.	\$ 950.00
<i>-hp-</i> 608D	10 to 420 MC	Output 0.1 μ v to 0.5 v into 50 ohm load. CW, pulse or AM mod. Direct calibration and crystal calibrator check	1,050.00
<i>-hp-</i> 612A	450 to 1,230 MC	Output 0.1 μ v to 0.5 v into 50 ohm load. Pulse, CW or amplitude modulation to 5 MC. Direct calibration.	1,200.00
<i>-hp-</i> 614A	800 to 2,100 MC	Output 0.1 μ v to 0.223 v into 50 ohm load. Pulse, CW or FM modulation. Direct calibration.	1,950.00
<i>-hp-</i> 616A	1,800 to 4,000 MC	Output 0.1 μ v to 0.223 v into 50 ohm load. Pulse, CW or FM modulation. Direct calibration.	1,950.00
<i>-hp-</i> 618B	3,800 to 7,600 MC	Output 0.1 μ v to 0.223 v into 50 ohm load. Pulse, CW, FM or square wave modulation. Direct calibration.	2,250.00
<i>-hp-</i> 620A	7,000 to 11,000 MC	Output 0.1 μ v to 0.223 v into 50 ohm load. Pulse, CW, FM or square wave modulation. Direct calibration.	2,250.00
<i>-hp-</i> 623B	5,925 to 6,575 MC; 6,575 to 7,175 MC; 7,175 to 7,725 MC	Output 70 μ v to 0.223 v into 50 ohm load. FM or square wave modulation. Separate power meter and wave meter section.	1,900.00
<i>-hp-</i> 624C	8,500 to 10,000 MC	Output 3.0 μ v to 0.223 v into 50 ohm load. Pulse, FM or square wave modulation. Separate power meter and wave meter section.	2,265.00
<i>-hp-</i> 626A	10,000 to 15,500 MC	Output 1 μ watt to 10 mw. Internal or external pulse, FM, or square wave modulation. Direct calibration.	3,250.00
<i>-hp-</i> 628A	15,000 to 21,000 MC	Output 1 μ watt to 10 mw. Internal or external pulse, FM, or square wave modulation. Direct calibration.	3,000.00



Your *-hp-* field engineer has complete data on all *-hp-* generators. Or, write direct.

HEWLETT-PACKARD COMPANY

Represented in Canada by
ATLAS RADIO CORPORATION, LTD.
50 Wingold Avenue, Toronto 10, Ontario
505 McIntyre Bldg., Winnipeg, Manitoba

complete coverage, outstanding value

DECCA RADAR AND DECCA NAVIGATOR UNSURPASSED FOR SAFETY AND ACCURACY *on land, sea and in the air!*



DECCA AIRFIELD RADAR

Decca Type 424 Airfield Control Radar offers an economical solution to the problem of providing an efficient and reliable approach aid under conditions of poor visibility at air terminals. Decca Airfield Surface Indicator is a revolutionary "Q" Band radar for control of all ground movement on airfields.

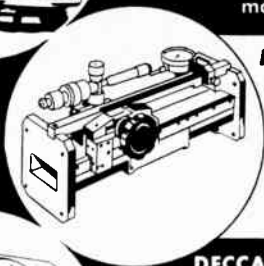

MICRO WAVE TEST GEAR

The Decca Radar Laboratories have developed a range of precision "S" Band and "X" Band microwave test gear. This range includes Standing Wave Meters, Attenuators, Oscillators, Matched Loads, Noise Sources and complete Test Benches, all built to the highest engineering standards.

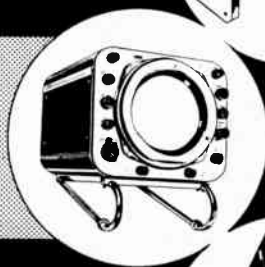

DECCA MARINE RADAR

In the past 6 years Decca Marine Radar has been installed aboard over 6000 vessels of the worlds Navies and Mercantile Fleets. This fact itself testifies to the performance and reliability of Decca Radar which leads the world in advanced design.



DECCA STORM WARNING RADAR

Decca Type 41 with a useful range beyond 200 miles provides the meteorologist with an essential aid, giving information on storm build up and movement in many cases virtually impossible to acquire by other means.

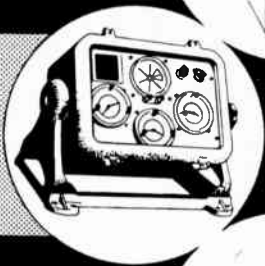

DECCA NAVIGATOR - MARINE

Over 3500 ships of all classes, including those of many navies testify to the high accuracy, reliability and simplicity in use of the Decca Navigator System.

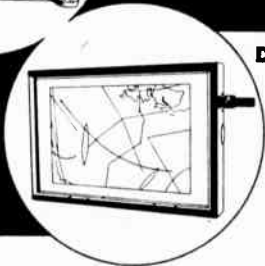

DECCA NAVIGATOR - AIR

The Decca Navigator System provides complete flexibility in flight planning, continuous fixing of position and the facility of map presentation using the Decca Flight Log. It is ideally suited for Helicopter operation having no "line of sight" limitation and being capable of pilot operation.



DECCA RADAR (CANADA) LIMITED
NAVIGATOR (CANADA) LIMITED

23 SIX POINTS ROAD, TORONTO 18, ONTARIO



write for sample installed on YOUR wire!

Inspect a SEALINK sample installed on *your* wire... only then will you grasp the significance of this newest of Burndy developments for wiring! Here is the very first fully water-sealed splice exceeding all immersion, dielectric, voltage drop and tensile strength requirements... a splice that keeps out the elements. Rapid, controlled SEALINK installations are made with the Burndy MR8 Hand Hytool without need for reversing the tool. SEALINKS are made for AWG conductor sizes 26 thru 10. Send us a sample of your wire—we'll send you an installed SEALINK plus full details on this new method for making insulated, sealed splices.

BURNDY

CANADA LTD.

381 GREENWOOD AVE., TORONTO 8, ONT.
QUEBEC and MARITIMES: 1434 ST. CATHERINE ST. W., MONTREAL 8, QUE.

REPRESENTED IN:

Winnipeg by NORMAN L. HANEY & CO.
Calgary and Vancouver by BUNSTON LTD.

CLM DARCY RELAYS



TYPE CK



**TYPE CG
WITH PLUG-IN BASE**

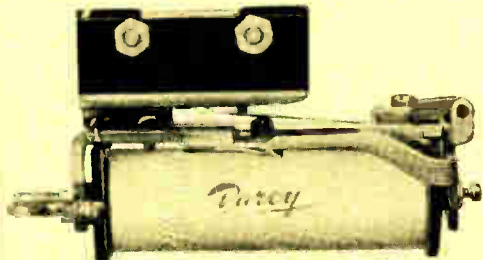

TYPE CCMS

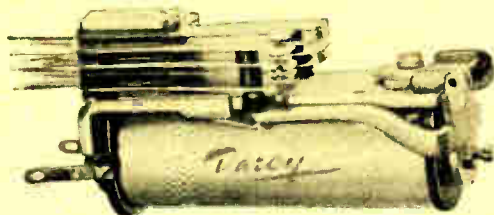

TYPE CC



TYPE CG

Now you can get fast delivery with Canadian made relays. All standard types are available and all are electrically and mechanically interchangeable with other makes.

Illustrated are only a few telephone type relays. Other spring and coil combinations are available.

For full information call or write Jack West, Sales Manager, Rectronic Division, Canadian Line Materials Limited, Toronto 13 or our nearest sales office.

SALES OFFICES and WAREHOUSES

MR. R. WATSON
624-9th Ave.
Calgary, Alberta
Tel.: 2-7328—6-3933

MR. H. L. STUART
10330-104th Street
Edmonton, Alberta
Tel.: 2-4453—2-7418

MR. A. WILLIAMSON
114 Myles Street
Fort William, Ontario
Tel.: 3-3483

MR. D. C. KEDDY
53-55 Upper Water St.
Halifax, N.S.
Tel.: 3-6229

MR. L. A. desAVOYE
220 Elm Street
Montreal, Quebec
Tel.: GLenview 4297-8

MR. C. R. THORNTON
168 Charlotte St.
Ottawa, Ontario
Tel.: CE. 5-3482

MR. F. HESELTINE
1120 Broad Street
Regina, Sask.
Tel.: 9-5659

MR. G. J. ROONEY
57-59 Dock Street
Saint John, N.B.
Tel.: 3-2503

MR. H. COLLINGWOOD
243 Water Street
St. John's, Nfld.
Tel.: 2101

MR. D. MCKINNON
125 Bay Street
Sault Ste. Marie, Ont.
Tel.: ALgoma 3-1213



MR. D. E. ANDERSON
3643 Kingsway
Vancouver, B.C.
Tel.: DExter 9330

MR. E. M. BRYDON
292 Princess Street
Winnipeg, Man.
Tel.: 93-9019

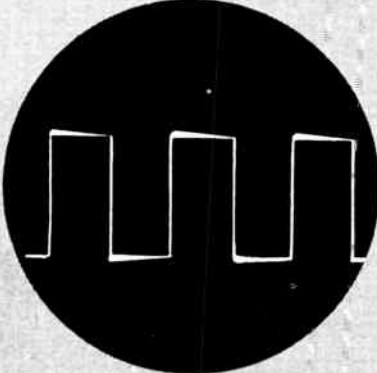
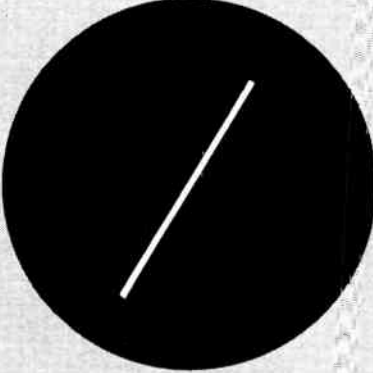

CLM-DARCY RELAYS

the All-purpose Scope!

SQUARE WAVE RESPONSE	PHASE MEASUREMENTS	RESPONSE CHARACTERISTIC
 <p>Overshoot is only 2 to 5%. Rise Time is 0.1 Microsecond. Square wave depicted 250 kc.</p>	 <p>Phase shift between horizontal-vertical amplifiers, 0-100 kc-0°, to 1 mc within 2°; by internal adjustment with gain controls at max 0° phase shift possible on any specific frequency to 6 mc.</p>	 <p>Note flatness throughout specified range; usable to 6 mc.</p>
<h2>980 LINE OSCILLOSCOPE</h2>		

SPECIFICATIONS: MODEL 983 OSCILLOSCOPE

Wide Band Frequency Response: Flat within 1.5 db from 0-3.58 mc and within -3 db to 4.5 mc on both vertical and horizontal amplifiers. Transient response: overshoot 2 to 5%. Rise time: 0.1 microsecond.

High Deflection Sensitivity: 15.0 millivolts per inch, RMS, on both vertical and horizontal amplifiers.

Phase Shift: Between horizontal-vertical amplifiers, 0-100 kc-0°, to 1 mc within 2°; by internal adjustment with gain controls at max 0° phase shift possible on any specific frequency to 6 mc.

Calibrating Voltages: 500 millivolts, 5 volts, 50 volts, 500 volts, peak to peak. Readily available and adjustable by front panel controls.

Z-Axis Modulation: Input terminal mounted on front panel.

Sweep Frequencies: 10-500,000 cps, variable. Preset TV/V position—30 cps. Preset TV/H Position—7875 cps. Retrace Time—better than 2% to 100 kc; at 500 kc less than 10%.

Internally Phased Sine Wave: Adjustable through 170°.

Vertical and Horizontal Polarity: Reversible.

Input Impedance: Vertical Amplifier (without Shielded Cable), 1 meg shunted by 60 mmf. Vertical Amplifier (with Shielded Cable), 1 meg shunted by 120 mmf. Vertical Amplifier (with Low Capacitance Probe), 10 meg shunted by 12 mmf. Horizontal Amplifier (without Shielded Cable), 1 meg shunted by 60 mmf.

Power Supply: 105/125 volts, 50/60 cycles.

Tube Complement: (1)-1V2, (1)-5U4-GA, (6)-6BQ7A, (4)-12BY7A, (4)-6AH6V, (1)-6U8, (1)-5U1, (1)-0D3, and (1)-5NO60T.

Case: Grey hammertone finished steel.

Panel: Aluminum finish with etched, black markings.

Size: 10" x 14" x 19.5" Approx. Weight: 40 lbs.

WESTON 980 LINE INSTRUMENTS

80 Volt-Ohm-Milliammeter
 981 Tubechecker
 Vacuum Tube Voltmeter
 Sweep Generator
 3 Calibrator

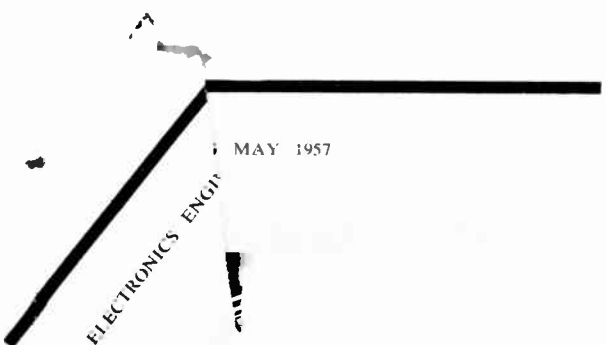

MAY 1957

ELECTRONICS ENGINEERING

SEND COUPON FOR COMPLETE DETAILS

DAYSTROM, LIMITED
 840 CALEDONIA RD.
 TORONTO, CANADA
 DIVISION OF DAYSTROM INC.

Please send literature on the 983 Scope and other 980 line instruments

NAME

ADDRESS

5701

TOP SECRET

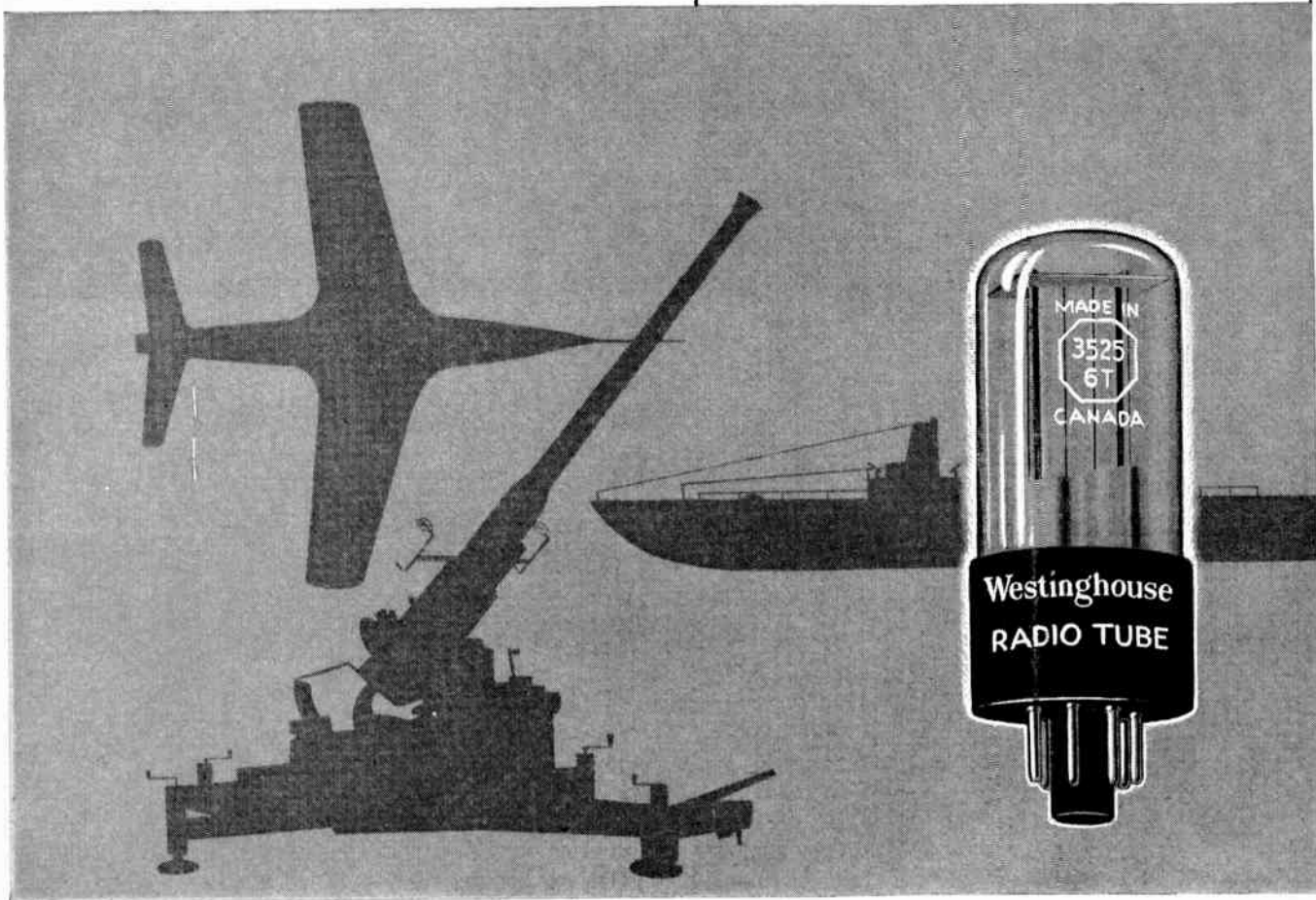

in the air - on land - under the sea

Westinghouse tubes are at work

From the Top Secret files of Westinghouse Electronics research laboratories come plans for Canada's future defence weapons.

Right now, Westinghouse tubes are working electronic magic — in the air — on land — on and under the sea.

These tubes pour out of Westinghouse Tube Works to activate new electronic devices for Canada's defence.

This same engineering skill and modern, up-to-the-minute equipment produce the tubes you receive for home TV and Radio use. Westinghouse Tubes are completely reliable for the first line of defence and for your line of work!

YOU CAN BE SURE...IF IT'S **Westinghouse**

CANADIAN WESTINGHOUSE SUPPLY CO. LTD.

Halifax • Quebec City • Montreal • Ottawa • Toronto • Hamilton • North Bay
Fort William • Winnipeg • Regina • Saskatoon • Edmonton • Calgary • Vancouver

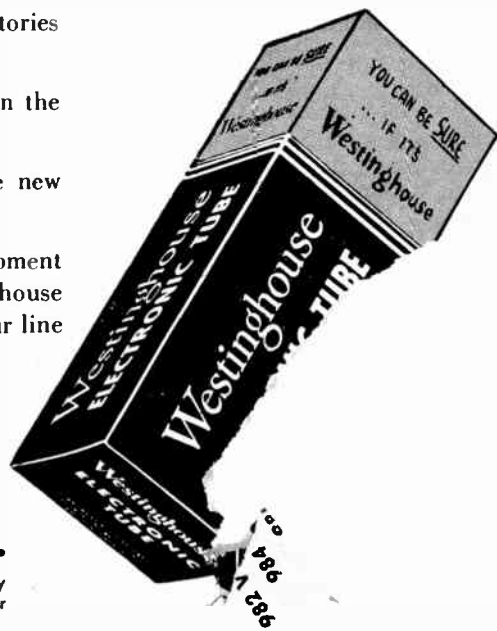

ELECTRONIC

OTHER

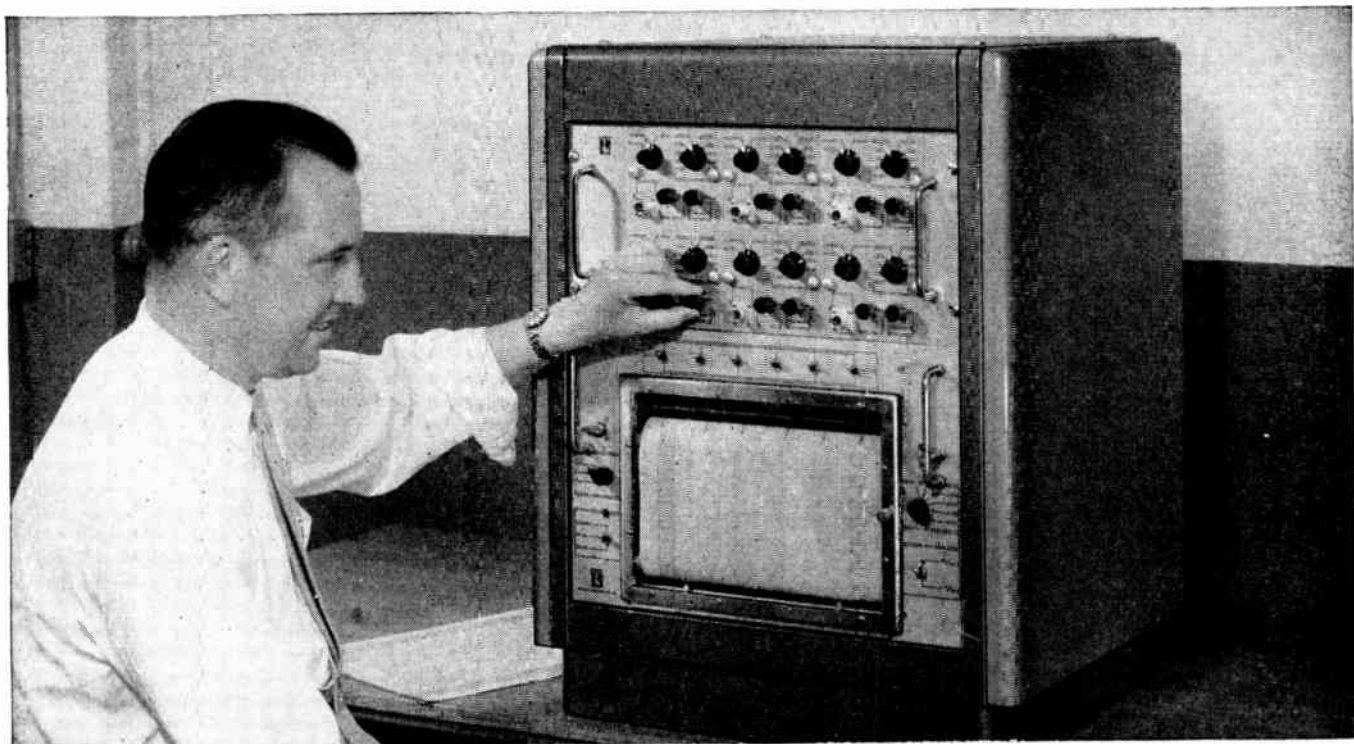

29½-inch console with new amplifiers contains complete six-channel recording system. New amplifiers take only ½ the space required by conventional units.

New instrumentation by Brush . . . 6-channel recording in far less space!

The new Brush amplifier permits more compact, flexible, multi-channel recording systems. Six completely interchangeable plug-in d.c. amplifier sections, plus power supply, plus a six-channel oscillograph, can now be mounted in a bench-top console only 29½ inches high.

The new design offers these outstanding features:

- *Measurement range from 0.050 to 400 volts*
- *Excellent zero line stability*
- *A unique internal calibration system*
- *Frequency response d.c. — 100 cycles*

Brush Recording Systems incorporating these new amplifiers are ideal for applications such as computer readout. Call your Brush representative, A. C. Wickman Limited.

BRUSH ELECTRONICS
3405 Perkins Avenue, Cleveland 14, Ohio



COMPANY

DIVISION OF



★ **FOR COMPLETE
INFORMATION
WRITE DEPT. EE5
ELECTRONICS DIVISION
AT**

EXCLUSIVE CANADIAN REPRESENTATIVE

**A.C. Wickman
LIMITED**
THE QUEENSWAY · TORONTO 14 · ONTARIO

from virgin forest . . . to a COMPLETE INSTALLATION

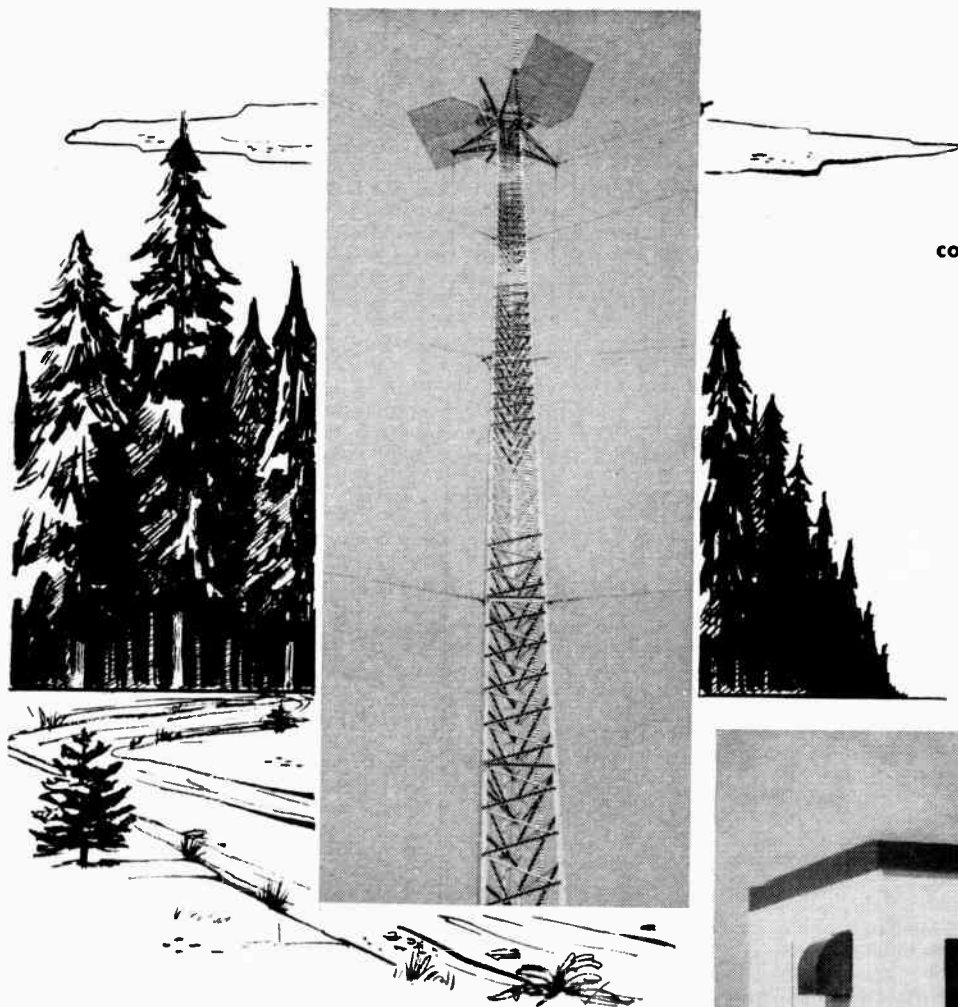

Micro-Tower Limited converts your communications requirements into an operating system by a **COMPLETE SERVICE** that includes:

- Preparation of the site;
- Construction of roads and buildings; erection of towers and antennas;
- Installation of power services, including engine generator sets;
- Installation of communications electronic equipment.

Yes, from concept to construction, **ONE** order and **ONE** responsibility.



Above, left: 300 ft. guyed microwave tower with two 10' x 15' reflectors, supplied and erected at Moorefield, Ontario, to relay television network programs from Kitchener to CKNX-TV, Wingham, Ontario.

This microwave system is owned and operated by the Canadian National Telegraphs and the Canadian Pacific Telegraphs.

▲ Repeater building for the Kitchener-Moorefield-Wingham system. Micro-Tower constructed road and building, supplied and installed standby diesel generator set; and installed microwave equipment, ready for final adjustment by equipment manufacturer's engineers.

FROM COAST TO COAST

Illustrative of the variety and scope of work undertaken by Micro-Tower Limited; some recent projects include:

- Rhombic transmitting arrays and multiple dipole receiving arrays, for communications with Australia and New Zealand, for Canadian Overseas Telecommunication Corporation near Vancouver.
- Providing microwave towers for the Canadian National Telegraphs between St. John's and Clarenville, Newfoundland. This microwave system will connect with the New Trans-Atlantic telephone cable.
- Supply and erection of VHF towers and antennas for the Manitoba Telephone System.

MICRO-TOWER LIMITED

891 O'CONNOR DRIVE
TORONTO • CANADA

BRUEL & KJAER

MODERN INDUSTRIAL MEASUREMENTS

ELECTRICAL TEST

DEVIATION BRIDGE for testing tolerance and phase angle of components compared to a standard. Resistance 10 ohms—10 Meg. Capacitance 50 μ F to 10 μ F. Inductance 2 mH to 100 H. Interchangeable scales provided, 1 to 25% FSD. 1000 cycle test frequency. Knee operated test jig available.



MEGOHMETER range from 100K to 10,000,000 Megohms, test voltage 10 to 100 V. Can be used as D.C. Voltmeter from 10mV to 2000 V with 1000 Megohm input impedance. Illustrated with high tension accessory extending range to 100,000,000 Megohms and voltage from 0-1000.



STRESS AND VIBRATION

STRAIN INDICATOR with 25 microinches/inch full scale sensitivity (4 active arms). Built-in carrier oscillator used, measuring static and dynamic strains to 300 cycles. D.C. bridge supply accessory permits measurement of dynamic strains up to 50,000 cycles.

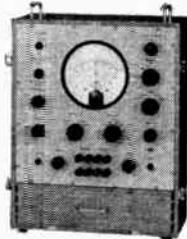

ACCELEROMETERS for displacement, velocity and acceleration measurement of any vibrating structure. Output 20 mV/g, 5-20,000 cycles. Measures 0.25 to 1000 g with B & K direct-reading self-calibrating amplifiers.

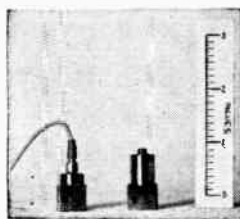

SOUND AND NOISE

SPECTRUM RECORDER is combined spectrometer and level recorder. Spectrometer has 27 fixed $\frac{1}{3}$ octave filters, 40-16,000 cycles, manual selection or driven by level recorder. Latter has 10 paper speeds, variable writing speed, log scale for wide range. Key instruments for vibration and noise measurements.



ACOUSTIC ANALYSIS AMPLIFIER, used with B & K precision mike, measures noise and sound level. Equipped with A.S.A. Standard weighting networks for use as precision noise and sound survey meter. Use B & K Level Recorder to record output.

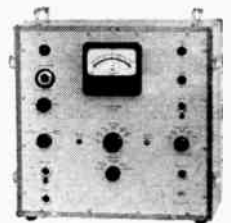

PRECISION MICROPHONE, condenser type with built-in cathode follower, low temperature coefficient. Calibrated within 0.5 DB 80-10,000 cycles. Measures noise level from 25 to 140 acoustic DB. Use with acoustic amplifier, spectrometer or frequency analyzer and level recorder.

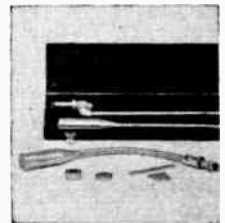

RADIOACTIVITY

RADIOACTIVITY COUNTER—Two channel counter, coincidence, anti-coincidence and straight count. Built-in 0-1500 V G-M tube supplies. Variable resolving time. Two timers, 1 minute to 12 hours. Each channel has scale of 10 and 4 digit register, plus multiplier. Single and dual tube sample holders available.

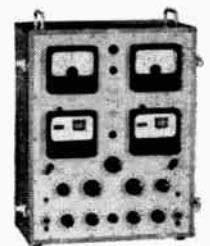

MEASURE • to speed tomorrow's products and profits • MEASURE

Bruel & Kjaer offers a complete range of matched units in the electrical, acoustic and vibration fields. B & K instruments are designed to meet exacting research requirements, yet can be operated by

non-technical personnel with equal ease and accuracy. These instruments are now stocked in Canada. Write for full catalog and price list.



R-O-R field engineers can help with your problems—ask for details.

R-O-R ASSOCIATES LIMITED
290 LAWRENCE AVE. W. TORONTO 12

MEASUREMENTS CORPORATION



Laboratory Standards

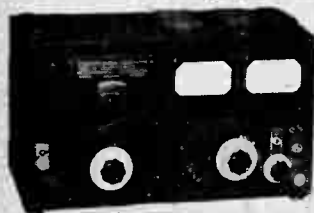

MODEL 80
STANDARD SIGNAL GENERATOR

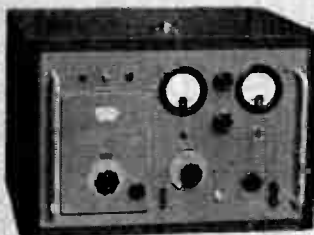

MODEL 95
STANDARD SIGNAL GENERATOR

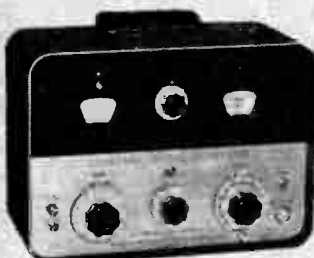

MODEL 210-A
FM STANDARD SIGNAL GENERATOR

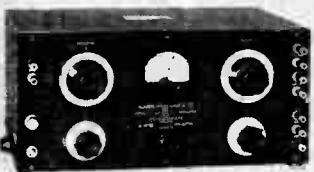

MODEL 71
SQUARE WAVE GENERATOR



MODEL 67
PEAK-TO-PEAK VOLTMETER

STANDARD SIGNAL GENERATORS

MODEL	FREQUENCY RANGE
65-B	75 Kc to 30 Mc
80	2 Mc to 400 Mc
80-R	5 Mc to 475 Mc
82	20 Cycles to 200 Kc 80 Kc to 50 Mc
84-R	300 Mc to 1000 Mc
84-TR	400 Mc to 1000 Mc
95	50 Mc to 400 Mc
210-A	86 Mc to 108 Mc

SQUARE WAVE GENERATOR

MODEL	FREQUENCY RANGE
71	6 to 100,000 Cycles Continuously variable

PULSE GENERATOR

MODEL	FREQUENCY RANGE
79-B	60 to 100,000 pulses per second

VHF FIELD STRENGTH METER

MODEL	FREQUENCY RANGE
58-AS	15 Mc to 150 Mc

HIGH FREQUENCY BARRETTER

MODEL	FREQUENCY RANGE
202-C	2 Mc to 1000 Mc

VACUUM TUBE VOLTMETERS

MODEL	FREQUENCY RANGE
62	30 cps to over 150 Mc
67	5 to 100,000 sine-wave cps.

MEGACYCLE "GRID-DIP" METERS

MODEL	FREQUENCY RANGE
59 LF	0.1 Mc to 4.5 Mc
59	2.2 Mc to 420 Mc
59 UHF	420 Mc to 940 Mc

CRYSTAL CALIBRATORS

MODEL	FREQUENCY RANGE
111	250 Kc to 1000 Mc
111-B	100 Kc to 1000 Mc



MODEL 59
MEGACYCLE "GRID-DIP" METER



MODEL 111
CRYSTAL CALIBRATOR

STANDARD TEST SET for TRANSISTORS



MODEL 505

Tests PNP and NPN small-signal, medium-power and switching transistors.

Checks for short-circuited emitter-collector junctions.

Measures collector-to-emitter leakage current.

Measures collector current and d-c gain.

Case Dimensions: 10" high x 14" wide x 7 1/4" deep.

Power Supply: Two F4BP 6-volt dry batteries.

Weight: Approximately 9 pounds without batteries.

MEASUREMENTS CORPORATION

BOONTON • NEW JERSEY

IN CANADA — H. ROY GRAY, LTD., 46 DANFORTH RD., TORONTO, CANADA

DO YOU USE OR MANUFACTURE TV CAMERAS?



TAKE A LOOK AT THESE PICK-UP TUBES

The most complete range of TV Pick-up tubes in the world are manufactured in Britain for Marconi by the English Electric Valve Company. The 4½" Image Orthicon has no equivalent. It stands unsurpassed for performance, the only tube of its kind in use. We would like to tell you more about its specific advantages. If you use or manufacture TV cameras, why not write for technical data on the complete line.

TYPE NO.	DESCRIPTION
P807	3" Image Orthicon
5820	3" Image Orthicon
P811	4½" Image Orthicon
6198	Vidicon for Industrial use
6326	Vidicon for film pick-up

ELECTRONIC TUBE AND COMPONENTS DIVISION

CANADIAN **Marconi** COMPANY

830 BAYVIEW AVENUE, TORONTO, ONTARIO

BRANCHES: Vancouver • Winnipeg • Montreal • Halifax • St. John's, Nfld.

For customer service our principals provide the best in electronic components backed by their years of engineering experience and we provide the link you need to weld the chain of information from these sources to your engineering staff. Our only request is that we may have an opportunity to assist you.

Ripley Company Inc.

PHOTO-ELECTRIC CONTROLS for —

Street Lighting
Protection Equipment
Registration

L-R BLOWERS

With or without Motors—1" to 3"
Free air output from 10 CFM to 150 CFM
Stocked and serviced in Canada
Write for Bulletins.

Barber-Colman Co.

The complete line of Barber-Colman Motors includes unidirectional Synchronous and Reversible Motors up to 1/20 H.P.

With and without reduction gearing — open or enclosed types.

Expert engineering service available to help you select the exact motor for your application.

Write for Catalogue F-4271.

RMB Miniature Ball and Roller Bearings

A complete line of Swiss-made miniature and instrument ball and roller bearings . . . Sizes range from the world's smallest anti-friction bearing, the C-1, with an OD of 1.1 mm (.043") to the largest roller bearing whose OD is 26 mm (1.024") . . . Retainer type radial ball bearings open and with FILMO-SEAL closures are made to ABEC-1, -3 and -5 tolerances. Pivot and Angular Contact Miniature Bearings are ideal for applications where low cost is the dominant factor . . . Quick delivery of experimental quantities. New catalog now available.

Shallcross Mfg. Co.

Precision Products

COMPONENTS

Resistors, Switches,
Delay Lines, Attenuators,
Unmounted Decades, Galvanometer
Movements.

INSTRUMENTS

Resistance Bridges, Low Resistance
Test Sets, Null Indicators, Relay Testers,
Galvanometers, Decade Resistance Boxes,
Decade Voltage Dividers.

Literature on Request!

Stevens-Arnold Inc.

NEW DC-AC CHOPPERS
50/60/94/120 cycle types and
FREQUENCY DOUBLERS

Long life—low noise level—
extreme reliability

WIDE SELECTION OF TYPES

DC-AC CHOPPERS
0-500 CPS for Military use

ULTRA-HIGH-SPEED MILLISEC RELAYS
200 microseconds to 1 millisecond
—65°C to +85°C

RESONANT RELAYS

Remote control by radio or carrier current
through frequency discrimination

Mucon Corp.

SUB-MINIATURE CERAMIC
CAPACITORS

Mucon simplifies your miniaturization programme with customer-engineered ceramic capacitors economically designed, speedily delivered — small or large quantities for transistor circuitry, guided missiles, hearing aids, computers, radio and TV, filters, radar, u.h.f.

Aemco. Inc.

AEMCO relays have rigidly met and surpassed design specifications for an ever increasing demand by military, industrial and commercial users.

Other products.—Time Switches, Sign Flashers, Program Clocks, Poultry Switches and Timers — automatic or manual reset, delayed action, interval and process.

JOHN HERRING and COMPANY LTD.

3468 Dundas St. W.

ROger 2-9824-5485

Toronto 9, Ont.



AT **Thompson Products**
 THE DECISION IS PRECISION . . .
 AND THE DECISION WAS

P	A	C	E
PRECISION	ANALOG	COMPUTING	EQUIPMENT

Another example of major industry breaking through the problem barrier: The New Device Research Department, a privately owned laboratory of Thompson Products, Inc., recently placed in operation one of the country's largest analog computing systems devoted to the solution of aeronautical control and nuclear control problems.

This PACE Computing System developed by Electronic Associates, Inc. will also be applied to industrial control problems.

The combination of non-linear and linear computing equipment enables wide-range simulation of electrical, mechanical, and pneumatic systems to be accomplished.

In research and simulation as vital as those at Thompson Products, the major decision is precision. And the high standard of accuracy of EAI Equipment sets the PACE for precision in the industry.

For a demonstration or for rental of time, contact our Computation Centers. There's a Center serving Eastern Industry in Princeton, N. J.—one serving Western Industry in Los Angeles, Calif. For equipment information, write Electronic Associates, Inc., Long Branch, N. J., Dept. EN-5.

<div style="border: 2px solid black; border-radius: 15px; padding: 5px; display: inline-block;"> <p style="margin: 0;">ELECTRONIC ASSOCIATES <i>Incorporated</i></p> </div>	E A I S E T S T H E	P	A	C	E
		PRECISION	ANALOG	COMPUTING	EQUIPMENT
LONG BRANCH • NEW JERSEY					

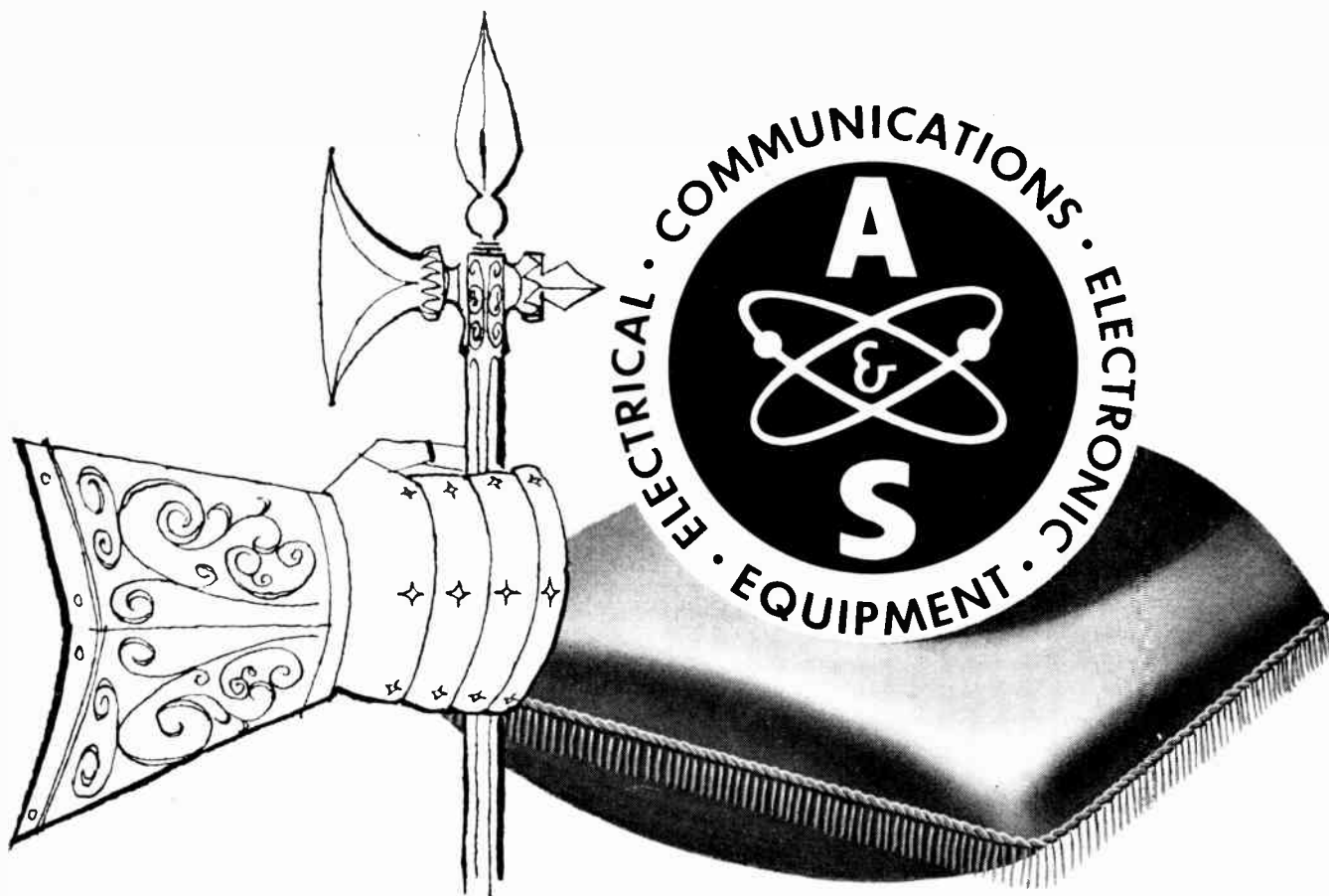

The Symbol of Assured Satisfaction

A Comprehensive Consulting Engineering and Sales Service on Behalf of these Renowned Manufacturers of Electronic and Electrical Equipment

Bauscher & Company K.G.
Hamburg, Germany

Eitel-McCullough Incorporated
San Bruno, California

Electrical Communications Inc.,
San Francisco, California

Elektromesstechnik Wilhelm Franz K.G.
Lahr/Baden, Germany

Hammarlund Manufacturing Co. Inc.
New York 1, New York

Dr. Rudolf Hell
Kiel, Germany

R. Jahre
Berlin, Germany

G. A. Philbrick Researches Inc.
Boston, Massachusetts

Radio Engineering Laboratories Inc.
Long Island City, New York

Diesel Engines and Generating Sets

Power Tubes, Klystron Amplifiers, Ceramic Tubes, Vacuum Capacitors, Vacuum Pumps and Gauges

Communication and Remote Control Equipment, Secode Selectors, Multiform Selector Devices and Signal Equipment

Broadcasting, Stage and Industrial Audio Sound Equipment including Microphone Suspension Systems and Test Equipment

Remote and Supervisory Control Equipment, Commercial Receivers

Morse, Telephoto, Facsimile and Hellfax Equipment

Precision Condensators and Test Equipment

Electronic Analog Computing Devices

Radio Transmitting and Receiving Equipment for point-to-point and Scatter Multiplex Communications

Rohde & Schwarz
Muenchen, Germany

Siemens & Halske A.G.
Muenchen, Berlin, Karlsruhe, Braunschweig, Germany

Siemens-Schuckertwerke A.G.
Erlangen, Berlin, Nuernberg, Bad Neustadt/Saale, Amberg/Opf., Muehleim/Ruhr, Germany

Specialty Engineering & Electronics Company Limited
Brooklyn, New York
H. W. Sullivan Limited
London, England

Telefunken G.m.b.H.
Berlin, Backnang, Ulm
Germany

Electrical and Electronic Measuring Instruments, HF and VHF Transmitters, Receivers and Communication Accessories

Telephone, Telegraph, Teletypewriter and Hell Equipment, Carrier Multiplexing Equipment, UHF and Microwave Communication Equipment, Wires and Cables, Railway Signalling Equipment, Audio Sound Equipment, Electron Tubes, Electrical and Electronic Measuring Equipment

Power Generating and Distribution Equipment for Industry and Transportation

Designers and Manufacturers of Commercial and Military Electronic Equipment

Electronic and Electronic Standard Measuring Equipment for Research and Telecommunication Engineering
VHF and Microwave Radio Links, Carrier Frequency Equipment, Television Transmitter, Industrial Heating and Test Equipment



THE AHEARN & SOPER COMPANY LTD.

384 BANKS ST. OTTAWA CANADA

5706

ELECTRONICS ENGINEERING MAY 1957

ALRIGHT!

PYE NOW HAS THE F.M. 2-way radio

You've been waiting for

After years of intensive research Pye has now produced the *ultimate* in radiotelephone communications—the F.M. Ranger. What's more, this addition makes PYE the most complete radio communications supplier in Canada — the *only* company with both A.M. and F.M. VHF equipment.

Meeting the latest D.O.T. standards, the PYE F.M. Ranger is fully capable of being modified to meet future requirements imposed by channel splitting. Your investment is protected for the life of the set.

As a completely new approach to frequency modulation the F.M. Ranger features:

- Fewer tubes
- Many circuit refinements for top performance
- Minimum battery drain
- Low initial cost — low maintenance cost
- Highly efficient noise limiting
- Transmitter standby switch
- Fully compatible with existing F.M. systems

Special versions of the F.M. Ranger are also available for duplex and trunk mounting. Complete details and delivery information will be gladly supplied by any one of our sales offices located across Canada.

P.S. Demand is heavy — order now for early delivery.

Manufacturers and engineers of H.F., V.H.F., U.H.F. radio systems, telephone apparatus of all kinds, scientific instruments, industrial and commercial television cameras, marine radiotelephones, fish finders and depth sounders.

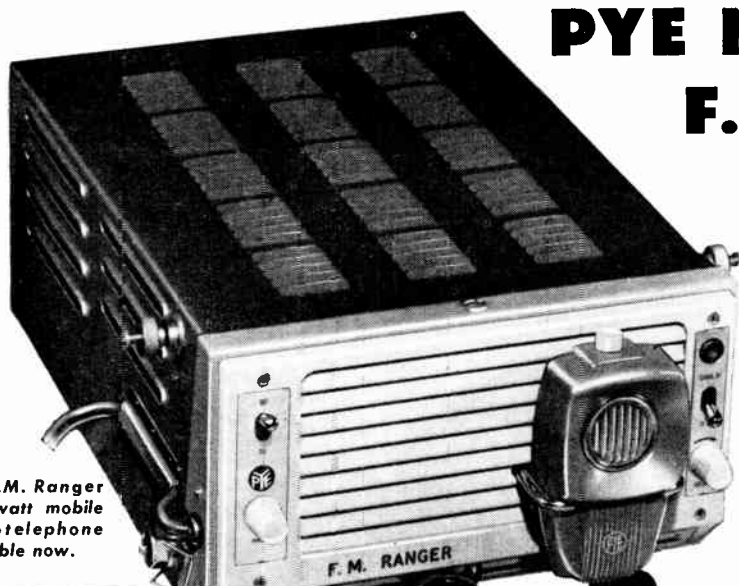

Pye F.M. Ranger
8-10 watt mobile
radiotelephone
available now.

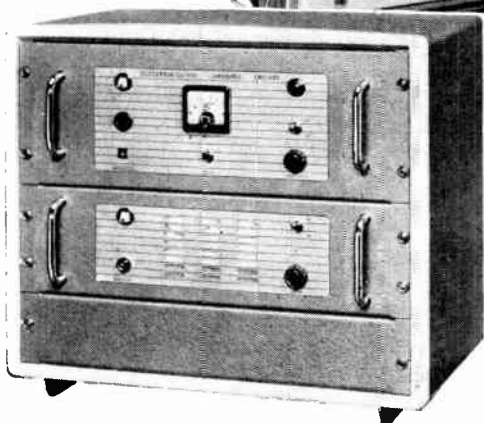

Pye F.M. 20-watt fixed station.
Available soon.



Head Office and Plant — 82 Northline Rd., Toronto 16
193 E. Hastings St., VANCOUVER 78 Bank St., OTTAWA
170 Dorchester St. E., MONTREAL 3 Duke St., HALIFAX

Here are **CARRIER*** systems

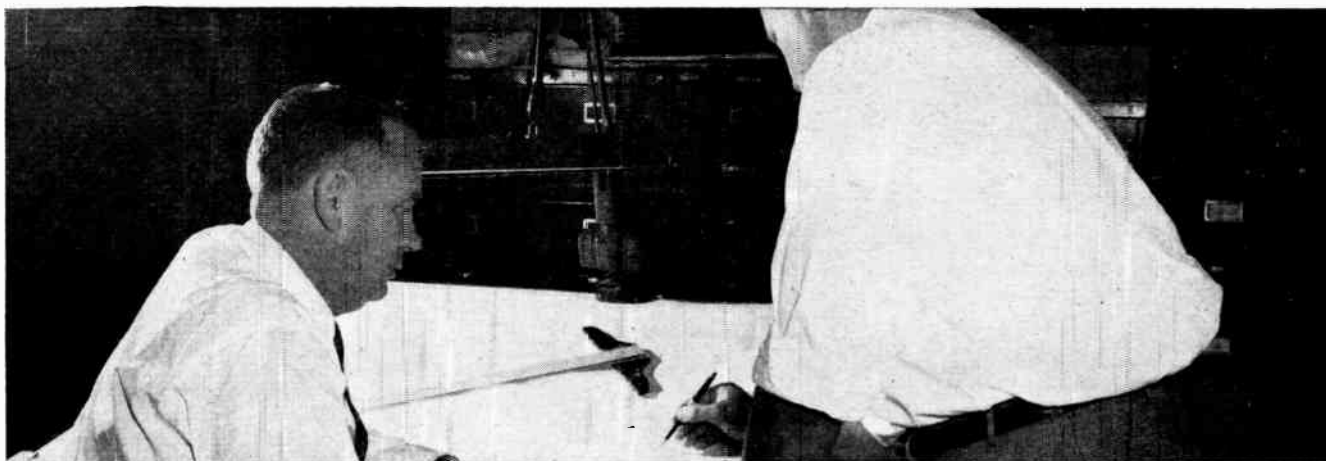

engineered by telephone men
.....



for telephone men
.....

The engineers you'll meet at Automatic Electric and Lenkurt *know* the telephone industry because they are telephone men themselves. With first-hand knowledge of telephone operations, these men are in a position to help solve the transmission needs of telephone companies—regardless of size. They specialize in the engineering, manufacture, and installation of systems adapted specifically to meet telephone toll plant requirements.

And, because they have available a complete line of systems, they'll be able to recommend the *best* system for you . . . whether it's carrier telephone equipment for open wire, cable, or radio . . . or radio equipment itself.

Why not give them a call? You'll find they talk your language.

Head Office: Automatic Electric Sales (Canada) Ltd.,
185 Bartley Drive, Toronto 16. Branches in Montreal, Ottawa,
Brockville, Hamilton, Winnipeg, Regina, Edmonton, Vancouver.

* They're
LENKURT'S
MULTI-CHANNEL
COMMUNICATION
SYSTEMS,
of course.

AUTOMATIC  **ELECTRIC**

ORIGINATORS OF THE DIAL TELEPHONE



World Radio History

5648



ELECTRONICS – CANADA'S CHALLENGE

Canada has a big part to play in this 20th century. In world affairs this country is making major contributions to peace and progress. In the new fields of electronics and nucleonics Canada is forging ahead, both in research and production.

Money and brains in both these fields now will mean vast rises in Canada's economic and industrial levels in the next few years.

Ideas and information are vital in any industry, much more so in a new and growing industry. "Electronics Engineering" will provide the platform for the technical ideas — the all-important "know-how" — in the electronics industry.

The research man, the designer, the test engineer will all be writing on their problems and their projects. They, like "Electronics Engineering," will always be looking ahead.

From the manufacturer and user of electronic equipment will come technical articles, reports and comments that will help the industry even more.

"Electronics Engineering" has a man-sized job to do — and it means to do it well.

OUR OWN SHOW

It has justifiably been claimed that the support given the 1956 IRE Canadian Convention resulted in the largest scientific convention and exposition ever held in Canada. Plans are now well in hand for the 1957 event, which with a 25% increase in floor space, looks like being an even more valuable occasion.

If the improvement in the National Convention in New York, reported elsewhere in this issue, is any guide, our own Canadian show should more than fulfil its present promise.

Has the computer reached its limit? What part will it play in design and other work in the future?

Answers to these and other questions are given in this review of the status of development of analog and digital computers. The fields of both general and special purpose computers are covered, with particular attention given to Canadian developments. Examples are given of the problems which are being solved by computers and the problems which computer engineers are solving in their development work.

HAROLD PRICE, EDITOR



Digital data-processing system including magnetic tape handling units, random access memory and main computer console

Computers — what next?

Computers have probably done more than any other machine to cut drudgery out of design work, data-processing and other types of calculation. But, up to recently, far too much time had to be spent preparing for each task.

So the design men went to work on the computer itself. There will be a lot more developments in the near future but the two important trends so far have been improvements in speed of operation and the incorporation of automatic operation features.

The two main types of computers are analog and digital. Analog computers obtain a solution by setting up an electrical analogy of the problem to be solved, just as a physical length analogy of the logarithms of numbers is set up on a slide rule. Digital computers perform calculations by counting, as in a mechanical adding machine. Either type may be a general-purpose or a special-purpose machine, although the majority of the latter are of the analog type.

General-purpose analog computers have improved in accuracy and now incorporate automatic operation features. Although there is no great likelihood of further improvement in future in the accuracy of analog computers, development along these lines having gone about as far as is needed, some of the latest methods are of interest.

Operational amplifiers are the heart of analog systems. These d-c amplifiers can be used for summation or integration and changed from one function to the other simply by changing external passive components in their input and feedback circuits. Up to a few years ago, the amplifiers were a principal source of error due to instability, unless their balance was checked at regular intervals. This was a time-consuming process with 30 or 40 amplifiers to check and readjust each time an additional problem run was made. Then the chopper-stabilized d-c amplifier was developed, eliminating the necessity for this continual re-balancing.



Operator types program for analog computer on machine which punches paper tape



Three basic units of the R-Theta Computer System and the repeater (bottom)

One manufacturer has recently added a further improvement which affects the amplifiers. In some computers, certain amplifiers are permanently arranged as summers, others as integrators. The appropriate combination for a particular problem is selected by means of the patchboard, an array of connector receptacles between which the circuit connections are made by plugging in patchcords. This new development allows the selection of amplifier function also to be made on the patchboard.

Obviously this leads to greater flexibility in a computer of a given size, but it also means that it is no longer necessary to remove computer power when removing the patchboard. Each amplifier output automatically returns to zero volts, since removal of the patchboard restores all amplifiers to "inverter" type operation. Thus another source of error, thermal transients in the amplifiers, is eliminated.

Components in an oven

The accuracy of summing or integrating amplifier circuits is primarily dependent on the accuracy of the precision resistors and capacitors external to the amplifier itself. The present trend is to mount these components, together with their associated relays and cabling, in trays which are located in an oven. The oven is maintained at a constant temperature, enabling accuracies of .001-.002 per cent for resistors and .005 per cent for capacitors to be achieved. Resistors are usually fixed values of 1 meg or 100 k, adjusted at operating temperature by trim pots. Adjustable polystyrene capacitors are used to provide the accuracy stated above.

Although introduced primarily to speed up the obtaining of problem solutions, many of the automatic operation features in present-day analog computers contribute to greater accuracy by eliminating some of the possibilities of human operator error in setting up the equipment.

This is particularly true of the setting of the many precision potentiometers used to establish coefficients and scale-factors in the computer. Previously these were hand-set by means of dials. Now the operator may select the required coefficient to three places by pressing three switches on a push-button panel. These switches control a voltage-divider network in the potentiometer setting servo system.

A more recent development is the addition of an electric typewriter on which the required potentiometer settings may be written out, a punched paper tape being produced simultaneously. The tape can then be checked and used later to set the potentiometers automatically, using minimum machine time and giving greater accuracy than hand setting. Similarly the typewriter can be arranged to print out the actual settings after the servo system has nulled, for direct comparison with the instructions contained in the original setting program.

Further uses of this typewriter/punched tape system include the reading of potentiometer settings at any time during the computing operation, scanning and printing out all pertinent voltages within the computer (amplifier outputs, function generator outputs, multiplier outputs, etc.), and reading in the operation commands to the computer—Reset, Hold, Compute, Check, etc. Thus maximum utilization of the computer is realized and the status of a problem solution at the end of one day's work can be recorded and reset automatically the next day.

Considerable work has been done in Canada in developing special-purpose analog computers for airborne navigation systems. Typical of these is the R-Theta navigational computer system, conceived by Wing Cmdr. J. G. Wright, DFC, RCAF, which has been developed and produced by a Canadian company. A particular feature of this equipment is that by transistorizing the servo amplifiers it was

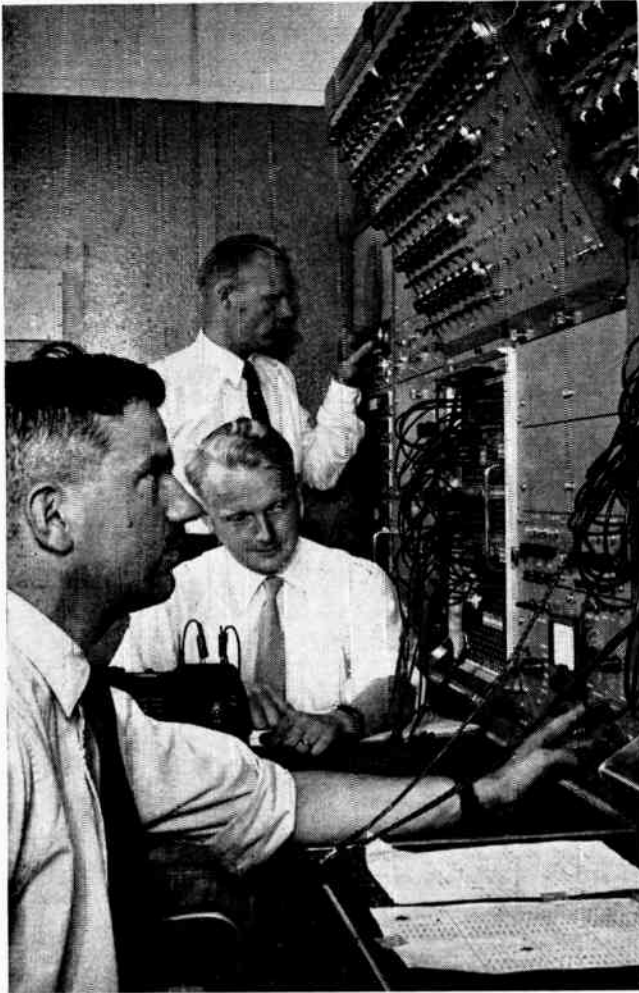

Three operators concentrate as they work on the computer

possible to reduce the total weight from 44 to 27 lb. Not only will the computer give the pilot continuous indication of the bearing and distance of his destination without the need of radio aids, but it is also capable of indicating and guiding an aircraft to intercept a moving target — a factor of especial value in military applications.

Although classified as a special analog computer, but much more complex and correspondingly larger than the previous example, is the flight simulator. The illustration shows the simulator developed and built in Canada for the CF-100 fighter aircraft, which provides a complete reproduction of the aircraft flight characteristics from ground run-up and take-off to landing inclusive. Most of the conventional analog techniques are used, including the representation of the many non-linear functions by contoured potentiometer cards; integration is carried out by velocity servos consisting of a motor-generator combination driven by an amplifier.

There is an increasing tendency to use analog computers as simulators, not only of the dynamic characteristics of aircraft, and it is expected that this will form a significant proportion of future computer applications.

Another classic example of a special purpose analog computer is the new control system for the B52 bomber four-gun tail turret. This system, integrated with the fire-control radar, is illustrated in the Picture Pages in this issue.

The extent to which small electronic analog computers can find a use as a design or research tool in industry or universities is amply illustrated by the appearance on the market of a "do-it-yourself" computer kit. Complete with

a convenient bench-top type cabinet, a kit for a computer containing up to 15 operational amplifiers and 30 coefficient potentiometers can be purchased for less than \$1,000. It will simulate equations or physical problems and save many hours of calculation or experimentation in situations where such a facility has previously been ruled out because of cost.

It is expected that as more reliable information becomes available on transistors, they will tend to be used more and more in these special-purpose computers, both for military and civil applications. This will result in reduced size, weight and power consumption, particularly important in air-borne equipment.

Digital Computers

The rate of development of new types, techniques and applications of this class of computer in the last few years has been phenomenal. It is estimated that about 1,500 machines of all sizes have been manufactured in the U. S., both for data-processing or as scientific computers. They have ranged from special-purpose machines for applications like keeping track of airline passenger space reservations, to giant general-purpose systems such as the BIZMAC. This machine keeps an inventory of the U. S. Army's more than 100 million tank and automotive spare parts around the world, catalogues them and forecasts requirements.

There is an increasing tendency for computer manufacturers to install machines on their premises which are made available on a rental basis. They also provide a facility for demonstration and for assistance to purchasers with their programming problems. Some of the purchasers are also renting machine time in order to get the maximum possible return on their investment. One authority has, however, suggested that many firms buy computers just because they think it is the thing to do and to keep up with their competition, and stressed that prospective purchasers should conduct a very thorough study of their organization before taking the plunge.

In Canada, one company reports eight medium-sized and two large computers already installed, with 25 and two respectively on order. Problems being tackled by these machines include traffic flow studies, wind tunnel data reduction, preparation of design tables for commercial fans, statistical quality control of continuous and noncontinuous processes, etc., etc.

As in the case of analog computers, transistors are being increasingly used in the logic circuits. This is demonstrated by MIT's TX-2 computer, which will be used for further experimentation and development in the fields of data-processing systems and their applications to automatic and real-time control problems. Another U. S. company has recently announced an all-transistorized data-processing system called TRANSAC, which is claimed to have outstanding speed and flexibility, low power consumption, small size and low heat dissipation.

Improvements are continually being made in the more conventional solid-state diode logic circuits, basic "add" times as low as one fifth of a microsecond having been achieved. Another manufacturer has developed a completely diode-less type of circuitry, in which the switching function is carried out by very small magnetic cores. Using ferrite cores of the same type used in coincident current storage arrays, circuits have been designed that perform the functions of delay, inversion, "and," "inclusive-or," "exclusive-or," "if and only if," "not if then," branching, and controlled branching.

The recent announcement of the "cryotron," a new component based on the phenomena of superconductivity at extremely low temperatures, opened up possibilities of cramming large amounts of logic circuitry into a very small space. Another new type of switching component,

based on the chemical process known as "photochromism," has also been announced. When certain materials are exposed to light of different colors, the materials themselves change color. The process is reversible and thus can provide the two stable states required for switching action.

The photochromic material can be enclosed as a very small droplet in a capsule or a cellular structure. Since each cell need only be about two and a half microns in diameter, up to 100 million could be accommodated in a single layer only one square inch in area. Using three different colors of light for the three operations of writing, reading and erasing, it can be arranged that the reading process does not destroy the information. This development is remarkable in that photochromism is probably much more akin to the basic processes used in the human brain than are the mechanisms of components such as transistors, diodes and magnetic cores.

Work is also being done on the use of thin ferromagnetic films to provide the basis of yet another new component, which is expected to perform successfully at switching speeds as low as one millimicrosecond. The basic phenomenon in these magnetic films is the reversal of magnetic spins. This can be accomplished in two ways, one of which is being thoroughly explored.

The need for these extremely high switching speeds was recently emphasized by Dr. Herbert Callen, Professor of Physics at the University of Pennsylvania. Pointing out that computer speeds are already approaching the limit beyond which nature will forbid further advance, he said, "this limit is set by the relativistic law that no physical signal can propagate with a velocity in excess of the velocity of light." He therefore maintained that the speed of calculation is limited by the times required to transfer information from point to point within the machine, explaining that a characteristic distance of ten centimetres corresponds to a time of one third of a millimicrosecond. Dr. Callen, who was addressing his remarks to an international symposium on the theory of switching at Harvard's Computation Laboratory, went on to suggest that computing times in the millimicrosecond range are only two or three orders of magnitude faster than presently planned machines, and are already being explored, the use of the ferromagnetic film probably being one of the ways in which they will be achieved.

New memory devices

Much development effort has been directed at the storage devices, or memories, in which pertinent data and programs are stored. From the early arrangements of electron tube flip-flops, through mercury delay lines and electro-

static devices, the present trend is to magnetic drums, lattices of magnetic cores and random-access devices using magnetic recording on discs. A fascinating area of current research is in the use of the magnetic moment of fluid molecules as a means of storing large amounts of information in a small space.

Input and output devices are another area which is claiming attention. These include punched cards, punched paper tape, magnetic tape and, for visual monitoring of information, automatic typewriters and printers and cathode ray tubes on which letters and numbers can be displayed.

Increasing emphasis is being placed on the overlapping of the input, processing and output operations, to ensure maximum utilization of the equipment. Magnetic tape handling systems capable of dealing with up to 70,000 characters per second have been built, some being able to start or stop in as little as one millisecond.

Means of ensuring reliability and self-checking features are another important area of development. The designers and builders of digital computers do not all agree on the extent to which self-checking arrangements should be built into the machine. Some rely on duplication of circuitry so that discrepancies indicate the occurrence of an error; others use the method known as redundancy checking, which involves using more components than is otherwise necessary so that valid and invalid conditions are separable.

By way of a general look at the future, it is expected that large digital computers will become even more complex and capable of handling major tasks in operations research and production control, two areas in which serious work has only just started. Although machines will certainly be built which will be larger than any in operation today, the increasing incorporation of new techniques, some of which have been mentioned in this review, should have important effects in reducing both size and cost.

Other applications which will assume increasing importance include language translation and the information retrieval problem. Translation has already been achieved by one company, but its further extension involves the systematizing of the grammar of the languages concerned, which is a major task. The problem of providing ready access to reference data, as in a reference library, is becoming so acute that in some cases it is cheaper to repeat an experiment than to search for the results obtained on a previous occasion. Computers are also finding a growing number of applications in medical and biological research, from the field of symptomatology to the study of the molecular structure of proteins and other such compounds.

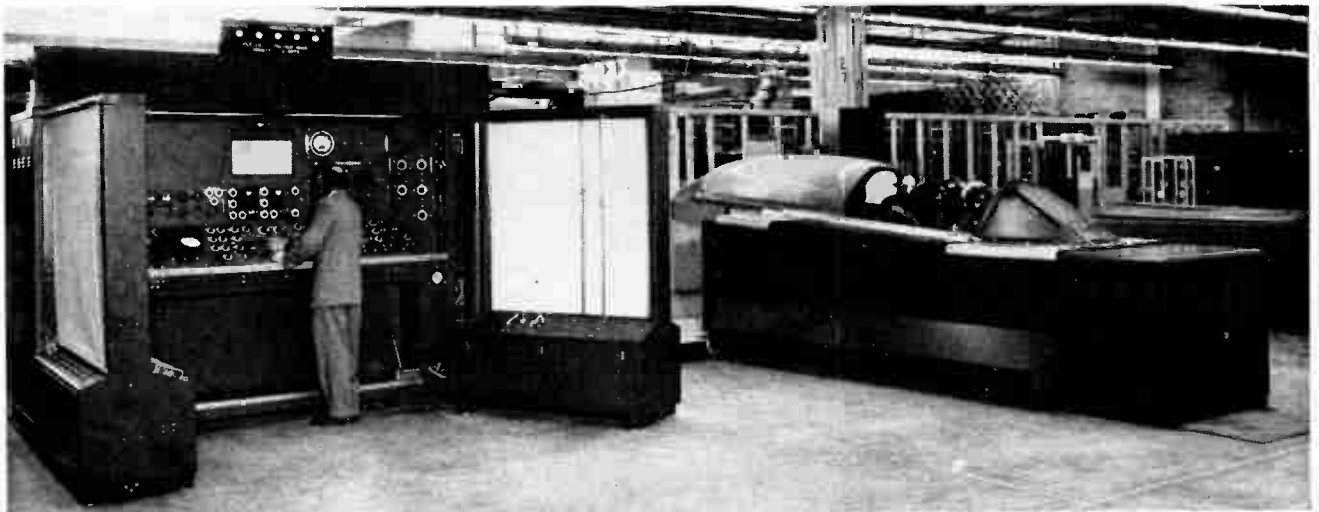

CF-100 Flight Simulator, showing instructor's console, recorders and crew compartment. Computer cabinets not shown

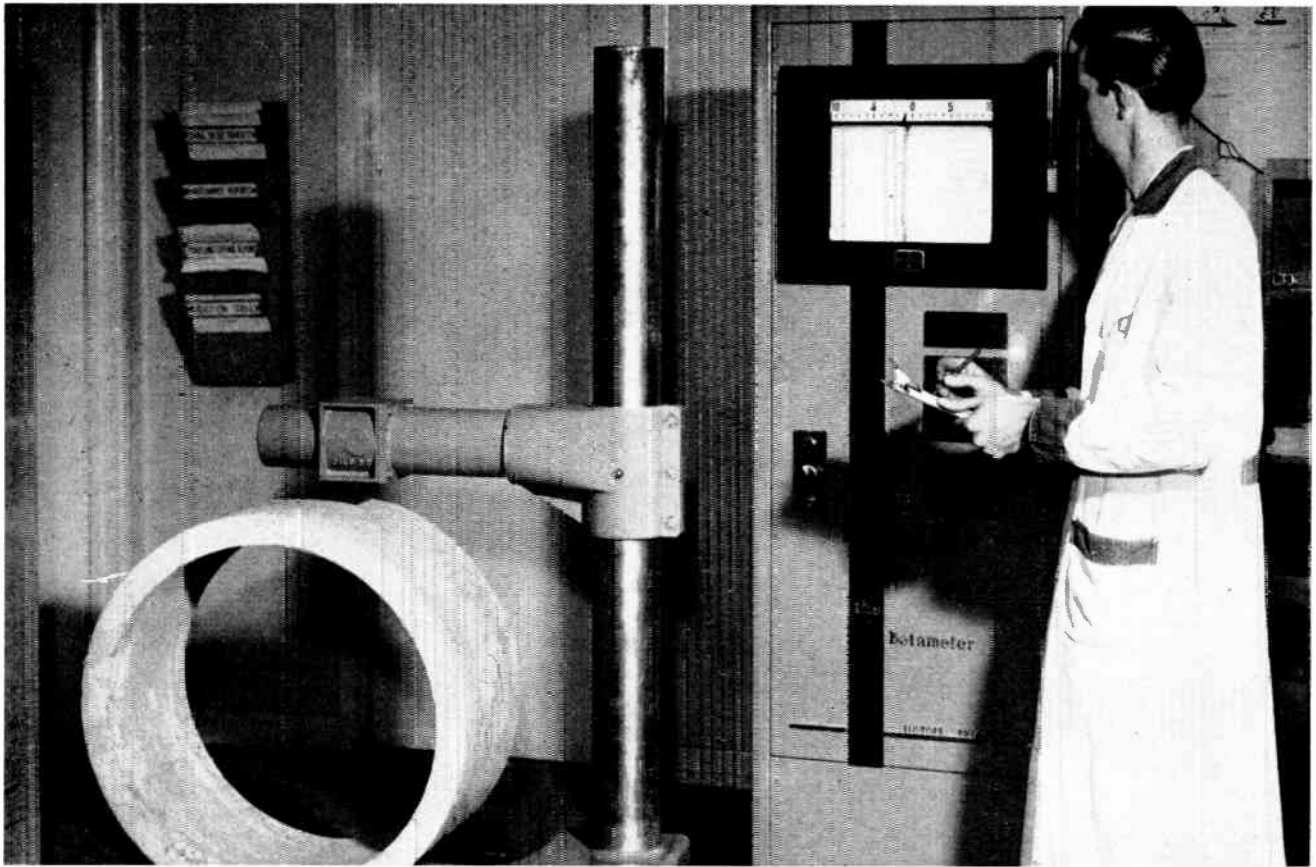

Beta rays probe for hidden flaws in cast pipe and relay the results to the continuous chart recorder of the betameter.

Without electronics it would not have been possible to probe our way into the heart of the atom. But now that we have, new fields are being opened up. Today we have nuclear reactors to produce power and radioactive isotopes to aid us in industry. In practically every case, electronics has played a major role in guiding and controlling the operations. This is a look at the new industry and its trends.

IAN R. DUTTON, ASSOCIATE EDITOR

Atoms create new jobs for electronics

When we learned to control the electron we started a mammoth industry and also opened the way to many new fundamental scientific discoveries. One path led toward the heart of the atom and a vast new field — atomic energy. This would not have been possible without prior knowledge of electronics; but the street is by no means "one way." Nucleonics has created many new jobs for electronics.

This intimate relationship should come as no surprise.

After all, we are dealing with a minute particle having a typical diameter of 10^{-8} cm. But to start the story, it may be well to recall some of the basic facts on the structure of the atom (Fig. 1). Electrons are relatively easy to control and have been used for carrying a charge (current flow) and producing electromagnetic radiations up to the frequency of X-rays. The nucleus, however, is a small, dense, positively charged group of particles that still holds back many secrets from man.

The particle accelerator

Much of our present knowledge has been gained through the process of bombarding the nucleus with particles—electrons, protons, neutrons, alpha particles, etc.—and observing the reactions. Electronics has made its contribution with the particle accelerator. This is essentially an electrostatic field into which the particles are introduced and, consequently, accelerated. Cascade generators, Van de Graaff generators, linear accelerators, cyclotrons, synchro-cyclotrons, betatrons, synchrotrons and traveling wave accelerators are in use at the present time, each with its own advantages and disadvantages.

The only cyclotron in use in Canada at the present time is located at McGill University. Two large Van de Graaff accelerators are also being used for nuclear research—one at Chalk River and one at the National Research Council. Another machine will go into operation in early 1958 at Chalk River. This is the Tandem Accelerator, consisting essentially of two Van de Graaffs in series and capable of providing potentials up to 10 or 12 MV.

One of the properties common to most nuclear radiations and particles is their ability to ionize the material through which they pass. This forms the basis of one class of radiation detection instruments, including ionization chambers, proportional counters and geiger counters. All three have the same basic design—an enclosure filled with a mixture of gases or vapors, containing two electrodes connected to a power supply. The particle entering the detector ionizes some of the atoms liberating electrons that move to the anode and positive ions that drift to the cathode. The resultant potential drop across the electrodes is registered as a "count."

Detection by scintillations

Another means of detection is based on scintillations. When certain phosphors are bombarded by ionizing particles or radiations, they give rise to small flashes of light. These can be detected by eye but the usual method now is to detect the scintillations with a photomultiplier tube. The resultant signal voltage can be recorded, or applied to a meter or headphones.

Neutrons, having no charge, will not cause ionization. Detection, therefore, is accomplished by secondary effects, such as the reaction of neutrons with boron. An alpha particle is liberated and can be detected as described above. The counters contain boron trifluoride or are constructed with a thin coating of boron (isotope B^{10}) on the side walls.

Other types of detecting instruments have been developed, and will undoubtedly be followed by many more. However this discussion is beyond the scope of the present article.

Reactor control instruments

There is a marked similarity between reactor instrumentation and instrumentation for other processes such as steam generating plants or chemical plants. Some of the major items to be measured and controlled are temperature, pressure, flow of coolant, neutron flux, power, position of the control rods and level of the liquid moderator. The reactor, however, does present its own problems. Corrosion must be avoided and there must be no path provided for the escape of radioactive materials.

The operating conditions vary extensively from one type of reactor to another, but none of them are beyond the range that might be encountered in other types of work. The design values of NPD are quite typical at: Pressure, 1,000 psi; Temperature, 530 F; Flow rate, 18 ft/sec.; Neutron flux, 10^{14} neutrons/cm²/sec.

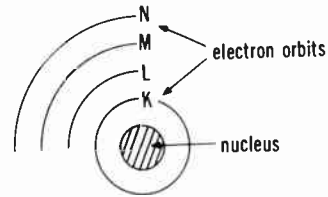
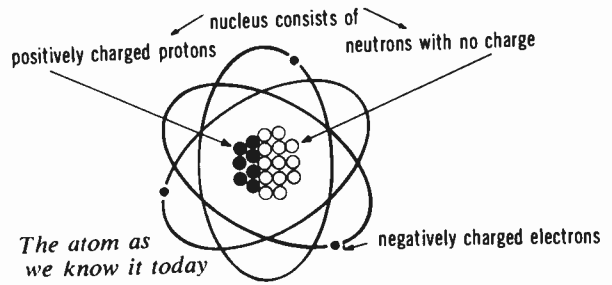

Electrons travel in well defined orbits which also represent energy levels. Electrons in the outer orbits are used for current conduction. Inner orbit electrons are used for production of X-rays.

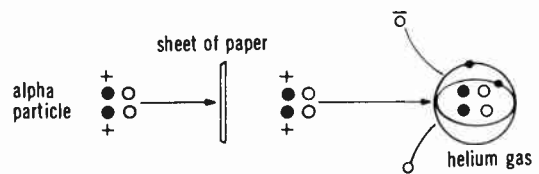
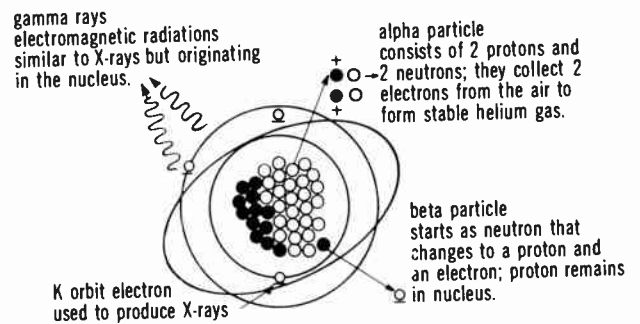

α particles have low penetrating power and can be stopped by a sheet of paper. Maximum travel in air is about three inches.

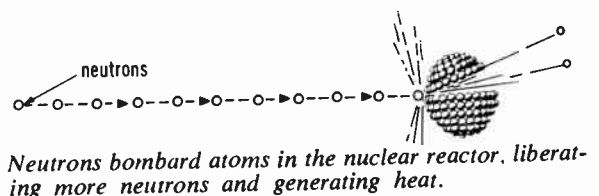
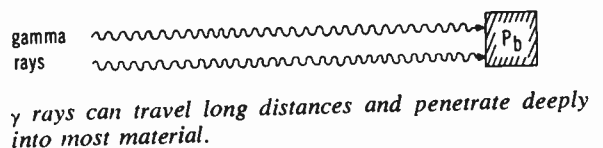
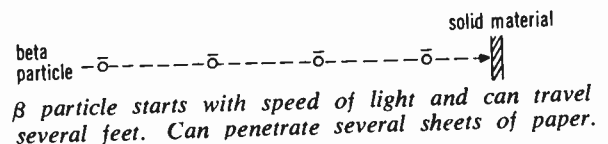

FIG. 1

Like other processes, nuclear reactors have their own operating characteristics that have, in many instances, led to the development of interesting electronic controls and instruments. One of the principal parameters is the rate of temperature change within the reactor, particularly during the start-up or change-of-power operation. However, temperature sensing devices are, in general, too slow to provide the desired control. The approach, then, is via the neutron.

Control by temperature

Temperature (and power) are a function of the number of fissions per unit time—in other words, the neutron flux within the reactor. Therefore, the rate of temperature change, or the rate of power change, can be measured by a neutron sensing device. In practice it is desirable to have a response time for the detector ranging down to a few milliseconds in order that it can initiate the corrective action for smooth control of the reactor.

In general, electronic equipment does not enjoy as high a reputation for reliability as does some of the mechanical, pneumatic or hydraulic metering and control equipment. Since reactors lend themselves most readily to electronic instrumentation, and, too, since reliability and long operating life are important for protection of operators and equipment, some interesting and novel approaches have been made to the problem. Tubes, being one of the weaker links in the chain, are used in "fail-safe" circuits where possible and are located for convenient monitoring. Reliable operation is further ensured by multiple circuits in some areas. A fault indication on one demands immediate investigation (frequently electronic equipment failure) while simultaneous indication on two or more instruments will

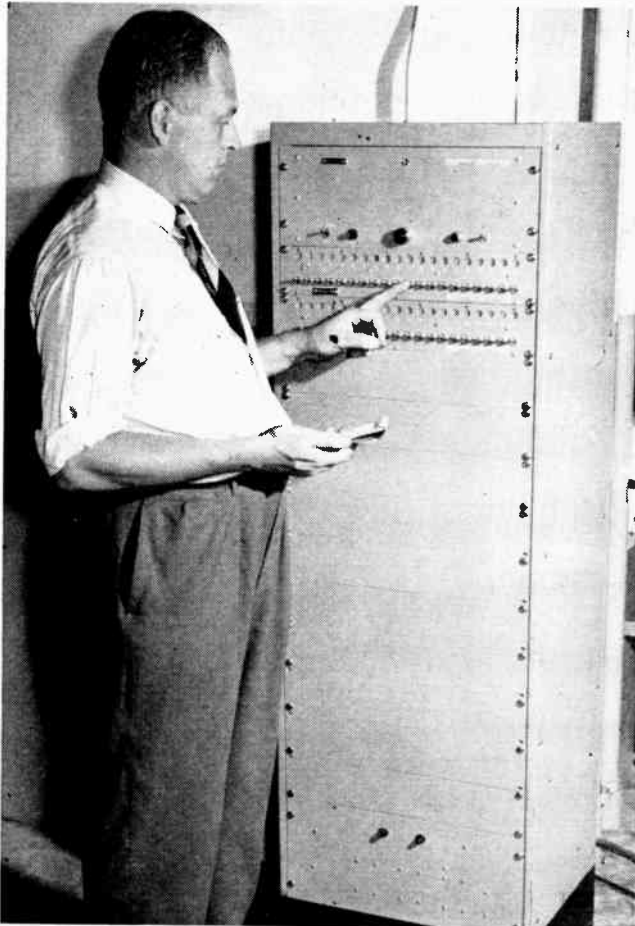

Monitor of nuclear reactor cooling-water leak detector. Water touching high resistance probe will actuate alarm.

apply corrective action to the appropriate reactor control.

The desire for reliability with reduction in physical size and power consumption, makes the transistor quite attractive in the eyes of the nuclear power engineer. Several new pieces of equipment designed at Chalk River have been based on the use of transistors, with very promising results so far. Whereas magnetic amplifiers were frequently preferred for reliability over circuits involving tubes, we may well see a change in the philosophy with transistors offering greater versatility along with the promise of good reliability.

Computers prevent accidents

Computers play an important role at the nuclear reactor site. The vast amount of design and experimental work at a test reactor is possible only with the aid of adequate computing facilities. A new Datatron plus IBM card sorting equipments have been installed at Chalk River and are a welcome asset there.

Other computers of a specialized nature are used too. Why risk an accident in a reactor when you can try out new circuits, controls and techniques on an analogue computer? The training of new operators can be done safely too, using all the standard controls and gauges but substituting the analogue computer for the reactor.

At the reactor computers help control the operations, particularly during the start-up or when changing power since operators are not capable of doing this function as smoothly. Another special purpose analogue computer at Chalk River is the Xenon computer. During operation, a reactor generates certain undesirable fission products, such as xenon, which absorb neutrons and cause a reduction in reactivity. The amount of reactivity loss will depend on the accumulated operating conditions. By supplying the operating parameters to the computer, it will provide a continuous record of the amount of reactivity loss. Another circuit, when operated, will plot a curve showing the calculated xenon build-up and decay if the reactor were to be suddenly shut down at that time. This information is important since it must be taken into consideration when planning to start up the reactor again.

Use of radioisotopes

Apart from the instrumentation and electronic controls used with a nuclear reactor or its associated research facilities, there are other areas where nucleonics is creating new jobs for electronics. With the advent of the nuclear reactor, production of radioactive isotopes became possible on a practical basis. When used with a sensitive radiation detector they can be put to work in such diversified applications as medical tracer work, control of liquid flow in pipes, chemical analysis and controlling machine operations.

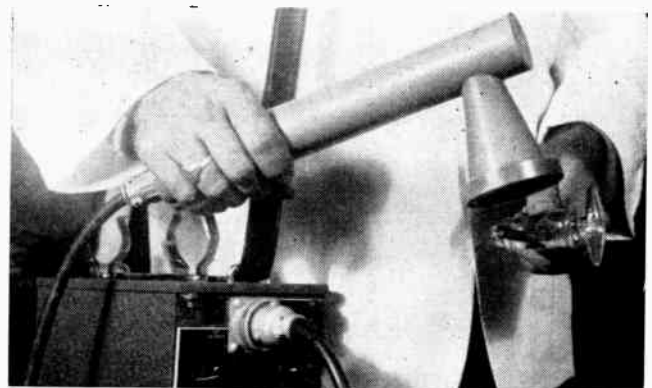

Where radioactive materials are used, the operators must be protected by careful monitoring for radiation contamination

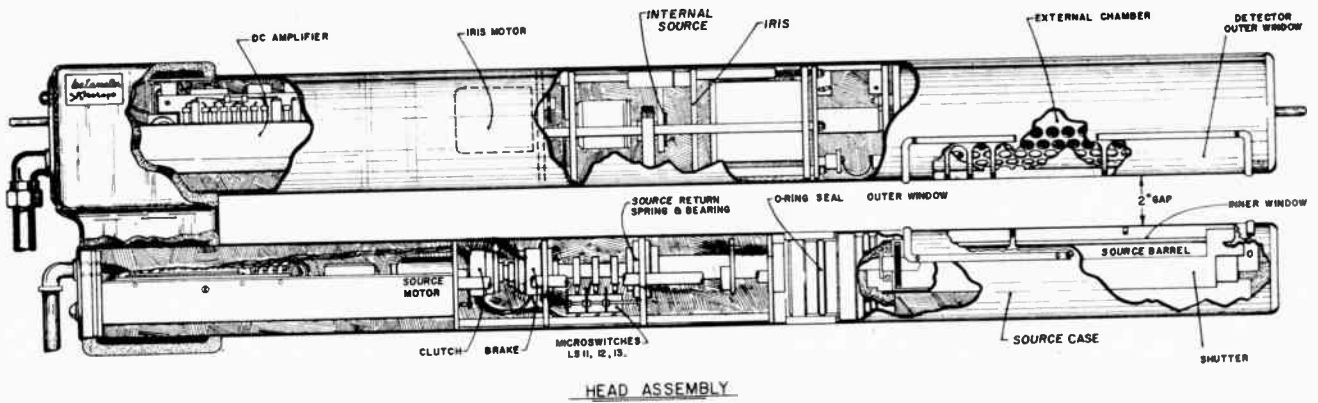

The head assembly of a beta thickness gauge contains the test and reference beta sources, ionization chamber and preamplifier. The diagram at right shows how the equipment is used to inspect and control the thickness of material in a rolling mill. Accuracy of $\pm 0.5\%$ can be obtained.

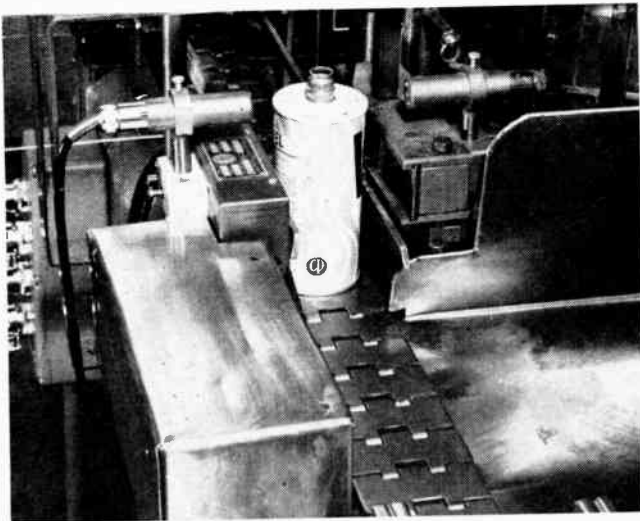
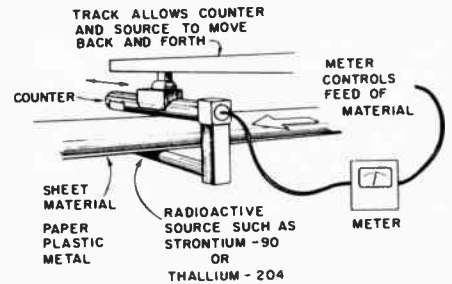

Is it full? Radioisotopes inspect the contents of cans on this assembly line and reject any not filled to proper level.

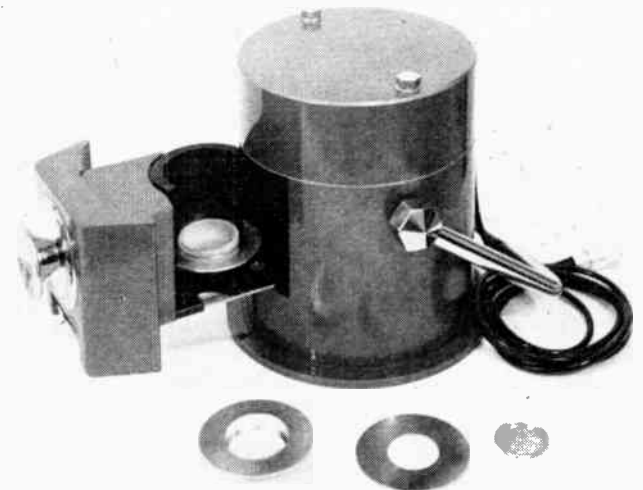

For accurate radiation measurements, lead castles with built-in detectors shield samples from extraneous radiations.

The signal from the detector can be applied to a meter, chart recorder or control equipment to automatically regulate the process under observation. A full discussion of the many applications and designs is, again, too lengthy to be considered here. However, mention of one or two will serve to illustrate what can be done.

Thickness gauges and flaw detectors are two instruments designed to utilize radioisotopes. All materials absorb gamma and beta rays in proportion to the mass of the material. By placing the radioactive source on one side of the material and the detector on the other it is possible to determine the thickness of the material, check it for uniformity, or detect flaws such as cracks. A good beta thickness gauge using a bridge arrangement between the test source and a standard, should be capable of giving accuracy in the order of $\pm 0.5\%$ when testing the thickness of paper or foil.

Another version of the technique is used to inspect the level of solids or liquids in containers moving down an assembly line. If the contents are not up to the proper level, sufficient gamma radiation will pass through to the detector to operate the reject mechanism.

This brief look at the world of nucleonics will give you some idea of the role electronics is playing and trends to watch in the near future. END

REFERENCES:

1. *Atomic Energy and Its Applications*, J. M. A. Lenihan. Sir Isaac Pitman and Sons, Limited, 1954.
2. *Introduction To Nuclear Engineering*, by R. Stephenson. McGraw-Hill Book Company, Inc., 1954.
3. *Atomic Energy In Canada*, by C. C. Kennedy. Atomic Energy of Canada Limited, 1956.

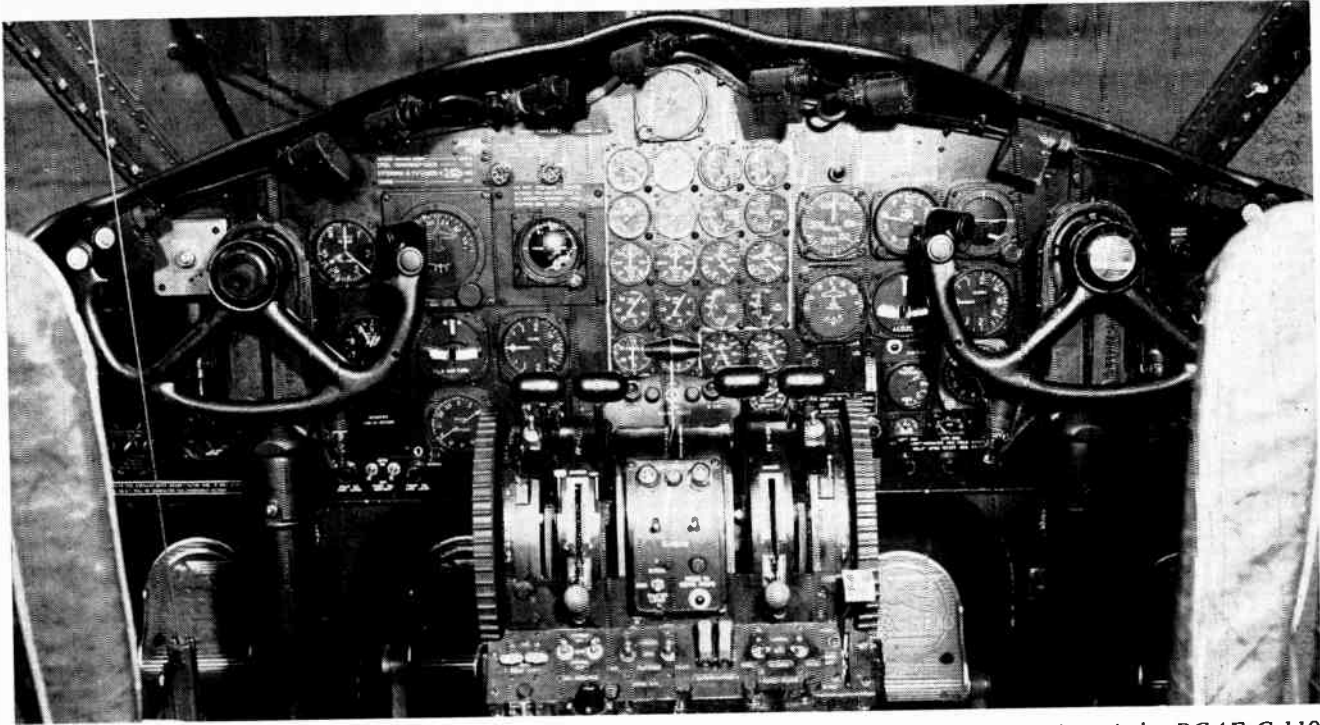

This is what the controls of a modern airplane look like to the pilot. Picture shows the interior of the RCAF C-119

The human operator— what is the limit?

KENNETH W. LINES, MANAGING EDITOR

Progress in electronics over the last few years has been phenomenal. But in the midst of all the machines and controls there is still the human operator. What are his reactions? How does he match up to the demands put on him by the machine? This article deals with recent research into the problem, including work at the University of Toronto. Of the future there is the problem of how to match the pseudo-intelligence of the machine to the flexibility of the human operator.

Man is usually considered—by himself—to be a pretty clever animal. But technological advances in the past few years have produced machines which extend man's capacity, as an operator, to the limit.

Design engineers, particularly in the electronics field, have been increasing the complexity of control functions. Applied research into the ability of the human operator has lagged behind development of the machines themselves. Only very recently has an appreciable amount of work been done in relation to the limits of man's capabilities as an operator.

Sometimes prejudice has played its part. During the war a completely automatic control unit was designed for a radar set. Service and Government chiefs vetoed it, saying that human operators could correct for errors

much better. So three men, turning the handles of range, azimuth and elevation, went on with their tasks.

But trials have shown that the best an operator can do is achieve a somewhat precarious "steady state" of limited oscillation. An electronic circuit could have done much better in this case.

Research into the problems of the human operator have been going on since the days of the early steam engine. Then it was a question of how a man would react when driving a train at 20 mph.; now it is how a pilot functions in a 1,000-mph. aircraft.

Even at this speed a man cannot see, think or move fast enough to control the plane in all possible flight situations. He is traveling at 1,500 feet a second. But it takes him a second to react if something shows up on his radar or instruments. He will, therefore, have traveled half a mile, and probably much farther, before he can effect a major alteration in course.

The methods of evaluation

A jet pilot, at 1,000 mph., is reported to have flown through a formation of planes without knowing it. Part of the tail structure of one of the planes was found in his wing when he landed but all he knew about it was that part of the trip had been "bumpy."

One of the big questions, which it is very difficult to answer satisfactorily, is "how can one evaluate the human operator?"

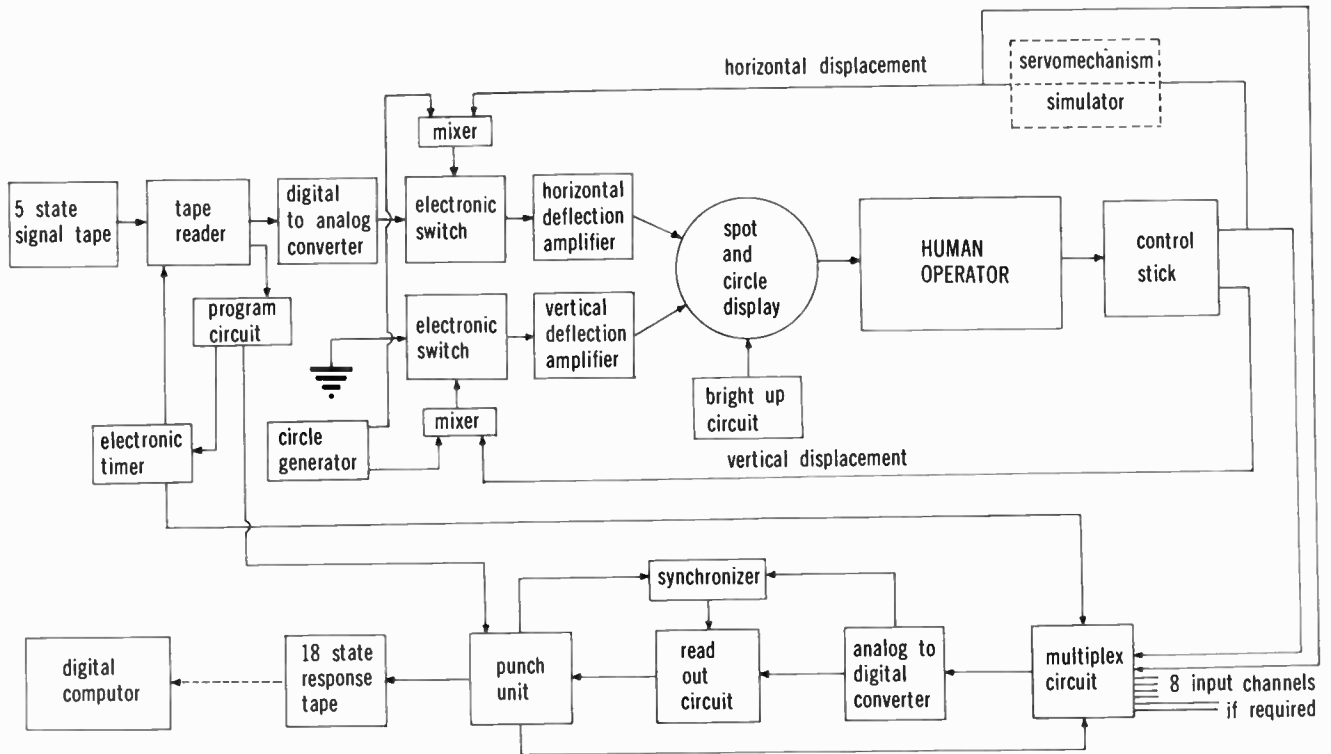

Fig. 1. Block diagram showing test equipment used by the University of Toronto. Input rates were 1.0 to 2.0 s/s

There are three zones of evaluation: reliability, versatility and flexibility. The human is just as likely to go wrong as the machine, but in a slightly different manner.

One way to obtain a general measure of skill is in the rate of transmission of information. This is measured in bits—each bit being a single unit of information such as a dot, a dash or a number. A high rate of transmission would be 10-15 bits a second, a moderate rate 5-6 and a slow rate 3-4. One example is of letter or card sorting where the rate is about six bits a second.

Recently research work on the problem has been done at the University of Toronto jointly by the Electrical Engineering and Psychology Departments under the supervision of Dr. James M. Ham and Dr. A. H. Shephard. A considerable amount of new testing equipment was designed and developed by the two departments with the co-operation of the Defence Research Medical Laboratories.

The initial experimental work has resulted in a report entitled "The Human Operator of control systems."

Advantages of the operator

The operator, as the report points out, is versatile and adaptable and is capable of compensating for malfunctions of his associated machine and, as a last resort, of taking emergency action. This facet of human behavior has been a boon to control engineers. No matter how inadequate the control system a good human operator can be relied on to utilize it to best advantage.

The task of the human operator is "both a monitoring and evaluating function and a motor response, or stimulus-response function."

As well as the transmission rate the operator's reaction time can be measured. In any control system, from the time the operator receives a stimulus to action—seeing

a light, movement of a needle, a spot on a radar tube—to the time he does something about it may be called the reaction time. This is around 180 milliseconds for a simple visual stimulus to 300 milliseconds if there is a choice of direction and a less well-defined stimulus.

Many other factors enter into the problem of reaction time. One is the time of transmission of nerve impulses from sense organ to brain and from brain to muscle. But reaction time is chiefly the time occupied by the processes of analysis and selection in the brain and about this next to nothing is known.

Again, circumstances may arise in tracking tasks where because of his doubts as to the accuracy of his judgment and the precision of his actions, the operator will prefer to do nothing to doing something wrong.

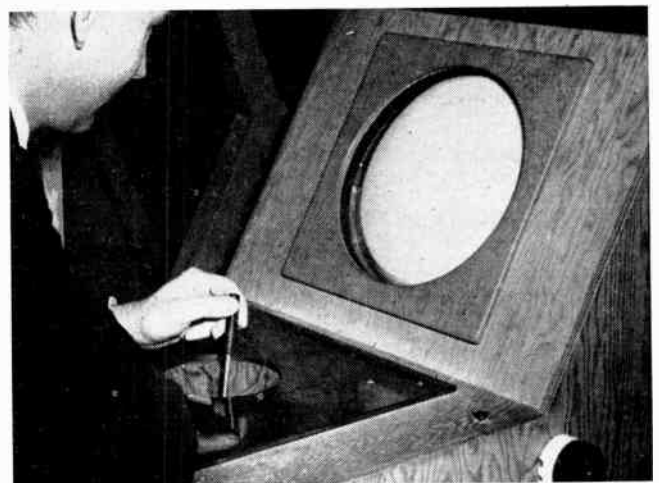

Following a plot—the lever moves over a circle to stay on a spot.

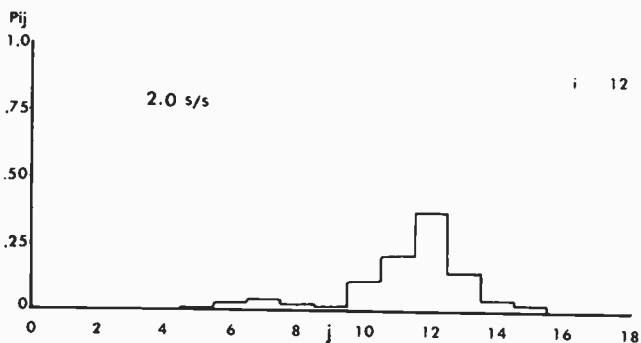
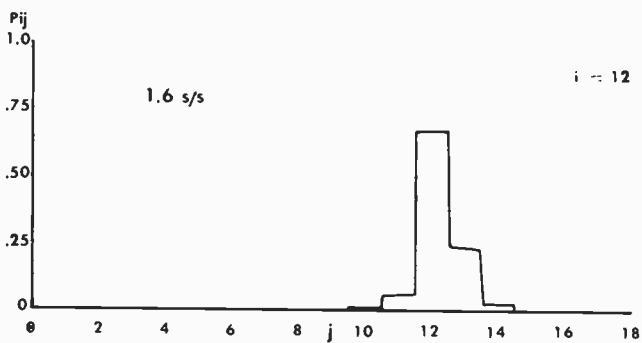
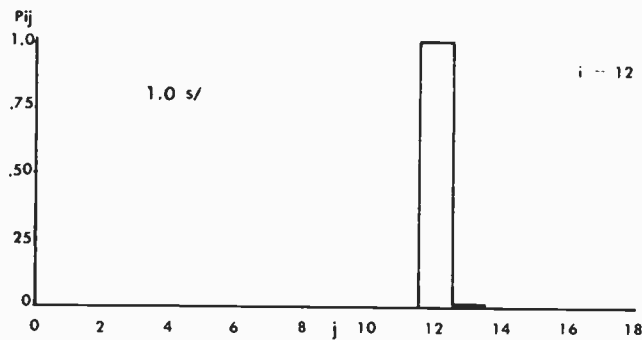

Fig. 2. Histograms for one operator at varying rates of input

These are by no means all the problems when it comes to evaluating the human operator. But they show how difficult it is to prove whether or not he will fit into a particular control system.

The University of Toronto's experiments were based on the operator's ability to track a spot of light on a cathode ray tube by centring it in a circle of light. The spot represented the stimulus and the ring the response, and by recording the two and comparing them an evaluation was made.

The test equipment is shown in block form in figure one. The control lever moved the ring of light in direct relation to its own mechanical movement. The data was recorded on punched tape for evaluation on a digital computer or, if this was not required, by pen recorder.

For tests involving simulation of human performance, part of an analogue computer was used for operator simulation and other analogue computer circuits for comparing the model with the real human which the model simulated.

Comparisons between operator performance and that of the analogue models were used to develop relative figures of merit for different types of models.

The stimulus for the operator began as a signal recorded

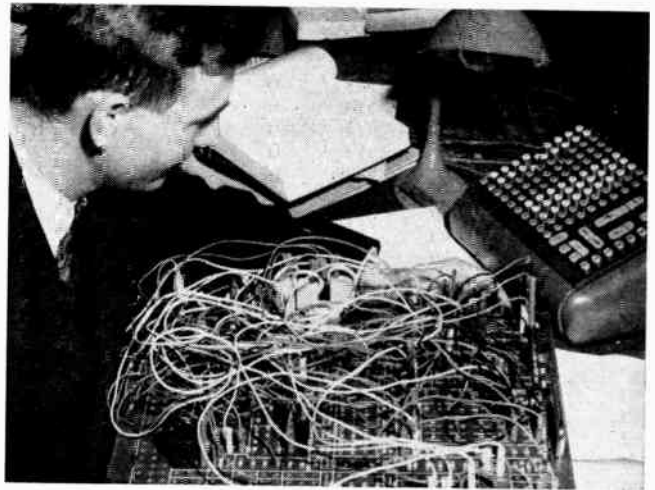

Ready for the operator: work on an analog computer board

on perforated tape. The tape was read by a photo-electric reader and the resulting electrical signals changed by a digital-to-analogue converter into a fluctuating voltage.

The output could be recorded as any one of 19 equally spaced states. Nine was the centre of the tube. The sequence of input states was in random order so that although the operator saw the spot moving about the tube it was impossible for him to predict the direction of motion.

A schedule of testing was drawn up in conjunction with the Applied Psychology Department of the University. The input rates were in the range from 1.0 to 2.0 stimuli per second (s/s). Initial test results suggested that operators could not follow the spot with high accuracy at input rates higher than 1.4 s/s.

Comparison of histograms

For each input i , there was a transitional probability p_{ij} that j was the output response when i was the input. Histograms of p_{ij} vs. j indicated the output distribution achieved by the operator in response to any one particular input i at any one particular input rate R .

The output of the operator was recorded every $1/R$ seconds after an input transition to give the subject the maximum time to achieve the correct response.

Three histograms at different input rates are compared in fig. 2. The input in each case was 12, which was off-centre of the tube. These histograms were for an average human operator. When a trained pilot was given the same tasks he showed better reproduction of the input at high rates of input but still produced the same form of output distribution about each individual input stimulus.

A review of all the histograms in the report shows that both the average operator and the trained pilot tended to reproduce input state 9 best, even as the input rate increased, and at very high input rates they failed quite badly on the extremes of 3 and 15.

The report goes on, among other experiments, to evaluate the variability of reaction-time delay and finds that the human operator's response was completed approximately 500 ms after the input state transition.

These, briefly, are some of the interesting properties that show up when the human operator is put to the test. Experiments of the type that are proceeding at the University will help the engineer and the applied psychologist to carry out a more quantitative analysis of the man-human system than has been possible.

On reliability it is interesting to quote the following story. A test was laid on to prove that a pilot would react correctly to engine failure without the need for an auto-



One test: the operator handles the joy-stick from a plane

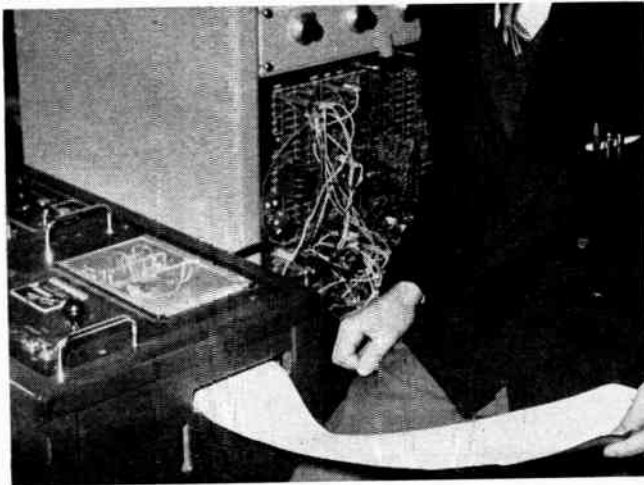

One of the test checks: output from a two channel recorder

matic device. He took up a two-engined plane. On the first test the observer cut out the port engine, the pilot feathered the port propellor and the plane climbed away.

On the second test the observer again cut out the port engine. This time the pilot feathered the starboard engine and there was a sudden silence in the cabin. Fortunately, he got the plane down safely.

But there were still other considerations. Versatility is the big pull that man has over the machine. Man as the operator can be fitted into the operation of a particular machine and to a certain extent he can modify his behavior to fit himself into another machine.

Dr. Ham has stated: * "Man has strictly limited short-time performance capabilities measured in terms of the parameters of capacity and time-delay either for physical work in transforming materials or data-handling.

"However, he has the power to effect an immense variety of transformations both because of his physical abilities to observe his environment and co-ordinate his limbs and because of his distinguishing ability to reason and contemplate."

When effecting some of the physical and mental functions of which man is capable, says Dr. Ham, machines can be designed to have much the greater and more reliable figure of merit of capacity and time-delay. However, the scope of these machine-reproduced functions in comparison with the total ability of man is extraordinarily limited.

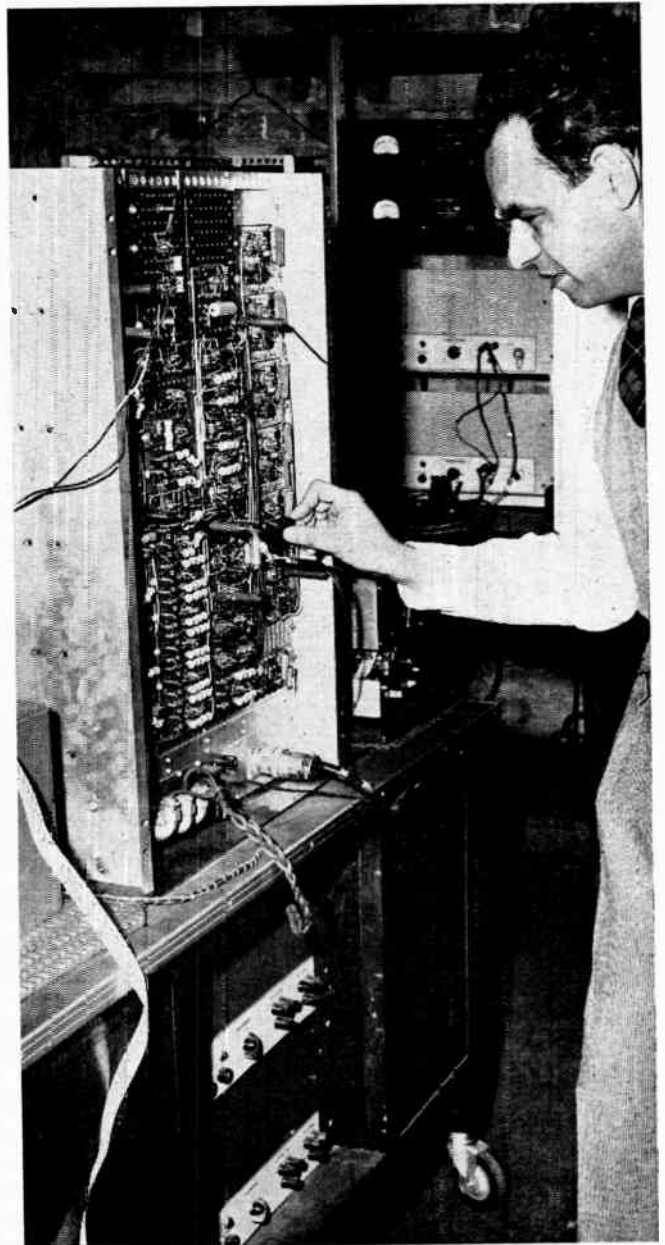

Adjustments on equipment. Punched tape provides signals which are converted to voltages and move the tube spot

So while the pilot of a space-ship may be a lightweight computer, man, in the words of a recent report by the American Association for the Advancement of Science, "will still retain abilities not to be duplicated by any machine." END

References: "The human operator of control systems," University of Toronto, October 1956. Part I, Introduction, Kenneth C. Smith B.A.Sc; Part II, Test Equipment, E. Ryll; Part III, Experimental Results, R. J. Richardson.

"The human operator of control mechanisms," W. E. Hick and J. A. V. Bates, British Ministry of Supply Monograph 17-204.

"Why the human operator?" W. E. Hick, Medical Research Council A.P.U. 181/52.

"The human transfer function in servo systems," J. D. North. "Automatic and manual control." Butterworth 1952.

**Commerce Journal, February 1957, published by the Commerce Club, Toronto.*

After a brief resumé of the theory of Harmonic Analysis based on Fourier's classic work, the author goes on to describe three types of instrument used in practical waveform analysis. The A. F. Analyser, in which a variable parallel-T network is used to separate the harmonics, is dealt with first. A complete description of a Wave Analyser follows; this instrument is based on the heterodyne principle for more precise measurements. Finally, reference is made to a Distortion Factor Meter, which is used when only the ratio of total harmonics to fundamental is required.

S. A. RYBB, P.ENG*

Methods of waveform analysis

Fourier's Theorem relates to periodic functions, of which many examples are found in both electrical and mechanical engineering theory and practice. It states that any periodic function can be expressed as the sum of a number of sine functions of different amplitudes, periods and phases.

Thus, however irregular the curve representing the function may be, so long as its ordinates repeat themselves after the same interval of time or space, it is possible to resolve it into a number of sine curves, the ordinates of which when added together give the ordinates of the original curve. This resolution of a curve into its component sine curves is known as Harmonic Analysis and is of considerable importance in modern engineering practice.

Expressed in mathematical symbols, Fourier's theorem reads:

$$y = f(t) = A_0 + B_1 \sin(pt + c_1) + C_1 \sin(2pt + c_2) + \dots + N \sin(npt + c_n) \dots \dots \text{ or, since } N \sin(npt + c_n) = A_n \cos npt + B_n \sin npt, \text{ we have}$$

$$y = A_0 + A_1 \cos pt + A_2 \cos 2pt + \dots + A_n \cos npt + \dots + B_1 \sin pt + B_2 \sin 2pt + \dots + B_n \sin npt + \dots$$

To simplify for the purpose of analysis, we substitute θ for pt , and the Fourier expression for y becomes:

$$y = A_0 + A_1 \cos \theta + A_2 \cos 2\theta + \dots + A_n \cos n\theta + \dots + B_1 \sin \theta + B_2 \sin 2\theta + \dots + B_n \sin n\theta + \dots$$

In mathematical analysis it is necessary to find the values of the coefficients $A_0, A_1, A_2, \dots, B_1, B_2, \dots$ etc. In the case of electrical wave-forms, these indicate the number of harmonics and their amplitudes. There are numerous methods which can be employed to derive the coefficient values, but the strictly analytical method is presented here, as a basis for the description of practical methods which follows.

Before proceeding with the details of this method, it is necessary to verify the following statements:

$$\int_0^{2\pi} \cos \theta \, d\theta = 0.$$

This is self-evident, since the area under one complete period of a cosine curve is obviously zero.

$$\int_0^{2\pi} \cos m\theta \cos n\theta \, d\theta = 0 \dots \dots \dots (1)$$

for $\cos m\theta \cos n\theta = \frac{1}{2} \cos(m+n)\theta + \frac{1}{2} \cos(m-n)\theta$, and hence

$$\int_0^{2\pi} \cos m\theta \cos n\theta \, d\theta = \frac{1}{2} \int_0^{2\pi} \cos(m+n)\theta \, d\theta + \frac{1}{2} \int_0^{2\pi} \cos(m-n)\theta \, d\theta = 0 + 0,$$

for both are cosine curves over the full period.

$$\int_0^{2\pi} \cos m\theta \sin n\theta \, d\theta = \frac{1}{2} \int_0^{2\pi} \sin(m+n)\theta \, d\theta - \frac{1}{2} \int_0^{2\pi} \sin(m-n)\theta \, d\theta = 0 \dots \dots \dots (2)$$

$$\int_0^{2\pi} \cos^2 \theta \, d\theta = \frac{1}{2} \int_0^{2\pi} \cos 2\theta \, d\theta + \frac{1}{2} \int_0^{2\pi} d\theta = 0 + \frac{1}{2}(2\pi - 0) = \pi \dots \dots \dots (3)$$

$$\int_0^{2\pi} \sin m\theta \sin n\theta \, d\theta = \frac{1}{2} \int_0^{2\pi} \cos(m-n)\theta \, d\theta - \frac{1}{2} \int_0^{2\pi} \cos(m+n)\theta \, d\theta = 0 \dots \dots \dots (4)$$

$$\int_0^{2\pi} \sin^2 \theta \, d\theta = \frac{1}{2} \int_0^{2\pi} d\theta - \frac{1}{2} \int_0^{2\pi} \cos 2\theta \, d\theta = \frac{1}{2}(2\pi - 0) - 0 = \pi \dots \dots \dots (5)$$

To proceed with the analysis, we have

$$y = A_0 + A_1 \cos \theta + A_2 \cos 2\theta + \dots + A_n \cos n\theta + \dots + B_1 \sin \theta + B_2 \sin 2\theta + \dots + B_n \sin n\theta + \dots$$

and we wish to find the values of $A_0, A_1, A_2, \dots, B_1, B_2, \dots$ etc.

If we integrate throughout, with the limits 0 and 2π , every term on the right hand side, except for the first, will vanish, i.e.

$$\int_0^{2\pi} y \, d\theta = A_0 \int_0^{2\pi} d\theta + 0 + 0 + \dots,$$

$$\text{or } \int_0^{2\pi} y \, d\theta = A_0(2\pi - 0),$$

$$\text{whence } A_0 = \frac{1}{2\pi} \int_0^{2\pi} y \, d\theta = \text{the mean value of } y.$$

Thus A_0 is found by averaging the ordinates; in the

*Dawe Instruments Ltd., Ottawa

majority of cases, however, an inspection will show that A_0 is zero.

To find A_1 we multiply throughout by its coefficient, $\cos \theta$, and integrate:

$$\int_0^{2\pi} y \cos \theta d\theta = \int_0^{2\pi} A_0 \cos \theta d\theta + \int_0^{2\pi} A_1 \cos^2 \theta d\theta + \int_0^{2\pi} A_2 \cos \theta \cos 2\theta d\theta + \dots + \int_0^{2\pi} A_n \cos \theta \cos n\theta d\theta + \dots + \int_0^{2\pi} B_1 \cos \theta \sin \theta d\theta + \int_0^{2\pi} B_2 \cos \theta \sin 2\theta d\theta + \dots + \int_0^{2\pi} B_n \cos \theta \sin n\theta d\theta + \dots$$

or, from (1), (2) and (3):

$$\int_0^{2\pi} y \cos \theta d\theta = 0 + \pi A_1 + 0 + 0 + \dots,$$

whence $A_1 = \frac{2}{2\pi} \int_0^{2\pi} y \cos \theta d\theta =$ twice the mean value of $y \cos \theta$. Thus A_1 is found by taking a number of values of y , multiplying each by the cosine of the angle for which each is the ordinate, obtaining the average of these products, and multiplying the resultant by two.

The values of $A_2, A_3,$ etc., may be found in a similar manner by multiplying throughout by $\cos 2\theta, \cos 3\theta,$ etc. in order, and performing the integration as above.

To find B_1 we multiply throughout by its coefficient, $\sin \theta$, and integrate:

$$\int_0^{2\pi} y \sin \theta d\theta = \int_0^{2\pi} A_0 \sin \theta d\theta + \int_0^{2\pi} A_1 \sin \theta \cos \theta d\theta + \int_0^{2\pi} A_2 \sin \theta \cos 2\theta d\theta + \dots + \int_0^{2\pi} A_n \sin \theta \cos n\theta d\theta + \dots + \int_0^{2\pi} B_1 \sin^2 \theta d\theta + \int_0^{2\pi} B_2 \sin \theta \sin 2\theta d\theta + \dots + \int_0^{2\pi} B_n \sin \theta \sin n\theta d\theta + \dots,$$

or, from (2), (4) and (5):

$$\int_0^{2\pi} y \sin \theta d\theta = 0 + 0 + 0 + \dots + 0 + \dots + \pi B_1 + 0 + \dots,$$

whence $B_1 = \frac{2}{2\pi} \int_0^{2\pi} y \sin \theta d\theta =$ twice the mean value of $y \sin \theta$. Similarly, the values of $B_2, B_3,$ etc. may be found.

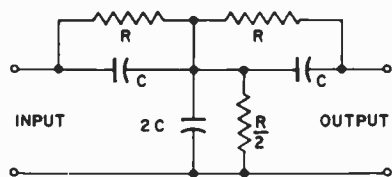

Fig. 1. Parallel-T network as used in the A.F. Analyzer.

The above considerations are applicable to cases where an actual curve can be plotted and this is not always possible, and, in actual practice, is rather tedious. As in so many other instances, the development of electronic techniques gave us instruments which have proved of invaluable assistance, performing the task of harmonic analysis without tedious calculations.

They can be applied to almost any periodic function encountered either in electrical or mechanical problems. In



Fig. 2. A.F. Analyzer for general sound and vibration work

cases of mechanical functions a suitable transducer must be used to convert the mechanical energy into an electrical signal.

There are two different forms of wave analyzers in common use for the determination of the amplitudes and frequencies of the components in a complex signal.

In the first type, the signal is applied to an audio-frequency amplifier, which is made frequency selective. A parallel-T network of the form shown in fig. 1 is one of the most commonly employed networks to achieve this purpose. If a signal containing a component of frequency f_0 is applied to the input terminals of this network and the condition

$$f_0 = \frac{1}{2\pi RC}$$

is fulfilled, there will be zero output from the network for the frequency f_0 , while components of other frequencies will develop a signal across the output terminals.

When this circuit is used as the negative feedback circuit in an amplifier, no feedback occurs at frequency f_0 with resulting maximum gain, while negative feedback occurs at the other component frequencies in the input signal causing considerably decreased gain at these frequencies.

This principle is utilized in the A.F. Analyzer, shown in fig. 2. In this instrument, the parallel-T network is the feedback chain from output to input of a three-stage direct coupled amplifier, the output of which is applied to a vacuum tube voltmeter with an approximately logarithmic scale. The resistance elements R are variable, controlled by a large dial directly calibrated in frequency, while the capacitors are switched to give a frequency range of 25 to 8,000 cps in five ranges. The parallel-T network provides constant percentage selectivity at all frequencies of 3 db attenuation at about 1% off the frequency to which the analyzer is tuned.

This type of instrument is used mainly in sound analysis, in conjunction with a suitable sound level meter or microphone and straight amplifier. A special version of this instrument, with the frequency range extended down to 2 cps can be used in analysis of mechanical vibrations and similar phenomena, provided suitable transducers are employed. One very interesting application of this latter version of the instrument was in the study of pressure pulses in liquids.

Where more precise measurements are required the second method of analysis is usually employed. In this method, the input signal is heterodyned in a balanced modulator by a variable frequency local oscillator to pro-



Fig. 3. Wave Analyzer gives accurate harmonic measure

duce, from the component to be measured, an intermediate-frequency signal which is passed to a highly selective i-f amplifier; the output of this amplifier is measured by a vacuum tube voltmeter.

The accuracy of such an instrument is dependent upon the careful design of the local oscillator to produce low distortion, good frequency stability and constant amplitude, and of the balanced modulator to suppress spurious cross-modulation products. An instrument of this type covers the whole audio-frequency range without switching, and deriving the selectivity from a fixed-tuned i-f amplifier gives a constant bandwidth of a few cycles per second at all frequencies under measurement.

An instrument incorporating all the above features is shown in fig. 3, and its functional diagram is represented by fig. 4. It employs a resistance-capacity tuned type of local oscillator, and automatic amplitude control is incorporated to ensure that the amplitude of the oscillation is constant as the frequency is varied and that the maintaining amplifier is operated well within its linear range when the distortion is extremely low.

The variable capacitors in the frequency selective circuit give a range of frequencies from 20 kc to 36 kc producing a difference intermediate frequency of 20 kc with an input signal range of 0 to 16 kc. To maintain frequency stability, wire-bound resistors are used in the frequency control circuit and the oscillator derives its h.t. from a stabilized power supply.

The use of a special lamp in the cathode circuit ensures the constancy of output amplitude. This gives automatic control of gain as the output voltage tends to change, by virtue of the change of resistance of the lamp as the alternating current through it changes. The output of the oscillator is applied to the paralleled cathodes of the pentodes in the balanced modulator circuit.

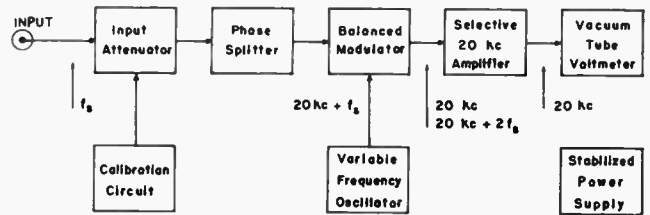

Fig. 4. Functional diagram, heterodyne type wave analyzer

The input signal to be analyzed, after passing through the meter multiplier switching arrangements, is applied to the control grid of a single tube phase-splitter with equal plate and cathode loads. The push-pull output obtained is then applied to the grids of the two tubes in the balanced modulator. If the frequency of the component of the input signal, whose amplitude is to be determined is f_s , the local oscillator should be tuned to $20\text{ kc} + f_s$. Signals of frequencies 20 kc and $20\text{ kc} + 2f_s$ only should appear in the output transformer of the modulator with no trace of the carrier frequency, $20\text{ kc} + f_s$, provided the circuit is perfectly balanced.

In the instrument under present discussion the reactive and resistive balancing is arranged by means of a differential variable capacitor and a potentiometer chain across the primary of the modular output transformer. Before operation, the local oscillator signal is reduced to a minimum by these controls, otherwise this signal will introduce errors when measurements are made at low frequencies. Spurious cross-modulation products are at least 65 db below the maximum input signal present and hum components at least 75 db below the maximum permissible signal on any of the four meter multiplier settings.

In the Wave Analyzer illustrated in fig. 3, the output of the balanced modulator is applied to the meter sensitivity attenuator and switch and then through one stage of amplification to the selective amplifier.

In heterodyne type wave analyzers two main methods are used to obtain selectivity in the amplifiers following the modulator. One consists of a crystal filter followed by tuned stages of amplification; the intermediate frequency used is usually 50 kc or 100 kc with this type and the selectivity curve resulting has a flat top of about 4 cps width, while the response is down 25 db at about 10 cps off resonance.

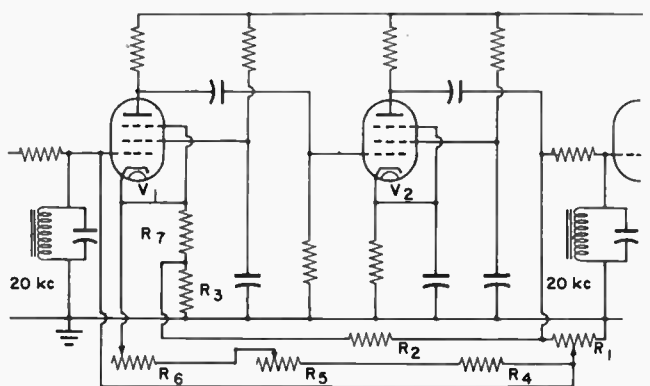

Fig. 5. Schematic diagram, Wave Analyzer amplifier stage

The second method employs resonant circuits with positive and negative feedback arranged to give the required high selectivity. Four similar stages of amplification are employed, each stage consisting of a two-tube amplifier; the circuit diagram of one of these stages is shown in fig. 5. It can be seen that a tuned circuit resonant to 20 kc

is provided in each stage of amplification; to ensure stability of the resonant circuits toroidal inductances and high-capacity silvered mica capacitors are used.

Three feedback circuits are provided from the output of the second tube of each stage. The first is a fixed negative feedback path through R_2 and R_3 ; the feedback through this path stabilizes the gain of each stage. The second is also a negative feedback path from R_1 via R_4 , R_5 , R_6 , R_7 and R_8 , while the third is a positive feedback path from R_1 to the grid of V_1 and to ground through the resonant circuit.

It is arranged that at resonant frequency of the tuned circuit the amount of positive feedback is balanced by the negative feedback. At frequencies off resonance, the impedance of the tuned circuit is decreased and hence the amount of positive feedback at these frequencies is less, while the amount of negative feedback remains unaffected. With the negative feedback thus predominating the gain of the stage at these frequencies is much less than at resonant frequency. This reduction in gain is additional to that due to the normal selectivity of the resonant circuit and hence a very high effective Q for the amplifying stage can be obtained.

The effective Q depends on the amount of feedback and is controlled by R_1 , which is ganged to the corresponding potentiometers in the other three stages. R_5 is a preset resistance in each stage while R_6 is one section of a four-gang variable; R_3 etc., are adjusted during initial setting-up to give minimum change of gain when the bandwidth control R_1 etc. is altered. R_4 etc. is a panel control compensating for small changes in the amplifier gain which may arise when the selectivity is changed. With the bandwidth control at the maximum selectivity, the attenuation for the four stages is 3 db at 3 cps off resonance, 10 db at 9.5 cps, 40 db at 35 cps and 60 db at 65 cps, which gives selectivity comparable to the crystal filter amplifier already mentioned.

Variable bandwidth

At minimum selectivity the attenuation is 3 db at 20 cps off resonance, 10 db at 50 cps, 40 db at 180 cps and 60 db at 320 cps. Thus a bandwidth variable by a ratio of approximately six to one is obtained. At low frequencies maximum selectivity is usually necessary, but for frequencies above 500 cps a lower selectivity is often sufficient and this simplifies considerably the tuning of the required component. The lower values of selectivity are also desirable where there are slight variations in frequency of the input signal.

The frequency range of the instrument described above is 50 to 16,000 cps with plus or minus 3% accuracy of calibration.

The main applications of the unit described, are in measuring wave-form distortion of all kinds of audio frequency amplifiers and oscillators, as well as the component frequencies and amplitudes within the very wide range specified, or any electrical wave-form derived from line supplies, rectifiers, vibration pickups, microphones and many similar sources.

The operation of the analyzer is very simple. The main tuning control, which controls the capacity elements in the frequency selective circuit of the R.C. oscillator is calibrated directly in input signal frequency. There is also a fine tuning control which is normally set at zero, when tuning, but is useful for final adjustment to the input frequency. Other controls on the main panel are the meter multiplier switch, the meter sensitivity switch, the bandwidth control and the negative feedback control.

Controls required for initial balancing and setting-up are located on a recessed panel below the main tuning dial.



Fig. 6. Distortion Factor Meter for total wave distortion

To analyze a signal of known frequency for harmonics, it is applied to the input terminals with the instrument controls set at minimum sensitivity. The main tuning dial is set to the fundamental frequency of the input signal and the meter switches adjusted to obtain a meter reading.

The instrument is then tuned to give maximum meter reading and the voltage is read. The main tuning dial is then tuned to twice the fundamental frequency and the meter sensitivity increased to obtain a reading. Again the voltage obtained at the maximum tuning position is read. This procedure is repeated for the third and higher harmonics.

To analyze an unknown complex waveform, the meter and the bandwidth control switches are set to maximum and the main tuning dial rotated through the entire range until a reading is obtained; it may be necessary to adjust the meter switches to obtain this reading. Once it is obtained, the instrument is tuned for a maximum and the voltage read. By increasing the sensitivity and tuning through the range, it is possible to select and measure other components; care must be taken not to overload the meter, when tuning through the components of large amplitude already measured. When the component frequencies are close together, it may be necessary to make further tests with increased selectivity.

There are many instances where all the facilities provided by an instrument of this nature are not needed. This is particularly true in cases where all that is necessary to know is the total distortion of a waveform.

The total distortion is defined as the ratio of the square root of the sum of the squares of all harmonics present to the input tone, and is usually represented in percentage.

The Distortion Factor Meter, shown in fig. 6, is the instrument used for this purpose. The measurement is effected by separating the harmonic and noise voltages from the fundamental and comparing the magnitude of the distortion components with that of the total input. The suppression of the fundamental is effected by a selective amplifier comprising a Wien Bridge with over-all negative feedback so that the null point is sharpened and harmonic components not attenuated.

The output from the selective amplifier is fed to a sensitive vacuum tube voltmeter driving a full-wave rectifier meter. To compare the amplitude of the input with the harmonic components, a portion of the input is fed to the vacuum tube voltmeter, enabling a direct reading of percentage harmonic content to be obtained on a resistive potential divider. The vacuum tube voltmeter is thus used as an indicator only and does not affect the distortion measurements.

END

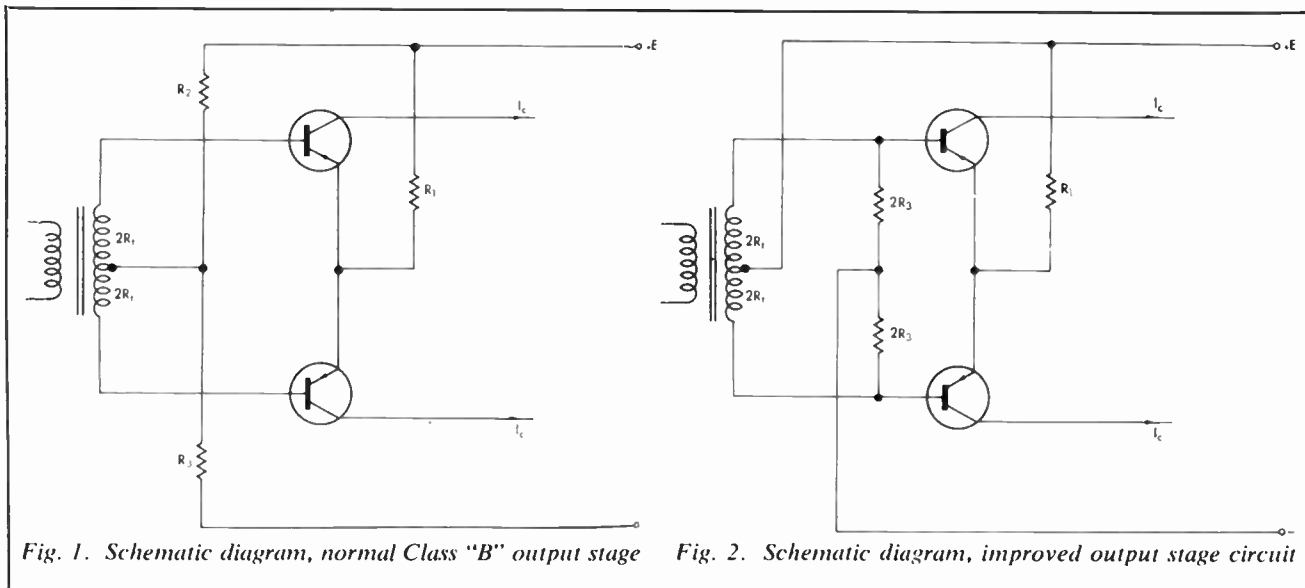

Fig. 1. Schematic diagram, normal Class "B" output stage

Fig. 2. Schematic diagram, improved output stage circuit

Improved transistor biasing

MAURICE PRICE, P.ENG*

During the development of a transistorized servo-amplifier intended for airborne use, a problem was encountered in maintaining stability of the push-pull output stage. A new bias network was developed which showed far superior performance as compared to the conventional circuit previously used. Schematic diagrams of both circuits are given, together with a table which contains comparative design formulae. Calculations based on these formulae for a particular example are used to show the improvement obtained.

During the design of a transistorized servo-amplifier intended for airborne applications, it was found that the stabilization of the output stage needed careful attention. The resistance of the input transformer secondary winding, usually considered negligible, had an adverse effect on the bias stabilization. The influence of this resistance, and a means for overcoming it, are indicated here.

In fig. 1 the usual arrangement of a Class "B" output stage is shown. The transformer secondary resistance is denoted by $4R_1$. This resistance acts in series with the base of the transistor, and degrades the stability factor. In practical designs, it is difficult to achieve a stability factor

$$S = \frac{\partial I_c}{\partial I_{c0}}$$

of less than about three without enlarging the input transformer to obtain a lower resistance, or increasing R_1 . Both these steps are undesirable, as the first wastes space while the second causes a loss of gain and maximum power output. In any case, the power dissipated in the bias network, denoted by P_b , is unnecessarily large.

The circuit of fig. 2 overcomes these difficulties by using the transformer resistance as an active part of the bias network in place of R_2 . The design equations used for the two circuits are given in the table.

EXAMPLE: The following example will illustrate the superiority of the amended circuit.

Data: a = current gain of transistors, common case = 0.92

I_c = required collector current per transistor = 10 mA

I_{c0} = collector cut-off current of transistors ≈ 0

E = supply voltage = 28 volts

S = bias stability factor = $\frac{\partial I_c}{\partial I_{c0}} = 3$

A typical value for the transformer resistance is $4R_1 = 48$ ohms.

In the case of fig. 1, an acceptable value for R_1 is 10 ohms. We then have:

- $R_3 = 1530$ ohms
- $R_2 = 14.3$ ohms
- $P_b = 0.52$ watts

The new arrangement gives the same stability factor with only 25% of the power loss. It will also yield more gain and maximum power output owing to the lower value of R_1 .

*Computing Devices of Canada Ltd., Ottawa

Parameter	Circuit of Fig. 1	Circuit of Fig. 2
$S = \frac{\partial I_c}{\partial I_{co}}$	$1 + \frac{R_1}{R_t + R_2 R_3 / (R_2 + R_3)}$ $(1 - \alpha) + \frac{R}{R_t + R_2 R_3 / (R_2 + R_3)}$	$1 + \frac{R_1}{R_3} + \frac{R_1}{R_t}$ $(1 - \alpha) + \frac{R_1}{R_3} + \frac{R_1}{R_t}$
R_3	$\frac{E \left\{ (S - 1) - \frac{R_t}{R_1} [1 - S(1 - \alpha)] \right\}}{2(I_c - S I_{co})}$	$\frac{E(S - 1)}{2(I_c - S I_{co})}$
R_2	$\frac{R_3 \{ (S - 1) R_1 - R_t [1 - S(1 - \alpha)] \}}{(R_3 + R_t) [1 - S(1 - \alpha)] - (S - 1) R_1}$	—
R_1	Determined from allowable gain and voltage loss.	$\frac{R_3 R_t}{R_3 + R_t} \cdot \frac{1 - S(1 - \alpha)}{S - 1}$
R_t	—	$\frac{R_1 R_3 (S - 1)}{\alpha S R_3 - (S - 1)(R_1 + R_3)}$
P_b	$\frac{E^2}{R_3}$	$\frac{E^2}{R_3}$

With the data given in this example, it is possible to reduce the S factor to two if the power loss and the value of R_1 remain at the original values. A value of S as low as this cannot be achieved at all with the original circuit.

Note that the dc in the transformer secondary remains

balanced and will not alter the transformer design except for the small heating effect.

CONCLUSION: The amended bias arrangement offers advantages over the conventional circuit in normal as well as critical applications. —END

Rush for electronics engineers at the IRE show



While the IRE exhibition was on, so was the recruiting drive. One part of the exhibition that always had a big crowd was a 15-foot section of wall with lots of cards pinned on under the title "Employment Opportunities."

Job advertisements filled the New York papers while a number of the big firms had special suites in nearby hotels in which to interview engineers. RCA kept ten people busy at the Waldorf-Astoria interviewing some 250 during the four days.

One firm explained that it had to hire men during the IRE convention to replace those who went elsewhere during the same period. Some firms kept their best engineers away from the show or limited their visits to one day.

Every day at the New York IRE Convention there was a crowd around the "jobs unlimited" notices. One approach was "... within easy reach of a white-sand beach and a lovely nine-hole course. For further information ..."

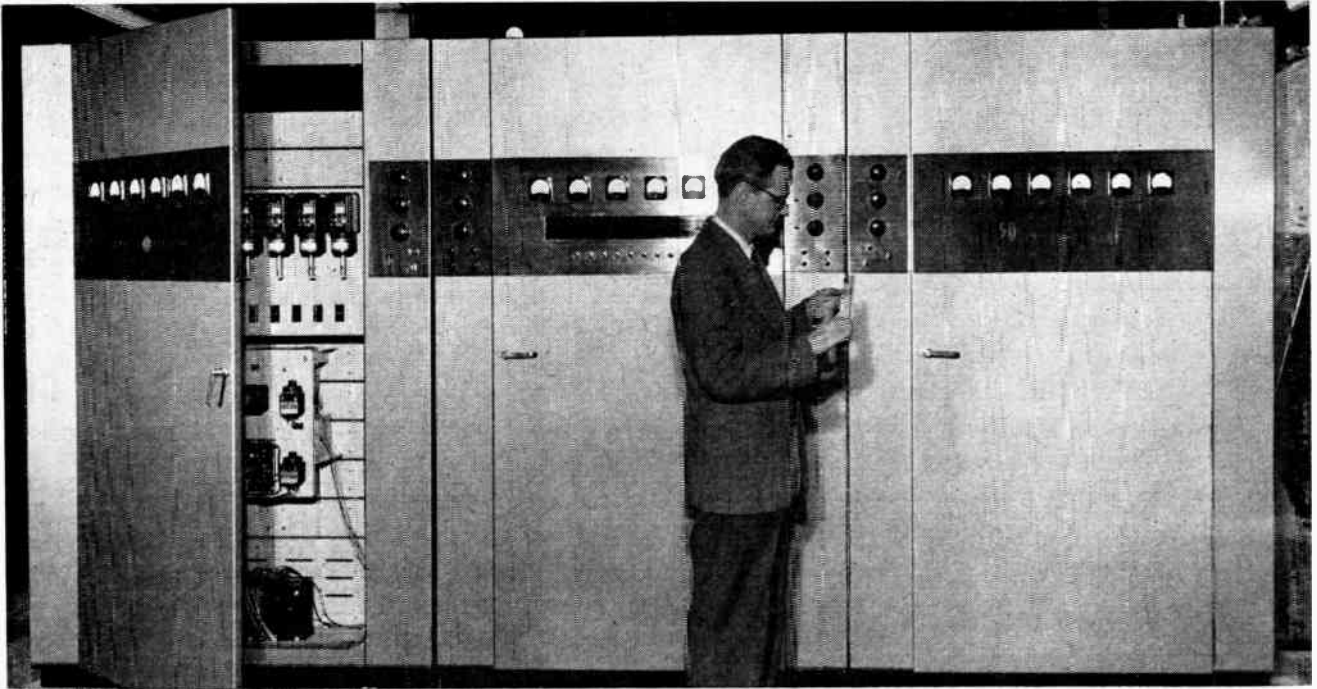

Front view of new 50 kw high level transmitter shows functional design, with meters and controls at a convenient level

New AM transmitter design

L. N. KOSKI*

How the designer goes to work on a new 50 kw AM transmitter for broadcasting work in the medium waveband. New developments made possible by advances in electronic components, increase compactness, accessibility, operating economy and reliability. Use of germanium rectifiers in the power supply circuits solved numerous d-c power supply problems and reduced power consumption and operating costs.

In designing a modern 50-kilowatt transmitter one of the important things to be remembered is the competition from television. This has meant a scarcity of well-trained operators. So to meet this problem the transmitter should be simple and its circuitry of conventional design.

Competition from television also means that the economics of a transmitting station are of vital concern. For example, the operating or "running" costs must be kept to a minimum—not only the cost of power bills, but the cost of the tubes. In addition, the tubes should have long life. Maintenance too has to be kept to a minimum, especially if the transmitter is to be remotely controlled. From the standpoint of transmitter reliability, keeping "off-air" time to a minimum and preventing costly and frequent repairs are considered of paramount importance. Another consideration is that the total cost of the transmitter has to be kept within reasonable limits. Finally, an aim for compactness is considered necessary in order to reduce building costs. For this same reason, provision has to be made for any large components to be mounted externally.

With the trend nowadays to remote control operation, circuitry should be incorporated into the transmitter to facilitate possible conversion to remote control at a future date. The transmitter should be well protected to prevent costly breakdown in the event of failure in a remote location and also robust in order to remain unaffected by wide temperature changes. Air cooling is thought desirable in order to prevent any danger of freezing in the winter. It is expected that the transmitter might have to operate in an unheated building.

*Canadian General Electric Co., Ltd.

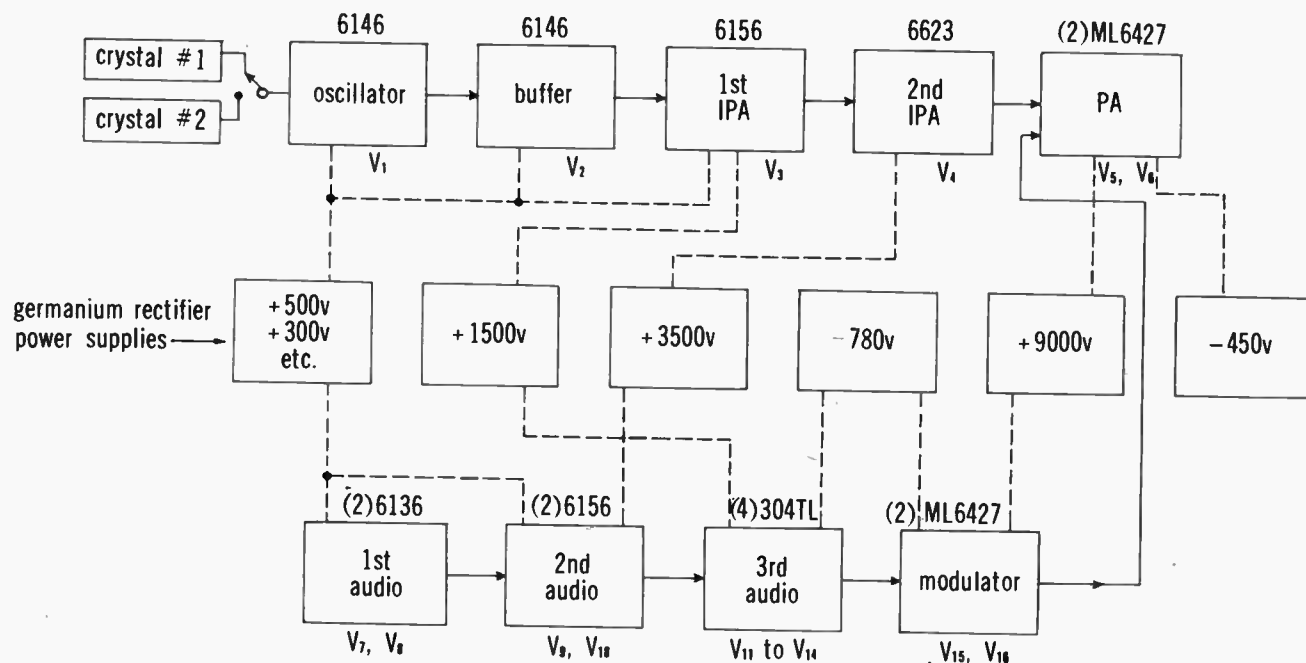

Block diagram of transmitter, showing principal units. ML-6427 tubes are used in both modulator and power amplifier

With these objectives in mind, the engineering team at Canadian General Electric Company Limited set out to design a modern high power broadcast transmitter, to be known as type BTC-50-A.

Attainment of the various objectives was achieved by (a) use of modern components, (b) design of reliable circuits and (c) mechanical improvements.

New type of tube cooling

One of the most helpful innovations in components was the availability of modern tubes. Particularly attractive from this point of view was the Machlett tube type 6427. Two of these tubes when operated in parallel give the required RF output and another two employed in the modulator circuit give the required modulator output.

These tubes have a new type of cooling in that the radiators are horizontal instead of being vertical. This method has the advantage of having the air to travel only a short path through the radiator—a path of about two inches compared with a path of about 10 inches in tubes of earlier design. Thus the air is not heated as much as in former tubes and the efficiency of cooling is much greater.

In addition, the type 6427 tube has a novel feature of aluminum fins on the radiator instead of the more conventional copper, resulting in a very great reduction in weight. For example, the type 895R tube used in a previous 50 kilowatt transmitter weighs 225 pounds, whereas the new type 6427 weighs only 20 pounds. The main advantage of this saving in weight is the fact that tube replacement is made much simpler. One operator can lift a 20-pound tube quite easily; however, two operators and a special hoist were needed to remove the older tubes.

Since the operation of a hoist took a considerable length of time, a spare tube had to be incorporated into the transmitter to be switched in during a fault, in order to cause minimum "off-air" time. Thus extra components and space had to be allowed for this extra tube. The cumulative effect of these new tubes is a very great saving of space.

A further advantage of the 6427 tube is that the power requirement for the filament has been reduced from approximately 10 kilowatts for the older type tungsten filaments to about 1.6 kilowatts for the 6427 thoriated tungsten filaments, thereby resulting in a saving of power consumption for the whole transmitter.

A major cause of trouble in older transmitters has been the plate circuit breaker. In this new transmitter, a component not used previously has been adopted—a vacuum switch to operate the primary supply to the plate transformers. These vacuum switches with their tungsten contacts in a vacuum will give a half-million operations without cleaning of the contacts being necessary. Owing to a very small mass, the operating speed is very fast. Vacuum capacitors, though not a new component, nevertheless play a major part in the reliability of the transmitter and in addition occupy a relatively small space. Ceramic capacitors have been used for coupling and d-c blocking in the RF circuits. These capacitors are far more reliable than any other type and in addition have a very long life. The largest capacitor used is 4,000 uuf with an operating voltage of 15 kv.

Another unconventional feature is the use of thyrite arrestors across the large reactors and transformers in place of the usual spark gaps. The advantage of the thyrite arrestors is twofold: they require no maintenance and give better protection since they are effectively in series with the gap.

High level transmitters in the past have had modulation transformers of large size. In this transmitter, the modulation transformer is much reduced in size due to modern design techniques. In order to achieve reliability, wherever possible relays have been chosen of the hermetically sealed type. Where this was not possible, relays have been chosen with large factors of safety. Similarly in the filament and low voltage power supplies, all small transformers have been specified for 40-year life in order that they remain cool in operation and offer long trouble-free service.

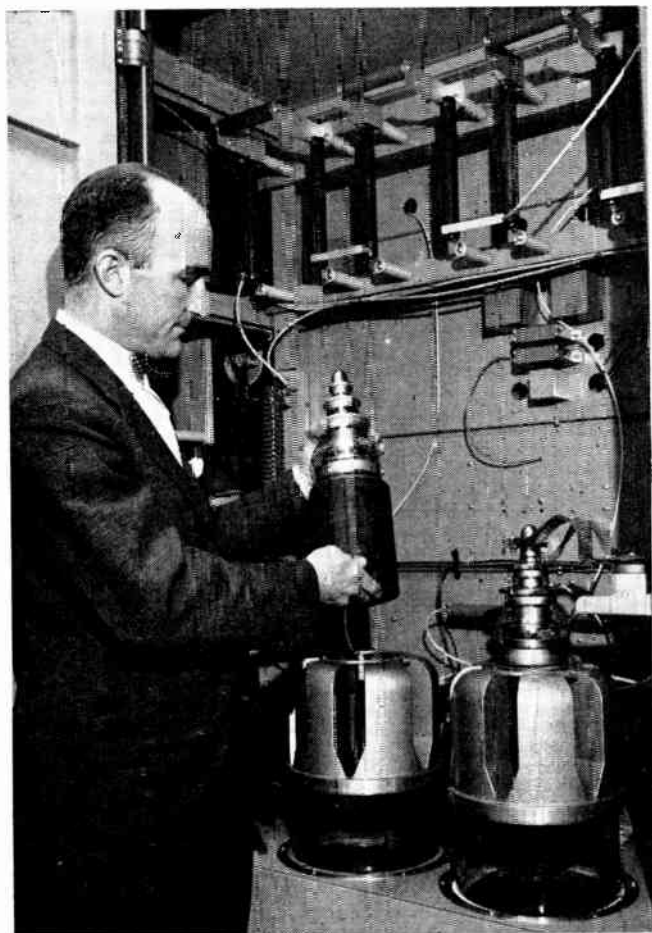

Prototype of modulator cubicle, showing ML-6427 tubes



Some of the components used in new BTC-50-A transmitter

Germanium rectifiers for d-c

The most revolutionary feature of this transmitter, however, is the use of germanium rectifiers throughout the transmitter for d-c power. Germanium rectifiers offer several advantages over the mercury vapor rectifiers used previously. In the first place there are no filaments to be heated. Consequently there is a saving in power, fragile filaments are eliminated and possibilities of failure are reduced. Secondly, no warm-up time is required for the germanium rectifiers, thus assuring a reduction in "off-air" time; it is also not necessary to keep a spare rectifier warmed up. Finally, germanium rectifiers are insensitive to ambient temperature, especially low temperatures, and they may be operated over a wide temperature range. The BTC-50-A transmitter may be used over a temperature range of from -40 deg F to 120 deg F, thereby requiring no heating of the building should the transmitter be in an unattended location.

The circuit for the germanium rectifiers is quite conventional throughout the transmitter — three-phase, full-wave rectifier circuitry has been used. To achieve the high inverse voltage required from the rectifiers, they have been connected in series to build up the necessary rating. Unlike selenium rectifiers, germanium rectifiers short out if they fail and this has the advantage that no ill effects arise through the shorting out of an occasional cell, the voltage being merely distributed on the remaining units. In this transmitter a sufficient number of cells have been added to the number strictly required, in order to provide a margin in case of failure of an individual cell.

As with any rectifier system, care must be taken with voltage and current surges and transients. Voltage surges have been reduced by use of damping resistors across reactors that are liable to build up high voltage due to sudden current changes. Current surges have been reduced by providing current limiting reactors in the primary of the high voltage supply. All circuits are well protected from overloads, particularly in the high voltage supply where very fast-acting overload relays operate the vacuum switches; the circuit is de-energized within one cycle of the a-c line frequency.

The application of germanium diodes being relatively new, it was felt that extensive tests should be conducted before the transmitter could be released. A bank of rectifiers similar to the type used in the new transmitter was installed in a 50 kw short-wave transmitter at Schenectady, N.Y. These rectifiers have now been in operation for nearly one year and the survival rate is 100%. Measurements show that no significant change has taken place in the characteristics of these rectifiers. Therefore from these results and other laboratory measurements it is expected that the rectifiers will last at least ten years in actual operation.

After careful consideration of different types of modulation methods, it was decided to design the transmitter employing conventional high level modulation. There are several reasons for this choice. The over-all efficiency, due to the use of modern components, is quite comparable to any other method of modulation. It was felt that since this

20

issues
for only

\$5

(regular rate
12 issues
for \$5)

Charter subscriber Charter subscriber

CHARTER

**Enroll NOW as a special
Charter Subscriber to**

**ELECTRONICS
ENGINEERING**

Use the handy postpaid cards below — for your own subscription and one for a key colleague or friend in the electronics field. Detach at perforation, complete and mail TODAY!

EE-3U-2U-1U

**Please enter me as a special
Charter Subscriber to**

**ELECTRONICS
ENGINEERING**

-

 20 issues \$5 (regular rate 12 issues \$5)
 payment enclosed **bill later**

EE-3L-2I-1L

**Please enter me as a special
Charter Subscriber to**

**ELECTRONICS
ENGINEERING**

-

 20 issues \$5 (regular rate 12 issues \$5)
 payment enclosed **bill later**

Keep as well posted
as the best informed
with the help of

ELECTRONICS ENGINEERING

regularly month by month

Reserve copies of the next 20 issues while this special Introductory Offer is available. Use one (or both) of the handy order cards below!

see
over

20

issues
for only

\$5

(regular rate
12 issues
for \$5)

BUSINESS REPLY CARD

NO POSTAGE STAMP NECESSARY IF MAILED IN CANADA

POSTAGE WILL BE PAID BY

MACLEAN-HUNTER

Publishing Company Limited

481 UNIVERSITY AVE.

Toronto 2, Canada



BUSINESS REPLY CARD

NO POSTAGE STAMP NECESSARY IF MAILED IN CANADA

POSTAGE WILL BE PAID BY

MACLEAN-HUNTER

Publishing Company Limited

481 UNIVERSITY AVE.

Toronto 2, Canada



circuitry was so familiar to every radio operator, there would be no problems of operating and maintaining this transmitter and special training courses would not be necessary for the majority of operators.

In addition this system of modulation requires fewer components and for remote control purposes simplicity and thus freedom from trouble was considered of paramount importance. A transmitter employing this type of modulation is not seriously affected by changes in the impedance of the antenna. This feature will assume more and more importance due to the ever-increasing use of directional arrays.

Developments in negative feedback technique have led to a significant reduction in distortion. In this transmitter two paths of feedback are used. The first path is from the primary of the modulation transformer back to the input, operating mostly at the higher audio frequencies.

Feedback of low frequencies from this source has a major disadvantage in that it increases the amount of noise due to hum in the r-f power amplifier filaments. Thus feedback for the low frequencies is obtained from the cathode of the r-f power amplifier and fed back to the input. The total amount of feedback applied is 10 db, by no means an excessive amount. It might be noted that the performance of the transmitter is quite acceptable without any feedback whatever.

With anticipation of legislation requiring low levels of harmonic radiation, a very different harmonic filter has been incorporated in the output circuit. A lightning trip circuit makes use of the reflectometer principle employed extensively in television transmitters. This circuit minimizes interruptions to the program due to lightning and also protects the complex tuning and phasing units used with modern directional arrays.

Mechanical improvements

The cooling system of the transmitter employs techniques which are new in the broadcast field. The air flow in this transmitter is the reverse of that used in previous designs, in that the air flows through the cabinet, past the tube radiators and directly into the exhaust ducts. Thus the components in the cabinet are not subjected to the heat generated by the tubes but are operating at very nearly the ambient temperature. Large r-f coils are forced air cooled, an adaptation from the idea used in large generators. The entire air cooling is achieved by use of one blower, thereby eliminating additional motors that would require frequent servicing.

TEST RESULTS

Power Output	53 Kilowatts
Noise	62 db below 100% modulation
Frequency Response	Within ± 1 db, 30 to 10,000 cps
Distortion (at 95% Modulation)	Less than 2%, 50 to 10,000 cps

Special care has been taken to simplify maintenance by making the transmitter as accessible as possible. Where walk-in space has not been provided, it is possible to reach in to remove any component. In the control circuits, racks retaining the relays are hinged and access is easy from front and back.

Economy has been furthered in several respects. The

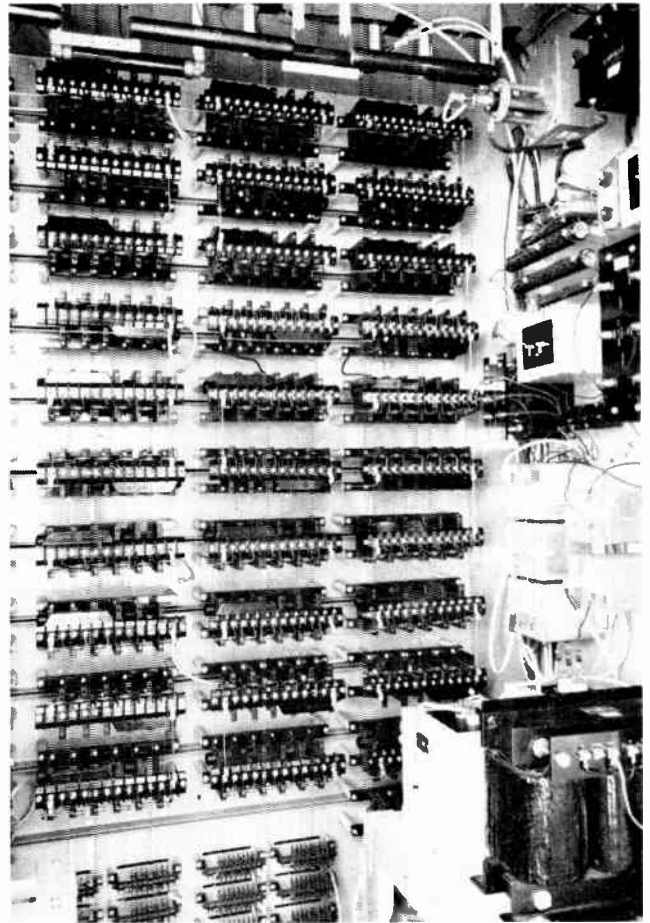

View of germanium rectifier d.c. power supplies cubicle

number of tubes in the new transmitter is 16 as compared to 30 or 40 in earlier designs. A large number of these were eliminated of course with the introduction of germanium rectifiers, but in addition great care has been taken to reduce the number of tubes in the circuit to a minimum.

The cost of the tubes has also been very materially reduced from earlier designs, the most important being the large tubes in the modulator and power amplifier stages. The total cost of a set of tubes for this transmitter is about 35% less than in previous designs (disregarding the cost of mercury vapor rectifiers). The number of tube types has been reduced to six, effecting a considerable saving in the storage of spares. A further step to economy has been a considerable reduction in the overall floor area occupied by the transmitter. It is less than half that of previous transmitters.

The transmitter cabinet has an actual area of 61 sq. ft., the size being 13½ ft. by 4½ ft. and 7 ft. high. External components are designed for operation either in a vault or out-of-doors. These components consist of three plate transformers, modulation transformer, modulation reactor, and low voltage distribution transformers.

Ease of operation has been achieved by several factors. Accessibility and simple circuitry as mentioned previously have aided considerably in this respect. One feature of major importance is the design of non-critical circuits. Tubes may be replaced without appreciably altering the distortion. Bias adjustments affect the static current but do not materially change the distortion. The transmitter may be maintained quite satisfactorily by an unskilled operator; however, sufficient controls have been provided to permit outstanding performance in the hands of experienced personnel.

END

New York's 1957 IRE National Convention was the biggest ever. The record crowds were an indication of the tremendous expansion of the electronics industry. Theme of the show, held in the recently opened Coliseum, was "something new."

SPECIAL REPORT
BY THE EDITORS

IRE show reflects electronics boom



Checking over new components at the Sprague booth are Wilkins (L) & Stubbs of PSC Applied Research, Toronto.

Next year the Institute of Radio Engineers national convention will be bigger than ever. To the 54,000 — A record attendance — who walked miles around this year's show in the New York coliseum this will be a staggering thought.

In fact the theme of this year's show was the "forward look." On the technical side Dr. Donald J. Fink, editor of the IRE said, "There is greater promise in the next ten years for electronic development than in any similar period in history."

From the manufacturers there were reports of "terrific" sales and a belief that the electronics industry would be expanding at an even greater rate in the near future.

Facts and figures on the show itself: All under one roof, for the first time, in the new Coliseum at Columbus Circle, were over 800 exhibitors, making it the world's largest technical exhibition. Visitors had to get around four floors—some three miles—to see all the \$10-million display.

Visitors from all over the United States and 35 other countries packed into 70 Manhattan hotels.

During the four days of the convention there were 55 technical sessions at the Waldorf-Astoria and Coliseum in which over 280 papers were presented. Subjects ranged from radio astronomy and medical electronics to color television and high fidelity.

At the annual meeting a Canadian was elected president of the IRE. He is Dr. John T. Henderson, Principal Research Officer of the National Research Council in Ottawa. Dr. Henderson suggested that there should be collaboration between IRE members and affiliates in working out common problems. Growth and increased specialization within the IRE would present difficulties but these would be worked out, he said.

At the same meeting Dr. Fink, speaking on "Electronics and the IRE in 1967" suggested that the most spectacular innovations would be in three major areas of electronics:

Nuclear power: The search for new sources of power is turning to fusionable materials such as deuterium. Electronics would contribute to the quest for controlled nuclear fusion.

Automation: Giant strides in this field could result in



New IRE President Dr. John T. Henderson (right) principal research officer of the NRC, Ottawa, with Mr. I. P. Garran, CMG, Minister (Commercial) British Embassy, Washington.

a four-day working week and in machines that would exercise judgment and make decisions.

Communications: The wholesale abandonment of many existing forms of communications and a vast market for new equipment.

Dr. Henderson announced the annual awards at the banquet. The Institute's highest technical award, the Medal of Honour, went to Julius A. Stratton, chancellor of the Massachusetts Institute of Technology, for outstanding contributions to the development of radio engineering as a teacher, physicist, engineer, author and administrator.

Among the Fellow Awards were two to Canadians: Dr. G. S. Field, for contributions to ultrasonics and to the defense research program of the Royal Canadian Navy and Mr. S. G. L. Horner, for contributions to radio communications in Canadian Northern and Arctic regions.

Tremendous work on computers

The show itself was dominated by computers, which were easy to see because they filled acres of floor space, and transistors, not nearly so noticeable but always in the background.

The emphasis in the computer field was on the reduction in set-up time. The EASE 1132, for instance, embodied new operational techniques and new set-up theory which make it possible for technicians and secretaries to handle a large percentage of the work. This relieves the engineer for problems requiring his technical training—problem preparation, solution evaluation or system design.

To accomplish this the system is designed to 1. set coefficient potentiometers automatically from a previously punched and checked paper tape; 2. read and print the setting of each coefficient potentiometer in the computer and simultaneously punch a tape for later re-entry; 3. scan and print out all pertinent voltages within the computer and 4. control the computer either manually or by means of punched tape.

The new Reeves Auto-Control system will make the larger analogue computers do their jobs 20 times faster and more accurately than when hand-operated by engineers.

Another feature of the Reeves system is "auto-cycling" which means that computing operations can be halted at any point, the work done up to that point fully recorded upon tape for examination and study and then the whole problem reinserted and the computation recommenced without repetition or loss of time.



This giant Eimac tube, claimed as world's largest klystron, dwarfs Sqdn. Ldr. Baxter and Flt. Lt. Turner (right), RCAF, Ottawa.



Large cutaway model helps McVity explain Fansteel Metallurgical Corp. capacitor to Vern Stauffer, Cdn. Westinghouse.

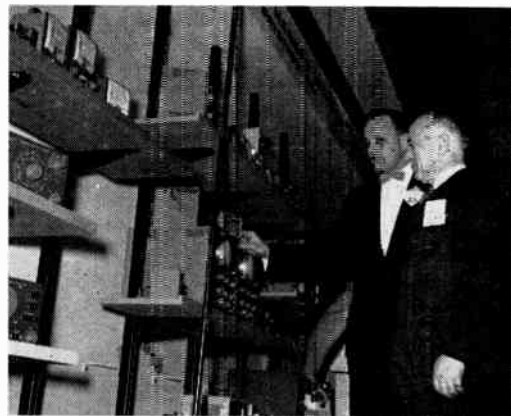

H. N. Reezes (R), Director. Audio Fairs was on the look-out for new kit designs. Mullings of Heathkit supplied answers.



The EASE computer is checked out by its new Canadian representatives (L to R) J. Root, T. Dalzell & R. Haywood, R-O-R Associates.

Computers are going into every field. Dr. Martin Lipkin of the New York Hospital, speaking at the Coliseum, said that computers had been highly successful in pinpointing the blood diseases in 80 patients. In some cases, where the computer showed that the characteristics of several diseases were present, the computer also indicated what further information was needed to determine exactly which disease the patient had. When the additional data were fed in, the computer correctly diagnosed a single disease.

One "build-it-yourself" firm, Heathkit of Benton Harbour, Michigan, were offering, along with hi-fi sets, a computer in kit form. It could be built in three sizes, with the top price around \$900.

Transistor sales were \$30 million

Transistors, and predictions about what they might do in the future, were everywhere. Speaking at the show Dr. Malcolm H. Hebb, of the General Electric Research Laboratory, Schenectady, New York, said that the transistor business, nonexistent five years ago, amounted to \$12 million in 1955, grossed \$30 million in 1956 and should reach \$200 million by 1960.

Of the 12 million transistors manufactured by U. S. industry in 1956 approximately half were used for enter-



Man and meter came to blows at Sensitive Research Instrument Corp. booth. Both survived.



Punching out printed circuit boards on the Wales Hydra New-Matic looked fascinating to the IRE visitors.



Two electronic engineers discuss vacuum capacitors and high power vacuum switches at Jennings booth.

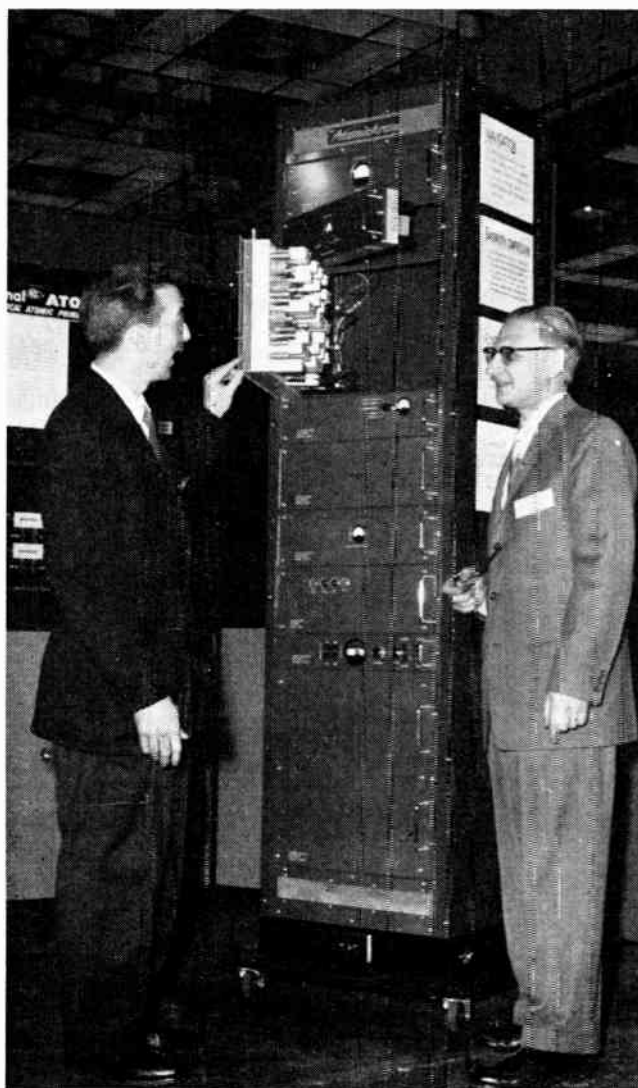

Solano (L) and Oxman prepare to show the National Co. Atomichron. This accurate primary frequency standard is controlled by resonant frequency of cesium atoms.

tainment, mainly in personal portable radios with some for automobile radios. About one eighth went into communications service and another eighth into computers and digital devices with the remaining quarter having other applications, including hearing aids.

An eye-catching gimmick was put on by Texas Instruments who had a transistorized radio-controlled tugboat. The miniature tugboat was controlled by a unit using seven transistors. The transmitter, using four transistors, operated at 27.2 mc.

According to Mr. E. M. Creamer of the Philco Development Laboratories several firms have built experimental television sets with completely transistorized circuits. They had screens of only eight or ten inches.

Printed circuits, and machines for the automatic insertion of components, also drew big crowds. One machine, made by the United Shoe Machinery Corporation, can insert axial lead components ranging from tiny diodes to capacitors an inch in diameter. It handles components with off-center and bent leads and after inserting components through pre-punched holes clinches the leads in any direction.

Original Edison tubes

Among the more interesting exhibits were tube collections, one the Princetown collection and the other shown under the title "Cavalcade of Electronics." They contained some of the original specimens of tubes made by Thomas A. Edison, Dr. Lee de Forest, Steinmetz, Marconi, Sir Ambrose Fleming and others.

The technical sessions and press conferences covered every aspect of the electronics field. Dr. L. H. Montgomery, of the Vanderbilt University School of Medicine, described a new experimental electronic system that enables a polio victim to use respiratory muscles that are still intact to control the breathing of his iron lung.

Even in the severest cases of paralysis, said Dr. Montgomery, the victim is left with control of a few muscles which contract when he tries to breathe. This contraction generates minute voltages that can be detected by sensitive electrodes placed on the skin. The voltages are then fed to electronic equipment which amplifies them and uses them to control the flow of air to and from the iron lung.

Also in the medical field, a new magnetic tape recording system for teaching electrocardiography was described by G. N. Webb and Dr. W. R. Milnor of the Johns Hopkins University School of Medicine.



A little reminiscing over an original DeForest Audion. H. Schrader (L), Curator, Princeton Tube Collection and E. N. Pickerill, associate of Dr. Lee de Forest.

With the system the variable electrical potentials from the heart are turned into a variable pitched sound and recorded on magnetic tape. When the tape is played, the sound is converted back into the electrical potentials and displayed visually on an oscilloscope, enabling the doctor to view the signals as he listens to the sound.

Two Canadians, M. M. Levy and A. Barszczewski described the electronic mail sorting system which is under development by the Canadian Post Office Department in Ottawa. Operators in special reading stations convert the names of towns, villages and streets into a special code suitable for electronic handling. After the code is marked on the envelope by a special keyboard the remaining operations may be performed completely automatically by high-speed electronic sorting equipment.

In a session on transistor applications A. Warnick and C. N. Savage of the Ford Motor Company described a new transistorized dc amplifier. In this unit signals as small as a millionth of a volt can be amplified 1,000 times without being masked by random noise. Use of transistors had reduced the size of the amplifier by ninety per cent.

W. T. Eddins, of Radiation Incorporated described a wide-band transistorized pulse amplifier. Previous direct-coupled amplifiers, he said, encountered serious difficulty due to the dc drift of the vacuum tubes. The drift could be greatly reduced by the use of silicon transistors and at the same time adequate bandwidth and high input impedance is maintained.

Problems of miniature components

The use of transistors and printed circuits has created other problems in the component field, largely because of the miniaturization that they have made possible. Peter P. Grad of the Aerovox Corporation reported that a modification in metallized paper capacitors had resulted in a 50 per cent volume reduction of the smallest available units of this type. At the same time insulation resistance and temperature coefficients have been greatly improved.

An image converter which makes it possible to take a series of photographs of a high-speed event, such as an explosion, with each exposure as short as ten billionth of a second, was described by R. G. Stoudenheimer and J. C. Moor of RCA.

The tube picks up light images by means of a photo-sensitive cathode at one end and transfers the images electronically to a viewing screen at the other end. By



Northern Electric's Brady tries out the Stromberg-Carlson selective radio Pagemaster as Nugent of S-C operates the controls at the master station.

subjecting the tube to an extremely short electrical pulse, the tube can be turned on and then off again almost instantaneously, capturing fast-moving events on the viewing screen where they remain visible long enough to be photographed.

Tests at 40 different locations in California have proved that high mountains can improve the reception of ultra-high-frequency signals, said R. E. Lacy of the Signal Corps Engineering Laboratories, Fort Monmouth, N.J. He said that the signal on the other side would be strengthened by as much as 100 million times. The tests were conducted over a wide range of frequencies above 50 megacycles.

UHF waves bend over mountains

It was deduced, said Mr. Lacy, that uhf radio waves, which act much like light waves, are bent down toward the ground when they pass over sharp mountain ridges, just as light waves are diffracted when passing by the edges of opaque objects.

A session on hi-fidelity drew a capacity audience of about 500. New developments in equipment and measuring techniques were described. Dr. W. E. Glenn of the General Electric Research Laboratory dealt with a new phonograph cartridge designed to give a lighter pressure which prolongs the life of both stylus and record, as well as a reduction in the moving mass of the stylus to about 1/200th that of standard cartridges. A sapphire stylus will last longer in the new cartridge than will a diamond in standard cartridges, said Dr. Glenn.

B. B. Bauer and L. Gunter, of Shure Brothers Inc., Evanston, Illinois, described a new high-fidelity reproducer designed for operation with substantially lowered needle force. Reproducers operating at loads of six to eight grams, they said, will erase the extreme high frequency content of the record and cause a significant surface noise after a few playings. The new reproducer operates in the one-gram range with the use of a jewel bearing to obtain extremely low friction.

So that was the 1957 IRE show. Everyone came away with a different impression because even four days of hard walking, talking and listening at technical sessions, could not cover the whole of the show. But as show manager Will Copp said, "It was all very, very satisfactory." END

Announcing the second annual: **IRE CANADIAN CONVENTION AND EXPOSITION** *Automotive Building, Exhibition Park, Toronto, Canada, October 16, 17, 18, 1957*

ELECTRONICS & NUCLEONICS

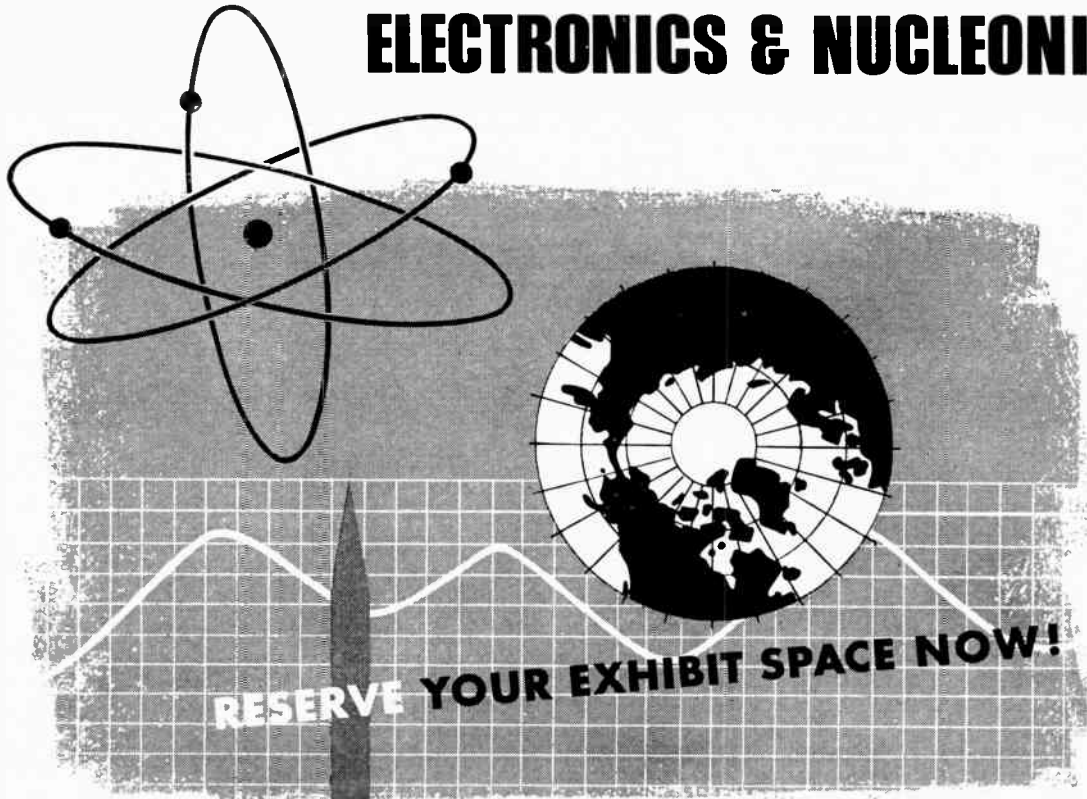

RESERVE YOUR EXHIBIT SPACE NOW!

Enlarged by 25 per cent to meet the demand for more exhibit space! The 1957 IRE Canadian Convention promises to draw an even larger attendance than last year's 10,038 engineers, technicians and buyers.

Now is the time to plan your company's exhibit participation in this great event. Write today for your copy of the brochure.

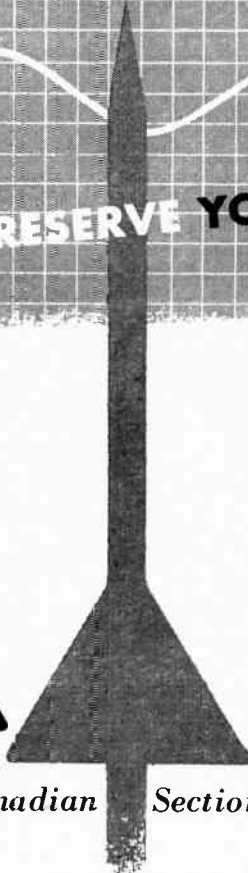

IRE CANADIAN CONVENTION

Sponsored by the Canadian Sections of the Institute of Radio Engineers

Office: 745 Mount Pleasant Road, Toronto 7, Canada
Telephone: HUdson 8-7768

CANADA'S LARGEST SCIENTIFIC CONVENTION AND EXPOSITION

Reliable automation with solid-state devices

The dependable servant

Much of the industry's interest in solid-state science is related to the importance of solid-state devices — particularly electronic devices — to automation. A key function of electronics in automation is control, and the key requirement for control elements is reliability.

Solid-state devices give every promise of providing the ultimate in long life, low maintenance and reliability that will be required if automation is to be a dependable servant instead of a sick relative requiring constant nursing and medication.

For sensing elements there are tiny devices that see, hear, feel and smell. I do not think of a solid that tastes, but it might be made if there were sufficient demand for it.

DR. MALCOLM H. HEBB

Realistic approach of Fowler

This (Fowler) report will not receive universal acceptance. But it undoubtedly represents the most realistic approach to broadcasting problems that could be attained by any body confronted with the same assignment. It reaffirms the place of both public and private broadcasting in a country subjected daily to influences from across the border, figures the cost of keeping a genuinely Canadian system for reasons of retaining a national identity and asks Canadians if they are willing to pay the bill.

THE OTTAWA CITIZEN

Two ways of saying it

It is recognized that talking about education to engineers, who have more than an average share of it, presents some hazards. I recall speaking at the annual meeting of the American Society for Engineering Education on our campus several years ago. The burden of my message was that while we had produced a wonderful array of machines and shiny gadgets, we had not yet achieved peace of mind. The suggestion was that we had been too intense in our teaching of the practical, leading to a worship of the machine and had skimmed in our teaching of the liberal and in our attention to the men who run the machines.

It was not until much later that I learned that Albert Einstein had long since said it better and much more briefly: "Why does this magnificent applied science which saves work and makes life easier bring us so little happiness? The simple answer runs: because we have not yet learned to make sensible use of it."

JOHN A. HANNAH, PRESIDENT
MICHIGAN STATE UNIVERSITY

Battery size of a button

The wide, future application of this atomic-powered battery in personal, portable articles such as miniature radios, hearing aids or even watches is extremely promising.

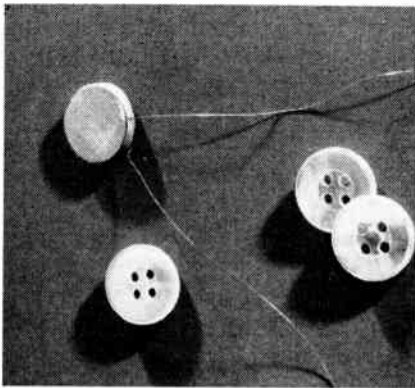

The button-sized battery will make possible for the first time the development of low-power instruments that will function continuously for years, yet require little or no human attention.

A unique feature of the cell is its superior performance in widely varying temperature ranges. This will make the cell highly valuable for use in high altitude rockets and missiles, used both as military equipment or deep space meteorological and radio-logical survey gear.

R. C. MILLER ON ELGIN'S
MIDGET NUCLEAR BATTERY

The art of talking

The success of the lecture does not depend upon the importance and number of points made, the soundness of the logic or the completeness with which the subject has been dealt, but on the answer to this simple question —how much can the average listener

Was Fowler realistic?

Sensible use of science

Bottleneck in the air

A new measurement

Are lectures too long?

tell his wife, if it is a popular one, or an interested colleague, if it is more technical, about the lecture next morning?

It is my impression that the majority of lectures are far too difficult to follow and that the lecturer tries to cram several times as much material into them as can be absorbed by his audience in an hour.

The first ten minutes of a lecture are critical because they give the lecturer his chance to establish contact with his audience.

SIR LAWRENCE BRAGG

A wavelength in height

The accepted Canadian unit of length is the international metre, and our yard is defined in terms of this metre. The international metre will soon be defined in terms of the wavelength of light which would be an indestructible measure. It would seem a natural development then to make our measurements in wavelengths. For a time we shall convert them to English or metric equivalents, but the time may come when we shall say: "Tom is so many wavelengths tall."

S. G. GAMBLE, DEPT. OF MINES

Bottleneck in air traffic control

All of us can remember when a hundred miles an hour was a good top speed for an aircraft. Our airspace was relatively uninhabited and our pilots were certainly uninhibited by regulations and controls. In the space of a few short years all this has changed.

Now we measure top speeds in Mach numbers instead of miles per hour and passengers flown in tens of billions. Increasingly large portions of our airspace are becoming crowded and our traffic control system and airport facilities are becoming growing bottlenecks.

For the first time in aviation history our forward progress is being threatened not by the capabilities of our aircraft or the demands for their use but by our own failure to provide adequate facilities to handle them.

EDWARD CURTIS, SPECIAL
ASSISTANT TO THE U.S. PRESIDENT

NOW—
PORTABLE
ELECTRICITY
 for Work or Play

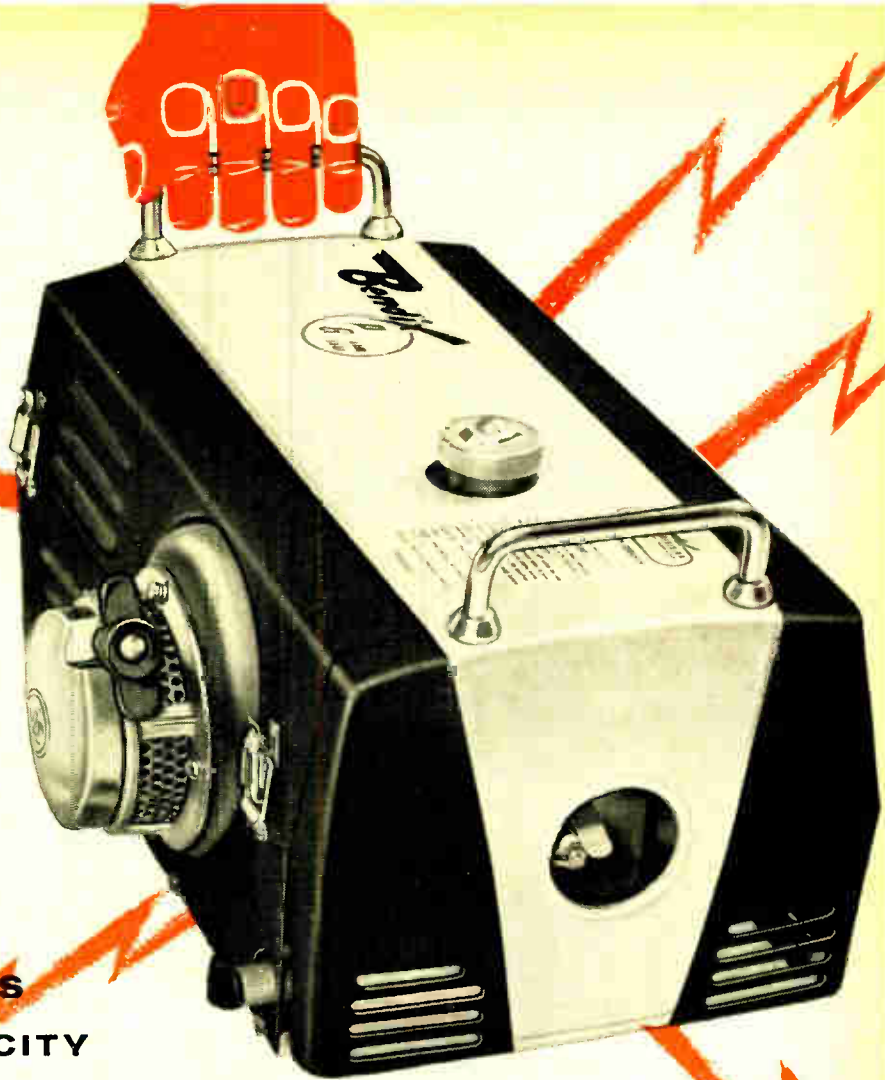

Bendix
 Portable Electric Generator



RADIO COMMUNICATIONS



FOR TRAILERS



ON BOATS



HUNTING AND FISHING TRIPS

PROVIDES
ELECTRICITY
FOR MANY PURPOSES

Weighing only 55 lbs., this small (19" x 11½" x 13") unit can provide you with modern living wherever you go!

Powered by a two cycle, 2 h.p. air-cooled engine, this 110V, 60 cycle A.C. portable generator will produce a power of over 800 watts —enabling you to take your power supply with you.

In emergencies, on trips into the bush, aboard boats or as a convenient power source at remote sites the BENDIX PORTABLE POWER GENERATOR is a MUST!

Write for details and descriptive literature today.

Dealer Inquiries Invited



CIVIL DEFENSE



HOME EMERGENCIES



URING CONSTRUCTION



FOR POWER TOOLS



ON THE FARM

AVIATION ELECTRIC
 LIMITED

200 LAURENTIEN BLVD., MONTREAL, P.Q.

HALIFAX • TORONTO • CALGARY • VANCOUVER

Star gazing with electronics

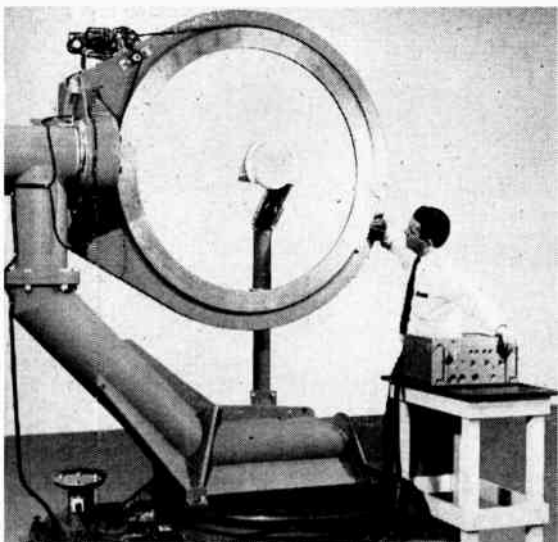

KEEPING RADAR ON THE BEAM

Beam deflection caused by the non-uniformity of plastic radomes lowers radar accuracy. The California Technical Industries Boresight—Error Measuring System tests deflection. Shown is the radome holding fixture which is part of the system.

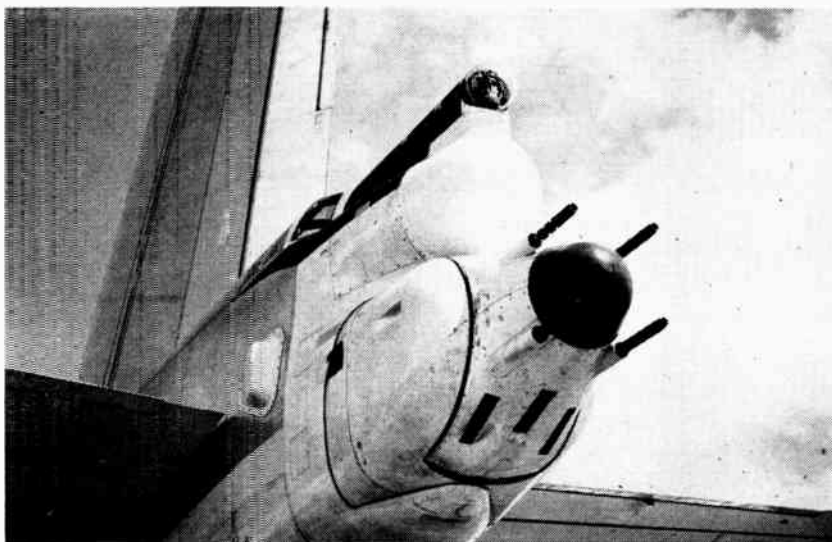

CITE IN THE TAIL

Electronic unit in the tail of the B52 bomber will lay the guns automatically on an enemy fighter. All the gunner has to do is fire a burst from the four guns when the control unit gives him the "on target" signal.

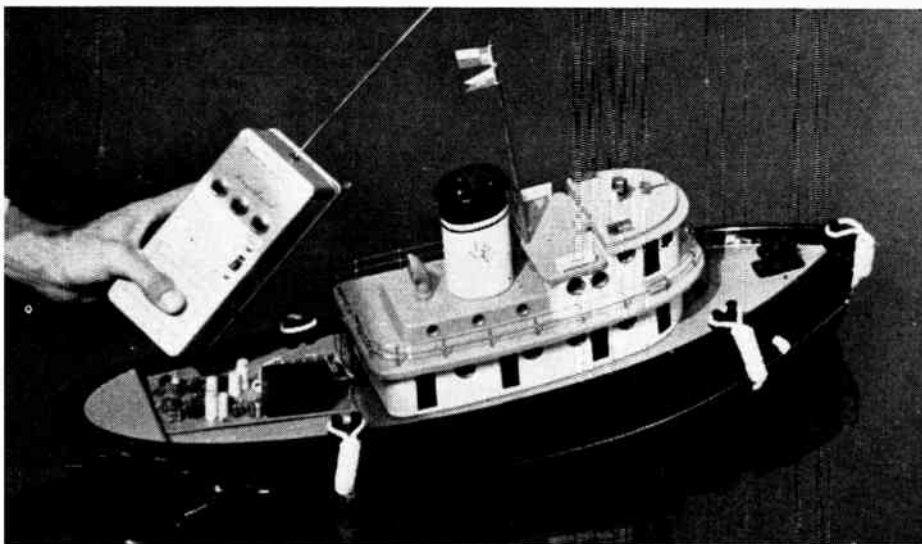

EVERYTHING UNDER CONTROL

A transistorized, radio-controlled tugboat at the Texas Instrument stand drew big crowds during the IRE show in New York. The control unit operated at 27.2 mc. Altogether eleven transistors were used.

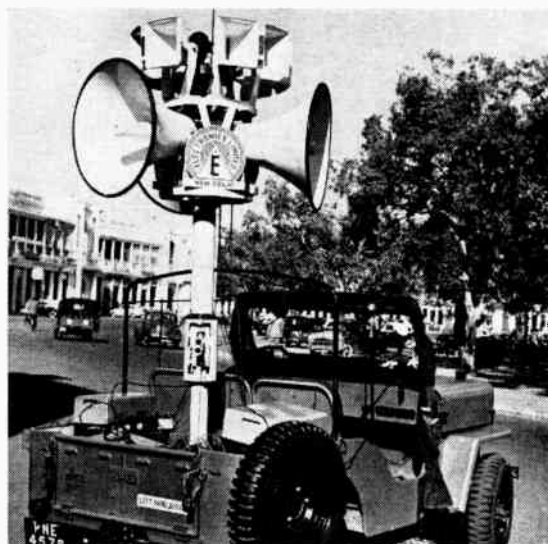

NOISE GETS AROUND

For electioneering in India there is the "Sound Bug," which can make itself heard to thousands. This one, pictured in a square in New Delhi, gives more power than is normally used at Canadian elections.

PICTURE OF THE MONTH

Electronics has come to the aid of the astronomer. Working below the visible spectrum, radio telescopes are providing new information on the structure of the Universe. Shown is a model of the radio telescope antenna for the Dunlap Observatory.

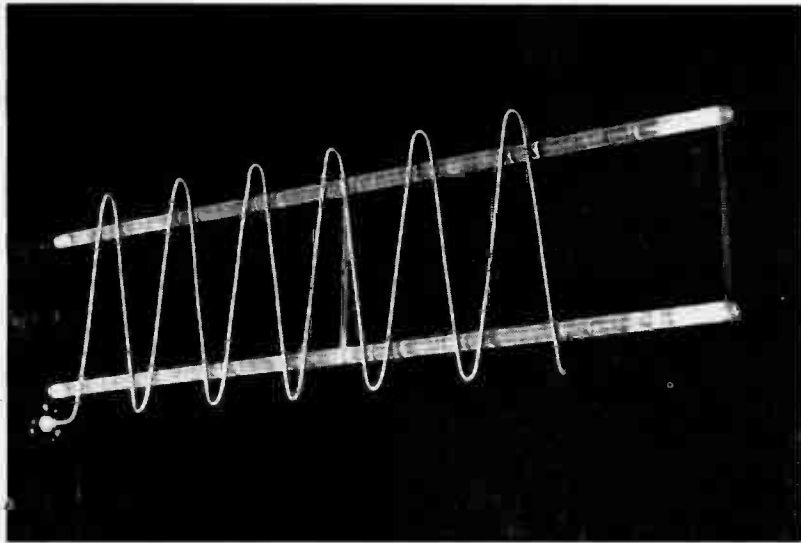

WHAT IS IT?

This sine wave traveling along the parallel rods is a new approach to antenna design. It is a single radiator from the new radio telescope antenna soon to be installed by the University of Toronto at the Dunlap Observatory.

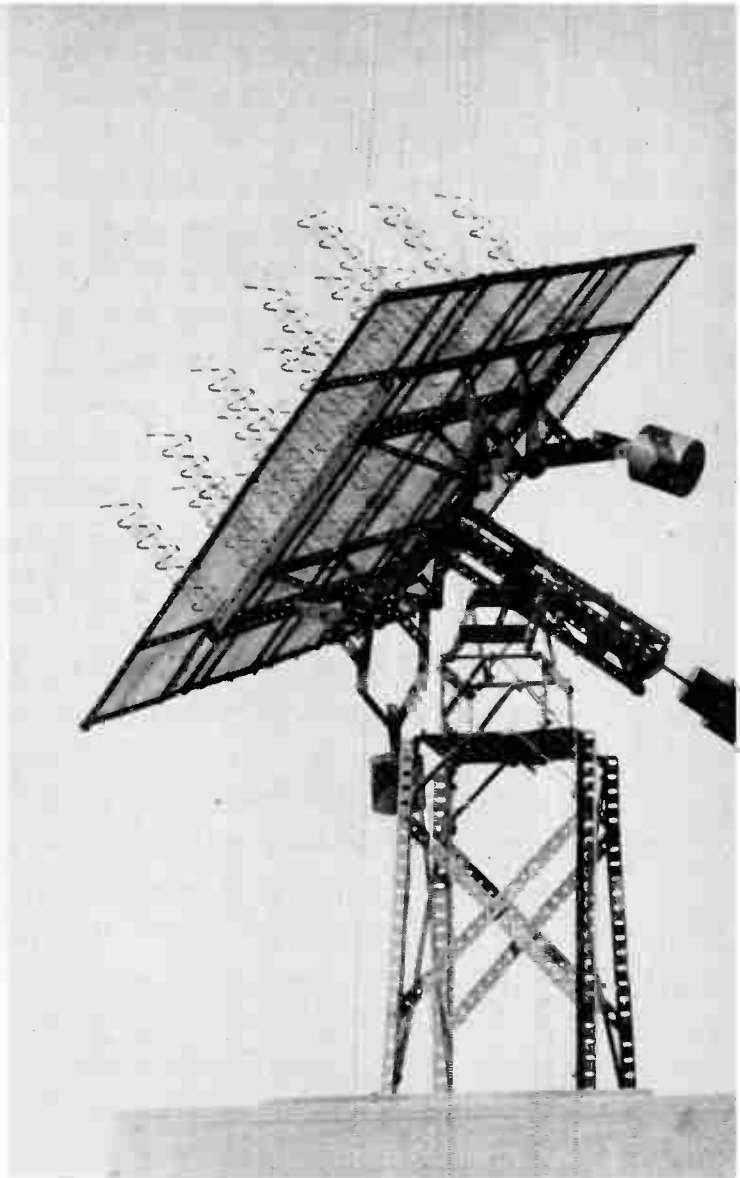

FOR A NEW VIEW OF THE UNIVERSE

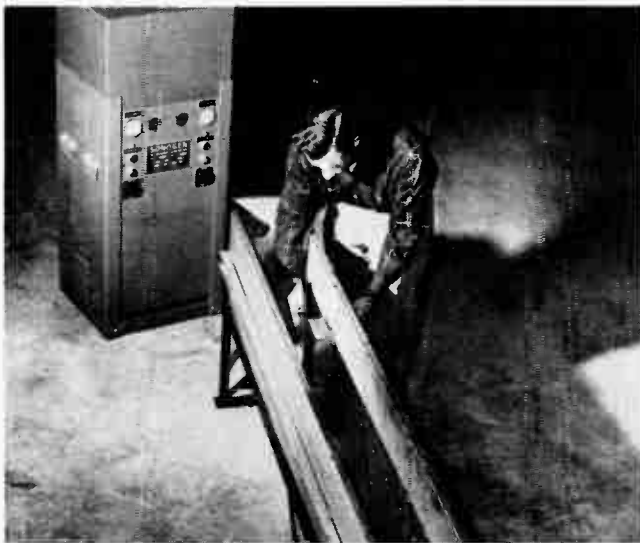

FOR A LONG CLEANING JOB

This 10-foot tank of stainless steel is equipped with 16 transducers for ultrasonic cleaning. Built by Branson Ultrasonic Corporation, Stamford, Conn., it is used for long parts or conveyORIZED systems.



OVER THE HORN WAVES

A traveling camera unit uses a Narda antenna horn instead of the usual parabolic dish. The broader beam from the horn allows a greater error in sighting between transmitter and receiver and reduces panning.

Frequency modulation — and its inventor

The Armstrong story
Understanding electronics
Thermistor manual
Use of transistors
Product catalogues

Frequency Modulation

L. B. Arguimbau & R. D. Stuart.
The Ryerson Press, Toronto, 96 p., \$1.75.

This is another in Methuen's excellent series of monographs on physical subjects, under the general editorship of B. L. Worsnop, B.Sc., Ph.D. This book will appeal primarily to those who are interested in frequency modulation as a system and who wish to discover not merely what its advantages and limitations are but also the fundamental reasons why these arise. It is not however a theoretical treatise. It assumes that the primary object of studying the subject is to produce the best possible practical system.

The first two chapters of the book show how the development of a clearer concept of the frequency-modulated wave freed the subject from the limitations of earlier formal mathematical analysis. The chapters on receivers and transmitters are wisely, considering the size of the book, centred on basic circuits which provide the major operations in the system. A detailed discussion of all types of interference and of how their effects can be minimized is followed by an extension of some of the earlier ideas to the case of picture transmission.

Both as an introduction to the subject and a useful reference work, this little book is certainly value for money. The bibliography comprises 27 items in all, the appropriate references appearing at the end of each chapter. (500)

Man of high fidelity

Lawrence Lessing, J. B. Lippincott Co., New York, 320 p. \$5.00.

This is the biography of Edwin Howard Armstrong, one of the great American inventors who rarely received the recognition which was his due.

Armstrong was the man who gave the world FM radio and before that the regenerative circuit and the super-heterodyne. He was one of the great individualistic inventors, probably the last one, who worked on his own and fought on his own.

This rugged independence may have

had much to do with the disillusionment which marked Armstrong's later years in life. For he spent much of his time and great fortune in long court fights over the protection of his patents. It all ended with a tragic suicide in New York in 1954.

Frequency modulation was first introduced by Armstrong to the IRE in New York in 1935. The transmitter was 17 miles away from the receiver and final tuning was only completed half an hour before the meeting. Just as Armstrong was leading up to the point in his lecture when the demonstration was to be given he was handed a note: "Keep on talking, a generator has burned out." Finally the station came in; but it is only in recent years that the full potentialities of FM have been realized. (501)

Principles of electronics

L. T. Agger B.E., Macmillan Co. of Canada, 340 p., \$3.40.

This is the second edition of a very sound textbook on electronics. It has already proved useful to students as an introduction to the subject. Also it contains much that is of value to others who want to know something of this vast field, including science students interested in electrical technique and practising engineers who, although primarily engaged on electrical power engineering, require some knowledge of electronics in connection with their work.

The book begins with the simple diode valve and develops its study from that point, dealing with rectification, voltage amplification, multi-electrode valves, amplifiers, oscillators, modulation, cathode-ray tubes and photocells.

There are a comprehensive set of problems which will provide useful practice, particularly for the private student, and examples are worked out in the text where it is necessary to indicate the method of approach. (502).

Photoconductors for industry

Infrared-sensitive lead sulphide photoconductors for detection and guidance systems are described in a new bulletin by Electronics Corpora-

tion of America, Cambridge, Mass.

Technical specifications and ordering information is given for four general cell types having a wide range of performance characteristics. Charts for cell response as a function of both wavelength and source temperature are shown.

Lead sulphide semiconductive surfaces have advantages over other radiation-sensitive materials in terms of response, sensitivity, response time, and signal-to-noise ratio, according to the bulletin. Their applications include missile guidance, fire control, aerial mapping, data reduction, and spectroscopy. (503)

Manual on thermistors

For a temperature range from —50 deg. C to 200 deg. C., resistance of copper or platinum, for example, doubles. Over the same temperature range, resistance of thermistors decreases by a factor of 10,000. With some thermistors it is possible to reduce resistance 50% with a temperature increase of 17 deg. C.

Large temperature coefficients and other nonlinear characteristics make thermistors ideal low-cost circuit elements for the measurement and control of minute temperature changes.

To help designers evaluate the circuit possibilities of thermistors, Canadian General Electric offers engineering assistance, and a 54-page technical manual. (504)

Terminal bulletin by Burndy

A complete line of production-installed Fingrip quick-disconnect strip terminals is described in a new four-page bulletin available from Burndy (Canada) Limited. Male, female, and right angle terminals are described for wiring applications in stoves, oil burners, switches, fans, timers, harnesses, and a variety of major and smaller electrical appliances.

The bulletin contains complete test data including pull-out, pull-off, and heat tests, and dimensional and installation information. The Termatic automatic installation machine for production installation of Fingrips is also described. (505)



* with apologies to
Thorne Smith.

TURNABOUT*

Made
in Canada . . .

Sold
in U.S.A.

Here is a Canadian Electronic Product which has built up a healthy American reputation. Welwyn Canada Limited is now one of the largest manufacturers of Deposited Carbon Resistors in the American market.

The Welwyn plant is located in London, Canada, and Canadian users of quality precision resistors can now enjoy all the advantages that result from Continent-wide distribution.

We would be pleased to discuss your requirements with you.



Welwyn Canada Limited

1255 Brydges St., LONDON, Ontario

Sold in U.S.A. through:

Welwyn International Inc., 3355 Edgecliff Terrace, Cleveland 11, Ohio

Transistors to the aid of prospectors

Transistors have been used in the Model 1001 Transcint to reduce weight, increase reliability and reduce power consumption. This radiation detector is gamma sensitive, using a thallium-activated sodium iodide crystal (1¼ in. diam. x 1 in. thick) sealed in silicone fluid. The detecting crystal, photo-multiplier tube (type 6292) and meter are mounted in a pistol type probe which can be removed for detailed survey work, core logging, radiometric assay, etc. For field work the instrument can be carried by means of a shoulder strap with the probe locked in the fiberglass case.

Four hundred hours continuous operation are claimed, using the four "D" flashlight cells. Rechargeable



nickel - cadmium flashlight batteries are available with charger as optional equipment. Eveready type 950 battery supplies the high voltage.

Canadian Aviation Electronics Ltd.
(509)

Transistorized megaphone

Transistors are used exclusively in this new electronic megaphone, resulting in a rugged instrument with an operating cost claimed to be in the order of 2c per hour under normal conditions. An output of 4 watts is available. An accessory bracket may

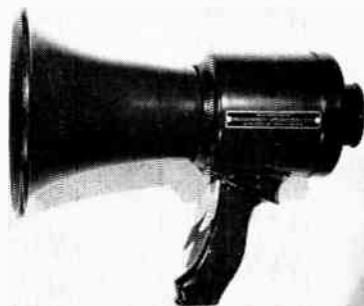

be used for car-top lectern and wall mounting.

Power supply consists of self contained flashlight cells or any 12 volt external supply such as a car or boat battery. Accessory units provide remote operation of several megaphones from a common microphone.

Measurement Engineering Ltd.,
Arnprior, Ont. (510)

Microwave tester

Made originally for measuring the stability of local oscillators in radar sets, the LFE Model 5004 Microwave Stability Tester has applications in any kind of measurement where drift and rate of drift information is needed. At S-Band, the change that can be indicated is less than 2 cps. Readings can be taken instantaneously and monitored continuously. In addition, the output of the instrument may be viewed on an oscilloscope or spectrum analyzer.

The range can be extended by the use of different heads as follows: S-L-band, 1120 mc to 3,200 mc; C-band, 5,200 mc to 6,100 mc; X-band, 7,000 mc to 10,000 mc.

Computing Devices of Canada Ltd.,
Ottawa. (511)

Ruggedized klystron

A new external cavity, pulseable, broad band ceramic klystron has been added to the Polarad Velocitron line. The ZV1009 tube has a continuously variable output frequency from 1,500 to 6,000 mc and rugged internal construction reduces microphonics to a minimum. A ceramic envelope permits operation at elevated cavity temperatures, obviating the need for blower cooling. Although the tube can be operated at higher ratings, it was de-

Lightweight megaphone
Microwave tester
New broadband klystron
Smaller generator
High speed counters

signed as an improved replacement for the type 5836 glass klystron.

Measurement Engineering Ltd.
Arnprior, Ont. (512)

Portable dictation machine

A new 4½ lb. portable dictation machine uses transistors and printed circuits to achieve small size, low weight and low power consumption. The battery powered Peirce Secretary is a complete dictation unit incorporating instant playback and review at any dictation point as often as desired; full context listening with end-of-letter and instruction marking on index slip. The coated Mylar magnetic belt dictation medium holds 15 minutes of dictation and belts may be mailed in ordinary envelopes, filed or reused many times.



A "press-to-talk" and "press-to-listen" microphone control actuates the motor immediately — eliminating warm-up time and extending battery life. Lights indicate when the machine is running and when batteries need replacement.

Peirce Dictation Systems Inc.,
Chicago. (513)

Portable electric generator

A portable (55 lb.) electric generator is now available to provide electricity in areas where power cannot be obtained from other sources. The Bendix Model 110 is powered by a 2 cycle, 2 hp air-cooled engine and will deliver over 800 watts at 110 volts, 60 cps. The engine is equipped with a re-wind starter, muffler and sound absorbing mount. The tank holds ½ gallon of fuel to operate the generator two to three hours, depending upon load, without refilling.

Aviation Electric Ltd., Montreal.
(514)

(Continued on page 70)

RAYTHEON VOLTAGE STABILIZERS

Standard Catalog Models										
Dimensions in Inches										
Catalog No.	Output Capacity Watts	Style	Overall			Mounting		Voltages		Net Wt. Lbs.
			L	W	H	L	W	Input	Output	
VR-6110	15	F	6 $\frac{1}{4}$	2 $\frac{3}{8}$	3	5 $\frac{1}{16}$	5 $\frac{1}{8}$	95-130	115	4
VR-61FO**	15	F	5 $\frac{3}{4}$	2 $\frac{3}{8}$	4 $\frac{1}{8}$	5 $\frac{3}{16}$	4 $\frac{1}{16}$	95-130	6.3	4
VR-61DO**	15	D	3 $\frac{1}{4}$	2 $\frac{3}{8}$	4 $\frac{1}{16}$	2 $\frac{1}{16}$	1 $\frac{3}{16}$	95-130	6.3	6
VR-6710**	25	W	7 $\frac{1}{2}$	3 $\frac{1}{4}$	3 $\frac{3}{8}$	7 $\frac{3}{8}$	1 $\frac{1}{2}$	95-130	6.0	4
VR-6101	30	E	7 $\frac{1}{2}$	3 $\frac{3}{8}$	4 $\frac{1}{8}$	6 $\frac{7}{8}$	2 $\frac{1}{4}$	95-130	6.0/7.5	5
VR-6111	30	E	7 $\frac{1}{2}$	3 $\frac{3}{8}$	4 $\frac{1}{8}$	6 $\frac{7}{8}$	2 $\frac{1}{4}$	95-130	115	5
VR-6111-CP	30	E	7 $\frac{1}{2}$	3 $\frac{3}{8}$	4 $\frac{1}{8}$	6 $\frac{7}{8}$	2 $\frac{1}{4}$	95-130	115	5
VR-6221	30	E	7 $\frac{1}{2}$	3 $\frac{3}{8}$	4 $\frac{1}{8}$	6 $\frac{7}{8}$	2 $\frac{1}{4}$	190-260	230	5
VR-6112***	60	E	7 $\frac{1}{2}$	3 $\frac{3}{8}$	4 $\frac{1}{8}$	6 $\frac{7}{8}$	2 $\frac{1}{4}$	95-130	115	8
VR-6112CP†	60	E	7 $\frac{1}{2}$	3 $\frac{3}{8}$	4 $\frac{1}{8}$	6 $\frac{7}{8}$	2 $\frac{1}{4}$	95-130	115	8
VR-6222	60	E	7 $\frac{1}{2}$	3 $\frac{3}{8}$	4 $\frac{1}{8}$	6 $\frac{7}{8}$	2 $\frac{1}{4}$	190-260	230	8
VR-6113***	120	E	7 $\frac{1}{2}$	3 $\frac{3}{8}$	5 $\frac{1}{8}$	6 $\frac{7}{8}$	2 $\frac{1}{4}$	95-130	115	14
VR-6113CP†	120	E	7 $\frac{1}{2}$	3 $\frac{3}{8}$	5 $\frac{1}{8}$	6 $\frac{7}{8}$	2 $\frac{1}{4}$	95-130	115	14
VR-6223	120	E	7 $\frac{1}{2}$	3 $\frac{3}{8}$	5 $\frac{1}{8}$	6 $\frac{7}{8}$	2 $\frac{1}{4}$	190-260	230	14
VR-6114	250	E	12 $\frac{3}{8}$	5	7 $\frac{3}{8}$	11 $\frac{1}{8}$	3 $\frac{1}{2}$	95-130	115	25
VR-6224	250	E	12 $\frac{3}{8}$	5	7 $\frac{3}{8}$	11 $\frac{1}{8}$	3 $\frac{1}{2}$	190-260	230	25
VR-6115	500	E	12 $\frac{3}{8}$	5	7 $\frac{3}{8}$	11 $\frac{1}{8}$	3 $\frac{1}{2}$	95-130	115	45
VR-6225	500	E	12 $\frac{3}{8}$	5	7 $\frac{3}{8}$	11 $\frac{1}{8}$	3 $\frac{1}{2}$	190-260	230	45
VR-6116	1000	H	13 $\frac{3}{8}$	14 $\frac{1}{8}$	9 $\frac{1}{8}$	11 $\frac{1}{8}$	12 $\frac{1}{8}$	95-130	115	92
VR-6226	1000	H	13 $\frac{3}{8}$	14 $\frac{1}{8}$	9 $\frac{1}{8}$	11 $\frac{1}{8}$	12 $\frac{1}{8}$	190-260	230	92
VR-6117	2000	H	36 $\frac{1}{4}$	14 $\frac{3}{8}$	10 $\frac{1}{8}$	34	12 $\frac{1}{8}$	95-130	115	185
VR-6227	2000	H	36 $\frac{1}{4}$	14 $\frac{3}{8}$	10 $\frac{1}{8}$	34	12 $\frac{1}{8}$	190-260	230	185
VR-7B	2000	C	16 $\frac{1}{4}$	14 $\frac{3}{8}$	11 $\frac{1}{8}$	9 $\frac{1}{8}$	13 $\frac{3}{8}$	115/230	115/230	200
VHF-6114*	250	E	14 $\frac{1}{8}$	13 $\frac{3}{8}$	9 $\frac{1}{8}$	12 $\frac{1}{8}$	11 $\frac{1}{8}$	95-130	115	49
VHF-6115*	500	E	14 $\frac{1}{8}$	13 $\frac{3}{8}$	9 $\frac{1}{8}$	12 $\frac{1}{8}$	11 $\frac{1}{8}$	95-130	115	75
VHF-6116*	1000	E	29 $\frac{1}{4}$	14 $\frac{3}{8}$	10 $\frac{1}{8}$	27 $\frac{1}{8}$	12 $\frac{1}{8}$	95-130	115	150

*Harmonic filtered models. Harmonic content less than 3%.

**Isolated secondary units.

***Available with isolated secondary if desired.

†Portable models, supplied with cord and plug and output receptacle.

FEATURES

1. Deliver accurate AC voltage within $\pm \frac{1}{2}\%$
2. Stabilize output with more precision
3. Regulate better at full load
4. Hold up better under over-load
5. Better no-load to full-load regulation
6. Accept wider input voltage range
7. Less voltage change as units heat up
8. Less change in output as frequencies fluctuate
9. Smaller, lighter, more compact; no moving parts
10. Cost less to operate



STYLE D

STYLE E



STYLE F

STYLE H

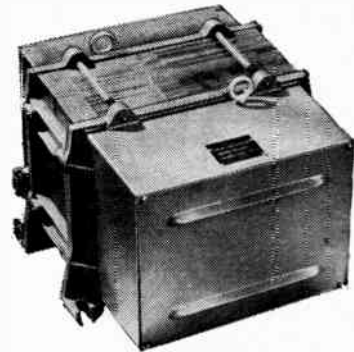
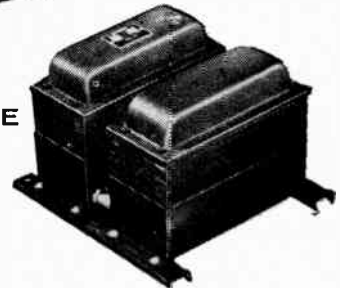

STYLE C

The complete line of Raytheon Voltage Stabilizers is available from Raytheon Canada, Limited. Special custom-built units, ranging from 5 to 10,000 watts are also available to meet special needs. Write for complete information.



A-4029

Excellence in
Electronics

RAYTHEON CANADA LIMITED

61 Laurel Street East, Waterloo, Ontario

CANADIAN MARCONI EQUIPMENT AVAILABLE THROUGHOUT THE WORLD



*pioneer research
and
production skill
have won
world-wide
recognition for*

Canadian Marconi electronic and communications equipment

*For further information please address
inquiries to head office:*

**WORLDWIDE AFFILIATIONS
AND REPRESENTATION**

- Micro-wave and radio relay equipment
- Marine radiotelegraph and radiotelephones, Direction Finders, Fish-finding equipment, Depth recorders, Radar, and other marine electronic apparatus
- Broadcast & TV Station equipment and receivers
- Electronic tubes and components
- Transistor microphones, Automatic Direction Finders, and other aviation electronic equipment.
- Mobile and point to point equipment.

**2442 Trenton Avenue,
Montreal 16, Canada.**

CANADIAN MARCONI COMPANY



MONTREAL 16, QUEBEC

CANADA'S LARGEST ELECTRONIC SPECIALISTS

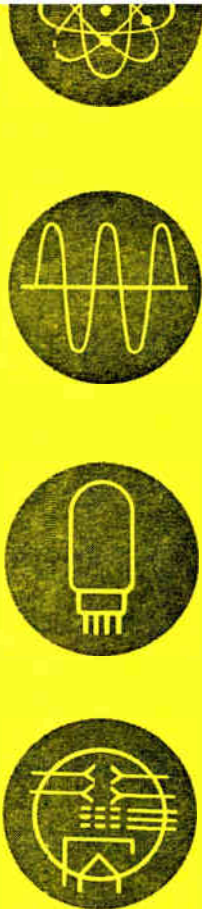

product information free

Use this special Reader Service Card to get all the latest information on products, methods and ideas.

Just enter the key number and fill in your name and address.

Postage is paid.

For advertisements the key number is on the Index-to-Advertisers page. For new equipment, literature, it follows the item.

ELECTRONICS ENGINEERING

please send information on the following items:

name _____

position _____

company _____

address _____

BUSINESS REPLY POSTCARD

No postage necessary if mailed in Canada



FIVE CENTS POSTAGE WILL BE PAID BY

ELECTRONICS ENGINEERING

481 University Avenue,
Toronto 2, Ontario



product information free



BUSINESS REPLY POSTCARD
No postage necessary if mailed in Canada

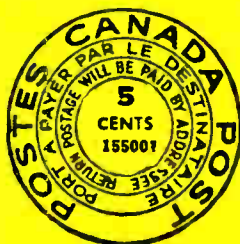

FIVE CENTS POSTAGE WILL BE PAID BY

**ELECTRONICS
ENGINEERING**

481 University Avenue,
Toronto 2, Ontario



**ELECTRONICS
ENGINEERING**

please send
information
on the
following
items:

name _____

position _____

company _____

address _____

Use this special Reader Service Card to get all the latest information on products, methods and ideas.

Just enter the key number and fill in your name and address.

Postage is paid.

For advertisements the key number is on the Index-to-Advertisers page. For new equipment, literature, it follows the item.

A 130-mile Westinghouse "proving ground" has been set up between Hamilton and Kinmount, Ontario. Here Westinghouse engineers obtain actual operating results to assist you in planning your communication system.

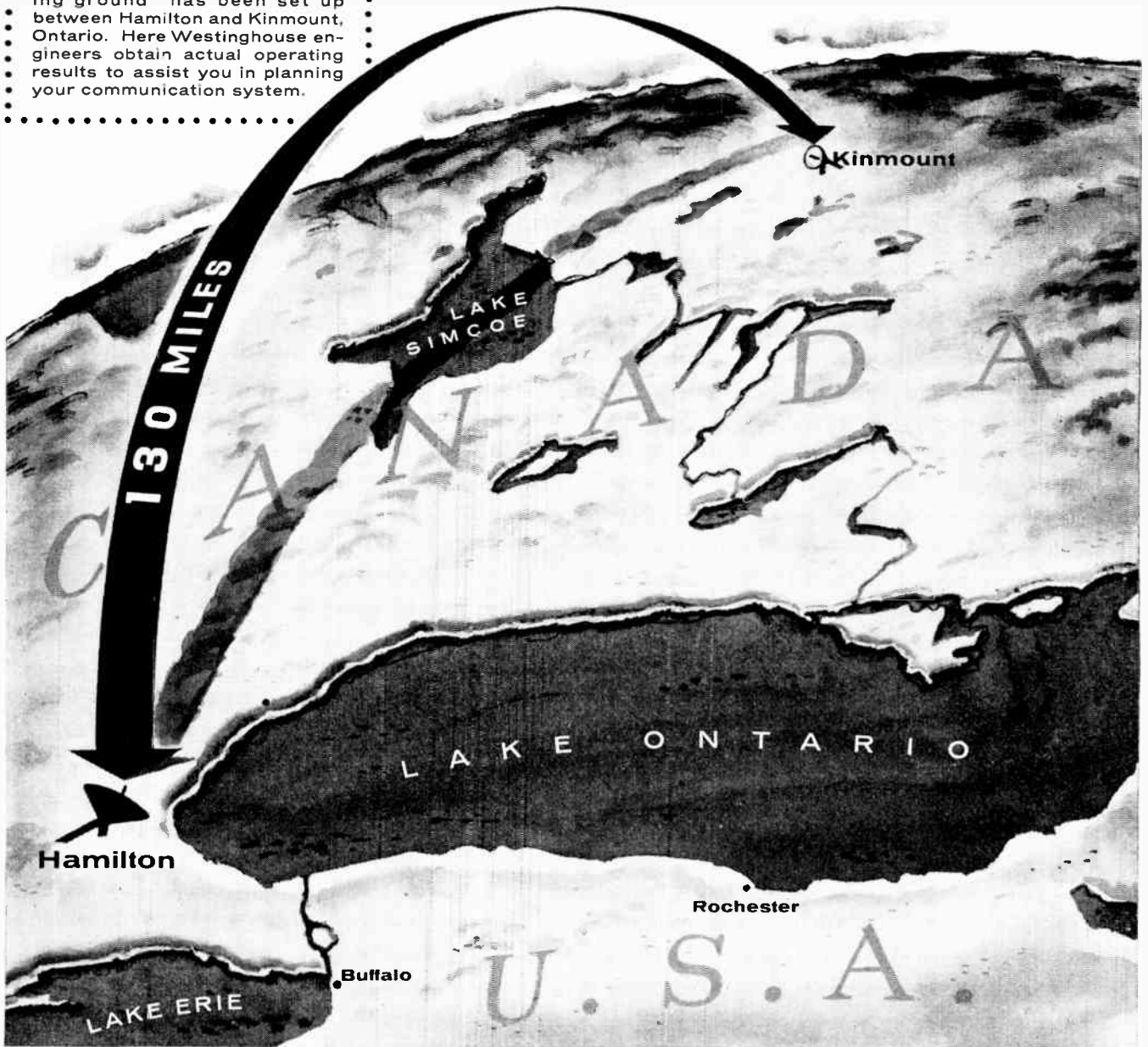

ANOTHER WESTINGHOUSE FIRST!

57-8-745

SHF "Scatter" Transmission

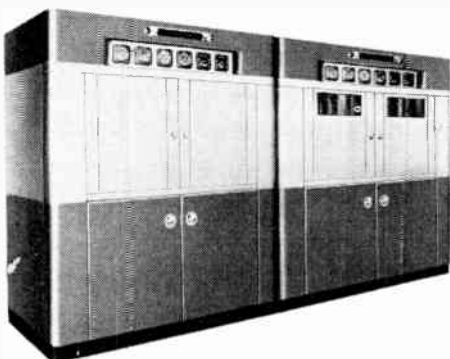

New Westinghouse 4400-5000 mc. Transmitting and Receiving Equipment is compactly and durably designed for truck mounting or fixed installation for either commercial or military application.

• Now for the first time in the communications field, scatter equipment for super-high frequency transmission for fixed or transportable operation has been introduced by Canadian Westinghouse.

The new Westinghouse "Scatter" communications equipment is designed for high quality, high reliability transmission of voice, teletype, telemetering, facsimile, television and data signals over hops of 100 to 200 miles. Voice capacity for multi-channel operation extends to 120-150 channels.

Contact your local Westinghouse Sales Office for Descriptive Bulletin H83-100 or write Canadian Westinghouse Company Limited, Electronics Division, Hamilton, Canada.

WATCH WESTINGHOUSE ELECTRONICS

...WHERE BIG THINGS HAPPEN FIRST

Enjoy Television's Top Dramatic Show, Westinghouse **STUDIO ONE**, every Monday at 10:00 o'clock

Computer will study heat in cables

(Continued from page 64)

A computer is now commercially available for the study of heat transfer problems in electrical cables. This analog computer allows the determination of the temperature rise at given times and at various locations in and outside the cable upon the application of a prescribed load cycle. This

eliminates complex calculations and saves time in the design and analysis of cable systems according to the manufacturer.

In use, the thermo constants of the cable and its surroundings are represented by the electrical constants of an R-C network. These are set up

by means of front panel controls together with the required load conditions. The latter can be in the form of a 24-hour load cycle. The thermo behaviour is then studied at pre-selected points and times by the aid of a VTVM, whereby one hour of actual time normally corresponds to one second of computing time.

Addison Electric Co. Ltd., London, England. (515)

Three universal bridges

Three universal bridges have been announced by A/S Danbridge for use in laboratories and shops to measure resistance (impedance), capacitance and inductance.

The model UB3 (shown) operates from a line supply of 220 or 110 volts at 40 to 60 cps. Model UB2 is battery operated and Model UB1 is a laboratory-type bridge requiring external power supply, indicator, etc.

Model UB3 contains the requisite standards, generator, amplifier and detector for both ac and dc measurements, with jacks provided for con-



nection to an external generator, ac detector or galvanometer. In addition to the R-L-C measurements the dissipation factor of capacitors and the Q-factor of coils may be measured.

There are seven ranges: resistance, 0 to 3 megohms with minimum 5 milliohms; inductance, 0 to 300 henrys with minimum 0.5 microhenries; capacitance, 0 to 300 microfarads with minimum 0.5 mmf; dissipation factor, 0 to 0.01 and 0 to 0.1; Q-factor, 1 to 10 and 0.1 to 1.

The J. W. Ellis Industries, Toronto 1. (516)

High speed stroboscope

A new high-speed stroboscope, the CML model 1201-B has recently been introduced into Canada. Major features include measurement of speed from 480 rpm to 72,000 rpm without the use of sub-multiple frequencies; and the location of the light source at the end of a four foot cable which allows it to be placed close to the work.

(Continued on page 73)

SEND THIS COUPON NOW

for complete information on

LM ERICSSON

MINIATURE, LONG-LIFE TUBES

2C51/396A	407A	5591/403B
5842/417A	5847/404A	6028/408A
6927/6J6L		6928/6AQ5L

- 10,000 hour lifetime for most types
- Quality and performance tested
- Ruggedized—mechanical robustness far exceeds international standards
- Specially selected high quality materials throughout
- Available from stock

ERICSSON

TELEPHONE SALES
OF
CANADA LIMITED

Ericsson Telephone Sales of Canada Limited
130 Bates Road, Montreal, 8, P.Q.

Please send me full information on your long life electronic tubes.

Name:

Company:

Address:

City: Prv:

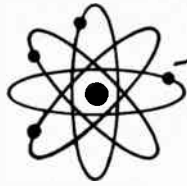

"Betameter"
introduces
Atomic Age
Quality Control
using

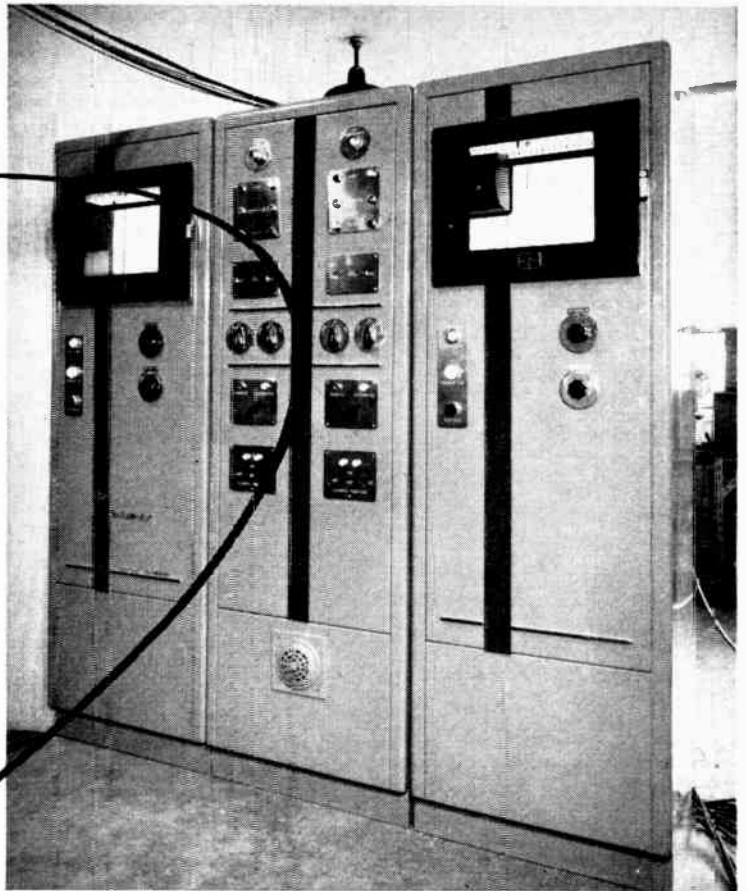

BRISTOL INSTRUMENTS

One of the electronic scientists' newest aids to industry, is the "Betameter" developed by Isotope Products Limited, Oakville, Ontario. This unique instrument utilizes radioactive material from the Chalk River pile to detect and control even the most minute product variations.

Using this Canadian development, paper makers, strip mills for steel and copper, plastic, linoleum and rubber manufacturers, all over the continent, are able to achieve a degree of product uniformity previously impossible. For instance, in bonding rubber to fabric in tire production the "Betameter", illustrated above, provides high precision

control of the thickness of the rubber. In this, as in other applications, Bristol provides the instrumentation which enables variations in radiation to be translated into recorded information. This is acted on, in turn, by Bristol controls which instantaneously and automatically adjust the production processes to maintain absolute uniformity.

Wherever there is a problem involving recording, measuring or controlling, Bristol can provide the dependable, economic answer. Get in touch with us—we will be pleased to make a specific survey, report and estimate.

B73

The **BRISTOL** *Company of Canada Limited*



TORONTO • MONTREAL • HAMILTON • VANCOUVER

HALIFAX
A. R. Williams Machinery Co. Ltd.

FORT WILLIAM
M. F. Mills Supply Limited

WINNIPEG
Filer-Smith Machinery Co. Ltd.

EDMONTON-CALGARY
Gorman's Ltd.

M E A S U R E M E N T O F I N D U S T R I A L P R O G R E S S

**WHAT DO
YOU
WANT
IN A TESTING METER**



The
**MODEL
8**

Avometer

GIVES YOU . . .

- Automatic cutout protection
- 20,000 ohms per volt movement
- 4 ac current ranges to 10 amps.
- 7 dc current ranges to 10 amps.
- 14 ac-dc voltage ranges to 2500 v.
- 3 resistance ranges zero to 20 megohms
- 4 easy-to-read scales
- polarity reversing button
- anti-parallax mirror
- external accessories for increased ranges.

ACCURATE • PORTABLE • LIGHTWEIGHT

R.H. Nichols LIMITED
2781 DUFFERIN STREET • TORONTO

DEPT. EN5

542A

ELECTRONICS ENGINEERING

is read by engineers engaged in electronics — at management, design and application levels — in these fields:

- | | |
|----------------------------------------------------------------------------------------------------------------------------------------------------------------------------------------------------------------------------------------------------------------------------------------------------------------------------|-------|
| 1. Manufacturers of Electronic Equipment & Components, Radio, Television & Communications Equipment | 2,350 |
| 2. Telephone & Telegraph Companies | 1,248 |
| 3. Public & Privately Owned Utilities (operations & communications personnel) | 979 |
| 4. Radio & Television Stations, Recording Studios | 525 |
| 5. Government (National Research Council, Defense Research Board, Atomic Energy, Dept. of Transport, Armed Services) | 525 |
| 6. Airline, Railway & Steamship Communications, Federal, Provincial & Municipal Police | 250 |
| 7. Universities & Private Research Laboratories | 248 |
| 8. Industries using Electronic Equipment in Manufacturing & Processing—Oil, Mines, Chemicals, Pulp & Paper, Automobile Plants, Textile, Rubber, etc. | 697 |
| 9. Hospitals | 381 |
| 10. Distributors of Electronic Equipment | 145 |
| 11. Engineering Firms & Individual Engineers | 558 |
| 12. Manufacturers incorporating electronic equipment in their finished product—Aircraft, Shipbuilders, Elevators, Machinery (Pulp & Paper, Machine Tools, Steel Mill Equipment, Packaging Machinery, Rubber Processing Machinery, Food & Drug Processing Machinery, Printing Machinery, Textile Machinery, etc.) | 587 |

TOTAL 8,493

New products news

Stop-motion stroboscope

(Continued from page 70)

Four speed ranges are available: 480 to 1,800 rpm, 1,700 to 6,000 rpm, 5,500 to 21,600 rpm, 20,000 to 72,000 rpm. There are all fundamental frequencies.



Calibration consists of 285 deg. dial rotation with a 100 division linear scale. Calibration chart curves can be read to 1% and the over-all accuracy is claimed to be better than $\pm 3\%$ over long periods of time.

A resonant reed actuated by the 115 volt power line is provided to enable the user to check the calibration on 60 cycle multiples and sub-multiples.

Measurement Engineering Ltd.,
Arnprior, Ont. (517)

Subminiature accelerometer

Endevco Corporation have announced a New Model 2216 accelerometer which mounts completely within a $\frac{3}{8}$ inch hole. Accurate vibration measurements to 10,000 cps are claimed by mounting it right in the device being tested, in addition to the usual surface mounting. This subminiature model, 0.635 inches high, provides 5 millivolt per G sensitivity with a natural frequency of 50,000 cps. Temperature characteristics are flat $\pm \%$ from 30 deg. F to 230 deg. F.

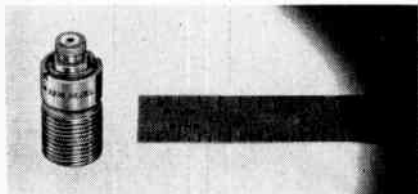

These wide range specifications, plus small size and weight (only 8 grams) are claimed by the manufacturer to resolve many problems in accurate measurement of vibration and shock

(Continued on page 74)

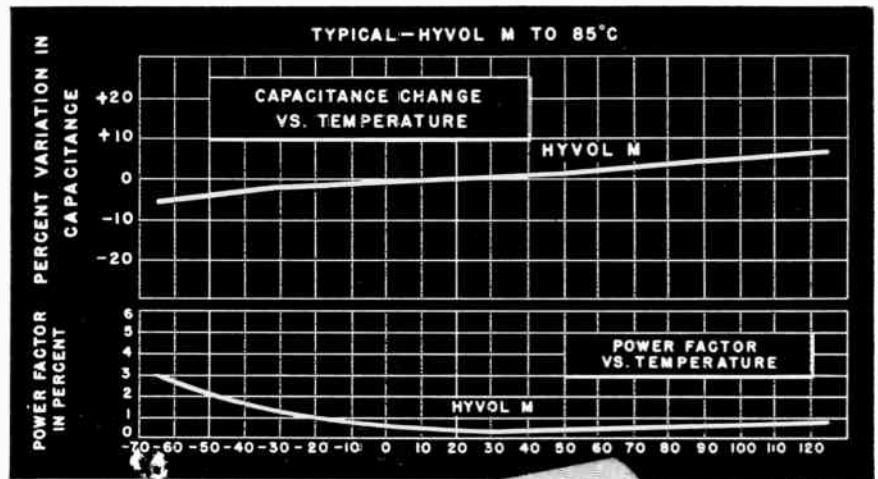

For the *Best* in
PAPER TUBULAR performance...

AEROVOX

Type P84 CM

CERAMIC-CASED CAPACITORS

Duramics (Aerovox Type P84 CM) combine quality and economy for engineers and designers seeking performance above that of conventional tubulars. Consider these features:

- Encased in dense steatite-grade ceramic tubing.
- Newly developed end-seals firmly adhere to ceramic tubing and wire terminals. Will not soften or flow, over unusually wide temperature range.
- Terminal lead wires will not work loose or pull out, under most severe operating conditions.
- Ceramic casing and end-seals provide exceptional protection against humidity.
- Rated temperature range of -55°C to $+85^{\circ}\text{C}$.
- Withstand a 250-hour humidity-resistance test as per REC-118.

Make your own tests. Write and ask us for a free sample of a Type P84 CM Duramic.



AEROVOX CANADA LIMITED

HAMILTON, CANADA

Manufacturers of fixed capacitors for all radio, TV, and electronic equipment.

Western Sales
Chas. L. Thompson Ltd., Vancouver, B.C.
In U.S.A.
Aerovox Corporation, New Bedford, Mass.

RF probe covers wide range

(Continued from page 73)

phenomena even under very limited space conditions. The accelerometer is supplied with adapters for surface mounting on vibration tables or devices being tested, and a matching $\frac{3}{8}$ inch tap for mounting within a device under test.

Computing Devices of Canada Ltd.,
Ottawa. (518)

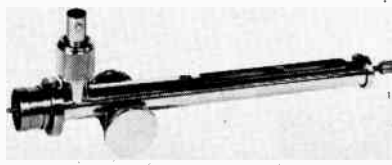

The Narda model 229 tuneable RF Probe is now available. Included is

an optional detector for use with all waveguide and coaxial slotted lines provided with a standard $\frac{3}{4}$ in. diameter mounting hole. Insertion loss is claimed at 25 db or less for most slotted lines.

The model 229 has a fine wire probe adjustable in depth over a wide range by a fine-pitch threaded knob. This is an extension of the centre conductor of a coaxial line which is provided with shunt and series tuning elements for tuning the probe pick-up over the range of 900 to 18,000 mc. These are two probe outputs.

A detector output, which takes a BNC series connector, has provision for a standard microwave crystal, series IN21 or IN23, or a Narda N-610B Bolometer. The r-f output allows the Probe to be used with microwave receivers or other internal detectors.

Measurement Engineering Ltd.,
Arnprior, Ont. (519)

CW, FM and AM Signals "All the Way Up" (10-470 mc/s)

with a MARCONI TF 1066 FM/AM SIGNAL GENERATOR

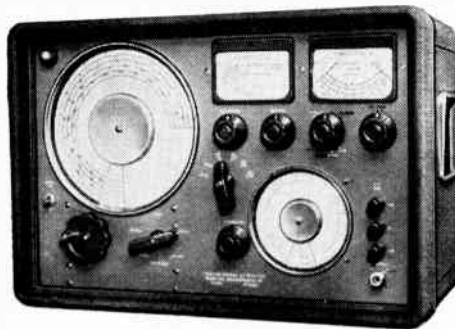

Sturdy light-grey cellulose finish
Dark-grey moulded plastic control knobs
Dimensions: 14½" x 23½" x 10½"

- Outstandingly high frequency stability — *less than 0.005%* drift, after reaching thermal equilibrium
- Continuous coverage from 10 - 470 mc/s in *FM and AM*
- Incremental tuning directly calibrated in Kc/s *regardless of carrier frequency* permitting small and precise changes in carrier frequency
- Frequency modulation *accurately indicated* on easy-to-read 0 - 20 Kc/s and 0 - 100 Kc/s meter scales
- Amplitude modulation up to 80% — indicated in the same manner
- Accessories available include 6 db pad, 20 db pad, 50 ohm unbalanced to 300 ohm balanced matching unit, and d-c isolating unit

Also available is the "premium" TF1066/1 similar to the above, but having 0.0025% drift and a switched incremental frequency control.

The above are only a few of the advanced electronic engineering features incorporated in these new Marconi Signal Generators. For complete specifications, write or wire today.

Marconi



CANADIAN MARCONI

COMPANY — MONTREAL 16, QUEBEC

Canada's Largest Electronic Specialists

Wide range precision dc supply

The Model 301C precision dc supply has been designed for a wide range of output voltages and currents with maximum regulation. The manufacturer lists the following specifications: Output voltage from 1.02 to 1012

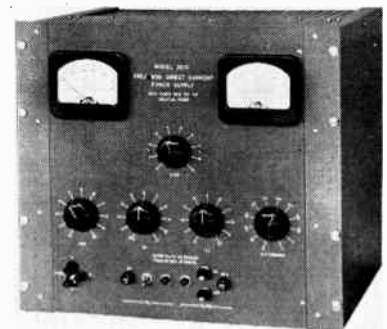

volts dc 0 - 400 ma. Positive, negative or floating ground. Resolution better than 0.5 mv at any output voltage. Calibration accuracy better than $\pm 0.1\%$.

Regulation better than 0.005% for 10% line voltage change or 200 ma load current change. Long term stability better than 0.01% per day.

The supply is chopper stabilized and referenced against a standard cell. It is equipped for removable cabinet for bench or rack mounting.

John Fluke Manufacturing Company Inc., Seattle. (520)

Stepping synchro

Development of a precision stepping synchro has been announced by G. M. Giannini & Co. Inc. Utilizing an electro-mechanical positioner to drive
(Continued on page 76)

STEDIVOLT Output Remains Constant

Regardless of • • • Changes of Load • Line Voltage Changes
• Power Factor • Waveform • Frequency Changes



While many stabilizers compensate for line voltage variations they do not compensate for the effects of changing load. Stedivolt regulators maintain *constant voltage independent of load* from zero to full rated output. Waveform distortion is often important . . . Stedivolts introduce *zero* distortion.

NO RE-SET—Should power supply drop or rise beyond the wide Stedivolt control range, the unit will still supply maximum correction. Even after a power shutdown the unit will still continue to operate at the selected output voltage without resetting.

EASY TO MAINTAIN—Separate control circuit fusing permits unregulated power to be fed to load without interruption should faults develop. All parts accessible from front. No relays . . . no thyratrons . . . only 3 tubes.

Specifications Model P17 Stedivolt

	For 115V Supply		For 230V Supply	
	Series	Parallel	Series	Parallel
Jumper Connections				
Input voltage range for 115 (or 230) V regulated output . . .	95-136	105-126	210-251	220-241
Output voltage adjustment range for nominal 115 or 230V input	98-141	107-128	213-256	221-243
Load Rating	30 amp	60 amp	30 amp	60 amp
KVA	3.5	7	7	14
Regulated output accuracy . . .	0.5%	0.5%	0.5%	0.5%

Other Stedivolt regulators now in production include units from 1 KVA up, rack mount styles, 3 phase models and 400 cycle units. Ask for details.

Manufactured in Canada by George Kelk Limited



R-O-R ASSOCIATES LIMITED
290 Lawrence Avenue W., Toronto 12

your future in microphones . . . TODAY!

ASTATIC

FUTURA

DYNAMIC MICROPHONES



Model 788 mounted on Desk Stand Model A-8

High Fidelity Dynamic Professional Microphones, Specially Designed for Telecasting, Broadcasting, Recording, Public Address and Communications



Floor Stand



Hand

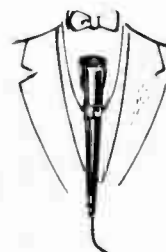

Lavalier

Here is a dramatic new concept in microphone design . . . the incomparable "FUTURA" series! Striking beauty, all-around versatility, and electronic engineering of the highest quality are combined in each of these slender, distinctive instruments. Never before has any one series of microphones brought so many startling "firsts" to the industry!

FIRST with high fashion-styling . . . non-reflecting satin black finishes . . . brushed chrome or gold trim . . . subtle color touch for a new note of smartness.

FIRST with diaphragm made of Du Pont "Mylar", newest and strangest of plastic films, to provide the ultimate in shockproof, weatherproof construction.

FIRST with Astatic "quick connect" adaptors to permit permanent cable installation . . . take the mike to the cable!

Now available at your Jabbers or write to

CANADIAN **ASTATIC** LIMITED

2273 Danforth Ave., Toronto 13, Ont.

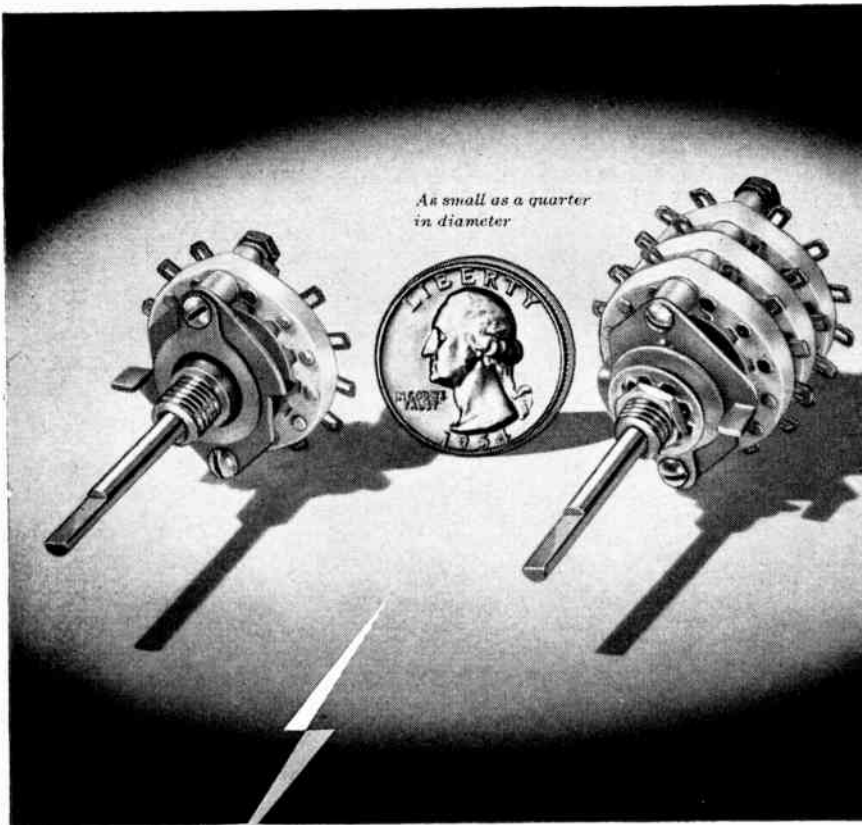

Multiple switching sequences

in a switch only 15/16" in diameter

For military and commercial applications...





Guided missiles

Band-switching in extra-small electronic equipment

Transistor circuits

Aircraft instruments

Centralab Series 100 Sub-Miniature Rotary Switch

-  A lightweight, ultra-small switch with the electrical rating of larger switches.
-  Available up to 12 positions. Make and break, resistance load, 1 ampere at 6 volts d.c.; 150 milliamperes at 110 volts a.c.; current-carrying capacity, 5 amperes.
-  Sections are ceramic — Centralab Grade L-5 Steatite. Wafers can be stacked up three sections per shaft.
-  Meets the corrosion-resistance requirements — and exceeds the insulation resistance — specified by MIL-S-3786.

Write for Technical Bulletin EP-73 for complete engineering data.

P-2756

Centralab Canada Ltd.

804 Mt. Pleasant Rd, Toronto 12, Ontario

A DIVISION OF GLOBE-UNION INC.

984E East Keele Avenue • Milwaukee 1, Wisconsin
In Canada: 804 Mt. Pleasant Road, Toronto, Ontario



VARIABLE RESISTORS



ENGINEERED CERAMICS



SWITCHES



PACKAGED ELECTRONIC CIRCUITS



CERAMIC CAPACITORS



SEMICONDUCTORS

New products news

Packaged circuits

(Continued from page 74)

the rotor of a differential synchro in fixed increments of one degree, these instruments produce an ac output that is synchronous with rotor position. Rotation of the mechanism is unlimited in both directions and is operated by an electrical input pulse at any speed up to 60 degrees per second.

Known as the Model 89161A-1, this stepping synchro incorporates the Giannini Rotostepper. The shaft output of the Rotostepper is adapted to position the rotor of the precision differential synchro.

G. M. Giannini & Co. Inc., Calif. (521)

Packaged electronic circuits

Packaged electronic circuits have been used in a new TV receiver to combine a complete plated circuit and so achieve simplicity.



By replacing 97 components with 17 Packaged Electronic Circuits, a reduction of 20% in area and 90% in wiring has been accomplished on a new Motorola TV receiver. These small group units not only save space — they reduce manufacturing costs and facilitate servicing.

Centralab, Milwaukee. (522)

Directional couplers cover big range

Four new models of 10 db coaxial directional couplers, covering a range of 225 to 4,000 mc, have been announced by the Narda Corp.

All four models, 3000-10, 3001-10, 3002-10 and 3003-10 take series N female connectors. Machined from solid blocks of aluminum, they provide flat coupling over a full octave frequency range with low VSWR.

All models have a maximum primary line VSWR of 1.15 and a power rating at peak of 1 kw. Models 3000-10, 3001-10 and 3002-10 have a for-

(Continued on page 78)

Canadian designed and
Canadian manufactured

ANTENNAS
FILTERS
DUPLEXERS
MICROWAVE EQUIPMENT

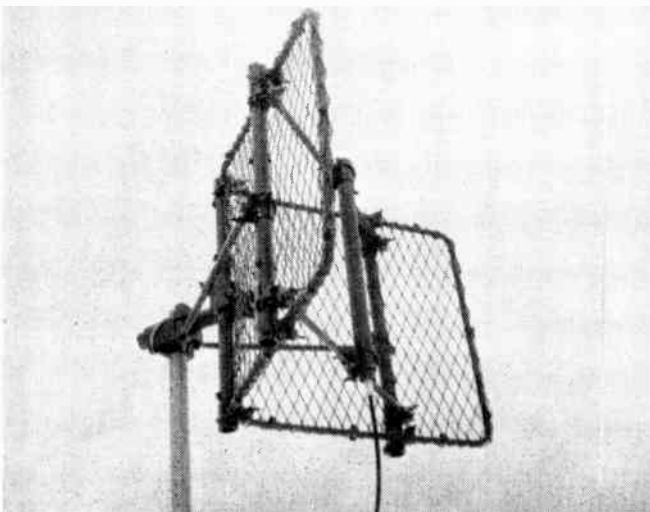

Sinclair Radio Laboratories is a Canadian owned and operated firm engaged in the design, development, and manufacture of all types of communications antennas and related equipment. Facilities are available for development and research work on antennas for aircraft, ships, microwave links and mobile communication systems.

Consulting service is offered on systems design and propagation problems.

Write or telephone for catalogues and technical information.

SINCLAIR RADIO LABORATORIES
LIMITED

70 Sheffield Street

Toronto 15

Tel. CH 4-5519

FREE
this informative
Die Casting Book

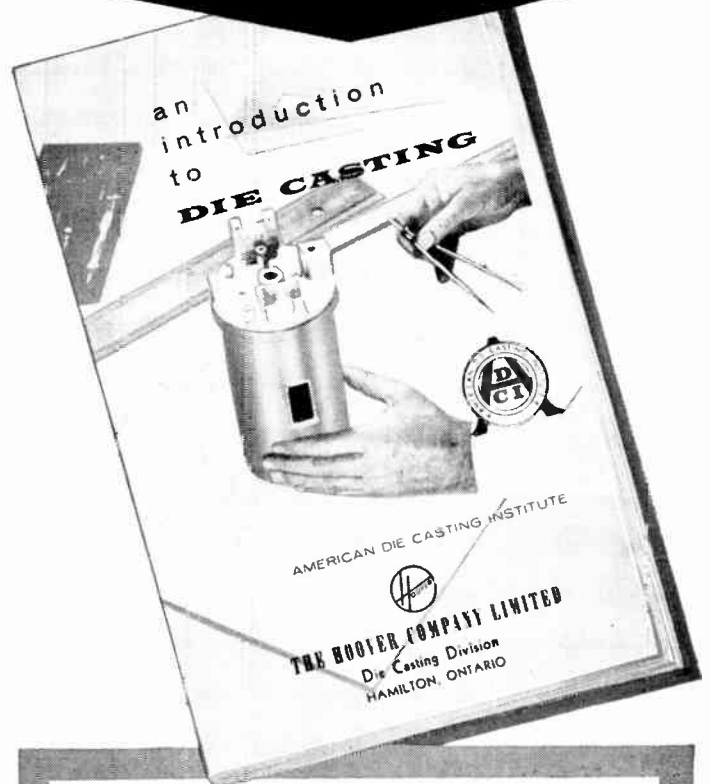

PRODUCT REFINEMENT—and subsequent cost reduction—often is simply achieved through application of Hoover Aluminum Die Castings. To help manufacturers, design engineers and production personnel become better acquainted with the various aspects of the Die-Casting process, Hoover offers this 29-page booklet without obligation. It contains a glossary of terms used, rules governing design, and the various advantages and limitations. To get your free copy, just fill in and mail this coupon . . .

HOOVER DIE CASTINGS BOOK,
P.O. Box 128, Station B,
Hamilton, Ontario.

Please send, without obligation, your 29-page booklet
"An Introduction to Die-Casting".



NAME _____

POSITION _____

COMPANY _____

ADDRESS _____

E.E.

Marine radio-telephone has six channels

(Continued from page 76)

ward power rating of 200 watts ave. and a reverse of 2 watts ave. Model 3003-10 has a forward power rating of 2,000 watts ave. and a reverse of 20 watts ave.

The coupling values are claimed to be within one db of nominal value over the specified range. Calibration charts are provided to ± 0.2 db accuracy. Coupling increases below the specified range at approximately 6 per octave. Directivity exceeds and remains above 20 db for all models except 3003-10 for which the directivity decreases below 2,000 mc.

Measurement Engineering Ltd.,
Arnprior, Ont. (523)

Adaptable marine radiotelephone

Designed primarily for marine use, the "Starfish" PCL-50 radiotelephone can also be adapted for use as a land station. It is capable of 52 watts RF power output with a choice of six crystal controlled channels in the fre-

quency range of 1.6 to 6.5 mc. The "Starfish" incorporates a non-blocking input circuit and a clipping and filter system allowing close range communications and greater voice power.

It is suitable for bulkhead or table mounting and has a separate power supply. It measures 12½ in. wide by 17 in. high by 8 in. deep and weighs 53 lb.

The "Starfish" is available for 12, 32, 110, 220 volts d-c and 117 volts a-c. It has been type-approved under specification 110 for compulsory-fitted vessels.

Pye Canada Ltd. (524)

Shielded cable tap connector

Single or multiple taps, from either the front or the back can be accommodated in the Uniring connector. Designed for rapid installation on shielded or coaxial cable, the connector is composed of a one-piece combined inner and outer ring and nylon insu-



lation. Assembly is by crimping.
Burndy of Canada Limited. (525a)

Swiss impulse counters

A comprehensive range of impulse counters manufactured by the Sodeco Co. in Geneva is now available in Canada. They are available with either dc or ac counting coils in voltages ranging from 2 to 260 volts and operating currents as low as 6.7 ma.

The J. W. Ellis Industries, Toronto.
(Continued on page 80) (525)

"MEL SALES" SERVES YOU WITH

***TECHNICAL ASSISTANCE**



In the application of products of these and other American firms: (please request complete listing)

- Acton Laboratories Inc.
- Electro-Measurements Corp.
- Krohn-Hite Corporation
- Kay Electric Co.
- Narda Co-operation
- Polarad Electronics Co-operation
- Post, Electronics Products Division
- Sanders Associates Inc.
- Sensitive Research Instrument Corporation

The MEL Sales team is trained in many aspects of the following fields:

- Basic instrumentation
- Communications
- Environmental testing
- High frequency through microwave
- Infra-red and invisible light systems
- Laboratory and production instrumentation
- Phase measurement
- R.F. Alignment
- Servo techniques
- System simulation
- Telemetering

"WRITE FOR OUR NEW PRODUCT LISTING"

HEAD OFFICE

ARNPRIOR,
ONTARIO, CANADA
PHONE 400



SALES

A DIVISION OF
MEASUREMENT ENGINEERING
LIMITED

BRANCH OFFICE

POST OFFICE BOX 50,
DON MILLS, TORONTO
ONTARIO
HICKORY 4-8172

In QUARTZ CRYSTALS



play it safe

specify **SNELGROVE**

*A Canadian owned, owner operated
company with an enviable reputation
for service and quality.*

C. R. Snelgrove Co. Limited

141 Bond Ave., Don Mills (TORONTO) Ont.

CANADA'S FOREMOST FREQUENCY CONTROL SPECIALISTS

— LICENSED BELL SYSTEM PATENTS

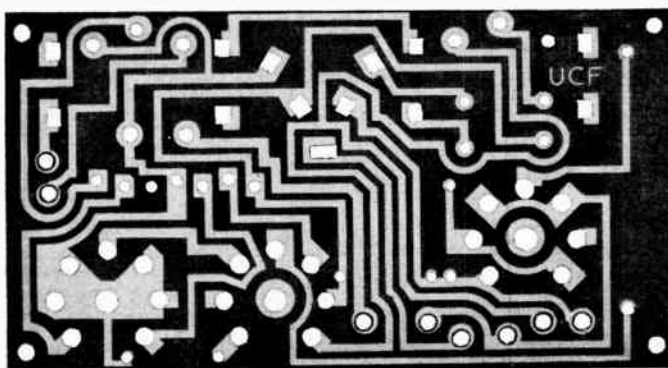
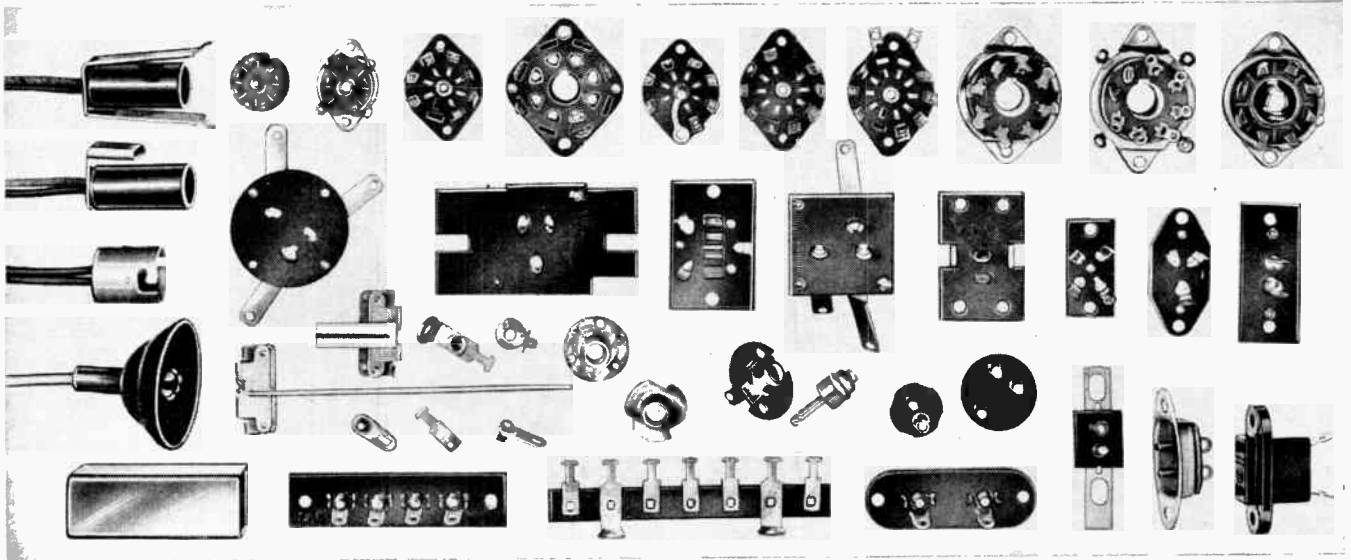

**Standard Parts for Radio
and Television,
plus Printed Wiring Boards
and Components.**

WRITE FOR FREE INFORMATION TO:

**UNITED CARR FASTENER COMPANY OF CANADA LIMITED
HAMILTON • CANADA**

QUALITY ELECTRONIC PRODUCTS

Commercially Designed
and many accepted for

A/N Nomenclature without change



Model RAC
RHOMBIC
ANTENNA
COUPLER
Bulletin 112

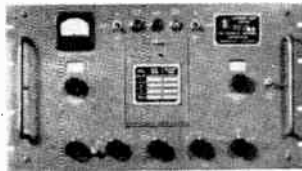

Model XFK
FREQUENCY SHIFT EXCITER
Bulletin 118

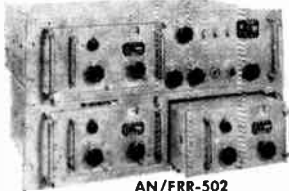

AN/FRR-502
COMMUNICATIONS
Model FFR
RECEIVER
Bulletin 124



AN/CU-50131/SRR Model AMC-6
ANTENNA MULTICOUPLER Bulletin 155

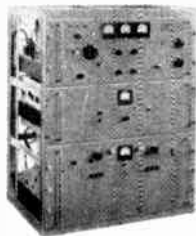

Model GPT-750
COMMUNICATIONS
TRANSMITTER
Bulletin 174



Model GPR-90
COMMUNICATIONS RECEIVER (General)
Bulletin 179

Full detailed information on each of these products is available in special Sales Bulletins. Request by bulletin number which appears with each unit.

TMC products serve commerce, amateur radio, and the special needs of the Armed Forces. Write for bulletins on HF Transmitters and Receivers, Diversity Receiving Equipment, Remote Control Systems, Precision Oscillators, Frequency Shift Terminals, Tone Channelling Equipment, Broadband Receiving and Transmitting Transformers, and Antenna Multicouplers.



T.M.C.
(CANADA) LTD.

In U.S.A. ...
TECHNICAL MATERIEL
CORPORATION
MAMARONECK, N.Y.

P.O. BOX 1006
BILLINGS BRIDGE
OTTAWA, ONT.

New products news

Rectifier handles the tough jobs

(Continued from page 78)

The Eimac type 2-450A rectifier has been designed for use in rectifier units or special application where conditions of extreme ambient temperatures, high operating frequency, or high peak inverse voltages prevent the use of gas-filled tubes.

The type 2-450A has a maximum d-c current rating of 1 ampere and a maximum peak inverse rating of 25,000 volts. Maximum peak plate current rating is 8 amperes.

Over-all height is 14 3/32 in. and the diameter is 4 1/2 in. Maximum plate dissipation is 450 watts.

Ahearn & Soper Co. Ltd., Ottawa.
(526)

UHF TV tuner

New 13-channel turret-type tuners are now being used in Canadian Admiral TV receivers. Conversion to UHF can be accomplished easily without sacrificing any of the regular 12 channels.

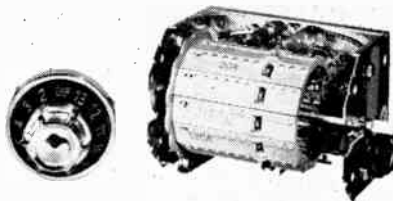

Conversion is accomplished by installing a UHF tuning strip in the open channel.

Canadian Admiral Corp. Ltd. (527)

Sturdy electronic multimeter

The model NE No. 7-20-M Electronic Multimeter is a compact, portable meter for measuring the rms values of ac voltage from 0 to 150 volts, dc voltages from 0 to 1,000 volts and dc resistance from 0 to 1,000 megohms. An rf adapter is furnished to extend the range into the values of rf voltages up to 40 volts rms with frequencies up to 500 mc. The over-all accuracy of the instrument is claimed to be $\pm 4\%$ in ohms, $\pm 5\%$ in dc volts and $\pm 6\%$ in ac volts.

The unit is housed in a gasket sealed aluminum case for protection against moisture or mechanical damage.

Computing Devices Of Canada,
Ltd., Ottawa. (528)

Twelve digit printer

Converting electronic count information into printed form is the purpose of this new CMC Model 400A digital printer. It features rapid print-out, parallel entry, and up to 12 digit printing without the use of stepping switches. It can be connected directly to other electronic counting instruments and will print, on standard adding machine tape, the total count accumulated by the basic instrument during each of its counting periods.

The printer has been designed to operate from 4-line 1-2-2-4 binary code.

Electromechanical Products, Agincourt, Ont. (529)

INSTRUMENTATION ENGINEERS

Excellent opportunity and interesting work is available with our rapidly expanding organization handling special electronic instruments and components. We require:

Sales Engineers
Service Technicians
Telemetering Systems Engineers
System Application Engineers
System Design Engineers

All replies and inquiries held in strict confidence. For further information write, phone or visit:

A. G. SHACK
Electromechanical Products
Markham Road and 401 Highway, Agincourt,
Ontario. Phone: Bus. AX. 3-7011, Home AX.
3-5761.

"INDUSTRIAL"

Automaton PRINTED CIRCUIT SOCKET

First socket designed expressly for AUTOMATION ...

Patent Pending



- EASY INSERTION** • Bullet nose terminals provide for easy location and insertion.
- MECHANICAL LOCK-IN** • Notches in terminals provide for locking of sockets into chassis. Will not loosen with vibration or handling.
- PERFECT SOLDER JOINT** • Round terminals contact copper foil on entire circumference of chassis hole.
- RIGID TERMINALS** • Will not deform in shipping or handling.
- Opening between socket and chassis provides for good heat dissipation. Available in 7 and 9 pins; also available with tube shield clip.

Samples and information on request.

INDUSTRIAL HARDWARE

Manufacturing Company, Inc.
109 PRINCE ST., NEW YORK 12, N.Y.

ELECTROLYTIC CAPACITORS



TWIST PRONG MOUNTING

Type RTP. Any capacity-voltage combination up to 4 sections supplied to order with standard or printed circuit mounting dimensions. Hermetically sealed aluminum can: 1" or 1 3/8" diam.

WAX FILLED CARDBOARD TUBULARS

Type CBT. Unexcelled quality, long life where high temperature ratings not required. Made to any specifications feasible in this class. All capacity-voltage combinations up to 4 sections.



DALY-ARROW LIMITED

140 KENDAL AVE.

TORONTO 4, ONT.

STARK MODEL 9-66

1st choice

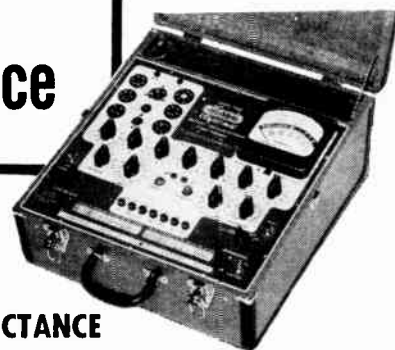

because it's
the only true
DYNAMIC
MUTUAL CONDUCTANCE
TUBE TESTER

- Dual Meter Readings, English and True Micromho in Three Ranges: 0-3,000—6,000—15,000
- Tests all Present Day and Future Tubes
- Gas Test for Rapid Disclosure of Tubes affecting AVC and IF stages
- Noise Test
- Uses Rectified Current to Energize both Plates and Grids, using Two Rectifiers.
- Tests Grid Controlled Rectifier Tubes, used in Industry
- Tests complete complement of 600 mil Series of Tubes
- Provides Vital Life Test
- Facilities for checking of CRT tube with adaptor
- Correctly Tests Gas-filled Rectifier and Starter Tubes



STARK ELECTRONIC INSTRUMENTS LTD.
Factories and Sales Office: Ajax, Ont.
Foreign Division: 276 West 43rd Street
New York 36, N.Y., U.S.A.
PHONE AJAX 125

Standardized
Electronic Hardware

Immediate Deliveries

COMPLETE REPRESENTATIVE STOCK of world's largest selection of standardized electronic hardware manufactured by USECO now warehoused in Toronto. Supported by factory inventory of 21 million pieces. Also prompt service on etched circuits and standard and special terminal boards.



LAKE ENGINEERING COMPANY

767 Warden Avenue, Scarborough, Ontario, Canada. Telephone PL 7-3253

This paper is a business paper—one of 100 trade . . . technical . . . service . . . and management publications covering every section of Canadian business and industry.



WHEN YOU WANT TO TALK BUSINESS
USE A BUSINESS PAPER

BUSINESS NEWSPAPERS ASSOCIATION

OF CANADA

137 WELLINGTON ST. W., TORONTO, CANADA



LABORATORY STANDARD
INDICATING HYGROMETER

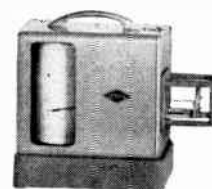

MICROHYGROGRAPH

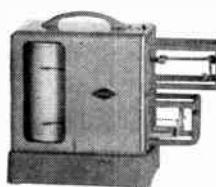

HYGROTHERMOGRAPH



HUMIDITY · TEMPERATURE
RECORDER CONTROLLER

SERDEX

HYGROMETRIC INSTRUMENTS

The most broadly used instruments in their field in laboratory research work and industrial efficiency studies and production.

Serdex instruments are unqualifiedly guaranteed as to accuracy for one year. We are proud of our ability to give this guarantee—it has accompanied every instrument bearing our name and is unmatched in this field of instrumentation.

Descriptive circular with prices and specifications on request.

91 Cambridge Street, Boston 14, Mass.

SERDEX

* ITEM OF THE MONTH

In stock — ready for immediate shipment

SYLVANIA ELECTRONIC TUBES



2N242
POWER
TRANSISTOR

- Microwave Crystal Diodes
- Transistors
- TR and ATR Tubes
- Gos Pressure Measuring Tubes
- Travelling Wave Tubes and Solenoids
- Magnetrons
- Klystrons
- Rocket Tubes
- Decade Counter Tubes
- Trigger Tubes
- Waveguide Windows

Available at

HACKBUSCH ELECTRONICS LTD.

Call or Write:—

23 Primrose Avenue

TORONTO, ONTARIO

LENNOX 1-2453

Another Esco First!



For the first time anywhere—a Radio Parts Catalogue devoted solely to the specialized electronic components and devices used in the Industrial, Military, Laboratory and Engineering fields. Ensure getting your FREE copy of this unique and informative book — write us today!

free!

Industrial Catalogue No. 56T

ELECTRO SONIC
SUPPLY CO. LTD.
543 YONGE ST., TORONTO 5
WA. 4-9301



MEET A NEW MEMBER OF OUR FAMILY

The 1/2" diam. 1/3 Watt Variable Composition Resistor, designed and produced to Military Specifications.

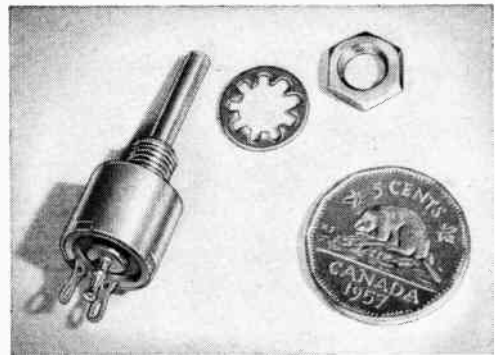

Manufactured entirely in Canada

by

**PRECISION ELECTRONIC COMPONENTS
(1956) LTD.**

50 Wingold Ave.

Toronto 10, Ont.

Write for further information

TRANSFORMERS by ATLAS

Hermetically Sealed & Encapsulated

- Power Transformers to 10 KVA
- Filter Reactors
- Smoothing Chokes
- Charging Reactors
- Audio Matching Transformers
- Audio Output Transformers
- Pulse Transformers
- Power Supplies

JCNAAF-T-19 & MIL-T-27 Specifications

**CANADIAN ATLAS TRANSFORMER COMPANY
LIMITED**

17 CARLAW AVE., TORONTO

Phone HO. 1-5513

HOME STUDY COURSES in all branches of ENGINEERING



105 page book, "Engineering Opportunities" describes in detail over 90 courses in engineering and academic subjects — aeronautical, A.F.R.Ae.S., Civil, A.M.I.C.E., mechanical, A.M.I. Mech.E., radio, electronics, electrical, industrial management, etc. courses compiled by world authorities. Individual or group training. Send for your copy free of cost or obligation to-day.

Canadian Institute of Science & Technology, Limited
Dept. 000 263 Adelaide St. West, Toronto, Ontario.

NAME.....
ADDRESS.....



Advertiser's Index

101	Aerovox Canada Ltd.	73
102	Ahern & Soper Co., Ltd., The	4, 24
103	Automatic Electric Sales (Canada) Ltd.	26
104	Aviation Electric Ltd.	59
105	Bristol Company of Canada Ltd.	71
106	Brush Electronics Co.	17
107	Burndy (Canada) Ltd.	13
108	Canadian Atlas Transformer Ltd.	82
109	Canadian Astatic Ltd.	75
110	Canadian Institute of Science & Technology Ltd.	82
111	Canadian Line Materials Ltd.	14
112	Canadian Marconi Co. (Montreal)	66, 74
113	Canadian Marconi Co. (Toronto)	21
114	Canadian Westinghouse Co. Ltd.	16, 69
115	Canadair Ltd.	IFC
116	Centralab (Division of Globe Union Inc.)	76
117	Clare & Co., C.P.	83
118	Collins Radio Company of Canada Ltd.	IBC
119	Computing Devices of Canada Ltd.	OBC
120	Daly-Arrow Ltd.	81
121	Daystrom Ltd.	15
122	Decca Rada (Canada) Ltd.	12
123	Eitel McCullough Inc.	4
124	Electronic Associates, Inc.	23
125	Electro Sonic Supply Co. Ltd.	82
126	Ericsson Telephone Sales of Canada Ltd.	70
127	Federal Wire & Cable Co. Ltd.	2
128	Hackbusch Electronics Ltd.	82
129	Herring & Co. Ltd., John	22
130	Hewlett Packard Co.	11
131	Hoover Co., The	77
132	Industrial Hardware Mfg. Co. Inc.	80
133	IRE Canadian Convention	57
134	Lake Engineering Co. Ltd.	81
135	Measurements Corp.	20
136	M.E.L. Sales (Division of Measurements Engineering Ltd.)	78
137	Nichols Ltd., R. H.	72
138	Precision Electronics Components (1956) Ltd.	82
139	P.S.C. Applied Research Ltd.	8, 9
140	Pye Canada Ltd.	25
141	Raytheon Canada Ltd.	65
142	R.O.R. Associates Ltd.	19, 75
143	Serdex Inc.	81
144	Sinclair Radio Laboratories Ltd.	77
145	Snelgrove & Co. Ltd., C. R.	79
146	Standard Telephone & Cables Mfg. Co. (Canada) Ltd.	10
147	Stark Electronic Instruments Ltd.	81
148	Texas Instruments, Inc.	6
149	T.M.C. (Canada) Ltd.	80
150	United Carr Fasteners Co. of Canada Ltd.	79
151	Welwyn Canada Ltd.	63
152	Wickman Ltd., A. C.	17



NO CONTACT WEAR OR BOUNCE

Contacts of CLARE Mercury-Wetted Contact Relays are constantly renewed. By capillary action, like that of a lamp wick, a new film of mercury coats each contact with every make and break.

The magnetic switch is hermetically sealed in a high-pressure hydrogen atmosphere in a glass capsule. Surrounded by the operating coil, the capsule is enclosed in a vacuum-tube-type steel envelope.

Unlike ordinary relay contacts, these contacts never wear down; never get dirty; never lock or weld; never get out of adjustment; never chatter.

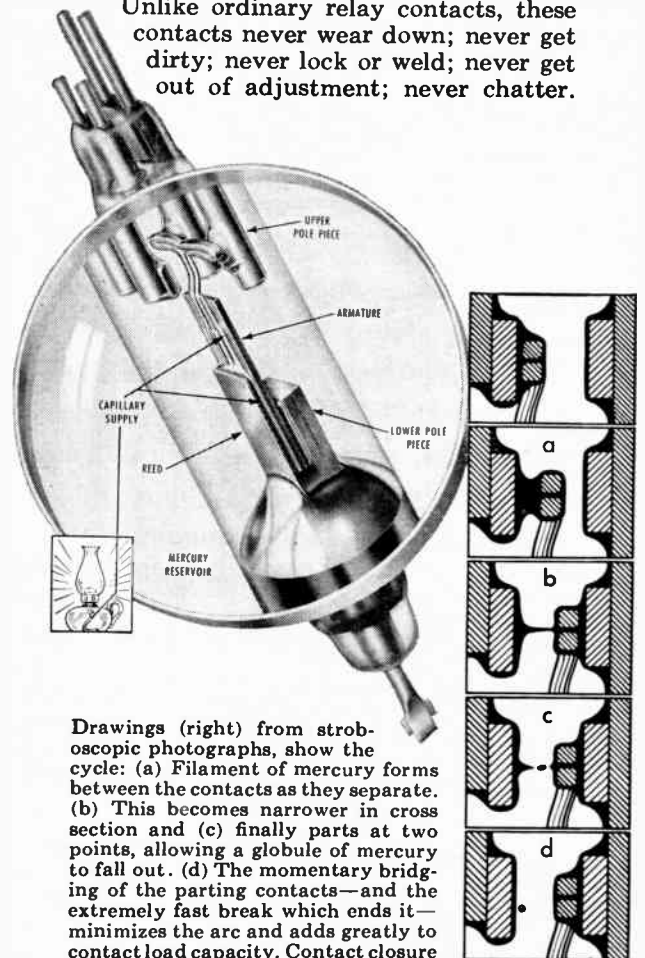

Drawings (right) from stroboscopic photographs, show the cycle: (a) Filament of mercury forms between the contacts as they separate. (b) This becomes narrower in cross section and (c) finally parts at two points, allowing a globule of mercury to fall out. (d) The momentary bridging of the parting contacts—and the extremely fast break which ends it—minimizes the arc and adds greatly to contact load capacity. Contact closure between the two liquid surfaces bridges any mechanical chatter and prevents any chatter from appearing in the electrical circuit.

● Send for Clare Engineering Bulletins Nos. 120 and 122. Address: C. P. Clare & Co., 3101 Pratt Blvd., Chicago 45, Ill. In Canada: C. P. Clare & Co., 659 Bayview Ave., Toronto 17. Cable Address: CLARELAY.

CLARE RELAYS
FIRST in the industrial field

Translators will spread TV to thousands

Canada should soon be experiencing a small TV boom. Thousands of homes, at present in blind areas, will be able to view programs from satellite stations, known in the industry as translators. These are stations that pick up programs off the air and retransmit to an area where normal reception is not possible.

Present weak signal areas are caused either by natural barriers, such as mountains, or by the distance to a primary station. The translator located at the most favorable area possible, and with antenna and receiving apparatus generally out of reach financially to most home viewers, converts the primary station's weak signal into a powerful UHF signal.

Most makes of translator contain automatic code station identification equipment and an automatic on-off switch unit controlled by the master broadcast signal.

Size of the area to be served depends on the height of the transmitting antenna but generally a radius of ten miles can be obtained. This is with a maximum of 100 watts ERP allowed by the Canadian Department of Transport.

Only Canadian programs

In its specification on translators the Department of Transport says that double side band transmission will be allowed only when there is no possibility of interference with other services in the lower adjacent spectrum space.

Translators can only be set up to transmit with the consent of the primary stations concerned and no re-broadcasting of the transmission of any station outside Canada will be allowed.

Many translators are operating in the States. In Utah the state authorized accumulated tax funds to be used to instal a translator. Cost of one is reckoned in the \$8,000-\$10,000 region.

Human engineering institute develops new attitudes

McGill University's Applied Psychology Centre have announced a Human Engineering Institute, planned for design engineers, to be held at the Centre on Sept. 9-20, 1957. Under the general planning of Dr. Reg. B. Bromily, chief of Applied Psychology Section, Defence Research Medical Laboratories, the course will be directed by Dr. Chester H. Baker, experimental psychologist, Defence Research Board.

Additional members of the teaching staff are drawn from Defence Research Medical Laboratories and the University of Toronto. Dr. N. H. Mackworth, Director of the Applied Psychology Unit of the Medical Research Council (England) will be guest lecturer for two days.

An intensive course

The Institute is intended to develop fresh attitudes toward problems of industrial design and will introduce class members to the technical literature in the area commonly called human engineering. This is one of the short intensive courses designed to supplement formal academic education and in-company staff development programs which McGill have been holding for the past ten years.

The fee of \$375 includes all supplies.

EVENTS FOR YOUR DIARY

May

- 7-17 Instruments, Electronics & Automation Exhibition, Olympia, London, England.
- 13-15 IRE National Conference on Aeronautical Electronics, Dayton, Ohio.
- 14-16 Industrial Nuclear Technology Conference, Chicago.
- 16-17 RETMA Annual Convention, Chicago.
- 20-23 Electronic Parts Distributors Show, Chicago.
- 26-29 Canadian Electrical Distributors

Assn. Annual Meeting, Honey Harbor, Ont.

June

- 20-21 RETMA Annual Convention, Ste. Adele en Haut, Quebec.

September

- 3-14 International Union of Geodesy & Geophysics, Eleventh General Assembly, University of Toronto.

October

- 16-18 IRE Canadian Convention & Exposition, Toronto.

Norris Again Chairman of IRE Show

The Institute of Radio Engineers in Canada has reappointed Clare A. Norris, P.Eng., as general chairman of its second annual convention and exposition to be held in Toronto, October 16-17-18.

Mr. Norris is a 1934 honors graduate in applied science of the University of Toronto. After three years of staff work at the university, he held various engineering and management positions with Canadian National



Telegraphs, Research Enterprises Ltd., International Resistance Co. Ltd. and J. R. Longstaffe and Associates. He is now general manager of Copper Wire Products Ltd.

Active in the affairs of RETMA and the IRE itself, of which he is a senior member, Mr. Norris has also been chairman of the advisory committee of Ryerson Institute of Technology.

As general chairman of the IRE Canadian Convention he is responsible for the over-all policy and smooth working of an exposition which fills the CNE Automotive Building.

Canadian radio week

The Canadian Association of Radio and Television Broadcasters have designated May 5-11 as this year's Canadian Radio Week. It is planned to underline the forward steps made by the Canadian electronics industry since regular broadcasting began in Canada in 1920.

SPECIALIZATION IN

Communication

The excellence now attainable in communication systems is a product of 20 years of electronic research at Collins. Collins engineering research, development, and manufacturing facilities are without equal. Staffs of communication experts assure the highest level of radio communication performance, which backs the Collins reputation. A Collins installation incorporates the most advanced techniques—Transhorizon "Scatter" Propagation, Microwave Relay, and Single Sideband HF Developments—all compatible with existing communication systems.

TRANSHORIZON

Multi-channel Transhorizon circuits offer highly reliable and economical long range communication over water, mountainous or sparsely populated terrain where construction of microwave facilities is impractical. Collins is the only company to have available now the entire "Scatter Propagation" line of basic equipment including transmitters, exciter modulators, frequency standards, RF filters and VHF and UHF antennas, together with multiplex and predicted wave signalling equipment. Complete system planning is tailored to meet the individual installation's requirements.

MICROWAVE

Collins Microwave Systems provide extremely reliable channels for long distance communication and remote control. Collins Mechanical Filters assure the most efficient channel usage, and permit reduction of the number of components to facilitate maintenance. Building block construction gives flexibility in future expansions as system requirements change.

HIGH FREQUENCY SSB

New single sideband transmissions solve many problems in HF communication. Concentrating RF power in the sidebands conserves spectrum space and reduces adjacent channel interference. Selective fading and interference problems of multipath transmissions are also minimized by SSB. Collins pioneering in SSB has produced the most advanced line in HF equipment.

When planning a radio communication system, consult Collins for assistance in all phases of the engineering. Technical literature is available for the over-all design and individual equipment.

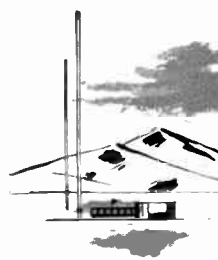
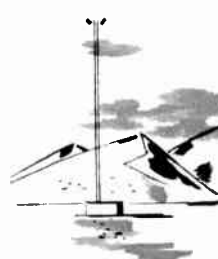

CREATIVE LEADER IN COMMUNICATION

Collins

COLLINS RADIO COMPANY OF CANADA, LTD.,
11 Bermondsey Road, Toronto 16, Ontario



INTRODUCING...

the first combined

G P C AND D D A



* GENERAL PURPOSE DIGITAL COMPUTER AND DIGITAL DIFFERENTIAL ANALYZER



*ultimate versatility
in solving complex
technical
problems...*

The general purpose digital computer solves most scientific and engineering problems with speed and accuracy... yet easier programming makes the digital differential analyzer a superior choice for solving differential equations. Bendix now combines the advantages of both in the *new* G-15D Computer and its optional DDA accessory. Working together, and supported by a full complement of input-output equipment, these units provide the *best* means of solution. And the rental or purchase cost is far below that of most general purpose computers alone.

A new brochure tells the details of the G-15D's talent for conserving your scarce engineering manhours. Let us send you a copy.

5702



COMPUTING DEVICES OF CANADA LIMITED
P.O. BOX 508 • OTTAWA • CANADA