

ENGINEERING REPORT
ON BEHALF OF
RADIO C H U M 1050
TORONTO, ONTARIO

PREPARED BY:

GEORGE MATHER & ASSOCIATES

AUGUST 23, 1960.

Report on Power Increase Study - C H U M Toronto

PURPOSE

It is the purpose of this report to set forth the results of studies with respect to the possibility of finding a solution which would enable CHUM Toronto to operate at increased power.

TERMS OF REFERENCE

It is becoming evident that the present CHUM signal is subject to increasing attenuation due to the development and building construction in the City of Toronto. These buildings, once erected, obstruct the passage of the CHUM signal and result in depreciation of the Station's coverage of the Market.

In view of the foregoing various alternatives were reviewed in order to ascertain if there was a solution which would fulfill the requirements of the Licensee and at the same time conform to the regulations of the Department of Transport. To this end three sites were fully explored as follows;

- a) Toronto Islands - present site
- b) Jordan Harbour - optioned site
- c) Streetsville - optioned site

It is to be noted that site availability was ensured in the event a solution was derived. This was believed to be a necessary precaution in order to facilitate completion of the project if there was merit in so doing.

PROCEDURE

A complete analysis of groundwave and skywave protection requirements was computed for each of the three possible transmitting sites. On the basis of this information, maximum permissible radiation was determined. Subsequently patterns were derived which would meet protection requirements and at the same time provide best possible signal levels over the Metropolitan area.

In the vicinity of Toronto a conductivity value of 6 was employed. Over Lake Ontario a conductivity of 15 was utilized. This latter value was confirmed by measurement and is borne out by the findings of the Department of Transport during comprehensive tests which were undertaken.

RESULTS

The results were derived predicated on employment of each of the three sites as follows;

a) Toronto Islands

A system was designed for 10 kw operation with different patterns day and night, and a complete engineering brief was compiled and filed with the Department of Transport. However, the Department ruled that the proposal did not conform to the "One Percent" rule and was technically unacceptable. Nonetheless, it should be borne in mind that in terms of coverage the 10 kw proposal was superior to the present 5.0/2.5 kw operation of CHUM.

Appendix 3, attached hereto, illustrates the coverage that could be achieved with 10 kw operation and the contours, as plotted, are self explanatory.

b) Jordan Harbour

Appendix 1 attached is a plot of a six tower 50 kw pattern based on operation from the Jordan Harbour site on the South shore of Lake Ontario. It is to be noted that in this instance one of the main objectives is to achieve maximum directivity in order to realize maximum signal levels in Toronto. However, with a power limit of 50 kw it was found that patterns with eight or more elements resulted in a narrow beam width and while the forward gain was satisfactory the beam was not wide enough to extend coverage to the extremities of the Metropolitan area.

Again the resultant coverage, as illustrated by the 38 mv/m and 25 mv/m contours, is plotted in Appendix 3. It may be observed that the coverage is most disappointing inasmuch as it just nicely compares with that presently enjoyed by CHUM.

c) Streetsville

Appendix 2 is a plot of a six tower 50 kw pattern for the Streetsville site. The main concern in this pattern design was to derive one which would afford protection to WSTS Massena and WSEN Baldwinsville and at the same time direct maximum radiation over Toronto. However, since the arc from WSEN to a bearing over Toronto represented only 30 degrees, the design problem was most difficult. It may be noted by reference to Appendix 3 that the coverage of the Metropolitan area is quite inadequate.

... 3

DISCUSSION

a) Toronto Islands

Reference to Appendix 3 will confirm that for the time being the 10 kw proposal for this site represents the best solution. While the Department has ruled that the proposal is technically unacceptable, nonetheless, a population count reveals that derogation of the 1% rule is not too much more severe than that realized by CKFH with 10 kw. The CKFH 10 kw proposal has been accepted by the Department of Transport.

b) Jordan Harbour

As previously outlined, maximum antenna gain is not an adequate solution in terms of coverage from this site, because a further increase in directivity depreciates coverage on the East and West extremities of the Market. However, the pattern derivation is not too difficult from this site because of the favourable orientation of assignments which require protection. Accordingly expansion of the pattern to 100 kw would be practical and possible to accomplish with a six tower antenna array.

It is regrettable, therefore, that the North American Regional Broadcasting Agreement limits Class II stations (CHUM) to a maximum power of 50 kw. Perhaps there may be some merit in exploring whether the Department of Transport would choose to make a "Trial" notification, in this instance, in order to ascertain International reaction to proposed 100 kw operation.

c) Streetsville

At first glance it would appear that a simple rotation of the pattern would result in adequate coverage of the Metropolitan area. However, since the arc between maximum and minimum radiation is so restricted, a practical pattern design does not appear likely. There is little probability that the Streetsville site is of any use as far as the 1050 kc/s channel is concerned.

RECOMMENDATIONS

The foregoing does not suggest much encouragement with regard to achieving a solution which would result in improved CHUM coverage of the Toronto area. Nonetheless, it is recommended that the following points be pursued with the Department of Transport;

1. Reconsideration of the 10 kw proposal predicated on the Island site,

- 2. Exploration of the possibility of the use of 100 kw by a Class II (CHUM) assignment.

CONCLUSION

On a long term basis it is believed that an alternate channel is perhaps the best solution for CHUM. While under present regulations there are currently no channels, nonetheless, a change in the provisions of the North American Regional Broadcasting Agreement could alleviate the situation. Specifically the restrictive provisions on the use of Class IA channels no longer serve any useful or practical purpose.

Under the present Agreement it is specified that where a Country has a Class IA priority on a channel, another Country may not use the channel at night within 650 miles of the common border and further there must be daytime protection along the entire common border. When it is considered that the United States has 25 such IA priorities, within a total complement of 107 channels, it is evident that this ruling imposes extreme hardship on Broadcast Allocations in Canada.

While Canada has seven IA channels, used exclusively by the Canadian Broadcasting Corporation, it should be mentioned that the IA rules have been derogated on most if not all of these channels. To date there has been no reciprocal arrangement whereby Canada has derogated the privileges of other Countries on their Class IA channels.

Inasmuch as the existing regulations are not realistic in terms of current conditions it is believed that the IA classification of channels should be abandoned. This opportunity would arise during the deliberations of the next North American Regional Broadcasting Conference. In view of the foregoing it is therefore urged that perhaps the Canadian Association of Broadcasters could undertake to pursue this cause through the appropriate organizations.

SEAL AND SIGNATURE



This report has been prepared and compiled by George Mather, a Consultant whose qualifications are known to and are recognized by the Department of Transport.

George Mather

George Mather, P.ENG.,
Consultant.

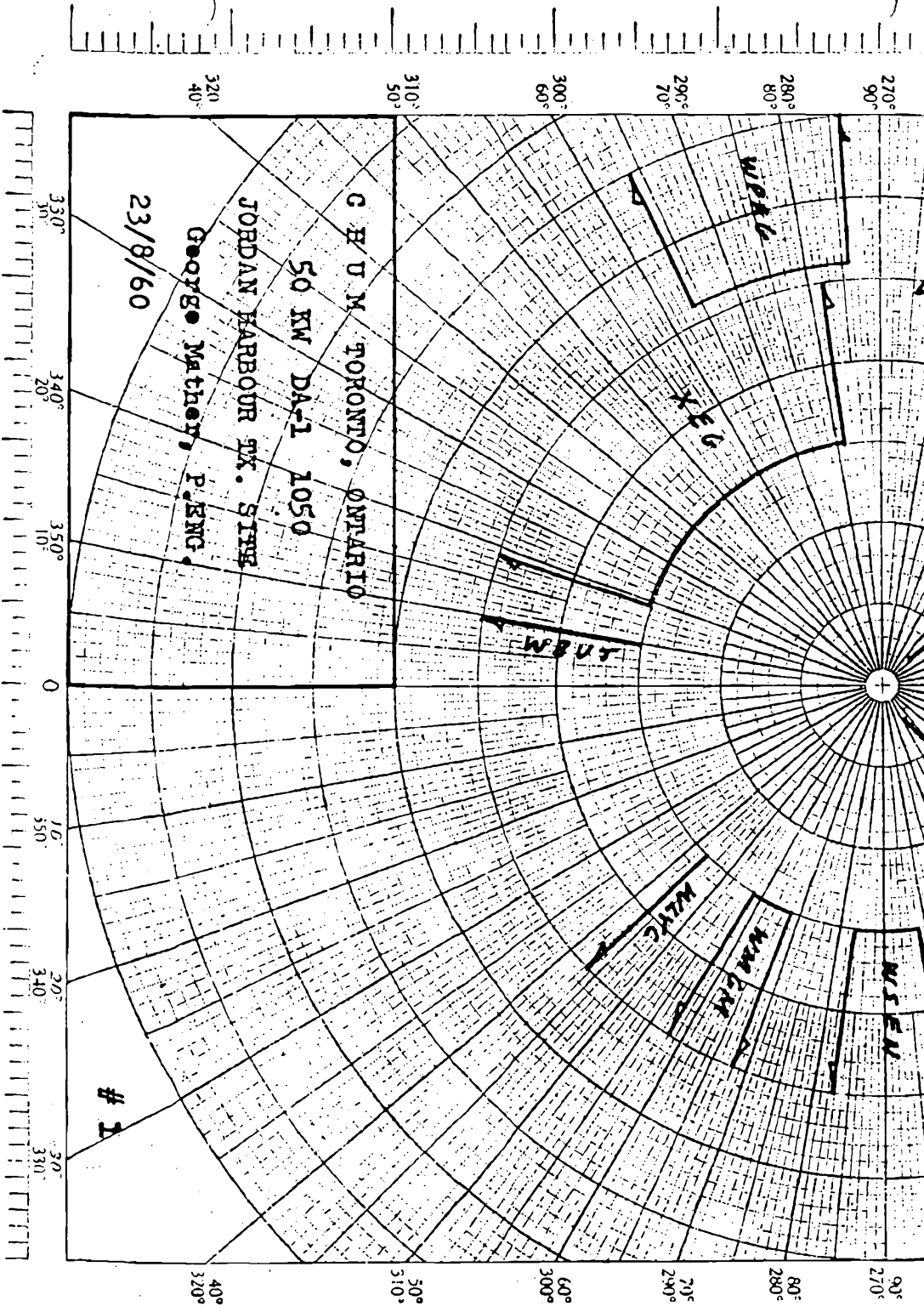

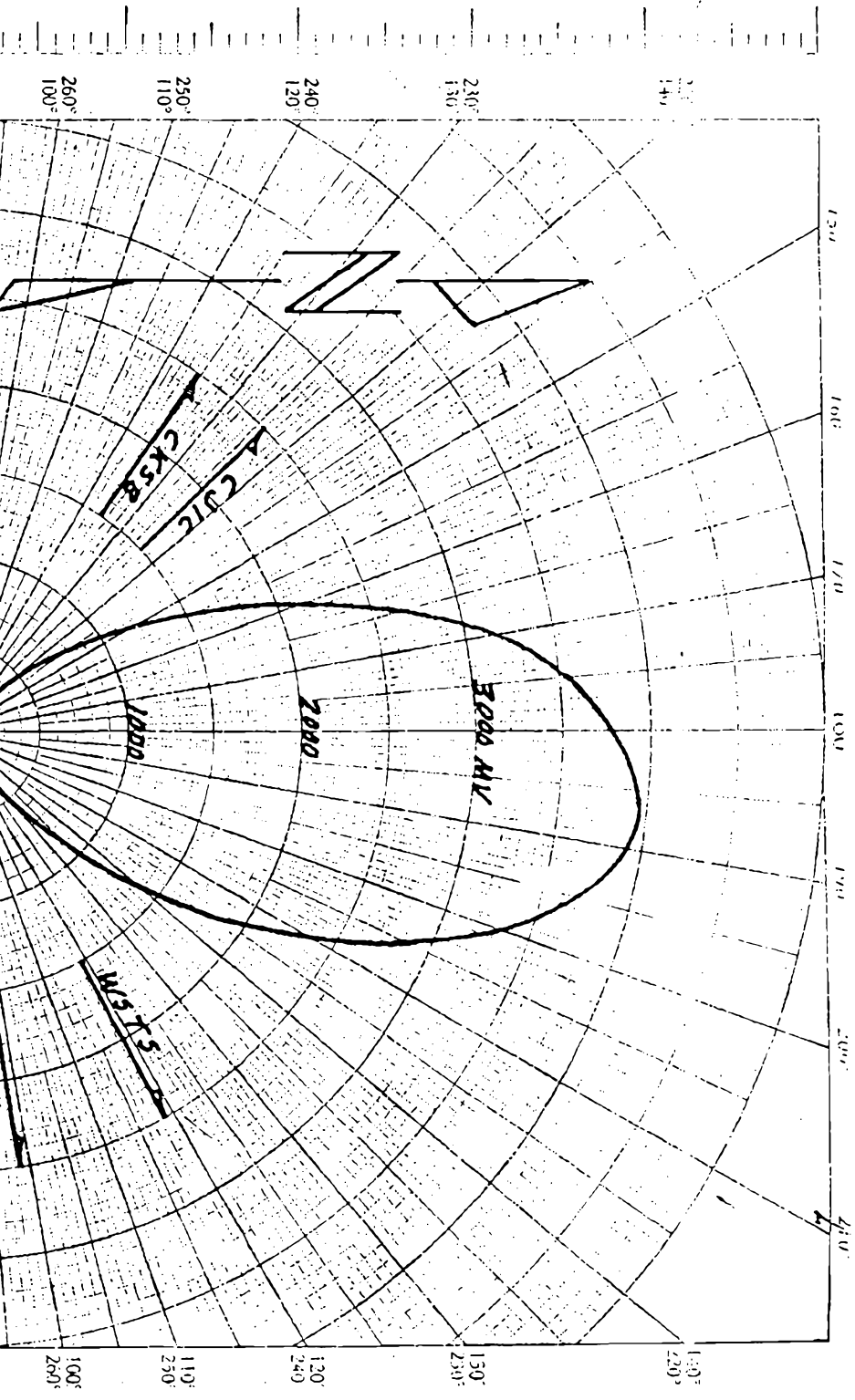

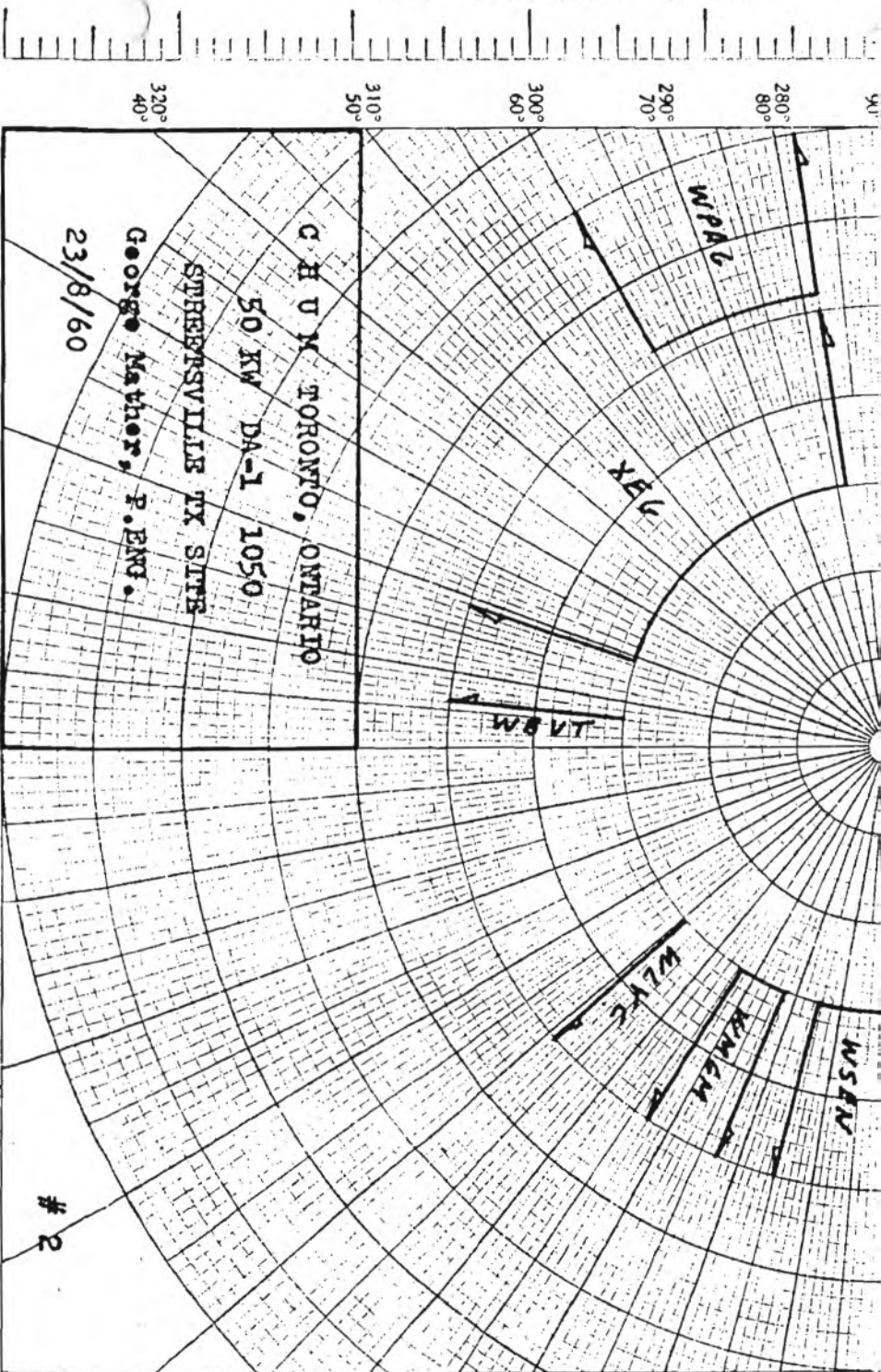

G H U N TORONTO, ONTARIO
 50 KW DA-1 1050
 SPHERSVILLE TX SITE
 George Mather, P. ENG.
 23/8/60

WPAK
 XEG
 WJWB
 WJYC
 WJWB
 WJWB
 WJWB

2

330° 340° 350° 0 10° 20° 30°
 30' 20' 10' 0 10' 20' 30'
 320° 310° 300° 290° 280°
 40° 50° 60° 70° 80°

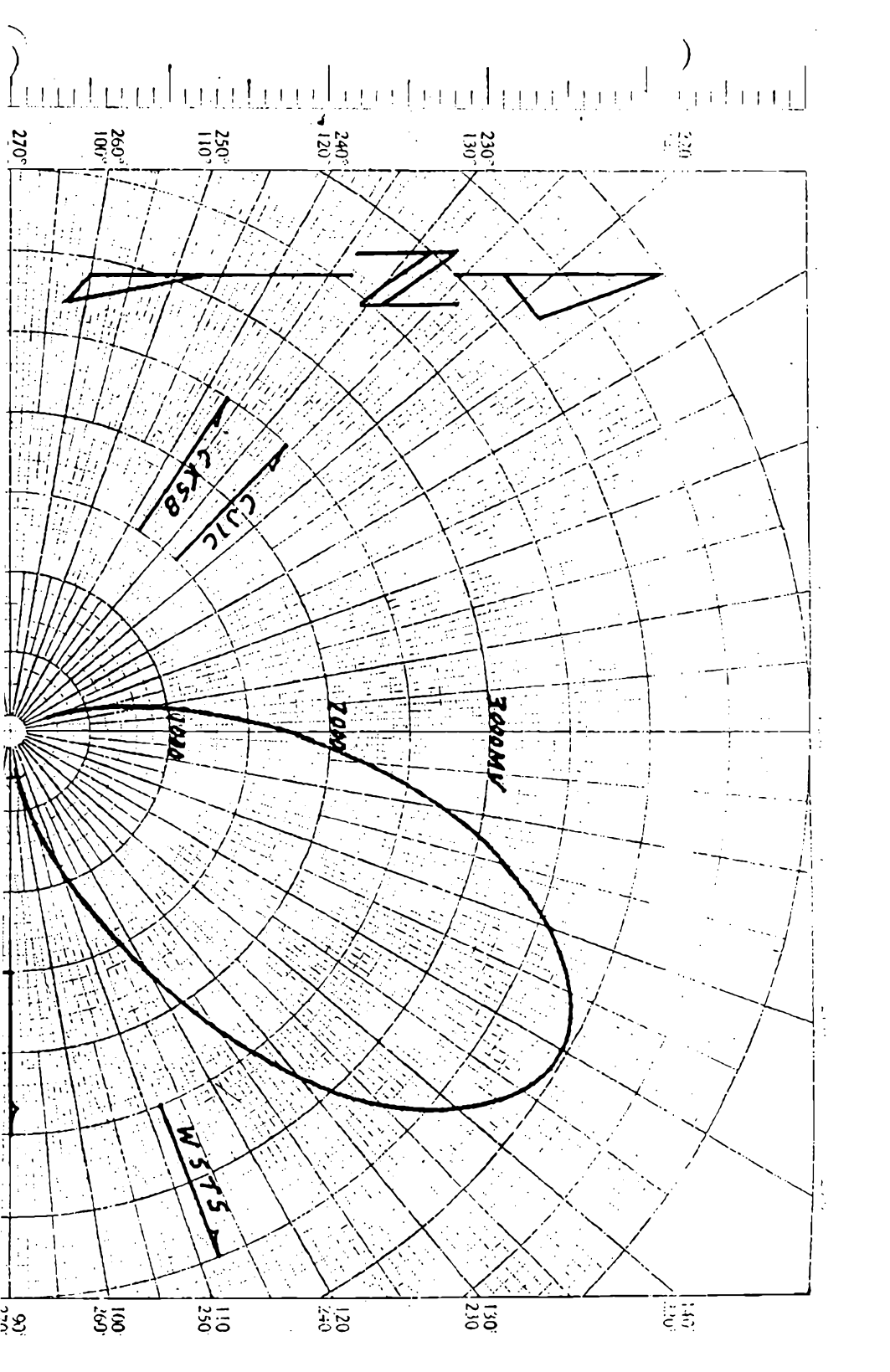

NOW THEREFORE KNOW YE that I,

Chum Ltd.

MACKINNON PHILLIPS, M.D. C.M., LL. D.,

Provincial Secretary,

under the authority of the hereinbefore in part recited Statute

Do by these Supplementary Letters Patent to

YORK BROADCASTERS LIMITED

incorporated by Letters Patent dated the
second day of October, A. D. 1944

CHANGE the name of the Company to

R a d i o CHUM-1050 L i m i t e d .

Given under my hand and Seal of office at the City of Toronto
in the said Province of Ontario this twenty-seventh
day of April in the year of Our Lord one thousand nine
hundred and fifty-nine.

S E A L

"M. PHILLIPS"

Provincial Secretary.

Schedule 4

Radio CHUM-1050 Limited
Head Office: 1331 Yonge Street
Toronto, Ontario, Canada

Last shareholders' Meeting - September 5, 1960

<u>Name</u>	<u>Nationality</u>	<u>Occupation and Office</u>	<u>Place and Date of Birth</u>	<u>Number Shares Held</u>
Allan F. Waters	Canadian	President and Manager	Toronto August 11/21	99,998 common and 1,910 prefer.
Eunice Carroll	Canadian	Secretary	Tillsonburg, Ont. April 19/22	1 common
Marjorie V. Waters	Canadian	Vice-President	Toronto February 14/22	1 common

All shareholders are directors.

Address over last 5 years:

A. Waters -- 52 Presteign Avenue, Toronto, and 21 Moorehill Drive, Toronto

M. Waters -- 52 Presteign Avenue, Toronto, and 21 Moorehill Drive, Toronto

E. Carroll -- Present: 639 Lake Shore Road, Toronto 14

9 Morningside Avenue, Toronto 3
468 Lynd Avenue, Port Credit

Schedule 7

I, Allan F. Waters, have purchased 99,998 shares
of common stock of Radio CHUM-1050 Limited listed
in this application.

Allan F. Waters
.....
Allan F. Waters

October 27, 1960

ENGINEERING BRIEF
ON BEHALF OF
RADIO CHUM-1050 LIMITED
IN SUPPORT OF
AN APPLICATION FOR AUTHORITY TO
INCREASE POWER AND CHANGE SITE

C H U M TORONTO, ONTARIO
50 kw DA-2 1050 kc/s
Class II Unlimited

PREPARED BY:

GEORGE MATHER & ASSOCIATES

JULY 1962.

RECEIVED

OCT 3 1962

BY SRE-B

SUBMITTED OCT/62.

a) PURPOSE

It is the purpose of this submission to set forth a technical proposal in support of an application by Radio CHUM-1050 Limited for authority to increase power to 50 kw, Day and Night, from 5.0/2.5 kw operation and to change the transmitting site. No change of frequency is contemplated and it is proposed that CHUM continue to operate on 1050 kc.

b) DISCUSSION

The proposed increase in power and change of site will result in improved service and consolidation of coverage in Toronto and the surrounding area. At the same time the proposed power increase will protect the channel for Canadian use inasmuch as it will preclude encroachment from stations in other Countries.

In the event that the operation of CKEY Toronto, on 590 kc/s, should result in oscillator radiation interference, the proposed power increase will to some extent help CHUM over-ride this interference.

- 1) With regard to Rule 2 of Procedure 1 it is to be noted that a population count has been requested of the Bureau of Statistics and when the data is provided it will be made available to the Department of Transport.
- 11) Daytime Rural service will be improved and CHUM should enjoy an increased signal level throughout its service area.
- 111) The night interference level is relatively high and an increase in power would help CHUM over-ride the incoming skywave interference.

It is proposed that CHUM continue to operate on the frequency of 1050 kc/s, with increased power. Indeed this is the only channel available to CHUM since no other frequency is open for practical use and service to the area.

The change of site and the increase of power are very much inter-related. At the moment CHUM has some problems in coverage of the Metropolitan area and thus an increase of power was indicated. However, the present site is limited in terms of maximum permitted power and therefore an alternate site was finally located. Due to the location of the proposed new site it is apparent that a power increase is required in order to afford adequate coverage of the Metropolitan area. It is believed that the combination of the new site and 50 kw operation represents the best possible engineering solution for CHUM, under present circumstances.

c) SOURCES OF INFORMATION

This submission is prepared in accord with the requirements of Broadcast Procedures 1 and 2 and in accord with Broadcast Specification number 1. Current standards of good engineering practice also governed in the preparation of this submission. The rule and regulations of the North American Regional Broadcasting Agreement, Washington - 1950, have been adhered to.

Existing and proposed station assignment information has been collated from data circulated by the Department of Transport. A list of pertinent assignments is appended hereto.

Geographic information has been taken from maps which are available at the Map Distribution Office of the Department of Mines and Technical Surveys. The sheets utilized in this submission are; 30M/5E, 30M/12E, 30M & S. Ont. 1:10⁶.

The coverage contours were derived from the standard propagation charts in conjunction with the New Canadian Map of Conductivity. Furthermore, the measured data from the CHUM proofs of performance were employed, where possible, in the derivation of coverage contours. It is to be noted that the coverage is an estimate predicated on the best available data at the time of preparation of this submission.

It is recommended that this submission be filed and processed as expeditiously as possible in order to ensure that subsequent assignments, at other locations, will not prejudice the validity of this submission.

d) GROUNDWAVE INTERFERENCE ANALYSIS

A groundwave interference analysis is appended to this submission. It is to be noted that there is an adequate margin of protection afforded to other assignments.

e) SKYWAVE INTERFERENCE ANALYSIS

A skywave interference analysis is appended to this submission and it may be noted that an adequate margin of protection is afforded to other assignments. With regard to the proposed Stephenville, Newfoundland assignment on 1050 kc/s it is to be noted that the proposed 50 kw operation of CHUM results in a night limit of 22.2 mV/m at Stephenville. Under present conditions the night limit at Stephenville is 18.16 mV/m and thus the proposed 50 kw operation of CHUM results in a $\frac{1}{4}$ mile decrease in the night coverage radius of the proposed Stephenville assignment for 1050 kc/s. If it is felt that this imposes a hardship on Stephenville it should be noted that the proposed station could function on 680, 790 or 910 kc/s where there would be equivalent or better coverage. It is therefore urged that the proposed Stephenville assignment not be permitted to prejudice 50 kw operation of CHUM.

f) OSCILLATOR RADIATION INTERFERENCE

The 1050 kc/s frequency is presently in use and to date no problem has been experienced. However, the proposed operation of CKEY Toronto on 590 kc/s may create a problem and in this event the proposed CHUM power increase will help override the oscillator radiation interference.

g) INTERMODULATION

The proposed CHUM site is 1.54 miles from CFRB and 7.17 miles from CHFI. In the event of any problems due to intermodulation, CHUM will assume the commitments set forth in Rule 3 of Broadcast Procedure 1.

With respect to CHFI it is believed that the separation of 7.17 miles, together with the frequency separation of 1050 kc/s and 1540 kc/s, will not lend to the development of any intermodulation problems. However, if filters are found to be necessary, they will be provided.

As far as CFRB is concerned a certain amount of caution may be required. It is to be noted, however, that the bearing of CHUM, from CFRB, is in the direction of CFRB pattern nulls and therefore the CFRB array, as a receiving system will have a natural attenuation of the CHUM signal. If filters are required at CFRB it is expected that the design problems will be no more severe than the isolation of visual and aural transmitters into a common antenna system for high band VHF television operation.

h) HARMONIC INTERFERENCE

There is no known frequency relationship which could result in an harmonic problem. Furthermore the frequency is presently in use and no problem has so far been encountered.

1) FACILITIES

A total complement of six equal height towers will be installed at the newly proposed transmitting site. Two six tower patterns are proposed as per the complete information set forth in the appendices.

The patterns have been analyzed for stability and efficiency and have been confirmed to be in accord with current standards of good engineering practice.

The site is clear of over-head power lines and appears to be ideally suited to the proposed use.

j) SEAL AND SIGNATURE



This submission has been prepared and compiled by George Mather, a Consultant whose qualifications are known to and are recognized by the Department of Transport.

George Mather

George Mather, P.ENG.,
Consultant.

k) APPENDICES FOLLOW

SUMMARY OF PERTINENT ASSIGNMENTS

<u>Freq</u>	<u>Call</u>	<u>Location</u>	<u>Power</u>	<u>Ant</u>
1020	KDKA	Pittsburgh, Penn	50 kw	ND-U
1030	WBZ	Boston, Mass	50	DA-1
1040	WHO	Des Moines, Iowa	50	ND-U
1050	CJIC	Sault Ste Marie, Ont	10/2.5	DA-N
	CKSB	St. Boniface, Man	10	DA-N
	WPAG	Ann Arbor, Mich	5	DA-D
	WSEN	Baldwinsville, N. Y.	0.25	ND-D
	WSTS	Massena, N. Y.	1	ND-D
	WHN	New York, N. Y.	50	DA-1
	WZIP	Cincinnati, Ohio	1	ED-D
	WBUT	Butler, Penn	0.25	ND-D
	WLYC	Williamsport, Penn	1	ND-D
	XEG	Monterey, Mexico	150	ND-U
	CFQP	Grand Prairie, Alta	10	DA-1
1060	WRCV	Philadelphia, Penn	50	DA-1
	WHFB	Benton Harbor, Mich	1	ND-U
	WCMW	Canton, Ohio	1	ND-U
1070	CHOK	Sarnia, Ont	5/1	DA-N
1080	WYSL	Amherst, N. Y.	1	ND-D

This submission has taken into account all allocations notified in the Canadian and International change lists up to and including;

Canadian change list #168, March 9, 1962

U. S. A. change list #947, February 21, 1962.

Reviewed up to and including;

Canadian change list #172, July 9, 1962

U. S. A. change list #969, July 25, 1962.

1

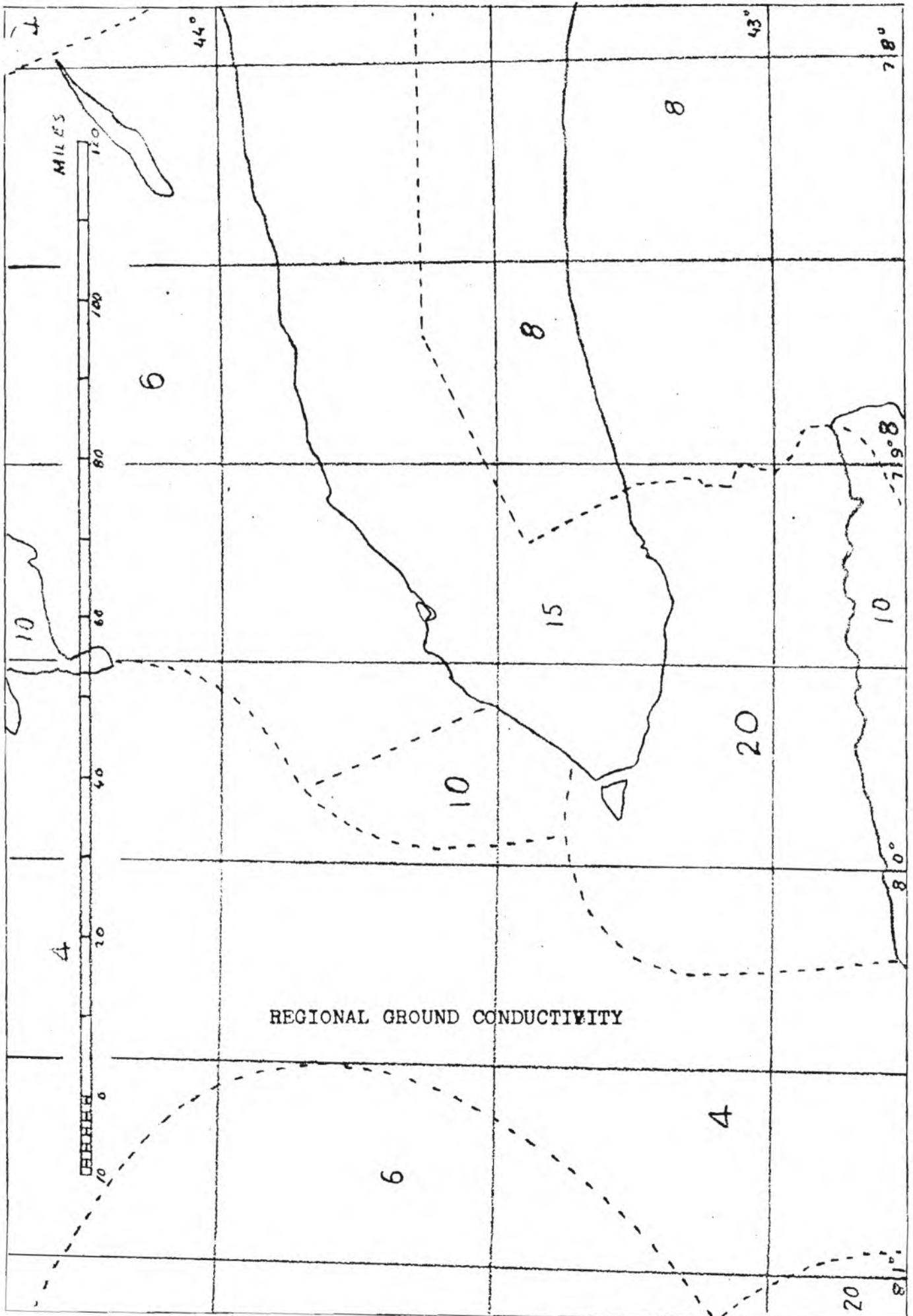

Skywave Interference Analysis		CHUM 1050													
To CALL	From CALL	MILES AZM	VERTICAL ANGLE	RADIATION HORIZ PERT	INTERFERENCE IN V/m	10% RSS At 100	10% RSS M/V/m	LIMIT M/V/m	PERM INTF	SSBLE TRAD	PROPOSED RAD	PROPOSED INTF	PROPOSED RSS	PROPOSED LIMIT	TOL %
CHUM	WJHN	340	13.3 - 22.5	990	906	1750	1750	35.0							
WJHN	YEG	1830	0	2760	2760	6.35	175	3.5	87	45.1	32.9	63.5	175	3.5	30
YEG	CHUM	340	13.3 - 22.5			193									
YEG	A	1600	0			8.75			25	286	100.7	8.76			17.7
B		1580	0			9.0				278	214	19.3			22.5
C		1553	0			9.4				266	214	20.1			17.1
D		1684	0			7.7				324	280	21.5			8.6
E		2170	0			4.2				595	357	15.0			5.9
CRSB	WJHN	1274	0.0 - 1.6	1700	1700	75.5	319	6.38							
CEGP		978	1.9 - 4.9	405	400	35									
YEG		1680	0	2760	2760	7.8									
CHUM		936	2.2 - 5.4	422	420	3.9			164	420	224	87.1	308	6.86	80
CJIC	WJHN	647	5.8 - 10.2	1123	1100	87	1290	25.8							
CHUM		312	14.7 - 24.5	435	411	210			863	411	380	76.1	1224	24.48	6.4
STEPH	WJHN	932	2.3 - 5.5	2270	2270	40	1085	21.7							
CHUM		1069	1.1 - 3.8	2230	2230	26.5			591	2230	2230	591	1085	21.7	-
									591	2230	2230	591	1085	21.7	

#36

6/24/50

PATTERN DERIVATION FORMULA

Horizontal Pattern

$F=I$

$$\begin{aligned} & \left[M_A f(b)_A + f(b)_B \cos(a_B + \frac{2\pi d_B \cos[\phi - \theta_B]}{\lambda}) \right. \\ & \left. + f(b)_C M_C \cos(a_C + \frac{2\pi d_C \cos[\phi - \theta_C]}{\lambda}) \right]^2 \\ & + \left[f(b)_B M_B \sin(a_B + \frac{2\pi d_B \cos[\phi - \theta_B]}{\lambda}) \right. \\ & \left. + f(b)_C M_C \sin(a_C + \frac{2\pi d_C \cos[\phi - \theta_C]}{\lambda}) \right]^2 \end{aligned}$$

Vertical Pattern

space phasing factor in above formula is multiplied by cosine of vertical angle.

$$\text{ie. } \frac{2\pi d_x \cos(\phi - \theta_x) \cos(b)}{\lambda}$$

Symbols

M_x = field ratio in antenna X

a_x = field phase in antenna X

d_x = spacing of antenna X in wavelengths

θ_x = bearing from reference point to antenna X

I = scale factor

ϕ = angle of azimuth

b = vertical angle

$f(b)$ = vertical radiation characteristic

GEORGE MATHER & ASSOCIATES

10/12/55

4

ANTENNA DESCRIPTION SHEET

DIRECTIONAL DA-2

STATION CALL: C H U M
 MAIN STUDIO: Toronto, Ontario.
 FREQUENCY: 1050 kc/s
 POWER: 50,000 watts
 CLASS: II
 TIME: Unlimited

NOTIFICATION REFERENCE:

GEOGRAPHICAL LOCATION: Lat 43°29'14", Lon 79°37'15"

ARRAY CHARACTERISTICS: Six elements, guyed, uniform cross section, base insulated, height 240 feet (92.2°), series feed. No top loading.

ELEMENT	ONE	TWO	THREE	FOUR	FIVE	SIX
space	Ref	411.5' 158°	823' 316°	864.8' 332°	465.5' 178.7°	156.3' 60°
azm	Ref	316°	316°	326.25°	335.3°	36°
Day R	1.000	1.212	0.4275	0.4061	1.151	0.950
∅	00°	-81.7°	-189°	-324°	-216.7°	-135°
Nite R	1.000	1.896	1.000	0.900	1.706	0.900
∅	00°	-20°	-38°	-161°	-143°	-123°

Ground system 120 radials per tower, #10 AWG bare soft copper wire, uniformly spaced, depth approximately 8 inches. Radials bonded along line between towers and bonded to soft copper strap at tower base. Maximum radial length 375 feet.

Predicted RMS DAY 1350 mv/m at 1 mile for 50 kw
 NIGHT 1279 mv/m at 1 mile for 50 kw
 DAY 191 mv/m at 1 mile for 1 kw
 Night 181 mv/m at 1 mile for 1 kw

210°
150°

200°
160°

190°
170°

180°

170°
190°

160°
200°

150°
210°

220°
140°

230°
130°

240°
120°

250°
110°

260°
100°

270°
90°

280°
80°

290°
70°

300°
60°

310°
50°

320°
40°

330°
30°

340°
20°

350°
10°

0

10°
350°

20°
340°

30°
330°

K&E POLAR COORDINATE 359-31
KLUFFEL & FESSER CO.

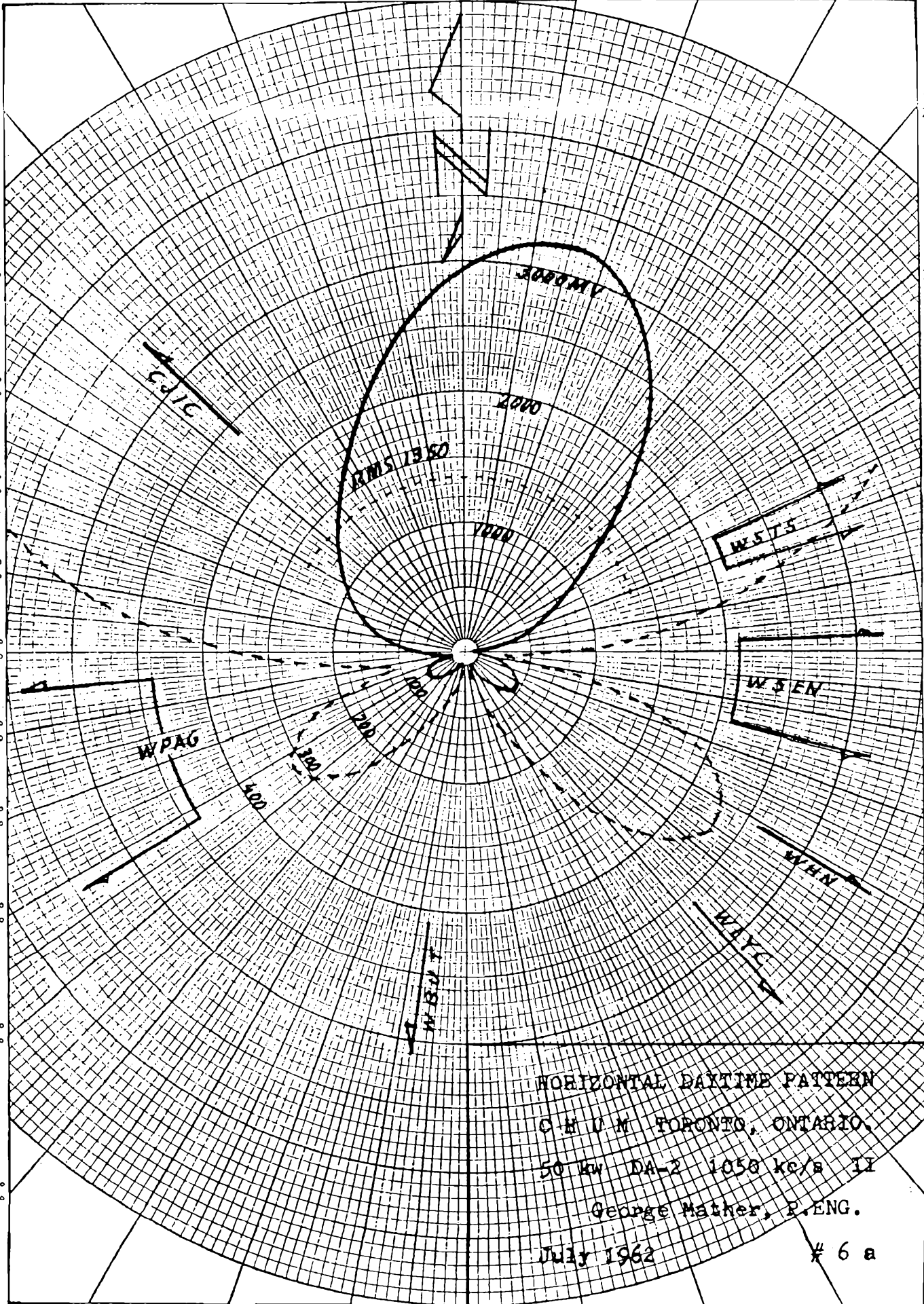
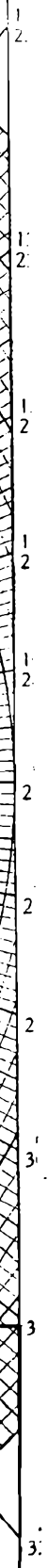
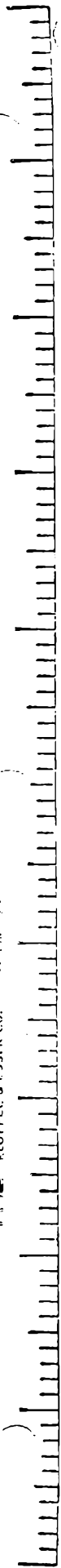

HORIZONTAL DAYTIME PATTERN
C.H.U.M. TORONTO, ONTARIO,
50 kw DA-2 1050 kc/s II
George Mather, P.ENG.
July 1962 # 6 a

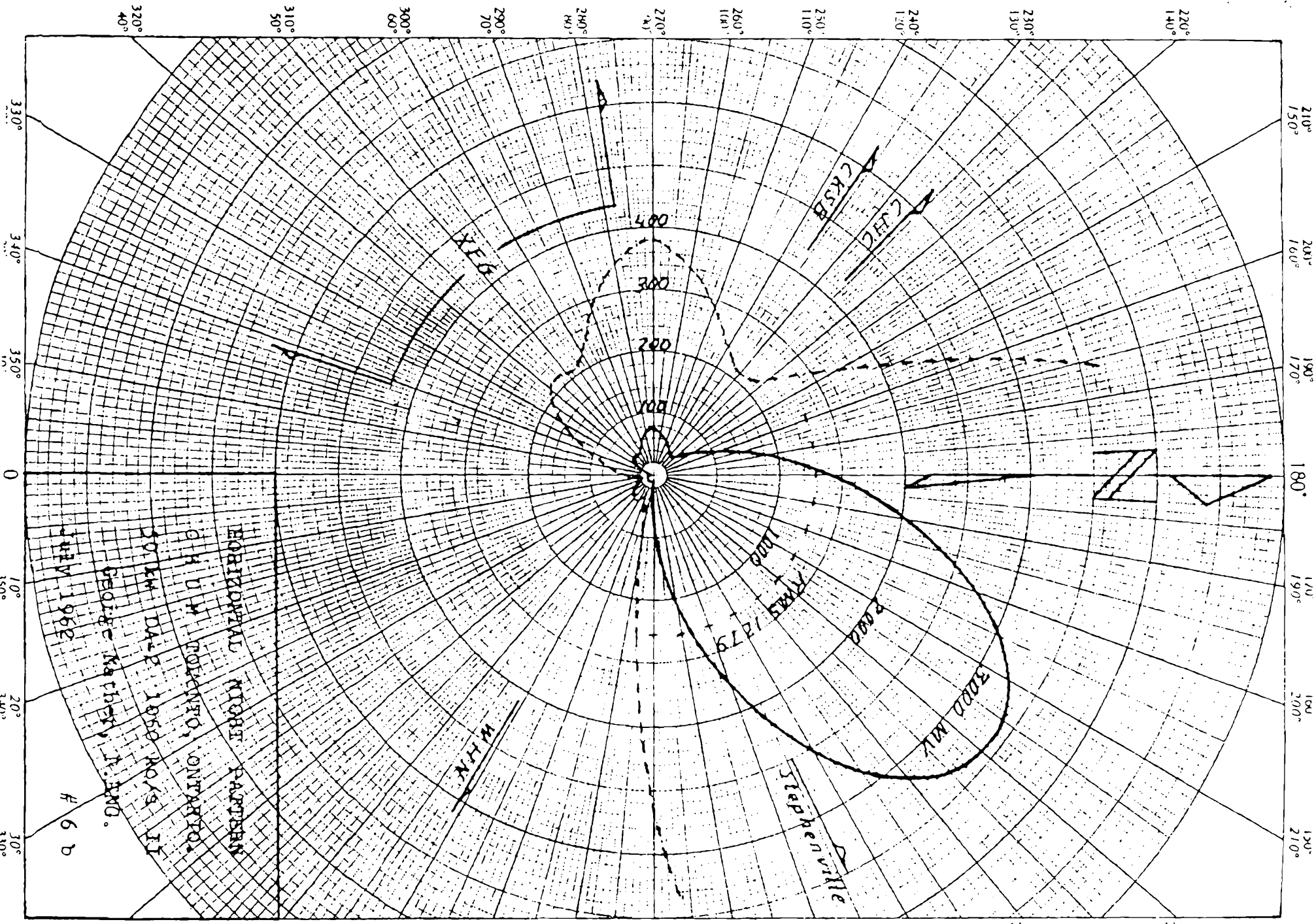
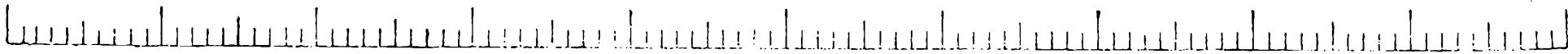

HORIZONTAL NITRIB PATTERN
C.H.D.M. TORONTO, ONTARIO
50 KM DAVE 1050 MOYS II
BEOLE KATHRYN J. JMD.
JULY 1962
6 b

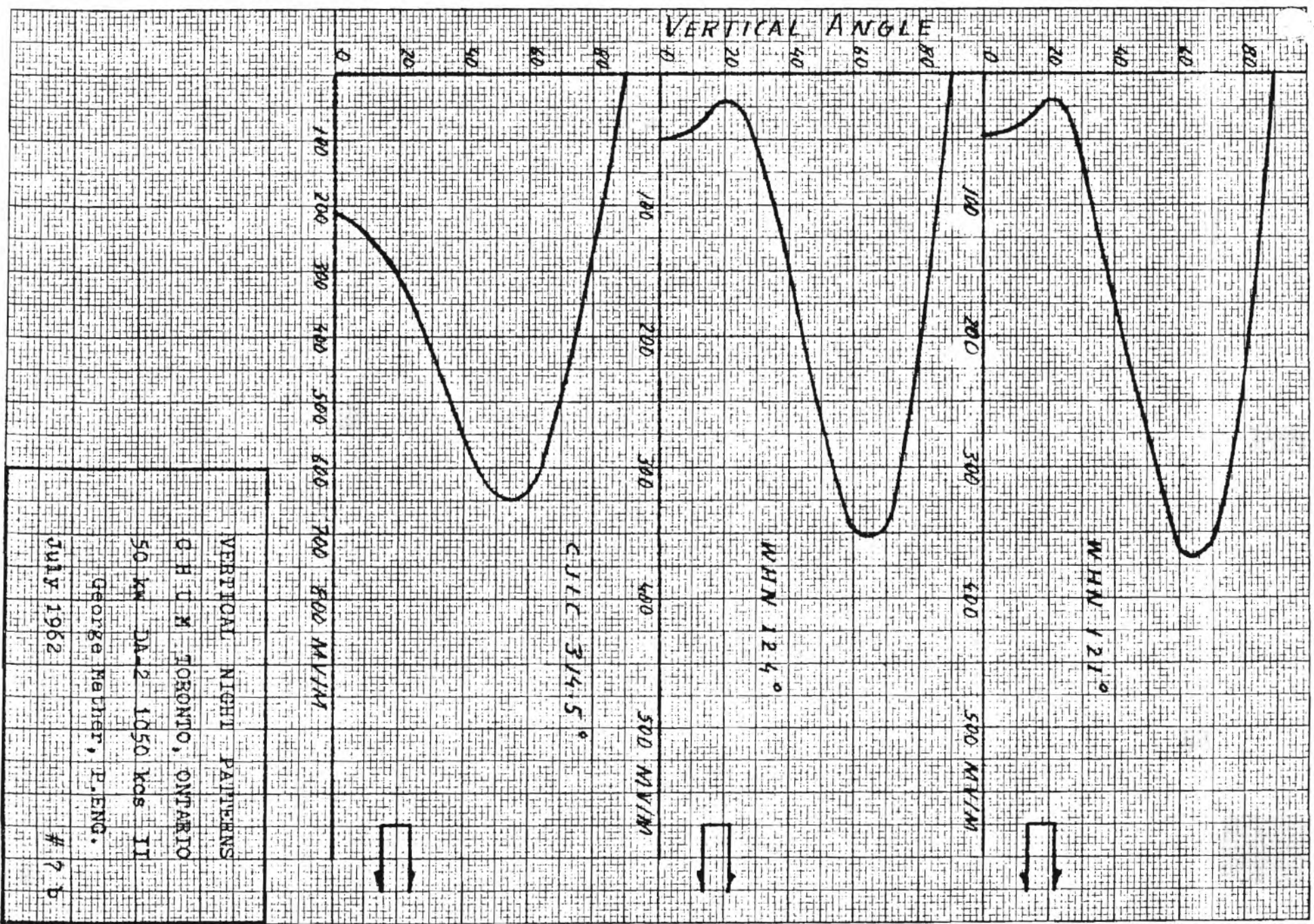

VERTICAL NIGHT PATTERNS

G H U M TORONTO, ONTARIO

50 KW DA-2 1050 Kcs IT

George Mather, P.ENG.

JULY 1962

7 b

C H U M TORONTO 50 kw DA-2 1050 kc/s

IMPEDANCE AND POWER ANALYSIS

<u>Element</u>		<u>ONE</u>	<u>TWO</u>	<u>THREE</u>	<u>FOUR</u>	<u>FIVE</u>	<u>SIX</u>
Self Z		49 + j110					
Mut Z	1	---	22.3/-110	14.0/+111	13.5/+97	20.6/-129	33.8/-28
	2		---	22.2/-110	20.6/-129	33.8/-28	22.1/-111
	3			---	33.8/-28	22.1/-111	14.2/+115
	4				---	22.3/-110	14.0/+111
	5					---	22.3/-110
Day R		1.0000	1.2120	0.4275	0.4061	1.1510	0.9500
∅		00	-81.7	-189	-324	-216.7	-135
Z		12.4+ j110	18.4+ j91	21.7+ j36	109.9+ j198	50.2+ j150	31.5+ j125
I		17.87	21.67	7.65	7.26	20.60	17.00
W		3960	8670	1270	5795	21300	9100
Night R		1.000	1.896	1.000	0.900	1.706	0.900
∅		00	-20	-38	-161	-143	-123
Z		3.7+ j105	6.5+ j90	-10.5+ j89	71.5+ j107	63.1+ j128	53.9+ j130
I		12.9	24.4	12.9	11.6	22.0	11.6
W		614	3865	-1747	9580	30500	7215

GEORGE MATHER & ASSOCIATES - RADIO FREQUENCY ENGINEERING

C H U M TORONTO 50 kw DA-2 1050 kc/s

ANTENNA PATTERN EFFICIENCIES

Power flow integration efficiency DAY = 1401 mv/m

NIGHT = 1324 mv/m

Estimated Operating Value

DAY

Element	Current	Ohmic Loss	Power Loss
1	17.87	2	640
2	21.67	2	942
3	7.65	2	117
4	7.26	2	105
5	20.60	2	850
6	17.00	2	578
			<u>3232</u>

$$\text{Efficiency} = 1401 + (50000 + 46768)^{\frac{1}{2}} = 1350$$

NIGHT

Element	Current	Ohmic Loss	Power Loss
1	12.9	2	332
2	24.4	2	1190
3	12.9	2	332
4	11.6	2	268
5	22.0	2	968
6	11.6	2	268
			<u>3358</u>

$$\text{Efficiency} = 1324 + (50000 + 46642)^{\frac{1}{2}} = 1279$$

8 b

PROPERTY AND GROUND SYSTEM LAYOUT

BROADCAST TRANSMISSION SYSTEM

C H U M TORONTO 50 kw DA-2 1050 kc/s

scale: 200 feet to 1 inch

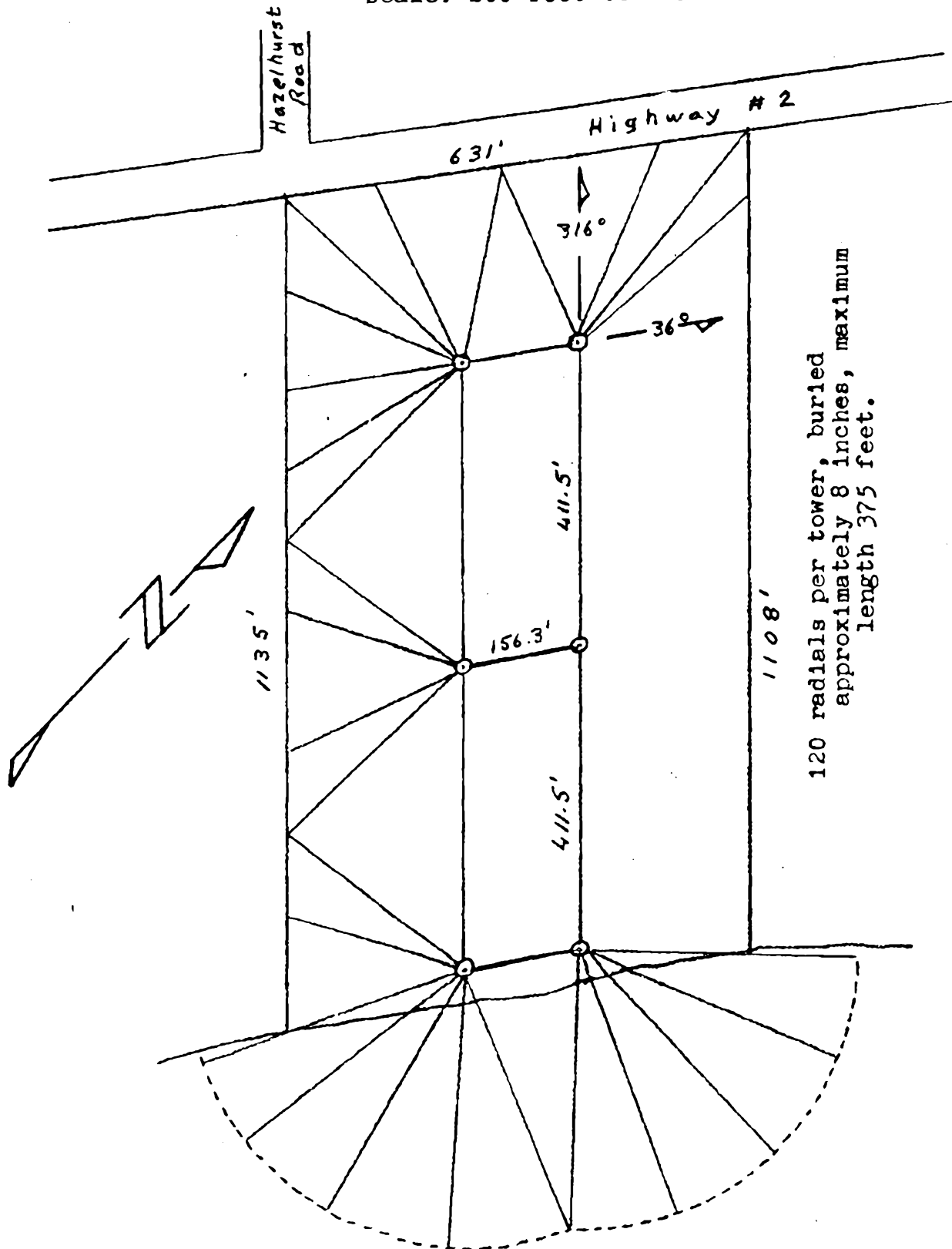

LAKE ONTARIO

9 c

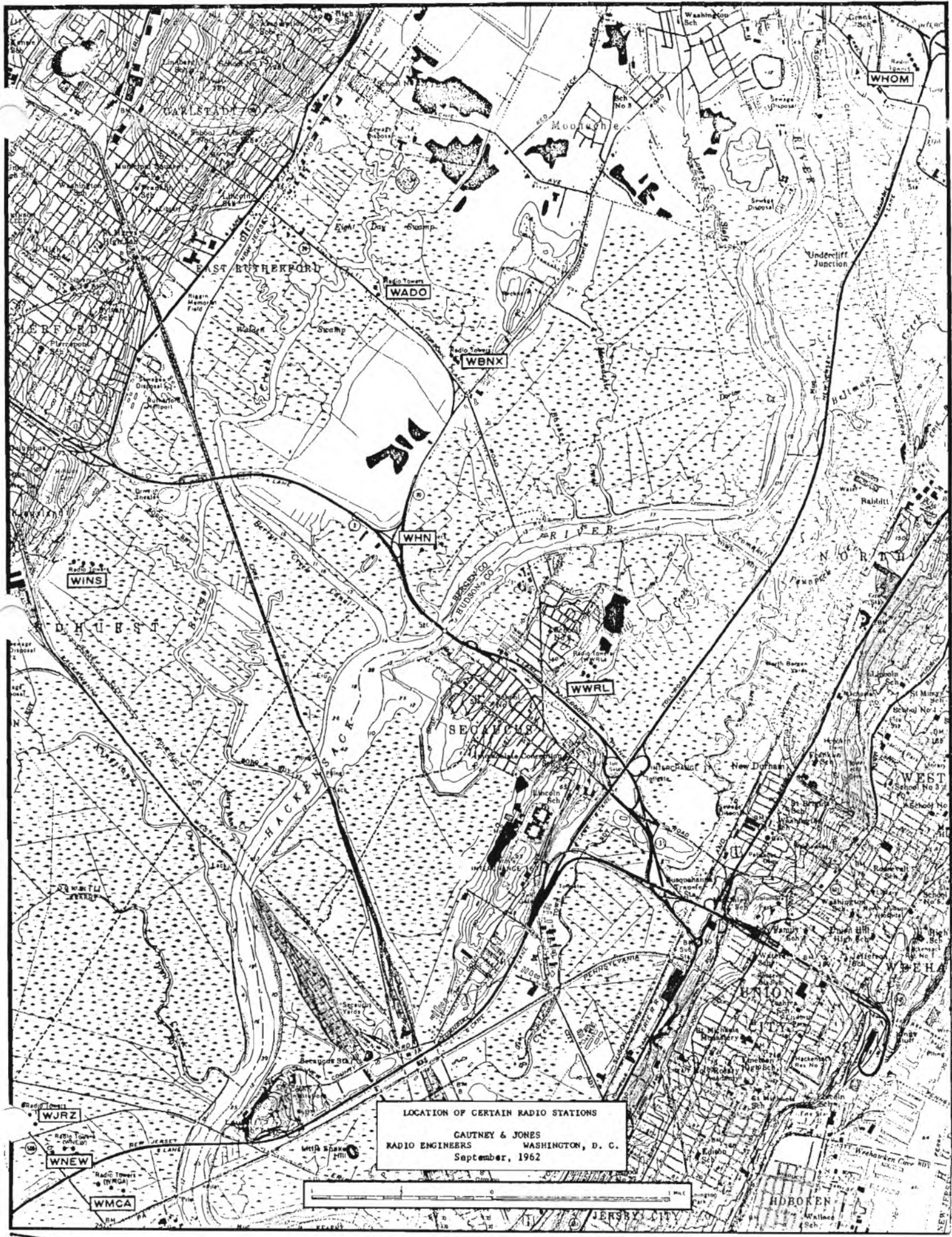

LOCATION OF CERTAIN RADIO STATIONS
 GAUTNEY & JONES
 RADIO ENGINEERS WASHINGTON, D. C.
 September, 1962



ENGINEERING REPORT
CONCERNING
PROBLEMS DUE TO
CLOSE PROXIMITY OF
HIGH POWER DIRECTIONAL BROADCASTING STATIONS

PRESENTED TO:

GEORGE MATHER & ASSOCIATES
Cooksville, Ontario

BY:

GAUTNEY & JONES

RADIO ENGINEERS WASHINGTON, D. C.

September, 1962

INTRODUCTION

The attached report, prepared at the request of George Mather and Associates, concerns itself with engineering problems occasioned by the close proximity of one high power directional broadcasting station to another. The report will concern itself primarily with experience, obtained over the years in the United States, on such types of operation. The report is non-mathematical in nature since the exact solutions of the various problems encountered will depend on an exact knowledge of the operation conditions of the stations concerned. Instead, the report will consider the problems in a general manner and will comment on solutions which have proven successful in this country.

In particular, the report will deal with comments concerning the possible mutual problems which may exist between Radio Station CHUM, Toronto, operating on 1050 kilocycles with a power of 50 kilowatts, DA-2 (at a location described in an engineering brief prepared by George Mather and Associates and dated July, 1962) and CFRB, Toronto, operating on a frequency of 1010 kilocycles with a power of 50 kilowatts, DA-2, operating at its assigned location. The discussion of these two stations will be in the light of similar experience in the United States.

Respectfully submitted September 14, 1962, by Gautney & Jones, Consulting Radio Engineers.



GEORGE E. GAUTNEY
Registered Professional Engineer
District of Columbia, No. 602

ENGINEERING REPORT
CONCERNING
PROBLEMS DUE TO CLOSE PROXIMITY OF
HIGH POWER DIRECTIONAL BROADCASTING STATIONS

Both theory and practice indicate that, when two high power directional broadcast stations operate in close proximity to each other, certain problems may arise. These problems may be separated into three rather broad classifications: (1) External cross-modulation, (2) Internal cross-modulation, and (3) Re-Radiation. These problems are discussed separately below.

1. External cross-modulation. In an area where the field intensities of two or more radio signals exceed approximately 1 volt per meter, it occasionally occurs that the program of one station will appear on the carrier of the other and/or that the programs of one or more of the stations will be heard at various frequencies other than their assigned frequencies. This problem has been treated in the literature particularly by A. James Ebel "A Note on the Sources of Spurious Radiations in the Field of Two Strong Signals," Proceedings of the IRE, Volume 30, Page 81, February, 1942, and by A. V. Eastman and L. C. F. Horle in "Generation of Spurious Signals by Non-linearity of the Transmission Path," proceedings of the IRE, Volume 28, Page 438, October, 1940.

Sometimes the spurious signals are due to overloading the input stages of the receiver. If this is the case, trap circuits tuned to the offending station will minimize or eliminate the difficulty. Sometimes the problem is due to non-linearity of conductors in the area. In either case, the area where difficulty is experienced is usually quite limited; and once the source of the offending difficulty is found, the remedy is straightforward.

2. Internal cross-modulation. When two transmitters operate in close proximity to each other, each station induces currents in the antenna of the other. If the coupling circuits of the first station are not sufficiently selective, then the carrier of the second station and its modulation can be imposed on the carrier of the first station. As a result of this superimposition, there will be generated new frequencies equal to the sum and difference of the two carriers; and also because of higher order curvature of the amplifier tubes of the transmitter, the modulation of the undesired station will appear on the carrier of the desired station. In addition, sum-and-difference frequencies of each possible combination of the harmonics of the desired and undesired station will also appear. The magnitude of these various sum-and-difference components will depend on the selectivity of the circuits involved.

The obvious cure of this type of cross-modulation is to prevent the carrier of the undesired station from inducing appreciable power in the final amplifier circuit of the desired station. This can be accomplished by inserting filter circuits of the "acceptor-rejector" type somewhere between the antenna of the desired station and its final amplifier. This type of circuitry and suitable locations for the circuits are discussed subsequently.

By the use of such circuits, there are numbers of broadcast stations in the United States which regularly operate in close proximity to each other without serious adverse effect. As a matter of fact, in an area near Secaucus, New Jersey, there are nine broadcasting stations located in an area of approximately 5 miles by 7 miles. A map showing the location of these stations is attached to this report. It will be noted that WJRZ and WNEW are located within approximately one-quarter of a mile of each other

and yet each is able to operate on its assigned frequency with its authorized directional pattern without undue difficulty. To further complicate the problem, WMCA is only approximately three-tenths of a mile from WNEW.

Of more particular interest here are the locations of WINS and WHN. WINS operates on a frequency of 1010 kilocycles, while WHN operates on 1050 kilocycles. It will be noted that these are exactly the same frequencies on which CHUM and CFRB operate.

An investigation shows that WINS radiates in the direction of WHN both day and night 3600 mv/m, unattenuated at 1 mile, based on its theoretical pattern. This is considerably more than CHUM will radiate in the direction of CFRB during daytime hours. During the day the radiation from CHUM to CFRB is 2250 mv/m unattenuated at 1 mile. It will also be noted that the distances are on the same order of magnitude. The distance between the centers of the arrays of WINS and WHN is 1.93 miles, while the distance between the centers of the arrays of CHUM and CFRB is 1.54 miles.

The installation of filter circuits such as mentioned above at the base of the antennas of WHN was all that was required to eliminate any cross-modulation in the transmitter of WHN. The problem did not exist in the reverse direction since the radiation from WHN to WINS was only 245 mv/m unattenuated at 1 mile.

It is believed that, based on the experience of WINS and WHN as well as the experience of the other stations shown on the attached map and at other locations throughout the United States where similar problems exist, if cross-modulation problems of this type exist between CHUM and CFRB, they can be eliminated by the installation of filter circuits either at the common point position at CFRB or, if this is not sufficient, at the base of CFRB's

antennas. It is not believed that the nighttime operation of CHUM will cause any difficulty to CFRB since during nighttime the radiation from CHUM toward CFRB is only 670 mv/m unattenuated at 1 mile. Nor is it believed that there will be any problems in the reverse direction since CFRB will radiate only 400 mv/m during daytime hours and 100 mv/m during nighttime hours toward CHUM.

3. Re-radiation. Of perhaps a more serious nature is the possibility of re-radiation, particularly the re-radiation by the antennas of CFRB of the signal from CHUM. Although an exact determination of the amount of re-radiation cannot be given theoretically without an exact knowledge of the antenna impedance of each of the antennas of CFRB as well as the circuitry involved in the directional antenna system of that station, some idea of the order of magnitude can be obtained by considering a single antenna at the midpoint of the CFRB array. This antenna will be considered as identical to each of the antennas presently used at CFRB. The physical height of the antennas corresponds to an estimated effective height of 48.5 meters. Since, ignoring attenuation occasioned by finite conductivity, CHUM will place an incident field at this hypothetical antenna of 1.46 mv/m, there will appear across the base of the antenna, if the antenna is open-circuited at its base, approximately 71 volts. If the hypothetical antenna is terminated in its conjugate impedance, approximately 1 ampere will flow in this antenna due to the incident field from CHUM. This 1 ampere of current flow corresponds to a re-radiation of approximately 37.5 mv/m unattenuated at 1 mile. While in general this small amount of re-radiation would cause no difficulty in the operation of CHUM, at certain bearings where suppression is quite heavy, this re-radiation could complicate the adjustment of CHUM.

It should be remembered that the above value of re-radiation of 37.5 mv/m unattenuated at 1 mile is based on the daytime operation of CHUM. During nighttime hours the corresponding re-radiation would be approximately 11.2 mv/m unattenuated at 1 mile.

These re-radiation values represent the result if the hypothetical antenna at the site of CFRB is terminated in its conjugate impedance and also if all losses due to finite conductivity and loss resistance of the antenna are ignored. It is hardly likely that this will be the case in practice; and accordingly, the re-radiation would be considerably less. Further, the installation of the filters mentioned above in connection with internal cross-modulation can, by open-circuiting (electrically) the antennas to the signal of CHUM, reduce the re-radiation to a negligible amount.

The reverse situation, that is re-radiation of the CFRB signal by the antennas of CHUM, is much less severe due to the relatively small radiation from CFRB in the direction of CHUM. Nevertheless, if such radiation should be a problem, filter circuits installed in the antennas of CHUM will either minimize or eliminate the problem.

No attempt is made here to minimize the problems due to close proximity, particularly the problem of re-radiation. In the experience gained in such operation in this country, the re-radiation problem has been by far the more difficult of solution. This is because the components used in filter circuits are not pure inductances or pure capacitances. Each inductor has some resistance and some distributed capacitance, which make its behavior differ somewhat from that attributed to it in the theoretical design. A discussion of such filter circuits follows this paragraph. As stated above, this report does not attempt to minimize the problem but only

to point out that, regardless of the magnitude of the problem from the theoretical standpoint or, for that matter, from a practical standpoint, the problems have been met and conquered in this country; and stations have been, and are, operating satisfactorily in close proximity to each other.

4. Discussion of Filter Circuits. Figure 1 on the attached sheet shows a series circuit composed of an inductance and a capacitance. Since the inductance will contain some resistance, this resistance is also indicated. If, at a specified frequency, the reactance of the capacitor is made exactly equal to the reactance of the inductor (series resonant), the only impedance which Figure 1 will present to the specified frequency is the residual resistance.

At a frequency higher than the series resonant frequency, the circuit shown in Figure 1 will present an impedance composed of the above-mentioned resistance plus an inductive reactance equal to the difference in reactance between the inductor and the capacitor. By placing a new capacitor in parallel with this combination as shown in Figure 2 and making the reactance of the new capacitor exactly equal to the inductive reactance at the new frequency, the circuit will become parallel resonant at the second frequency without in any way disturbing its operation at the series resonant frequency. At the higher frequency the parallel resonant combination will present an impedance considerably higher than its impedance at the series resonant frequency. Thus, there will be a discrimination between the series resonant frequency and the higher parallel resonant frequency.

If the second frequency is lower than the series resonant frequency, an inductor can be placed in parallel with the series resonant combination as shown in Figure 3; and again the discrimination between the two frequencies is present.

Either of the two circuits will present a low impedance path to the series resonant frequency and a high impedance to the parallel resonant frequency.

Similar circuits to the above, based on starting with a parallel resonant combination at the frequency to be rejected and making this combination series resonant at the desired frequency by the addition of a new component, are shown in Figures 4 and 5. The circuits shown in Figure 2 and Figure 3 are somewhat superior to those shown in Figures 4 and 5 since the losses at series resonance are less in the first two figures. However, Figures 4 and 5 will present a greater impedance to the undesired frequency than will Figures 2 and 3.

Figure 6 shows such a combination inserted in the feed line to an antenna and also shows a by-pass circuit designed along similar considerations. In Figure 6, L_1 and C_1 are tuned to series resonance at the frequency to be passed; and the combination of these two is tuned to parallel resonance by C_2 . L_2 and C_3 are tuned to series resonance at the undesired frequency in order to by-pass this frequency to ground, and the resulting combination is tuned to parallel resonance by L_3 .

It can be shown that the higher the Q of a circuit similar to the above-mentioned circuits, the greater will be the discrimination between the desired and undesired frequencies. It can also be shown that the discrimination is a function of the separation between the two frequencies. In other words, if the two frequencies are quite far apart, discrimination is quite high. If, on the other hand, the frequencies are quite close together, then very high Q circuits are necessary to obtain the desired discrimination.

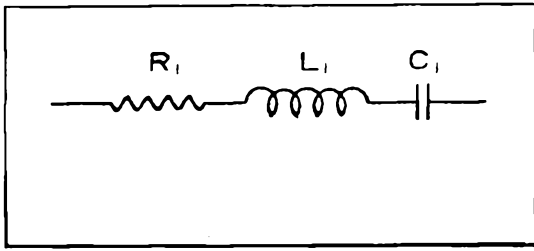

Fig. 1

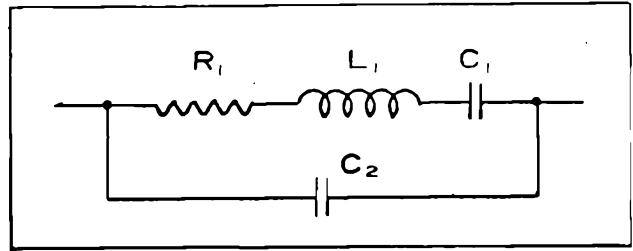

Fig. 2

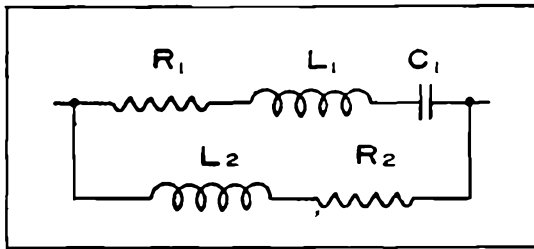

Fig. 3

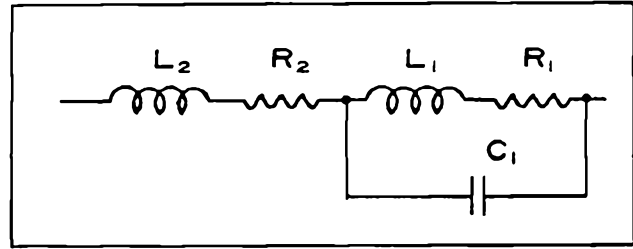

Fig. 4

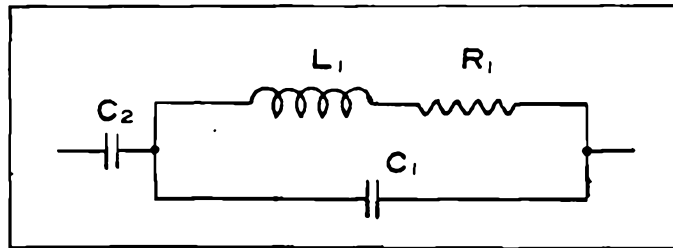

Fig. 5

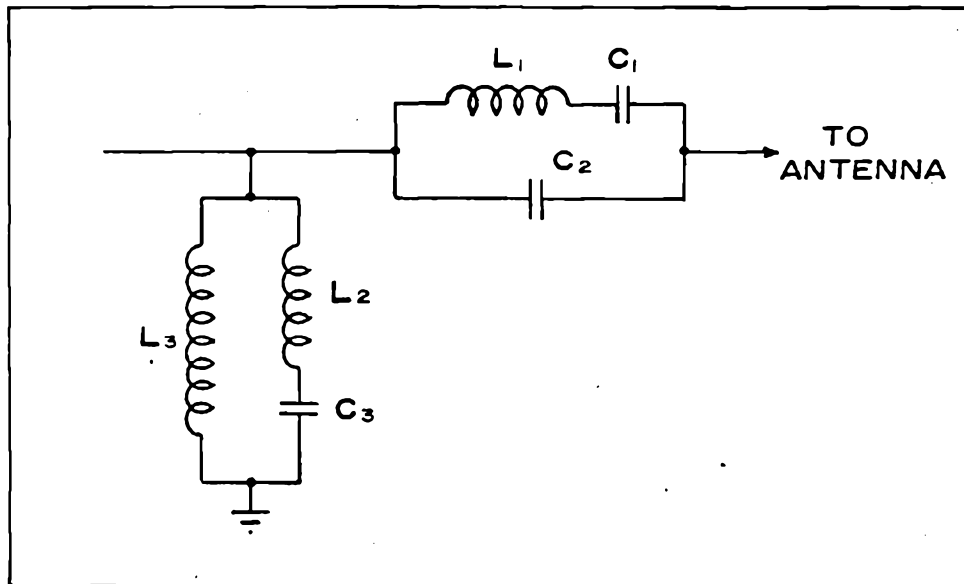
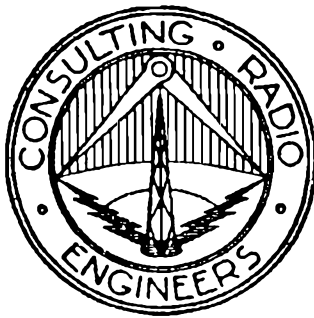

Fig. 6

File

ENGINEERING TESTIMONY
ON BEHALF OF
CFRB, LTD.
BEFORE THE
BOARD OF BROADCAST GOVERNORS
OTTAWA, ONTARIO

June 6, 1963



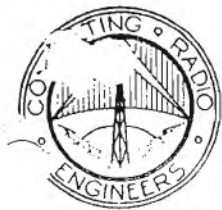

A. D. RING

HOWARD T. HEAD

MARVIN BLUMBERG

A. D. RING & ASSOCIATES

CONSULTING RADIO ENGINEERS

1710 H STREET, N. W.

WASHINGTON 6, D. C.

TELEPHONE
298-6850
AREA CODE 202

CABLE ADDRESS:
RINGCO
WASHINGTONDC

ENGINEERING TESTIMONY
ON BEHALF OF
CFRB, LTD.
BEFORE THE BOARD OF BROADCAST GOVERNORS
OTTAWA, ONTARIO

June 6, 1963

My name is Howard T. Head. I am a consulting radio engineer, a partner in the firm of A. D. Ring & Associates, 1710 H Street, N. W., Washington 6, D. C., U.S.A. Our firm, one of the best known firms in this practice, was organized in 1941. I have been with the firm more than 17 years, since the close of World War II in 1945. I am a registered professional engineer (Registration No. 2521) in the District of Columbia.

At the request of CFRB, Ltd., the licensee of Radio Station CFRB, Toronto, Ontario, I have made detailed studies of a pending proposal by Radio Station CHUM, Toronto, to move to a new transmitter site and to increase power to 50 kw. This proposal is of particular concern to CFRB for three related reasons. First, there is a very close frequency separation between the two stations. CFRB operates on 1010 kc and CHUM on 1050 kc, the closest frequency separation permitted for operation in the same city

by the Regulations of the Department of Transport and international agreements to which Canada is a party. Second, both stations will operate with 50 kw power; CFRB so operates at the present time, and the CHUM proposal calls for an increase to 50 kw. Third, and a matter of principal concern to CFRB, CHUM proposes to operate with 50 kw power at a transmitter site at very close proximity to that where CFRB now operates. The distance between the centers of the two antenna systems would be only 1.42 miles. So far as I am aware, this is a closer separation than now obtains for any two directional 50 kw stations anywhere in North America. The combination of the closeness of the two sites, the high power and close frequency separation is a matter of real concern to CFRB.

CHUM proposes to operate employing a six-tower directional antenna, which would be adjusted to provide different radiation patterns day and night. The location of the CHUM site with respect to that of CFRB is such that the proposed CHUM radiation patterns would lay down quite high fields at the CFRB site. Our estimate of the fields to be laid down, based on measurements made by the CFRB engineering staff, is that the CHUM field at CFRB would be 1450 mv/m day and 350 mv/m at night. These fields are sufficiently high that technical measures would be required to minimize adverse effects on CFRB.

There are two principal effects which may occur which are expected to require corrective measures. The first is so-called internal cross-modulation, as a result of which the CHUM program may be heard in the background on the CFRB operating frequency. The second is reradiation of the CHUM signal from the CFRB towers. In this phenomenon, the CFRB towers, in the absence of corrective measures, would reradiate the CHUM signal at 1050 kc, giving rise to distortion of the CHUM patterns, which, if unchecked, could be quite severe.

Our analysis of the engineering problems presented leads us to the conclusion that the control of these adverse effects would require the installation of filters at the base of each of the four towers of the CFRB directional antenna. The need for such filters is recognized by CHUM in a report for CHUM prepared by Gautney & Jones of Washington, D. C., dated September, 1962. The Gautney & Jones report explains the problem in detail and discusses several types of filters which might be employed for the purpose.

The design of filters for this purpose is not a simple matter under any circumstances. Given the combination of high power and close frequency separation, the design problem becomes extremely difficult, and filters

employing very large components are needed. As an example of the size of such filters, a cabinet approximately 6' x 8' x 4' is required to contain a single filter, and this cabinet is well filled with filter components. It appears likely that individual filters would be required to be installed at the base of each of the four CFRB towers to control cross-modulation and reradiation.

Because of the size and complexity of these filters, extensive construction would be required at the base of each of the CFRB towers. The installation of the filters will disrupt the tuning of the CFRB directional antenna for both the day and night patterns. The filters must be tuned for proper operation at both 1010 kc and 1050 kc, and the tuning process, plus the requirement for the readjustment of the CFRB directional antenna array, will require CFRB to leave the air over an extended number of nights.

Experience with the problems involved in obtaining proper performance of antenna systems under these circumstances has been relatively limited, since high-power directional operation with close frequency separation is ordinarily avoided at such short distances. A closely comparable situation exists, however, at New York City,

where Station WINS operates on 1010 kc and Station WHN operates on 1050 kc. It will be noted that these are the same frequencies as are involved at Toronto. Both WINS and WHN operate with 50 kw power, and the distance between the antennas is 1.95 miles, compared with a separation of 1.42 miles between CFRB and the CHUM proposal. WINS increased power to 50 kw in 1946, employing a directional antenna pattern which laid down a field at the WHN antenna of approximately the same magnitude as CHUM will deliver to the CFRB transmitter site. The similarities of the two situations are summarized in the following table:

TABLE I

COMPARISON OF
CFRB - CHUM AND WINS - WHN
TRANSMITTER SITE CONDITIONS

	<u>Toronto</u>		<u>New York</u>	
	<u>CFRB</u>	<u>CHUM</u>	<u>WINS</u>	<u>WHN</u>
Frequencies	1010 kc	1050 kc	1010 kc	1050 kc
Power	50 kw	50 kw	50 kw	50 kw
Distance between Sites	1.42 mi.		1.95 mi.	
No. of Towers in Directional Antenna	4	6	4	2

Table I (Cont'd.)

		<u>Toronto</u>		<u>New York</u>	
		<u>CFRB</u>	<u>CHUM</u>	<u>WINS</u>	<u>WHN</u>
CHUM				WINS	
Inverse	Day	-	2050 mv/m	Inverse	Day - 3100 mv/m
Field	Night	-	500	Field	Night - 3100
toward				toward	
CFRB				WHN	
Incident				Incident	
Field	Day	-	1450 mv/m	Field	Day - 1600 mv/m
CHUM at	Night	-	350	WINS at	Night - 1600
CFRB				WHN	

To further illustrate the similarity, I have prepared Figures 1 and 2, which show the location of the two transmitter sites both at Toronto and at New York, and which show the 1 v/m field strength contours for WINS and for the CHUM proposal.

It was found necessary at New York City to install individual filters at each of the WHN towers to minimize the effects of cross-modulation and reradiation. Numerous problems arose in the adjustment of the filters and the tuning of the WINS directional array, and extensive work at the WHN transmitting installation over a period of many months was required. At that time, WHN was not operating on a regular broadcasting schedule during the after-midnight hours. CFRB, however, operates on a 24-hour schedule, and the installation and adjustment of the filters for CHUM will require CFRB to interrupt its operating schedule for the

purpose. Based on the experience at WINS and WHN, CFRB will be obliged to remain off the air intermittently for many nights over an extended period. Furthermore, at any time that readjustment of the CHUM antenna must be undertaken, there is always the risk that CFRB may be put to the repeated inconvenience of interrupting its operating schedule to accommodate the need for verifying the adjustment of the CHUM antenna system.

It should be noted that the installation of the filters in the CFRB towers will not completely eliminate mutual effects between the stations, but will merely minimize these effects. The presence of the filters will to some extent degrade the CFRB audio frequency response, and any residual cross-modulation from CHUM will reduce the CFRB audio noise performance. Also, any aging or deterioration of the filter components may result in distortion of the CFRB radiation pattern. The CFRB night pattern is quite critical and must be retuned following the installation of the filters. Also, if any changes are made or occur in the filters, the CFRB pattern must be readjusted following any such changes. It would be expected that numerous such changes might be required during the process of the readjustment of the CHUM pattern. This was the experience at New York City.

Thus far, this discussion has dealt with the installation of filters only at CFRB. Calculations indicate that filters will probably not be required at CHUM to reject the CFRB signal, but this must be verified by actual measurements. These will require complete analyses of audio, transmitter and directional antenna performance both before and after the CHUM construction. If these measurements should show more effect of CHUM on the CFRB operation than expected, filtering of CFRB at CHUM might also be required, further complicating the problems of restoring the CFRB patterns to proper adjustment and further disrupting the operating schedule of CFRB.

The presence of the CFRB towers will present an especially difficult problem to CHUM, because the CHUM proposal already involves substantial additional problems. These include the following:

- (a) The proposed radiation patterns are critical and must be adjusted to very close tolerance to minimize interference to other stations, both in Canada and in the United States. In some instances, the calculated patterns already cause some interference to other stations. The addition of a reasonable tolerance above the calculated patterns, as is considered good engineering practice, both in Canada and the United States,

would further increase the difficulty of adjusting the patterns toward these stations.

- (b) There is a large chimney located approximately one-half mile from the proposed CHUM antenna, in a region of high field (3000 mv/m) for the proposed daytime operation. The location of this chimney is shown in Figure 1. This chimney is capable of reradiating up to 120 mv/m; such re-radiation, together with the problem of detuning the CFRB array, would complicate the problem of attaining proper adjustment of the CHUM array.
- (c) Two of the six towers proposed by CHUM will be within a few feet of the shore of Lake Ontario. The proposed ground system must be run down a steep escarpment into the Lake. This topography will make for antenna instability and pattern distortion, and will complicate the problems of achieving and maintaining proper adjustment of the CHUM antenna.

Respectfully submitted,

A. D. RING & ASSOCIATES

Howard J. Head
Howard T. Head

Registered Professional Engineer
District of Columbia
Registration No. 2521

June 6, 1963

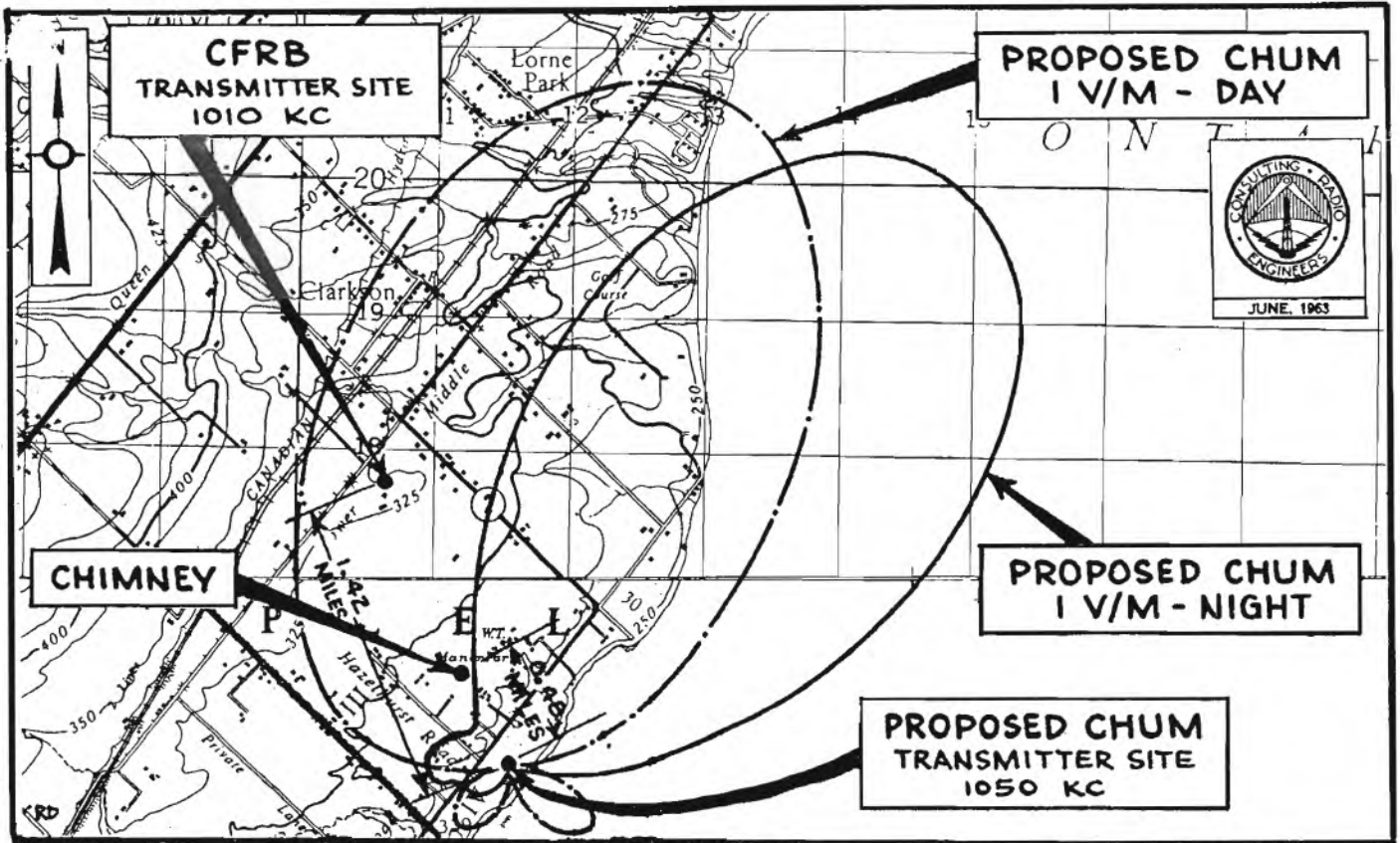

FIG.1 - CFRB AND PROPOSED CHUM TRANSMITTER SITES NEAR TORONTO

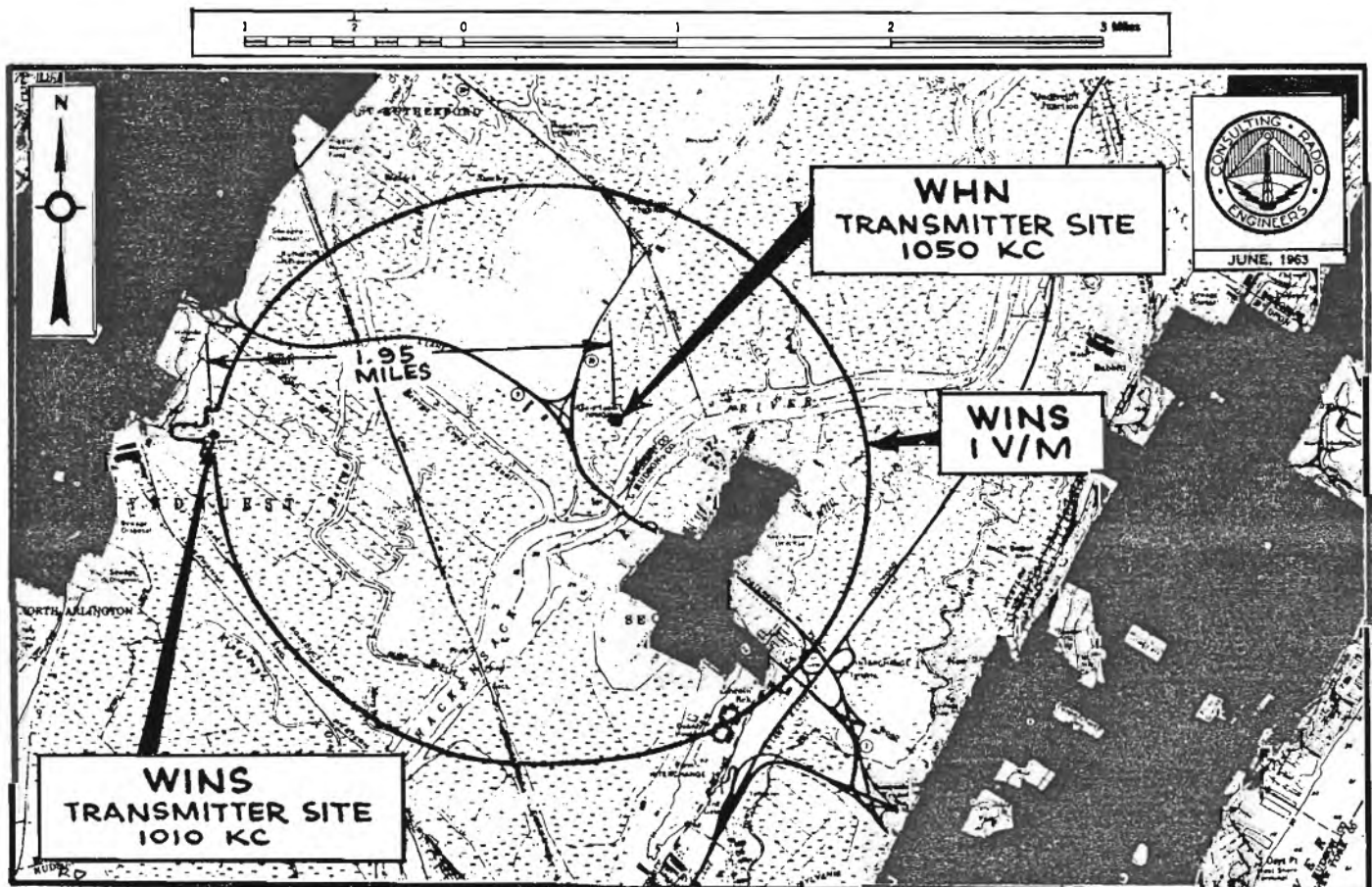

FIG.2 - WINS AND WHN TRANSMITTER SITES NEAR NEW YORK CITY

"NOTES ON THE WINS PROJECT"

TESTIMONY ON BEHALF OF

CFRB LIMITED

before the

BOARD OF BROADCAST GOVERNORS

at

OTTAWA, ONTARIO

by

MR. CLYDE HAEHNLE,
SENIOR PROJECT ENGINEER,
CROSLY BROADCASTING CORPORATION,
CINCINNATI, OHIO

JUNE 7, 1963

NOTES ON WINS PROJECT

In mid or late 1947, I was assigned the project of satisfying the terms of our construction permit for our Station WINS, New York City, for 50 kw. There were four major problems:

1. Array instability
2. Re-radiation
3. Adjustment of the WINS array
4. Cross modulation

Relative to Problem #1, the phasing and matching components in the array were designed for 10 kw operation and showed excessive heating and drifting at 50 kw. New components were designed and constructed in Crosley's Engineering Shop in Cincinnati. In early 1948, I personally moved to New York City as Resident Project Engineer. All components in the array were replaced with the newly designed Crosley-built components.

Relative to Problem #2, we determined through helicopter measurements that the re-radiation from the WHN array was approximately 90 mv/m at a mile which was far in excess of the required protection nulls of the WINS array. Because of the vast swampland in the area of the transmitter location, it was necessary to resort to helicopter measurement techniques. A technique was developed to measure the re-radiation field when immersed in a direct radiation field of approximately 1.6 volts per meter. This was accomplished by measuring space standing wave pattern caused by the direct radiation field and the re-radiation field along several radials from the re-radiation source. High "Q" filters or traps were designed to control the base termination of the WHN towers to control the current distribution from the induced field. Adjustments were made on the traps on each of the two towers, and radial measurements of the space standing

ve patterns were made for each adjustment. After many months of experimenting, it was found that an optimum adjustment could be reached which appeared to suppress the re-radiation.

The WINS array was then adjusted to conform as closely as possible to the theoretical design value. Because of other re-radiation sources, such as a high tension line running through the major lobe and back into a protection null radial direction, the towers of the WOV antenna system and the towers of the WBNX array, it was found impossible to meet the WINS protection requirements. A study was then made to attempt to adjust the WINS array from field measurements within a few hundred feet of the towers. This was done by accurately locating measuring points with a surveyors transit, accurately determining distances to each element of the array and accurately calculating the vectorial sum of the four field vectors at these close-in locations. After completion of this phase, it was felt that the WINS array was performing as close as possible to theoretical values. However, the field along the required protection nulls would not meet specifications. Filters or traps were designed for the towers of WOV and WBNX in order to adequately suppress re-radiation. Helicopter measurements were also made to determine the degree of improvement.

After installation of the traps in the WHN array, it was found that we had an increased problem of cross modulation between WINS and WHN. This was caused by the impedance of the traps at the WINS frequency creating a termination on the WHN transmission lines at 1010 kc which resulted in transformer action through the WHN transmission lines and caused a high voltage node at the transmitter output. Since the WHN transmitter used overall R.F. feedback, this undesired 1010 kc voltage was demodulated by their feedback rectifier and fed back through the system which resulted in cross modulation. It was found necessary to install

a filter at the output of the transmitter which had an extremely high "Q" in order to reflect a low impedance at 1010 kc and a high impedance at 1050 kc, plus or minus 10 kc. It was necessary to construct a coil of 3/4" copper pipe and apply triple silver plating to achieve the necessary "Q". This work continued to mid 1950 at which time I was called back to Cincinnati. A few months later, in November 1950, a severe hurricane went through the New York City area and blew down the towers of the WHN array, at which time a complete ground proof of performance was made on the WINS antenna system which showed compliance with the terms of the construction permit. Following reconstruction of the WHN towers, new traps were installed and concentration of effort was placed on suppressing re-radiation from the new towers. After this was finished, a report was filed with the Commission and a full-time license was granted.

After my three years experience on the WINS project I am of the opinion that the CHUM problem is not a comparable situation, it is a much more complex problem for these reasons. In New York the WHN array was a simple 2 element array. The CFRB array is a very critical 4 element array. In addition, the 550 foot smoke stack presents a whole new field of problems and much more difficult than if it were a broadcast tower. I would view the problems faced by CHUM not as an engineering project, but as an engineering career.

BEGIN REVISION 17 10-0

3 TH

FEDERAL COMMISSION ON COMMISSION

FOR OPERATIONAL

Approved:

W. Gordon, Director
LIFE EDUCATION FOUNDATION
1000 ...
... (416)

ENGINEERING SUBMISSION PREPARED BY J. GORDON ELDER
ON BEHALF OF STORER RADIO INC.

1-INTRODUCTION

The investigation described in this report was undertaken on behalf of Storer Radio Inc., licensee of station WHN, New York. It was carried out by the writer, with the cooperation of their consulting engineers, A. D. Ring and Associates. It is understood that, commencing in the fall of 1964, objectionable skywave interference has been received consistently, within the 3 mV/m night limitation contour of station WHN. Our investigation was initiated after the interference had been traced to station CHUM, Toronto, Ontario. This station also operates on 1050 kc/s and increased power to 50 kW last summer.

2-OBJECTIVE

The principal requirement was to establish the radiated field from CHUM's night time pattern towards WHN's protected contour.

3-DISCUSSION

GENERAL

CHUM's antenna site is located on the shore of Lake Ontario, such that the critical arc of 115° - 126° is entirely over water for the first thirty miles or so. Even in mid winter the lake does not freeze over more than a short distance off shore. Most measurements had therefore to be made by boat or helicopter.

All field intensity measurements were made on a Nems Clarke 120E field intensity meter, serial number 824. During

1964, readings obtained from this instrument were compared with those from new and recalibrated 120E's, which confirmed its accuracy.

The first set of CHUM measurements was taken on the 22nd November 1964 and the last set on the 14th January 1965. Normally, all small boats are removed from the lake during November, to avoid ice damage. It was therefore very difficult to obtain one for this project. Time was lost waiting for calm water and good visibility. By late December, hull insurance was extended on a daily basis depending upon weather conditions.

Canadian air regulations prohibited night flying in the helicopter, therefore tests had to be completed within half an hour after dusk.

When using the field intensity meter, it was always positioned with the plane of its loop antenna in line with the object under test to obtain maximum signal pick-up from it.

In planning the various measurements on 1050 kc/s, it was recognized that skywave interference from WHN could cause appreciable errors in the measurement of low field intensities. Based upon the curve in Appendix E of NARBA, the interference is predicted to exceed 1.75 mV/m for 10% of the time. Accordingly, measurements were made as soon as possible after dusk and CHUM's pattern change, in the hope that the interference would not have built up to its full night time value. The level was assessed from time to time, as mentioned later. (No significant fading was noted except in the case of some of the lakeshore measurements, as noted on table 10).

The complete programme of measurements will now be described, under four main headings.

3(a) BOAT MEASUREMENTS

Reference: Tables 1 - 3; Figures 1 - 4

Three sub radials were run on the 26th November, on true bearings from the array of approximately 115°, 120° and 125°. A twenty-six foot wooden hulled cabin cruiser was used. With a constant engine speed of 1250 rpm, an actual speed of about 7 mph was obtained. The speed was later checked over a measured course. The compass was recalibrated and had an accuracy of $\pm 1^\circ$.

Each radial was commenced at a range of three to four miles from the CHUM array. Cross bearings were first taken on prominent landmarks using the hand-held prismatic compass. CHUM towers 2 - 6 and 3 - 5 were in line for the 115° radial and towers 3 - 6 were in line for the 125° radial.

The field intensity meter was hand-held, in the open stern of the boat. Readings were usually taken at two minute intervals.

Additional measurements were made on the 28th December from a steel hulled boat. It is approximately forty feet long and does not have a mast or other superstructure.

A radial was commenced at a range of about ten and one half miles. The field intensity meter was mounted on wood four feet above the bows. Measurements were made from 6.21 P.M. until 7.46 P.M., normally at one minute intervals, with the instrument orientated for maximum direct signal from CHUM. It was also nulled on the desired signal occasionally, to assess the level of skywave interference plus reradiation.

Close in transverse measurements were taken after completing the radial. The 120E was mounted on a box near the stern of the boat. Readings were commenced broadside to the array on a bearing from it of 136° true. The boat was steered towards the Lakeview generating station on an approximate heading of 029° true. The estimated distance from the array varied from 1.4 to 1.65 miles, subject to an estimated error of 0.2 mile or less. The bearing error is about $\pm 2^\circ$.

3(b) HELICOPTER MEASUREMENTS

Reference: Tables 4 - 7; Figures 4 - 7

A Bell 47-G4 machine was employed. It was first established that proximity to the engine etc., introduced errors of $\pm 10\%$ or less when measuring field intensities on 1050 kc/s.

Radial and cross minima transverse paths were followed on the 17th December. Navigation was a problem due partly to a 20 mph westerly wind and to the lack of sights on the helicopter's compass. The errors in distance and bearing measurements were estimated to be $\pm 5\%$ and $\pm 2^\circ$ respectively. Navigational details are as follows:

	<u>Radial</u>	<u>Transverse</u>
Indicated Air Speed	65 mph	70 mph
Ground Speed	45 mph	85 mph
Heading	-	035° true
Wind	west 20 mph	west 20 mph
Course	297° true	045° true
Altitude above Lake Level	50' - 100'	100' - 200'
Frequency of Readings	80 per mile	43 per mile

The radial was run on an approximate bearing from the array of 117° true and commencing at 13.5 miles from it. The cross minima commenced about five miles south of the array. A heading of 035° true was followed until readings indicated that we were entering the main lobe of CHUM's pattern.

The output of the field intensity meter was fed via a differential amplifier to a Rustrak Model # 88 strip chart recorder. A chart speed of one inch per minute was used. The recorder and amplifier were powered by an ATR Model 28URSF Inverter. The system was checked periodically against a 4.0 volt reference mercury battery.

Additional measurements were taken on the 14th January of the vertical radiation pattern within the critical arc. Distances were estimated from cross bearings taken on prominent landmarks, with the recalibrated hand-held prismatic compass. The wind was north westerly and gusting at 15 - 30 mph. Since a steady rate of descent would have been difficult to maintain, field intensity recordings would have been less reliable than direct readings. These were taken at definite altitude increments.

3(c) Lakeshore Measurements

Reference: Tables 8 - 10; Figures 9, 10

The first measurements for this project were made on CHUM's signal, just before and after pattern change on the 22nd November. Unobstructed locations were chosen near the lake immediately west of Niagara-on-the-Lake. Averaged cluster readings were used in all cases.

On the 17th January a radial was run on station CJBC Toronto, which operates at 50 kW ND on 860 kc/s. This was done to establish the conductivity of Lake Ontario over the critical arc. The check point locations are shown on figure 9 and include those previously used in November.

While the radial measurements were being made in the vicinity of Niagara-on-the-Lake, additional spot measurements were made at each point, of CHUM's signal.

3(d) RERADIATION MEASUREMENTS

Reference: Tables 11, 12; Figures 11 - 14

Station CFRB operates at 50 kW, DA-2 on 1010 kc/s. Its array is 1.4 miles or eight wavelengths northerly from CHUM's array. The night pattern of CHUM creates a field intensity in the order of 0.5 V/m at CFRB's array. The latter is therefore liable to reradiate some of the energy received on 1050 kc/s.

Arcs of circles were drawn to each of CFRB's towers. Diameters were the lines from the tower to the centre of CHUM's array. The arcs are shown on figure 14. They were surveyed during daytime using an optical rangefinder and compass. A dozen stakes with reflector tape were driven in as markers.

Measurements were made on the 1st December. At each check point the field intensity meter was held with its loop normal to the direction of CHUM's array and therefore facing the tower under test. At most points a null was obtained on or close to this bearing. The direct signal from CHUM was in the range 300 to 700 mV/m which agrees with predictions.

Spot checks were made in an orchard marked on figure 14. It is about one mile from both CFRB's and CHUM's arrays on the desired arc. Its bearings from these arrays are 205° and 295° respectively.

Similar measurements were made on the 18th December to determine the reradiation from the St. Lawrence Cement Company's chimney. It has a spiral steel stairway within the outer wall, which contains four or more lightning rods. It is understood to be 540 feet in height, which is equivalent to 0.575 wavelength or 207° at 1050 kc/s. Readings were corrected for the inductive field proximity effect, in accordance with the procedure described on page 9.22 of the NAB Engineering Handbook. Measurement results are contained in table 12 and plotted on figure 13.

4-RESULTS

4(a) BOAT

Reference: Tables 1 - 3; Figures 1 - 4

Three short radials are plotted on figures 1 and 2. They yield a direct radiated field* of about 100 mV/m with a superimposed indirect or reradiated field in the range 25 to 40 mV/m. The theoretical pattern's radiated field over the critical arc is 45 to 50 mV/m.

Unfortunately the bearing of the longer radial proved to be 135° true. This resulted from undue reliance on the hand held compass, which, to save time had not been recalibrated. Errors are estimated to be $\pm 1^\circ$ in bearing and $\pm 10\% \pm 0.1$ mile in distance. With the loop of the field intensity meter nulled on the desired signal, the residual signal was generally 1 to 2 mV/m, but rose to 4.5 mV/m at "41" minutes (7.02 P.M.). The direct radiated field is apparently 200 mV/m at one mile with an indirect or reradiated field of about 100 mV/m.

The transverse measurements are plotted on figure 4. The radiated field is apparently about 100 mV/m over the critical arc.

* In this report the unattenuated horizontal field intensity at one mile is abbreviated to "radiated field".

4(b) HELICOPTER

Reference: Tables 4 - 7; Figures 4 - 8

The radial of figure 5 yields a radiated far field equivalent to about 150 mV/m at one mile. All plotted points are representative and all significant maxima and minima are shown. This can be verified by reference to the strip chart of recording of figure 6. Results are in satisfactory agreement with those obtained by boat. The recording system operated reliably throughout these tests.

Evidence of reradiation is quite apparent, but due to proximity to the various sources of reradiation, an exact analysis of it does not seem possible. The measured distances between successive deep minima are 0.3 and 1.15 mile. Based upon this and the results of the reradiation tests, one may conclude that the first pair are caused by the chimney and the second by CFRB's array. On 117° true from CHUM's array, the calculated effective distances from them are 0.39 and 1.06 mile respectively.

Based on the transverse measurements of figure 7, the radiated field towards WHN is about 100 to 120 mV/m, which confirms previous measurements.

For the vertical pattern measurements, the horizontal distances from the CHUM array of two and four miles are somewhat greater than intended due to wind drift. The maximum elevation angle of 21° is therefore less than the maximum critical value of 24.2° on 120° true. The maximum radiation towards WHN's 3 mV/m protected contour appears to be 90 mV/m or 2.5 times the permissible value, on about 120° true.

4(c) LAKESHORE

Reference: Tables 8 - 10; Figures 9, 10

The original Niagara-on-the-Lake measurements were taken in November. For their analysis, Lake Ontario was assumed to have a conductivity of 15 mmhos/m and a dielectric constant of 15. 15 mmhos/m is the nominal value shown on the Department of Transport's provisional ground conductivity map dated June 1, 1960. A dielectric constant of 15 is assumed in Appendix I of NARBA and in most propagation work involving the standard broadcast band.

The January radial measurements on station CJBC are plotted in figure 10, together with relevant attenuation curves copied from graph 9, Appendix I of NARBA. This method of analysis yields a lake conductivity value of about 8.5 mmhos/m.

A more exact analysis could have been made, assuming a dielectric constant of 80. The technique is described in section 3.184 of the Federal Communications Commission's Rules and Regulations, volume III. However, use of the approximate method is considered to be fully justified in this case. The resulting error in calculating the radiated field on 1050 kc/s is insignificant.

The January measurements on CHUM confirmed and extended those made during November. Based upon the lower value of lake conductivity, the apparent radiated field from CHUM's night pattern towards WHN's protected contour is in the range 120 to 550 mV/m. This is from 2.4 to 11.5 times the theoretical value.

4(d) RERADIATION

Reference: Tables 11, 12; Figures 11 - 14

With both stations on night pattern, the reradiated 1050 kc/s fields from CFRB's towers were at least 14, 16, 17 and 35 mV/m respectively.

The results of the orchard measurements were as follows:

1010 kc/s 720 and 8 mV/m

1050 kc/s 450 and 25± mV/m

The 1010 kc/s results appear to be normal. The 1050 kc/s direct signal is higher than predicted.

When measuring the reradiation from the tall chimney, the direct field intensity was approximately 1 V/m. High minima were noted at points 12 and 13, probably due to the increasing aperture effect. The reradiated field from the chimney is approximately 38 mV/m.

5-CONCLUSIONS

Most of the foregoing measurements were made to establish the radiated field from CHUM towards WHN's night limitation contour. All indications are that the actual radiated field is substantially greater than the permissible field of 45 to 50 mV/m at one mile in the pertinent directions.

In general, the apparent value of the radiated field increased as the distance between the measurement point and the array increased. This discrepancy is partly due to the fact that the parasitic radiators are a considerable distance (8λ) from CHUM's array. For example, to observe the full effect of the

reradiation from CFRB's array, the point of measurement should be ten to twenty miles away. The rapid change in apparent radiation versus bearing, observed during the lakeshore measurements, may also be attributed to the wide spacing between CHUM's radiators and reradiators. For a spacing of eight wavelengths, the average angle between nulls or minima is about eleven degrees of azimuth.

It is understood that during CHUM's preliminary proof of performance, little if any reradiation was noted from the tall chimney or from CFRB's towers and that consequently, detuning was not considered necessary. However, our results show that the reradiated field measured from CFRB's array and from the tall chimney are of the same order of magnitude as the permissible radiated field over the critical arc. We believe that the required suppression could not be achieved or maintained unless these reradiators were carefully detuned. Other shorter structures may also require detuning. Some pattern distortion may be unavoidable due to shoreline refraction.

Based on the data contained in this report it seems probable that, as presently adjusted, the CHUM array would not develop the authorized pattern, even after detuning of the reradiators. This situation may have existed on completion of the proof of performance. Alternatively, it may have arisen due to subsequent changes in the system or damage to it.

6-ENGINEER'S SEAL AND SIGNATURE

This report is respectfully submitted by the under-
signed, a Canadian consultant practicing in the field of
broadcast engineering.

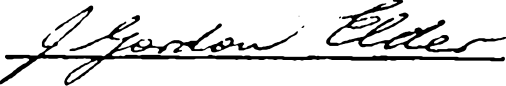

J. G. ELDER, P. Eng.

Subscribed and sworn to before me
on this 22nd day of February 1965

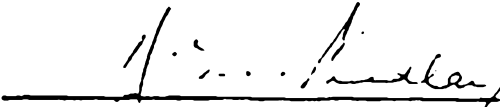

D. M. FINDLAY, Q. C.

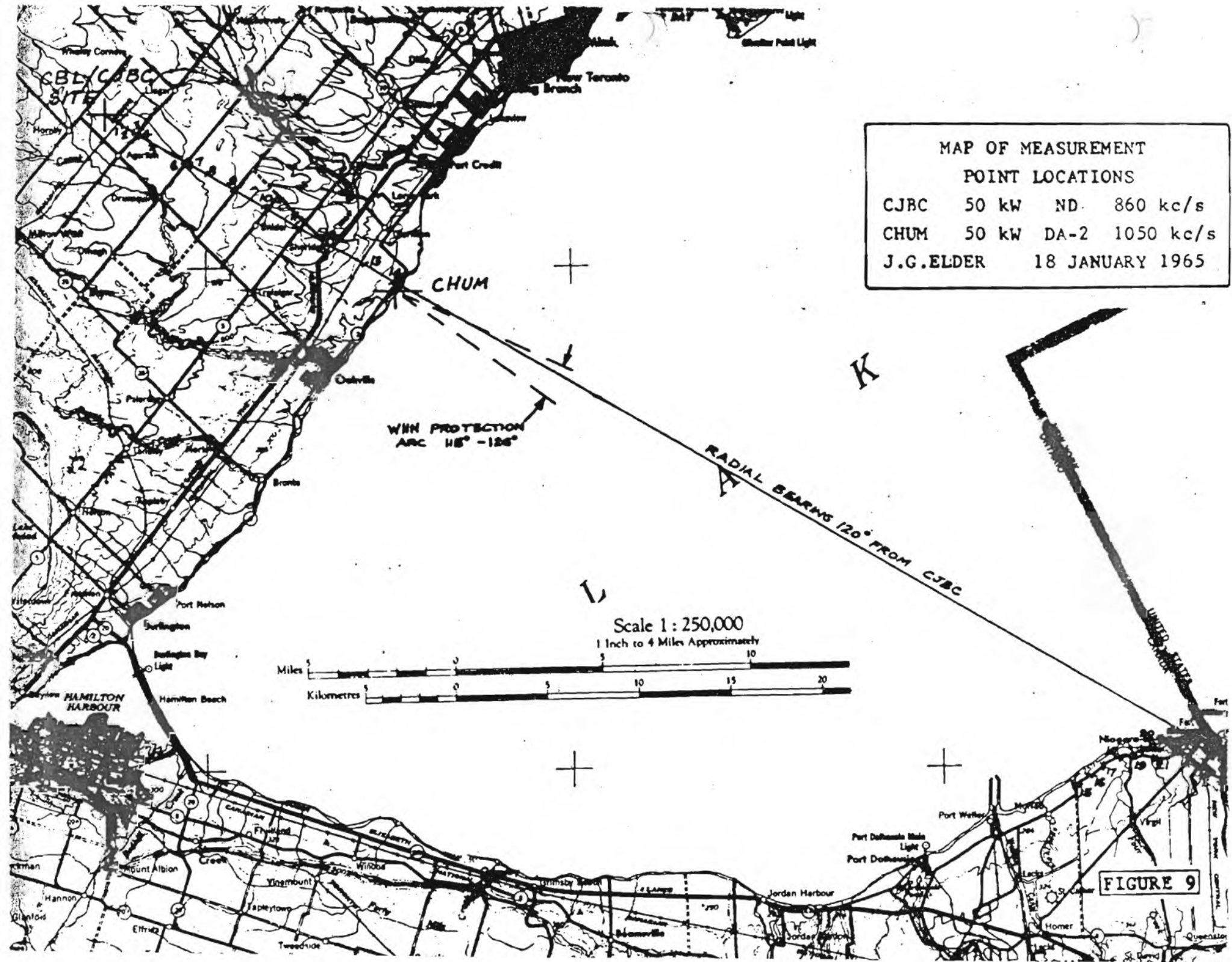

(6206158)

FEDERAL COMMUNICATIONS COMMISSION
WASHINGTON, D. C. 20554

ADDRESS ALL COMMUNICATIONS
TO THE SECRETARY

March 17, 1965

IN REPLY REFER TO:

8850

Mr. F. G. Nixon
Director, Telecommunications &
Electronics Branch
Department of Transport
Ottawa, Ontario, Canada

Dear Mr. Nixon:

This refers to the operation of Station CHUM, Toronto, Ontario, on 1050 kc/s with 50kw power and a directional antenna (DA-2) as notified in Canadian Change List No. 177 dated May 7, 1963.

In a telegram dated July 17, 1963, the Commission advised that it would object to the supplementary information supplied for Station CHUM because of objectionable daytime interference to Station WSTS, Massena, New York.

As a result of the Commission's objection a modification of the CHUM proposal was supplied in the form of a technical brief for comment with your letter of August 2, 1963. In a telegraphic reply dated August 13, 1963, the Commission advised that the revised proposal appeared to provide adequate protection and that notification of the revised pattern would resolve the Commission's objections. In the meantime an official objection was registered with the OIR/PAU pending notification of the modification. It is to be noted that we have no record that the modification was ever notified and the official objection remains outstanding.

At this time we are in receipt of letters dated March 9, 1965, and a supporting Engineering brief on behalf of Station WHN, New York, New York, copies enclosed, which appear to indicate that the nighttime directional antenna for Station CHUM does not reproduce the theoretical pattern in actual operation, and that interference is caused to the service of Station WHN in excess of that permitted by the NARBA.

Your early comments would be appreciated.

Very truly yours,

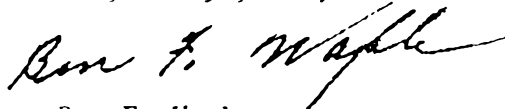

Ben F. Waple
Secretary

Enclosure

3-9-65

Storer
BROADCASTING
COMPANY

*Suite 711 Madison Building
1155 - 15th Street, N. W. Washington, D. C. 20005
Telephone 296-7453*

WARREN C. ZWICKY
WASHINGTON STAFF COUNSEL

March 9, 1965

Mr. Ben F. Waple
Secretary
Federal Communications Commission
Washington, D. C. 20554

Ré: Station WHN, New York, New York

Dear Mr. Waple:

This will supplement the letter dated and filed by this office October 2, 1964, which requested that the Commission communicate with the Canadian Government looking toward the taking of such steps as may be necessary to ensure that the increased-power operation of Station CHUM, 1050 kc, Toronto, Ontario, complies with its notified specifications and provides the protection to co-channel Station WHN, New York, New York, as required by NARBA.

Transmitted herewith are the reports of two engineering consultants retained to make studies of the CHUM operation as related to WHN protection requirements. The Report of Mr. J. Gordon Elder, of Elder Engineering Ltd., King City, Ontario, describes and sets forth the results of an intensive program of measurements made in Canadian territory by boat, helicopter, and on land; the Report of Mr. Howard T. Head, of A. D. Ring and Associates, analyzes the Elder data and adds a description of field strength recordings made under Mr. Head's instructions within the WHN nighttime theoretical interference-free service area.

Both Engineering Reports conclude that the radiation from CHUM toward WHN, as indicated by the Elder measurements, is far in excess of that allowable under NARBA. The helicopter measurements, for example, indicate that the radiation at the pertinent vertical angle toward WHN is double the allowable value. And, as suggested in Mr. Head's Report, the actual radiated field at greater distances toward WHN may be even higher than that indicated by the measurements, because of reradiation from objects with a relatively wide separation from the CHUM antenna.

Mr. Ben F. Waple

- 2 -

March 9, 1965

This tends to be confirmed by the field strength recordings made in the WHN service area, which, for the eleven periods recorded, showed medians ranging from 150 uv/m to 550 uv/m (with an average of 275 uv/m) as opposed to the 16 uv/m median value to be expected if the CHUM antenna were properly adjusted. It is also confirmed by day-to-day listening experience of WHN personnel residing within the nighttime calculated interference-free contour, who, if desired by the Commission, could supply affidavits attesting that CHUM's music and talk programming creates an almost constant and extremely annoying background disruption to WHN's nighttime service.

While the field strength recordings and listening experience within WHN's service area are not intended to be probative in themselves, they provide meaningful corroboration of the measurement data and conclusions set forth in the accompanying Engineering Reports.

In its July 2, 1963 reply to our letter requesting an objection to the original notification of the proposed CHUM power increase, the Commission indicated that all parties would be entitled to rely on the Canadian Administration to ensure that its notified assignments would provide in practice the protections required under NARBA. The material furnished herewith shows such protection not to have been achieved. Accordingly, in order to eliminate an extremely serious interference situation, it is again respectfully requested that the Commission communicate with the Canadian Government looking toward the taking of such steps as may be necessary to bring CHUM's operation within its notified specifications and the requirements of NARBA.

Very truly yours,

Warren C. Zwicky

Enclosures

3 9 65

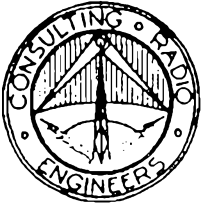

A. D. RING & ASSOCIATES
CONSULTING RADIO ENGINEERS
1710 H STREET, N. W.
WASHINGTON, D. C. 20006

TELEPHONE
200-6850
AREA CODE 202

CABLE ADDRESS:
RINGCO
WASHINGTONDC

A. D. RING
HOWARD T. HEAD
MARVIN BLUMBERG

March 9, 1965

City of Washington }
District of Columbia } SS

Howard T. Head, being first duly sworn, upon oath deposes and says that he is a consulting radio engineer, a partner in the firm of A. D. Ring & Associates, with offices at 1710 H Street, N.W., Washington, D. C. He is a registered professional engineer (Reg. No. 2521) in the District of Columbia. His qualifications as an engineer are a matter of record with the Federal Communications Commission.

The firm of A. D. Ring & Associates has been retained by Storer Radio, Inc., licensee of Standard Broadcast Station WHN, New York, N. Y., to make engineering studies of possible objectionable interference to WHN arising from the operation of Station CHUM, Toronto, Ontario.

WHN is a Class II station licensed for operation on 1050 kc with a power of 50 kw, unlimited time, DA-1. Station CHUM is also a Class II station operating on 1050 kc. Prior to August, 1964, CHUM operated with a power of 5 kw day, 2.5 kw night, DA-2. About August 24, 1964, however, CHUM shifted operation to a new transmitter location,

increased power to 50 kw both day and night, and installed a new directional antenna system for 50 kw operation, employing different radiation patterns for day and night use.

Shortly after CHUM began operation with increased power, reports of interference to WHN from CHUM were received. Investigation of the situation indicated that at several locations within the WHN calculated nighttime interference-free contour, CHUM could be heard in the background, frequently to an annoying degree. In view of these findings, it was decided to undertake a thorough investigation.

Storer engineers set up field strength recording equipment at locations inside the calculated WHN nighttime interference-free contour, and the services of Canadian engineer J. Gordon Elder, of Elder Engineering Ltd., King City, Ontario, were retained to make field studies of the CHUM signal in the immediate vicinity of the new CHUM antenna location. The results of Mr. Elder's studies are contained in a separate report dated February 22, 1965, which accompanies this affidavit.

The distance from CHUM to WHN is 340 miles. The calculated nighttime interference level (second-hour) of WHN is 3.5 mv/m, resulting from Station XEG, Monterrey, N.L., Mexico. Applying the NARBA Engineering Standards, it is found that the radiation from CHUM toward WHN at the pertinent vertical angle must not exceed 41.5 mv/m inverse

at one mile at the angle of highest suppression. Suppression of approximately the same magnitude must be maintained over a range of azimuthal angles from 114.5° to 126° True, and over a range of vertical angles from 12.3° to 24.2° above the horizontal.

It will be noted from the Elder report that all of the measurement data indicate radiation from CHUM toward WHN far in excess of that capable of causing serious objectionable interference to WHN. His boat measurements (Figures 1-4) show values of radiation ranging as high as 180 mv/m inverse in the horizontal plane, and helicopter measurements (Figure 8) show radiation at the pertinent vertical angles of over 80 mv/m. A value of 80 mv/m at the pertinent vertical angle toward WHN would be capable of raising the WHN nighttime RSS limitation from 3.5 mv/m to 4.67 mv/m.

Field strength recordings made by the Storer staff inside the WHN normally-protected contour also show a much higher level of received skywave fields from CHUM than would be expected. For example, the calculated median field strength from CHUM, assuming the proper adjustment of the CHUM directional antenna, should be approximately 16 $\mu\text{v}/\text{m}$. However, during a total of 11 quarter-hour recording periods, during which the CHUM skywave signal was recorded, an analysis of the recording tapes shows received median quarter-hour values ranging from 150 $\mu\text{v}/\text{m}$ to 550 $\mu\text{v}/\text{m}$, with an average median value of 275 $\mu\text{v}/\text{m}$. If these values are representative of the actual expected CHUM skywave fields, they would result in a ten percent skywave limitation

imposed on WHN to approximately the 10 mv/m contour.

Actually it is difficult to establish precise values of radiated field from CHUM toward WHN, and the actual radiated signal may be even higher than indicated by the Elder measurements. This arises by reason of the fact that much of the distortion of the CHUM pattern appears to be caused by reradiation from a large chimney at a distance of 0.48 miles from the CHUM antenna, and the four towers of the CFRB directional antenna (1010 kc) at a distance of 1.42 miles from the CHUM antenna. This relatively wide separation from the CHUM antenna results in a standing-wave pattern produced by slow relative phase changes in the reradiation from the chimney and from the CFRB antenna as one proceeds outward along a radial route from the CHUM antenna, as well as a very close-spaced series of maxima and minima for bearing changes on the order of only 2°. For example, the alternate minima and maxima shown on Figures 1, 2, 3, and 5 of the Elder report can be explained with relative ease by assuming the presence of a fairly large reradiated component from the CFRB towers. The rapid changes with small increments of azimuthal angle appear in Elder's Figures 4 and 7. This effect is so large, however, that it becomes quite difficult to determine from the Elder data the extent to which the excessive signal from CHUM toward WHN is the result of the reradiation alone, or the fact that the CHUM antenna may have been adjusted in an

attempt to compensate to some extent for the reradiation effects.

In order to establish the protection from CHUM toward WHN, it will first be necessary that the reradiation from the chimney, from the CFRB towers, and from any other significant sources of reradiation be reduced to a negligible value. The CHUM antenna must then be readjusted so as to produce the calculated radiation pattern toward WHN. As will be noticed from the Elder report, the presence of Lake Ontario directly toward New York City will require more than the usual attention to techniques for measuring the radiation along the bearings toward WHN.

Affiant states that the calculations and exhibits in this report were made by him personally or under his direction and that all facts contained herein are true of his own knowledge except where stated to be on information or belief, and as to those facts, he believes them to be true.

Howard T. Head, Affiant

Subscribed and sworn to before me this 9th day of March, 1965.

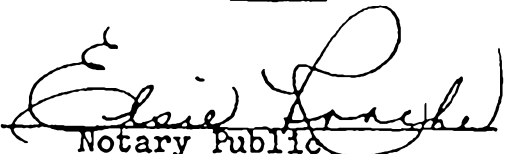
Notary Public

My Commission expires: March 31, 1968